

Errata

Title & Document Type: 6200-Series Regulated DC Power Supply
Operating and Service Manual

Manual Part Number: 5950-1765

Revision Date: January 1976

HP References in this Manual

This manual may contain references to HP or Hewlett-Packard. Please note that Hewlett-Packard's former test and measurement, semiconductor products and chemical analysis businesses are now part of Agilent Technologies. We have made no changes to this manual copy. The HP XXXX referred to in this document is now the Agilent XXXX. For example, model number HP8648A is now model number Agilent 8648A.

About this Manual

We've added this manual to the Agilent website in an effort to help you support your product. This manual provides the best information we could find. It may be incomplete or contain dated information, and the scan quality may not be ideal. If we find a better copy in the future, we will add it to the Agilent website.

Support for Your Product

Agilent no longer sells or supports this product. You will find any other available product information on the Agilent Test & Measurement website:

www.tm.agilent.com

Search for the model number of this product, and the resulting product page will guide you to any available information. Our service centers may be able to perform calibration if no repair parts are needed, but no other support from Agilent is available.

***OPERATING AND
SERVICE MANUAL***

**REGULATED DC POWER SUPPLY
HP MODELS 6256B, 6263B, 6264B,
6265B, 6266B, 6267B,
6271B, AND 6274B**

HP Part No. 5950-1765



**HEWLETT
PACKARD**



HEWLETT
PACKARD

**OPERATING AND
SERVICE MANUAL**
REGULATED DC POWER SUPPLY
HP MODELS 6256B, 6263B, 6264B,
6265B, 6266B, 6267B,
6271B, AND 6274B
HP Part No. 5950-1765

MODEL 6256B, SERIALS 1542A-01167 AND ABOVE
MODEL 6263B, SERIALS 1542A-01227 AND ABOVE
MODEL 6264B, SERIALS 1539A-01656 AND ABOVE
MODEL 6265B, SERIALS 1529A-01231 AND ABOVE
MODEL 6266B, SERIALS 1539A-01671 AND ABOVE
MODEL 6267B, SERIALS 1539A-02341 AND ABOVE
MODEL 6271B, SERIALS 1543A-00746 AND ABOVE
MODEL 6274B, SERIALS 1539A-01811 AND ABOVE

* For instruments with serial numbers above those
listed, a change page may be included.

MANUAL CHANGES
Model 6263B, 6264B, 6266B, 6267B, 6274B
 Manual HP P/N 5950-1765
 Manual Printing Date 01/76
 Change Date 03/22/93

Make all corrections in the manual according to errata, then check the following tables for your power supply serial number and enter any listed changes(s) in the manual.

MODEL 6263B

SERIAL		MAKE
Prefix	Number	CHANGES
ALL		ERRATA
1643A	01512-02021	2
1826A	02022-03111	2,4
2030A	03112-04001	2,4,6
2252A	04002-04141	2,4,6,12
2333A	04142-04341	2,4,6, 12,15
2417A	04342-04621	2,4,6,12, 15,16,19*
2546A	04622-04641	2,4,6,12, 15,16,19
2550A	04642-04991	2,4,6,12, 15,16,19, 20*
2746A	04992-05161	2,4,6,12, 15,16,19, 20,24
2746A	05162-05371	2,3,6,12, 15,16,19, 20,24,25
3020A	05372-up	2,3,6,12, 15,16,19, 20,24,25, 28

MODEL 6264B

SERIAL		MAKE
Prefix	Number	CHANGES
ALL		ERRATA
2248A	04731-04955	1-3,6, 9,10,11
2323A	04956-05155	1-3,6, 9-11,14
2334A	05156-07230	1-3,6, 9-11,14, 15
2536A	07231-07895	1-3,6, 9-11,14, 15,18
2714A	07896-08235	1-3,6, 9-11,14, 15,18,23
2714A	08236-08485	1-3,6, 9-11,14, 15,18,23, 25
2949A	08486-08555	1-3,6, 9-11,14, 15,18,23, 25,27
3018A	08556-08760	1-3,6, 9-11,14, 15,18,23, 25,27,28
3233A	08761-up	1-3,6, 9-11,14, 15,18,23, 25,27,28, 31

MODEL 6266B

SERIAL		MAKE CHANGES
Prefix	Number	
ALL		ERRATA
1701A	02016-02465	2
1828A	02466-02685	2,4
1913A	02686-03125	2,4,5
2033A	03126-04165	2,4,5,6
2251A	04165-04435	2,4,5, 6,12
2335A	04436-04675	2,4-6, 12,15
2335A	04676-04705	2,4-6 12,15,16
2419A	04706-05365	2,4-6,12, 15,16,19*
2549A	05366-05795	2,4-6,12, 15,16,19
2745A	05796-06170	2,4-6,12, 15,16,19, 24
3019A	06171-up	2,4-6,12, 15,16,19, 24,28

MODEL 6267B

SERIAL		MAKE CHANGES
Prefix	Number	
ALL		ERRATA
1643A	02961-03000	1
1644A	03001-03180	1,2
1710A	03181-05875	1,2,3
2033A	05876-07115	1,2,3,6
2206A	07116-07765	1-3,6,8
2240A	07766-07865	1-3,6,8 10
2245A	07866-08215	1-3,6, 8-11
2322A	08216-08415	1-3,6,8 10,11,14
2333A	08416-09591	1-3,6,8 10,11,14 15
2537A	09592-10316	1-3,6,8, 10,11,14, 15,16,18
2712A	10317-11016	1-3,6,8, 10,11, 14-16,18, 23
2712A	11017-11276	1-3,6,8, 10,11, 14-16,18, 23,25
2945A	11277-11396	1-3,6,8, 10,11 14-16,18
3022A	11397-11816	23,25,27 1-3,6,8, 10,11 14-16,18 23,25,27 28
3231A	11817-up	1-3,6,8, 10,11, 14-16,18, 23,25,27, 28,31

MODEL 6274B

SERIAL		MAKE CHANGES
Prefix	Number	
ALL		ERRATA
1643A	02171-02330	1,2
1712A	02331-04440	1,2,3
2031A	04441-06025	1,2,3,6
2241A	06026-06075	1-3,6,10
2245A	06076-06075	1-3,6,10, 11
2305A	06276-06475	1-3,6, 10,11,13
2323A	06476-07975	1-3,6,10, 11,13,14
2537A	07976-08200	1-3,6,10, 11,13,14, 18
2552A	08201-08250	1-3,6,10, 11,13,14, 18,21
2607A	08251-08910	1-3,6,10, 11,13,14, 18,21,22
2713A	08911-09790	1-3,6,10, 11,13,14, 18,21-23
2713A	09791-10210	1-3,6,10, 11,13,14, 18,21-23, 25
2936A	10211-10310	1-3,6,10, 11,13,14, 18,21-23, 25,26
2948A	10311-10430	1-3,6,10, 11,13,14, 18,21-23, 25-27
3017A	10431-10550	1-3,6,10, 11,13,14, 18,21-23, 25-27,28
3035A	10551-11060	1-3,6,10, 11,13,14, 18,21-23, 25-29
3035A	11061-11070	1-3,6,10, 11,13,14, 18,21-23, 25-30
3213A	11071-11130	1-3,6,10, 11,13,14, 18,21-23, 25-30

MODEL 6274B (Cont)

SERIAL		MAKE CHANGES
Prefix	Number	
3222A	11131-up	1-3,6,10, 11,13,14, 18,21-23, 25-30,31

ERRATA:

In Table 1-1 "Specifications", list only the following:

- Input (Voltage and Frequency only)
- Load Effect (Load Regulation)
- Load Transient Recovery Time
- Output
- PARD (Ripple and Noise)
- Source Effect (Line Regulation)

Change the definition of all other parameters in Table 1-1 from "Specifications" to "Supplemental Characteristics". "Supplemental Characteristics" are type tested or typical values based on product sampling. While representative, Supplemental Characteristics are NOT guaranteed for all instruments. The Specifications (listed above) are guaranteed, factory tested prior to shipment, and can be verified for MIL STD "A" calibration.

In paragraph 5-18, change the reference of Figure 5-2 to "fig. 5-2A."

In paragraph 5-25, change the second reference to figure 5-2A to read "fig. 5-2B."

On page 3-15, correct the following errors in the battery discharging procedure: Change the word "negative" to "positive" (3 places) and the "positive" to "negative" (2 places) in steps c through e of paragraph 3-86. Also correct Figure 3-15 according to the corrections in steps c through e.

ERRATA:

Add the following notice to paragraph 1-16: "Effective December 1, 1975, extra manuals may be obtained by ordering Option 910 when ordering your instrument. The number of extra manuals depends on the number of Option 910's ordered.

Effective January 1, 1977, Option 007 (10-turn voltage control) and 008 still available combined as Option 009. Likewise, Options 013 (10-turn voltage control with decadal) and 014 (10-turn current control with decadal) are no longer available individually, but they are available combined into a single new option designated Option 015. Options 020 and 021 (voltage and current programming adjustments) are also no longer available individually, but they are still available combined as Option 022. Make these changes wherever Option 007, 008, 013, 014, 020, or 021 is mentioned in the manual.

In Table 1-1, add the statement: "No line cord is provided with the 6264B, 6267B, or 6274B": after the first sentence under Input Power Connections.

Add three 3/8-32 nylon hex nuts, HP P/N 2950-0144, to the parts list under A3 Front Panel Ass'y. Mechanical. These hex nuts mount the binding posts added by Change 2.

In Models 6263B, 6264B, 6266B, 6267B, and 6274B, change variable resistor R122, R124, R126, R128 (p. 6-18) to 20k, 1/2 W, HP P/N 2100-0558.

For all instruments delivered on or after July 1, 1978, change fuseholder to fuseholder body, HP P/N 2110-0564, and fuseholder carrier, HP P/N 2110-0565. Change fuseholder nut to HP P/N 2110-0569. If old fuseholder must be replaced for any reason, replace complete fuseholder and nut with new fuseholder parts. Do not replace new parts with old parts.

In replaceable parts table on page 6-6, change HP P/N of SCR A1CR57 to 1884-0058. Also change Q24 to HP P/N 1854-0823.

In Table 5-2 on page 5-9, change the normal VDC readings in steps 2 and 3 to read: "6.2 +/-5%".

In the replaceable parts list, page 6-13 under A2 RFI filter Ass'y. Mechanical make the following changes: Change PC board mounting standoff, .938" (qty 4) HP P/N 0380-0576 to Standoff, Hex, Male/female .938" LG steel, HP P/N 0380-1497. Change cover standoff, .312" (Qty 4) HP P/N 0380-0356 to Standoff, Hex, Male/female .312" LG steel HP P/N 0380-1496 (qty 4).

On page 6-1, in the second sentence of paragraph 6-2, change Table 6-3 to Table 6-4. Make the same change in subheading f. and in paragraph 6-4.

On page 6-2, under Chassis Electrical, change B1 to ball bearing fan, HP P/N 3160-0369.

Change the part number of DS1 to 1450-0566. This new light is more reliable than the former one.

The value of R108, which determines the maximum crowbar trip voltage, is no longer specified. Instead this resistor is selected for optimum performance in each unit. The nominal values for R108 are as follows: In the Models 6264B, 6266B, and 6267B, the nominal value for R108 is 2k, 1%, 1/8W, HP P/N 0757-0283. In the Model 6263B is 2.37k, 1%, 1/8W, HP P/N 0698-3150. In the model 6274B it is 3k, 2%, 1/8W, HP P/N 0757-0935. Make these corrections to the schematics, the schematic tables, and the parts list.

The drift specification for this power supply is oriented towards the systems designer and therefore based on remote programming. The specification is realizing a low temperature coefficient (<10ppm/ degree C) programming resistance. If the output is set via the front panel controls, the drift may be ten times indicated value.

For HP 6274B, on page 6-16, under OPTION 005, change R76 from: fxd, comp 430k 5% 1/2W (HP P/N 0686-4345) to: fxd, comp 620k 5%, 1/2W (HP P/N 0686-6245). On page 6-10 of the replaceable parts list, change fuse F1 for Models 6263B and 6266B to P/N 2110-0010. This is a fast-acting fuse; the obsolete part is a slow-blow fuse.

CHANGE 1:

In the Models 6264B, 6267B, and 6274B only, A2R3 in the RFI Filter Ass'y. has been changed to 22 ohms, 2 W, HP P/N 0698-3609. Make this change to the parts list and to Figure 7-4 schematic.

CHANGE 2:

The front panel binding posts have been changed to a type with better designed insulation. Delete the two types of posts listed under A3 on page 6-14 and add: black binding post, HP P/N 1510-0107, (qty 1); and red binding post, HP P/N 1510-0091, (qty 2).

CHANGE 3:

The red barrier strip cover listed in the manual for the ac input to the 5-inch models has been deleted to be replaced by a new strain relief assembly, HP P/N 5060-2744. This assembly includes a new transparent barrier strip cover, which is attached to the supply when it is shipped.

The remaining parts are partially assembled and enclosed in a protective bag in the shipping carton. Installation instructions are also enclosed. The strain relief assembly must be attached when the power supply is installed to reduce the possible hazard of an accidental disconnecting of the ac power cable. The complete assembly includes:

1. machine screw, 6-32 1.25 in. HP P/N 2460-0020
2. barrier block cover (qty 1) HP P/N 5060-2741
3. strain relief support (qty 1) HP P/N 5060-2721
4. strain relief bracket (qty 1) HP P/N 5020-2565
5. machine screw, 8-32 0.875 in. (qty 2) HP P/N 2515-0007

CHANGE 4:

In all models change capacitor A1C28 to .015uF (RIFA cap.), HP P/N 0160-3969. In Model 6263B only, change capacitor A1C5 to 4700pF, HP P/N 0160-0157, Add ferrite bead, HP P/N 9170-0894, to emitter of transistor Q4.

CHANGE 5:

In the model 6266B only, add ferrite bead, HP P/N 9170-0894, to the replaceable parts list and to Figures 7-6 and 7-7. The ferrite bead is placed over the emitter lead of transistor Q4.

CHANGE 6:

In all models change resistor A1R39 to 100k, 5%, 1/2 W HP P/N 0686-1045.

CHANGE 7:

In the replaceable parts list, page 6-6 add L1 ferrite bead HP P/N 9170-0894 Qty (1). In the power supply L1 is located on the emitter of A1Q4.

CHANGE 8:

In the replaceable parts list, page 6-16, under Option 005, R74 will now also apply to Model 6267B.

CHANGE 9:

*This change also applies to instruments with Serial Numbers 2032A-04333, 04335, 04336, 04341, 04349, 04360, 04365, and 04367.

In the replaceable parts list, page 6-16, under Option 005, R74 will now also apply to Model 6264B.

CHANGE 10:

In Section I, on page 1-1, change the last sentence of paragraph 1-6 to read: "...or the supply's output may be floated at up to 120 volts above ground."

CHANGE 11:

In the replaceable parts list page 6-10 under A3 Front Panel Electrical, delete capacitors C28-30 HP P/N 0160-2568, qty 3. On page 6-11 under Rear Panel Electrical, add capacitors C28-30, 0.1uF, 250Vac, HP P/N 0160-4355, qty 3.

CHANGE 12:

On page 1-1, paragraph 1-6, change the last sentence to read ..."the supply's output may be floated at up to 120 volts above ground.

CHANGE 13:

In the replaceable parts list, page 6-10, under A3 Front Panel Electrical, add the following part to Model 6274B: Fuse, F1, 400mA, slow blow, 250V, HP P/N 2110-0340, Qty 1.

On page 6-13 under A3 Front Panel Ass'y. Mechanical add the following parts to model 6274B; Fuseholder Body HP P/N 2110-0564, Qty 1, Fuseholder Cap HP P/N 2110-0565, Qty 1, Fuseholder Nut HP P/N 2110-0569, Qty 1.

On page 6-18 under Option 027 and 028 add Fuse, F1, 250mA, slow blow, HP P/N 2110-0201, Qty 1.

On the schematic Figure 7-4 add F1 as shown below to the 6274B.

MODEL 6274B ONLY

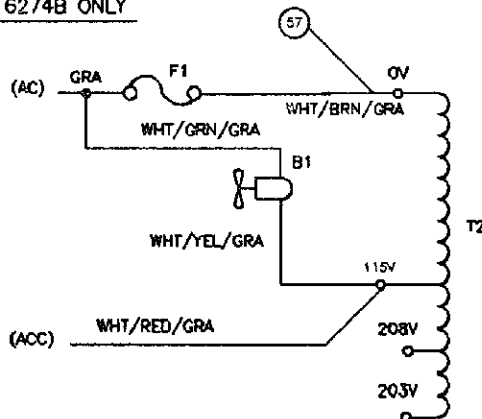

CHANGE 14:

Add Bushing (rubber) HP P/N 1251-6532 Qty 1 to the Strain Relief Assembly HP P/N 5060-2744 added in Change 3. On the strain Relief Installation Instructions (provided with each power supply) Bushing (rubber) should be listed as Item #10. Also, change step#2 to read as follows: Route the cable lugs through the rubber bushing then up to the lower connection screws and connect them.

CHANGE 15:

In the replaceable parts list, page 6-11, delete S1 HP P/N 3101-0946, and add S1, line switch, HP P/N 3101-2456, qty 1.

This change only applies to Models 6264B, 6267B and 6274B. In the replaceable parts list, page 6-14, change TB2 to HP P/N 0360-2199.

In the replaceable parts list, page 6-13 under A1 Main PC Board Mechanical, change barrier strip jumpers (qty.6) and (qty.7) to HP P/N 0360-1935.

CHANGE 16:

In the replaceable parts list, page 6-15, for Models 6263B and 6266B, change the rear panel HP Part No. to 5020-2666. On the same page, for the same models change grommet, 7/8", (qty 2), to grommet-strain relief, HP Part No. 0400-0013, qty 1, and line cord to HP Part No. 8120-0050, qty 1.

CHANGE 17:

*This change also pertains to units having serial numbers 2345A-02184 through 2345A-02227.

CHANGE 18:

In the replaceable parts list delete capacitors C28,29,30 which were moved due to CHANGE 11 from the Front Panel Electrical to the Rear Panel Electrical. Add on the bottom of page 6-11, RFI Board Assembly, HP P/N 5060-2876, TQ 1. The RFI Board consists of the following components; C28,C29, fxd met, .01uf, 10% HP P/N 0160-4355, TQ 2, C30, fxd poly, 1.0uf, 20%,HP P/N 0160-4962, TQ 1 and R22, fxd comp, 820K, 5%, 1/2W, HP P/N 0686-8245, TQ 1.

On the schematic diagram figure 7-4 for Models 6264B, 6267B and 6274B add the RFI Board Assembly to the schematic.

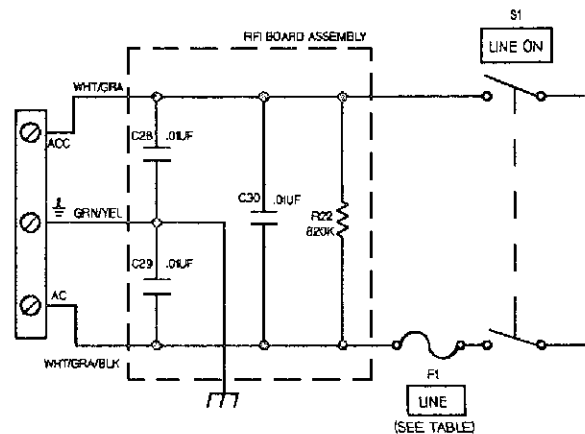

CHANGE 19:

This change also applies to the serial numbers listed below.

6263B:

2417A-04441, 2417A-04503, 2417A-04519,
2417A-04549, 2417A-04600, 2417A-04602
through 2417A-04621

6266B:

2419A-04976, 2419A-05021, 2419A-05185,
2419A-05301 through 05306, 2419A-05058
through 05060, 2419A-05311, 2419A-05336
through 2419A-05365.

In the replaceable parts list, under Rear Panel Electrical change Q3 to HP P/N 1854-0072, under A1 Board Electrical add C80, 0.047uf, 10%, 100 VDC, HP P/N 0160-4834, TQ 1. On the schematic diagram, Figure 7-7, add C80 from the base to collector of Q6. On the A1 Component Location drawing, Figure 7-6, C80 is added where Q3 for the 6265B was once installed (ref. near center of PC Board.)

*CHANGE 20:

This change only applies to Model 6263B option 005 and will also include serial numbers; 2546A-04622 and 2546A-04623.

In the replaceable parts list, page 6-16, under OPTION 005 50Hz AC Input, add Model number 6263B to resistor R74 (this resistor is now included in the 6263B).

CHANGE 21:

For Model 6274B, on page 6-11, under Rear Panel Electrical change Q3 to HP P/N 1854-0917.

CHANGE 22:

In the replaceable parts list, page 6-11, under Rear Panel Electrical, change Q6-7 for model 6274B to HP P/N 1854-1096.

CHANGE 23:

MODEL 6264B, -67B and -74B

In the replaceable parts list, under A1 Main PC Board, change A1R56 and A1R63 to 200 ohms, 10%, HP P/N 2100-3212, A1R30 and A1R75 to 5K, 10%, HP P/N 2100-3252, and A1T3, T4 to HP P/N 5080-2055.

On page 6-14, under Rear Panel Ass'y Mechanical, in the Ref. Desig. (and Models) column, add model numbers 6263B and 6266B next to: insulator bushing, CR11, CR34, Q3, (qty. 3), and directly under this, add 6264B, 67B and 74B, insulator bushing, CR11, CR34, (qty. 2), HP P/N 0340-0169.

MODEL 6274B

In the replaceable parts list, page 6-14, under Rear Panel Ass'y Mechanical, change Rear Chassis HP P/N 06274-60010 to HP P/N 06274-60011.

If Rear Chassis HP P/N 06274-60010 is unavailable for replacement, and Rear Chassis HP P/N 06274-60011 is ordered, a new A1 Board Assembly HP P/N 06274-60024 must be ordered.

In the replaceable parts list, page 6-11, under Rear Panel Electrical, for Model 6274B change Q3 to HP P/N 1854-1017.

MODEL 6264B and 6267B

In the replaceable parts list, under Rear Panel Ass'y Mechanical, change rear chassis HP P/N 06264-60005 to HP P/N 06264-60007. If rear chassis HP P/N 06264-60005 is unavailable for replacement and rear chassis 06264-60011 is ordered, a new A1 Board Assembly, (for Model 6264B HP P/N 06264-60024 and for Model 6267B HP P/N 06267-60024) must be ordered. Change transistor screw insulator, Q3,6,7 (qty. 6) to a quantity of 12, and transistor insulator, mica, Q3 to HP P/N 0340-0181.

On page 6-11, under Rear Panel Electrical change Q3 to HP P/N 1854-1070 and Q6,7 to HP P/N 1854-1124.

On page 6-5, in the Ref. Desig. (and Models) column, add C38, fxd cer, 0.05uf, +/- 20% @ 400Vdc, HP P/N 0150-0052.

On page 6-5, in the Ref. Desig. (and Models) column, add C38, fxd cer, 0.05uf, +/- 20% @ 400Vdc, HP P/N 0150-0052. On the schematic, (Figure 7-4), add C38 to the Series Regulator & Driver circuit from the emitter to collector of A1Q3. On the Component Location Drawing, (Figure 7-6) add C38 above and to the right of R102.

CHANGE 24:

In the replaceable parts list, page 6-12, under Chassis Electrical Q3 to HP P/N 1854-1070 and Q6 to HP P/N 1854-1124. On page 6-15 change transistor insulator, mica, Q3, HP P/N 0340-0180 to transistor mica, Q3 and Q6, HP P/N 0340-0174. In the replaceable parts list (Table 6-4) change the part number for the rear panel from HP P/N 5020-2666 to HP P/N 5020-2686.

MODEL 6263B only

In the replaceable parts list, under A1 Main PC Board add C80, fxd cer, 0.047uf, +-10% @ 100VDC, HP P/N 0160-4834. On the schematic Figure 7-4, in the Series Regulator & Driver Circuit add C80 between the emitter and collector of Q3.

CHANGE 25:

In the replaceable parts list for the main assembly, change the part number for the Washer-Shoulder from HP P/N 2190-0898 to HP P/N 3050-1321 (qty 4).

CHANGE 26:

In the replaceable parts list, change the part number for Q6 and Q7 from HP P/N 1854-1096 to HP P/N 1854-0458 (qty 2).

ERRATA:

In the Operating and Service manual, for units with Option 040, add the following note.

NOTE

When calibrated for Option 040, units may not meet full output voltage or current specification when used with the front panel potentiometer. This is due to the resistance tolerance of the potentiometer and the programming coefficient accuracy required for Option 040.

In the replaceable parts list, change the part number for CR57 from HP P/N 1884-0058 to HP P/N 1884-0219 for the following models: HP 6263B, HP 6264B, HP 6266B, HP 6267, and HP 6274B.

On page 5-18, below paragraph 5-93, add the following note:

CAUTION

When disabling the crowbar, also lift one side of R109 (Overvoltage Adjust Pot).

CHANGE 27:

In the replaceable parts list, for the RFI assembly (HP P/N 5060-2657) (and Option 028) change the part number for the standoff from HP P/N 0380-1497 to HP P/N 0380-1496 (qty 4). For the same assembly, change the part number for CR1 TRIAC from HP P/N 1884-0218 to HP P/N 1884-0334 (qty 1).

In the replaceable parts list, for Sub-Assembly - RFI (HP P/N 5060-2765) (and Option 028) add Connector, Quick Disconnect (HP P/N 0362-0662) (qty 1) and Connector, Quick Disconnect (HP P/N 1252-2342) (qty 2).

For the rear deck assembly HP P/N 062xx-6000x pc board assembly HP P/N 062xx-60024), change Q18 from HP P/N 1854-0087 to HP P/N 1855-0549 (qty 1).

For the pc board assembly HP P/N 062xx-60124, in the replaceable parts list and on the schematic, change C18 from 0.22uF (HP P/N 0160-2453) to 1.8uF (HP P/N 0180-0405) (qty 1).

In the replaceable parts list, and on the schematic, change R71 from 1.8K, 1/2W, CC. (HP P/N 0686-1825) to 470 ohms (HP P/N 0686-4715) (qty 1). Also change R84 from 10 ohms, 1/2W, CC. (HP P/N 0686-1005) to 1.8 ohms (HP P/N 0698-6254) (qty 1).

Note that the connections for the new triac (HP P/N 1884-0334) are shown in Figure 1 and the Pin-Out of the new Q18 is shown in Figure 2.

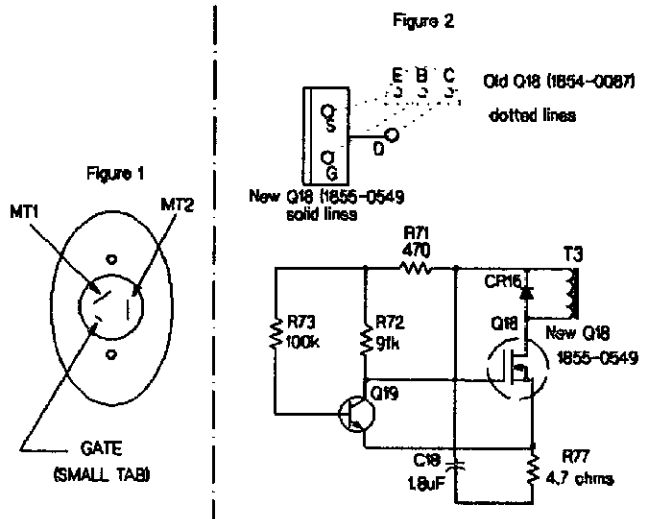

CHANGE 28:

MODELS 6263B,6264B,6266B,6267B & 6274B

On A1 Component Location drawings (Figures 7-3 and 7-6), disconnect anode end of CR5 from its present connection to C3 and connect it to a solder pin (HP P/N 0360-2076) now installed at the end of R20 that is electrically connected to R21. Follow this new wiring procedure whenever replacing CR5 on all units.

ERRATA:

On page 6-10 of the replaceable parts list, change inductor A2L1 to HP P/N 5080-2138 and delete A2C4 P/N 0160-0899.

On page 6-13 of the replaceable parts list, delete cover HP P/N 5020-2283 and standoff P/N 0380-1496.

MODEL 6266B

On page 6-12 of replaceable parts list, change Q3 to HP P/N 1854-1070. When using this transistor on all serial numbers, omit capacitor C80 HP P/N 0160-4834 if it was previously added under CHANGE #19.

MODELS 6264B,6267B & 6274B

On page 6-14 of the replaceable parts list, change Assembly A3 meter bezel (qty. 2) to HP P/n 4040-0297.

MODELS 6263B,6264B,6267B & 6274B

On page 6-15 of the replaceable parts list, change shoulder washer from HP P/N 2190-0898 to P/N 3050-1321.

On schematic diagrams (Figures 7-4 and 7-7), move the cathode end of diode CR5 to opposite side of R20.

MODELS 6264B, 6267B, & 6274B

Change the part number of C30 (added to page 6-11 in change 18) to HP P/N 0160-7606.

CHANGE 29:

On page 6-12 of the parts list, change Q6,7 for Model 6274B to HP P/N 1854-1096.

CHANGE 30:

This change modifies the ac input power connection circuit to meet the requirements of CE-92. The circuit includes the barrier block to which the input power cable is installed (see "Power Cable", page 2-3).

On page 6-11 of the parts list, delete RFI Board Assembly HP P/N 5060-2876. (This assembly was added in CHANGE 18). In its place, add the following parts:

Capacitors C503 and C504, 0.015 uF, 10% (2) P/N 0160-3969.

RFI Printed Circuit Board Assembly #Z10, HP P/N 5060-3299 containing the following electrical parts:

Capacitor, 0.015 uF, 10% (2) P/N 0160-3969
Capacitor, 1.0 uF, 20% (3) P/N 0160-7606
Resistor, 300 k, 5%, 2W P/N 0698-3667

Capacitors C503 and C504 are mounted on the ac barrier block and are connected from each side of the ac line to ground. Capacitors 0160-3969 and resistor 0698-3667 replace C28,C29, and R40 of deleted filter P/N 5060-2876. The three 1 uF capacitors (P/N 0160-7606) are connected across the ac line.

CHANGE 31:

This change modifies the ac input power connection circuit to meet the requirements of UL 1244. The circuit is modified as shown in the schematic for CHANGE 31. On page 6-13 of the Replaceable Parts list, change T1 to the following part number:

Model	HP P/N
6264B	06264-80091
6267B	06267-80091
6274B	06274-80091

For field modification, order the following transformer service kits and service kit instruction notes:

Model	HP Kit P/N	Service Note P/N
6264B	06264-60010	5960-5515
6267B	06267-60010	5960-5595
6274B	5060-3478	5969-5596

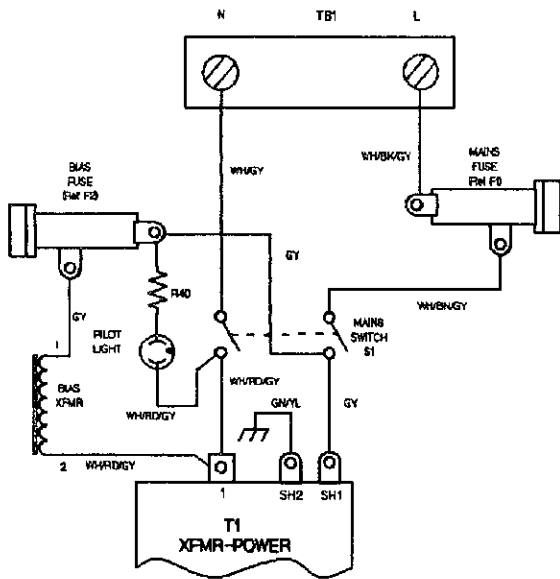

Present Wiring

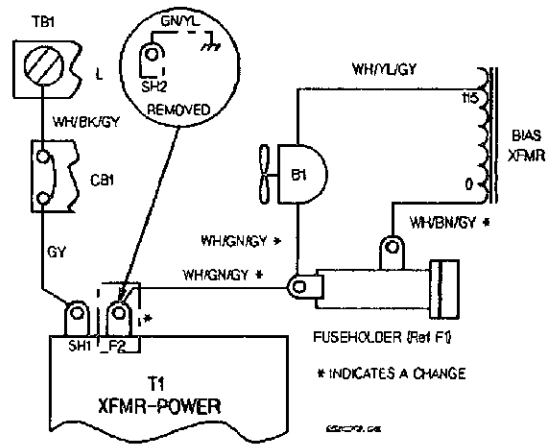

Model 6274B

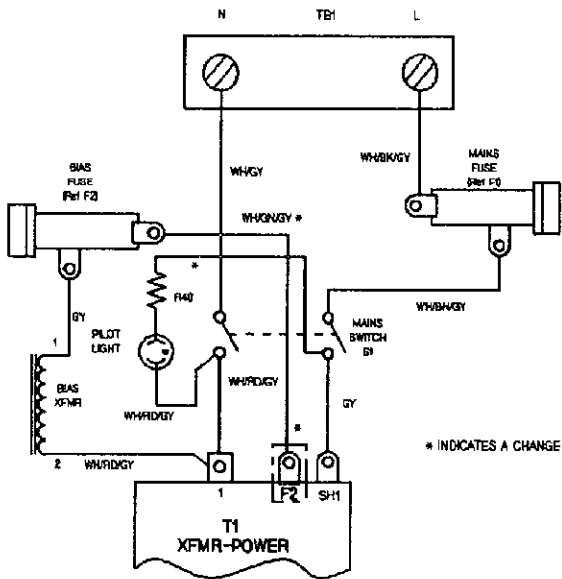

New Wiring

Models 6264B and 6267B

SAFETY SUMMARY

The following general safety precautions must be observed during all phases of operation, service, and repair of this instrument. Failure to comply with these precautions or with specific warnings elsewhere in this manual violates safety standards of design, manufacture, and intended use of the instrument. Hewlett-Packard Company assumes no liability for the customer's failure to comply with these requirements.

BEFORE APPLYING POWER.

Verify that the product is set to match the available line voltage and the correct fuse is installed.

GROUND THE INSTRUMENT.

This product is a Safety Class 1 instrument (provided with a protective earth terminal). To minimize shock hazard, the instrument chassis and cabinet must be connected to an electrical ground. The instrument must be connected to the ac power supply mains through a three-conductor power cable, with the third wire firmly connected to an electrical ground (safety ground) at the power outlet. For instruments designed to be hard-wired to the ac power lines (supply mains), connect the protective earth terminal to a protective conductor before any other connection is made. Any interruption of the protective (grounding) conductor or disconnection of the protective earth terminal will cause a potential shock hazard that could result in personal injury. If the instrument is to be energized via an external autotransformer for voltage reduction, be certain that the autotransformer common terminal is connected to the neutral (earthed pole) of the ac power lines (supply mains).

INPUT POWER MUST BE SWITCH CONNECTED.

For instruments without a built-in line switch, the input power lines must contain a switch or another adequate means for disconnecting the instrument from the ac power lines (supply mains).

DO NOT OPERATE IN AN EXPLOSIVE ATMOSPHERE.

Do not operate the instrument in the presence of flammable gases or fumes.

KEEP AWAY FROM LIVE CIRCUITS.

Operating personnel must not remove instrument covers. Component replacement and internal adjustments must be made by qualified service personnel. Do not replace components with power cable connected. Under certain conditions, dangerous voltages may exist even with the power cable removed. To avoid injuries, always disconnect power, discharge circuits and remove external voltage sources before touching components.

DO NOT SERVICE OR ADJUST ALONE.

Do not attempt internal service or adjustment unless another person, capable of rendering first aid and resuscitation, is present.

Instruments which appear damaged or defective should be made inoperative and secured against unintended operation until they can be repaired by qualified service personnel.

DO NOT EXCEED INPUT RATINGS.

This instrument may be equipped with a line filter to reduce electromagnetic interference and must be connected to a properly grounded receptacle to minimize electric shock hazard. Operation at line voltages or frequencies in excess of those stated on the data plate may cause leakage currents in excess of 5.0 mA peak.

SAFETY SYMBOLS.



Instruction manual symbol: the product will be marked with this symbol when it is necessary for the user to refer to the instruction manual (refer to Table of Contents).



Indicates hazardous voltages.



or



Indicate earth (ground) terminal.

WARNING

The WARNING sign denotes a hazard. It calls attention to a procedure, practice, or the like, which, if not correctly performed or adhered to, could result in personal injury. Do not proceed beyond a WARNING sign until the indicated conditions are fully understood and met.

CAUTION

The CAUTION sign denotes a hazard. It calls attention to an operating procedure, or the like, which, if not correctly performed or adhered to, could result in damage to or destruction of part or all of the product. Do not proceed beyond a CAUTION sign until the indicated conditions are fully understood and met.

DO NOT SUBSTITUTE PARTS OR MODIFY INSTRUMENT.

Because of the danger of introducing additional hazards, do not install substitute parts or perform any unauthorized modification to the instrument. Return the instrument to a Hewlett-Packard Sales and Service Office for service and repair to ensure that safety features are maintained.

SAFETY SUMMARY (continued)



















GENERAL

Any LEDs used in this product are Class 1 LEDs as per IEC 825-1.

ENVIRONMENTAL CONDITIONS

This instrument is intended for indoor use in an installation category II, pollution degree 2 environment. It is designed to operate at a maximum relative humidity of 95% and at altitudes of up to 2000 meters. Refer to the specifications tables for the ac mains voltage requirements and ambient operating temperature range.

SAFETY SYMBOL DEFINITIONS

Symbol	Description	Symbol	Description
	Direct current		Terminal for Line conductor on permanently installed equipment
	Alternating current		Caution, risk of electric shock
	Both direct and alternating current		Caution, hot surface
	Three-phase alternating current		Caution (refer to accompanying documents)
	Earth (ground) terminal		In position of a bi-stable push control
	Protective earth (ground) terminal		Out position of a bi-stable push control
	Frame or chassis terminal		On (supply)
	Terminal for Neutral conductor on permanently installed equipment		Off (supply)
	Terminal is at earth potential (Used for measurement and control circuits designed to be operated with one terminal at earth potential.)		Standby (supply) Units with this symbol are not completely disconnected from ac mains when this switch is off. To completely disconnect the unit from ac mains, either disconnect the power cord or have a qualified electrician install an external switch.

Herstellerbescheinigung

Diese Information steht im Zusammenhang mit den Anforderungen der Maschinenlärminformationsverordnung vom 18 Januar 1991.

* Schalldruckpegel $L_p < 70$ dB(A) * Am Arbeitsplatz * Normaler Betrieb
* Nach EN 27779 (Typprüfung).

Manufacturer's Declaration

This statement is provided to comply with the requirements of the German Sound Emission Directive, from 18 January 1991.

* Sound Pressure $L_p < 70$ dB(A) * At Operator Position * Normal Operation
* According to EN 27779 (Type Test).

DECLARATION OF CONFORMITY

according to ISO/IEC Guide 22 and EN 45014

Manufacturer's Name: Hewlett-Packard Company

Manufacturer's Address: 150 Green Pond Road
Rockaway, New Jersey 07866
U.S.A.

declares that the Product

Product Name: Power Supply

Model Number: HP 6260B
HP 6268B, 6269B
HP 6274B

conforms to the following Product Specifications:

Safety: IEC 348:1978 / HD 401S1: 1981¹

EMC: CISPR 11:1990 / EN 55011:1991 - Group 1 Class B
IEC 801-2:1991 / EN 50082-1:1992 - 4 kV CD, 8 kV AD
IEC 801-3:1984 / EN 50082-1:1992 - 3 V / m
IEC 801-4:1988 / EN 50082-1:1992 - 0.5 kV Signal Lines
1 kV Power Lines

Supplementary Information:

The product herewith complies with the requirements of the Low Voltage Directive 73/23/EEC and the EMC Directive 89/336/EEC and carries the CE-marking accordingly.

Note 1: The product family was introduced prior to 12/93.

New Jersey January 1997
Location Date



Bruce Krueger / Quality Manager

European Contact: Your local Hewlett-Packard Sales and Service Office or Hewlett-Packard GmbH,
Department TRE, Herrenberger Strasse 130, D-71034 Boeblingen (FAX:+49-7031-14-3143)

SECTION I GENERAL INFORMATION

1-1 DESCRIPTION

1-2 The eight constant-voltage/constant-current power supply models included in this manual use a transistor series-regulator combined with a triac preregulator for high efficiency, excellent regulation, and low ripple and noise. These supplies are suitably packaged for either bench or relay rack operation. The Models 6256B, 6264B, 6267B, and 6274B are housed in a 5 1/4-inch high full-rack-width cabinet, and the Models 6263B, 6265B, 6266B, and 6271B are housed in a similar 3 1/2-inch high cabinet.

1-3 The outputs of these supplies can be varied from zero to full rated voltage or current by setting coarse and fine voltage and current controls on the front panel or they can be programmed remotely by resistance or voltage inputs to rear panel terminals. When the voltage controls are used to establish a constant output voltage, the current controls establish a current limit that can protect the load from over-current; when the current controls are used to establish a constant output current, the voltage controls establish a voltage limit that can protect the load from excessive voltage. The crossover from constant-voltage to constant-current operation, or vice versa, occurs automatically when the load current reaches the value established by the current controls or the voltage reaches the value established by the voltage controls. The output voltage and current can both be monitored continuously on front panel meters.

1-4 Output loads are further protected by a built-in fast-acting overvoltage protection crowbar circuit that automatically shorts the supply's output terminals if a preset voltage limit is exceeded. A front panel control sets the voltage at which the crowbar trips and can be adjusted from approximately 10% to 110% of the supply's maximum rated voltage. When several supplies are installed in the same system, whether in series, parallel, or independently, their crowbar circuits can be interconnected so that all will trip simultaneously whenever any one of them does.

1-5 The Model 6274B supply is forced-air cooled; the other models covered by this manual are cooled by convection.

1-6 The ac input connections to the supplies in 5 1/4-inch cabinets are made at rear panel terminals; the 3 1/2-inch units are equipped with 3-wire line cords. All dc output, remote sensing, and remote programming connections

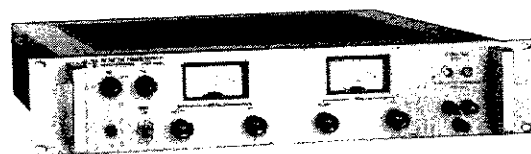

MODELS 6263B, 6265B, 6266B, 6271B

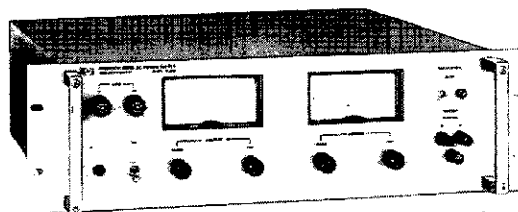

MODELS 6256B, 6264B, 6267B

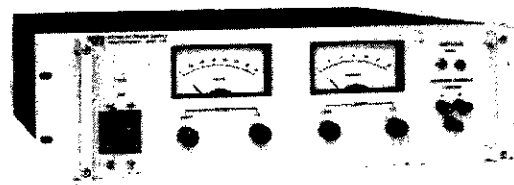

MODEL 6274B

are made at rear panel terminals. (The output terminals on the front panel are for monitoring purposes only and are rated at 3 amps maximum.) Either the positive or negative output terminal of a supply may be grounded or the supply's output may be floated at up to 300 volts above ground.

1-7 Remote programming, remote sensing, and several methods of operating supplies in combinations of two or three are made possible by rear panel terminals that allow access to control points within the regulator circuits. These capabilities are described below.

a. Remote Programming. The power supply's output voltage or current (or both) can be controlled from a remote location by varying a resistance or a voltage input signal to the supply's voltage or current regulator circuit.

b. Remote Sensing. Connecting the voltage regulator's feedback circuit to the load terminals rather than to the supply's output terminals prevents the voltage drop in the load leads from impairing voltage regulation at the load

when operating in the constant voltage mode. A separate pair of sensing leads which carry no load current extend the feedback loop to the load terminals.

c. Auto-Parallel Operation. Two or three similar supplies connected in parallel can be made to share loads equally and can be controlled by the voltage and current controls (or remote programming terminals) of one of the supplies designated the master if they are connected for auto-parallel operation. Normally, only supplies having the same model number are connected in auto-parallel, but auto-parallel operation can be used with any of the supplies covered by this manual that have equal current capabilities.

d. Auto-Series Operation. Two or three supplies can be connected in series and have their outputs simultaneously controlled by the voltage and current controls (or remote programming terminals) of one of the supplies designated the master. The voltage contributed by each slave is maintained in a constant ratio to that of the master. These ratios can be set as desired. Auto-series operation provides higher output voltages in constant voltage operation and greater voltage compliance in constant current operation. Any HP supply that offers auto-series operation can serve as a slave supply; the master supply does not have to be an auto-series model.

e. Auto-Tracking Operation. Auto-tracking is similar to auto-series operation except that two or three supplies share a common negative output bus and are interconnected so that the output voltage of each slave supply is maintained at some constant fraction of that of the master supply. All of the supplies are controlled through the master supply, and each supply feeds a separate load.

1-8 SPECIFICATIONS

1-9 Detailed specifications for these power supplies are given in Table 1-1.

1-10 OPTIONS

1-11 Options are customer-requested factory modifications of a standard instrument. The following options are available for the instruments covered by this manual. Where necessary, detailed coverage of the options is included throughout the manual.

<u>Option No.</u>	<u>Description</u>
005	<u>Realignment for 50Hz Operation:</u> Standard instruments are designed for 57 to 63Hz operation. For 50Hz operation, several resistors in the preregulator control circuit are changed in value and the preregulator is realigned.

007	<u>Ten-Turn Output Voltage Control:</u> A ten-turn control replaces the coarse voltage control for improved resolution in setting the output voltage.
008	<u>Ten-Turn Output Current Control:</u> A ten-turn control replaces the coarse current control for improved resolution in setting the output current.
009	<u>Ten-Turn Output Voltage and Current Controls:</u> This option includes Options 007 and 008 in the same instrument.
010	<u>Chassis Slides:</u> Factory installed slides permit convenient access to the interior of a rack-mounted supply for maintenance.
013	<u>Three-Digit Graduated Decadal Voltage Control:</u> To improve mechanical stability and permit accurate resetting of the output voltage, Option 013 replaces the coarse voltage control with a ten-turn control equipped with a 3-digit turns-counting dial.
014	<u>Three-Digit Graduated Decadal Current Control:</u> To improve mechanical stability and permit accurate resetting of the output current, Option 014 replaces the coarse current control with a ten-turn control equipped with a 3-digit turns-counting dial.
020	<u>Adjustable Voltage Programming:</u> Two screwdriver-adjustable controls mounted on the rear panel allow the voltage programming coefficient and zero output voltage to be adjusted conveniently to an accuracy of 0.1%.
021	<u>Adjustable Current Programming:</u> Two screwdriver-adjustable controls mounted on the rear panel allow the current programming coefficient and zero output current to be adjusted conveniently to an accuracy of 0.1%.
022	<u>Adjustable Voltage and Current Programming:</u> This option includes Options 020 and 021 in the same instrument.
027	<u>Rewiring for 208Vac \pm10% Single-phase Input:</u> This factory modification reconnects the input transformers and the preregulator choke, and replaces the fuses and the pilot light resistor for 208Vac operation.

- 028 Rewiring for 230Vac \pm 10% Single-phase Input: This factory modification reconnects the input transformers and the preregulator choke, and replaces the fuses and the pilot light resistor for 230Vac operation.
- 040 Interfacing for Multiprogrammer Operation: This factory modification prepares standard power supplies for resistance programming by the 6940B Multiprogrammer or the 6941B Multiprogrammer Extender. Operation with either of these instruments requires that the power supply be subjected to a special calibration and a protection checkout. The special calibration insures that the power supply can be accurately set to zero and to the maximum rated output voltage or current when programmed by the multiprogrammer. The protection checkout insures that the power supply will not be damaged by the rapid repetitive programming possible with the multiprogrammer. This option includes Option 022.

1-13 Hewlett-Packard power supplies are identified by a two-part serial number. The first part is the serial number prefix, a number-letter combination that denotes the date of a significant design change and the country of manufacture. The first two digits indicate the year (10 = 1970, 11 = 1971, etc.), the second two digits indicate the week, and the letter "A" designates the U. S. A. as the country of manufacture. The second part is the power supply serial number. A different sequential number is assigned to each power supply, starting with 00101.

1-14 If the serial number on your instrument does not agree with those on the title page of the manual, Change Sheets supplied with the manual define the differences between your instrument and the instrument described by this manual.

1-15 ORDERING ADDITIONAL MANUALS

1-16 One manual is shipped with each power supply. Additional manuals may be purchased from your local Hewlett-Packard field office (see list at rear of this manual for addresses). Specify the model number, serial number prefix, and HP part number shown on the title page.

1-12 INSTRUMENT/MANUAL IDENTIFICATION

Table 1-1. Specifications: Models 6256B, 6263B, 6264B, 6265B, 6266B, 6267B, 6271B, and 6274B.

<p>INPUT: 115Vac \pm10%, single phase, 57-63Hz for the standard models. (For other input voltages or 50Hz operation, see the option listings in paragraph 1-10. Input power requirements are listed in paragraph 2-15.</p> <p>OUTPUT:</p> <table> <tbody> <tr> <td>Model 6256B</td> <td>0-10 volts at 0-20 amps</td> </tr> <tr> <td>6263B</td> <td>0-20 volts at 0-10 amps</td> </tr> <tr> <td>6264B</td> <td>0-20 volts at 0-20 amps</td> </tr> <tr> <td>6265B</td> <td>0-40 volts at 0-3 amps</td> </tr> <tr> <td>6266B</td> <td>0-40 volts at 0-5 amps</td> </tr> <tr> <td>6267B</td> <td>0-40 volts at 0-10 amps</td> </tr> <tr> <td>6271B</td> <td>0-60 volts at 0-3 amps</td> </tr> <tr> <td>6274B</td> <td>0-60 volts at 0-15 amps</td> </tr> </tbody> </table> <p>LOAD EFFECT (LOAD REGULATION): <u>Constant Voltage</u> — Less than 0.01% of output plus 200μV for a load change equal to the current rating of the supply. <u>Constant Current</u> — Less than 0.02% of output plus 500μA for a load change equal to the voltage rating of the supply.</p> <p>SOURCE EFFECT (LINE REGULATION): <u>Constant Voltage</u> — Less than 0.01% of output plus 200μV for a change in line voltage between 104 and 127Vac (or 208 and 254Vac) at any output voltage and current</p>	Model 6256B	0-10 volts at 0-20 amps	6263B	0-20 volts at 0-10 amps	6264B	0-20 volts at 0-20 amps	6265B	0-40 volts at 0-3 amps	6266B	0-40 volts at 0-5 amps	6267B	0-40 volts at 0-10 amps	6271B	0-60 volts at 0-3 amps	6274B	0-60 volts at 0-15 amps	<p>within rating. <u>Constant Current</u> — Less than 0.02% of output plus 500μA for a change in line voltage between 104 and 127Vac (or 208 and 254Vac) at any output voltage and current within rating.</p> <p>PARD (RIPPLE AND NOISE): <u>Constant Voltage</u> — Less than 200μV rms or 10mV p-p, 20Hz to 20MHz (except for the Model 6274B, which has less than 200μV rms or 20mV p-p). <u>Constant Current</u> — Models 6256B, 6264B, and 6274B — Less than 5mA rms, 20Hz to 20MHz. Models 6263B, 6265B, 6266B, 6267B, and 6271B — Less than 3mA rms, 20Hz to 20MHz.</p> <p>TEMPERATURE COEFFICIENT: <u>Constant Voltage</u> — Less than 0.01% plus 200μV change in output per degree Celsius change in ambient following a 30-minute warmup. <u>Constant Current</u> — Models 6256B, 6263B, 6264B, and 6274B — Less than 0.01% plus 2mA change in output per degree Celsius change in ambient following a 30-minute warmup. Models 6265B, 6266B, 6267B, and 6271B — Less than 0.01% plus 1mA change in output per degree Celsius change in ambient following a 30-minute warmup.</p>
Model 6256B	0-10 volts at 0-20 amps																
6263B	0-20 volts at 0-10 amps																
6264B	0-20 volts at 0-20 amps																
6265B	0-40 volts at 0-3 amps																
6266B	0-40 volts at 0-5 amps																
6267B	0-40 volts at 0-10 amps																
6271B	0-60 volts at 0-3 amps																
6274B	0-60 volts at 0-15 amps																

Table 1-1. Specifications: Models 6256B, 6263B, 6264B, 6265B, 6266B, 6267B, 6271B, and 6274B (continued).

<p>DRIFT (STABILITY): (Change in output (dc to 20Hz) over an 8-hour interval under constant line, load, and ambient temperature following a 30-minute warmup.) Constant Voltage — Less than 0.03% of output plus 500μV (except for the Models: 6267B and 6274B, which have a drift of less than 0.03% of output plus 2mV). Constant Current — Models 6256B, 6263B, and 6264B — Less than 0.03% of output plus 6mA. Models 6265B, 6266B, 6267B, and 6271B — Less than 0.03% of output plus 3mA. Model 6274B — Less than 0.03% of output plus 5mA.</p>			<p>REMOTE PROGRAMMING COEFFICIENTS:</p>			
<p>RESOLUTION: (Minimum output voltage or current change that can be obtained using the front panel controls.)</p>			<p>Output Voltage Programming</p>			
<u>Model</u>	<u>Constant Voltage</u>	<u>Constant Current</u>	<u>Model</u>	<u>Resistance Control ($\pm 1\%$)</u>	<u>Voltage Control ($\pm 1\%$)</u>	
6256B	1mV	20mA	6256B	200 Ω /V	1V/V	
6263B	2mV	10mA	6263B	200 Ω /V	1V/V	
6264B	2mV	20mA	6264B	200 Ω /V	1V/V	
6265B	5mV	3mA	6265B	200 Ω /V	1V/V	
6266B	5mV	5mA	6266B	200 Ω /V	1V/V	
6267B	5mV	10mA	6267B	200 Ω /V	1V/V	
6271B	10mV	3mA	6271B	300 Ω /V	1V/V	
6274B	10mV	15mA	6274B	300 Ω /V	1V/V	
<p>OUTPUT IMPEDANCE (TYPICAL): Approximated by a resistance in series with an inductance as follows:</p>			<p>Output Current Programming —</p>			
<u>Model</u>		<u>Model</u>	<u>Model</u>	<u>Resistance Control ($\pm 10\%$)</u>	<u>Voltage Control ($\pm 10\%$)</u>	
6256B	0.1m Ω , 1 μ H	6266B	6256B	10 Ω /A	25mV/A	
6263B	0.5m Ω , 1 μ H	6267B	6263B	100 Ω /A	50mV/A	
6264B	0.2m Ω , 1 μ H	6271B	6264B	10 Ω /A	25mV/A	
6265B	2m Ω , 1 μ H	6274B	6265B	300 Ω /A	167mV/A	
			6266B	200 Ω /A	100mV/A	
			6267B	100 Ω /A	50mV/A	
			6271B	300 Ω /A	167mV/A	
			6274B	67 Ω /A	33.3mV/A	
<p>LOAD TRANSIENT RECOVERY TIME: Less than 50μsec is required for output voltage recovery (in constant voltage operation) to within 10mV of the nominal output following a change in output current equal to the current rating of the supply or 5 amps, whichever is smaller.</p>			<p>REMOTE PROGRAMMING SPEED: (Typical time required to nonrepetitively change from zero to within 99.9% of the maximum rated output voltage, or from the maximum rated output voltage to within 0.1% of that voltage above zero.)</p>			
<p>OVERVOLTAGE PROTECTION CROWBAR: To avoid false tripping, the recommended trip margin above the output voltage is 5% of the output voltage plus 1 volt. The approximate crowbar trip voltage ranges are:</p>			<p>Up, Full Load</p>			
Model	6256B 2V–12V	Model	6266B 2.5V–45V	<u>Model</u>	<u>Down, Full Load</u>	
	6263B 2V–23V		6267B 2.5V–45V	6256B	60ms	
	6264B 2.5V–23V		6271B 6V–66V	6263B	150ms	
	6265B 2.5V–45V		6274B 6V–66V	6264B	140ms	
				6265B	275ms	
				6266B	275ms	
				6267B	275ms	
				6271B	600ms	
				6274B	600ms	
				<u>Model</u>	<u>Up, No Load</u>	
				6256B	60ms	
				6263B	150ms	
				6264B	140ms	
				6265B	275ms	
				6266B	275ms	
				6267B	275ms	
				6271B	600ms	
				6274B	600ms	
					<u>Down, No Load</u>	
					6256B	5 sec
					6263B	7 sec
					6264B	10 sec
					6265B	12 sec
					6266B	13 sec
					6267B	13 sec
					6271B	7 sec
					6274B	40 sec

Table 1-1. Specifications: Models 6256B, 6263B, 6264B, 6265B, 6266B, 6267B, 6271B, and 6274B (continued).

<p>PANEL METERS: The accuracy of the front panel voltmeter and ammeter is $\pm 2\%$ of full scale. The ranges of these meters are:</p> <table border="0"> <tr> <td>Model 6256B 12V, 24A</td> <td>Model 6266B 50V, 6A</td> </tr> <tr> <td>6263B 24V, 12A</td> <td>6267B 50V, 12A</td> </tr> <tr> <td>6264B 24V, 24A</td> <td>6271B 70V, 4A</td> </tr> <tr> <td>6265B 50V, 4A</td> <td>6274B 70V, 18A</td> </tr> </table> <p>TEMPERATURE RATINGS: Operating 0 to 55°C Storage -40 to +75°C</p> <p>COOLING: Convection cooling is used except in the Model 6274B, which is forced air cooled by a single fan.</p> <p>OPTIONS AVAILABLE: Options 005, 007, 008, 009, 010, 013, 014, 020, 021, 022, 027, 028, and 040. (See paragraph 1-10 for descriptions.)</p>	Model 6256B 12V, 24A	Model 6266B 50V, 6A	6263B 24V, 12A	6267B 50V, 12A	6264B 24V, 24A	6271B 70V, 4A	6265B 50V, 4A	6274B 70V, 18A	<p>INPUT POWER CONNECTIONS: In the Models 6256B, 6264B, 6267B, and 6274B, input power is connected by way of a 3-terminal barrier strip on the rear panel. The Models 6263B, 6265B, 6266B, and 6271B are equipped with a 5-foot 3-wire line cord.</p> <p>DIMENSIONS: (See Figure 2-1 outline diagrams.)</p> <p>WEIGHT:</p> <table border="0"> <thead> <tr> <th style="text-align: left;"><u>Model</u></th> <th style="text-align: left;"><u>Net</u></th> <th style="text-align: left;"><u>Shipping</u></th> </tr> </thead> <tbody> <tr> <td>6256B</td> <td>35 lbs (15.8kg)</td> <td>40 lbs (18.1kg)</td> </tr> <tr> <td>6263B</td> <td>34 lbs (15.4kg)</td> <td>41 lbs (18.6kg)</td> </tr> <tr> <td>6264B</td> <td>47 lbs (21.3kg)</td> <td>54 lbs (24.5kg)</td> </tr> <tr> <td>6265B</td> <td>34 lbs (15.4kg)</td> <td>41 lbs (18.6kg)</td> </tr> <tr> <td>6266B</td> <td>34 lbs (15.4kg)</td> <td>41 lbs (18.6kg)</td> </tr> <tr> <td>6267B</td> <td>39 lbs (17.7kg)</td> <td>46 lbs (20.8kg)</td> </tr> <tr> <td>6271B</td> <td>34 lbs (15.4kg)</td> <td>41 lbs (18.6kg)</td> </tr> <tr> <td>6274B</td> <td>48 lbs (21.7kg)</td> <td>54 lbs (24.5kg)</td> </tr> </tbody> </table>	<u>Model</u>	<u>Net</u>	<u>Shipping</u>	6256B	35 lbs (15.8kg)	40 lbs (18.1kg)	6263B	34 lbs (15.4kg)	41 lbs (18.6kg)	6264B	47 lbs (21.3kg)	54 lbs (24.5kg)	6265B	34 lbs (15.4kg)	41 lbs (18.6kg)	6266B	34 lbs (15.4kg)	41 lbs (18.6kg)	6267B	39 lbs (17.7kg)	46 lbs (20.8kg)	6271B	34 lbs (15.4kg)	41 lbs (18.6kg)	6274B	48 lbs (21.7kg)	54 lbs (24.5kg)
Model 6256B 12V, 24A	Model 6266B 50V, 6A																																			
6263B 24V, 12A	6267B 50V, 12A																																			
6264B 24V, 24A	6271B 70V, 4A																																			
6265B 50V, 4A	6274B 70V, 18A																																			
<u>Model</u>	<u>Net</u>	<u>Shipping</u>																																		
6256B	35 lbs (15.8kg)	40 lbs (18.1kg)																																		
6263B	34 lbs (15.4kg)	41 lbs (18.6kg)																																		
6264B	47 lbs (21.3kg)	54 lbs (24.5kg)																																		
6265B	34 lbs (15.4kg)	41 lbs (18.6kg)																																		
6266B	34 lbs (15.4kg)	41 lbs (18.6kg)																																		
6267B	39 lbs (17.7kg)	46 lbs (20.8kg)																																		
6271B	34 lbs (15.4kg)	41 lbs (18.6kg)																																		
6274B	48 lbs (21.7kg)	54 lbs (24.5kg)																																		

SECTION II INSTALLATION

2-1 INITIAL INSPECTION

2-2 Before shipment, this instrument was inspected and found to be free of mechanical and electrical defects. As soon as the instrument is unpacked, inspect for any damage that may have occurred in transit. Save all packing materials until the inspection is completed. If damage is found, file a claim with the carrier immediately. The Hewlett-Packard Sales and Service office should be notified as soon as possible.

2-3 Mechanical Check

2-4 This check should confirm that there are no broken knobs or connectors, that the cabinet and panel surfaces are free of dents and scratches, and that the meter is not scratched or cracked.

2-5 Electrical Check

2-6 The instrument should be checked against its electrical specifications. Section V includes an "in-cabinet" performance check to verify proper instrument operation.

2-7 INSTALLATION DATA

2-8 The instrument is shipped ready for permanent rack installation or bench operation. It is necessary only to connect the instrument to a source of power and it is ready for use.

2-9 Location and Cooling

2-10 The Model 6274B is fan-cooled; the other models are cooled by convection. The Model 6274B must be installed with sufficient space for cooling air to reach the sides and rear of the instrument. The other models require a free flow of air past the cooling fins on the rear panel only. These power supplies should be used in an area where the ambient temperature does not exceed 55°C.

2-11 Outline Diagram

2-12 Figure 2-1 shows the outline shape and dimensions of these supplies.

2-13 Rack Mounting

2-14 This instrument is full rack size and can be easily

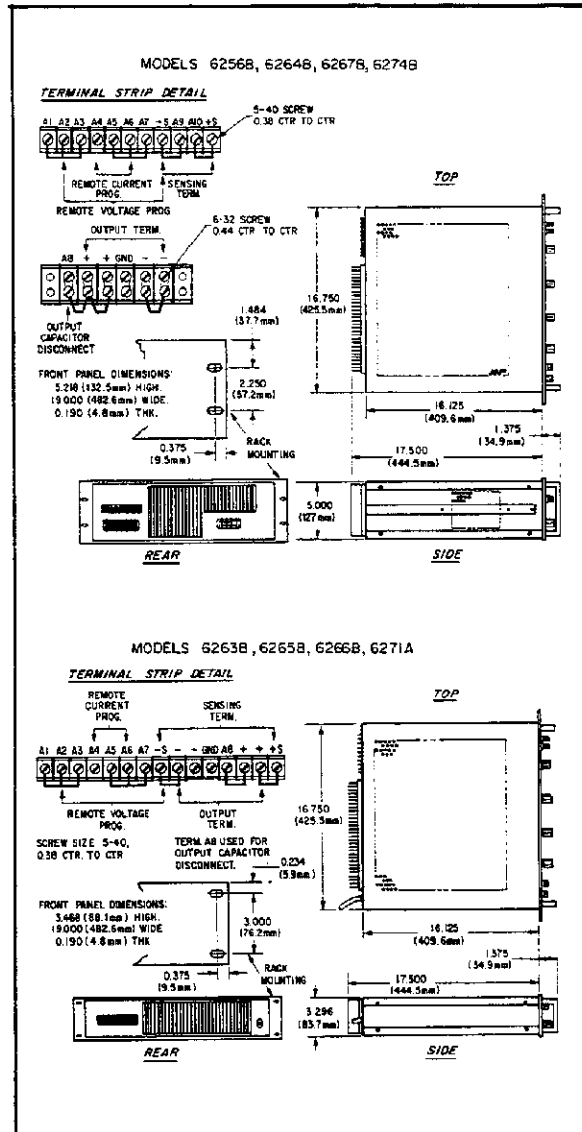

Figure 2-1. Outline Diagrams

rack mounted in a conventional 19-inch rack panel using standard mounting screws.

2-15 INPUT POWER REQUIREMENTS

2-16 The standard instrument as shipped from the factory is wired for a nominal input of 115Vac 57-63Hz. Instruments with special options also available from the

factory include some equipped for 208-volt or 230-volt operation (Option 027 or 028) and for 50Hz operation (Option 005). The required input voltage and frequency is marked on the rear panel of the supply. The standard instrument can also be converted by the user to 208-volt or 230-volt and to 50Hz operation by following the instructions given in the following paragraphs. The standard instrument requires the input current and power listed below when operated at full load from a 115-volt source. When the supply is operated from a 208-volt or 230-volt source, the input current is approximately half the amount listed.

<u>Model</u>	<u>Input Current</u>	<u>Input Power</u>
6256B	5A	375W
6263B	4A	350W
6264B	8A	600W
6265B	3A	180W
6266B	4A	325W
6267B	8A	550W
6271B	4A	300W
6274B	15A	1200W

2-17 INPUT LINE VOLTAGE OR FREQUENCY CONVERSION

2-18 When it is wired for 115-volt operation, this power supply has the two primary windings of each of its two input transformers (T1 and T2) connected in parallel (except for bias transformer T2 in the Model 6274B, which has a single multi-tapped primary). The two windings of the pre-regulator choke (A2L1A and A2L1B) are also connected in parallel. Conversion of the supply to 208-volt or 230-volt operation involves connecting these windings in series, replacing the fuses (except in the Model 6274B), and replacing the pilot light resistor. Complete line voltage conversion instructions are given in paragraphs 2-20 and 2-22.

2-19 Converting a 60Hz instrument to 50Hz operation involves replacing several resistors and making some adjustments. Line frequency conversion instructions are given in paragraph 2-25.

2-20 Converting A Standard Instrument To 208-Volt Operation

2-21 To convert a 115-volt instrument to 208-volt operation, proceed as follows:

- Disconnect instrument from power source and remove top and bottom covers and A2 RFI Assembly cover.
- Replace pilot light resistor R40 (mounted on rear of pilot light DS1 on front panel) with a 120k Ω 5% 1/2W resistor. (HP Part No. 0686-1245.)

- Remove jumpers J1, J2, and J4 from the A2 RFI Assembly circuit board and install a jumper in the position marked "J3".
- Remove the jumpers from power transformer T1 that connect terminals 1 with 3 and 2 with 5, and install a jumper between terminals 2 and 3. (See Figure 2-2B.)
- Disconnect T1 input lead from terminal 5 and connect it to terminal 4. (See Figure 2-2B.)
- (Model 6274B only) Disconnect input lead from the "115V" tap on bias transformer T2 and connect it instead to the "208V" tap. Leave cooling fan B1 connected to the "115V" tap. (See Figure 2-3B.)
- (Models 6256B through 6271B only) Remove the jumpers from bias transformer T2 that connect terminals 1 with 3 and 2 with 5, and install a jumper between terminals 2 and 3. (See Figure 2-2B.)
- (Models 6256B through 6271B only) Disconnect T2 input lead from terminal 5 and connect it to terminal 4. (See Figure 2-2B.)
- (Models 6256B through 6271B only) Replace bias fuse F2 with a 1/16A slo-blo fuse (HP Part No. 2110-0311).
- (Models 6256B through 6271B only) Replace line fuse F1 with a fuse of the rating listed below.

<u>Model</u>	<u>Rating</u>	<u>HP Part No.</u>
6256B	5A 250V	2110-0227
6263B, 6266B, 6271B	3A 250V	2110-0003
6264B, 6267B	6A 250V	2110-0056
6265B	2A 250V	2110-0002

2-22 Converting A Standard Instrument To 230-Volt Operation

2-23 **Models 6256B Through 6271B.** To convert any of these models from 115-volt operation to 230-volt operation, follow the instructions given in paragraph 2-21, but omit steps (e) and (g). (Leave the input leads to T1 and T2 on terminal 5. See Figure 2-2C.)

2-24 **Model 6274B.** To convert the Model 6274B from 115-volt operation to 230-volt operation, follow the instructions given in paragraph 2-21, but omit step (e) and change step (f) as follows: connect the T2 input lead to the "230V" tap instead of the "208V" tap. (See Figures 2-2C and 2-3C.)

2-25 Converting A Standard Instrument To 50Hz Operation

2-26 To convert a 60Hz instrument to 50Hz operation, proceed as follows:

- Replace R74, R76, R78, and R79 if new values are listed below. HP Part Numbers for these resistors may be found on page 6-16 of the parts list.

Model	R74	R76	R78	R79
6256B	--	150k Ω	750 Ω	--
6263B	--	200k Ω	270 Ω	4.7k Ω
6264B	--	200k Ω	270 Ω	4.7k Ω
6265B	--	300k Ω	270 Ω	4.7k Ω
6266B	8.2k Ω	150k Ω	270 Ω	4.7k Ω
6267B	--	750k Ω	270 Ω	4.7k Ω
6271B	--	360k Ω	270 Ω	4.7k Ω
6274B	--	430k Ω	270 Ω	--

b. After replacing the necessary resistors, perform the preregulator tracking adjustment procedure given in paragraph 5-86.

c. Check the ripple balance adjustment by the procedure given in paragraph 5-84.

2-27 POWER CABLE

2-28 To protect operating personnel, the National

Electrical Manufacturers Association (NEMA) recommends that the instrument panel and cabinet be grounded. Model 6263B, 6265B, 6266B, and 6271B power supplies are equipped with a three conductor power cable. When the cable is plugged into an appropriate receptacle, the instrument is grounded through the offset pin on its three-prong connector. In no event shall this instrument be operated without an adequate cabinet ground connection. To preserve the protection feature when operating the instrument from a two-contact outlet, use a three-prong to two-prong adapter (if permitted by local regulations) and connect the green lead on the adapter to ground.

2-29 Model 6263B, 6265B, 6266B, and 6271B supplies are equipped at the factory with a power cord plug appropriate for the user's location. Figure 2-4 illustrates the standard configurations of power cord plugs used by HP. Above each drawing is the HP option number for that configuration of power connector pins. Below each drawing

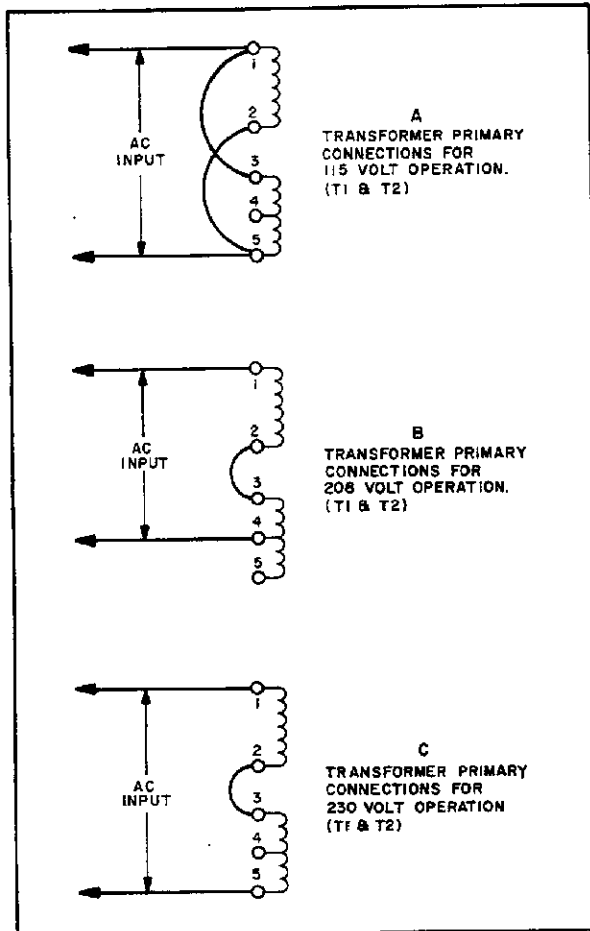

Figure 2-2. Transformer T1 and T2 Primary Connections for 208V and 230V Operation (except T2 in Model 6274B)

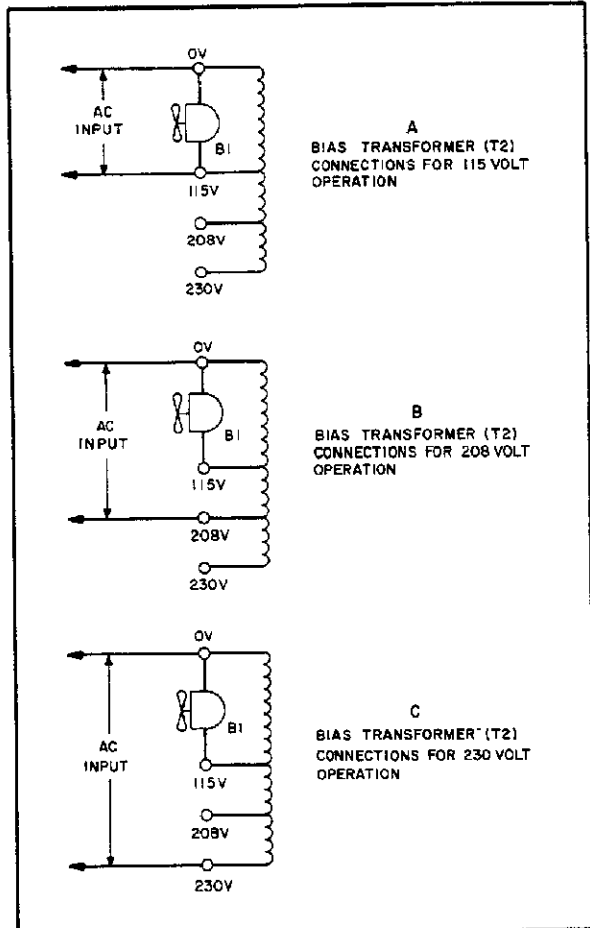

Figure 2-3. Bias Transformer T2 Primary Connections for 208V and 230V Operation (Model 6274B only)

is the HP part number for a replacement power cord equipped with a plug of that configuration. Notify the nearest HP Sales and Service Office if the appropriate power cord is not included with the instrument.

2-30 No power cable is supplied with Model 6256B, 6264B, 6267B, or 6274B power supplies. It is recommended that the user-supplied power cable have three conductors (with the third conductor grounded) and be of adequate wire size to handle the input current drawn by the supply (see paragraph 2-15). Note that when the supply is operated from a 208-volt or 230-volt source, the input current is approximately half that shown in paragraph 2-15.

2-31 REPACKAGING FOR SHIPMENT

2-32 To insure safe shipment of the instrument, it is recommended that the package designed for the instrument be used. The original packaging material is reusable. If it is not available, contact your local Hewlett-Packard field office to obtain the materials. This office will also furnish the address of the nearest service

office to which the instrument can be shipped and provide the Authorized Return label necessary to expedite the handling of your instrument return. Be sure to attach a tag to the instrument which specifies the owner, model number, full serial number, and service required, or a brief description of the trouble.

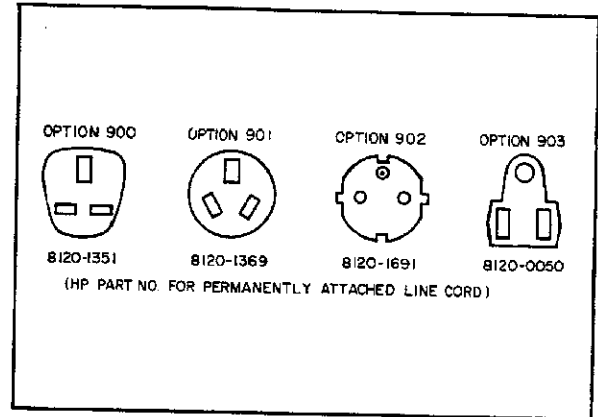

Figure 2-4. Power Cord Configurations

SECTION III OPERATING INSTRUCTIONS

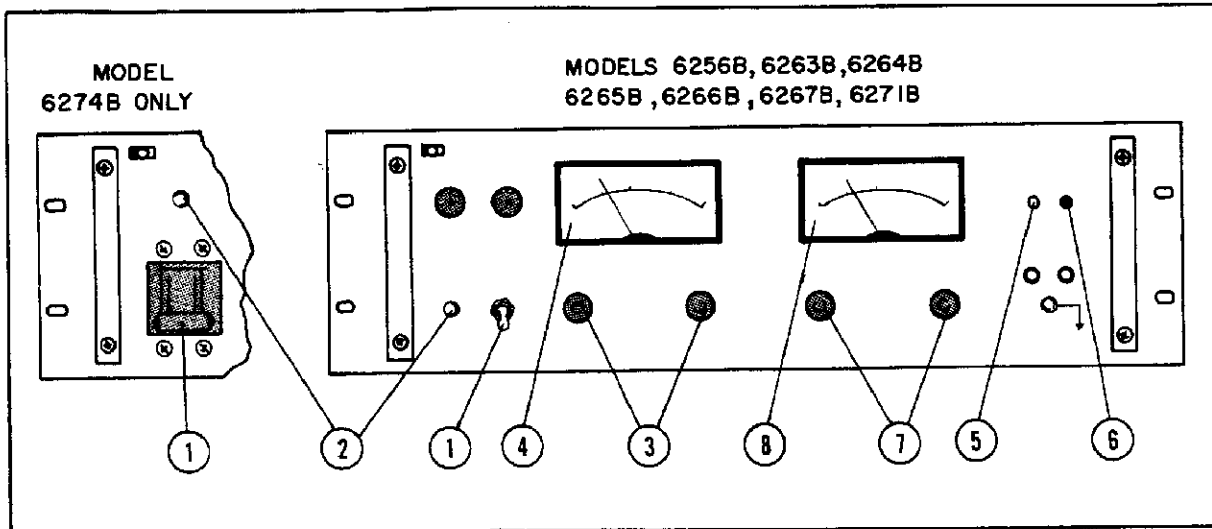

Figure 3-1. Front Panel Controls and Indicators

3-1 TURN-ON CHECKOUT PROCEDURE

3-2 The following steps describe the use of the front panel controls and indicators illustrated in Figure 3-1 and serve as a brief check that the supply is operational. This checkout procedure or the more detailed performance test of paragraph 5-5 should be followed when the instrument is received and before it is connected to any load equipment. Proceed to the more detailed test and troubleshooting procedures in Section V if any difficulties are encountered.

a. Turn CURRENT controls ⑦ and OVERVOLTAGE ADJUST potentiometer ⑤ fully clockwise and check that rear panel straps are connected as shown in Figure 3-2, but do not connect load R_L .

— CAUTION —

Do not energize a Model 6256B, 6264B, 6267B, or 6274B supply unless the jumpers are installed that connect together the two (+) terminals and the two (-) terminals.

b. Plug in line cord (Models 6263B, 6265B, 6266B, 6271B) or connect ac power of the appropriate voltage and frequency to the rear panel ac and acc terminals (Models

6256B, 6264B, 6267B, 6274B). The supply's input rating is identified on its rear panel.

— CAUTION —

Do not interchange the ac and acc input lines; connect the ac input terminal to the hot side and the acc input terminal to the grounded side of the ac line. Do not fail to connect the input ground terminal (⊥) securely to an external earth ground.

c. Set LINE switch or circuit breaker ① ON and observe that pilot lamp ② lights.

d. Adjust COARSE and FINE VOLTAGE controls ③ for desired indication on voltmeter ④

e. Ensure that overvoltage crowbar circuit is operational by slowly turning OVERVOLTAGE ADJUST control ⑤ counterclockwise with a screwdriver until OVERVOLTAGE lamp ⑥ lights and voltmeter indication drops to zero volts.

f. Reset crowbar by returning OVERVOLTAGE ADJUST control to its maximum clockwise position and turning off the supply. On turning the supply back on, the voltage should be the same value as was set in step (d).

g. To check the constant current circuit, first turn off the supply, connect a short across the rear panel output

terminals (see Figure 3-2), and turn it back on.

NOTE

The front panel MONITORING TERMINALS are intended only for monitoring the supply's output. They cannot be used for measuring the supply's performance specifications. These terminals have a 3-amp current limitation.

- h. Adjust COARSE and FINE CURRENT controls ⑦ until ammeter ⑧ indicates desired output current or current limit. (The VOLTAGE controls must be set for a greater-than-zero output to obtain the output current programmed.)
- i. Turn off the supply, remove the short from its output, and read the remainder of these operating instructions before connecting the supply to an actual load.

3-3 OPERATING MODES

3-4 This power supply is designed so that its mode of operation can be selected by making strapping connections between terminals on its rear panel. The following paragraphs first describe normal operation using the normal strapping pattern as it is connected at the factory. Later paragraphs cover some optional operating modes including remote voltage sensing, remote programming, and some methods of operating these power supplies in combinations of two or three.

3-5 The DC Power Supply Handbook, Application Note 90A, is a useful source of additional information on using regulated power supplies effectively. This 138-page handbook includes chapters on operating principles, ac and load connections, optional operating modes, and performance measurements and is available at no charge from your local HP sales office. The address of your local sales office can be found in the back of this manual.

3-6 NORMAL OPERATING MODE

3-7 This power supply was shipped with the proper rear panel strapping connections made for constant-voltage/constant-current operation with local sensing and local programming. This strapping pattern is illustrated in Figure 3-2. By means of the front panel voltage and current controls, the operator selects either a constant-voltage or a constant-current output. Whether the supply functions in the constant-voltage or the constant-current mode depends on the settings of the voltage and current controls and on the resistance of the output load. For values of load resistance greater than a critical crossover value equal to the voltage setting divided by the current setting, the supply

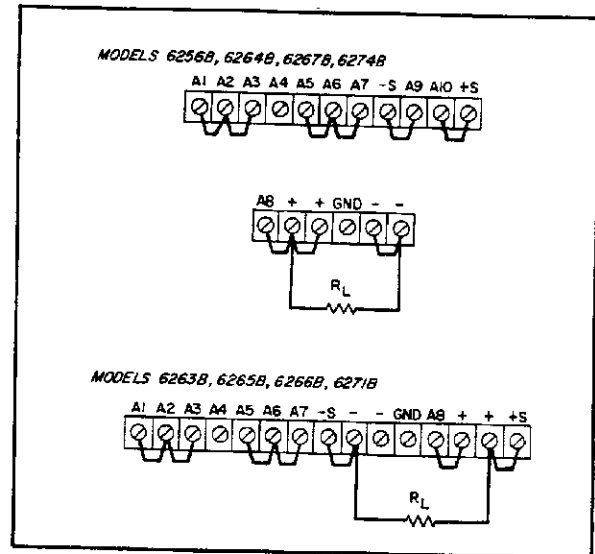

Figure 3-2. Normal Strapping Patterns

operates in the constant-voltage mode. With a load resistance smaller than this critical value, it operates in the constant-current mode. The transition occurs automatically; no switches need to be operated or connections changed.

3-8 Constant Voltage Operation

3-9 To adjust the supply for constant voltage operation:

- a. Turn on supply and, with output terminals open, adjust the VOLTAGE controls for the desired output voltage.
- b. Connect a short across the rear panel output terminals and adjust the CURRENT controls for the desired maximum output current. If a load change causes this current limit to be exceeded, the supply automatically crosses over to constant current operation at this preset current limit and the output voltage drops proportionately. In setting the current limit, make an adequate allowance for high peak currents that could cause unwanted crossover. (Refer to paragraph 3-69.)

3-10 Constant Current Operation

3-11 To adjust the supply for constant current operation:

- a. Connect a short across the rear output terminals and adjust the CURRENT controls for the desired output current.
- b. Open the output terminals and adjust the VOLTAGE controls for the desired maximum output voltage. If a load change causes this voltage limit to be exceeded, the supply automatically crosses over to constant voltage operation at this preset voltage limit and the output current drops

proportionately. In setting the voltage limit, make an adequate allowance for high peak voltages that could cause unwanted crossover. (Refer to paragraph 3-69.)

3-12 Overvoltage Trip Point Adjustment

3-13 The crowbar trip voltage is adjusted by using the screwdriver control on the front panel. The approximate trip voltage ranges are listed in Table 1-1. When the crowbar trips, an SCR shorts the output and the amber OVER-VOLTAGE indicator on the front panel lights. Rotating the control clockwise sets the trip voltage higher. (It is set to maximum at the factory.) Paragraph 5-92 contains instructions for completely disabling the crowbar, if this is desired.

3-14 When adjusting the crowbar trip point, the possibility of false tripping must be considered. If the trip voltage is set too close to the supply's operating voltage, a transient in the output would falsely trip the crowbar. For this reason it is recommended that the crowbar be set higher than the output voltage by 7% of the output voltage plus one volt.

3-15 Connecting The Load

3-16 To satisfy the requirements of safety, the wires to the load should be at least heavy enough not to overheat while carrying the power supply current that would flow if the load were shorted. Generally heavier wire than this is required to obtain good regulation at the load. If the load regulation is critical, use remote voltage sensing. (Refer to paragraph 3-25.)

3-17 If multiple loads are connected to one supply, each load should be connected to the supply's output terminals using separate pairs of connecting wires. This minimizes mutual coupling effects between loads and takes full advantage of the supply's low output impedance. Each pair of connecting wires should be as short as possible and twisted or shielded to reduce noise pickup.

3-18 If load considerations require the use of output distribution terminals that are located remotely from the supply, then the power supply output terminals should be connected to the remote distribution terminals by a pair of twisted or shielded wires and each load should be separately connected to the remote distribution terminals. Remote voltage sensing would be required under these circumstances. (Refer to paragraph 3-25.)

3-19 Either positive or negative voltages can be obtained from this supply by grounding one of the output terminals or one end of the load. Always use two wires to connect the load to the supply regardless of where or how the system is grounded. Never ground the system at more than

one point. This supply can be operated up to 300 volts above ground if neither output terminal is grounded.

3-20 Operation Beyond Rated Output

3-21 The supply may be able to provide voltages and currents greater than its rated maximum outputs. Operation can extend into the shaded areas on the meter faces without damage to the supply, but performance cannot be guaranteed to meet all specifications.

3-22 OPTIONAL OPERATING MODES

3-23 The optional operating modes discussed in the following paragraphs include:

- a. Remote voltage sensing
- b. Remote programming
- c. Auto-Parallel operation
- d. Auto-Series operation
- e. Auto-Tracking operation

Special operating instructions for instruments equipped with Option 040 to permit their interfacing with a Model 6940B Multiprogrammer or a 6941B Multiprogrammer Extender are not included but can be found in the manual covering the programmable resistance cards that are necessary to complete the interface. Special calibration instructions for power supplies equipped with Option 040 are included in Section V of this manual.

3-24 By changing its rear panel strapping pattern according to the instructions which follow, any of the

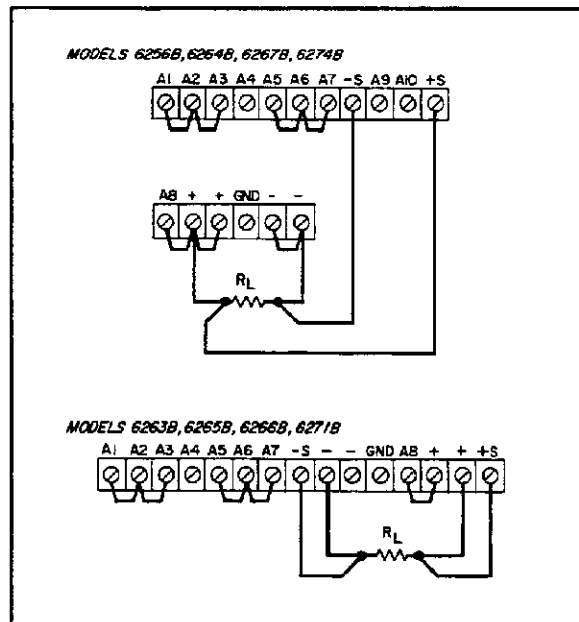

Figure 3-3. Remote Sensing

supplies covered by this manual can be operated in any of the modes listed above.

— CAUTION —

Disconnect input ac power before changing any rear panel connections and make certain all wires and straps are properly connected and terminal strip screws are securely tightened before reapplying power.

3-25 Remote Voltage Sensing

3-26 Because of the unavoidable voltage drop developed in the load leads, the normal strapping pattern shown in Figure 3-2 will not provide the best possible voltage regulation at the load. If, for example, one were to use 8-gauge wire to connect a load that is located only 5 feet from a Model 6256B 10V 20A supply, the regulation measured at the load would be about 120 millivolts as compared to the 1.2 millivolt regulation that could be measured at the supply's output terminals. Thus even relatively short load leads can cause a considerable degradation of the supply's performance. The remote sensing connections shown in Figure 3-3 improve the voltage regulation at the load by monitoring the voltage there instead of at the supply's output terminals. (The advantages of remote sensing apply only during constant voltage operation. This is because in the constant current mode the resistance of the load leads has no adverse effect on a supply's performance.)

3-27 As can be seen in Figure 3-3, remote sensing involves removing the (+S) and (-S) jumpers from the rear panel terminals, connecting the load leads normally, and using a separate pair of wires to connect the (+S) and (-S) sensing terminals to the load. The following paragraphs discuss some precautions that should be observed when making a remote sensing installation.

NOTE

The (+S) jumper is the one that links the (+S) terminal to the (+OUT) or (A10) terminal when the supply's terminals are strapped for normal operation as shown in Figure 3-2. The (-S) jumper is the one that links the (-S) terminal to the (-OUT) or (A9) terminal.

3-28 The load leads should be of the heaviest practicable wire gauge, at least heavy enough to limit the voltage drop in each lead to one volt. This limitation is dictated by the adverse effect that a greater load lead voltage drop has on bias voltages within the supply when remote sensing is used. Twisting the load leads may help to minimize noise pick-up.

While there are practical limitations on the distance that separates a power supply from its load when using remote sensing, it isn't possible to define these limits precisely due to a variety of factors that are unique to each particular installation.

3-29 Since the sensing leads carry only a few milliamps, the wires used for sensing can be much lighter than the load leads (22 AWG is generally adequate), but they should be a shielded, twisted pair to minimize the pickup of external noise. Any noise picked up on the sensing leads will appear at the supply's output. The shield should be grounded at one end only and should not be used as one of the sensing conductors. The sensing leads should be connected as close to the load as possible.

3-30 The sensing leads are part of the supply's programming circuit, so they should be connected in such a way as to make it unlikely that they might inadvertently become open circuited. If the sensing leads were to open during operation, the output voltage would tend to rise. Although the increase would be limited by protective resistors R58 and R59, damage to the supply or to the load might occur if the loss of sensing were accompanied by a load transient. For this reason no switch, relay, or connector contacts should be included in the remote sensing path.

— CAUTION —

When using remote voltage sensing, it is possible to damage the supply by disconnecting a load lead while the sensing lead is still connected and the supply is energized. If a load lead becomes disconnected, current flows through internal protection resistors R58 and R59, the sensing leads, and the load and may burn out the resistors. Additional factors could compound the damage caused by an opened load lead. If the output of the supply is connected to an inductive load or a battery, or is connected in parallel with another supply, then opening a load lead would allow current from the external source to flow through the sensing leads and damage the supply's input circuits. If the crowbar fires, the damage could even be greater.*

For these reasons, if there is any risk of an opened load circuit while remote sensing is used, 1/16-amp fuses should be installed in both sensing leads. Fuses in the sensing leads will not affect the performance of the supply and should protect against costly damage.

**Remote sensing is not recommended when charging or discharging a battery. See paragraphs 3-79 and 3-83.*

3-31 Another factor to be considered when making a remote sensing installation is the inductance of the long load leads. Although dc and low frequency performance are improved by remote sensing, the higher inductance of longer leads does impair transient response and could affect the stability of the feedback loop seriously enough to cause oscillation. Disconnecting the supply's output capacitor and connecting a similar capacitor directly across the load helps to overcome these problems. Disconnect output capacitor C20 by removing the rear panel jumper from between terminals (+) and (A8) and connect another capacitor having approximately the same capacitance, an equal or greater voltage rating, and good high frequency characteristics across the load using short leads. It may also be beneficial to readjust transient recovery control R30 located on the main circuit board.

3-32 Remote Programming

3-33 The output voltage or current of these power supplies can be remotely controlled by connecting an external resistor or applying an external voltage to rear panel terminals. If resistance programming is used, a variable resistor can control the output over its entire range, or, by being connected in series with a fixed resistor, can have its control restricted to a limited portion of the output range. Alternately, a switch can be used to select fixed values of programming resistance to obtain a set of discrete voltages or currents. (The switch must have make-

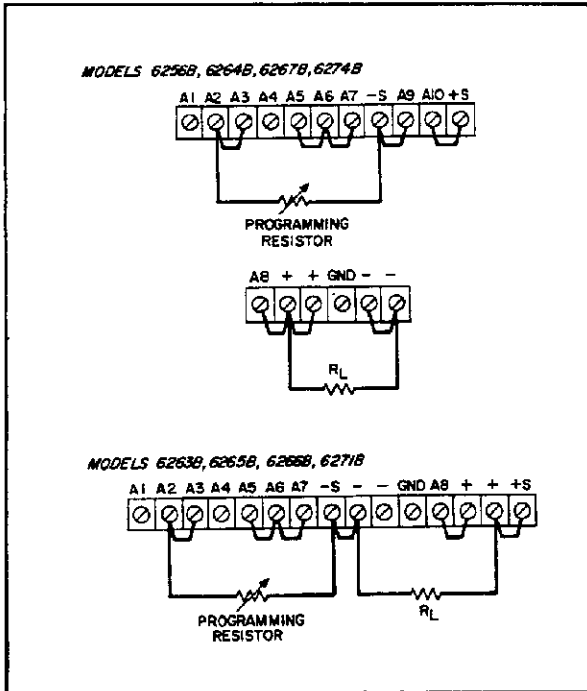

Figure 3-4. Resistance Programming of Output Voltage

before-break contacts to avoid producing the output voltage transients that momentarily opening the programming terminals would cause.) To maintain the temperature and stability specifications of the supply, programming resistors must be stable, low noise resistors with a temperature coefficient of less than 30ppm per °C and a power rating at least 30 times what they will actually dissipate.

3-34 Both voltage and current outputs can also be controlled through a voltage input. When voltage programming the output voltage, the choice can be made between using a connection that produces a unity gain relationship between input and output or another connection that produces variable voltage gains. (Only the unity gain connection is included in this manual, but methods of voltage programming that provide gains greater or less than unity are discussed in Application Note 90A, which is described in paragraph 3-5.)

3-35 Connecting a supply for remote voltage or current programming disables the corresponding front panel controls.

3-36 The following paragraphs discuss in greater detail the methods of remotely programming the output voltage or current using either a resistance or a voltage input.

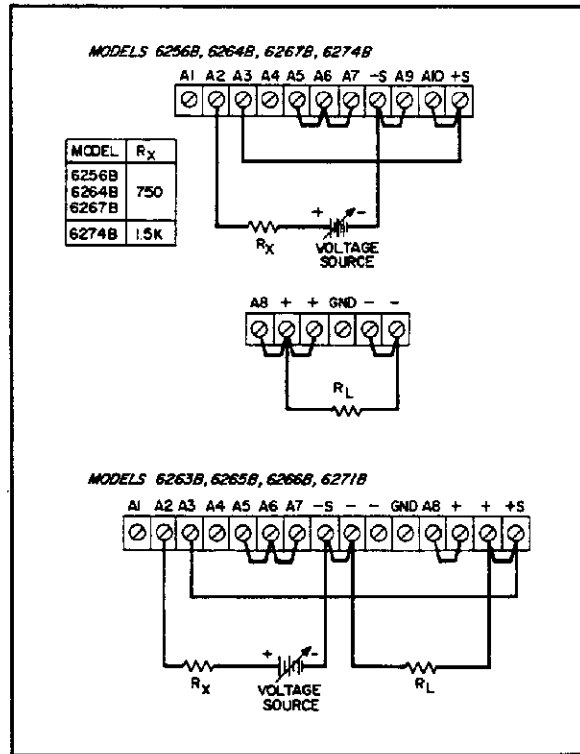

Figure 3-5. Voltage Programming of Output Voltage (Unity Gain)

Whichever method is used, the wires connecting the programming terminals of the supply to the remote programming device must be shielded to reduce noise pickup. The outer shield of the cable should not be used as a conductor but should be connected to ground at one end only.

3-37 Constant Voltage Output, Resistance Input. The rear panel connections shown in Figure 3-4 allow the output voltage to be varied by using an external resistor to program the supply. The supply's constant voltage programming current determines its programming coefficient. In the Models 6256B, 6263B, 6264B, 6265B, 6266B, and 6267B, this programming current is factory adjusted to within 1% of 5mA, resulting in a programming coefficient of 200 ohms per volt. In the Models 6271B and 6274B, a programming current of 3.33mA \pm 1% produces a programming coefficient of 300 ohms per volt. If a greater programming accuracy is required, it can be obtained either by changing resistor R13 as discussed in paragraph 5-74 or, if the instrument is equipped with Options 020 or 022, by adjusting potentiometer R122 as discussed in paragraph 5-75.

3-38 With the programming terminals shorted (terminals A2 to -S), the no-load output voltage of the supply should be $-10\text{mV} \pm 5\text{mV}$. If a minimum output voltage is required that is closer to zero than this, it can be obtained either by changing resistor R6 or R8 as discussed in paragraph 5-71 or, if the instrument is equipped with Option 020 or 022, by adjusting potentiometer R124 as discussed in paragraph 5-72.

— CAUTION —

Do not allow programming terminals (A2) and (-S) to become open circuited while resistance programming the output voltage. If they do become open circuited, the supply's output voltage tends to rise beyond its rated maximum. If the supply's current controls and overvoltage crowbar trip point are properly adjusted, however, no damage to the power supply or load should result.

3-39 Constant Voltage Output, Voltage Input. The rear panel connections shown in Figure 3-5 allow the output voltage to be varied by using an external voltage source to program the supply. In this mode, the output voltage varies in a 1 to 1 ratio with the programming voltage. The load on the programming voltage source is less than 20 microamperes. Impedance matching resistor R_X is required to maintain the temperature coefficient and stability specifications of the supply.

3-40 Constant Current Output, Resistance Input. The rear panel connections shown in Figure 3-6 allow the output

current to be varied by using an external resistor to program the supply. The supply's constant current programming current, which is factory adjusted to 0.5mA \pm 10%, determine the exact value of its programming coefficient. The programming coefficients for the supplies included in this manual are as follows:

Models 6256B, 6264B	10 ohms/ampere
6263B, 6267B	100 ohms/ampere
6265B, 6271B	300 ohms/ampere
6266B	200 ohms/ampere
6274B	67 ohms/ampere

If the \pm 10% accuracy of these coefficients is not adequate, they may be adjusted either by changing resistor R19 as discussed in paragraph 5-80 or, if the instrument is equipped with Option 021 or 022, by adjusting potentiometer R126 as discussed in paragraph 5-81.

3-41 With zero ohms placed across the programming terminals, the output current of the supply may be set to exactly zero either by changing resistors R25 and R28 as described in paragraph 5-78 or, if the instrument is equipped with Option 021 or 022, by adjusting potentiometer R128 as discussed in paragraph 5-79.

— CAUTION —

Do not allow programming terminals (A4) and (A6) to become open-circuited while resistance programming the output current. If they do open, the supply's output current rises to a value that may damage the supply or the load. If in the particular programming configuration used there is a chance that the terminals might open, we suggest that a resistor of the following value be connected across the programming terminals:

Models 6256B, 6264B	200 ohms
6263B, 6266B	1000 ohms
6267B, 6274B	1000 ohms
6265B, 6271B	900 ohms

Of course, when this resistor is used, the resistance value actually programming the supply is the parallel combination of the remote programming resistance and the resistor across the programming terminals. Like the programming resistor, this resistor should be a low noise, low temperature coefficient type.

3-42 Constant Current Output, Voltage Input. The rear panel connections shown in Figure 3-7 allow the output current to be varied by using an external voltage source to program the supply. The constant current programming

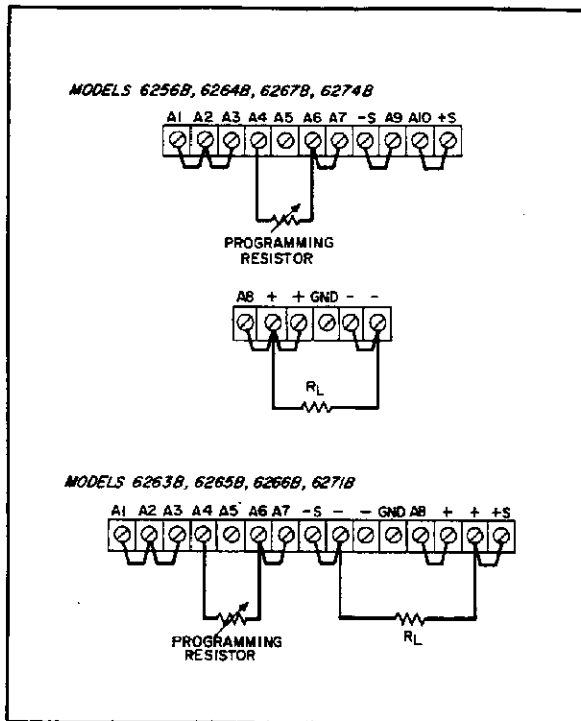

Figure 3-6. Resistance Programming of Output Current

coefficients for the supplies included in this manual are as follows ($\pm 10\%$):

Models 6256B, 6264B	25mV/ampere
6263B, 6267B	50mV/ampere
6265B, 6271B	167mV/ampere
6266B	100mV/ampere
6274B	33.3mV/ampere

The load on the programming voltage source is less than 20 microamperes. The programming voltage required to obtain maximum rated current from these supplies is about 500 millivolts. An input greater than 600mV may damage the instrument through excessive power dissipation. Impedance matching resistor R_X is required to maintain the temperature coefficient and stability specifications of the supply.

3-43 Auto-Parallel Operation

3-44 Use the rear panel and circuit board interconnections shown in Figure 3-8 or 3-9 to auto-parallel two or three supplies. This mode of operation provides a greater current capacity than can be obtained from a single supply while maintaining nearly equal load sharing among the paralleled supplies under all load conditions. Supplies having the same model number make the most practical auto-parallel combinations, but any of the supplies included in this manual that have equal current ratings may be used.

NOTE

Use wires of equal length and gauge to connect each auto-paralleled supply to the load. Load sharing accuracy is affected unless the positive leads connecting each supply to the load are all equal in resistance.

3-45 **Setting the Voltage and Current Controls.** The auto-parallel combination of two or three supplies behaves as if it were a single constant-voltage/constant-current supply controlled by the voltage and current controls of the master supply. The voltage controls of the slave(s) are disabled, but their current controls remain operative and must be set to maximum to prevent a slave supply from independently reverting to constant current operation as would occur if the output current setting of the master supply exceeded that of a slave.

3-46 **Overvoltage Protection in Auto-Parallel.** The interconnections shown in Figures 3-8 and 3-9 between transformer T4 in the master and T4 in the slave(s) must be made to permit the overvoltage crowbar in the master to fire the SCRs in the master and the slave(s) if an overvoltage condition occurs. The circuit board pads to be interconnected are marked "EXT TRIG" and their locations are indicated on the component location diagrams

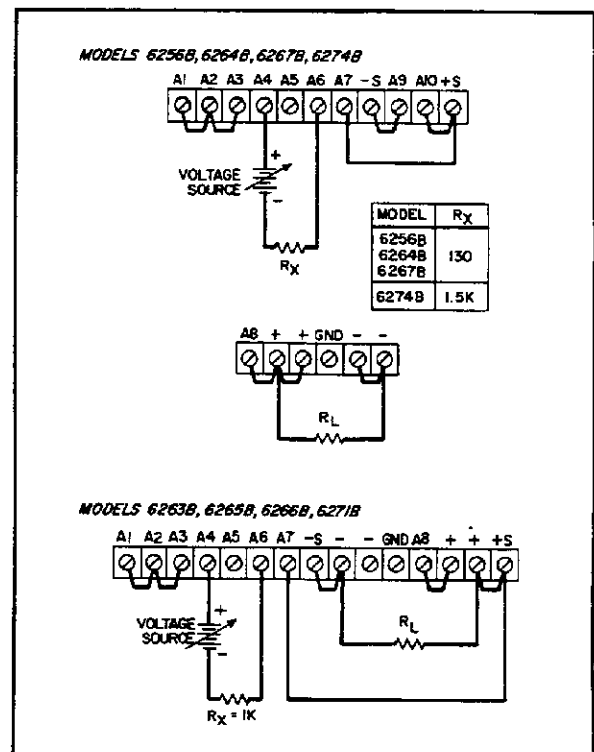

Figure 3-7. Voltage Programming of Output Current

in Section VII. Be sure to connect them with correct polarity, terminal 5 to 5 and 6 to 6. Set the slave supply overvoltage potentiometer(s) to maximum (clockwise) to disable them, and adjust the overvoltage trip point at the master supply.

3-47 Auto-Parallel With Remote Sensing. To combine auto-parallel operation with remote sensing, connect the supplies as described above but remove the (+S) and (-S) jumpers from the master supply and connect the (+S) and (-S) terminals directly to the (+) and (-) ends of the load. Observe the precautions outlined under paragraph 3-25.

3-48 Auto-Parallel With Remote Programming. When two or three supplies are connected in auto-parallel, their combined output voltage, current, or both can also be remotely programmed. Refer to the appropriate sections of paragraph 3-32 for the additional rear panel connections required and make these connections to the master supply only. Observe all precautions outlined in the paragraphs on remote programming. The simultaneous use of remote sensing and remote programming is also possible during auto-parallel operation.

3-49 Auto-Series Operation

3-50 Figures 3-10 and 3-11 show the rear panel and circuit board interconnections required to operate two or three supplies in the auto-series mode. This mode of operation allows two or three series-connected supplies to be simultaneously programmed by the voltage and current controls of a master supply. The master supply must always be the one at the positive end of the series combination. The output voltage of each slave supply varies in direct proportion to that of the master and the ratio of each slave's output voltage to the master's is established by the settings of the slave supplies' voltage controls. The resulting combination of two or three supplies behaves as if it were a single constant-voltage/constant-current supply. The supply with the lowest current rating limits the maximum output current of the combination. Any of the supplies included in this manual can be used as an auto-series slave, and any well-regulated variable output supply can be used as the master.

3-51 In applications where coordinated positive and negative voltages are required, grounding the center tap of an auto-series combination of supplies allows simultaneous proportional control of both supply voltages.

3-52 Determining the Value for R_X . Each slave supply has an external resistor R_X associated with it that supplies its voltage programming current. If the temperature coefficient and stability specifications of the supplies are to be maintained, these must be stable, low noise resistors

with a temperature coefficient of less than 30ppm per °C and a power rating at least 30 times what they will actually dissipate. The proper value for R_X (when using two units in auto-series) or for R_{X1} (for the first slave when using three units) is calculated by first finding the voltage programming current of the slave supply. This is calculated by referring to Table 1-1 for the remote voltage programming resistance control coefficient and taking its reciprocal. For example, the voltage programming current in the Model 6256B is $1 / (200\Omega/V)$ or 5mA. Next, divide this current into the maximum voltage rating of the master supply to determine R_X for the first slave. If our master supply were a zero-to-25-volt unit, for example, R_X or R_{X1} would be $25V/5mA = 5000$ ohms.

3-53 When operating three supplies in auto-series, find R_{X2} by dividing the voltage programming current of the second slave, calculated as in paragraph 3-52, into the maximum voltage expected from the first slave.

3-54 Setting the Voltage Controls. The voltage each slave supply contributes is determined by its voltage control setting. The output voltage of the first slave supply tracks the voltage of the master, and the voltage of the second

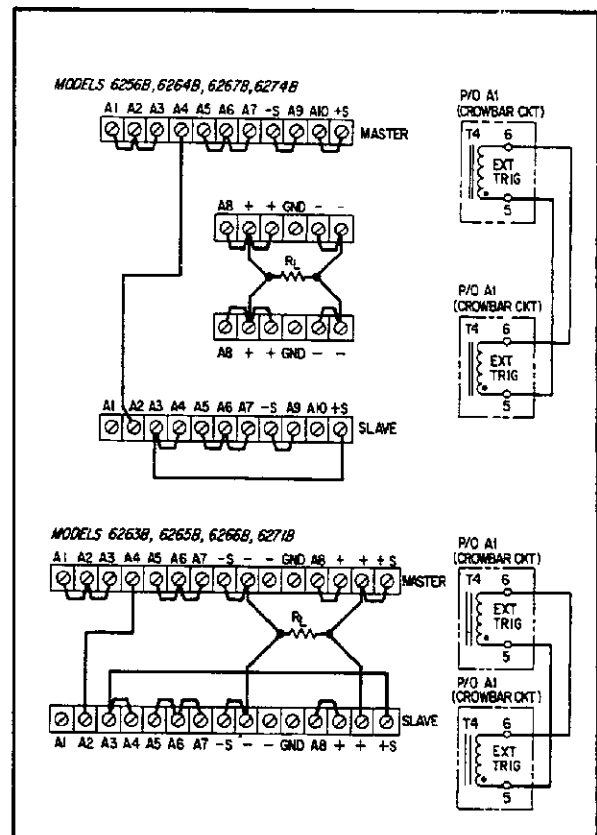

Figure 3-8. Auto-Parallel Operation of Two Units

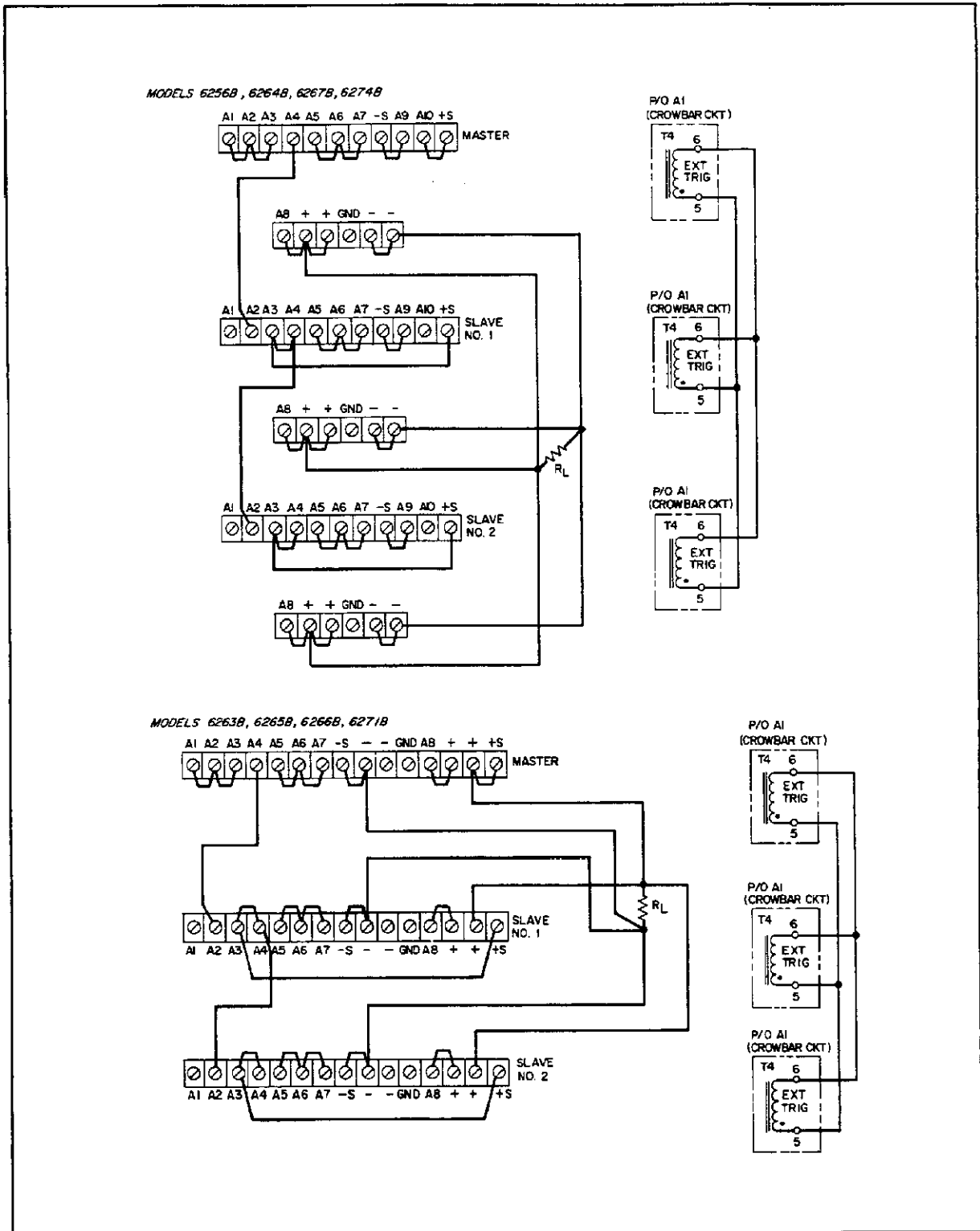

Figure 3-9. Auto-Parallel Operation of Three Units

slave (if used) tracks the voltage of the first slave. For this reason, the voltage of the master must be adjusted to maximum, and then each slave, in turn, must be set to the corresponding voltage desired during initial setup of the auto-series combination. Once this has been done, the total voltage of the combination can be controlled by the voltage controls of the master supply or it can be remotely programmed through the master supply.

3-55 Setting the Current Controls. Auto-series operation leaves the current controls of all supplies operative, but the supply whose current control has the lowest setting determines the point at which automatic crossover to constant current operation begins to lower its output voltage and thus that of the series combination. The constant current circuit of a supply has no effect on the outputs of the supplies connected in a more positive position in the series combination, but it does affect its own output and the outputs of the supplies connected in a more negative position. If the current controls of one of the slave supplies are set the lowest, then an overload or short circuit at the output will cause the master supply (or the master and the first slave) to force current through the reverse voltage protection diodes at the outputs of the downstream slaves. Because this current could be excessive either for the diodes or the load, the current controls of the slave supplies should be set to maximum and the master supply's current controls used to establish the output current or current limit.

3-56 Overvoltage Protection in Auto-Series. The interconnections shown in Figures 3-10 and 3-11 between transformer T4 in the master and T4 in the slave(s) must be made to permit the overvoltage crowbar in any one of the interconnected supplies to fire the SCRs in all of them if an overvoltage condition occurs. The circuit board pads to be interconnected are marked "EXT TRIG" and their locations are indicated on the component location diagrams in Section VII. Be sure to connect them with correct polarity, terminal 5 to 5 and 6 to 6. Set the overvoltage potentiometer in each supply so that it trips at a point slightly above the voltage that supply will contribute.

3-57 Auto-Series With Remote Sensing. To combine auto-series operation with remote sensing, connect the supplies as described above but remove the (+S) jumper from the master supply and the (-S) jumper from the last slave supply and connect the (+S) and (-S) terminals directly to the (+) and (-) ends of the load. Observe the precautions outlined under paragraph 3-25.

3-58 Auto-Series With Remote Programming. When two or three supplies are connected in auto-series, their combined output voltage, current, or both can also be remotely programmed. Refer to the appropriate sections of paragraph 3-32 for the additional rear panel connections

required and make these connections to the master supply only. Observe all precautions outlined in the paragraphs on remote programming. The simultaneous use of remote sensing and remote programming is also possible during auto-series operation.

3-59 Auto-Tracking Operation

3-60 Figures 3-12 and 3-13 show the rear panel interconnections required to operate two or three supplies in the auto-tracking mode. This mode of operation allows two or three supplies that share a common negative output bus to power separate loads and have their outputs simultaneously programmed by the voltage and current controls of a master supply. Unless their outputs are to be equal, the supply that is to have the greatest output voltage must be selected as the master. The output voltage of each slave supply remains a constant percentage of the master's with the percentage for each slave established by that slave's voltage control settings and the choice of its

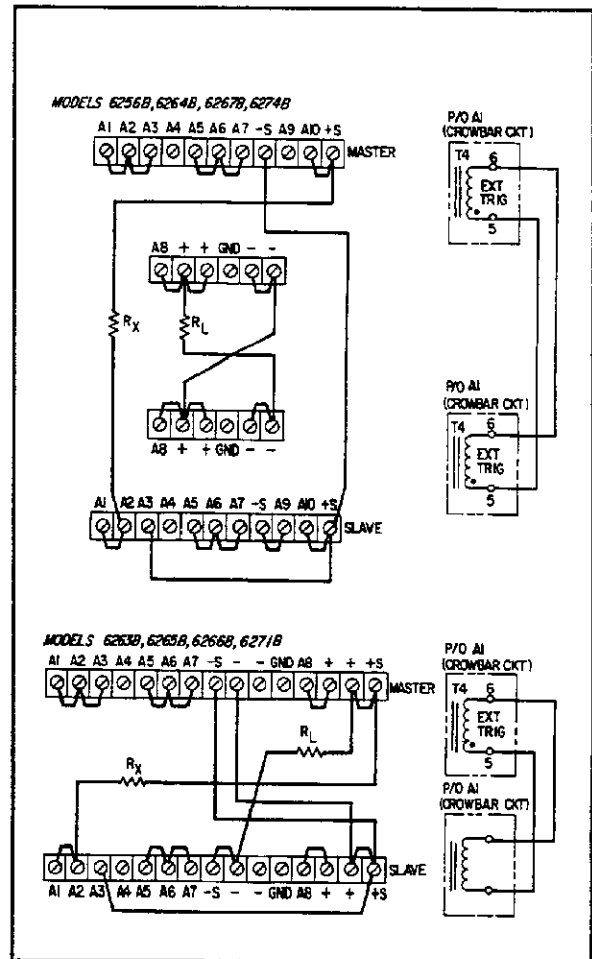
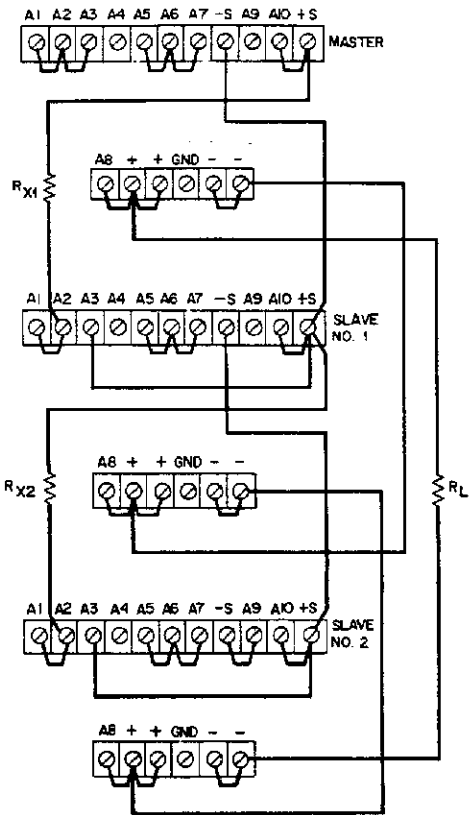
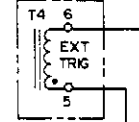

Figure 3-10. Auto-Series Operation of Two Units

MODELS 6256B, 6264B, 6267B, 6274B



P/O AI (CROWBAR CKT)



P/O AI (CROWBAR CKT)

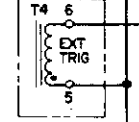

P/O AI (CROWBAR CKT)

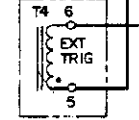

MODELS 6263B, 6265B, 6266B, 6271B

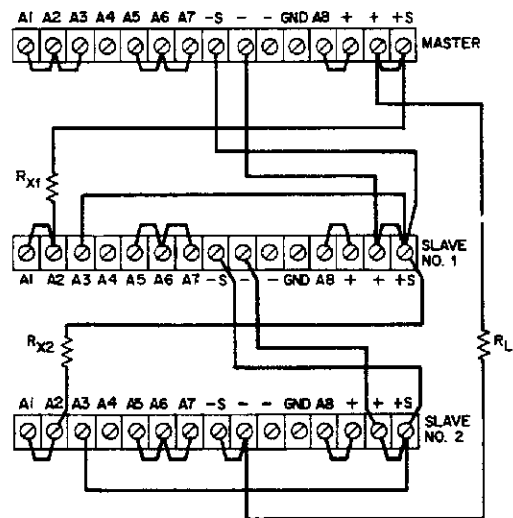

P/O AI (CROWBAR CKT)

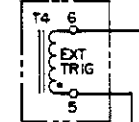

P/O AI (CROWBAR CKT)

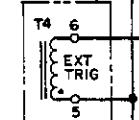

P/O AI (CROWBAR CKT)

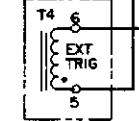

Figure 3-11. Auto-Series Operation of Three Units

external programming resistor R_X . Any of the supplies included in this manual can be used as an auto-tracking slave, and any well-regulated variable output supply can be used as the master.

3-61 Determining the Value for R_X . Each slave supply has an external resistor R_X associated with it that supplies its voltage programming current. If the temperature coefficient and stability specifications of the supplies are to be maintained, these must be stable, low noise resistors with a temperature coefficient of less than 30ppm per °C and a power rating at least 30 times what they will actually dissipate. To calculate the proper value for R_X for each slave, the following information is required:

- E_M , the rated maximum voltage of the master supply
- E_S , the corresponding maximum voltage desired of the slave supply with its voltage control set to maximum.
- R_P , the resistance of the slave supply's coarse voltage control.

The R_P values for the supplies included in this manual are as follows:

Model 6256B	2.5k Ω
6263B, 6264B	5k Ω
6265B, 6266B, 6267B	10k Ω
6271B, 6274B	20k Ω

To find R_X use the formula:

$$R_X = (E_M R_P / E_S) - R_P$$

For example, if the slave supply is a Model 6263B and we want its output to vary from zero to 10 volts as the master supply varies from zero to 40 volts, the solution for R_X is:

$$R_X = (40V \times 5k\Omega / 10V) - 5k\Omega$$

$$R_X = 15k\Omega$$

3-62 It is also possible to make an auto-tracking slave's voltage equal the output of the master supply. To do this, make a direct connection from the (+S) terminal of the master to the (A2) terminal of the slave instead of using a programming resistor, and remove the slave's (A1) to (A2) jumper.

3-63 Setting the Voltage and Current Controls. The voltage control of each slave must be set fully clockwise to obtain the voltage ratios established by the formula for R_X given in paragraph 3-61. By lowering the settings of the slave's voltage controls, the voltage of the slave can be made a smaller percentage of the master supply's voltage. The current controls of all supplies in an auto-tracking combination are independently operative and can be used to set current limits for each individual load. If the master supply goes into constant current mode, the output voltages of the slaves continue to track that of the master. If a slave supply goes into constant current mode, however, no other

supply is affected.

3-64 Overvoltage Protection in Auto-Tracking. Paralleling the crowbar circuits, as is required for the auto-parallel and auto-series modes, is optional in the auto-tracking mode. If the external trigger windings of transformer T4 in the master and in the slave supplies are not paralleled, the overvoltage protection circuit in each supply independently monitors the voltage across its own load. Then if the master supply crowbars, the output voltage of the slave(s) also decreases, but if one of the slaves crowbars, no other supply is affected.

3-65 In order to have all supplies in an auto-tracking combination crowbar simultaneously if any of them has an overvoltage condition, parallel their crowbar circuits as shown in Figure 3-10 or 3-11 and described in paragraph 3-56.

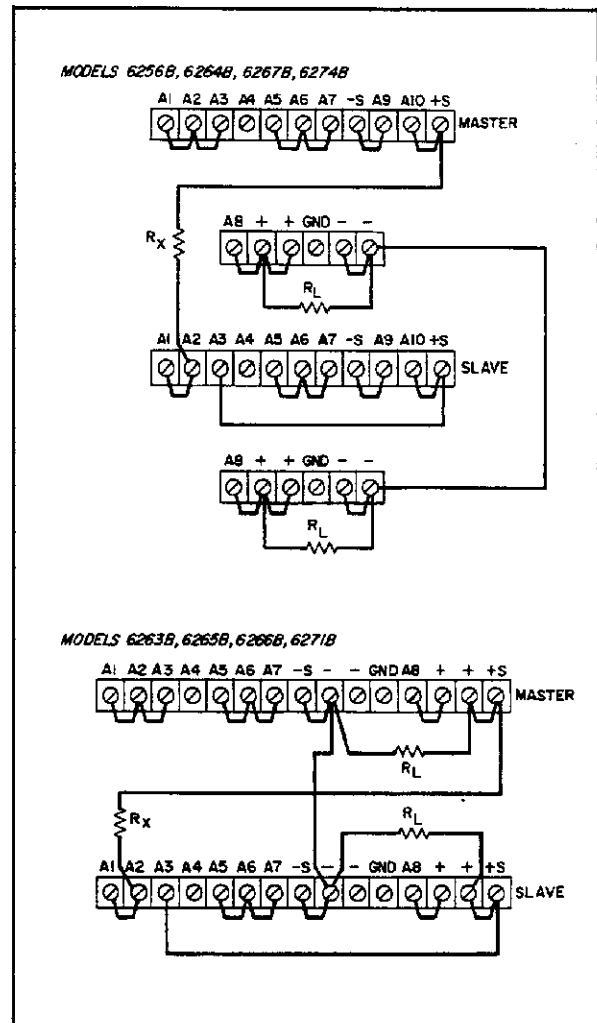

Figure 3-12. Auto-Tracking Operation of Two Units

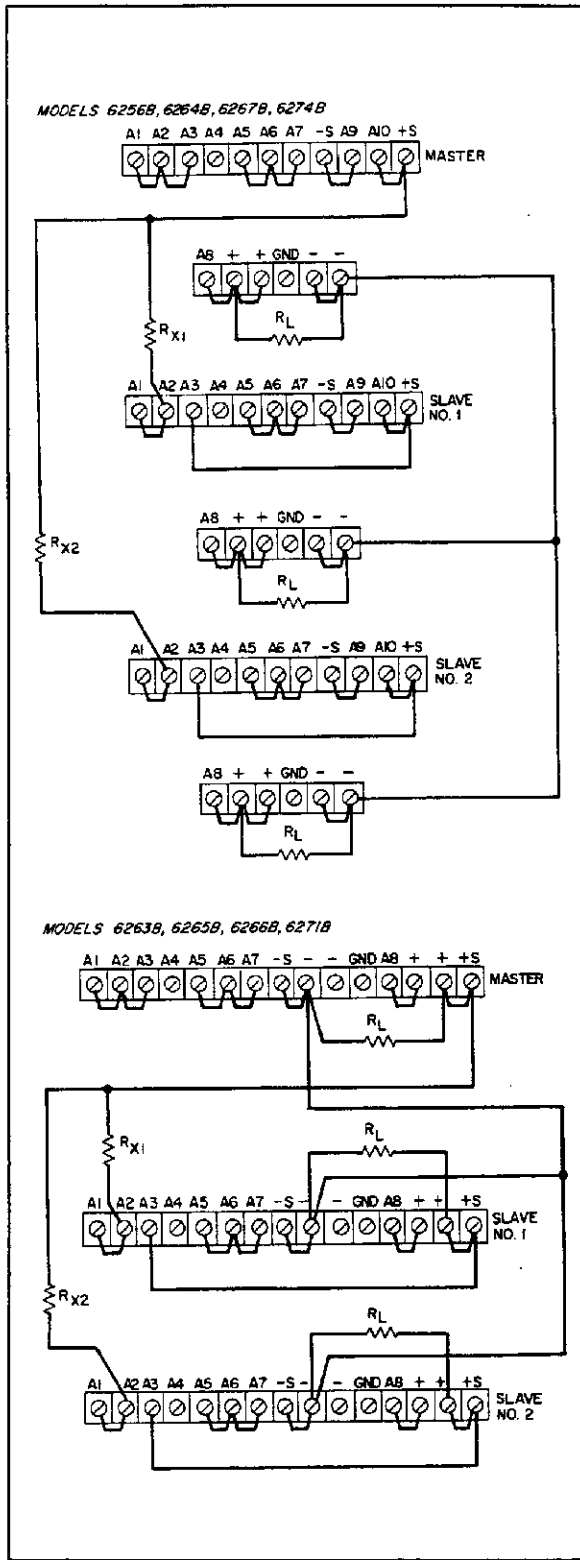

Figure 3-13. Auto-Tracking Operation of Three Units

3-66 Auto-Tracking With Remote Sensing. To combine auto-tracking operation with remote sensing, connect the supplies as described above but remove the (+S) and (-S) jumpers from each supply and connect the (+S) and (-S) terminals directly to the (+) and (-) ends of its load. Observe the precautions outlined under paragraph 3-25.

3-67 Auto-Tracking With Remote Programming. When two or three supplies are connected for auto-tracking operation, their output voltages can be remotely programmed but their currents cannot. Refer to the appropriate sections of paragraph 3-32 for the additional rear panel connections required and make these connections to the master supply only. Observe all precautions outlined in the paragraphs on remote programming. The simultaneous use of remote sensing and remote programming is also possible during auto-tracking operation.

3-68 SPECIAL OPERATING CONSIDERATIONS

3-69 Pulse Loading

3-70 The power supply automatically crosses over from constant-voltage to constant-current operation, or the reverse, in response to an increase beyond the preset voltage or current limit. Although the preset limit may be set higher than the average output current or voltage, high peak currents or voltages may exceed the preset limit and cause crossover to occur. If this current or voltage limiting is not desired, set the current or voltage controls somewhat above the peak rather than the average requirement.

3-71 Output Capacitance

3-72 An internal capacitor (C20) connected across the output terminals of the supply helps to supply high-current pulses of short duration during constant voltage operation. In applications where the availability of high peak output currents should be reduced, this capacitor can be removed from the circuit by removing the strap connected between rear panel terminals (A8) and (+).

NOTE

The removal of C20 from the circuit may permit the supply to oscillate. If the supply appears unstable, it may be beneficial to readjust transient recovery control R30 located on the main circuit board.

3-73 It may also be desirable to remove C20 from the circuit when the supply is being used in the constant-current mode for the following reasons:

- a. With C20 connected, the output impedance of the supply decreases with increasing frequency.

b. With C20 connected, the output current takes longer to recover from the effects of a change in the load resistance.

c. With C20 connected, a rapid reduction in load resistance can produce a large surge current that could cause a high power dissipation in the load.

3-74 Reverse Voltage Protection

3-75 An internal diode (CR34) connected with reverse polarity across the output terminals of the supply protects the output electrolytic capacitors and series transistors from the effects of a reverse voltage applied across the supply's output. Such a reverse voltage might inadvertently be applied when operating supplies in series if one of them were to be turned on or off before the other. The current rating of CR34 is equal to the rated output current of the supply.

3-76 The series regulator transistors are also protected against reverse voltage by diode CR11. This diode shunts the series regulators if the supply is connected in parallel with another supply but is deenergized.

3-77 Reverse Current Loading

3-78 An active load connected to the power supply may actually deliver a reverse current to the supply during a portion of its operating cycle. If an external source is allowed to pump current into the supply, it will cause a loss of regulation and might possibly damage the output capacitor. To avoid these effects, it is necessary to pre-load the supply with a dummy load resistor so that it

delivers current through the entire operating cycle of the load device.

3-79 Battery Charging

3-80 The automatic crossover between constant-voltage and constant-current exhibited by these supplies makes them ideal for battery charging applications. Using this feature, a battery may be charged at a constant-current until the maximum charge voltage is reached, at which point the supply reverts to constant-voltage operation and continues to supply a trickle charge current sufficient to maintain full charge. Thus, the charging operation can be unattended after properly setting the charging rate and maximum charge voltage and connecting the battery to the output terminals of the supply.

— CAUTION —

Any time these supplies are used to charge a battery, be sure to install a protective diode CR_P in series with the battery as shown in Figure 3-14 to prevent the battery from discharging into the supply if the supply is turned off. Extensive damage to the supply could result if this diode were omitted.

The use of remote voltage sensing provides no advantages when performing a constant-current battery charge as discussed in paragraph 3-81 or a taper charge as discussed in paragraph 3-82. Because of a serious risk of damage to the supply, the use of remote voltage sensing should not be attempted when charging (or discharging) a battery. Also see the CAUTION following paragraph 3-30.

NOTE

A large battery, connected as a load, presents a large capacitance to the output terminals. This capacitance could cause the supply to oscillate. If the supply appears unstable, it may be beneficial to readjust transient recovery control R30 located on the main circuit board.

3-81 Constant-Current Charge. To perform a constant-current battery charge, set the charging rate and full charge voltage as follows:

- Turn both the VOLTAGE and CURRENT controls fully counterclockwise (CCW).
- Connect a short circuit across the output terminals and rotate the VOLTAGE control fully clockwise (CW).

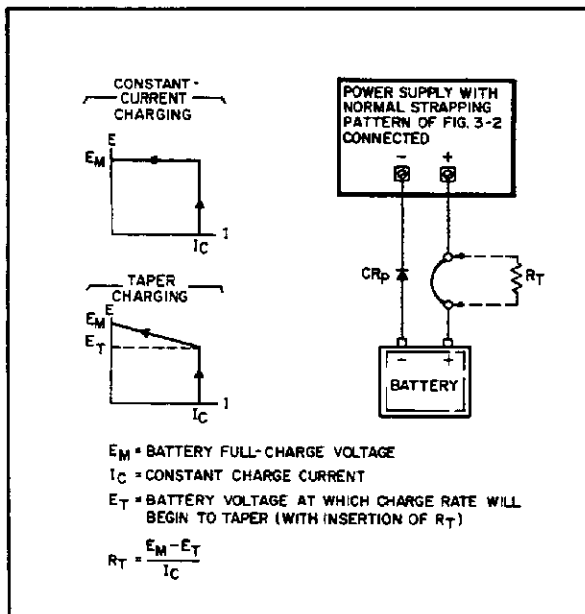

Figure 3-14. Battery Charging

- c. Adjust the CURRENT control for the desired charging rate as read on the front panel ammeter.
- d. Rotate VOLTAGE control fully CCW and remove the short circuit.
- e. Adjust the VOLTAGE control for an output voltage 0.7 volts greater than the desired full charge voltage. (The added 0.7 volts compensates for the drop across CR_p.) The supply may then be connected to the battery terminals, positive to positive and negative to negative as shown in Figure 3-14 (omit R_T).

3-82 Taper Charge. When charging lead-acid cells, many manufacturers recommend that the charging current be reduced as the charge nears completion. This can be accomplished by inserting a small resistance (R_T) in series with one of the load leads from the supply to the battery. (See Figure 3-14.) This resistor alters the normally rectangular charging plot in such a manner as to provide a taper charge for the last portion of the charge. The proper value for this resistor is the difference between the full charge voltage and the voltage at which the tapering is to start, divided by the initial charging current. Set the initial charging rate and full charge voltage as instructed in paragraph 3-81.

3-83 Battery Discharging

3-84 These power supplies are also useful when batteries must be discharged at a constant current in order to test them. Connecting a supply as shown in Figure 3-15 and following the instructions below makes an unattended constant-current discharge possible by automatically shutting off the output of the supply when the battery voltage reaches zero.

3-85 The supply operates in the constant-current mode, delivering the current set by the current control. This constant current flowing through dropping resistor R_X produces a constant voltage across the resistor. Initially, the battery voltage is high and the supply's output voltage is low, but as the battery voltage decreases during discharge, the supply voltage increases. When the battery voltage reaches zero, the supply senses this through the connection to its (A2) terminal and reduces the output current to zero. As shown in Figure 3-15, R_X must be selected so that its IR drop is less than the maximum rated output voltage of the supply, but greater than the initial battery voltage.

3-86 To give a battery a constant-current discharge, proceed as follows:

- a. Turn off the power supply and disconnect the jumpers from terminal (A1) to (A2) and from (A2) to (A3).
- (This step disables the supply's VOLTAGE controls.)

- b. Connect terminal (A3) to (+S) and leave all other jumpers connected as for normal operation as shown in Figure 3-15.
- c. Connect the negative terminal of the battery to (A2) through a 10kΩ resistor.
- d. Connect the negative terminal of the supply to the positive terminal of the battery.
- e. Connect R_X between the positive terminal of the supply and the negative terminal of the battery, rotate the supply's current control fully counterclockwise (CCW), energize the supply, and set the current control for the desired discharge current as indicated on the front panel meter.

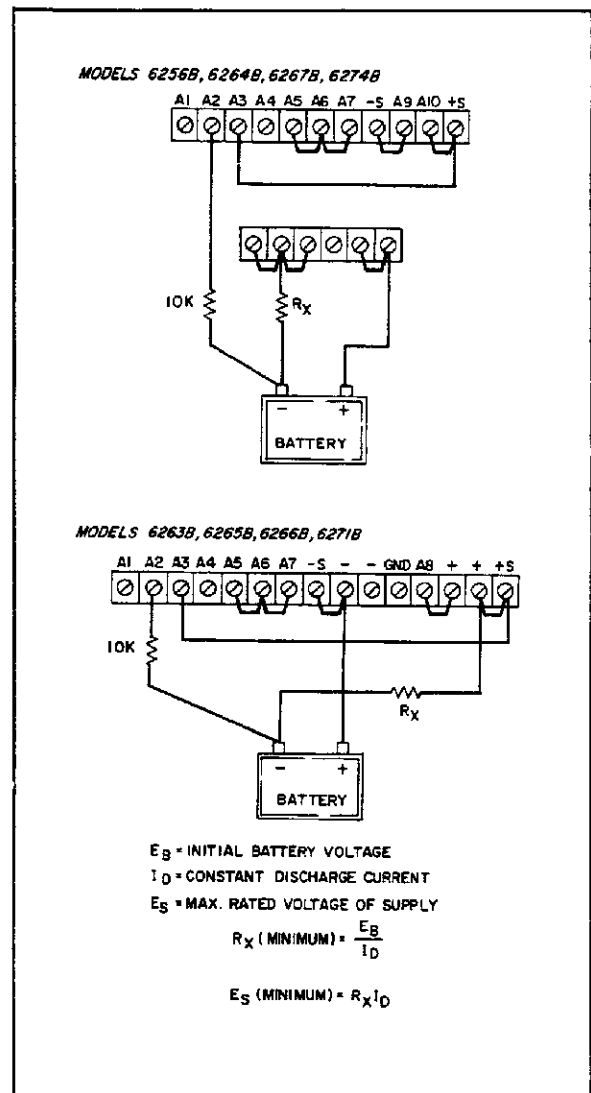

Figure 3-15. Battery Discharging

SECTION IV PRINCIPLES OF OPERATION

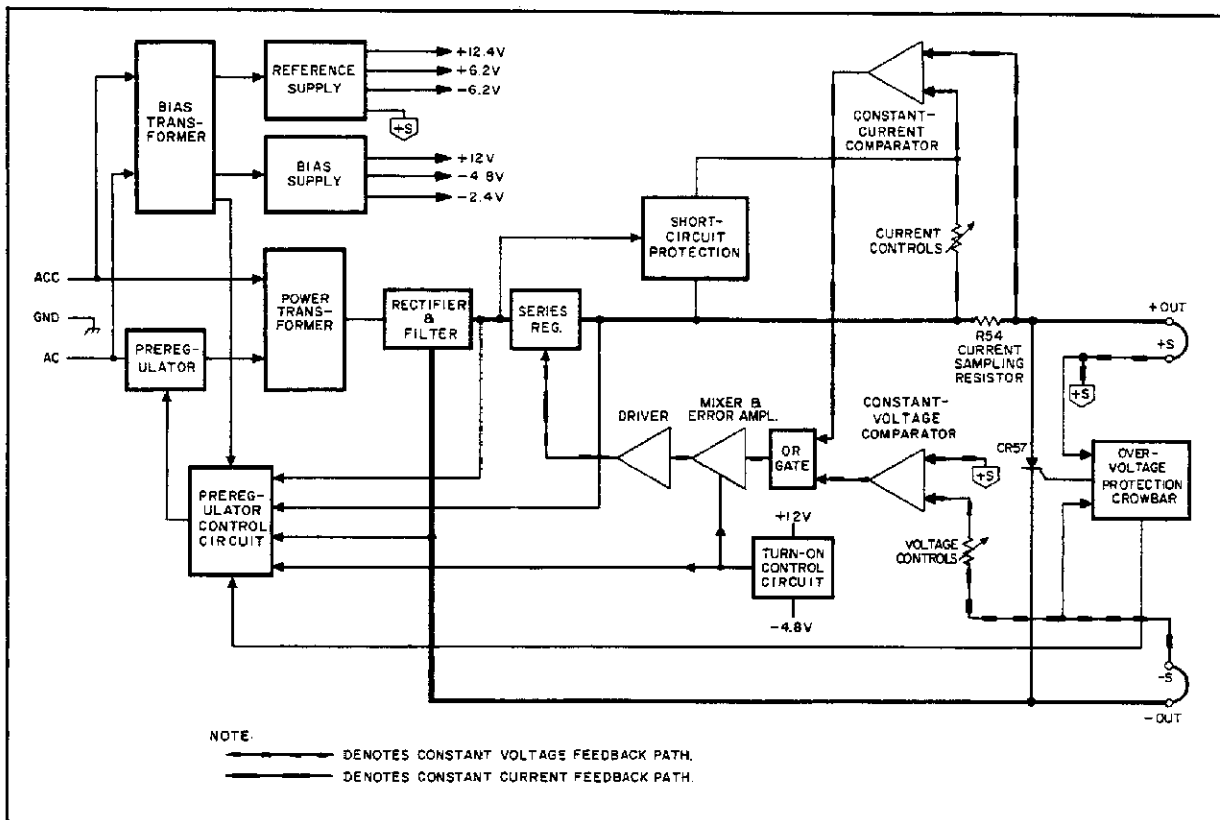

Figure 4-1. Overall Block Diagram

4-1 OVERALL BLOCK DIAGRAM DISCUSSION

4-2 The major circuits of the power supply are shown on the overall block diagram of Figure 4-1. The ac input to the power transformer is preregulated by a triac, which forms a feedback loop in conjunction with the preregulator control circuit. This feedback loop maintains a low and constant voltage drop across the series regulator in order to minimize dissipation in the series regulator transistors.

4-3 To accomplish this, the preregulator control circuit issues a phase-adjusted firing pulse to the triac once during each half cycle of the ac input. The control circuit continuously samples the input line voltage, the dc input to the series regulator, and the voltage across the series regulator. On the basis of these inputs it controls the time at which each firing pulse is generated.

4-4 The output of the triac preregulator is stepped down by the power transformer, full-wave rectified, and filtered. The resulting preregulated dc voltage is applied to the series regulator, which varies its conduction to provide a regulated voltage or current at the output terminals.

4-5 The series regulator is part of another feedback loop which consists of the error and driver amplifiers, the constant-voltage comparator, and the constant-current comparator. The series regulator feedback loop makes rapid, low magnitude adjustments to the output while the preregulator feedback loop handles large, relatively slow regulation demands.

4-6 The feedback signals that control the conduction of the series regulator originate in the constant-voltage or constant-current comparator. During constant-voltage operation the constant-voltage comparator compares the

output voltage of the supply with the drop across the VOLTAGE controls. If these voltages are not equal, the comparator produces an error signal that is amplified and fed back to the series regulator with the correct phase and amplitude to make them equal. In this manner, the constant-voltage comparator holds the output voltage at the level established by the VOLTAGE controls.

4-7 During constant-current operation, the constant-current comparator detects any difference between the voltage drop developed by load current flowing through the current sampling resistor and the voltage across the CURRENT controls. If the two inputs to the comparator are momentarily unequal, an error signal is generated that alters the conduction of the series regulator by the amount necessary to reduce the error voltage at the comparator's input to zero. Hence, the IR drop across the current sampling resistor, and therefore the output current, is held at a constant value.

4-8 Since the constant-voltage comparator causes the output impedance to be low and allows the output current to change whenever the load resistance changes, while the constant-current comparator causes the output impedance to be high and allows the output voltage to change in response to a load resistance change, it is obvious that the two comparison amplifiers cannot control the output simultaneously. For any given value of load resistance, the power supply must act either as a constant-voltage source or as a constant-current source. The outputs of both comparators are connected through an OR gate. This enables one comparator or the other to take control.

4-9 Figure 4-2 shows the output characteristic of a constant-voltage/constant-current power supply. With no load connected, the output current (I_{OUT}) is zero and the output voltage (E_{OUT}) equals the front panel voltage control setting (E_S). When a load resistance is connected to the output terminals of the supply, the output current increases while the output voltage remains constant. Point D thus represents a typical constant-voltage operating point. Further decreases in load resistance are accompanied by further increases in I_{OUT} with no change in the output voltage until the output current reaches I_S , a value equal to the front panel current control setting. At this point the supply automatically changes its mode of operation and becomes a constant-current source. Still further decreases in the value of load resistance are accompanied by a drop in the supply's output voltage with no accompanying change in its output current. With a short circuit across the load terminals, $I_{OUT} = I_S$ and $E_{OUT} = 0$.

4-10 The "crossover" value of load resistance can be defined as $R_C = E_S/I_S$. Adjustment of the front panel voltage and current controls permits this "crossover"

resistance R_C to be set to any desired value from 0 to ∞ . If R_L is greater than R_C , the supply is in constant-voltage operation; if R_L is less than R_C , the supply is in constant-current operation.

4-11 The short-circuit protection circuit (see Figure 4-1) protects the series regulator in the event the output is shorted while the controls are set to a high output voltage and current. The protection circuit monitors the voltage drop across the series regulator. If this voltage rises above a preset level, the protection circuit limits the current through the series regulator until the preregulator can reduce the voltage across the series regulator. Once this voltage returns to normal, the short-circuit protection circuit is turned off and has no effect on operation of the supply.

4-12 The overvoltage protection crowbar monitors the output of the supply and, if it exceeds a preset threshold, fires an SCR which short circuits the supply. The crowbar also sends a turn-down signal to the preregulator control circuit.

4-13 The turn-on control circuit is a long-time-constant network that gives the supply a gradual turn-on characteristic. The slow turn-on feature protects the preregulator triac and the series regulator from damage that might occur when ac power is first applied to the unit. At turn-on, the control circuit sends inhibiting voltages to the preregulator control and the series regulator (via the error and driver amplifiers). After a brief delay, the inhibiting voltages are removed and the circuit has no further control over the operation of the supply.

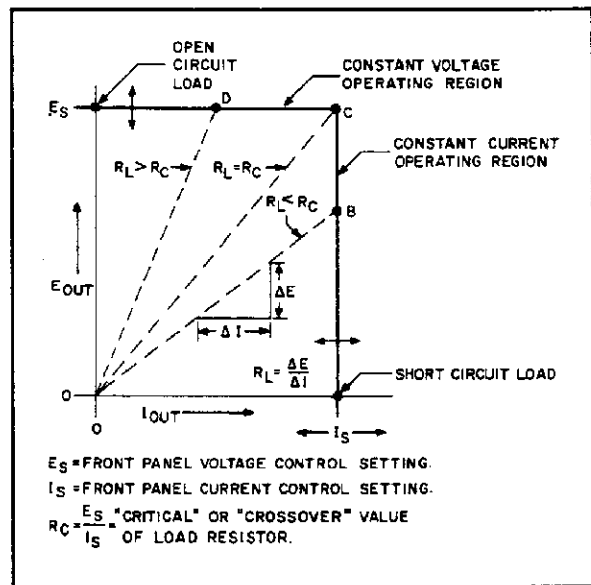

Figure 4-2. Operating Locus of a CV/CC Power Supply

4-14 The reference supply provides stable reference voltages used by the constant-voltage and current-comparators. Less critical operating voltages are obtained from an unregulated bias supply.

4-15 DETAILED CIRCUIT ANALYSIS (See Figure 7-4 or 7-7)

4-16 Preregulator Control Circuit

4-17 The preregulator minimizes the power dissipated by the series regulating transistors during input line voltage or dc output voltage variations. Preregulation is accomplished by a phase control circuit using triac A2CR1 as the switching element.

4-18 The triac is a bi-directional device; that is, it can conduct current in either direction. Hence, the device fires whenever it receives a gating pulse regardless of the polarity of the ac voltage applied to it. The triac is fired once during each half-cycle of the ac input (see Figure 4-3). Notice that when the triac is fired early in the half-cycle, the ac level applied to the power transformer is relatively high. When the triac is fired later in the half-cycle, the ac level is relatively low.

4-19 Normally the ac input must be above a certain minimum potential before a triac will conduct. However, A2C1 and A2R1 provide a holding current that allows the triac to conduct at any time during the ac input cycle. RFI choke A2L1A/A2L1B slows down the turn-on of the triac in order to minimize spikes at the output of the supply.

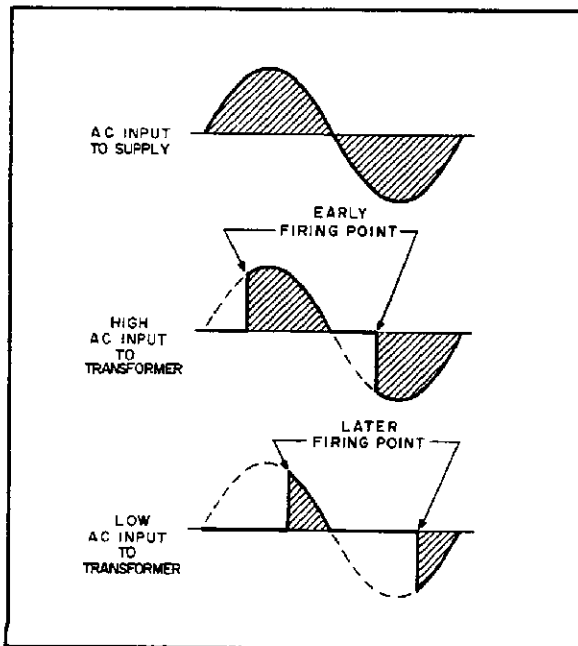

Figure 4-3. Triac Phase Control of AC Input Amplitude

The components of the A2 RFI Assembly are all mounted inside a shielded box to minimize radiated and reflected RFI. Further RFI suppression is provided by line bypass capacitors.

4-20 The preregulator control circuit samples the input line voltage, the dc input to the series regulator, and the voltage across the series transistor. It generates firing pulses that fire the triac and adjusts the phase of these pulses so that the dc voltage across the series regulator remains constant.

4-21 The inputs to the control circuit are algebraically summed across capacitor C15. All inputs affect the time required to charge C15. The input line voltage is rectified by CR27, CR28, CR31, and CR33, attenuated by voltage divider R68 and R69, and applied to the summing point at the collector of Q22 (TP73) via capacitor C15. Capacitor C16 is used for smoothing purposes.

4-22 Transistor Q22, connected in a common base configuration, provides a charging current to the summing capacitor which varies with the input signals applied to its emitter. Resistor R86, connected between the negative output line and the emitter of Q22, furnishes a signal proportional to the output voltage. Resistors R87 and R79 sample the voltage across, and the current through, the series regulator. Resistors R74 and R75 are the source of a constant offset current to the summing point, which ensures that the triac will fire at low output voltages. Capacitor C17 and resistor R78 stabilize the entire preregulator feedback loop.

4-23 The summation of these input signals results in a voltage waveform at TP73 similar to that shown in waveform (A) of Figure 4-4. When the linear ramp portion of the waveform reaches a certain negative threshold, diodes CR43 and CR44 become forward biased. These diodes couple a negative voltage to the base of transistor Q19. Transistors Q19 and Q18 form a bistable circuit similar to a Schmitt trigger. Prior to firing time, Q19 is conducting due to the positive bias supplied to its base through R73, and transistor Q18 is cut off because its base is driven negative by the collector of Q19.

4-24 When the negative threshold voltage is reached, transistor Q19 is turned off and Q18 is turned on. The conduction of Q18 allows capacitor C18 to discharge rapidly through pulse transformer T3, generating a firing pulse across the secondary of T3. Diode CR40 blocks any positive overshoot.

4-25 The control circuit is reset once every 8.33 milliseconds when the rectified ac voltage at the junction of CR36, CR37, and CR38 (TP64) forward biases diode CR38. Summing capacitor C15 is then allowed to discharge through CR38. Diodes CR44 and CR43 become reverse biased at

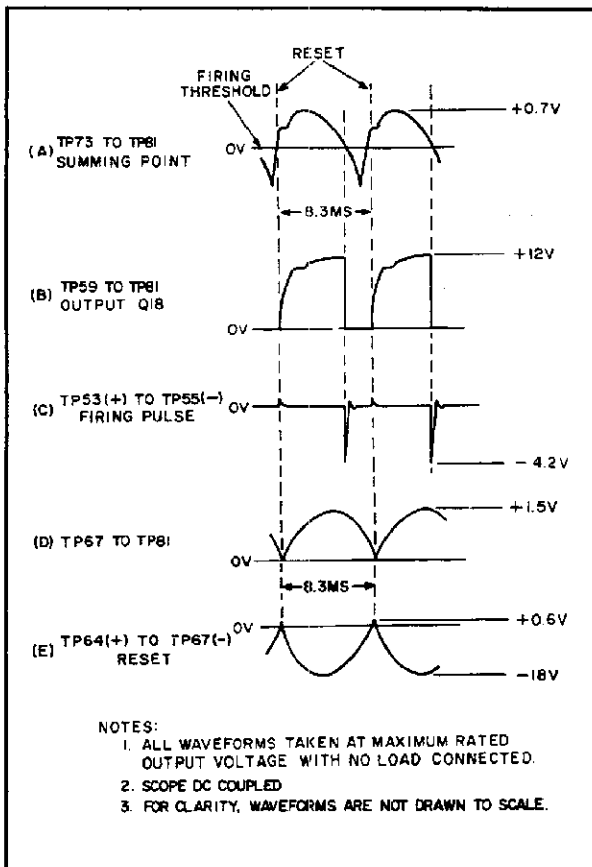

Figure 4-4. Preregulator Control Circuit Waveforms

reset, allowing Q19 to turn on. Consequently, Q18 is turned off and capacitor C18 charges up through R71 at a comparatively slow rate until the collector voltage of Q18 reaches approximately +12 volts.

4-26 Series Regulator And Driver

4-27 The series regulator consists of transistor Q6 (in the 3 1/2-inch-high models) or Q6 and Q7 connected in parallel (in the 5 1/4-inch-high models). These transistors serve as the series element which provides precise and rapid control of the output. The series transistor(s) are controlled by driver Q3. Diode CR11 is connected across the regulator circuit to protect the series elements from reverse voltages that could develop if one supply is turned on or off before the other during parallel operation.

4-28 Short-Circuit Protection

4-29 The short-circuit protection circuit protects the series regulator against damage due to a simultaneous full-voltage full current condition as might occur if the output were shorted while the controls were set to

deliver a high output voltage and current. If this occurs, the preregulator is shut off and Q13 is turned on due to the increased voltage across the series regulator. The conduction of Q13 puts R66 in parallel with the current controls to limit the output current to less than 10% of the supply's rating. The input capacitor then begins to discharge through the series regulator, and the voltage across the regulator decreases until Q13 turns off. The discharge time (typically 1/2 to 4 seconds) depends on the voltage and current ratings of the supply, the size of the main filter capacitor, and the control settings. Once this recovery time has elapsed, the output current returns to the level set by the current controls, and the preregulator returns the voltage across the series regulator to the normal 4-volt level.

4-30 Constant-Voltage Comparator

4-31 The constant-voltage comparator consists of programming resistors R10 and R11, differential amplifier Z1, and associated components. An integrated circuit is used for the differential amplifier to minimize voltage differentials due to mismatched transistors or temperature differences.

4-32 The constant-voltage comparator compares the voltage drop across the VOLTAGE controls with the supply's output voltage. If a difference exists, it produces an error voltage proportional to this difference. This error signal alters the conduction of the series regulator, which changes the output voltage until it is equal to the voltage drop across the VOLTAGE controls. Hence, through feedback action, the difference between the two inputs to Z1 is held at zero volts.

4-33 One input of the differential amplifier (pin 10) is connected to the output voltage sensing terminal of the supply (+S) through impedance equalizing resistor R5. Resistors R6 and R8 zero bias the input. If the supply is equipped with Option 020 or 040, resistor R123 and potentiometer R124 provide a variable input bias that allows the output voltage to be easily adjusted to exactly zero volts when the supply is programmed for zero output. The other input of the differential amplifier (pin 1) is connected to a summing point (terminal A2) at the junction of the programming resistors and current pullout resistors R9, R12, and R13. Instantaneous changes in the output voltage or changes in the voltage at the summing point due to changes in the VOLTAGE control setting produce a difference voltage between the two inputs of the differential amplifier. This difference voltage is amplified and appears at the output of the differential amplifier (pin 12) as an error voltage which ultimately varies the conduction of the series regulator.

4-34 Resistor R1, in series with the summing point

input to the differential amplifier, limits the current flowing into the differential amplifier during rapid voltage turn-down. Diode CR20 prevents excessive current drain from the +6.2 volt reference supply during rapid down-programming. Diodes CR1 and CR2 prevent excessive voltage excursions from overdriving the differential amplifier.

4-35 During constant-voltage operation, the programming current flowing through the programming resistors (VOLTAGE controls) is constant because the summing point is held constant at zero volts by feedback action and virtually all of the reference supply current flowing through pull-out resistors R9, R12, and R13 flows through VOLTAGE controls R10 and R11. Linear constant-voltage programming is thus assured. Resistor R13 serves as a trimming adjustment for the programming current flowing through R10 and R11. If the supply is equipped with Option 020 or 040, resistor R121 and potentiometer R122 allow the programming current to be adjusted over a narrow range around its nominal value. In practice, this adjustment sets the power supply output to exactly the maximum rated voltage when programmed to that level.

4-36 Main output capacitor C20, connected across the output terminals of the supply, stabilizes the series regulator feedback loop when the normal strapping pattern shown on the schematic is used. This capacitor can be removed (by unstrapping terminal A8) to avoid output current surges or to increase the programming speed of the supply. If C20 is removed, capacitor C19 insures loop stability.

4-37 Constant-Current Comparator

4-38 The constant-current comparator is similar in appearance and operation to the constant voltage comparator. It consists of programming resistors R16 and R17, differential amplifier Z1, and associated components.

4-39 The constant-current comparator circuit compares the voltage drop across the CURRENT controls with the voltage drop across current sampling resistor R54. If a difference exists, the differential amplifier produces an error signal proportional to this difference. The remaining components in the feedback loop (amplifiers and the series regulator) maintain the drop across the current sampling resistor, and hence the output current, at a constant value.

4-40 One input of the differential amplifier (pin 7) is connected to the output bus through impedance equalizing resistor R26. Its other input (pin 4) is connected to a summing point (terminal A6) at the junction of programming resistors R16 and R17 and current pullout resistors R18 and R19. Instantaneous changes in the output current due to load changes or changes in the voltage at the summing

point due to changes in the CURRENT control setting produce a difference voltage between the two inputs of the differential amplifier. This difference voltage is amplified and appears at the output of the differential amplifier (pin 6) as an error voltage which ultimately varies the conduction of the series regulator.

4-41 Resistor R19 serves as a trimming adjustment for the programming current flowing through R16 and R17. If the supply is equipped with Option 021 or 040, resistor R125 and potentiometer R126 allow the programming current to be adjusted over a narrow range around its nominal value, and resistor R127 and potentiometer R128 provide a variable input bias to allow the output current to be easily adjusted to exactly zero when the supply is programmed for zero output. Diode CR5 limits excessive voltage excursions at the summing-point input to the differential amplifier.

4-42 Voltage Clamp Circuit

4-43 The voltage clamp circuit keeps the constant-voltage programming current relatively constant when the power supply is operating in the constant-current mode. This is accomplished by clamping terminal A2, the voltage summing point, to a fixed bias voltage. During constant-current operation the constant-voltage programming resistors are a shunt load across the output terminals of the supply. When the output voltage changes, the current through these resistors also tends to change. Since this programming current flows through the current sampling resistor, it is erroneously interpreted as a load change by the current comparator circuit. The voltage clamp eliminates this undesirable effect by maintaining the programming current at a constant level.

4-44 The voltage divider consisting of Z2A, Z2B, and VR3 back biases CR30 and Q10 during constant-voltage operation. When the power supply goes into constant-current operation, CR30 becomes forward biased by the voltage at pin 12 of Z1. This results in conduction of Q10 and the clamping of the summing point at a potential only slightly more negative than the normal constant-voltage potential. Clamping this voltage at approximately the same potential that exists in constant-voltage operation results in a constant voltage across, and consequently a constant current through, current pullout resistors R9, R12, and R13.

4-45 Mixer and Error Amplifiers

4-46 The mixer and error amplifiers amplify the error signal received from the constant-voltage or constant-current input circuit to a level sufficient to drive the series regulator transistors. Mixer amplifier Q5 receives the error voltage

input from either the constant-voltage or constant-current comparator via the OR-gate diode (CR3 or CR4) that is conducting at the time. Diode CR3 is forward biased and CR4 reverse biased during constant-voltage operation. The reverse is true during constant-current operation.

4-47 Transistor Q11 provides a constant current to the collector of Q5 and also generates a negative-going turn-off signal for the series regulator when the unit is first turned off. Feedback network C5 and R30 shapes the high frequency rolloff in the loop gain response in order to stabilize the series regulator feedback loop.

4-48 Error amplifiers Q4 and Q12 serve as the pre-driver elements for the series regulator.

4-49 Overvoltage Protection Crowbar

4-50 The overvoltage protection crowbar circuit protects sensitive loads against the application of an excessively high voltage, as might result from a series regulator transistor failure. It accomplishes this by immediately shorting the output of the supply as soon as a preset threshold voltage is exceeded. Until silicon controlled rectifier CR57 has been triggered, it acts as an open circuit and has no effect on the output voltage. Transistors Q24 and Q25 detect an overvoltage condition and trigger the SCR to fire. When the SCR fires, it shorts the supply's output.

4-51 During normal operation, Q24 is biased on by current through R110, Q25 is kept turned off by Q24, and CR59 is reverse biased by the voltage divider formed by resistors R106, R108, and R109. Zener diode VR5 provides a stable reference voltage with which the $-S$ potential is compared. Potentiometer R109 (OVERVOLTAGE ADJUST) establishes the output voltage at which CR59 becomes forward biased and turns Q24 off. When Q24 turns off, Q25 begins to conduct, sending a positive-going trigger pulse to CR57 and causing it to create a near short circuit across the output. When CR57 fires, overvoltage lamp DS2 turns on, completing a path for a +12V unregulated holding current through DS2. (R101 supplies the holding current if lamp DS2 should open.) This current holds CR57 on even after the output voltage has fallen. CR57 remains in conduction until the supply is turned off. R102 protects CR56 and CR57 from the large surge current that occurs when CR57 is first fired. CR58 damps out negative overshoot in the trigger pulse.

4-52 The firing of CR57 biases Q23 into conduction. This places approximately +12 volts on the cathode of CR44 in the preregulator control circuit to reverse bias CR43 and CR44. By preventing transistor Q19 from turning off, this prevents the generation of any trigger pulses and turns off the preregulator.

4-53 The crowbar circuit creates an extra current path during normal operation of the supply, thus changing the current that flows through the sampling resistor. Diode CR9 keeps this extra current at a fixed level for which compensation can then be made in the constant-current comparator circuit.

4-54 A slaving arrangement for the crowbar circuits in more than one supply is made possible by an extra secondary winding (terminals 5 and 6) on T4. When units have these windings connected in parallel, their crowbars are activated if any one of the crowbars is tripped. To reset the crowbars in this arrangement, all of the units must be turned off and then on. Polarity must be observed when connecting units in this fashion.

4-55 Turn-On Control Circuit

4-56 The turn-on control circuit is a long-time-constant network which protects the triac and the series regulator from possible damage during turn-on. When the supply is first turned on, C22 applies a positive voltage to the anodes of CR47 and CR50. Diode CR50 couples this voltage to the cathode of CR44 in the preregulator control circuit to ensure that it is initially reverse biased. After C22 becomes sufficiently charged, CR50 becomes reverse biased and the preregulator control circuit is permitted to fire the triac.

4-57 Diode CR47 performs a similar function for the series regulator. This diode initially couples a positive voltage to Q5, which inverts it and applies it to the series regulator. This negative voltage keeps the regulator cut off until C22 charges up. Diode CR45 provides a discharge path for C22 when the supply is turned off.

4-58 Reference Regulator

4-59 The reference circuit is a feedback power supply similar to the main supply. It provides stable reference voltages used throughout the unit. All the regulated reference voltages are derived from dc obtained from full-wave rectifier CR10 and CR12 and filter capacitor C10. Zener diodes VR1 and VR2 establish well regulated potentials of +6.2V and -6.2V with respect to common point +S, while the regulator circuit establishes a well regulated potential of +12.4 volts. Resistor R48 establishes an optimum bias current through the zener diodes.

4-60 The regulating circuit consists of series regulating transistor Q9, driver Q16, and differential amplifier Q14 and Q15. The voltage across zener diodes VR1 and VR2 is compared to the voltage across resistor Z2J, and any difference is amplified by Q14 and Q15. The error voltage thus appearing at the collector of Q14 is amplified by driver stage Q16 and applied to series regulator Q9 in the

correct phase and amplitude to maintain the +12.4 volt output at a constant level.

4-61 Diode CR7, connected from voltage divider R34 and R39 to the base of Q16, serves as a turn-on circuit for series regulator transistor Q9. When the supply is first turned on, CR7 biases driver Q16 on, thus turning on the series regulator. When the reference supply reaches normal output, the base voltage of Q16 is sufficient to reverse bias CR7, thus effectively removing it from the circuit. Capacitor C9, connected across the output of the reference supply, removes spikes and stabilizes the reference regulator loop.

4-62 A separate winding on transformer T2, diodes CR13 and CR14, and filter capacitor C12 provide an unregulated +12Vdc output. Additional reference voltages of -2.4 volts and -4.8 volts are provided by zener diodes VR6 and VR7. Resistor R60 biases the zeners. Diode CR15 prevents reverse current flow from damaging the main supply series regulator transistor(s). Diode CR20, shown on the schematic near current pullout resistors R9, R12, and R13, protects the zener diodes in the reference circuit by providing a path for surge currents that occur during rapid down-programming.

4-63 Meter Circuit

4-64 The front panel voltmeter and ammeter provide continuous indications of output voltage and current. Both meter movements can withstand an overload of

many times the maximum rated output without damage.

4-65 The ammeter, together with its series resistors R62 and R63, is connected across current sampling resistor R54. As mentioned previously, the voltage drop across R54 varies in proportion to the output current. Potentiometer R63 permits calibration of the ammeter.

4-66 The voltmeter, in series with R44 and R49 and shunted by R56 and R57, is connected directly across the output terminals of the supply. Potentiometer R56 permits calibration of the voltmeter.

4-67 Additional Protection Features

4-68 The supply contains several special purpose components that protect it in the event of unusual circumstances. One of these components is diode CR34. Connected across the output terminals of the supply, it prevents internal damage from reverse voltages that might be applied across the supply. This could occur, for example, during Auto-Series operation if one supply were turned on or off before the other.

4-69 Resistors R58 and R59 limit the output of the supply if the straps between the output buses and the sensing terminals (+S and -S) are inadvertently removed.

4-70 Diode CR11, previously mentioned in the series regulator description, protects the regulating transistor from reverse voltages.

SECTION V MAINTENANCE

5-1 INTRODUCTION

5-2 Upon receipt of the power supply, the performance test (paragraph 5-5) should be made. This test is suitable for incoming inspection. If a fault is detected in the power supply while making the performance test or during normal operation, proceed to the troubleshooting procedures (paragraph 5-49). After troubleshooting and repair (para-

graph 5-60) perform any necessary adjustments and calibrations (paragraph 5-62). Before returning the power supply to normal operation, repeat the applicable portions of the performance test to ensure that the fault has been properly corrected and that no other faults exist. Before performing any maintenance checks, turn on the power supply and allow a half-hour warm-up.

Table 5-1. Test Equipment Required

TYPE	REQUIRED CHARACTERISTICS	USE	RECOMMENDED MODEL
Digital Voltmeter	Sensitivity: 100 μ V full scale (min.) Input impedance: 10M Ω (min.)	Measure dc voltages; calibration procedures.	HP 3450B
Oscilloscope	Sensitivity and bandwidth: 100 μ V/cm and 400kHz for all measurements except noise spike; 5mV sensitivity and 20MHz bandwidth for noise spike measurement.	Measure ripple; display transient recovery waveform; measure noise spikes.	HP 180C with 1821A time base and 1806A vertical plug-in; 1803A plug-in for spike measurement
Variable Voltage Transformer	Range: 90-130 volts. Output current: 200% (min.) of supply input current listed in para. 2-16.	Vary ac input for line regulation measurement.	---
Digital or Analog Multimeter		Measure ac and dc voltages, resistance.	HP 3490A or HP 427A
Repetitive Load Switch	Switching rate: 60-400Hz. Rise time: 2 μ sec.	Measure transient recovery time.	See Figure 5-4.
Resistive Load	Values: see Figures 5-1 and 5-4.	Power supply load resistor.	---
Current Sampling Resistor	Value: see Figure 5-7.	Measure output current; calibrate ammeter.	---
Terminating Resistors	Value: 50 ohms, 1/2 watt, \pm 5% non-inductive. (Four required.)	Noise spike measurement.	---
Blocking Capacitors	Value: 0.01 μ F, 100Vdc. (Two required.)	Noise spike measurement.	---

5-3 TEST EQUIPMENT REQUIRED

5-4 Table 5-1 lists the test equipment required to perform the procedures described in this section.

5-5 PERFORMANCE TEST

5-6 The following test can be used as an incoming inspection check. Appropriate portions of the test can be repeated either to check the operation of the instrument after repairs or for periodic maintenance tests. The tests are performed using a 115Vac 60Hz single-phase input power source. If the correct result is not obtained for a particular check, do not adjust any internal controls; instead proceed to troubleshooting (paragraph 5-49).

5-7 CONSTANT-VOLTAGE TESTS

5-8 Connect all of the measuring devices used in the constant voltage performance tests directly to the power supply sensing terminals ($\pm S$). For best accuracy, the sensing terminals must be used rather than the output terminals, since the measuring instruments must be connected to the same pair of terminals to which the feedback amplifier within the power supply is connected. This is particularly important when measuring the regulation, transient response, or ripple of the power supply. Note that the measuring instruments should not be connected across the load. A measurement made across the load includes the impedance of the leads to the load and such lead lengths can easily have an impedance several orders of magnitude greater than the supply impedance (typically 1 milliohm at dc), thus invalidating the measurement.

5-9 To avoid mutual coupling effects, connect each monitoring device to the sensing terminals by a separate pair of leads. Use twisted pairs or shielded two-wire cables to avoid pickup on the measuring leads. Connect the load resistor across the output terminals as close to the supply as possible. When measuring the constant-voltage performance specifications set the current controls well above (at least 10% above) the maximum output current the supply will draw, since the onset of constant-current operation will cause a drop in output voltage, increased ripple, and other performance changes not properly ascribed to the constant-voltage operation of the supply.

5-10 **Voltage Output and Voltmeter Accuracy.** To check that the supply will furnish its rated output voltage, proceed as follows:

- Connect load resistor (R_L) indicated in Figure 5-1 across output terminals of supply.
- Connect digital voltmeter across (+S) and (-S) terminals of supply, observing correct polarity.

- Turn CURRENT controls fully clockwise.
- Turn on supply and adjust VOLTAGE controls until front panel meter indicates exactly maximum rated output voltage.

- e. Digital voltmeter should indicate:
- | | |
|---------------------|-----------------|
| 6256B | 10 \pm 0.2Vdc |
| 6263B, 6264B | 20 \pm 0.4Vdc |
| 6265B, 6266B, 6267B | 40 \pm 0.8Vdc |
| 6271B, 6274B | 60 \pm 1.2Vdc |

5-11 Load Effect (Load Regulation).

Definition: The change ΔE_{OUT} in the static value of dc output voltage resulting from a change in load resistance from open circuit to a value which yields maximum rated output current, or vice versa.

5-12 To check the constant-voltage load effect, proceed as follows:

- Connect test setup shown in Figure 5-1.
- Turn CURRENT controls fully clockwise.
- Turn on supply and adjust VOLTAGE controls until front panel meter indicates exactly maximum rated output current.
- Read and record voltage indicated on digital voltmeter.
- Disconnect load resistor.
- Reading on digital voltmeter should not differ from reading recorded in step (d) by more than :

- | | |
|---------------------|-------|
| 6256B | 1.2mV |
| 6263B, 6264B | 2.2mV |
| 6265B, 6266B, 6267B | 4.2mV |
| 6271B, 6274B | 6.2mV |

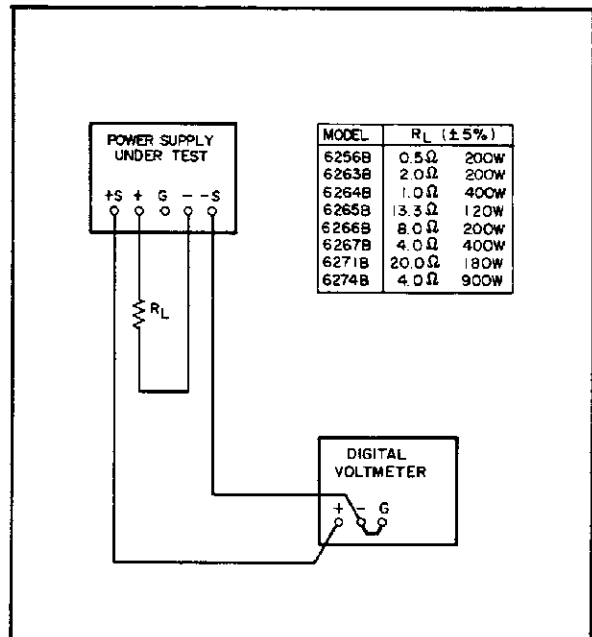

Figure 5-1. Constant-Voltage Load Regulation Test Setup

5-13 Source Effect (Line Regulation).

Definition: The change ΔE_{OUT} in the static value of dc output voltage resulting from a change in ac input voltage over the specified range from low line to high line, or from high line to low line.

5-14 To check the source effect, proceed as follows:

- Connect test setup shown in Figure 5-1.
- Connect variable autotransformer between input power source and power supply power input.
- Adjust autotransformer for 104Vac input.
- Turn CURRENT controls fully clockwise.
- Turn on supply and adjust VOLTAGE controls until front panel meter indicates exactly maximum rated output voltage.
- Read and record voltage indicated on digital voltmeter.
- Adjust variable autotransformer for 127Vac input.
- Digital voltmeter reading should not differ from reading recorded in step (f) by more than:

6256B	1.2mV
6263B, 6264B	2.2mV
6265B, 6266B, 6267B	4.2mV
6271B, 6274B	6.2mV

5-15 PARD (Ripple and Noise)

Definition: The residual ac voltage superimposed on the dc output of a regulated power supply. Ripple and noise measurements may be made at any input ac line voltage combined with any dc output voltage and load current within the supply's rating.

5-16 The amount of ripple and noise present on the power supply output is measured either in terms of its rms or (preferably) peak-to-peak value. The peak-to-peak measurement is particularly important for applications where noise spikes could be detrimental to sensitive loads such as logic circuitry. The rms measurement is not an ideal representation of the noise since fairly high output noise spikes of short duration can be present in the ripple without appreciably increasing the rms value.

5-17 **Ripple Measurement Techniques.** Figure 5-2A shows an incorrect method of measuring peak-to-peak ripple. Note that a continuous ground loop exists from the third wire of the input power cord of the supply to the third wire of the input power cord of the oscilloscope via the grounded power supply case, the internal jumper connecting the power supply negative output and sensing terminals, the wire between the negative sensing terminal of the power supply and the vertical input of the scope, and the grounded scope case. Any ground current circulating in this loop as a result of the difference in potential E_G between the two ground points causes an IR drop which is in series with the scope input. This IR drop, normally having a 60Hz line frequency fundamental,

plus any pickup on the unshielded leads interconnecting the power supply and scope, appears on the face of the CRT. The magnitude of this resulting noise signal can easily be much greater than the true ripple developed between the plus and minus sensing terminals of the power supply and can completely invalidate the measurement.

5-18 The same ground current and pickup problems can exist if an rms voltmeter is substituted for the oscilloscope in Figure 5-2. However, the oscilloscope display, unlike the true-rms meter reading, tells the observer immediately whether the fundamental period of the signal displayed is 8.3 milliseconds (1/120Hz) or 16.7 milliseconds (1/60Hz). Since the fundamental ripple frequency present on the output of an HP supply is 120Hz (due to full-wave rectification), an oscilloscope display showing a 120Hz fundamental component indicates a "clean" measurement setup, while the presence of a 60Hz fundamental usually means that an improved setup will result in a more accurate (and lower) value of measured ripple.

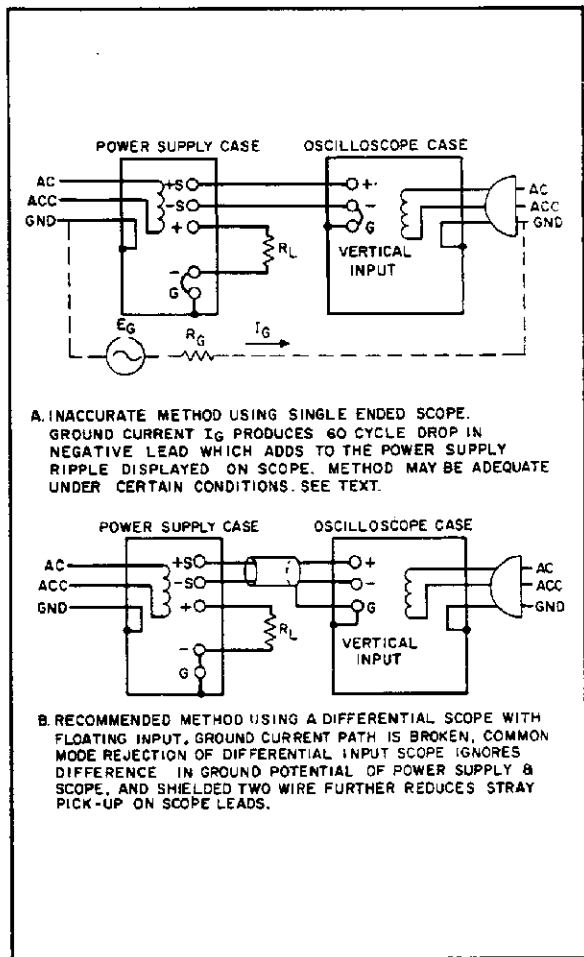

Figure 5-2. Ripple Test Setup

5-19 Although the method shown in Figure 5-2A is not recommended for ripple measurements, it may prove satisfactory in some instances provided certain precautions are taken. One method of minimizing the effects of ground current flow (I_G) is to ensure that both the supply and the test instrument are plugged into the same ac power bus.

5-20 To minimize pickup, a twisted pair or (preferably) a shielded two-wire cable should be used to connect the sensing terminals of the power supply to the vertical input terminals of the scope. When using a twisted pair, take care that the same wire is connected both to the grounded terminal of the power supply and the grounded input terminal of the oscilloscope. When using shielded two-wire cable, it is essential for the shield to be connected to ground at only one end to prevent any ground current flowing through this shield from inducing a signal in the shielded leads.

5-21 To verify that the oscilloscope is not displaying ripple that is induced in the leads or picked up from the grounds, short the (+) scope lead to the (-) scope lead at the power supply terminals. The ripple value obtained when the leads are shorted should be subtracted from the indicated ripple measurement.

5-22 If the foregoing measures are used, the single-ended scope of Figure 5-2A might be adequate to eliminate extraneous ripple components so that a satisfactory measurement can be obtained. However, in stubborn cases or in measurement situations where it is essential that both the power supply case and the oscilloscope case be connected to ground (if both are rack-mounted, for example), it may be necessary to use a differential scope with floating input as shown in Figure 5-2B. If desired, two single-conductor shielded cables may be substituted in place of the shielded two-wire cable with equal success. Because of its common mode rejection, a differential oscilloscope displays only the difference in signal between its two vertical input terminals, thus ignoring the effects of any common mode signal produced by the difference in the ac potential between the power supply case and scope case. Before using a differential input scope, however, it is imperative that the common mode rejection capability of the scope be verified by shorting together its two input leads at the power supply and observing the trace on the CRT. If this trace is a straight line, then the scope is properly ignoring any common mode signal present. If this trace is not a straight line, then the scope is not rejecting the ground signal and must be realigned in accordance with the manufacturer's instructions so that proper common mode rejection is attained.

5-23 **Ripple Measurement Procedure.** To check the ripple output, proceed as follows:

- Connect oscilloscope or rms voltmeter as shown in Figures 5-2A or 5-2B.
- Turn CURRENT controls fully clockwise.
- Turn on supply and adjust VOLTAGE controls until front panel meter indicates maximum rated output voltage.
- The observed ripple should be less than:

All models except 6274B	200 μ V rms, 10mV p-p
6274B	200 μ V rms, 20mV p-p

5-24 **Noise Spike Measurements.** An instrument of sufficient bandwidth must be used when making a high frequency spike measurement. An oscilloscope with a bandwidth of 20MHz or more is adequate. Measuring noise with an instrument that has insufficient bandwidth may conceal high frequency spikes that could be detrimental to the load.

5-25 The test setup illustrated in Figure 5-2A is generally not adequate for measuring spikes; a differential oscilloscope is necessary. Furthermore, the measurement technique of Figure 5-2A must be modified as follows if accurate spike measurement is to be achieved:

- As shown in Figure 5-3, two coax cables must be substituted for the shielded two-wire cable.
- Impedance matching resistors must be included to eliminate standing waves and cable ringing, and capacitors must be connected to block dc current.
- The length of the test leads outside the coax is critical and must be kept as short as possible. The blocking capacitor and impedance matching resistor should be connected directly from the inner conductor of the cable to the power supply sensing terminal.
- Notice that the shields at the power supply end of the two coax cables are not connected to the power supply ground since such a connection would give rise to a ground current path through the coax shield and result in an erroneous measurement.

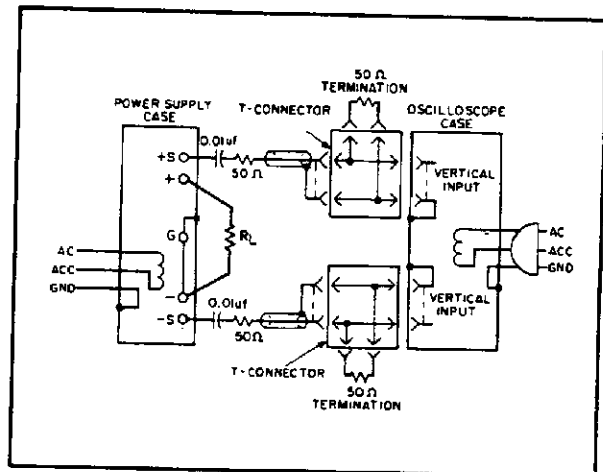

Figure 5-3. Noise Spike Measurement Test Setup

5. Since the impedance matching resistors constitute a 2-to-1 attenuator, the noise spikes observed on the oscilloscope should be less than 10mV p-p for the Model 6274B or less than 5mV p-p for the other models.

5-26 The circuit of Figure 5-3 can also be used for the normal measurement of low frequency ripple. Simply remove the four terminating resistors and the blocking capacitors and substitute a higher gain vertical plug-in for the wide-band plug-in required for spike measurements. Notice that with these changes, Figure 5-3 becomes a two-cable version of Figure 5-2B.

5-27 Load Transient Recovery Time.

Definition: The time "X" for output voltage recovery to within "Y" millivolts of the nominal output voltage following a "Z" amp step change in load current, where: "Y" is specified as 10mV; the nominal output voltage is defined as the dc level halfway between the static output voltage before and after the imposed load change; and "Z" is the specified load current change of 5 amps or the full-load current rating of the supply, whichever is less. Load transient recovery time may be measured at any input line voltage combined with any output voltage and load current within rating.

5-28 **Measurement Techniques.** Care must be taken in switching the load resistance on and off. A hand-operated switch in series with the load is not adequate since the resulting one-shot displays are difficult to observe on most oscilloscopes and the arc energy occurring during switching completely masks the display with a noise burst. Transistor load switching devices are expensive if reasonably rapid load current changes are to be achieved.

5-29 We suggest that a mercury-wetted relay connected in the load switching circuit shown in Figure 5-4 be used for loading and unloading the supply. When this load switch is connected to a 60Hz ac input, the mercury-wetted relay opens and closes 60 times per second. The 25k control adjusts the duty cycle of the load current switching to reduce jitter in the oscilloscope display. This relay may also be used with a 50Hz ac input. The load resistance shown in Figure 5-4 is the minimum resistance that can be used without damaging the mercury-wetted relay contacts.

5-30 **Measurement Procedure.** To check the load transient recovery time, proceed as follows:

- a. Connect test setup shown in Figure 5-4.
- b. Turn CURRENT controls fully clockwise.
- c. Turn on supply and adjust VOLTAGE controls until front panel ammeter indicates either 5 amps or the full-load current rating of the supply, whichever is less.
- d. Close line switch on repetitive load switch setup.
- e. Set oscilloscope for internal sync and lock on either the positive or negative load transient spike.

f. Set vertical input of oscilloscope for ac coupling so that small dc level changes in power supply output voltage will not cause display to shift.

g. Adjust the vertical centering on the scope so that the tail ends of the no-load and full-load waveforms are symmetrically displaced about the horizontal centerline of the oscilloscope. This centerline now represents the nominal output voltage defined in the specification.

h. Adjust the horizontal positioning control so that the trace starts at a major graticule division. This point then represents time zero.

i. Increase the sweep rate so that a single transient spike can be examined in detail.

j. Adjust the sync controls separately for the positive and negative-going transients so that not only the recovery waveshape but also as much as possible of the rise time of the transient is displayed.

k. Starting from the major graticule division representing time zero, count to the right 50µsec and vertically 10mV. Recovery should be within these tolerances as illustrated in Figure 5-5.

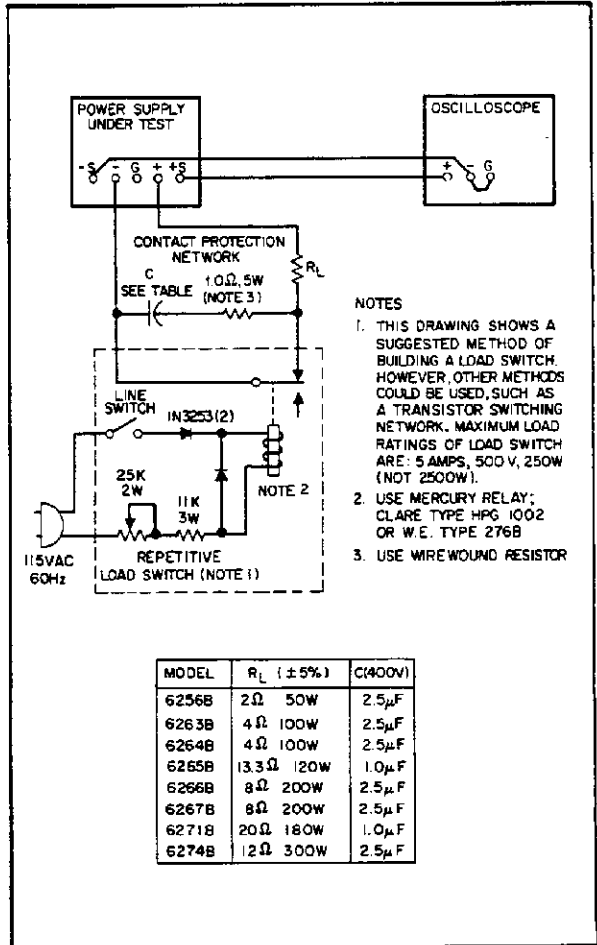

Figure 5-4. Load Transient Recovery Time Test Setup

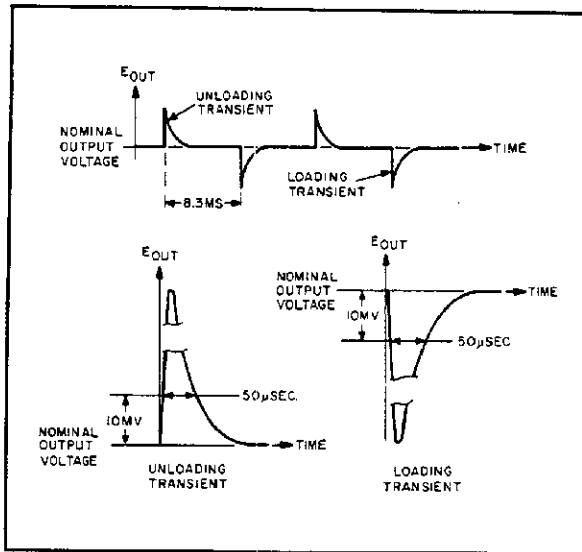

Figure 5-5. Load Transient Recovery Time Waveforms

5-31 Temperature Coefficient.

Definition: The change in output voltage per degree Celsius change in the ambient temperature measured while ac line voltage, output voltage setting, and load resistance are all held constant.

5-32 The temperature coefficient of a power supply is measured by placing the power supply in an oven and varying it over any temperature span within its rating. (Most HP power supplies are rated for operation from 0°C to 55°C.) The power supply temperature must be allowed to stabilize for a sufficient time at each measurement temperature.

5-33 The temperature coefficient given in the specifications is the maximum temperature-dependent output voltage change which will result over any one-degree interval. The digital voltmeter used to measure the supply's output voltage change should be placed outside the oven and should have a long-term stability adequate to insure that its drift will not affect the overall measurement accuracy.

5-34 To check the temperature coefficient, proceed as follows:

- Connect load resistance and digital voltmeter as illustrated in Figure 5-1.
- Turn CURRENT controls fully clockwise.
- Turn on supply and adjust front panel VOLTAGE controls until front panel voltmeter indicates maximum rated output voltage.
- Place power supply in temperature-controlled oven (digital voltmeter remains outside oven). Set temperature to 30°C and allow 30 minutes warm-up.

- Record digital voltmeter reading.
- Raise temperature to 40°C and allow 30-minutes warm-up.

g. Observe digital voltmeter reading. Difference in voltage reading between steps (e) and (g) should be less than:

6256B	12mV
6263B, 6264B	22mV
6265B, 6266B, 6267B	42mV
6271B, 6274B	62mV

5-35 Drift (Stability):

Definition: The change in output voltage for the first eight hours following a 30-minute warm-up period. During the interval of measurement, input line voltage, load resistance, and ambient temperature, are all held constant.

5-36 This measurement is made by monitoring the output of the power supply on a digital voltmeter over the stated measurement interval. A strip chart recorder can be used to provide a permanent record. Place a thermometer near the supply to verify that the ambient temperature remains constant during the period of measurement. The supply should be located away from any source of stray air currents. If possible, place the supply in an oven and hold it at a constant temperature. Take care that the measuring instrument has an eight-hour stability at least an order of magnitude better than the stability specification of the power supply being tested. Typically, a supply will drift less over the eight-hour measurement interval than during the half-hour warm-up period.

5-37 To check the output stability, proceed as follows:

- Connect load resistance and digital voltmeter as illustrated in Figure 5-1.
- Turn CURRENT controls fully clockwise.
- Turn on supply and adjust front panel VOLTAGE controls until digital voltmeter indicates maximum rated output voltage.
- Allow 30 minutes warm-up, then record digital voltmeter reading.
- After 8 hours, digital voltmeter reading should not differ from the step (d) reading by more than:

6256B	3.5mV
6263B, 6264B	6.5mV
6265B, 6266B	12.5mV
6267B	14mV
6271B	18.5mV
6274B	20mV

5-38 CONSTANT-CURRENT TESTS

5-39 The instruments, methods, and precautions for the proper measurement of constant-current power supply characteristics are for the most part identical to those

already described for the measurement of constant-voltage characteristics. There are, however, two main differences: First, the power supply performance will be checked between short circuit and full load rather than open circuit and full load. Second, a current monitoring resistor is inserted between the output of the power supply and the load.

5-40 For all output current measurements, the current sampling resistor must be connected as a four-terminal device in the same manner as a meter shunt would be. The load current is fed to the extremes of the wire leading to the resistor while the sampling terminals are located as close as possible to the resistance element itself (see Figure 5-6). A current sampling resistor should have low noise, low temperature coefficient (less than 30ppm/°C) and should be used at no more than 5% of its rated power so that its temperature rise will be minimized.

NOTE

In case of difficulty obtaining a low resistance, high current resistor suitable for current sampling, a duplicate of the sampling resistor used in this unit (R54) may be obtained from the factory.

5-41 **Current Output and Ammeter Accuracy.** To check that the supply will furnish its rated output current, proceed as follows:

- a. Connect test setup shown in Figure 5-7.
- b. Turn VOLTAGE controls fully clockwise.
- c. Turn on supply and adjust CURRENT controls until front panel ammeter indicates maximum rated output current.
- d. Digital voltmeter should read 0.5 ± 0.01 Vdc.

5-42 **Load Effect (Load Regulation).**

Definition: The change ΔI_{OUT} in the static value of the dc output current resulting from a change in load resistance from short circuit to a value which yields maximum rated output voltage, or vice versa.

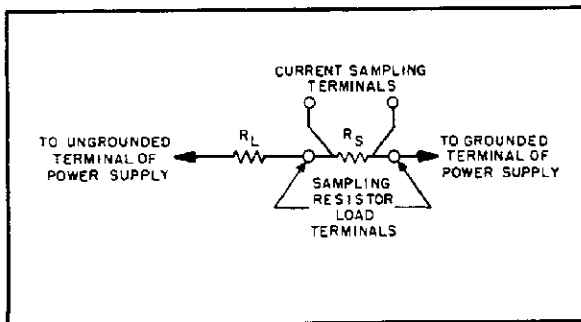

Figure 5-6. Current Sampling Resistor Connections

5-43 To check the constant-current load effect proceed as follows:

- a. Connect test setup shown in Figure 5-7.
- b. Turn VOLTAGE controls fully clockwise.
- c. Turn on supply and adjust CURRENT controls until front panel ammeter indicates exactly maximum rated output current.
- d. Read and record voltage indicated on digital voltmeter.
- e. Short circuit load resistor (R_L).
- f. Digital voltmeter reading should not differ from reading recorded in step (d) by more than:

6256B, 6264B	113 μ V
6263B, 6267B	125 μ V
6265B, 6271B	184 μ V
6266B	150 μ V
6274B	116 μ V

5-44 **Source Effect (Line Regulation).**

Definition: The change ΔI_{OUT} in the static value of dc output current resulting from a change in ac input voltage over the specified range from low line to high line or from high line to low line.

5-45 To check source effect, proceed as follows:

- a. Connect test setup shown in Figure 5-7.
- b. Connect variable autotransformer between input power source and power supply power input.
- c. Adjust autotransformer for 104Vac input.
- d. Turn VOLTAGE controls fully clockwise.
- e. Turn on supply and adjust CURRENT controls until front panel ammeter reads exactly maximum rated output current.
- f. Read and record voltage indicated on digital voltmeter.
- g. Adjust autotransformer for 127Vac input.
- h. Digital voltmeter reading should not differ from reading recorded in step (f) by more than:

6256B, 6264B	113 μ V
6263B, 6267B	125 μ V
6265B, 6271B	184 μ V
6266B	150 μ V
6274B	116 μ V

5-46 **PARD (Ripple and Noise).**

Definition: The residual ac current superimposed on the dc output of a regulated power supply. Ripple and noise measurement may be made at any input ac line voltage combined with any dc output voltage and load current within the supply's rating.

5-47 Most of the instructions pertaining to the ground loop and pickup problems associated with constant-voltage ripple and noise measurement also apply to the measurement of constant-current ripple and noise. Figure 5-8 illustrates the most important precautions to be observed when measuring the ripple and noise of a constant-current

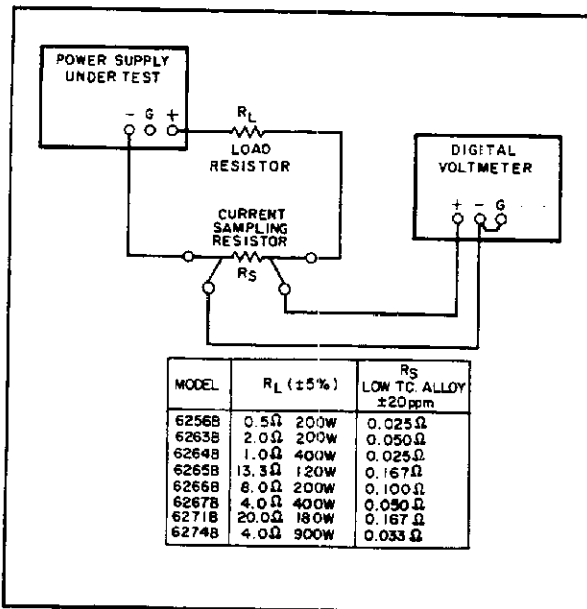

Figure 5-7. Constant-Current Load Regulation Test Setup

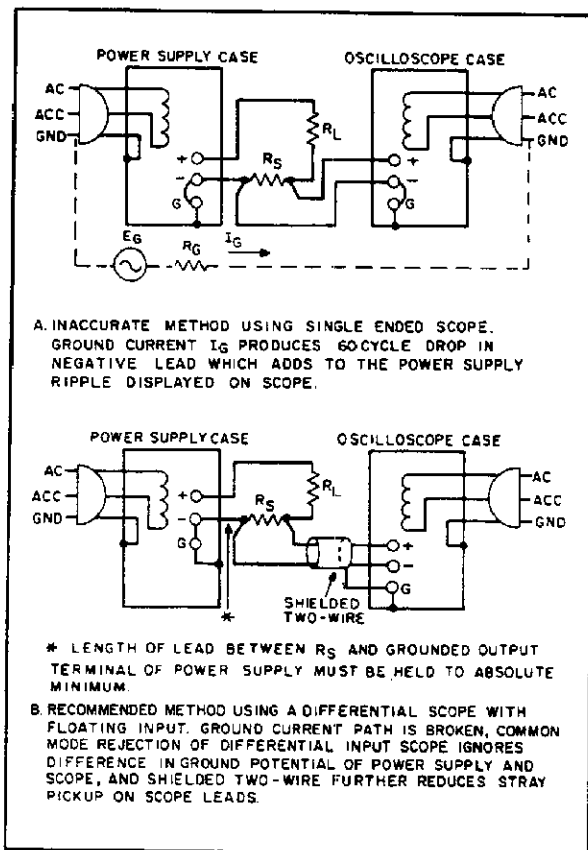

Figure 5-8. Constant-Current Ripple and Noise Test Setup

supply. The presence of a 120Hz waveform on the oscilloscope normally indicates a correct measurement method. A waveshape having 60Hz as its fundamental component usually indicates an incorrect measurement setup.

5-48 To check the ripple and noise, proceed as follows:

a. Connect oscilloscope or rms voltmeter as shown in Figure 5-8A or 5-8B.

b. Rotate VOLTAGE controls fully clockwise.

c. Turn on supply and adjust CURRENT controls until front panel ammeter reads exactly maximum rated output current.

d. The observed ripple and noise should be less than:

6256B, 6264B	125 μV rms
6263B, 6267B	150 μV rms
6265B, 6271B	501 μV rms
6266B	300 μV rms
6274B	165 μV rms

5-49 TROUBLESHOOTING

5-50 Before attempting to troubleshoot this instrument, ensure that the fault is with the instrument and not with an associated circuit. The performance test (paragraphs 5-5 through 5-48) enables this to be determined without removing the instrument from the cabinet.

5-51 A good understanding of the principles of operation is a helpful aid in troubleshooting, and it is recommended that the reader review Section IV of the manual before attempting to troubleshoot the unit in detail. Once the principles of operation are understood, refer to the overall troubleshooting procedures in paragraph 5-54 to locate the symptom and probable cause.

5-52 The schematic diagram contains normal voltage readings adjacent to some test points. (Test points are identified by circled numbers.) The measurement conditions are listed in the Schematic Notes. Consult the component location diagrams in Section VII to determine the locations of components and test points.

5-53 If a component is found to be defective, replace it and re-conduct the performance test. When a component is replaced, refer to the repair and replacement (paragraph 5-60) and adjustment and calibration (paragraph 5-62) sections of this manual.

5-54 OVERALL TROUBLESHOOTING PROCEDURES

5-55 To locate the cause of trouble, follow steps 1, 2, and 3 in sequence:

(1) Check for obvious troubles such as a defective power cord, an input power failure, or a defective meter.

Next, remove the top and bottom covers and inspect for open connections, charred components, or any other visible defects. If the trouble source cannot be detected by visual inspection, proceed to step (2).

(2) In almost all cases, the trouble can be caused by incorrect dc bias or reference voltages; thus, it is a good practice to check the voltages in Table 5-2 before proceeding with step (3).

(3) Disconnect the load and examine Table 5-3 for your symptom and its probable cause.

5-56 Table 5-3 contains symptoms and probable causes of many possible troubles. If either high or low output voltage is a symptom, Table 5-4 contains the steps necessary to isolate the trouble to one of the feedback loops and instructions directing the tester to the proper table for further isolation. Because of the interactions between loops, it is necessary to refer to Table 5-4 before proceeding to Tables 5-5, 5-6, or 5-7.

5-57 Tables 5-5, 5-6, and 5-7 contain troubleshooting procedures for the series regulator and preregulator feedback

loops once the fault has been isolated to one of them. Tables 5-5 and 5-6 contain instructions for driving each stage into conduction or cut-off. By following the steps in these tables, the fault can be isolated to a circuit or a component.

5-58 Table 5-7 contains troubleshooting procedures for the preregulator feedback loop. Troubleshooting is accomplished by comparing waveform illustrations with the waveforms found at various test points and then checking the components most likely to be at fault.

5-59 After troubleshooting the unit, it may be necessary to perform one or more of the calibration procedures given in this section.

WARNING

Some circuits in this power supply are connected directly to the input ac power line. The red-painted case and heatsink of the A2 RFI Assembly are also at ac line potential. Exercise extreme caution when working on energized circuits.

Table 5-2. Reference and Bias Voltages
(Refer to schematic and component location diagrams in Section VII for test point locations)







STEP	METER COMMON	METER POSITIVE	NORMAL VDC	NORMAL RIPPLE (P-P)	PROBABLE CAUSE
1		TP31	12.4 ±5%	2.0mV	Q9, 14, 15, 16; VR1, 2; CR7
2		TP25	6.2 ±2%	0.5mV	VR1, VR2, R48
3	TP24		6.2 ±2%	2.0mV	VR1, VR2, R48
4		TP44	12 ±15%	2.0V	CR13, CR14, C12
5	TP45		4.8 ±10%	0.8V	CR13, CR14, C12, VR6, VR7
6	TP80		2.4 ±10%	0.4V	CR13, CR14, C12, VR6, VR7

Table 5-3. Overall Troubleshooting

SYMPTOM	PROBABLE CAUSE
Low or no output voltage (OVERVOLTAGE lamp may be on or off)	<ul style="list-style-type: none"> a. Front panel meter defective. b. Crowbar not reset or defective. Refer to Table 5-4. c. Series regulator or preregulator feedback loop defective. Refer to Table 5-4.
High output voltage	<ul style="list-style-type: none"> a. Front panel meter defective. b. Series regulator or preregulator loop defective. If crowbar does not trip, it too is faulty. Refer to Table 5-4.

Table 5-3. Overall Troubleshooting (Continued)

SYMPTOM	PROBABLE CAUSE
High ripple	a. Ground loops in operating setup. Refer to paragraph 5-17. b. Incorrect reference or bias voltages. Refer to Table 5-2. c. Supply crossing over to constant-current operation under loaded conditions. Check current limit setting or constant-current comparator circuit (Z1 and associated components).
Poor line regulation	a. Improper measurement technique. Refer to paragraph 5-13. b. Incorrect reference or bias voltages. Refer to Table 5-2.
Poor load regulation (Constant-voltage)	a. Improper measurement technique. Refer to paragraph 5-11. b. Incorrect reference or bias voltages. Refer to Table 5-2. c. Supply current limiting. Check constant-current comparator circuit (Z1 and associated components).
Poor load regulation (Constant-current)	a. Incorrect reference or bias voltages. Refer to Table 5-2. b. Supply voltage limiting. Check constant-voltage comparator circuit (Z1 and associated components) and voltage clamp circuit, Q10. c. Leaky C19, C20. d. CR9 defective.
Oscillates (Constant-current or constant-voltage)	a. Adjustment of R30. Refer to paragraph 5-82. b. Faulty C5, C6, C19, C20, R30, R33. c. Open sensing lead (+S).
Instability (Constant-current/constant-voltage)	a. Incorrect reference or bias voltages; CR9 defective. Refer to Table 5-2. b. Noisy voltage or current controls (R10, R11, or R16, R17.) c. Integrated circuit Z1 defective. d. CR1, CR2, CR5, or CR6 leaky. e. R1, R2, R9, R12, R13, R18, R19, R20, C1 noisy or drifting.
Cannot reach maximum output	Q13 shorted.

Table 5-4. Feedback Loop Isolation

STEP	ACTION	RESPONSE	PROBABLE CAUSE
1	Check fuses or inspect LINE circuit breaker.	a. Fuse blown or breaker tripped. b. Fuses and breaker OK; output voltage high. c. Fuses and breaker OK; output voltage low.	a. Check rectifier, filter, and triac for short. Proceed to step 3. b. Proceed to step 2. c. Proceed to step 2.

Table 5-4. Feedback Loop Isolation (Continued)

STEP	ACTION	RESPONSE	PROBABLE CAUSE
2	Inspect OVERVOLTAGE lamp on front panel.	a. On. b. Off; output voltage high. c. Off; output voltage low.	a. Check setting of OVERVOLTAGE ADJUST (R109). Check CR57 for short. Proceed to step 3. b. Check OVERVOLTAGE ADJUST (R109). Check CR57 for open. Also check Q24 and Q25. Proceed to step 3. c. Check OVERVOLTAGE ADJUST (R109). Check CR57 for open. Also check Q24 and Q25. Proceed to step 3.
3	Isolate fault to series regulator or preregulator by proceeding as follows: (1) Open the gate lead of triac A2CR1 (TP53). (2) Observing correct polarity, connect a small dc power supply across input capacitor (C13 or C14). A 0-10V, 1A supply is sufficient. (3) Set external supply to ten volts. (4) Vary front panel voltage controls.	a. Output voltage normal (variable from 0 volts to about 9 volts). b. Output voltage high. Varying controls has little or no effect. c. Output voltage low. Varying controls has little or no effect.	a. Faulty preregulator. Disconnect external source and proceed to Table 5-7. b. High voltage condition in series regulator. Proceed to Table 5-5. Leave external source connected. c. Low voltage condition in series regulator loop. Proceed to Table 5-6. Leave external source connected.

Table 5-5. Series Regulator Troubleshooting, High Output Voltage

STEP	ACTION	RESPONSE	PROBABLE CAUSE
Make these tests with external source connected as described in step 3 of Table 5-4.			
1	Check turn-off of driver and series regulator transistors Q3, Q6, (and Q7) by momentarily shorting rear panel terminal A4 to base of Q3 (TP45).	a. Output voltage remains high. b. Output voltage decreases.	a. Q6, Q7, CR11 or Q3 shorted. b. Proceed to step 2.
2	Check conduction of Q4 by momentarily shorting Q12 emitter to collector (TP74 to TP45).	a. Output voltage remains high. b. Output voltage decreases.	a. Q4 open. b. Proceed to step 3.
3	Check conduction of Q12 by momentarily connecting base (TP83) to collector (TP45).	a. Output voltage remains high. b. Output voltage decreases.	a. Q12 open. b. Proceed to step 4.
4	Check turn-off of Q5 by momentarily connecting base (TP84) to emitter (TP85).	a. Output voltage remains high. b. Output voltage decreases.	a. Q5 shorted. b. Proceed to step 5.

Table 5-5. Series Regulator Troubleshooting, High Output Voltage (Continued)

STEP	ACTION	RESPONSE	PROBABLE CAUSE
5	Check turn-off of Z1 by momentarily connecting a 10k Ω resistor between pin 10 (TP89) and +6.2V supply (TP25).	a. Output voltage remains high. b. Output voltage decreases.	a. CR1 open. Z1 defective. b. R5, R6, R10, or R11 open, strap between A1 and A2 open.

Table 5-6. Series Regulator Troubleshooting, Low Output Voltage

STEP	ACTION	RESPONSE	PROBABLE CAUSE
	Make these tests with external source connected as described in step 3 of Table 5-4.		
1	Check turn-off of Q4 by momentarily shorting base (TP69) to emitter (TP75).	a. Output voltage remains low. b. Output voltage rises.	a. Q4 shorted. Q3, Q6, (Q7) open. b. Proceed to step 2.
2	Check turn-off of Q12 by momentarily shorting base (TP83) to emitter (TP74).	a. Output voltage remains low. b. Output voltage rises.	a. Q12 shorted. b. Proceed to step 3.
3	Isolate fault to constant-voltage comparator or constant-current comparator by opening the cathode of CR4.	a. Output voltage rises. b. Output voltage remains low.	a. Z1 defective; strap between A6 and A7 open; R16, R17 shorted. b. Reconnect lead and proceed to step 4.
4	Check turn-on of Q5 by momentarily shorting base (TP84) to collector (TP83).	a. Output voltage remains low. b. Output voltage rises.	a. Q5 or CR8 open, Q11 shorted. b. Proceed to step 5.
5	Check turn-on of Z1 by momentarily connecting a 10k Ω resistor between pin 10 (TP89) and -6.2V supply (TP24).	a. Output voltage remains low. b. Output voltage rises.	a. Z1 defective. b. R10 or R11 shorted, strap between A2 and A3 open, R9 open, C1 shorted, CR20 shorted.

Table 5-7. Preregulator Troubleshooting (See Figure 4-4 for Waveforms)

STEP	ACTION	RESPONSE	PROBABLE CAUSE
1	Connect oscilloscope between TP59 (+) and TP81 (-).	a. Normal waveform. b. Little or no voltage.	a. Proceed to step 2. b. Defective Q18, Q19, or C18. Proceed to step 3.
2	Connect oscilloscope between TP53 (+) and TP55 (-).	a. Normal waveform. b. Little or no voltage.	a. Defective A2CR1, A2L1A/A2L1B, T1, A2C1, A2C3. b. Defective T3, CR40, R84. Proceed to step 3.
		WARNING	
<i>To avoid a potentially lethal shock hazard, a differential oscilloscope must be used in making this measurement.</i>			

Table 5-7. Preregulator Troubleshooting (See Figure 4-4 for Waveforms) (Continued)

STEP	ACTION	RESPONSE	PROBABLE CAUSE
3	Connect oscilloscope between TP73 (+) and TP81 (-).	a. Amplitude incorrect. b. Period incorrect.	a. Defective Q22, C15, C17, CR43, CR44, R78, R86, or R87. b. CR38 defective. Proceed to step 4.
4	Connect oscilloscope between TP64 (+) and TP67 (-).	Amplitude, dc reference, or period incorrect.	Defective CR28, CR33, CR36, CR37, CR38. Check R70.
5	Connect oscilloscope between TP67 (+) and TP81 (-).	Amplitude, dc reference, or period incorrect.	Defective CR27, CR31, R68, R69, C16.

Table 5-8. Checks and Adjustments Required After Semiconductor Replacement

REFERENCE	FUNCTION OR CIRCUIT	CHECK	ADJUST
Z1	Constant-voltage and constant-current differential amplifiers	Constant-voltage (CV) line and load regulation. Zero volt output. Constant-current (CC) line and load regulation. Zero current output.	R6 or R8 (or R124 if Option 020 or 040). R25 or R28 (or R128 if Option 021 or 040). See para. 5-70 and 5-77).
Q3, Q4, Q12	Driver and error amplifiers.	CV/CC load regulation.	--
Q5, Q11	Mixer amplifier.	CV/CC load regulation. CV transient response.	R30 (See para. 5-82).
Q6 (Q7)	Series regulator.	CV/CC load regulation.	--
Q9, Q14, Q15, Q16	Reference regulator.	+12.4V reference voltage; constant voltage line regulation.	--
Q10	Voltage clamp circuit.	CC load regulation.	--
Q13	Short circuit protection.	Output current.	--
Q18, Q19, Q22	Preregulator control.	Output voltage, ripple imbalance, and preregulator waveforms.	R75, R78 (See para. 5-84 and 5-86).
Q23, Q24, Q25	Crowbar.	Trip voltage, voltage across series regulator when tripped.	R108, R109 (See para. 5-88 and 5-90).
CR1, CR2	Limiting diodes.	CV load regulation, stability.	--
CR3 - CR5	OR gate and limiting diode.	CV/CC load regulation.	--

Table 5-8. Checks and Adjustments Required After Semiconductor Replacement (Continued)

REFERENCE	FUNCTION OR CIRCUIT	CHECK	ADJUST
CR6, CR8, CR46	Temperature stabilizing diodes.	Temperature coefficient.	---
CR7, CR20	Reference regulator.	+12.4 and +6.2 reference voltages.	--
CR9, CR56 – CR60	Crowbar.	Trip voltage, voltage across series regulator when crowbar is tripped, supply stability.	R108, R109. (See para. 5-88 and 5-90).
CR10, 12 – 14, CR21 – 24, 27, CR28, 31, 33	Rectifier diodes.	Voltage across appropriate filter capacitor.	--
CR15	Bias supply.	+12V unregulated bias voltage.	--
CR11, CR34	Reverse voltage protection.	Output voltage.	--
CR30, CR32	Voltage clamp circuit.	CC load regulation.	--
CR36 – 38, 40 CR43, 44, 51 CR52	Preregulator control.	Output voltage, ripple imbalance, and preregulator waveforms.	R75, R78. (See para. 5-84 and 5-86).
CR45, 47, 50	Turn-on circuit.	Preregulator control turn-on delay.	--
A2CR1	Preregulator.	Output voltage.	R75 (See para. 5-86).
VR1, VR2	Reference supply.	+6.2V and –6.2V reference voltages.	--
VR3	Voltage clamp circuit.	CC load regulation.	--
VR4	Mixer amplifier stabilization diode.	CV transient response.	R30 (See para. 5-82).
VR5	Crowbar.	Trip voltage.	R108, R109 (See para. 5-88 and 5-90).
VR6, VR7	Bias voltage supply.	–2.4V and –4.8V bias voltages.	--

5-60 REPAIR AND REPLACEMENT

5-61 Section VI of this manual contains a list of replaceable parts. If the part to be replaced does not have a standard manufacturer's part number, it is a special part and must be obtained directly from Hewlett-Packard. After replacing a semiconductor device, refer to Table 5-8 for the checks and adjustments that may be necessary.

5-62 ADJUSTMENT AND CALIBRATION

5-63 Adjustment and calibration may be required after performance testing, troubleshooting, or repair and replacement. Perform only those adjustments that affect the operation of the faulty circuit.

5-64 Meter Zero Adjustment

5-65 The meter pointer must rest on the zero calibration mark on the meter scale when the instrument is at normal operating temperature, resting in its normal operating position, and turned off. To zero the meter proceed as follows:

- Turn on instrument and allow it to come up to normal operating temperature (about 30 minutes).
- Turn instrument off and wait two minutes for power supply capacitors to discharge completely.
- Insert pointed object (pen point or awl) into small indentation near top of round black plastic disc located directly below meter face.
- Rotate plastic disc clockwise until meter reads zero, then rotate counterclockwise slightly in order to free adjustment screw from meter suspension. Pointer should not move during latter part of adjustment.

5-66 Voltmeter Calibration

5-67 To calibrate the voltmeter, proceed as follows:

- Connect digital voltmeter across plus and minus output terminals of supply, observing correct polarity.
- Turn on supply and adjust VOLTAGE controls until digital voltmeter reads exactly the maximum rated output voltage.
- Adjust R56 until front panel voltmeter also indicates exactly the maximum rated output voltage.

5-68 Ammeter Calibration

5-69 To calibrate the ammeter, proceed as follows:

- Connect test setup shown in Figure 5-7.
- Turn VOLTAGE controls fully clockwise.
- Turn on supply and adjust CURRENT controls until digital voltmeter reads 500mV.
- Adjust R63 until front panel ammeter indicates exactly maximum rated output current.

5-70 Constant-Voltage Programming Calibration

5-71 **Zero Output Voltage, Standard Instrument.** To calibrate the zero voltage programming accuracy of a standard instrument, proceed as follows:

- Connect digital voltmeter between the +S and -S terminals, observing correct polarity.
- If unit is to be used in local programming mode, turn VOLTAGE controls fully counterclockwise. If unit is to be used in remote programming mode, connect remote programming setup (Figure 3-4 or 3-5) and adjust remote resistance or voltage to zero.
- Rotate CURRENT controls fully clockwise and turn on supply.
- Observe digital voltmeter reading. If reading is more positive than 0 volts, shunt resistor R6 with decade resistance box.
- Adjust decade resistance until digital voltmeter reads exactly zero, then shunt R6 with fixed, metal film, $\pm 1\%$, 1/4 or 1/8 watt resistor of value equal to that of decade box.
- If reading of step (d) is more negative than 0 volts, shunt resistor R8 with decade resistance box.
- Adjust decade resistance until digital voltmeter reads exactly zero, then shunt R8 with fixed, metal film, $\pm 1\%$, 1/4 or 1/8 watt resistor of value equal to that of decade box.

NOTE

The internal temperature rise of the power supply has an effect on the accuracy of the programming coefficient. For example, an internal temperature rise of 15°C (typical of the temperature difference between no-load and full-load operation) causes the supply output to change by 0.15%. Since the factory calibration procedure for instruments equipped with Option 020 or 040 sets the voltage programming coefficient to within 0.1%, the resulting accuracy specification including the effect of the 15°C temperature rise would be 0.25%.

5-72 **Zero Output Voltage, Option 020.** To calibrate the zero voltage programming accuracy of an instrument equipped with Option 020, proceed as follows:

- Perform steps (a) through (c) of paragraph 5-71.
- Adjust potentiometer R124 (labeled "VOLTAGE ZERO" and accessible through hole in rear panel) until digital voltmeter reading is zero volts $\pm 1\text{mV}$.

5-73 **Zero Output Voltage, Option 040.** To calibrate the zero voltage programming accuracy of an instrument equipped with Option 040, proceed as follows:

- Connect supply for remote resistance programming as shown in Figure 3-4 and adjust programming resistor

for 10 ohms $\pm 1\%$.

- b. Connect a digital voltmeter between the +S and –S terminals, observing correct polarity.
- c. Rotate CURRENT controls fully clockwise and turn on supply.
- d. Adjust potentiometer R124 (labeled "VOLTAGE ZERO" and accessible through hole in rear panel) until digital voltmeter reads zero volts $\pm 1\text{mV}$.

5-74 CV Programming Accuracy, Standard Instrument.

To calibrate the constant-voltage programming current of a standard instrument, proceed as follows:

- a. Connect a $\pm 0.1\%$ 1/4 watt resistor of the value shown below between terminals –S and A2 on the rear barrier strip and disconnect jumper between A1 and A2.

6256B	2k Ω
6263B, 6264B	4k Ω
6265B, 6266B, 6267B	8k Ω
6271B, 6274B	18k Ω
- b. Connect a digital voltmeter between the +S and –S terminals.
- c. Connect decade resistance in place of R13.
- d. Rotate CURRENT controls fully clockwise and turn on supply.
- e. Adjust decade resistance box until digital voltmeter indicates full rated output voltage $\pm 0.1\%$.
- f. Replace decade resistance with $\pm 5\%$, 1/2 watt resistor of appropriate value in R13 position.

5-75 CV Programming Accuracy, Option 020. To calibrate the constant-voltage programming current of an instrument equipped with Option 020, proceed as follows:

- a. Perform steps (a) and (b) of paragraph 5-74.
- b. Rotate CURRENT controls fully clockwise and turn on supply.
- c. Adjust potentiometer R122 (labeled "VOLTAGE PROG" and accessible through hole in rear panel) until digital voltmeter indicates full rated output voltage $\pm 0.1\%$.

5-76 CV Programming Accuracy, Option 040. To calibrate the constant-voltage programming current of an instrument equipped with Option 040, proceed as follows:

- a. Connect a $\pm 0.1\%$ 1/4 watt resistor of the value shown below between terminals –S and A2 on rear barrier strip and disconnect jumper between A1 and A2.

6256B	2010 Ω
6263B, 6264B	4010 Ω
6265B, 6266B, 6267B	8010 Ω
6271B, 6274B	18010 Ω
- b. Connect a digital voltmeter between the +S and –S terminals.
- c. Rotate CURRENT controls fully clockwise and turn on supply.
- d. Adjust potentiometer R122 (labeled "VOLTAGE PROG" and accessible through hole in rear panel) until digital voltmeter indicates full rated output voltage $\pm 0.1\%$.

5-77 Constant-Current Programming Calibration

5-78 Zero Output Current, Standard Instrument. To calibrate the zero current programming accuracy of a standard instrument, proceed as follows:

- a. Connect test setup shown in Figure 5-7, except substitute a short circuit for load resistor R_L .
- b. If unit is to be used in local programming mode, turn CURRENT controls fully counterclockwise. If unit is to be used in remote programming mode, connect remote programming setup (Figure 3-6 or 3-7) and adjust remote resistance or voltage to zero.
- c. Rotate VOLTAGE controls fully clockwise and turn on supply.
- d. Observe digital voltmeter reading. If reading is more positive than 0 volts, shunt resistor R25 with decade resistance box.
- e. Adjust decade resistance until digital voltmeter reads exactly zero, then shunt R25 with fixed, metal film, $\pm 1\%$, 1/4 or 1/8 watt resistor of value equal to that of decade resistance.
- f. If reading of step (d) is more negative than 0 volts, shunt resistor R28 with decade resistance box.
- g. Adjust decade resistance until digital voltmeter reads exactly zero, then shunt R28 with fixed, metal film, $\pm 1\%$ 1/4 or 1/8 watt resistor of value equal to that of decade box.

5-79 Zero Output Current, Option 021 or 040. To calibrate the zero current programming accuracy of an instrument equipped with Option 021 or 040, proceed as follows:

- a. Perform steps (a) through (c) of paragraph 5-78.
- b. Adjust potentiometer R128 (labeled "CURRENT ZERO" and accessible through hole in rear panel) until digital voltmeter reading is zero volts $\pm 2\text{mV}$.

5-80 CC Programming Accuracy, Standard Instrument. To calibrate the constant-current programming current of a standard instrument, proceed as follows:

- a. Connect test setup shown in Figure 5-7, except substitute a short circuit for load resistor R_L .
- b. Disconnect jumper between A5 and A6 on rear barrier strip.
- c. Connect a $\pm 0.1\%$, 1/4 watt resistor of the value shown below between terminals A4 and A6 on rear barrier strip.

6256B, 6264B	200 Ω
6263B, 6266B	1000 Ω
6267B, 6274B	1000 Ω
6265B, 6271B	900 Ω
- d. Connect decade resistance box in place of R19.
- e. Rotate VOLTAGE controls fully clockwise and turn on supply.
- f. Adjust decade resistance until digital voltmeter indicates 500 $\pm 10\text{mV}$.
- g. Replace decade resistance with $\pm 5\%$, 1/2 watt

resistor of appropriate value in R19 position.

5-81 CC Programming Accuracy, Option 021 or 040.

To calibrate the constant-current programming current of an instrument equipped with Option 021 or 040, proceed as follows:

- a. Perform steps (a) through (c) of paragraph 5-80.
- b. Rotate VOLTAGE controls fully clockwise and turn on supply.
- c. Adjust potentiometer R126 (labeled "CURRENT PROG" and accessible through hole in rear panel) until digital voltmeter indicates $500 \pm 10\text{mV}$.

5-82 Load Transient Recovery Time Adjustment

5-83 To adjust the transient response, proceed as follows:

- a. Connect test setup shown in Figure 5-4.
- b. Repeat steps (a) through (k) as outlined in paragraph 5-30.
- c. Adjust R30 (transient recovery) until transient response is within specification as shown in Figure 5-5.

5-84 Ripple Balance Adjustment

5-85 This procedure ensures balanced triac operation by ensuring that its conduction time is within 25% of being equal in both directions. To check for imbalance, proceed as follows:

- a. Connect load resistor specified in Figure 5-1 across rear output terminals of supply.
- b. Connect variable autotransformer between input power source and power supply input and adjust it for a 115Vac input to the supply.
- c. Connect ac-coupled oscilloscope across series regulator (between TP47 and TP81).
- d. Turn CURRENT controls fully clockwise, turn on supply, and adjust VOLTAGE controls for maximum rated output voltage.
- e. Adjust oscilloscope to observe 120Hz sawtooth waveform. Peak amplitudes of adjacent sawtooth peaks should be within 25% of each other.
- f. If amplitude difference is greater than 25%, turn off supply and replace R78 with decade resistance.
- g. Turn on supply and adjust decade resistance to reduce imbalance to within 25%.
- h. Vary input line voltage from 104 to 127Vac and insure that excessive imbalance does not exist anywhere within this range.

5-86 Preregulator Tracking Adjustment

5-87 To adjust the voltage drop across the series regulator, proceed as follows:

- a. Connect load resistor specified in Figure 5-1 across

rear output terminals of supply.

- b. Connect variable autotransformer between input power source and power supply input and adjust it for a 115Vac input to the supply.
- c. Connect dc voltmeter across series regulator (between TP47 and TP81).
- d. Turn CURRENT controls fully clockwise.
- e. To check voltage drop across regulator at low output voltage, short circuit the load resistor and adjust VOLTAGE controls for maximum rated output current on front panel ammeter.
- f. Adjust R75 (RAMP ADJ.) until voltmeter reads 3.7Vdc.
- g. To check the voltage drop at high output voltage, remove short circuit from across load resistor and adjust VOLTAGE controls for maximum rated output current. Voltmeter reading should again be 3.7Vdc.
- h. Vary input line voltage from 104 to 127Vac. Voltmeter reading should vary between 3.1 and 4.3Vdc. If reading exceeds this range, proceed to step (i).
- i. Replace R76 with decade box. Vary input line voltage between 104 and 127Vac and adjust decade box until voltmeter reading varies between 3.1 and 4.3Vdc. Replace decade box with equivalent resistor.

5-88 Crowbar Trip Voltage Adjustment

5-89 To adjust the voltage at which the crowbar fires, proceed as follows:

- a. Turn front panel OVERVOLTAGE ADJUST potentiometer R109 fully clockwise.
- b. Turn on supply.
- c. Set output voltage to desired trip voltage.
- d. Turn R109 slowly counterclockwise until the crowbar fires (amber OVERVOLTAGE lamp lights and voltmeter indication falls to zero).
- e. Turn off supply and turn down output voltage controls.
- f. Turn on supply and set desired output voltage.

NOTE

It is recommended that the crowbar trip voltage be set higher than the normal output voltage by no less than 7% of the desired output voltage plus one volt in order to avoid false tripping of the crowbar.

5-90 Maximum Crowbar Trip Voltage Adjustment

5-91 To adjust the maximum voltage at which the crowbar fires, proceed as follows:

- a. Rotate R109 (OVERVOLTAGE ADJUST) and CURRENT controls fully clockwise.
- b. Connect decade resistance box in place of R108.

c. Turn on supply and adjust VOLTAGE controls for output voltage as follows:

6256B	12Vdc
6263B, 6264B	23Vdc
6265B, 6266B, 6267B	45Vdc
6271B, 6274B	66Vdc

d. Adjust decade resistance box until crowbar fires.

e. Replace decade resistance with appropriate value resistor in R108 position. Maximum crowbar trip voltage

is now set at voltage given in step (c).

5-92 Disabling The Crowbar

5-93 To disable the crowbar completely, disconnect the cathode of CR57. This can be easily accomplished by removing the jumper connecting the cathode to the printed circuit board. This jumper is accessible from the component (top) side of the board.

SECTION VI REPLACEABLE PARTS

6-1 INTRODUCTION

6-2 This section contains information for ordering replacement parts. Table 6-3 lists parts in alpha-numeric order by reference designators and provides the following information:

- a. Reference Designators. Refer to Table 6-1.
- b. Description. Refer to Table 6-2 for abbreviations.
- c. Manufacturer's Part Number or Type.
- d. Manufacturer's Federal Supply Code Number. Refer to Table 6-3 for manufacturer's name and address.
- e. Hewlett-Packard Part Number.
- f. Parts not identified by a reference designator are listed at the end of Table 6-3 under Mechanical and/or Miscellaneous. The former consists of parts belonging to and grouped by individual assemblies; the latter consists of all parts not immediately associated with an assembly.

6-3 ORDERING INFORMATION

6-4 To order a replacement part, address order or inquiry to your local Hewlett-Packard sales office (see lists at rear of this manual for addresses). Specify the following information for each part: Model, complete serial number, and any Option or special modification (J) numbers of the instrument; Hewlett-Packard part number; circuit reference designator; and description. To order a part not listed in Table 6-3, give a complete description of the part, its function, and its location.

Table 6-1. Reference Designators

A = assembly	E = miscellaneous electronic part
B = blower (fan)	F = fuse
C = capacitor	J = jack, jumper
CB = circuit breaker	K = relay
CR = diode	L = inductor
DS = device, signaling (lamp)	M = meter

Table 6-1. Reference Designators (Continued)

P = plug	V = vacuum tube, neon bulb, photocell, etc.
Q = transistor	VR = zener diode
R = resistor	X = socket
S = switch	Z = integrated circuit or network
T = transformer	
TB = terminal block	
TS = thermal switch	

Table 6-2. Description Abbreviations

A = ampere	mod. = modular or modified
ac = alternating current	mtg = mounting
assy. = assembly	n = nano = 10^{-9}
bd = board	NC = normally closed
bkt = bracket	NO = normally open
$^{\circ}$ C = degree Centigrade	NP = nickel-plated
cd = card	Ω = ohm
coef = coefficient	obd = order by description
comp = composition	OD = outside diameter
CRT = cathode-ray tube	p = pico = 10^{-12}
CT = center-tapped	P.C. = printed circuit
dc = direct current	pot. = potentiometer
DPDT = double pole, double throw	p-p = peak-to-peak
DPST = double pole, single throw	ppm = parts per million
elect = electrolytic	pvr = peak reverse voltage
encap = encapsulated	rect = rectifier
F = farad	rms = root mean square
$^{\circ}$ F = degree Fahrenheit	Si = silicon
fxd = fixed	SPDT = single pole, double throw
Ge = germanium	SPST = single pole, single throw
H = Henry	SS = small signal
Hz = Hertz	T = slow-blow
IC = integrated circuit	tan. = tantalum
ID = inside diameter	Ti = titanium
incnd = incandescent	V = volt
k = kilo = 10^3	var = variable
m = milli = 10^{-3}	ww = wirewound
M = mega = 10^6	W = Watt
μ = micro = 10^{-6}	
met. = metal	
mfr = manufacturer	

Table 6-3. Code List of Manufacturers

CODE	MANUFACTURER	ADDRESS	CODE	MANUFACTURER	ADDRESS
00629	EBY Sales Co., Inc.	Jamaica, N.Y.	07137	Transistor Electronics Corp.	Minneapolis, Minn.
00656	Aerovox Corp.	New Bedford, Mass.	07138	Westinghouse Electric Corp.	Elmira, N.Y.
00853	Sangamo Electric Co.		07263	Fairchild Camera and Instrument	Mountain View, Calif.
	S. Carolina Div.	Pickens, S.C.	07387	Birtcher Corp., The	Los Angeles, Calif.
01121	Allen Bradley Co.	Milwaukee, Wis.	07397	Sylvania Electric Prod. Inc.	Mountainview, Calif.
01255	Litton Ind.	Beverly Hills, Calif.	07716	IRC Div. of TRW Inc.	Burlington, Iowa
01281	TRW Semiconductors, Inc.	Lawndale, Calif.	07910	Continental Device Corp.	Hawthorne, Calif.
01295	Texas Instruments, Inc.	Dallas, Texas	07933	Raytheon Co. Components Div.	Mountain View, Calif.
01686	RCL Electronics, Inc.	Manchester, N.H.	08484	Breeze Corporations, Inc.	Union, N.J.
01930	Amerock Corp.	Rockford, Ill.	08530	Reliance Mica Corp.	Brooklyn, N.Y.
02107	Sparta Mfg. Co.	Dover, Ohio	08717	Sloan Company, The	Sun Valley, Calif.
02114	Ferroxcube Corp.	Saugerties, N.Y.	08730	Vemaline Products Co. Inc.	Wyckoff, N.J.
02606	Fenwal Laboratories	Morton Grove, Ill.	08806	General Elect. Co. Minature	Lamp Dept. Cleveland, Ohio
02660	Amphenol Corp.	Broadview, Ill.	08863	Nylomatic Corp.	Norrisville, Pa.
02735	Radio Corp. of America, Solid State and Receiving Tube Div.	Somerville, N.J.	08919	RCH Supply Co.	Vernon, Calif.
03508	G.E. Semiconductor Products Dept.	Syracuse, N.Y.	09021	Airco Speer Electronic Components	Bradford, Pa.
03797	Eidema Corp.	Compton, Calif.	09182	*Hewlett-Packard Co. New Jersey Div.	Rockaway, N.J.
03877	Transitron Electronic Corp.	Wakefield, Mass.	09213	General Elect. Co. Semiconductor Prod. Dept.	Buffalo, N.Y.
03888	Pyrofilm Resistor Co., Inc.	Cedar Knolls, N.J.	09214	General Elect. Co. Semiconductor Prod. Dept.	Auburn, N.Y.
04009	Arrow, Hart and Hegeman Electric Co.	Hartford, Conn.	09353	C & K Components Inc.	Newton, Mass.
04072	ADC Electronics, Inc.	Harbor City, Calif.	09922	Burndy Corp.	Norwalk, Conn.
04213	Caddell & Burns Mfg. Co. Inc.	Mineola, N.Y.	11115	Wagner Electric Corp.	Tung-Sol Div. Bloomfield, N.J.
04404	*Hewlett-Packard Co. Palo Alto Div.	Palo Alto, Calif.	11236	CTS of Berne, Inc.	Berne, Ind.
04713	Motorola Semiconductor Prod. Inc.	Phoenix, Arizona	11237	Chicago Telephone of Cal. Inc.	So. Pasadena, Calif.
05277	Westinghouse Electric Corp.	Semiconductor Dept. Youngwood, Pa.	11502	IRC Div. of TRW Inc.	Boone, N.C.
05347	Ultronix, Inc.	Grand Junction, Colo.	11711	General Instrument Corp.	Newark, N.J.
05820	Wakefield Engr. Inc.	Wakefield, Mass.	12136	Philadelphia Handle Co.	Camden, N.J.
06001	General Elect. Co. Electronic Capacitor & Battery Dept.	Irmo, S.C.	12615	U.S. Terminals, Inc.	Cincinnati, Ohio
06004	Bassik Div. Stewart-Warner Corp.	Bridgeport, Conn.	12617	Hamlin Inc.	Lake Mills, Wisconsin
06486	IRC Div. of TRW Inc.	Semiconductor Plant Lynn, Mass.	12697	Clarostat Mfg. Co. Inc.	Dover, N.H.
06540	Amatom Electronic Hardware Co. Inc.	New Rochelle, N.Y.	13103	Thermalloy Co.	Dallas, Texas
06555	Beede Electrical Instrument Co.	Penacook, N.H.	14493	*Hewlett-Packard Co.	Loveland, Colo.
06666	General Devices Co.	Indianapolis, Ind.	14655	Cornell-Dubilier Electronics Div.	Federal Pacific Electric Co. Newark, N.J.
06751	Semoor Div. Components, Inc.	Phoenix, Arizona	14936	General Instrument Corp. Semiconductor Prod. Group	Hicksville, N.Y.
06776	Robinson Nugent, Inc.	New Albany, N.Y.	15801	Fenwal Elect.	Framingham, Mass.
06812	Torrington Mfg. Co.	Van Nuys, Calif.	16299	Corning Glass Works	Raleigh, N.C.

*Use Code 28480 assigned to Hewlett-Packard Co., Palo Alto, California

Table 6-3. Code List of Manufacturers

CODE	MANUFACTURER	ADDRESS	CODE	MANUFACTURER	ADDRESS
16758	Delco Radio Div. of General Motors Corp.	Kokomo, Ind.	59730	Thomas and Betts Co.	Philadelphia, Pa.
17545	Atlantic Semiconductors, Inc.	Asbury Park, N.J.	61637	Union Carbide Corp.	New York, N.Y.
17803	Fairchild Camera and Instrument Corp.	Mountain View, Calif.	63743	Ward Leonard Electric Co.	Mt. Vernon, N.Y.
17870	Daven Div. Thomas A. Edison Industries	Orange, N.J.	70563	Amperite Co. Inc.	Union City, N.J.
18324	Signetics Corp.	Sunnyvale, Calif.	70901	Beemer Engrg Co.	Fort Washington, Pa.
19315	Bendix Corp. The Navigation and Control Div.	Teterboro, N.J.	70903	Belden Corp.	Chicago, Ill.
19701	Electra/Midland Corp.	Mineral Wells, Texas	71218	Bud Radio, Inc.	Willoughby, Ohio
21520	Fansteel Metallurgical Corp.	No. Chicago, Ill.	71279	Cambridge Thermionic Corp.	Cambridge, Mass.
22229	Union Carbide Corp. Electronics Div.	Mountain View, Calif.	71400	Bussmann Mfg. Div. of McGraw & Edison Co.	St. Louis, Mo.
22753	UID Electronics Corp.	Hollywood, Fla.	71450	CTS Corp.	Elkhart, Ind.
23936	Pamotor, Inc.	Pampa, Texas	71468	I.T.T. Cannon Electric Inc.	Los Angeles, Calif.
24446	General Electric Co.	Schenectady, N.Y.	71590	Globe-Union Inc.	Milwaukee, Wis.
24455	General Electric Co.	Nela Park, Cleveland, Ohio	71700	General Cable Corp. Wire Co. Div.	Cornish Williamstown, Mass.
24655	General Radio Co.	West Concord, Mass.	71707	Coto Coil Co. Inc.	Providence, R.I.
24681	LTV Electrosystems Inc. Memcor/Components Operations	Huntington, Ind.	71744	Chicago Miniature Lamp Works	Chicago, Ill.
26982	Dynacool Mfg. Co. Inc.	Saugerties, N.Y.	71785	Cinch Mfg. Co. and Howard B. Jones Div.	Chicago, Ill.
27014	National Semiconductor Corp.	Santa Clara, Calif.	71984	Dow Corning Corp.	Midland, Mich.
28480	Hewlett-Packard Co.	Palo Alto, Calif.	72136	Electro Motive Mfg. Co. Inc.	Willimantic, Conn.
28520	Heyman Mfg. Co.	Kenilworth, N.J.	72619	Dialight Corp.	Brooklyn, N.Y.
28875	IMC Magnetics Corp.	Rochester, N.H.	72699	General Instrument Corp.	Newark, N.J.
31514	SAE Advance Packaging, Inc.	Santa Ana, Calif.	72765	Drake Mfg. Co.	Harwood Heights, Ill.
31827	Budwig Mfg. Co.	Ramona, Calif.	72962	Elastic Stop Nut Div. of Amerace Esna Corp.	Union, N.J.
33173	G.E. Co. Tube Dept.	Owensboro, Ky.	72982	Erie Technological Products	Erie, Pa.
35434	Lectrohm, Inc.	Chicago, Ill.	73096	Hart Mfg. Co.	Hartford, Conn.
37942	P.R. Mallory & Co.	Indianapolis, Ind.	73138	Beckman Instruments	Fullerton, Calif.
42190	Muter Co.	Chicago, Ill.	73168	Fenwal, Inc.	Ashland, Mass.
43334	New Departure-Hyatt Bearings Div. General Motors Corp.	Sandusky, Ohio	73293	Hughes Aircraft Co. Electron Dynamics Div.	Torrance, Calif.
44655	Ohmite Manufacturing Co.	Skokie, Ill.	73445	Amperex Electronic	Hicksville, N.Y.
46384	Penn Engr. and Mfg. Corp.	Doylestown, Pa.	73506	Bradley Semiconductor Corp.	New Haven, Conn.
47904	Polaroid Corp.	Cambridge, Mass.	73559	Carling Electric, Inc.	Hartford, Conn.
49956	Raytheon Co.	Lexington, Mass.	73734	Federal Screw Products, Inc.	Chicago, Ill.
55026	Simpson Electric Co. Div. of American Gage and Machine Co.	Chicago, Ill.	74193	Heinemann Electric Co.	Trenton, N.J.
56289	Sprague Electric Co.	North Adams, Mass.	74545	Hubbell Harvey Inc.	Bridgeport, Conn.
58474	Superior Electric Co.	Bristol, Conn.	74868	Amphenol Corp. Amphenol RF Div.	Danbury, Conn.
58849	Syntron Div. of FMC Corp.	Homer City, Pa.	74970	E.F. Johnson Co.	Waseca, Minn.

Table 6-3. Code List of Manufacturers

CODE	MANUFACTURER	ADDRESS	CODE	MANUFACTURER	ADDRESS
75042	IRC Div. of TRW, Inc.	Philadelphia, Pa.	82866	Research Products Corp.	Madison, Wis.
75183	*Howard B. Jones Div. of Cinch Mfg. Corp.	New York, N.Y.	82877	Rotron Inc.	Woodstock, N.Y.
75376	Kurz and Kasch, Inc.	Dayton, Ohio	82893	Vector Electronic Co.	Glendale, Calif.
75382	Kilka Electric Corp.	Mt. Vernon, N.Y.	83058	Carr Fastener Co.	Cambridge, Mass.
75915	Littlefuse, Inc.	Des Plaines, Ill.	83186	Victory Engineering	Springfield, N.J.
76381	Minnesota Mining and Mfg. Co.	St. Paul, Minn.	83298	Bendix Corp.	Eatontown, N.J.
76385	Minor Rubber Co. Inc.	Bloomfield, N.J.	83330	Herman H. Smith, Inc.	Brooklyn, N.Y.
76487	James Millen Mfg. Co. Inc.	Malden, Mass.	83385	Central Screw Co.	Chicago, Ill.
76493	J.W. Miller Co.	Compton, Calif.	83501	Gavitt Wire and Cable	Brookfield, Mass.
76530	Cinch	City of Industry, Calif.	83508	Grant Pulley and Hardware Co.	West Nyack, N.Y.
76854	Oak Mfg. Co. Div. of Oak Electro/Netics Corp.	Crystal Lake, Ill.	83594	Burroughs Corp.	Plainfield, N.J.
77068	Bendix Corp., Electrodynamics Div.	No. Hollywood, Calif.	83835	U.S. Radium Corp.	Morristown, N.J.
77122	Palnut Co.	Mountainside, N.J.	83877	Yardeny Laboratories	New York, N.Y.
77147	Patton-MacGuyre Co.	Providence, R.I.	84171	Arco Electronics, Inc.	Great Neck, N.Y.
77221	Phaotron Instrument and Electronic Co.	South Pasadena, Calif.	84411	TRW Capacitor Div.	Ogallala, Neb.
77252	Philadelphia Steel and Wire Corp.	Philadelphia, Pa.	86684	RCA Corp.	Harrison, N.J.
77342	American Machine and Foundry Co.	Princeton, Ind.	86838	Rummel Fibre Co.	Newark, N.J.
77630	TRW Electronic Components Div.	Camden, N.J.	87034	Marco & Oak Industries	Anaheim, Calif.
77764	Resistance Products Co.	Harrisburg, Pa.	87216	Philco Corp.	Lansdale, Pa.
78189	Illinois Tool Works Inc.	Elgin, Ill.	87585	Stockwell Rubber Co.	Philadelphia, Pa.
78452	Everlook Chicago, Inc.	Chicago, Ill.	87929	Tower-Olschan Corp.	Bridgeport, Conn.
78488	Stackpole Carbon Co.	St. Marys, Pa.	88140	Cutler-Hammer Inc.	Lincoln, Ill.
78526	Stanwyck Winding Div. San Fernando Electric Mfg. Co. Inc.	Newburgh, N.Y.	88245	Litton Precision Products Inc, USECO	Van Nuys, Calif.
78553	Tinnerman Products, Inc.	Cleveland, Ohio	90634	Gulton Industries Inc.	Metuchen, N.J.
78584	Stewart Stamping Corp.	Yonkers, N.Y.	90763	United-Car Inc.	Chicago, Ill.
79136	Waldes Kohinoor, Inc.	L.I.C., N.Y.	91345	Miller Dial and Nameplate Co.	El Monte, Calif.
79307	Whitehead Metals Inc.	New York, N.Y.	91418	Radio Materials Co.	Chicago, Ill.
79727	Continental-Wirt Electronics Corp.	Philadelphia, Pa.	91506	Augat, Inc.	Attleboro, Mass.
79963	Zierick Mfg. Co.	Mt. Kisco, N.Y.	91637	Dale Electronics, Inc.	Columbus, Neb.
80031	Mepco	Morristown, N.J.	91662	Elco Corp.	Willow Grove, Pa.
80294	Bourns, Inc.	Riverside, Calif.	91929	Honeywell Inc.	Freeport, Ill.
81042	Howard Industries	Racine, Wisc.	92825	Whitso, Inc.	Schiller Pk., Ill.
81073	Grayhill, Inc.	La Grange, Ill.	93332	Sylvania Electric Prod.	Woburn, Mass.
81483	International Rectifier	El Segundo, Calif.	93410	Essex Wire Corp.	Mansfield, Ohio
81751	Columbus Electronics	Yonkers, N.Y.	94144	Raytheon Co.	Quincy, Mass.
82099	Goodyear Sundries & Mechanical Co. Inc.	New York, N.Y.	94154	Wagner Electric Corp.	Livingston, N.J.
82142	Airco Speer Electronic Components	Du.Bois, Pa.	94222	Southco Inc.	Lester, Pa.
82219	Sylvania Electric Products Inc.	Emporium, Pa.	95263	Leecraft Mfg. Co. Inc.	L.I.C., N.Y.
82389	Switchcraft, Inc.	Chicago, Ill.	95354	Methode Mfg. Co.	Rolling Meadows, Ill.
82647	Metals and Controls Inc.	Attleboro, Mass.	95712	Bendix Corp.	Franklin, Ind.
			95987	Weckesser Co. Inc.	Chicago, Ill.
			96791	Amphenol Corp.	Janesville, Wis.
			97464	Industrial Retaining Ring Co.	Irvington, N.J.
			97702	IMC Magnetics Corp.	Westbury, N.Y.
			98291	Sealectro Corp.	Mamaroneck, N.Y.
			98410	ETC Inc.	Cleveland, Ohio
			98978	International Electronic Research Corp.	Burbank, Calif.
			99934	Renbrandt, Inc.	Boston, Mass.

*Use Code 71785 assigned to Cinch Mfg. Co., Chicago, Ill.

Table 6-4. Replaceable Parts

REF. DESIG. (AND MODELS)	DESCRIPTION	MFG. PART NUMBER	MFG. CODE	HP PART NUMBER
C1	A1 Main PC Board (See Note 1)			
6256B,-63B,-64B,-65B, -66B,-67B	fxd, elect. 5 μ F 50V	30D505G050BB2	56289	0180-0301
6271B,-74B	fxd, elect. 5 μ F 65V	D33689-DSM	56289	0180-1836
C3	fxd, polyester 0.1 μ F 200V	192P10492	56289	0160-0168
C5				
6256B,-63B,-64B,-65B, -66B,-67B,-71B	fxd, polyester 1000pF 200V	192P10292	56289	0160-0153
6274B	fxd, polyester 2200pF 200V	292P22292	56289	0160-0154
C6, 7	fxd, polyester .01 μ F 200V	192P10392	56289	0160-0161
C9	fxd, elect. 4.7 μ F 35V	150D475X9035B2	56289	0180-0100
C10	fxd, elect. 100 μ F 50V		28480	0180-1852
C11	fxd, cer. .05 μ F 500V	33617A	56289	0150-0052
C12	fxd, elect. 325 μ F 35V	D34656-DEE	56289	0180-0332
C15	fxd, elect. 1 μ F 35V	150D105X9035A2	56289	0180-0291
C16,17	fxd, elect. 5 μ F 50V	30D505G050BB2	56289	0180-0301
C18	fxd, polyester 0.22 μ F 80V	192P2249R8	56289	0160-2453
C19				
6263B	fxd, elect. 22 μ F 35V	150D226X0035R2	56289	0180-0160
6265B,-66B	fxd, elect. 15 μ F 50V	150D156X0050R2	56289	0180-1834
6271B	fxd, elect. 10 μ F 100V	30D106G100DC2	56289	0180-0091
C22	fxd, elect. 20 μ F 50V	30D206G050C02	56289	0180-0049
C27				
6256B,-64B,-67B,-74B	fxd, cer. 0.47 μ F 25V	5C11B7-CML	56289	0160-0174
C28				
6263B,-65B,-66B,-71B	fxd, cer. .01 μ F 500V	811-000-Y5U-0-103Z	72982	0150-0081
C29				
6263B,-65B,-66B,-71B	fxd, polyester 0.1 μ F 600V	6630W10496W	84411	0160-0710
C33	fxd, cer. 0.47 μ F 25V	5C11B7-CML	56289	0160-0174
C34	fxd, polyester 4700pF 200V	292P47292	56289	0160-0157
CR1-7	diode, Si. 180V 200mA	1N485		1901-0033
CR8	diode, Si. 3-junction	STB 523	03508	1901-0460
CR9	diode, Si. 180V 200mA	1N485		1901-0033
CR10	diode, Si. 200V 1A	1N5059		1901-0327
CR11				
6265B,-71B	diode, Si. 200V 1.5A	1N4999		1901-0416
CR12-15	diode, Si. 200V 1A	1N5059		1901-0327
CR16,20	diode, Si. 180V 200mA	1N485		1901-0033
CR21-24				
6265B,-71B	diode, Si. 200V 1.5A	1N4999		1901-0416
CR27,28,30-33	diode, Si. 180V 200mA	1N485		1901-0033
CR34				
6265B,-71B	diode, Si. 200V 1.5A	1N4999		1901-0416
CR36	diode, Si. 3-junction	STB 523	03508	1901-0460
CR37,38,43-47,50	diode, Si. 180V 200mA	1N485		1901-0033
CR51,52	diode, Si. 10V 200mA	SG9309	03877	1901-0461
CR56	diode, Si. 100V 40A	1N1184A	05277	1901-0317

Note 1: This assembly is designed for component-level repair; replacement assemblies cannot be supplied.

Table 6-4. Replaceable Parts

REF. DESIG. (AND MODELS)	DESCRIPTION	MFG. PART NUMBER	MFG. CODE	HP PART NUMBER
CR57	SCR	2N3898*		1844-0058
CR58-60	diode, Si. 180V 200mA	1N485		1901-0033
Q3				
6265B	SS NPN Si.	MM2258	04713	1854-0271
Q4	SS PNP Si.	2N4036		1853-0041
Q5	SS PNP Si.	TZ 173	56289	1853-0099
Q9	SS PNP Si.	2N4036		1853-0041
Q10	SS PNP Si.	TZ 173	56289	1853-0099
Q11	SS NPN Si.	2N3391		1854-0071
Q12	SS PNP Si.	TZ 173	56289	1853-0099
Q13-16	SS NPN Si.	2N3391		1854-0071
Q18	SS NPN Si.	2N3417**		1854-0087
Q19	SS NPN Si.	2N3391		1854-0071
Q22, 23	SS PNP Si.	TZ 173	56289	1853-0099
Q24	SS NPN Si.	2N3391		1854-0071
Q25	SS NPN Si.	2N3417**		1854-0087
R1				
6256B,-63B,-64B,-65B, -66B,-67B	fxd, ww 1k 5% 3W	242E1025	56289	0813-0001
6271B,-74B	fxd, ww 2k 5% 3W	242E1025	56289	0811-1806
R2				
6256B	fxd, comp 43 5% 1/2W	EB-4305	01121	0686-4305
6263B,-64B	fxd, comp 82 5% 1/2W	EB-8205	01121	0686-8205
6265B,-66B,-67B	fxd, comp 160 5% 1/2W	EB-1615	01121	0686-1615
6271B,-74B	fxd, comp 240 5% 1/2W	EB-2415	01121	0686-2415
R5	fxd, film 1.5k 1% 1/8W	CEA T-0	07716	0757-0427
R6	fxd, comp 360k 5% 1/2W	EB-3645	01121	0686-3645
R7	fxd, film 61.9k 1% 1/8W	CEA T-0	07716	0757-0460
R8	fxd, comp 560k 5% 1/2W	EB-5645	01121	0686-5645
R9				
6256B,-63B,-64B,-65B, -66B,-67B	fxd, ww 600 5% 5W	243E6015	56289	0811-1860
6271B,-74B	fxd, ww 1k 5% 5W	RS-5	91637	0812-0099
R12				
6256B,-63B,-64B,-65B, 66B,-67B	fxd, ww 680 5% 5W	243E6815	56289	0811-2099
6271B,-74B	fxd, ww 1k 5% 5W	RS-5	91637	0812-0099
R13	fxd, comp (selected)	EB	01121	
R14	fxd, comp 3.3 5% 1/2W	EB-33G5	01121	0686-0335
R15				
6256B,-63B,-71B	fxd, comp 750k 5% 1/2W	EB-7545	01121	0686-7545
6264B,-67B	fxd, comp 1.5M 5% 1/2W	EB-1555	01121	0686-1555
6265B	fxd, comp 560k 5% 1/2W	EB-5645	01121	0686-5645
6266B	fxd, comp 1M 5% 1/2W	EB-1055	01121	0686-1055
6274B	fxd, comp 3.3M 5% 1/2W	EB-3355	01121	0686-3355
R18				
6256B,-64B	fxd, ww 3k 5% 3W	242E3025	56289	0812-0010
6263B,-65B,-66B,-67B, -71B,-74B	fxd, ww 14k 3% 2W	222E14K00H	56289	0811-2692

*nearest commercial equivalent

**leads must be properly bent

Table 6-4. Replaceable Parts

REF. DESIG. (AND MODELS)	DESCRIPTION	MFG. PART NUMBER	MFG. CODE	HP PART NUMBER
R19	fxd, comp (selected)	EB	01121	
R20	fxd, film 1k 1% 1/4W	CEB T-0	07716	0757-0338
R21	fxd, comp 1k 5% 1/2W	EB-1025	01121	0686-1025
R24				
6256B,-64B,-67B,-74B	fxd, ww .05 5% 6W		28480	0811-3364
R25	fxd, comp 360k 5% 1/2W	EB-3645	01121	0686-3645
R26	fxd, film 1.5k 1% 1/8W	CEA T-0	07716	0757-0427
R27				
6256B,-64B,-67B,-74B	fxd, ww .05 5% 6W		28480	0811-3364
R28	fxd, comp 560k 5% 1/2W	EB-5645	01121	0686-5645
R29	fxd, film 7.5k 1% 1/8W	CEA T-0	07716	0757-0440
R30	var. ww 5k	110-F4	11236	2100-1824
R31	fxd, comp 1k 5% 1/2W	EB-1025	01121	0686-1025
R32	fxd, film 160k 1% 1/8W	CEA T-0	07716	0698-5092
R33				
6256B,-63B,-64B,-65B, -66B,-67B,-71B	fxd, comp 330 5% 1/2W	EB-3315	01121	0686-3315
6274B	fxd, comp 24 5% 1/2W	EB-2405	01121	0686-2405
R34	fxd, comp 33k 5% 1/2W	EB-3335	01121	0686-3335
R35	fxd, film 1k 1% 1/8W	CEA T-0	07716	0757-0280
R36	fxd, film 1.5k 1% 1/8W	CEA T-0	07716	0757-0427
R37	fxd, film 560 1% 1/4W	CEB T-0	07716	0698-5146
R38	fxd, comp 10k 5% 1/2W	EB-1035	01121	0686-1035
R39	fxd, comp 200k 5% 1/2W	EB-2045	01121	0686-2045
R41	fxd, film 5.49k 1% 1/8W	CEA T-0	07716	0698-3382
R42	fxd, met. ox. 180 5% 2W	RG42	11502	0698-3626
R43	fxd, film 2k 1% 1/4W	CEA T-0	07716	0757-0739
R44	fxd, film 471 1% 1/8W	CEA T-0	07716	0698-5514
R45	fxd, comp 100k 5% 1/2W	EB-1045	01121	0686-1045
R46	fxd, film 600 1% 1/8W	CEA T-0	07716	0757-1100
R47	fxd, film 7.5k 1% 1/8W	CEA T-0	07716	0757-0440
R48	fxd, film 499 1% 1/4W	CEB T-0	07716	0698-3207
R49				
6256B	fxd, film 6k 1% 1/8W	CEA T-0	07716	0698-3476
6263B,-64B	fxd, film 12k 1% 1/8W	CEA T-0	07716	0698-5088
6265B,-66B,-67B	fxd, film 27.4k 1% 1/8W	CEA T-0	07716	0757-0452
6271B,-74B	fxd, film 39k 1% 1/8W	CEA T-0	07716	0698-6076
R50	fxd, comp 390 5% 1/2W	EB-3915	01121	0686-3915
R51	fxd, film 3.4k 1% 1/8W	CEA T-0	07716	0698-4440
R53	fxd, comp 10 5% 1/2W	EB-1005	01121	0686-1005
R56	var ww 250	110-F4	11236	2100-0439
R57				
6256B,-63B,-64B	fxd, film 471 1% 1/8W	CEA T-0	07716	0698-5514
6265B,-65B,-66B, -71B,-74B	fxd, film 600 1% 1/8W	CEA T-0	07716	0757-1100
R58,59	fxd, comp 100 5% 1/2W	EB-1015	01121	0686-1015
R60	fxd, comp 3k 5% 1/2W	EB-3025	01121	0686-3025

Table 6-4. Replaceable Parts

REF. DESIG. (AND MODELS)	DESCRIPTION	MFG. PART NUMBER	MFG. CODE	HP PART NUMBER
R61 6256B,-64B,-67B, -71B,-74B	fxd, ww 135 5% 3W	242E	56289	0812-0112
6263B,-65B,-66B	fxd, ww 390 5% 3W	242E3915	56289	0811-1799
R62	fxd, film 471 1% 1/8W	CEA T-0	07716	0698-5514
R63	var. ww 250	110-F4	11236	2100-0439
R64				
6256B,-63B,-64B,-65B, -66B,-67B,-71B,	fxd, film 7.5k 1% 1/8W	CEA T-0	07716	0757-0440
6274B	fxd, film 160k 1% 1/8W	CEA-993	07716	0698-5092
R65				
6256B,-63B,-64B,-65B, -66B,-67B,-71B	fxd, film 5.49k 1% 1/8W	CEA T-0	07716	0698-3382
6274B	fxd, film 91k 1% 1/8W	CEA-993	07716	0698-6080
R66				
6256B,-64B	fxd, film 21.5 1% 1/8W	CEA T-0	07716	0698-3430
6263B,-67B,-74B	fxd, film 100 1% 1/8W	CEA T-0	07716	0757-0401
6265B,-66B,-71B	fxd, film 196 1% 1/8W	CEA T-0	07716	0698-3440
R67				
6256B,-63B,-64B	fxd, ww 150 5% 10W	247E1515	56289	0811-1906
6265B	fxd, ww 600 5% 10W	247E6015	56289	0811-1910
6266B,-67B	fxd, ww 400 5% 10W	247E4015	56289	0811-0942
6271B,-74B	fxd, ww 800 5% 10W	10XM	63743	0811-0944
R68	fxd, ww 220 5% 2W	BWH	07716	0811-1763
R69	fxd, comp 22 5% 1/2W	EB-2205	01121	0686-2205
R70	fxd, met. ox. 1.5k 5% 2W	C42S	16299	0698-3338
R71	fxd, comp 1.8k 5% 1/2W	EB-1825	01121	0686-1825
R72	fxd, comp 9.1k 5% 1/2W	EB-9125	01121	0686-9125
R73	fxd, comp 100k 5% 1/2W	EB-1045	01121	0686-1045
R74				
6256B,-63,-64B, -65B,-66B,-67B	fxd, comp 4.3k 5% 1/2W	EB-4325	01121	0686-4325
6271B	fxd, comp 6.8k 5% 1/2W	EB-6825	01121	0686-6825
6274B	fxd, comp 10k 5% 1/2W	EB-1035	01121	0686-1035
R75	var. ww 5k	110-F4	11236	2100-1824
R76				
6256B	fxd, comp 75k 5% 1/2W	EB-7535	01121	0686-7535
6263B	fxd, comp 160k 5% 1/2W	EB-1645	01121	0686-1645
6264B	fxd, comp 100k 5% 1/2W	EB-1045	01121	0686-1045
6265B,-66B	fxd, comp 200k 5% 1/2W	EB-2045	01121	0686-2045
6267B	fxd, comp 390k 5% 1/2W	EB-3945	01121	0686-3945
6271B,-74B	fxd, comp 300k 5% 1/2W	EB-3045	01121	0686-3045
R77	fxd, comp 4.7 5% 1/2W	EB-47G5	01121	0698-0001
R78	fxd, comp 510 5% 1/2W	EB-5115	01121	0686-5115
R79				
6256B,-63B,-64B,-65B, -66B,-67B,-71B,	fxd, comp 2.4k 5% 1/2W	EB-2425	01121	0686-2425
6274B	fxd, comp 5.1k 5% 1/2W	EB-5125	01121	0686-5125
R84	fxd, comp 10 5% 1/2W	EB-1005	01121	0686-1005

Table 6-4. Replaceable Parts

REF. DESIG. (AND MODELS)	DESCRIPTION	MFG. PART NUMBER	MFG. CODE	HP PART NUMBER
R86				
6256B	fxd, comp 51k 5% 1/2W	EB-5135	01121	0686-5135
6263B,-64B	fxd, comp 100k 5% 1/2W	EB-1045	01121	0686-1045
6265B,-66B,-67B	fxd, comp 200k 5% 1/2W	EB-2045	01121	0686-2045
6271B	fxd, comp 300k 5% 1/2W	EB-3045	01121	0686-3045
6274B	fxd, comp 360k 5% 1/2W	EB-3645	01121	0686-3645
R87				
6256B,-63B,-64B,-65B, -66B,-67B,-71B	fxd, comp 3.3k 5% 1/2W	EB-3325	01121	0686-3325
6274B	fxd, comp 6.2k 5% 1/2W	EB-6225	01121	0686-6225
R90	fxd, comp 180k 5% 1/2W	EB-1845	01121	0686-1845
R91	fxd, comp 15k 5% 1/2W	EB-1535	01121	0686-1535
R94	fxd, comp 10k 5% 1/2W	EB-1035	01121	0686-1035
R96				
6256B,-64B,-71B,-74B	fxd, met. ox. 270 5% 2W	C42S	16299	0698-3629
6263B	fxd, met. ox. 560 5% 2W	BWH	07716	0811-2114
6265B	fxd, met. ox. 1.5k 5% 2W	C42S	16299	0698-3338
6266B	fxd, met. ox. 1k 5% 2W	C42S	16299	0764-0016
6267B	fxd, met. ox. 560 5% 2W	C42S	16299	0764-0015
R97	fxd, comp 5.1k 5% 1/2W	EB-5125	01121	0686-5125
R98				
6256B,-63B,-64B,-65B, -66B,-67B,-74B	fxd, comp 270 5% 1/2W	EB-2715	01121	0686-2715
6271B	fxd, comp 1.5k 5% 1/2W	EB-1525	01121	0686-1525
R99				
6256B,-64B,-65B,-66B, -67B,-71B,-74B	fxd, comp 100 5% 1/2W	EB-1015	01121	0686-1015
6263B	fxd, comp 300 5% 1/2W	EB-3015	01121	0686-3015
R101	fxd, comp 200 5% 1W	GB-2015	01121	0689-2015
R102	fxd, ww 0.125 10% 5W	CWS-2	91637	0811-1846
R103	fxd, comp 200k 5% 1/2W	EB-2045	01121	0686-2045
R104	fxd, ww 135 5% 5W	RS-5	91637	0812-0098
R105	fxd, comp 10 5% 1/2W	EB-1005	01121	0686-1005
R106				
6256B,-63B,-64B,-65B, -66B,-67B	fxd, film 470 1% 1/4W	CEB T-0	07716	0698-3506
6271B,-74B	fxd, film 1.33k 1% 1/4W	CEB T-0	07716	0698-3134
R107	fxd, comp 510 5% 1/2W	EB-5115	01121	0686-5115
R108				
6256B,-64B,-67B,-74B	fxd, film 1.5k 1% 1/8W	CEA T-0	07716	0757-0427
6263B,-65B,-66B	fxd, film 1.33k 1% 1/4W	CEB T-0	07716	0698-3134
6271B	fxd, film 2k 1% 1/4W	CEB T-0	07716	0757-0739
R110	fxd, comp 10k 5% 1/2W	EB-1035	01121	0686-1035
R112	fxd, comp 4.7 5% 1/2W	EB-47G5	01121	0698-0001
R113	fxd, comp 3.9k 5% 1/2W	EB-3925	01121	0686-3925
R114	fxd, film 4.7k 5% 1/4W	CCA-993	07716	0758-0005
T2				
6256B,-63B,-64B,-65B, -66B,-67B,-71B	power transformer		28480	9100-2193
6274B	power transformer		28480	5080-7152

Table 6-4. Replaceable Parts

REF. DESIG. (AND MODELS)	DESCRIPTION	MFG. PART NUMBER	MFG. CODE	HP PART NUMBER
T3,4 VR1,2 VR3,4 VR5 VR6,7 Z1 Z2	pulse transformer diode, zener 6.2V diode, zener 4.22V diode, zener 6.19V diode, zener 2.37V dual diff. amp IC resistor network	1N825 SZ 10939-74 SZ 10939-122 SZ 10939-2 CA 3026	28480 04713 04713 04713 02735 28480	5080-7192 1902-1221 1902-3070 1902-0049 1902-3002 1820-0240 1810-0042
C1 C3 C4 CR1 6256B,-64B,-67B,-74B 6263B,-65B,-66B,-71B J1,2,4 L1A/L1B R1 R2 6256B,-64B,-67B,-74B 6263B,-65B,-66B,-71B R3 RV1	A2 RFI Filter Ass'y. (See Note 1) fxd, paper 0.1 μ F 250V fxd, paper .047 μ F 250Vac fxd, cer. 5000pF 1kV thyristor, Si. (Triac) thyristor, Si. (Triac) jumpers for 115Vac operation inductor fxd, met. ox. 1.5k 5% 2W fxd, met. ox. 330 5% 2W fxd, met. ox. 180 5% 2W fxd, met. ox. 220 5% 2W varistor 250Vac	C023B102G502ZS31 2N5446 SC250M2* FP-42 FP-42 FP-42 FP-42 V250LA40B	28480 28480 56289 03508 28480 27167 27167 27167 27167 03508	0160-4065 0160-4323 0160-0899 1884-0218 1884-0222 5080-1780 0698-3338 0698-3631 0698-3626 0698-3628 0837-0117
C1-3 6263B,-65B,-66B,-71B C28-30 6256B,-64B,-67B,-74B CB1 6274B DS1 DS2 F1 6256B 6263B,-66B,-71B 6264B,-67B 6265B F2 6256B,-63B,-64B,-65B, -66B,-67B,-71B M1 6256B 6263B 6264B 6265B,-66B 6267B 6271B 6274B	A3 Front Panel Electrical fxd, cer .01 μ F 3kV fxd, cer. .01 μ F 3kV circuit breaker, 20A 250Vac LINE ON indicator light, neon OVERVOLTAGE indicator light LINE fuse fuse, 8A 250V fuse, 5A 250V fuse, 10A 250V fuse, 4A 250V BIAS fuse, 1/10A 250V voltmeter, 0-12Vdc voltmeter, 0-24Vdc voltmeter, 0-24Vdc voltmeter, 0-50Vdc voltmeter, 0-50Vdc voltmeter, 0-70Vdc voltmeter, 0-70Vdc	41C121A5-CDH 41C121A5-CDH AM2-A3-A-20-2 599-237-White MCL-B3-1738 314008 314005 314010 312004 313.100 28480 28480 28480 28480 28480 28480 28480	56289 56289 74193 72765 07137 75915 75915 75915 75915 75915 28480 28480 28480 28480 28480 28480 28480	0160-2568 0160-2568 3105-0035 1450-0419 1450-0306 2110-0342 2110-0227 2110-0051 2110-0055 2110-0234 1120-1170 1120-1159 1120-1171 1120-1161 1120-1173 1120-1162 1120-1174

* nearest commercial equivalent

Table 6-4. Replaceable Parts

REF. DESIG. (AND MODELS)	DESCRIPTION	MFG. PART NUMBER	MFG. CODE	HP PART NUMBER
M2				
6256B,-64B	ammeter, 0-24A		28480	1120-1178
6263B	ammeter, 0-12A		28480	1120-1168
6265B,-71B	ammeter, 0-4A		28480	1120-1166
6266B	ammeter, 0-6A		28480	1120-1167
6267B	ammeter, 0-12A		28480	1120-1176
6274B	ammeter, 0-18A		28480	1120-1177
R10	VOLTAGE — COARSE control			
6256B	var. ww 2.5k	Series 43	12697	2100-2745
6263B,-64B	var. ww 5k	Series 43	12697	2100-1853
6265B,-66B,-67B	var. ww 10k	Series 43	12697	2100-1854
6271B,-74B	var. ww 20k	Series 43	12697	2100-1855
R11	VOLTAGE — FINE control			
6256B,-63B,-64B,-67B	var. ww 50	Series 43	12697	2100-1858
6265B,-66B	var. ww 100	Series 43	12697	2100-1987
6271B,-74B	var. ww 1k	Series 43	12697	2100-1847
R16	CURRENT — COARSE control			
6256B,-64B	var. ww 200	Series 43	12697	2100-1856
6263B,-65B,-66B,-67B, -71B,-74B	var. ww 1k	Series 43	12697	2100-1847
R17	CURRENT — FINE control			
6256B,-64B	var. ww 10	Series 43	12697	2100-1857
6263B,-65B,-66B,-67B, -71B,-74B	var. ww 100	Series 43	12697	2100-1987
R40	fxd, comp 33k 5% 1/2W	EB-3335	01121	0686-3335
R109	OVERVOLTAGE ADJUST			
6256B	var. ww 2.5k	Series 43	12697	2100-2745
6263B,-64B	var. ww 5k	Series 43	12697	2100-1853
6265B,-66B,-67B	var. ww 10k	Series 43	12697	2100-1854
6271B,-74B	var. ww 20k	Series 43	12697	2100-1855
S1				
6256B,-63B,-64B,-65B, -66B,-67B,-71B	switch, DPST toggle, LINE ON	8926K317	27191	3101-0946
C19	Rear Panel Electrical (See Note 2)			
6256B,-64B	fxd, elect. 22 μ F 35V	150D226X0035R2	56289	0180-0160
6267B	fxd, elect. 15 μ F 50V	150D156X0050R2	56289	0180-1834
6274B	fxd, elect. 10 μ F 100V	30D106F100DC2	56289	0180-0091
CR11	diode, Si. 100V 40A	1N1184A	05277	1901-0317
CR34	diode, Si. 100V 40A	1N1184AR	05277	1901-0318
Q3				
6256B,-64B,-67B	power NPN Si.	40250	02735	1854-0224
6274B	power NPN Si.	60744***	02735	1854-0464
Q6,7				
6256B,-64B	power NPN Si.	2N3771*		1854-0245

*nearest commercial equivalent ***center (collector) lead is cut off

Note 2: Models 6256B,-64B,-67B,-74B only. The rear panel components of the remaining models are included under Chassis Electrical.

Table 6-4. Replaceable Parts

REF. DESIG. (AND MODELS)	DESCRIPTION	MFG. PART NUMBER	MFG. CODE	HP PART NUMBER
Q6 6263B,-66B 6265B 6271B R54 6263B 6265B,-71B 6266B T1 6256B 6263B 6264B 6265B 6266B 6267B 6271B 6274B	power NPN Si. power NPN Si. power NPN Si. current sampling resistor fxd, low t. c. alloy, 0.050 ohms fxd, low t. c. alloy, 0.167 ohms fxd, low t. c. alloy, 0.100 ohms power transformer power transformer power transformer power transformer power transformer power transformer power transformer power transformer power transformer	2N3771* 2N3772 60675	02735 28480 28480 28480 28480 28480 28480 28480 28480 28480 28480	1854-0245 1854-0225 1854-0458 06263-80001 5080-7125 06266-80001 06256-80091 06263-80091 06264-80091 06265-80091 06266-80091 06267-80091 06271-80091 06274-80091
TB1 6256B,-64B,-67B,-74B 6263B,-65B,-66B,-71B 6256B,-64B,-67B,-74B 6263B,-65B,-66B,-71B	A1 Main PC Board Mechanical barrier strip, 11-terminal barrier strip, 15-terminal barrier strip jumpers (qty. 6) barrier strip jumpers (qty. 7)		28480 28480 28480 28480	0360-1238 0360-1548 0360-1143 0360-1143
	A2 RFI Filter Ass'y. Mechanical heat sink heat sink mounting standoff, .687" (qty. 3) PC board mounting standoff, .938" (qty. 4) washer, fiber, L1A/L1B insulator cover cover standoff, .312" (qty. 4)		28480 28480 28480 28480 28480 28480	5020-2281 0380-0625 0380-0576 3050-0697 5020-2283 0380-0356
6256B 6263B 6264B 6265B 6266B 6267B 6271B 6274B 6256B,-63B,-64B,-65B, -66B,-67B,-71B 6256B,-63B,-64B,-65B, -66B,-67B,-71B	A3 Front Panel Ass'y. Mechanical front panel front panel front panel front panel front panel front panel front panel front panel fuseholder (qty. 2) hex-nut, nylon, fuseholder (qty. 2)	342014	28480 28480 28480 28480 28480 28480 28480 28480 75915 28480	06256-60006 06263-60004 06264-60006 06265-60004 06266-60004 06267-60006 06271-60004 06274-00014 1400-0084 2950-0131

*nearest commercial equivalent

Table 6-4. Replaceable Parts

REF. DESIG. (AND MODELS)	DESCRIPTION	MFG. PART NUMBER	MFG. CODE	HP PART NUMBER
6256B,-63B,-64B,-65B,-66B,-67B,-71B 6256B,-64B,-67B,-74B 6263B,-65B,-66B,-71B	lockwasher, fuseholder (qty. 2) meter bezel (qty. 2) meter bezel (qty. 2) spring, compression, meter mount (qty. 8) knob (qty. 4) binding post, black (qty. 2) binding post, red bushing, R109 mount retainer, push-on, DS1 and DS2 (qty. 2)	DF21BC DF21RC	28480 28480 28480 28480 58474 58474 28480 28480	2190-0054 4040-0293 4040-0414 1460-0256 0370-0084 1510-0039 1510-0103 1410-0052 0510-0123
6256B 6264B,-67B 6274B TB3 TB2 6256B,-64B,-67B 6274B	Rear Panel Ass'y. Mechanical (See Note 3) rear chassis rear chassis rear chassis heat sink, 4 5/8" x 5 1/8" heat sink, 4 5/8" x 2 1/2" barrier strip, 3-term, ac input insulator, ac barrier strip (qty. 2) barrier strip, 6-term, output jumper, output barrier strip (qty. 3) hex standoff, .750", R54 (qty. 2) transistor insulator, mica, Q6,7 (qty. 2) transistor insulator, mica, Q3 transistor, insulator, mica, Q3 transistor pin insulator, Q6, 7 (qty. 4) transistor screw insulator, Q3,6,7 (qty. 6) insulating bushing, CR11, CR34, Q3 (qty. 3) insulator, mica, CR11, 34 (qty. 2)	603-3 601-YSY-6	28480 28480 28480 28480 28480 75382 28480 75382 28480 28480 28480 28480 28480 28480 28480 28480 28480 28480	06256-60005 06264-60005 06274-60010 5020-8066 5020-8071 0360-1596 0380-0703 0360-1224 0360-1541 0380-0091 0340-0181 0340-0180 0340-0703 0340-0166 0340-0168 0340-0169 2190-0710
6256B,-64B,-67B,-74B 6263B,-65B,-66B,-71B 6256B,-63B,-64B,-65B,-66B,-67B,-71B 6274B	Chassis Mechanical chassis assembly (includes left and right sides, center tray, and front panel supports) chassis assembly (includes left and right sides, center tray, and front panel supports) printed circuit board guide (qty. 2) covers, top and bottom, perforated (qty. 2) covers, top and bottom, solid (qty. 2)		28480 28480 28480 28480 28480	5060-7951 5060-7952 0403-0150 5000-9440 06274-00013

Note 3: Models 6256B,-64B,-67B,-74B only. The rear panel components of the remaining models are included under Chassis Mechanical.

Table 6-4. Replaceable Parts

REF. DESIG. (AND MODELS)	DESCRIPTION	MFG. PART NUMBER	MFG. CODE	HP PART NUMBER
6256B,-64B,-67B,-74B	handles (qty. 2)		28480	5020-5715
6263B,-65B,-66B,-71B	handles (qty. 2)		28480	5020-5751
	screw, 10-32, 1.75" (for handles, qty. 4)		28480	2680-0173
6263B,-65B,-66B,-71B	rear panel		28480	5020-2502
6263B,-65B,-66B,-71B	heat sink (qty. 2)		28480	5020-8065
6263B,-65B,-66B,-71B	hex standoff, .250", R54 (qty. 2)		28480	0380-0716
6263B,-65B,-66B,-71B	barrier strip cover, (for 15-term.strip)		28480	5000-3098
6256B,-64B,-67B,-74B	barrier strip cover,(for 11-and 6-term strips)		28480	5000-9452
6256B,-64B,-67B,-74B	barrier strip cover, (for ac input)		28480	5000-6249
6263B,-65B,-66B,-71B	line cord			8120-0852
6263B,-65B,-66B,-71B	strain relief bushing, line cord			0400-0098
6256B,-64B,-74B	capacitor clamp, C13,14		28480	5000-6017
6267B	capacitor clamp, C13		28480	06267-00001
6256B,-64B,-67B,-74B	capacitor clamp, C20			0180-0078
6263B,-65B,-66B,-71B	capacitor clamp, C14		28480	5000-6223
6263B,-65B,-66B,-71B	capacitor clamp, C20		28480	5000-6267
6256B,-64B,-67B,-74B	grommet, 7/8" (qty. 2)		28480	0400-0063
6256B,-64B,-74B	bus bar for C13, 14 (qty. 2)		28480	5000-6038
6274B	fan spacer		28480	06274-00010
6263B,-66B	insulator, mica, CR11,34 (qty. 2)		28480	2190-0710
6263B,-66B	insulating bushing, CR11,34 (qty. 2)		28480	0340-0169
6256B,-63B,-64B, -67B,-74B	insulator, mica, CR21-24 (qty. 4)		28480	2190-0710
6256B,-63B,-64B, -67B,-74B	shoulder washer, CR21-24 (qty. 4)		28480	2190-0898
6266B	insulator, mica, CR21-24 (qty. 4)		28480	2190-0498
6266B	shoulder washer, CR21-24 (qty. 4)		28480	2190-0492
6263B,-66B,-71B	transistor screw insulator, Q3 (qty. 2)		28480	0340-0168
6263B,-66B,-71B	insulating bushing, Q3		28480	0340-0169
6263B,-66B	transistor insulator, mica, Q3		28480	0340-0180
6271B	transistor insulator, mica, Q3		28480	0340-0703
6263B,-65B,-66B,-71B	transistor pin insulator, Q6 (qty. 2)		28480	0340-0166
6263B,-65B,-66B,-71B	transistor screw insulator, Q6 (qty. 2)		28480	0340-0168
6263B,-65B,-66B,-71B	transistor insulator, mica, Q6		28480	0340-0181
6256B,-64B,-67B,-74B	carton			9211-1178
6256B,-64B,-67B,-74B	floater			9220-1401
6263B,-65B,-66B,-71B	carton			9211-1176
6263B,-65B,-66B,-71B	floater			9220-1400

Table 6-4. Replaceable Parts

REF. DESIG. (AND MODELS)	DESCRIPTION	MFG. PART NUMBER	MFG. CODE	HP PART NUMBER
	OPTIONS:			
	OPTION 005 50Hz AC Input			
R74 6266B	fxd, comp 8.2k 5% 1/2W	EB-8225	01121	0686-8225
R76 6256B,-66B 6263B,-64B	fxd, comp 150k 5% 1/2W	EB-1545	01121	0686-1545
6265B	fxd, comp 200k 5% 1/2W	EB-2045	01121	0686-2045
6267B	fxd, comp 300k 5% 1/2W	EB-3045	01121	0686-3045
6271B	fxd, comp 750k 5% 1/2W	EB-7545	01121	0686-7545
6274B	fxd, comp 360k 5% 1/2W	EB-3645	01121	0686-3645
R78 6256B	fxd, comp 430k 5% 1/2W	EB-4345	01121	0686-4345
6263B,-64B,-65B,-66B,- -67B,-71B,-74B	fxd, comp 750 5% 1/2W	EB-7515	01121	0686-7515
R79 6263B,-64B,-65B,-66B, -67B,-71B	fxd, comp 270 5% 1/2W	EB-2715	01121	0686-2715
	fxd, comp 4.7k 5% 1/2W	EB-4725	01121	0686-4725
	OPTION 007 10-Turn Voltage Control			
R10 6256B 6263B,-64B 6265B,-66B,-67B 6271B,-74B	var. ww 2k 10-turn	Series 8400	84048	2100-2029
	var. ww 5k 10-turn	Series 8400	84048	2100-1865
	var. ww 10k 10-turn	Series 8400	84048	2100-1866
	var. ww 20k 10-turn	Series 8400	84048	2100-1867
	knob		28480	0370-0137
	OPTION 008 10-Turn Current Control			
R16 6256B,-64B 6263B,-65B,-66B,-67B, -71B,-74B	var. ww 200 10-turn	Series 8400	84048	2100-1863
	var. ww 1k 10-turn	Series 8400	84048	2100-1864
	knob		28480	0370-0137
	OPTION 009 10-Turn Voltage and Current Controls			
R10 6256B 6263B,-64B 6265B,-66B,-67B 6271B,-74B	voltage control			
	var. ww 2k 10-turn	Series 8400	84048	2100-2029
	var. ww 5k 10-turn	Series 8400	84048	2100-1865
	var. ww 10k 10-turn	Series 8400	84048	2100-1866
	var. ww 20k 10-turn	Series 8400	84048	2100-1867
R16 6256B,-64B 6263B,-65B,-66B,-67B, -71B,-74B	current control			
	var. ww 200 10-turn	Series 8400	84048	2100-1863
	var. ww 1k 10-turn	Series 8400	84048	2100-1864
	knob (qty. 2)		28480	0370-0137

Table 6-4. Replaceable Parts

REF. DESIG. (AND MODELS)	DESCRIPTION	MFG. PART NUMBER	MFG. CODE	HP PART NUMBER
6256B,-64B,-67B,-74B	OPTION 010 Chassis Slides slides spacer, slide (qty. 2)	SS-168-NT 20-21-25/32-BK0106C	83508 28480	1490-0872 5000-6234
R10 6256B 6263B,-64B 6265B,-66B,-67B 6271B,-74B	OPTION 013 3-Digit Decadial Voltage Control var. ww 2k 10-turn var. ww 5k 10-turn var. ww 10k 10-turn var. ww 20k 10-turn 3-digit turns-counting dial	Series 8400 Series 8400 Series 8400 Series 8400 411	84048 84048 84048 84048 12697	2100-2029 2100-1865 2100-1866 2100-1867 1140-0020
R16 6256B,-64B 6263B,-65B,-66B,-67B, -71B,-74B	OPTION 014 3-Digit Decadial Current Control var. ww 200 10-turn var. ww 1k 10-turn 3-digit turns-counting dial	Series 8400 Series 8400 411	84048 84048 12697	2100-1863 2100-1864 1140-0020
R121 R122 R123 R124	OPTION 020 Adjustable Voltage Programming fxd, film 221k 1% 1/8W var. ww 15k fxd, film 249k 1% 1/8W var. ww 15k	CEA T-0 CT-100-4 CEA T-0 CT-100-4	07716 84048 07716 84048	0757-0473 2100-0896 0757-0270 2100-0896
R125 6256B,-64B 6263B,-65B,-66B,-67B, -71B,-74B R126 R127 R128	OPTION 021 Adjustable Current Programming fxd, film 23k 1% 1/8W fxd, film 200k 1% 1/8W var. ww 15k fxd, film 390k 1% 1/8W var. ww 15k	CEA-993 CEA-993 CT-100-4 CEA-993 CT-100-4	07716 07716 84048 07716 84048	0698-3269 0757-0472 2100-0896 0698-5093 2100-0896
R121 R122 R123 R124	OPTION 022 Adjustable Voltage and Current Programming fxd, film 221k 1% 1/8W var. ww 15k fxd, film 249k 1% 1/8W var. ww 15k	CEA T-0 CT-100-4 CEA T-0 CT-100-4	07716 84048 07716 84048	0757-0473 2100-0896 0757-0270 2100-0896

Table 6-4. Replaceable Parts

REF. DESIG. (AND MODELS)	DESCRIPTION	MFG. PART NUMBER	MFG. CODE	HP PART NUMBER
R125 6256B,-64B 6263B,-65B,-66B,-67B, -71B,-74B R126 R127 R128	fxd, film 23k 1% 1/8W fxd, film 200k 1% 1/8W var. ww 15k fxd, film 390k 1% 1/8W var. ww 15k	CEA-993 CEA-993 CT-100-4 CEA-993 CT-100-4	07716 07716 84048 07716 84048	0698-3269 0757-0472 2100-0896 0698-5093 2100-0896
F1 6256B 6263B,-66B,-71B 6264B,-67B 6265B F2 6256B,-63B,-64B,-65B, -66B,-67B,-71B J3 R40	OPTION 027 208Vac Input LINE fuse fuse, 5A 250V fuse, 3A 250V fuse, 6A 250V fuse, 2A 250V BIAS fuse fuse, 62mA 250V (Disconnect J1, J2, and J4 in the A2 RFI Ass'y. and install J3. See Section II for complete input voltage conversion instructions.) fxd, comp 120k 5% 1/2W	314005 312003 312006 312002 313.062 EB-1245	75915 75915 75915 75915 75915 01121	2110-0227 2110-0003 2110-0056 2110-0002 2110-0311 0686-1245
F1 6256B 6263B,-66B,-71B 6264B,-67B 6265B F2 6256B,-63B,-64B,-65B, -66B,-67B,-71B J3 R40	OPTION 028 230Vac Input LINE fuse fuse, 5A 250V fuse, 3A 250V fuse, 6A 250V fuse, 2A 250V BIAS fuse fuse, 62mA 250V (Disconnect J1, J2, and J4 in the A2 RFI Ass'y. and install J3. See Section II for complete input voltage conversion instructions.) fxd, comp 120k 5% 1/2W	314005 312003 312006 312002 313.062 EB-1245	75915 75915 75915 75915 75915 01121	2110-0227 2110-0003 2110-0056 2110-0002 2110-0311 0686-1245
	OPTION 040 Interfacing for Multiprogrammer Operation (The replaceable parts for Option 040 are the same as for Option 022.)			

SECTION VII CIRCUIT DIAGRAMS AND COMPONENT LOCATION DIAGRAMS

This section contains the circuit schematics and component location diagrams necessary for the maintenance of this power supply. Separate schematics, circuit board component location diagrams, and chassis component location diagrams are provided for the models in 5 1/4-inch-high cabinets (Models 6256B, 6264B, 6267B, and 6274B) and for the models in 3 1/2-inch-high cabinets (Models 6263B, 6265B, 6266B, and 6271B). The A2 RFI Assembly circuit

board shown in Figure 7-1 is common to all eight models. The circuit board shown in Figure 7-2 is used only in instruments with Option 020, 021, 022, or 040. Some of the components on this board are not used with some options. The test points on the schematics indicated by circled numbers correspond to those on the component location diagrams and in the troubleshooting procedures in Section V.

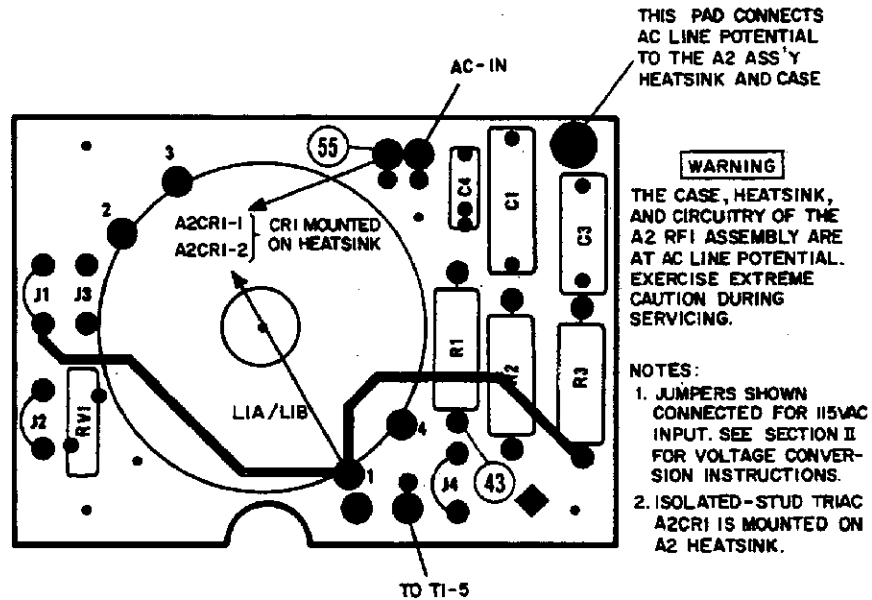

Figure 7-1. A2 RFI Assembly Component Locations

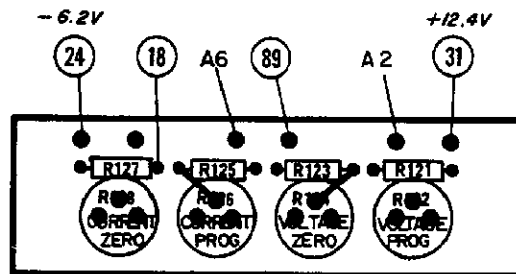

Figure 7-2. Option 020, 021, 022, 040 Circuit Board Component Locations

WARNING
 SOME CIRCUITS ON THIS CIRCUIT BOARD ARE CONNECTED DIRECTLY TO THE INPUT AC POWER LINE. EXERCISE EXTREME CAUTION WHEN WORKING ON ENERGIZED CKTS.

PREREGULATOR CONTROL CIRCUIT

TURN-ON CONTROL

OVERVOLTAGE PROTECTION CROWBAR

EXT TRIG
 T4-5
 T4-6

MIXER & ERROR AMPLIFIER

REFERENCE CIRCUIT

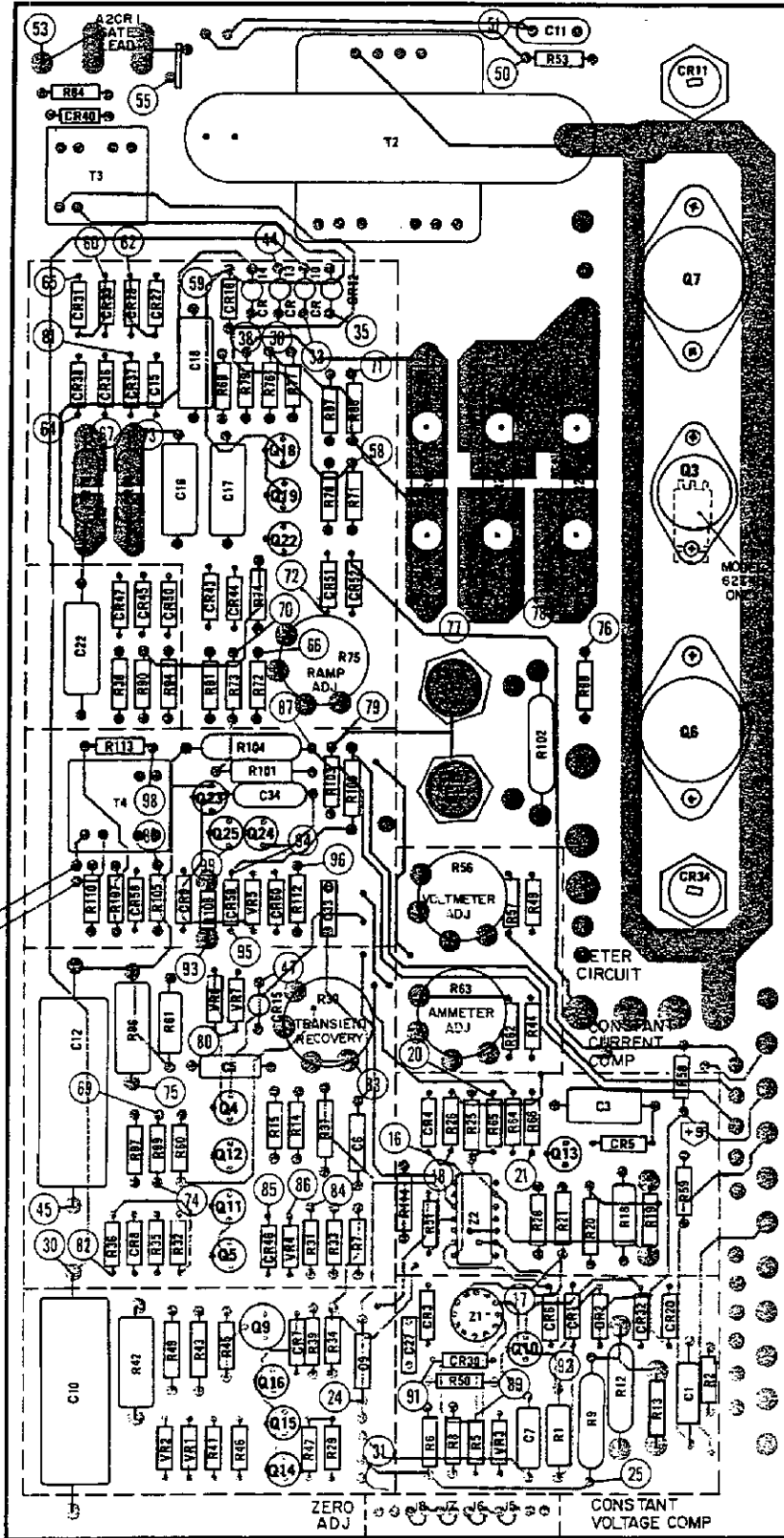

Figure 7-3. A1 Board Component Locations for Models 6256B, 6264B, 6267B, and 6274B

WARNING

THE CASE AND HEAT SINK OF THE A2 RFI ASSEMBLY ARE AT AC LINE POTENTIAL. EXERCISE EXTREME CAUTION DURING SERVICING.

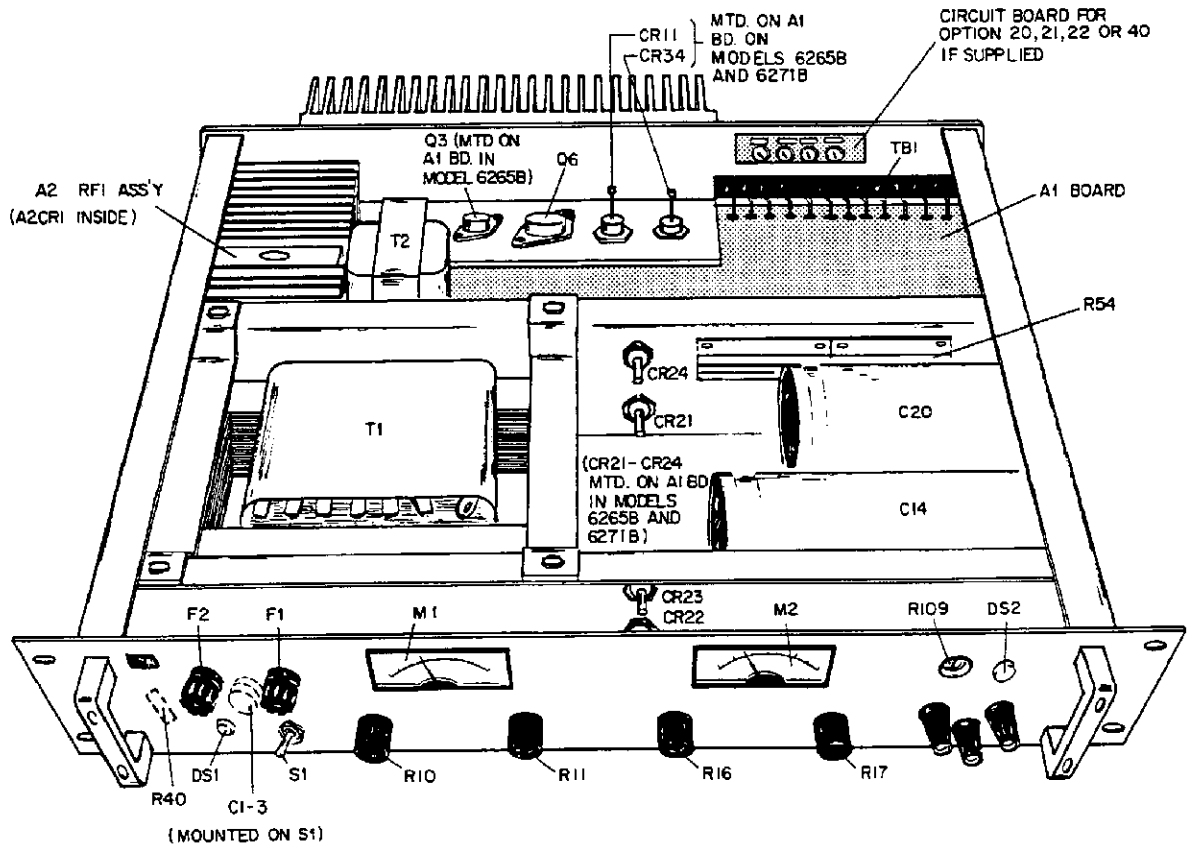

Figure 7-8. Chassis Component Locations for Models 6263B, 6265B, 6266B, and 6271B

ADDENDUM

I. Generally Applicable Annotations

Consistent with good engineering practice, leads attached to customer accessible signal/monitoring ports (such as the 10-pin Control Connector, the 7-pin Analog Connector, the 4-pin Digital Port/Trigger Connector, screw terminal Barrier Blocks, etc.) should be twisted and shielded to maintain the instrument's specified performance.

II. CE'92 Product Specific Annotations

When tested for radiated susceptibility as called for in EN 50082-1 per the EC EMC directive, the following changes in the Supplementary Characteristics of the 6260B have been noted:

When subjected to radiated field strengths of 3 volts/meter in the vicinity of 70 MHz, the full scale programming accuracy increases from 100 millivolts at 10 volts output to 250 millivolts.

The accuracy reverts to the published value of 100 millivolts when the field is reduced to 1.0 volt/meter.