

Errata

Title & Document Type: 6448B DC Power Supply Operating and Service Manual

Manual Part Number: 06448-90001

Revision Date: April 1968

About this Manual

We've added this manual to the Agilent website in an effort to help you support your product. This manual provides the best information we could find. It may be incomplete or contain dated information, and the scan quality may not be ideal. If we find a better copy in the future, we will add it to the Agilent website.

HP References in this Manual

This manual may contain references to HP or Hewlett-Packard. Please note that Hewlett-Packard's former test and measurement, life sciences, and chemical analysis businesses are now part of Agilent Technologies. The HP XXXX referred to in this document is now the Agilent XXXX. For example, model number HP8648A is now model number Agilent 8648A. We have made no changes to this manual copy.

Support for Your Product

Agilent no longer sells or supports this product. You will find any other available product information on the Agilent Test & Measurement website:

www.agilent.com

Search for the model number of this product, and the resulting product page will guide you to any available information. Our service centers may be able to perform calibration if no repair parts are needed, but no other support from Agilent is available.



**DC POWER SUPPLY
SCR-1P SERIES
MODEL 6448B**

OPERATING AND SERVICE MANUAL

FOR SERIALS 6L0182 - 0241*

*For Serials above 6L0241
Check for inclusion of
change page.

*For Serials Below 6L0182
Refer to Appendix A.

100 Locust Avenue, Berkeley Heights, New Jersey 07922

TABLE OF CONTENTS

Section	Page No.	Section	Page No.
I GENERAL INFORMATION	1-1	III OPERATING INSTRUCTIONS (Cont'd.)	
1-1 Description	1-1	3-48 Reverse Current Loading	3-5
1-4 Operating Capabilities	1-1		
1-10 Specifications	1-2	IV PRINCIPLES OF OPERATION	4-1
1-12 Options	1-2	4-1 Overall Description	4-1
1-14 Instrument/Manual Identification	1-2	4-12 Detailed Circuit Analysis	4-3
1-17 Ordering Additional Manuals	1-2	4-13 AC Input	4-3
		4-15 DC Output	4-3
		4-17 Feedback Loop	4-3
II INSTALLATION	2-1	4-22 Voltage Comparison Amplifier	4-3
2-1 Initial Inspection	2-1	4-25 Current Comparison Amplifier	4-4
2-3 Mechanical Check	2-1	4-28 Gating Circuit	4-4
2-5 Electrical Check	2-1	4-31 SCR Regulator Control	4-4
2-7 Installation Data	2-1	4-39 SCR Regulator	4-5
2-9 Location	2-1	4-44 Bias and Reference Circuit	4-6
2-11 Rack Mounting	2-1		
2-13 Input Power Requirements	2-1	V MAINTENANCE	5-1
2-15 Modifications for 208 or 230Vac Operation	2-1	5-1 Introduction	5-1
2-17 50Hz Operation	2-1	5-3 Test Equipment Required	5-1
2-19 Power Cable	2-1	5-5 Performance Test	5-2
2-22 Repackaging for Shipment	2-1	5-7 Constant Voltage Tests	5-2
		5-33 Output Impedance	5-6
III OPERATING INSTRUCTIONS	3-1	5-43 Constant Current Tests	5-8
3-1 Turn-on Checkout Procedure	3-1	5-50 Troubleshooting	5-9
3-3 Operating Modes	3-1	5-55 Overall Troubleshooting Procedure	5-9
3-5 Normal Operating Mode	3-1	5-59 Repair and Replacement	5-11
3-7 Constant Voltage	3-2	5-61 Adjustment and Calibration	5-11
3-9 Constant Current	3-2	5-63 Meter Zero	5-12
3-11 Connecting Load	3-2	5-65 Voltmeter Adjustment	5-12
3-14 Operation of Supply Beyond Rated Output	3-2	5-67 Ammeter Adjustment	5-12
3-16 Optional Operating Modes	3-2	5-69 Voltage Programming Accuracy	5-12
3-17 Remote Programming, Constant Voltage	3-2	5-71 Current Programming Accuracy	5-14
3-24 Remote Programming, Constant Current	3-3	5-73 Transient Recovery Time	5-14
3-29 Remote Sensing	3-3	5-75 Overvoltage Protection Adjustment	5-14
3-33 Parallel Operation	3-4	5-77 Ripple Imbalance Adjustment	5-14
3-37 Auto-Tracking Operation	3-5		
3-40 Special Operating Considerations	3-5	VI REPLACEABLE PARTS	6-1
3-41 Pulse Loading	3-5	6-4 Ordering Information	6-1
3-43 Output Capacitance	3-5		
3-46 Reverse Voltage Loading	3-5	VII CIRCUIT DIAGRAMS	7-1
		APPENDIX A	A-1

LIST OF TABLES

Table	Page No.
1-1 Specifications	1-2
5-1 Test Equipment Required	5-1
5-2 Reference and Bias Voltages	5-9
5-3 Overall Troubleshooting	5-10
5-4 Low Output Voltage Troubleshooting	5-11
5-5 High Output Voltage Troubleshooting	5-12
6-1 Reference Designators	6-1
6-2 Description Abbreviations	6-1
6-3 Code List of Manufacturers	6-2
6-4 Replaceable Parts	6-5

LIST OF ILLUSTRATIONS

Figure	Page No.	Figure	Page No.
1-1 DC Power Supply, Model 6448B	1-1	5-1 Differential Voltmeter Substitute Test Setup	5-2
3-1 Front Panel Controls and Indicators	3-1	5-2 Front Panel Terminal Connections	5-3
3-2 Normal Strapping Pattern	3-2	5-3 Constant Voltage Test Setup	5-3
3-3 Remote Resistance Programming	3-2	5-4 CV Ripple and Noise, Test Setup	5-4
3-4 Remote Voltage Programming (Constant Voltage)	3-3	5-5 CV Noise Spike, Test Setup	5-5
3-5 Remote Resistance Programming (Constant Current)	3-3	5-6 Transient Recovery Time, Test Setup	5-6
3-6 Remote Sensing	3-4	5-7 Transient Recovery Time, Waveforms	5-7
3-7 Normal Parallel Connections	3-4	5-8 Output Impedance, Test Setup	5-7
3-8 Auto Parallel, Two and Three Units	3-4	5-9 Output Current Measurement Technique	5-8
3-9 Auto Tracking, Two and Three Units	3-5	5-10 Output Current, Test Setup	5-8
4-1 Overall Block Diagram	4-1	5-11 Servicing Printed Wiring Boards	5-13
4-2 Operating Locus of a CV/CC Power Supply	4-2	5-12 Ripple Imbalance Waveform	5-14
4-3 SCR Regulator Control, Timing Diagram	4-4		

SECTION I GENERAL INFORMATION

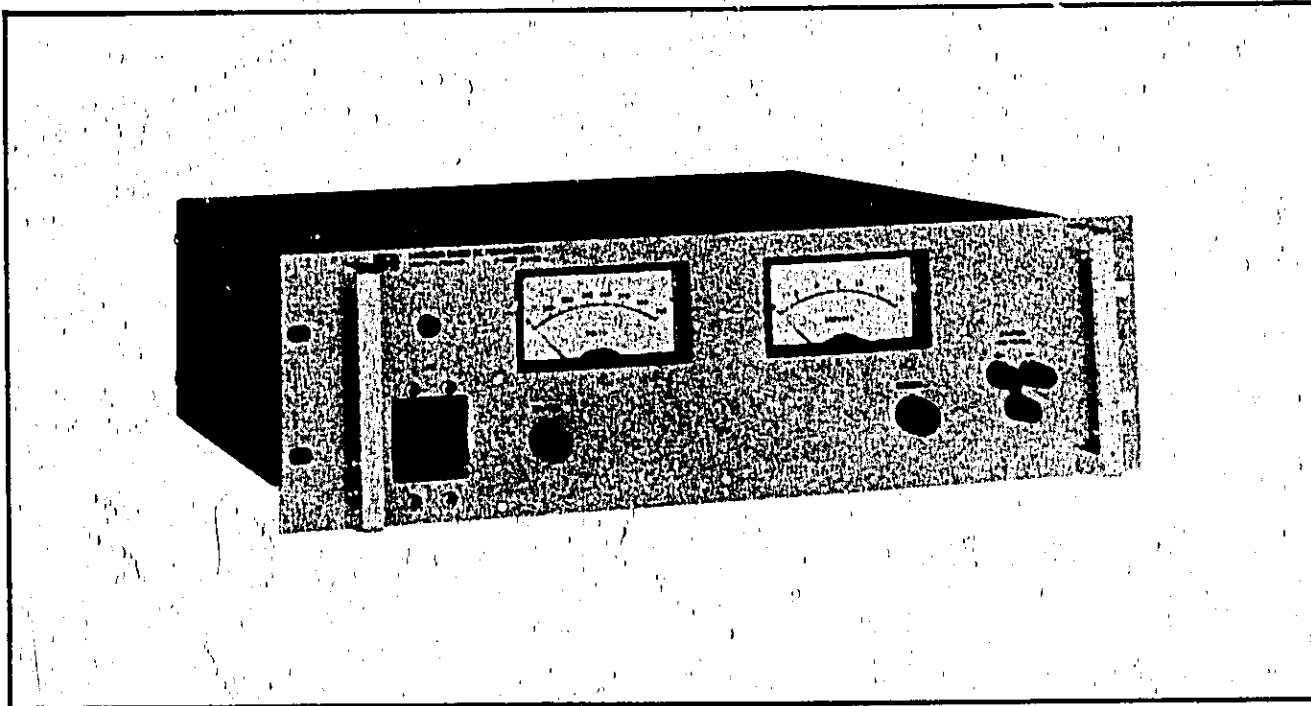

Figure 1-1. DC Power Supply, Model 6448B

1-1 DESCRIPTION

1-2 This power supply, Figure 1-1, is completely transistorized and suitable for bench or rack operation. It is a well-regulated, Constant Voltage/Constant Current supply that will furnish full rated output voltage at the maximum rated output current or can be continuously adjusted throughout the output range. The front panel CURRENT controls can be used to establish the output current limit (overload or short circuit) when the supply is used as a constant voltage source and the VOLTAGE control can be used to establish the voltage limit when the supply is used as a constant current source. The supply will automatically crossover from constant voltage to constant current operation and vice-versa if the output current or voltage exceeds the limits established by these controls.

1-3 Output voltage and current can be continuously monitored on the two front panel meters. The power supply has both front and rear output terminals. Either the positive or negative output terminal may be grounded or the power supply can

be operated floating at up to a maximum of 300 Volts off ground.

1-4 OPERATING CAPABILITIES

1-5 Terminals at the rear of the unit allow access to various control points within the unit to expand the operating capabilities of the instrument. A brief description of these capabilities is given below.

1-6 Remote Programming. The power supply may be programmed (controlled) from a remote location by means of an external voltage source or resistance.

1-7 Remote Sensing. The degradation in regulation which would occur at the load because of the voltage drop in the load leads can be reduced by using the power supply in the remote sensing mode of operation.

1-8 Auto-Parallel Operation. The power supply may be operated in Auto-Parallel with a similar

unit when greater output current capability is required. Auto-Parallel operation permits one knob control of the total output current from a "master" supply.

1-9 **Auto-Tracking.** The power supply may be used as a "master" supply, having control over one (or more) "slave" supplies that furnish various voltages for a system.

1-10 SPECIFICATIONS

1-11 Detailed specifications for the power supply are given in Table 1-1.

1-12 OPTIONS

1-13 Options are factory modifications of a standard instrument that are requested by the customer. The following options are available for the instrument covered by this manual. Where necessary, detailed coverage of the options is included throughout the manual.

Option No.	Description
05	50Hz Regulator Realignment. Standard instruments will operate satisfactorily at both 60 and 50Hz without adjustment. However, Option 05 factory realignment results in more efficient operation at 50Hz, and is recommended for all applications when continuous operation from a 50Hz ac input is intended.
10	Chassis Slides. Enables convenient access to power supply interior for maintenance purposes. Slides are attached at the factory.
17	208Vac ±10%, Single Phase Input. Factory modification includes the in-

18

stallation of 208 Volt input power transformer, bias transformer, and SCR's to replace the standard 115 or 230 Volt components.

230Vac ±10%, Single Phase Input. Factory modification includes the installation of a 230 Volt input power transformer, bias transformer, and SCR's to replace the standard 115 or 230 Volt components.

1-14 INSTRUMENT/MANUAL IDENTIFICATION

1-15 Hewlett-Packard power supplies are identified by a three-part serial number tag. The first part is the power supply model number. The second part is the serial number prefix, which consists of a number-letter combination that denotes the date of a significant design change. The number designates the year, and the letter A through M designates the month, January through December, respectively, with "I" omitted. The third part is the power supply serial number; a different sequential number is assigned to each power supply.

1-16 If the serial number on your instrument does not agree with those on the title page of the manual, Change Sheets supplied with the manual or Manual Backdating Changes in Appendix A define the differences between your instrument and the instrument described by this manual.

1-17 ORDERING ADDITIONAL MANUALS

1-18 One manual is shipped with each power supply. Additional manuals may be purchased from your local Hewlett-Packard sales office (see list at rear of this manual for addresses). Specify the model number, serial number prefix, and part number provided on the title page.

Table 1-1. Specifications

INPUT: 115Vac ±10%, 57-63Hz, single phase, 16 Amperes, 1200 Watts maximum.	Constant Current - Less than 15mA for a change in line voltage from 103.5 to 126.5 (or 126.5 to 103.5).
OUTPUT: 0-600 Volts @ 0-1.5 Amperes.	LOAD REGULATION: Constant Voltage - Less than 600mV for a change in output current from no load to full load or full load to no load. Constant Current - Less than 15mA for a change in output voltage from no load to full load or full load to no load.
LINE REGULATION: Constant Voltage - Less than 600mV for a change in line voltage from 103.5 to 126.5 (or 126.5 to 103.5).	

Table 1-1. Specifications (Continued)

RIPPLE AND NOISE:

Less than 600mVrms/2V p-p (dc to 20MHz).

LOAD TRANSIENT RECOVERY:

Less than 200msec is required for output voltage recovery to within 3000mV of the nominal output voltage following a load change from full load to half load or half load to full load. Excluding the initial narrow spike of approximately 100µsec duration (significant only with load rise times faster than 0.1A/µsec), the transient amplitude will be less than 20 Volts/Amp for any load change between 20% and 100% of rated output current.

LINE TRANSIENT RECOVERY:

Less than 200msec is required for output voltage recovery to within 30 Volts of the nominal output voltage following a change in the nominal line voltage from 103.5 to 126.5Vac.

TEMPERATURE RANGES:

Operating: 0°C to 55°C. Storage: -40°C to +75°C.

TEMPERATURE COEFFICIENT:

Constant Voltage - Less than (0.03% + 100mV) output change per degree centigrade change in ambient following 30 minutes warm-up.
Constant Current - Less than 5mA output change per degree centigrade change in ambient following 30 minutes warm-up.

STABILITY:

Constant Voltage - Less than 0.1% +300mV total drift for 8 hours following 30 minutes warm-up under constant ambient, constant line voltage, and constant load.
Constant Current - Less than 15mA total drift for 8 hours following 30 minutes warm-up under constant ambient, constant line voltage, and constant load.

INTERNAL IMPEDANCE AS A CONSTANT VOLTAGE SOURCE:

Less than 0.5 ohms from DC to 0.5Hz.
 Less than 5.0 ohms from 0.5Hz to 100Hz.
 Less than 3.5 ohms from 100Hz to 1kHz.
 Less than 5.0 ohms from 1kHz to 100kHz.

METERS:

A front panel voltmeter (0-700V) and ammeter (0-1.8A) are provided. Meters have 2% accuracy; all units have meter calibrating potentiometers.

OUTPUT CONTROLS:

10-Turn voltage and single-turn current controls located on the front panel permit continuous adjustment of the output voltage and current from zero to the maximum output rating of the supply.

OUTPUT TERMINALS:

An output barrier strip located on the rear of the chassis includes dc output terminals as well as all necessary terminals for remote error sensing, remote programming, Auto-Parallel, etc. Either the positive or negative terminal may be connected to the chassis via a separate ground terminal or the supply may be operated floating at up to 600 Volts off ground. Front panel terminals may be used for monitoring purposes or for loads up to 3 Amperes.

ERROR SENSING:

Error sensing is normally accomplished at the front terminals if the load is attached to the front or at the rear terminals if the load is attached to the rear terminals. Also, provision is included on the rear terminal strip for remote sensing.

RESOLUTION:

Constant Voltage - 60mV minimum output change that can be accomplished by the front panel output control.
Constant Current - 0.75mV minimum output change that can be accomplished by the front panel output control.

REMOTE PROGRAMMING:

Constant voltage remote programming is approximately 300 ohms per Volt with an accuracy of 2%. In constant current mode of operation, the current can be remotely programmed at approximately 600 ohms per Amp with 6% accuracy. Remote programming control is accomplished either with input resistance or input voltage.

COOLING:

The unit is cooled by forced air from an internal fan.

SIZE:

5-1/4" H x 16-3/4" D x 19" W. The unit can be mounted in a standard 19" rack panel.

WEIGHT: 61 lbs. net, 70 lbs. shipping.

FINISH: Light gray front panel with dark gray case.

SECTION II INSTALLATION

2-1 INITIAL INSPECTION

2-2 Before shipment, this instrument was inspected and found to be free of mechanical and electrical defects. As soon as the instrument is unpacked, inspect for any damage that may have occurred in transit. Save all packing materials until the inspection is completed. If damage is found, proceed as described in the Claim for Damage in Shipment section of the warranty page at the rear of this manual.

2-3 MECHANICAL CHECK

2-4 This check should confirm that there are no broken knobs or connectors, that the cabinet and panel surfaces are free of dents and scratches, and that the meters are not scratched or cracked.

2-5 ELECTRICAL CHECK

2-6 The instrument should be checked against its electrical specifications. Section V includes an "in-cabinet" performance check to verify proper instrument operation.

2-7 INSTALLATION DATA

2-8 The instrument is shipped ready for bench operation. It is necessary only to connect the instrument to a source of power and it is ready for operation.

2-9 LOCATION

2-10 This instrument is cooled by forced air from the cooling fan. It should not be used in an area where the ambient temperature may exceed 55°C.

2-11 RACK MOUNTING

2-12 This instrument is full rack size and can be easily rack mounted in a conventional 19 inch rack panel using standard mounting screws.

2-13 INPUT POWER REQUIREMENTS

2-14 This power supply may be operated from a nominal 115V, 208V, or 230 Volt, 57-63Hz power source. The unit, as shipped from the factory, is

wired for 115 Volt operation. The input power required when operated from a 115Vac, 60Hz power source is 1200 Watts, 16 Amps.

2-15 MODIFICATIONS FOR 208 OR 230VAC OPERATION

2-16 The supply is normally shipped with a 115Vac input. For Option 17 or 18, 208 or 230Vac input, transformers T1 and T2, SCRs CR17 and CR18, and resistors R21 and R58 should be replaced. Part information is given in Table 6-4 under Options 17 and 18.

2-17 50HZ OPERATION

2-18 To permit optimum operation at 50Hz, the output ripple imbalance must be realigned as described in Paragraph 5-78.

2-19 POWER CABLE

2-20 To protect operating personnel, the National Electrical Manufacturers' Association (NEMA) recommends that the instrument panel and cabinet be grounded. This instrument is equipped with a three conductor power cable. The third conductor is the ground conductor and when the cable is plugged into an appropriate receptacle, the instrument is grounded. The offset pin on the power cable three-prong connector is the ground connection.

2-21 To preserve the protection feature when operating the instrument from a two-contact outlet, use a three-prong to two-prong adapter and connect the green lead on the adapter to ground.

2-22 REPACKAGING FOR SHIPMENT

2-23 To insure safe shipment of the instrument, it is recommended that the package designed for the instrument be used. The original packaging material is reusable. If it is not available, contact your local Hewlett-Packard field office to obtain the materials. This office will also furnish the address of the nearest service office to which the instrument can be shipped. Be sure to attach a tag to the instrument which specifies the owner, model number, full serial number, and service required, or a brief description of the trouble.

OPERATION

THEORY

SECTION III OPERATING INSTRUCTIONS

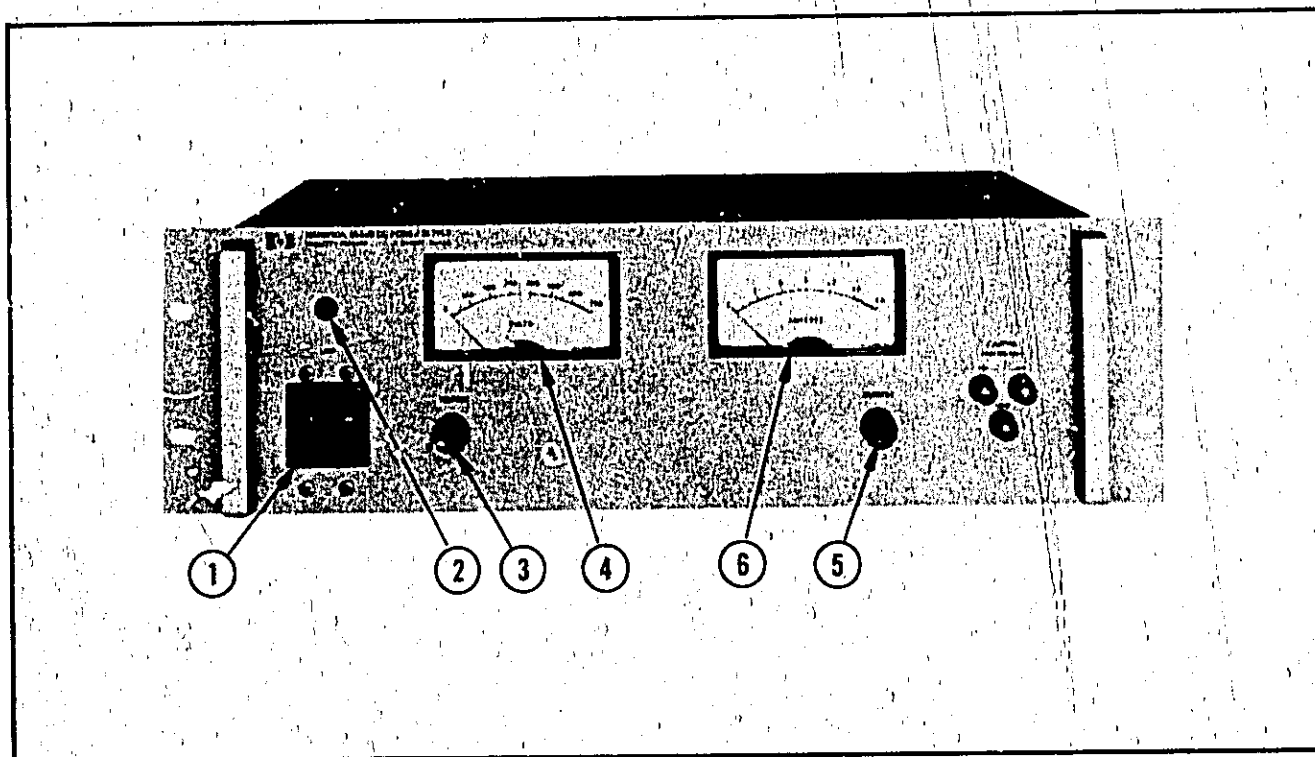

Figure 3-1. Front Panel Controls and Indicators

3-1 TURN-ON CHECKOUT PROCEDURE

3-2 The following checkout procedure describes the use of the front panel controls and indicators and ensures that the supply is operational.

- a. Set LINE breaker (1) to ON; pilot lamp (2) should light.
- b. Adjust VOLTAGE controls (3) until desired output voltage is indicated on voltmeter (4).
- c. To ensure that constant current circuit is operational, turn off supply and short-circuit rear output terminals.
- d. Turn on supply and adjust CURRENT controls (5) until desired output current is indicated on ammeter (6).
- e. Remove short and connect load to output terminals.

3-3 OPERATING MODES

3-4 The power supply is designed so that its mode of operation can be selected by making strapping connections between particular terminals

on the terminal strip at the rear of the power supply. The terminal designations are stenciled in white on the power supply above their respective terminals. Although the strapping patterns illustrated in this section show the positive terminal grounded, the operator can ground either buss or operate the power supply up to 600Vdc off ground (floating). The following paragraphs describe the procedures for utilizing the various operational capabilities of the power supply. A more theoretical description concerning the operational features of this supply is contained in Application Note 90, Power Supply Handbook; available at no charge from your local Hewlett-Packard sales office. Sales office addresses appear at the rear of the manual.

3-5 NORMAL OPERATING MODE

3-6 The power supply is normally shipped with its rear terminal strapping connections arranged for Constant Voltage/Constant Current, local sensing, local programming, single unit mode of

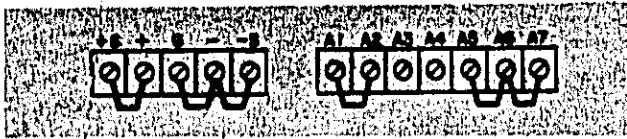

Figure 3-2. Normal Strapping Pattern

operation. This strapping pattern is illustrated in Figure 3-2. The operator selects either a constant voltage or a constant current output using the front panel controls (local programming, no strapping changes are necessary).

3-7 CONSTANT VOLTAGE

3-8 To select a constant voltage output, proceed as follows:

a. Turn-on power supply and adjust VOLTAGE control for desired output voltage (output terminals open).

b. Short output terminals and adjust CURRENT control for maximum output current allowable (current limit), as determined by load conditions. If a load change causes the current limit to be exceeded, the power supply will automatically cross-over to constant current output at the preset current limit and the output voltage will drop proportionately. In setting the current limit, allowance must be made for high peak current which can cause unwanted cross-over. (Refer to Paragraph 3-41.)

3-9 CONSTANT CURRENT

3-10 To select a constant current output, proceed as follows:

a. Short output terminals and adjust CURRENT control for desired output current.

b. Open output terminals and adjust VOLTAGE controls for maximum output voltage allowable (voltage limit), as determined by load conditions. If a load change causes the voltage limit to be exceeded, the power supply will automatically cross-over to constant voltage output at the preset voltage limit and the output current will drop proportionately. In setting the voltage limit, allowance must be made for high peak voltages which can cause unwanted crossover. (Refer to Paragraph 3-41.)

3-11 CONNECTING LOAD

3-12 Each load should be connected to the power supply output terminals using separate pairs of connecting wires. This will minimize mutual coupling effects between loads and will retain full advantage of the low output impedance of the power supply. Each pair of connecting wires should be as short as possible and twisted or shielded to reduce noise pickup. (If shield is used, connect one

end to power supply ground terminal and leave the other end unconnected.)

3-13 If load considerations require that the output power distribution terminals be remotely located from the power supply, then the power supply output terminals should be connected to the remote distribution terminals via a pair of twisted or shielded wires and each load separately connected to the remote distribution terminals. For this case, remote sensing should be used (Paragraph 3-29.)

3-14 OPERATION OF SUPPLY BEYOND RATED OUTPUT

3-15 The shaded area on the front panel meter face indicates the amount of output voltage or current that is available in excess of the normal rated output. Although the supply can be operated in this shaded region without being damaged, it cannot be guaranteed to meet all of its performance specifications. However, if the line voltage is maintained above 115Vac, the supply will probably operate within its specifications.

3-16 OPTIONAL OPERATING MODES

3-17 REMOTE PROGRAMMING, CONSTANT VOLTAGE

3-18 The constant voltage output of the power supply can be programmed (controlled) from a remote location if required. Either a resistance or voltage source can be used for the programming device. The wires connecting the programming terminals of the supply to the remote programming device should be twisted or shielded to reduce noise pickup. The VOLTAGE control on the front panel is disabled by the following procedures.

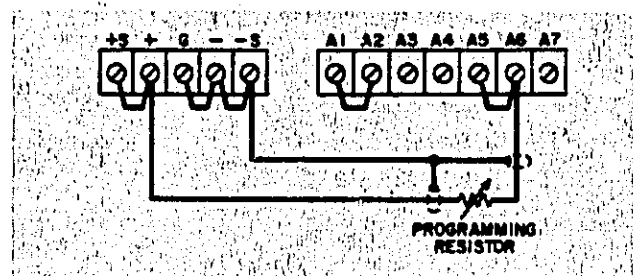

Figure 3-3. Remote Resistance Programming

3-19 Resistance Programming (Figure 3-3). In this mode, the output voltage will vary at a rate determined by the programming coefficient (300 ohms per Volt). The output voltage will increase 1 Volt for each 300 ohms added in series with the programming terminals. The programming coefficient is determined by the programming current. This

current is factory adjusted to within 2% of 3.3mA. If greater programming accuracy is required, it may be achieved by changing resistor R39 as discussed in Paragraph 5-70.

3-20 To maintain the stability and temperature coefficient of the power supply, use programming resistors that have stable, low noise, and low temperature (less than 30ppm per degree Centigrade) characteristics. A switch can be used in conjunction with various resistance values to obtain discrete output voltages. The switch should have make-before-break contacts to avoid momentarily opening the programming terminals during the switching interval.

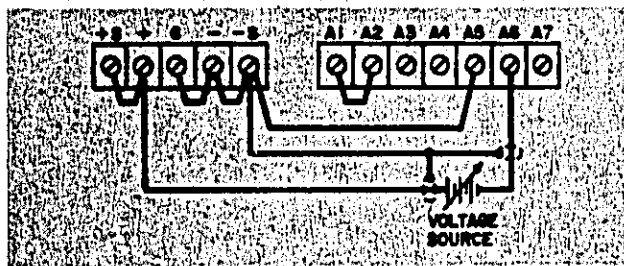

Figure 3-4. Remote Voltage Programming (Constant Voltage)

3-21 Voltage Programming (Figure 3-4). Employ the strapping pattern shown on Figure 3-4 for voltage programming. In this mode, the output voltage will vary in a 1 to 1 ratio with the programming voltage (reference voltage) and the load on the programming voltage source will not exceed 20 microamperes.

3-22 An impedance matching resistor of approximately 1000 Ω should be connected in series with the voltage source to maintain the temperature and stability specifications of the power supply.

3-23 Methods of voltage programming with gain are discussed in Application Note 90, Power Supply Handbook; available at no charge from your local Φ Sales Office.

3-24 REMOTE PROGRAMMING, CONSTANT CURRENT

3-25 Either a resistance or a voltage source can be used to control the constant current output of the supply. The CURRENT controls on the front panel are disabled according to the following procedures.

3-26 Resistance Programming (Figure 3-5). In this mode, the output current varies at a rate determined by the programming coefficient (600 ohms/Ampere). The programming coefficient is adjusted

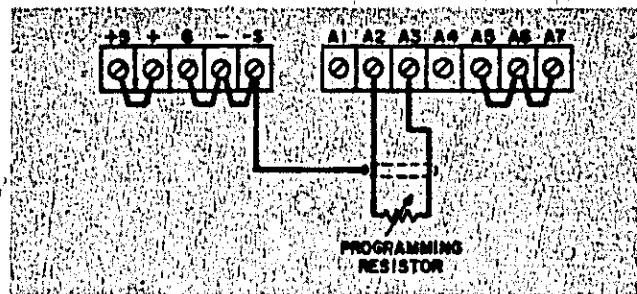

Figure 3-5. Remote Resistance Programming (Constant Current)

for an accuracy of 6% at the factory. If greater programming accuracy is required, it may be achieved by changing resistor R41 as outlined in Paragraph 5-72.

3-27 Use stable, low noise, low temperature coefficient (less than 30ppm/ $^{\circ}$ C) programming resistors to maintain the power supply temperature coefficient and stability specifications. A switch may be used to set discrete values of output current. A make-before-break type of switch should be used since the output current will exceed the maximum rating of the power supply if the switch contacts open during the switching interval.

CAUTION

If the programming terminals (A2 and A4) should open at any time during this mode, the output current will rise to a value that may damage the power supply and/or the load. To avoid this possibility, connect a 200 ohm resistor across the programming terminals. Like the programming resistor, this resistor should be of the low noise, low temperature coefficient type.

3-28 Methods used to voltage program a power supply with gain are discussed in Application Note 90, Power Supply Handbook; available at no charge from your local Φ Sales Office.

3-29 REMOTE SENSING (See Figure 3-6)

3-30 Remote sensing is used to maintain good regulation at the load and reduce the degradation of regulation which would occur due to the voltage drop in the leads between the power supply and the load. Remote sensing is accomplished by utilizing the strapping pattern shown in Figure 3-6. The power supply should be turned off before changing strapping patterns. The leads from the +S terminals to the load will carry much less cur-

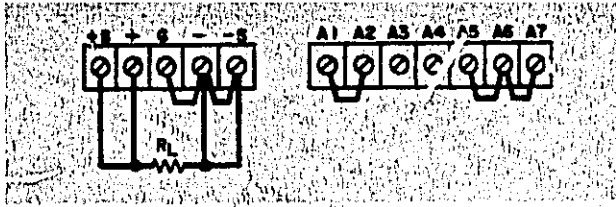

Figure 3-6. Remote Sensing

rent than the load leads and it is not required that these leads be as heavy as the load leads. However, they must be twisted or shielded to minimize noise pickup.

3-31. Note that it is desirable to minimize the voltage drop in the load leads and it is recommended that the drop not exceed 1 Volt per lead if the power supply is to meet its dc specifications. If a larger drop must be tolerated, please consult a sales engineer.

NOTE

Due to the voltage drop in the load leads, it may be necessary to readjust the current limit in the remote sensing mode.

3-32 Although the strapping patterns shown in Figures 3-3 through 3-5 employ local sensing, note that it is possible to operate a power supply simultaneously in the remote sensing and Constant Voltage/Constant Current remote programming modes.

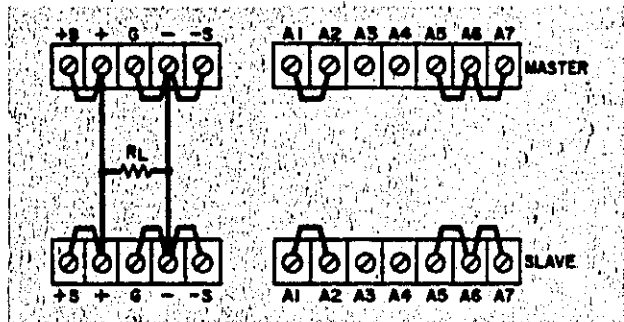

Figure 3-7. Normal Parallel Connections

3-33 PARALLEL OPERATION.

3-34 Normal Parallel Connections (Figure 3-7). Two or more power supplies can be connected in parallel to obtain a total output current greater

than that available from one power supply. The total output current is the sum of the output currents of the individual power supplies. The output CURRENT controls of each power supply can be separately set. The output voltage controls of one power supply should be set to the desired output voltage; the other power supply should be set for a slightly larger output voltage. The supply set to the lower output voltage will act as a constant voltage source; the supply set to the higher output will act as a constant current source, dropping its output voltage until it equals that of the other supply. The constant voltage source will deliver only that fraction of its total rated output current which is necessary to fulfill the total current demand.

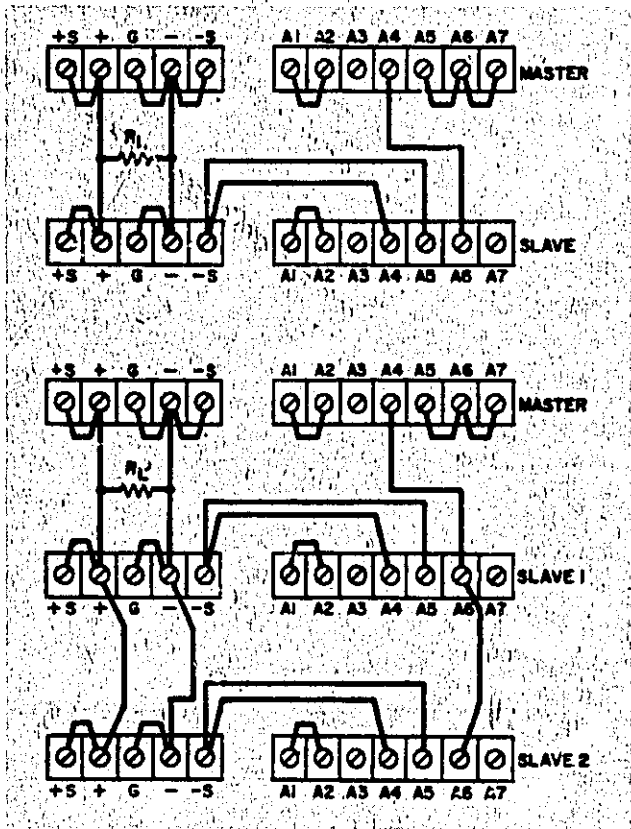

Figure 3-8. Auto Parallel, Two and Three Units

3-35 Auto-Parallel. The strapping patterns for Auto-Parallel operation of three power supplies are shown in Figure 3-8. Auto-Parallel operation permits equal current sharing under all load conditions, and allows complete control of the output current from one master power supply. The output current of each slave will be approximately equal to the master's regardless of the load conditions. Because the output current controls of each slave are operative, they should be set to maximum to avoid having the slave revert to constant current

operation; this would occur if the master output current setting exceeded the slave's.

3-36 Additional slave supplies may be added in parallel to the Master/Slave combination. All the connections between the Master and Slave #1 are duplicated between Slave #1 and the added Slave supply. In addition, the strapping pattern of the added Slave should be the same as Slave #1.

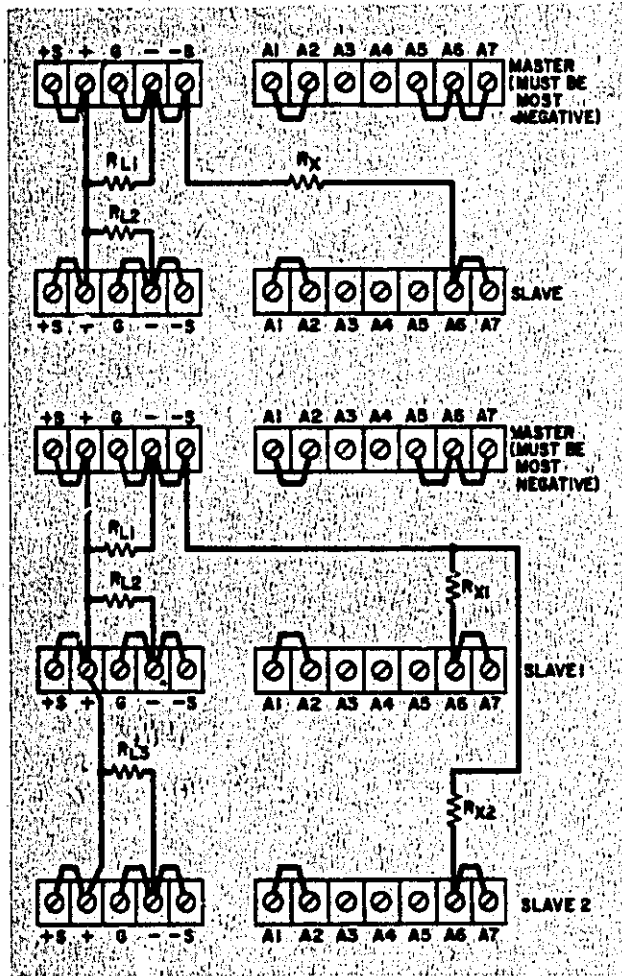

Figure 3-9. Auto Tracking, Two and Three Units

3-37 AUTO-TRACKING OPERATION (See Figure 3-9)

3-38 The Auto-Tracking configuration is used when it is necessary that several different voltages referred to a common buss, vary in proportion to the setting of a particular instrument (the control or master). A fraction of the master's output voltage is fed to the comparison amplifier of the slave supply, thus controlling the slave's output. The master must have the largest output voltage of any power supply in the group (must be the most negative supply in the example shown on Figure 3-9).

3-39 The output voltage of the slave is a percentage of the master's output voltage, and is determined by the voltage divider consisting of R_X and the voltage control of the slave supply, R_p , where $E_S = E_M(R_p/R_X + R_p)$. Turn-on and turn-off of the power supplies are controlled by the master. Remote sensing and programming can be used; although the strapping patterns for these modes show only local sensing and programming. In order to maintain the temperature coefficient and stability specifications of the power supply, the external resistors should be stable, low noise, low temperature coefficient (less than 30ppm per°C) resistors.

3-40 SPECIAL OPERATING CONSIDERATIONS

3-41 PULSE LOADING

3-42 The power supply will automatically cross over from constant voltage to constant current operation, or the reverse, in response to an increase (over the preset limit) in the output current or voltage, respectively. Although the preset limit may be set higher than the average output current or voltage, high peak currents or voltages (as occur in pulse loading) may exceed the preset limit and cause crossover to occur. If this crossover limiting is not desired, set the preset limit for the peak requirement and not the average.

3-43 OUTPUT CAPACITANCE

3-44 Internal capacitors (C15 and C16) connected across the output terminals of the power supply, help to supply high-current pulses of short duration during constant voltage operation. Any capacitance added externally will improve the pulse current capability, but will decrease the safety provided by the constant current circuit. A high-current pulse may damage load components before the average output current is large enough to cause the constant current circuit to operate.

3-45 The effects of the output capacitor during constant current operation are as follows:

- a. The output impedance of the power supply decreases with increasing frequency.
- b. The recovery time of the output voltage is longer for load resistance changes.
- c. A large surge current causing a high power dissipation in the load occurs when the load resistance is reduced rapidly.

3-46 REVERSE VOLTAGE LOADING

3-47 Diodes are connected across the output terminals. Under normal operating conditions, the diodes are reverse biased (anode connected to negative terminal). If a reverse voltage is applied to the output terminals (positive voltage applied to negative terminal), the diodes will conduct, shunt-

ing current across the output terminals and limiting the voltage to the forward voltage drop of the diode. The diodes protect the series transistors and the output electrolytic capacitor.

3-48 REVERSE CURRENT LOADING

3-49 Active loads connected to the power supply may actually deliver a reverse current to the power

supply during a portion of its operating cycle. An external source cannot be allowed to pump current into the supply without loss of regulation and possible damage to the output capacitor. To avoid these effects, it is necessary to preload the supply with a dummy load resistor so that the power supply delivers current through the entire operation cycle of the load device.

SECTION IV PRINCIPLES OF OPERATION

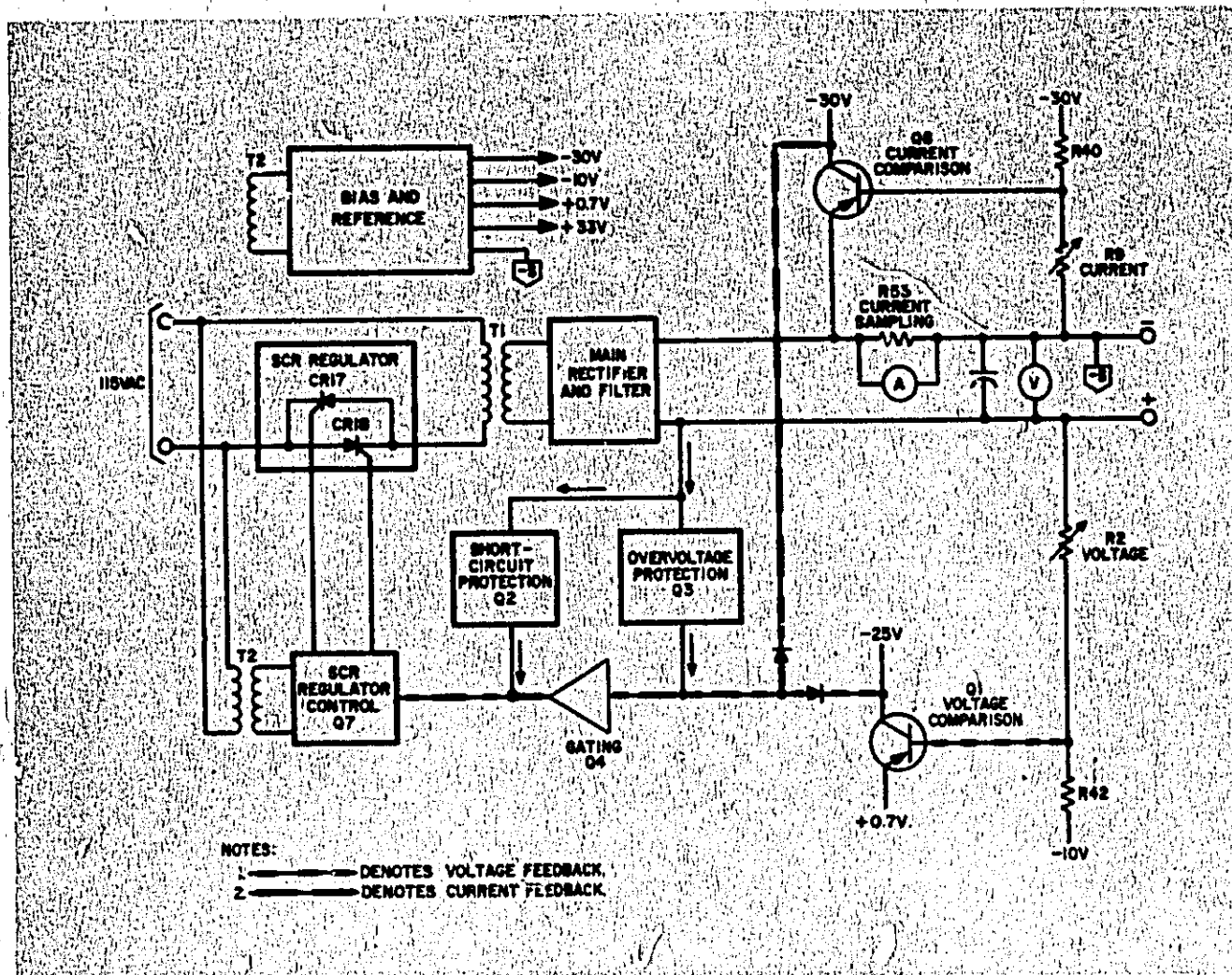

Figure 4-1. Overall Block Diagram

4-1 OVERALL DESCRIPTION (See Figure 4-1)

4-2 The main power transformer T1 isolates the ac input from the power supply and increases it to the voltage level required. Rectification and filtering produces a smoothed dc output across the - and + terminals. A large capacitor is connected across the - and + terminals for low ac output impedance and to help supply large pulse currents. SCR regulators control the ac input to provide good regulation of the dc output. Transformer T2 powers the SCR regulator control circuit and the bias and reference circuit which produces dc bias and reference voltages for the power supply.

4-3 The SCR regulators are controlled by the SCR regulator control circuit which operates in response to signals developed by the voltage or current comparison circuit. A gating circuit assures that only one input circuit is used at a time.

4-4 The voltage and current comparison circuits operate in a similar manner. Each circuit has an amplifier that amplifies an error voltage that is proportional to the difference between the actual output and the programmed output. The programmed output is determined by the resistance of the programming resistors (voltage and current controls). Each programming resistor has a constant

current through it which is maintained by the bias and reference circuit.

4-5 The voltage comparison amplifier Q1 detects the error voltage that is proportional to the difference between the voltage across its programming resistor R2 and +0.7 Volts on the emitter. The error voltage is amplified and passed through the gating circuit to the SCR regulator which triggers the SCR regulator. The SCR regulator increases or decreases the ac input voltage to the main power transformer as required to maintain a constant load voltage that is equal to the programmed value. In constant voltage operation, the gating circuit is biased to inhibit the input from the current comparison circuit.

4-6 The current comparison amplifier detects the error voltage that is proportional to the difference between the voltage across its programming resistor R9 and the voltage across current monitoring resistor R53. The voltage across R53 is proportional to the load current. The SCR regulator responds to the amplified error voltage by increasing or decreasing the ac input current to the main power transformers as required to maintain a constant load current. In constant current operation, the gating circuit is biased to inhibit the input from the voltage input circuit.

4-7 Two input amplifiers are included in a CV/CC supply, one for controlling output voltage, the other for controlling output current. Since the constant voltage amplifier tends to achieve zero output impedance and alters the output current whenever the load resistance changes, while the constant current comparison amplifier causes the output impedance to be infinite and changes the output voltage in response to any load resistance change, it is obvious that the two comparison amplifiers cannot operate simultaneously. For any given value of load resistance, the power supply must act either as a constant voltage source or as a constant current source—it cannot be both; transfer between these two modes is accomplished at a value of load resistance equal to the ratio of the output voltage control setting to the output current control setting.

4-8 Figure 4-2 shows the output characteristic of a CV/CC power supply. With no load attached ($R_L = \infty$), $I_{OUT} = 0$, and $E_{OUT} = E_S$, the front panel voltage control setting. When a load resistance is applied to the output terminals of the power supply, the output current increases, while the output voltage remains constant; point D thus represents a typical constant voltage operating point. Further decreases in load resistance are accompanied by further increases in I_{OUT} with no change in the output voltage until the output current reaches I_S , a value equal to the front panel

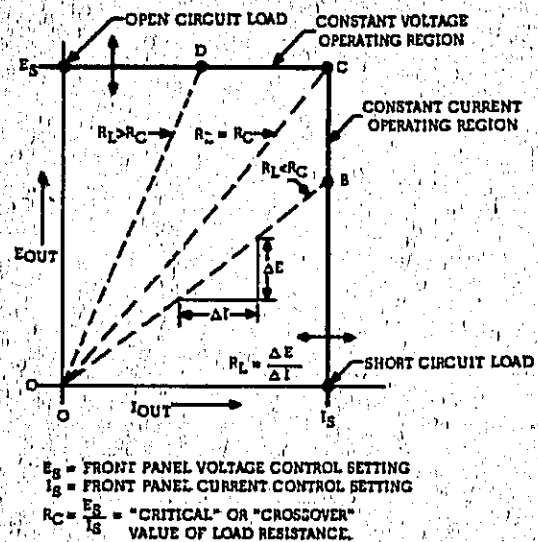

Figure 4-2. Operating Locus of a CV/CC Power Supply

current control setting. At this point the supply automatically changes its mode of operation and becomes a constant current source; still further decreases in the value of load resistance are accompanied by a drop in the supply output voltage with no accompanying change in the output current value. Thus, point B represents a typical constant current operating point. Still further decreases in the load resistance result in output voltage decreases with no change in output current, until finally, with a short circuit across the output load terminals, $I_{OUT} = I_S$ and $E_{OUT} = 0$.

4-9A By gradually changing the load resistance from a short circuit to an open circuit the operating locus of Figure 4-2 will be traversed in the opposite direction.

4-9B Full protection against any overload condition is inherent in the Constant Voltage/Constant Current design principle since no load condition can cause an output which lies outside the operating locus of Figure 4-2. Whether one is primarily concerned with constant voltage or constant current operation, the proper choice of E_S and I_S insures optimum protection for the load device as well as full protection for the power supply itself.

4-10 The line connecting the origin with any operating point of the locus of Figure 4-2 has a slope which is proportional to the value of load resistance connected to the output terminals of the supply. One can define a "critical" or "crossover" value of load resistance $R_C = E_S / I_S$; adjustment of the front panel voltage and current controls permits this "crossover" resistance R_C to be set to any desired value from 0 to ∞ . If R_L is greater than

R_C , the supply is in constant voltage operation, while if R_L is less than R_C , the supply is in constant current operation.

4-11 The Short-Circuit Protection circuit, Q2, monitors the positive (+) output of the supply and prevents any damage to the supply when the output terminals are shorted. The Overvoltage Protection circuit, Q3, monitors the positive (+) output of the power supply. Its output is fed to the SCR Regulator Control circuit to establish an output voltage ceiling that will not be exceeded, even if the VOLTAGE control becomes open-circuited.

4-12 DETAILED CIRCUIT ANALYSIS (Refer to Figure 7-3, Schematic Diagram.)

4-13 AC INPUT

4-14 The standard ac input voltage is 115Vac \pm 10%, 57-63Hz; 208 and 230Vac input are optional as discussed in Section I. The standard input frequency is 57-63Hz; 50Hz input is optional and requires circuit adjustments as described in Section V. The ac input is applied to transformer T2 and to the series combination of transformer T1 and SCR's CR17 and CR18 which are in parallel opposition. The SCR's are used to regulate the dc output by controlling the average value of the ac input to transformer T1. LC network L2, C9, C10, and C11 is an RFI filter that inhibits noise spikes generated by the SCR's from the ac input line. Capacitors C7 and C12 smooth transients to prevent the SCR's from being triggered by a rapidly changing voltage from anode to cathode. Resistor R21 damps oscillations that may occur due to resonance of C12 and the leakage inductance of T1. The leakage inductance of T1 limits the peak input current.

4-15 DC OUTPUT

4-16 The output of the secondary of transformer T1 is full-wave rectified by CR20 and CR21 and filtered by pi-section filter C13, C14, L1, C15, and C10 and R29. The dc output is regulated to a constant value by the SCR's CR17 and CR18. Capacitors C15 and C17 are the output capacitors. Diodes CR21 and CR22 are connected across the filtered dc output to protect the power supply from reverse voltage applied to the output terminals. Resistor R53 is the current monitoring resistor; the full load current flows through it. Potentiometers R25 and R27 are used to calibrate the voltmeter and ammeter, respectively.

4-17 FEEDBACK LOOP

4-18 The voltage and current feedback loops Q1, Q4, Q7, Q8 and CR17 and 18 function continuously to keep the output voltage constant during constant voltage operation, and the output current constant during constant current operation. For purposes of this discussion, assume that the unit is in constant voltage operation and that the VOLTAGE control

programming resistor R2 has been adjusted so that the supply is yielding the desired output voltage. Further assume that the output voltage instantaneously rises (goes positive) due to a variation in the external load circuit.

4-19 Note that the change may be in the form of a slow rise in the output voltage or a positive going ac signal. An ac signal is coupled to Q1 through capacitor C1 and a dc voltage is coupled to Q1 through R2.

4-20 The rise in output voltage causes the voltage at the base of Q1 to increase (go positive). Q1 now decreases its conduction and its collector voltage rises negatively. The negative going error voltage is amplified and inverted by Q4 and fed to the SCR Regulator Control circuit, which decreases the conduction of SCR regulators CR17 and CR18. This lowers the AC voltage to transformer T1, decreasing the rectified output voltage a sufficient amount to offset the error.

4-21 If the external load resistance is decreased to a certain crossover point as discussed in Paragraph 4-8 the output current increases until transistor Q8 begins to conduct. During this time, the output voltage has also decreased to a level so that the base of Q1 is at a negative potential.

4-22 VOLTAGE COMPARISON AMPLIFIER

4-23 This circuit consists of programming resistor R2 and amplifier stage Q1, and associated components. The voltage comparison amplifier continuously compares a fixed reference voltage with a portion of the output voltage and, if a difference exists, produces an error voltage whose amplitude and phase is proportional to the difference. The error output is fed back to the SCR Regulator Control circuit through an OR gate. The error voltage changes the conduction of the SCR regulators which, in turn, alter the output voltage so that the difference between the two input voltages applied to the comparison amplifier is reduced to zero. The above action maintains the output voltage constant.

4-24 The emitter of Q1 is connected to a stable +0.7V. The base of Q1 is connected to a summing point at the junction of the programming resistor R2 and R42. Instantaneous changes in output voltage result in an increase or decrease in the summing point potential. Q1 is then made to conduct more or less in accordance with the summing point voltage change. The resultant output error voltage is fed back to the series regulator via OR-gate diode CR7 and the remaining components of the feedback loop. Resistor R1 in series with the base of Q1, limits the current through the programming resistor during rapid voltage turn down. Diode CR1 is a limiter that prevents excessive voltage excursions from over-driving stage Q1. Capacitor C1 shunting the programming resistor R2,

increasing the high frequency gain of the amplifier Q1. RC network C4, R13, and R14 introduce negative feedback in Q1 to eliminate oscillation. R13 is selected to eliminate ringing and minimize overshoot for load transient recovery time, discussed in Paragraph 5-73.

4-25 CURRENT COMPARISON AMPLIFIER

4-26 This circuit is similar in appearance and operation to the voltage comparison amplifier. It consists basically of current programming resistor R9, current sampling resistor R53, and stage Q8.

4-27 The current comparison amplifier continuously monitors the voltage drop across current sampling resistor R53. When a preset voltage is exceeded, the amplifier produces an error voltage which forward biases CR8. The remaining stages in the feedback loop function to maintain the drop across the current sampling resistor and, consequently, the output current at a constant value. RC network R47 and C23 provide negative feedback to stabilize the current comparison amplifier and the feedback loop.

4-28 GATING CIRCUIT

4-29 Transistor Q3 draws current from the SCR regulator control circuit (capacitor C25). The magnitude of this current is determined by either the voltage or current comparison amplifier. For constant voltage operation, diode CR7 is forward biased to permit the voltage circuit to drive Q4; diode CR8 is reverse biased to inhibit the input from the current input circuit. For constant current operation, the reverse occurs.

4-30 To prevent transients in the dc output when the power supply is turned-on, the turn-on of Q4 is delayed by capacitor C24 which charges through R57 and CR15. When C24 charges sufficiently to reverse bias CR15, all the current through R57 flows to the collector of Q4 to turn it on. Base current is controlled by the voltage or current circuits via CR7 or CR8, respectively. For example, during constant voltage operation the collector voltage of Q1 (voltage input) forward biases CR7 (CR8 reverse biased by Q8), the current through CR7 will vary as Q1 collector voltage varies and thus vary Q4 base current; therefore, the collector current of Q4 is controlled by the voltage input. In a similar manner, the current input circuit controls the collector current of Q4 during constant current operation.

4-31 SCR REGULATOR CONTROL (Refer to Figure 4-3, SCR Control Timing Diagram.)

4-32 The SCR regulator control is basically a blocking oscillator (Q7 and T3) that applies pulses

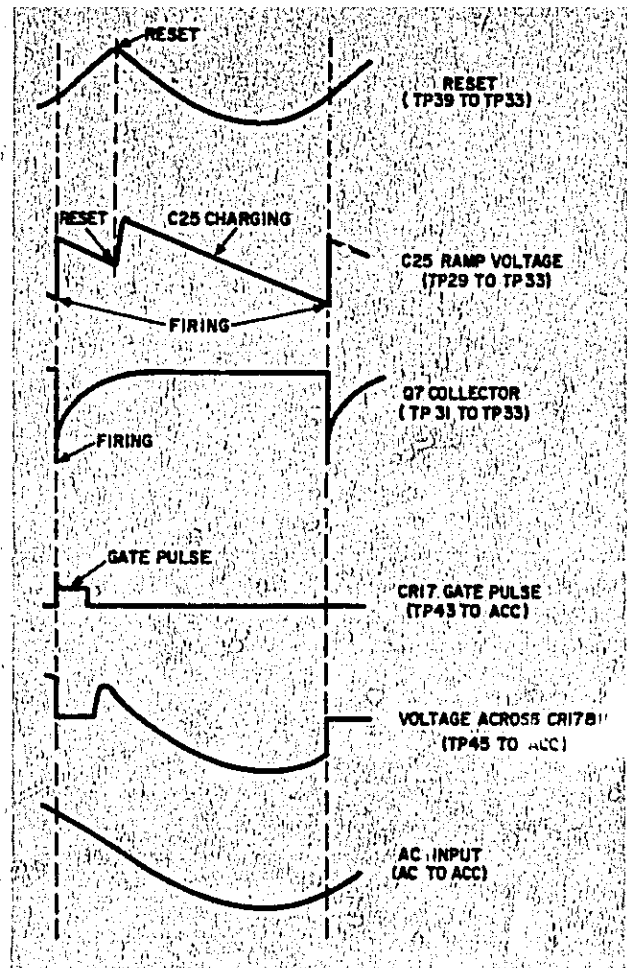

Figure 4-3. SCR Regulator Control, Timing Diagram

to the SCR regulator in response to error signals detected by the voltage or current comparison circuit. When transistor Q7 conducts, the pulse developed in winding 1-2 of transformer T3 is coupled to the base of Q7 (positive feedback) and to the SCR regulator (CR17 and CR18). Capacitor C27 charges in opposition to the feedback voltage and cuts off Q7. The charge time of C27 determines the pulse duration in the collector of Q7 (approximately 20 microseconds). The 32Vdc bias supplies current through R52, CR46, and CR44 to discharge C27 after Q7 stops conducting.

4-33 Gate Input. Throughout the operation of the blocking oscillator, capacitor C25 supplies most of the collector current for Q4 in the gating circuit (refer to Paragraph 4-30). The amount of current pulled from C25 by Q4 is determined by the input (from the voltage or current comparison circuit) to the gating circuit. As a result of this current flow from C25, the voltage across C25 increases negatively with respect to the +0.7V bias and has a waveshape that approximates a linear ramp. Thus, the slope of this ramp is determined by the volt-

age or current comparison circuit. Due to the time delay in the feedback loop, the slope of the ramp is constant for a half cycle of the ac input. The voltage on C25 is the emitter bias (forward bias when negative) for Q7 and therefore helps determine the point at which Q7 conducts.

4-34 AC Input. The ac input to transformer T2 is stepped-down and full-wave rectified by bridge rectifier CR39 through CR43. The output of the bridge rectifier is a negative-going pulsating dc (120Hz). Voltage divider R50-R51 supplies a portion of this pulsating dc through C27 to the base of Q7; thus, the base is reverse biased.

4-35 Firing. A point is reached during each cycle of the 120Hz pulsating dc when the reverse bias on the base and the forward bias (capacitor C25) on the emitter of Q7 are equal, and therefore Q7 has zero bias. As the ramp voltage across C25 goes more negative than the base voltage, the base-emitter junction of Q7 begins to become forward biased. When the emitter is more negative than the base by approximately 0.5 Volts, Q7 conducts. The firing point of Q7 is therefore determined by both the dc output error and the line voltage change. Because Q7 saturates when it conducts, the collector voltage approximates a rectangular wave with a negative going pulse width of approximately 20 microseconds (determined by C27 and R51). The conduction of Q7 charges C25 in the positive direction (clamped by CR49). When Q7 stops conducting, the ramp across C25 begins again. However, Q7 is held cut-off by the charge on C27.

4-36 Reset. At the beginning of each cycle of the 120Hz pulsating dc, certain initial conditions must be established on capacitors C25 and C27. When the negative-going pulsating dc is at the end of its cycle, at its most positive voltage, CR44 and CR45 become forward biased and current flows from the 32Vdc bias through R52, CR46, and CR44 to discharge C27 to approximately zero Volts and through R52 and CR45 to charge C25 to approximately -0.7 Volts (clamped by CR49). This discharge and charge occurs rapidly, so that it is completed before the next cycle begins and Q7 can conduct again. Diode CR47 provides another path for the current through CR44 so that the voltage to which C27 discharges remains predictable. As the negative-going pulsating dc increases in the next cycle, CR44 and CR45 become reverse biased.

4-37 Bridge Rectifier. At the zero cross-over region of the voltage waveform on secondary winding 3-4 of transformer T2, the voltage is insufficient to forward bias the rectifiers in the bridge. In order to maintain definition between the end of

one cycle of the rectified output and the beginning of the next cycle, diode CR41 provides approximately 0.7 Volts at the rectified output. The current for CR41 is supplied through CR46. As the voltage across the secondary winding moves away from the zero cross-over region, CR41 becomes reverse biased.

4-38 Transients, Decoupling and Protection. Transients in the pulsating dc are reduced by R56 and C28. The base of Q7 is decoupled by C3. The voltage spike in the collector of Q7, induced by secondary winding 1-2 of transformer T3 when Q7 cuts-off, is clamped by CR48. The collector is decoupled by R53 and C26. TS1 is a temperature sensitive switch mounted on the heat sink for CR17 and CR18. If the heat sink becomes too hot, because the fan is not operating, TS1 opens, Q7 shuts off, and the output voltage drops to zero.

4-39 SCR REGULATOR

4-40 The SCR regulator (CR17 and CR18) controls the ac input voltage and current to main power transformer T1 in response to the voltage and current error signals. In constant voltage operation, the ac input voltage to T1 is adjusted so that the output voltage remains constant with changing loads. In constant current operation, the ac input current to T1 is adjusted so that the output current remains constant with changing loads and the output voltage is allowed to vary.

4-41 Gating. Each half cycle of the ac input, either CR17 or CR18 is forward biased. The pulse induced in secondary windings 5-6 and 7-8 of T3 by the SCR control, turns on the SCR that is forward biased when the pulse occurs. The other SCR is not affected by the gate pulse because it is reverse biased. A gate pulse occurs each half cycle of the ac input, unless the output is open. The timing of the gate pulse with respect to the ac input is determined by the error in the dc output via the loop action.

4-42 AC Input Control. When an SCR is gated on, it conducts until its anode-to-cathode voltage goes to approximately zero. Thus, the earlier an SCR is gated on, the greater the portion of the ac input that will be applied to T1. Because of the leakage inductance of T1, the conduction of an SCR may extend into the next half cycle. The conduction period may be shortened at high output by the voltage across capacitor C13 through C16 being reflected back into the primary. By controlling the ac input to T1 each half cycle, the average value of the voltage or current at the output of rectifier CR19 and CR20 is adjusted so that dc output voltage or current is maintained constant.

4-43 Protection. Diodes CR50 and CR51 prevent anode induced reverse gate currents from being fed back to the control circuit. Resistors R54 and R55 limit current in the SCR gates.

4-44 BIAS AND REFERENCE CIRCUIT

4-45 The bias and reference circuit supplies four voltages (+33, +0.7, -10 and -30V) for internal power supply operation, and maintains the programming currents constant. The -28 and -10V outputs are regulated.

4-46 The output of secondary winding 5-6 of transformer T2 is full-wave rectified by CR30 and CR31. Capacitors C20 and C21 each charge to the peak rectified voltage (voltage doubling). The 0.7Vdc (with respect to -S) is maintained by diode CR14. The +33Vdc is the voltage across C21. The

-33V across C20 provides the unregulated input to the regulator.

4-47 For the -30Vdc, transistor Q10 is the error detector/amplifier. Zener diode VR1 and diode CR6 provide a reference voltage at the emitter of Q10. Voltage divider R35-R36 supplies an error voltage to the base of Q10 which amplifies and applies it to the base of series regulator Q11. The base drive of Q11 adjusts the voltage across Q11 as required to compensate for the error in the -30V. Resistor R37 sets the optimum current through temperature-compensated zener diode VR1. Resistor R33 reduces power dissipation in Q11 and capacitor C22 stabilizes the loop. The -30V is divided down to -10V by stage Q5. The conduction of Q5 is held constant by VR1 on the base and R39 is selected to provide exactly -10V output.

MAINTENANCE

SECTION V MAINTENANCE

5-1 INTRODUCTION

5-2 Upon receipt of the power supply, the performance check (Paragraph 5-5) should be made. This check is suitable for incoming inspection. If a fault is detected in the power supply while making the performance check or during normal operation, proceed to the troubleshooting procedures (Paragraph 5-50). After troubleshooting and repair (Paragraph 5-59), perform any necessary adjustments and calibrations (Paragraph 5-61). Before returning the power supply to normal operation,

repeat the performance check to ensure that the fault has been properly corrected and that no other faults exist. Before performing any maintenance checks, turn-on power supply and allow a half-hour warm-up.

5-3 TEST EQUIPMENT REQUIRED

5-4 Table 5-1 lists the test equipment required to perform the various procedures described in this section.

Table 5-1. Test Equipment Required

TYPE	REQUIRED CHARACTERISTICS	USE	RECOMMENDED MODEL
Differential Voltmeter	Sensitivity: 1mV full scale (min.). Input impedance: 10 megohms (min.).	Measure DC Voltages; calibration procedures	Ⓢ 3420 (See Note)
Variable Voltage Transformer	Range: 200-260Vac/90-130Vac. Equipped with voltmeter accurate within 1 Volt.	Vary AC Input	---
AC Voltmeter	Accuracy: 2%. Sensitivity: 1mV full scale deflection (min.).	Measure AC voltages and ripple	Ⓢ 403B
Oscilloscope	Sensitivity: 100 μ v/cm. Differential input.	Display transient response waveforms	Ⓢ 140A plus 1400A plug in. 1402A plug-in for spike measurements only.
DC Voltmeter	Accuracy: 1%. Input resistance: 20,000 ohms/Volt (min.).	Measure DC voltages	Ⓢ 412A
Repetitive Load Switch	Rate: 60 — 400Hz, 2 μ sec rise and fall time.	Measure transient response	See Figure 5-6.
Resistive Load	Carbon Composition Resistor 900 Ω , \pm 5%, 900 Watts.	Power supply load resistor	---
Current Sampling Resistor	1 Ω , 12.5 Watts \pm 20ppm, wire-wound	Measure current; calibrate meter	R53; see Parts Table.

Table 5-1. Test equipment Required (Continued)

TYPE	REQUIRED CHARACTERISTICS	USE	RECOMMENDED MODEL
Resistive Load	300 Ω , 450 Watts	Load resistors for transient recovery time	---
Resistor	Value: 180K \pm 0.1%, 4 Watt.	Calibrate Constant Voltage programming current	---
Decade Resistance Box	Range: 0-500K. Accuracy: 0.1% plus 1 ohm. Make-before-break contacts.	Adjust programming currents, ripple imbalance, and over-voltage limit	---

NOTE

A satisfactory substitute for a differential voltmeter is to arrange a reference voltage source and null detector as shown in Figure 5-1. The reference voltage source is adjusted so that the voltage difference between the supply being measured and the reference voltage will have the required resolution for the measurement being made. The voltage difference will be a function of the null detector that is used. Examples of satisfactory null detectors are: Φ 419A null detector, a DC coupled oscilloscope utilizing differential input, or a 50mV meter movement with a 100 division scale. For the latter, a 2mV change in voltage will result in a meter deflection of four divisions.

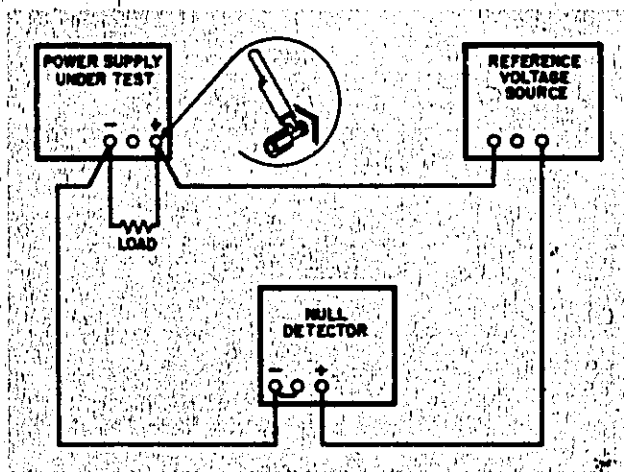

Figure 5-1. Differential Voltmeter Substitute Test Setup

CAUTION

Care must be exercised when using an electronic null detector in which one input terminal is grounded to avoid ground loops and circulating currents.

5-5 PERFORMANCE TEST

5-6 The following test can be used as an incoming inspection check and appropriate portions of the test can be repeated either to check the operation of the instrument after repairs or for periodic maintenance tests. The tests are performed using a nominal 115Vac, 60Hz single-phase input power for the unit. If the correct result is not obtained for a particular check, do not adjust any controls; proceed to troubleshooting (Paragraph 5-50).

5-7 CONSTANT VOLTAGE TESTS

5-8 The measuring device must be connected across the rear sensing terminals (+S) and (-S) or as close to the front output terminals as possible when measuring the output impedance, transient response, regulation, or ripple of the power supply in order to achieve valid measurements. A measurement made across the load includes the impedance of the leads to the load and such lead lengths can easily have an impedance several orders of magnitude greater than the supply impedance, thus invalidating the measurement.

5-9 The monitoring device should be connected to the +S and -S terminals (Figure 3-2) or as shown in Figure 5-2. The performance characteristics should never be measured at the front terminals if the load is connected across the rear terminals. Note that the monitoring leads are connected at A, not B, as shown in Figure 5-2. Failure to connect the measuring device at A will result in a measure-

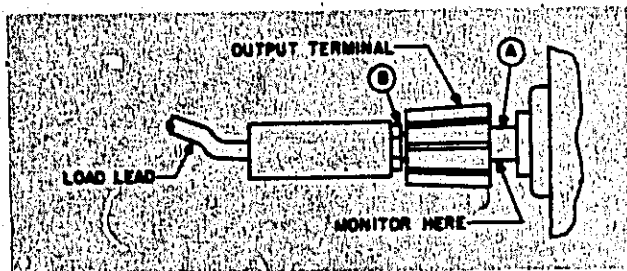

Figure 5-2. Front Panel Terminal Connections

ment that includes the resistance of the leads between the output terminals and the point of connection.

5-10 When measuring the constant voltage performance specifications, the current controls should be set well above the maximum output current which the supply will draw, since the onset of constant current action will cause a drop in output voltage, increased ripple, and other performance changes not properly ascribed to the constant voltage operation of the supply.

5-11 Output Voltage and Voltmeter Accuracy.
Proceed as follows:

- a. Connect load resistance across rear output terminals of supply. (Figure 5-3 shows values of load resistor used throughout the performance tests.)
- b. Connect differential voltmeter across +S and -S terminals of supply observing correct polarity.
- c. Turn on supply and adjust VOLTAGE controls until front panel voltmeter indicates exactly the maximum rated output voltage.
- d. Differential voltmeter should read $600 \pm 12\text{Vdc}$.

5-12 Load Regulation.

Definition: The change ΔE_{OUT} in the static value of DC output voltage resulting from a change in load resistance from open circuit to a value which yields maximum rated output current (or vice versa).

5-13 To check the Constant-Voltage load regulation, proceed as follows:

- a. Connect test setup as shown in Figure 5-3.
- b. Turn CURRENT controls fully clockwise.
- c. Turn-on supply and adjust VOLTAGE controls until front panel voltmeter indicates exactly the maximum rated output voltage.
- d. Read and record voltage indicated on dif-

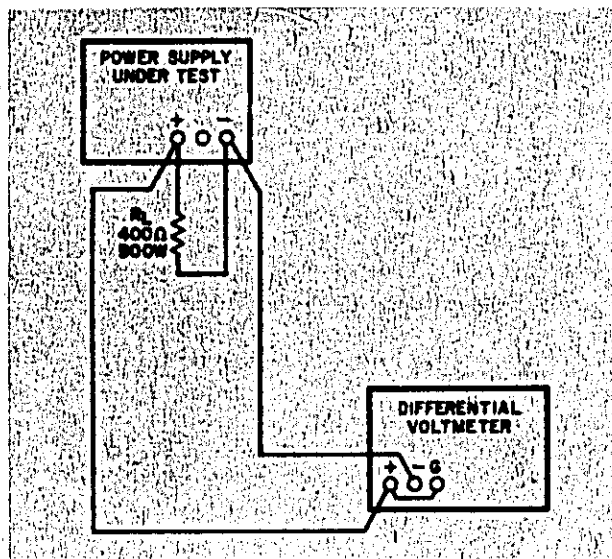

Figure 5-3. Constant Voltage Test Setup

ferential voltmeter.

- e. Disconnect load resistors.
- f. Reading on differential voltmeter should not vary from reading recorded in step d by more than 600mV.

5-14 Line Regulation.

Definition: The change, ΔE_{OUT} in the static value of DC output voltage resulting from a change in AC input voltage over the specified range from low line 10% less than nominal to high line 10% more than nominal or from high line to low line.

5-15 To test the Constant Voltage line regulation, proceed as follows:

- a. Connect variable auto transformer between input power source and power supply power input.
- b. Turn CURRENT controls fully clockwise.
- c. Connect test setup shown in Figure 5-3.
- d. Adjust variable auto transformer for low line (103.5Vac).
- e. Turn on supply and adjust VOLTAGE controls until front panel voltmeter indicates exactly the maximum rated output voltage.
- f. Read and record voltage indicated on differential voltmeter.
- g. Adjust variable auto transformer for high line (126.5Vac).
- h. Reading on differential voltmeter should not vary from reading recorded in step g by more than 600mV.

5-16 Ripple and Noise.

Definition: The residual AC voltage which is superimposed on the DC output of a regulated power supply.

Ripple and noise may be specified and measured in terms of its RMS or (preferably) peak-to-peak value.

Ripple and noise measurement can be made at any input AC line voltage combined with any DC output voltage and load current within rating.

5-17 The amount of ripple and noise that is present on the power supply output is measured either in terms of the RMS or (preferably) peak-to-peak value. The peak-to-peak measurement is particularly important for applications where noise spikes could be detrimental to a sensitive load, such as logic circuitry. The RMS measurement is not an ideal representation of the noise, since fairly high output noise spikes of short duration could be present in the ripple and not appreciably increase the RMS value.

5-18 The technique used to measure high frequency noise or "spikes" on the output of a power supply is more critical than the low frequency ripple and noise measurement technique; therefore the former is discussed separately in Paragraph 5-26.

5-19 Ripple and Noise Measurements. Figure 5-4A shows an incorrect method of measuring p-p ripple. Note that a continuous ground loop exists from the third wire of the input power cord of the supply to the third wire of the input power cord of the oscilloscope via the grounded power supply case, the wire between the negative output terminal of the power supply and the vertical input of the scope, and the grounded scope case. Any ground current circulating in this loop as a result of the difference in potential E_G between the two ground points causes an IR drop which is in series with the scope input. This IR drop, normally having a 60Hz line frequency fundamental, plus any pickup on the unshielded leads interconnecting the power supply and scope, appears on the face of the CRT. The magnitude of this resulting noise signal can easily be much greater than the true ripple developed between the plus and minus output terminals of the power supply, and can completely invalidate the measurement.

5-20 The same ground current and pickup problems can exist if an RMS voltmeter is substituted in place of the oscilloscope in Figure 5-4. However, the oscilloscope display, unlike the true RMS meter reading, tells the observer immediately whether the fundamental period of the signal displayed is 8.3 milliseconds (1/120Hz) or 16.7 milliseconds (1/60Hz). Since the fundamental ripple frequency present on the output of an ϕ_p supply is

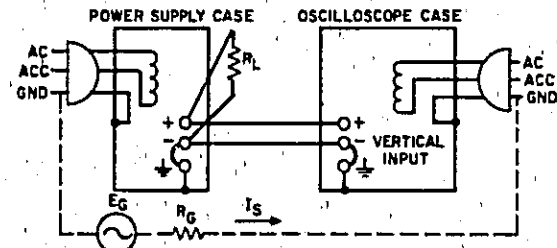

A. INCORRECT METHOD—GROUND CURRENT I_S PRODUCES 60 CYCLE DROP IN NEGATIVE LEAD WHICH ADDS TO THE POWER SUPPLY RIPPLE DISPLAYED ON SCOPE.

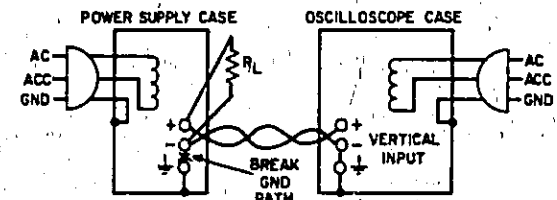

B. A CORRECT METHOD USING A SINGLE-ENDED SCOPE. OUTPUT FLOATED TO BREAK GROUND CURRENT LOOP. TWISTED PAIR REDUCES STRAY PICKUP ON SCOPE LEADS.

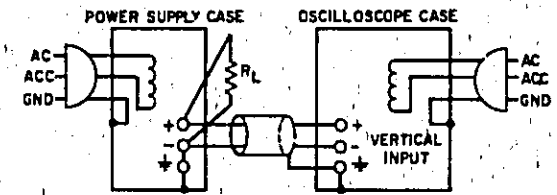

C. A CORRECT METHOD USING A DIFFERENTIAL SCOPE WITH FLOATING INPUT. GROUND CURRENT PATH IS BROKEN; COMMON MODE REJECTION OF DIFFERENTIAL INPUT SCOPE IGNORES DIFFERENCE IN GROUND POTENTIAL OF POWER SUPPLY & SCOPE; SHIELDED TWO WIRE FURTHER REDUCES STRAY PICK-UP ON SCOPE LEADS.

Figure 5-4. CV Ripple and Noise, Test Setup

120Hz (due to full-wave rectification), an oscilloscope display showing a 120Hz fundamental component is indicative of a "clean" measurement setup, while the presence of a 60Hz fundamental usually means that an improved setup will result in a more accurate (and lower) value of measured ripple.

5-21 Figure 5-4B shows a correct method of measuring the output ripple of a constant voltage power supply using a single-ended scope. The ground loop path is broken by floating the supply output. Note that to ensure that no potential difference exists between the supply and the oscilloscope, it is recommended that whenever possible they both be plugged into the same AC power buss. If the same buss cannot be used, both AC grounds must be at earth ground potential.

5-22 Either a twisted pair or (preferably) a shielded two-wire cable should be used to connect the output terminals of the power supply to the verti-

cal input terminals of the scope. When using a twisted pair, care must be taken that one of the two wires is connected to the grounded input terminal of the oscilloscope. When using shielded two-wire, it is essential for the shield to be connected to ground at one end only so that no ground current will flow through this shield, thus inducing a noise signal in the shielded leads.

5-23 To verify that the oscilloscope is not displaying ripple that is induced in the leads or picked up from the grounds, the (+) scope lead should be shorted to the (-) scope lead at the power supply terminals. The ripple value obtained when the leads are shorted should be subtracted from the actual ripple measurement.

5-24 In most cases, the single-ended scope method of Figure 5-4B will be adequate to eliminate non-real components of ripple and noise so that a satisfactory measurement may be obtained. However, in more stubborn cases it may be necessary to use a differential scope with floating input as shown in Figure 5-4C. If desired, two single conductor shielded cables may be substituted in place of the shielded two-wire cable with equal success. Because of its common mode rejection, a differential oscilloscope displays only the difference in signal between its two vertical input terminals, thus ignoring the effects of any common mode signal introduced because of the difference in the AC potential between the power supply case and scope case. Before using a differential input scope in this manner, however, it is imperative that the common mode rejection capability of the scope be verified by shorting together its two input leads at the power supply and observing the trace on the CRT. If this trace is a straight line, the scope is properly ignoring any common mode signal present. If this trace is not a straight line, then the scope is not rejecting the ground signal and must be realigned in accordance with the manufacturer's instructions until proper common mode rejection is attained.

5-25 To check the ripple and noise output, proceed as follows:

- a. Connect the oscilloscope or RMS voltmeter as shown in Figures 5-4B or 5-4C.
- b. Adjust VOLTAGE control until front panel meter indicates maximum rated output voltage.
- c. The observed ripple and noise should be less than 600mVrms and 2V p-p.

5-26 Noise Spike Measurement. When a high frequency spike measurement is being made, an instrument of sufficient bandwidth must be used; an oscilloscope with a bandwidth of 20MHz or more is

adequate. Measuring noise with an instrument that has insufficient bandwidth may conceal high frequency spikes detrimental to the load.

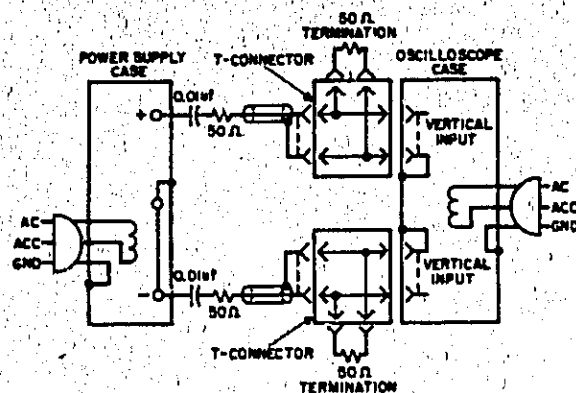

Figure 5-5. CV Noise Spike, Test Setup

5-27 The test setups illustrated in Figures 5-4A and 5-3B are generally not acceptable for measuring spikes; a differential oscilloscope is necessary. Furthermore, the measurement concept of Figure 5-4C must be modified if accurate spike measurement is to be achieved:

1. As shown in Figure 5-5, two coax cables, must be substituted for the shielded two-wire cable.
2. Impedance matching resistors must be included to eliminate standing waves and cable ringing, and the capacitors must be connected to block the DC current path.
3. The length of the test leads outside the coax is critical and must be kept as short as possible; the blocking capacitor and the impedance matching resistor should be connected directly from the inner conductor of the cable to the power supply terminals.
4. Notice that the shields of the power supply end of the two coax cables are not connected to the power supply ground, since such a connection would give rise to a ground current path through the coax shield, resulting in an erroneous measurement.
5. Since the impedance matching resistors constitute a 2-to-1 attenuator, — the noise spikes observed on the oscilloscope should be less than 1V p-p instead of 2V p-p.

5-28 The circuit of Figure 5-5 can also be used for the normal measurement of low frequency ripple and noise; simply remove the four terminating resistors and the blocking capacitors and substitute

a higher gain vertical plug-in in place of the wide-band plug-in required for spike measurements. Notice that with these changes, Figure 5-5 becomes a two-cable version of Figure 5-4C.

5-29 Load Transient Recovery Time.

Definition: The time "X" for output voltage recovery to within "Y" volts of the nominal output voltage following a "Z" amp step change in load current — where: "Y" is specified as 10 millivolts. The nominal output voltage is defined as the DC level half way between the static output voltage before and after the imposed load change, and "Z" is the specified load current change, which is 5 Amperes.

5-30 A mercury-wetted relay, as connected in the load switching circuit of Figure 5-6 should be used for loading and unloading the supply. When this load switch is connected to a 60Hz AC input, the mercury-wetted relay will open and close 60 times per second. Adjustment of the 25K control permits adjustment of the duty cycle of the load current switching and reduction in jitter of the oscilloscope display.

5-31 The maximum load ratings listed in Figure 5-5 must be observed in order to preserve the mercury-wetted relay contacts. Switching of larger load currents can be accomplished with mercury pool relays; with this technique fast rise times can still be obtained, but the large inertia of mercury pool relays limits the maximum repetition rate of load switching and makes the clear display of the transient recovery characteristic on an oscilloscope more difficult.

5-32 To check the transient recovery time, proceed as follows:

- Connect test setup shown in Figure 5-6.
- Turn CURRENT controls fully clockwise.
- Turn on supply and adjust voltage controls until front panel ammeter indicates exactly 1.5 Amperes.
- Close the line switch on the repetitive load switch setup.
- Set the oscilloscope for internal sync and lock on either the positive or negative load transient spike.
- Set the vertical input of the oscilloscope for ac coupling so that small dc level changes in the output voltage of the power supply will not cause the display to shift.
- Adjust the sync controls separately for the positive and negative going transients so that

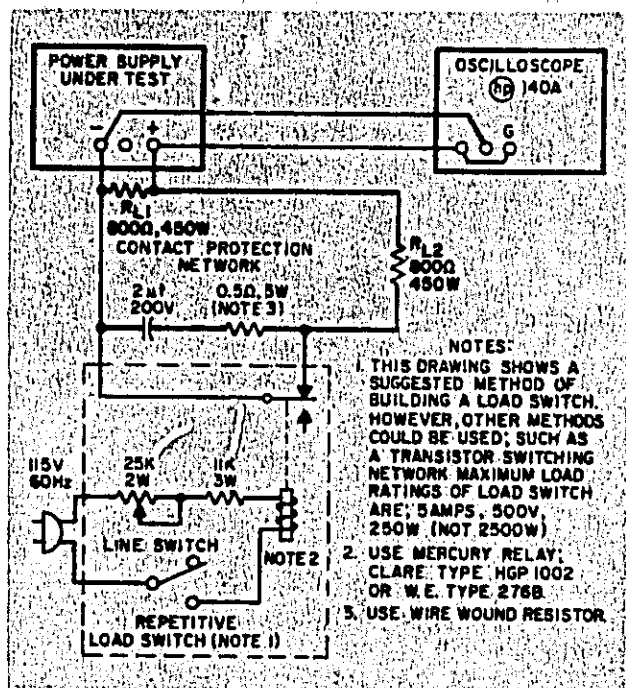

Figure 5-6. Transient Recovery Time, Test Setup

not only the recovery waveshape but also as much as possible of the rise time of the transient is displayed.

h. Starting from the major graticule division representative of time zero, count to the right 200 msec and vertically 3V. Recovery should be within these tolerances as illustrated in Figure 5-7. If recovery is not correct, adjust R13 as described in Paragraph 5-73.

5-33 Output Impedance.

Definition: At any given frequency of load change, $\Delta E_{OUT}/\Delta I_{OUT}$. Strictly speaking the definition applies only for a sinusoidal load disturbance, unless, of course, the measurement is made at zero frequency (DC). The output impedance of an ideal constant voltage power supply would be zero at all frequencies, while the output impedance for an ideal constant current power supply would be infinite at all frequencies.

The output impedance of a power supply is normally not measured, since the measurement of transient recovery time reveals both the static and dynamic output characteristics with just one measurement. The output impedance of a power supply is commonly measured only in those cases where the exact value at a particular frequency is of engineering importance.

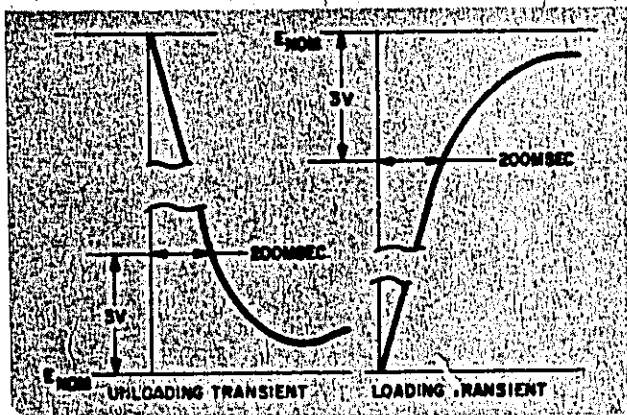

Figure 5-7. Transient Recovery Time, Waveforms

5-34 To check the output impedance, proceed as follows:

- Connect test setup shown in Figure 5-8.
- Turn on supply and adjust VOLTAGE controls until front panel meter reads 20 Volts.
- Set AMPLITUDE control on Oscillator to 10 Volts (E_{in}), and FREQUENCY control to 0.5Hz.
- Record voltage across output terminals of the power supply (E_o) as indicated on AC voltmeter.
- Calculate the output impedance by the following formula:

$$Z_{out} = \frac{E_o R}{E_{in} - E_o}$$

E_o = rms voltage across power supply terminals.

$R = 1000$

$E_{in} = 10$ Volts

- The output impedance (Z_{out}) should be less than 0.5 ohm.
- Using formula of step f, calculate output impedance at frequencies of 100Hz, 1kHz, and 100kHz. Values should be less than 5, 3.5 and 5 ohms.

5-35 Temperature Coefficient.

Definition: The change in output voltage per degree Centigrade change in the ambient temperature under conditions of constant input AC line voltage, output voltage setting, and load resistance.

5-36 The temperature coefficient of a power supply is measured by placing the power supply in an oven and varying it over any temperature span within its rating. (Most power supplies are rated for operation from 0°C to 55°C.) The power supply must be allowed to thermally stabilize for a sufficient period of time at each temperature of measurement.

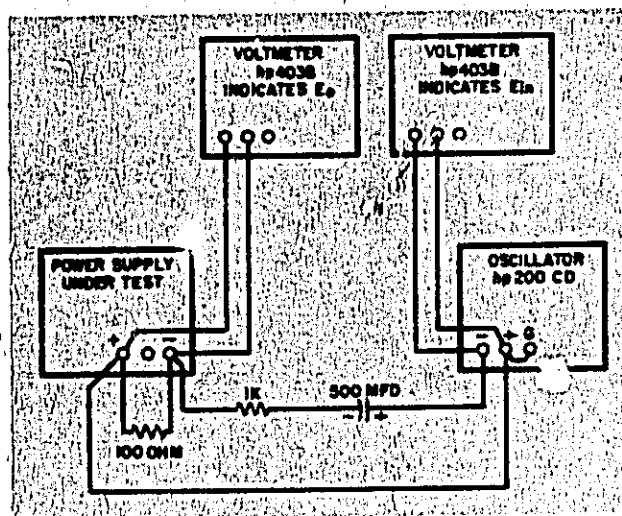

Figure 5-8. Output Impedance, Test Setup

5-37 The temperature coefficient specified is the maximum temperature-dependent output voltage change which will result over any 10°C interval. The differential voltmeter or digital voltmeter used to measure the output voltage change of the supply should be placed outside the oven and should have a long term stability adequate to insure that its drift will not affect the overall measurement accuracy.

5-38 To check the temperature coefficient, proceed as follows:

- Connect test setup shown in Figure 5-3.
- Turn CURRENT controls fully clockwise and adjust front panel VOLTAGE controls until the front panel voltmeter indicates 600Vdc.
- Insert the power supply into the temperature — controlled oven (differential voltmeter and load resistance remain outside oven). Set the temperature to 30°C and allow 30 minutes warm-up.
- Record the differential voltmeter indication.
- Raise the temperature to 40°C and allow 30 minutes warm-up.
- The differential voltmeter indication should change by less than 2.8V from indication recorded in step d.

5-39 Output Stability.

Definition: The change in output voltage for the first eight hours following a 30 minute warm-up period. During the interval of measurement all parameters except ambient temperature are held constant. Ambient temperature is permitted to vary over a span of 3°C.

5-40 This measurement is made by monitoring the output of the power supply on a differential voltmeter or digital voltmeter over the stated measurement interval; a strip chart recorder can be used to provide a permanent record. A thermometer should be placed near the supply to verify that the ambient temperature remains constant during the period of measurement. The supply should be put in a location immune from stray air currents (open doors or windows, air conditioning vents); if possible, the supply should be placed in an oven which is held at a constant temperature. Care must be taken that the measuring instrument has a stability over the eight hour interval which is at least an order of magnitude better than the stability specification of the power supply being measured. Typically, a supply may drift less over the eight hour measurement interval than during the 1/2 hour warm-up period.

5-41 The stability measurement can be made while the supply is remotely programmed with a fixed wire-wound resistor, thus avoiding accidental changes in the front panel setting due to mechanical vibration or "knob-twiddling."

5-42 To check the output stability, proceed as follows:

- a. Connect test setup shown in Figure 5-2.
- b. Turn CURRENT controls fully clockwise and adjust VOLTAGE controls for 600Vdc output.
- c. Allow 30 minutes warm-up then record the differential voltmeter indication.
- d. After 8-hours, differential voltmeter should change by less than 900mV from indication recorded in step c.

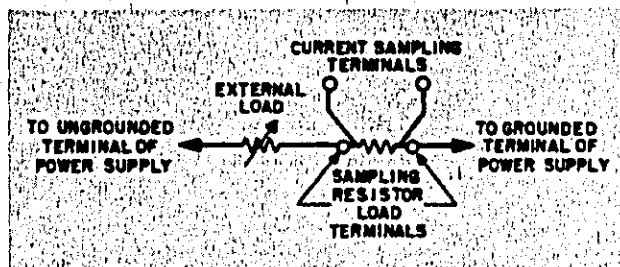

Figure 5-9. Output Current Measurement Technique.

5-43 CONSTANT CURRENT TESTS

5-44 For output current measurements, the current sampling resistor must be treated as a four terminal device. In the manner of a meter shunt, the load current is fed to the extremes of the wire leading to the resistor while the sampling terminals are located as close as possible to the resistance portion itself (see Figure 5-9). Generally,

any current sampling resistor, should be of the low noise, low temperature coefficient (less than 30ppm/°C) type and should be used at no more than 5% of its rated power so that its temperature rise will be minimized. The latter, reduces resistance changes due to thermal fluctuations. It is recommended that the user obtain a duplicate of the sampling resistance (R53) that is used in this unit for his constant current checks (see Table 6-4).

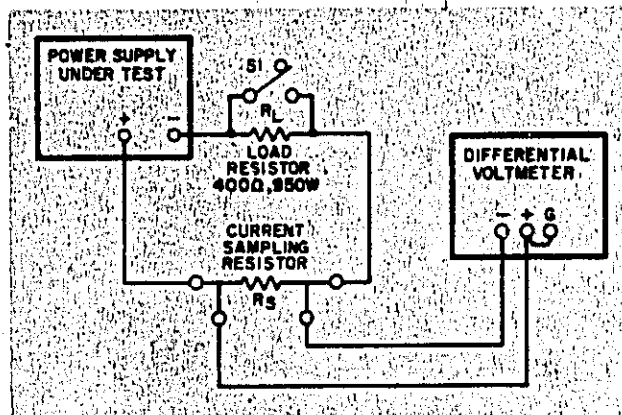

Figure 5-10. Output Current, Test Setup

5-45 Current Output and Ammeter Accuracy. Proceed as follows:

- a. Connect test setup shown in Figure 5-10 leaving switch S1 open throughout check.
- b. Turn VOLTAGE controls fully clockwise.
- c. Turn-on supply and adjust CURRENT controls until front panel ammeter indicates exactly the maximum rated output current.
- d. Differential voltmeter should read 1.5Vdc ± 30 mV.

5-46 Load Regulation.

Definition: The change, ΔI_{OUT} , in the static value of DC output current resulting from a change in load resistance from short circuit to a value which gives maximum rated output voltage (or vice versa).

5-47 To check the constant current load regulation, proceed as follows:

- a. Connect test setup as shown in Figure 5-10.
- b. Turn VOLTAGE controls fully clockwise.
- c. Turn on supply and adjust CURRENT controls until front panel ammeter reads exactly the maximum rated output current.
- d. Read and record voltage indicated on differential voltmeter.
- e. Short out load resistor (R_L) by closing switch S1.

f. Reading on differential voltmeter should not vary from reading recorded in step d by more than 15mV.

5-48 Line Regulation.

Definition: The change, ΔI_{OUT} , in the static value of DC output current resulting from a change in AC input voltage over the specified range from low line (10% below nominal) to high line (10% above nominal) or from high line to low line.

5-49 To test the constant current line regulation proceed as follows:

- a. Utilize test setup shown in Figure 5-10, leaving switch S1 open throughout test.
- b. Connect variable auto transformer between input power source and power supply power input.
- c. Adjust auto transformer for 103.5Vac input.
- d. Turn VOLTAGE controls fully clockwise.
- e. Turn on supply and adjust CURRENT controls until front panel meter reads exactly the maximum rated output current.
- f. Read and record voltage indicated on differential voltmeter.
- g. Adjust variable auto transformer for 126.5Vac input.
- h. Reading on differential voltmeter should not vary from reading recorded in step f by more than 15mV.

5-50 TROUBLESHOOTING

5-51 Before attempting to troubleshoot this instrument, ensure that the fault is with the instrument and not with an associated circuit. The performance test (Paragraph 5-5) enables this to be determined without having to remove the instrument from the cabinet.

5-52 A good understanding of the principles of operation is a helpful aid in troubleshooting, and it is recommended that the reader review Section IV of the manual before attempting to troubleshoot the unit in detail. Once the principles of operation are understood, refer to the overall troubleshooting procedures in Paragraph 5-55 to locate the symptom and probable cause.

5-53 The schematic diagram at the rear of the manual (Figure 7-3) contains normal voltage readings taken at various points within the circuits. These voltages are positioned adjacent to the applicable test points (identified by encircled numbers). Component and test point designations are marked directly on the printed wiring board.

5-54 If a defective component is located, replace it and re-conduct the performance test. When a component is replaced, refer to the repair and replacement and adjustment and calibration paragraphs in this section.

5-55 OVERALL TROUBLESHOOTING PROCEDURE

5-56. To locate the cause of trouble follow steps 1, 2, and 3 in sequence.

(1) Check for obvious troubles such as open fuse, defective power cord, input power failure, or defective voltage or current meter. Next remove the top and bottom covers (each held by four retaining screws) and inspect for open connections, charred components, etc. If the trouble source cannot be detected by visual inspection, proceed with step 2.

(2) In almost all cases, the trouble can be caused by improper DC bias or reference voltages; thus, it is a good practice to check voltages in Table 5-2, before proceeding with step 3.

(3) Disconnect the load and examine Table 5-3 to determine your symptom and probable cause.

Table 5-2. Reference and Bias Voltages (Refer to Schematic for Test Point Locations)

STEP	METER COMMON	METER POSITIVE	NORMAL VDC	NORMAL RIPPLE (P-P)	PROBABLE CAUSE
1	51	-S*	30mV	20mV	Q11, CR30, C20
2	20	-S*	10	8mV	Q5, R39, R38
3	-S*	33	0.7V	1mV	CR14, R59
4	-S*	40(C21+)	33V	15mV	C21, CR31
5	11 (Q4 Emitter)	-S*	25V	1mV	CR6, VR1

* -S terminal is located on rear of power supply

Table 5-3. Overall Troubleshooting

SYMPTOM	PROBABLE CAUSE
Low or no output voltage	<ul style="list-style-type: none"> a. Front panel meter defective. b. Series regulator loop defective. Refer to Paragraph 5-57, then Table 5-4.
High output voltage	<ul style="list-style-type: none"> a. Front panel meter defective. b. Series regulator feedback loop defective. Refer to Paragraph 5-57, then Table 5-5.
High ripple	<ul style="list-style-type: none"> a. Check operating setup for ground loops. b. Check reference and bias voltages (Table 5-2) for excessive ripple. c. Supply crossing over to constant current operation under loaded conditions. Check current limit setting or constant current comparator circuit.
Poor line regulation	<ul style="list-style-type: none"> a. Improper measurement technique (Paragraph 5-8). b. Check reference voltages (Table 5-2).
Poor load regulation (Constant Voltage)	<ul style="list-style-type: none"> a. Measurement technique (Paragraph 5-8). b. Check reference voltages (Table 5-2). c. Check the regulation characteristics of zener diode VR1 as follows: <ul style="list-style-type: none"> (1) Connect differential voltmeter across VR1. (2) Connect appropriate load resistor (R_L), given in Figure 5-3, across (+) and (-) output terminals. (3) Perform steps b through f of Paragraph 5-13. (4) If the differential voltmeter reading varies by more than 10mV, replace VR1. d. Ensure that supply is not current limiting. Check constant current comparator circuit.
Poor load regulation (Constant Current)	<ul style="list-style-type: none"> a. Check reference voltages (Table 5-2). b. C15, C16, CR21, CR22 leaky. c. Ensure that supply is not voltage limiting. Check constant voltage comparator circuit.
Oscillates (Constant Voltage/Constant Current)	<ul style="list-style-type: none"> a. Selection of R13 (Paragraph 5-73). b. Check C4 and R14. c. Open sensing lead (+S).
Instability (Constant Voltage/Constant Current)	<ul style="list-style-type: none"> a. Reference circuit (Table 5-2). b. Noisy voltage or current controls (R2 or R9). c. Stage Q1 or Q8 defective. d. CR1 leaky. e. R1, R5, R42, R40, R41, C1 noisy or drifting.

5-57 Regulating Loop Troubles. If the voltages in Table 5-2 have been checked to eliminate the reference and bias circuits as a source of trouble; the malfunction is caused by the voltage regulating loop. If any component in a feedback loop is defective, measurements made anywhere in the loop may appear abnormal. Under these circumstances it is very difficult to separate cause from effect with the loop closed. As described in Tables 5-4 and 5-5, the loop is effectively opened by checking the conduction and cutoff capability of each stage as follows:

1. Shorting the emitter to collector of a transistor simulates saturation, or the full ON condition.

2. Shorting the emitter to base or opening the collector lead of a transistor cuts it off, and simulates an open circuit between emitter and collector.

5-58 For low or high output voltage perform the in-

structions in Tables 5-4, or 5-5, respectively. Although a logical first choice might be to start near the loop mid-point, and then perform successive subdividing test, it is more useful to trace the loop from the series regulator backwards a stage at a time, since loop failures occur more often at the higher power levels.

5-59 REPAIR AND REPLACEMENT

5-60 Before servicing a printed wiring board, refer to Figure 5-11. Section VI of this manual contains a list of replaceable parts.

5-61 ADJUSTMENT AND CALIBRATION

5-62 Adjustment and calibration may be required after performance testing, troubleshooting, or repair and replacement. Perform only those adjustments that affect the operation of the faulty circuit and no others.

Table 5-4. Low Output Voltage Troubleshooting

STEP	ACTION	RESPONSE	PROBABLE CAUSE
1	Turn front panel VOLTAGE and CURRENT controls fully clockwise		
2	To eliminate the current comparison circuit as a cause of the malfunction, remove CR8 cathode or anode lead	a. Output increases b. Output remains low	a. CR8 or current comparison circuit defective b. Reconnect CR8 and proceed to Step 3
3	Check ripple waveform between CR20 anode and CR19 cathode	 <p>a. Ripple waveform is half-wave (16msec) b. No ripple waveform</p>	a. CR17 or CR18 is open or the applicable gating circuit is open. To check the gate circuit, remove gate leads from CR17 and CR18, and check the resistance of the leads to test points 45 and ACC. If the resistance is greater than 125 ohms, the gate circuit is defective. Refer to Figure 7-1 for location of test points. b(1)CR17 and CR18 defective. (2)T1 defective. (3)SCR Regulator Control Circuit defective. Proceed to Step 4.

Table 5-4. Low Output Voltage Troubleshooting (Continued)

STEP	ACTION	RESPONSE	PROBABLE CAUSE
4	Check the operation of the SCR Regulator Control by removing the collector lead of Q4. Turn the supply on and off rapidly	a. Output voltage remains low b. Output voltage increases	a. SCR Regulator Control Circuit Q7 or associated components defective. Refer to waveforms on Figure 7-2 b. Proceed to Step 5
5	Check the turn-off capability of Q4 by removing the collector lead of Q1. Turn the supply on and off rapidly	a. Output voltage remains low b. Output voltage increases	a. Q4 or associated components defective b. Q1 or associated components defective

Table 5-5. High Output Voltage Troubleshooting

STEP	ACTION	RESPONSE	PROBABLE CAUSE
1	Turn front panel VOLTAGE control to mid-position and CURRENT control fully clockwise		
2	Using the AC voltmeter, check the voltage between ACC and 45	a. Less than 1Vac b. More than 1Vac	a. CR17 or CR18 shorted. b. Proceed to Step 3.
3	Check the operation of the SCR Regulator Control Circuit by shorting Q4 emitter to collector	a. Output remains high b. Output decreases	a. SCR Regulator Control Circuit Q7 or associated components defective. Refer to waveforms on Figure 7-2. b. Proceed to Step 4.
4	Check the conduction capability of Q4 by shorting Q1 emitter to collector	a. Output remains high b. Output decreases	a. Q4 or associated components defective. b. Q1 or associated components defective.

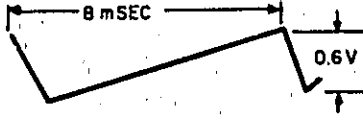
5-63 METER ZERO

5-64 The meter pointer must rest on the zero calibration mark on the meter scale when the instrument is at normal operating temperature, resting in its normal operating position, and the instrument is turned off. To zero-set the meter proceed as follows:

- a. Turn on instrument and allow it to come

up to normal operating temperature (about 20 minutes).

- b. Turn the instrument off. Wait one minute for power supply capacitors to discharge completely.

- c. Insert sharp pointed object (pen point or awl) into the small indentation near top of round black plastic disc located directly below meter face.

Excessive heat or pressure can lift the copper strip from the board. Avoid damage by using a low power soldering iron (50 watts maximum) and following these instructions. Copper that lifts off the board should be cemented in place with a quick drying acetate base cement having good electrical insulating properties.

A break in the copper should be repaired by soldering a short length of tinned copper wire across the break.

Use only high quality rosin core solder when repairing etched circuit boards. NEVER USE PASTE FLUX. After soldering, clean off any excess flux and coat the repaired area with a high quality electrical varnish or lacquer.

When replacing components with multiple mounting pins such as tube sockets, electrolytic capacitors, and potentiometers, it will be necessary to lift each pin slightly, working around the components several times until it is free.

WARNING: If the specific instructions outlined in the steps below regarding etched circuit boards without eyelets are not followed, extensive damage to the etched circuit board will result.

1. Apply heat sparingly to lead of component to be replaced. If lead of component passes through an eyelet in the circuit board, apply heat on component side of board. If lead of component does not pass through an eyelet, apply heat to conductor side of board.

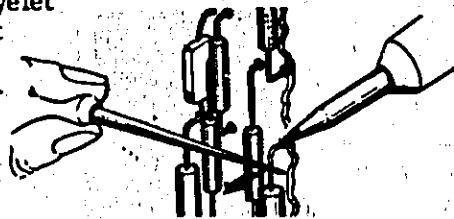

2. Reheat solder in vacant eyelet and quickly insert a small awl to clean inside of hole. If hole does not have an eyelet, insert awl or a #57 drill from conductor side of board.

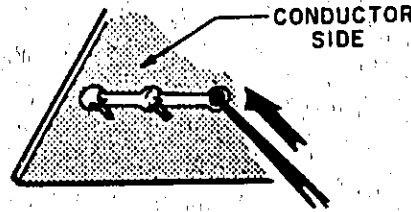

3. Bend clean tinned lead on new part and carefully insert through eyelets or holes in board.



4. Hold part against board (avoid overheating) and solder leads. Apply heat to component leads on correct side of board as explained in step 1.

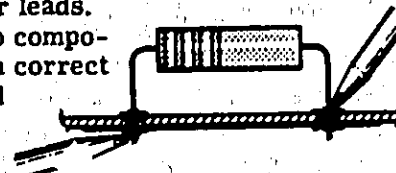

In the event that either the circuit board has been damaged or the conventional method is impractical, use method shown below. This is especially applicable for circuit boards without eyelets.

1. Clip lead as shown below.

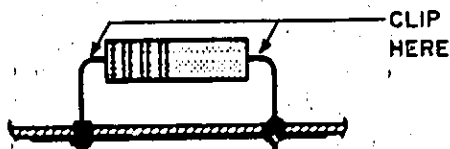

2. Bend protruding leads upward. Bend lead of new component around protruding lead. Apply solder using a pair of long nose pliers as a heat sink.

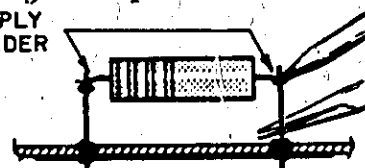

This procedure is used in the field only as an alternate means of repair. It is not used within the factory.

Figure 5-11. Servicing Printed Wiring Boards

d. Rotate plastic disc clockwise (cw) until meter reads zero, then rotate ccw slightly in order to free adjustment screw from meter suspension. If pointer moves, repeat steps c and d.

5-65 VOLTMETER ADJUSTMENT

5-66 To calibrate the voltmeter, proceed as follows:

- Connect differential voltmeter across supply, observing correct polarity.
- Turn on supply and adjust VOLTAGE controls until differential voltmeter reads exactly the maximum rated output voltage.
- Adjust R25 until front panel voltmeter also indicates maximum rated output voltage.

5-67 AMMETER ADJUSTMENT

5-68 To calibrate ammeter proceed as follows:

- Connect test setup shown in Figure 5-10 leaving switch S1 open.
- Turn VOLTAGE controls fully clockwise.
- Turn on supply and adjust current controls until differential voltmeter reads 1.5Vdc.
- Adjust R27 until front panel ammeter indicates exactly 1.5 Amperes.

5-69 VOLTAGE PROGRAMMING ACCURACY

5-70 To calibrate the constant voltage programming current, proceed as follows:

- Turn power supply off.
- Remove jumper connecting A7 to A6 on rear barrier strip.
- Connect 180K, 4W, 0.1% precision resistor between A6 and +S terminals on the rear barrier strip.
- Connect differential voltmeter between +S and -S terminals.
- Remove R39 and connect a decade resistance in its place.
- Turn on the supply and adjust the decade resistance until the differential voltmeter indicates exactly 600Vdc.
- Replace decade resistance with resistor of appropriate value in R39 position.

5-71 CURRENT PROGRAMMING ACCURACY

5-72 To calibrate the constant current programming current, proceed as follows:

- Turn off supply and short the output (+) to (-).
- Turn the VOLTAGE and CURRENT controls fully clockwise.
- Remove R41 and connect a decade resistor

set to 90K ohms in its place.

d. Turn on the supply and adjust the decade resistance until the front panel meter indicates 1.8 Amps.

5-73 TRANSIENT RECOVERY TIME

5-74 To minimize the transient resulting from a load change, proceed as follows:

- Perform the procedure in Paragraph 5-32.
- Remove R13 and connect a decade resistance in its place. Vary the decade resistance until the load transient is within specification as described in Paragraph 5-32.

5-75 OVERVOLTAGE PROTECTION ADJUSTMENT

5-76 To adjust the overvoltage protection circuit Q3, proceed as follows:

- Remove R17 and connect a decade resistance set to 90K in its place.
- Remove the jumper connecting A6 to A7 on the rear barrier strip.
- Turn on the supply and adjust the decade resistance until the voltmeter indicates 675Vdc.
- Substitute the nearest value, carbon composition, 1/2 Watt resistor.

5-77 RIPPLE IMBALANCE ADJUSTMENT

5-78 This adjustment should be performed when the supply is being operated from a 50Hz input to set the output ripple imbalance to an acceptable level, proceed as follows:

- Connect the oscilloscope to +S and -S terminals on the rear of the supply.
- Connect a 400 Ω , 900 Watt load resistor across the output terminals.
- Set the output voltage to 600Vdc.
- Remove R13 and connect a decade resistance, set to 90K, in its place.
- Adjust the decade resistance for a ripple imbalance (E1/E2) of less than 0.5 as shown in Figure 5-12.
- Resistance value of R13 must permit transient recovery time to be met as specified in Paragraph 5-73.

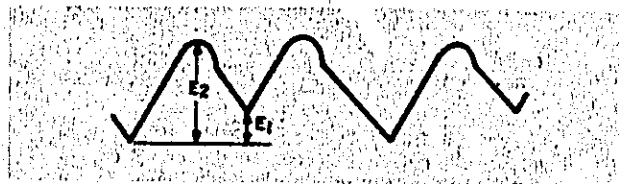

Figure 5-12. Ripple Imbalance Waveform

PARTS LIST

SECTION VI REPLACEABLE PARTS

6-1 INTRODUCTION

6-2 This section contains information for ordering replacement parts. Table 6-4 lists parts in alphanumeric order by reference designators and provides the following information:

- a. Reference Designators. Refer to Table 6-1.
- b. Description. Refer to Table 6-2 for abbreviations.
- c. Total Quantity (TQ). Given only the first time the part number is listed except in instruments containing many sub-modular assemblies, in which case the TQ appears the first time the part number is listed in each assembly.
- d. Manufacturer's Part Number or Type.
- e. Manufacturer's Federal Supply Code Number. Refer to Table 6-3 for manufacturer's name and address.
- f. Hewlett-Packard Part Number.
- g. Recommended Spare Parts Quantity (RS) for complete maintenance of one instrument during one year of isolated service.
- h. Parts not identified by a reference designator are listed at the end of Table 6-4 under Mechanical and/or Miscellaneous. The former consists of parts belonging to and grouped by individual assemblies; the latter consists of all parts not immediately associated with an assembly.

6-3 ORDERING INFORMATION

6-4 To order a replacement part, address order or inquiry to your local Hewlett-Packard sales office (see lists at rear of this manual for addresses). Specify the following information for each part: Model, complete serial number, and any Option or special modification (J) numbers of the instrument; Hewlett-Packard part number; circuit reference designator; and description. To order a part not listed in Table 6-4, give a complete description of the part, its function, and its location.

Table 6-1. Reference Designators

A	= assembly	E	= miscellaneous electronic part
B	= blower (fan)	F	= fuse
C	= capacitor	J	= jack, jumper
CB	= circuit breaker	K	= relay
CR	= diode	L	= inductor
DS	= device, signaling (lamp)	M	= meter

Table 6-1. Reference Designators (Continued)

P	= plug	V	= vacuum tube, neon bulb, photocell, etc.
Q	= transistor	VR	= zener diode
R	= resistor	X	= socket
S	= switch	Z	= integrated circuit or network
T	= transformer		
TB	= terminal block		
TS	= thermal switch		

Table 6-2. Description Abbreviations

A	= ampere	mfr	= manufacturer
ac	= alternating current	mod.	= modular or modified
assy.	= assembly	mtg	= mounting
bd	= board	n	= nano = 10^{-9}
bkt	= bracket	NC	= normally closed
OC	= degree Centigrade	NO	= normally open
cd	= card	NP	= nickel-plated
coef	= coefficient	Ω	= ohm
comp	= composition	obd	= order by description
CRT	= cathode-ray tube	OD	= outside diameter
CT	= center-tapped	p	= pico = 10^{-12}
dc	= direct current	P.C.	= printed circuit
DPDT	= double pole, double throw	pot.	= potentiometer
DPST	= double pole, single throw	p-p	= peak-to-peak
elect	= electrolytic	ppm	= parts per million
encap	= encapsulated	pvr	= peak reverse voltage
F	= farad	rect	= rectifier
OF	= degree Fahrenheit	rms	= root mean square
fxd	= fixed	Si	= silicon
Ge	= germanium	SPDT	= single pole, double throw
H	= Henry	SPST	= single pole, single throw
Hz	= Hertz	SS	= small signal
IC	= integrated circuit	T	= slow-blow
ID	= inside diameter	tan.	= tantalum
incnd	= incandescent	Ti	= titanium
k	= kilo = 10^3	V	= volt
m	= milli = 10^{-3}	var	= variable
M	= mega = 10^6	ww	= wirewound
μ	= micro = 10^{-6}	W	= Watt
met.	= metal		

Table 6-3. Code List of Manufacturers

CODE NO.	MANUFACTURER	ADDRESS	CODE NO.	MANUFACTURER	ADDRESS
00629	EBY Sales Co., Inc.	Jamaica, N. Y.	07138	Westinghouse Electric Corp.	
00656	Aerovox Corp.	New Bedford, Mass.		Electronic Tube Div.	Elmira, N. Y.
00853	Sangamo Electric Co.		07263	Fairchild Camera and Instrument Corp.	Semiconductor Div.
	S. Carolina Div.	Pickens, S. C.			Mountain View, Calif.
01121	Allen Bradley Co.	Milwaukee, Wis.	07387	Birtcher Corp., The	Los Angeles, Calif.
01255	Litton Industries, Inc.	Beverly Hills, Calif.	07397	Sylvania Electric Prod. Inc.	
				Sylvania Electronic Systems	
01281	TRW Semiconductors, Inc.	Lawndale, Calif.		Western Div.	Mountain View, Calif.
01295	Texas Instruments, Inc.		07716	IRC Div. of TRW Inc.	Burlington Plant
	Semiconductor-Components Div.				Burlington, Iowa
		Dallas, Texas	07910	Continental Device Corp.	
01686	RCL Electronics, Inc.	Manchester, N. H.			Hawthorne, Calif.
01930	Amerock Corp.	Rockford, Ill.	07933	Raytheon Co. Components Div.	
02107	Sparta Mfg. Co.	Dover, Ohio		Semiconductor Operation	
02114	Ferroxcube Corp.	Saugerties, N. Y.			Mountain View, Calif.
02606	Fenwal Laboratories	Morton Grove, Ill.	08484	Breeze Corporations, Inc.	Union, N. J.
02660	Amphenol Corp.	Broadview, Ill.	08530	Rellance Mica Corp.	Brooklyn, N. Y.
02735	Radio Corp. of America, Solid State and Receiving Tube Div.	Somerville, N. J.	08717	Sloan Company, The	Sun Valley, Calif.
03508	G. E. Semiconductor Products Dept.	Syracuse, N. Y.	08730	Vemaline Products Co. Inc.	Wyckoff, N. J.
03797	Eldema Corp.	Compton, Calif.	08806	General Elect. Co. Mjnia- ture Lamp Dept.	Cleveland, Ohio
03877	Transitron Electronic Corp.	Wakefield, Mass.	08863	Nylomatic Corp.	Norrisville, Pa.
03888	Pyrofilm Resistor Co. Inc.	Cedar Knolls, N. J.	08919	RCH Supply Co.	Vernon, Calif.
04009	Arrow, Hart and Hegeman Electric Co.	Hartford, Conn.	09021	Airco Speer Electronic Components	Bradford, Pa.
04072	ADC Electronics, Inc.	Harbor City, Calif.	09182	*Hewlett-Packard Co.	New Jersey Div.
04213	Caddell & Burns Mfg. Co. Inc.	Mineola, N. Y.			Rockaway, N. J.
04404	*Hewlett-Packard Co. Palo Alto Div.	Palo Alto, Calif.	09213	General Elect. Co. Semiconductor Prod. Dept.	Buffalo, N. Y.
04713	Motorola Semiconductor Prod. Inc.	Phoenix, Arizona	09214	General Elect. Co. Semiconductor Prod. Dept.	Auburn, N. Y.
05277	Westinghouse Electric Corp. Semiconductor Dept.	Youngwood, Pa.	09353	C & K Components Inc.	Newton, Mass.
05347	Ultronix, Inc.	Grand Junction, Colo.	09922	Burndy Corp.	Norwalk, Conn.
05820	Wakefield Engr. Inc.	Wakefield, Mass.	11115	Wagner Electric Corp.	
06001	General Elect. Co. Electronic Capacitor & Battery Dept.	Irmo, S. C.		Tung-Sol Div.	Bloomfield, N. J.
06004	Bassik Div. Stewart-Warner Corp.	Bridgeport, Conn.	11236	CTS of Berne, Inc.	Berne, Ind.
06486	IRC Div. of TRW Inc. Semiconductor Plant	Lynn, Mass.	11237	Chicago Telephone of Cal. Inc.	So. Pasadena, Calif.
06540	Amatom Electronic Hardware Co. Inc.	New Rochelle, N. Y.	11502	IRC Div. of TRW Inc.	Boone Plant
06555	Beede Electrical Instrument Co.	Penacook, N. H.			Boone, N. C.
06666	General Devices Co. Inc.	Indianapolis, Ind.	11711	General Instrument Corp Rectifier Div.	Newark, N. J.
06751	Semcor Div. Components, Inc.	Phoenix, Arizona	12136	Philadelphia Handle Co. Inc.	
06776	Robinson Nugent, Inc.	New Albany, Ind.			Camden, N. J.
06812	Torrington Mfg. Co., West Div.	Van Nuys, Calif.	12615	U. S. Terminals, Inc.	Cincinnati, Ohio
07137	Transistor Electronics Corp.	Minneapolis, Minn.	12617	Hamlin Inc.	Lake Mills, Wisconsin
			12697	Clarostat Mfg. Co. Inc.	Dover, N. H.
			13103	Thermalloy Co.	Dallas, Texas
			14493	*Hewlett-Packard Co. Loveland Div.	Loveland, Colo.
			14655	Cornell-Dubilier Electronics Div. Federal Pacific Electric Co.	Newark, N. J.
			14936	General Instrument Corp. Semicon- ductor Prod. Group	Hicksville, N. Y.
			15801	Fenwal Elect.	Framingham, Mass.
			16299	Corning Glass Works, Electronic Components Div.	Raleigh, N. C.

*Use Code 28480 assigned to Hewlett-Packard Co., Palo Alto, California

Table 6-3. Code List of Manufacturers (Continued)

CODE NO.	MANUFACTURER	ADDRESS	CODE NO.	MANUFACTURER	ADDRESS
16758	Delco Radio Div. of General Motors Corp.	Kokomo, Ind.	70563	Amperite Co. Inc.	Union City, N.J.
17545	Atlantic Semiconductors, Inc.	Asbury Park, N.J.	70901	Beemer Engrg. Co.	Fort Washington, Pa.
17803	Fairchild Camera and Instrument Corp		70903	Belden Corp.	Chicago, Ill.
	Semiconductor Div. Transducer Plant	Mountain View, Calif.	71218	Bud Radio, Inc.	Willoughby, Ohio
17870	Daven Div. Thomas A. Edison Industries		71279	Cambridge Thermionic Corp.	Cambridge, Mass.
	McGraw-Edison Co.	Orange, N.J.	71400	Bussmann Mfg. Div. of McGraw & Edison Co.	St. Louis, Mo.
18324	Stignetics Corp.	Sunnyvale, Calif.	71450	CTS Corp.	Elkhart, Ind.
19315	Bendix Corp. The Navigation and Control Div.	Teterboro, N.J.	71468	I. T. T. Cannon Electric Inc.	Los Angeles, Calif.
19701	Electra/Midland Corp.	Mineral Wells, Texas	71590	Globe-Union Inc.	
21520	Fansteel Metallurgical Corp.	No. Chicago, Ill.		Centralab Div.	Milwaukee, Wis.
22229	Union Carbide Corp. Electronics Div.	Mountain View, Calif.	71700	General Cable Corp. Cornish Wire Co. Div.	Williamstown, Mass.
22753	UID Electronics Corp.	Hollywood, Fla.	71707	Coto Coil Co. Inc.	Providence, R. I.
23936	Pamotor, Inc.	Pampa, Texas	71744	Chicago Miniature Lamp Works	Chicago, Ill.
24446	General Electric Co.	Schenectady, N.Y.	71785	Cinch Mfg. Co. and Howard B. Jones Div.	Chicago, Ill.
24455	General Electric Co. Lamp Div. of Consumer Prod. Group	Nela Park, Cleveland, Ohio	71984	Dow Corning Corp.	Midland, Mich.
24655	General Radio Co.	West Concord, Mass.	72136	Electro Motive Mfg. Co. Inc.	Willimantic, Conn.
24681	LTV, ElectroSystems Inc Memcor/Components Operations	Huntington, Ind.	72619	Dialight Corp.	Brooklyn, N.Y.
26982	Dynacool Mfg. Co. Inc.	Saugerties, N.Y.	72699	General Instrument Corp.	Newark, N.J.
27014	National Semiconductor Corp.	Santa Clara, Calif.	72765	Drake Mfg. Co.	Harwood Heights, Ill.
28480	Hewlett-Packard Co.	Palo Alto, Calif.	72962	Elastic Stop Nut Div. of Amerace Esna Corp.	Union, N.J.
28520	Heyman Mfg. Co.	Kenilworth, N.J.	72982	Erie Technological Products Inc.	Erie, Pa.
28875	IMC Magnetics Corp.		73096	Hart Mfg. Co.	Hartford, Conn.
	New Hampshire Div.	Rochester, N.H.	73138	Beckman Instruments Inc.	
31514	SAE Advance Packaging, Inc.	Santa Ana, Calif.		Hellpot Div.	Fullerton, Calif.
31827	Budwig Mfg. Co.	Ramona, Calif.	73168	Fenwal, Inc.	Ashland, Mass.
33173	G.E. Co. Tube Dept.	Owensboro, Ky.	73293	Hughes Aircraft Co. Electron Dynamics Div.	Torrance, Calif.
35434	Lectrohm, Inc.	Chicago, Ill.	73445	Amperex Electronic Corp.	Hicksville, N.Y.
37942	P.R. Mallory & Co. Inc.	Indianapolis, Ind.	73506	Bradley Semiconductor Corp.	New Haven, Conn.
42190	Muter Co.	Chicago, Ill.	73559	Carling Electric, Inc.	Hartford, Conn.
43334	New Departure-Hyatt Bearings Div.		73734	Federal Screw Products, Inc.	Chicago, Ill.
	General Motors Corp.	Sandusky, Ohio	74193	Heinemann Electric Co.	Trenton, N.J.
44655	Ohmite Manufacturing Co.	Skokie, Ill.	74545	Hubbell Harvey Inc.	Bridgeport, Conn.
46384	Penn Engr. and Mfg. Corp.	Doylestown, Pa.	74868	Amphenol Corp. Amphenol RF Div.	Danbury, Conn.
47904	Polaroid Corp.	Cambridge, Mass.	74970	E. F. Johnson Co.	Waseca, Minn.
49956	Raytheon Co.	Lexington, Mass.	75042	IRC Div. of TRW, Inc.	Philadelphia, Pa.
55026	Simpson Electric Co. Div. of American Gage and Machine Co.	Chicago, Ill.	75183	*Howard B. Jones Div. of Cinch Mfg. Corp.	New York, N.Y.
56289	Sprague Electric Co.	North Adams, Mass.	75376	Kurz and Kasch, Inc.	Dayton, Ohio
58474	Superior Electric Co.	Bristol, Conn.	75382	Kilka Electric Corp.	Mt. Vernon, N.Y.
58849	Syntron Div. of FMC Corp.	Homer City, Pa.	75915	Littlefuse, Inc.	Des Plaines, Ill.
59730	Thomas and Betts Co.	Philadelphia, Pa.	76381	Minnesota Mining and Mfg. Co.	St. Paul, Minn.
61637	Union Carbide Corp.	New York, N.Y.	76385	Minor Rubber Co. Inc.	Bloomfield, N.J.
63743	Ward Leonard Electric Co.	Mt. Vernon, N.Y.	76487	James Millen Mfg. Co. Inc.	Malden, Mass.
			76493	J. W. Miller Co.	Compton, Calif.

*Use Code 71785 assigned to Cinch Mfg. Co., Chicago, Ill.

Table 6-3. Code List of Manufacturers (Continued)

CODE NO.	MANUFACTURER	ADDRESS	CODE NO.	MANUFACTURER	ADDRESS
76530	Cinch	City of Industry, Calif.	83508	Grant Pulley and Hardware Co.	West Nyack, N. Y.
76854	Oak Mfg. Co. Div. of Oak		83594	Burroughs Corp. Electronic Components Div.	Plainfield, N. J.
77068	Bendix Corp., Electrodynamics Div.	No. Hollywood, Calif.	83835	U. S. Radium Corp.	Morristown, N. J.
77122	Palnut Co.	Mountainside, N. J.	83877	Yardeny Laboratories, Inc.	New York, N. Y.
77147	Patton-MacGuyer Co.	Providence, R. I.	84171	Arco Electronics, Inc.	Great Neck, N. Y.
77221	Phaotron Instrument and Electronic Co.	South Pasadena, Calif.	84411	TRW Capacitor Div.	Ogallala, Neb.
77252	Philadelphia Steel and Wire Corp.	Philadelphia, Pa.	86684	RCA Corp. Electronic Components	Harrison, N. J.
77342	American Machine and Foundry Co.		86838	Rummel Fibre Co.	Newark, N. J.
77630	Potter and Brumfield Div. Princeton, Ind.		87034	Marco & Oak Industries a Div. of Oak Electro/netics Corp.	Anaheim, Calif.
77764	Resistance Products Co.	Harrisburg, Pa.	87216	Philco Corp. Lansdale Div.	Lansdale, Pa.
78189	Illinois Tool Works Inc. Shakeproof Div.	Elgin, Ill.	87585	Stockwell Rubber Co. Inc.	Philadelphia, Pa.
78452	Everlock Chicago, Inc.	Chicago, Ill.	87929	Tower-Olschan Corp.	Bridgeport, Conn.
78488	Stackpole Carbon Co.	St. Marys, Pa.	88140	Cutler-Hammer Inc. Power Distribution and Control Div. Lincoln Plant	Lincoln, Ill.
78526	Stanwyck Winding Div. San Fernando Electric Mfg. Co. Inc.	Newburgh, N. Y.	88245	Litton Precision Products Inc, USECO Div. Litton Industries	Van Nuys, Calif.
78553	Tinnerman Products, Inc.	Cleveland, Ohio	90634	Gulton Industries Inc.	Metuchen, N. J.
78584	Stewart Stamping Corp.	Yonkers, N. Y.	90763	United-Car Inc.	Chicago, Ill.
79136	Waldes Kohlfloor, Inc.	L. I. C., N. Y.	91345	Miller Dial and Nameplate Co.	El Monte, Calif.
79307	Whitehead Metals Inc.	New York, N. Y.	91418	Radio Materials Co.	Chicago, Ill.
79727	Continental-Wirt Electronics Corp.	Philadelphia, Pa.	91506	Augat, Inc.	Attleboro, Mass.
79963	Zierick Mfg. Co.	Mt. Kisco, N. Y.	91637	Dale Electronics, Inc.	Columbus, Neb.
80031	Mepco Div. of Sessions Clock Co.	Morristown, N. J.	91662	Elco Corp.	Willow Grove, Pa.
80294	Bourns, Inc.	Riverside, Calif.	91929	Honeywell Inc. Div. Micro Switch	Freeport, Ill.
81042	Howard Industries Div. of Msl Ind. Inc.	Racine, Wisc.	92825	Whitso, Inc.	Schiller Pk., Ill.
81073	Grayhill, Inc.	La Grange, Ill.	93332	Sylvania Electric Prod. Inc. Semi-conductor Prod. Div.	Woburn, Mass.
81483	International Rectifier Corp.	El Segundo, Calif.	93410	Essex Wire Corp. Stemco Controls Div.	Mansfield, Ohio
81751	Columbus Electronics Corp.	Yonkers, N. Y.	94144	Raytheon Co. Components Div.	Quincy, Mass.
82095	Goodyear Sundries & Mechanical Co. Inc.	New York, N. Y.	94154	Wagner Electric Corp. Tung-Sol Div.	Livingston, N. J.
82142	Airco Speer Electronic Components	Du Bois, Pa.	94222	Southco Inc.	Lester, Pa.
82219	Sylvania Electric Products Inc. Electronic Tube Div. Receiving Tube Operations	Emporium, Pa.	95263	Leecraft Mfg. Co. Inc.	L. I. C., N. Y.
82389	Switchcraft, Inc.	Chicago, Ill.	95354	Method Mfg. Co.	Rolling Meadows, Ill.
82647	Metals and Controls Inc. Control Products Group	Attleboro, Mass.	95712	Bendix Corp. Microwave Devices Div.	Franklin, Ind.
82866	Research Products Corp.	Madison, Wis.	95987	Weckesser Co. Inc.	Chicago, Ill.
82877	Rotron Inc.	Woodstock, N. Y.	96791	Amphenol Corp. Amphenol Controls Div.	Janesville, Wis.
82893	Vector Electronic Co.	Glendale, Calif.	97464	Industrial Retaining Ring Co.	Irvington, N. J.
83058	Carr Fastener Co.	Cambridge, Mass.	97702	IMC Magnetics Corp. Eastern Div.	Westbury, N. Y.
83186	Victory Engineering Corp.	Springfield, N. J.	98291	Seaelectro Corp.	Mamaroneck, N. Y.
83298	Bendix Corp. Electric Power Div.	Eatontown, N. J.	98410	ETC Inc.	Cleveland, Ohio
83330	Herman H. Smith, Inc.	Brooklyn, N. Y.	98978	International Electronic Research Corp.	Burbank, Calif.
83385	Central Screw Co.	Chicago, Ill.	99934	Renbrandt, Inc.	Boston, Mass.
83501	Gavitt Wire and Cable Div. of Amerace Esna Corp.	Brookfield, Mass.			

Table 6-4. Replaceable Parts

REF. DESIG.	DESCRIPTION	TQ	MFR. PART NO.	MFR. CODE	PART NO.	RS
C1	fxd, paper .15 μ f 100Vdc	1	160P154910	56289	0160-2482	1
C2	fxd, elect 1 μ f 35Vdc	4	150D105X9035A2	56289	0180-0291	1
C3	fxd, film .0022 μ f 200Vdc	1	192P22292	56289	0160-0154	1
C4	fxd, elect .47 μ f 35Vdc	1	150D474X9035A2	56289	0180-0376	1
C5, 6, 17-19	NOT ASSIGNED	-	-	-	-	-
C7-10	fxd, paper .047 μ f 600Vdc	4	160P47396	56289	0160-0005	1
C11	fxd, paper .47 μ f 600Vdc	1	161P47406	56289	0160-2464	1
C12	fxd, paper 0.1 μ f 400Vdc	1	160P10494	56289	0160-0013	1
C13-16	fxd, elect 1000 μ f 400Vdc	4	36D102F400CE2A	56289	0180-1842	1
C20, 21	fxd, elect 200 μ f 65Vdc	2	D70996	56289	0180-1884	1
C22, 23	fxd, elect 1 μ f 35Vdc	-	150D105X9035A2	56289	0180-0291	-
C24	fxd, elect 20 μ f 50Vdc	1	30D206G050DC4	56289	0180-0049	1
C25	fxd, elect 1 μ f 35Vdc	-	150D105X9035A2	56289	0180-0291	-
C26, 27	fxd, film .082 μ f 200Vdc	2	192P82392	56289	0160-0167	1
C28	fxd, film .22 μ f 80Vdc	1	192P2249R8	56289	0160-2453	1
CB1	Circuit Breaker 20A 250Vac Max	1	AM33 Curve 4 obd	74193	2110-0212	1
CR1	Rect. si. 200mA 15prv	10	1N4828	03508	1901-0461	6
CR2-5, 10-12, 16, 24-27, 29, 32-38	NOT ASSIGNED	-	-	-	-	-
CR6	Rect. si. 200mA 15prv	-	1N4828	03518	1901-0461	-
CR7-9, 13	Rect. si. 200mA 200prv	13	1N485B	93332	1901-0033	7
CR14, 15	Rect. si. 200mA 15prv	-	1N4828	03508	1901-0461	-
CR17, 18	SCR 25A 200prv	2	C30B	03508	1884-0017	2
CR19, 20	Rect. si. 3A 200prv	2	MR1038B	04713	1901-0492	2
CR21, 22	Rect. si. 1A 400prv	2	1N5060	03508	1901-0328	2
CR23	Rect. si. 200mA 15prv	-	1N4828	03508	1901-0461	-
CR28	Rect. si. 200mA 200prv	-	1N485B	93332	1901-0033	-
CR30, 31	Rect. si. 500mA 200prv	2	1N3253	02735	1901-0389	2
CR39-45	Rect. si. 200mA 200prv	-	1N485B	93332	1901-0033	-
CR46, 47	Rect. si. 200mA 15prv	-	1N4828	03508	1901-0461	-
CR48	Rect. si. 200mA 200prv	-	1N485B	93332	1901-0033	-
CR49-51	Rect. si. 200mA 15prv	-	1N4828	03508	1901-0461	-
DS1	Indicator Light Neon	1	599-124	72765	1450-0048	1
L1	Choke, Filter	1	obd	09182	9100-1870	1
L2	Inductor, Filter	1	obd	09182	9100-2169	1
Q1	SS PNP si.	4	2N2907A	03508	1853-0099	4
Q2	SS NPN si.	2	2N3391	03508	1854-0071	2
Q3	SS PNP si.	-	2N2907A	03508	1853-0099	-
Q4	SS NPN si.	-	2N3391	03508	1854-0071	-
Q5	SS NPN si.	1	2N3390	03508	1854-0202	1
Q6, 9	NOT ASSIGNED	-	-	-	-	-
Q7	SS NPN si.	1	2N3417	03508	1854-0087	1
Q8, 10	SS PNP si.	-	2N2907A	03508	1853-0099	-
Q11	SS NPN si.	1	2N2193	03508	1854-0244	1
R1	fxd, met. film 182K Ω \pm 1% $\frac{1}{2}$ W	2	Type CEC T-O obd	07716	0757-0311	1
R2	var. ww 200K Ω 10Turn	1	Model 3400 obd	80294	2100-2000	1

REF. DESIG.	DESCRIPTION	TQ	MFR. PART NO.	MFR. CODE	Ⓢ PART NO.	RS
R3	fxd, met. film 100K _n ±1% 1/8W	2	Type CEA T-O obd	07716	0757-0465	1
R4, 6, 20, 22, 31, 43	NOT ASSIGNED	-	-	-	-	-
R5	fxd, met. film 182K _n ±1% 1/2W		Type CEC T-O obd	07716	0757-0311	
R7	fxd, comp 100K _n ±5% 1/2W	1	EB-1045	01121	0686-1045	1
R8	fxd, met. ox 300K _n ±5% 2W	6	Type C42S obd	16299	0698-3667	2
R9	var. ww 1K _n	1	obd	09182	2100-1847	1
R10	fxd, met. ox 300K _n ±5% 2W		Type C42S obd	16299	0698-3667	
R11	fxd, met. film 15K _n ±1% 1/8W	3	Type CEA T-O obd	07716	0757-0449	1
R12	fxd, met. film 61.9K _n ±1% 1/8W	2	Type CEA T-O obd	07716	0757-0460	1
R13	fxd, comp Selected ±5% 1/2W	4	Type EB obd	01121		1
R14	fxd, comp 30K _n ±5% 1/2W	1	EB-3035	01121	0686-3035	1
R15	fxd, comp 1 MEG ±5% 1/2W	1	EB-1055	01121	0686-1055	1
R16	fxd, met. film 27.4K _n ±1% 1/8W	1	Type CEA T-O obd	07716	0757-0452	1
R17	fxd, comp Selected ±5% 1/2W		Type EB obd	01121		
R18	fxd, met. film 23K _n ±1% 1/8W	1	Type CEA T-O obd	07716	0698-3269	1
R19	fxd, met. film 61.9K _n ±1% 1/8W		Type CEA T-O obd	07716	0757-0460	
R21	fxd, ww 10 _n ±5% 1W	1	GB-1005	01121	0689-1005	1
R23	fxd, ww 1 _n ±0.5% 8W	1	Type T-7A obd	01636	0811-2133	1
R24	fxd, met. film 19.1K _n ±1% 1/8W	1	Type CEA T-O obd	07716	0698-4484	1
R25	var. ww 5K _n (Modify)	1	Type 110-F4 obd	11236	2100-1824	1
R26	fxd, met. film 1.33K _n ±1% 1/4W	2	Type CEB T-O obd	07716	0698-3134	1
R27	var. ww 1K _n (Modify)	1	Type 110-F4 obd	11236	2100-0391	1
R28	fxd, met. ox 300K _n ±5% 2W		Type C42S obd	16299	0698-3667	
R29	fxd, comp 100 _n ±5% 1W	1	GB-1015	01121	0689-1015	1
R30	fxd, ww 20K ±5% 40W CT	1	2BR-37/5800 Short	63743	0811-2134	1
R32	fxd, met. ox 300K _n ±5% 2W		Type C42S obd	16299	0698-3667	
R33	fxd, comp 2K _n ±5% 1/2W	1	EB-2025	01121	0686-2025	1
R34	fxd, comp 10K _n ±5% 1/2W	3	EB-1035	01121	0686-1035	1
R35	fxd, met. film 2K _n ±1% 1/8W	1	Type CEA T-O obd	07716	0757-0283	1
R36	fxd, met. film 3K _n ±1% 1/8W	1	Type CEA T-O obd	07716	0757-1093	1
R37	fxd, met. film 1.33K _n ±1% 1/4W		Type CEB T-O obd	07716	0698-3134	
R38	fxd, met. film 3.01K _n ±1% 1/4W	1	Type CER T-O obd	07716	0757-0339	1
R39	fxd, comp Selected ±5% 1/2W		Type EB obd	01121		
R40	fxd, met. film 15K _n ±1% 1/8W		Type CEA T-O obd	07716	0757-0449	
R41	fxd, comp Selected ±5% 1/2W		Type EB	01121		
R42	fxd, ww 3K _n ±5% 5W	1	243E3025	56289	0812-0050	1
R44	fxd, comp 470 _n ±5% 1/2W	1	EB-4715	01121	0686-4715	1
R45	fxd, met. film 15K _n ±1% 1/8W		Type CEA T-O obd	07716	0757-0449	
R46	fxd, met. film 100K _n ±1% 1/8W		Type CEA T-O obd	07716	0757-0465	
R47	fxd, comp 10K _n ±5% 1/2W		EB-1035	01121	0686-1035	
R48, 49	fxd, met. ox 300K _n ±5% 2W		Type C42S obd	16299	0698-3667	
R50	fxd, comp 3K _n ±5% 1/2W	1	EB-3025	01121	0686-3025	1
R51	fxd, comp 180 _n ±5% 1/2W	1	EB-1815	01121	0686-1815	1
R52	fxd, met. ox 3K _n ±5% 2W	1	Type C42S obd	16299	0698-3642	1
R53	fxd, comp 10K _n ±5% 1/2W		EB-1035	01121	0686-1035	
R54, 55	fxd, comp 47 _n ±5% 1/2W	2	EB-4705	01121	0686-4705	1
R56	fxd, comp 39 _n ±5% 1/2W	2	EB-3905	01121	0686-3905	1
R57	fxd, comp 20K _n ±5% 1/2W	1	EB-2035	01121	0686-2035	1
R58	fxd, comp 33K _n ±5% 1/2W	1	EB-3335	01121	0686-3335	1
R59	fxd, comp 39 _n ±5% 1/2W		EB-3905	01121	0686-3905	
T1	Transformer, Power	1	obd	09182	9100-1869	1
T2	Transformer, Bias	1		09182	9100-1876	1
T3	Transformer, Pulse	1	obd	09182	9100-1875	1

REF. DESIG.	DESCRIPTION	TQ	MFR. PART NO.	MFR. CODE	Ⓢ PART NO.	RS
TS1	Thermal Switch Open to Rise 167°F ±5°F Close on Fall 137°F ±10°F	1	obd	09182	0440-0042	1
VR1	Zener 9.4V ±5% 500mW	1	1N2163A	06751	1902-0763	1
	Main Chassis Assembly	1	obd	09182	5060-6114	
	Rear Chassis Assembly	1	obd	09182	06448-60001	
	Front Panel Assembly	1	obd	09182	06448-60002	
	Rear Chassis	1	obd	09182	06448-60001	
	Cover (Top or Bottom)	2	obd	09182	06448-60003	
	P. C. Board Assembly (Loaded)	1	obd	09182	06448-60020	
	Printed Circuit Board (Blank)	1	obd	09182	06448-20020	
	Angle Bracket, P. C. Board	1	obd	09182	5000-6012	
	U-Bracket, P. C. Board	1	obd	09182	5000-6014	
	Heat Sink (For CR17 and CR18)	1	obd	09182	5020-5501	
	Capacitor Clamp, Aluminum (For C13, 14, 15, 16)	3	obd	09182	5000-6017	
	Cover, Angle (For 7-terminal barrier strip)	1	obd	09182	5020-5718	
	Cover (For 5-terminal barrier strip)	1	obd	09182	06448-20003	
	Cover (For 3-terminal barrier strip)	1	obd	09182	5020-5513	
	Handle 5½"	2	obd	09182	5020-5512	
	Shaft, Insulated 2-3/8" long (For VOLTAGE control R2)	1	obd	09182	06448-20001	
	Shaft, Insulated 1-3/8" long (For CURRENT control R9)	1	obd	09182	06448-20004	
	Bracket, Mounting (For potentiometer R9)	1	obd	09182	06448-00003	
	Washer, shoulder (For heat sink standoff)	2	obd	09182	2190-0491	
	Barrier Strip, 5 terminal	1	602-Y-5	75382	0360-1259	1
	Barrier Strip, 3 terminal	1	602-3	75382	0360-1213	1
	Barrier Strip, 7 terminal	1	obd	09182	0360-1237	1
	Jumper (For 5 terminal barrier strip)	2	602-J	75382	0360-1280	1
	Jumper (For 7 terminal barrier strip)	5	422-13-11-013	71785	0360-1143	1
	Voltmeter, 0-700 Volts	1	obd	09182	1120-1240	1
	Ammeter, 0-1.8 Amps	1	obd	09182	1120-1245	1
	Bezel, Meter	2	obd	09182	4040-0296	1
	Spring, Meter	8	obd	09182	1460-0256	2
	Fastener, DS1	1	C17373-012-24B	89032	0510-0123	1
	HP LOGO, Front Panel	1	obd	09182	7120-1254	1
	5 Way Binding Post, Front Panel, Maroon	1	DF21Mn	09182	1510-0040	1
	5 Way Binding Post, Front Panel, Black	2	DF21BC	58474	1510-0039	1
	Rubber Bumper, Rear Panel	4	Type 2097W obd	87585	0403-0089	1
	Knob, CURRENT Control	1	obd	09182	0370-0084	1
	Knob, VOLTAGE Control	1	obd	09182	0370-0137	1
	Universal Coupling, Voltage Control	2	#39002	76487	1500-0067	1
	Motor, Fan	1	obd	09182	3140-0010	1
	Casting, Fan	1	obd	09182	5243A-20A	1
	Blade, Fan	1	4LHB182B	09182	3160-0034	1
	Bushing, Front Panel Control	2	#119	83330	1410-0758	1
	Insulator, Heat Sink	4	obd	09182	0340-0172	1
	Standoff, Insulator, For C12 and R21	1	7A1-A6	92825	0360-1449	1

REF. DESIG.	DESCRIPTION	TQ	MFR. PART NO.	MFR. CODE	Ⓒ PART NO.	RS
	Spacer, HEX, 6-32 x 3/4" (For rear barrier strip)	1	obd	09182	0380-0091	1
	Spacer, HEX, 8-32 x 3/8" (For rear barrier strip)	4	obd	09182	0380-0718	1
	Spacer, #8 x 5/8 LG (For 3-terminal barrier strip)	2	obd	09182	0380-0723	1
	Spacer, Alum, Tubular (Mounted on heat sink) 3/8 Diam x 5/8 Long	1	9323-A-194-0	06540	0380-0396	1
	Washer, Nylon, Shoulder, CR18	1	obd	05277	2190-0898	1
	Grommet, 5/8"	6	1661	73734	0400-0062	1
	Rubber Bumper, Black, Rear Panel	4	3066	87585	0403-0085	1
	Wafer, Metal Mounting CR18	1	H4021	61637	0340-0175	1
	Cable Clamp 1/4 I. D., For C11	1	T4-4	79307	1400-0330	1
	Washer, Insulated, Front Panel Controls	4	obd #2658	83330	2190-0497	1
	OPTION 17 and/or 18					
CR17, 18	SCR 35A 400prv	2	38639	02735	1884-0058	2
R21	fxd, comp 22 Ω \pm 5% 1W	1	GB-2205	01121	0689-2205	1
R58	fxd, met. ox 75K Ω \pm 5% 2W	1	Type C42S obd	16299	0764-0027	1
T1	Transformer, Power	1	obd	09182	06448-80091	1
T2	Transformer, Bias	1	obd	09182	9100-2195	1

SCHEMATIC DIAGRAMS

APPENDIX

SECTION VII CIRCUIT DIAGRAMS

This section contains the schematic diagram (Figure 7-1) for the unit. Component and test point reference designations shown on the schematic are marked directly on the main printed wiring board. Voltages are given on the schematic adjacent to the applicable test points; identified by encircled numbers on both the schematic and printed wiring board. Included on the schematic apron are the waveforms associated with the SCR control circuit portion of the unit.

APPENDIX A
MANUAL BACKDATING CHANGES

Manual backdating changes describe changes necessary to adapt this manual to earlier instruments. To adapt the manual to serial numbers prior to 6L0182, make the following changes.

CHANGE 1: Q1, 3, 8, 10 to 2N3906, Motorola 04713, CP Part No. 1853-0036. These transistors should be replaced by 1853-0065 as shown in Table 6-4 under Q1, 3, 8, 10.

CHANGE 2: R24 to 33K $\pm 1\%$, 1/8W, CP Part No. 0698-5089. This resistor should be replaced by 0698-4484 as shown in Table 6-4 under R24.

CHANGE 3: R25 to 10K, Type 110, CP Part No. 2100-0396. This potentiometer should be replaced by 2100-1824 as shown in Table 6-4 under R25.

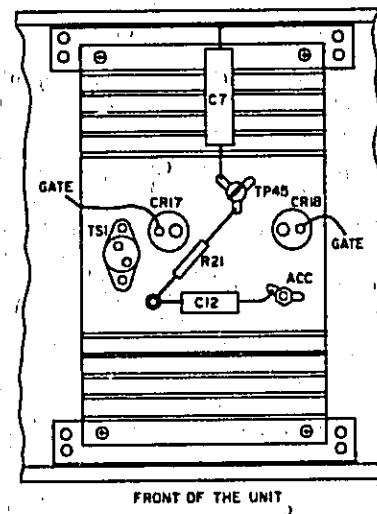
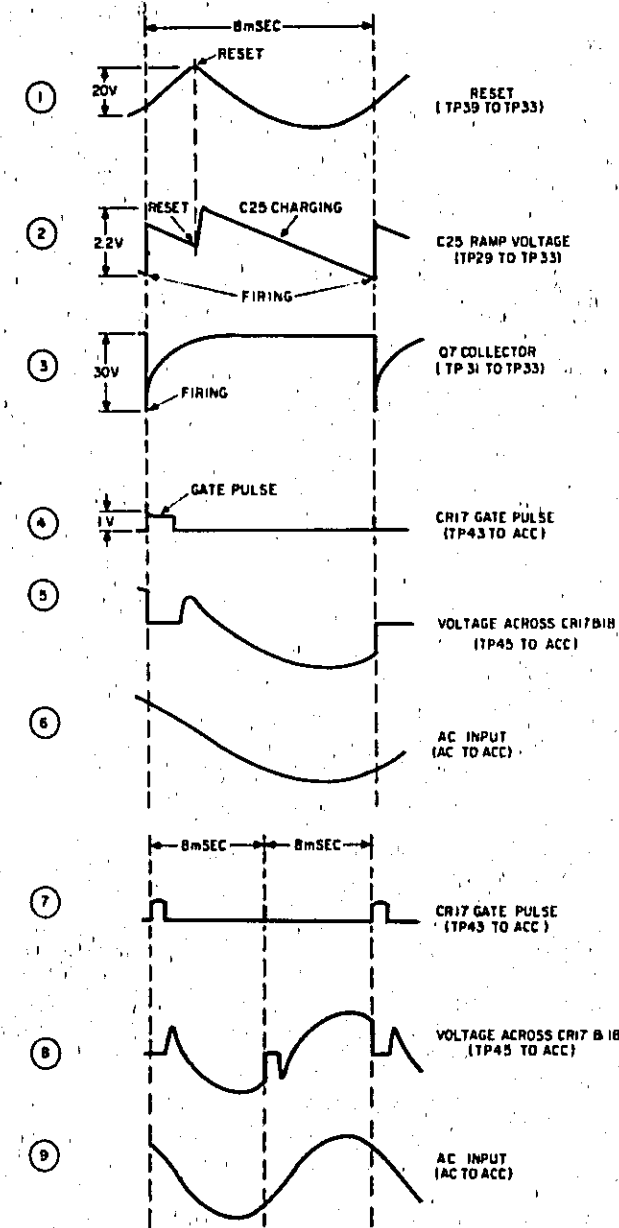
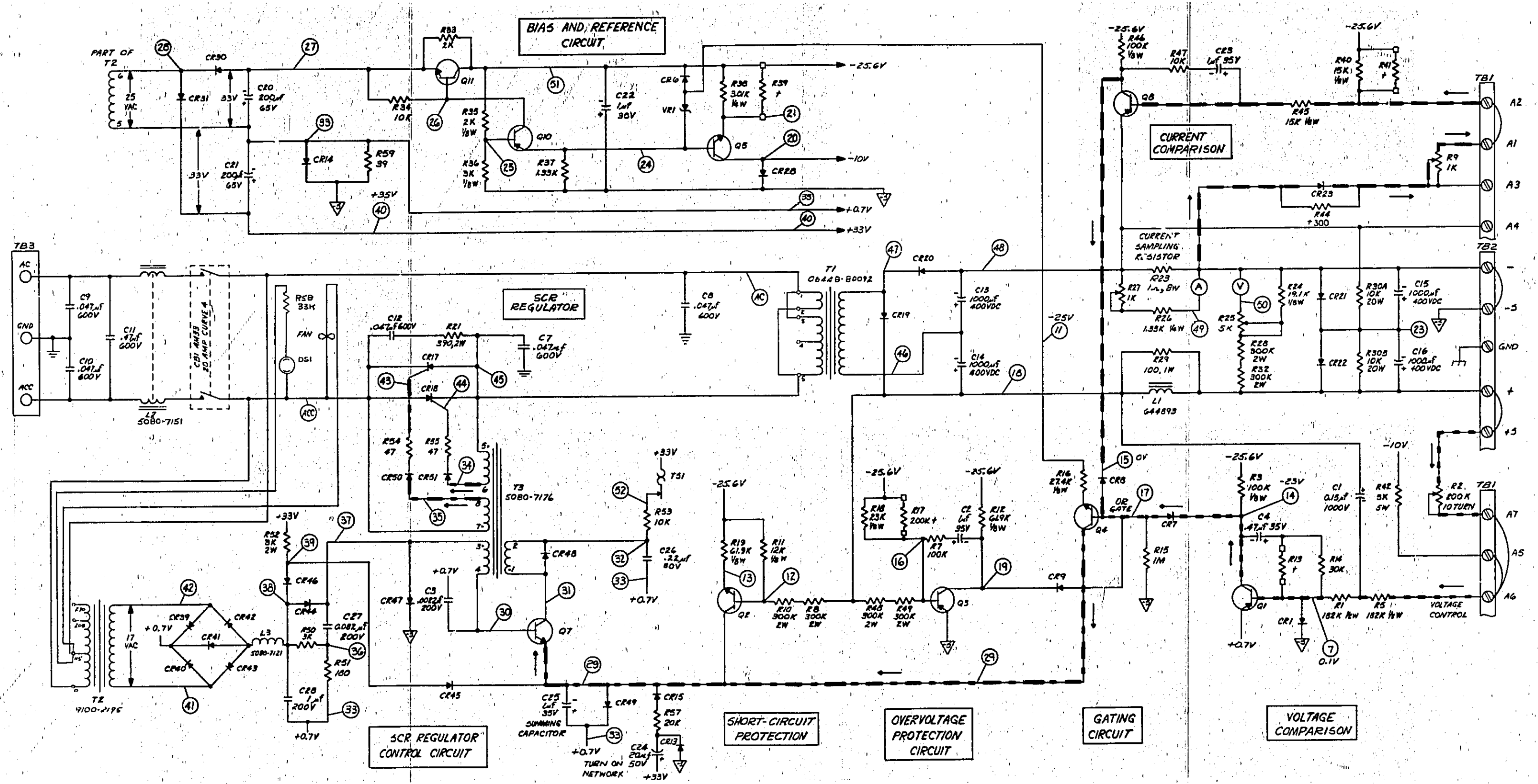

Figure 7-1. Heat Sink Component Location



NOTE: WAVEFORMS WERE TAKEN WITH THE OUTPUT SET AT 600VDC AND NO LOAD CONNECTED.

Figure 7-2. Timing Waveform Diagram



- NOTES:
1. ALL RESISTORS ARE 1/8W, 5% UNLESS OTHERWISE NOTED.
 2. ALL 1/8W AND 1/4W RESISTORS ARE 1% IN TOLERANCE.
 3. REAR TERMINALS ARE SHOWN IN NORMAL STRAPPING FOR USE OF FRONT PANEL CONTROLS.
 4. — DENOTES VOLTAGE FEEDBACK SIGNAL.
 5. — DENOTES CURRENT FEEDBACK SIGNAL.
 6. TRANSFORMER SHOWN STRAPPED FOR 115 VAC OPERATION. SEE INSTRUCTION MANUAL FOR 220 VAC.
 7. * DENOTES NOMINAL VALUE, COMPONENTS SELECTED FOR OPTIMUM PERFORMANCE.

CIRCUIT PATENTS APPLIED FOR. LICENSE TO USE MUST BE OBTAINED IN WRITING FROM HEWLETT-PACKARD, HARRISON DIVISION.

Figure 7-3. DC Power Supply, Model 6448B, Schematic Diagram

MANUAL CHANGES

MANUAL CHANGES

DC POWER SUPPLY
Model 6448B
Manual HP Part No. 06448-90001

Make all corrections in the manual according to errata below, then check the following table for your power supply serial number and enter any listed change(s) in the manual.

SERIAL		MAKE CHANGES
Prefix	Number	
All	-	Errata
9E	0402-0561	1
9E	0562-0641	1,2
0H	0642-0670	1,2,3
0H	0671-0751	1 thru 4
0H	0752-0791	1 thru 5
0H	0792-0811	1,2,3,4,6
1139A	0812-1741	1 thru 8
1624A	1742-1816	1 thru 9
1644A	1817-1864	1 thru 10
1712A	1865-2116	1 thru 11
1825A	2092-2166	1 thru 12
1836A	2167-2216	1 thru 13
1844A	2217-2801	1 thru 14
2038A	2802-2951	1 thru 15
2117A	2952-up	1 thru 16

ERRATA

On Figure 3-8, remove the strap between (-) and (-S) on all SLAVE supplies. Add a strap between (A5) and (-S) on all SLAVE supplies.

On page 4-4, paragraph 4-30, change the fourth sentence to read as follows:

For example, during constant voltage operation the collector voltage of Q1 (voltage input) forward biases CR7 (CR8 reversed biased by Q8), the current through CR7 will vary as Q1 collector voltage varies and thus vary Q4 base current; therefore, the collector current of Q4 is controlled by the voltage input.

On page 2-1, delete paragraphs 2-19, 2-20 and 2-21 since they are not applicable to this supply.

In specifications table and all other places where output is mentioned, change it to read:

1-600 Volts.

Add the following note to the specification table (1-1) and Paragraph 2-14: "The minimum ac power line protection capacity required for SCR firing surges is 20 amperes when operated from a 115 volt line, and 10 amperes when operated from a 230 volt line."

On the schematic, change the reference designator and value of the current sampling resistor from R53 to R23, 1 Ω , 8W.

In the replaceable parts table, add:

Lockwasher, internal tooth, 29/64 ID x 27/32 OD x .062 thick, Shakeproof 1422-00 (for R2).

On the schematic diagram, reverse the polarity of diodes CR39 and CR43. Change the voltage at Test Point 51 from -30V to -25.6V. In addition, everywhere else in the schematic where "-30V" appears, change it to "-25.6V."

CHANGE: 1

In replaceable parts table make the following changes:

CR17, 18: Change to 38639, Φ Part No. 1884-0058.

R21: Change to 100 Ω \pm 5% 2W, A. B., Φ Part No. 0698-3620.

Motor, Fan: Change to Φ Part No. 3140-0052.

CHANGE 2:

In the replaceable parts table and on the schematic diagram, make the following changes:

R17: Change from selected value to 200k Ω , \pm 5%, $\frac{1}{4}$ W, HP Part No. 0686-2045.

Handles: Change HP Part No. to 5020-5715, qty. 2.

Machine Screw, handles: Add, HP Part No. 2680-0173, qty. 4.

CHANGE 3:

The serial number prefix of the instrument has been changed from "9E" to "0H."

In the replaceable parts table, make the following change:

L2, Line Choke: Change the HP Part No. to 5080-7151.

CHANGE 4:

In the replaceable parts table, make the following changes:

R44: Change to "Selected for optimum performance," nominal value is 300 Ω , \pm 5%, $\frac{1}{4}$ W.

OPTION 17/18:

R21: Change to 220 Ω , 5%, 2W, HP Part No. 0698-3628.

C12: Add C12, 0.047 μ F, 600V, HP Part No. 0160-0005.

CHANGE 5:

This change applies to the schematic diagram only. It applies only to units bearing serial numbers between 0H0752 and 0H0791.

On the schematic diagram (Figure 7-3), make the following changes:

- C12: Change to 0.1 μ F, 400V, HP Part No. 0160-0013.
- C26: Change to 0.082 μ F, 200V, HP Part No. 0160-0167.
- C28: Change to 0.22 μ F, 80V, HP Part No. 0160-2453.
- L3: Delete (short-out) L3, connected between TP38 and rectifier bridge (anodes CR41, CR42, CR43).
- R11: Change to 15k, \pm 1%, HP Part No. 0757-0446.
- R21: Change to 100 Ω , \pm 5%, HP Part No. 0698-3620.
- R56: Add R56, (39 Ω , $\frac{1}{2}$ W) between junction of CR44 (anode), CR46 (cathode), R50, and C28.
- T1: Change to 115Vac transformer, HP Part No. 9100-1869.
- T2: Change to 115Vac transformer, HP Part No. 9100-1876.
- T3: Change to HP Part No. 9100-1875.

CHANGE 6:

In the replaceable parts table make the following changes:

- C12: Change to 0.047 μ F, 600V, HP Part No. 0160-0005.
- C26: Change to 0.22 μ F, 80V, HP Part No. 0160-2453.
- C28: Change to 1 μ F, 200V, HP Part No. 0160-2465.
- Add L3: HP Part No. 5080-7121.
- R11: Change to 12k, 1%, HP Part No. 0698-5088.
- R21: Change to 390 Ω , 2W, HP Part No. 0698-3633.
- R56: Delete R56.
- T1: Change to HP Part No. 06448-80092.
- T2: Change to HP Part No. 9100-2195.
- T3: Change to HP Part No. 5080-7176.

In Chapter 2, delete paragraph 2-16 and substitute the following:

2-16. CONNECTIONS FOR 208/230 VOLT OPERATION (Option 27 and 28 respectively)

T1 is rewired as follows:

- Connection between terminals 1 and 3 is removed.
- Connection between terminals 2 and 5 is removed.
- Terminal 2 is connected to terminal 3.

For 208V (Option 27) only, the ACC input connection to terminal 5 of T1 is removed and connected to terminal 4.

T2 is rewired:

The AC input connection to the "115V" terminal is removed and connected to the "208V" or "230V"

terminal as applicable. The fan and pilot light remains connected to the 115V terminal.

ERRATA:

Page 5-12, Table 5-5, change "action" column in Step 3 to read:

"Check operation of SCR regulator control circuit by disconnecting collector lead of Q4."

CHANGE 7:

In the replaceable parts list and on the schematic diagram, add three new diodes: CR32 (1901-0050), CR33 (1901-0330) or CR34 (1901-0033).

CR32 is connected between base (anode) and emitter (cathode) of Q8. CR33 is connected between collector of Q8 (anode) and R46 (cathode). CR34 is connected between base (cathode) and emitter (anode) of Q4.

ERRATA:

On Page 1-2, in Table 1-1, Specifications and in the Constant Voltage and Constant Current Load Regulation Performance Tests in Section V, make the following changes:

- Constant Voltage Load Regulation is less than 1V.
- Constant Current Load Regulation is less than 40mA.

The following replaces Paragraphs 5-30 through 5-32.

Transient recovery time should be checked with a manually-operated switch (a Rex Rheostat can be used) in place of the repetitive load switch shown in Figure 5-6. The manual switch is connected in place of the contact protection network so as to place R_{L2} in parallel with R_{L1} when closed and to remove R_{L2} from the circuit when opened. Further, since transient recovery time is less than 200msec, the oscilloscope should be dc coupled in which case a 600V supply should be connected between the + output terminal and the oscilloscope in a series-opposing configuration. After the above test set-up has been established, the transient recovery time waveforms (Figure 5-7) will be observed when the switch is opened and closed.

The constant current remote programming specification is now 600ohms/amp \pm 20%. Make the following changes in the manual:

- Table 1-1: Under REMOTE PROGRAMMING, change the remote programming current accuracy to 20%.
- Page 3-3, Paragraph 3-26, top line in right column now reads: "for an accuracy of 20% at the factory. If greater..."

The standard colors for this instrument are now mint gray (for front and rear panels) and olive gray (for all top, bottom, side, and other external surfaces). Option X95 designates use of the former color scheme of light gray and blue gray. Option A85 designates use of a light gray front panel with olive gray used for all other external surfaces. New part numbers are shown at bottom.

DESCRIPTION	HP PART NO.		
	STANDARD	OPTION A85	OPTION X95
Front Panel, Lettered	06448-60005	06448-60002	←
Cover	5000-9804	←	5000-6009
Rear Chassis Ass'y	06439-60006	←	06439-60001
Welding Assembly, Chassis	5060-7970	←	5060-6114

CHANGE 8:

In the replaceable parts table, change the HP Part No. of Circuit Breaker CBI to 3105-0035.

ERRATA:

Add the following note after paragraph 3-33:

WARNING

When operating two or more supplies in parallel (either normal or Auto-Parallel), they can be damaged by being down-programmed too rapidly. Never reduce the output abruptly by shorting the programming input terminals. (The maximum rate at which the voltage can be programmed lower depends on the load resistance.)

Add the following note after paragraph 3-34:

WARNING

When operating a master supply in Auto-Parallel with one or more slave supplies, the master supply must be the first to be energized and the last to be deenergized.

ERRATA:

In Table 1-1 and 5-33, change the INTERNAL IMPEDANCE AS A CONSTANT VOLTAGE SOURCE (Output Impedance) specification to read as follows:

OUTPUT IMPEDANCE (TYPICAL): Approximated by a 0.5 ohm resistance in series with a 10-microhenry inductance

ERRATA:

In the third sentence of paragraph 3-4, change the word "positive" to "negative."

Add the following notice to paragraph 1-18: "Effective December 1, 1975, extra manuals may be obtained by ordering Option 910 when ordering your instrument. The number of extra manuals depends on the number of Option 910s ordered."

In the parts list, change the HP Part No. of pilot lamp DS1 to 1450-0566. The new pilot lamp is more reliable because its leads are crimped instead of being spot welded.

CHANGE 9:

Make the following changes to the parts list: Delete capacitors C7 thru C11. Add C101 and C102, 0.015 μ F, 250Vac, HP Part No. 0160-3969. Add C103, 0.22 μ F, 250Vac, HP Part No. 0160-4259. Add C104, 0.022 μ F, 250Vac, HP Part No. 0160-4048. Add C105 and C106, 0.0047 μ F, 4kV, HP Part No. 0160-0543. Add resistor R60, 1M Ω , 5%, 1/2W, HP Part No. 0686-1055. C101, C102, C103, and R60 are physically located on the RFI filter assembly. C104 is mounted on power transformer T1, and C105 and C106 are mounted on the output barrier strip. Electrically, these added components are connected as shown in the revised partial schematic shown below. This schematic also shows the transformer connections discussed in Change 6. Make all of these changes to the schematic in the manual. The purposes of the changed capacitors are to reduce the line leakage current for better safety and to improve the RFI filtering.

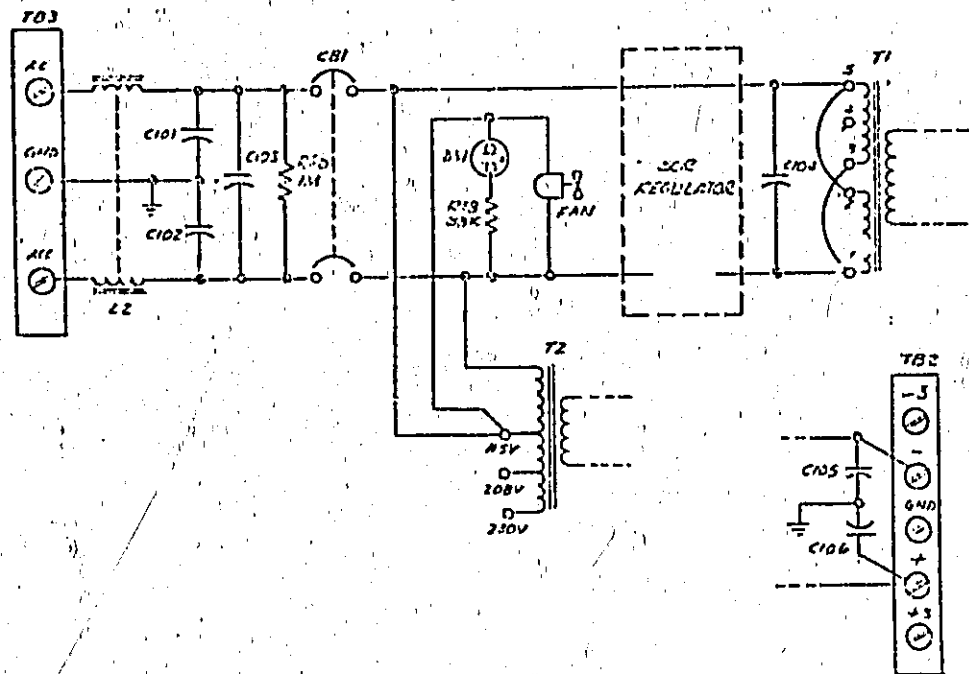

CHANGE 10:

Three of the capacitors and one of the resistors (C101, C102, C103, and R60) in the revised RFI filter circuit shown in Change 9 have been relocated to a new RFI Assembly circuit board. The new circuit board assembly replaces the circuit board that was formerly part of the inductor-filter assembly. The ac input wiring schematic accompanying Change 9 still applies.

The front panel binding posts have been changed to a type with better designed insulation. Delete the two types of posts listed on page 6-7 and add: black binding post, HP Part No. 1510-0107, (qty. 1); and red binding post, HP Part No. 1510-0091, (qty. 2).

In the parts list and on the schematic, change C12 in the SCR snubber circuit to 0.047 μ F, 250Vac, HP Part No. 0160-4323. Also change the part number of the C12/R21 insulated standoff to 0380-0849 (qty. 2).

CHANGE 11:

This change replaces SCR's CR17 and CR18 with a new type, HP Part No. 1884-0218, and adds a MOV varistor designated RV1 across the load side of the line switch. The part number of the varistor is 0837-0117.

ERRATA:

Add three 3/8-32 nylon hex nuts, HP Part No. 2950-0144, to the parts list. These hex nuts mount the new binding posts added by Change 10.

ERRATA:

On page 2-1, delete paragraph 2-20 and 2-21, and add the following note:

NOTE

No line cord is provided with this power supply.

CHANGE 12:

In the replaceable parts list and on the schematic, replace CR17, CR18, R55, CR51, and C7 with triac CR52, HP Part No. 1884-0218; change C12 to C33, HP Part No. 0160-4323; change R21 to R61, 390 Ω , 0.5W, HP Part No. 0686-3915; change T51 to HP Part No. 0440-0079; change T3 to HP Part No. 5080-1914. Replace the section of schematic shown below on left with the drawing on right.

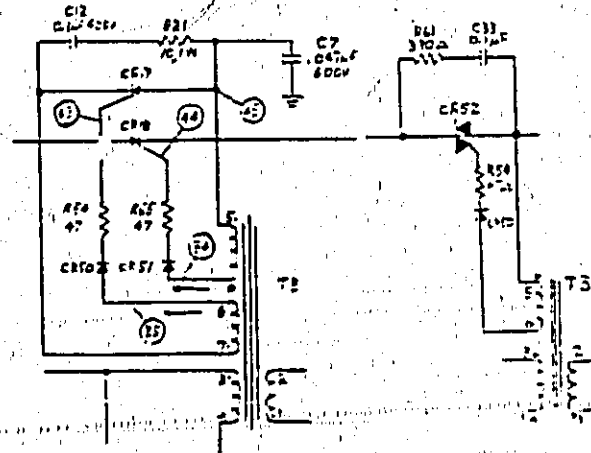

CHANGE 13:

Delete cover barrier strip, HP Part No. 5020-5513. Add strain relief, HP Part No. 5060-2791.

Change zener diode VR1 to 9V, HP Part No. 1902-0785.

Change resistor R37 to 1.8K Ω , 1%, HP Part No. 0698-3640. Change resistor R35 to 1.8K Ω , 1%, HP Part No. 0757-0930. Change resistor R36 to 2.87K Ω , 1%, HP Part No. 0698-3151.

CHANGE 14:

Add one plastic insert, HP Part No. 06448-80002, to the parts list. This part is installed on the shaft of potentiometer R2.

CHANGE 15:

Replace Fan Motor, Casting, and Blade with Fan, tube axial, HP Part No. 3160-0056.

CHANGE 16:

In the Replaceable parts list page 6-5, add the following parts C34 .22 μ F 250V HP P/N 0160-4259, CR53 HP P/N 1901-0050, page 6-6 add R62 1.6k Ω HP P/N 0686-1625, page 6-7 add VR2 400mw 23.7 V HP P/N 1902-3256.

On the schematic C34 is to be placed on the inboard side of the circuit breaker from AC to ACC.

On the schematic install R62, CR53 and VR2 as shown below:

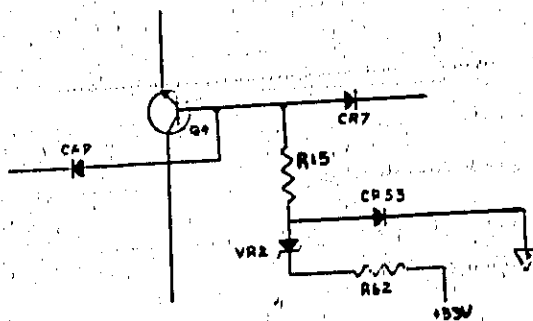

► In the replaceable parts list page 6-10 under chassis Electrical, change fan B, (previously added in change 15) to ball bearing fan HP Part No. 3160-0369.

10-31-01