

このドキュメントについて

このドキュメントは、アジレント・テクノロジー ウェブサイトによって、お客様に製品のサポートをご提供するために公開しております。印刷が判読し難い箇所または古い情報が含まれている場合がございますが、ご容赦いただけますようお願いいたします。今後、新しいコピーが入手できた場合には、アジレント・テクノロジー ウェブサイトに追加して参ります。

本製品のサポートについて

この製品は、既に販売終了またはサポート終了とさせていただいている製品です。弊社サービスセンターでは、この製品の校正は実施できる可能性があります（修理部品が不要な場合など）が、その他のサポートはご提供いたしかねます。誠に恐縮ではございますが、ご理解願います。

なお、この製品に関するその他の情報や、代替製品情報などは、弊社 電子計測 ウェブサイト <http://www.agilent.co.jp/find/tm> にて、できるだけご提供しておりますので、ご利用ください。

訂正のお願い

本文中に「HP」または「YHP」とある語句を、「Agilent」と読み替えてください。また、「横河・ヒューレット・パッカード株式会社」、「日本ヒューレット・パッカード株式会社」とある語句は、それぞれ、「アジレント・テクノロジー株式会社」と読み替えてください。ヒューレット・パッカード社の電子計測、自動計測、半導体製品、ライフライフサイエンスのビジネス部門は、1999年11月に分離独立してアジレント・テクノロジー社となりました。社名変更に伴うお客様の混乱を避けるため、製品番号の前に付されたブランドのみHPからAgilent へと変更しております。（例：旧製品名 HP 8648は、現在 Agilent 8648として販売いたしております。）



Agilent Technologies

Getting Started Guide

HP 54120 Series Digitizing Oscilloscope

Consisting of: HP 54120B
HP 54121A
HP 54122A
HP 54123A
HP 54124A



© Copyright Hewlett-Packard Company 1990

Publication 5090-4309

Printed in the U.S.A. February 1990

Introduction

About this book...

This manual is a quick introduction to the HP 54120 series digitizing oscilloscope family. Our purpose is to get you familiar and productive with this instrument as quickly as possible.

To make this book easier to use, we have put the names of keys (**AUTOSCALE**) in bold.

If you have never used this type of instrument, we think you'll find *Feeling Comfortable with Digitizing Oscilloscopes* valuable reading. We also recommend that you do all the exercises in this manual. If you are an experienced user, refer to the *Front-Panel Operation Reference* for details on the features and functions of your Instrument.

Table of Contents

Introduction

Chapter 1: Getting Reliable Performance from Your Instrument

- 1-1 Electrostatic Discharge (ESD) Precautions
-

Chapter 2: Basic Oscilloscope Measurements

- 2-1 Preparing for a Basic Oscilloscope Measurement
 - 2-7 Making Automatic Measurements
 - 2-10 Making Custom Measurements
 - 2-11 Voltage Markers
 - 2-13 Time Markers
 - 2-14 Review of Basic Oscilloscope Measurements
-

Chapter 3: Statistical Measurements

- 3-1 Preview of Statistical Measurements
- 3-1 Getting a Picture on Screen
- 3-2 Making Jitter Measurements with Time Histograms
- 3-5 Making Noise Measurements with Voltage Histograms
- 3-8 Histograms Review

Table of Contents (Continued)

Chapter 4:

Network Measurements

- 4-1 Preview of Network Measurements
 - 4-2 Reflection Measurements (TDR)
 - 4-2 Making Reflection Measurements (TDR)
 - 4-5 TDR Cursor Measurements
 - 4-7 Making Normalized Reflection Measurements
 - 4-14 Making Transmission Measurements
-

Chapter 5:

What's Next

- 5-1 Where to Go Next
- 5-2 Tips on Handling Your Own Signals
- 5-3 Tips on Triggering
- 5-4 Other Tips
- 5-4 Summary of Electrostatic Discharge Procedures

Getting Reliable Performance from Your Instrument

Electrostatic Discharge (ESD) Precautions

Here are a few precautions you should take to keep an electrostatic discharge (ESD) from damaging your instrument or your test devices.

Note

The trigger and channel inputs were shipped with shorts attached. Always leave these shorts on any input you are not using for a measurement.

Caution

Electrostatic discharge can seriously damage the test set's inputs. To eliminate any electrostatic build up from a cable you're connecting to the test set's front panel, connect a female short to either end of the cable. Touch the short to the test set's frame or to the ground clip on the antistatic mat. This will discharge any electrostatic build up to ground. Remove the female short. Use this procedure for all cables before connecting them to the test set.

- When you open the shipping carton, place the HP 54120B mainframe and the test set to one side on your workbench.
- Take the antistatic mat out of the carton and place it on the bench where you want to locate the instrument.

- Connect the grounding lead from the antistatic mat to an earth ground. (See the illustration below.) Earth ground can be the chassis ground of the instrument or some point on the bench connected to an earth ground.

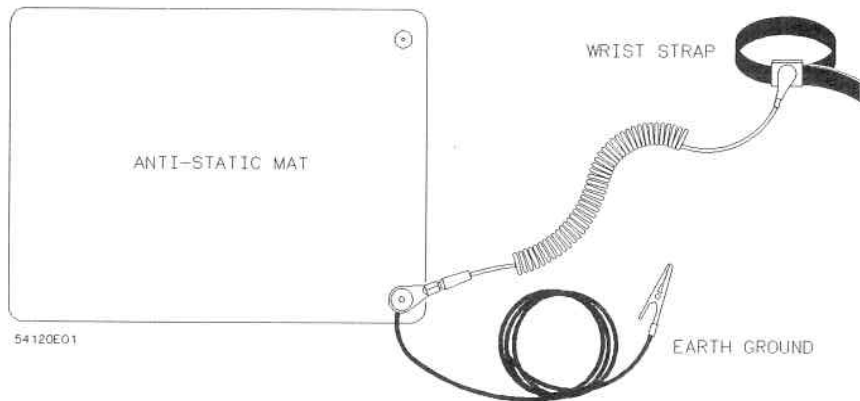

- Connect the wrist strap to the antistatic mat at the same location you connected the grounding lead. This will provide the shortest electrical path to ground for the wrist strap.
- Place the test set on the antistatic mat.
- Use the wrist strap whenever you're using the test set. This precaution will help avoid ESD damage to your instrument and those devices you are testing with the instrument.

Getting Reliable Performance from Your Instrument

- Connect the wide interface cable from the mainframe to the test set. The cable has been designed so there is no way to get the polarity wrong. (See the illustration below.) Make sure the cable between the instruments is connected properly so the mainframe and test set work together.

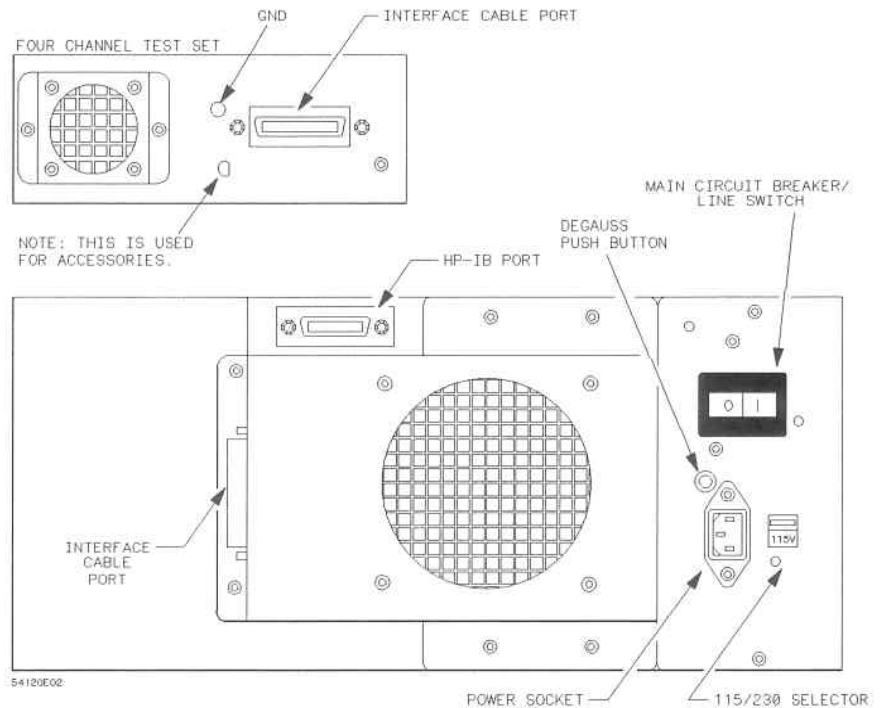

- Make sure the voltage selector switch on the rear of the mainframe is in the proper position, 115 or 230. (See illustration above for the location of the voltage selector switch.) For 100 volt lines use the 115 volt position.
- Check to make sure your power source meets the instrument's specifications. 115/230 VAC - 25% to + 15%, 48 to 66 Hz

Getting Reliable Performance from Your Instrument

- Use the connector savers provided with the instrument to save the channel input connectors from excessive wear.
- If you are going to use a printer or plotter on your instrument you must order the HP-IB cable separately (HP 10833A/B/C/D).

Getting Reliable Performance from Your Instrument

1-4

Preparing for a Basic Oscilloscope Measurement

If you've followed our earlier tips, your instrument is ready to power up and use for measurements. In this chapter you'll learn how to get a signal on screen, adjust the sweep speed, volts/div, and offset to center the signal on screen, and to make measurements on that signal. First let's power up.

1. Turn on the main circuit breaker/line switch at the rear of the instrument.
2. Turn the power switch on the front of the instrument to ON .

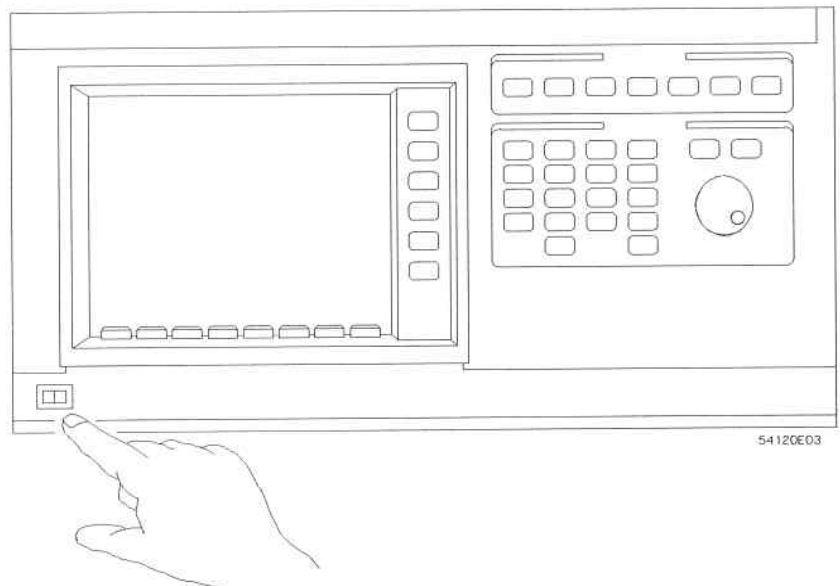

54120E03

The instrument should go through a self-test and be ready for you to learn how to use it. Let's get started by getting a signal on screen. Use a general purpose signal source like an HP 8116A. Here's how.

1. Setup the signal source to generate a pulse 14 ns wide, amplitude 500 mV, offset 0 V, and a frequency of 10 MHz.

Caution



Electrostatic discharge can seriously damage the test set's inputs. To eliminate any electrostatic build up from a cable you're connecting to the test set's front panel, connect a female short to either end of the cable. Touch the short to the test set's frame or to the ground clip on the antistatic mat. This will discharge any electrostatic build up to ground. Remove the female short. Use this procedure for all cables before connecting them to the test set.

2. Connect the equipment as shown below.

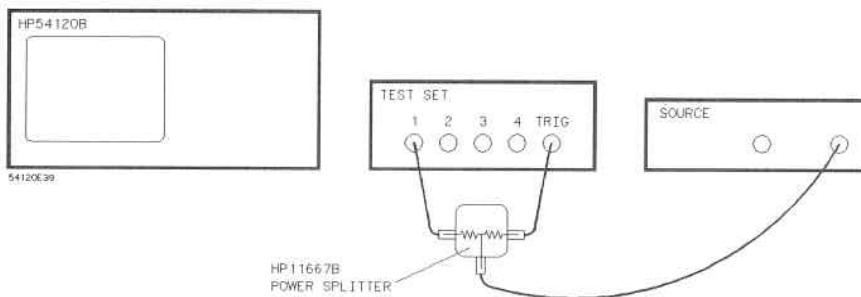

3. Press **AUTOSCALE** on the mainframe.

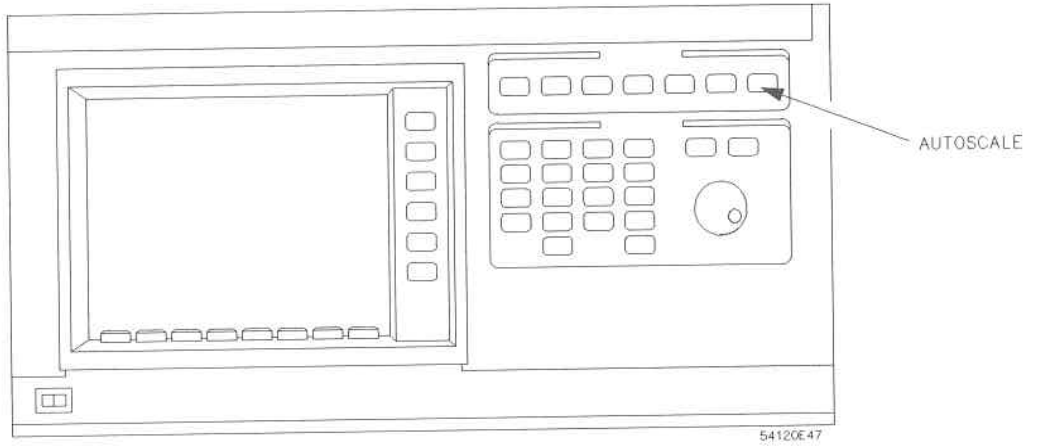

You should now have a signal on screen that looks like this:

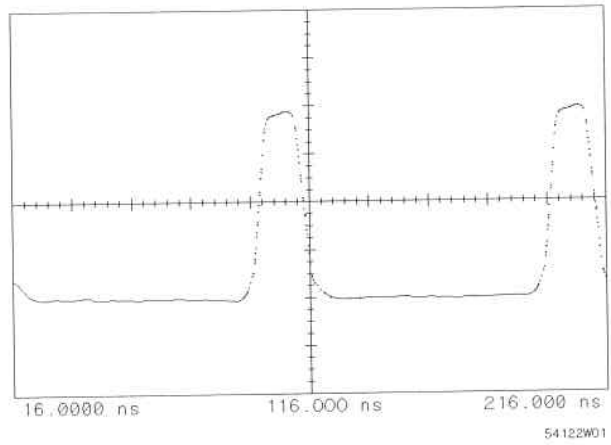

Menu keys are on the bottom of the screen and function keys are on the right side of the screen.

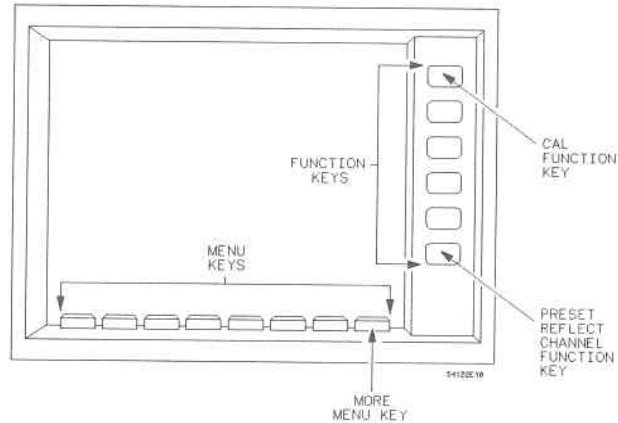

Note 

The following steps, 4 through 7, are only for the HP 54122A test set. If you have a different test set go to step 8.

The HP 54122A test set has built in switchable attenuators of 1:1, 3:1, 10:1, and 30:1 for scaling an input signal.

4. Increase the amplitude of the pulse source from 400 mV to 1 V. Notice the top and bottom portion of the displayed signal moved off the screen.
5. Press the **Channels** menu key.
6. Press the **Internal Atten** function key.

Notice the Internal Atten ratio changed from 1:1 to 30:1 and the displayed signal changed also. This switches the internal attenuators to different ranges. Try pressing the Internal Atten function key several times and see the effect on the displayed signal. You can change the attenuator ranges by either pressing the Internal Atten key or programming over the bus using HP-IB.

7. Change the pulse source back to 400 mV and the **Internal Atten** function key back to 1:1.

Basic Oscilloscope Measurements

Let's expand the signal and move it to the center of the screen where it is easier to work with.

8. Press **Timebase**.

9. Select **Delay/Ref at/Left**.

The sweep speed expands and compresses the display about the delay reference point. The delay reference point can be selected as either the left edge of the screen or center screen and is shown by an arrow at the bottom of the waveform display. By pressing this control a few times, you can see this arrow change position from the left to the center and back again.

Left reference causes the TIME/DIV controls to operate similarly to the TIME/DIV controls of an analog oscilloscope.

Center reference makes it simpler to expand a waveform about an edge for risetime or falltime measurements. When the sweep speed is changed with the TIME/DIV key, the waveform expands about center screen, without requiring interactive adjustments of DELAY and TIME/DIV, as needed in an analog oscilloscope.

For now, let's use Center reference.

10. Press the **TIME/DIV** function key.

The value of the sweep speed is displayed at the top of the screen.

We'll use the $\leftarrow\downarrow$ $\uparrow\rightarrow$ (decrement/increment) keys to change the sweep speed and expand the signal about the center delay reference point.

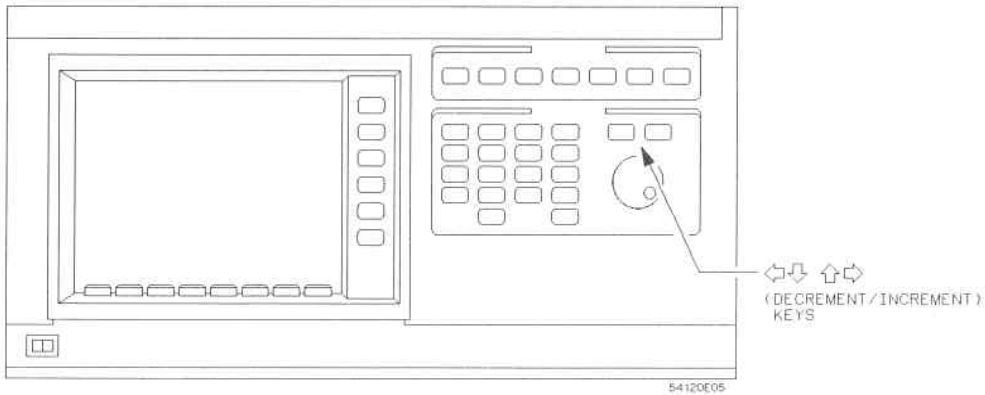

11. Press the $\uparrow\rightarrow$ key two times to obtain a display like that shown in the illustration below:

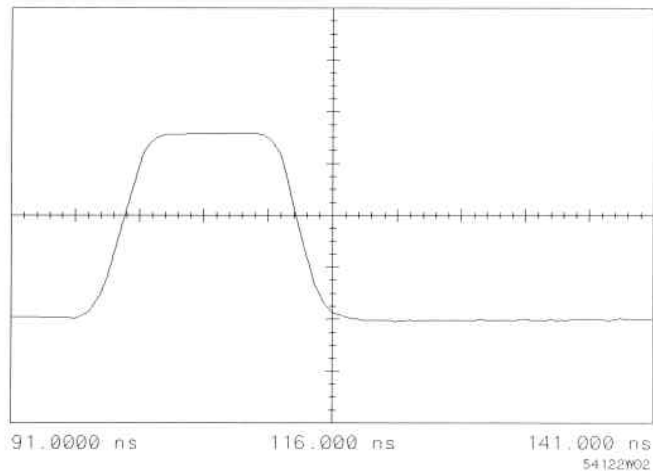

You've changed the sweep speed to increase the time resolution of the display. Now let's make an automatic measurement of the signal.

Basic Oscilloscope Measurements

Making Automatic Measurements

A number of common pulse parameters can be measured automatically.

1. Press **More** on the menu keys so that **Measure** shows.
2. Press **Measure**.
3. Press **More** on the function keys until the **Precision** function key is showing.
4. Press the **Precision** function key until **Coarse** is selected.

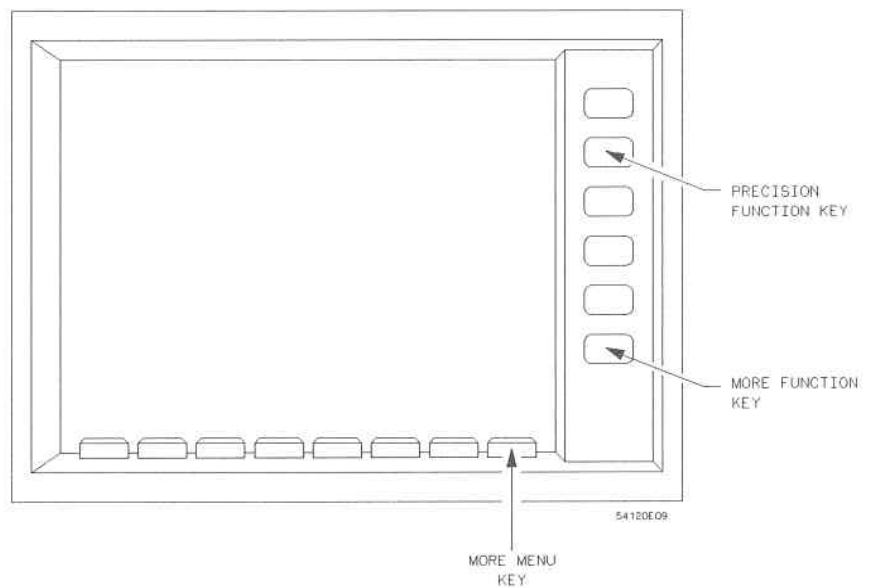

5. Press the **All** function key.

All the characteristics of the signal are shown at the bottom of the screen. Note the values of the measurements. The screen should look like this:

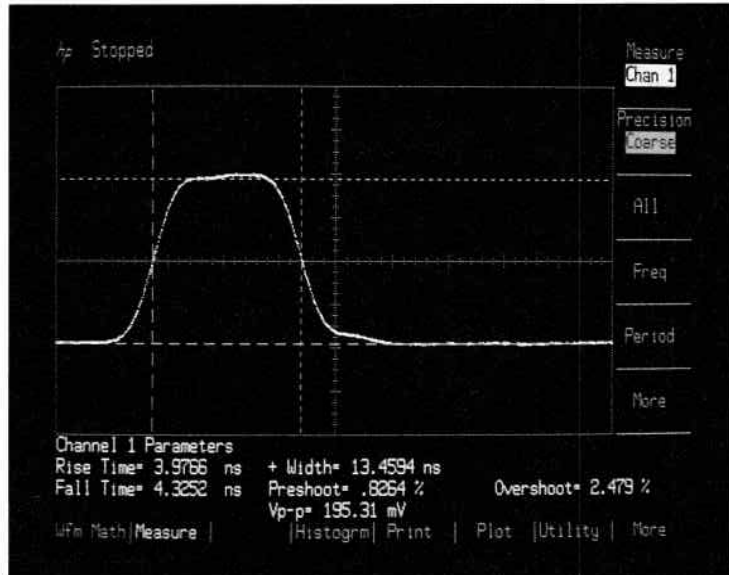

Now let's see what happens when you select Fine precision.

1. Press the **Precision** function key to select **Fine**.
2. Press the **All** function key.

Note that the measurement took a bit longer than it did during the Coarse measurement. The instrument rescales the timebase during the Fine measurement to increase the resolution of the measurement. Use Coarse precision when you need fast measurements. Use Fine precision when you need more resolution.

Basic Oscilloscope Measurements

Now let's examine the rising edge of the waveform in more detail.

1. Press the **More** menu key.
2. Select the **Channels** menu key.
3. Select **Chan 1** with the top function key.
4. Press the **OFFSET** function key. Notice that the value of the offset is shown at the top of the screen.
5. Set Offset to -5 mV with the numeric entry keys.

Press **- , 5 , mV**.

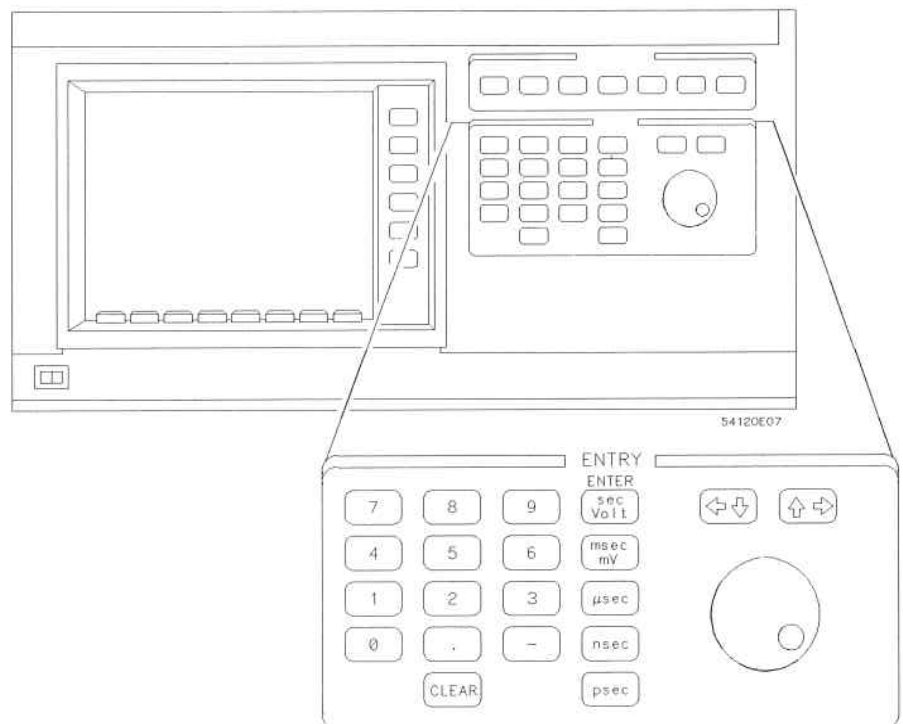

6. Press the **VOLTS/DIV** function key. Note that the value of **VOLTS/DIV**, or vertical sensitivity, is shown at the top of the screen.
7. Set sensitivity to 30 mV/div with the numeric entry keys.

Press **3, 0, mV**.

The change in **VOLTS/DIV** and **OFFSET** should now give you an expanded signal that you can examine and looks like this:

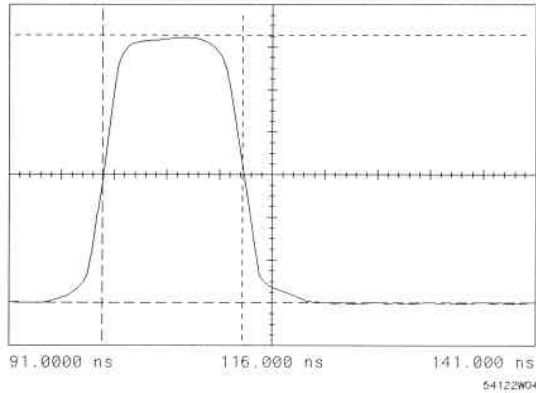

Let's review how to expand the waveform vertically. First, decide which portion of the waveform you want to expand. Second, use **Offset** to place this portion of the waveform at center screen. Last adjust the **VOLTS/DIV** setting until you have the desired resolution.

Making Custom Measurements

We've seen how to make automatic measurements. Now let's expand the timebase about the rising edge and make some custom measurements with the markers.

1. Select **Timebase** from the menu keys.
2. Press the **DELAY** function key.

Basic Oscilloscope Measurements

3. Turn the knob counterclockwise until the rising edge of the signal is centered on the center line of the screen.

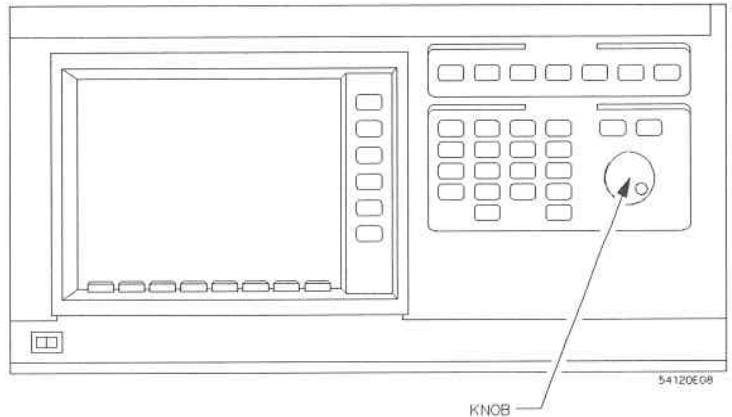

4. Press the **TIME/DIV** function key.
5. Set the sweep speed to 1 ns/div with the knob.

Voltage Markers Now let's use the voltage markers to measure the amplitude of the step.

1. Press the **Delta V** menu key.
2. Turn **V Markers ON** with the top function key.

The V Markers may already be on because of the automatic measurements we did earlier.

3. Press the **MARKER 1/POSITION** function key.

Turn the knob and notice the marker moving up and down. Also notice the readout of V(1) and Delta V at the bottom of the screen. Place the marker at the baseline of the displayed waveform.

4. Press the **MARKER 2/POSITION** function key.

- Turn the knob and notice the second marker moving up and down. Again notice the readout of V(2) and Delta V at the bottom of the screen. Delta V is the difference between the two voltage markers.

Place Marker 2 at the top of the displayed waveform. Read the amplitude of the step as Delta V.

You can also make channel-to-channel voltage measurements and measure the difference between an active channel and a stored waveform in memory, or between two waveforms stored in memory. If another channel or memory is turned on, a selection field in the **MARKER/POSITION/CHAN** function key would show you the channel or memory choices available. Let's try this.

1. Press the **Channels** menu key.
2. Press the top function key until **Channel 2** is selected.
3. Press the **Display** function key to select **ON**.
4. Press the **Delta V** menu key.
5. Press the **Marker 1/Position/Chan** key a few times. Do the same for the **Marker 2/Position/Chan** key. Note the selections available.

Return to the Channels menu and turn off channel 2 for now. Let's see how the oscilloscope can set the voltage markers for you automatically.

1. Return to the **Delta V** menu.
2. Press the **Preset Levels** function key until **0-100%** is selected.
3. Press the **Auto/Level/Set** function key.
This positions the markers automatically to the 0 and 100% levels of the waveform as determined by a voltage histogram of the waveform.

4. Read the amplitude of the step at the bottom of the screen as Delta V.

Let's review the Delta V markers. The Delta V markers can be adjusted manually (by using the **MARKER/POSITION** function key) or set to preset levels of 0-100%, 10-90%, 20-80%, or user-selected variable levels (by using the **Preset Levels** function key). The Delta V markers can be used for single channel measurements or channel-to-channel measurements. The Delta V markers can also be used to make measurements on waveforms stored in memory.

Time Markers

Let's use the time markers to measure the 20-80% risetime of the step. We can make this measurement by first setting the voltage markers at the 20-80% level and then moving the time markers to where the voltage markers intersect the waveform.

1. Press the **Preset Levels** function key until **20-80%** is selected.

Since the 0-100% histogram levels were already determined in step 3 before, we don't need to press **Auto/Level/Set** this time.

2. Press the **Delta t** menu key.

3. Select **T Markers On** with the top function key.

They may already be on because of the automatic measurements we did earlier.

4. Press **START ON/POS EDGE/1**.

This moves the start marker to where voltage marker 1 intersects the first positive edge of the waveform. If you press the key again the start marker will try to move to the first negative edge although the negative edge is off screen right now.

You can also use the knob, the numeric keyboard, or the \leftarrow \downarrow \uparrow \rightarrow keys to enter the number of the edge you want to assign the time markers to.

For now, select **START ON/POS EDGE/1**.

5. Select **STOP ON/POS EDGE/1**.

This moves the stop marker to where voltage marker 2 intersects the first positive edge of the waveform.

6. Read the 20-80% risetime as Delta t at the bottom of the screen.

Note that the start marker is always assigned to voltage marker 1, and the stop marker is always assigned to voltage marker 2.

We've seen that the Delta t markers can be used interactively with the Delta V markers to make measurements like risetime, falltime and propagation delay. The Delta t markers can also be used manually by selecting the **START MARKER** and **STOP MARKER** function keys and using the knob to adjust their position.

Review of Basic Oscilloscope Measurements

We have used the menu keys to select control functions so we can configure the instrument to make various measurements. We have used the knob, keypad, and \leftarrow \downarrow \uparrow \rightarrow keys to enter specific setup information. Finally, we have used the automatic measurements and voltage and time markers to make some example measurements.

Now would be a good time to use this knowledge to get to know the rest of the oscilloscope. Experiment with some of the other menus to change the display from the persistence mode to the average mode to display four channels, or to turn the grid on. You can save waveforms in the Waveform Save menu or subtract waveforms in the Waveform Math menu. The *Front-Panel Operation Reference Manual* supplied with your instrument can help you if you have problems or questions.

After you've experimented a little, come back and we'll move on to making statistical measurements with histograms in chapter 3.

Statistical Measurements

Preview of Statistical Measurements

Statistical measurements are made in the Histogram menu. This is a new measurement capability for oscilloscopes, so a few words of explanation are in order before we proceed with the measurements.

Statistics quantify hard-to-interpret noise and jitter measurements. With histograms, you specify the total number of samples to be taken within a time or voltage window. The oscilloscope then counts the number of samples that occur at each voltage or time interval within the specified window and displays this information as a histogram. Mean and standard deviations of the displayed distributions are available with the push of a button.

Making a histogram measurement is a three-step process. First, the area of interest is defined in the Window submenu. Next, the data is gathered in the Acquire submenu. Finally, the results are analyzed in the Results submenu.



Histograms automatically set the display mode to infinite persistence.

Getting a Picture on Screen

Before making a histogram measurement, we'll need a signal to analyze. Let's use the the same signal from chapter 2: pulse width 14 ns, amplitude 500 mV, offset 0 V, frequency 10 MHz.

Select a VOLTS/DIV of 30 mV, OFFSET of -5 mV, TIME/DIV of 1 ns/div, and adjust DELAY to place the rising edge at center screen. Your display should look like this:

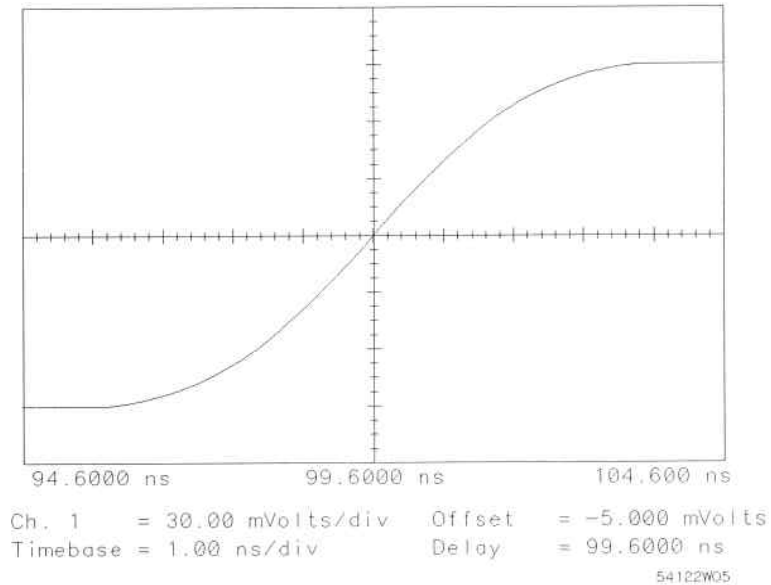

Making Jitter Measurements with Time Histograms

Let's use the Histogram menu to measure the jitter of the waveform.

1. Press the **More** menu key.
2. Press the **Histogram** menu key.
3. Select **Window** with the top function key.
4. Select **Chan 1** by using the **Source** is function key.
5. Select **Time** by using the **Histogram** function key.
6. Press the **WINDOW/MARKER1** function key.

Statistical Measurements

7. Adjust **WINDOW/MARKER1** with the knob so the marker is at the -1.8750 mV level. The voltage of window marker 1 is shown at the bottom of the screen.
8. Press the **WINDOW/MARKER2** function key.
9. Adjust **WINDOW/MARKER2** with the knob so that the marker is at the -7.5000 mV level. Again the voltage of window marker 2 is shown at the bottom of the screen.

Your screen should look like this:

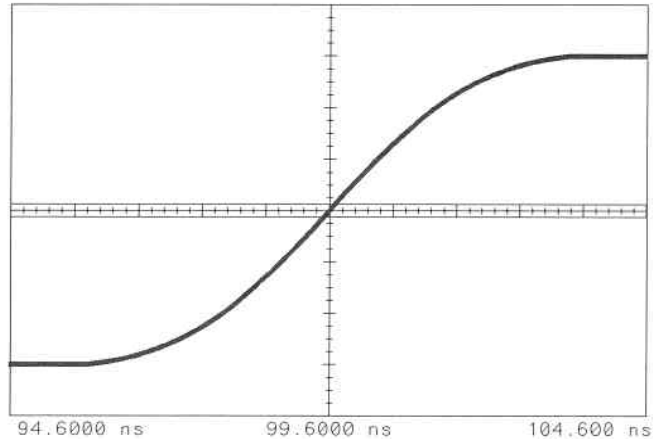

```

Ch. 1      = 30.00 mVolts/div      Offset   = -5.000 mVolts
Timebase = 1.00 ns/div           Delay    = 99.6000 ns
Delta Winda=5.6250 mVolts
Window 1 = -1.8750 mVolts        Window 2 = -7.5000 mVolts
# Samples = 10000
Trigger on External at Pos. Edge at -6.500 mVolts

```

54122W06

For this jitter measurement, you have chosen to make a time histogram and have specified the voltage interval over which you want to gather the data. Now let's choose the number of samples the oscilloscope will collect and start the collection process.

10. Select **Acquire** by using the top function key.

11. Use the numeric entry keys to set 1000 samples.

You must press one of the ENTER keys, Volts, for example, to cause the value you have entered to be used. If you just press the numeric keys without pressing an ENTER key, the instrument will use the value that was previously set.

12. Press the **Start/Acquiring** function key.

Note the "% complete" display in the upper left part of the screen. If it becomes obvious that the collection process will take too long because of the number of samples, you can stop the process by pressing the Stop/Acquiring function key.

And here's what the histogram should look like:

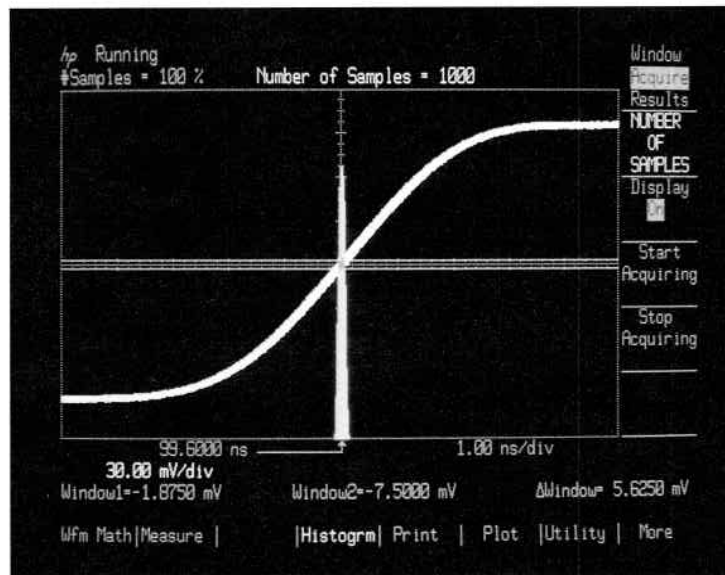

The next step is to examine the histogram displayed in blue for the information it presents.

13. Select **Results** from the top function key.

Statistical Measurements

14. Press the **Mean** function key.

Note the value of the mean displayed at the bottom of the screen. The marker has moved to show the location of the mean.

15. Press the **Sigma** function key.

Note the values of sigma and mean displayed at the bottom of the screen. The markers have moved to show the location of one sigma either side of the mean.

Using a time histogram, you have just quantified the jitter of the signal. You can make the voltage window arbitrarily narrow to approximate the jitter at a given voltage. It takes the oscilloscope longer to acquire the data with a smaller window, however, as fewer samples per unit time fall within the window.

Making Noise Measurements with Voltage Histograms

Now let's make a noise measurement with a voltage histogram.

1. Select the **Window** function from the top function key.
2. Select **Voltage Histogram** with the third function key from top.
3. Press the **WINDOW/MARKER1** function key.
4. Set the marker to the left edge of the screen by using the knob.
5. Press the **WINDOW/MARKER2** function key.
6. Set the marker to the right edge of the screen by using the knob.
7. Select **Acquire** on the top function key.
8. Set 10,020 samples with the numeric entry keys or the knob (remember to press one of the ENTER keys).
9. Press the **Start/Acquiring** function key.

Notice that the acquisition of data is faster in this axis. Here's what your screen should look like:

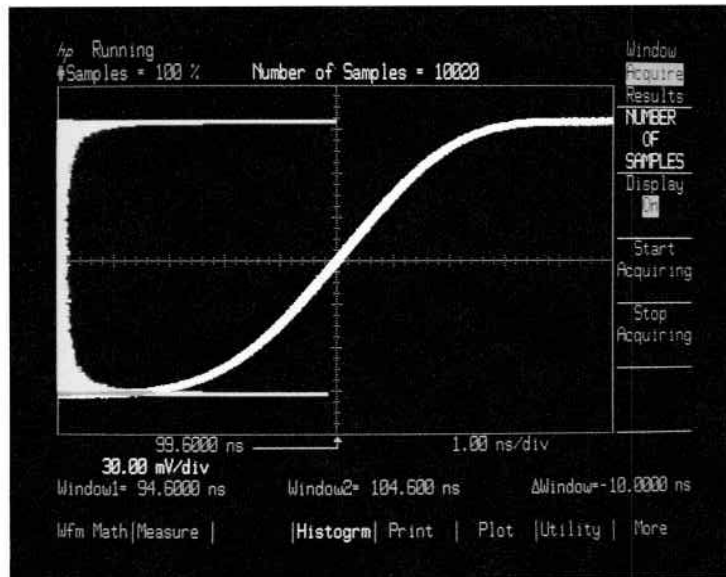

Notice that you have a bi-modal histogram. The flat top of the waveform produced the upper horizontal bar of the histogram because there were many data points at the same voltage level. The same is true of the baseline and the lower bar. Let's determine the mean and sigma values of just the upper portion of this bi-modal distribution.

1. Select **Results** from the top function key.
2. Press the **UPPER/DIST/LIMIT** function key.
3. Set the marker above the top of the upper peak in the histogram by using the knob.
4. Press the **LOWER/DIST/LIMIT** function key.

- Set the marker below the bottom of the upper distribution area by using the knob.

Your screen should look like this:

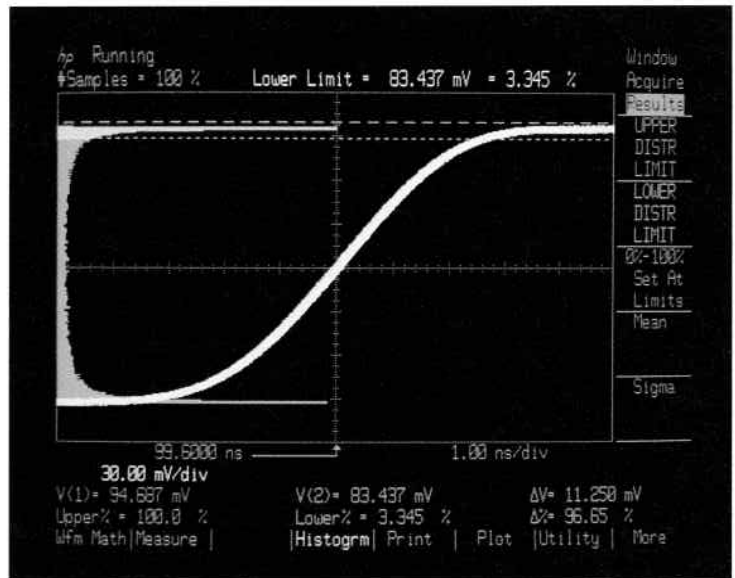

- Press the **0 - 100%/Set At/Limits** function key.

Note the color change on the screen. The highlighted area is the region for which the instrument will compute a mean and sigma.

- Press the **Mean** function key.

Note the marker at the mean and the value shown at the bottom of the screen. This is the mean for the range you have specified with the upper and lower distribution limits.

8. Press the **Sigma** function key.

Note the locations of the markers. Again, they represent one sigma either side of the mean. The values of mean and sigma again appear at the bottom of the screen.

Histograms Review

You've measured jitter by specifying a voltage window and acquiring a time histogram. You've measured noise with a voltage histogram. And you've used the distribution limit markers to partition a distribution so you can look at only a portion of the entire data.

Histograms quantify noise and jitter measurements that have previously depended heavily on operator interpretation. That interpretation is now handled through statistical analysis to give you quantitative, repeatable results.

Additional information on the use of histograms can be found in product note 54120-1 "Histograms and Statistical Analysis of Signals for use with HP 54120T Digitizing Oscilloscope", HP part number 5954-2693

Network Measurements

(Available in Test Sets With TDR Capability)

Preview of Network Measurements

Time domain network analysis (TDNA) includes both time domain reflectometry (TDR) and time domain transmission (TDT) measurements.

TDR involves sending a very fast voltage step down a transmission line and then measuring the reflections from changes in impedance in the transmission line or from the load. The intuitive nature of TDR makes it relatively easy to identify and locate discontinuities in interconnections and transmission lines such as IC packages, PC board traces, and coaxial connectors.

In TDT measurements the oscilloscope applies a fast voltage step to the device under test and measures the output from the device. TDT can be used to measure the gain of a linear amplifier circuit or the propagation delay through a digital gate. TDT normalization shows the response of your device to a mathematically ideal step stimulus.

Reflection Measurements (TDR)

TDR in your test set can be examined at three levels:

1. At a glance, TDR can identify the nature and physical location of a discontinuity. Capacitive, inductive, or impedance changes in discontinuities can be identified intuitively.
2. With the TDR cursor or the automatic maximum and minimum reflection measurements, TDR quantifies reflections and their location in time or distance, measured from a reference plane.
3. With normalization, your instrument's TDR can compensate for imperfect connectors and cables between the test set and the reference plane. Normalization also may be used to adjust the risetime of the measurement. This shows how a transmission path responds to edge speeds similar to actual operating conditions rather than the 35 ps edge provided by the test set.

Let's start by taking a look at some simple TDR responses, the responses to a short, open, and $50\ \Omega$ load. We'll be using an SMA short, male and female; an SMA $50\ \Omega$ termination, male and female; a $50\ \Omega$ SMA cable, male to male; and a 20 dB attenuator. These are supplied with the instrument (except with option 090).

Making Reflection Measurements

You'll now be using the inputs on the test set for the next set of measurements. If you've come back from a break remember to put on the antistatic wrist strap. You don't want to run the risk of damaging the instrument's inputs while you're learning to use it. Develop good antistatic habits now.

The first thing you must do is set up the instrument to make reflection measurements. Because of the kind of measurements you'll be making, we'll want a signal on screen that persists long enough for you to see its characteristics, but not so long as to obscure its activity. Therefore, we'll set the persistence level to 300 ms.

1. Disconnect all input cables from the test set and attach the SMA shorts that were supplied with the test set. It is very important to ensure the SMA shorts are screwed in snugly.
2. Press the **More** menu key.
3. Press the **Display** menu key.
4. Select **Persist** on the top function key.
5. Set persistence to 300 ms with the numeric entry keys or the knob.
6. Press the **More** menu key.
7. Press the **Network** menu key.
8. Select **Cal** on the top function key.
9. Press the **Preset/Reflect/Channel** function key.

The instrument is now properly set up to make reflection measurements. Let's first look at some of the qualitative aspects of the signal you have on screen.

1. Notice the display you have on screen with a short on the TDR output. The step has traveled from the generator to the short and has been reflected back to the source out of phase resulting in the pulse shape.

2. Remove the short from the channel 1 input connector saver. See the following illustration for the location of the channel 1 input.

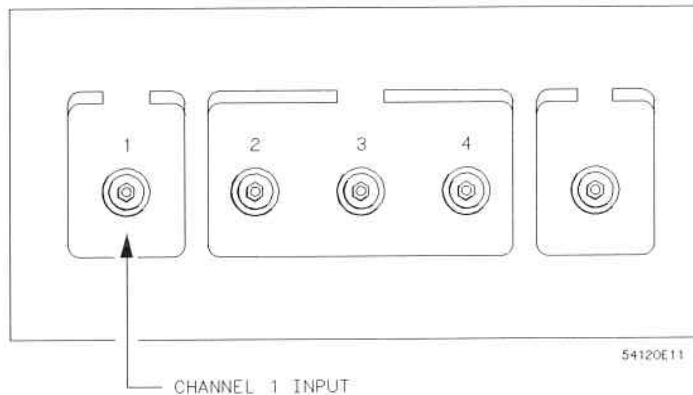

As you remove the short, note that the signal no longer looks like a pulse, but rather has three discrete voltage levels. What you see is the incident step followed by the reflection of an open circuit. The step is reflected in phase back to the source doubling the amplitude.

3. Connect a male 50 Ω load to the channel 1 input connector saver.

Note how the signal now drops from the high level of the open circuit so now we only see a step. This indicates a good impedance match since no energy is reflected back to the source by the load.

The screens you've been looking at will give you some idea of what the incident step, base, and amplitude of a reflected signal look like. The shorted signal has a pulse shape with the signal dropping back to the base level signal. The 50 Ω load signal looks like an infinitely long step, while the open circuit appears as a double amplitude rise.

Notice that the display changed at a point that corresponds to the physical location of the load. Nothing to the left of this point changed, only the waveform to the right of this point shifted. This fact can be used to relate the physical locations of reflections to the displayed waveform.

In the following illustration, the physical layout of a pc trace is related to a TDR display. The impedance of the main part of the trace is about 50Ω . Notice the narrow section of the trace. It is inductive and is related to the peak in the TDR response. Now notice the wide section of the trace. It is capacitive and is related to the valley in the TDR response.

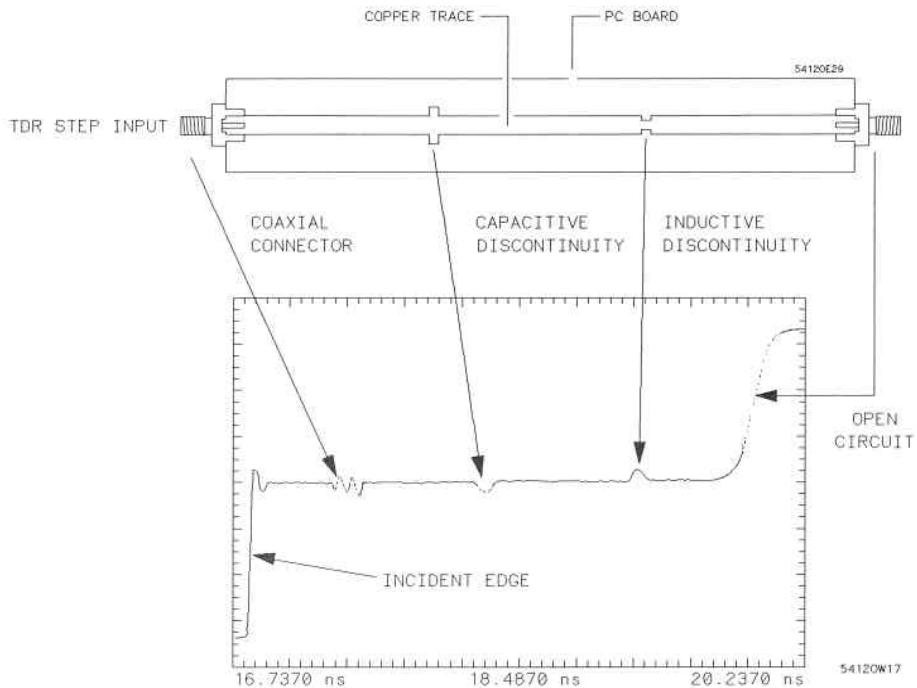

TDR Cursor Measurements

Now let's use the TDR cursor to quantify the displayed information. The TDR cursor requires a calibration to define a reference plane from which all time and distance measurements are made. The calibration also defines the calibration termination to be 50Ω .

1. Press the **Reflect/Cal** function key.

Note the instructions on screen. As you follow them, note that the instrument lets you know what it is doing by displaying its actions in the upper left corner of the screen.

2. Connect a male short to the channel 1 input connector saver.
3. Press the **Reflect/Cal** function key.
4. Remove the short and connect a male 50 Ω load to the channel 1 input connector saver.
5. Press the **Reflect/Cal** function key.

Now the instrument is calibrated, defining the reference plane (distance = 0) to be at the short, and the calibration 50 Ω load to be 50 Ω . The cursor can now be used at any timebase or voltage setting.

For the device under test, we'll use a length of cable that came with your instrument. For distance measurements, you'll first have to enter the dielectric constant or velocity constant of the cable. The Gore cable supplied with the instrument has a relative dielectric constant of 1.4.

1. Select **Dielect** with the **Constant** function key.
2. Set the Dielectric Constant (top of screen) to 1.4 with the numeric entry keys. Use the **sec/Volt** entry key.

Now let's make a distance measurement on a device under test. We'll use the 50 Ω cable supplied with the instrument.

1. Select **Reflect** by using the top function key.
2. Disconnect the 50 Ω load from the channel 1 input connector.

Caution



Electrostatic discharge can seriously damage the test set's inputs. To eliminate any electrostatic build up from a cable you're connecting to the test set's front panel, connect a female short to either end of the cable. Touch the short to the test set's frame or to the ground clip on the antistatic mat. This will discharge any electrostatic build up to ground. Remove the female short. Use this procedure for all cables before connecting them to the test set.

3. Connect the cable to the channel 1 input connector saver.

4. Press the **CURSOR** function key.

Note that an orange cursor appears on the signal trace. Use the knob to move the cursor along the signal. Read the round-trip time and one-way distance from the reference plane in the upper left corner of the screen. You can also read percent reflection and impedance values.

5. Move the cursor to where the distance, in the upper left corner of the screen, reads approximately 300 mm.

The display in the upper left corner of the screen also shows the impedance at this point on the cable.

6. Move the cursor to the reflection from the open circuit at the end of the cable.

You have measured the length of the cable. Again, look at the display in the upper left corner of the screen. Note that it shows the length of the cable in millimeters.

You've calibrated the instrument to identify the reference plane and made distance measurements by using the TDR cursor. These distance measurements were only valid for the dielectric constant that you entered. You also measured the impedance of the cable by using the cursor.

Making Normalized Reflection Measurements

Now let's move on to see how your instrument can normalize a measurement so you can determine the effect of risetime on the reflection properties of the system. Normalization also can be used to remove errors introduced by the test system. In this exercise, we'll look at the reflections of a 20 dB attenuator at the end of a cable. We'll use normalization to see what these reflections would look like if a 35 ps or 100 ps transition were applied.

When making normalized measurements, you typically want more accurate measurements. For greater accuracy, we'll change from the persistence display mode to the averaging display mode.

When deciding how many averages to use, remember that the more averages you specify, the more accurate your measurement will be. Of course, more averages take more time. For this demonstration we'll use 32 averages. The Front-Panel Operation Reference gives a more detailed description of the trade-offs involved in selecting the number of averages.

For this demonstration, you'll again use the shorts and loads supplied in the instrument accessory bag. For more precise measurements, we recommend that you use the shorts and loads in the HP 54007A accessory kit. These components are accurate, low-loss parts, which help you make more accurate network measurements. For example, the APC 3.5 mm connectors in the HP 54007A accessory kit are designed to operate up to 26.5 GHz while the SMA accessories supplied with the instrument are only rated up to 18 GHz.

1. Press the **More** menu key.
2. Press the **Display** menu key.
3. Select **Average** on the top function key.
4. Set averages to 32 with the numeric entry keys.
5. Press the **Bandwidth** function key to select 12.4 GHz (low) bandwidth. This reduces the noise you'll see in the measurement.

Calibrating for Normalization

You'll be doing a calibration now. We'll define the open end of the cable to be the reference plane. This is similar to the calibration you did while learning to use the TDR cursor, but this time we'll access more information from the calibration. We'll access this information through the TDR normalization function keys.

The normalization procedure requires that the calibration be done at the same timebase settings that will be used for measurements. So when calibrating for normalization, you must set up the timebase first. For calibration, the reflection seen when you are using the calibration short (the reference plane) must be on screen.

1. Connect a 20 dB attenuator to the end of the cable.

At the present VOLTS/DIV setting, you probably can't see any mismatch of this load. Let's expand the signal vertically to see the mismatch.

2. Press the **More** menu key.
3. Press the **Channels** menu key.
4. Select **Channel 1** with the top function key.
5. Select **OFFSET** and enter 200 mV.
6. Select **VOLTS/DIV**. Vary the sensitivity until you can clearly examine the mismatch.

Now let's get more time resolution by expanding the timebase.

7. Press the **Timebase** menu key.
8. Press the **TIME/DIV** function key.
9. Set the Sweep Speed to 200 ps with the numeric entry keys.
10. Adjust **DELAY** until the mismatch is about one division from the left edge of the screen (about 22-25 ns).
11. Remove the 20 dB attenuator from the end of the cable.

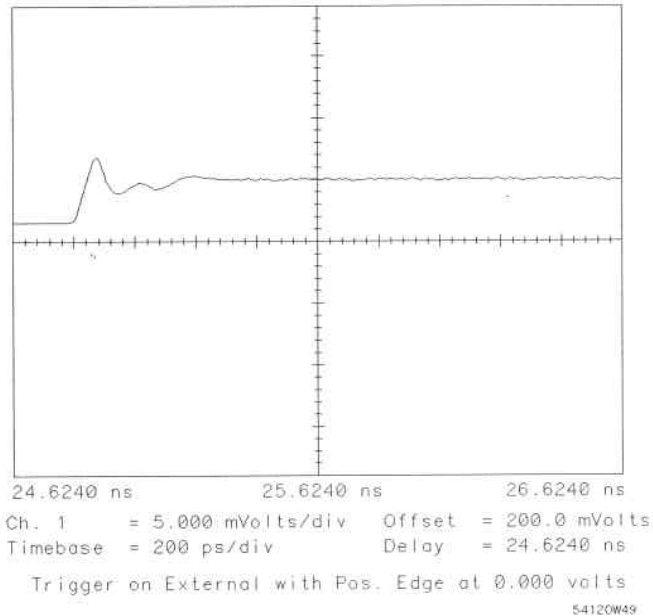

Now that the instrument is set up for the desired time window that will be used in the measurement, we can perform the TDR calibration.

1. Press the **More** menu key.
2. Press the **Network** menu key.
3. Select **Cal** from the top function key.
4. Press the **Reflect Cal** function key and follow the directions as they appear on the display.

We want to define the end of the cable to be the reference plane, so connect the calibration short and the calibration 50 Ω load to the end of the cable as directed.

Notice in the upper left corner that the instrument takes 32 averages of the waveform before doing each calibration; 32 was chosen when you selected 32 averages in the Display menu.

Making a Normalized TDR Measurement

Now let's make a normalized TDR measurement of the 20 dB attenuator.

1. Connect the 20 dB attenuator to the end of the cable.
2. Connect the other end of the 20 dB attenuator to the channel 4 input connector saver.

The impedance of the 20 dB attenuator is $50\ \Omega$ only when it is terminated into $50\ \Omega$. We are just using channel 4's $50\ \Omega$ input to terminate the attenuator.

3. Press the **Clear Display System Control** key.

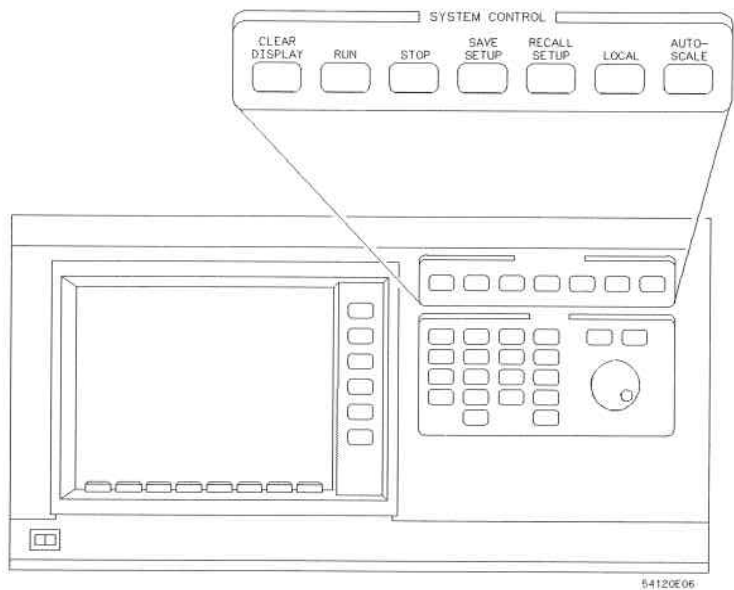

This makes sure that the averaging process starts over so that the average value only includes data taken after you connected the 20 dB attenuator.

4. Select **Reflect** by using the top function key.
5. Select the **NORMALIZED RISETIME** function key.
6. Enter 35 ps on the numeric keyboard.

This 35 ps will normalize the TDR response to the same risetime as the TDR generator. This normalization will correct for the imperfections in cabling and connectors prior to the reference plane, but will not significantly change the risetime of the response.

This entry does not change anything on the live waveform.

7. Press the **Normalize to Mem 1** function key.

This starts the normalization process. When normalization is finished, the results are stored in memory 1 and are displayed in blue.

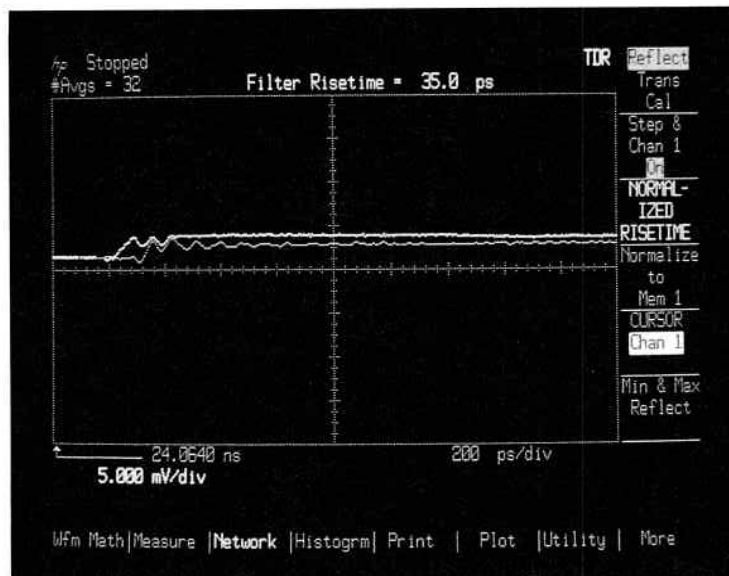

Notice that the stored waveform differs from the live waveform. The effects of all imperfections prior to the reference plane (the cable and SMA connectors) have been normalized to 50Ω , and you see only the reflection caused by the 20 dB attenuator.

But are these reflections significant to your system? GaAs, for example, has a typical transition time of 100 ps. How will the system respond to a 100 ps transition? Let's normalize to a 100 ps risetime and see if the reflections differ.

1. Select the **NORMALIZED RISETIME** function key.
2. Enter 100 ps on the numeric keyboard.
3. Press the **Normalize to Mem 1** function key.

Examine the normalized waveform. Are the reactive peaks and valleys still there or is the reflection mainly just a shift in impedance?

Let's use the cursor to see what other differences there might be between the live waveform and the normalized waveform.

1. Press the **Cursor** function key.
2. Use the knob to measure the impedance of the cable.

Remember, the cable is represented by the leftmost part of the screen.

3. Press the **Cursor** function key to switch the cursor to the normalized waveform in memory 1.
4. Use the knob to measure the impedance of the cable (leftmost part of the screen).

Notice that deviations from 50Ω , prior to the reference plane ($d < 0$) have been corrected by the normalization.

Review of Normalized Reflection Measurements

Normalized measurements are used when accuracy is very important and errors due to interconnections and test cables must be removed.

The averaged display mode improves the accuracy of the calibration and normalization process.

When normalizing, you must use the same timebase settings you use when calibrating, so it's best to set up the timebase with the device under test first. Then calibrate by using a short and 50 Ω termination. We recommend cables, shorts, and 50 Ω terminations with APC-3.5 connectors for best results. These parts are available in the HP 54007A Accessory Kit.

The calibration is only the first part of the normalization process. Next, the normalization risetime is selected, then the response is normalized and the results stored in memory 1. These results may be examined by using the TDR cursor and the automatic percent reflection measurements.

Making Transmission Measurements

Now you'll learn the procedures for making network transmission measurements. Again, the instrument will give you very accurate measurements and will show you the effects of normalized risetimes on the device under test.

To clean up the screen for this next exercise, let's turn off the normalized waveform in memory 1.

1. Press the **More** menu key.
2. Press the **Wfm Save** menu key.
3. Select **WAVEFORM MEMORY 1** by using the top function key.
4. Press the **Display** function key to select **Off**.

Now we're ready to set the instrument up for a transmission measurement.

1. Remove the 20 db attenuator from the cable. Reconnect the cable to the channel 4 input connector saver.
2. Press the **More** menu key.
3. Press the **Timebase** menu key.
4. Select **Left** by using **Delay/Ref** at function key.
5. Press the **TIME/DIV** function key.
6. Set the Sweep Speed to 2 ns/div.
7. Press the **DELAY** function key.
8. Set the Delay to 16.0 ns.
9. Press the **Channels** menu key.
10. Press the **VOLTS/DIV** function key.
11. Set the Sensitivity to 80 mV/div.
12. Press the **More** menu key.
13. Press the **Network** menu key.
14. Select **Trans** with the top function key.
15. Turn channel 4 **On** with the **Step &/Chan 4** function key.
16. Select **Cal** with the top function key.

17. Press the **Trans/Cal** function key and follow the instructions as they appear on the display.

Now you have calibrated the system and are ready to insert a device under test and make some transmission measurements. Calibration removes errors in the measurement introduced by the cable and connectors.

1. Disconnect the cable from the channel 4 input connector saver.
2. Connect a 20 dB attenuator to the end of the cable.

The 20 dB attenuator gives a 10:1 voltage reduction in the signal. We will see what effect the attenuator has on the signal's propagation delay and gain.

3. Connect the attenuator and cable to the channel 4 input connector saver.
4. Press the **CLEAR DISPLAY** System Control key.
5. Select **Trans** on the top function key.
6. Press the **Prop/Delay & Gain** function key, and see the propagation delay (time) and the gain. The distance measurement is calculated using the dielectric constant for the Gore cable.

Before we forget, replace the shorts on the inputs you have used after you have removed the cable and attenuator.

What's Next?

Where to Go Next

Now you're ready to start using the oscilloscope. You've already done most of the procedures for using the instrument in everyday measurements. When you feel the need to learn more — for example to perform a measurement you haven't learned in this guide — refer to the *Front-Panel Operation Reference* provided with your instrument.

If you need programming information, refer to the *Programming Reference Manual*.

Tips on Handling Your Own Signals

- When connecting an unknown signal to the test set inputs, press the **AUTOSCALE** key on the system control panel. For test set's with TDR capability, pressing the autoscale key turns off the TDR step generator.
- The maximum input voltage is listed on the front panel of your test set. For input signals greater than specified for your test set, add external attenuators to the test set's input. If you are adding external attenuators, refer to the *Front-Panel Operation Reference* for information on how to set the voltage scaling properly.
- If you accidentally press the **AUTOSCALE** key during a procedure, you can recover the setup by pressing the **RECALL SETUP** key and then the **AUTOSCALE** key.
- Always put the signal with the lowest frequency on channel 1 for best autoscaling results. The instrument uses the lowest numbered channel with a signal on it to determine the sweep speed.
- In test sets with TDR capability, channel 1 is useful for all signal measurements, not just TDR measurements.

Tips on Triggering

- The instrument will not trigger unless a signal is applied to the trigger input.
- What signal are you going to trigger on? Are you viewing a signal other than the one on which you will trigger?
- Will you trigger on the same signal you will examine? If so, use a power splitter so one part of the signal can go to the trigger input and one part to a channel input.
- When making TDR measurements, disconnect any external trigger from the test set. This will reduce the chances of that trigger signal introducing errors into your measurements.

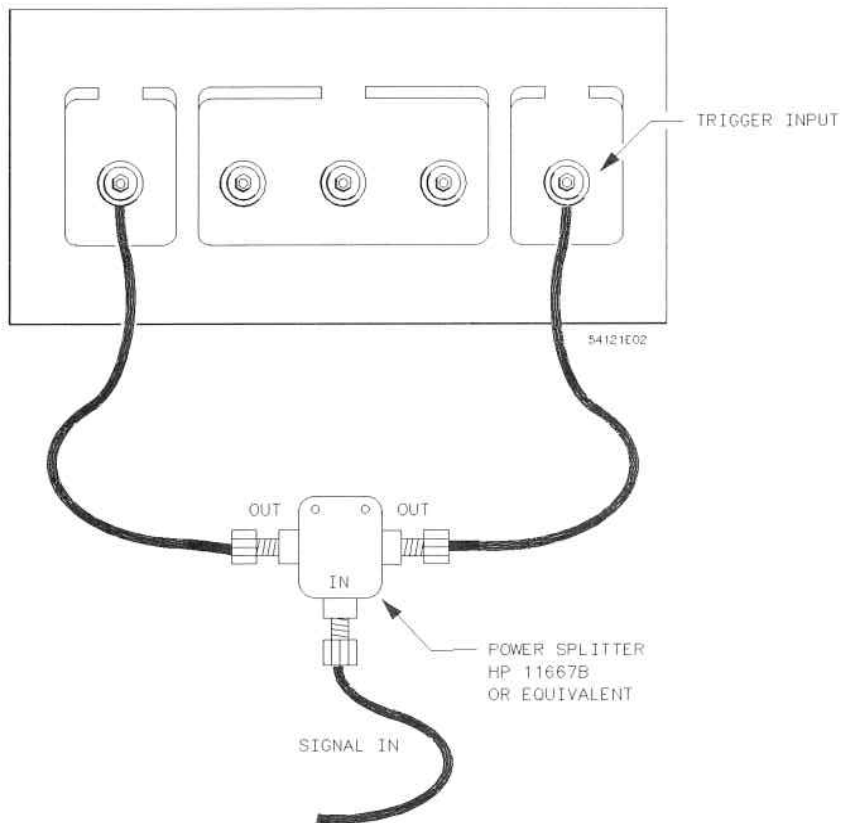

What's Next
5-2

- To see the trigger point on screen, you'll have to provide at least a 16 ns delay to the signal going into a channel input relative to the trigger input signal. The HP 54008A 22 ns Delay Line is used for this purpose.

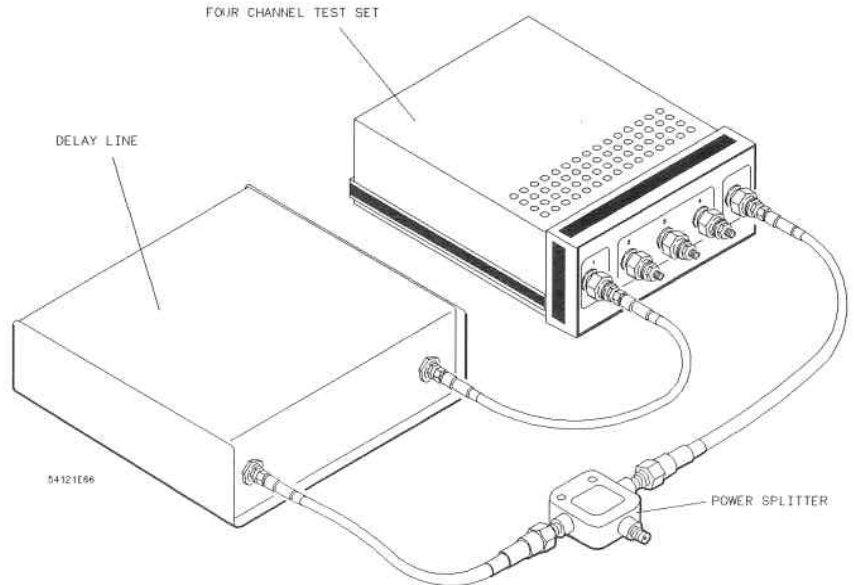

- Will you trigger on a positive or negative edge?

Other Tips

- If you are going to use a printer or plotter on your instrument you must order the HP-IB cable (HP 10833A/B/C/D) separately.
- Use the connector savers provided with the instrument to save the channel input connectors from excessive wear.
- When attaching a connector to the test set, hold the connector in position and turn the hex knob on the test set. This helps make the connection properly and avoids scratching the mating surfaces of the connectors and test ports.
- Read Appendix B of the *Front-Panel Operation Reference* for more information on the proper procedures for care and cleaning of channel and trigger input connectors.

Summary of Electrostatic Discharge Procedures

- Place the test set on the antistatic mat and connect the grounding lead on the antistatic mat to earth ground. Wear the antistatic wrist strap when connecting or disconnecting cables from the channel or trigger inputs.
- Leave the shorts provided with the system on any inputs you are not using.

Caution



Electrostatic discharge can seriously damage the test set's inputs. To eliminate any electrostatic build up from a cable you're connecting to the test set's front panel, connect a female short to either end of the cable. Touch the short to test set's frame or to the ground clip on the antistatic mat. This will discharge any electrostatic build up to ground. Remove the female short. Use this procedure for all cables before connecting them to the test set.

What's Next

5-4



HEWLETT
PACKARD



HP PART NUMBER: 5090-4309

Printed in U.S.A.