

Agilent Reliable Electronic Component Evaluation and Circuit Design with the 4294A 110 MHz Precision Impedance Analyzer

Product Note 4294-1



Introduction

With the trend toward lower power consumption, smaller size and higher performance in electronic equipment, it is crucial to evaluate electronic components and circuits used in electronic equipment. Electronic components such as inductors, capacitors, or resistors behave as ideal components with theoretical impedance characteristics (as mentioned in the basics of circuit

theory) only under certain conditions. The characteristics under other conditions are not ideal due to a variety of causes that are dependent on component structure. If the design of electronic equipment, operating over a wide frequency or signal level range, only includes component characteristics specified under certain conditions, the actual performance might not be as

expected. Component and circuit impedance characterization under actual operating conditions is very important to circuit design. This product note describes how to perform reliable component and circuit evaluation with the 4294A precision impedance analyzer.



Agilent 4294A Profile Review

The 4294A is a modern impedance analyzer, succeeding and expanding the main features of the 4194A impedance/gain-phase analyzer. Note that the 4294A does not have Gain-Phase measurement capability.

(1) Accurate impedance measurement up to 110 MHz

The 4294A enables impedance measurement using the auto-balancing bridge technique over the frequency range 40 Hz to 110 MHz, while the Agilent 4194A covers only to 40 MHz. This advantage permits accurate evaluation of impedance characteristics for a wide variety of electronic devices within a wide frequency range (power line through FM frequencies). Typical devices include capacitors, inductors, resistors, resonators, varactor diodes, dielectric materials (such as ceramic), and electronic circuits such as an amplifier circuit (where input and output impedance characterization is performed)

(2) Variety of analysis functions and interface types

The 4294A graphically displays impedance measurement results. This permits easy analysis of the resonant frequency and impedance values of electronic components using the marker and the line cursor functions. The wide signal-level ranges enable device evaluation under actual operating conditions. The test signal level range is 5 mVrms to 1 Vrms or 200 μ Arms to 20 mArms, and the dc bias range is 0 V to ± 40 V or 0 mA to ± 100 mA. Accurate signal-level dependencies of a Device Under Test (DUT) can be evaluated using the signal-level monitor function. This function can monitor the test signal current and voltage that are actually applied to the DUT.

In particular, dc bias dependency can be easily and accurately evaluated with the dc Bias Auto Level Control function. This function maintains a specified dc voltage or current bias that is applied to, or through a DUT. In addition, the combination of the accumulate mode (to superimpose traces) and the list sweep function permits observation of the change in a DUT's characteristics due to a change in the measurement condition.

The built-in floating power supply enables grounded device measurements with the 42941A impedance probe kit or the 42942A terminal adapter. In particular, the impedance of components mounted on a printed circuit board can be easily measured with the 42941A. The 4194A is a very old impedance analyzer with many weak points in terms of data analysis. For example, since the built-in programming function called the Auto Sequential Programming (ASP) function is unique to this instrument, and since a keyboard cannot be connected, it is very hard to sequentially program for automatic measurement and data analysis. Only two markers are available on the display and the marker movement is very slow, thereby making analysis of data more troublesome. Data manipulation on a PC is also inconvenient because there is no floppy disk.

The 4294A is equipped with a Local Area Network (LAN) interface, an GPIB interface, as well as a floppy disk drive. These standard features simplify data transfer and analysis with a PC. Moreover, measurement and instrument state (setup) data can be stored in the 10 Mbyte built-in non-volatile memory. These ease-of-use features make data analysis more efficient. Versatile and high-speed automatic testing is possible using the list sweep function in conjunction with the limit line function. The list-sweep function provides the ability to enhance test throughput by segmenting the sweep to include only necessary measurement frequencies, while the limit-line function (for Go/No-Go testing) provides the ability to apply test limits within each segment. An 8-bit or a 24-bit interface assists efficient communication with an automatic handler or a switch.

These functions greatly support the quality and performance required to evaluate modern and improved electronic components, equipment and materials.

(3) Abundance of accessories

New Four-Terminal Pair test fixtures are introduced to complement the 4294A with its broad frequency range.

- Agilent 16047E test fixture for leaded components
- Agilent 16034G test fixture for small size SMD components

In addition, the 42942A terminal adapter enables the use of the 7 mm test fixtures.

The 42941A impedance probe kit (1.5 m), which covers 40 Hz to 110 MHz, is available for measurements that require a probe. The probe pitch (or gap) is adjustable from 0.5 mm to 13.5 mm, and can be used to evaluate components and circuits.

The permittivity of a dielectric solid or liquid material can be accurately measured using existing dielectric test fixtures, such as the Agilent 16451B or the Agilent 16452A. Impedance measurement, permittivity calculation, and data analysis can be automatically and efficiently executed using the built-in Instrument BASIC (IBASIC) programming function and/or the GPIB or LAN interface.

The Agilent 16454A magnetic material (7 mm) test fixture (for toroidal cores) can also be used with the 4294A/ 42942A configuration. These various accessories satisfy a wide variety of fixture needs.

(4) Powerful error compensation and correction functions for fixtures and cable extensions

The 4194A cannot perform open/short/load and port extension corrections on a 7 mm fixture. Only 1 m cable extension is available, which is limited to 15 MHz.

The 4294A can perform open/short/load and port extension corrections on the 42942A 7 mm connector. As well, open/short/load compensation can be performed directly on the fixture. Cable extension (for both 1 m and 2 m cables) is available to 110 MHz when using a Four-Terminal Pair lead (either the 16048G or the 16048H).

These powerful functions minimize measurement errors caused by the parasitic impedance of a fixture, or by the electrical length of a port extension. Accurate measurements can be performed using these functions, even where a fixture design is electrically stable, but not perfect.

Table 1. Major specification comparison between the 4294A and the 4194A

	Agilent 4194A	Agilent 4194A with Agilent 41941A	Agilent 4294A
Frequency	100 Hz to 40 MHz	10 kHz to 100 MHz	40 Hz to 110 MHz
Test signal	10 mV to 1 V	10 mV to 1.26 V	5 mV to 1 V
DC bias	0 to 40 V	External (150 V)	0 to 40 V
Number of points	401	401	801
Basic Z accuracy	0.17%	1.50%	0.08%
Cable length	0 m 1 m (up to 15 MHz)	1.5 m (41941A) 3 m (41941B)	0 m 1 m, 2 m 1.5 m (41941A)
Meas. time	3.7ms/pt.	3.7 ms/pt	3.0 ms/pt.
FDD	None	None	2HD (DOS)
Programming	Auto sequence program	Auto sequence program	IBASIC
Interface	GPIB, 8 bit I/O	GPIB, 8 bit I/O	LAN, GPIB, 8 bit I/O, 24 bit I/O
Printer I/F	GPIB	GPIB	Centronics

Electronic Component and Circuit Evaluation

Capacitor evaluation

Different values and types of capacitors are used in applications such as a switching regulator, oscillation circuit, LC filter, etc. With the many different types of capacitors used in a wide variety of applications, it is apparent that a broad set of electrical characteristics determines the performance of these circuits.

Generally, a capacitor consists of the capacitor itself as well as the inductance and resistance of the lead wire or electrode (in series). It is expressed as shown in figure 1.

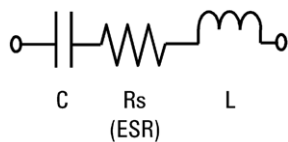

Figure 1. Capacitor equivalent circuit

For most capacitors, within the frequency range below the series resonant frequency, impedance normally decreases as the frequency increases. Series resonance is caused by the interaction of series inductance with series capacitance. Between series resonance and parallel resonance, a capacitor's impedance normally increases with frequency. The normal result is a capacitor that acts as an inductor (in this region). This indicates that the series inductance (L_s) contributes significantly to a capacitor's impedance.

Capacitor evaluation parameters include the capacitance vs. frequency characteristics, resonant frequency, dissipation factor (D), equivalent series resistance (R_s or ESR), and also (in some cases) equivalent series inductance (L_s or ESL).

Even when capacitors have the same nominal value, the characteristics of each capacitor may be different, since electrical characteristics depend on a variety of factors such as the shape, size, dielectric material, withstanding voltage, etc. Therefore, the characteristics should be evaluated under the actual operating conditions (in terms of test signal level, dc bias voltage, frequency, etc.). In particular, capacitors manufactured with a high dielectric constant material exhibit voltage-level dependency as a function of both the applied ac test-signal and the applied dc bias voltage. Evaluation of these dependencies is very important, regardless of the degree of dependency. Figure 2 shows an example in which the impedance vs. frequency characteristic is different between three types of 2.2 μF capacitors (ceramic, film, and tantalum).

The tantalum capacitor characteristic is very different due to its high loss.

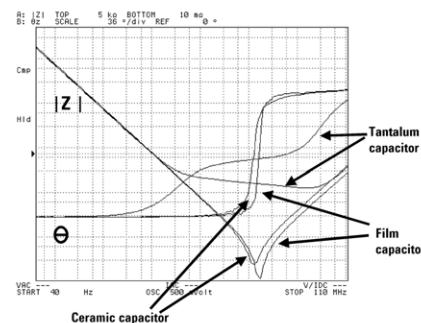

Figure 2. Impedance vs. frequency characteristic

Current problems

The following are some typical capacitor evaluation problems. Since the impedance and capacitance of a capacitor depend on frequency and test signal (voltage), the test-signal level range, swept-frequency range, as well as the accurate impedance measurement range of the instrument must be wide enough to observe these dependency characteristics.

The 4194A, an existing LF impedance analyzer, employs the auto-balancing-bridge technique, enabling accurate measurement, but with frequency limited to 40 MHz. Also, the basic impedance measurement accuracy of 0.17% is becoming insufficient for recently tightening evaluation requirements. In many cases, the 4194A cannot apply the required dc bias voltage to a DUT, since a dc bias automatic level control function is not available. In other words, measurements with dc bias voltage cannot accurately represent the actual operating conditions.

The size of surface-mount capacitors has been getting smaller. In EIA sizes, 0201 (0603 in EIAJ) is currently the smallest standard size. In order to measure such small capacitors, appropriately sized test fixtures as well as functionally adequate measurement instruments are necessary. So far, Agilent has not provided surface-mount device (SMD) test fixtures to meet the small size.

Modern lead-type, as well as surface-mount, capacitors are more often characterized at higher frequencies. However, there have been no Four-Terminal Pair test fixtures at frequencies higher than 40 MHz, because auto-balancing-bridge impedance measurement instruments that operate beyond 40 MHz have not been available.

Solution with the Agilent 4294A

Accurate impedance measurement to 110 MHz

The 4294A designed with the latest technology enables measurements with the auto-balancing-bridge technique as high as 110 MHz. The basic impedance measurement accuracy of 0.08% meets accurate measurement needs. In addition, ESR as low as 10 mΩ can be measured with 10% accuracy (typical). These capabilities are exceptionally improved from that of the existing auto-balancing-bridge technique. It is the best solution for low-loss capacitor evaluation. Figure 3 shows an evaluation example of the capacitance and dissipation factor vs. frequency characteristics of a ceramic capacitor.

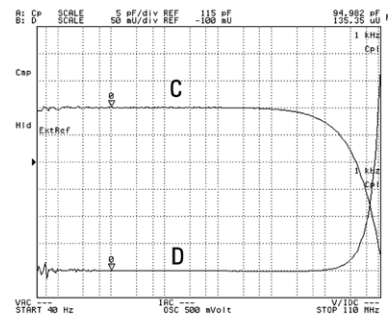
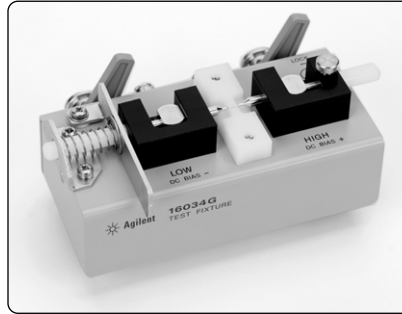

Figure 3. Capacitance and dissipation factor vs. frequency characteristics of a ceramic capacitor

The test signal level range is wide, at 5 mVrms to 1 Vrms. Since the signal-level actually applied to the DUT can be monitored with the monitor function, the Automatic Level Control (ALC) operation is possible when using the IBASIC programming function. The dc bias voltage range is also wide, at 0 V to ±40 V. The dc Bias ALC function is a built-in function, which makes it possible to perform measurements under the actual operating conditions. Figure 4 shows an ac signal-level dependency evaluation example. Figure 5 shows an example of a dc bias level dependency measurement using the dc voltage bias ALC function.

A new Four-Terminal Pair test fixture, the 16034G, can accommodate SMD's as small as 0201 -EIA- (0603-EIAJ-), and can be used to 110 MHz. Also, another new Four-Terminal Pair test fixture, the 16047E, is available for leaded component measurement to 110 MHz



Agilent 16034G

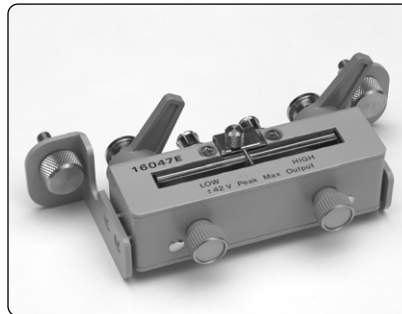

Agilent 16047E

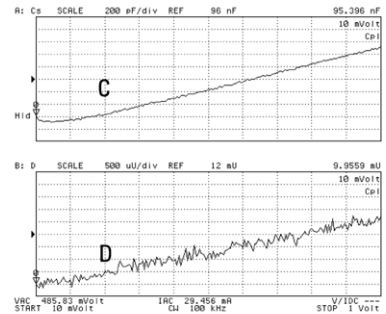

Figure 4. Ac signal level dependency evaluation of a capacitor

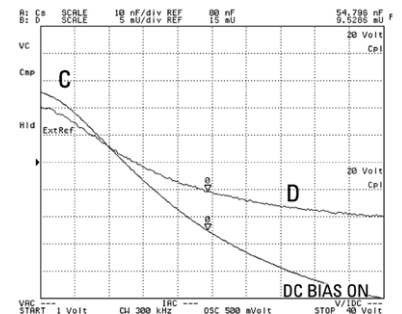

Figure 5. Capacitor dc bias level dependency using the dc voltage bias ALC function

Wide variety of analysis functions

While LCR meters only display measurement parameters of a two-element equivalent circuit, the 4294A is equipped with the equivalent circuit analysis function which permits modeling of a capacitor with a three-element equivalent circuit (see figure 1). This function makes the following analysis possible:

- Extract the parameter of each element of the equivalent circuit from actual measurement data
- Simulate the frequency characteristic with the extracted parameters

The following is an example:
Swept frequency measurement to 110 MHz of a 0.1 μF ceramic capacitor.

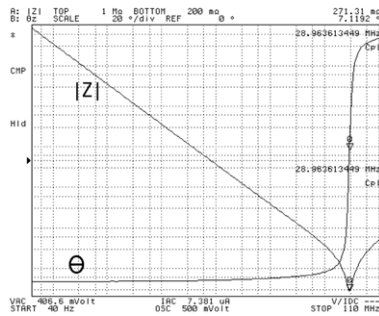

Figure 6. Capacitor measurement result

There are five circuit models available in the equivalent circuit analysis function. The equivalent circuit model D is the three-element circuit model shown in the figure 1. It is a good fit to the characteristics of many ceramic capacitors.

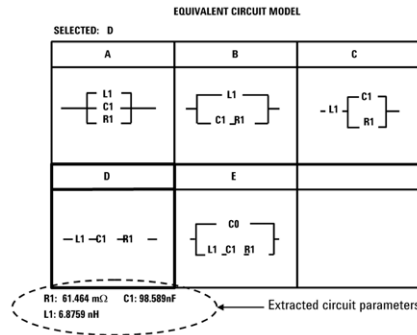

Figure 7. Five equivalent circuit models / circuit parameters approximated with the circuit model D.

The frequency characteristic using these parameters can be simulated and compared with actual measurement data. Figure 8 shows a comparison result, where the simulated data is very close to the actual measurement data.

The ease with which a capacitor can be modeled with an equivalent circuit greatly aids efficient circuit design.

Inductor Evaluation

Inductors are used in many applications such as oscillation circuits and LC filters. To adequately evaluate the characteristics of inductors, many measurement parameters are necessary.

Generally, the impedance of an inductor consists of inductance, resistance of the wire and electrodes, as well as the inter-winding capacitance and any stray capacitance. Many inductors can be expressed with the equivalent circuit model shown in figure 9.

For most inductors, within the frequency range below the self-resonant frequency (SRF also termed parallel resonance), impedance normally increases with frequency. Parallel resonance is caused by the interaction of parallel capacitance with parallel inductance. Between SRF and any secondary resonance, an inductor's impedance normally decreases as frequency increases. The normal result above SRF (and below secondary resonance) is an inductor that acts as a capacitor. This indicates that parallel capacitance (C_p) contributes significantly to an inductor's impedance.

Inductor evaluation parameters include the inductance vs. frequency characteristic, dissipation factor (D), quality factor (Q), dc resistance (DCR), and (in some cases) the parallel capacitance (C_p).

Generally, the inductance of an inductor is a function of core material, the number of turns in the coil (or trace), overall geometry, as well as the applied signal levels (especially current). Highly permeable cores can cause large inductance values in small packages. The impedance of an inductor with a highly permeable core is highly dependent on ac as well as dc current. When large currents flow, the inductance is likely to decrease due to magnetic saturation in the core. The ac or dc current dependency is a very important evaluation parameter. This characteristic significantly effects the actual operating characteristics.

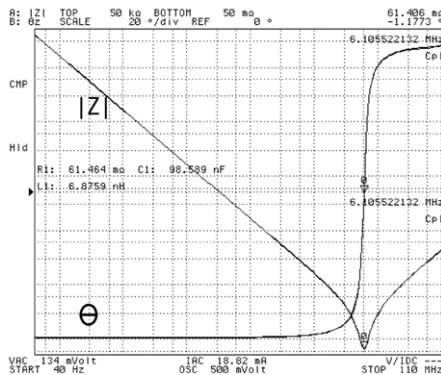

Figure 8. Simulation using the equivalent circuit analysis function

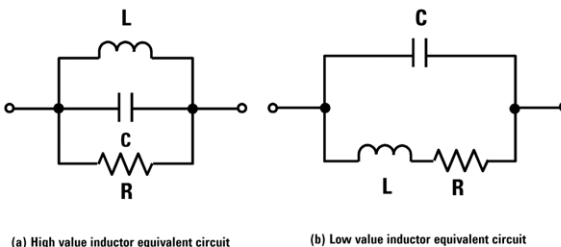

Figure 9. Example of an inductor equivalent circuit model

Current problems

The following are some typical inductor evaluation problems. Since the impedance of an inductor depends on frequency and test signal (current), the test-signal level range, swept-frequency range, as well as the accurate impedance measurement range of the instrument must be wide enough to observe these dependency characteristics.

The 4194A, an existing LF impedance analyzer, employs the auto-balancing-bridge technique, enabling accurate measurement, but with frequency limited to 40 MHz. Also, the basic impedance measurement accuracy of 0.17% is becoming insufficient for recently tightening evaluation requirements. The ac signal level cannot be set using a current value, but only a voltage level. Moreover, the 4194A cannot apply the required dc bias current to a DUT, since the dc current bias

Automatic Level Control (ALC) function is not available. In other words, measurements with dc current bias cannot be made under the actual operating conditions.

The size of surface-mount inductors has been getting smaller. In terms of EIA chip capacitor sizes, 0402 (1005-EIAJ-) is currently the smallest standard size inductor. So far, Agilent has not provided test fixtures to handle such small SMD's. Lead type as well as surface-mount inductors are more often measured at higher frequencies. However, there have been no Four-Terminal Pair test fixtures at frequencies higher than 40 MHz, since no auto-balancing-bridge, impedance measurement instruments have been available that operate beyond 40 MHz. The demand for Four-Terminal Pair fixture designs to accommodate smaller chips (and other devices) at higher frequencies has been increasing.

Solution with the Agilent 4294A

Accurate impedance measurement to 110 MHz

The 4294A, designed with the latest technology, enables measurements with the auto-balancing-bridge technique to 110 MHz, with basic impedance measurement accuracy improved to 0.08%. Typical Q measurement accuracy at Q=300 (at 10 MHz) is 9%, which is exceptionally improved from that with the existing auto-balancing-bridge technique. It is Agilent Technologies's best solution for high Q inductor evaluation. Figure 10 shows an example of the inductance and quality factor (Q) vs. frequency characteristics of an inductor.

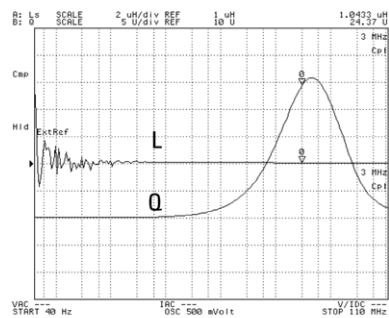

Figure 10. Inductance and quality factor (Q) vs. frequency characteristic of an inductor.

The ac test signal level can be set, using a current value, with a range of 200 μ Arms to 20 mArms. Since the test signal current applied to the DUT can be monitored with the monitor function, an ac signal ALC function is possible using the IBA-SIC programming function. The dc current bias range is from 0 mA to \pm 100 mA. The dc current bias ALC function is built-in, therefore, measurements representative of actual operating conditions can be made. Figure 11 shows the evaluation of ac signal level dependency of an inductor. Figure 12 shows an inductor measurement example with dc current bias dependency using the dc current bias ALC function.

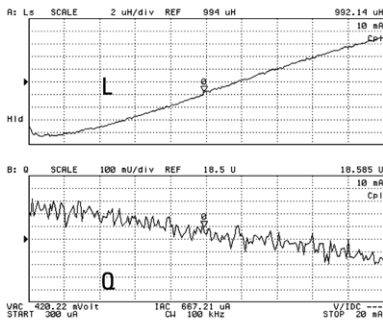

Figure 11. Ac signal level dependency

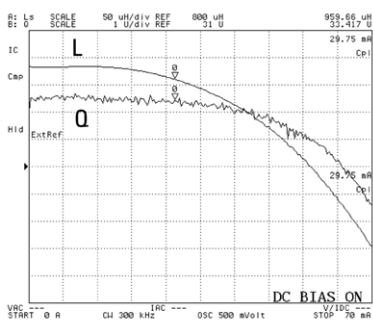

Figure 12. Dc current bias dependency with dc current bias ALC function

A new Four-Terminal Pair test fixture, the 16034G, can accommodate SMD's as small as 0402 -EIA- (1005-EIAJ-), and can be used to 110 MHz. Also, another new Four-Terminal Pair test fixture, the 16047E is available for leaded component measurement to 110 MHz.

Wide variety of analysis functions

While LCR meters use only two-element circuit models, the 4294A is equipped with the equivalent circuit analysis function that enables the modeling of an inductor with a three-element equivalent circuit. This function makes the following analysis possible:

- Extract the parameter of each element of the equivalent circuit from actual measurement data
- Simulate frequency characteristic with the extracted parameters

This is an example:
A swept frequency measurement to 110 MHz of a 1 μ H inductor.

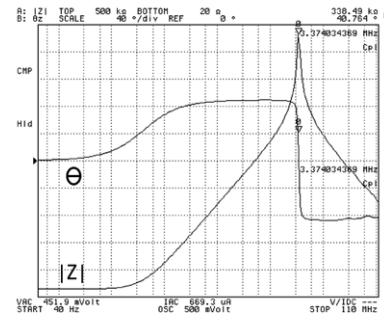

Figure 13. Impedance vs. frequency characteristic of an inductor

The equivalent circuit model B is the three-element circuit model shown in figure 9. It is a good fit to the characteristics of many inductors.

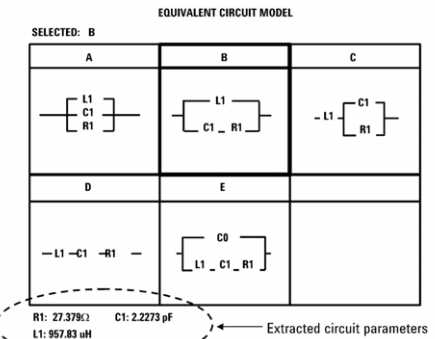

Figure 14. Five equivalent circuit models. / circuit parameters approximated with the circuit model B.

The frequency characteristic using these parameters can be simulated and compared with actual measurement data. Figure 15 shows a comparison result, where the simulated data is very close to the actual measurement data.

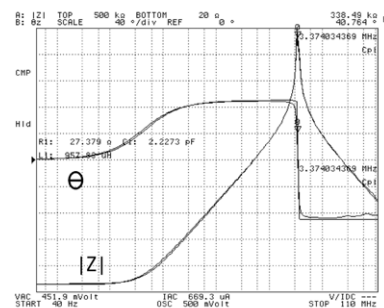

Figure 15. Simulation with the equivalent circuit analysis function

The ease with which an inductor can be modeled with an equivalent circuit greatly aids efficient circuit design.

Resonator Evaluation

Resonators are made of piezoelectric material, for example, an amorphous dielectric (such as ceramic) or a crystal. They are used in an oscillation circuit or a filter in many different applications (office automation equipment, auto-mobiles, etc.). Characteristic evaluation has been getting more important for quality equipment design. A resonator is generally expressed as the equivalent circuit shown in figure 16.

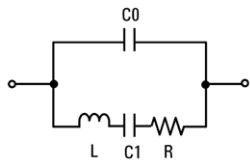

Figure 16. Resonator equivalent circuit resonator evaluation

With the increase of the frequency applied to a resonator, the series resonance (due to the series capacitance C1 and the inductance L1) occurs at a frequency first, then the parallel resonance (anti-resonance) (due to the inductance L1 and the parallel capacitance C0) occurs at a higher frequency. The higher the frequency is, the more overtone resonant characteristics occur.

The main resonator evaluation parameters are the resonant frequency, resonant impedance, anti-resonant frequency, and anti-resonant impedance at the fundamental and over-tone frequencies. In addition spurs are of interest with both crystal and ceramic resonator evaluation, while ripples are measured during ceramic resonator evaluation only. Since resonators are made of piezoelectric material, other required evaluations include the drive (power) level dependency as well as frequency characteristics.

In crystal resonator measurements, the resonant frequency and impedance are basically defined at the points where the phase angle is 0°. Figure 17 shows a typical crystal resonant characteristic including a

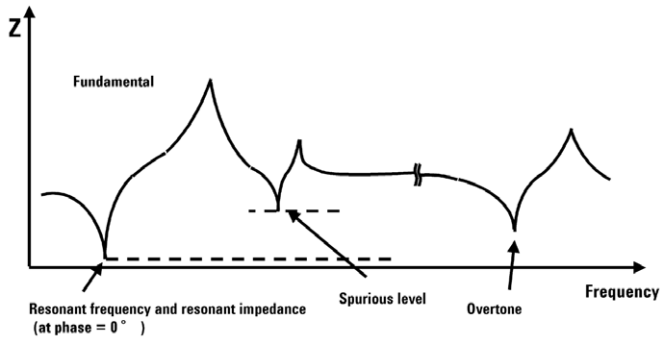

Figure 17. Typical crystal resonant characteristic and evaluation parameters

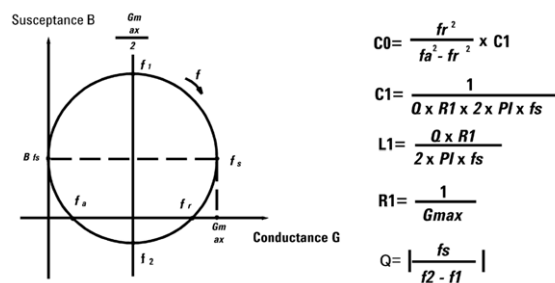

Figure 18. Crystal resonator equivalent circuit analysis using the admittance measurement data

spurious characteristic. The four equivalent circuit parameters of a crystal resonator (shown in the figure 16), as well as the Q value, are calculated from the measurement data using the admittance circle (shown in figure 18). In some cases, the C0 value is defined as the capacitance at a frequency lower than the resonant frequency (typically 90% of the resonant frequency).

The resonant points of a ceramic resonator are basically defined as the maximum and minimum impedance. The impedance vs. frequency characteristic of a ceramic resonator includes ripples (in most cases), because the resonance mode is different from that of a crystal resonator.

The main ceramic resonator evaluation parameters include the resonant frequency (Fmin), anti-resonant frequency (Fmax), resonant impedance (Zmin), anti-resonant impedance (Zmax) and ripples.

Current problems

Recently, resonator evaluation has used mainly network analyzers for testing, with the trend toward higher frequency and more efficient measurement. Network analyzers can make high-speed measurements, however, they do not have as wide an impedance measurement range as an impedance analyzer.

Therefore, network analyzers cannot precisely measure the very high impedance, in particular, of high Q resonators. Note that the anti-resonant impedance of a ceramic resonator is typically greater than 100 k Ω , while those of a crystal resonator are typically greater than several M Ω .

A ceramic resonator loaded by capacitors at both sides (a capacitor-loaded, three-terminal ceramic resonator) is shown in figure 20. This type of resonator permits the reduced size and number of components used in computer peripheral equipment such as CD-ROMs and hard-disk-drives (HDD's), since the load capacitors are also contained in the resonator package. Demand for these smaller, efficient, and flexible devices is growing among many equipment manufacturers. The capacitor-loaded three-terminal ceramic resonator is used for the stable oscillation of a circuit, regardless of temperature variation. The resonator characteristic that can be observed when the resonator is not loaded by the capacitors is the main evaluation parameter. This characteristic must be measured with the load capacitors attached in the circuit. The resonator characteristic can not be directly measured with measurement instruments such as a network analyzer, because the load capacitors shift the phase of the signal. Therefore, a special external circuit is required to avoid changes in input and output voltage. Resonator characteristics can be easily measured with a Four-Terminal Pair impedance analyzer, since the test signal through the load capacitor does not affect the measurement. This is accomplished with the guard effect.

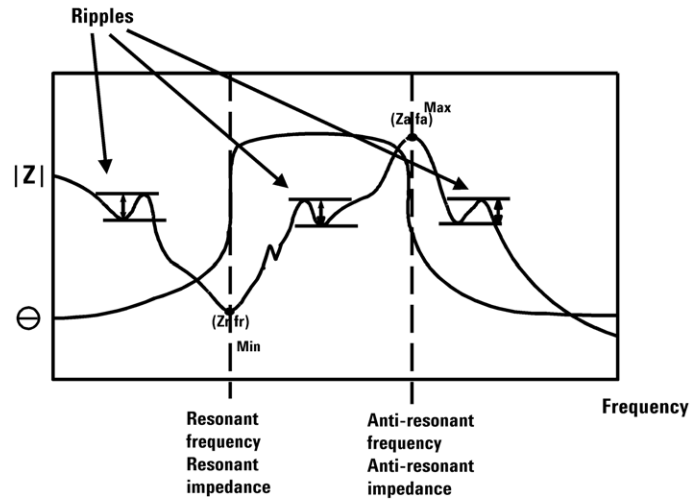

Figure 19. Ceramic resonator frequency characteristic. / main evaluation parameters.

The guard effect can be achieved by connecting the guard terminal of the DUT with that of the measurement instrument. The 4194A cannot meet this measurement requirement due to a few shortcomings. Since test fixtures with built-in guard terminals have not been available, the guard terminal of a DUT and that of the instrument have to be connected with a cable. However, the cable might cause a voltage drop between the terminals, which affects the guard effect. In addition, the frequency limitation of 40 MHz is becoming insufficient for high frequency resonator evaluation requirements.

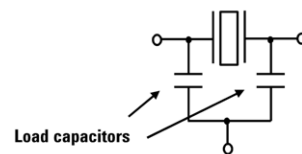

Figure 20. Capacitor-loaded, three-terminal ceramic resonator circuit diagram

Solution with the Agilent 4294A

The 4294A with the latest auto-balancing bridge technique achieves a wide impedance measurement range and accurate measurement to 110 MHz. This meets the current high-frequency measurement requirement for these devices. In addition, it enables accurate measurement of high, anti-resonance impedance while maintaining good repeatability. Accurate measurement of high anti-resonance impedance, with good repeatability, is impossible using a network analyzer. Figure 21 shows the fundamental and overtone resonance characteristics of a crystal resonator, as measured using the 4294A list sweep function.

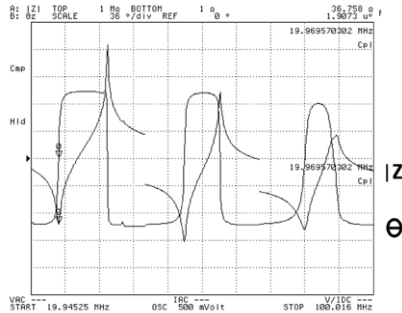

Figure 21. Crystal resonator frequency characteristic

Since the 4294A can display an admittance measurement data trace in polar coordinates (as shown in figure 22), the Q value and equivalent circuit parameters of a crystal resonator can be evaluated. These parameters can be easily extracted with the GPIB command, “EQUC-PARS4” instead of manually calculating these parameters from the measurement data displayed as a circle in the admittance plane. The 4294A list sweep function can

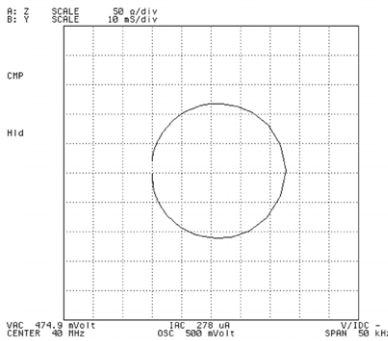

Figure 22. Crystal resonator evaluation using the admittance circle

superimpose data traces within the same frequency range. This permits easy evaluation of drive level characteristics for a crystal resonator (superimpose different values of required test signal levels). Figure 23 shows an example.

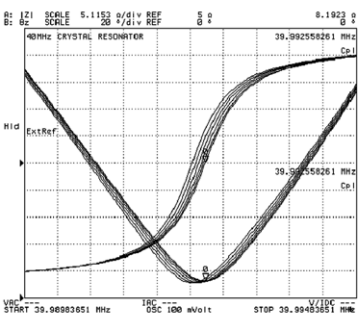

Figure 23. Crystal resonator drive level characteristic

The equivalent circuit parameters of a ceramic resonator are generally approximated with the circuit model E, using the 4294A equivalent circuit analysis function. Figure 24 shows each parameter extracted from a ceramic resonator measurement result using the equivalent circuit analysis function. Figure 25 shows the simulation result with the extracted equivalent circuit parameters.

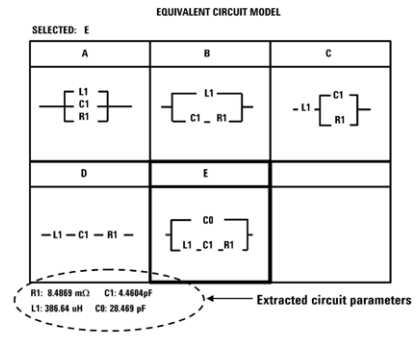

Figure 24. Five equivalent circuit models with each parameter approximated using circuit model E

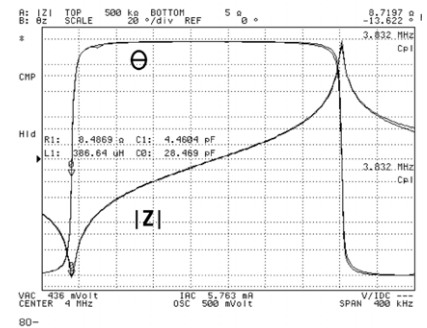

Figure 25. Simulation result using the equivalent circuit analysis function

The evaluation parameters for crystal resonators include the mechanical Q factor (Qm), the capacitance ratio (r), and the figure of merit (M). These parameters are used to evaluate the mechanical resonance quality at the resonant frequency. The extracted equivalent circuit parameters can be used to calculate these evaluation parameters.

These parameters are calculated as follows.

Mechanical Q factor, Qm

$$Q_m = \frac{1}{(2 \times \pi \times F_r \times C_1 \times R_1)}$$

Capacitance ratio, r = C0 / C1

Figure of Merit, M

$$M = \frac{1}{(2 \times \pi \times F_s \times C_0 \times R_1)}$$

For instance, the result given in the figures 24 and 25 are listed as follows.

Fr = 3.832 MHz
 C1 = 4.4604 pF
 C0 = 28.460 pF
 R1 = 8.4869 Ω

These parameters can be calculated from this result as follows.

Qm = 1098
 r = 6.3826
 M = 171.8

In addition, the electromechanical coupling coefficient is also sometimes used for piezoelectric material evaluation. That of a ceramic resonator can be calculated with the following equation:

$$K_t = \sqrt{\frac{\pi}{2} \times \frac{F_r}{F_a} \tan \left(\frac{\pi}{2} \times \frac{(F_a - F_r)}{F_a} \right)}$$

For example, Kt is calculated as 0.402 from the above result, Fr = 3.832 MHz and Fa = 4.122 MHz. These parameters can be automatically calculated using the built-in IBASIC programming function. The test fixture for leaded components, the 16047E, is equipped with a guard terminal near the electrodes. With this configuration, a guard connection between the device and the measurement instrument is not required, even for the capacitor-loaded three-terminal ceramic resonator measurement. The 4294A with the 16047E permits easy and accurate measurement, not only for common resonators, but also for this special type of ceramic resonator.

Varactor Diode Evaluation

Varactor diodes are often used as variable capacitors in radio, television, and an assortment of other electronic tuning circuits. The capacitance value can be controlled as a function of the reverse voltage applied to the PN junction.

Current problems

The main varactor diode evaluation parameters include the linearity of capacitance and quality factor vs. reverse bias voltage characteristics, (C, Q-V characteristics). Although the demand for more accurate evaluation of the C-V or Q-V characteristic has recently been growing, the 4194A dc voltage bias accuracy of $\pm 0.12\%$ may not be accurate enough to precisely set the reverse voltage. GPIB is the only way to download measurement data from the 4194A, and it is inconvenient when documenting the analysis of measurement results on a PC. The Agilent 4279A 1 MHz C-V meter is the dedicated C-V characteristic measurement instrument, and is equipped with an adequately accurate dc bias setting. This is the best solution when the evaluation frequency is 1 MHz; however, it cannot meet the requirement of evaluation at the other frequencies.

Solution with 4294A

The 4294A can set dc voltage bias with 0.1% accuracy, and has a 1 mV resolution for the range of 0 V to ± 40 V. Since the basic measurement accuracy is 0.08%, and the typical Q measurement accuracy is 9% at $Q = 300$ and 10 MHz, precise varactor diode evaluation under necessary conditions can be performed. Figure 26 shows a varactor diode C-V measurement.

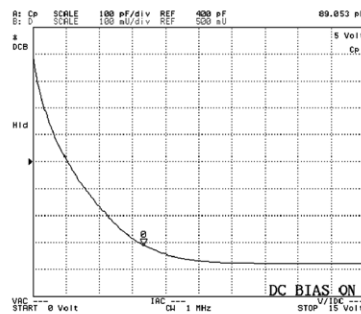

Figure 26. Varactor diode C-V measurement example

The accumulate mode can be used to superimpose data traces on the display. This makes data comparison under different conditions easier. As an example, the Q vs. frequency characteristic measurement data can be compared by specifying a fixed reverse voltage, measuring Q, and then changing the voltage and measuring Q again (repeat if necessary). A measurement example is shown in figure 27.

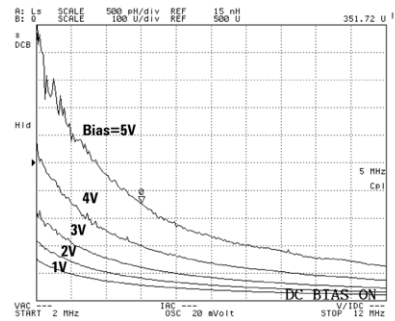

Figure 27. Q vs. frequency characteristics using the accumulate Mode

The displayed measurement result can be saved in the TIFF file format (for graphics) or as ASCII (for data). These files can be stored on a 3.5-inch floppy disk, or it can be transferred to a PC via the built-in LAN or GPIB interface. With these features, information can be easily imported to a document on a PC, such as for technical reports.

Printed Circuit Board Evaluation

Printed circuit boards (PCB's) are used in electronic instruments. PCB evaluation is required when mounting electronic components and maintaining the designed electronic circuit performance. The main PCB evaluation parameters include the permittivity of dielectric material, pattern inductance, and stray capacitance between patterns.

Current problems

The permittivity of dielectric materials used with PCB's is required to be measured around 100 MHz. Since the 4194A and the 16451B supports measurements only to 15 MHz, evaluation with the auto-balancing-bridge technique (which provides the most accurate impedance measurement) has, previously, not been performed under actual operating conditions. Also, in many cases, since the pattern inductance and the stray capacitance between patterns are usually very small, the impedance measurement range of 1 Ω to 1 M Ω , with the existing probe technique (I-V technique), may not be wide enough to measure accurately with good repeatability.

Solution with the Agilent 4294A

Permittivity measurements to 30 MHz can be made with the 4294A using the 16451B and the sample IBASIC permittivity measurement program (included with the 4294A). Figure 28 shows a measurement example. Please refer to application note 1369-1 (P/N 5980-2862EN) for the details of permittivity measurements beyond 30 MHz.

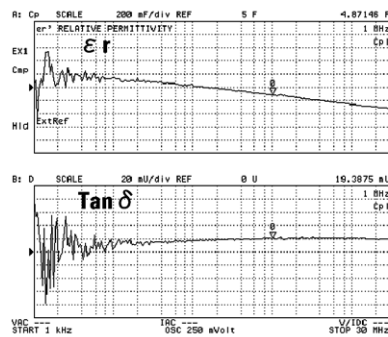

Figure 28. Permittivity measurement of PC board dielectric material used in a PCB with the 4294A and the 16451B

The 4294A used with the 42941A impedance probe kit is the new probe measurement configuration, which covers from 40 Hz to 110 MHz. This configuration greatly expands the impedance measurement range from that of the existing probe configuration (4294A + 42941A=> [100 m Ω to 100 M Ω]). As shown in figure 29, the distance between the 42941A probe pins (pitch) is variable (0.5 mm to 13.5 mm), and the center pin is designed with a spring-loaded (pogo) pin. Very low pattern inductance or stray capacitance between patterns can thereby be measured with good repeatability. Figure 30 shows an actual measurement example of the inductance of a 6mm pattern.

Measurement data can be downloaded to a PC through the built-in LAN or GPIB interface. This enables efficient circuit simulation of PCB mounted electronic components on the PC.

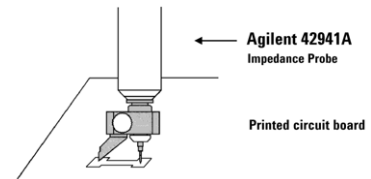

Figure 29. Agilent 42941A impedance probe kit.

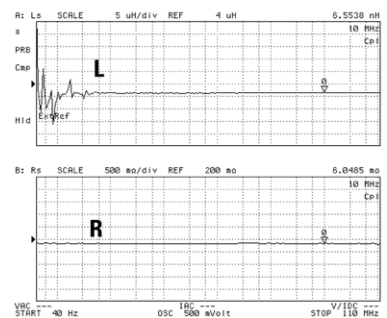

Figure 30. Pattern inductance measurement example

Circuit Input and Output Impedance Evaluation

When an electronic circuit is designed, basic circuit blocks, such as an amplifier or filter circuit, are first designed, and then the whole circuit is assembled. In order to shorten development-cycle time, the characteristics of each circuit block can be evaluated before the circuit is assembled. Input and output impedance evaluation of each circuit block, or component, is very important, since the impedance between these basic circuit blocks should be well understood and matched.

Current problems

Since grounded measurement is essential in the evaluation of circuit impedance, the 4194A with the 41941A impedance probe has mainly been used to evaluate the input and output impedance of grounded circuits to 100 MHz. Grounded impedance measurement is not simple. The impedance range of this configuration is much narrower than that of the auto-balancing-bridge technique (as employed by the 4294A), therefore, accurate measurements cannot be made in most cases

Solution with the 4294A

The 4294A with the 42941A enables grounded circuit impedance measurements from 40 Hz to 110 MHz. Since the impedance measurement accuracy and range have been greatly expanded from that of the existing probe measurement technique, high input impedance or low out-put impedance can be measured more accurately with good repeatability. As shown in figure 29, the 42941A impedance probe kit with variable pitch and the spring-loaded center pin- makes more reliable DUT contacts. Figure 31 shows a measurement example of the input impedance of an amplifier circuit mounted on a PC board.

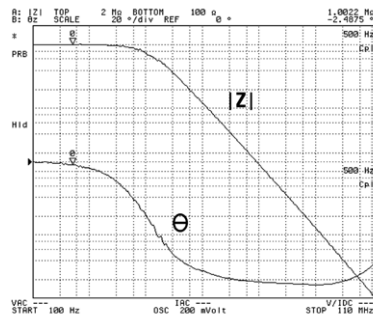

Figure 31. Amplifier input impedance measurement

Conclusion

The 4294A precision impedance analyzer enables both accurate impedance measurements to 110 MHz and reliable electronic component/ circuit evaluation for a wide variety of electronic devices.

Agilent Technologies Test and Measurement Support, Services, and Assistance

Agilent Technologies aims to maximize the value you receive, while minimizing your risk and problems. We strive to ensure that you get the test and measurement capabilities you paid for and obtain the support you need. Our extensive support resources and services can help you choose the right Agilent products for your applications and apply them successfully. Every instrument and system we sell has a global warranty. Support is available for at least five years beyond the production life of the product. Two concepts underlie Agilent's overall support policy: "Our Promise" and "Your Advantage."

Our Promise

Our Promise means your Agilent test and measurement equipment will meet its advertised performance and functionality. When you are choosing new equipment, we will help you with product information, including realistic performance specifications and practical recommendations from experienced test engineers. When you use Agilent equipment, we can verify that it works properly, help with product operation, and provide basic measurement assistance for the use of specified capabilities, at no extra cost upon request. Many self-help tools are available.

Your Advantage

Your Advantage means that Agilent offers a wide range of additional expert test and measurement services, which you can purchase according to your unique technical and business needs. Solve problems efficiently and gain a competitive edge by contracting with us for calibration, extra-cost upgrades, out-of-warranty repairs, and on-site education and training, as well as design, system integration, project management, and other professional engineering services. Experienced Agilent engineers and technicians worldwide can help you maximize your productivity, optimize the return on investment of your Agilent instruments and systems, and obtain dependable measurement accuracy for the life of those products.

By internet, phone, or fax, get assistance with all your test & measurement needs

Online assistance:

www.agilent.com/find/assist

Phone or Fax

United States:
(tel) 1 800 452 4844

Canada:

(tel) 1 877 894 4414
(fax) (905) 282 6495

China:

(tel) 800 810 0189
(fax) 1 0800 650 0121

Europe:

(tel) (31 20) 547 2323
(fax) (31 20) 547 2390

Japan:

(tel) (81) 426 56 7832
(fax) (81) 426 56 7840

Korea:

(tel) (82 2) 2004 5004
(fax) (82 2) 2004 5115

Latin America:

(tel) (305) 269 7500
(fax) (305) 269 7599

Taiwan:

(tel) 080 004 7866
(fax) (886 2) 2545 6723

Other Asia Pacific Countries:

(tel) (65) 375 8100
(fax) (65) 836 0252
Email: tm_asia@agilent.com

Product specifications and descriptions in this document subject to change without notice.

Copyright © 2001 Agilent Technologies
Printed in USA , August 31, 2001
5968-4505E



Agilent Technologies