

Current Drain Analysis Enhances WLAN Network Card Design and Test

Application Note 1468

The trend is clear. Wireless Local Area Networks (WLANs) are quickly supplanting conventional LAN connections. Newer WLAN standards with improved interoperability and greater data rates are rapidly being developed and deployed. Critical to the success of new laptop WLAN network cards is minimizing their current drain. Their high power demand can reduce the battery operating time of their host laptop or notebook PC as much as 50%. Considerable effort is being made on reducing power consumption of WLAN network cards, from further integration at the silicon level to enhanced power management at the Medium Access Control (MAC) layer. These efforts all start with having effective means for measuring and evaluating the current drain of designs in their various operating modes and assessing the impact of subsequent design improvements. Going beyond basic

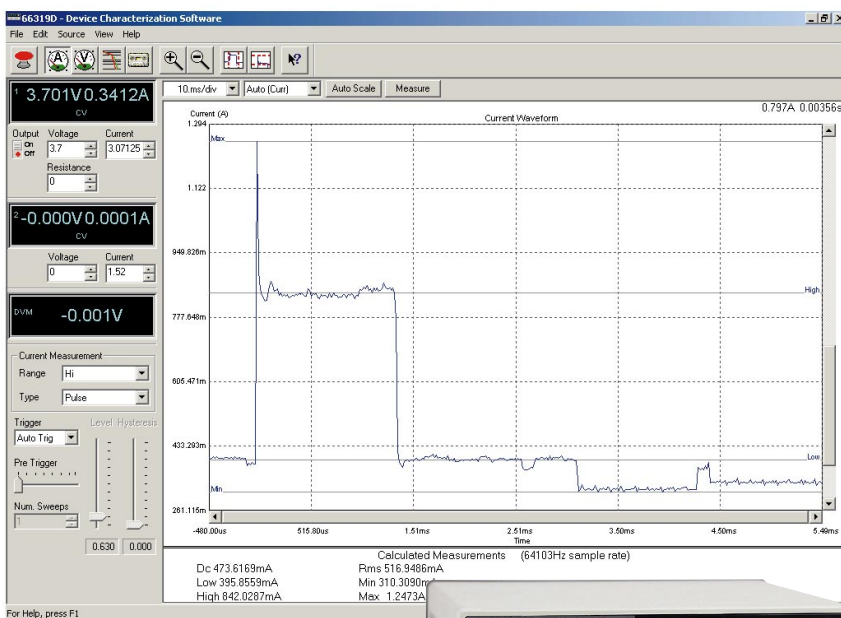

measurements, analyzing the dynamics of the current drain signal provides valuable insight to the WLAN card's behavior and on optimizing its operation. Accurately making these DC and dynamic current measurements can turn out to be quite challenging in practice.



Agilent DC sources and application software simplify measurement and analysis of current drain consumption on WLAN network cards

The Agilent 66319B and 66321B DC Sources have specialized capabilities suited for powering and measuring the current drain on WLAN network cards during test, whether for R&D, design verification, or manufacturing. The Agilent 14565B Device Characterization Software captures, analyzes, and visualizes dynamic current drain activity over long periods, making it ideal for evaluating and optimizing power consumption of WLAN network cards in R&D and verification testing.

This application note demonstrates how these products can be applied to simplify the complex task of accurately measuring and evaluating the current drain of a WLAN network card for its various operating modes, in this case an 802.11a WLAN card.

Key Operating States and Modes for Current Drain Measurements

WLAN network cards typically feature multiple operating states to enhance their performance as a networked device, while still minimizing power consumption.

As a minimum the operating states include:

- 1.Active/transmit state
- 2.Active/receive state
- 3.Sleep state(s)

These operating states each have a specific level of activity with a corresponding level of power consumption. There may be several sleep states having different power levels with corresponding wake up times. The MAC determines the state of operation. The DC current drain for each of these states is a good indicator of correct operation and hence, is useful to measure, whether for R&D, verification, or manufacturing test. These states, however, being under control of the MAC, are not typically directly selectable, making it difficult to measure their respective current drains.

There are various power savings settings that can be selected, such as:

- 1.Power savings-off (always active mode) setting
- 2.Normal power savings-on (doze mode) setting
- 3.Maximum power savings-on (deeper doze mode) setting

The power savings-off setting provides the fastest level of response, as all sub circuits on the WLAN card are always active. Operation switches back and forth between transmit and receive states as needed. Depending on the power savings-on setting selected, the MAC will switch the WLAN card into, and have it spend a portion of its time in a sleep state, periodically switching back to the active states to check for messages. Deeper dose mode shuts more of the card's circuits down and takes longer to wake up again. When awakened, the WLAN card will remain active until it is told it is no longer needed.

The relative amount of time the WLAN card remains in each of its various states depends on the use activity and MAC power management design. Good use models need to account for extremely random use nature. Developing more effective power management

algorithms requires running representative long-term use models while measuring the corresponding current drain for the duration of the trial.

WLAN Network Card Test Set Up

The test set up is depicted in **Figure 1**. A WLAN network card and laptop is referred to as a Station. A commercial PCMCIA extender card provides access to V_{CC} and ground for powering and making current drain measurements on the WLAN card under test, while interfacing it to the Station laptop. An Agilent 66319B DC source is used to directly power the WLAN card, after removing the extender card jumpers to isolate the laptop's PCMCIA V_{CC} output.

Powering the WLAN card directly with the 66319B DC source has some advantages:

- A stable and accurate DC voltage powers the DUT.
- The wide range of DUT drain currents can be accurately measured directly by the DC source for all of the DUT operating modes. As such, an external shunt, which degrades the source voltage's regulation, is not needed.
- It has a built-in high-speed digitizer for acquiring dynamic current drain signals.

When powering the WLAN card directly from an external power supply, PCMCIA hot swap operation has to be considered. This feature

allows PCMCIA I/O cards to be swapped out while the laptop is on. It is important that V_{CC} is present before the digital I/O is engaged to avoid possible damage to a PCMCIA I/O card.

Key to making advanced measurements for visualizing and analyzing the dynamics of the current drain signal is a means for high-speed digitization and subsequent display for short and long periods of time. The Agilent 14565B software in conjunction with the 66319B DC source provides a convenient means for accomplishing this task.

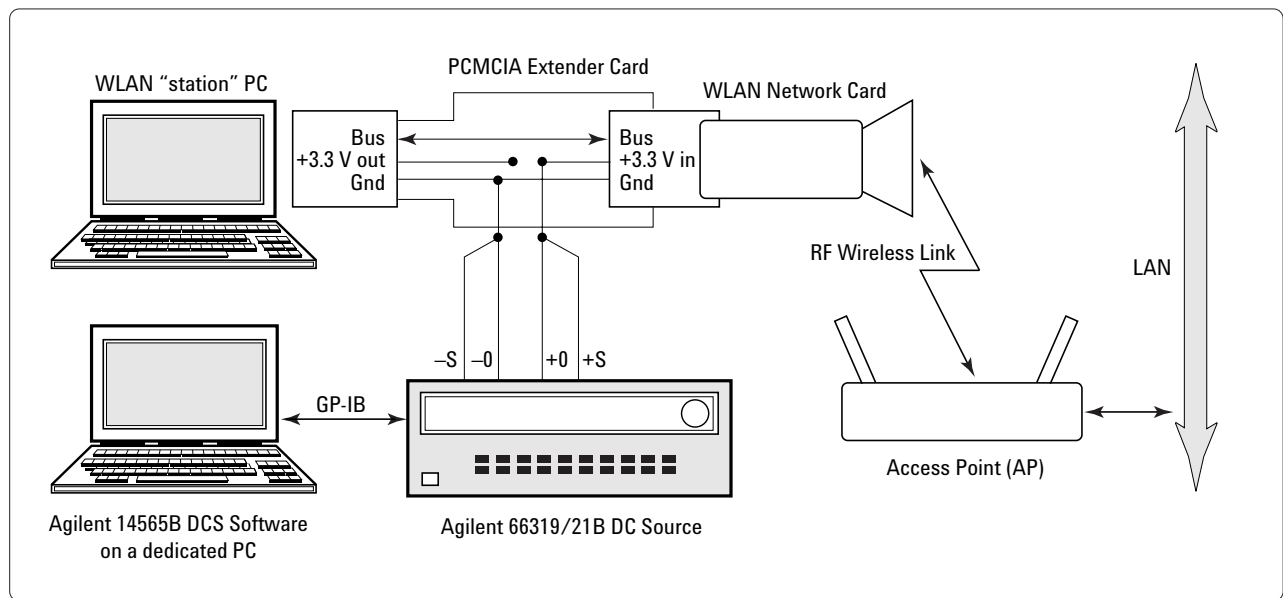

Figure 1. WLAN network card test set up configuration

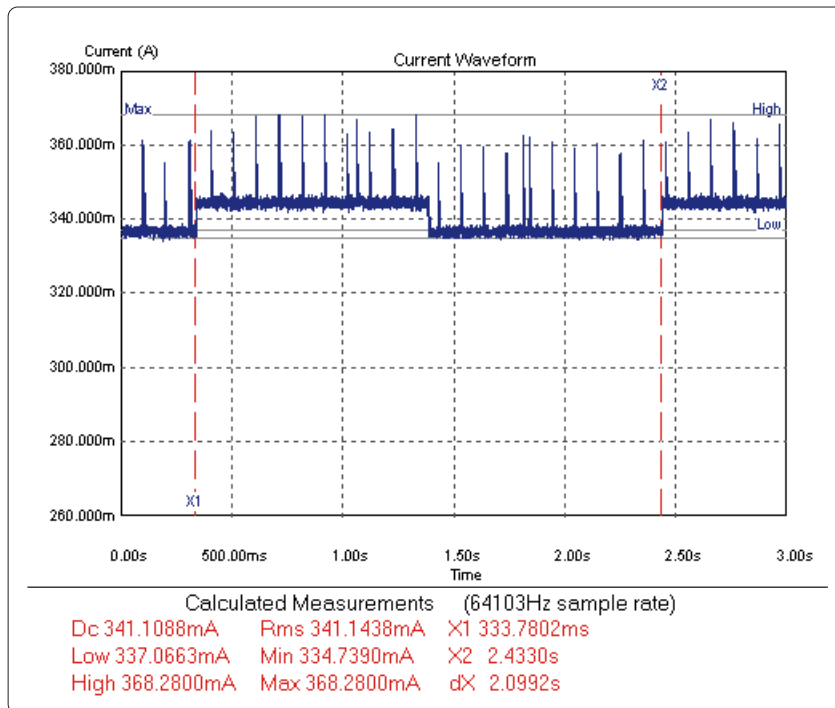

Figure 2. WLAN Card Idle Active Current Drain Waveform Capture

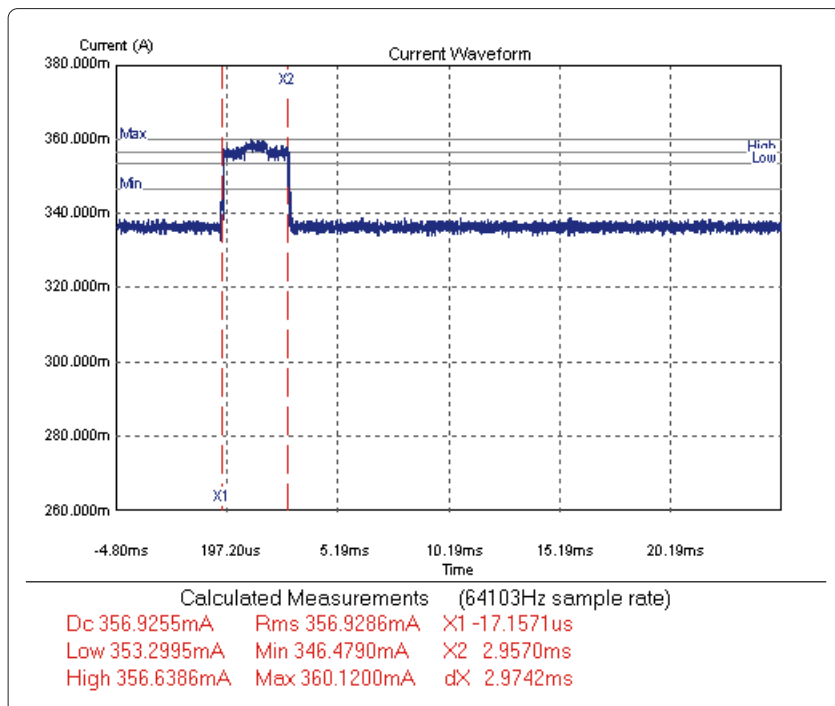

Figure 3. WLAN Card Transmit Beacon Current Drain Pulse

Active Mode Operation and Current Drain Measurement Results

The 14565B software, set to its Waveform Capture Mode, was used to acquire three seconds of the WLAN card's active mode operation current drain, sampled at a high rate, as shown in Figure 2. The WLAN card was communicating to the Access Point (AP) but otherwise idle. Several things become apparent reviewing the signal's dynamic characteristics:

- The active receive current drain level is the 0.5 Hz square wave switching between 336 mA and 345 mA. This pulsing is due to a blinking indicator LED. The receive current drain is found to be 341.1 mA when correctly averaged.
- The pulses riding on top of this current waveform are active transmit bursts related to the RF beacon signal. These pulses occur approximately every 100 msec for this mode of operation.
- An expanded view of a transmit pulse is shown in Figure 3. It is found that the transmit current level is 20 mA greater than the receive level. At 3 msec wide these beacon

transmit pulses are contributing approximately only an additional 0.6 mA to the average current drain. In contrast to this idle activity, when data is being actively uploaded, the data payloads and resulting transmit pulse widths get correspondingly longer.

Making average current-drain measurements or low-speed sampled measurements do not provide this desired level of insight and amount of results. Even the basic values, the receive and transmit current levels, and average current drain, can all be determined by a single signal capture. Beyond this, multiple details and insights on the card's internal activities are now readily observable, as illustrated here.

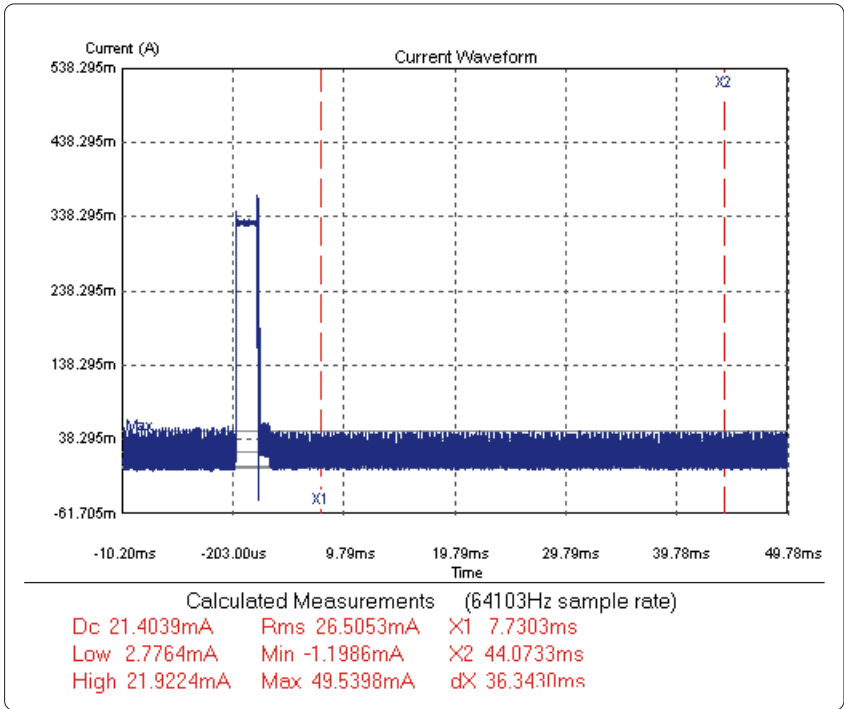

Figure 4. WLAN Card Doze Mode Current Drain Waveform Capture

Doze Mode Operation and Current Drain Measurement Results

When a power savings-on setting is selected and the Station is idle for a sufficient period, it drops into a doze mode. The WLAN card's doze mode current drain waveform is shown in Figure 4. For this example it was found that:

- The average current drain for doze mode is measured to be 22 mA. This low current level greatly extends battery life while in this mode.

- Approximately every 1.024 seconds the Station wakes up and registers with the AP. The resulting 330 mA, 2 msec long transmit current drain pulses contribute an average of approximately 0.6 mA, or 3 % to the doze mode current drain.
- The baseline sleep state current drain is 21.4 mA.

Again, much more insight and amount of results are obtained over other means used to measure current drain. In addition, high peak currents combined

with low average and minimum values demand more measurement accuracy and range of the instrument. The 66319B and 66321B DC sources feature multiple measurement ranges, high accuracy, and low offset error, making them well suited for measuring doze mode current drain.

Running Long-term Trials Validates Power Consumption

Because the power consumption is high when the Station is active, the effectiveness of power savings operation is in large part a function of how well the Station can minimize time spent active, and then drop back to a doze mode for the remaining time. Another factor is using sufficient, but not excessive transmit power. Use patterns are extremely random and vary greatly among users. Also, frequent background activity occurs

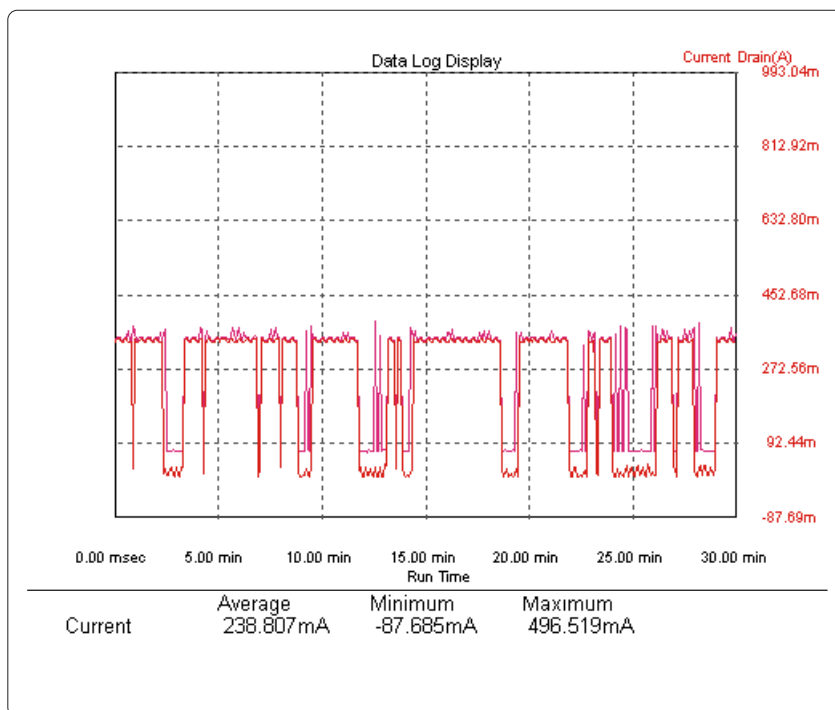

Figure 5. Power Savings-on Long-term Power Consumption Data Log

to address necessary system housekeeping. In practice achieving an effective power savings is a difficult task for WLAN operation. Adequate Station performance and response times are in constant conflict with its power savings.

There is really no substitute for developing good use models that account for the range of user patterns and running actual long-term trials to verify actual performance and power consumption. The effectiveness of the power savings algorithm, as well as any unexpected consequences, becomes apparent.

As a simple illustration, the 14565B software, set to its Data Log Mode, was used to validate long-term power consumption for the Station's three different power savings settings, by running 30-minute trials for each, under mostly idle activity. The resulting data log for the normal power savings-on setting is shown in Figure 5. A 30.9% power savings was realized over the power savings-off setting. Even greater benefit was observed in the maximum power savings-on setting, but at the consequence of poor networking performance due to too slow of a response time.

Statistical Analysis for Optimizing Power Savings Algorithms

The current drain amplitude's relative occurrence distribution (histogram) for long-term operation is useful for evaluating the effectiveness of power savings algorithms. By using the 14565B software, set to its Complimentary Cumulative Distribution Function (CCDF) Mode, differences can be quantified for the WLAN card's power savings-off and -on settings, as shown in **Figure 6**. A CCDF graph is an alternate form of histogram. The key advantage of using a CCDF graph is it gives a concise way to quantify and compare the relative duration at a given amplitude to determine differences between the two trials. A data log alone is not well suited for this task. Here it was determined the normal power savings-on setting allowed the WLAN card to drop into its doze mode 31.5% of the time, providing the 30.9% power consumption savings over the power savings-off setting.

An outcome of this testing suggests it would be more effective to improve the power savings response time, rather than trying to reduce the doze mode current, because in practice the WLAN card was able to drop into doze mode only 31.5% of the time.

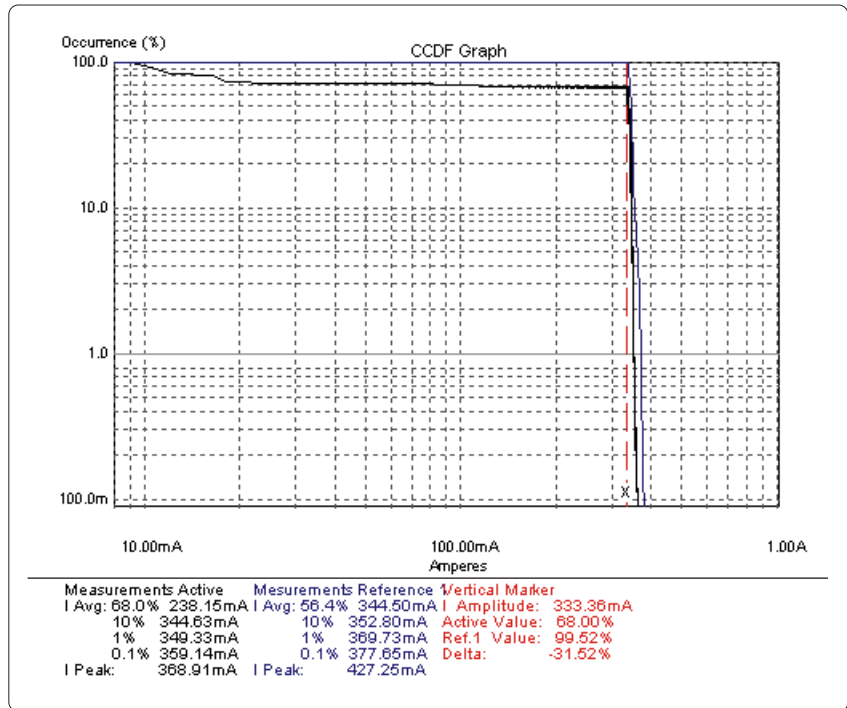

Figure 6. CCDF Analysis Quantifying Power Savings Gains

Summary

Critical to the success of WLAN network cards is minimizing their current drain. As such considerable efforts for reducing power is being made on all aspects of their design. These efforts all start with having an effective means for measuring and evaluating the current drain for their various operating modes and assessing the impact of subsequent design improvements. Going beyond basic measurements, analyzing the dynamics of the current drain signal provides valuable insight to the WLAN card's behavior. Long-term trials with corresponding current measurement are useful for optimizing power savings algorithms.

The Agilent 66319B and 66321B DC Sources have specialized capabilities well suited for powering and measuring the current drain on WLAN cards, including high speed digitizing and multiple measurement ranges. Accurate current drain levels for the WLAN card's receive, transmit, and sleep states are easily measured.

The Agilent 14565B Device Characterization Software captures, analyzes, and visualizes dynamic current drain activity over long periods of operation. Operated in conjunction with running trials simulating actual use makes it ideal for evaluating and optimizing WLAN network card designs and their power management algorithms during development.

 **Agilent Email Updates**

www.agilent.com/find/emailupdates
Get the latest information on the products and applications you select.

 **Agilent Direct**

www.agilent.com/find/quick
Quickly choose and use your test equipment solutions with confidence.

 **Agilent Open**

www.agilent.com/find/open
Agilent Open simplifies the process of connecting and programming test systems to help engineers design, validate and manufacture electronic products. Agilent offers open connectivity for a broad range of system-ready instruments, open industry software, PC-standard I/O and global support, which are combined to more easily integrate test system development.

 is the U.S. registered trademark of the LXI Consortium.

Remove all doubt

Our repair and calibration services will get your equipment back to you, performing like new, when promised. You will get full value out of your Agilent equipment throughout its lifetime. Your equipment will be serviced by Agilent-trained technicians using the latest factory calibration procedures, automated repair diagnostics and genuine parts. You will always have the utmost confidence in your measurements.

Agilent offers a wide range of additional expert test and measurement services for your equipment, including initial start-up assistance onsite education and training, as well as design, system integration, and project management.

For more information on repair and calibration services, go to

www.agilent.com/find/removealldoubt

www.agilent.com

For more information on Agilent Technologies' products, applications or services, please contact your local Agilent office. The complete list is available at:

www.agilent.com/find/contactus

Phone or Fax

United States:

(tel) 800 829 4444
(fax) 800 829 4433

Canada:

(tel) 877 894 4414
(fax) 800 746 4866

China:

(tel) 800 810 0189
(fax) 800 820 2816

Europe:

(tel) 31 20 547 2111

Japan:

(tel) (81) 426 56 7832
(fax) (81) 426 56 7840

Korea:

(tel) (080) 769 0800
(fax) (080) 769 0900

Latin America:

(tel) (305) 269 7500

Taiwan:

(tel) 0800 047 866
(fax) 0800 286 331

Other Asia Pacific Countries:

(tel) (65) 6375 8100
(fax) (65) 6755 0042
Email: tm_ap@agilent.com

Revised: 09/14/06

Product specifications and descriptions in this document subject to change without notice.

© Agilent Technologies, Inc. 2006
Printed in USA, December 14, 2006
5989-0565EN



Agilent Technologies