

HEWLETT-PACKARD JOURNAL

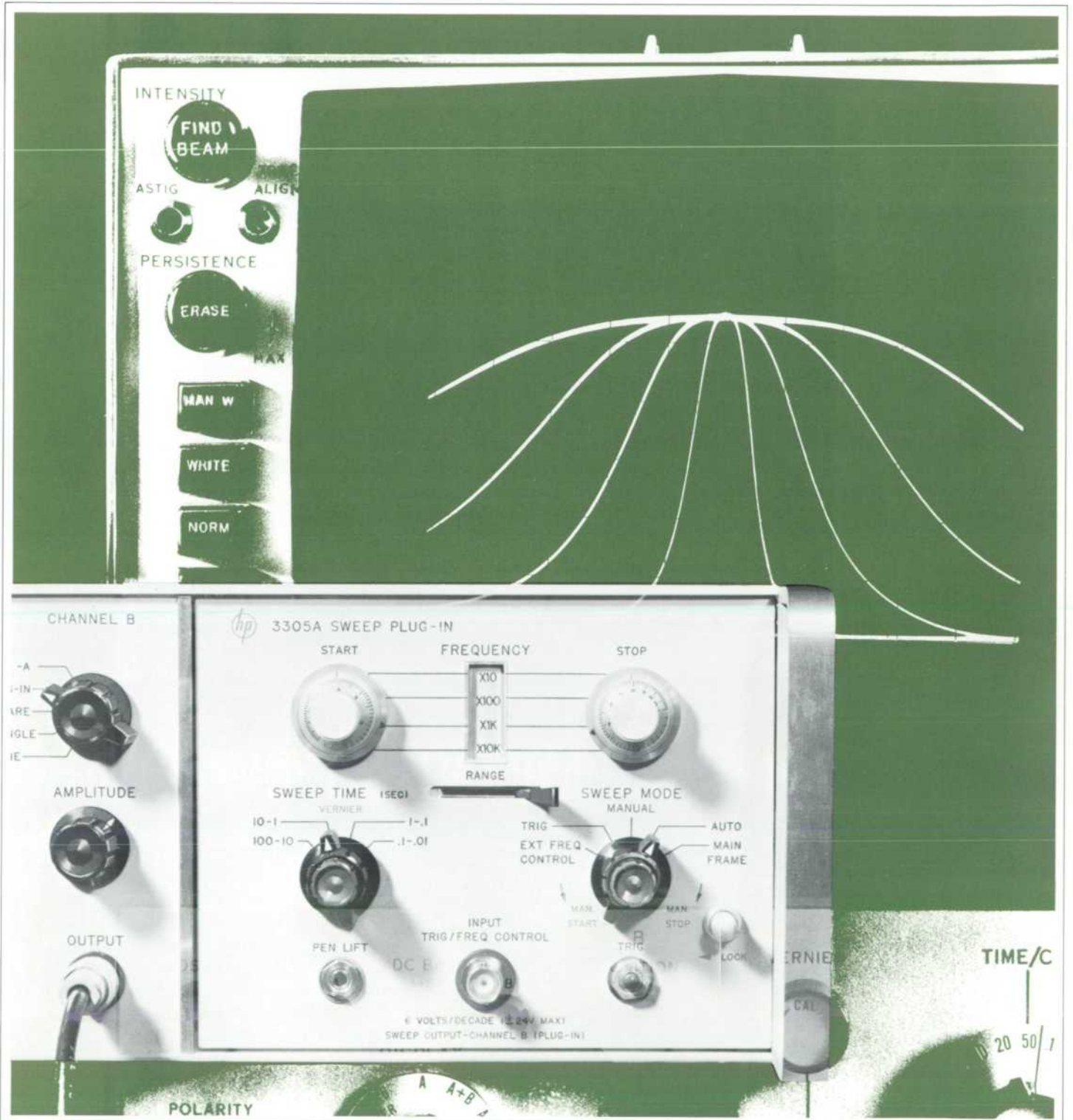

MAY 1968

Sweeping Four Decades at Low Frequencies

Using an interesting current and capacitor switching technique, a new precision sweep plug-in provides broadband logarithmic sweep for testing low-frequency devices.

By William T. Cowan

SWEEP FREQUENCY TECHNIQUES are generally accepted as the most desirable means of testing many low-frequency, broadband devices. Frequency response curves of loudspeakers, filters and servo controls, for example, can be determined more easily, and much more rapidly with sweep frequency techniques. However, low-frequency sweep generators of the desired precision have not been available with accurately calibrated sweeps over more than about a decade of frequency.

In many applications, work is speeded by the ability to see the whole frequency-response curve, over several decades. Adjusting interacting controls is an example. It's valuable to know the frequency response of elements

within the loop, in feedback amplifiers and servo systems, to assure desired performance in the whole system. Response well outside designed system bandpass should be known with precision in these cases, so smooth sweeps up to four decades wide would often find need.

With a new HP Model 3305A Sweep Plug-In (Fig. 1) for the HP Model 3300A Function Generator,¹ it is possible to sweep four decades of frequency. Full frequency range of the instrument is 0.1 Hz to 100 kHz. A single sweep will cover from 0.1 Hz to 1 kHz, or 1 Hz to 10 kHz, or 10 Hz to 100 kHz. Any portion of these fre-

¹Robert L. Dudley, 'A Voltage-Programmable Low-Frequency Function Generator,' *Hewlett-Packard Journal*, Vol. 17, No. 3, Nov. 1965, p. 2.



Fig. 1. Sweep frequencies from 0.1 Hz to 100 kHz, available from the Model 3305 Sweep Plug-In, permit quick and accurate testing of equipment ranging from subaudio through ultrasonic.

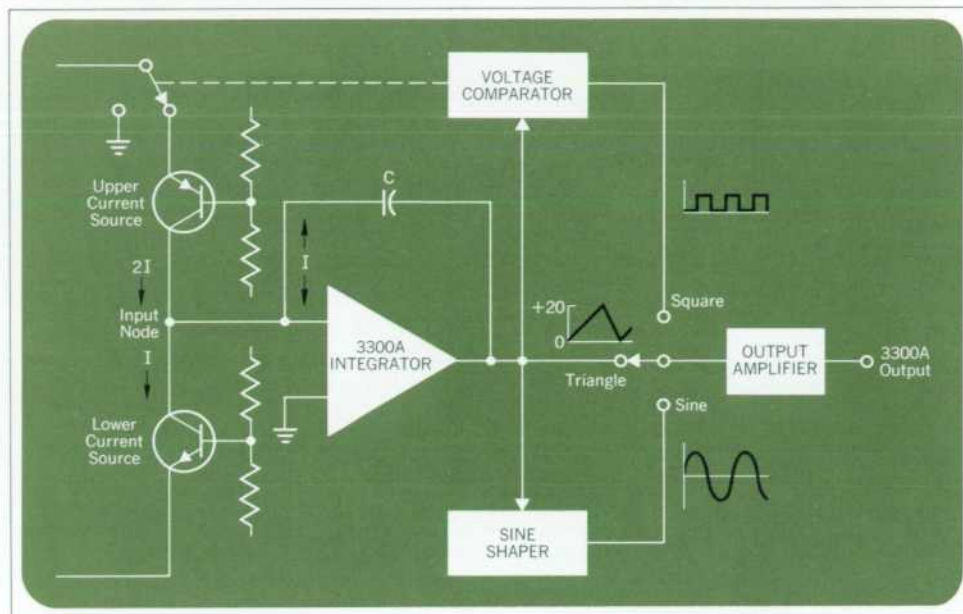

Fig. 2. In the Model 3300A mainframe, the flow of current into and out of the integrator results in the triangle waveform shown at the integrator output. The triangle is converted to a sine wave, and the square wave is a byproduct of the triangle.

frequency ranges may be swept, so that a particularly interesting region on a wideband sweep can be expanded to cover the entire width of the display.

Because the sweep is logarithmic, there is neither a loss of resolution nor crowding of the display at the low frequency end, even on the widest sweeps. Sweep width is set by calibrated front-panel start and stop controls. When resetting sweep width, no readjustment of amplitude is required. Sweep output voltage is independent of frequency, unaffected by sweep time or width.

Sweep times are continuously adjustable from 0.01 to 100 seconds. The slower speeds are for use with X-Y recorders. Pen lift is provided on the two lower ranges of sweep speed. Within any band selected by setting the start and stop settings, one may manually explore response with a single-turn potentiometer. At any point, the precise frequency may be determined with a counter.

Mainframe Operation

Basically, the HP Model 3305A produces a controlling current for the circuit of the Model 3300A. The precision with which this current is generated, and the manner in which it is used are the keys to the ability of the instrument to generate an accurate, wideband sweep.

As shown in Fig. 2, the Model 3300A when used as a function generator, requires that a current, I , be taken from the lower current source continuously, and at the same time a current $2I$ must be supplied for 50 percent of the time (zero current for the other 50 percent) to the

upper current source. Thus, the integrator is supplied a current of I , or must supply a current of I . This current reversal at the integrator input node produces a triangle voltage waveform output. The comparator which switches the upper source off and on produces the square wave, and the triangle waveform is converted to a sine wave by standard piecewise linear techniques (a network of linear resistors and diodes used to produce a nonlinear function). With the addition of output amplifiers, attenuators, and function selection switches, the sine, triangle and square waves are supplied as outputs.

Cover: The new HP Model 181A Variable Persistence Oscilloscope displays the responses of a 5 kHz bandpass filter when swept by the HP Model 3300A Function Generator and its new HP Model 3305A Sweep Plug-in. The four responses were achieved by sweeping the filter with four different sweep widths ranging from 40 kHz for the narrow response to 1.6 kHz for the wide response.

In this Issue: Sweeping Four Decades at Low Frequencies; **page 2.** Applications of Low-Frequency Sweepers; **page 8.** Easier and Brighter Display of High-Frequency Signals; **page 10.** Space Signals Studied; **back cover.**

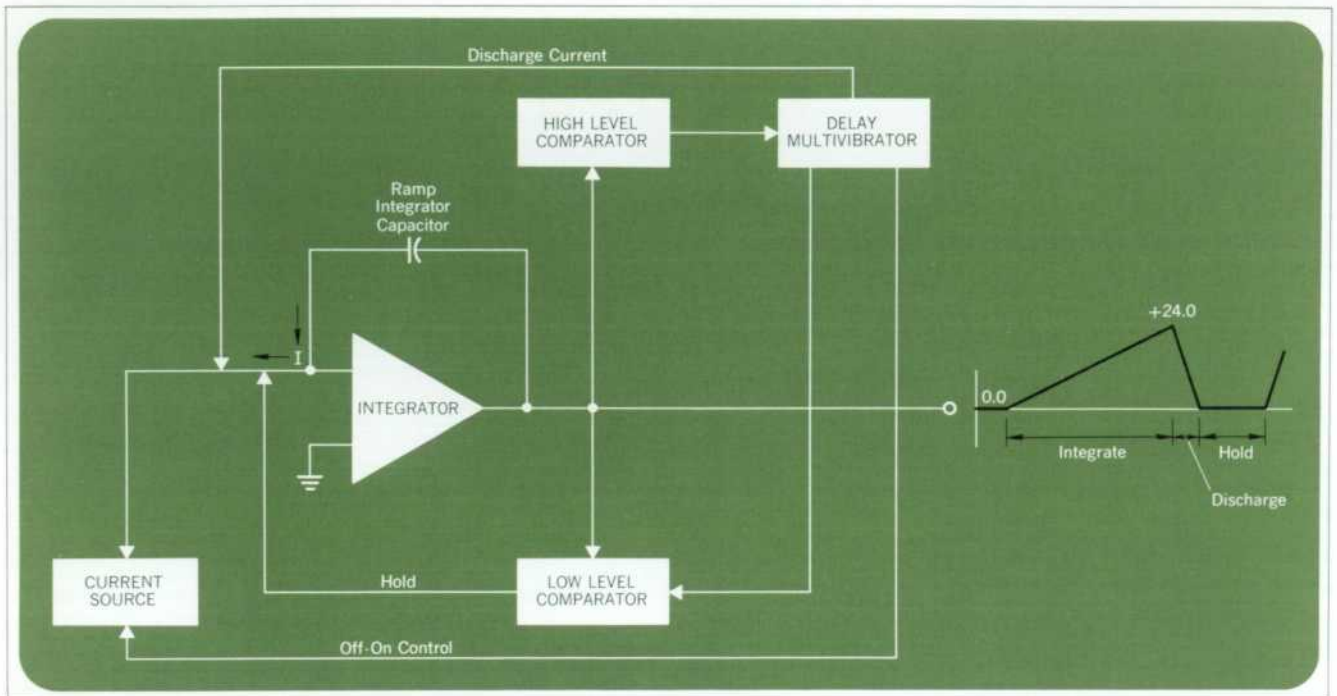

Fig. 3. In this ramp generator circuit of the Model 3305A Plug-In, the sweep time is changed by switching various integrator capacitors and adjusting the current source.

The Model 3300A output frequency is given by:

$$f = K \frac{I}{C} \quad (1)$$

where f is the frequency in Hz; I is the integrator current in amperes; C is the integrator capacitance in farads; and K is a constant which includes parameters which

characterize the integrator.

Equation (1) then, defines the requirements of the function generator which have to be fulfilled by the sweep plug-in. With the constant K fixed by the Model 3300A main frame, I and C can be controlled in the plug-in to effect the desired frequency change or sweep.

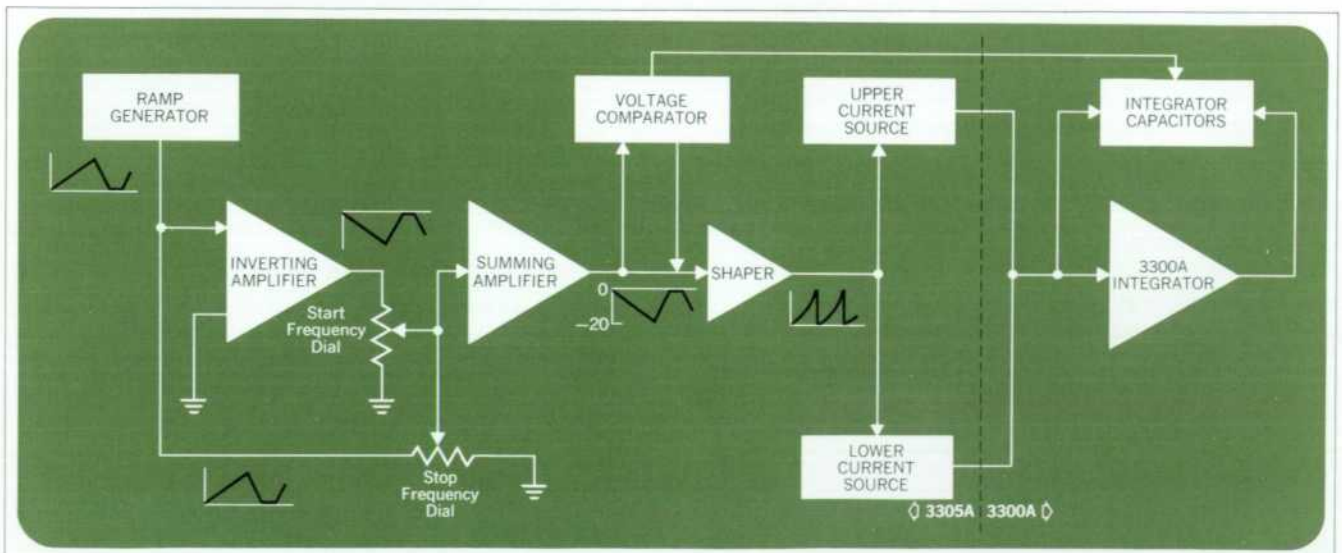

Fig. 4. Upper and lower current sources in the Model 3305A are designed with more precise control of currents to allow four decades of sweep. The sweep mode selection is effected by switching within the ramp generator.

As indicated in Eq. (1) a change in frequency of four decades requires a four decade change in integrator current for a fixed capacitor. Unless expensive chopper-stabilized methods are used, the control of currents to within a few percent with a range in magnitude of 10,000 to 1, is beyond practical design today.

Current and Capacitance are Switched

To achieve a four-decade frequency sweep, both I and C in Eq. 1 are changed in combination. It works like this: the integrator current is varied over a two decade range, then the integrator capacitor is changed and the two decade change in current is repeated. Thus the effective range of frequency variation is four decades. In the normal mode, that is sweeping with frequency increasing, phase continuity is preserved when the capacitor is changed, thus maintaining a continuous sweep. When sweeping narrow bands in high Q systems, a transient could be generated when passing through the capacitor switch point; this could cause a frequency or phase discontinuity. However, the three frequency ranges overlap, permitting up to two decades to be swept up or down without switching the capacitor.

To bring about the change in frequency or sweep, the current supplied to the integrator is varied by generating a voltage ramp that is linear with time. Later in the system this sweeping voltage is converted to supply the I and $2I$ described earlier as required.

The voltage ramp is synthesized in the ramp generator section shown in the simplified block diagram of Fig. 3. The ramp generator is composed of a current source, a Miller integrator and two voltage comparators. As the current source pulls current through the capacitor, the integrator output voltage rises in a linear fashion until its level is high enough to trigger the high-level comparator and the delay multivibrator. The current then supplied discharges the capacitor causing the ramp voltage to fall to, and remain at its lower

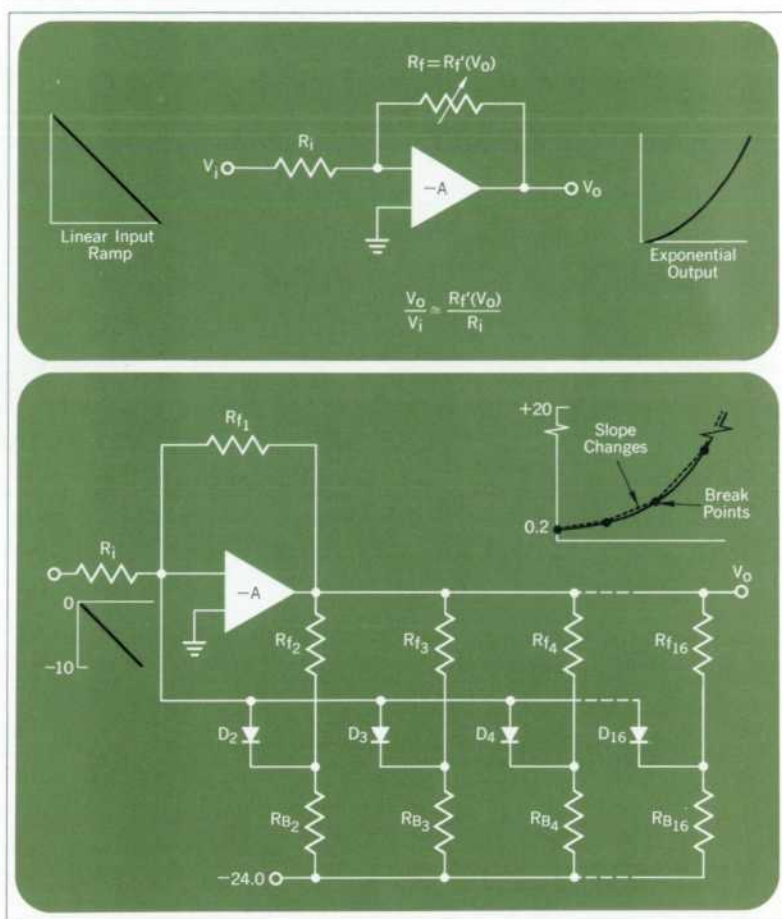

Fig. 5. The closed loop gain of the shaper amplifier (top) varies as a function of the output voltage causing the linear input to be converted into an exponential at the output. The incremental gain or slope of the output increases as each feedback resistor, R_{f1} through R_{f16} (bottom) is disconnected from the amplifier input in sequence by the diodes D_2 through D_{16} .

level, as defined by the second comparator. A short time later the multivibrator changes back to its original state, allowing the ramp to begin rising, repeating the cycle.

The time required for the ramp to move from its low to high level, i.e., the sweep time, is determined by the sweep time control, which selects various integrator capacitors and current ranges.

As shown by the block diagram, Fig. 4, the ramp is supplied to the stop frequency control by way of the inverting amplifier. The start and stop potentiometer outputs are summed, producing a ramp which is proportional to the difference between the start and stop settings. In addition, the resultant ramp's slope and dc level depend on the start and stop dial settings. For example, the resultant ramp at the out-

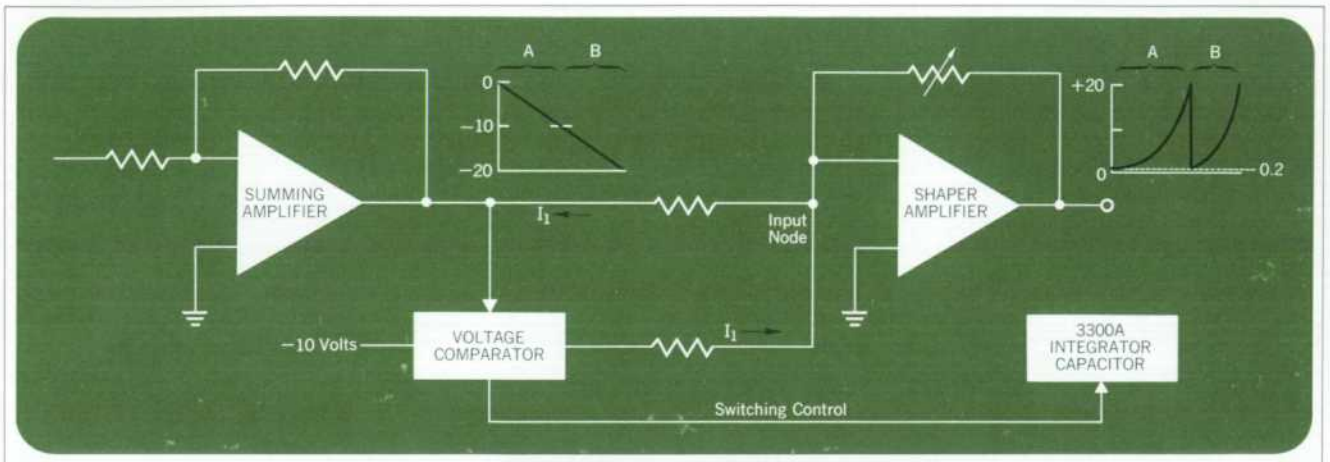

Fig. 6. The two exponential curves at the right are generated from the single ramp at the left. As the ramp voltage goes from 0 to -10 , current is drawn from the shaper amplifier causing its output to rise exponentially from 0.2 to 20 volts. At -10 volts on the ramp, the voltage comparator switches the precise amount of current being drawn. This causes the shaper amplifier to reset to 0.2 volt. The voltage comparator continues to supply current as the ramp proceeds from -10 to -20 volts, resulting in the second exponential B, at the right.

put of the summing amplifier moves from 0 to -20 volts when sweeping up from 10 Hz to 100 kHz; when sweeping down from 100 kHz to 10 kHz the ramp moves from -20 to -15 volts.

Logarithmic Sweep

A four-decade linear sweep has the disadvantage of crowding the lower three decades of response into $1/10$ of the display. To display each decade equally, and to produce Bode plots directly, the linear voltage ramp is

made to vary in an exponential manner. This causes display to be proportional to the log of the frequency.

To shape the linear ramp exponentially, a standard operational amplifier is used with a nonlinear feedback resistance, Fig. 5(a). The feedback resistance R_f is a function of the shaper output voltage V_o .

Integrated Circuit Shaper

To synthesize a two-decade exponential it is necessary to change the shaper gain over two decades, or by a fac-

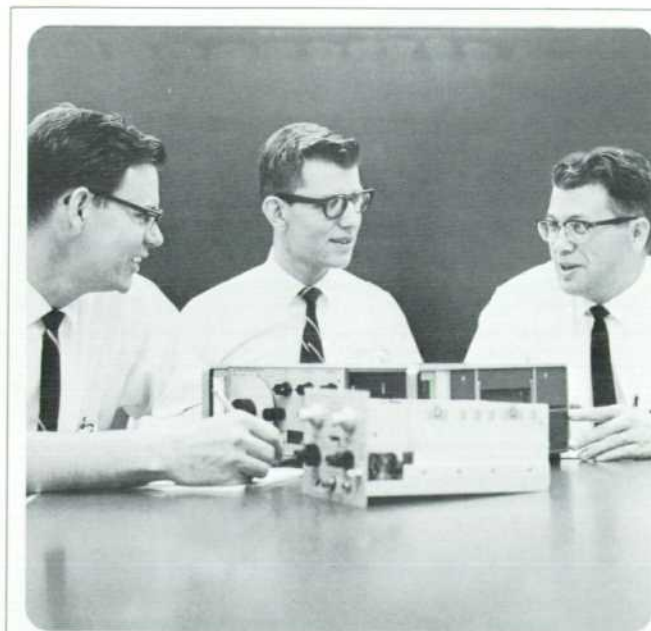

Author **Will Cowan**, left, received his BS in EE from Lamar State College of Technology in January, 1961 and did some postgraduate work at Tulane University. He worked at the University of New Mexico Research Center in the field of Electromagnetics while attending graduate school. Will graduated from the University of New Mexico in 1965 with an MS in EE.

He came directly to Hewlett-Packard in Loveland and began work in low frequency sweepers as a circuit designer. He became Project Engineer for the 3305A in January, 1967. Presently his work is in the voltmeter area in the Loveland R&D Labs.

Will is a member of Eta Kappa Nu and the Lamar Honor Society.

Steve Venzke, center, is a graduate of the University of Minnesota with a BS in EE. He has been with HP since 1965 and worked on circuit design for the HP Model 3305A.

Virgil Leenerts, right, did the product design on the HP Model 3305A. He joined HP in 1963 after graduating from the University of Illinois with a BS in EE.

tor of 100 to 1. With the input voltage at zero, Fig. 5(b), the output voltage V_o is +0.2 volts, and all of the diodes D_2 through D_{16} are forward biased. These diodes may be thought of as switches which are all closed. Therefore, all of the resistances, R_{f1} , R_{f2} , $R_{f3} \dots R_{f16}$ are connected in parallel causing the equivalent R_f to be at its lowest value, resulting in a shaper gain of approximately 0.1. As the shaper input voltage e_1 falls, V_o begins to rise. At a predetermined value fixed by the resistors R_{f2} and R_{B2} (break point #1), the voltage across D_2 becomes zero. In other words, switch D_2 is opened. This removes R_{f2} from the parallel combination of the feedback resistances, causing an increase in shaper gain, and a corresponding slope change in the output waveform. As e_1 continues falling, the output voltage V_o rises causing the remaining diodes to open in succession at the proper break points, changing the gain incrementally until the highest gain of approximately 10 is reached. This occurs just before $e_1 = -10$ volts when all of the diodes are reverse biased and only R_{f1} remains as the feedback resistance. This piecewise linear shaping is shown in Fig. 5(b). The number of piecewise segments was determined by the design objective, which was to allow a maximum shaping error of 1.0% of the output voltage setting. For example, if the output is +1.5 volts, the error is less than ± 15 millivolts. Typically, the shaping errors are about 0.5% because of the smoothing effect of the diodes.

An analysis of the shaper will show that discrete diodes are unsatisfactory because of the matching problem and strong temperature dependence of their forward voltage drops. These problems were solved by using integrated circuit diodes. Excellent matching, with temperature variation effects rejected by two orders of magnitude compared to discrete diode variations, is achieved by special integrated circuits, designed and manufactured by Hewlett-Packard.

Actually, the linear ramp output of the summing amplifier is converted into 2 two-decade exponentials at the input to the shaper amplifier, Fig. 6. This is accomplished as follows: As the summing amplifier ramp reaches its halfway point of -10 volts, the shaper output has moved through its full excursion from 0.2 volts to 20 volts. However, at the midpoint of the shaper input waveform, an accurate comparator injects a precise current into the shaper input node, causing the shaper output to be reset to 0.2 volt. The summing amplifier ramp continues toward -20 volts, moving through its second half. This causes the shaper output to repeat its full excursion for a second time. Note that the comparator which resets the shaper also causes the integrator capacitor, C in

SPECIFICATIONS

HP Model 3305A

Sweep Plug-In

FREQUENCY RANGE

0.1 Hz to 100 kHz in 3 overlapping ranges.

SWEEP WIDTH: Limits adjustable 0 to 4 decades in any of three 4-decade bands; 0.1 Hz to 1 kHz, 1 Hz to 10 kHz, 10 Hz to 100 kHz.

START-STOP DIAL ACCURACY: $\pm 5\%$ of setting, 0.1 Hz to 20 kHz; $\pm 7\%$ of setting, 20 kHz to 100 kHz.

SWEEP MODES

AUTOMATIC: Repetitive logarithmic sweep between start and stop frequency settings.

MANUAL: Vernier adjustment of frequency between start and stop frequency settings.

TRIGGER: Sweep between start and stop frequency settings and retrace with application of external trigger voltage or by depressing front-panel trigger button.

TRIGGER REQUIREMENTS: AC coupled, positive going at least 1 V peak with > 2 V per ms rise rate.
Max. input, ± 90 V peak.

SWEEP TIME

0.01 s to 100 s in 4 decade steps; continuously adjustable vernier.

RETRACE TIME

0.001 s for 0.1 to 0.01 s sweep times, 0.01 s for 1 to 0.1 s sweep times, 2 s for 100 to 1 s sweep times.

BLANKING

Sine and triangle outputs, 0 V during retrace

PEN LIFT

Terminals shorted during sweep; open during retrace in auto and trigger modes for 100 to 1 s sweep times.

SWEEP OUTPUT

Linear ramp at CHANNEL B OUTPUT (PLUG-IN): Amplitude adjustable independently of sweep width; max. output > 15 V p-p into open circuit, > 7 V p-p into 600 Ω .

EXTERNAL FREQUENCY CONTROL

SENSITIVITY: 6 V/decade (referenced to START setting). ± 24 V max.

V-to-F CONVERSION ACCURACY: For each 6 V change in programming voltage, frequency changes 1 decade $\pm 5\%$ of final frequency.

INPUT IMPEDANCE: 400 K Ω .

MAXIMUM RATE: 100 Hz.

GENERAL

Main frame operation is possible without removing plug-in.

DIMENSIONS: 6- $\frac{1}{2}$ in wide, 4- $\frac{3}{4}$ in high, 10- $\frac{1}{4}$ in deep (153.9 x 120.7 x 260.4 mm).

WEIGHT: Net 4 lbs 6 oz (2 kg); shipping 6 lbs 6 oz (2.9 kg).

PRICE: HP 3305A, \$975.

MANUFACTURING DIVISION:

LOVELAND DIVISION
P.O. Box 301
815 Fourteenth Street S.W.
Loveland, Colorado 80537

Fig. 4, to be changed at the midpoint of the summing amplifier output ramp.

Following the shaper amplifier are the precision current sources: the lower source takes the current I from Model 3300A Integrator; and the upper source supplies the required current of 2I. These current sources are accurate and stable to maintain required symmetry and frequency accuracy.

Acknowledgments

The advice and guidance of our Group Leader, Robert L. Dudley, and the work done by Steve Venzke and Virgil Leenerts is gratefully acknowledged. The contributions of Jerry Folsom and Larry Lopp in the design of the integrated circuits are also recognized.

An advantage of sweep testing any device is the ability to see the entire frequency response curve at one time. Where controls or component values need to be adjusted, the results of these changes are available instantly. With the new HP Model 3305A Sweep Plug-in, the advantages of broadband sweeping are combined with precise calibration of sweep frequencies. Shown on this page are four types of applications for which this plug-in is useful.

Narrow Band Sweep Application

Checking the frequency response of a 50 kHz IF transformer. Sweep start is set at 40 kHz and sweep stop is at 60 kHz. Adjustments are made while observing the curve on the oscilloscope.

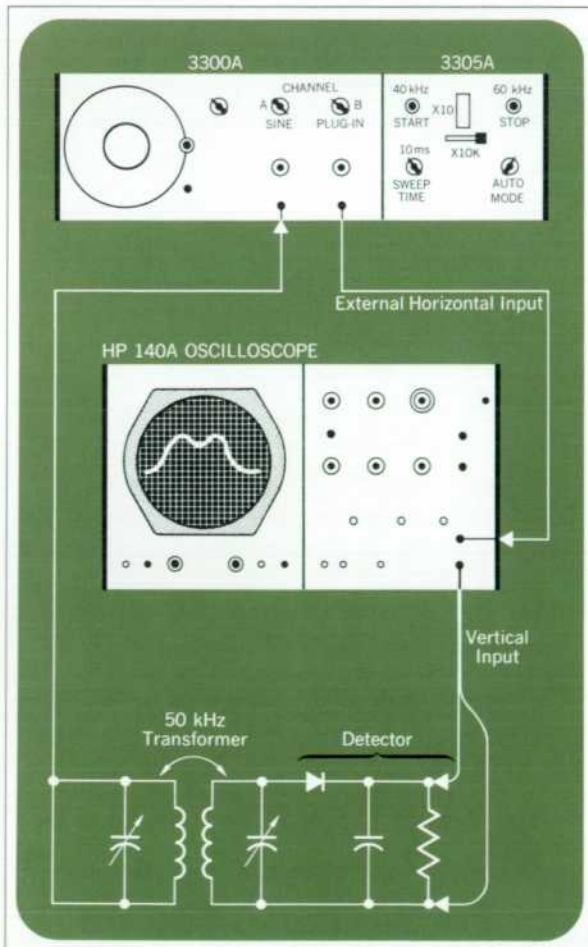

Full Audio Range Measurements

The design and production of loudspeakers and enclosures is largely empirical because of the number of variables involved. The designer must take point by point response plots, make modifications and then replot the curve to check the effect of the change. With a four decade sweep, a plot of more than the entire audio range can be obtained in about two minutes.

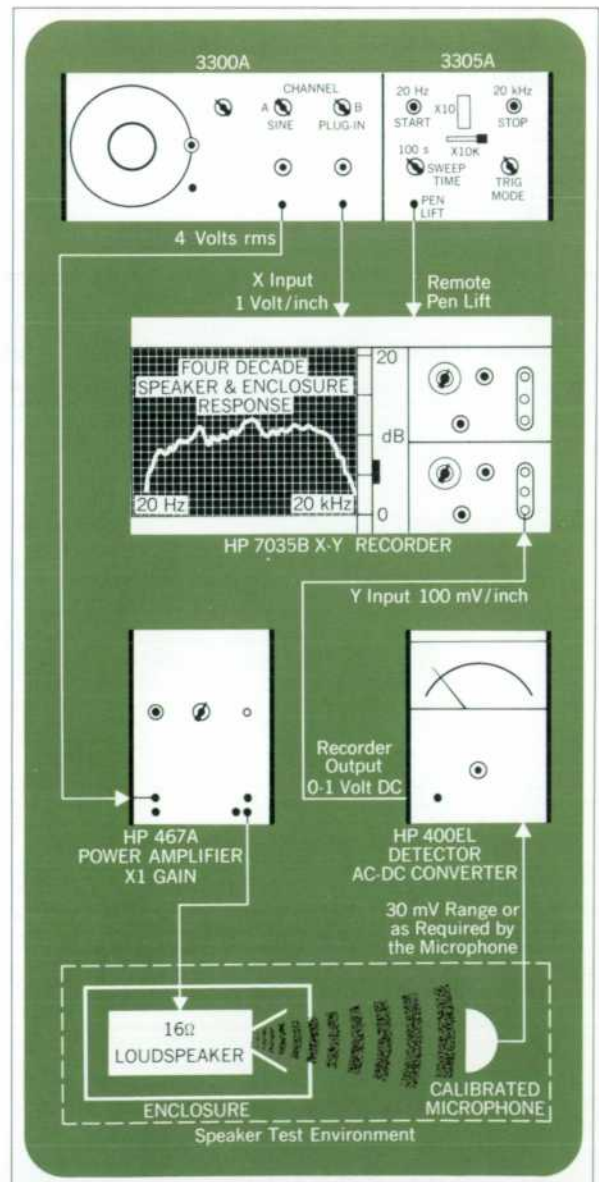

Frequency Sweepers

Discrete Frequency Programming

In production testing of active or passive filters, it is often desired to measure the output voltage at several discrete frequencies instead of making a complete response curve. In the example shown, the bandpass filter will meet its specifications if the output at 4 kHz is less than 200 mV, greater than 3 V at 7 kHz and less than 200 mV at 9 kHz. These frequencies can be programmed in this system. Setting or reading dials is not necessary.

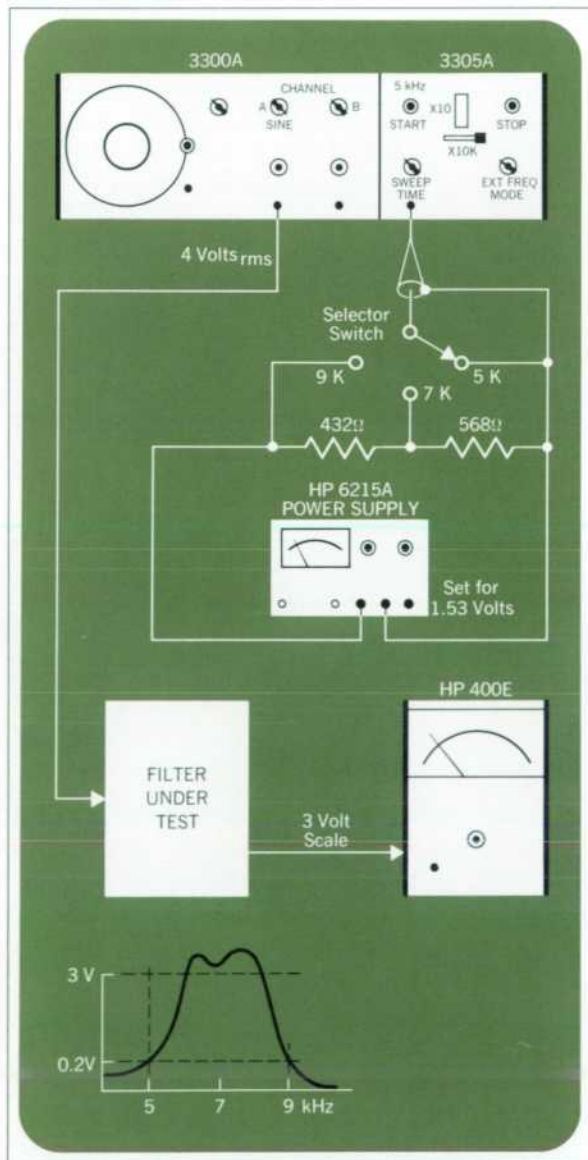

Wide Band Discrete Frequency Programming

A useful test performed on low frequency power amplifiers in production is the low and high frequency square wave check. At about 40 Hz, flatness and sag in the amplifier can be evaluated; at 10 kHz the square wave test will show transient response, any overshoot, and the rise time of the amplifier. The square wave frequency input to the amplifier and the oscilloscope sweep time are automatically selected. This system checks only two frequencies, but several frequencies could be selected with a single programmer.

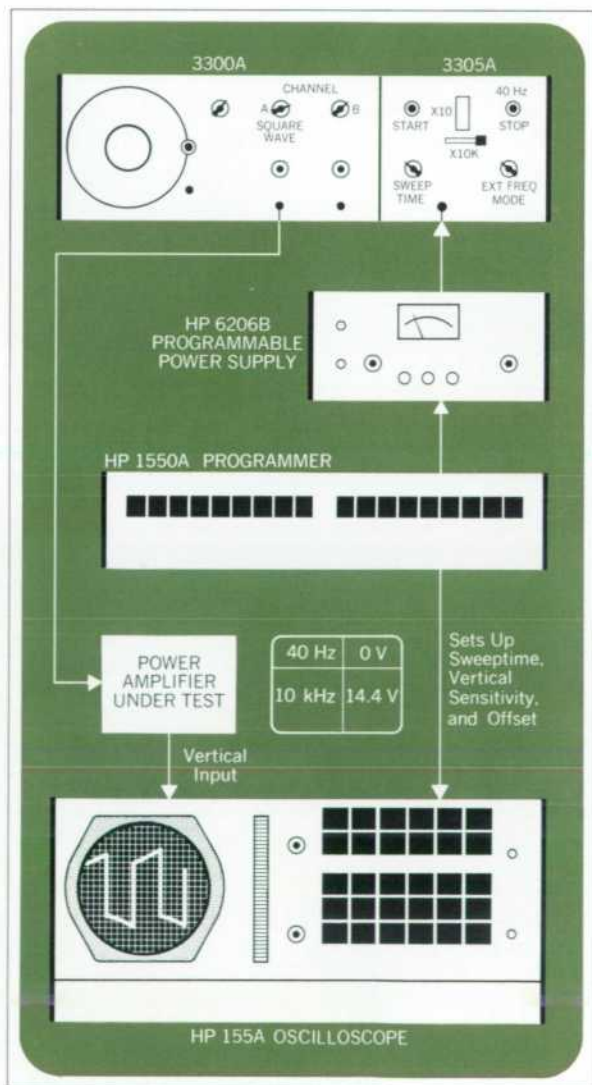

Easier and Brighter Display of High-Frequency Signals

Variable persistence and storage added to a high-frequency oscilloscope increase measurement versatility.

By Charles A. Donaldson and Charles A. Gustafson

VARIABLE PERSISTENCE ADDS AN IMPORTANT DIMENSION to the usefulness of conventional and storage oscilloscopes. The ability to vary the length of time that the trace afterglow remains on the screen opens the way to easier study of many kinds of waveforms. Slow-moving traces may be displayed in their entirety and slowly erased just as the next one comes along; waveforms of constantly changing signals may be superimposed on the screen for comparison; and a group of one-shot signals may be held on the screen for study without resorting to photography.

With variable persistence, a complete sweep can be displayed on the screen without overlap from one sweep to the next. This is accomplished by adjusting the persistence so that the old trace fades from view just as the new trace is being written. There is no annoying flicker and no need for continuous adjustment of the oscilloscope controls. This allows observation of slow-moving, constantly changing waveforms such as those produced by biomedical phenomena, vibration, or dynamic strain.

There are many other situations in which the variable persistence oscilloscope will provide the best display of a signal which is difficult to observe. In time-domain reflectometry, spectrum analysis, or swept-frequency measurements, maximum resolution is attained when the display rate is slow. By adjusting the variable persistence and intensity controls on the scope, the information on the CRT can be made much easier for the operator to interpret.

Variable persistence is also useful for high frequency work. To view low-repetition-rate, fast risetime pulses, a viewing hood is often required to see the dim waveform on a normal oscilloscope. With variable persist-

ence, the trace can be allowed to 'integrate up' and a bright display can be obtained.

The variable persistence oscilloscope is actually three scopes in one. It can be used as a conventional oscilloscope, a variable persistence oscilloscope and a storage oscilloscope. As a storage scope, the instrument can be used to observe single-shot events, to compare events which occur at different times, or to preserve events for observation at a later time.

Variable persistence was introduced by HP in the Model 141A Oscilloscope¹. Now a high-frequency oscilloscope, with the portability and flexibility of the all solid-state HP Model 180A,² has been designed for 100 MHz scope operation in addition to storage and variable persistence in the same main frame, Fig. 1. The new scope is designated the HP Model 181A, and uses the standard 180A system plug-ins.

Fast Rise Time, Low Repetition Rate Signals

With variable persistence a scope can integrate from trace to trace; variable persistence is a useful feature in a high-frequency oscilloscope, especially for examining low-repetition-rate, high frequency phenomena. In Fig. 2, the repetition rate is 750 Hz and the sweep is 10 ns/cm for both traces. The top trace was obtained by using the variable persistence NORMAL WRITE mode and the display was allowed to 'integrate up' for 10 seconds. The mode was switched to STORE and a one second exposure photo was taken. The trace on the CRT was easily visible to the eye.

The bottom trace is the same pulse; however the scope controls were set to NORMAL (or conventional) scope operation. The trace could be seen on the CRT only by using a viewing hood, and then only with difficulty. The photo was obtained with the same settings as for the top trace, but the exposure was 10 seconds.

Slow-moving, Constantly Changing Signals

Electrocardiography signals and many other biomedical and mechanical phenomena such as vibration and dynamic strain, produce waveshapes that are slow-moving and constantly changing. With variable persistence, it is possible to find the best compromise between least flicker and best response to new waveshapes. The trace is made to linger long enough so that its entire shape may be easily seen, yet fade fast enough so that a new waveshape is not confused by previous shapes.

¹ Robert H. Kolar, 'Variable Persistence Increases Oscilloscope's Versatility,' *Electronics*, Vol. 38, No. 24, Nov. 29, 1965, pp. 66-70.

² Floyd G. Siegel, 'A New DC-50 MHz Transistorized Oscilloscope,' *Hewlett-Packard Journal*, Vol. 17, No. 12, Aug. 1966, pp. 2-12.

Single Shot Transients

One of the most frustrating measurements is that of a one-shot transient. Normally it involves taking a photograph of the waveform with a scope camera. To examine a transient this way, while varying circuit parameters, becomes tedious. Variable persistence and storage can make many of these measurements easy, however. An example, Fig. 3, shows what happens to the output of a solid-state sine-wave oscillator when power is applied. That is important information about the oscillator, especially if it is going to be used in a programmable system. As can be seen from the photo, it takes about four seconds for the output to reach its final value. This determines how soon a measurement can be made after a program is changed, and is also a major factor in determining the measurement speed of the system. This same technique can be used when frequency range changes are made or when amplitudes are switched.

Another common measurement using the single-shot storage capability is evaluation of reed relays. Closure time and contact bounce are easily captured for analysis.

A common use for variable persistence and storage is the examination of instantaneous current and voltage (or power) in a series regulator transistor when the power supply output is shorted to ground, Fig. 4. A dual-trace plug-in is used to monitor both voltage and current. The time-base is set to SINGLE SWEEP and the power supply is shorted. From this transient photo,



Fig. 1. The new HP Model 181A adds variable persistence and storage to a portable, all solid-state oscilloscope. This scope accepts all the HP Model 180A system plug-ins with bandwidths to 100 MHz.

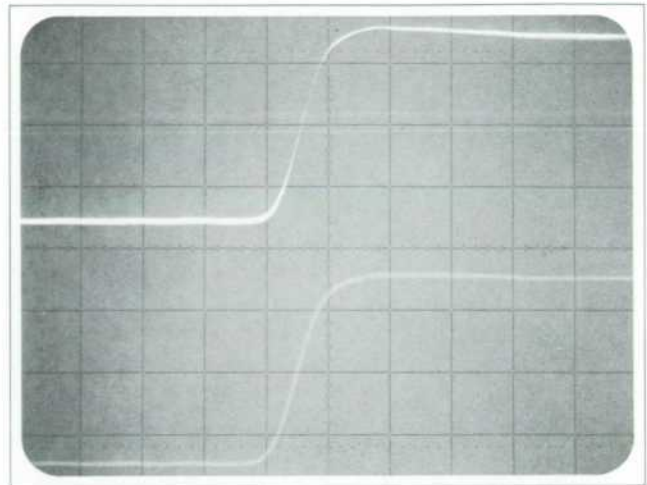

Fig. 2. Double exposure photo of a fast rise time, low repetition rate pulse. The lower trace was exposed for 10 seconds with conventional scope operation. The upper trace was exposed for 1 second after letting the trace integrate up for 10 seconds in the variable persistence mode.

instantaneous power dissipated by the regulator transistor could be plotted.

Another application is elimination of low frequency noise from a relatively fast signal. For example, the signal to be measured contains low-frequency interference such as 60-Hz hum. In Fig. 5, the thick trace is produced when a 60-Hz signal is superimposed on a 10-kHz pulse train. The bottom trace shows a single shot presentation of the pulse train which eliminates the 60-Hz interference.

Eliminating Display Flicker

When oscilloscope sweep speed is slower than about two milliseconds per centimeter, flicker results. This is especially annoying on sweeps of 50 milliseconds per centimeter and slower. Variable persistence allows selection of the optimum settings for persistence and intensity to eliminate flicker and obtain a bright, easy to read display.

Display flicker in sampling oscilloscopes occurs at higher signal repetition rates than it does in a real time scope because it takes many repetitions of the input signal to obtain a display. When high dot densities are used in sampling, the flicker can be annoying. Here again, variable persistence eliminates flicker and is a very useful tool when used with sampling oscilloscopes.

Waveform Comparison

The storage and variable persistence capabilities are convenient for storing two or more waveforms for comparison. Fig. 6 shows a comparison between three 50 Ω

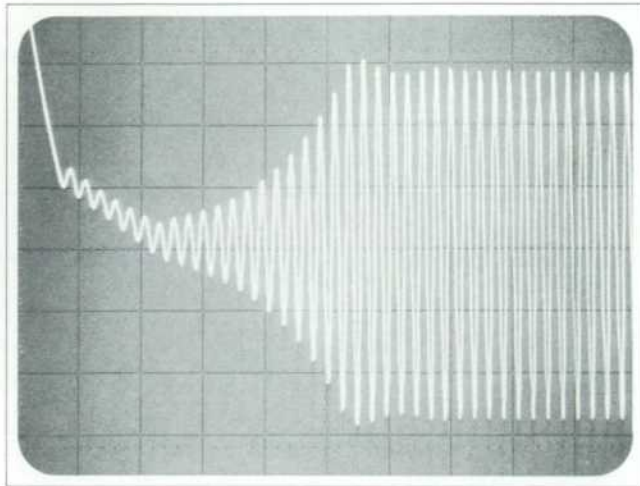

Fig. 3. A fast, easy way to determine how long it takes for an oscillator to stabilize. Here it takes the oscillator about 4 seconds to rise to its peak-to-peak value. This type of measurement is important in determining the measurement speed of a system.

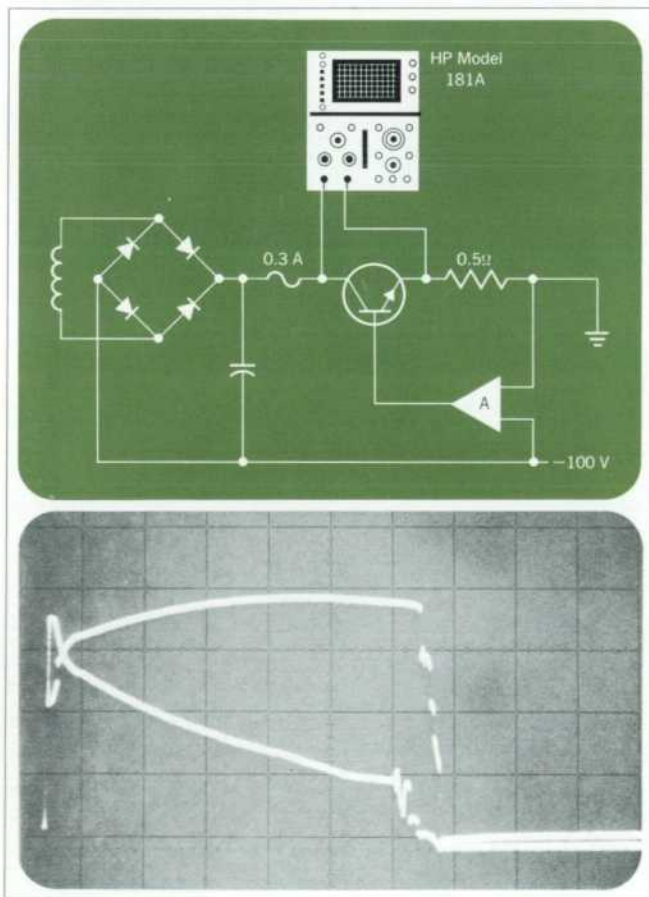

Fig. 4. To examine current and voltage in the series regulator when the output is shorted, the scope is connected as in the schematic. Current and voltage curves (transients) are as shown. Instantaneous power can be plotted by multiplying current and voltage for a number of difference instants in time.

terminations examined with an HP 1415A Time Domain Reflectometer, in the HP Model 141A Oscilloscope.

The top trace shows an inductive spike at the termination, the bottom trace shows a capacitive spike, and the middle trace shows a compensated termination. The three traces were obtained using the variable persistence NORMAL WRITE mode and then stored for comparison for about one hour.

CRT Design

Several important features are incorporated into the design of the CRT for the HP Model 181A Oscilloscope. The rectangular 8 by 10 division CRT is the first rectangular, variable-persistence CRT to be manufactured in large quantities. (The rectangular configuration requires less panel space than a round CRT.)

Storage information is contained in a storage mesh located behind the phosphor. This allows a post-accelerator to be used so that bright displays are obtained in both conventional and variable persistence modes.

The use of the rugged P31 phosphor adds to the viewing brightness, since its light output spectrum closely matches the spectral response of the human eye. These CRT's have a minimum specification of 100 foot-lamberts brightness in the variable persistence mode of operation, which is comparable to the brightness of a standard oscilloscope.

CRT Construction

The CRT consists of a conventional electron gun with deflection plates (write gun), an aluminized phosphor viewing screen, a pair of flood guns operated in parallel, flood beam shaping and accelerating grids, a flood collimator, a collector mesh and a storage mesh, all shown in Fig. 7. The write gun functions as a conventional electrostatic deflection gun, delivering high-velocity electrons to write the waveform on the screen. The elements which provide storage and variable persistence are located between the write gun and the phosphor.

Storage Operation

The storage of information is on the storage mesh, located about 0.08 inch behind the CRT phosphor. The back of the mesh is coated with a layer of non-conductive material (storage surface). A positively-charged pattern, written on the storage surface by the write gun, is etched on the storage surface by dislodging electrons (secondary emission).

The pair of flood guns, which are the source of electrons to effect the storage action, direct a broad, uniform spray of low-velocity electrons toward the screen. This

electron cloud is accelerated toward the storage mesh and viewing screen by various elements within the tube. After passing through the collector mesh, the flood electrons are further controlled by the storage surface.

Most of the low-velocity electrons are captured by the collector mesh, and the CRT screen remains dark where this occurs. The more positive charge of the storage surface, (written areas) allow the low velocity electrons through the storage mesh, which then strike the phosphor to produce the visible trace.

The manner in which information can be stored on a nonconductive material is explained by the secondary emission ratio curve, Fig. 8. At an energy of about 40 electron volts (eV), the number of electrons leaving the surface is equal to the number arriving. This point, where the secondary emission ratio is unity, is called for convenience the 'first crossover'. If the surface is bombarded with electrons with more than 40 eV of energy, the surface potential rises because more electrons are leaving than arriving. If the surface is bombarded by electrons with less than 40 eV of energy, the surface potential decreases.

Preparing the Storage Surface

When the ERASE push button on the Model 181A is pressed, the storage mesh is changed to the same potential as the collector mesh (+156V). The storage surface is also charged to nearly this same potential by capacitive coupling. Since the surface is then being bombarded by electrons with energies much higher than first crossover energy, the entire storage surface potential becomes equal to +156 volts. The surface potential cannot increase beyond +156 volts because the collector mesh would then repel the emitted electrons back to the storage surface, tending to decrease the surface potential.

When the ERASE push button is released, the storage mesh goes to +3.3 volts and the storage surface follows to the same potential by capacitive coupling. The surface potential then decays to zero volts since the flood gun electron beam acts as a resistive short to ground. After 100 milliseconds, the storage mesh is raised to +13.3 volts and held there for 200 milliseconds. The storage surface goes from zero to +10 volts by capacitive coupling, but again decays to zero volts due to the flood gun electron beam. At the end of the 200 milliseconds, the storage mesh returns to +3.3 volts. The storage surface is reduced from zero volts to +10 volts by capacitive coupling.

Since the write gun electrons reach the storage surface with energy much higher than first crossover energy, they

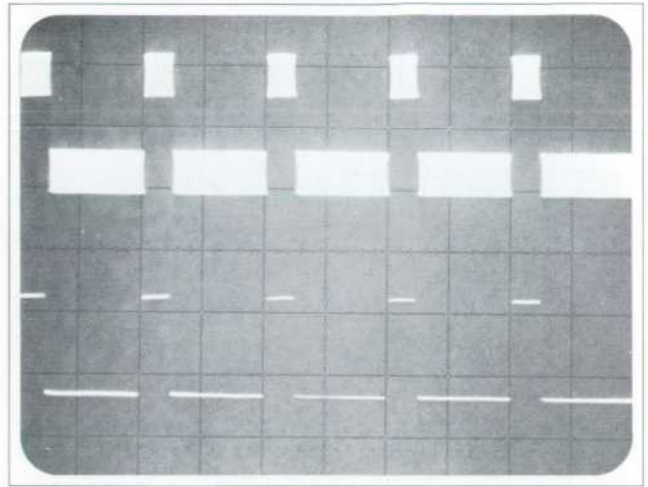

Fig. 5. The top trace demonstrates a thick trace produced when a 60 Hz signal is superimposed on the pulse train. The bottom trace shows a single-shot presentation which eliminates the effect of the 60 Hz interference.

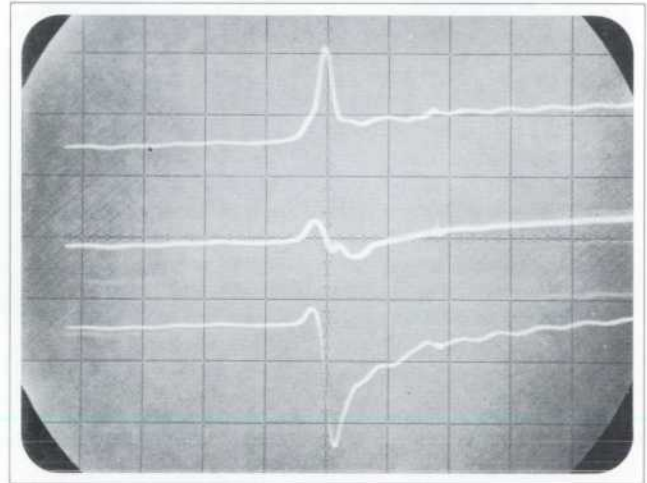

Fig. 6. Comparison of three 50-ohm terminations using a variable persistence scope and the HP Model 1415A Time Domain Reflectometer. The top trace shows an inductive spike at the termination, the bottom trace shows a capacitive spike and the middle trace is compensated termination. These traces were stored for comparison for about one hour.

Definition of Persistence

Persistence of a cathode-ray-tube phosphor is generally defined as the time it takes for the light output of the phosphor to decline to 10% of its peak intensity after it has been struck by a beam of electrons. The persistence of the phosphor in most general-purpose oscilloscopes is less than one second. For example, the P31 phosphor used in many general-purpose oscilloscopes has a persistence of about 40 microseconds. Long-persistence phosphors, such as P2 and P7, have persistences of one to three seconds.

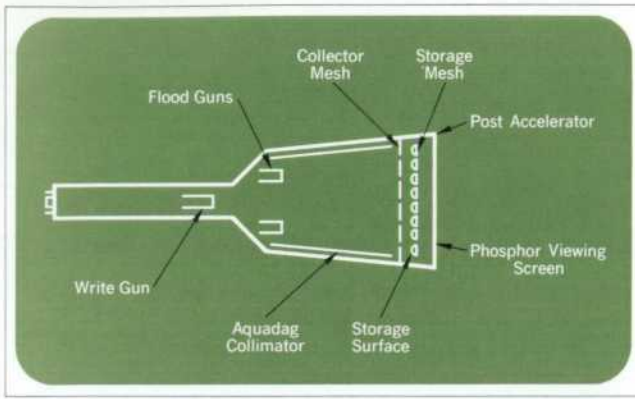

Fig. 7. In addition to the usual CRT electrode, the new HP variable persistence CRT has flood gun, collimating electrodes, a collector mesh, and a storage mesh.

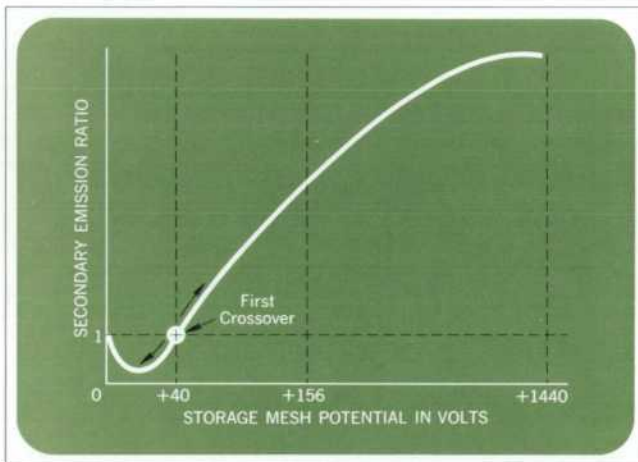

Fig. 8. At the 'first crossover' point, the number of electrons leaving the surface is equal to the number bombarding the surface, (about 40 electron volts).

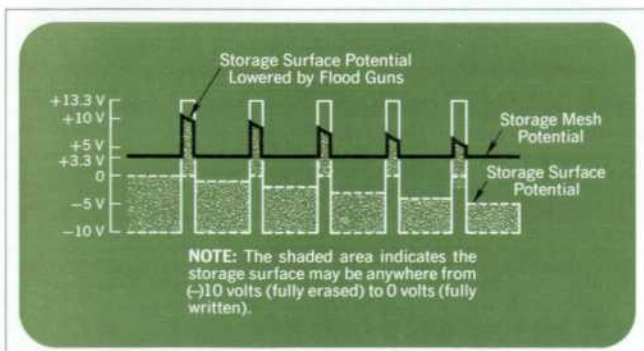

Fig. 9. Shaded area represents the storage surface potential. Successive pulses reduce the voltage tending to erase the trace.

charge the surface in a positive direction wherever they strike. This charge pattern on the storage surface remains for a considerable length of time since the storage material is a very good insulator.

Those areas of the storage surface which are charged to near zero volts allow the field created by the high positive potential on the post-accelerator to 'reach through' and capture flood gun electrons, accelerating them to strike the phosphor viewing screen, thereby causing the phosphor to emit light. Thus the pattern of charge on the storage surface is made visible.

The secondary electrons emitted by the storage surface where the write gun electrons strike must charge the surface from its erased potential to about -5 volts before flood electrons can be captured by the post-accelerator. Thus the writing speed of the CRT could be enhanced by erasing the surface to just below this 'cutoff' level. This is done in the MAX WRITE mode.

The trade-off penalties of operating in the MAX WRITE mode are reduced storage time and reduced contrast ratio. The 'cutoff' potentials of various areas of the storage surface may not be exactly the same. Thus, background illumination may not be uniform when the storage surface is erased in the MAX WRITE mode.

Variable Persistence, Write Mode

After erasure, the unwritten storage surface is at approximately -10 volts, Fig. 9. Those areas of the storage surface struck by electrons from the write gun become charged to near zero volts. A 1 kHz, $+10$ volt variable-duration pulse applied to the storage mesh moves the unwritten areas of the storage surface to near zero volts and the written areas to near $+10$ volts.

While at this potential, the written areas of the storage surface attract and capture flood gun electrons, tending to lower the potential of these areas. When the storage mesh returns to its normal level, the storage surface drops 10 volts. The written areas return to a slightly negative potential, more negative than their initial value. This decrease in potential reduces the ability of the post accelerator potential to reach through and capture flood electrons, thus reducing the trace brightness slightly.

If this procedure is repeated many times, the stored trace will eventually be erased. The time required to accomplish this erasure is controlled by varying the duty cycle of the pulses applied to the storage mesh.

During the time the storage mesh is pulsed positive, flood electrons are allowed through to the phosphor viewing screen. Thus a dim background glow is visible when the CRT is used in the variable persistence mode.

Store Mode

Persistence is limited to about 60 seconds due to the generation of positive ions inside the CRT. Eventually the storage surface voltage would rise above cut-off, losing written information. These positive ions are generated by the flood guns. By reducing the time that the flood guns are on, it is possible to increase the storage time. In the STORE mode, the flood guns are pulsed off 95% of the time, which decreases the number of positive ions produced and allows storage times of one hour or more. The pulse that turns off the flood guns is derived from the erase pulse circuitry. The price paid is a decrease in the brightness of the display. The trace is still readily visible, however.

View Mode

To view the trace at increased intensity, the VIEW mode may be used. The VIEW mode is identical to the maximum persistence mode except that the INTENSITY and PERSISTENCE controls and the ERASE button are disconnected to prevent accidental writing over, or erasure of the stored information. The viewing intensity in this mode is equal to that in the variable persistence mode and the storage time is about 60 seconds. Sometime after 60 seconds the screen will 'fade positive' (entire screen illuminated), and the information will be lost.

Conventional CRT Operation

In the NORMAL mode, the storage mesh potential is reduced to -25 volts and acts as a control grid to flood gun electrons, preventing them from reaching the phosphor. This has little effect on write gun electrons, allowing many of them to reach the phosphor viewing screen. Thus, the CRT appears as a conventional CRT without variable persistence or storage.



Chuck Donaldson (right) graduated from the University of Colorado in 1962 with a Bachelor of Science in EE and Business. Prior to joining Hewlett-Packard in 1965 he worked in sampling oscilloscope design. He is presently working on applications of pulse generators and sampling scopes.

Chuck is a member of Eta Kappa Nu, Tau Beta Pi and Sigma Tau.

Chuck Gustafson (left) graduated from the University of Colorado in 1962 with a Bachelor of Science in EE. He received his MS in EE from Massachusetts Institute of Technology in 1963. Prior to joining HP in 1965, he was engaged in the design of telephone switching equipment. Chuck had project responsibility for the HP Model 181A Variable Persistence Oscilloscope and is presently project leader in the low frequency oscilloscope laboratory.

Chuck is a member of Tau Beta Pi, Eta Kappa Nu, Sigma Tau and Sigma Xi.

Acknowledgments

The authors would like to thank Paul Carnahan and Frank Balint who designed the cathode ray tube, Norm Overacker who did the product design, John Riggen for his helpful suggestions and assistance, and many others who also contributed to the Model 181A project.

SPECIFICATIONS

HP Model 181A/AR Oscilloscope

HORIZONTAL AMPLIFIER

EXTERNAL INPUT:

BANDWIDTH: dc coupled, dc to 5 MHz; ac coupled, 5 Hz to 5 MHz.

DEFLECTION FACTOR (SENSITIVITY): 1 V/cm, X1; .2 V/cm, X5; .1 V/cm, X10; vernier provides continuous adjustment between ranges. Dynamic range ± 5 V.

INPUT R_i: 1 megohm shunted by approximately 30 pF.
SWEEP MAGNIFIER: X1, X5, X10; magnified sweep accuracy, $\pm 5\%$.

CALIBRATOR:

TYPE: approximately 1 kHz square wave, 3 μ s rise time.
VOLTAGE: 10 volt peak-to-peak, $\pm 1\%$.

CATHODE RAY TUBE AND CONTROLS:

TYPE: post accelerator storage tube; 8.5 kV accelerating potential; aluminumized P31 phosphor.

GRATICULE: 8 x 10 div parallax-free internal graticule marked in 0.95 cm squares. Sub-divisions of .2 div on major axes. Front panel recessed TRACE ALIGN aligns trace with graticule. Y axis may be aligned to be perpendicular with X axis with internal control, for accurate rise time measurements.

BEAM FINDER: pressing Find Beam control brings trace on CRT screen regardless of setting of horizontal or vertical controls.

INTENSITY MODULATION: approximately +2 volts, dc to 15 MHz, will blank trace at normal intensity. Input R_i, 5.1 k ohms.

PERSISTENCE: normal, natural persistence of P31 phosphor. Variable, continuously variable from less than 0.2 seconds to more than 1 minute.

STORAGE WRITING RATE:

Write mode: greater than 20 cm/ms.

Max. Write mode: greater than 1 cm/ μ s.

BRIGHTNESS: measured with entire screen faded positive; greater than 200 foot lamberts.

STORAGE TIME: store mode, traces can be stored for more than one hour at reduced intensity. View mode, stored traces can be viewed at normal intensity for a cumulative time of more than one minute.

ERASE: manual, push-button erasure takes approximately 300 ms.

OUTPUTS:

Four emitter follower outputs for main and delayed gates, main and delayed sweeps. Maximum current available, ± 3 ma. Outputs will drive impedances down to 1 k ohm without distortion.

GENERAL:

ACTIVE COMPONENTS: all solid state, no vacuum tubes (except CRT).

ENVIRONMENT: 181A scope operates within specifications over the following ranges:

Temperature: 0°C to +65°C.

Humidity: to 95% relative humidity to 40°C.

Altitude: to 15,000 ft.

Vibration: vibrated in three planes for 15 min each with 0.010" excursion 10 to 55 Hz.

POWER: 115 or 230 volts, $\pm 10\%$, 50-400 Hz, less than 115 watts at normal line, convection cooled.

WEIGHT: (without plug-ins) Model 181A; net, 24 lbs (10.9 kg); shipping, 32 lbs (14.5 kg). Model 181AR net, 26 lbs (11.8 kg); shipping, 35 lbs (15.9 kg).

ACCESSORIES FURNISHED: mesh contrast filter, two 10004A probes, rack mounting hardware (181AR only).

PRICE: HP Model 181A (cabinet), \$1850; HP Model 181AR (modular rack), \$1925.

MANUFACTURING DIVISION:

COLORADO SPRINGS DIVISION
1900 Garden of the Gods Road
Colorado Springs, Colorado 80907

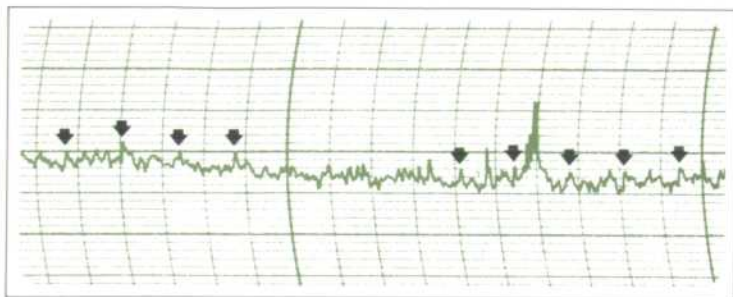

Strip chart recording of detected 405 MHz signal from Stanford's radio astronomy antenna. Pulsar signals are found visually as shown, but the characteristic waveform which identifies the pulsar being monitored is nearly impossible to see.

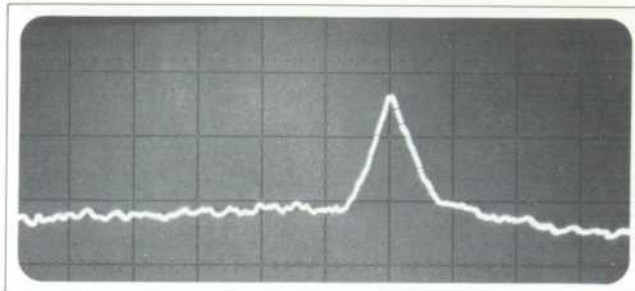

Characteristic shape of a pulsar waveform. This is CP0950, the strongest of the originally published pulsars.

Stanford Scientists Study Space Signals

Signal averager pulls pulsar signals out of noise for real time display on CRT.

By Laurence D. Shergalis

By connecting an engineering prototype of the HP Model 5480A Signal Averager¹ to the output of the Center for Radar Astronomy's² dish antenna, two Stanford University researchers are able, for the first time at Stanford, to display continuously the incoming signals from pulsars. In addition, by use of a precisely calibrated synchronizing source, they are able to calculate the pulse repetition rate to very high accuracies.

Pulsars, the newly discovered, rapidly-pulsing radio sources from outer space, emit vast amounts of energy over broad frequency ranges. At one of the monitoring frequencies, 405 MHz, it is difficult to display these signals due to noise. They can occasionally be found by recording the detected antenna output on a strip chart. The strip chart is then studied by a tedious, time consuming method in which pulses of a known rep rate can sometimes be located. Using the Signal Averager, Taylor Howard and Ned Conklin of Stanford University were able, within minutes, to see the characteristic waveform of a pulsar. In their experiments on April 27-29, 1968, they were able to verify the findings of the British radio astronomers who first discovered the known pulsars, and also have been able to easily measure and correct the repetition rate of two of them. The Signal Averager increases the ability to discover new sources and obtain accurate information about their characteristics.

The uniformity and high stability of these signals at first caused some speculation about the possibility of an intelligent source. However, the broad frequency distribution of the energy appears to indicate natural sources. Nonetheless, radio astronomers around the world are excited since study of these sources could well provide clues to the origin of the universe.

¹ See 'Hewlett-Packard Journal,' Vol. 19, No. 8, April 1968.

² The Stanford Center for Radio Astronomy is a joint organization comprised of Stanford University and Stanford Research Institute.

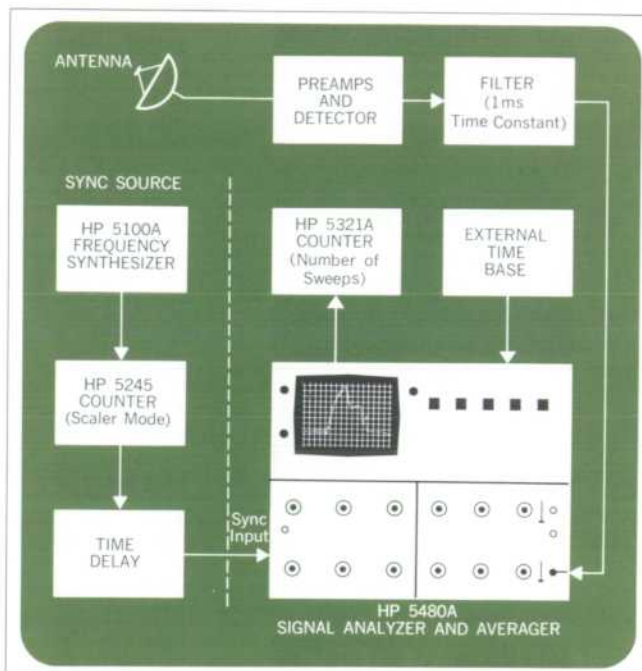

In the system for viewing the pulsar signals, the time delay is used so that the pulses may be shifted on the CRT screen. An external time base was used to obtain two periods across the CRT.

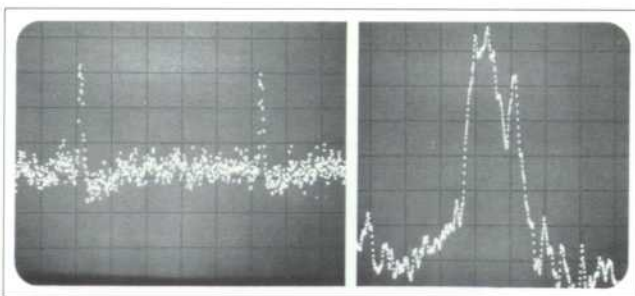

Signal analyzer display of two pulses (left) averaged for 32 sweeps. These pulses are buried in noise in the raw input signal to the averager and are barely discernible. Their spacing serves to identify this source, known as CP1919. An expanded view (right) shows its characteristic shape.