

# Device Design and Process Considerations for Millimeter-Wave Diode Integrated Circuits

Eric Ehlers  
Domingo Figueredo  
Sigurd Johnsen  
Mark Zurakowski

Microwave Technology Division  
1400 Fountain Grove Parkway  
Santa Rosa, CA 95401

RF & Microwave  
Measurement  
Symposium  
and  
Exhibition



**HEWLETT  
PACKARD**

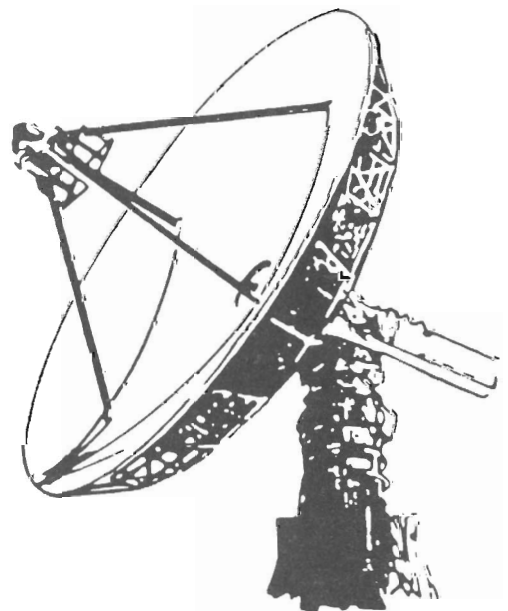

# Device Design and Process Considerations for Millimeter-Wave Diode Integrated Circuits

## GaAs DIODE INTEGRATED CIRCUITS

- Design Concepts
- Fabrication Process
- Characterization
- Applications

At the front end of nearly all of HP's new line of mm-wave instrumentation can be found a GaAs diode integrated circuit developed and manufactured at HP's Microwave Technology Division in Santa Rosa, California.

## COMPONENTS AVAILABLE FOR INTEGRATION

- Schottky Diodes  
 $C_{jo} \sim 1.5 \text{fF}/\mu\text{m}^2$
- Thin Film Resistors  
 $R_s = 50 \Omega/\text{sq.}$
- Thin Film Capacitors  
 $C = .67 \text{fF}/\mu\text{m}^2$
- Beam leads

The GaAs integrated diode circuits consist of a number of Schottky diodes, thin film resistors and capacitors. These components are fabricated on a small GaAs chip with beam leads making connections to the outside environment.

## COMPOSITE MASK

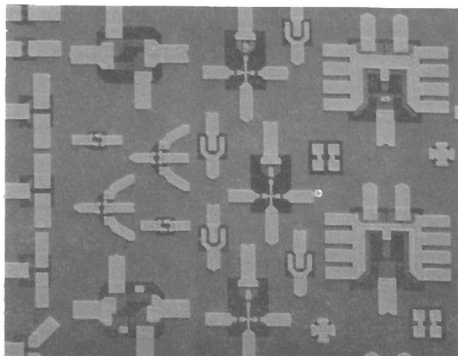

The process technology used to fabricate these devices is being supported in manufacturing and prototype environments. The prototype environment provides engineers with the flexibility of designing their own customized circuit using the GaAs diode I.C. process. Composite mask sets containing several circuits are processed to provide the designer with samples for evaluation and optimization.

Device samples from composite mask runs are in sufficient quantities to supply the needs for the early phase of the instrument development cycle. When the device design is finalized, it is stepped on to a dedicated mask set for manufacturing.

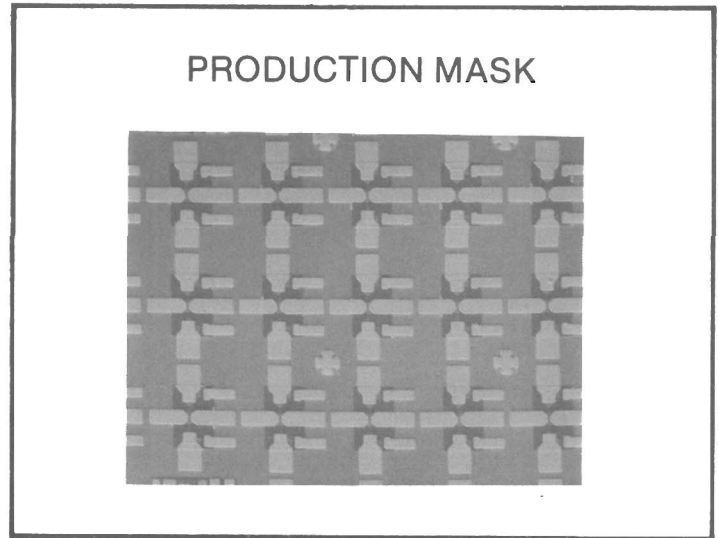

This diode integrated circuit technology is ideal for mm-wave applications involving frequency translation and other non-linear functions such as mixing, frequency multiplication, detection, sampling and limiting. The ability to integrate diodes, resistors, capacitors and beam leads allows on-chip diode biasing and impedance matching. It also decreases the parts count from previous hybrid versions leading to lower cost and higher reliability while achieving higher performance.

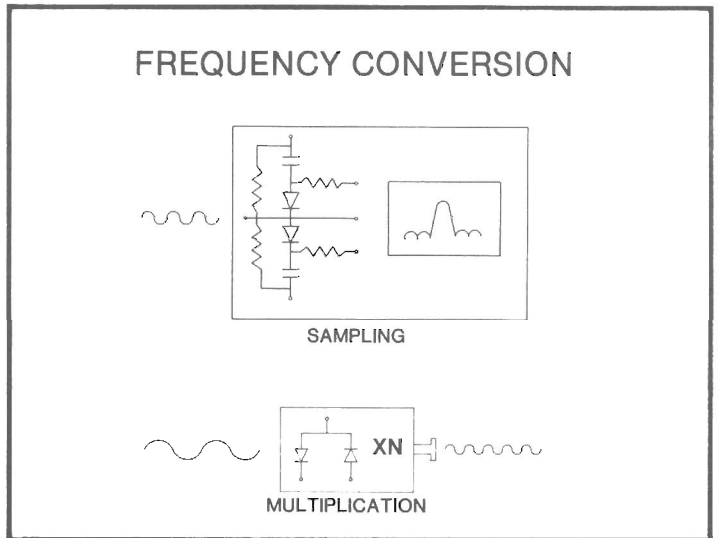

The main building block for these diode integrated circuits is the GaAs Schottky barrier diode. GaAs is the material of choice for mm-wave applications due to its extremely high electron velocity compared to silicon.

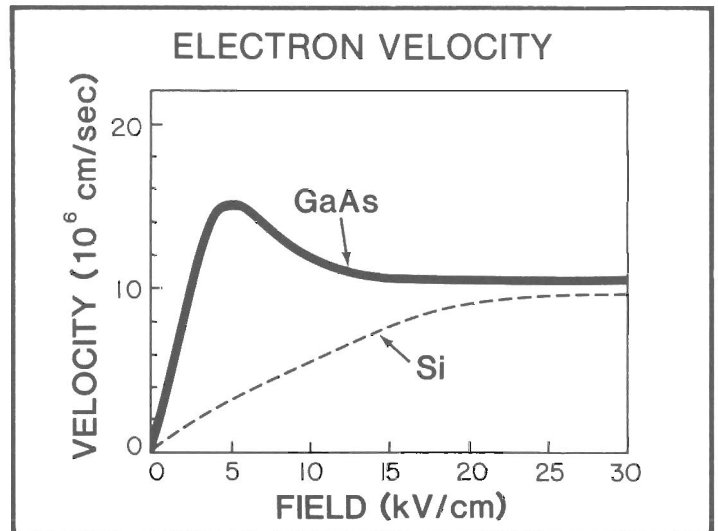

## SCHOTTKY BAND DIAGRAM

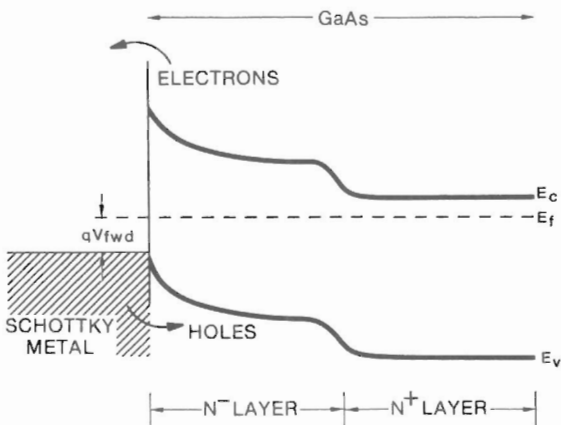

A Schottky barrier is formed at the interface between a metal and a semiconductor. The energy band diagram for the N on N+ Schottky barrier diode is shown here. Low resistance and low capacitance is due to the optimization of N+ and N layers respectively. High frequency response is the result of the high electron mobility in GaAs and its small charge storage capacitance.

## FABRICATION PROCESS FOR GaAs DIODE INTEGRATED CIRCUITS

The fabrication process will now be described in sequence. Most processing steps rely on standard optical contact lithography and lift off for pattern definition.

## EPITAXIAL STRUCTURE

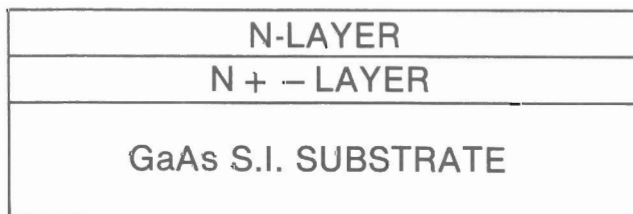

Using liquid phase epitaxy, an N+ layer and N layer are sequentially grown on a semi-insulating GaAs substrate. The Schottky barrier is formed in the N layer. The N+ layer reduces the diode series resistance.

A high degree of isolation is achieved in between devices by proton bombardments. A heavy dose of protons is implanted at high energies into the substrate except in those areas where the diodes will be fabricated.

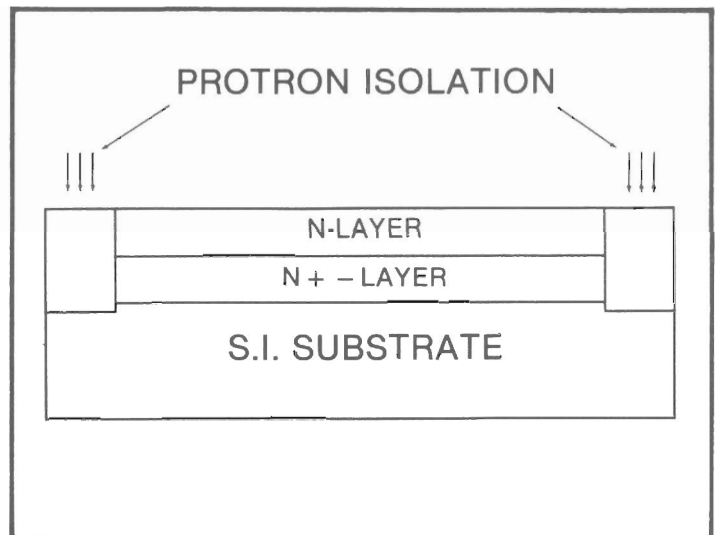

The N layer is selectively etched and ohmic contacts are formed by alloying the ohmic metal to the N+ epi. This provides a low resistance, linear contacts to the device.

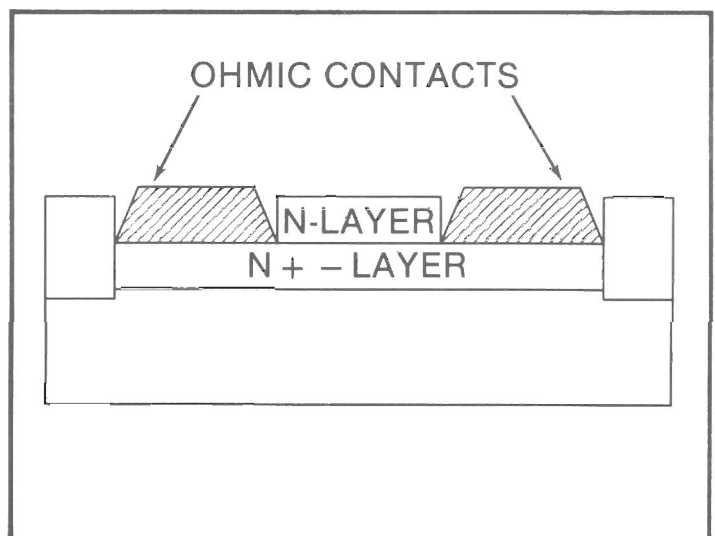

The ohmic metalization also serves as the bottom plate of the integrated capacitors. The capacitor is patterned on the proton isolated GaAs to reduce the parasitic capacitance.

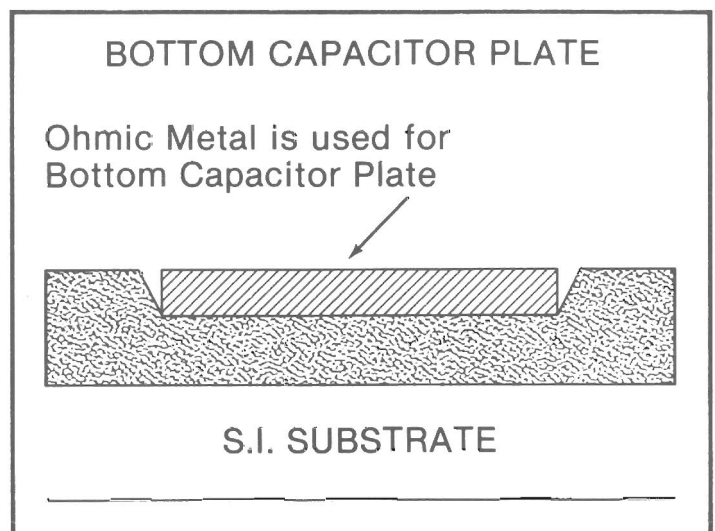

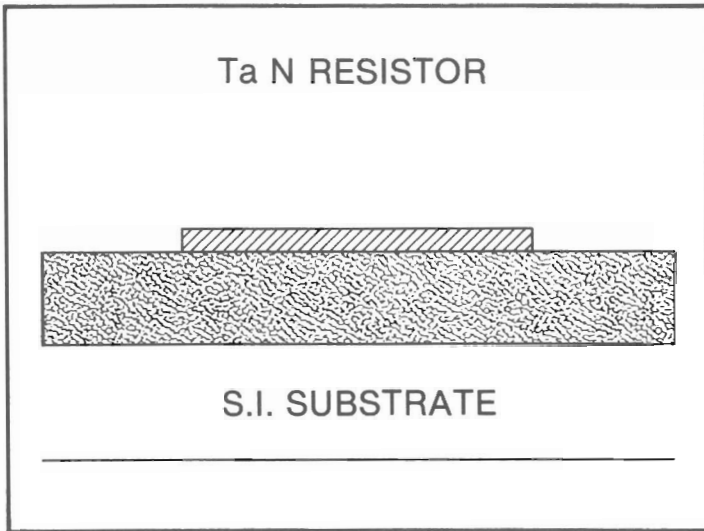

Tantalum nitride is deposited and patterned by a dry etch process in the proton bombarded field to form thin film resistors. The sheet resistivity of the Ta<sub>2</sub>N is 50 ohms per square.

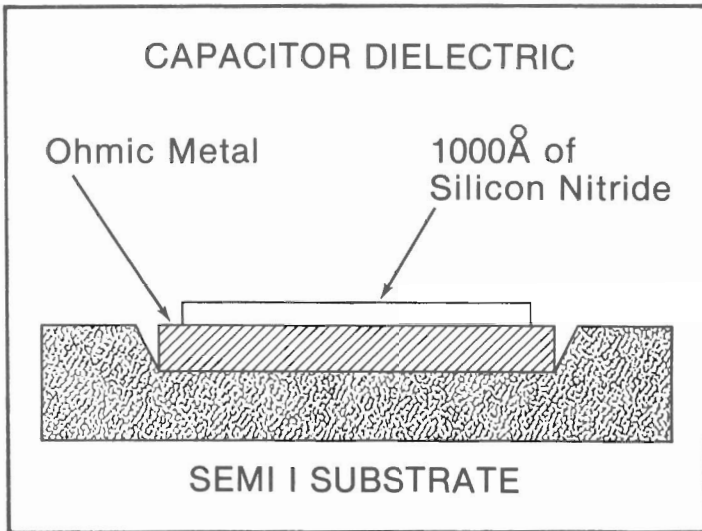

Silicon nitride is deposited to a 1000 Å thick film which is used as the capacitor dielectric. The dielectric is patterned by a dry etch using a photoresist mask. This dielectric has a capacitance density of .67 fF/sq. um.

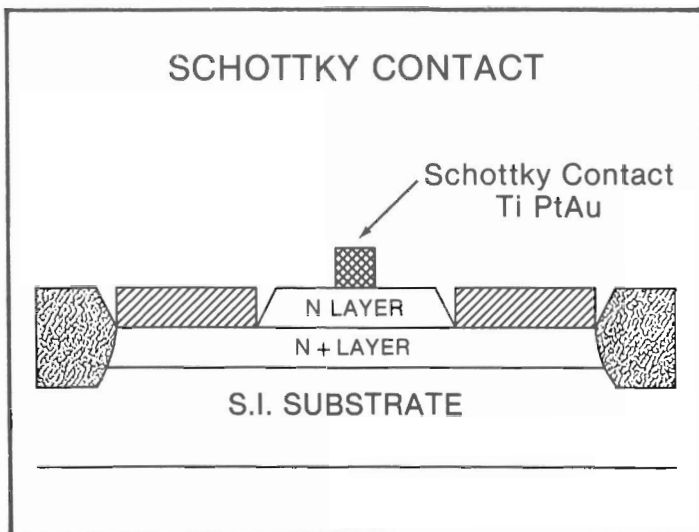

The TiPtAu Schottky metalization is defined on the N layer. The Schottky forms the anode of the diode. Minimum design rules allows for a .8 um anode finger geometry.

The Schottky metal is also used to form the top capacitor plate and the interconnection for the capacitor, diode and resistor components.

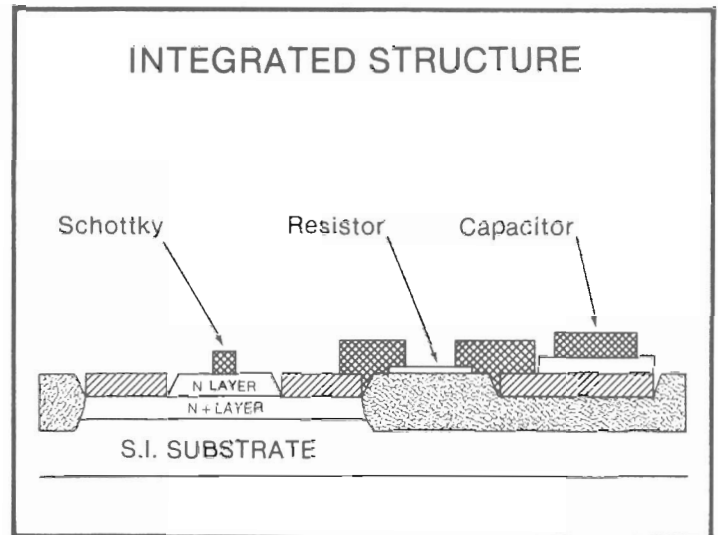

The diode I.C. is passivated with a thick layer of polyimide. Via holes are defined in the polyimide to make electrical contact to the diode I.C. components.

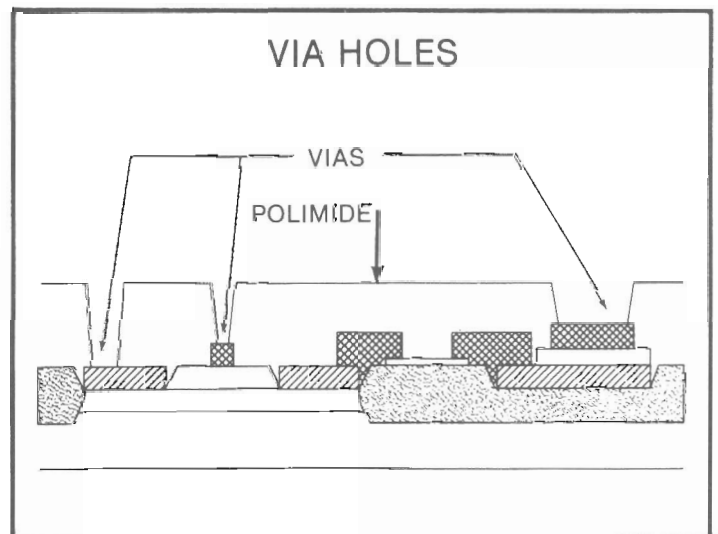

Beam leads are plated through the via holes to provide electrical contact and bonding capability.

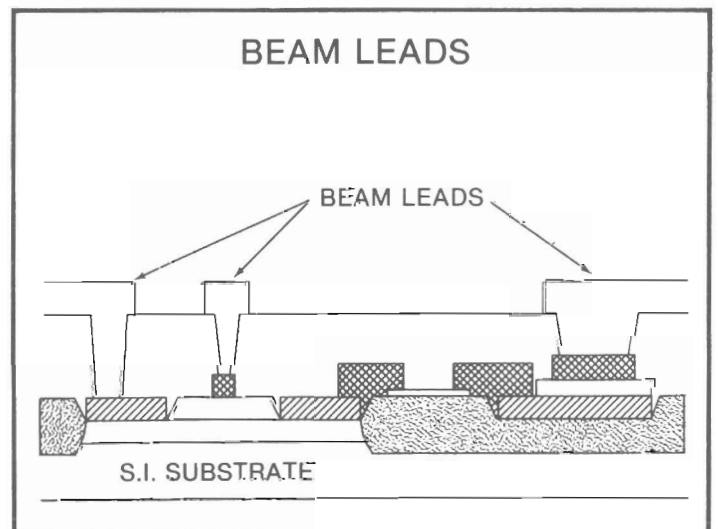



## SEPARATION

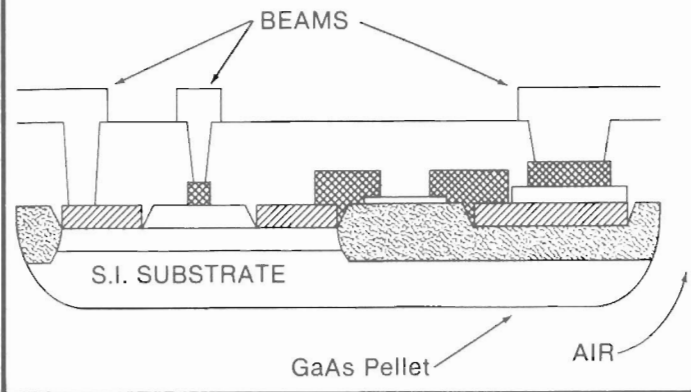

The wafer is thinned to 50  $\mu\text{m}$ , and the field in between the devices is etched away leaving a small GaAs pellet with beam leads extending out from the side.

## DEVICE BONDED ON + REL. TEST CIRCUIT

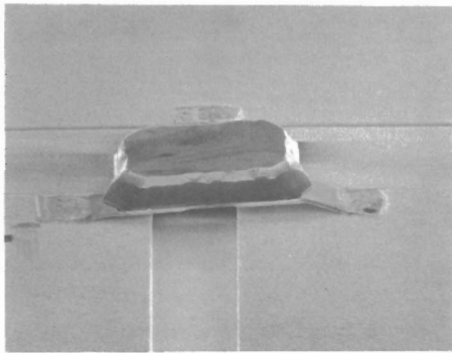

The device is now completed and ready for assembly.

## DEVICE CHARACTERIZATION

The device characterization process includes dc and rf tests.

Accurate current vs. voltage plots can be made with the HP4145 Semiconductor Parameter Analyzer. Incremental resistance ( $\Delta V/\Delta I$ ) is also plotted on the graph.

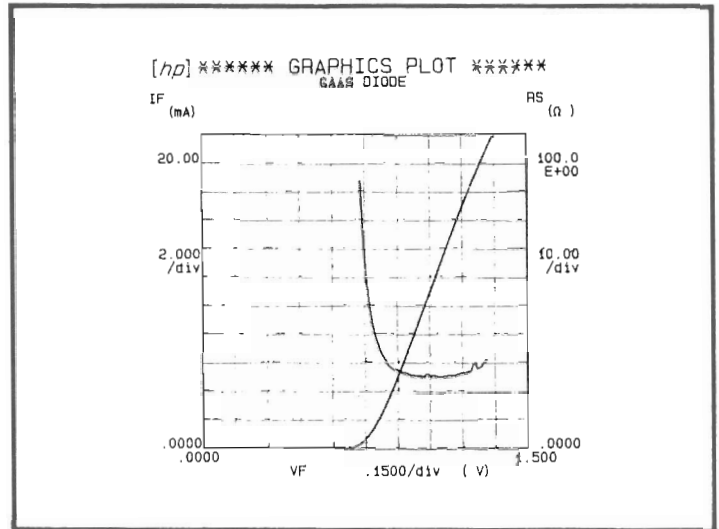

The ideal diode equation defines the following key diode parameters:

- $I_0$  = saturation current
- $R_s$  = series resistance
- $n$  = ideality factor

### IDEAL DIODE EQUATION

$$I = I_0 \left[ \exp \left\{ \frac{q (V - IR_s)}{nkT} \right\} - 1 \right]$$

- $I_0$  = saturation current
- $R_s$  = series resistance
- $n$  = ideality factor

A plot of log current vs. voltage is often useful. Extrapolation to zero volts yields the saturation current which can be used to calculate the barrier height. The barrier height for GaAs Schottky-barrier diodes is typically .7 to .8 volts.

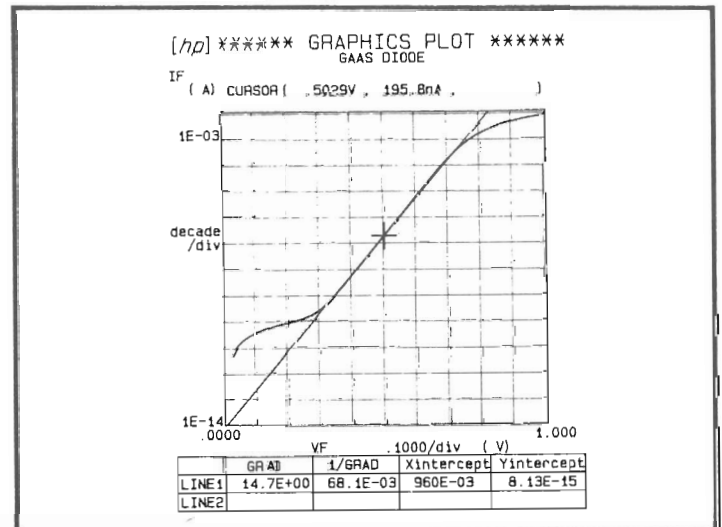

## 26.5 GHz TEST PACKAGE

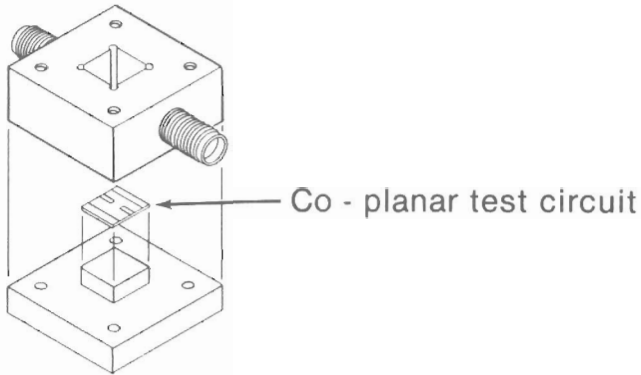

Small-signal characterization of diodes at microwave frequencies is most easily accomplished by measuring S-parameters. For this measurement, beam lead diodes can be conveniently mounted on microstrip or co-planar transmission line test circuits. This co-planar test circuit and fixture has been used successfully to 26.5 GHz.

## DEVICE ON COPLANAR SUBSTRATE

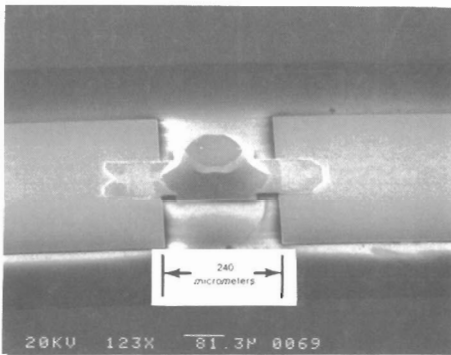

This Scanning Electron Micrograph shows a single GaAs Schottky-barrier diode with beam leads bonded upside down on a co-planar transmission line test circuit.

## FINLINE TEST PACKAGE

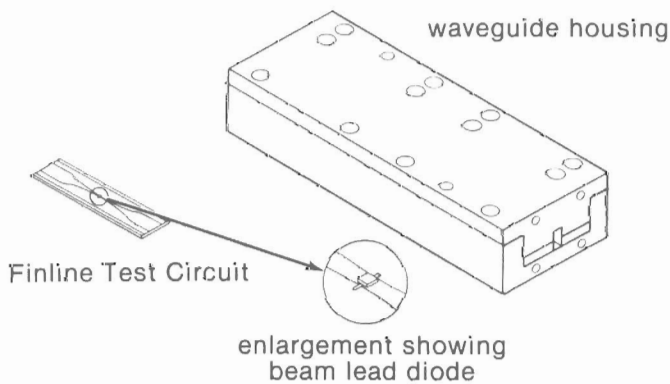

A waveguide test fixture is more convenient for measuring scattering parameters at frequencies above 26.5 GHz. This unilateral finline test circuit is useful for measuring beam lead diodes.

Three applications of GaAs diode I.C.'s are mixers, multipliers, and samplers.

# GaAs DIODE IC APPLICATIONS

- Mixers
- Multipliers
- Samplers

The frequency range of microwave spectrum analyzers can be extended to mm-waves with the use of external mixers. An "anti-parallel" pair of GaAs Schottky-barrier diodes has been used successfully in this application as an even-harmonic mixer.

## SPECTRUM ANALYZER mm-WAVE MIXER

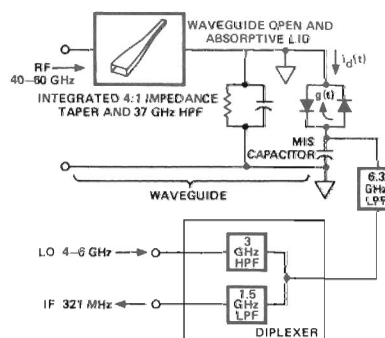

The two diodes in the mm-wave mixer have well-matched characteristics to minimize odd harmonic mixing and the beam leads serve the dual purpose of minimizing inductance and simplifying assembly in the waveguide.

## INTEGRATED MIXER DIODE

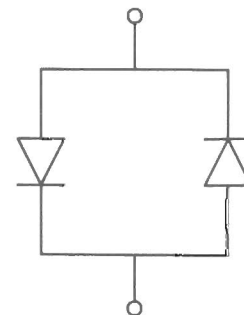
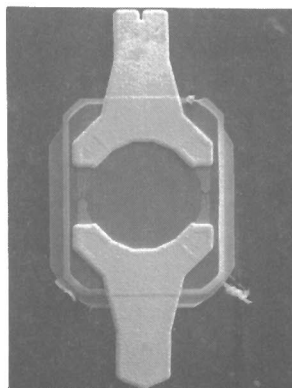

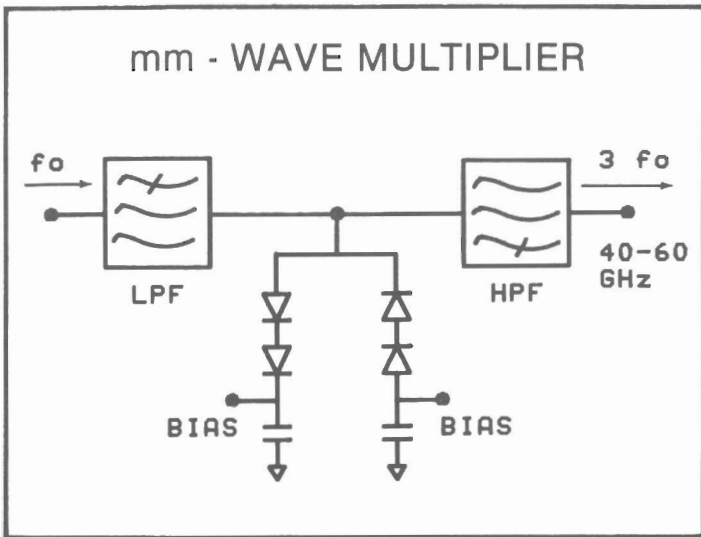

Diode multipliers can be used to extend the frequency range of microwave sweepers. One example is this tripler, designed for an output of 40 to 60 GHz.

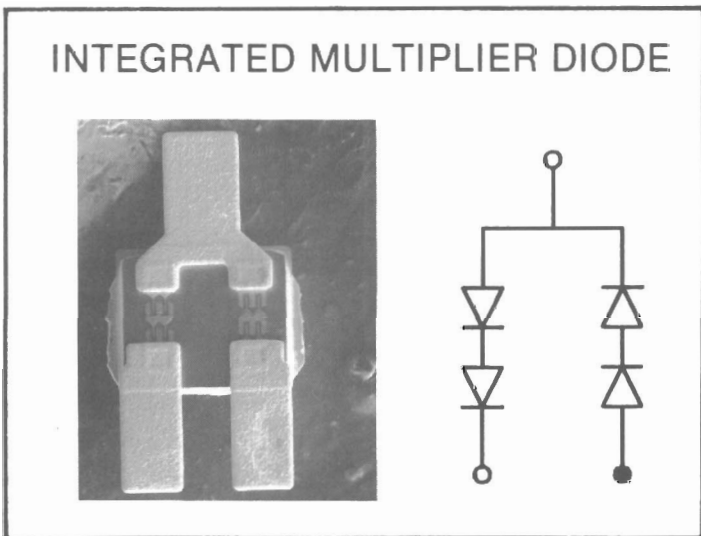

The two diodes for the tripler have well-matched characteristics to suppress even harmonics at the output and the three beam lead connections allow separate biasing of the diodes.

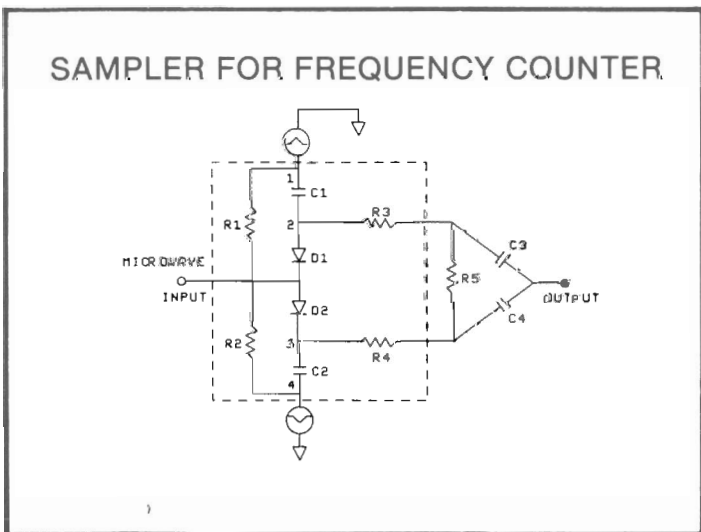

Integrating diodes, resistors and capacitors onto one chip can improve performance by providing matched components and interconnections that are electrically short in length and reproducible. Instrument cost can also be reduced by decreasing the number of separate components that must be assembled. As an example, all of the components shown inside the dashed line of this sampler circuit have been integrated on to a single GaAs chip.

The integrated sampler has two diodes, four resistors and two capacitors on a single chip with beam leads.

## INTEGRATED SAMPLER

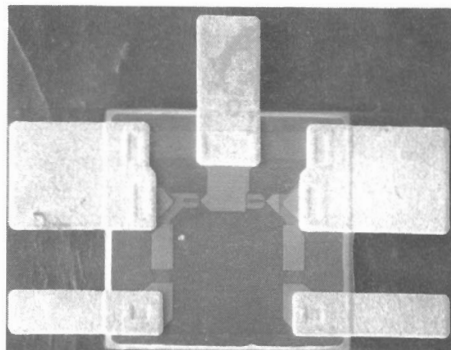

References:

1. R.J. Matreci and F.K. David, "Un-biased Sub-harmonic Mixers for Millimeter Wave Spectrum Analyzers", in 1983 IEEE MTT-S International Microwave. Symposium Sigest, pp. 130-132
2. S. Gibson, "GaAs I.C. Adds Power to Low-cost Frequency Counters", *Microwaves & RF*, Jan. 1985 , pp. 127-132
3. Sze, *Physics of Semiconductor Devices*, 2nd edition.

