

# MILLIMETER-WAVE MULTIPLIERS RELY ON DIODE INTEGRATED CIRCUITS IN FINLINE STRUCTURES FOR HIGH OUTPUT POWER

ARLEN DETHLEFSEN, ROLF DALICHOW,  
DALE ALBIN, DAVID WILSON  
NETWORK MEASUREMENTS DIVISION  
1400 FOUNTAIN GROVE PARKWAY  
SANTA ROSA, CALIFORNIA 95401

**RF & Microwave  
Measurement  
Symposium  
and  
Exhibition**

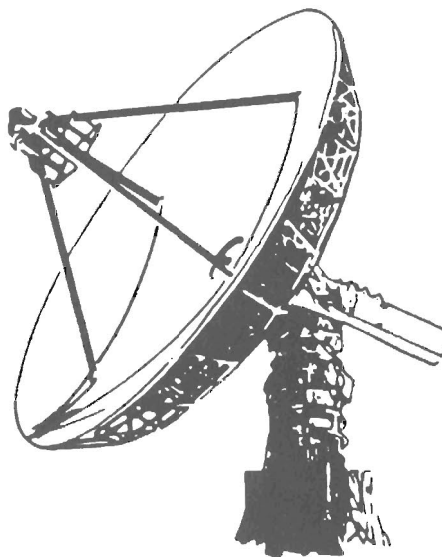

MILLIMETER-WAVE MULTIPLIERS RELY ON  
DIODE INTEGRATED CIRCUITS  
IN FINLINE STRUCTURES FOR HIGH OUTPUT POWER

This paper presents several design aspects of HP's new frequency-multiplying millimeter-wave source modules. The tradeoffs between using fundamental oscillators vs. frequency multiplying techniques are examined, followed by a discussion of various ways of realizing both frequency doublers and triplers at millimeter-wave frequencies. A diode integrated circuit, which forms the heart of both the doubler and tripler circuits by achieving very good conversion efficiency, is also described. The block diagram of the source modules and their typical performance are presented.

Authors: Arlen Dethlefsen, Engineering Section Manager for scalar network measurements, HP Network Measurements Division, Santa Rosa, CA. BSEE and BS (Mathematics), California State Polytech Univ., 1961; MSEE, Northeastern Univ., 1963. Seven years with Bell Telephone Labs. With HP since 1968 designing microwave microcircuits for HP sweepers, then managing sweeper development projects. Now responsible for swept sources and scalar network analyzer development.

Rolf Dalichow, Engineering Section Manager for precision sources, HP Network Measurements Division, Santa Rosa, CA. Ing. grad. degree, Staatliche Ingenieurschule Giessen, W. Germany (1961). Joined HP in 1973 with 12 years experience designing hybrid RF circuits and communications transmitters in Germany and U.S. Was design project leader for portion of HP 8505A RF network analyzer, then project manager for HP 8350 sweep oscillator and its RF plug-ins, also for HP 8349A microwave amplifier and millimeter-wave source modules. Now managing R&D section developing synthesized sweepers, millimeter sources and microwave amplifiers.

Dale Albin, Design Project Leader for 83554A, 83555A, 83556A millimeter sources. BSEE, University of Texas at Arlington, 1977. Joined HP in 1977 as a manufacturing engineer involved with processing and testing of GaAs and silicon transistors. Designed finline couplers, detectors, and triplers for the millimeter sources, as well as 11-20 GHz power amp.

David Wilson, Development Engineer for millimeter sources, HP Network Measurements Division, Santa Rosa, CA. BSEE (1981) and M. Eng. (1983), California Polytechnic State University, San Luis Obispo. With HP since 1981 developing finline components and microcircuits for millimeter sources.

## MILLIMETER-WAVE MULTIPLIERS RELY ON DIODE INTEGRATED CIRCUITS IN FINLINE STRUCTURES FOR HIGH OUTPUT POWER

3606

This paper will give an overview of various methods of achieving millimeter wave swept sources. The concepts of doubling and tripling will be reviewed and the design of millimeter wave doublers and triplers using diode integrated circuits in a finline structure will be described.

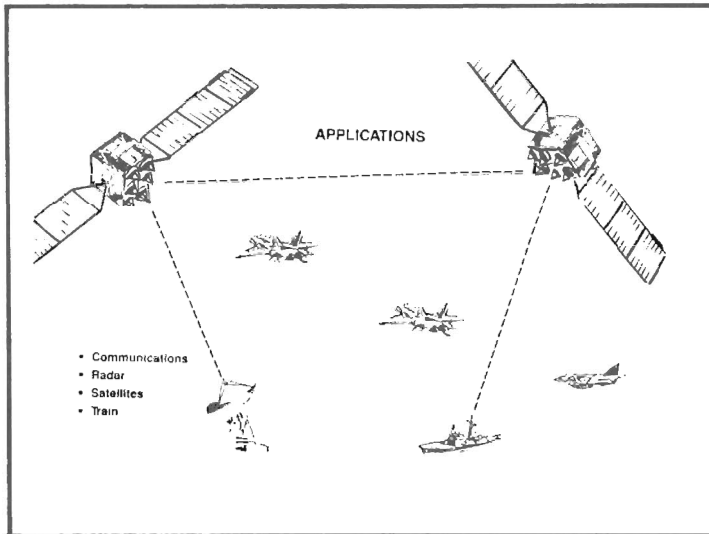

3607

The past ten years have seen increased applications for millimeter waves both in commercial and defense activities. The primary categories have been in the fields of communication and radar.

## MILLIMETER-WAVE PROGRAMS

- Direct Broadcast (20 & 30 GHz)
- Milstar (44 & 60 GHz)
- Guided Munitions (75-110 GHz)
- Helicopter and Tank Radar (85-95 GHz)

3608

Some of the major programs implemented during this period and others still in the development phase are shown here. Because of these programs, the demand for millimeter wave test instrumentation is expected to grow significantly. One of the major instruments needed in these programs are swept solid-state millimeter wave sources.

Before starting the design of millimeter wave sources the design objectives were reviewed and were broken down into the two categories shown here.

## MM SOURCE DESIGN OBJECTIVE CATEGORIES

- Electrical Performance
- User Convenience

3609

Under electrical performance, one of the major design objectives for the sources was a concept capable of working to 100 GHz, as based on the market needs shown earlier. Output power at these frequencies is very important so an attempt was made to achieve relatively high power while maintaining broad frequency coverage. Noise, spurious signals and harmonics were also an important consideration.

## ELECTRICAL PERFORMANCE

- Frequency Coverage
- Tuning Range to Cover Standard Waveguide Bands
- Output Power + 10 dBm to 40 GHz  
+ 5 dBm to 60 GHz  
0 dBm to 100 GHz
- Harmonics < -20 dBc

3610

To be convenient for the user a swept source used for test instrumentation should have leveled and calibrated output power and should be easily frequency-stabilized. Pulse and FM modulation capability are important considerations. Portability and ease of use are also to be considered as well as providing good performance at reasonable cost.

## USER CONVENIENCE

- Leveled and Calibrated Output Power
- Easily Stabilized
- Pulse and FM Modulation
- Portability & Flexibility
- Reasonable Cost

3611

## TECHNIQUES FOR GENERATING MM FREQUENCIES

- YIG Tuned Gunn Diode Oscillators
- YIG Tuned GaAs FET Oscillators
- Impatt Oscillators
- Frequency Multipliers

3612

Currently there are several techniques available that will generate millimeter wave frequencies with solid-state instrumentation. Their main difference is that the first three generators use fundamental oscillators while the last employs a frequency multiplication technique.

### YIG TUNED OSCILLATORS

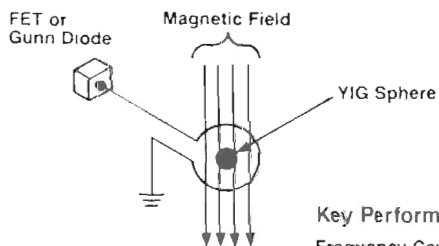

#### Key Performance Data:

Frequency Coverage:  $\leq 40$  GHz  
 Tuning Range: 26-40 GHz  
 Output Power:  $\sim 10$  mW  
 Single Side Band Noise:  $-80$  dBc  
 (100 kHz Offset, 1 Hz BW)

3613

YIG-Tuned oscillators employ Gallium-Arsenide FETs, or Gunn diodes as active devices. These oscillators can tune over a whole waveguide band. At present, the technology on hand cannot manufacture an oscillator that will go beyond 40 GHz. However, they provide good output power and good phase-noise performance.

### IMPATT DIODE OSCILLATOR

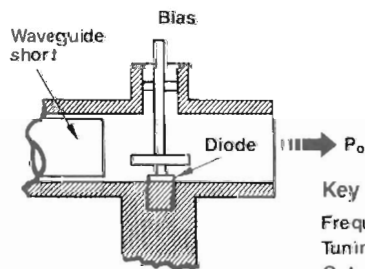

#### Key Performance Data:

Frequency Coverage:  $\leq 160$  GHz  
 Tuning Range: 6-10 GHz  
 Output Power (CW): 1-3 mW  
 Single Side Band Noise:  $-40$  dBc  
 (100 kHz Offset, 1 Hz BW)

3614

Impatt Diode oscillators have been used for many years, and their outstanding feature is that they can operate up to very high frequencies. Their disadvantages are a narrow tuning range and limited output power. Their phase-noise performance is relatively poor.

Frequency multipliers use a non-linear device to create harmonics from a lower frequency. Bandpass filters have to be used to reject unwanted harmonics or subharmonics.

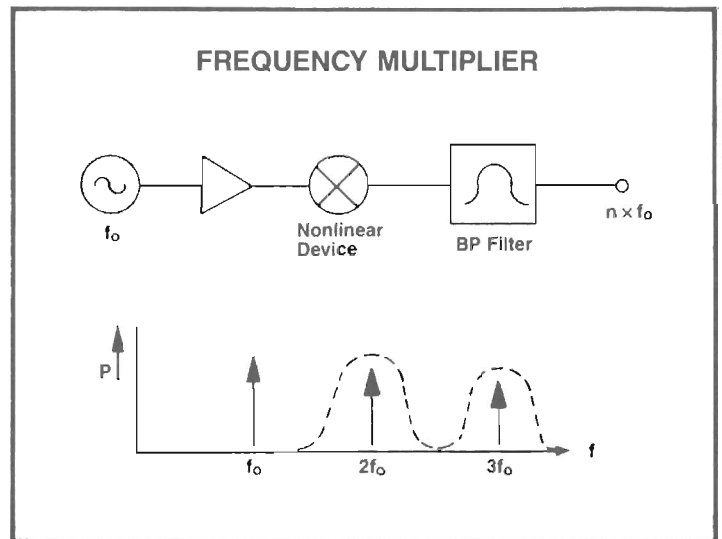

3615

A comparison between the different millimeter wave generators in terms of frequency coverage, tuning range and leveled output power shows their advantages and limitations.

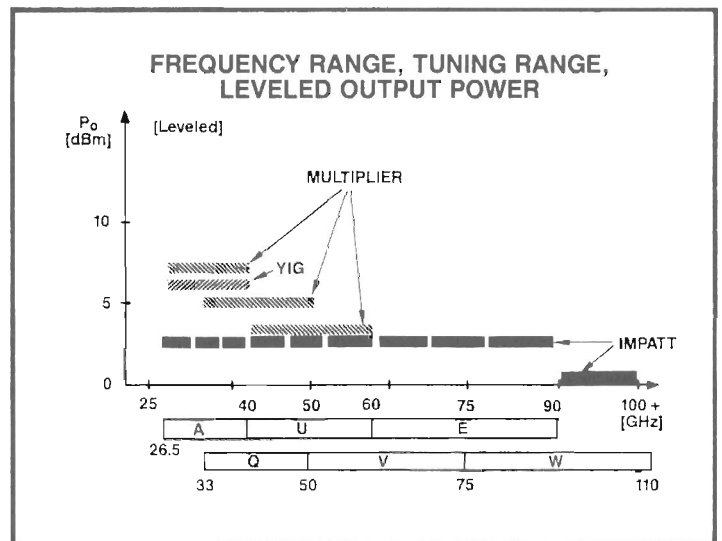

3616

Examining the phase-noise performance of the generators shows a range from the Impatt diodes having the poorest performance to the excellent results achieved by multipliers driven by microwave synthesizers.

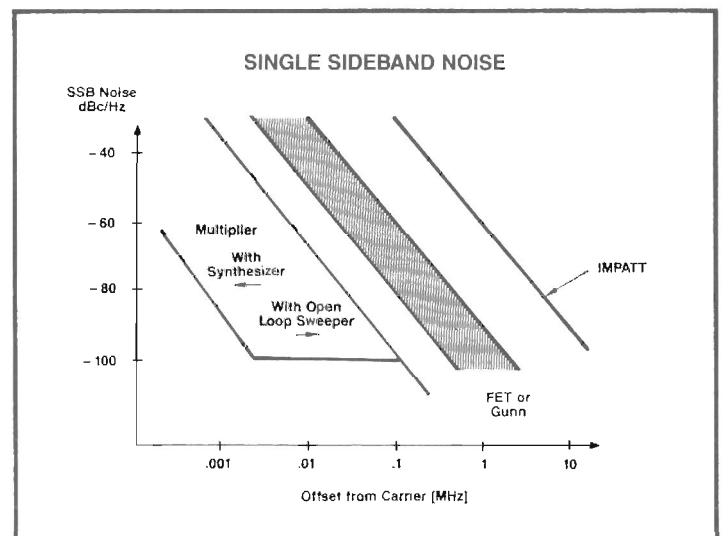

3617

## HARMONICS/SUBHARMONICS

- **Fundamental Oscillators:**  $< -20$  dBc (Harmonics Only)
- **Frequency Multipliers:**  $< -20$  dBc (Harmonics & Subharmonics)

Fundamental oscillators have harmonics better than 20 dB below the carrier. Because the waveguide bands cover less than one octave frequency range, the problem of harmonic signals does not occur if proper low-pass filters are used. The performance of frequency multipliers allows harmonically related spurs to be on the order of 20 dB below the carrier, but these spurs can be in band. This of course can degrade the measurement accuracy and the dynamic range of receivers in certain test setups.

3618

## FUNDAMENTAL OSCILLATOR BLOCK DIAGRAM

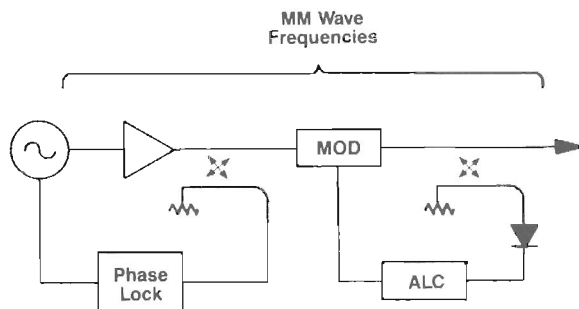

3619

Another aspect to consider is the system performance of fundamental oscillators versus frequency multipliers. If a fundamental oscillator is being used a modulator has to be implemented within the signal pass to provide a levelled output. This modulator reduces available output power by its insertion loss. If a frequency stabilization circuit has to be used the insertion loss of the necessary coupler also reduces the output power.

## FREQUENCY MULTIPLIER BLOCK DIAGRAM

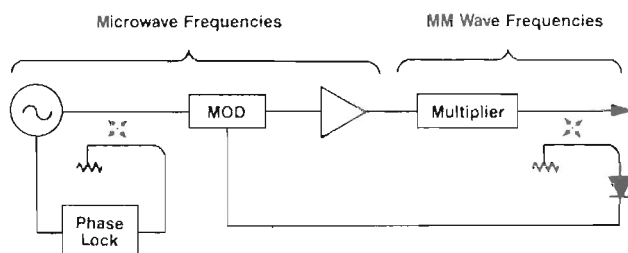

3620

In the case of frequency multiplication, amplitude modulation and frequency stabilization are being performed at the more convenient microwave frequencies, thus reducing the power losses and simplifying the necessary circuitry for phase-lock and leveling. AM and FM modulation techniques are also simplified.

In summary, the advantages of the multiplying concept are in the area of higher broadband output power, full waveguide coverage up to higher frequencies, better phase noise, and improved system performance with respect to phase lock and levelling. The only disadvantage of the multiplying approach is the harmonic/subharmonic performance. Taking all these facts into consideration, the multiplying technique to generate swept millimeter wave frequencies was chosen.

We will now look at the methods of doubling and tripling to achieve frequency multiplication at mm wave frequencies.

Doubling can be achieved by using diodes as full-wave rectifiers. The full-wave rectifier approach generates second harmonics of the input signal which are theoretically 7.4 dB below the input signal level. The fourth harmonic is 21.4 dB below the input signal level. If the circuit is perfectly balanced there will be no odd-order products.

## ADVANTAGES OF MULTIPLYING TECHNIQUE

- High Output Power
- Full WG Bandwidth Coverage
- Phase Noise
- System Performance

3621

## FREQUENCY MULTIPLICATION METHODS

- Doubling
- Tripling

3622

### DOUBLING CONCEPT

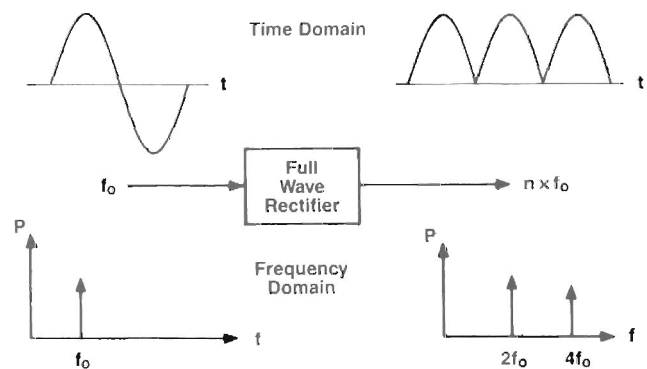

3623



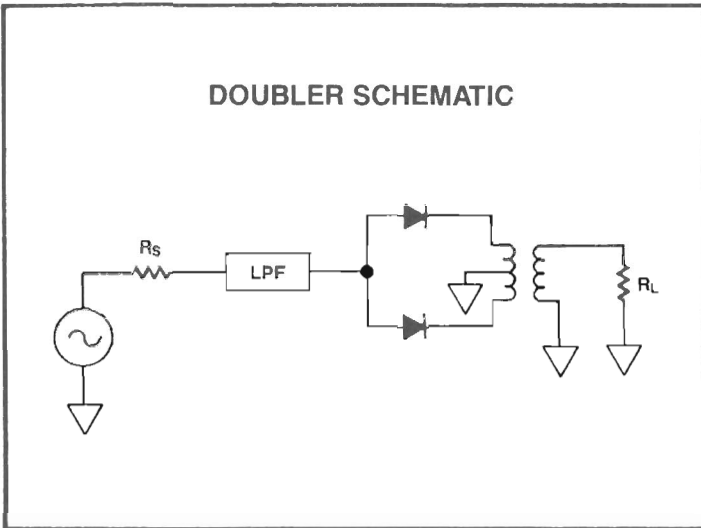

3624

A schematic for doubling is shown here. The input signal is rectified by the diodes and the second harmonic is coupled to the load by the transformer.

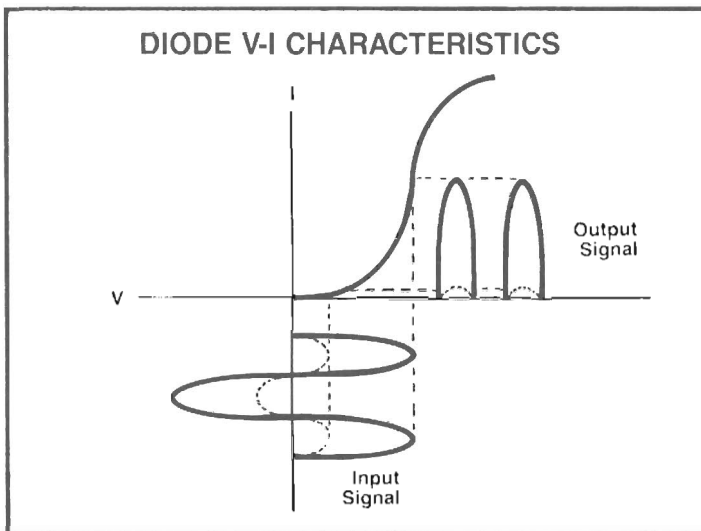

3625

In the doubler design, the diodes are not completely turned on at low input power levels so the conversion loss is high. As input power increases the conversion loss improves until the diodes begin to experience current saturation.

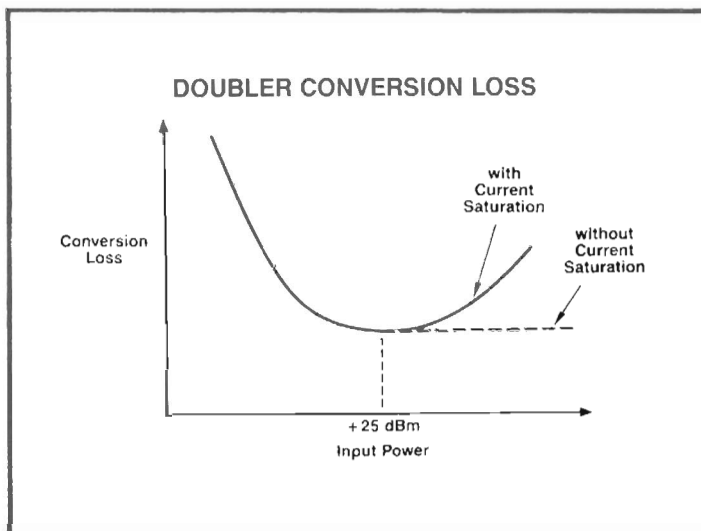

3626

This results in a conversion loss that varies as a function of input power as shown in this slide. If current saturation does not occur the conversion loss remains constant once the diodes are fully turned on.

Tripling at millimeter frequencies can be achieved by symmetrically clipping the input signal with a limiter. This technique generates odd order products and if the wave is completely symmetrical there will be no even-order products.

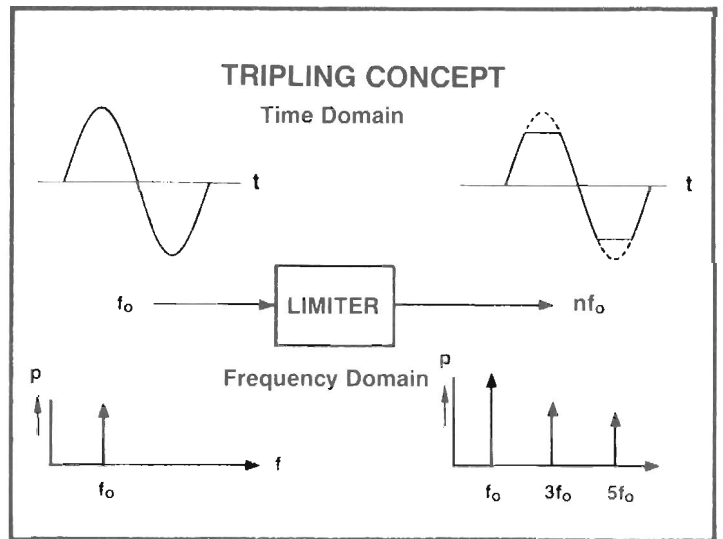

3627

In the tripler schematic shown the input signal,  $f_0$ , is limited by anti-parallel diodes. The diodes conduct when the input voltage exceeds the barrier height of the diode, thereby clipping the input wave.

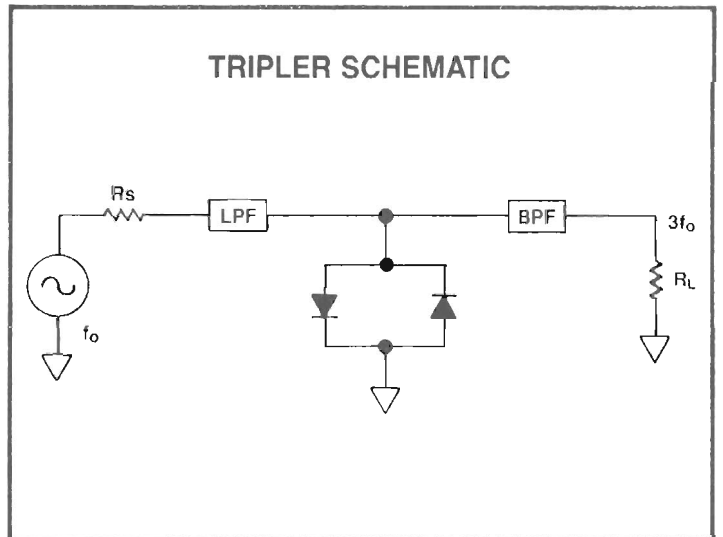

3628

Since there will be little clipping at small input levels there will only be a small third order component generated. Therefore the conversion loss at the tripled frequency will be high. As the input power increased the clipping is greater resulting in less conversion loss. As the signal continues to increase the output waveform does not change significantly. This causes the conversion loss of the tripler to once again begin to increase.

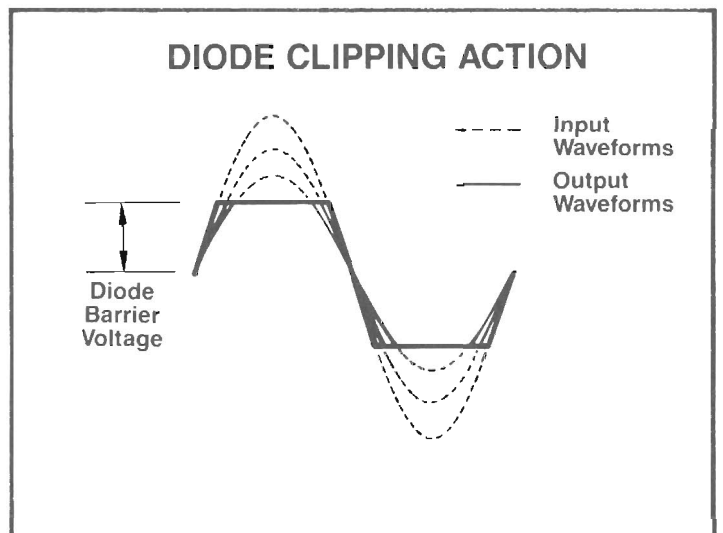

3629

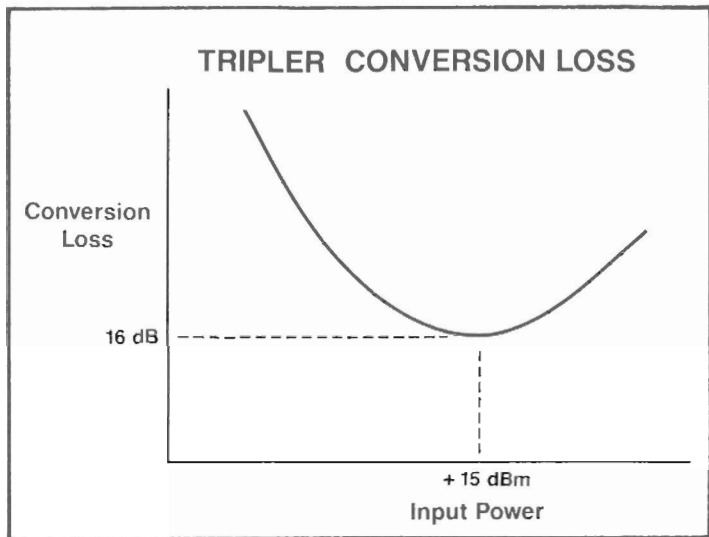

3630

Since the barrier height of the diode is small, the minimum conversion loss of the tripler occurs at a relatively low input power of +15 dBm as shown here. This presents a problem if the tripler is expected to deliver high output power.

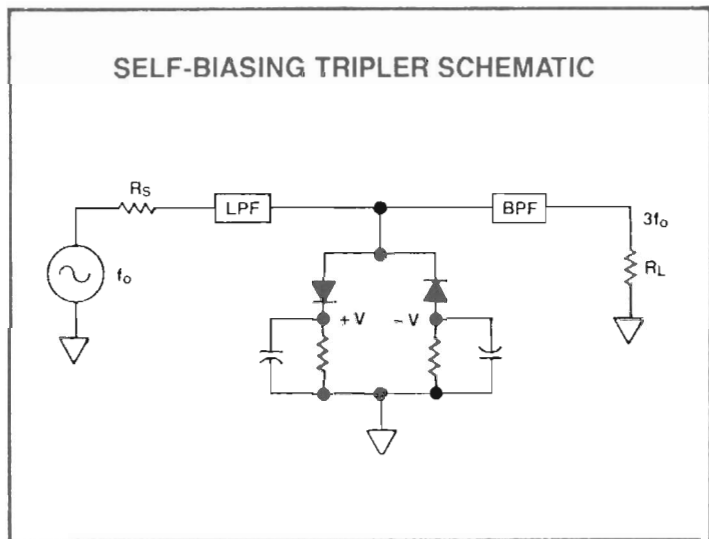

3631

In order to maintain low conversion loss at high input power levels a self-biasing technique was used in which the diode bias is increased with increasing input power, this was accomplished by the addition of resistive/capacitive elements attached to the diodes.

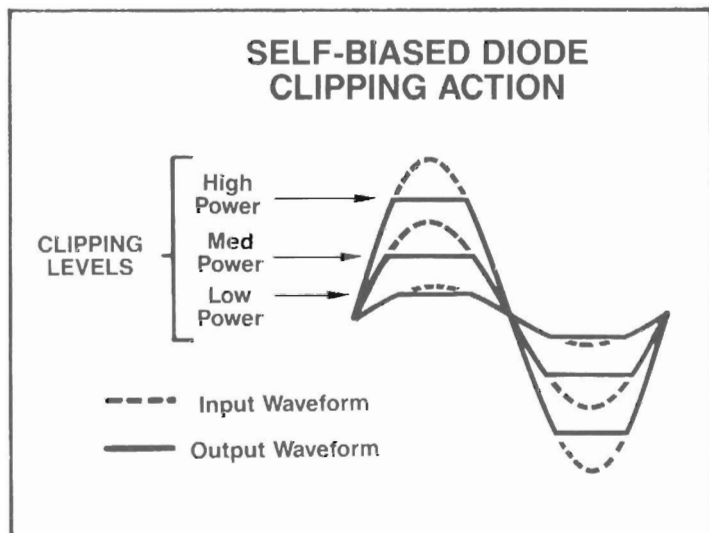

3632

The output waveshapes of the self-biased tripler shown here indicate how the tripler automatically adjusts to the input signal power level. As the input power increases the self bias increase causing the diode clipping to occur at higher voltage levels.

It can be shown by Fourier analysis of a clipped sinusoid that for minimum conversion loss the input signal should be clipped approximately at 0.6 of its peak value.

The resulting tripler conversion loss as a function of power for the self-biased tripler is shown here.

Now that it has been shown how to double and triple signals using diodes as the nonlinear device, it is necessary to focus in on the type of diode needed to provide the performance objectives at millimeter frequencies. In order to determine the diode parameters we had to determine block diagram possibilities first. Two presented themselves. The amplifier, to compensate for the occurring conversion losses, could have been placed before or after the actual multiplier circuit. If it had been placed after the multiplier, its frequency range would need to be the same as the output frequency. At the present time, however, there are no broadband solid state amplifiers available which work above 40 GHz. Placing the amplifier in front of the multiplier requires that the multiplier diodes be able to handle high rf power levels. We chose to opt for this approach because we wanted to cover frequencies in excess of 40 GHz.

Once the decision was made to use high-power input signals to the multiplying diodes it proved necessary to design a millimeter diode capable of handling input powers on the order of +27 dBm. This required breakdown voltages of greater than 16 volts and current densities of less than  $1 \times 10^6$  amps per square centimeter to assure the reliability of the device. In addition, diode symmetry was necessary to assure a low level of unwanted harmonic products. Low diode resistance and capacitance have to be present in the diode if they are to work up to 100 GHz.

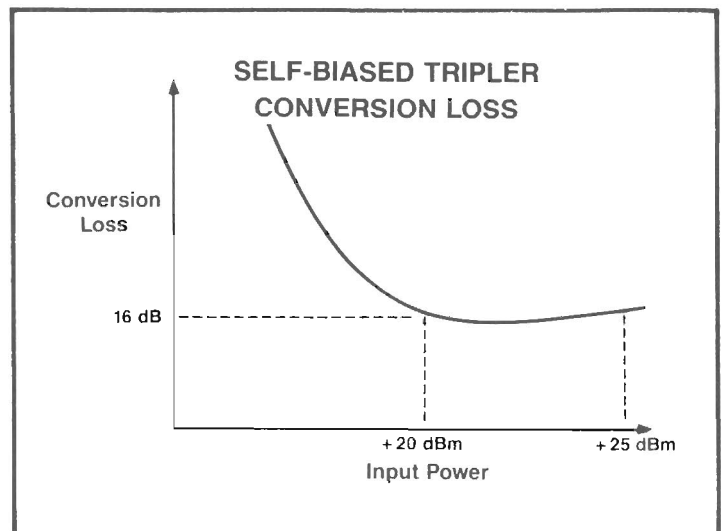

3633

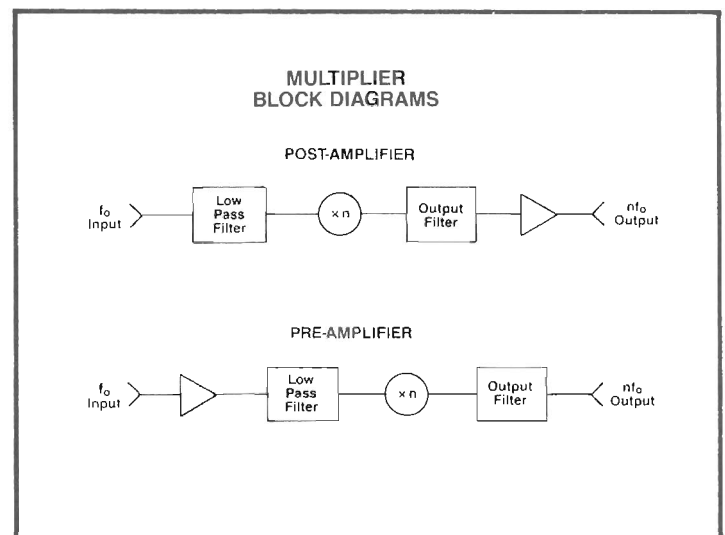

3634

## DIODE ELECTRICAL REQUIREMENTS

- +27 dBm of Input Power
- > 16 V Breakdown Voltage
- Current Density up to  $< 1 \times 10^6$  AMPS/CM<sup>2</sup>
- Capacitance < 50fF to 100 fF
- Better Than 5% Symmetry

3635

## MM DIODE INTEGRATED CIRCUITS

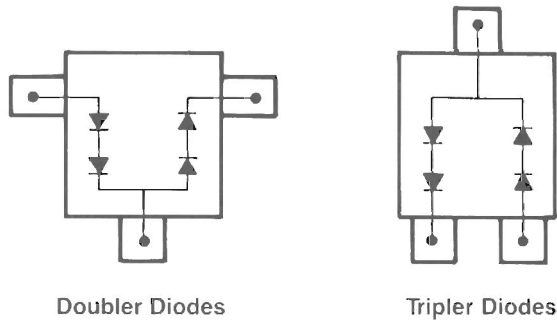

3636

These diode parameters were achieved by designing the diodes on millimeter integrated circuits mounted in a beam lead package. This allowed multiple diode configurations which would achieve the breakdown voltage and current density requirements. It also minimized the diode stray capacitance and inductance.

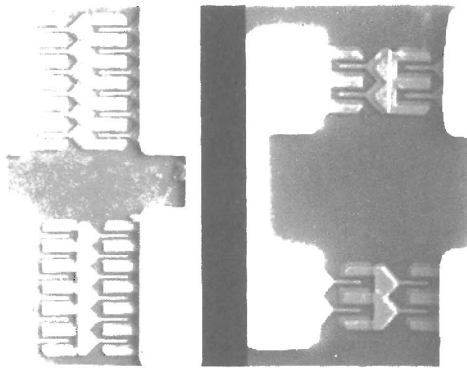

DOUBLER IC

TRIPLER IC

3637

Photographs of the integrated circuit diodes are shown here. The multiple fingers can be seen which allow the diodes to handle high input power while keeping the current densities low. The doubler circuit requires more fingers because the diodes conduct more current than the tripler diodes. The doubler integrated circuit can handle +30 dBm of input power without experiencing current limiting.

## FINLINE STRUCTURE

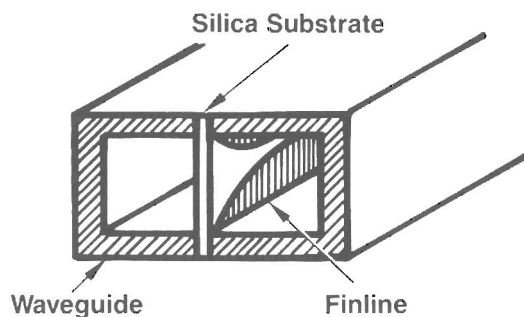

3638

Since it was a design goal to have the sources go to 100 GHz it was necessary to provide a means to take an input signal of 10 to 20 GHz in a coaxial configuration, multiply it and then couple it into a waveguide environment. The method that was used involved the finline structure. The structure is shown in this slide. The finline structure is a modified form of double-ridged waveguide whose ridges are very thin metallizations supported by a dielectric substrate. This structure makes a convenient method of transition between a coax input and waveguide output. It also allows for easy integration of multiple functions such as filters, couplers, and detectors. All of the critical dimensions are confined to the thin film circuits. Since these circuits are produced using standard thin film technology, the manufacturing process maintains dimensional integrity without adding undue cost.

These multiplying concepts have first been implemented in the three sources shown here.

## MM SOURCES

- 26.5-40 GHz Doubler
- 33-50 GHz Tripler
- 40-60 GHz Tripler

3639

The overall block diagram of the 26.5 - 40 GHz doubler source is shown here. It has an input power amplifier, low pass filter and doubler. The directional coupler and detector are used for leveling and power sensing.

### 26.5-40 GHz SOURCE BLOCK DIAGRAM

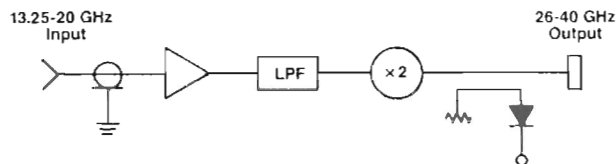

3640

The input power amplifier shown here has a frequency range of 11 to 20 GHz, gain of 9 dB and a saturated output power of +25 dBm. The output stage consists of two GASFET transistors combined with a Wilkinson combiner. This amplifier was designed to be the driver for all the multipliers.

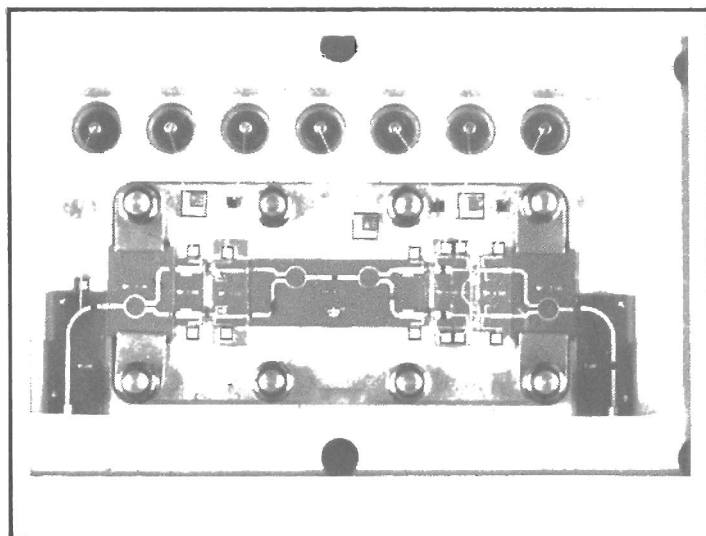

3643

## DOUBLER CIRCUIT REALIZATION

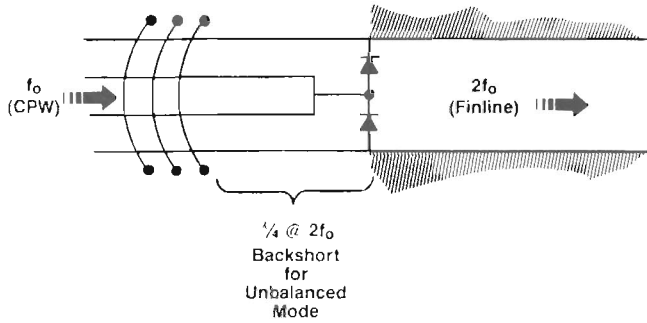

3641

A number of different techniques could be used to realize the full-wave rectifier doubler. The technique that was used is shown here. The input signal is applied to the diodes by a thin film coplanar waveguide transmission line. The rectifying diodes are placed at the coplanar wave-slot line junction. The second harmonic is back shorted by bondwires across the slot line. This back short also reduces the fourth harmonic, since it is a half wavelength long at the fourth harmonic frequency.

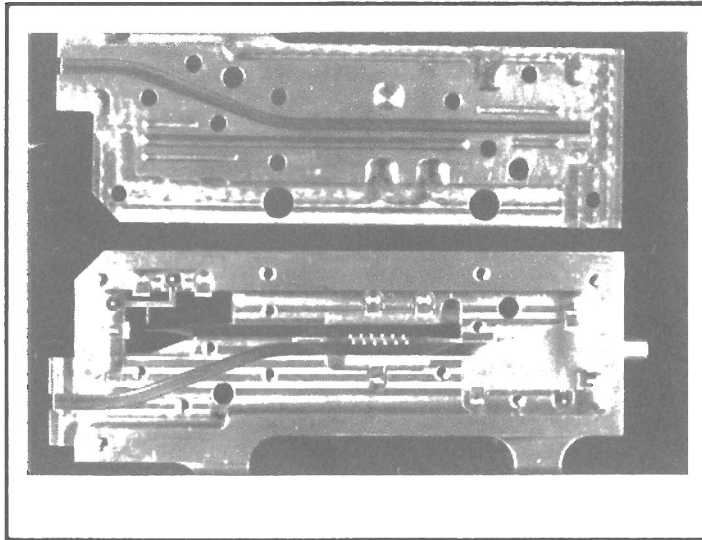

3642

This slide shows the coplanar input circuit, the directional coupler/detector mounted in the finline structure. The cover contains the slots necessary to complete the other half of the waveguide structure. It also contains millimeter wave absorptive material to eliminate unwanted resonances.

## 26.5-40 GHz DOUBLER OUTPUT POWER

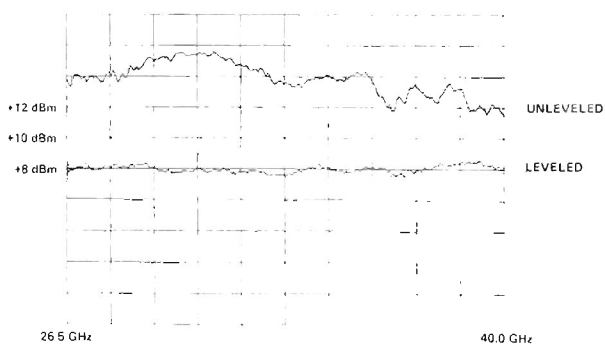

3644

The typical output power of the 26.5 - 40 GHz source is shown here.

The leveled output power is at +8 dBm and is flat to within +1dB. The unleveled output power of the unit is typically greater than +11dBm. The unwanted harmonically related signals are greater than 30 dB below the desired signal.

The overall block diagram of the tripler is shown here. It uses the same input amplifier as the doubler.

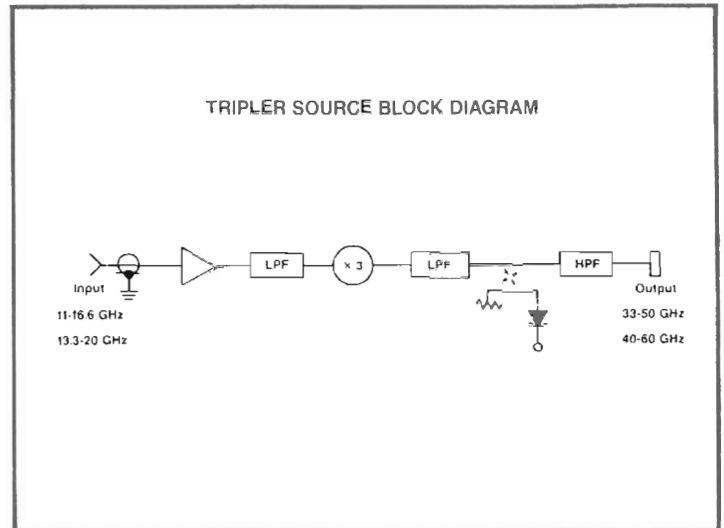

3649

The self biased tripler circuit was realized by designing the input low pass filter on a thin film co-planer wave structure. The anti-parallel diodes are placed across the wave-guide in a finline structure. The backshort is set to be a quarter wave at the third harmonic of the input signal. The high pass filtering is accomplished by using reduced width wave guide. The lower order signals are filtered by the cut-off frequency of the finline structure.

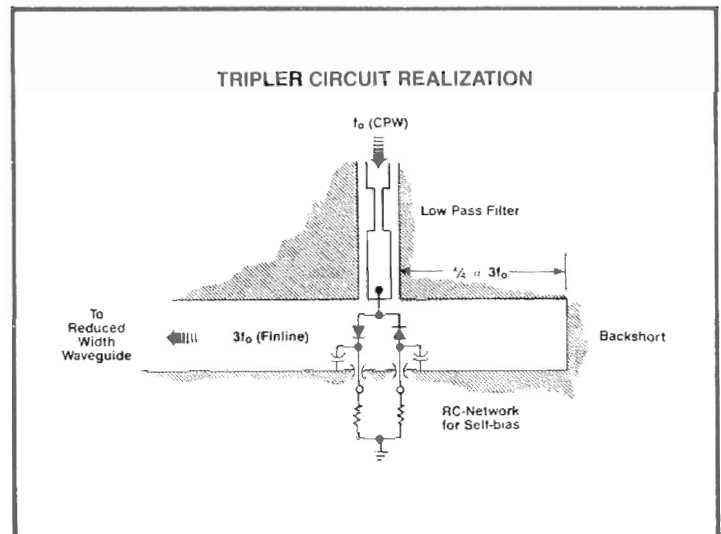

3646

The 40 - 60 GHz tripler source is shown here. The input circuit with the low-pass filter can be seen. Filtering of unwanted harmonics are provided by the highpass filter structure machined into the waveguide.

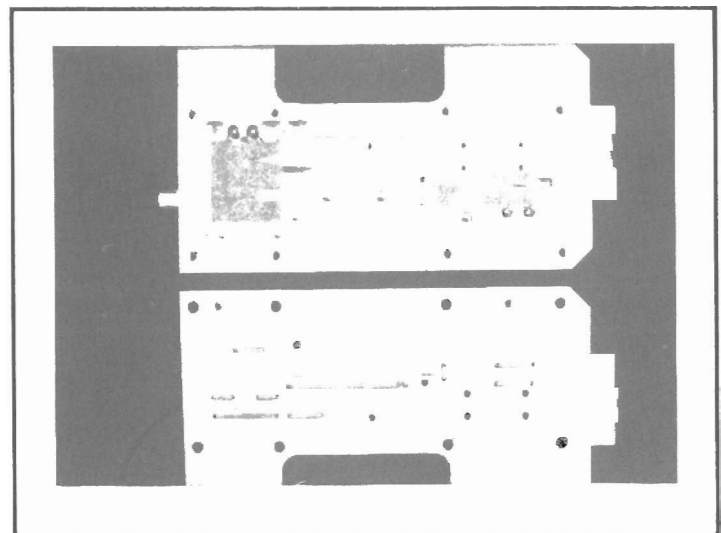

3647



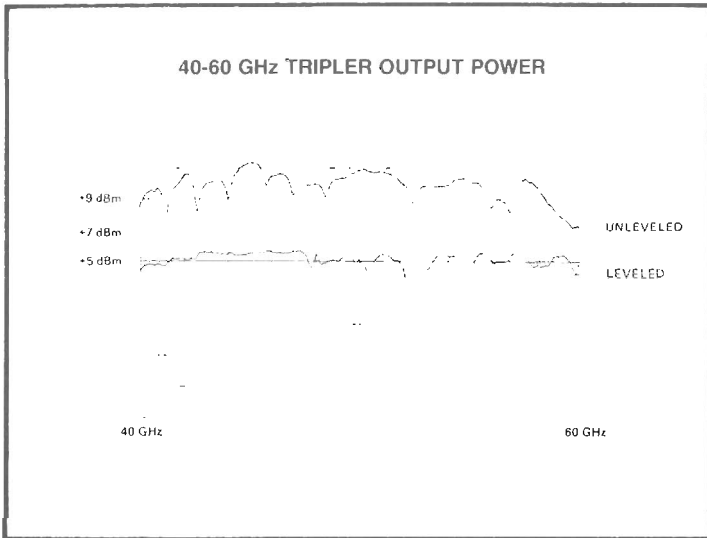

3648

The typical output power of the 40 - 60 GHz source is shown here. The leveled output is shown at +5 dBm. It can be seen that the typical output power is greater than +7 dBm for this unit. The unwanted harmonic products occurring at 2/3 and 4/3 the output frequency are more than 20 dB below the desired signal.

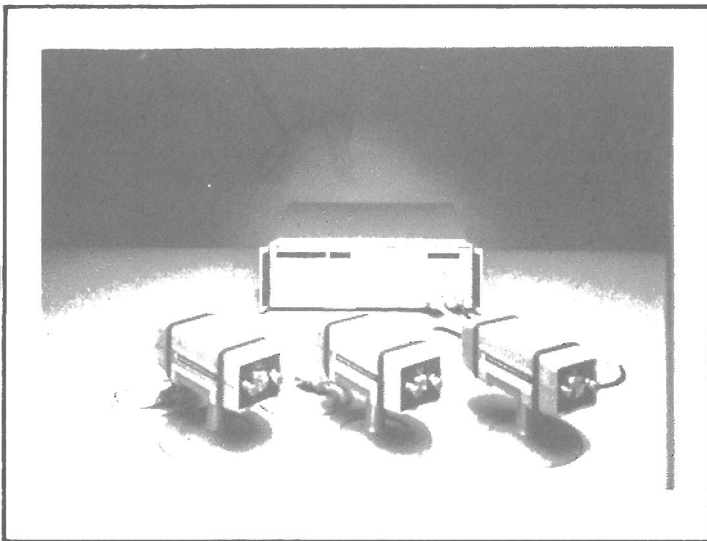

3703

In summary, we have shown that a broadband millimeter source capable of relatively high output power and good harmonics can be achieved using millimeter diode integrated circuits as a multiplying device. The objectives of user convenience and circuit integration were achieved using the finline structure in a small, portable unit which can easily be driven by either a microwave sweep oscillator or synthesizer as shown in these slides. These concepts can be readily extended to provide millimeter sources up to frequencies of 100 GHz.

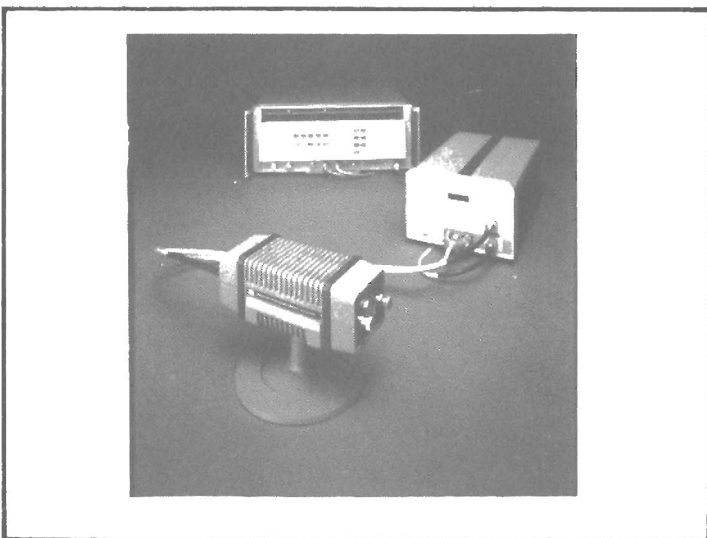

3704

