

AUTOMATED VECTOR NETWORK ANALYSIS AT MILLIMETER-WAVE FREQUENCIES

JEFF CAUFFIELD

Network Measurements Division
1400 Fountain Grove Parkway
Santa Rosa, Ca. 95401

**RF & Microwave
Measurement
Symposium
and
Exhibition**

 **HEWLETT
PACKARD**

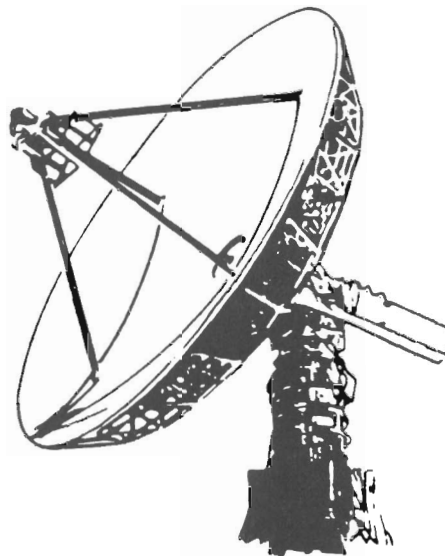

AUTOMATED VECTOR NETWORK ANALYSIS AT MILLIMETER-WAVE FREQUENCIES

This paper describes both the hardware and software techniques used to extend the measurement capabilities of the HP 8510 network analyzer to cover the 26.5 to 60 GHz waveguide bands using available hardware. System operation, methods of calibration, calibration standards, and other factors affecting system performance will be discussed. Measurement results, including group delay and time domain, will be shown for a variety of devices.

Author: Jeff Cauffield, R&D Engineer, HP Network Measurements Division, Santa Rosa, CA. BS Engineering Physics (1977) and Master of Engineering (1978), Cornell University. With HP since 1978, contributed to the design of the HP 8510A Network Analyzer. Currently involved with the extension of the HP 8510 to millimeter-wave frequencies.

AUTOMATED VECTOR NETWORK ANALYSIS AT MILLIMETER-WAVE FREQUENCIES

3651

OUTLINE OF TOPICS

I. DESCRIPTION OF SYSTEM

II. CALIBRATION

III. SYSTEM PERFORMANCE

IV. TYPICAL MEASUREMENTS

3652

I. DESCRIPTION OF SYSTEM

3653

Hardware and software techniques used to extend the measurement capabilities of the HP 8510A Network Analyzer to cover the 26.5 to 60 GHz waveguide bands using available hardware will be described. Calibration standards and techniques will be discussed and results demonstrated. Factors affecting system performance are explained. Finally, measurement results on typical devices will be shown, including group delay and time domain.

Some key features of the system include: a dynamic range of 80 to 100 dB depending on averaging, data acquisition rate, and accuracy similar to a microwave HP 8510 operated in stepped CW mode, stimulus control via an external calculator, bypassing the HP 8510 samplers for less conversion loss, and a reflection/transmission test set with flexible heads. These features offer impressive new measurement capabilities.

FEATURES

- Dynamic range of 80 to 100 dB depending on averaging.
- Accuracy and speed similar to microwave HP 8510 stepped CW operation.
- Series 200 controller replaces HP 8510 stimulus block. Sources are controlled by calculator, not HP 8510.
- No HP 8510 series test set required. No sampler conversion loss.
- Reflection/Transmission test set with flexible heads.

3657

The simplified block diagram shows the HP 8510 Network Analyzer, two 8341 Synthesizers, 8349 Power Amplifier, doubler or tripler, reflection/transmission test, and an HP 9000 Series-200 Computer. Portions of the incident, reflected, and transmitted signals are coupled from the main signal path and applied to each of three millimeter-wave harmonic mixers. One synthesizer, amplifier, and multiplier serves as the millimeter source. The other synthesizer serves as the common local oscillator for each of the harmonic mixers. Frequencies are chosen so that the intermediate frequency is exactly 20 MHz which is routed directly to the 85102 IF/Detector bypassing the standard HP 8510 Test Set.

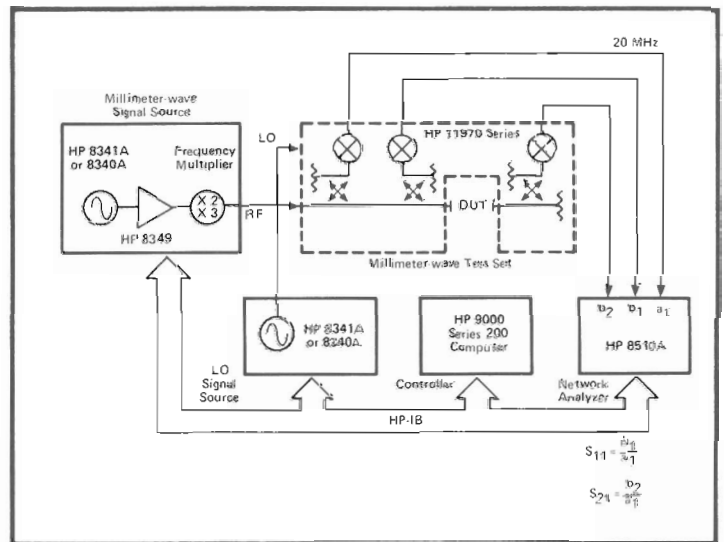

3654

The reflectometer head consists of a frequency multiplier for the millimeter source, a dual arm directional coupler to sample incident and reflected signals, and two harmonic mixers. Isolators (optional) can be used for improved source match and mixer spur reduction. A 2-8 GHz power splitter provides a common LO to the harmonic mixers. IF preamplifiers are used to raise the signals to the proper level for the HP 8510. The reflectometer head generally remains fixed. Incident power can be leveled at the 20 MHz IF, the 11-20 GHz multiplier input, or at the millimeter output frequency.

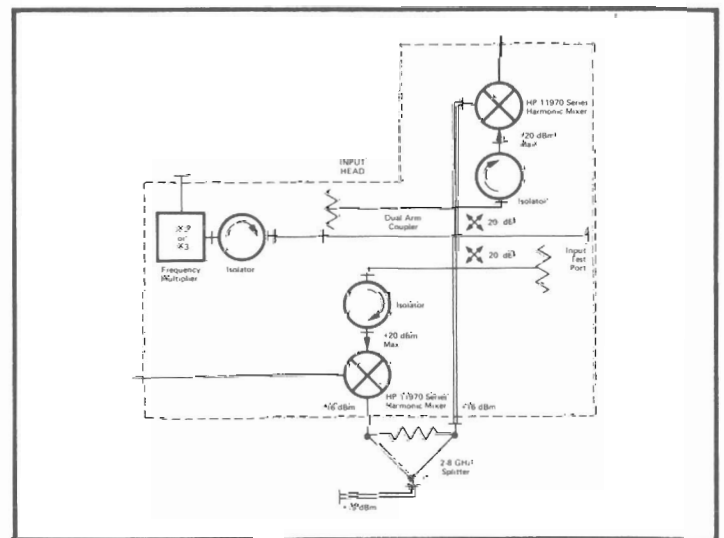

3655

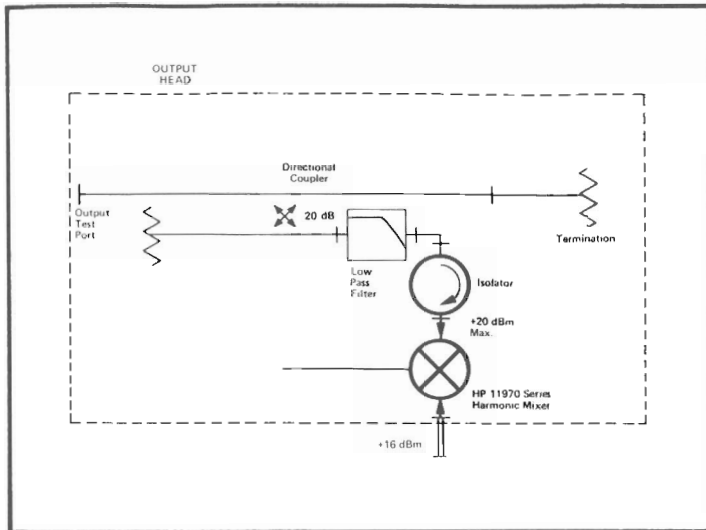

3656

BLOCK DIAGRAM NOTES

- System departs from the traditional mix-up, mix-down and sample block diagram.
- Multiply up, mix down directly to 20 MHz I.F.
- 3 Bands (R,Q,U) 26.5 GHz to 60 GHz.
- Easy to change bands.
- System is easily duplicated

* Reference: HP Product Note 8510-1A

3658

OPERATING CONSIDERATIONS

- HP 8510 feature set is preserved, including time domain
- No phaselock. 20 MHz I.F. is guaranteed by synthesis.
- HP 8510 requires 20 MHz I.F. exactly for proper averaging.
- Controller computes millimeter test frequencies for exact 20 MHz I.F.
- Incident power leveled.

3659

The transmission head consists of a single directional coupler, termination, low-pass filter and isolator, and harmonic mixer. The low-pass filter and isolator are recommended for best dynamic range as they reduce mixer spurs. The transmission head LO uses a long, .141-inch, semi-rigid cable for flexibility. The head can be moved to allow insertion of the device under test eliminating the need for a custom waveguide return path. Electrical lengths are not balanced due to the mix of dispersive waveguide and non-dispersive coaxial cable. At the least, a simple frequency response calibration balances the lengths. Frequency drift is not a problem since the millimeter source is synthesized.

The multiply-up, mix-down-directly technique offers improved dynamic range. Commercially available hardware exists to assemble millimeter systems in the WR-28, WR-22, and WR-19 waveguide bands. Because of the modular nature of the reflection and transmission heads, one millimeter system can cover three waveguide bands. The heads are easy to change in a matter of minutes. Because of the use of off-the-shelf hardware, the system is easily assembled and duplicated.

The use of the external controller for stimulus control only preserves the entire feature set of the HP 8510 including calibration, time domain, display formats, plotting, etc. There is no phase lock, the proper IF being guaranteed by frequency synthesis from a common time base. The IF must be exactly 20 MHz for the averaging algorithm to work correctly. This task is taken care of by the external controller. Incident power can be leveled at the IF of 20 MHz, the multiplier input of 11-20 GHz, or directly at millimeter frequencies. Most of the data taken here used IF leveling.

The external controller software performs two principal functions: stimulus control and calibration kit definition. The controller replaces the STIMULUS menu (frequency domain only) on the HP 8510 front panel and issues all commands to the millimeter source and local oscillator. After program initialization, a band selection menu appears. The band is specified and the appropriate calibration kit is loaded into the HP 8510. Next, the STIMULUS menu appears allowing choice of number of points, start and stop frequency, and source power. Default values can be used if desired. Then the measurement loop is entered until interrupted by a key hit from the HP 8510A, resulting in return to local control.

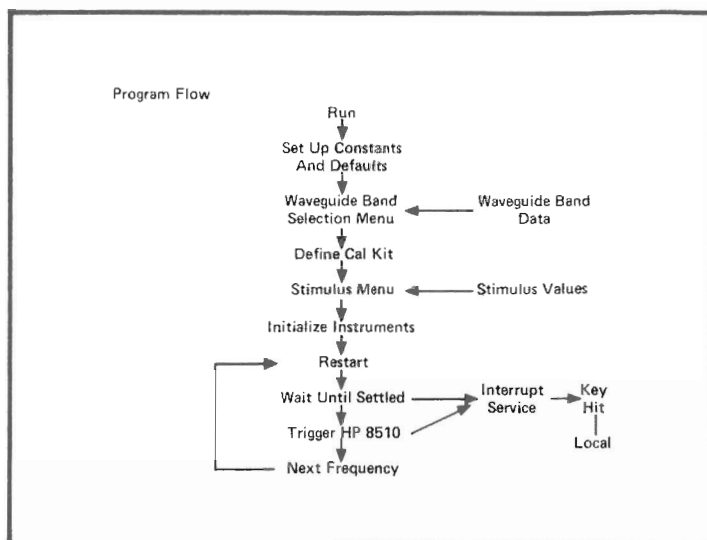

3670

The user need only follow these steps:

1. RUN
2. Select waveguide band
3. Select stimulus values
4. Perform calibration
5. Save instrument state
6. Measure device under test

The stimulus settings on the HP 8510 must match those in the controller. In recalling instrument state, the controller has no way of knowing if calibration set stimulus matches its stimulus settings. The responsibility rests with the user.

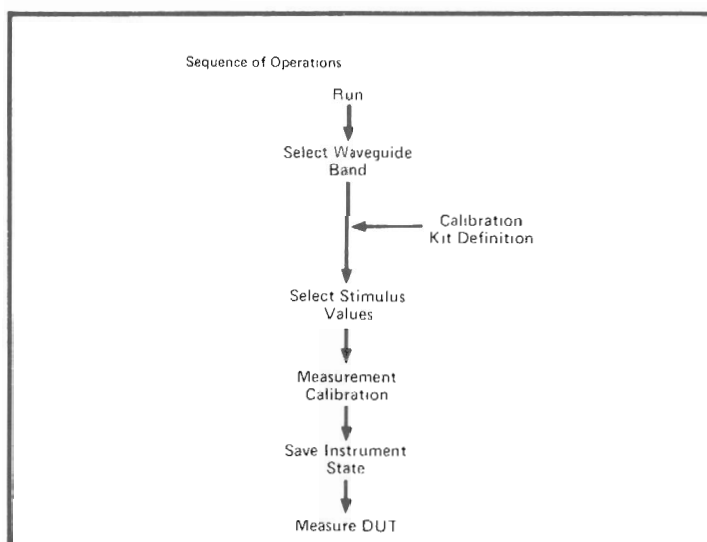

3672

This polar plot shows the short-term phase stability of a_1 , the incident power signal. This was done at a CW frequency. If the IF (intermediate frequency) were not exactly 20 MHz, then a_1 would rotate around the chart at a rate corresponding to the difference from 20 MHz. For the averaging algorithm to work properly, a_1 must be phase stable. The short-term deviation of about 10 degrees results from the multiplied phase noise of both the RF and LO. The absolute phase of a_1 is common with b_1 and b_2 , hence, is ratioed out in the computation of S-parameters.

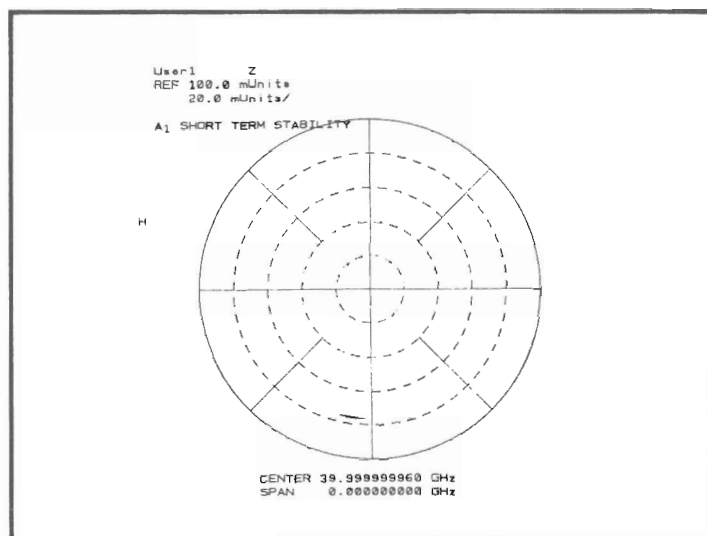

3672

OTHER TECHNIQUES

POWER METERS / SIX PORT

- cost effective magnitude or vector measurements
- slow speed or CW measurements only
- limited dynamic range

SCALAR NETWORK ANALYZERS

- cost effective magnitude measurements
- limited dynamic range

UP-CONVERT, DOWN-CONVERT, AND SAMPLE

- uses existing microwave analyzer
- multiple conversion limits dynamic range

Other techniques for millimeter-wave measurements have made use of power meters, scalar network analyzers, and existing microwave network analyzers. Dynamic range was limited by detector linearity, sensitivity, or multiple frequency conversions. This system, however, combines high dynamic range, vector accuracy enhancement, and relatively fast data acquisition. In addition, the feature set of the HP 8510 is retained. Multiple data formats, time domain, and other system functions were not re-invented in the controller.

3673

II. CALIBRATION

3674

TYPES OF CALIBRATION

FREQUENCY RESPONSE: short or thru standards
-corrects magnitude and phase tracking

ONE-PORT: short, offset short, sliding load
-vector correction of directivity, source match, tracking

ONE-PATH TWO-PORT: one-port plus thru and isolation
-measures 4 s-parameters with R/T test set
-device must be reversed

Various methods of calibration exist which require a differing number of standards, complexity, time required to perform, and results. The simplest and fastest is a frequency response calibration with a short for reflection or a thru for transmission. Only magnitude and phase frequency tracking errors are corrected. The one-port calibration requires three standards and several measurements but provides vector correction of directivity, source match, and tracking. A one-path, two-port calibration is used with a reflection and transmission test set and provides vector correction of four S-parameters. The device under test must be manually reversed, however.

3675

A flush short which can be used in combination with a quarter-wave shim is shown. The screw holes are such that the same captive screw can be used to hold the shim in place as well as the flush short by itself. The thickness of the shim must be measured exactly and entered into the calibration kit. These standards are commercially available as part of the HP 11644A calibration kit. They are manufactured to better tolerances than the standard flange but are still compatible. In addition, alignment pins can be used to improve performance.

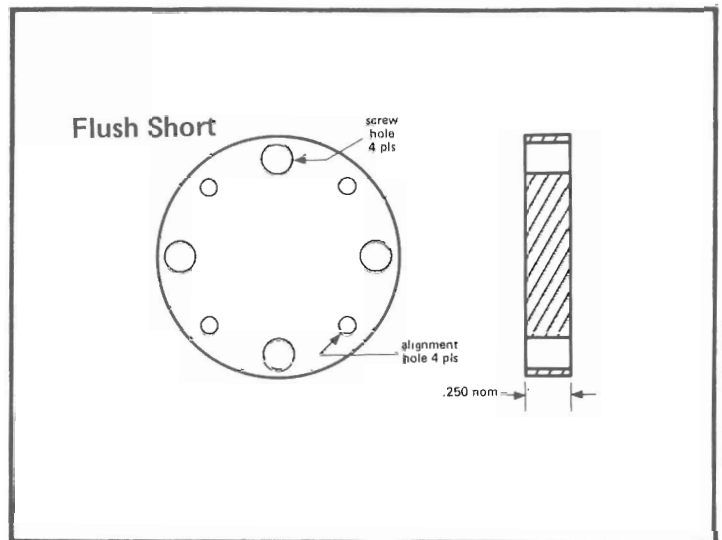

3676

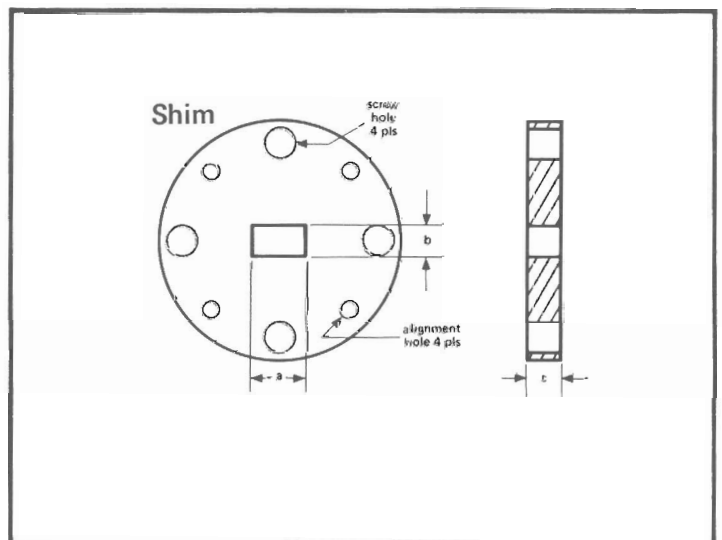

3677

Uncorrected source match and directivity cause ripples in the measurement of an offset short. In this case, the short is at the end of 3 inches of WR-19. The return loss is measured with two different calibrations. The large (1.5 dB) ripples result from a simple frequency response calibration with 24 dB source match and 32 dB directivity. Source match is the primary contributor. The smaller (.2 dB) ripples result from a one-port calibration with 38 dB source match and 40 dB directivity. The vector accuracy enhancement results in a superior measurement. The round-trip loss to the short is seen to be about .3 dB.

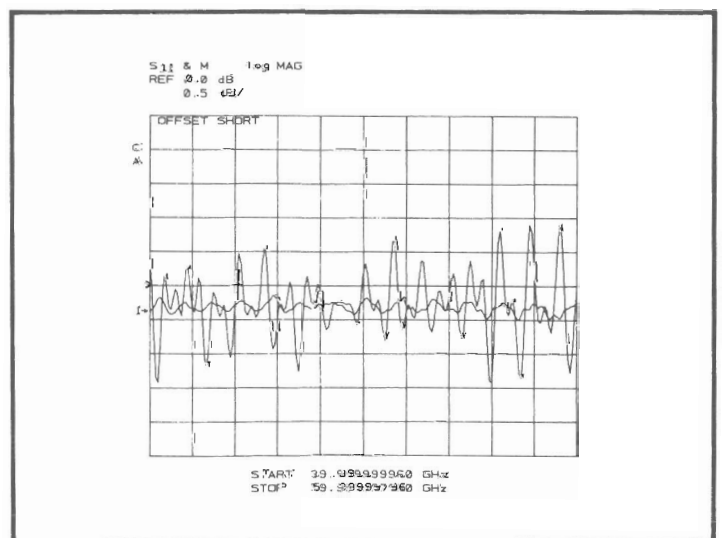

3678

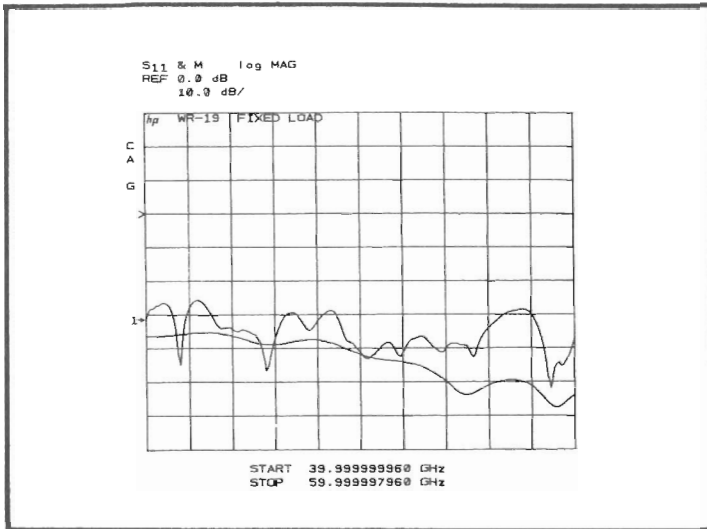

3679

The return loss of a fixed load specified at 32 dB was measured using two different calibrations. The upper trace used a simple frequency response calibration with a flush short. The load appears out of specification. However, this is due to the uncorrected directivity of about 30 dB. The lower trace used a one-port calibration with a flush short, offset short, and a sliding load. In addition, time domain gating was used around the test port flange and load. This further reduces directivity and source match errors. The fixed load is now seen to be within specification at 35 dB worst case.

III. SYSTEM PERFORMANCE

3680

BAND (GHz)	MIXER HARMONIC NUMBER	TEST SIGNAL RESOLUTION (HP 834X bandno x freq. multiplier, Hz)	LEAST COMMON MULTIPLE (Hz)	RESOLUTION FREQUENCY (Hz)
26.5-40	8	3 x 2	24	24
33-50	10	33-40.5 GHz: 2 x 3 40.5-50 GHz: 3 x 3	30 90	90
40-60	10	40-40.5 GHz: 2 x 3 40.5-60 GHz: 3 x 3	30 90	90

3681

Because the HP 8510 IF must be exactly 20 MHz, certain constraints are placed upon the millimeter source and local oscillator. The LO can move in 1 Hz steps and is multiplied by 8 or 10 times in the harmonic mixers. The microwave input to the doubler or tripler can move in 2 or 3 Hz steps. The millimeter test frequency must be an integer multiple of the least common multiple of all the multiplication factors. The software in the external controller calculates start and stop frequencies based on these constraints. The worst case deviation from the desired frequencies is equal to the number of points times half the resolution frequency (18 kHz worst case).

Measurement speed is proportional to the number of points and also a function of how many averages are taken at each point. Stepping between points and waiting for the synthesizers to settle requires about 70 ms. The number of points can be 51, 101, 201, or 401. Averaging number can be 1 to 4096 in powers of 2. The system defaults to 201 points and 64 averages which take little time. This results in a sweep time of 28 seconds.

Measurement speed

NO. OF POINTS	AVG FACTOR	SWEEP TIME (sec)	TIME/PT (msec)
51	64	7	140
51	1024	18	340
401	64	56	140
401	1024	140	340

3682

Effective measurement accuracy depends highly upon the calibration devices used. Using a commercial waveguide sliding load and calibration devices such as a flush and quarter-wave offset short, typical measurement port characteristics after calibration can be as shown. The flange repeatability, sliding load uniformity, accuracy of offset short lengths, and cable phase stability add up to performance specifications dependent upon the user's devices and measurement technique. For reflection measurements, these factors are several orders of magnitude worse than the contributions of the HP 85102 IF/Detector.

TYPICAL PERFORMANCE

	BAND (GHz)		
	26.5-40	33-50	40-60
Effective directivity	45 dB	40 dB	38 dB
Effective port match	40 dB	38 dB	35 dB
Effective frequency response	+/- 0.1 dB		

3683

Effective directivity after one-port calibration was measured with a sliding load. Multiple settings are used to do the signal separation between residual directivity and the load element. The sliding load itself was only specified as 32 dB return loss. The peaks and nulls are due to the vector addition of residual directivity and the load element. A null means that the directivity and the load element were approximately the same magnitude but adding out of phase. The peak occurs when they add in phase. Effective directivity is 6 dB from the top of a null. Where the load element is much smaller than the directivity, the effective directivity is about the average of the traces. This is seen to be better than 40 dB over most of the band.

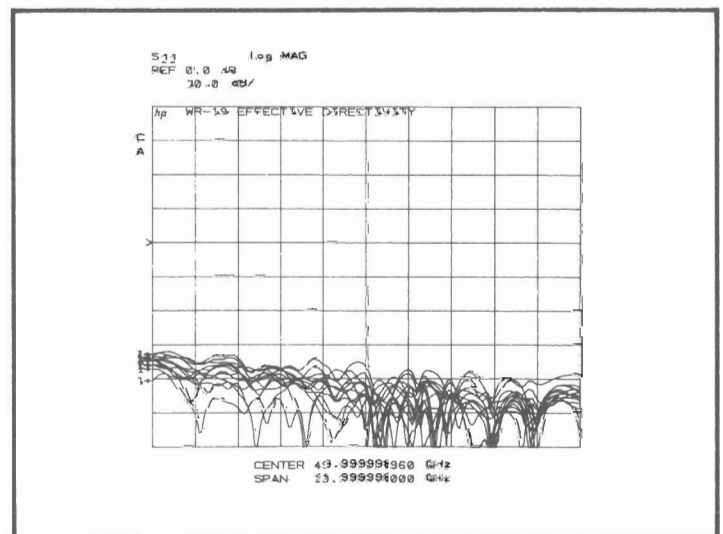

3684

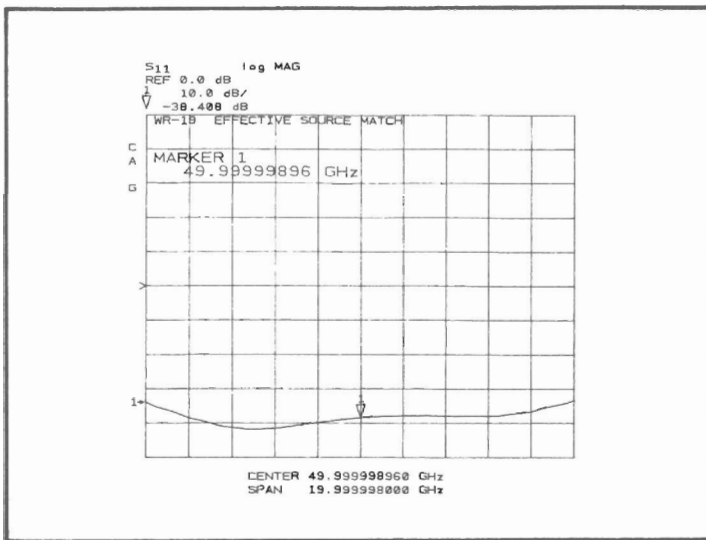

3685

Effective source match after one-port calibration was measured with the aid of time domain bandpass mode. An offset short was used to examine the quality of the calibration. The response of an offset short has three contributors when viewed in the time domain in this order: directivity leakage, the impulse response of the short, and lastly, the source match reflection. Gating in the time domain around the source match reflection and transforming to the frequency domain produces this result. The effective source match is 38 dB, consistent with the ripples in the frequency domain. The turn-up at the band edges is an artifact of the gating process.

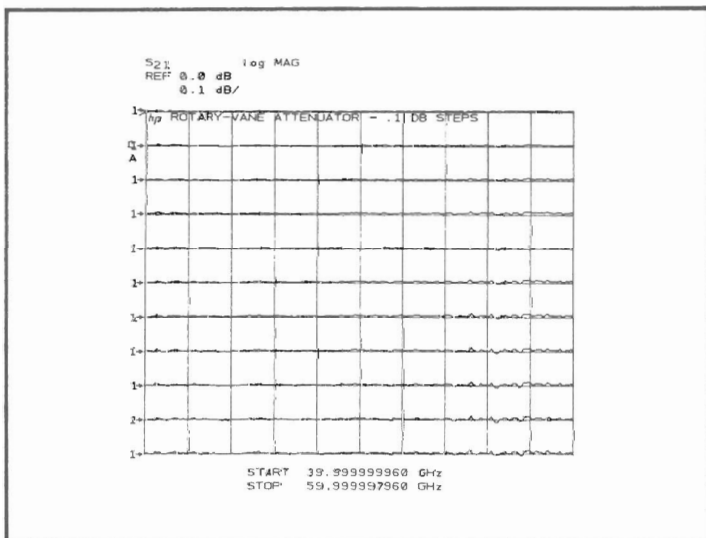

3686

A precision rotary-vane attenuator was used to produce this plot. First, the attenuator was set at 0 dB insertion loss and a simple frequency response calibration was performed. The top trace shows the result of the calibration. Residual tracking error and trace noise total about .01 dB. Next, attenuation was increased in .1 dB steps. The bottom line is -1.0 dB. The resulting data are well within the attenuator's specified accuracy of .1 dB or 2% of reading, whichever is greater. This demonstrates the performance in measuring small insertion loss.

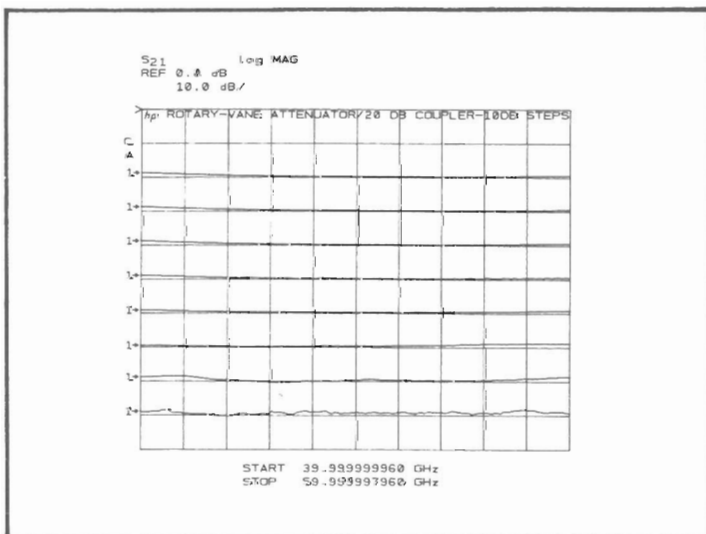

3687

The same attenuator and two 20 dB couplers were used to produce this example of dynamic range. The same frequency response calibration was used. The first trace is the 20 dB coupling factor. Next, the attenuator was incremented in 10 dB steps down to a total of -70 dB. Then, another 20 dB coupler was inserted for the bottom two traces at -80 and -90 dB. The averaging number was 64 down to -50 dB and 1024 down to -90 dB. At the center of the band, where the coupling factor is exactly 20 dB, the accuracy of the 10 dB steps is seen to be better than 1 dB at -70 dB and 2 dB at -90 dB.

For the ultimate dynamic range in measuring a filter, different techniques must be used. Harmonic mixers are transmitters of odd LO harmonics into the mainline. These out-of-band signals may go through the passband of a filter while we are measuring the stopband. A mechanism exists to create an unwanted 20 MHz IF because of this. These spurs can be eliminated by either measuring b2 only and turning off the LO to the reflectometer or inserting isolators and low-pass filters in the harmonic mixers to make them receivers only. A 30 dB spur reduction is possible as shown in this measurement of a 50 GHz high pass filter.

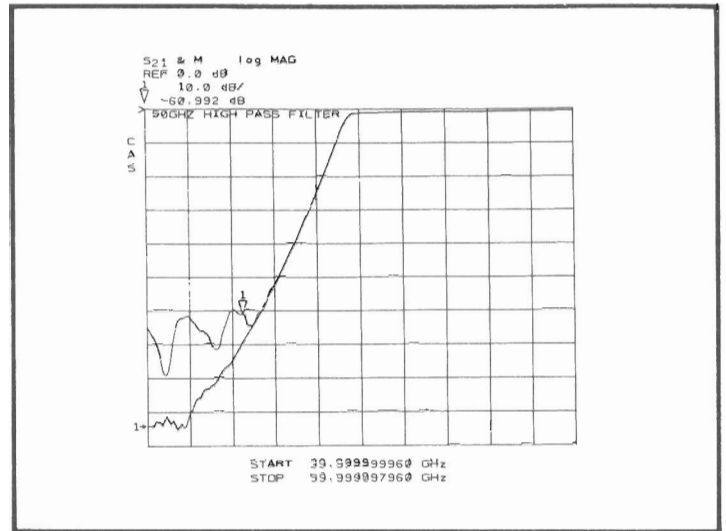

3688

Flange and cable repeatabilities are the major contributors to error after calibration. The local oscillator cable to the transmission head is the most sensitive since it must be flexible. The center trace is the error left after a simple frequency response calibration with a thru. Next, the transmission head was removed and moved about as if a device under test were to be inserted. This was repeated several times. Together, the flange and cable magnitude repeatability is about .02 dB in WR-19. Semi-rigid, .141 inch cable was used.

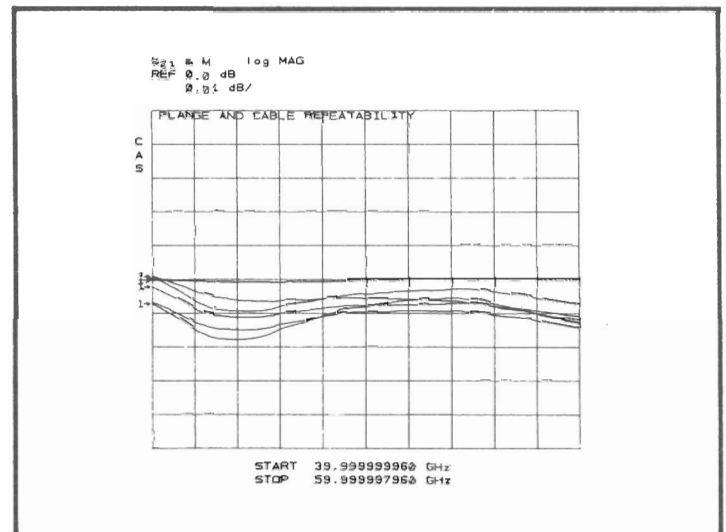

3689

Cable phase stability is sensitive to movement and temperature. Cable phase also "creeps" for hours after major deformations. If the elastic limit is not exceeded, performance is much better. The same calibration was used but now to measure insertion phase. Again the transmission head was removed and the cable flexed to simulate the insertion of a device under test. The result is about +/-1 degree. This corresponds to .1 degree phase stability at 4-6 GHz, the local oscillator frequency. If the cable were to undergo a severe deformation, the repeatability would be 3-5 degrees.

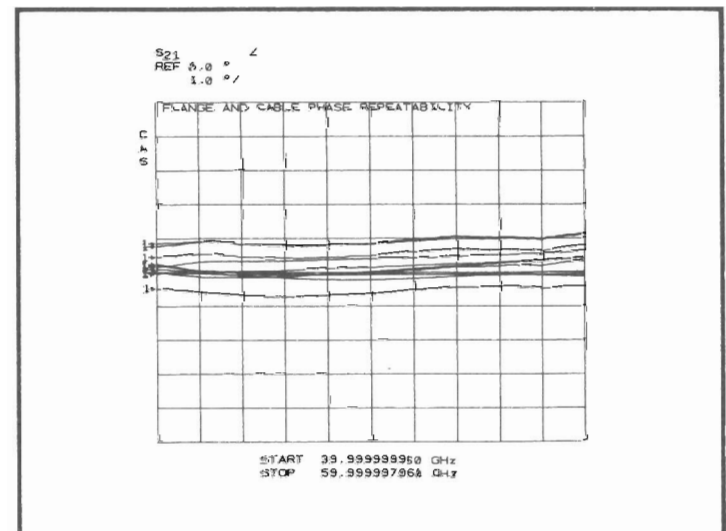

3690

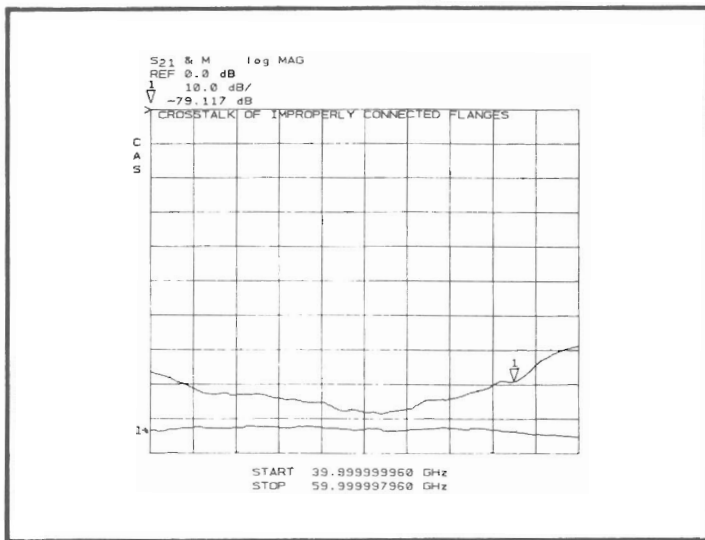

3691

It is quite easy to improperly connect waveguide flanges. If the screws on one side of the flange are tightened before the flange is properly positioned, a small gap may remain which can radiate energy. Two such gaps can easily affect a measurement of high insertion loss and also the accuracy of a low-insertion loss measurement. The upper trace is the crosstalk between two small gaps in flanges placed three inches apart. The lower trace is the isolation and noise floor. Such gaps are most easily detected with a white piece of paper placed behind the flange.

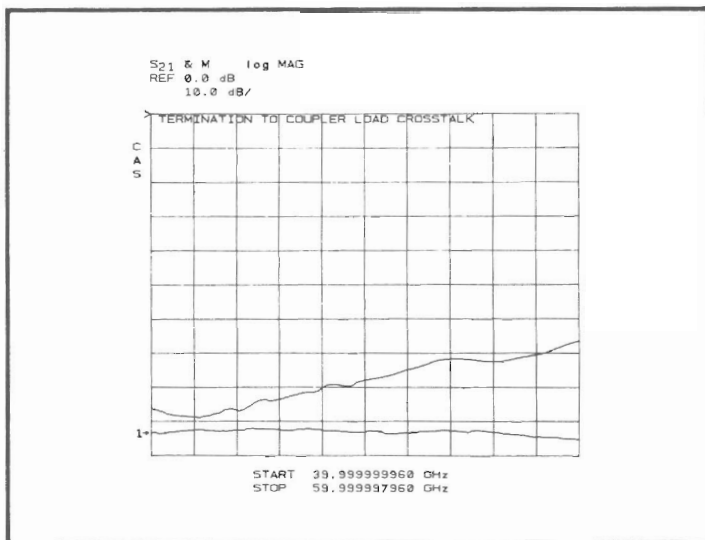

3692

Certain load elements radiate a small amount of energy. They can also act as small antennas. This plot shows an isolation measurement under two conditions. The bottom trace is the isolation and noise floor with 1024 averages. This is about 92 dB for WR-19. The upper trace shows what happens when a termination is placed in proximity to a directional coupler load element. If physical layout is ignored, such crosstalk can limit a high dynamic range measurement. When measuring isolation, terminate all ports and keep the reflection and transmission heads well apart from each other.

IV. TYPICAL MEASUREMENTS

3693

After a simple frequency response calibration with a flush short, the return loss of a 58 GHz iris-coupled waveguide cavity resonator was measured over a 50 MHz bandwidth. As both the millimeter source and local oscillator are synthesized with a precision frequency standard, measurement of devices with very high Q are possible. The marker is displayed to 10 Hz accuracy. The minimum span is equal to the number of points times the resolution frequency. This is tiny compared to responses of physical devices. If desired, the time base could also be locked to an atomic standard.

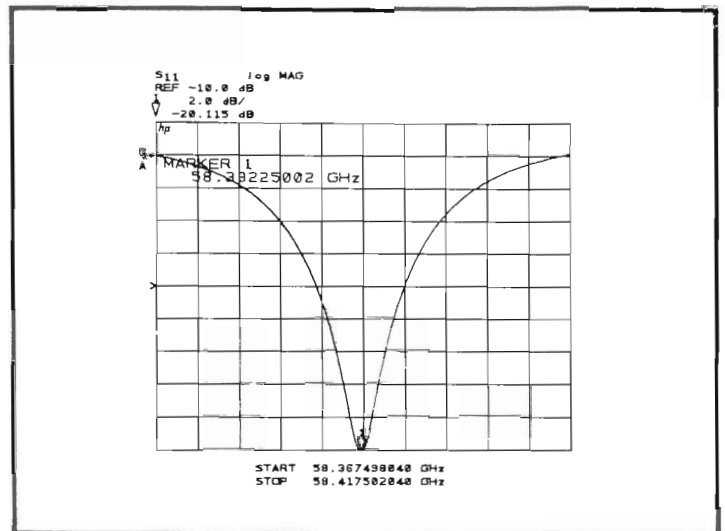

3694

The S11 bandpass response of a sliding short placed near the calibration plane is shown on the left side of the plot. Time domain bandpass responses in waveguide become smeared or spread out the farther that measurements are made from the calibration plane. This is evidenced by the rightmost response, the band pass response of the same sliding short placed at the end of a section of waveguide. The time domain response is correct in waveguide, and the marker reads the correct time, but the distance domain information is incorrect due to dispersion. Time domain in waveguide is most useful near the plane of calibration and could be misleading for long devices.

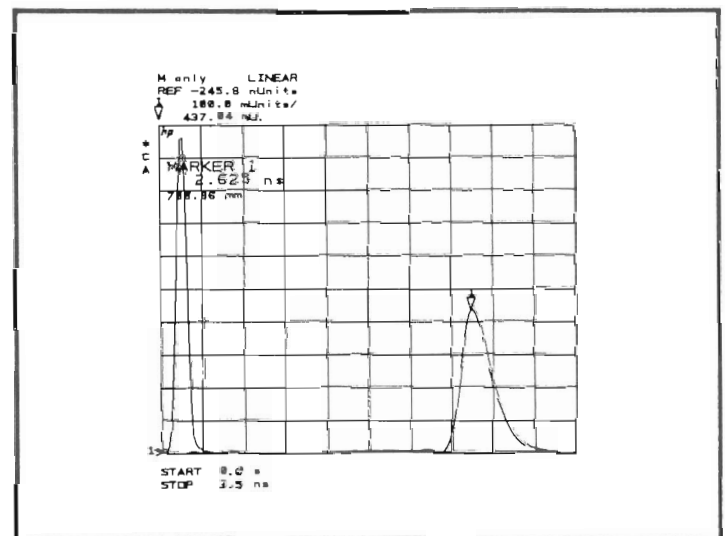

3695

Viewing the b2 transmission channel after a simple frequency response thru calibration, dynamic range can be greater than 95dB. This filter was constructed of two WR-28 to WR-19 adapters with a 3 inch section of WR-19 sandwiched between them. It was measured over a 2 GHz bandwidth with an averaging factor of 4096. Full band isolators were installed in the coupler arms and a low-pass filter was also installed in the transmission coupler arm. WR-19 cuts off at 31.357 GHz, so it is easy to make a 100 dB brick wall filter using this technique. This measurement required four minutes to take 201 points with 4096 averages, about the same time required to screw the flanges together.

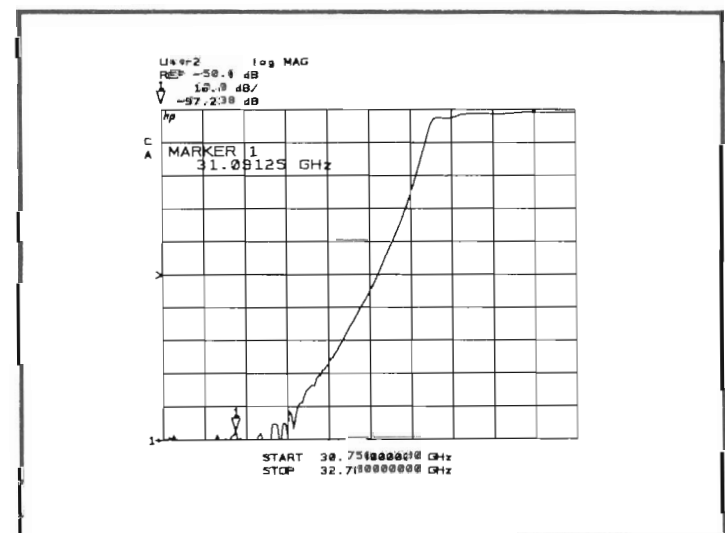

3696

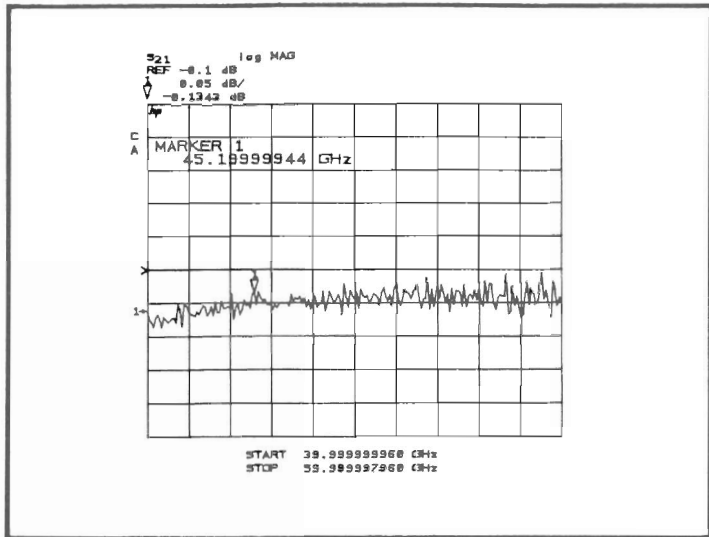

3697

The insertion loss of 3 inches WR-19 was measured using a frequency response calibration. This is a demonstration of the capability of measuring small insertion losses. The insertion loss is about .12 dB and slightly higher at the low end of the band which is closer to cutoff. The "noise" is due to load match and source match and is quite repeatable from trace to trace. The actual trace noise is less than .01 dB. This type of measurement has been used to evaluate the loss of several different platings in waveguide.

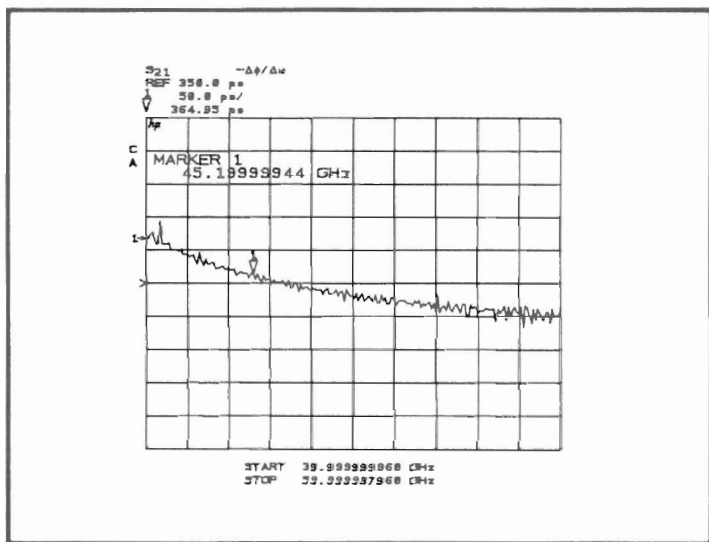

3698

Group delay of 3 inches WR-19 was measured using a frequency response calibration. Group delay is defined to be proportional to the negative derivative of phase with frequency. At the low end of the band, the group delay increases as the guide wavelength increases. At the high end of the band, the group delay is nearly constant. Group delay measurements are important to communications systems since frequency dependent group delay can cause distortion on modulated signals. The group delay aperture can be varied with the smoothing function.

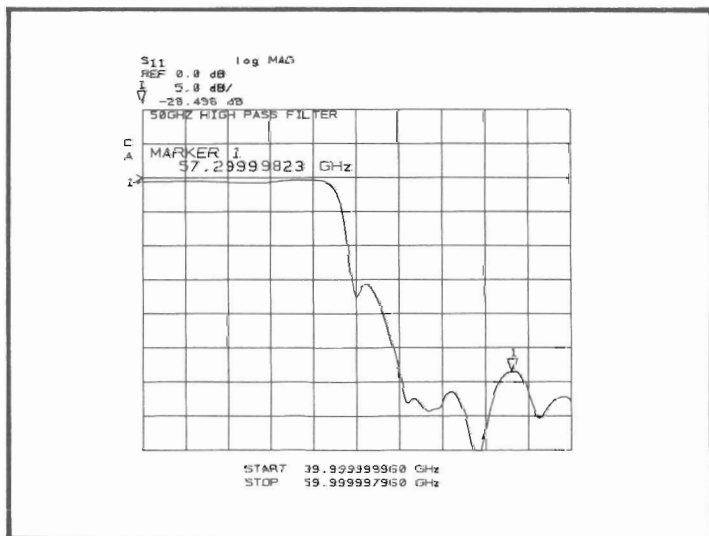

3699

The return loss of a high pass filter is displayed using a full one-port calibration. The filter reflects energy in the stopband and looks like a good match in the passband. The filter was terminated with a fixed load specified at 32 dB return loss. This sets the uncorrected load match at 32 dB. The passband match can be measured to no better than the load match plus effective directivity. The marker can read out exact frequency, return loss, or standing wave ratio, if that format had been chosen.

The insertion phase of the same filter was measured using a simple frequency response calibration. Note that the phase measurement is stable even at high insertion losses. At the high end of the band, the phase is almost linear. As this filter approaches cutoff frequency, the effects of waveguide dispersion can be seen as the guide wavelength approaches infinity. Electrical length can be added to flatten somewhat the high end of the band; however, electrical length adds linear phase with frequency which is not correct due to dispersion. Group delay and time domain are correct, however.

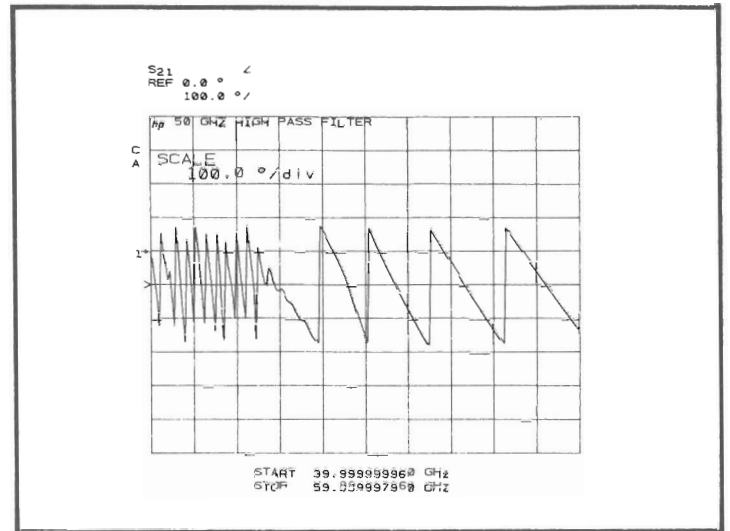

3700

The impedance of a magnetically tunable ferrite resonator is displayed in Smith chart format. The center of the Smith chart has been normalized to 1 ohm. Several modes are present, but the dominant mode is easily discernible on the Smith chart. In a log magnitude display, the several modes would be difficult to separate. The marker reads out impedance but just as easily could read out real and imaginary, linear magnitude and phase, or log magnitude and phase. A simple frequency response calibration with a short was used. The 201 point trace did not miss any responses that might have slipped through with less points.

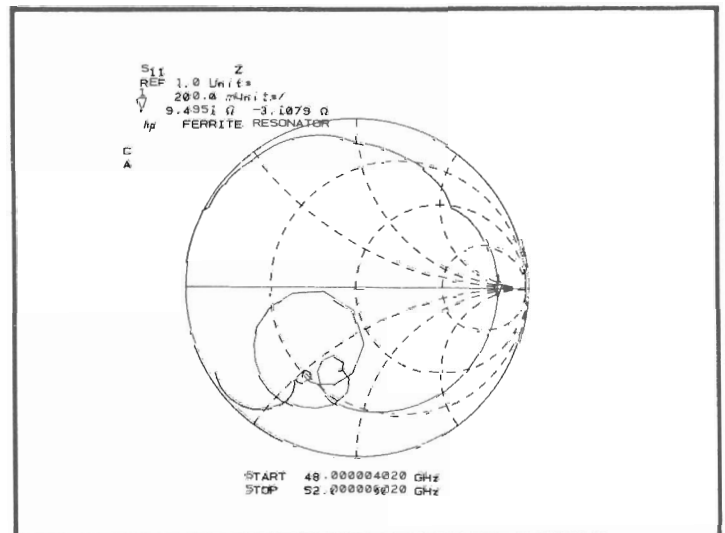

3701

A high performance automated millimeter-wave network analyzer has been described. Several methods of calibration, and calibration standards were discussed. Typical system performance was measured under various conditions and contributing factors were demonstrated. Finally, several measurements were made on actual devices to provide examples of measurement capability.

SUMMARY

SYSTEM DESCRIPTION

CALIBRATION METHODS

TYPICAL SYSTEM PERFORMANCE

ACTUAL DEVICE MEASUREMENTS

3702

ACKNOWLEDGMENTS

The following individuals at Hewlett-Packard Network Measurements Division have made technical contributions to these millimeter-wave measurement techniques:

Doug Rytting

Bruce Donecker

Bob Dildine

John Barr

I would also like to thank Dr. Roger Pollard of the University of Leeds for his assistance in calibration techniques and software.

REFERENCES

- [1] Hewlett-Packard Co., Product Note 8510-1A
- [2] Fitzpatrick, J., "Survey of Millimeter-wave Network Analyzers", 23rd ARFTG Conference Digest (Spring 1984)
- [3] Rytting, D., "An Analysis of Vector Measurement Accuracy Enhancement Techniques", Hewlett-Packard RF&MW Symposium (1980)
- [4] Rytting, D., "Let Time Domain Response Provide Additional Insight into Network Behavior", Hewlett-Packard RF&MW Symposium (1984)

