

Data Acquisition

3480B DIGITAL VOLTMETER - 2912A SCANNER - 2547A COUPLER

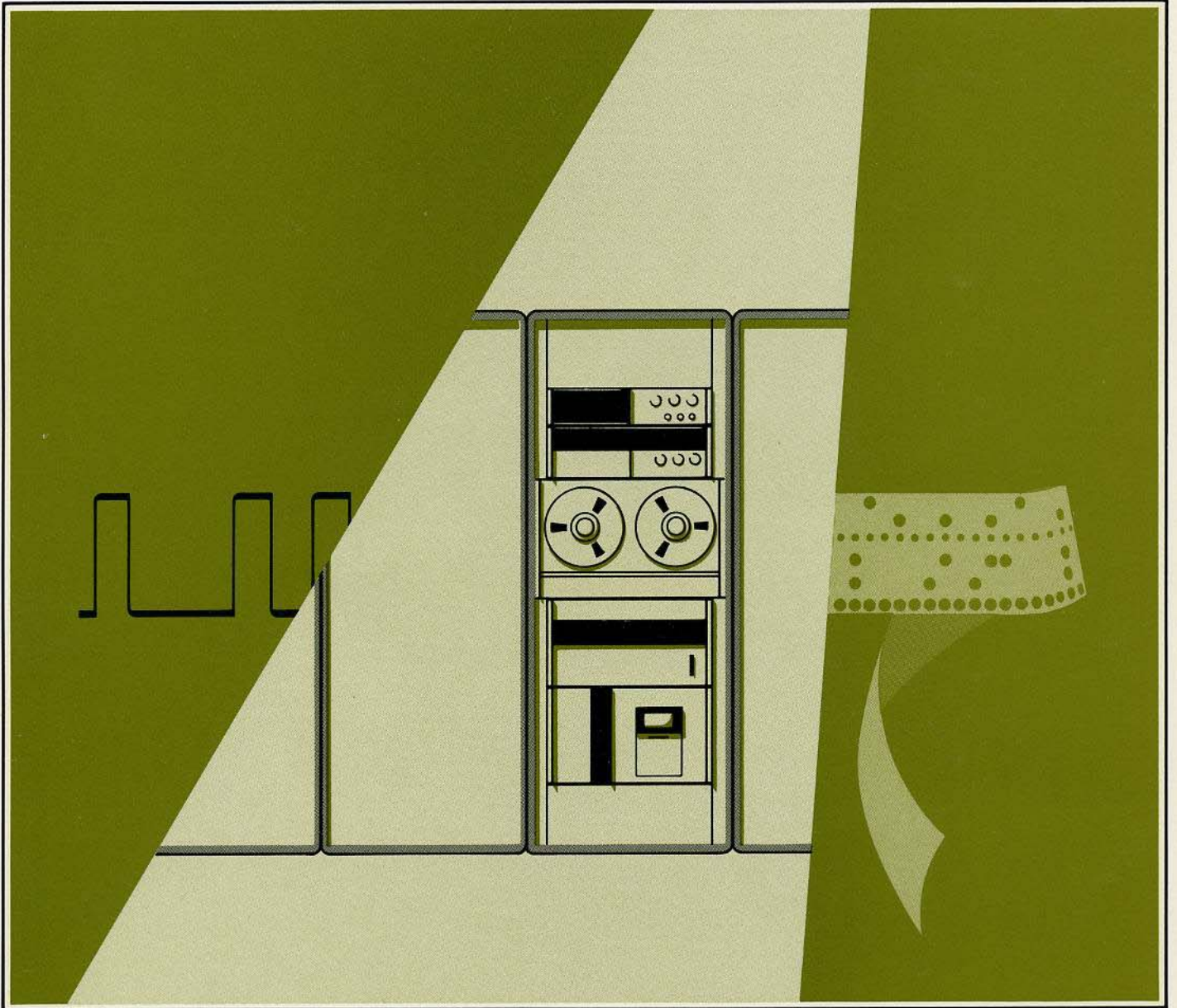

Data Acquisition

November 2, 1970

Copyright 1970 by **HEWLETT-PACKARD COMPANY**

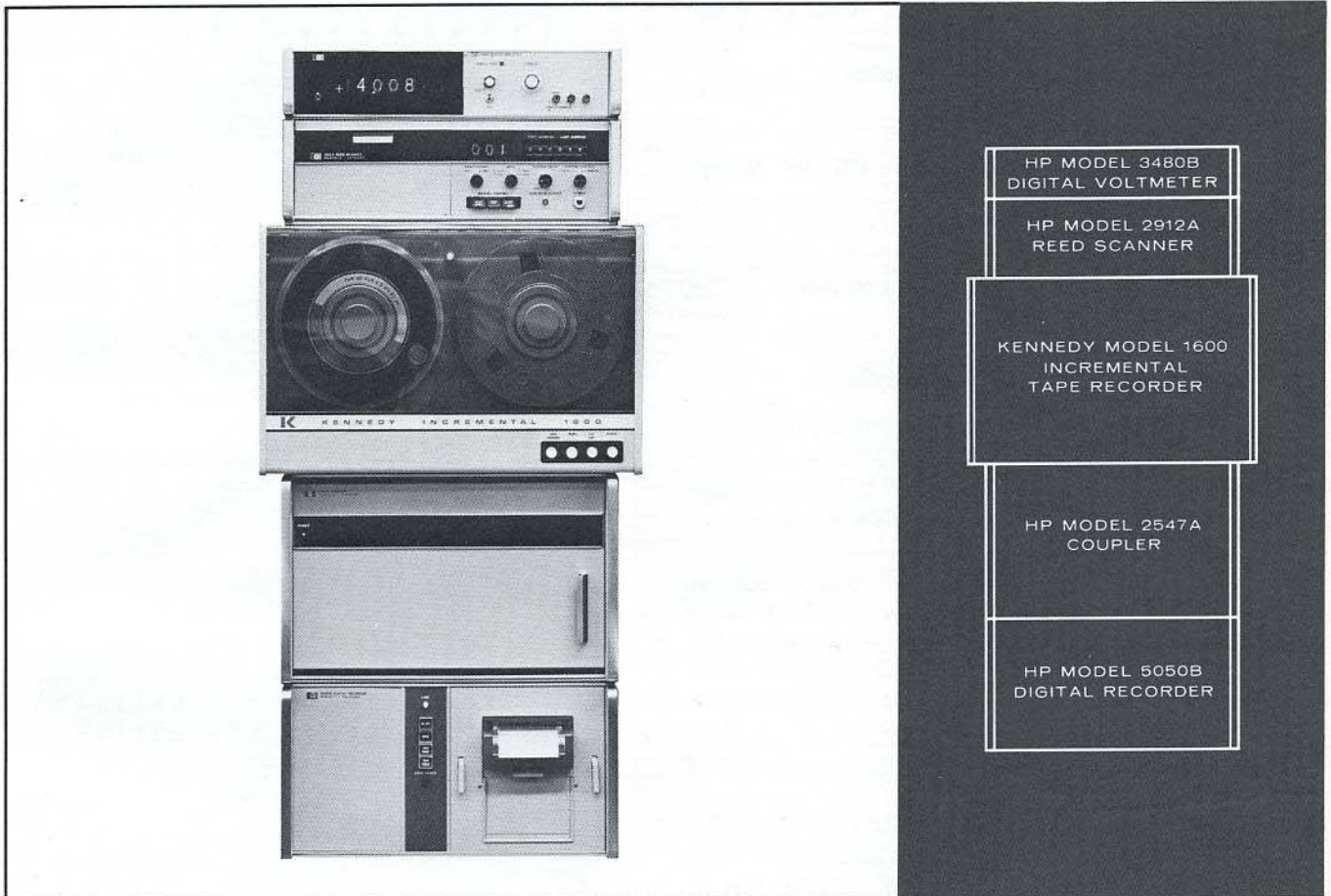

INTRODUCTION

A common use of the digital voltmeter is automated data acquisition. This Applications Note is devoted to the use of the 3480A/B Digital Voltmeter in such an application.

General interfacing requirements for the 3480A/B DVM are discussed briefly. In addition, a large portion of this note explains how to build and use a 3480A/B DVM in a data acquisition system utilizing the 2912A scanner and 2547A coupler.

Although Hewlett-Packard Company builds most of the equipment used in the system described here, it is not available as an assembled system. However, with the aid of the instructions in this booklet and some reference to the individual instrument Operating and Service Manuals, the user will be able to build and operate his own system.

INTERFACING THE 3480A/B

THE 3480A/B DIGITAL VOLTMETER

The 3480A/B DVM is a highly versatile four digit voltmeter with plug-in functional units. Some of its features are listed below:

- 4 DIGIT PLUS 50% OVERRANGE DISPLAY
- 1000 READINGS/SECOND
- PLUG-IN FLEXIBILITY
- 5 TRUE RMS AND DC RANGES; 100 mV through 1000 V
- FILTERED DC MEASUREMENTS
- DC RATIO (3-terminal), (optional)
- TRUE RMS AC; capacitive and direct coupling
- RESISTANCE MEASUREMENTS
- BCD OUTPUT (optional)
- REMOTE PROGRAMMING (isolated optional)

Because of its flexibility, the 3480A/B DVM is useful on the bench or in a system. In particular, its speed (1000 readings/second), programmability, and BCD output make the instrument suitable for recorded data acquisition or computer controlled measurements.

Four functions are available in three plug-in units. A buffer amplifier, the 3481A plug-in, has one 10 V range of dc voltage with no filtering. The 3482A plug-in has full five range dc capability with filtering and autorange. True RMS ac voltage, dc voltage, and resistance measurements are all available with the 3484A plug-in.

Since the 3480A/B DVM works on the principal of successive approximation, normal mode noise rejection is provided by filtering. The 3482A and 3484A plug-ins offer two filter positions for 30 dB and 80 dB of rejection. Time delays may be selected to allow for the response time of these filters. Guarded measurements can be made to reduce the effects of common mode noise.

INTERFACING THE 3480A/B

A BCD output, 8-4-2-1 code, is available as an option on the rear of the 3480A/B mainframe. This output permits the transfer of the voltmeter reading to a data recording device. Remote programming capability is available on the rear of all DVM plug-ins and permits remote control of all front panel functions. All BCD and remote control signal requirements are listed in Table 1. The connector pin configuration is shown in Figure 1 and Figure 2.

Both the BCD and REMOTE are provided in either non-isolated or isolated form. For use in a system, isolated BCD and remote are necessary since a lack of isolation may seriously degrade the instrument's common mode rejection.

Hewlett-Packard also offers a computer interface card compatible with all Hewlett-Packard computers. This card provides complete programming and data transfer for the 3480A/B DVM.

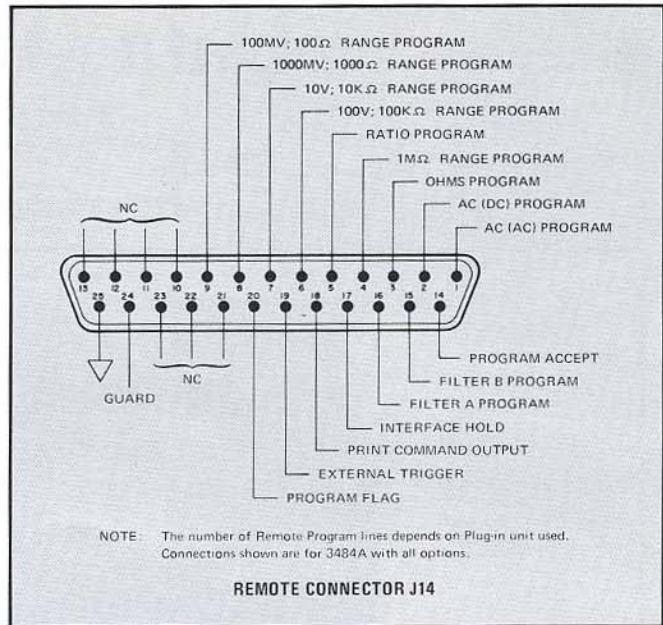

FIGURE 1. Remote Connector J14

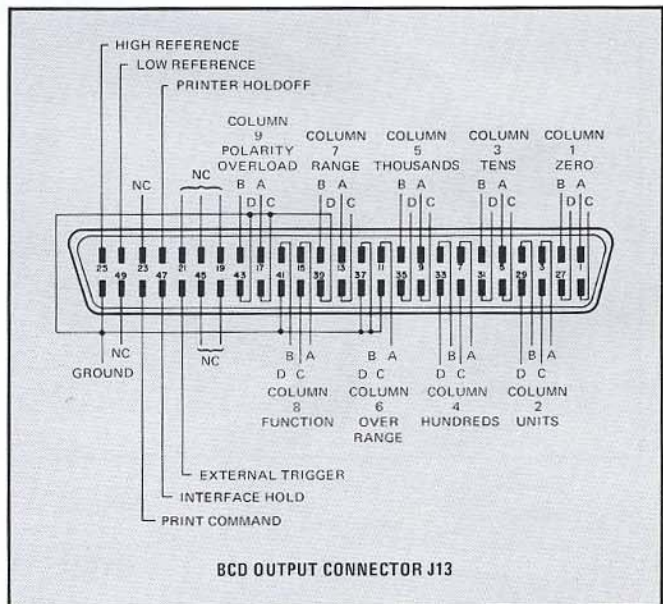

FIGURE 2. BCD Output Connector J13

3480A/B DATA ACQUISITION

A DATA RECORDING SYSTEM

The data acquisition system discussed in this booklet consists of the 3480A/B DVM and its plug-ins, the 2912A Reed Scanner, the 2547A Coupler (an interface instrument), and either a Kennedy Incremental Magnetic Tape Recorder or a modified Tally High Speed Punch. There are many possible modifications to this arrangement, which are left up to the user's imagination. Figure 3 illustrates the arrangements of equipment in this system and some of the modifications that can be made.

As described in this booklet, the system is capable of measuring and recording up to 40 fully guarded dc inputs as fast as 500 recorded characters/second. Three terminal dc ratio measurements can also be made at the same rate. The maximum input voltage is ± 100 V peak, and the minimum sensitivity is 10 microvolts.

Input scanning may be done continuously, one scan at a time, one channel at a time, or one channel may be selected and monitored. Each of these modes may be started manually or in response to an external trigger.

Range, polarity, function, overload, reading, and channel number characters or any combination of these can be recorded for each measurement. Recording device control characters can be programmed to format the record.

Putting this system together, operating, and troubleshooting it are all fairly straightforward. Although essentially all the information needed is contained in this booklet, a great deal of additional and more detailed information can be found in the individual instrument Operating and Service Manuals.

It may be helpful for you to read the Glossary before continuing on in this booklet.

3480A/B DVM

The analog-to-digital conversion for the system is done by the 3480A/B DVM. Plug-in functional units are available to make a full range of ac or dc measurements. The DVM is fully guarded to enable measurements of low level signals to be made in a noisy environment.

2912A Reed Scanner

Multiple channel input to the 3480A/B DVM is provided by a reed relay scanner. Each source to be measured by the DVM is connected to the Reed Scanner. These inputs are sampled one by one using reed relays and the output of this sampling process goes to the 3480A/B DVM.

Hermetically sealed dry reed contacts mounted on an electrically and thermally isolated guard are incorporated in the 2912A. The basic unit consists of a mainframe with system control logic and four reed module positions, a total

SIGNAL	CONDITIONS
ENCODE (EXTERNAL TRIGGER) Initiates a measurement period	TRIGGER = 0 V to + 0.5 V for minimum of 50 microseconds Level between trigger commands must be +2.4 V or greater or open circuit for minimum of 50 microseconds.
INHIBIT (INTERFACE HOLD) Prevents 3480A/B from sampling unless manual or external trigger command is given.	INHIBIT = 0 V to + 0.5 V FREE RUN = +2.4 V or greater or open circuit.
INHIBIT (PRINTER HOLDOFF) Prevents 3480A/B from sampling automatically until Printer or other external equipment is ready. An External Trigger command during this period will initiate a measurement.	INHIBIT = +6 V to + 15 V FREE RUN = 0 V to +2.4 V or open circuit.
REMOTE PROGRAM SELECTION Ratio, Filter, Range, AC, Ohms	SELECT = 0 V to + 0.5 V NOT SELECT = +2.4 or greater or open circuit.
ISOLATED REMOTE PROGRAM SELECTION (Not available with 3481A). Same as above.	SELECT = 0 V to + 0.5 V NOT SELECT = +2.4 V or greater or open circuit. Referenced to Chassis (Power Line) ground.
PROGRAM ACCEPT (ISOLATED REMOTE PROGRAM ONLY) Executes program or change in program selected. Program execution requires 1 millisecond.	PROGRAM ACCEPT line must be 0 V to +0.5 V for minimum of 10 microseconds to actuate. Line must be +2.4 V or greater between Program Accept Commands.
DATA OUTPUT (3480A/B Option 003 or 004) BCD Output, 1-2-4-8 Code, "1" state positive.	"1" = 2.4 V or greater "0" = 0 V to +0.5 V High Reference = 5 V Low Reference = 0 V (ground) Isolated BCD Output (Option 004) referenced to Chassis ground.
FLAG (PRINT COMMAND OUTPUT) Indicates receipt of Encode (Trigger) command and completion of measurement period. Print Command Output is present only if 3480A/B includes Option 003 or 004.	+2.4 V or greater indicates start of measurement period. 0 V to +0.5 V indicates completion of measurement period (Print Command). Duration of HIGH portion of signal is dependent upon Function and Filter programming.

TABLE 1. Interface Signals

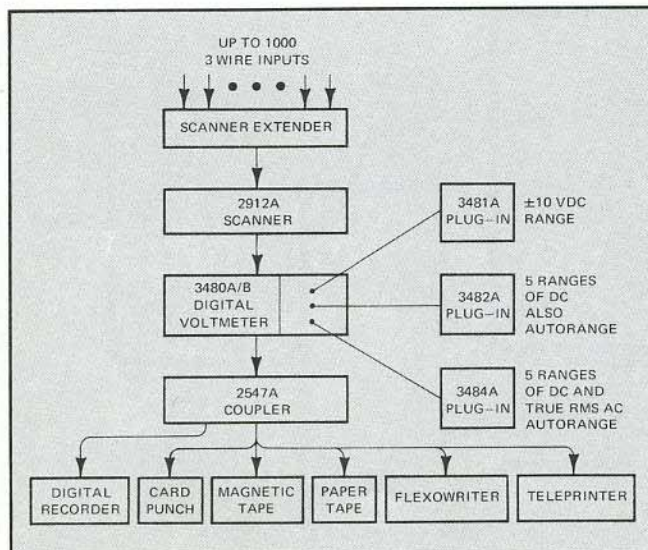

FIGURE 3. System Block Diagram

of 40 possible inputs. Input channel capacity can be extended to 1000 by using 2920A Reed Scanner Extenders.

There are two reed modules available for use with a voltage measuring system. One module, the 2912A Low Volts Module, is used for voltages within ± 10 V peak; the other, the 2922A High Volts Module is for voltages within ± 100 V peak. Both have fully guarded three terminal inputs for each channel.

2547A Coupler

In order to interface the DVM, the Scanner, and the recording device, an instrument called the Coupler is needed. It accepts different logic levels, changes parallel data to serial, and formats the data.

Many different output devices may be connected to the 2547A Coupler as shown in Figure 3.

Output devices other than magnetic tape or punched paper tape are described in the 2547A data sheet or the 2547A Operating and Service Manual.

K1600 Incremental Magnetic Tape Recorder

Maximum speed is achieved when recording on magnetic tape. This recorder will record at 500 characters/second in 7 track or 9 track IBM compatible codes.

2753A High Speed Tape Punch

This punch records IBM eight level or ACSII code at a maximum of 120 characters/second on paper tape.

SYSTEM SPECIFICATIONS

Table 2 lists the system specifications for the arrangement described in this booklet. These specifications can be expanded for other arrangements as long as none of the instruments are expected to operate outside their individual specifications.

Guarded Measurement Capability

A BCD output option is a requirement for the basic system. To maintain system Common Mode Rejection, isolated BCD is required.

As shown in Figure 4, when non-isolated BCD output is used, the signal low is connected to the data low. This makes the system's common mode rejection dependent on the recording device. For this reason, isolated BCD output is required for system applications.

DC Ratio

In order to make ratio measurements, the 3480A/B mainframe must have Option 002. This must be factory installed.

FEATURE	HIGH SPEED PUNCH	MAGNETIC TAPE
Functions	DC Voltage DC Ratio AC Voltage	DC Voltage DC Ratio AC Voltage
Range max voltage	± 100 volts peak *	± 100 volts peak *
Sensitivity	10 microvolts	10 microvolts
Input Number	40 channels 1000 channels with extenders	40 channels 1000 channels with extenders
Speed ** maximum minumum	120 character / sec (2 character minimum) .1 measurements/sec/ character	500 character /sec (2 character minimum) .1 measurements/sec/ character
Modes	Continuous scan Single scan Manual scan Monitor	Continuous scan Single scan Manual scan Monitor
External Command level	Start "1" equals -1 V to +7 V "0" equals +4.5 V to +15 V	Start "1" equals -1 V to +7 V "0" equals +4.5 V to +15 V
Recording Medium	Punched paper tape	Magnetic tape
Record Format Code	8 level IBM or ASCII	9 level EBCDIC or 7 level IBM
Control Character	CR CR/LF	Interrecord gap
Operating Conditions	10°C to 40°C (50°F to 104°F)	10°C to 32°C (50°F to 90°F)
<p>*The voltage between any two channels of a Scanner High Volts Module cannot exceed 200 volts peak. The voltage between any two channels of a Scanner Low Module cannot exceed 10 volts peak.</p> <p>** Since the system measurement speed is a function of the number of characters recorded, this specification is stated in its most general way. To compute the speed, divide the appropriate specification by the number of characters to be recorded.</p>		

TABLE 2. Systems Specifications

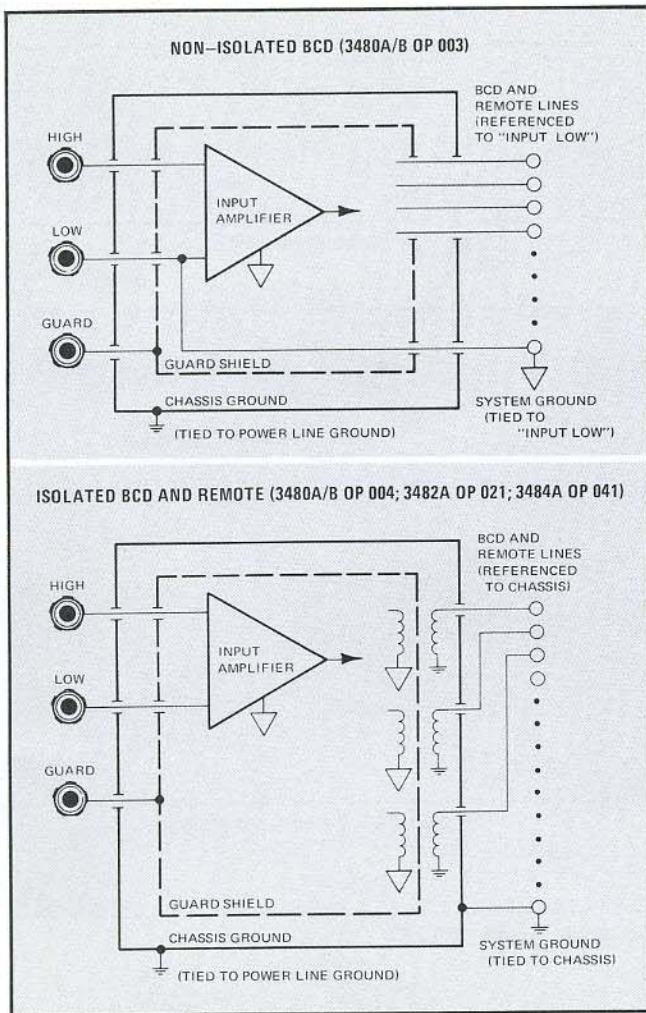

FIGURE 4. The Grounding System Used for Non-isolated and Isolated Remote Options in the 3480A/B

Range and Function

Scanner modules and 3480A/B plug-ins are selected by the type of measurement to be made and its peak magnitude range. The choices are outlined here.

± 1 vdc through ± 10 vdc:

- 3481A Buffer Amplifier Plug-in
- 2921A Low Volts Module

± 1 vdc through ± 14.999 vdc:

- 3481A Buffer Amplifier Plug-in
- 2922A High Volts Module

0 vdc through ± 10 vdc:

- 3482 dc Ranging Plug-in
- 2921 Low Volts Module

0 vdc through ± 100 vdc:

- 3482A dc Ranging Plug-in
- 2922A High Volts Module

0 vac through ± 10 vac peak:

- 3484A Option 043 Multifunction Plug-in
- 2921A Low Volts Module

0 vac through ± 100 vac peak:

- 3484A Option 043 Multifunction Plug-in
- 2922A High Volts Module

The Scanner Modules can be mixed in the scan sequence. However, if a Low Volts Module follows a High Volts Module, the three input terminals of the last channel in the High Volts Module must be shorted to ground and a dummy reading taken on that channel.

EQUIPMENT REQUIREMENTS AND INSTALLATION

BASIC SYSTEM

In all cases, the following instruments are required:

- 3480A or B Digital Voltmeter
- 3481A, 3482A or 3484A Voltmeter plug-ins
- 2912A Reed Relay Scanner
- 2547A Coupler
- K1600 Incremental Magnetic Tape Recorder
- or
- H1600 Incremental Magnetic Tape Recorder
- or
- 2753 High Speed Tape Punch

Ordering information is as follows:

- Digital Voltmeter - 3480A (bench) or 3480B (rack mount) with Option 004
- Voltmeter Plug-in - 3481A single range dc or 3482A 5 ranges of dc or 3484A 5 ranges of dc Option 043 True rms ac
- Scanner - 2912A with
 - 2921A Low Level DC module (10 channels)
 - or
 - 2922A dc ac module (10 channels)
- Coupler* - 2547A with
 - Option 02 - 10 digit data input and
 - Option 01 - channel I.D. input and
 - Option 34 and 73 - tape punch output-ASCII
 - or
 - Option 34 and 128 - tape punch output IBM 8-level
 - or
 - Option 94 - 7 track magnetic tape or
 - Option 99 - 9 track magnetic tape

Interconnections

In addition to the instruments themselves, several interconnecting cables are needed to install the system. These cables are listed in Table 3 and shown in Figure 5. All cables except C5 and C6 are included with the 2547A Coupler and its options. Cables C5 and C6 must be fabricated by the user.

Coupler Connections

Each cable to the Coupler will have a hood connector on one end. This end goes through the back of the Coupler, underneath the card frame, and over the front of the appropriate card. It will be necessary to remove the back plate first. The other end goes to the appropriate device.

*(all output options include the recording device)

NAME	FROM	TO	DESCRIPTION	PART NO.
C1	Coupler	DVM	cable	02547-6040
C2	Coupler	Scanner	cable	02547-6039
C3	Coupler	Mag Tape	cable	12667-6003
		9 Track		12668-60021
		7 Track		02116-6118
C4	Coupler	Paper Tape	cable	
C5	Scanner	DVM	encode cable	NONE
C6	Scanner	DVM	signal cable	NONE

TABLE 3. Interconnection Cables

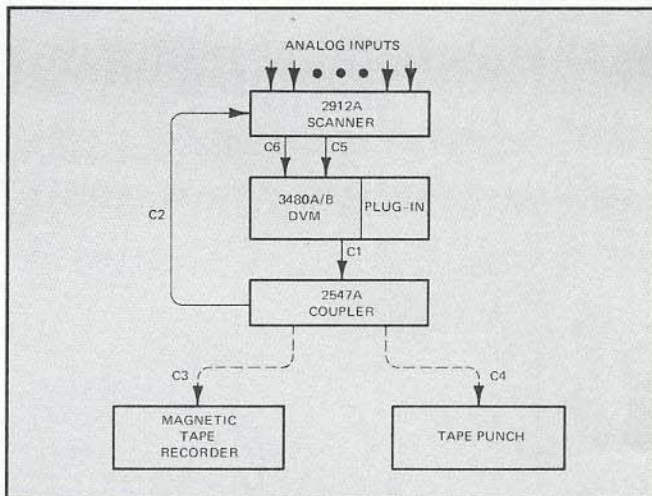

FIGURE 5. Cable Connections

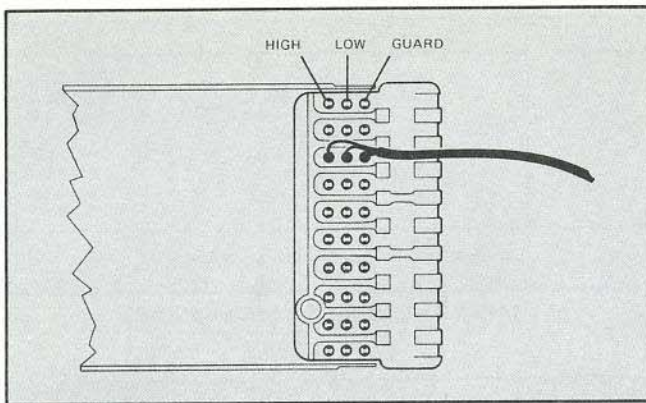

FIGURE 6. Scanner Connections

DVM Connections

Three cable connections must be made to the DVM.

BCD information and the Print Command are carried to the Coupler by C1. One end of C1 is a 50 pin connector that plugs into the BCD output of the 3480A/B main-frame. The other end connects to a Data Storage Card in the Coupler. Switch S1 on the 3480A/B BCD card must be in the 5 volt position. This provides a 5 volt print command which is necessary for proper operation.

The Encode Command (external trigger) goes from the Scanner to the DVM by way of C5. One end is a 25 pin connector that plugs into the program input on the rear of the plug-in. The other end of C5 is a BNC connector that goes to J3, Encode output, on the rear of the Scanner.

A second connection must be made from the Scanner to the DVM. This cable is C6 which carries the analog signal that the DVM is to measure. One end of C6 is a three-prong "banana" plug that goes into the rear terminal input of the DVM plug-in. The prong marked GND goes in the blue, guard banana jack. The other end of this cable is a guarded connector that goes to J8 on the rear of the Scanner.

Scanner Connections

Input connections to both the low volts and high volts modules are three terminals, guarded. In order to reduce noise, it is best, particularly in the case of low level measurements, to use shielded cable with two inner conductors and connect them as shown in Figure 6.

Each module has ten, three-wire channels which means there will be a maximum of ten shielded cables for each module. Refer to the Scanner manual for instructions on the Scanner Extender.

BCD output for channel identification and Scan Advance input are available through J4 on the rear of the scanner. These signals are connected to the Coupler through C2.

As mentioned earlier, the Encode signal to the 3480A/B is available at J3 on the rear of the scanner.

Magnetic Tape Connection

Only one cable is needed to interface the Magnetic Tape recorder and the Coupler. This cable is C3 which connects to the rear of the recorder.

Paper Tape Connection

The paper tape punch also requires one cable, C4, which has a rear panel connection.

Sample Rate Control Inhibit

Pin 17 of the remote program connector is grounded by the shield of the encode cable. This inhibits the front panel Sample Rate Control on the DVM plug-in so that there will be no false trigger.

External Start Command

If it is desirable to start each scan by an external source, the start command signal cable should be connected to J1 on the rear panel of the Scanner.

General

There are many possible variations that could be made of this system. Before attempting to make any other connections, be sure to carefully read the manual of each of the instruments.

INSTALLATION

After carefully unpacking and inspecting the equipment, place the instruments in the position they are to be used. It is recommended that the equipment be mounted in an equipment rack for convenience and reliability. Read the section on Installation in each of the Operating and Service Manuals.

Make certain that the cards in the Coupler are in their proper slot. The card in Slot 15 will depend on the recording device.

See that the appropriate 3480A/B plug-in is securely fastened in the mainframe.

Place the Scanner modules in their correct slots.

Make the appropriate interconnections using the cables previously described. If guarded measurements are desirable, be sure to observe the proper grounding and guarding rules to avoid common mode noise.

Adequate ventilation should be allowed for keeping the instruments within their operating temperatures.

Special Cable Construction

Cables C5 and C6 must be constructed. The parts needed to make them are listed in Tables 4 and 5. Construction instructions are given in Figure 7 and Figure 8.

2912A Modification

A minor modification is required to the 2912A scanner. This modification reduces the Encode signal from the scanner from +12 volts to +5 volts. To perform the modification, replace capacitor C5 on board A21 with a 5 volt zener diode. The diode should be installed with its cathode connected to the Encode line.

NAME	DESCRIPTION	PART NO.
P1	BNC connector	1250-0061
W1	Coaxial cable, RG 58 c/u (specify length needed)	8120-0017
P2	Multiple pin connector shell	1251-2417
	contact (two required)	1251-2384
	boot	1251-0392
	retainer	1251-1042

These parts are used to make the encode cable, C5.

TABLE 4. Encode Cable Components

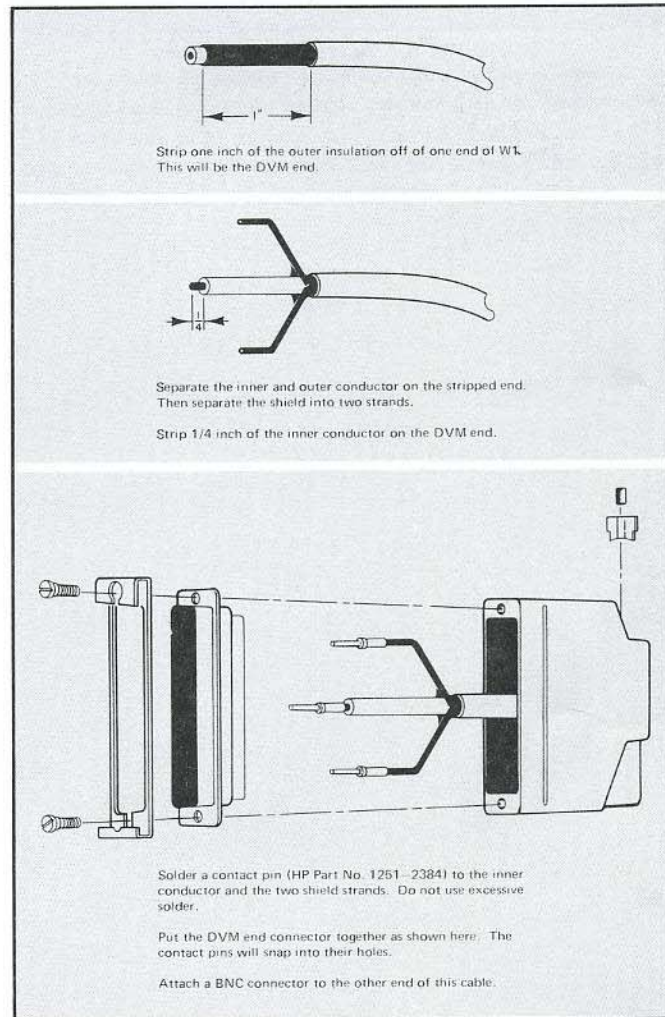

FIGURE 7. Construction of C5

NAME	DESCRIPTION	PART NO.
P3 P4	Guarded connectors with wire 3-prong banana connector	11065A 1251-2552
These parts are used to make the signal cable, C6.		

TABLE 5. Signal Cable Components

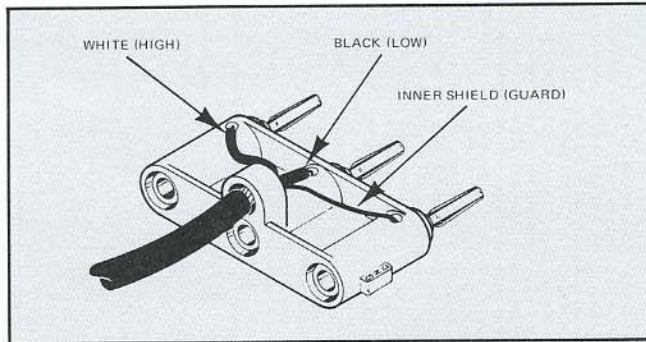

FIGURE 8. Construction of C6

OPERATION

In general, the user is referred to the instrument Operating and Service Manuals for detailed explanations of each instrument control. However, those controls which directly affect system speed are treated in this booklet.

CONTROLS THAT AFFECT SYSTEM SPEED

System Delay

This control is located on the Scanner front panel. It adjusts the time between the receipt of a Scan Advance Command and the issuance of an Encode Command.

System Delay has the greatest range of speed control on the system. With this control, the speed can be adjusted from its maximum speed to as slow as ten seconds between measurements.

Filter

Located on the 3482A and 3484A plug-ins, this switch will only affect speed if the plug-in has been programmed for the delay mode. Otherwise, reading period is always 1 ms.

Function

Only the 3484A Function switch affects system speed and only if the plug-in is programmed for delay mode. In this case, the encoding time will be 1 sec in the ac function.

Coupler Pulse Width Adjust

This control is a potentiometer adjustment on the Data Storage Card, A11, of the Coupler. It sets the length of a pulse which determines the settling of the BCD input lines. A minimum setting is sufficient and necessary if maximum speed is to be achieved.

TYPICAL OPERATION

A typical magnetic tape operating condition is demonstrated by the following sequence:

1. Switch coupler RECORD switch to OFF.
2. Set the DVM FUNCTION and FILTER controls if appropriate. Make sure the TERMINAL control is on "REAR".
3. Set the first and last channel number on the Scanner.
4. Set the Scanner CONTROL switch to "LOCAL" and the RESET/START switch to "MAN" unless an external "START" trigger is to be applied.
5. Put the system in the appropriate mode with the Scanner MODE control.
6. Unless a slower speed is desired, switch the SYSTEM DELAY control to "MIN".
7. Thread the magnetic tape on the tape transport.

8. Press LOAD FORWARD. The tape will run until it reaches a starting mark at which time the READY button will light. The Tape Recorder is now ready to operate.
9. Switch the Coupler RECORD and CONTROL switches to "ON" and "REMOTE" respectively.
10. Start the system by manually pressing START or supplying an external START command as required.

You should now be making measurements!

PROGRAMMING THE SYSTEM

There are three kinds of programming involved in a system of the sort described here. The first determines which characters of the data source are to be recorded, where any blank characters are to be placed in the data word, and the length of the data word. This will be referred to as word format.

Record format is the second programming task. This is the manner in which data words are grouped on the recording medium.

Time Delay programming is the last kind. This involves setting the system speed.

Word Format

A data word is made up of selected BCD characters from the DVM and Scanner outputs plus appropriate blanks. The Coupler has provisions for special characters, but they are not used in this system.

Characters are selected for the data word by a patch panel on the Coupler Format Card, A13. See Figure 9. The top two rows represent the order in which characters are to be serialized. Row Three represents the characters from the data card in Slot 8, 10 or 12, and Row Four represents the characters in Slot 7, 9 or 11. For purposes of simplicity, this explanation assumes that the DVM card is in Slot 11 and the Scanner card is in Slot 12. Row Five represents blank characters, special characters, and the end-of-word (EOW) signal.

To program a word, the user should patch a contact in Rows One or Two to one of the character contacts in the other rows according to the order in which he wants that character to be transmitted to the recording device. The last contact used in the top rows should be patched to the EOW contact in order to terminate the data word. See the example in Table 6.

Record Format

Recorded words are grouped according to the number of measurements, the number of scans, or both. The Coupler groups the words by supplying a control character to the recording device at selected intervals.

A control character, called an interrecord gap (IRG), is recorded on magnetic tape by supplying a signal to a

Conditions:			
Ten channels are being measured (0 through 9).			
Channel identification is to be recorded first.			
Range and Function are constant.			
Overload is not possible			
All significant digits of data are to be recorded.			
Blanks should separate information.			
CHARACTER ORDER	CHARACTER	CHARACTER ROW	NUMBER
1	Blank	5	B
2	Chan. I.D. 10 ⁰	4	20
3	Blank	5	8
4	Polarity	3	2
5	Blank	5	B
6	DVM Overrange	3	5
7	DVM 10 ³	3	6
8	DVM 10 ²	3	7
9	DVM 10 ¹	3	8
10	DVM 10 ⁰	3,5	9, EOW
11			
12			
13			
14			
15			
16			
17			
18			
19			
20			

TABLE 6. Programming Example

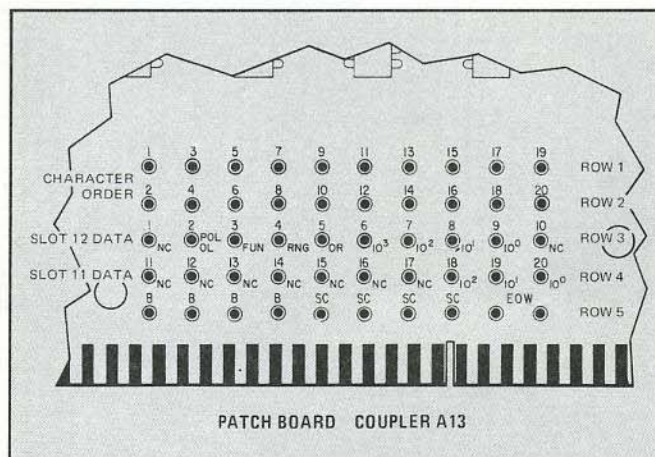

FIGURE 9. Patch Board

SYMBOL	DESCRIPTION	RANGE	CONTROL
T1	ENCODE pulse width	1.5 ms to 100 ms	Scanner Program Card
T2	reading period	1 ms to 1 s	DVM programming and filter and function controls
T3	BCD coupler input setting time	100 μ s to 2 ms	All, R103 Coupler Data Storage Card
T4	scan advance pulse width	50 μ s	fixed
T5	system delay time	.5 ms to 10 s	Scanner System Delay
T8	recording time/character	2 ms Mag. Tape 8 ms Punch	fixed
T9	GIP pulse width	175 to 550 ms (depends on tape density)	fixed

TABLE 7. Time Parameters for Calculating System Speed

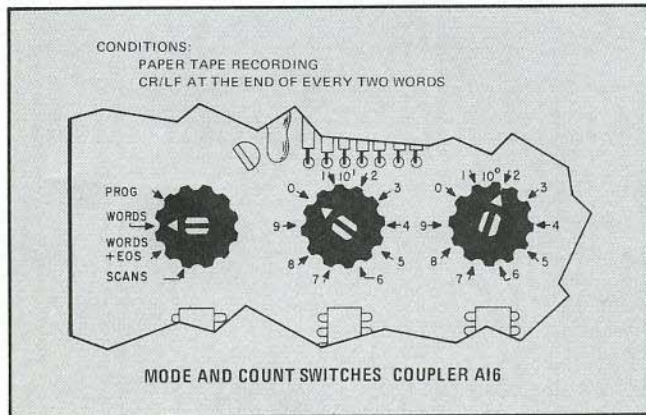

FIGURE 10. Programming Example

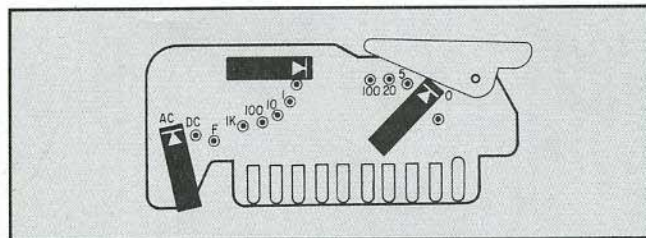

FIGURE 11. Scanner Program Card

special IRG control line. The control character for the Tape Punch is a carriage return (CR) which is generated by the Coupler Output Card and recorded like any other character.

Word grouping is selected by the Mode switch on the Control Card of the Coupler. There are four positions to this switch.

PROG: In this position an external command may cause a control character to be issued. This system does not use the PROG position unless no control character is wanted.

WORDS: In this position, the Coupler will count a selected number of words and issue a control character.

SCANS: The Coupler will count a selected number of scans and issue a control character.

WORDS + EOS: The Coupler will issue a control character at the end of a selected number of words and at the end of each scan.

There are two count switches on the Control Card that are used to select the number of words or scans. These select two digit numbers. If the Magnetic Tape is used, there is a count switch for a third or hundreds digit on the Magnetic Tape Output Card of the Coupler.

Figure 10 illustrates the Coupler Mode and count switches and shows how they may be used.

An IRG considerably affects system speed since it takes between 175 and 550 ms depending on the tape density. The user may want to place them as infrequently as possible if he has many rapid consecutive measurements to make.

Time Delay

Several conditions affect the system speed. Before attempting this programming, it may be helpful to read THEORY OF OPERATION.

Table 7 lists the time parameters used to determine the system speed. Speed is given in "measurements/second" and is equal to $1/T$ where T is the measurement period.

Each Scanner module can be programmed separately for the length of the ENCODE command, T1. In the front of the Scanner, there is a program card (Figure 11) for every two modules. The top of this card programs the first of these two, and the bottom programs the second. Only the ENCODE delay is programmable in this system; changes of RANGE and FUNCTION between modules will produce a 5 ms delay between those modules.

ENCODE delays are selected for a module by placing the diode jumper in the 0, 5, 20, or 100 ms positions. There is always at least a 1.5 ms delay. These delays are the length of the ENCODE command. The 3480A/B triggers on the negative going-edge of this pulse.

Reading period time is determined by the DVM plug-in. If measurements are being made in ac or with either filter, the delay mode will be needed to allow for settling time. The DVM delay mode is selected by a jumper in the DVM plug-in.

The pulse width adjustment, R103 on the Data Storage Card (A11) of the Coupler should always be set to its minimum value for a 100 microsecond settling time, T3, if maximum speed is desired.

If slower system speeds are needed, the easiest way is to use the Systems Delay control on the Scanner.

System Speed:

System speed is determined by the following equations:

If $(T1 + T2 + T3 + T4 + T5) > [(No. of characters) \times T8]$ then speed = $1 / (T1 + T2 + T3 + T4 + T5)$
 otherwise speed = $1 / [(No. of characters) \times T8]$

All the parameters, except T3, can be measured from oscilloscope connections on the interface lines.

CONNECTOR DIAGRAMS

Figures 12, 13 and 14 illustrate the connector diagrams for each of the instruments in the system.

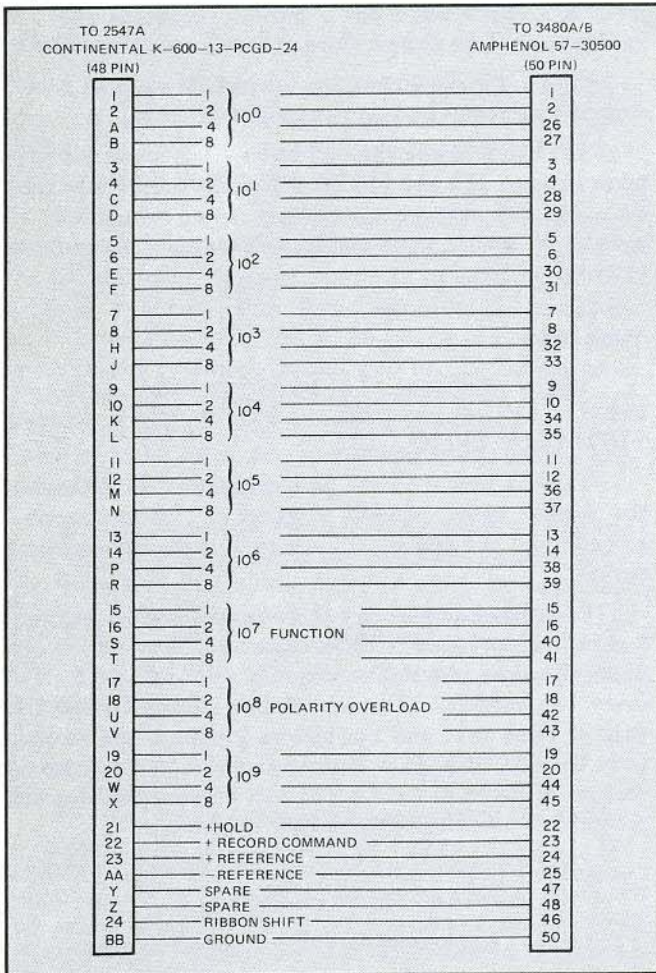

FIGURE 12. DVM-Coupler Cable

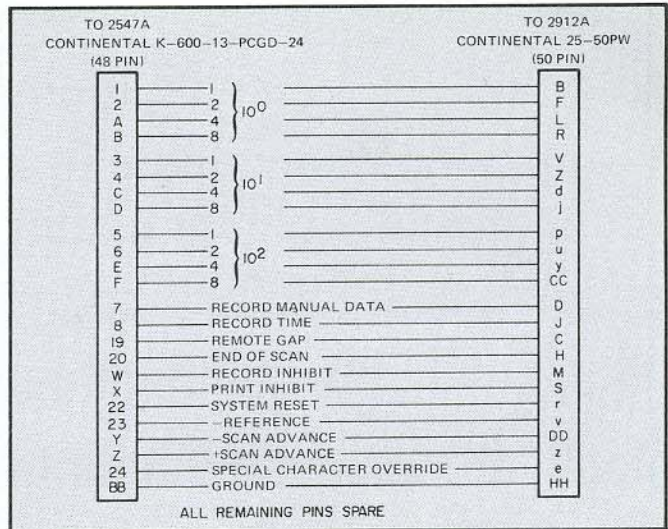

FIGURE 13. Scanner-Coupler Cable

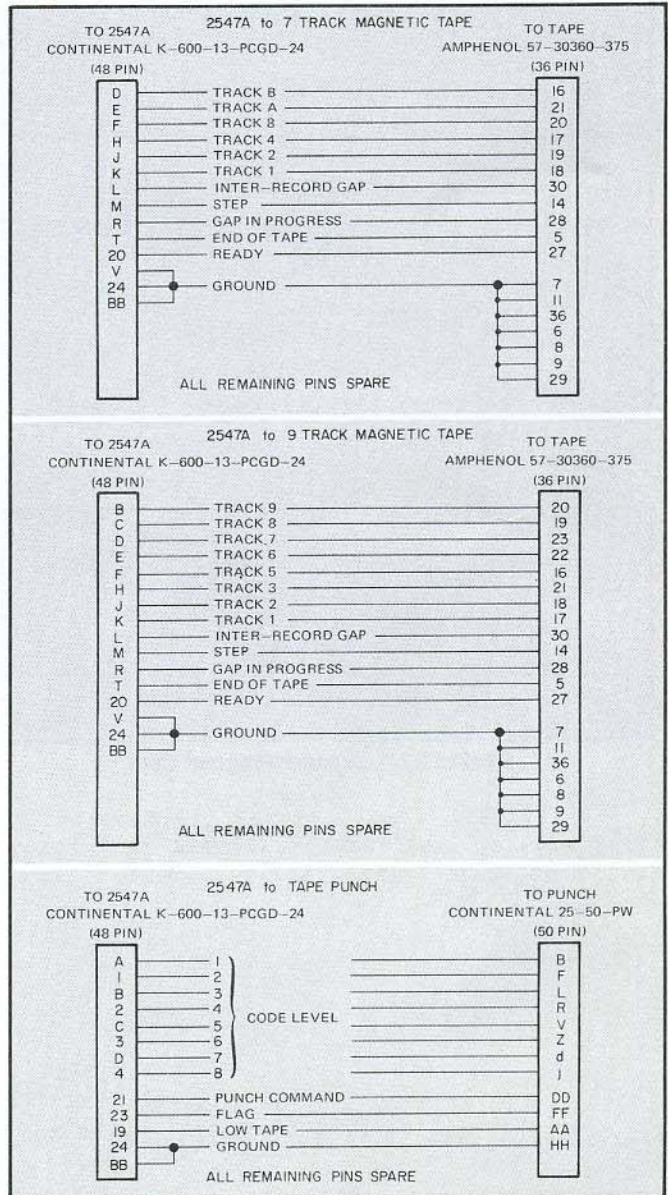

FIGURE 14. Output Cables

THEORY OF OPERATION

System operation starts with an ENCODE command issued from the Scanner. This signal, connected to the EXTERNAL TRIGGER input of the DVM plug-in, tells the DVM to take a measurement. These signals are shown in the block diagrams in Figures 15 and 16.

After the DVM has completed its measurement, it issues a PRINT command to the Coupler. A PRINT command indicates that BCD data is available at the DVM output.

As soon as a PRINT command has been received from the 3480A/B and recording of the previous data has been completed, the Coupler transfers the BCD data from the DVM. Then it issues a SCAN ADVANCE command to the Scanner and starts to transmit BCD data to the recording device serially. The format and number of BCD characters recorded depends upon the Coupler programming.

In the case of the Paper Tape Punch, the Coupler first presents a BCD character at its output, then a PUNCH command to the Punch. Upon receipt of a PUNCH command, the Punch issues a FLAG to the Coupler until it has completed transferring the character information and recording it. When the Punch FLAG is removed, the Coupler presents another character, and so on, until it is done. Recording data on paper tape is a closed loop operation.

Incremental magnetic tape recording is an open loop operation. The Coupler first presents a BCD character at its output then issues a STEP command. When the Incremental Recorder receives a STEP command, it transfers the data and records the character. The Coupler waits a pre-determined length of time and outputs another character, etc.

A SCAN ADVANCE command causes the Scanner first to go to the next consecutive channel, then issues an ENCODE command if the Scanner is in a scan mode. In the Monitor mode, the Scanner will stay on the same channel but issues an ENCODE command. Thus, the system continues to operate in a closed loop.

3480A/B DVM

Measurement time of the DVM, without a programmed delay, is 1 ms. That is, the time from the trailing edge of the ENCODE command to the leading edge of the PRINT command is 1 ms, without delay.

It is possible and useful to increase the DVM reading time to allow for instrument response time. For dc measurements, a time delay mode may be selected. If this mode is selected, measurement time with Filter A will be 200 ms, with Filter B it will be 1 sec and without a filter, it is 4 ms. Selecting DVM delay mode will also produce a 1 sec delay for ac measurements.

2912A REED SCANNER

If the System Delay control is in its "MIN" position,

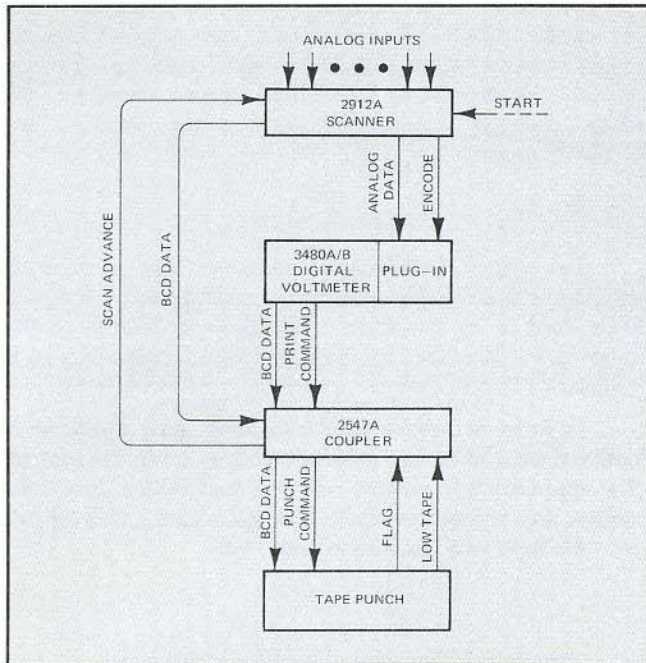

FIGURE 15. Punched Tape Block Diagram

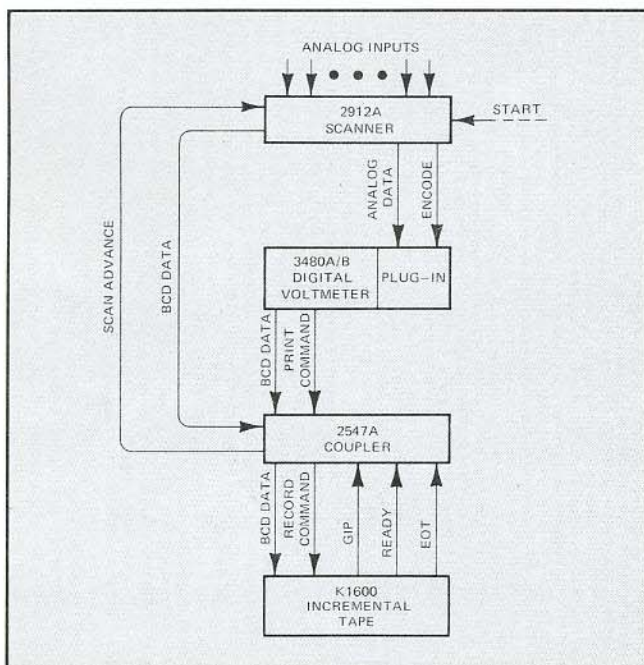

FIGURE 16. Magnetic Tape Block Diagram

the time between the leading edge of the SCAN ADVANCE command and the actual closing of the next consecutive reed relay is 0.5 ms. This time can be stretched to about 10 sec by switching the System Delay control out of its "MIN" position.

Since reed relays do not open and close perfectly, a settling period of at least 1.5 ms is required between the application of power to the relay and the trailing edge of the ENCODE command. This time is the pulse width of the ENCODE command, and it can be programmed to be 1.5 ms, 5 ms, 20 ms, or 100 ms for each module.

2547A COUPLER

Data is transferred simultaneously from the DVM and the Scanner in character-parallel, bit-parallel fashion. The time required for this transfer can be adjusted from 0.524 ms to 1.524 ms.

As soon as the data transfer is complete, the Coupler transmits the data in character-serial, bit-parallel fashion to the recording device and issues a RECORD or PUNCH command. The Coupler cannot accept more data until this process is complete. The recording process takes 2 ms per character recorded on the Magnetic Tape. It takes 8.5 ms per character on Paper Tape.

K1600 INCREMENTAL MAGNETIC TAPE

Since the Recorder does not return a FLAG in response to the STEP command, the time between successive STEP commands is set in the Coupler at 2 ms.

In addition to the STEP command, several other control lines connect the Tape Recorder to the Coupler. It is possible to program a control character at certain output intervals. When the Magnetic Tape is used, the control character is an interrecord gap which the Recorder automatically produces when the Coupler issues a command on the IRG control line. This gap takes from 175 to 550 ms depending on recording density. During this period, the Recorder returns a hold off signal to the Coupler to indicate that there is a gap in process. The GIP signal, as it is called, prevents the Coupler from accepting any more data until the IRG is complete.

A hold off signal is also supplied to the Coupler if the Recorder is either not ready or at the end of its tape.

2753A HIGH SPEED TAPE PUNCH

Each PUNCH command issued by the Coupler to the Punch is answered by a FLAG. The FLAG lasts as long as it takes to punch a character which is 8.5 ms, and it holds off the next PUNCH command.

A carriage return is the control character used with the PUNCH. This character takes the same amount of time as any other.

EXTERNAL START COMMAND

In the S/SCAN mode, the Scanner will make one complete scan when it receives a START command (manu-

ally or from an external source) then it will stop and wait for another START command. The scan rate is at system speed, but the rate at which individual scans are made is the same as the rate of START commands. However, the scans cannot be made any faster than they could in the C/SCAN mode.

TIMING CHARTS

Two system timing charts are shown here. Each chart includes a control character at the end of each word, and each word is ten characters long. System speed is the inverse of the Measurement Period shown on these diagrams (Figures 17 and 18).

In order to reduce troubleshooting time, a scheme is outlined here to isolate system problems to an instrument. The approach is to assume only one malfunction, locate the source, and proceed to repair that instrument. This scheme is in the form of a troubleshooting tree.

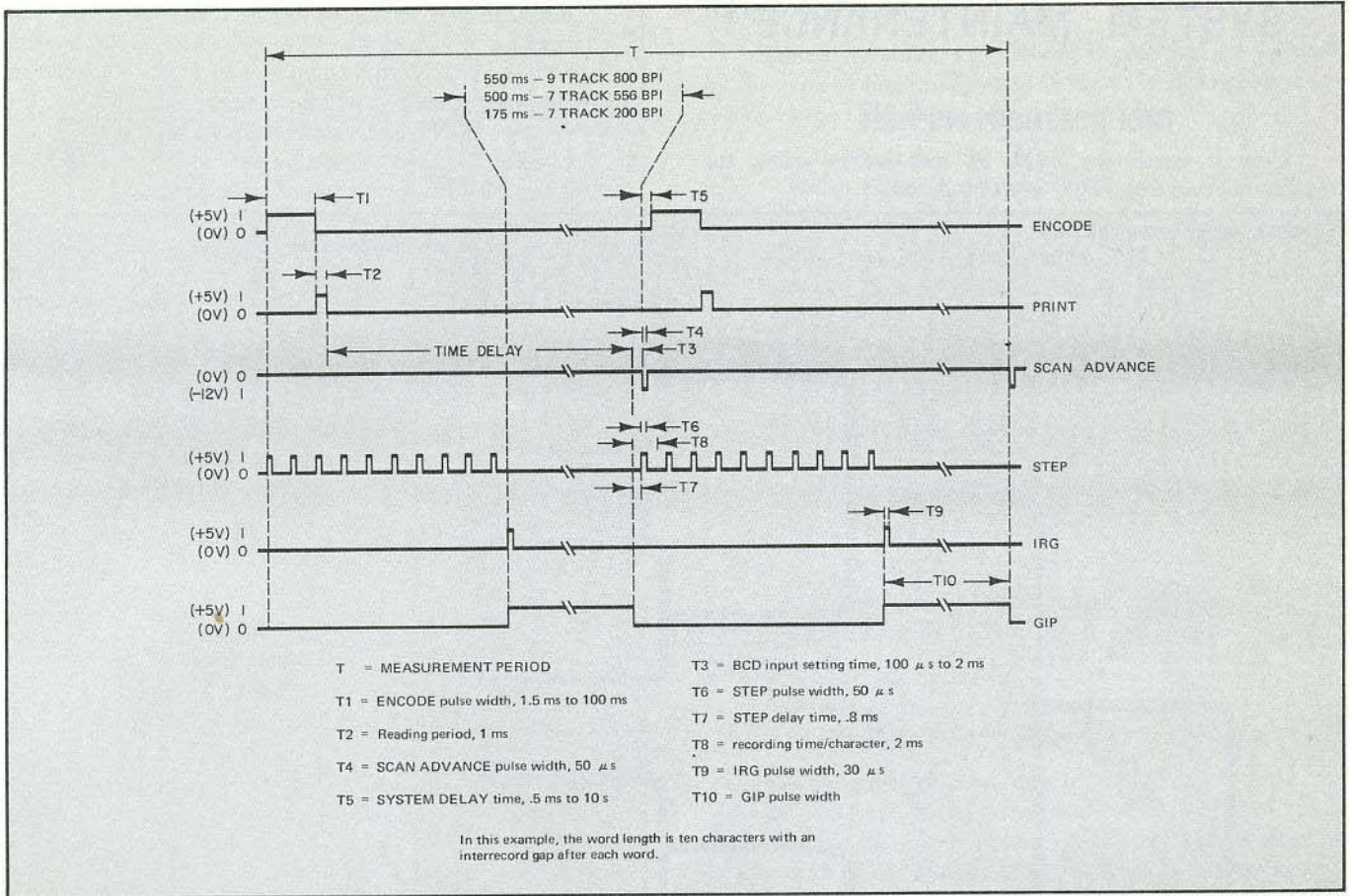

FIGURE 17. Timing Chart for Incremental Magnetic Tape

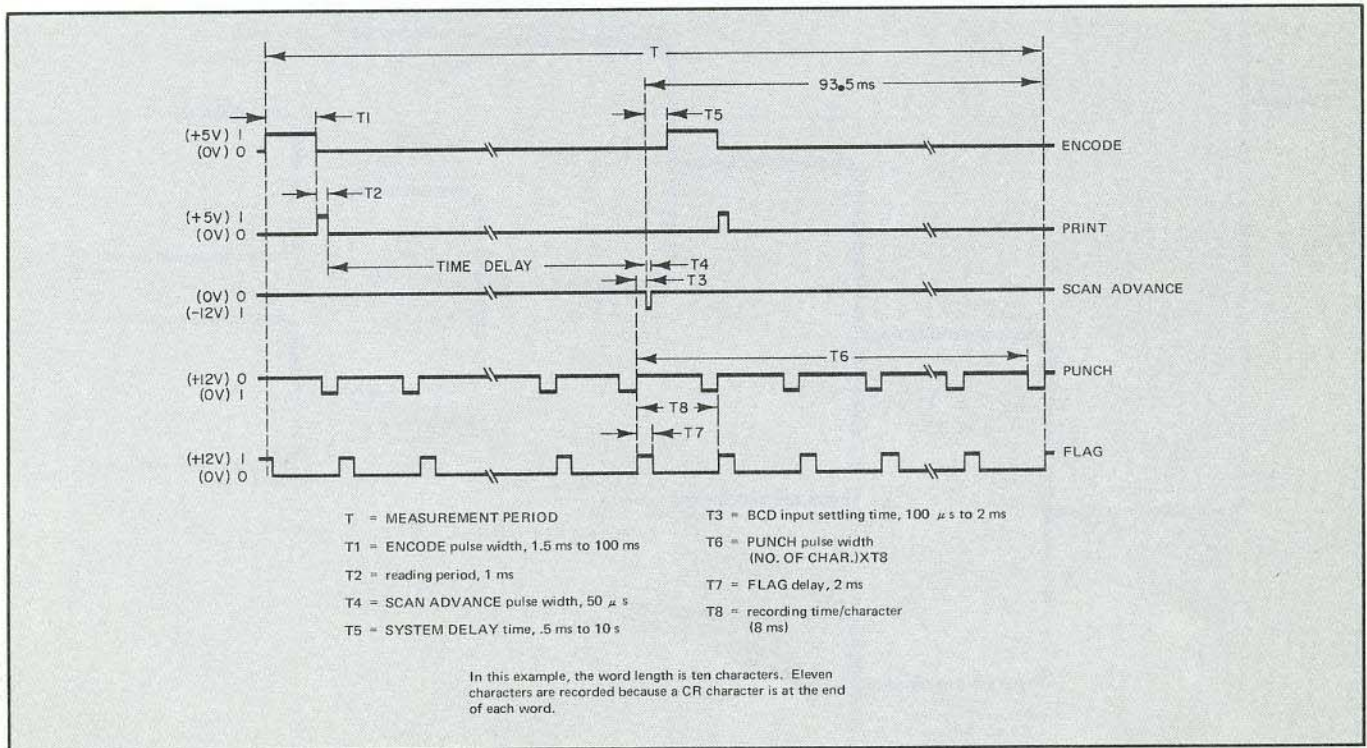

FIGURE 18. Timing Chart for High Speed Tape Punch

SYSTEM MAINTENANCE

TROUBLESHOOTING TREE

Several conditions must be met before using the troubleshooting tree. They are as follows:

Reset/START should be in MAN position.
 Scanner MODE should be in S/SCAN.
 SYSTEM CONTROL should be in LOC.
 Recorder/Punch should be on and ready.
 Coupler CONTROL should be in REM.
 Coupler RECORD should be ON.
 Turn POWER to ON for all instruments.

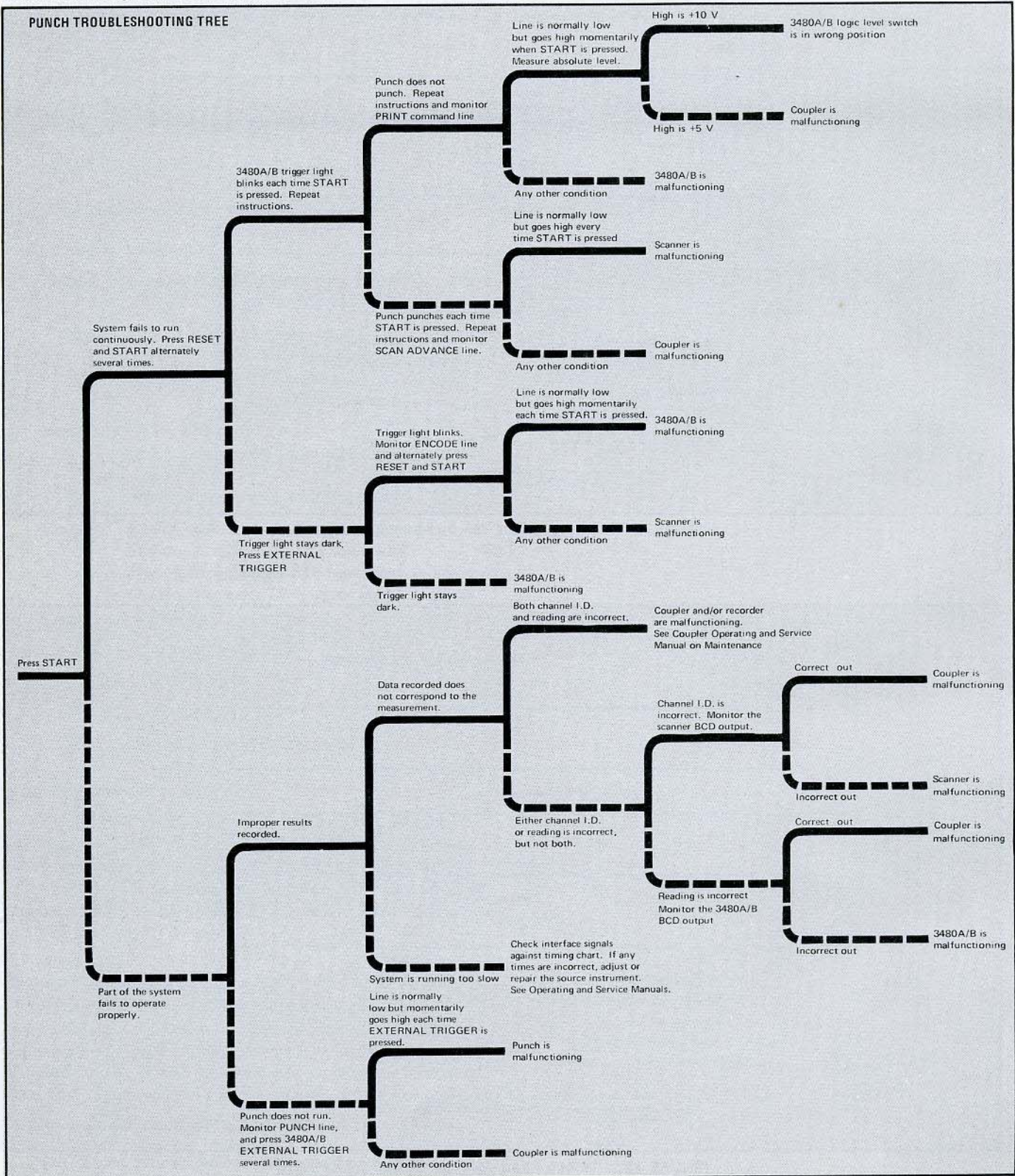

MAGNETIC TAPE RECORDING TROUBLE SHOOTING TREE

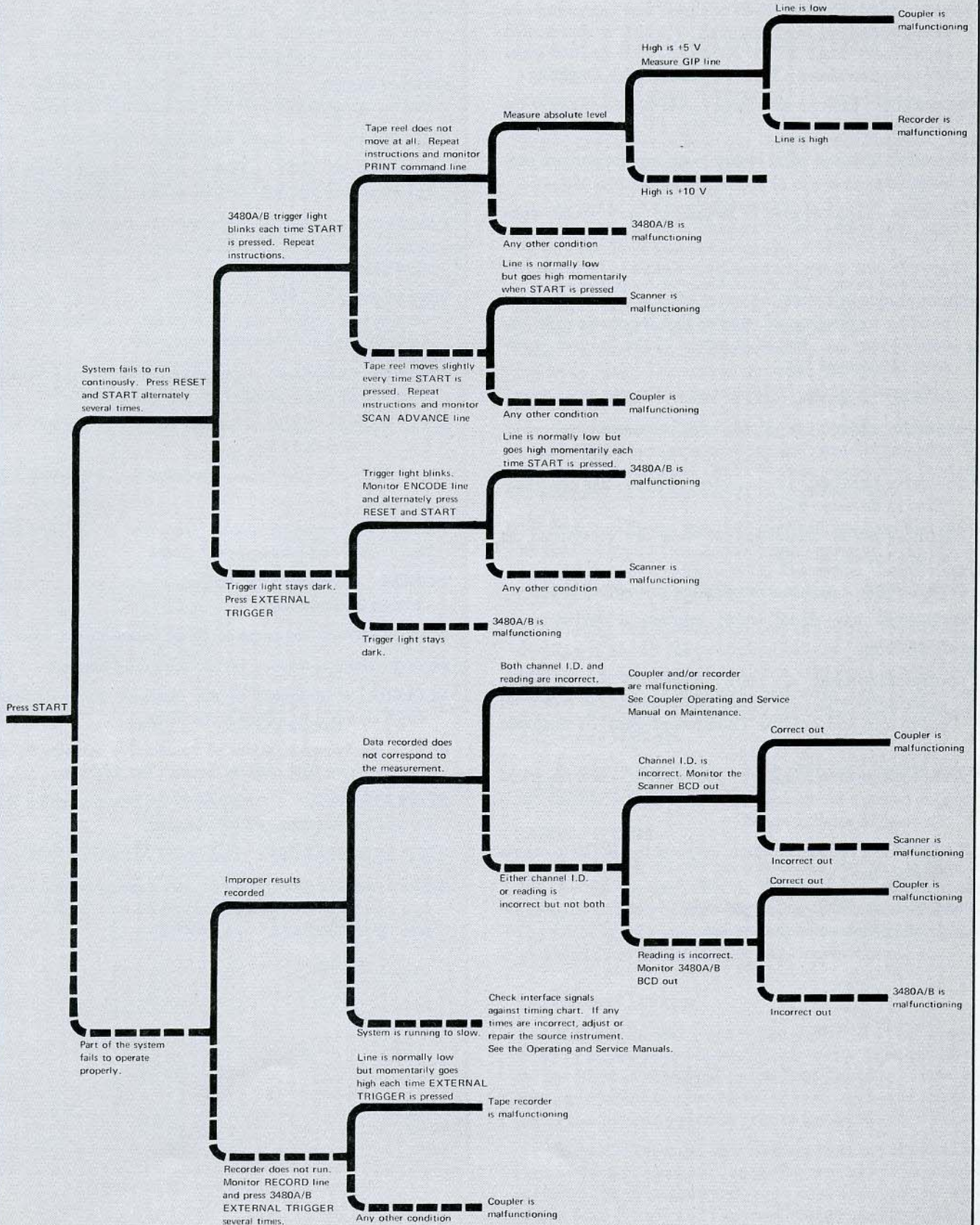

GLOSSARY

binary coded decimal BCD: a signal that represents one or more decimal numbers, each of which is represented by a binary code. In the 3480A/B, each decimal number is represented by four bits with 8-4-2-1 weighting.

bit-parallel: each bit of a binary code is recognized at the same time.

bit-serial: the bits of a binary code are recognized consecutively.

blank: a character that is recognized as a space when printed.

channel: one of the Scanner input signals to be measured.

channel identification, channel I.D.: a number corresponding to the channel number that the Scanner is presently sampling. The BCD output of the Scanner represents the channel I.D.

character: a symbol, digit, or letter.

character order: the order in which characters are recognized. This is significant in a character-serial output.

character parallel: all characters of same data are recognized at the same time.

character serial: characters of data are recognized in some consecutive order.

closed loop: a system controlled by a feedback path.

command: any signal which instructs a device to do something.

control character: a "mark" placed on the recording medium to format the record. It is a carriage return on paper tape and on IRG (Interrecord gap) on magnetic tape.

DVM measurement speed: the speed at which the DVM can convert an analog input to a digital output. It is the same as reading speed.

ENCODE: a command which instructs the DVM to take a measurement.

end of scan, EOS: an output signal from the Scanner indicating that a scan is complete.

end of word, EOW: a signal generated when the last character of a data word has been transmitted by the system coupler. It refers to the end of a data word.

external trigger: an input to the DVM that tells it to make a measurement. It is the same as ENCODE.

flag: a reply or feedback signal from any device.

gap in process, GIP: a control signal from the Tape Recorder indicating that an IRG is being recorded.

guarded measurement: a technique that uses an extra (guard) chassis and input to reduce the effect of common mode noise.

interrecord gap, IRG: a 3/4 inch blank space recorded on magnetic tape so that the recorded data can be recognized by the data processing equipment.

isolated: an input or output signal is electrically isolated from the internal circuitry of the instrument.

scan: a signal amplitude value; or, one of the bits of a binary coded character.

open loop: a system whose operation is not controlled by feedback.

PRINT: an output command from the DVM indicating that it has completed a measurement.

PUNCH: a command to the paper tape punch to record data on the paper tape.

reading speed: the same as DVM measurement speed.

record: the information on the recording medium.

RECORD: a command to the Magnetic Tape Recorder which causes it to record a character.

level: one complete series of consecutive samples by the Scanner from first address through last address.

SCAN ADVANCE: a command to the Scanner telling it to sample the next consecutive channel.

STEP AND MEASURE: same as SCAN ADVANCE.

system measurement speed: the speed at which a system can sample, measure, and record data from a channel; given in channels per second.

