

**Spectrum Analyzer Series**  
**APPLICATION NOTE 150-5**

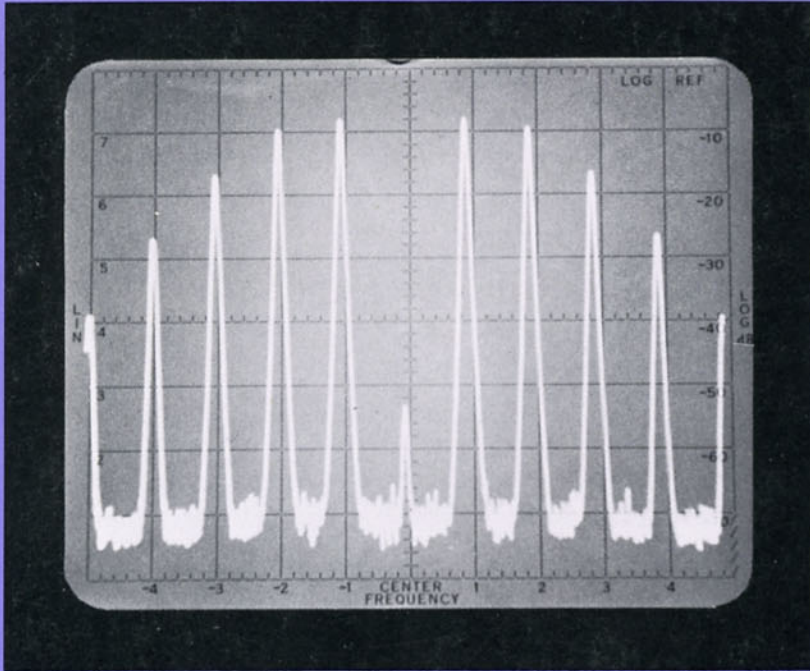

**SPECTRUM ANALYSIS. . . .**

**CRT Photography and  
X-Y Recording Techniques**

## **APPLICATION NOTE 150-5**

### **SPECTRUM ANALYSIS ... CRT Photography and X-Y Recording Techniques**

Printed May 1973

HEWLETT  PACKARD

## CONTENTS

	Page
INTRODUCTION .....	1
CHAPTER 1. SPECTRUM PHOTOGRAPHY	
General Considerations .....	2
Standard Persistence CRT .....	3
Variable Persistence CRT .....	6
Examples of Poor Photography .....	10
CHAPTER 2. RECORDING TECHNIQUES	
X-Y Recorders .....	11
Strip Chart Recorders .....	13
Magnetic Recorders .....	16
Digital Recorders .....	18
CHAPTER 3. SPECIAL RECORDING APPLICATIONS	
Log/Log X-Y Plots .....	20
Peak Holding X-Y Plots .....	21
APPENDIX .....	22

## INTRODUCTION

In spectrum analysis applications, the need exists for making plots and photographs to keep as permanent records. Application Note 150-5 offers the reader practical help in making cathode ray tube (CRT) photographs and X-Y recordings of spectrum displays.

This note is written around Hewlett-Packard's 8550 series spectrum analyzers. These analyzers are used with two types of displays: Standard Persistence CRT and Variable Persistence CRT. The 140S, 140T, and 143S mainframes have standard persistence displays while the 141S and 141T mainframes have variable persistence plus storage. Since the 143S is a large-screen CRT (8 x 10 inches), it lends itself to standard photography techniques and, therefore, it will not be covered in this Application Note.

The camera we refer to in this note is HP Model 197A. As to the recorders, several HP models can be used for each of the four recorder types discussed here. These models are:

1. X-Y Recorders: 7004B, 7005B, 7034A, 7035B, and 7044A
2. Strip Chart Recorders: 7100B, 7101B, 7127A, 7128A, 680, 680M, 7123A/B, and 7143B
3. Magnetic Recorders: 3950 series and 3960 series
4. Digital Recorders: 5050B and 562A

The techniques described here will generally be applicable to cameras and recorders similar in principle to these HP models.

# CHAPTER 1

## SPECTRUM PHOTOGRAPHY

### GENERAL CONSIDERATIONS

A properly exposed CRT photograph is one that provides a three-tone contrast between the trace, the graticule lines, and the background. To produce such a photograph, the analyzer has three variables which we must consider: trace intensity, scan time, and phosphor type (standard persistence or variable persistence). Likewise, the camera has three variables which affect the quality of the photograph; these are lens f/NO, shutter speed, and graticule illumination. Because of the interplay among these variables, it is recommended that one or more trial exposures be taken when first starting or when operating conditions are changed considerably.

The first step in preparing the CRT display for exposure is to adjust trace intensity so that a good trace detail is obtained and no halo or blooming exists. It is recommended that this adjustment be made while the camera is mounted to the analyzer bezel, and trace be viewed through the camera face mask. This recommendation is made because a trace that may seem convenient to the eye in a well-lit room can be too bright in the environment of the film chamber, thus resulting in over-exposure. Often, however, we find that trace intensity is somewhat dependent on the analyzer scan time, so we have to increase the intensity during fast scans and reduce it during slow scans.

Approximately the same exposure is obtained with several combinations of shutter speeds and lens f/NO's. This is so because each lens f/NO has twice the opening of the f/NO preceding it, with f/16 being the smallest and f/1.9 being 64 times as big. The same is true of the shutter speed positions. Thus, if an exposure is correct with f/5.6 at 1 sec, then other correct exposures can be taken with f/8 at 2 sec, f/4 at ½ sec, and f/28 at ¼ sec, etc. A quick hint to remember is that the lens f/NO control and shutter speed control move an equal number of steps but in opposite directions. We should keep this characteristic in mind; it will be useful, as we shall see, whenever adjustments are needed.

Now, let's look at specific procedures for producing good quality CRT photographs. We will treat each type of display separately and let's begin with standard persistence.

#### Note

In this chapter we have used two terms that should be clarified: lens f/NO and shutter speed. Lens f/NO refers to the lens shutter opening which is continuously variable, with f/16 being the smallest and f/1.9 64 times as big. To avoid confusion, we used the term "increase/decrease shutter opening" rather than increase/decrease f/NO. When we increase the lens shutter opening, we are simply making the opening wider (using lesser f/NO) and vice versa. Shutter speed, on the other hand, refers to the length of time the lens shutter stays opened. Since speed is the inverse of time, when we increase speed we are actually decreasing exposure time and vice versa. This meaning has been retained in this Application Note.

## STANDARD PERSISTENCE CRT

We can use two methods to make photographs of a standard persistence CRT display:

1. Single exposure using CALIBRATED shutter speeds.
2. Multiple exposure using UNCALIBRATED (T or B position) shutter speed.

For convenience and simplicity, single exposure should be used when the analyzer scan time is 0.2 sec/division or less and multiple exposure should be used with scan times equal to or greater than 0.5 sec/division.

### Single Exposure

We should begin our setup with the blue-coded recommended positions on the camera, i.e.:

lens f/NO: 8  
shutter speed: 1 sec  
graticule illuminator control: 8-9  
graticule illumination: ON

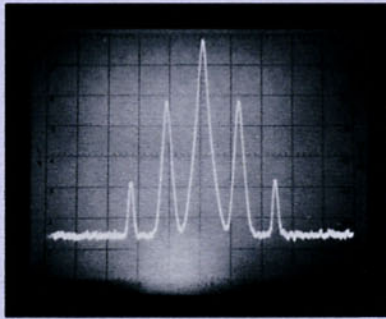
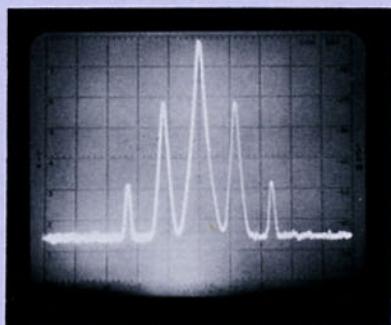

Figure 1.

This photograph was taken at f/8 and 1 sec. Analyzer scan time is 0.1 sec/division.

The analyzer scan time should be set to 0.1 sec/division so that it makes one scan cycle during the time the camera shutter is opened. The analyzer should be amplitude calibrated at this scan time setting; if not, increase scan time to 0.2 sec/division and adjust the camera shutter speed to 2 sec and lens f/NO to 11. A trial exposure should be taken at the recommended settings and adjustments made as needed. See "Examples of Poor Photography," page 10, for suggested adjustments.

Now let's look at two problems which are often encountered in this method, trace after-glow and trace short-term instability. After-glow is a characteristic of P7 phosphor used in standard persistence CRT's. Its duration increases with an increase in intensity. Thus when after-glow occurs, it causes the trace to be non-uniform and over-exposed as shown in Figure 2. To correct this condition, trace intensity should be adjusted until the



**Figure 2. Trace After-glow.**

This photograph is for the same signal shown in Figure 1. It was taken at  $f/8$  and 1 sec. Analyzer scan time is 0.1 sec/division.

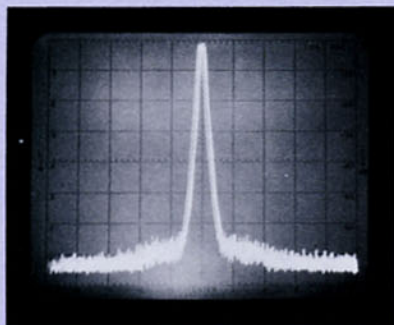

**Figure 3. Trace Jitter**

This is an unstable signal under zoom conditions (narrow scan and narrow bandwidth). Notice trace thickness. The camera was set to  $f/16$  and 2 sec. Analyzer scan time is 0.1 sec/division.

trace is just slightly visible above the background. This adjustment, as we indicated earlier, should be made with the camera mounted to the analyzer and viewing made through the face mask.

Trace short-term instability, on the other hand, is a characteristic of the signal under test and it appears as trace jitter on the CRT. Figure 3 shows such a signal. Thus if the analyzer makes several scan cycles during the time the camera shutter is opened, the photograph will show a wider or thicker trace (compared to the one seen on the CRT). Clearly then, this photograph is not a faithful reproduction of the test signal spectrum; it is, however, a photograph of the short-term instability of the signal. To overcome this problem, the camera shutter speed should be adjusted so that it is equal to or slightly greater than the analyzer's time per scan cycle. As an illustration, suppose the analyzer scan time is set to 50 msec/division (0.5 sec total), then the camera shutter speed should be set at  $\frac{1}{2}$  sec. If the shutter speed is set at 1 sec, trace fluctuations will be photographed, but if it is set to  $\frac{1}{4}$  sec, half of the trace will be missing.

Once we arrive at a proper exposure combination, we can maintain constant exposure by adjusting shutter speed and lens  $f/NO$  as described earlier. So if the analyzer scan time is changed, we can adjust the lens  $f/NO$  to maintain constant exposure.

Since the analyzer has a manually triggered single scan capability, it would be convenient to utilize this capability to synchronously trigger the camera shutter as well. Figure 4 shows such a configuration. This arrangement is easy to do; all we need is a simple contact relay and a +14-volt supply. Before the analyzer is triggered, it supplies the pen lift terminal with +14 volts, bucking the 14 V supply, thus no current flows through the coil and the relay contacts are open. As the analyzer is triggered, the analyzer-supplied pen lift voltage drops to zero, current flows through the coil and contact closes. When this happens, the +14 volts from the external supply is applied to

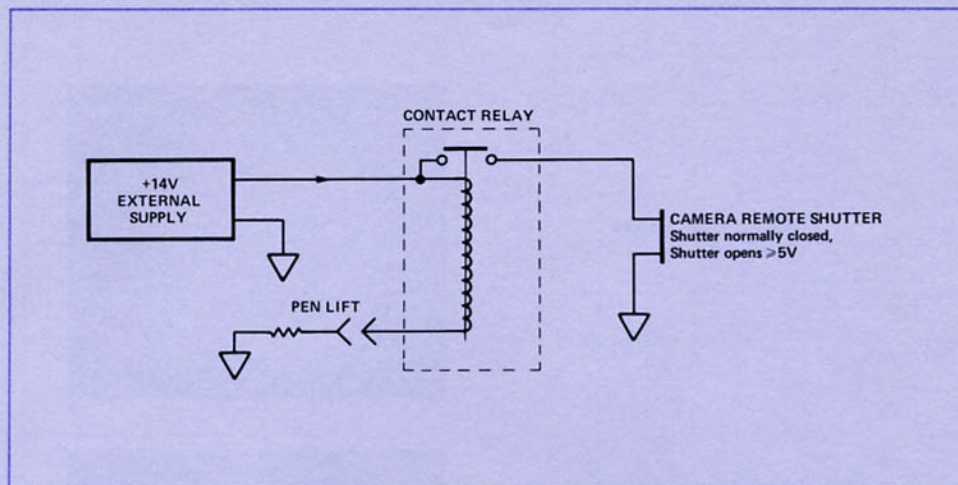

Figure 4. Simultaneous Triggering of Both Analyzer and Camera.

the camera remote shutter terminal and triggers the camera. The delay time between triggering the analyzer and having the shutter fully opened is approximately 12 ms, thus it is recommended that this configuration be used with scan times 50 ms/division or longer.

With a variable persistence CRT, unstable signals are photographed more easily. The analyzer is simply single scanned, the display is stored and then photographed. Variable persistence is far more convenient and versatile.

### Multiple Exposure<sup>1</sup>

For slow analyzer scans (5 - 100 sec), it is cumbersome to adjust the graticule illumination to prevent background over-exposure since the illumination control is not calibrated and the camera lens has to be opened five seconds or more. So the approach we use here is to expose the background separately from the trace as follows:

#### Background Exposure:

shutter speed: 4 sec  
 graticule illumination control: 8 - 9  
 graticule illumination: FLASH<sup>2</sup>  
 f/NO: 8  
 trace intensity: CCW

Expose the background and use as a trial exposure. If under-exposed increase graticule illumination control. Record the final control settings.

#### Trace Exposure:

shutter speed: T or B  
 graticule illumination: OFF  
 f/NO: 11 - 16

<sup>1</sup> If single exposure is desired with slow scan times, we can modify this procedure as follows: graticule illumination ON, f/NO 16, adjust both trace intensity and graticule illumination controls until the proper exposure is obtained. This adjustment has to be repeated every time the scan time is changed.

<sup>2</sup> UV light is on for 1 sec when camera shutter is opened.



A. Background Exposure  
f/8 and 4 sec

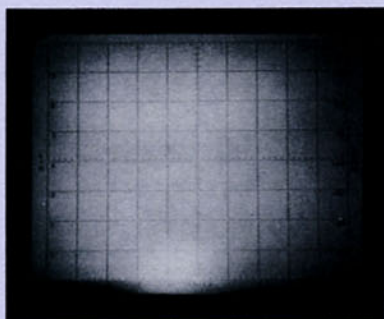

B. Trace Exposure  
f/16 and B (10 sec)

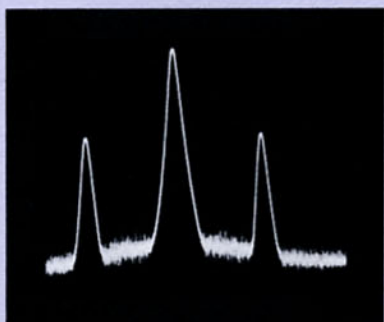

C. This photograph was multi-exposed using  
the settings in A and B above

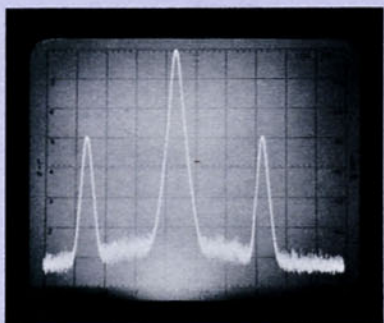

Figure 5. Multiple Exposure with Standard Persistence.

Adjust trace intensity so that the trace is clearly visible, switch the analyzer scan mode to single, trigger the camera and then the analyzer. Observe the analyzer scan light and release the camera shutter after the light is off. Adjust the lens  $f/NO$  or trace intensity to correct any deficiency in the photograph. Record the camera and analyzer setting and proceed to photograph the test signal.

#### VARIABLE PERSISTENCE CRT

Variable persistence provides convenient and flexible viewing. Fast and slow scans can be viewed with ease and simplicity. Since these mainframes feature both variable persistence and storage, we can photograph the CRT display in three ways:

1. Single Exposure: using storage with UV light.
2. Single Exposure: using variable persistence with no UV light.
3. Double Exposure: separate exposure of trace and background with no UV light.

In general, when the UV light is used to illuminate the CRT, persistence should be at or near maximum. If persistence is not at or near maximum, the film will be over-exposed even with the fastest shutter speed and smallest lens aperture.

#### Single Exposure (with UV light)

This method is easier and faster than the other two methods. No limitation exists regarding the analyzer scan time or trace instability. To set up the display, simply single scan the analyzer at maximum persistence and store the display. Adjust the time control so that the trace is visible above the background without being excessively bright. Now, adjust the camera as follows:

lens f/NO: 8  
shutter speed: 1 sec  
graticule illumination control: 8-9  
graticule illumination: ON

Trigger the camera for a trial exposure and adjust controls as needed. Figure 6 is a stored display, single-exposed.

#### Single Exposure (no UV light)

The initial setup here is a little more difficult to establish compared to standard persistence because we have no guidelines to follow. However, in general the three o'clock position of the variable persistence control is a good start for background illumi-

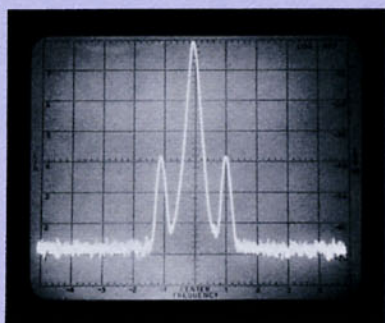

Figure 6. Single Exposure.

This signal was stored first and then exposed, using the camera UV light for background illumination. The camera was set to f/8 and 1 sec.

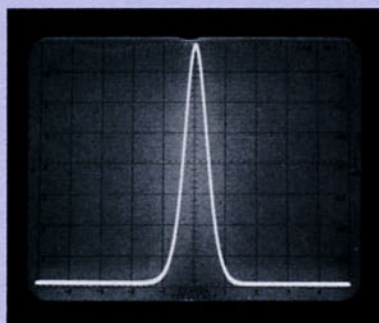

Figure 7. Single Exposure.

This photograph was taken using the analyzer variable persistence control to provide background illumination. Camera was set to f/11 and 1/30 sec. Analyzer scan time is 2 millisecond/division.

nation. In this position, there is usually good contrast between the trace and the background. So, the following settings may be used to start with initially:

lens f/NO: 8  
shutter speed: 1 sec  
graticule illumination: OFF  
analyzer scan time: 0.1 sec/division  
persistence: 3 o'clock position

Make a trial exposure. Adjust one variable at a time (refer to page 10 for suggested adjustments) and repeat exposure until an acceptable quality is obtained. Record the final setting for future reference. Often we find that the trace is over-exposed in this method, so care must be exercised to reduce trace intensity to an adequate level. The photograph shown in Figure 7 was taken with this method.

Here again, if the analyzer scan time is changed, we can simply adjust the shutter speed and lens f/NO to maintain constant exposure and photograph only one scan cycle.

This method has two limitations: it is difficult to use with slow analyzer scan times (5 to 100 seconds) and with unstable signals. In both cases, the trace should be stored as above or multi-exposed as explained below.

### Multiple Exposure

We can simplify this procedure by exposing the background and the trace using the same lens f/NO and shutter speed. The recommended initial setup is as follows:

#### Background Exposure:

lens f/NO: 8  
shutter speed: 1 sec  
graticule illumination: OFF  
analyzer persistence: 3 o'clock position  
analyzer intensity: fully CCW

Take a trial exposure and adjust controls as needed. Mark and record all settings.

Now single scan the analyzer and store the trace. Expose the trace as follows:

lens f/NO: as obtained above  
shutter speed: as obtained above  
graticule illumination: OFF  
analyzer time control: 3 o'clock position

Take a trial exposure and adjust the analyzer time control as needed. Mark its position when an acceptable quality photograph is obtained. Photographs A, B, and C, shown in Figure 8, illustrate this procedure.

A. Background Exposure  
f/8 and 1/2 sec

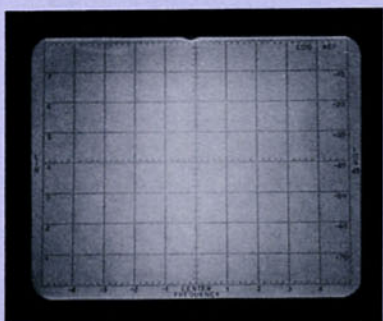

B. Trace Exposure  
f/8 and 1/2 sec

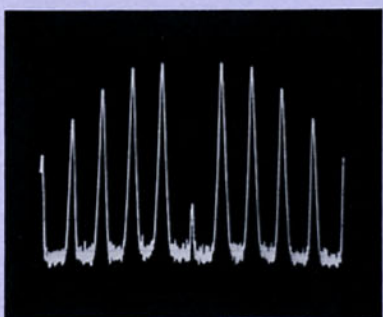

C. This photograph is multi-exposed. Notice that the lens f/NO and shutter speed are the same for this multi-exposure.

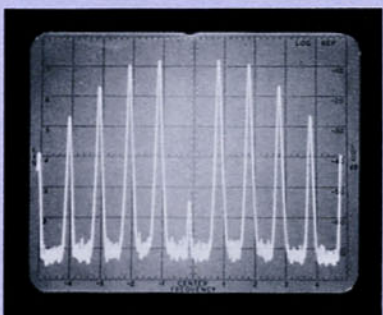
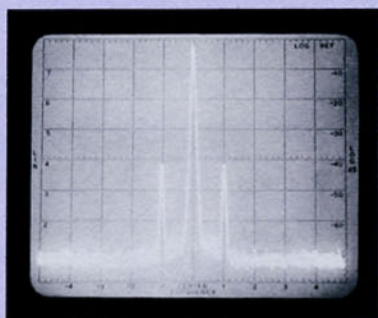

Figure 8. Multiple Exposure with Variable Persistence.

## EXAMPLES OF POOR PHOTOGRAPHY

We have identified four commonly encountered situations and suggested corrective action. In general, corrective adjustments should be made one at a time, and we should weigh their effect on the quality of the photograph before taking another trial exposure.



**Figure 9. Over-exposure.**  
Increase shutter speed  
and/or  
Decrease shutter opening

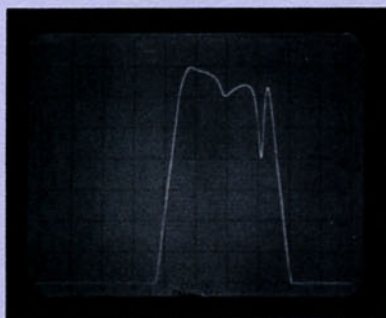

**Figure 10. Under-exposure.**  
Decrease shutter speed  
and/or  
Increase shutter opening

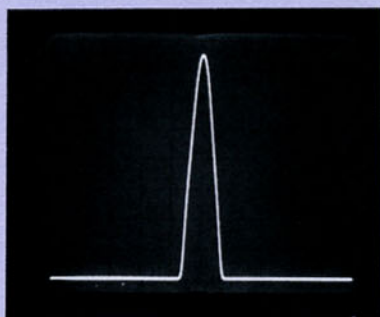

**Figure 11. Poor Contrast.**  
Increase trace intensity  
(avoid blooming) or  
Increase background illumination

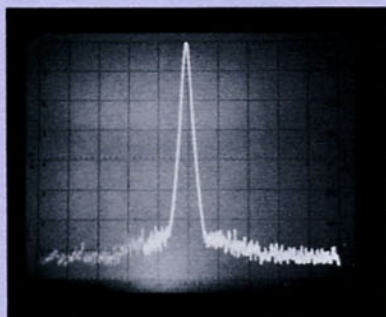

**Figure 12. Incomplete Trace.**  
Increase analyzer scan time  
and/or  
Decrease shutter speed

## CHAPTER 2

### RECORDING TECHNIQUES

We will discuss four types of recorders: X-Y, strip chart, magnetic, and digital. X-Y and strip chart recorders are used to expand the CRT display, while magnetic recorders are used when several channels (sources of data) are to be recorded simultaneously. Digital recorders are simply used to record in digital form the frequency and amplitude of the displayed signal. Let's look at each of these recorders, see how it is connected to the analyzer, and briefly discuss two pertinent applications: Log/Log X-Y plots and peak-holding X-Y plots.

#### X-Y RECORDERS

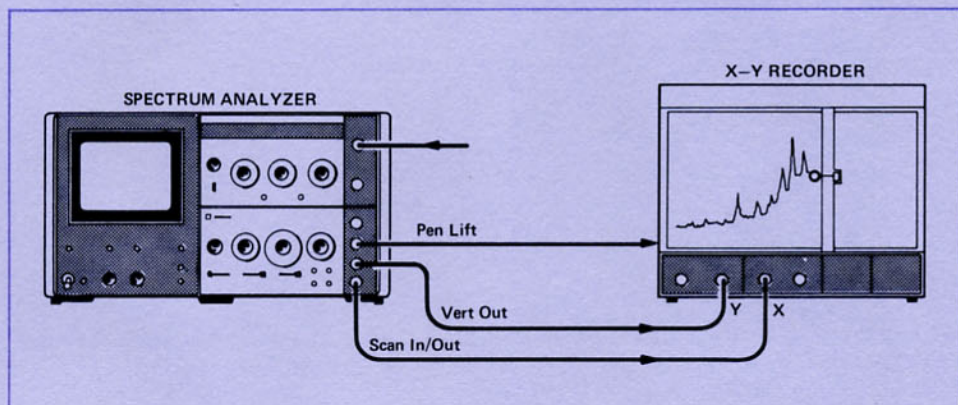

Figure 13. X-Y Recording.

The X-Y Recorder is connected to the analyzer as shown in Figure 13. The bandwidth of most X-Y recorders is 1 - 2 Hz, thus an X-Y recorder introduces an averaging effect very much the way the analyzer video filter does. Furthermore, with such a narrow bandwidth, the recorder response time is very slow so that the analyzer must be scanned at a sufficiently *slow rate* to allow the recorder to fully respond to the input signal. A rule of thumb is to scan the analyzer at 2 sec/division or more. 5 and 10 seconds/division are fully adequate for the vast majority of X-Y recorders.

#### X and Y Axes Calibration

The recorder can be calibrated using either the fixed or the variable<sup>1</sup> (with vernier) gain positions of the X and Y axes. We will describe a simple and fast procedure using the fixed gain positions, and then briefly show how the same procedure can be used with the variable gain positions. This procedure assumes that an 8 x 10-inch graph is desirable.

The Vertical output of the analyzer is  $-0.8$  volt for an 8-division CRT display, and the scan out ramp is  $-5$  to  $+5$  volts with 0 volts occurring at the center of the CRT. But we know that two reference points are needed to calibrate each axis, thus we only need establish the 0 V and  $-0.8$  V points for the Y-axis, and the 0 V and either the  $-5$  V or  $+5$  V points for X-axis. These points can be established as follows:

<sup>1</sup> Fixed gain calibration is more accurate than variable gain, but variable gain allows using any size paper accepted by the recorder.

1. Y-axis: Turn the analyzer Log Reference Level fully counter-clockwise and disconnect the signal from the analyzer input. The Vertical output should be at or near 0 V. Position the pen at the zero level using the zero control. Select the 0.1 V/inch gain. Adjust the Log Reference Level control for full 8-division CRT display of the signal. Verify that the pen moves 8 vertical inches for a full screen display. The 30 MHz built-in calibration signal can be used for vertical calibration in absence of your own signal.
2. X-axis: Manually<sup>2</sup> scan the analyzer to the middle of the CRT and with the recorder zero control move the pen carriage so the pen sits at the midpoint of the X-axis, i.e., at the 5-inch point. Select 1 V/inch gain and again with the Manual Scan Control verify that the pen moves across the full length of the X-axis.

From the above, we see that the Y-axis is calibrated if

$$\frac{0.8}{\text{Y-axis gain}} = Y \text{ inches}$$

and that the X-axis is calibrated if

$$\frac{5}{\text{X-axis gain}} = \frac{X}{2} \text{ inches}$$

<sup>2</sup> Since the 8552A has no manual scan, select 10 sec/division scan time and when the scan gets to the middle of the CRT, adjust the zero control to position the pen at the midpoint of the X-axis.

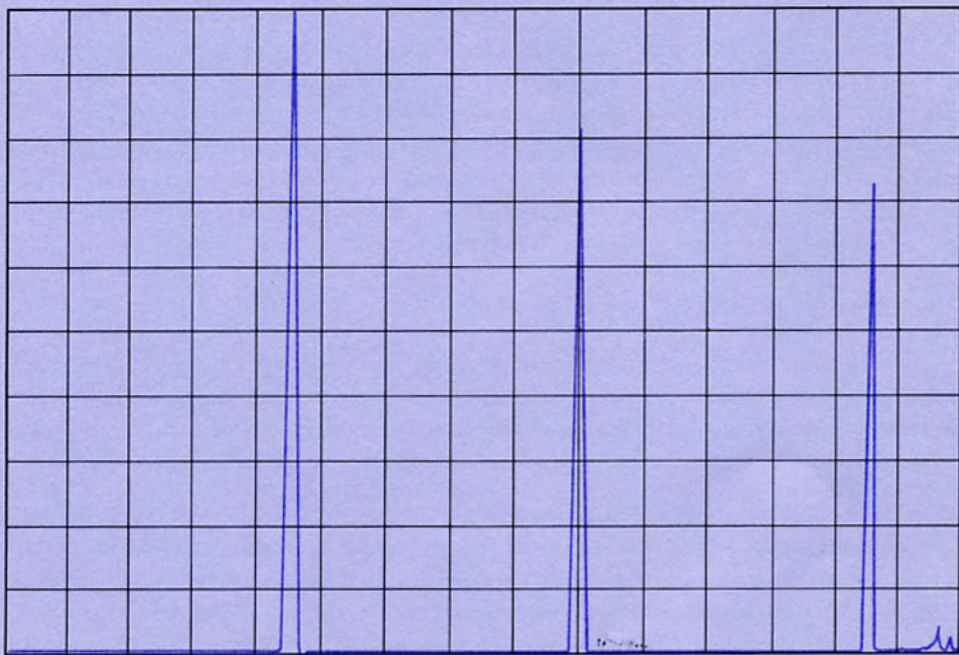

Figure 14. X-Y plot of the 30 MHz calibration signal and its harmonics. This plot is 1/3 of an actual 10 x 15-inch plot. Note that this reduced version is still twice as big as a CRT photograph.

Now, let's assume that a 10 x 15-inch plot is desirable. Obviously, we have to use the variable gain positions to calibrate for this plot. To do this, we use the same procedure as above, except as modified below:

1. Use the above equations to solve for the required X and Y gain, i.e.,

$$\text{Y-axis gain} = \frac{0.8}{10} = 0.08 \text{ V} = 80 \text{ mV and}$$

$$\text{X-axis gain} = \frac{5}{15} = 0.67 \text{ V}$$

2. Select the Y-axis gain position between 100 mV and 10 mV and adjust the vernier so that the pen moves 10 vertical divisions for a full 8 vertical division CRT response.
3. Select the X-axis gain between 1 V and 100 mV and adjust the vernier so that the pen moves across the full length of the 15-inch X-axis.

The above calibration procedures are used for Internal and Single Scan modes. When the analyzer is externally scanned, however, the same voltage ramp that scans the analyzer should also be applied to the recorder X-axis. Since a 0 to +8 V ramp is used to externally scan the analyzer, 0 V and +8 V are used to establish the needed reference points for calibrating the X-axis. The Y-axis calibration remains unchanged.

## STRIP CHART RECORDERS

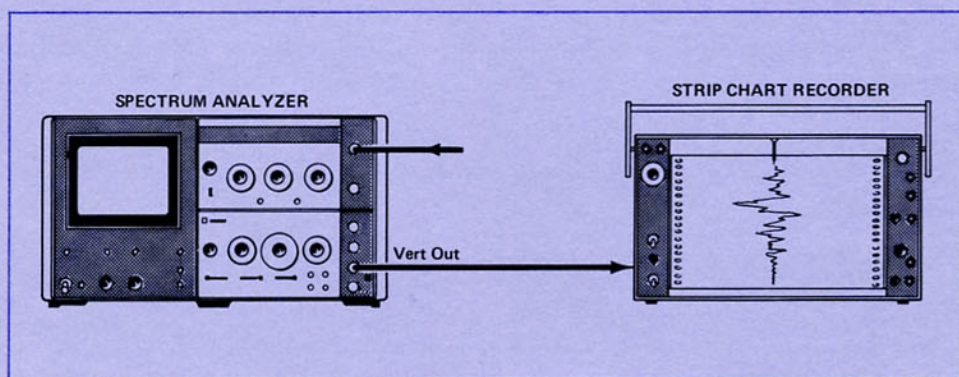

Figure 15. Strip Chart Recording.

Strip Chart Recorders have their own time base, so we only have to connect the analyzer vertical output to the recorder input as shown in Figure 15. These recorders are used primarily to expand the spectrum display (e.g., pulse spectrum and high resolution analyses) and to record frequency and amplitude drift versus time.

The spectrum analyzer is usually scanned at a slow rate for most high resolution analyses. Thus by driving the strip chart recorder at high speed we can expand the frequency axis several orders of magnitude. For example, suppose the analyzer is scanning at 5 sec/division, and the recorder is driven at 4.2 cm/sec, then each horizontal CRT division corresponds to 4.2 cm. The amplitude can also be expanded using a 10-inch wide recorder and a 1 volt full scale range. Figure 16 shows a recorded pulse spectrum.



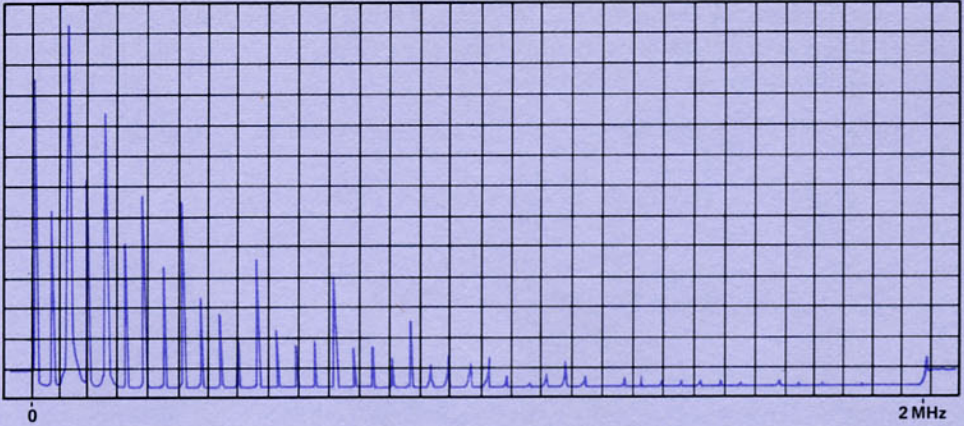

Figure 16. Recorded Pulse Spectrum.

### Amplitude Drift

Amplitude drift is easy to measure, simply connect the signal to the analyzer input and center it in the middle of the CRT. Switch the analyzer to zero scan and let the recorder run. For this measurement the analyzer IF bandwidth should be larger than the signal (frequency) drift. This means that any variations in amplitude are due to actual fluctuations in the signal level rather than to drifting out of the IF bandwidth.

### Frequency Drift

We can measure frequency drift using slope detection (FM to AM conversion) as outlined:

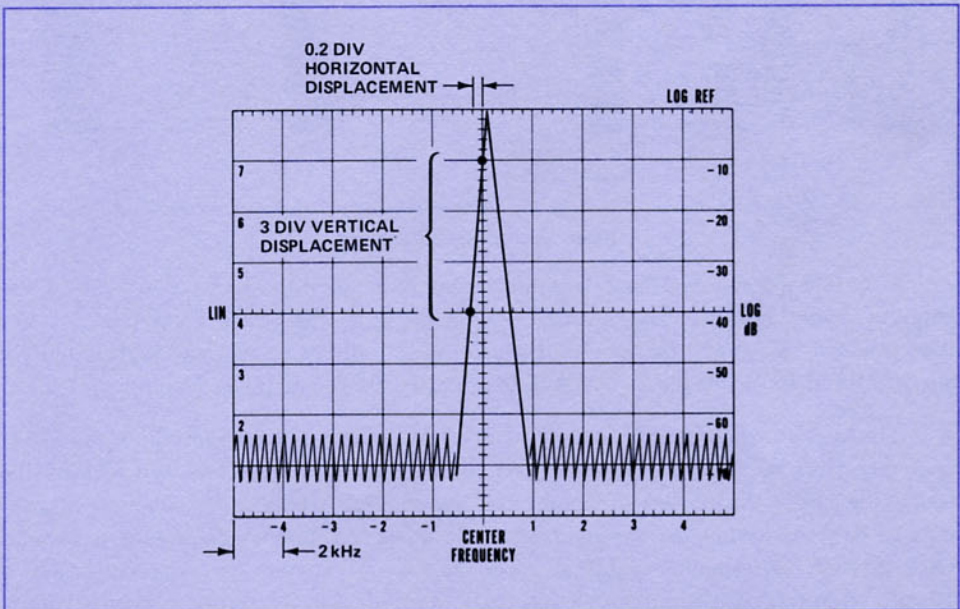

Figure 17. FM to AM Conversion.

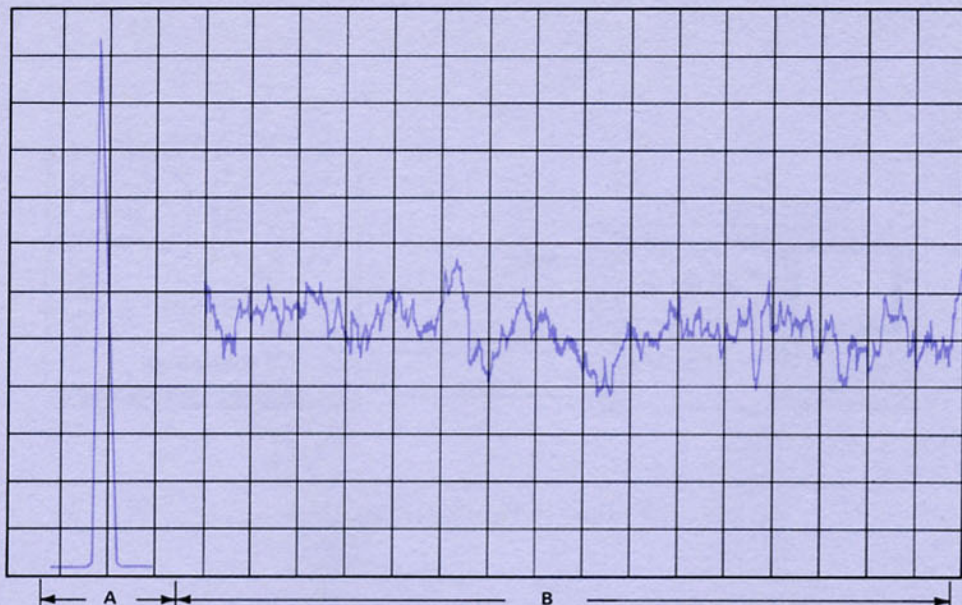

Figure 18. A 60 MHz CW Signal and its Frequency Drift During 30 Minutes.

1. Estimate the peak-to-peak drift to be measured and select an IF bandwidth that is equal to or larger than this value.
2. Adjust the analyzer for linear display and tune so that the upward linear portion of the IF skirt intersects the frequency graticule line 1 division from the top as shown in Figure 17. Note where the skirt intersects the middle horizontal graticule line. From Figure 17 we see that a minor division horizontal displacement equals three major divisions vertical displacement. Since the horizontal displacement equals 400 Hz ( $0.2 \times 2$  kHz), each vertical division =  $\frac{400}{3}$  or 133 Hz.
3. Turn the recorder on and record the signal. Mark the three divisions which correspond to the three divisions we calibrated in step 2 above. From A of Figure 18, we see that each CRT division equals  $\frac{4}{8}$  inch or  $\frac{1}{2}$  inch. Thus 1 inch = 266 Hz.
4. Turn the analyzer to zero scan and fine tune for a CRT response within the calibrated three divisions.
5. Run the recorder for the amount of time desired and measure the peak-to-peak fluctuations. Multiply by the factor calculated in step 3, this value is the peak-to-peak frequency drift.

Figure 18 part B shows the frequency drift of a 60 MHz signal for thirty minutes. This drift equals  $1.1 \times 266$  Hz = 288 Hz.

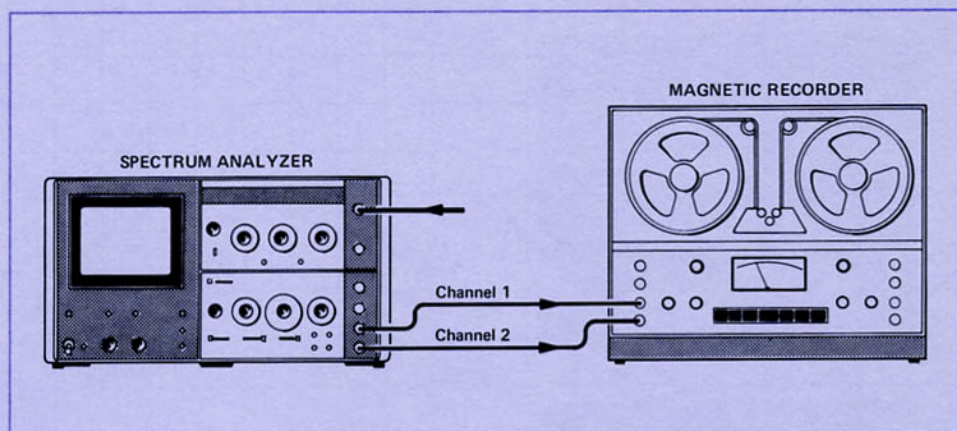

Figure 19. Magnetic Recording.

Magnetic recording is used when future retrieval is desired or when several sources of data must be recorded simultaneously. Two recording methods are available: direct recording and frequency modulation recording.

Direct recording provides the greatest bandwidth available from a recorder. In this method, the intensity of magnetization on tape is made proportional to the instantaneous amplitude of the input signal. However, in the reproduce process a signal is induced in response to changes in flux on the recorded tape, hence the direct reproduce process can not extend down to dc. One other limitation of direct recording is amplitude instability caused by surface inhomogeneities in the tape.

Frequency modulation recording, on the other hand, overcomes some of the basic limitations of the direct recording process but at the expense of reducing the high frequency bandwidth. It does, however, go down to dc. In FM recording, an oscillator is frequency modulated by the input signal. The oscillator's center frequency corresponds to zero-level input, and deviation from the center frequency is proportional to the amplitude of the input signal. The polarity of the signal determines the direction of deviation. FM recording is used primarily when the dc component of the signal is to be preserved, or when the amplitude variations of the direct recording method cannot be tolerated. Accuracy of the reproduce process is another consideration, with FM recording being more accurate.

The tape speed restricts the bandwidth (frequency response) of the recorder. For example, if the bandwidth is 10 kHz at 60 ips (inches per second), then it is 5 kHz at 30 ips, 2.5 kHz at 15 ips, etc. Thus, to record high rate data, we should select fast tape speeds. Furthermore, FM recording is extremely sensitive to tape speed fluctuations (flutter) since in either the record or reproduce mode, tape speed variations produce unwanted modulation of the carrier, i.e., noise.

The percentage deviation,  $\frac{\Delta f}{f_c} \times 100$ , where  $f_c$  = carrier center frequency,  $\Delta f$  = carrier deviation from  $f_c$ , is another factor in FM recording. Low percentage deviation

<sup>1</sup> Refer to AN 89 for detailed treatment of magnetic recording techniques and applications.

systems essentially multiply the effect of flutter with a corresponding increase in noise. For instance, if a 7.5% frequency deviation corresponds to 100% input signal, a 1% flutter will appear as  $100/7.5 = 13.3\%$  noise signal. The same flutter imposed on a 40% frequency deviation system will cause only  $100/40 = 2.5\%$  noise signal. Thus, the higher percentage deviation systems are less influenced by tape speed flutter.

The maximum signal level which can be recorded is defined as the signal which has 1% total harmonic distortion. The dynamic range of the recorder, on the other hand, is the ratio of the maximum signal to the minimum signal which can be recorded; the latter is determined by the noise level of the entire system over the bandwidth of interest. Hence, flutter reduces the dynamic range of the recorder; however, we can minimize its effect using higher tape speeds.

Figure 19 shows a magnetic recorder connected to the analyzer. The analyzer vertical output is simply connected to one channel and the scan out ramp is connected to another channel. To reproduce the display, an oscilloscope is connected to the output of the two channels. The recorder second channel externally synchronizes the oscilloscope.

FM recording is required for our purposes here because the analyzer scan out ramp has a dc component, and as indicated above, FM recording gives better reproduction and amplitude accuracy. The two CRT photographs in Figure 20 show the spectrum of an AM signal. Photograph A is made directly from the analyzer display; photograph B is reproduced from tape using FM recording and viewed on an HP oscilloscope. Although the dynamic range of the spectrum analyzer is 70 dB, the dynamic range of the overall system is typically limited by the dynamic range of the recorder as shown in Figure 20. The recorder used in this measurement has an S/N ratio of 48 dB.

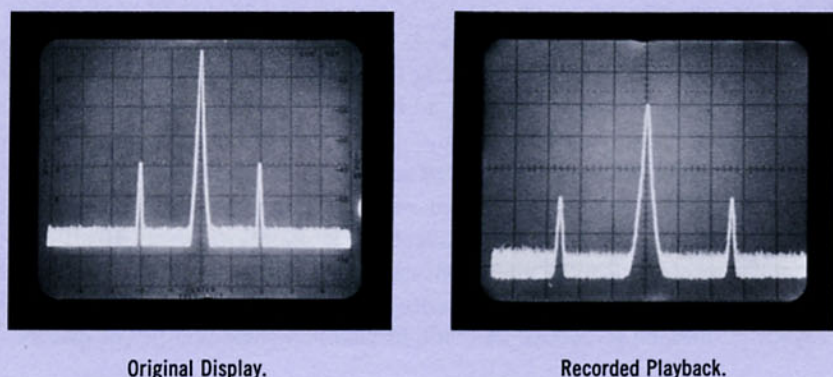

Figure 20.

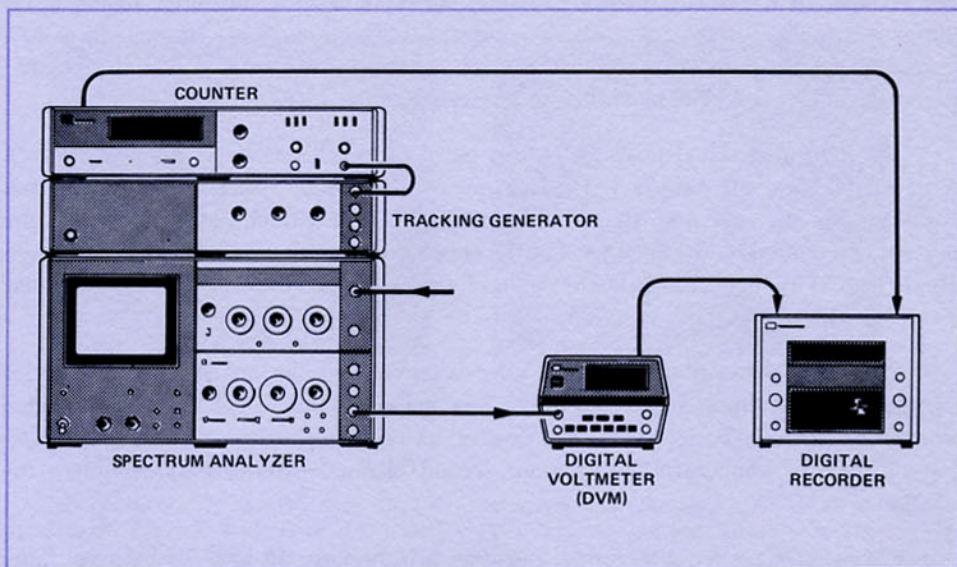

Figure 21. Digital Recording.

Figure 21 shows a configuration where the frequency and *relative* amplitude of an unknown signal are converted into digital form and then recorded on a digital recorder. The unknown signal is connected to the analyzer where it is resolved into its components and displayed on the CRT. The tracking<sup>1</sup> generator frequency tracks the analyzer tuning but its output level is constant regardless of the level of the unknown signal. The tracking generator drives a counter and the counter output is connected to the recorder. Since the tracking generator tracks the analyzer, the recorded frequency is equal to the frequency of the unknown signal. The digital voltmeter (DVM) simply measures the vertical output of the analyzer (an 8-division display corresponds to  $-0.8$  V; or  $-0.1$  V/division) and its digital output is then connected to the recorder.

Before we can record a signal, the DVM should be adjusted to issue a print command for voltage levels below a certain value. This value can be made to correspond to any signal level in dBm by changing the Log Reference Level. However, since the DVM measures peak values, we should add an additional 10 dB (one major division) to the signal level to ensure that the print command will not be for a false reading. For example, if  $-0.2$  V is the level below which a print command is issued (this corresponds to 2 divisions on the CRT), the smallest signal we can record is equal to the sensitivity of the analyzer (which is bandwidth dependent) plus 30 dB ( $2 + 1, 10$  dB/division). Notice that the recorded level of the signal is entirely relative since the DVM measures signals whose deflection on the CRT equals or exceeds 3 divisions and the deflection of many signals of unequal levels can be made to have the same number of divisions.

To record a signal, display it on the CRT and adjust the Log Reference Level so that the vertical output voltage is less than the limit set in the DVM.

<sup>1</sup> Refer to AN 150-3 for more on tracking generators. Digital recording cannot be made above 1300 MHz since tracking generators are not available above this frequency.

Figure 22 is an inexpensive alternative configuration for digital recording of amplitude and frequency. The analyzer VERTICAL output is connected to DVM-1 and the amplitude is recorded as described above. The SCAN output (-5 V to +5 V) is connected to DVM-2 and the output of DVM-2 is recorded. Since the SCAN OUT voltage is always the same regardless of the frequency SCAN WIDTH, a correlation factor should be calculated for every SCAN WIDTH. For example, if we tune to 50 MHz and SCAN WIDTH is 1 MHz/division (total SCAN WIDTH is 10 MHz), then 0 V corresponds to 50 MHz and the correlation factor is 1 MHz/volt.

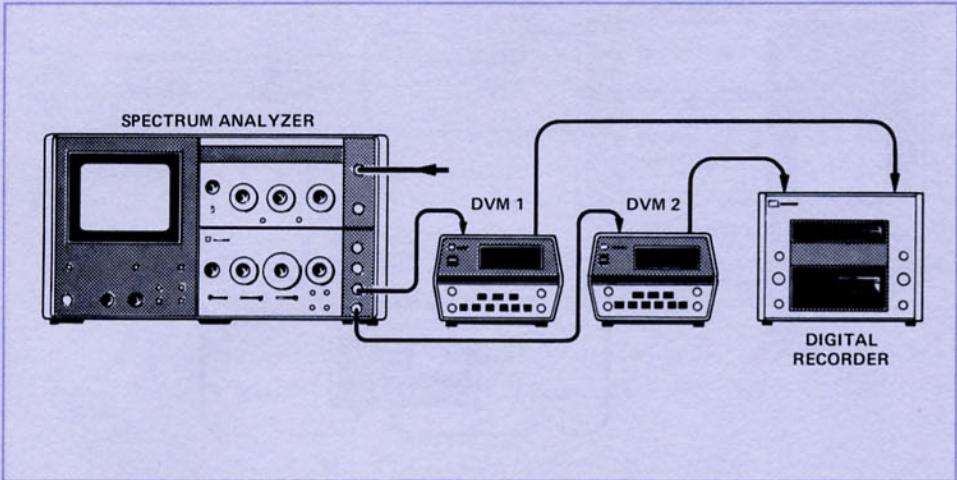

Figure 22. Another Digital Recording Configuration.

## CHAPTER 3

### SPECIAL RECORDING APPLICATIONS

#### LOG/LOG X-Y PLOTS

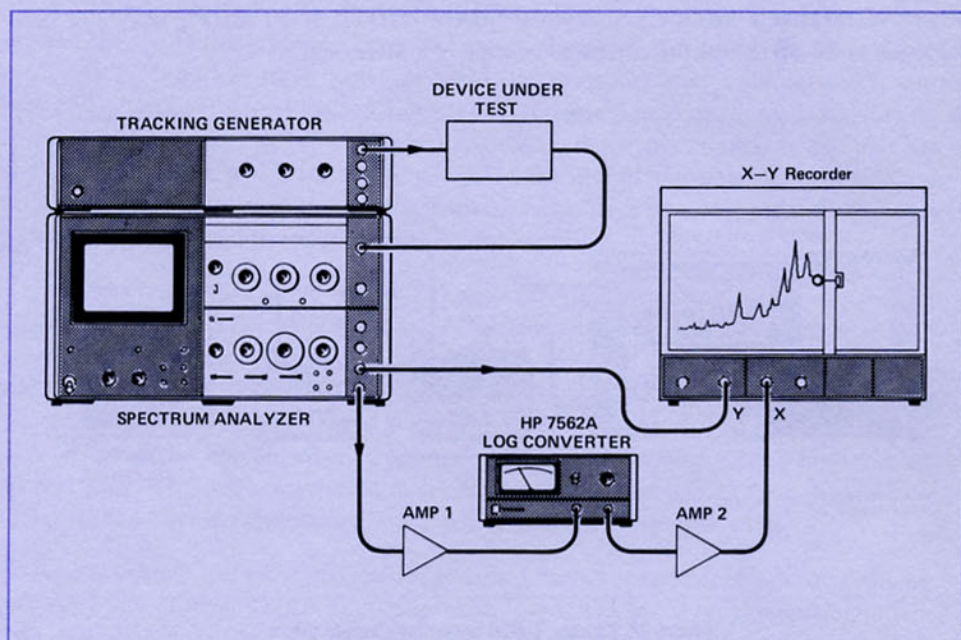

Figure 23. Log/Log X-Y Plot Configuration.

The analyzer frequency axis is linear, and its amplitude axis is either linear or logarithmic. For some applications, however, it is desirable to plot amplitude vs. frequency in Log/Log form. Feedback circuit analysis is one such application where loop gain vs. frequency (known as Bode plot) is plotted in log coordinates. Device characterization is another application where insertion loss/gain vs. frequency is sometimes plotted in Log/Log form. Signal analysis is a third application where a Log frequency scale may be desirable as well.

Figure 23 shows a configuration for making Log/Log plots. The tracking generator, as we know, is a companion instrument to the spectrum analyzer; its frequency tracks the analyzer tuning so that the frequency response of the device under test is displayed on the CRT. The Hewlett-Packard 7562A Log Converter converts the scan out ramp of the analyzer from linear to Log while the analyzer Vertical Output is connected directly to the recorder Y-axis since it is already logarithmic.

Conversion of the scan out ramp is done easily and quickly. The first amplifier<sup>1</sup> provides a dc offset so that the ramp is changed (from  $-5$  to  $+5$  V) to  $0$  to  $+10$  V. The 7562A accepts this dc voltage and produces a dc voltage which is logarithmically related to the input. The output of the 7562A is then amplified by the second amplifier<sup>1</sup> and connected to the Y-axis of the recorder.

<sup>1</sup> A typical circuit is provided in the Appendix.

## Frequency Axis Calibration

Up to three frequency decades may be plotted with this configuration. However, before any Log/Log plots can be made, we have to make some initial adjustments and then frequency calibrate the X-axis. Let's go through these adjustments assuming that we have to plot three frequency decades:

1. Connect the output of the first amplifier to an oscilloscope and adjust the bias (+20 V in the schematic shown in the Appendix) supply for zero volts at the end of the analyzer retrace. This provides +5 V dc offset.
2. Connect the amplifier back in the configuration and set the analyzer to manual scanning.
3. Manual scan to the right-most graticule line and adjust the first amplifier dc balance for a  $-60^2$  dB reading on the 7562A (three decades of frequency =  $20 \log 1000$  or 60 dB).
4. Adjust the X-axis gain so the output of the second amplifier fits the desired X-axis width.
5. Connect a comb generator to the analyzer and display the three frequency decades on the CRT. Manual scan to each frequency, marking its position on the recorder's X-axis.

## PEAK HOLDING X-Y PLOTS

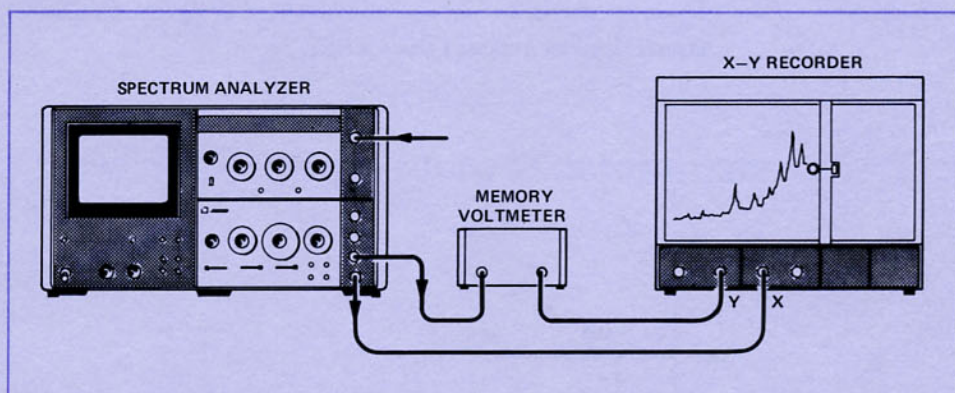

Figure 24. Peak Holding X-Y Plot.

Impulse-type signals which are encountered in electromagnetic interference (EMI) measurements are characterized by fast rise and fall times. They are also random in time and normally only their peak values are of interest to the EMC engineer. These signals can be viewed on a variable persistence CRT so a photograph can be easily made, but if an X-Y plot is desired for permanent record, we must resort to the peak holding configuration shown in Figure 24. This configuration is necessary because the X-Y recorder cannot follow the fast rise and fall times of these impulse-type signals and may in fact miss detecting them entirely.

The memory voltmeter<sup>3</sup> is a peak detecting device with fast rise time and slow decay time. Thus any fast rising signals can be readily detected by the voltmeter and held long enough for the recorder to respond.

<sup>2</sup> If two frequency decades are desired, this figure will be  $-40$  dB.

<sup>3</sup> Microinstrument Model 5201C is such a device.



## APPENDIX

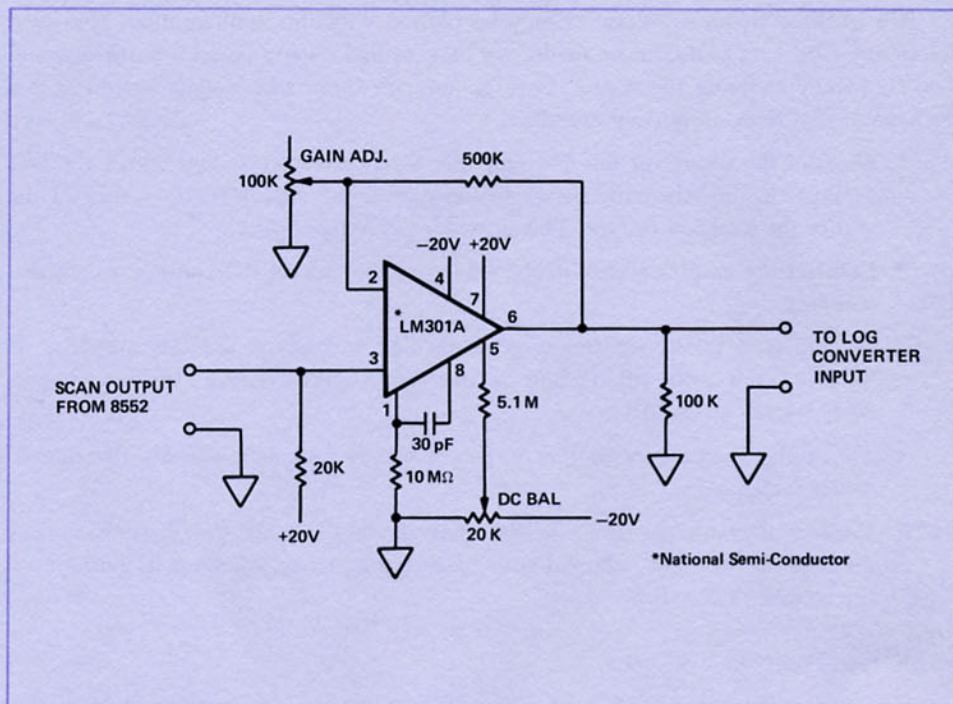

Example circuit for Amplifier 1 shown in Figure 23.

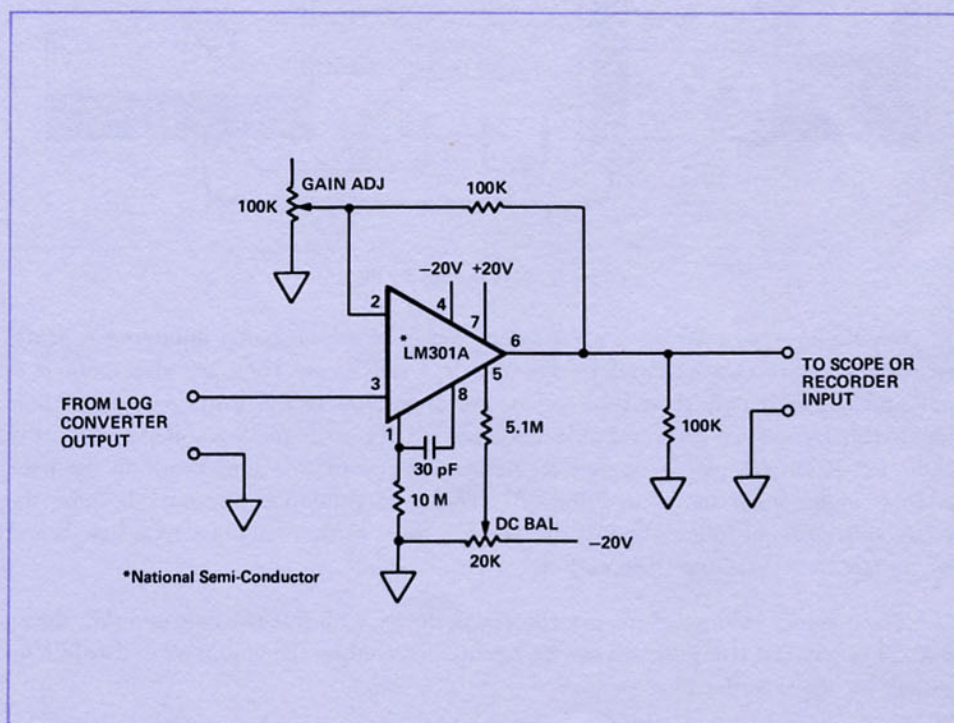

Example circuit for Amplifier 2 shown in Figure 23.

