

Spectrum Analysis

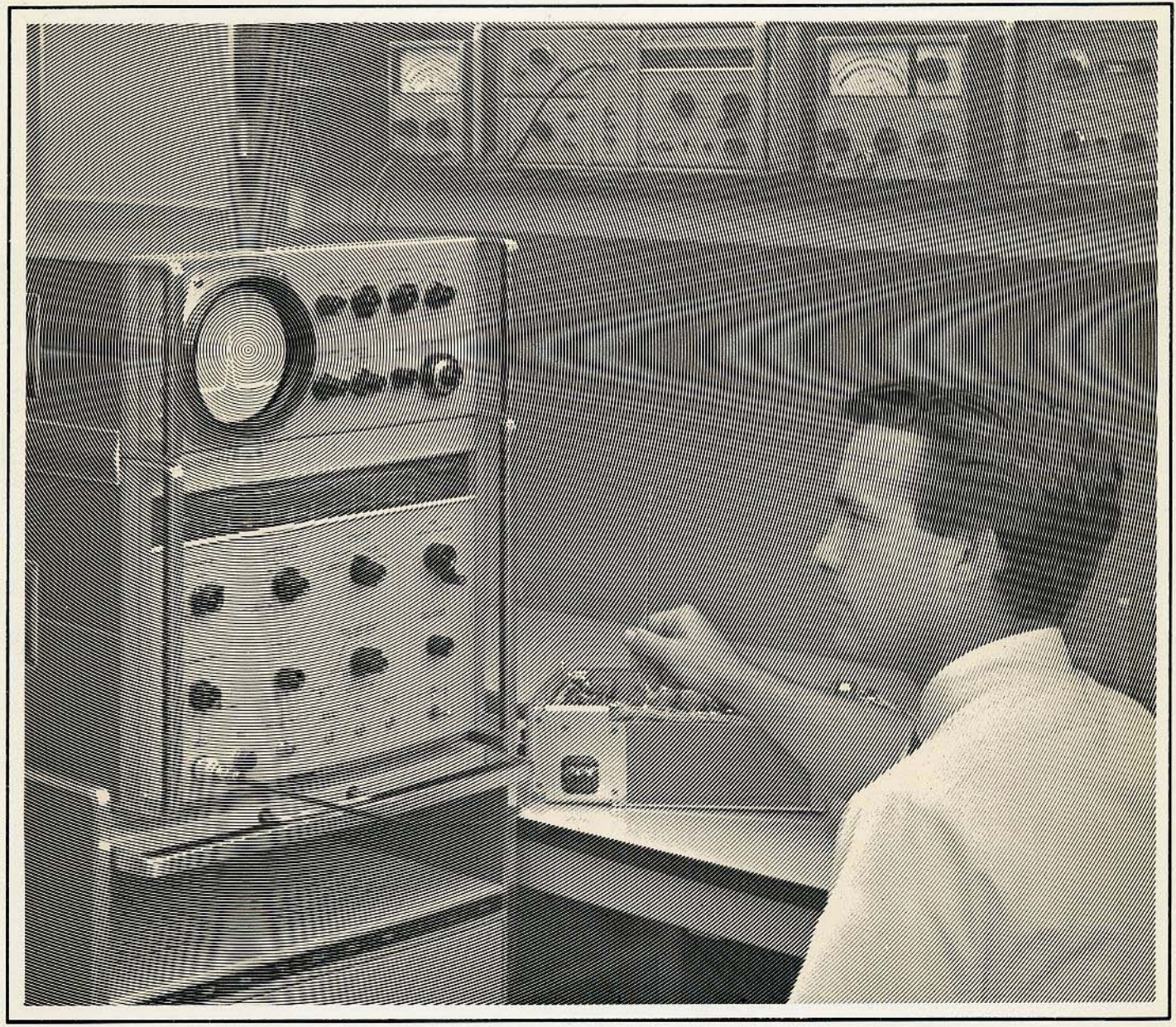

HEWLETT  PACKARD



APPLICATION NOTE 63

SPECTRUM ANALYSIS

HEWLETT-PACKARD COMPANY

1501 Page Mill Road, Palo Alto, California, U.S.A.

Cable "HEWPACK" Telephone (415) 326-7000

HEWLETT-PACKARD S.A.

54 Route des Acacias, Geneva, Switzerland

Cable "HEWPACKSA" Tel. No. (022) 42.81 50

Printed: AUG 1968

TABLE OF CONTENTS

Section	Page
I INTRODUCTION	1
Scope	1
History	1
The Spectrum Analyzer	1
II SPECTRAL DISPLAY	3
Time vs Frequency Domain	3
Spectra of Common Signals	3
III DESIGN CONSIDERATIONS FOR SPECTRUM ANALYZERS	9
Frequency Coverage	9
Spurious Responses	9
Resolution	11
Sensitivity and Amplitude Response	12
Dynamic Range	13
Detector and Video Amplifier	13
General Considerations	13
IV APPLICATIONS	15
Pulse Radar Performance Checks	15
Parametric Amplifier Tuning	18
Varactor Multiplier Tuning	18
Another Solid-State Harmonic Generator	20
FM Deviation Measurement	20
Radio Frequency Interference Testing	21
Spectrum Signature and Spectrum Surveillance	26
Antenna Pattern Measurements	27
Frequency Measurements with the Spectrum Analyzer	29
APPENDIX A	33
Section I -	33
Waveform Analysis	33
Interpretation of the Analyzer Response	35
Section II- Table of Important Transforms	36
APPENDIX B	40
IF Amplifier Response	40
Distortion	41

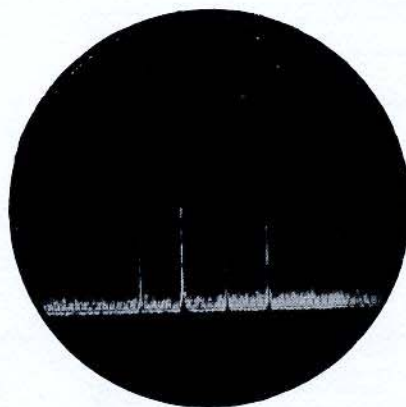
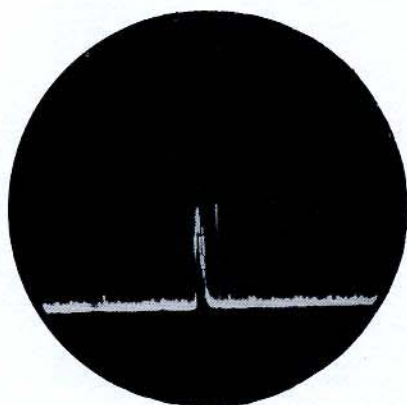
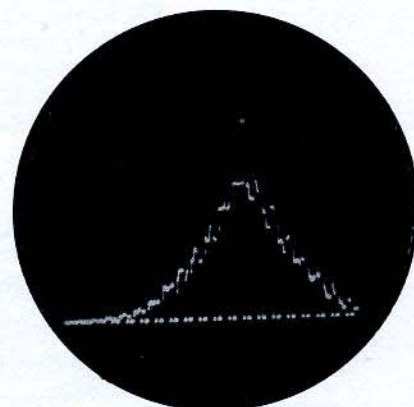
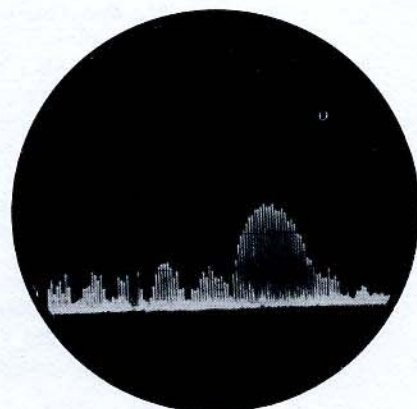

SECTION I INTRODUCTION

SCOPE

Spectrum Analysis may be defined as the study of energy distribution across the frequency spectrum for a given electrical signal. From this study comes valuable information about bandwidths, effects of various types of modulation on oscillators, and spurious signal generation enabling engineers to design and test RF and pulse circuitry for maximum efficiency.

Spectrum analysis is usually divided into two categories because of measurement equipment capabilities and the use of the resulting information. These are Audio Spectrum Analysis and RF Spectrum Analysis. This Application Note will deal with measurements at radio frequencies from 10 megacycles to 40 gigacycles which includes the vast majority of communications, entertainment, industrial, navigation and radar bands.

While it is impossible to cover the complete theory and application of spectrum analysis in this Note, we shall discuss the basic principles involved, interpretation of spectral displays, design considerations and limitations of the instrument and finally applications of the wide band Spectrum Analyzer employing a 2000-Mc sweep.

HISTORY

Spectrum analysis originally received its greatest attention during World War II in designing radar oscillators with their associated modulation circuits, and radar receivers. A radar pulse needed to have reasonably fast rise and decay times to provide good resolution of the time between transmitted and received signals. Furthermore, the pulse duration had to be short with respect to its repetition rate to give adequate "listening" time for returning pulses from distant targets. A pulse of this description generated a broad band of frequencies which a radar receiver had to accept for faithful reproduction of the pulse. Broadening the receiver's bandwidth for maximum return pulse fidelity necessarily meant a serious reduction in gain while degradation of the transmitted pulse sacrificed target distance accuracy.

By viewing the spectra of a burst of RF with a newly developed instrument called a spectrum analyzer, scientists at the Massachusetts Institute of Technology Radiation Laboratory and other key locations were able to determine the required bandwidths of receivers for optimum gain and fidelity of a returning radar pulse. Perhaps an even more important application of the spectrum analyzer was in detecting transmitter misfiring and frequency pulling effects. The Spectrum Analyzer was originally developed specifically for this work and it has since found wide application as a sensitive receiver for attenuation, FM deviation, and frequency measurements as well as a basic tool for RF pulse study.

The first analyzers were little more than RF indicators which lacked calibrated controls or broad spectrum coverage but sufficed for the task then at hand. Subsequent analyzers have not improved much since the war, yet the need for better instrumentation has grown steadily. The introduction of a calibrated wide band spectrum analyzer by ϕ now opens the way to more accurate and convenient displays and measurements not even possible with previous instruments.

THE SPECTRUM ANALYZER

A Spectrum Analyzer is an instrument designed to graphically present amplitude as a function of frequency in a portion of the spectrum. The most common and best known approach to this incorporates a narrow band superheterodyne receiver and an oscilloscope. The receiver is electronically tuned in frequency by applying a sawtooth voltage to the frequency control element of a voltage tuned local oscillator. The same sawtooth voltage is simultaneously applied to the horizontal deflection plates of the cathode-ray tube in the oscilloscope. The output signal of the receiver is applied to the vertical deflection plates thus producing a plot of signal amplitude versus frequency on the screen. A block diagram of a basic analyzer is shown in Figure 1.

The reception and display of a signal by the instrument is easily explained. Referring to Figure 1, an RF signal is applied to the input of the mixer. As the local oscillator is swept through the band by the sawtooth generator it will pass through a frequency that will beat with the input signal producing the required IF. This IF signal is then amplified, detected, and applied to the vertical deflection plates of the CRT producing a plot of amplitude versus frequency.

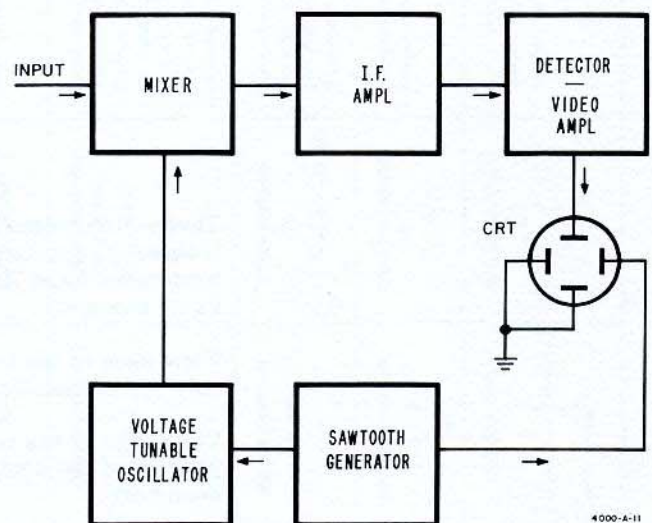
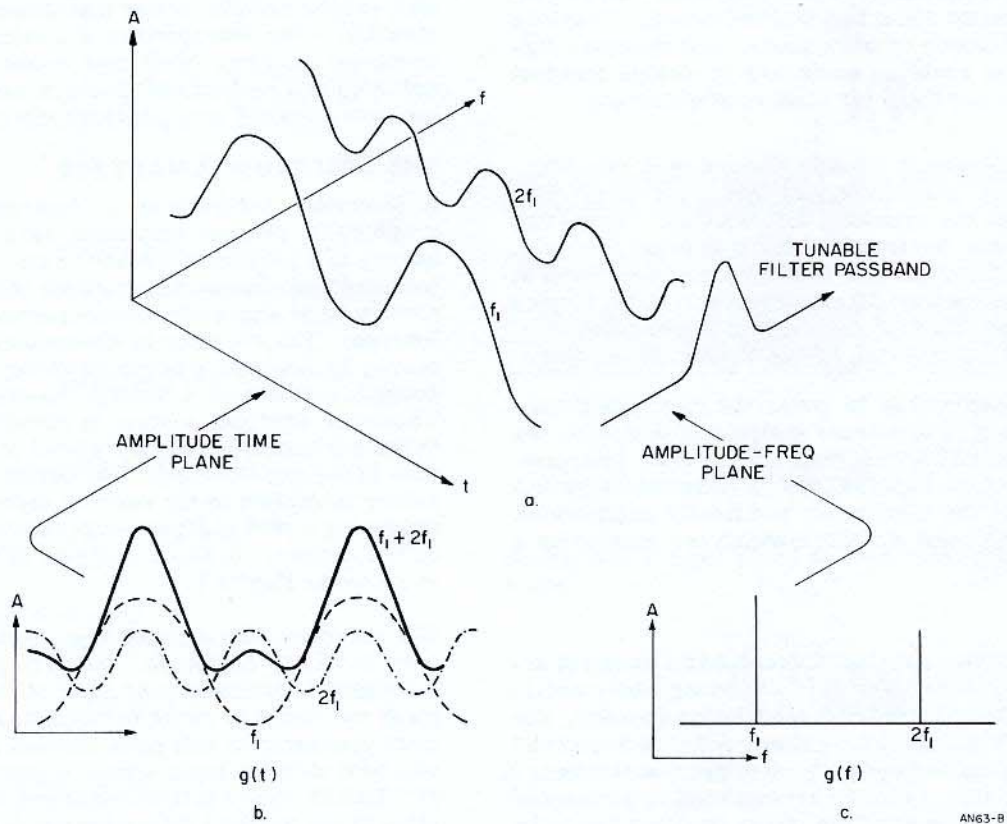

Figure 1. Simplified Spectrum Analyzer of the Swept-Receiver Design



- a. Three-dimensional coordinates showing time, frequency, and amplitude. The addition of a fundamental and its second harmonic is shown as an example.
- b. View seen in the t-A plane. On an oscilloscope, only the composite $f_1 + 2f_1$ would be seen.
- c. View seen in the f-A plane. Note how the components of the composite signal are clearly seen here.

Figure 2.

SECTION II SPECTRAL DISPLAY

TIME VS FREQUENCY DOMAIN

To gain a better understanding of the usefulness and application of the Spectrum Analyzer, it is important that we have a clear understanding of what the spectral display is and how to interpret it.¹

We are accustomed to observing electrical functions with respect to time on an oscilloscope. Such measurements are said to be in the time domain. Pulse rise time, width, and repetition rate are read directly on the X-axis of a calibrated cathode-ray tube. Sinusoidal signals up to about 100 megacycles may be displayed on conventional high frequency oscilloscopes and with sampling techniques, up to 12.4 Gc. In all cases the observed pattern is signal amplitude versus time.

The Spectrum Analyzer, you recall from the earlier discussion, presents signal amplitude versus frequency. These are measurements in the frequency domain where signals are broken down into their individual frequency components and displayed along the X-axis of the CRT which is calibrated in frequency. The most powerful tool in spectrum analysis is the Fourier integral which provides the means for evaluating the spectral display. The application of Fourier analysis is contained in Appendix A and may also be found in a great many texts. In this portion of the Application Note, however, we prefer to discuss the display in more basic terms.

SPECTRA OF COMMON SIGNALS

CW Signals. If the analyzer's local oscillator sweeps through a CW input signal slowly, the resulting response on the screen is simply a plot of the IF amplifier passband. A pure CW signal will by definition have energy at only one frequency and should therefore appear as a single spike on the analyzer screen. This will occur provided the total RF sweep width or so-called "spectrum width" is wide compared to the IF bandwidth in the analyzer. As spectrum width is reduced the spike response begins to spread out until the IF bandpass characteristic begins to appear in detail as in Figure 3.

Amplitude Modulation. When a CW signal of frequency F_c is amplitude-modulated by a single tone f_a , sidebands are generated at $F_c \pm f_a$. The analyzer display of this will be the carrier frequency F_c flanked by the two sideband frequencies whose amplitude relative to the carrier depends on the percentage of modulation as shown in Figure 4.

Note that if the frequency, spectrum width, and vertical response of the analyzer are calibrated you are able to determine: 1) Carrier frequency, 2) Modulation frequency, 3) Modulation percentage, 4) Non-

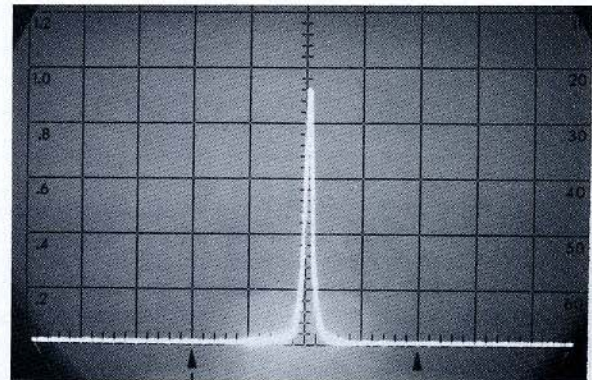

Figure 3. Spectrum of a CW Signal

linear modulation, 5) Incidental FM (as evidenced by jitter of the spectral lines), and 6) Spurious signal location and strength.

Frequency Modulation. If a CW signal F_c is frequency modulated at a rate f_r , it will theoretically produce an infinite number of sidebands.² These will be located at intervals of $F_c \pm n f_r$ where $n = 1, 2, 3, \dots$

As a practical matter only the sidebands containing significant power are usually considered. For a quick approximation of the bandwidth occupied by the significant sidebands, multiply the sum of the carrier deviation and the modulating frequency by two: i. e., $BW = 2(\Delta F_c + f_r)$. An FM display is shown in Figure 5.

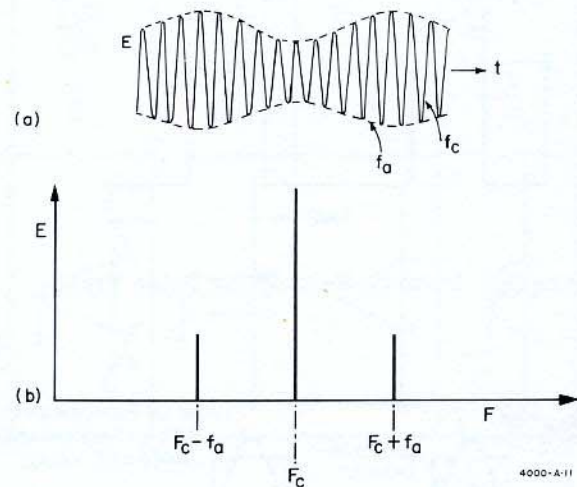

Figure 4. A Single Tone Amplitude Modulation,
a) Time Amplitude Plot b) Frequency Amplitude Plot.

¹ A mathematical analysis may be found in Appendix A, Section I.

² C. L. Cuccia "Harmonics Sidebands and Transients in Communication Engineering," First Ed. p. 255, McGraw-Hill.

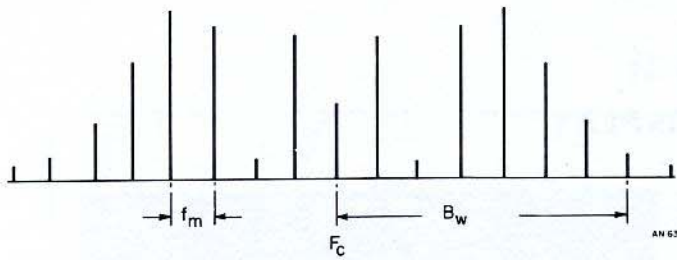

Figure 5. Amplitude Spectrum of Single Tone Frequency Modulation

Pulse Modulation. The formation of a square wave from a fundamental sine wave and its odd harmonics is a good way to start an explanation of the spectral display for non-sinusoidal waveforms. You will recall perhaps at one time plotting a sine wave and its odd harmonics on a sheet of graph paper, then adding up all the instantaneous values. If there were enough harmonics plotted at their correct amplitudes and phases the resultant waveform began to approach a square wave. The fundamental frequency determined the square wave rate, and the amplitudes of the harmonics varied inversely to their number.

A rectangular pulse is merely an extension of this principle, and by changing the relative amplitudes and phases of harmonics, both odd and even, we can plot an infinite number of waveshapes.³ The Spectrum Analyzer effectively "un-plots" waveforms and presents the fundamental and each harmonic contained in the waveform.

³ M. I. T. Radar School Staff "Principles of Radar", Second Ed. pp. 4-12, McGraw-Hill, 1946.

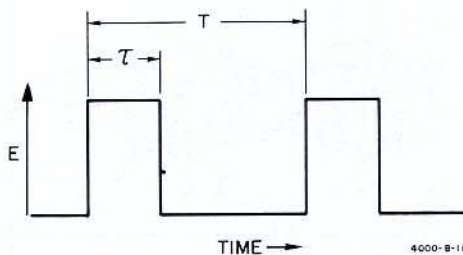

Figure 6a. Periodic Rectangular Pulse Train

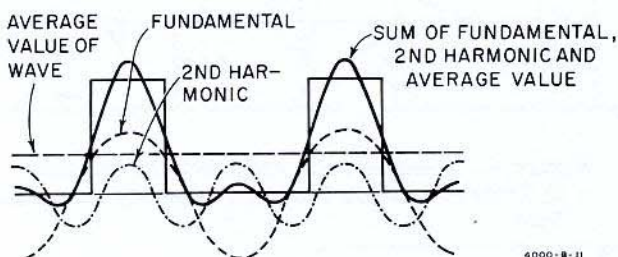

Figure 6b. Addition of a Fundamental Cosine Wave and its Harmonics to Form Rectangular Pulses

Consider a perfect rectangular pulse train as shown in Figure 6a, perfect in the respect that rise time is zero and there is no overshoot or other aberrations. This pulse is shown in the time domain and we wish to examine its spectrum so it must be broken down into its individual frequency components. Figure 6b superimposes the fundamental and its second harmonic plus a constant voltage to show how the pulse begins to take shape as more harmonics are plotted. If an infinite number of harmonics were plotted the resulting pulse would be perfectly rectangular. A spectral plot of this would be as shown in Figure 7.

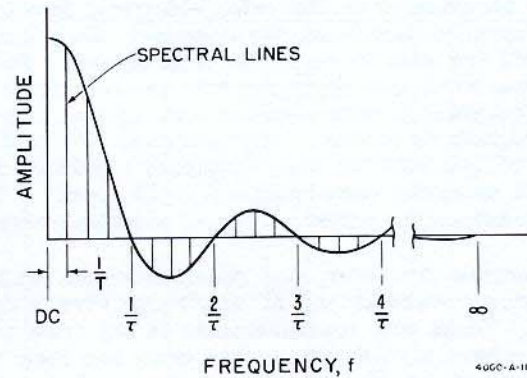

Figure 7. Spectrum of a perfectly rectangular pulse. Amplitudes and phases of an infinite number of harmonics are plotted resulting in smooth envelope as shown.

There is one major point that must be made clear before going into the analyzer display further. We have been talking about a square wave and a pulse without any relation to a carrier or modulation. With this background we now apply the pulse waveform as amplitude modulation to an RF carrier. This produces sums and differences of the carrier and all of the harmonic components contained in the modulating pulse.

You recall from the discussion on single tone AM how the sidebands were produced above and below the carrier frequency. The idea is the same for a pulse except that the pulse is made up of many tones thereby producing multiple sidebands, which are commonly referred to as spectral lines on the analyzer display. In fact, there will be twice as many sidebands or spectral lines as there are harmonics contained in the modulating pulse.

Figure 8 shows the spectral plot resulting from rectangular amplitude pulse modulation of a carrier. The individual lines represent the modulation product of the carrier and the modulating pulse repetition frequency with its harmonics. Thus, the lines will be spaced in frequency by whatever the pulse repetition frequency might happen to be. The spectral line frequencies may be expressed as:

$$F_L = F_c + nf_r$$

where F_c = carrier frequency
 f_r = pulse repetition frequency
 $n = 0, 1, 2, 3, \dots$

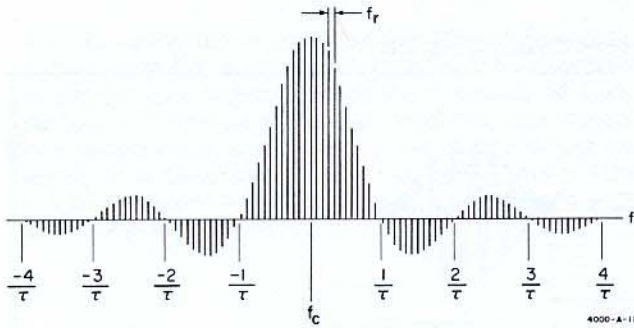

Figure 8. Resultant Spectrum of a Carrier Amplitude Modulated with a Rectangular Pulse

The "main lobe" in the center and the "side lobes" are shown as groups of spectral lines extending above and below the baseline. For perfectly rectangular pulses and other functions whose derivatives are discontinuous at some point, the number of sidelobes is infinite.

The main lobe contains the carrier frequency represented by the longest spectral line in the center. Amplitude of the spectral lines forming the lobes vary as

a function of frequency according to the expression

$$\frac{\sin \omega \frac{\tau}{2}}{\omega \frac{\tau}{2}}$$

for a perfectly rectangular pulse. Thus, the points where these lines go through zero amplitude are determined by the modulating pulse width only for a given carrier frequency. As pulse width becomes shorter, minima of the envelope become further removed in frequency from the carrier, and the lobes become wider. The sidelobe widths in frequency are related to the modulating pulse width by the expression $f = 1/\tau$. Since the main lobe contains the origin of the spectrum (the carrier frequency), the upper and lower sidebands extending from this point form a main lobe $2/\tau$ wide. Remember, however, that the total number of sidelobes remains constant so long as the pulse quality, or shape, is unchanged and only its repetition rate is varied. Figure 9 compares the spectral plots for two pulse lengths, each at two repetition rates with carrier frequency held constant.

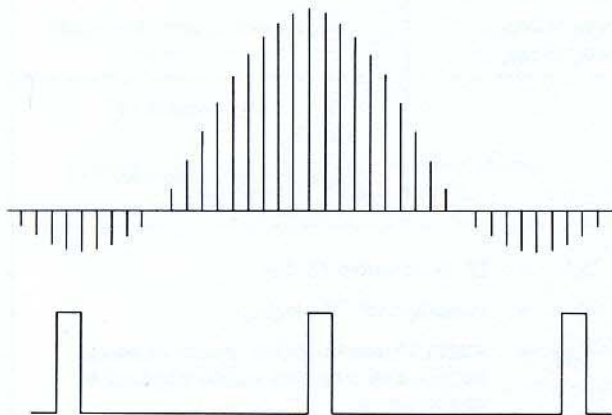

Figure 9a. Narrow pulse width causes wide spectrum lobes, high PRF results in low spectral line density.

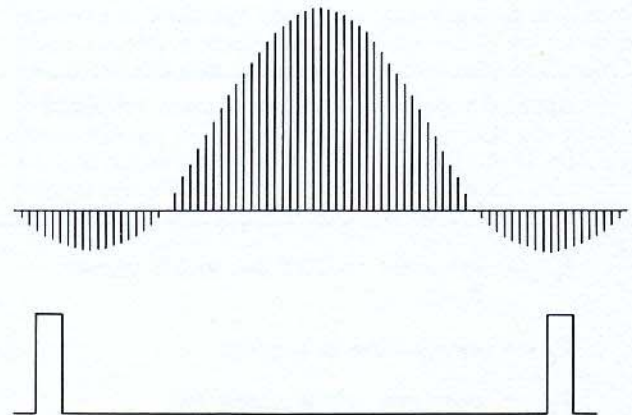

Figure 9c. PRF lower than 9a results in higher spectral density. Lobe width is same as a since pulse widths are identical.

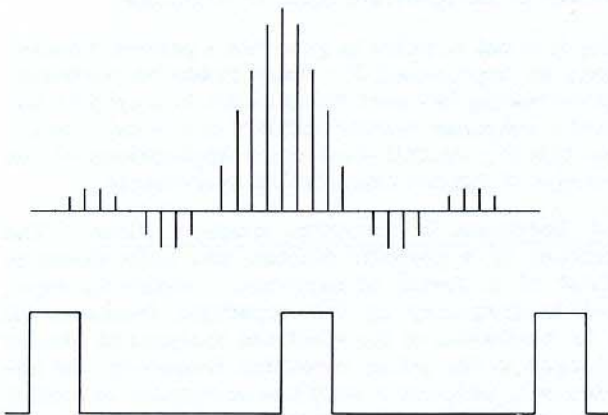
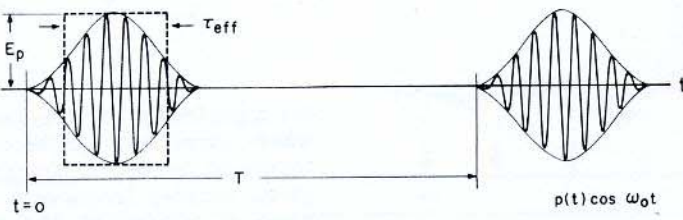

Figure 9b. Wider pulse than 9a causes narrower lobes but line density remains constant since PRF is unchanged.



Figure 9d. Spectral density and PRF unchanged from 9c but lobe widths are reduced by wider pulse

Table 1. Summary of Pulse Spectra Characteristics



	Line Spectrum	Spectral Intensity Plot
Requirement for each type of spectrum	$\Delta f \ll \frac{1}{T}$, $\frac{\Delta f^2 T_s}{F_s} \gg 1$	$\frac{1}{T} \ll \Delta f \ll \frac{1}{\tau_{eff}}$
Amplitude of spectrum display at $\omega = \omega_0$	$\frac{\tau_{eff}}{T} E'_p$	$K \tau_{eff} \Delta f E'_p$
Number of responses per cm on CRT	$T F_s$ changes with spectrum width, not sweep time.	$\frac{T_s}{T}$ changes with sweep time, not spectrum width.
Approximate time duration of each response	$\frac{\Delta f T_s}{F_s}$	$\frac{1}{\Delta f}$, independent of spectrum width and sweep time.

E'_p = response on CRT due to CW signal $E_p \cos \omega_0 t$ T_s = sweep time in sec/cm F_s = spectrum width in cps/cm	Δf = IF bandwidth (3 db) K = constant of IF amplifier τ_{eff} = width of rectangular pulse of same height and area as pulse applied to analyzer = $\int_0^t \frac{p(t) dt}{E_p}$
--	---

Figures 8 and 9 bring about an important consideration about the actual display on a spectrum analyzer. Notice in the drawings how the spectral lines extend below the baseline as well as above. This corresponds to the harmonics in the modulating pulse having a phase relationship of 180° with respect to the fundamental of the modulating waveform. Since the Spectrum Analyzer can only detect amplitudes and not phase, it will invert the negative-going lines and display all amplitudes above the baseline. Thus the phase spectrum is lost and the display is not unique for a given function. Further discussion of this may be found in Appendix A, Section IB. This does not seriously limit the usefulness of the Spectrum Analyzer, however, as will be evident in Section IV dealing with applications.

A special case of the rectangular pulse spectrum is the spectrum of an "impulse" function. If the process of narrowing a single pulse could be continued far enough, the result would be a main lobe infinitely wide and hence would exhibit constant amplitude across the spectrum. A perfect impulse is a rectangular pulse

of infinite height and zero width with unit area. If such a function could be produced it would contain all frequencies in the spectrum equal in amplitude.

While it is not possible to generate a perfect impulse it may be approached for many practical purposes. Impulse testing has been found useful in amplifier and network response testing and RFI meter calibration. In Section IV, we will show some applications of the spectrum analyzer to impulse measurements.

Line Spectrum & Spectrum Intensity Plots. The spectrum of a periodic function has been shown to consist of a series of harmonic components separated in frequency by the repetition frequency. If the IF bandwidth of the spectrum analyzer is narrow compared to the pulse repetition frequency, the analyzer will respond to only one component at a time. If the analyzer is swept slowly past the spectrum, a true amplitude spectrum display of lines will result (true in the sense that there is exactly one response or line for each frequency component within the swept region). Figure 10a.

In many instances, it is neither possible nor desirable to make a fine grain line-by-line analysis of a spectrum. A good example of such a case is a train of short RF pulses at a low repetition frequency. Not only must the IF bandwidth become inconveniently narrow, but often the frequency modulation on the pulsed carrier would be so excessive as to make the resulting display confusing.

In such a case, it is possible to obtain a plot of the spectral envelope, but without individual lines. To do this, it is only necessary that the analyzer IF bandwidth be narrow compared to the reciprocal of the pulse width rather than the pulse repetition rate. As the analyzer is swept slowly past the pulse

spectrum, the IF amplifier responds to several spectrum lines at once (Figure 10b). If the pulse repetition rate is low enough, the display is essentially the impulse response of the IF amplifiers (see Figure 10c). When the analyzer is swept past the spectrum, the response appears as a series of "pulses", rather than lines, having amplitudes corresponding to average values of the magnitude of the input pulse spectrum lines. The number of these "pulses" is a function of the PRF and the scan time. In fact, reducing the frequency scan to zero will enable you to see the time domain pulse waveform. This is the spectral intensity plot. Because of the importance of spectral intensity analysis, the display characteristics are summarized in Table 1.

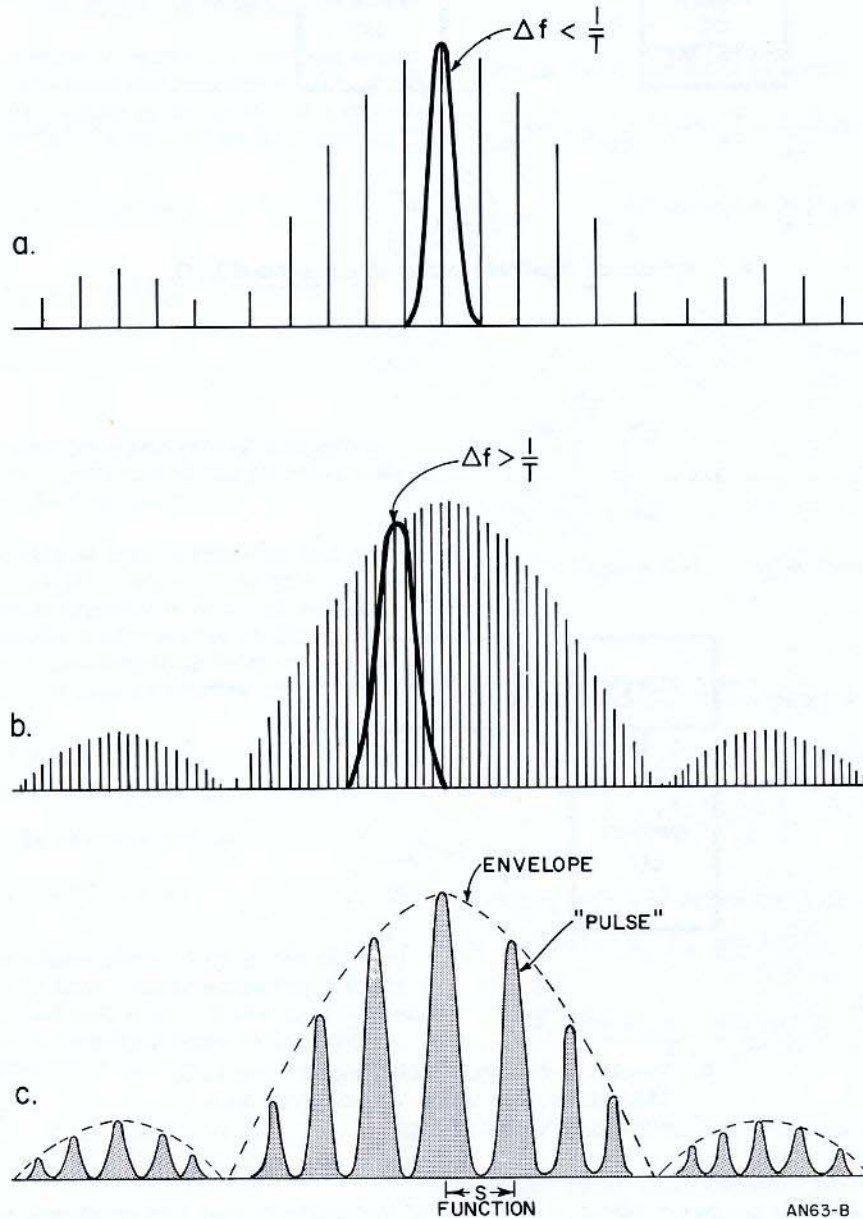

- a. Line Spectrum
- b. Bandwidth containing several spectral lines
- c. The lines within the bandwidth of (b) are averaged when the pulse is "on" to present the spectral intensity plot. "S" is a function of scan time and PRF.

Figure 10.

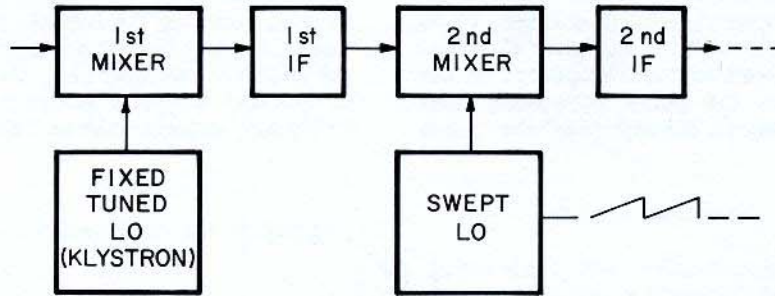

a. Spectrum Analyzer using swept second L.O.

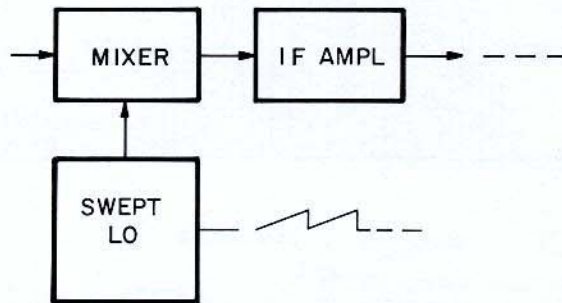

b. Spectrum Analyzer using swept first L.O.
This facilitates using the analyzer as a
general laboratory tool

Figure 11.

SECTION III

DESIGN CONSIDERATIONS FOR SPECTRUM ANALYZERS

FREQUENCY COVERAGE

Spectrum Width and Tuning Range. The widest range of frequencies that can be observed in a single sweep is known as spectrum width. The basic limitation to spectrum width is the sweeping capability of the local oscillator.

The maximum sweep width of various oscillator types is reasonably well fixed by their inherent design. Klystron local oscillators have long been employed because they offer fundamental frequencies in the radar band and are capable of limited electronic sweep. Using a klystron local oscillator in the arrangement shown in Figure 1, reflector voltage sweep will typically produce maximum spectrum widths of 50 to 80 megacycles.

In recent years most spectrum analyzers have used a double conversion scheme with a wideband first IF and a swept second local oscillator of the triode-reactance tube modulator variety. (Figure 11a) The advantages here are that stable sweep circuits are easier to design at the lower IF frequency and sweep calibration does not change as the input frequency is tuned. With such a system, however, the spectrum width is reduced to the bandwidth of the first IF which is again about 80 Mc.

Basic input tuning range is restricted to that of the klystron first LO which must be tuned through mechanical linkages to the cavity, repeller tracking potentiometers and a frequency dial. This method is subject to the age-old problem of tuning backlash and mode tracking. If a multi-band analyzer is desired, there either must be a local oscillator for each band with its corresponding tuning mechanism or a broadband mixer employing local oscillator harmonics to extend the frequency range without additional local oscillators. The latter method results in some loss of sensitivity and increased possibility of spurious responses (discussed later). By careful design of the mixer, these problems can be largely overcome and the convenience of harmonic mixing enjoyed.

The newest approach to solving spectrum width problems employs a backward-wave oscillator (BWO) as a swept first local oscillator. (Figure 11b) Hewlett-Packard has chosen a 2 to 4 Gc BWO for the 8551A Spectrum Analyzer which allows the instrument to sweep as wide as it can tune and results in 2-Gc spectrum coverage in a single display. Frequency is determined by the BWO helix voltage virtually eliminating tuning backlash and providing the required ability to be electronically swept. A BWO inherently exhibits more residual FM than a klystron which becomes serious when analyzing narrow spectra. The ϕ analyzer overcomes this with a unique frequency stabilizing circuit that reduced BWO residual FM from 30kc to less than 1kc. A high-frequency, wide-sweeping local oscillator plus careful selection of the IF frequency will result in more usable spectrum width.

Usable Spectrum Width. The mixer and swept local oscillator jointly translate a signal at frequency F_s to a response-producing signal at the IF frequency F_{if} whenever

$$mF_s = nF_{10} \pm F_{if} \quad (1)$$

where $m = 1, 2, 3, \dots$

$n = 1, 2, 3, \dots$

F_{10} = local oscillator frequency.

If the amplitude of signals at frequency F_s are small compared to the local oscillator voltage, the system is said to be operating linearly and $m = 1$.

Assuming $m = 1$, two families of analyzer tuning curves may be plotted from equation (1) for two choices of IF frequency. These curves are shown in Figure 12. Figure 12a represents the response locations when the IF frequency is chosen to be equal to the minimum local oscillator frequency which is 2 Gc in this case. Figure 12b is the result when the IF is chosen to be one tenth of the minimum local oscillator frequency or 200 Mc.

For each n there are two possible bands of signal reception: one above and one below the frequency nF_{10} . These are shown as $n+$ and $n-$ respectively. The separation of these bands of possible responses is twice the frequency F_{if} . In most applications, the presence of the so-called "image" signal is sufficiently annoying to reduce the usable spectrum width to half of this value or F_{if} . Note the comparatively wide separation of responses for each n when F_{if} is chosen to be equal to f_{10} (min). This, of course, allows a much greater spectrum width to be displayed that is free from image responses. For this reason a 2-Gc IF is used in the ϕ analyzer.

SPURIOUS RESPONSES

Whenever a nonlinear resistive element such as a diode mixer is excited by an RF signal of sufficient amplitude to vary the mixer's conductance, there will be harmonics generated. This can be advantageous in the case where harmonic mixing is desired to extend the frequency range of the spectrum analyzer. In this case the local oscillator voltage is large enough to vary the conductance at the local oscillator rate resulting in harmonic generation and mixing action.

Unfortunately, the conductance can also vary at the input signal rate. As the input signal amplitude approaches the local oscillator voltage level, vigorous harmonics are generated which can combine with the local oscillator harmonics to produce the IF frequency. This is then passed through the IF amplifier to the detector and subsequently appears on the analyzer display. Such responses are termed "spurious" since they do not represent true input signals of the indicated frequency. The amplitude of spurious responses is

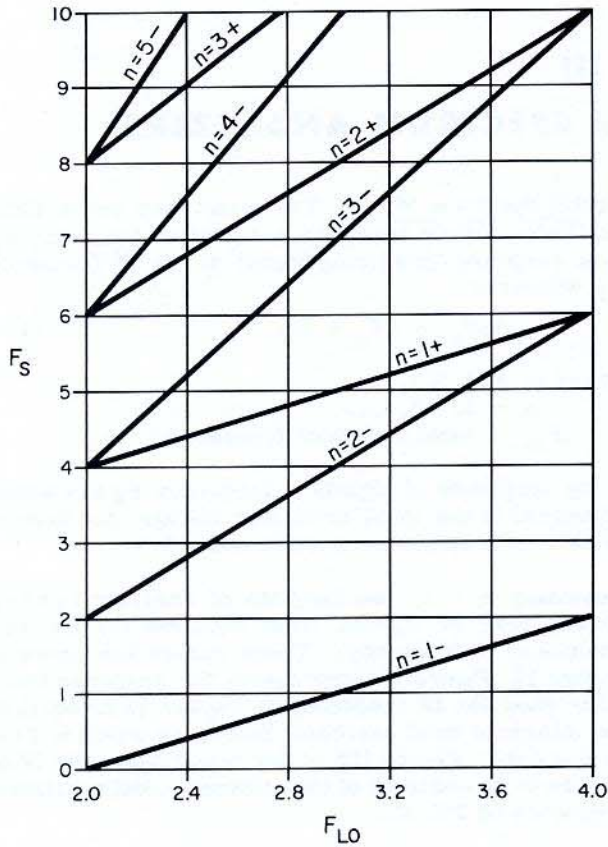

Figure 12a. Analyzer Tuning Curves for
 $F_{if} = F_{LO}(\text{min})$
 $F_s = nF_{LO} \pm 2 \text{ gc}$

nonlinearly related to input signal level and can seriously clutter the display of a spectrum analyzer making it impossible to distinguish true inputs from the false signals produced by the mixer. No spurious responses would be visible on the analyzer display if the input signals were kept extremely small. Doing this, however, would severely limit the amplitude range of the instrument, making it of little practical value.

Many analyzer discussions ignore spurious responses or define them as those responses that appear with no input signal applied at all. Such phenomena are better defined as "residual responses" and should not be confused with spurious responses when discussing analyzer specifications.

By careful design of the coaxial mixer in the ϕ analyzer, spurious responses are greatly reduced over those in other analyzers. This is accomplished without imposing impractical limitations to the input level, and the 60-dB dynamic range of the instrument is maintained.

Figure 12c is a plot of the ϕ analyzer input tuning curves from equation (1) with the spurious producing frequencies added. The heavy solid lines represent the best tuning range for each local oscillator harmonic number n . The lighter solid extension of these lines merely shows that primary signal reception is possible above and below the heavy lines, but not useful because the tuning curves become too closely

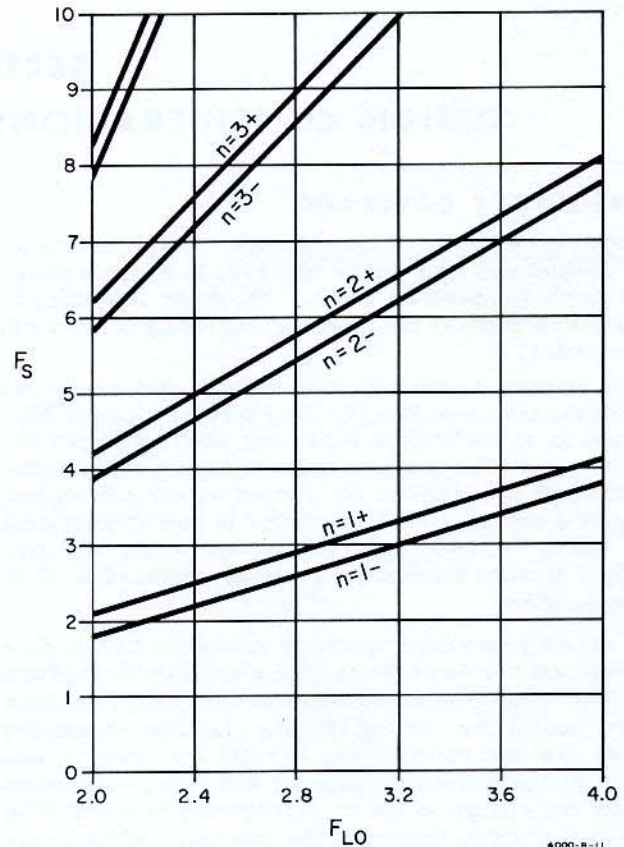

Figure 12b. Analyzer Tuning Curves for
 $F_{if} = \frac{F_{LO}(\text{min})}{10}$
 $F_s = nF_{LO} \pm 200 \text{ mc}$

spaced at either end. This narrow spacing would cause a single frequency at the high or low end of the sweep to appear twice at close intervals on the analyzer display.

The dashed lines solve equation 1 for input frequencies of -30 dbm amplitude which will produce spurious responses less than 60 db below the input reference level. The figures in parentheses at the end of each line represent the n, m and \pm terms respectively, satisfying the equation $mfs = nf_{LO} \pm f_{if}$. The db figure shown along each line is the typical amplitude of the spurious response compared to a -30 dbm signal frequency of mf_s if such a signal were applied to the input. Stronger input signals cause larger spurious responses and more of them. It is recommended that the analyzer input attenuator be used to keep signal input to the mixer at -30dbm or less for minimum spurious generation and full 60-dB dynamic range.

Here is an example of how to use Figure 12c in predicting spurious responses for a given frequency input. We are operating the analyzer on the $n = 2$ range because we are interested in some signal in the 2 to 10Gc region and therefore want to use the second harmonic of the local oscillator to tune this band. Assume there is also a -30 dbm signal applied to the mixer of 1.8 Gc. To find the frequency of the spurious response caused by the 1.8-Gc signal, enter the graph at 1.8Gc on the ordinate. Move across the graph until

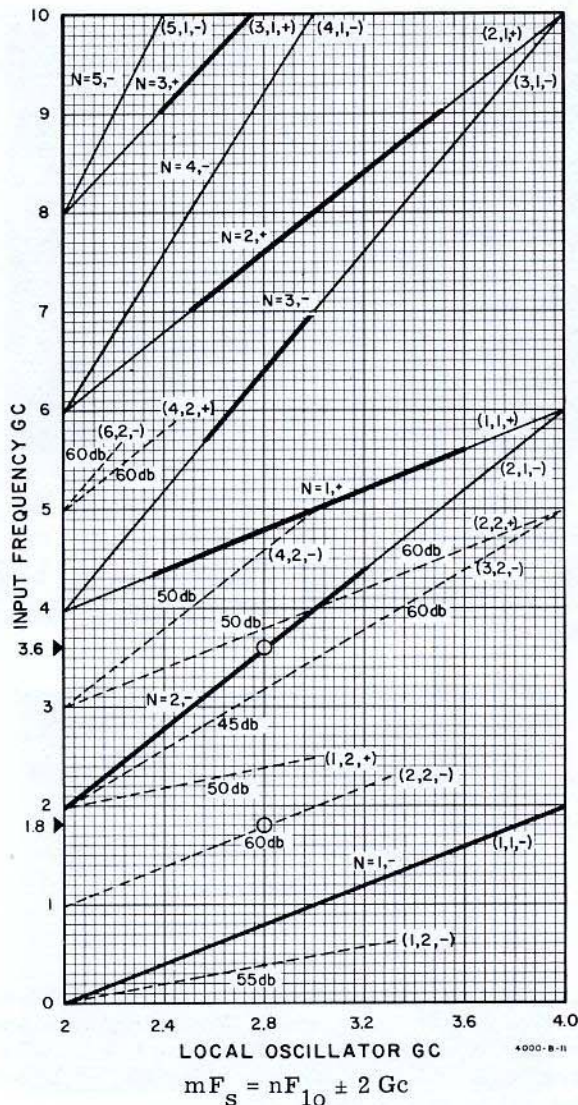

Figure 12c. hp Spectrum Analyzer Tuning Curves. Heavy solid lines indicate desired response locations for input signals of 10 Mc to 10 Gc. Spurious responses are indicated by the dashed lines.

intersecting the dashed line at a local oscillator frequency of 2.8 Gc as indicated on the abscissa. Note the figures in parentheses at the end of the line to see which mixing product results in a spurious response. In this example the figures are (2, 2-) which indicate the lower mixing product of the local oscillator second harmonic and the second harmonic of the 1.8 Gc input cause a spurious response. Now move vertically from the intersection just located until intersecting the main heavy tuning curve for $n = 2-$. Read the ordinate point directly opposite this intersection for the frequency of the spurious response as indicated on the display. This response is 60 db below the normal response to a -30 dbm input signal at 3.6 Gc.

Notice that some of the dashed lines in the graph do not extend the full range of the local oscillator sweep. This indicates that spurious signals produced above these points are more than 60 db down referred to the

input, thus making them insignificant since they fall into the noise level on the analyzer display. See Section IV on applications in RFI testing to see how pre-selection filters may be used to provide virtually spurious-free analyzer displays.

RESOLUTION

In general, resolution is the ability of the analyzer to give an accurate presentation of the frequency distribution of the signals present at the input. A more precise definition would be purely arbitrary. Several factors affect the resolving capabilities of an analyzer. Since the response to a CW signal is a plot of the frequency response of the IF amplifier, the most serious limitation to resolution is the width and shape of the passband. Two signals with a frequency separation much less than the IF bandwidth would not be individually distinguishable.

Another consideration is the sweep rate. If the local oscillator is swept past the input frequency at too great a rate, the apparent bandwidth of the IF amplifier will be wider than the actual bandwidth.¹ This can be explained in simple terms as follows: in Figure 13 we see two response curves for a gaussian IF amplifier superimposed. If the input frequency is swept slowly through the IF amplifier passband, the output level will have time to reach full amplitude, tracing out curve A. Note the 3-db points of this curve with respect to frequency -- this is the true bandwidth. If, however, the local oscillator sweeps through at a high rate, the amplifier output will not have time to reach its full amplitude before the input is gone. This results in the lower amplitude curve B. Here the 3-db points are much wider with respect to frequency giving the impression that IF bandwidth is wider than it actually is and overall sensitivity has been reduced.

If frequency modulation is present on the local oscillator (other than the linear sweep tuning) the effect is equivalent to having a signal input that is frequency-modulated. As a result, the analyzer will present an FM spectrum rather than a single response, seriously limiting the resolving ability. The effect of local oscillator FM on a CW signal is shown in Figure 14.

Let's consider an FM spectrum for a moment. As a general rule, the approximate bandwidth of an FM spectrum is that of the peak-to-peak deviation of the signal provided the frequency deviation is much larger than the modulation rate. If, then, the peak-to-peak deviation of the local oscillator is large compared to the IF bandwidth in the analyzer, two CW signals must be separated in frequency by an amount greater than the deviation in order to be displayed as separate signals.² The local oscillator stabilizing circuit in the hp spectrum analyzer, mentioned earlier, enables full utilization of the narrowest IF bandwidth setting which is 1 kc. Thus, resolving power is about 3 kc.

¹ See Appendix B.

² Ibid.

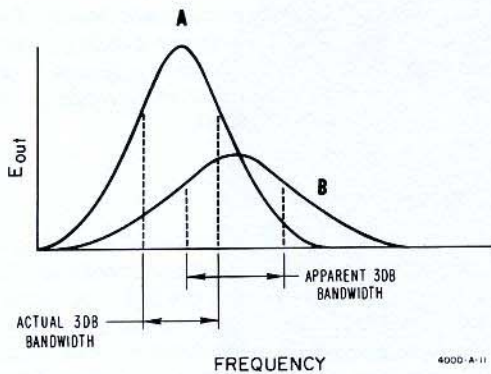

Figure 13. Curve A shows actual bandpass for gaussian IF amplifier. Curve B represents output when local oscillator frequency is swept too fast for IF amplifier to fully respond.

SENSITIVITY AND AMPLITUDE RESPONSE

Sensitivity is a measure of the analyzer's ability to detect small signals. There are several common ways to measure sensitivity in receivers depending primarily on the input stage. In communications, the input stage is usually an RF amplifier and the method of verifying sensitivity is to measure signal-to-noise ratio under specific conditions. In radar the input is usually direct to a diode mixer whose noise behavior is uncertain making signal-to-noise ratio difficult to accurately determine. Here, required input power to the receiver for minimum discernible signal out of the video amplifier is commonly referred to as sensitivity. This, however, is too arbitrary for consistent measurements. A more specific measure would be in terms defined by the system noise figure. In any case, inherent noise is the ultimate limitation to receiver sensitivity and since the spectrum analyzer is a receiver, let's see how sensitivity may be defined with relation to noise.

The mixer and IF amplifier comprise a system of stages in cascade, each contributing its own noise. We can therefore express the overall noise figure of the analyzer in db as follows¹

$$F_R = F_m + L_c (F_{if} - 1) \tag{2}$$

- where F_R = overall noise figure
- F_m = noise figure of mixer
- L_c = conversion loss of mixer*
- F_{if} = noise figure of IF amplifier.
- * Note: $L_c = \frac{1}{\text{gain}}$

Since F_m is not measurable, a noise ratio N_r is generally specified for diode mixers and may be substituted in the above formula. With appropriate factoring the equation becomes

$$F_R = L_c (N_r + F_{if} - 1)$$

¹ See Terman & Pettit "Electronic Measurements" 2nd edition, p. 361, Noise Figure of Systems in Cascade, McGraw-Hill.

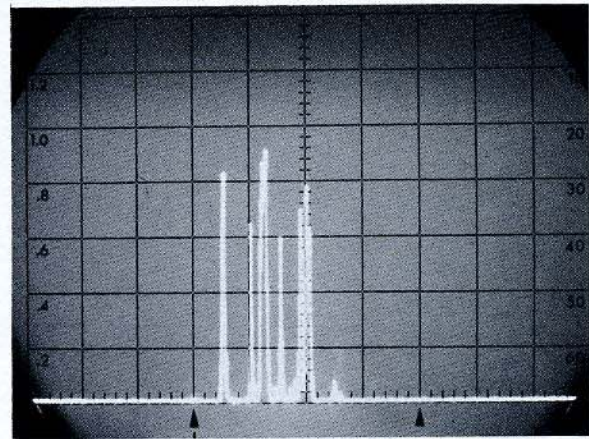

Figure 14. Appearance of a CW spectrum when analyzer's local oscillator has excessive FM.

Now, considering the overall noise figure F_R , we can show the equivalent noise power to the input of the analyzer as

$$P_{in} = F_R KTB \tag{3}$$

- where K = Boltzmann's constant of 1.37×10^{-23} joule/° Kelvin
- T = absolute temperature in ° Kelvin
- B = equivalent noise bandwidth of the IF amplifier.

P_{in} as defined in equation (3) is generally accepted as receiver sensitivity. A signal of this amplitude would produce an output signal-to-noise ratio of unity if there were no deleterious effects such as local oscillator FM or excess sweep rate.

In specifying analyzer sensitivity, it is essential that the associated IF bandwidth is also known as can be seen from the formula. Only under these conditions can one predict the signal-to-noise ratio for pulse signals or determine an upper limit on sweep rate and the tolerable local oscillator FM. The equivalent noise bandwidth is defined by the equation

$$B = \int_{-\infty}^{\infty} \frac{H(f)^2}{H_0^2} df$$

- where $H(f)$ = frequency response characteristic of IF amplifier
- H_0 = center frequency gain of IF amplifier.

As a rule of thumb, the equivalent noise bandwidth is about the same as the 3-db bandwidth for a gaussian IF amplifier, and the value of KT at 290° Kelvin (room

temperature) is -114 dbm/Mc. Thus the above relationships become quite simple for calculation of analyzer sensitivity, viz

$$\text{Sensitivity (dbm)} = F_r - \frac{114 \text{ dbm}}{\text{Mc}} + 10 \log \frac{B}{1 \text{ Mc}}$$

Using typical values for the ϕ_p analyzer we can calculate sensitivity for any IF bandwidth setting and system noise figure. For fundamental mixing the ϕ_p analyzer's noise figure is typically 29 db. If we choose the 10 kc IF bandwidth, the sensitivity of the analyzer is

$$29 - 114 + 10 \log \frac{.01 \text{ Mc}}{1 \text{ Mc}} = 29 - 114 - 20 = -105 \text{ dbm.}$$

Amplitude response of a spectrum analyzer is closely related to sensitivity. If the system is to present equal amplitude deflections for signals of equal amplitude independent of frequency, it is vital that the conversion loss L_c be independent of frequency. Earlier mention was made of the use of harmonic mixing to extend the frequency range of a system. In this case, we define a quantity L_{cn} as the conversion power loss of the mixer when mixing with the n th harmonic of the local oscillator.

It has been shown that if the oscillator voltage is relatively large compared to the input voltage, the conductance of a diode mixer will be time varying at the local oscillator rate. During the period when the local oscillator biases the mixer off, an average mixer conductance level exists from the forward bias effects of stored charges in distributed circuit capacitances. Conversion loss L_{cn} is dependent on the ratio of conversion conductance to this average conductance.⁴ Unless special means are taken to control L_{cn} (such as extremely small conduction times or conduction angle adjustment), the possibility of large variations in L_{cn} is very high. As an empirical rule, if conduction angle is optimized, L_{cn} can be expected to fall off at a rate of about $1/n^2$.

DYNAMIC RANGE

There are commonly two measures of a spectrum analyzer's dynamic range. The first is the ratio of largest to smallest signals which can be simultaneously displayed on the analyzer screen. This is usually extended by providing the IF amplifier with an optional logarithmic response. In the HP 851/8551 the dynamic display range is 60 db. Distortion due to saturation in the IF amplifier stages can also limit dynamic range if it occurs prior to overloading the mixer with large inputs. A well designed analyzer will have sufficient IF gain control so the IF amplifier will not be the limiting factor in dynamic range. In the HP analyzer any on-scale display will not saturate the IF amplifier and signal levels of 60 db difference may be simultaneously observed without distortion.

The second measure of dynamic range is the ratio of the largest signal that can be applied at the input without serious amplitude distortion, to the smallest signal that can be detected (sensitivity). Distortion occurs when the applied signal is large enough to cause the mixer conductance to vary with the applied signal. This happens when the peak signal voltage to the mixer approaches the magnitude of the local oscillator drive voltage. It is therefore desirable to limit large input signals to the mixer with a suitable input attenuator. An input attenuator of 60 db will increase the saturation to noise dynamic range by 60 db. This is the input range.

The dynamic range is greatly reduced when analyzing pulse signals since the mixer saturates at peak levels but the displayed response is attenuated by the slow rise time of the IF amplifier. The exact value of this attenuation may be calculated provided the IF bandwidth is known. See "Amplitude of Spectrum Display" in Table 1. This again emphasizes the importance of knowing the IF bandwidth at which the sensitivity of an analyzer is specified (or preferably that the overall system noise figure be known).

DETECTOR AND VIDEO AMPLIFIER

For most purposes, it is preferable to use an envelope (peak) detector at the output of the IF amplifier. In some of the earlier spectrum analyzers, square-law detectors were used which resulted in a response that presented a power spectrum display; however, detector square law characteristics cannot be relied upon for accurate spectrum measurements. It is generally better to use a linear envelope detector and shape the gain characteristics of the IF amplifier to obtain a response other than linear when required. This is the approach taken in the design of the ϕ_p spectrum analyzer. Linear, logarithmic (db), or square law (power) displays may be selected by a "vertical display" control on the front panel.

The basic duty of the video amplifier is to drive the CRT without excessive loss in amplitude because of its bandwidth. It should be the IF bandwidth and not the video bandwidth that determines the resolving capabilities of the analyzer. Since the fastest transient available from the IF amplifier is its response to an impulse, the video amplifier bandwidth is usually of the same order of magnitude as the IF bandwidth. Other than this, the characteristics of the video amplifier are relatively unimportant.

GENERAL CONSIDERATIONS

To perform meaningful measurements with a spectrum analyzer, it is necessary to be able to accurately determine amplitudes and frequencies. For amplitude comparisons, an accurate IF attenuator is generally used since it can be calibrated very closely at a single frequency, that of the IF. The ϕ_p analyzer employs a 0 to 80 db step attenuator calibrated in terms of IF gain. Accuracy is ± 0.5 db on the 10 db/step section, and ± 0.1 db for the 1 db/step. A vernier is also included for continuous adjustment over a 1-db range.

To avoid distortion in the mixer at high input signal levels, an RF attenuator is also desirable as pre-

⁴ E. W. Herrold, "Frequency Mixing in Diodes," Proc. IRE Vol. 31, October 1943.

viously explained. This attenuator need not be particularly accurate but must be flat to maintain the overall amplitude response of the system. Waveguide-beyond-cutoff type attenuators have usually been employed in analyzers for simplicity and wide frequency range. The problem with this is that insertion loss is typically 20 db or more requiring an RF patch panel to bypass the input attenuator for weak signal inputs. Also, this type attenuator is not flat with frequency. A recent advancement in film attenuator design by Hewlett-Packard allows both low insertion loss and flat frequency response which is ideal for this work. The hp analyzer uses a 0 to 60 db RF step attenuator of this type that has zero insertion loss at 10 Mc increasing to only 2 db at 10 Gc.

A calibrated input frequency dial and accurate sweep linearity is essential for properly determining energy

distribution. Many analyzers employ built-in crystal marker generators which produce responses at accurate frequency intervals. This technique makes frequency difference measurements more accurate by eliminating the analyzer's sweep linearity error. The limitation to this approach is that the actual frequencies of spectral components cannot be determined any more accurately than the basic tuning accuracy of the analyzer. The hp analyzer was designed to provide good frequency accuracy (1%) and spectrum width linearity sufficient for most spectrum measurements. When increased accuracy is required, an external marker generator may be fed into the analyzer's input. By doing this, both frequency difference and actual frequency measurement accuracy is increased. The use of an external marker generator also allows more flexibility for frequency measurement of passive devices as illustrated in Section IV.

SECTION IV APPLICATIONS

In Section II, we learned how to interpret various displays without concern as to their source. Now we shall apply this information to illustrate the value of a wideband calibrated analyzer. The examples shown in this section are only a few chosen from many, with emphasis on newer applications made possible by the HP 851/8551. Because of their continued importance, some of the older applications of spectrum analyzers are also included.

PULSE RADAR PERFORMANCE CHECKS

One of the earliest applications of a spectrum analyzer continues to be of major importance. This involves measuring a pulse radar's magnetron output to ensure stable oscillation, free of moding and spurious signals. The HP 851/8551 is ideal for radar measurements for several reasons, one being its wide range. Any radar frequency may be received with this one instrument and broad spectrum widths allow complete displays of spectrum signatures. Wide image separation (4 Gc) and comparatively few spurious responses keep the display uncluttered for accurate presentation of radar spectra. The spectrum width may be quickly reduced for detailed examination of the main or side lobe structure, if desired.

A. Magnetron Pulse Operation.

Connect the analyzer RF input to a sample of the radar transmitter power through a directional coupler of at least 30 db coupling. Most radars have built-in couplers providing a test output of a milliwatt or so. Figure 15 shows this setup. With the radar high voltage on, tune the analyzer to the transmitter frequency which will center the main lobe of the radar's pulse spectrum on the analyzer screen. Check for overloading of the analyzer's mixer by increasing the RF input attenuator of the analyzer by 10 db. The amplitude of the lobes should decrease by 10 db on the analyzer's display. If they do not, continue increasing RF attenuation until this condition is reached. The IF gain may be used to increase the display amplitude in accurate 10-db steps as RF attenuation is added.

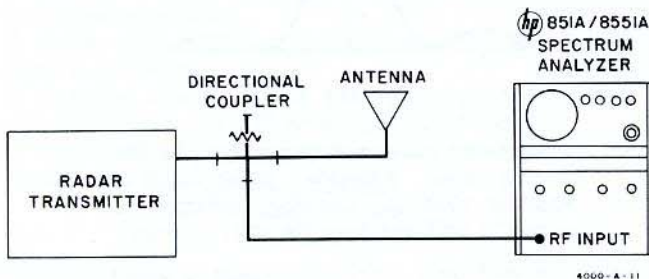

Figure 15. Spectrum Analyzer Connected for Checking Radar Magnetron Operation

The display should be symmetrical approximating the envelope shown in Figure 16a (Figures 16a through 16f are shown on a linear scale). If incidental FM is present, it will show up as a loss of power in the main lobe and increased power in the side lobes as shown in Figures 16b and 16c. The addition of linear AM causes the spectrum to become unsymmetrical as shown in Figures 16d and 16e. Incidental AM alone causes the side lobe amplitudes to decrease while the main lobe remains symmetrical as illustrated in Figure 16f. For closer observation of the side lobes, switch the analyzer to a logarithmic display so the main lobe will be compressed and the side lobes enlarged by the response of the analyzer. The photos in Figure 16g, h, and i are examples of good and bad spectra commonly encountered in the field. Figure 16j points up the advantage of the accurate log display used in 16i for good side lobe detail.

B. Measure Pulse Width and Repetition Frequency.

With the equipment still connected as in Figure 15, measure the frequency spread of the main lobe using the calibrated Spectrum Width control and CRT graticule. Remember to measure this width at the minima of the main lobe. Calculate the modulating pulse width τ in microseconds from this by the equation

$$\tau (\mu\text{sec}) = \frac{2}{f(\text{Mc})}$$

where $f(\text{Mc})$ = measured main lobe width in megacycles.

Pulse width may be calculated from measurements of any of the side lobes also, depending on the preference of the operator. Simply divide the right-hand member of the equation by 2, since the side lobes are exactly half the main lobe width.

There are occasions when it is desirable to check radar performance at a location where direct connection to the radar is impossible. In such instances, pulse repetition frequency (PRF) cannot be measured in the conventional manner with a crystal detector and oscilloscope, since there is insufficient power available from a pickup horn.

The Spectrum Analyzer has the required sensitivity for good spectral displays using waveguide horns in proximity with the radar antenna. To measure PRF in remote locations, connect the analyzer's RF input to a suitable horn aimed at the radar antenna. Now connect the 20-Mc IF output from the rear of the 8551 to the input of a high frequency oscilloscope and tune the analyzer to the radar center frequency. Now the calibrated sweep time of the oscilloscope can be used to measure the time between bursts of the 20-Mc IF output which correspond to the radars pulse repetition period. The radar PRF is the reciprocal of the period measured. If the PRF were high enough, it

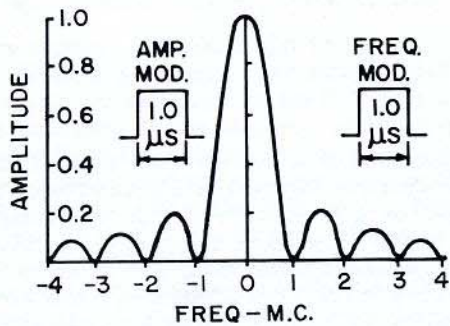

(a)
Spectrum of rectangular pulse without AM or FM occurring during pulse. Shape is that of $\frac{\sin \omega T/2}{\omega T/2}$ function.

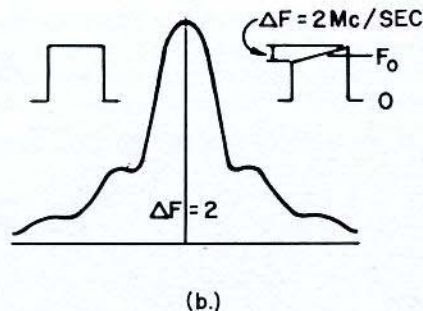

(b)
Spectrum of rectangular pulse with linear FM resulting in increased sidelobe amplitude and minimas not reaching zero.

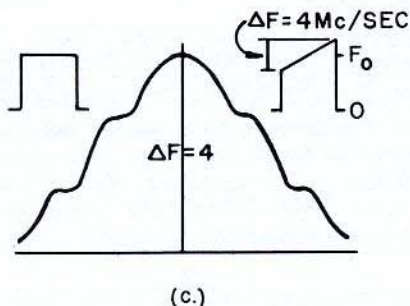

(c)
Same pulse spectrum as (b) with more severe FM

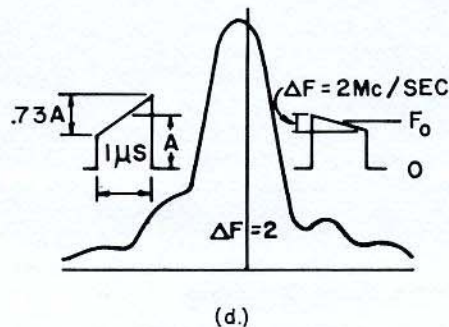

(d)
Effect of linear AM and FM during pulse. Note loss in symmetry due to pulse amplitude slope.

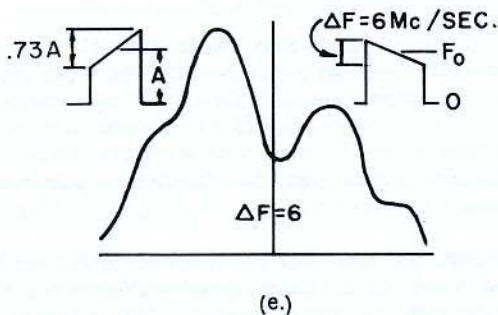

(e)
More severe case of FM and AM occurring during pulse.

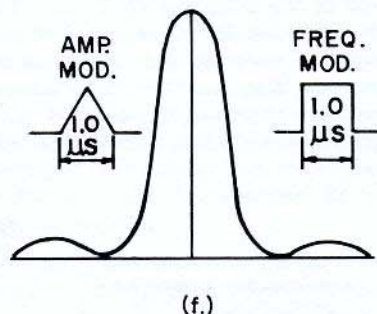

(f)
Triangular pulse spectrum without FM during pulse. Effective pulse width is shorter than (a) causing minimas to occur at wider intervals of frequency.

4000-A-11

Figure 16. Common Pulse Spectra

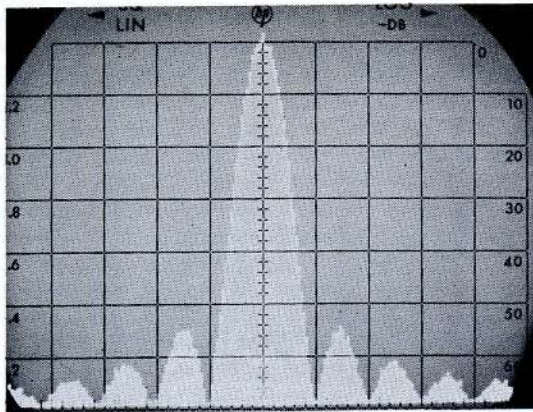

(g)

Good $\frac{\sin \omega \tau / 2}{\omega \tau / 2}$ spectrum of a 1- μ sec RF pulse. Analyzer set for linear vertical display and 1 MC/CM spectrum width.

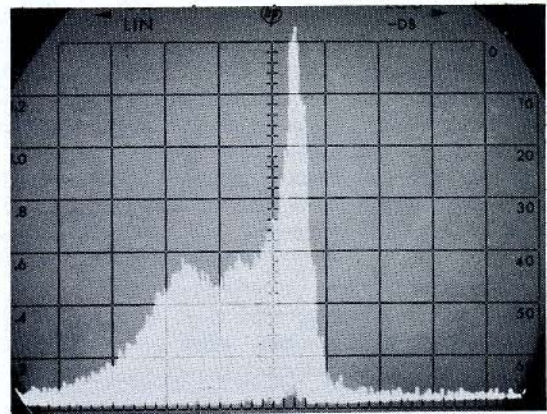

(h)

Reflector modulation of a klystron with 1-kc square wave. Linear display, 1 MC/CM. Note lack of symmetry due to incidental FM along with AM.

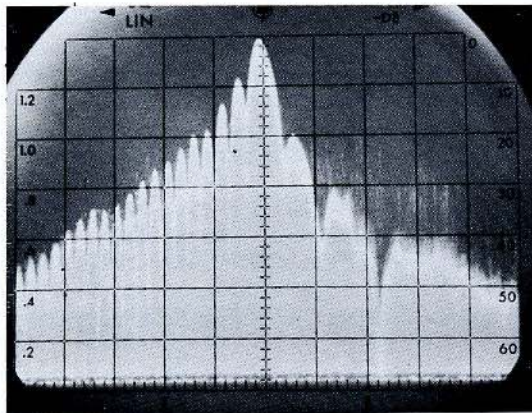

(i)

Spectrum of a 4.5- μ sec RF pulse at 300 pps showing AM and FM effect caused from a poorly operating magnetron. Vertical Display set to Log.

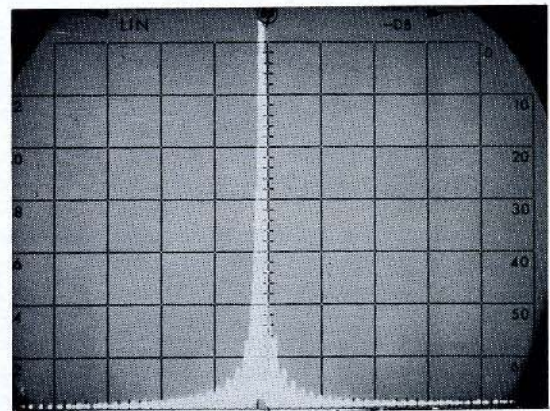

(j)

Same as spectrum (i) showing loss in sidelobe detail because of analyzer Vertical Display set for Linear.

4000-A-11

Figure 16. Common Pulse Spectra (cont'd)

could be measured directly by the spacing of spectral lines on the analyzer display. However, most pulse radars have a PRF of 1 kc or less, resulting in spectral line spacing too close for even high resolution analyzers such as the HP 851/8551 to distinguish.

C. Frequency Stability.

Two checks of magnetron frequency stability include frequency drift and magnetron "pulling". Frequency drift may be checked with the analyzer connected as in Figure 15 or through a waveguide horn as in Paragraph B. (When using the latter pickup technique, it is best to stop rotation of the antenna so its radiated power is toward the horn for constant spectrum amplitude on the display.) With the main tuning dial on the analyzer, place the center of the main lobe

at some convenient reference mark along the X axis of the CRT. Then watch for a continuous movement of the entire spectrum across the screen which will indicate frequency drift of the magnetron. The drift in frequency is easily determined by noting the total shift of the spectrum in centimeters on the X axis and multiplying by the SPECTRUM WIDTH setting of the analyzer.

The following check for magnetron pulling requires connecting to the radar as in Figure 15 since transmitter power must be sampled before it reaches the rotary joints of the antenna system. With the antenna scan system operating, observe the behavior of the spectrum. As the antenna rotates, watch for a periodic shift left and right or a breathing effect of the entire spectrum. This is magnetron "pulling" which is a

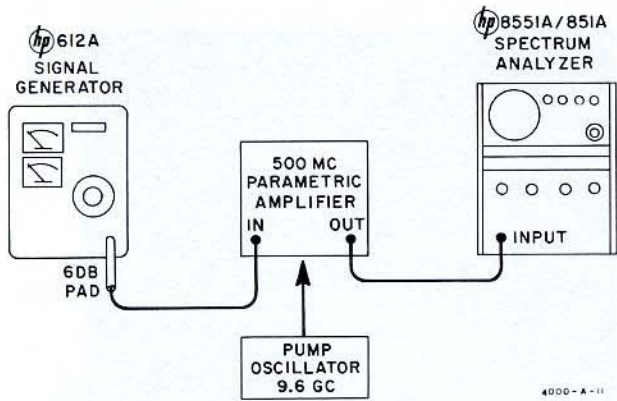

Figure 17. Parametric Amplifier Tuning Using Wide Spectrum Display of Analyzer

shift in operating frequency as the phase of the load impedance reflection coefficient is varied through 360 degrees. The pulling effect can be measured by noting the maximum shift in centimeters of the main lobe on the screen and multiplying by the SPECTRUM WIDTH setting as done for measuring drift. A moderate shift is normal for radars not employing ferrite isolators at the magnetron output; however, excess pulling may be due to an improperly tuned magnetron or high load VSWR.

PARAMETRIC AMPLIFIER TUNING

In tuning a parametric amplifier, it is extremely useful to see the output, pump, idler (lower sideband) and upper sideband frequencies simultaneously. This is because of their interdependence for optimum gain and low noise operation. Since these frequencies are often widely separated, the HP 8551 Spectrum Analyzer with its broad spectrum width is ideal for this application. An example of this is shown in Figure 17 where a signal generator provides the test signal and the paramp (parametric amplifier) output is connected to the analyzer RF input. In this example, the desired paramp output frequency is 500 Mc, the same as the input, and

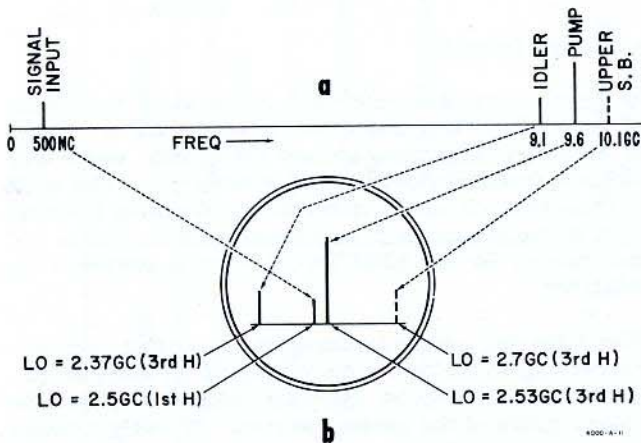

Figure 18. (a) Paramp Signals on a Linear Scale
(b) Paramp Signals on Spectrum Analyzer Display

the pump operates at 9.6 Gc. The resulting idler frequency will be at 9.1 Gc and the upper sideband at 10.1 Gc. Figure 18a shows these frequencies on a linear scale. After connecting the equipment, the analyzer is tuned to 500 Mc and its spectrum width adjusted to about 450 Mc (using VERNIER) to obtain the display illustrated in Figure 18b. When the analyzer local oscillator sweeps through 2500 Mc, it will mix with the paramp 500 Mc output to produce the required 2 Gc IF for the analyzer resulting in a spike in the center of the display. As the local oscillator sweeps through its range its third harmonics will mix with the idler, pump, and upper sideband frequencies resulting in the analyzer display as shown in Figure 18. Positive frequency identification of the various responses on the display may be made with the analyzer's signal identifier.

Now adjustments can be made to the paramp pump and idler circuits for maximum gain while suppressing the upper sideband and any spurious signals being generated.

VARACTOR MULTIPLIER TUNING

A varactor is a semiconductor junction diode that appears as a capacitance to RF and microwave frequencies when reverse-biased. The capacitance (hence capacitive reactance) may be varied in a non-linear relationship with the reverse bias making it useful for frequency multiplying and other applications.

The efficiency of a varactor multiplier at low order harmonics is substantially better than a conventional diode operating in the non-linear resistance mode. Figure 19 compares the efficiency of a particular varactor and the ideal rectifier diode for harmonic orders

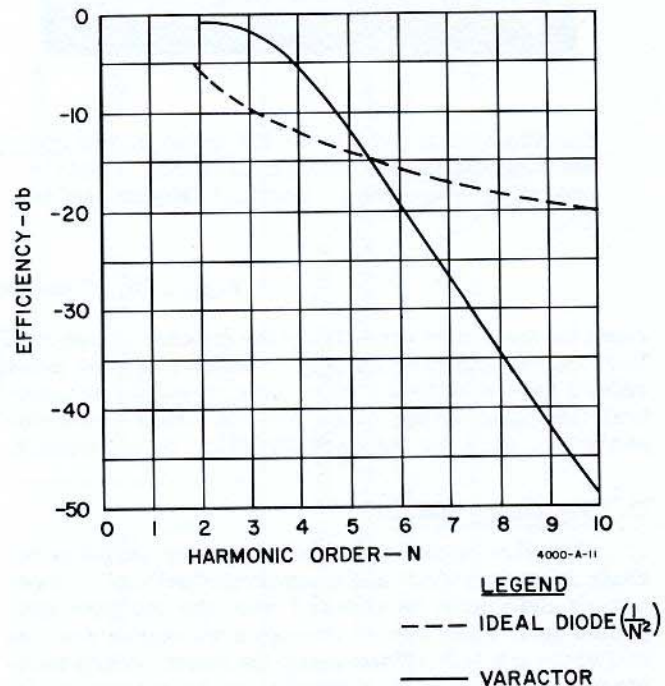
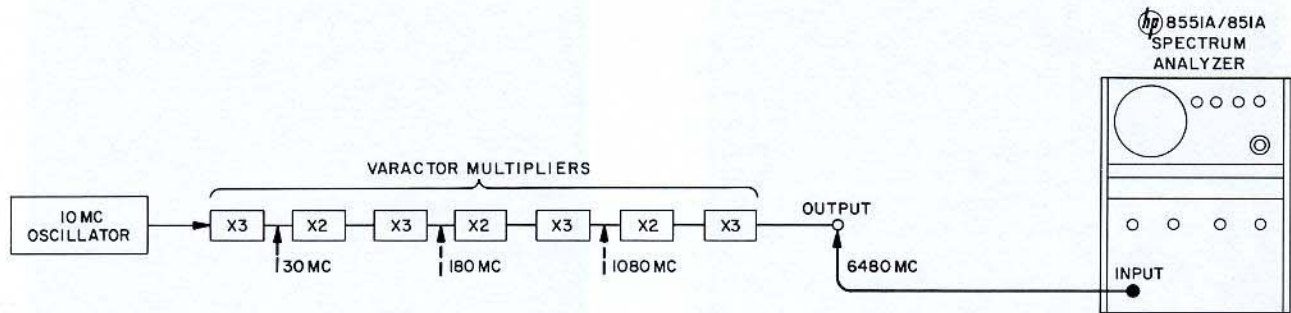
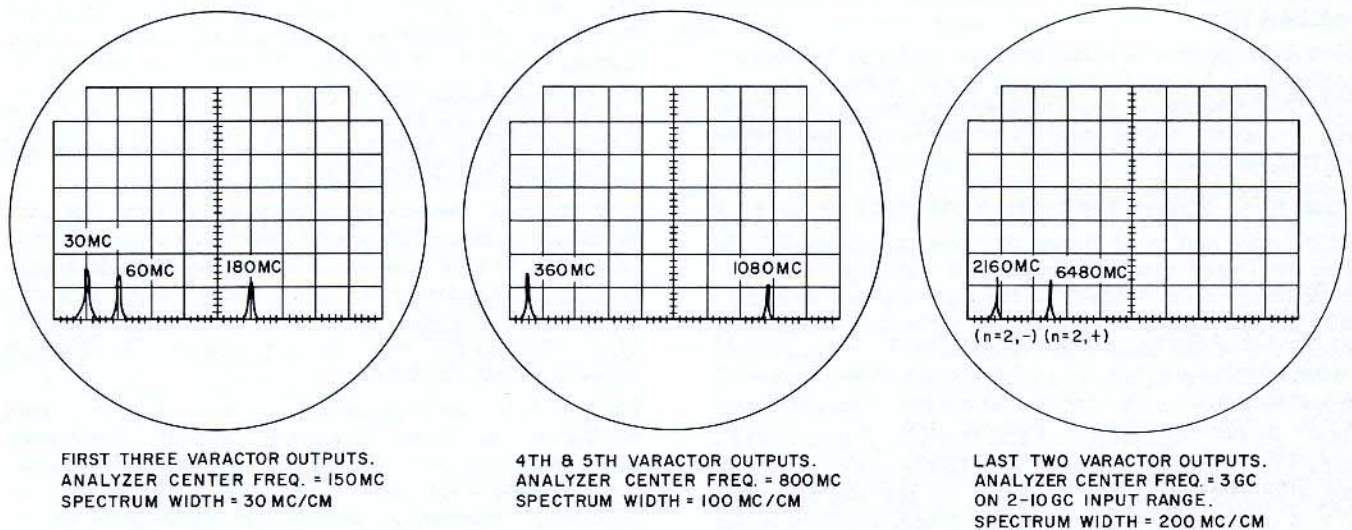

Figure 19. Comparison of Varactor and Rectifying Diode Harmonic Efficiency



20 a. Test Setup for Varactor Multiplier Tuning



FIRST THREE VARACTOR OUTPUTS.
ANALYZER CENTER FREQ. = 150MC
SPECTRUM WIDTH = 30 MC/CM

4TH & 5TH VARACTOR OUTPUTS.
ANALYZER CENTER FREQ. = 800MC
SPECTRUM WIDTH = 100 MC/CM

LAST TWO VARACTOR OUTPUTS.
ANALYZER CENTER FREQ. = 3 GC
ON 2-10 GC INPUT RANGE.
SPECTRUM WIDTH = 200 MC/CM

4000-C-11

20 b. Analyzer Display Locations for Varactor Outputs

Figure 20. Spectrum Analyzer allows monitoring of desired multiplier output plus any submultiple feedthrough from individual varactors. Varactor traps and filters may be fine tuned for best overall operation.

2 through 10. By using a series of varactor doublers or triplers in cascade, overall multiplying efficiency can be as much as 33 db greater than that of a single rectifier diode at orders approaching 100.

A transistorized low-frequency oscillator in conjunction with a varactor multiplier chain offers the design engineer a completely solid state microwave source of several milliwatts output. Among the rapidly growing applications of this technique are uses as local oscillators for advanced missile radar and transmitters for spacecraft communications where solid-state reliability is extremely important.

Tuning such a multiplier string can be tedious and time-consuming and there is a good chance of tuning

one of the multipliers to the wrong harmonic unless special care is taken. The HP 851/8551 spectrum analyzer may be used as a calibrated indicator to materially reduce alignment time and assure accurate results.

After the multipliers have been rough tuned to their approximate frequencies, the analyzer is connected to the output as shown in Figure 20a. The desired output frequency in the example shown is 6480 Mc but there is a good chance of other frequencies being present, namely, those of the individual varactor outputs plus spurious signals generated by the multipliers. For an overall display of frequencies out of the multiplier, the analyzer is tuned to the 1-Gc point on the frequency dial and SPECTRUM WIDTH set to

200 MC/CM. Since the analyzer has no preselection, any signal from 10 Mc up to 10 Gc will appear on the screen. By reducing spectrum width and tuning the analyzer frequency, the individual responses may be observed in more detail and their frequencies accurately determined using the analyzer's signal identifier. Now the various filters and traps in the multiplier may be tuned to eliminate all but the desired frequency output. Figure 20b shows the display locations and analyzer settings for observing signals getting through to the output. Here medium spectrum width settings are used for better resolution of the individual signals while tuning. This makes it easier to keep track of their frequency while tuning the filters and traps in the multiplier. After the tuning is completed, the analyzer can again be set to maximum spectrum width to verify overall clean operation and maximum output at the desired frequency.

ANOTHER SOLID-STATE HARMONIC GENERATOR

Harmonic generators that produce multiple harmonics rather than a single frequency at the output are very useful in frequency control and measurement. They are currently being used with reference oscillators for frequency and phase locking, frequency calibration, and frequency synthesis.

Extremely fast rise times are possible using "Boff" step recovery diodes resulting in wide spectral distribution. This "comb" of frequencies makes available precise signals up into the microwave region at intervals of the reference oscillator; typically 1 to 10 Mc. Figure 21 shows the spectrum generated by a step-recovery diode driving a shorted transmission line. In the application of this device, it was necessary to get a spectrum that was fairly uniform. With the wide sweep and flat response of the HP 851/8551 it was easy to see and adjust for discontinuities in the system.

FM DEVIATION MEASUREMENT

Accurate frequency deviation measurement of FM transmitters and signal generators is easily made with the Spectrum Analyzer. By knowing the modulation frequency and the modulation indexes where the carrier amplitude goes to zero (all energy in the sidebands) you can check FM deviation. For single tone FM, the modulation index is given by the formula

$$m = \frac{\Delta f_c}{f_a}$$

where m = modulation index
 Δf_c = carrier deviation
 f_a = modulation frequency.

Since carrier deviation is the unknown in this application, we transpose the above formula to

$$\Delta f_c = m f_a$$

The values of m corresponding to zero carrier amplitude are listed in Table 2 for convenience. The table is valid for any combination of carrier deviation and modulation frequency producing the modulation indexes listed.

Table 2. Values of Modulation Index for which Carrier Amplitude is Zero

Order of Carrier Zero	Modulation Index
1	2.40
2	5.52
3	8.65
4	11.79
5	14.93
6	18.07
$n (n > 6)$	$18.07 + \pi (n-6)$

Figure 22 is a pictorial diagram of an FM signal generator being checked for accurate frequency deviation.

The generator is first placed in CW operation by disconnecting the 204B from the external FM jack of the generator. The analyzer and generator are tuned to the desired carrier frequency producing a single CW response in the center of the analyzer display. The frequency of the analyzer is then stabilized and the attenuator and IF gain controls adjusted for a good display. The SPECTRUM WIDTH control is switched to the 10 KC/CM position and its vernier used to further reduce spectrum width to about 2 KC/CM. The IF BANDWIDTH is switched to 1 KC for good resolution of the carrier and sidebands.

Now the 204B Oscillator is connected to the FM generator as shown in Figure 22 and its frequency accurately set to 6250 cps as indicated by the electronic counter. This frequency when multiplied by a modulation index of 2.40 results in a carrier deviation of 15 kc which is full scale on one range of the Boonton 202-J's deviation meter.

Then, with the 204B amplitude control, the audio modulating signal voltage is slowly increased from zero until the amplitude of the carrier response on the analyzer display first goes to zero. As the carrier amplitude is decreasing, sidebands begin appearing at intervals of 6250 cps above and below the carrier, and when the carrier amplitude is zero all of the energy is contained in the sidebands. At this point the generator deviation is 15 kc and the deviation meter is checked for full scale accuracy. If the 204B amplitude is slowly increased further the carrier amplitude will increase again to some maximum and then begin decreasing until it goes to zero amplitude for the second time. At this point the modulation index is 5.52 as indicated in Table 2 for a second order carrier zero. Note that any deviation, within limits of the generator of course, may be set up by choosing the correct combinations of modulation index and modulation frequency. This technique is known as the Crosby Zero Method for measuring frequency deviation.

The wide dynamic range of the HP 851/8551 makes it possible to accurately determine when the carrier is zero because the IF gain may be increased, as carrier zero is approached, for maximum sensitivity without the large adjacent sidebands saturating the IF. Accurate carrier zero is essential for correct deviation measurements. It should also be stated that the analyzer must have a resolution at least three times better than the modulation frequency to be used in order to distinguish between the carrier and first sideband responses. Resolving capability of the analyzer, you recall, is largely determined by the IF

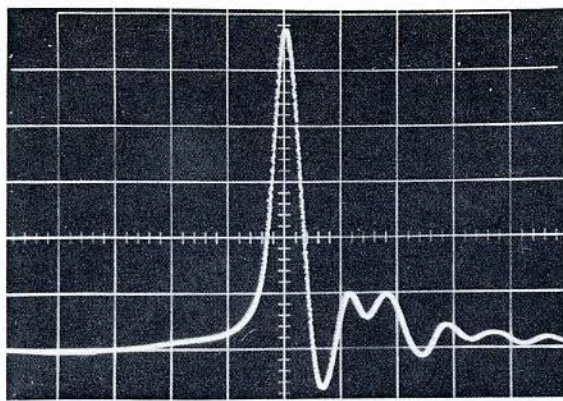

0.5 ns/cm

TIME FUNCTION

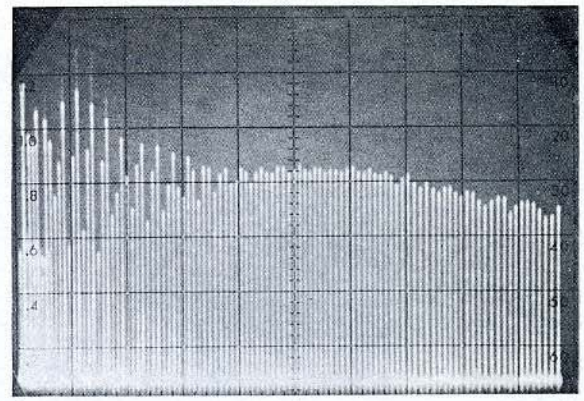

FREQUENCY FUNCTION

Figure 21. Spectrum of a Boff Step-Recovery Diode

bandwidth. The narrowest bandwidth on the hp analyzer is 1 kc allowing modulation frequencies down to about 3 kc to be used with this method of frequency deviation measurement. Modulating frequencies below the analyzer's resolution may be used, and approximate deviations inferred by the width of the spectrum produced by the modulating signal.

Residual FM of signal generators may also be checked provided the peak-to-peak deviation is 10 kc or greater. This is done by switching the SYNC control on the analyzer to INT and setting the SWEEP TIME slightly different than the power line frequency or submultiple (3 msec/cm for 60-cps line). With the generator set for CW operation and the analyzer tuned to the operating frequency, residual FM will be indicated by a slow periodic movement of the CW response back and forth on the analyzer display. This movement will be at the differential rate of the line frequency and the analyzer's sweep time. The peak-to-peak deviation of the generator's residual FM is then measured by noting the maximum horizontal excursion of

the CW response, and reading the frequency from the calibrated SPECTRUM WIDTH control.

RADIO FREQUENCY INTERFERENCE TESTING

A. Background.

Some forty years ago there were only 30 standard AM broadcast stations transmitting in the United States. In 1925 only eight per cent of all U.S. homes had radio receivers, but by 1940 this figure had risen to 77 per cent, representing over 45 million sets. As the use of the electromagnetic spectrum grew more intense with the addition of more communications, TV, Facsimile, Radar, and navigation aids, the prevention of radio frequency interference (RFI) became extremely important.

Aside from the obvious importance of careful channel assignments and frequency control of transmitters, there is the need for preventing RFI from other sources. Spurious signals, harmonics, RF leakage and transients are some forms of interference that can be caused by an electronic or electrical device. The U. S. Government establishes standard methods for determining RFI emanating from a device and documents them in the form of Military Standards. Careful testing and control of RFI is required on all electronic equipment to be supplied for Government installations.

Interference may occur anywhere in the spectrum and the problem of checking for its presence and intensity is manifold. The common approach has been to tune a number of receivers, with various antennas or probes, through their frequency ranges searching for undesired signals indicated on a calibrated signal strength meter. The process is long and tedious with band-switching, slideback detector adjustments, mechanical cranking and the constant concern that you may have "blinked" when you went through a signal missing its meter deflection completely. Some improvement has been made, however, by using a motor drive and mechanical linkage to alleviate the drudgery

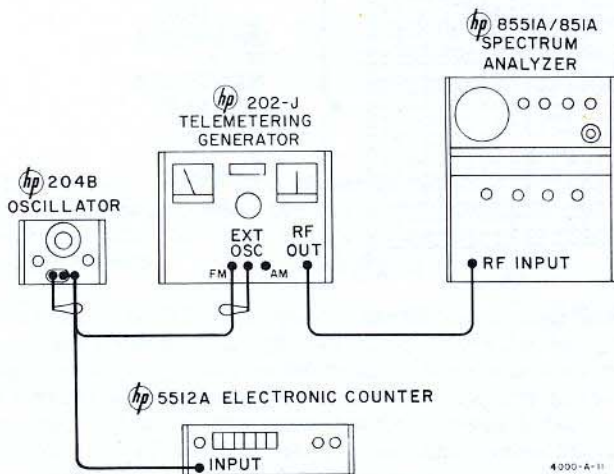

Figure 22. FM Deviation Measurement Using hp Spectrum Analyzer to Monitor Carrier Zero

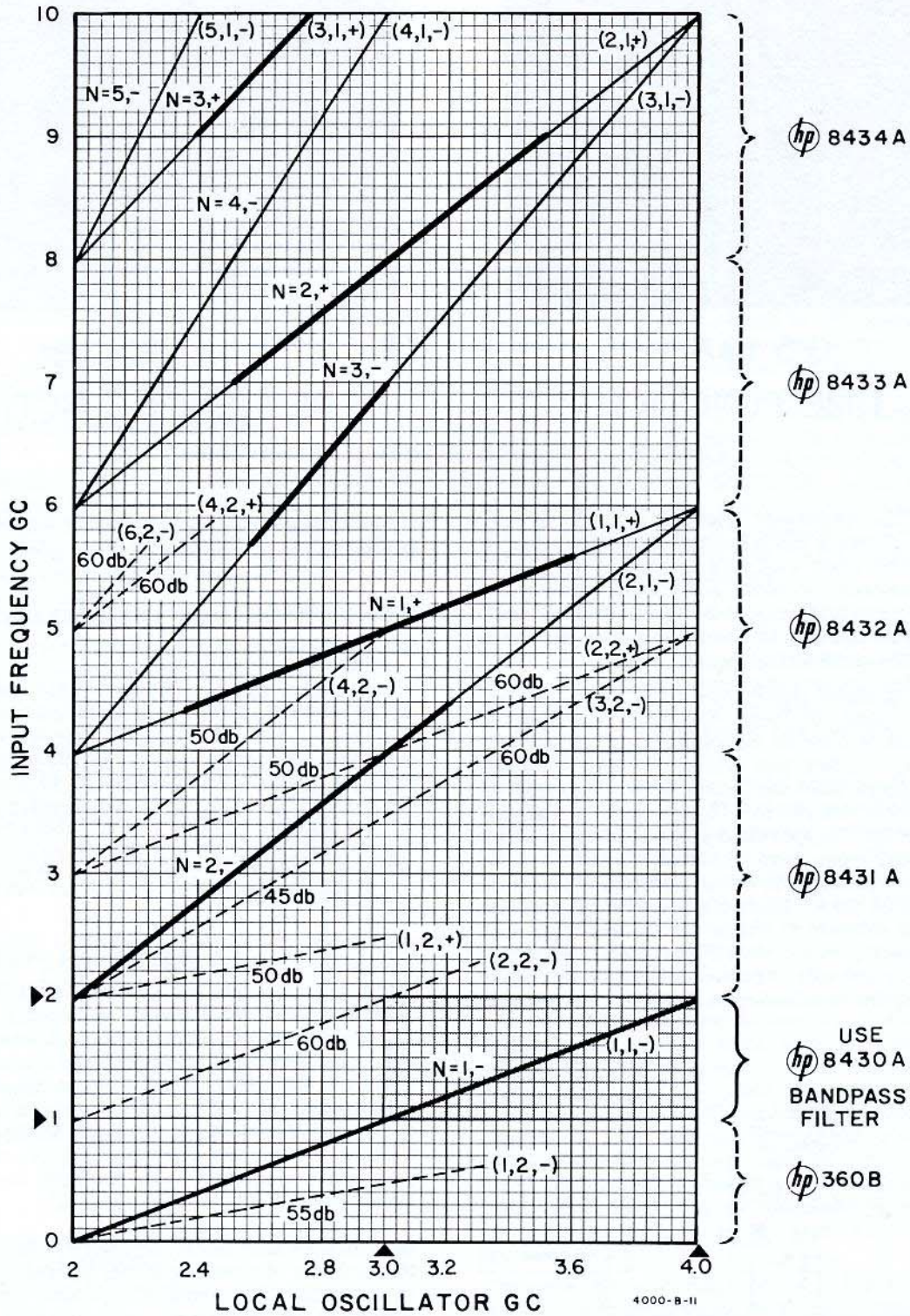

Figure 23. HP 851/8551 tuning curves allow selection of RF filters and local oscillator sweeps for eliminating spurious responses. Shaded area represents spurious-free display range of analyzer using an HP 8430A filter and 3-4 Gc local oscillator sweep.

of manual tuning, and X-Y recording of the detector output has solved the "blinking" problem. But what about the case of transients or closely spaced signals swept through too fast for the X-Y recorder to respond to their true amplitudes? Many times the closing of relay contacts or a switch will produce serious transients and continuous monitoring of the entire spectrum of interest is the only way it can be detected. The HP 851/8551 Spectrum Analyzer with its rapid electronic spectrum sweep over wide ranges at high sensitivities has an important role in RFI testing and spectrum surveillance work. This single instrument presents continuous visual coverage of the spectrum from 10 megacycles to 12.4 gigacycles for rapid location of interference. Two external waveguide mixers extend the frequency range to 40 Gc.

B. Preselection Filters.

RFI can be of two general types: narrow band, such as transmitter harmonics which are sharply defined in frequency, and broadband, such as electrical noise produced by electric motor brushes, switches, and high-voltage discharge. Spurious responses in a spectrum analyzer used for RFI testing must be controlled to prevent their being mistaken for actual RFI signals. This is particularly true when measuring broadband noise where it is virtually impossible to separate the spurious signals from true inputs.

Recall from the discussion on spurious signals in Section III that the amplitude of a spurious response is not linearly proportional to the input signal causing it. This makes it easy to identify a spurious response if there are relatively few signals on the display. Simply note the amplitude of a signal on the logarithmic display of the hp analyzer and switch in 10 db more input attenuation. If the amplitude of the response decreases by 10 db (1 cm on the log display) the signal is genuine. If the amplitude decreases by more than 10 db the response is spurious.

It is best to eliminate input signals that can cause spurious responses by using preselection filters at the analyzer input when making specific RFI measurements. By careful choice of filters and local oscillator sweep widths, spurious responses can be completely eliminated. Generally total elimination imposes heavy restrictions on spectrum width and requires more filters than is economically feasible. The hp 360B Low-Pass Filter (1200 Mc cutoff) and 8430A series of interdigital bandpass filters comprise a good working set of filters for the hp analyzer, allowing reasonable spectrum width and virtually clean displays.

The information given in Figure 23 enables you to choose a preselection filter for spurious-free displays in any frequency range of interest. Figure 23 shows, for example, how a 1- to 2-Gc filter can provide a completely spurious-free display on the hp Spectrum Analyzer. The hp 8430A Filter passes only those frequencies from 1 to 2 Gc, rejecting all others. The only spurious-producing signal crossing this band on the graph is the (2, 2-) curve. We have eliminated all others by preventing their reaching the mixer with the filter. Now we see that we can cover the octave range from 1 to 2 Gc by sweeping the local oscillator from

3.0 to 4.0 Gc with primary signal reception along the heavy $n = 1$ - tuning curve. By setting the local oscillator sweep for these limits (main tuning at 3.5 Gc and spectrum width at 100 Mc/cm) a boundary is set on the graph which excludes all spurious responses. The spurious-free area is shown by the shaded rectangle in Figure 23. The bandpass filter requirements and local oscillator sweep limits for any region of the spectrum may be quickly determined in this manner. Table 3 includes the proper hp filters to use for the RFI tests that follow.

The -hp- 8441 Preselector is an electronically tunable filter designed for use with the -hp- 851/8551. Information on this unit is available in AN63B.

C. Measuring Absolute RF Levels.

To make absolute measurements of RF levels with any instrument, it is necessary for its input to be calibrated with known standards. Conventional RFI meters cover a comparatively narrow band of frequencies, yet exhibit large variations in gain versus input frequency. This greatly complicates absolute amplitude calibration. Some RFI meters utilize extensive calibration charts for setting gain as frequency is changed so that levels may be read directly from a meter indication. Other RFI meters are used as transfer standards employing a calibrated impulse generator. In this case, the meter indication serves only as a reference and the actual RF voltage is read from the output dial of the impulse generator. This eliminates the requirement for charts but does not solve the problem of continual calibration for small frequency changes.

The hp Spectrum Analyzer has a remarkably flat input response (including the input attenuator) across any range plus accurate relative IF gain calibration and known IF bandwidth.

These characteristics greatly simplify absolute RF measurements using a form of the transfer technique described for impulse calibration. Since there have been some doubts raised about the calibration accuracy of impulse generators, we will show the use of signal generators at CW in this application.

If no preselection filters were used at the analyzer input, only four calibrating frequencies would need to be used for amplitude reference: one for each local oscillator harmonic used in tuning the analyzer from 10 Mc to 10 Gc. Since we are to include preselection filters in the absolute measurement of RFI, we must be able to provide signal generator outputs within the passband of each filter; thus, variations in the filter's response will not introduce error into the measurement. Also, transmission losses can be taken into account with this technique.

One further consideration must be made about the analyzer at this point and that is pulse desensitization. When measuring pulsed signals and comparing their spectrum amplitudes with those for CW signals, the shape and bandwidth of the IF amplifier in the analyzer must be known. Because the analyzer must be selective for resolving spectra, its IF bandwidth does not admit all of the frequency components contained in a pulse at one time. Therefore, the peak amplitude of the main lobe of a pulse's spectrum represents only a portion of the total energy contained in the pulse. The main lobe of a pulse's spectral display is typically

Table 3. Antennas and ϕ Spectrum Analyzer Settings for Radiated RFI Measurements

Measured Frequency Range	Antenna	Preselection Filter	Analyzer Frequency	Spectrum Width	Spectrum Displayed
10 - 25 Mc	Rod, 1/2 Meter elec. length	ϕ 360B Low-Pass	20 Mc	3 Mc/cm	5 - 35 Mc
25 - 200 Mc	Dipole tuned to 35 Mc	ϕ 360B Low-Pass	150 Mc	30 Mc/cm	0 - 300 Mc
200 - 1000 Mc	Conical Logarithmic Spiral*	ϕ 360B Low-Pass	500 Mc	100 Mc/cm	0 - 1 Gc
1 - 10 Gc	Conical Logarithmic Spiral**	ϕ 8430A Band Pass	1.5 Gc	100 Mc/cm	1 - 2 Gc
10 - 12.4 Gc ¹	Waveguide Horn (X Band)	ϕ 8431A Band Pass	3 Gc (2-10 Gc)	200 Mc/cm	2 - 4 Gc
12.4 - 18.0 Gc ²	Waveguide Horn (P Band)	ϕ 8432A Band Pass	5 Gc (range)	200 Mc/cm	4 - 6 Gc
18.0 - 26.5 Gc ²	Waveguide Horn (K Band)	ϕ 8433A Band Pass	7 Gc	200 Mc/cm	6 - 8 Gc
26.5 - 40.0 Gc ²	Waveguide Horn (R Band)	ϕ 8434A Band Pass	9 Gc	200 Mc/cm	8 - 10 Gc
		none	11 Gc (8-18 Gc range)	200 Mc/cm	10 - 12 Gc
		none	13 Gc (8-18 Gc range)	200 Mc/cm	12 - 14 Gc
		none	15 Gc	200 Mc/cm	14 - 16 Gc
		none	17 Gc	200 Mc/cm	16 - 18 Gc
		none	19, 21, 23, 25 Gc	200 Mc/cm	18 - 26 Gc (in 2-Gc segments)
		none	27 - 39 Gc (in 2-Gc steps)	200 Mc/cm	26 - 40 Gc (in 2-Gc segments)

¹ Use ϕ 11521A X-Band Waveguide Mixer

² Use ϕ 11517A P-K-R Band Waveguide Mixer and taper sections

* Stoddart Aircraft Radio Co. Model 93490-1, Electromechanics Co. CLP-1A, or equivalent.

** Stoddart Model 93491-1, Electromechanics CLP-1B, or equivalent.

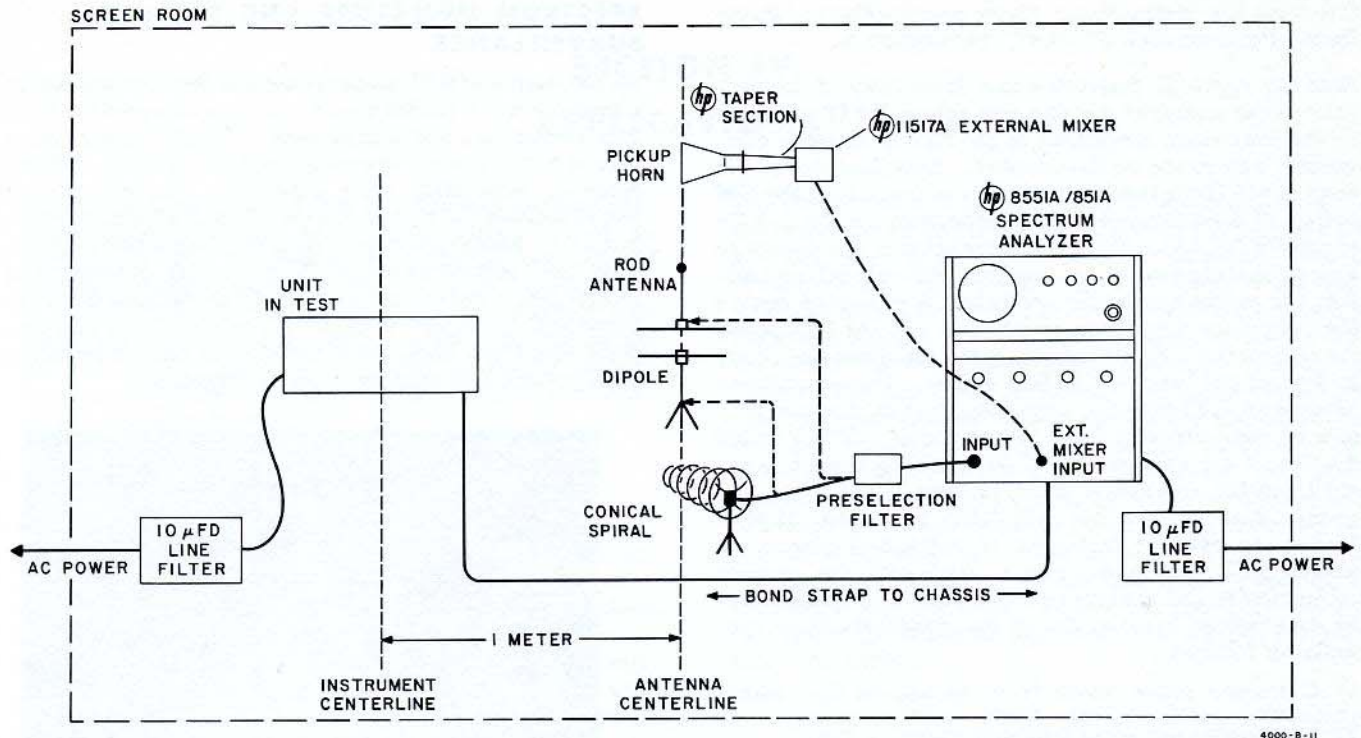

Figure 24. Suggested setup for measuring radiated RFI with the Spectrum Analyzer and appropriate antennas.

20 db lower than the response to a CW signal of equal peak value to that of the pulse. This is termed pulse desensitization and is given in terms of db loss by the equation $\alpha = 20 \log \tau BW_i$

where α = attenuation of pulse spectrum main lobe relative to a CW signal of equal strength
 BW_i = Impulse bandwidth for the particular 851 being used*
 τ = Measured pulse width in sec
 Δf = IF bandwidth selected on the analyzer.

An example of how to use this information is shown in the following example for an RFI measurement.

* May be determined by measuring α with an hp 8614A Signal Generator and 8714A Modulator as follows:

- 1) Set up a known CW reference level and note its spectrum amplitude.
- 2) Pulse modulate the CW signal with the 8714A PIN diode modulator.
- 3) Note the attenuation of the pulse spectrum main lobe relative to the CW reference amplitude.
- 4) Calculate BW_i by transposing the desensitization formula to

$$BW_i = \frac{1}{\tau \log^{-1} \left[\frac{\alpha(\text{db})}{20} \right]}$$

using the value of attenuation from step 3 in db, pulse width selected on the 8714A, and IF bandwidth of the analyzer. This value should only need to be determined once for each bandwidth unless changes are made in the IF alignment.

D. How to Measure RFI with the Spectrum Analyzer.

Here is how you may use the hp analyzer in a typical RFI measurement. Set up the equipment as shown in Figure 24, selecting a suitable test environment of low ambient RF signals. A screen or shielded room is ideal if one is available or choose a location where the ambient noise is at least 6 db below the maximum allowable RFI from the device in test. Follow the manufacturer's recommended turn-on procedure for all equipment to be used in the test. Tune the hp Spectrum Analyzer to 1.5 Gc and set SPECTRUM WIDTH to 100 MC/CM for this example. This sets up a spectral sweep from 1 to 2 Gc. Initially set IF BANDWIDTH to 100 KC, IF GAIN (DB) to 80, VERT DISPLAY to LOG and turn the input attenuator to the "0" db position for maximum sensitivity of the analyzer. Table 3 gives the frequency settings of the analyzer along with the recommended antennas and filters for each band throughout the analyzer's range. From this table, determine the appropriate antenna and filter for 1-2 Gc. Connect the antenna to the analyzer input through a low loss coax cable and the preselection filter (hp 8430A).

Now move the antenna slowly around the unit in test at a distance of about one meter, watching the analyzer display for a signal indication. If signals appear, maximize their amplitude with antenna positioning, keeping it one meter away from the tested unit. Reduce the analyzer IF gain and increase input attenuation as required for an on-screen display of the interference signals. Check for overload of the mixer

following the instructions given previously in "Pulse Radar Performance Checks", Paragraph A.

Note the vertical deflection and frequency of the signals on the analyzer display and adjust the IF gain until the maximum amplitude of the RFI is at some convenient reference on the display. Now disconnect the coax cable from the antenna and connect it to the CW output of a calibrated signal generator in the 1-2 Gc range (hp 8614A). Tune the generator's frequency to approximately that of the largest RFI signal and adjust the output attenuator until the CW response equals the reference amplitude previously set. At this point, the attenuator indicates directly the absolute amplitude in dbm of the largest CW RFI signal. The amplitudes of weaker RFI signals appearing on the display may now be read directly from the graticule. When in log display, 1 cm represents 10 db, enabling direct readout from the reference point in dbm. The linear or square display may be calibrated and used, if preferred, to readout in terms of voltage or power. If pulsed RFI signals were observed with the antenna connected to the analyzer, their peak amplitudes may be determined making use of the desensitization formula as follows:

- 1) Calculate pulse width from measured lobe width.
- 2) Note indicated main lobe amplitude in dbm.
- 3) Calculate peak pulse power in dbm from the formula

$$P_{pk} = P_i + 20 \log K\tau \Delta f$$

where P_i = level noted in step 2.

Now that the absolute calibration is known, you may record the interference measured. The best technique is to photograph the display with an oscilloscope camera. If the shutter of the camera is held open long enough for about 100 3-msec/cm sweeps of the analyzer trace, the photo will include transients, intermittent noise, and random spikes that would be impossible to see in an X-Y plot or manual tuning operation.

E. Spectrum Analysis Photographs.

Many people have their own "best way" for making photographs of CRT displays but the following suggestions may help when working with the analyzer and hp 196B camera.

- 1) Remove the blue filter from the CRT face when photographing spectra.
- 2) With trace intensity turned off, expose the CRT graticule at full intensity of the ultraviolet light source in the 196B. Using 3000-speed film, use an aperture opening of about f:8 and a shutter speed of 1/5 sec.
- 3) Turn off the U. V. light source and set the exposure time to bulb. Adjust the trace intensity for normal viewing and analyzer SWEEP TIME for 3 MSEC/CM. Leave the aperture opening at f:8 and with the RFI displayed, open the shutter for about 3 seconds.
- 4) Develop the print and log the absolute scale calibration and frequency range swept on the back.

SPECTRUM SIGNATURE AND SPECTRUM SURVEILLANCE

An extension of RFI measurement is the vast spectrum signature work performed for the government by various companies and institutions. Spectrum signature refers to the energy distribution, both desired and undesired, emanating from a device. For example, it would include the main and side lobes of a pulsed transmitter or signal generator plus any undesired outputs. This information is useful in statistical prediction of interference caused by the outputs of various devices. Previous spectrum analyzers could not look at complete spectrum signatures because of their restricted sweep width and narrow image separation.

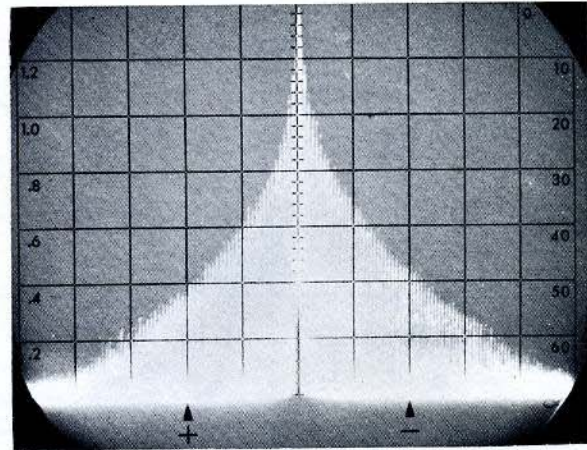

Figure 25. Spectrum Signature of a 0.5 μ sec Pulse

Figure 25 is a photo of the spectrum signature of a 0.5-microsecond pulse with a rise time of less than 20 nanoseconds as seen on the hp analyzer display. Here the spectrum width of the analyzer is set to 30 Mc/cm giving a 300-Mc wide display of the main and side lobes. The logarithmic vertical display has been selected so the side lobes down to 60 db below the main lobe are visible. Notice that the spectrum of the pulse is over 200 Mc wide 60 db down.

The HP 851/8551 is invaluable for spectrum surveillance work also, where the relative amplitudes and frequencies of all electromagnetic radiation at a location are desired. An application of this would be in a missile or spacecraft launch site or tracking station where multiple command, communications, and radar tracking signals are transmitted at various times, often simultaneously.

The far-ranging sidebands of radar transmitters, intermodulation products of telemetry and communication transmitters, or spurious signals can blot out reception of valuable data. It can also be responsible for accidental triggering of control links for detonation devices in missiles and retro-rocket firing in spacecraft. To spot such signals and eliminate them before they cause trouble the hp Spectrum Analyzer can be set up with appropriate antennas in the launching vicinity and used as a spectrum monitor.

Figure 26 depicts such an installation where several antennas for the analyzer are selectable by the

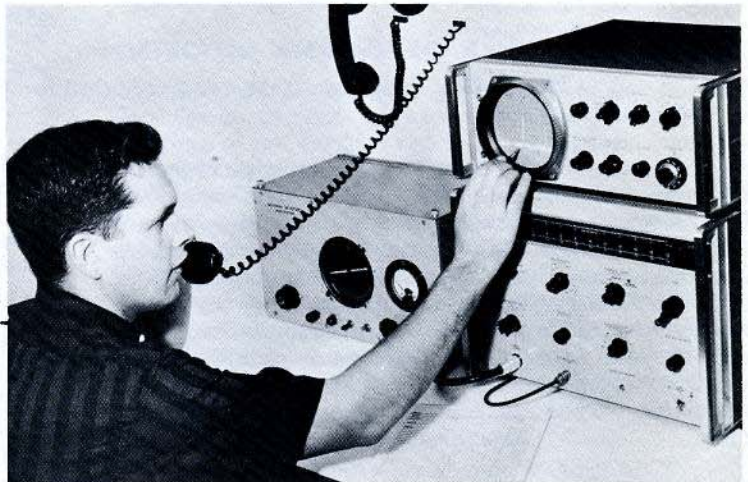
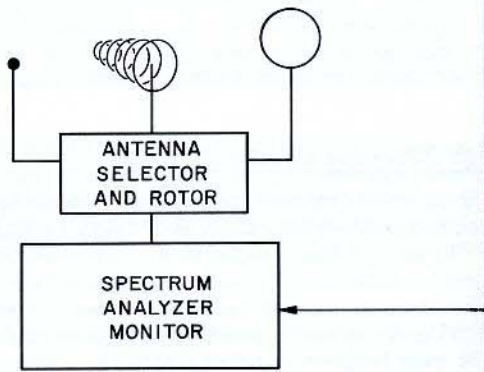
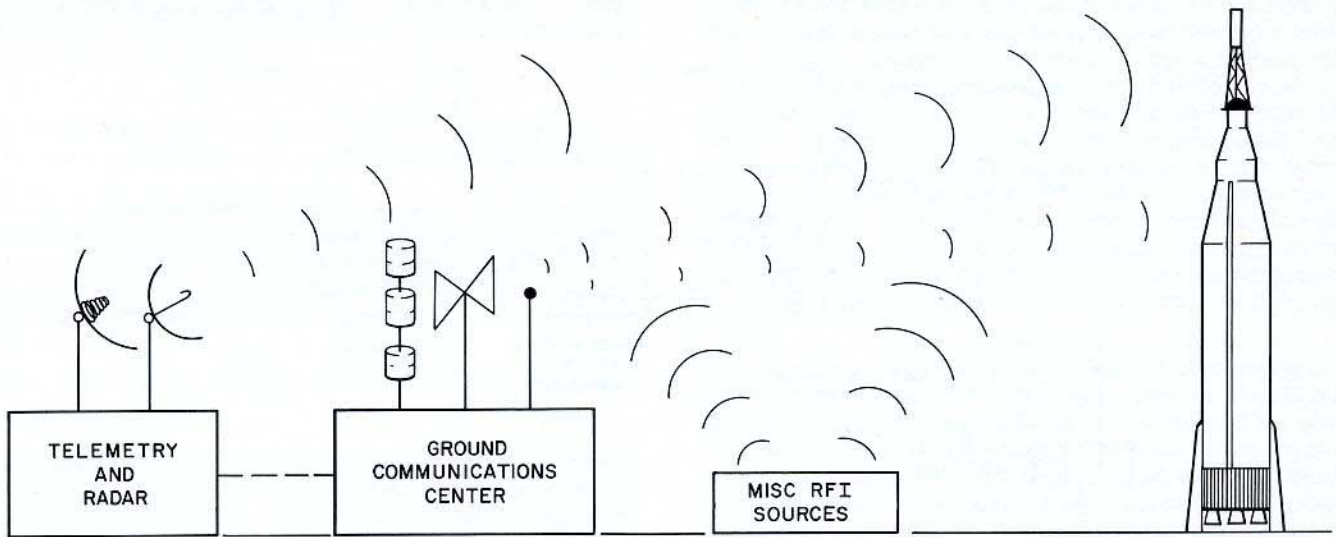

4000-B-11

Figure 26. Broadband Spectrum Surveillance using hp Spectrum Analyzer. Operator monitors electromagnetic radiation in vicinity of launch area to ensure clear data channels and tracking frequencies.

operator through a coaxial switch. With the broadband omni-directional antenna connected to the analyzer input the operator scans wide segments of the spectrum watching for interfering signals. If any are seen, he can quickly narrow down the analyzer sweep for a detailed examination of the interference, determining if it is of pulsed or CW nature. The operator can then select a directional antenna whose positioning is controllable from the monitoring point and determine the direction from which the undesired signal is emanating. For additional sensitivity, RF preamplifiers may be connected ahead of the analyzer input. By knowing the nature of the interfering signal, its frequency and direction, the monitoring station can dispatch technicians to determine and eliminate the problem if possible. If the problem cannot be cleared the monitor could advise the use of other frequencies away from the interference and proceed with the launch.

ANTENNA PATTERN MEASUREMENTS

An interesting application of the hp Spectrum Analyzer is its use not as a wide-sweeping device but rather as a CW single frequency receiver for antenna field pattern measurement. The general qualifications of a pattern receiver are high sensitivity with low noise, good frequency stability, wide dynamic range and good shielding. As we have seen earlier the hp analyzer meets these requirements well and has the added features of selectable vertical displays for linear, log (db), or square (power) patterns plus X-Y recorder output signals. The logarithmic display is by far the most useful in this application since it allows simultaneous on-scale viewing of the main lobe of an antenna's field pattern along with side lobes that are down 60 db.

To make rectilinear pattern plots with the spectrum

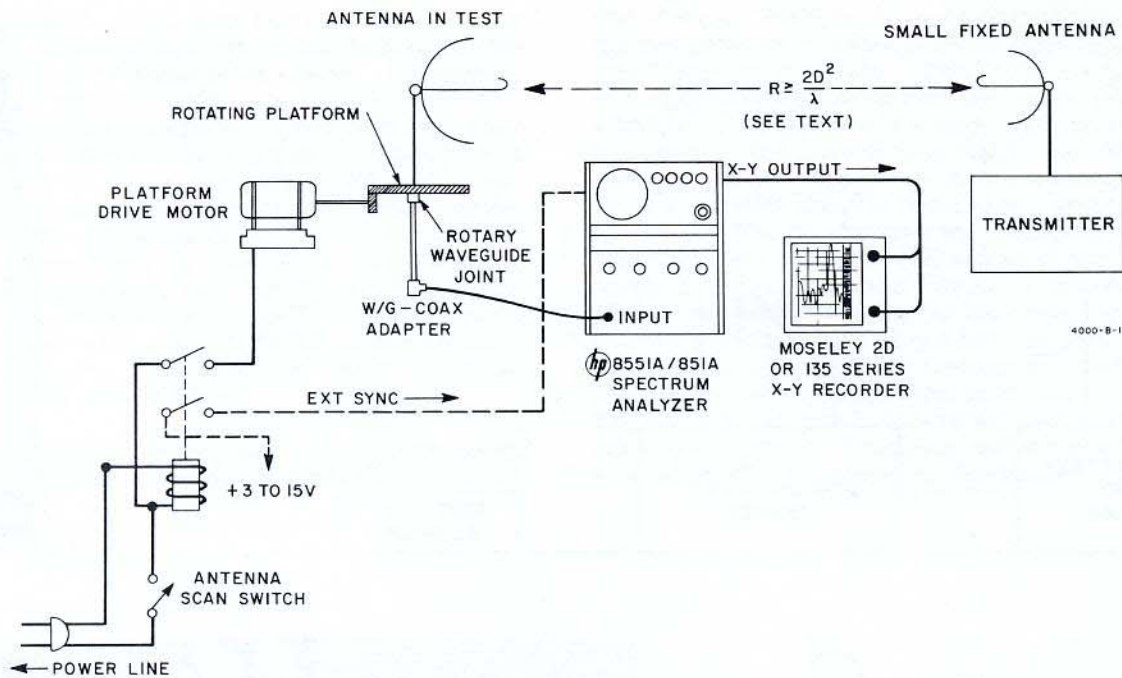

Figure 27. Spectrum Analyzer Connected for Rectilinear Antenna Pattern Plots

analyzer connect the output of the antenna in test to the analyzer input as shown in Figure 27. Connect the X-Y recorder output jack of the analyzer display unit to the Moseley 2-D or 135 series X-Y recorder inputs. The illustration shows the antenna in test mounted on a rotary platform which is common at antenna range installations. This platform allows the antenna in test to be rotated through 360 degrees in azimuth while coupling the antenna coaxial transmission line or waveguide through a rotating joint to the analyzer input.

A smaller directional transmitting antenna capable of being aimed for maximum signal at the receiving antenna is located at a range or distance R , for field measurement, away. This range should satisfy the equation $R \geq 2D^2/\lambda$ for minimum error in received power due to mutual coupling effects of the two antennas,

where R = range (distance between antennas)
 D = largest aperture dimension of antenna
 λ = free space wavelength of test frequency
 (all dimensions in identical units,
 i. e., meters, feet, etc).

Ideally, the two antennas would be mounted on towers above flat unobstructed terrain to minimize multipath reception due to ground waves and reflections from buildings and trees. Set up the equipment as follows:

At the Transmitter Location:

- 1) Set CW frequency and power output of transmitter as desired.
- 2) Stabilize frequency with phase lock or AFC system.
- 3) Aim transmitting antenna toward receiving antenna.

At the Receiving Location:

- 1) Tune spectrum analyzer to approximate transmitter frequency with SPECTRUM WIDTH at 1 MC/CM, SYNC at INT, and IF BANDWIDTH at AUTO-SELECT.
- 2) Rotate test antenna for a maximum CW response on CRT. Vertically position test antenna for desired angle with respect to transmitting antenna.
- 3) Stabilize analyzer local oscillator per Operating and Service Manual.
- 4) Select log display on analyzer so vertical scale is now calibrated in db. Adjust IF gain and input attenuator for full scale indication of test signal.
- 5) Reduce spectrum width to zero keeping the response centered on the display with fine tuning. The analyzer is now operating at only the test signal frequency. Retune analyzer frequency slightly to peak vertical response and touch up IF gain so response is just 7 cm high
- 6) Adjust SWEEP TIME to some value slightly longer than the total time required to rotate the test antenna through 360 degrees of azimuth. For example, to X-Y record pattern, a relatively slow sweep time is required; therefore set SWEEP TIME to 3 SEC/CM and rotate antenna at 2-1/3 rpm. This results in a horizontal display of 42 degrees rotation per centimeter of display.
- 7) Set X-Y recorder gain and position controls to coincide with analyzer horizontal sweep and vertical deflection limits.
- 8) Now rotate antenna 180° away from the maximum reception point just set up. This will position the antenna in the correct relationship with the start of the

sweep in the analyzer to cause the main lobe of the pattern to appear in the center of the display when the plot is made.

9) Set analyzer SYNC to single sweep and turn on X-Y recorder servo and pen down switches.

10) Simultaneously push SINGLE SWEEP button on analyzer and start antenna scan drive motor. The trace on the CRT and the X-Y recorder will now move horizontally at the 3-sec/cm rate set up with analyzer sweep time, and be deflected vertically by strength of the received signal as the antenna rotates through 360 degrees. Thus a rectilinear plot of the antenna field pattern is obtained. The analyzer sweep may also be triggered from an external +3 to +15 volts which can be synchronized with the antenna scan motor switch eliminating the need to manually operate the single sweep button. Exact synchronism is not particularly important since the sweep time of the analyzer is longer than one rotational cycle of the antenna in test. This allows the operator to locate the identical contours on the left and right edges of the plot denoting the 360° boundaries.

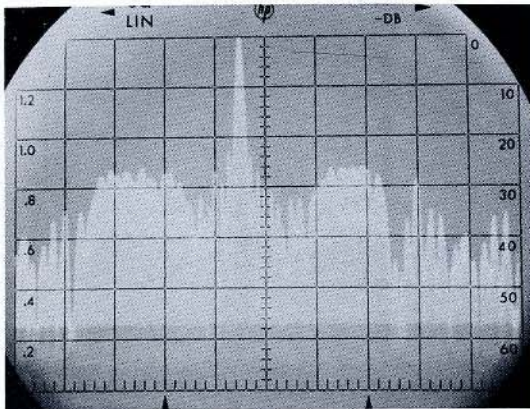

Figure 28. Antenna pattern obtained from Spectrum Analyzer. Vertical and horizontal outputs on rear panel also allow X-Y recording of display.

Figure 28 is a time-exposed photo of an antenna pattern plot on the Φ analyzer (the alternate method of trace recording). Notice the deep minima in the plot, some extending nearly 60 db below the main lobe. This illustrates the importance of the logarithmic display and 60 db dynamic range. Previous spectrum analyzers commonly have had only a 40-db dynamic range which would obscure the actual minima of such a plot and therefore not be a true representation of the antenna characteristics.

FREQUENCY MEASUREMENTS WITH THE SPECTRUM ANALYZER

The basic frequency dial accuracy of the HP 8551 is 1% which is adequate for most applications of the analyzer. However, there are occasions when much higher accuracy will enhance the instrument's usefulness. Fast, accurate frequency measurements are

possible using the Φ Spectrum Analyzer and a good reference marker generator. The marker generator provides a number of accurately known frequencies which are displayed on the spectrum analyzer. A frequency to be measured is then simultaneously fed to the analyzer input and compared to the reference frequency markers. When the unknown frequency coincides with one of the markers on the display both are at the same frequency and the unknown signal is determined. If the markers are at intervals of 1 to 10 Mc, accurate interpolation of unknown frequencies may be made using the CRT graticule. This technique may be varied slightly to measure passive frequency meters also.

A step-recovery diode impulse generator whose repetition rate is determined by an accurate crystal-controlled oscillator makes an ideal reference mark generator for this application. A generator of this type which produces useful harmonics up to about 6 Gc, is the HP 8406A. Three repetition rates controlled by a .01% crystal give accurate reference markers at 1, 10, or 100 Mc intervals. This allows quick first approximations with a few widely-spaced markers at 100 Mc, or high resolution measurements using the 1-Mc markers. Impulse generators using mechanical switching (mercury-wetted relays) will not work in this application because of their instability and inherently low repetition rates

Figure 29a shows an active frequency measurement setup using a step-recovery diode impulse generator and the spectrum analyzer. The impulse generator is connected to the analyzer input through a coaxial tee providing the reference marks on the display. A small pickup loop is connected to the other arm of the tee which brings in a sample of the frequency to be measured. In this example a VHF transmitter is to be adjusted to 108.0 Mc.

The spectrum analyzer is tuned to 100 Mc and SPECTRUM WIDTH set to 10 MC/CM. The centimeter marks on the graticule now represent 10-Mc intervals from 50 to 150 Mc. The impulse generator is switched to the 100-Mc repetition rate resulting in a single 100-Mc reference mark appearing in the center of the analyzer display. Now the transmitter is keyed momentarily and its approximate frequency noted from its position on the display. If the transmitter is reasonably close to 108 Mc, the center marker representing 100 Mc is moved to the 1-cm graticule line on the left side of the display by fine tuning the analyzer frequency. Next the SPECTRUM WIDTH is set at 1 MC/CM and the analyzer's local oscillator is stabilized. The analyzer is now sweeping from 99 to 109 Mc and the impulse generator is switched to the 1-Mc repetition rate producing a marker at each centimeter of the display graticule. The spectrum width VERNIER may be used to place the markers exactly over the centimeter marks if necessary. Now the transmitter is keyed and its frequency compared to the calibrated screen. When the transmitter is correctly adjusted, its output response on the analyzer display will appear eight centimeters above the 100 Mc markers. The photo in Figure 29a shows the 100-Mc marker and the 108-Mc transmitter signal.

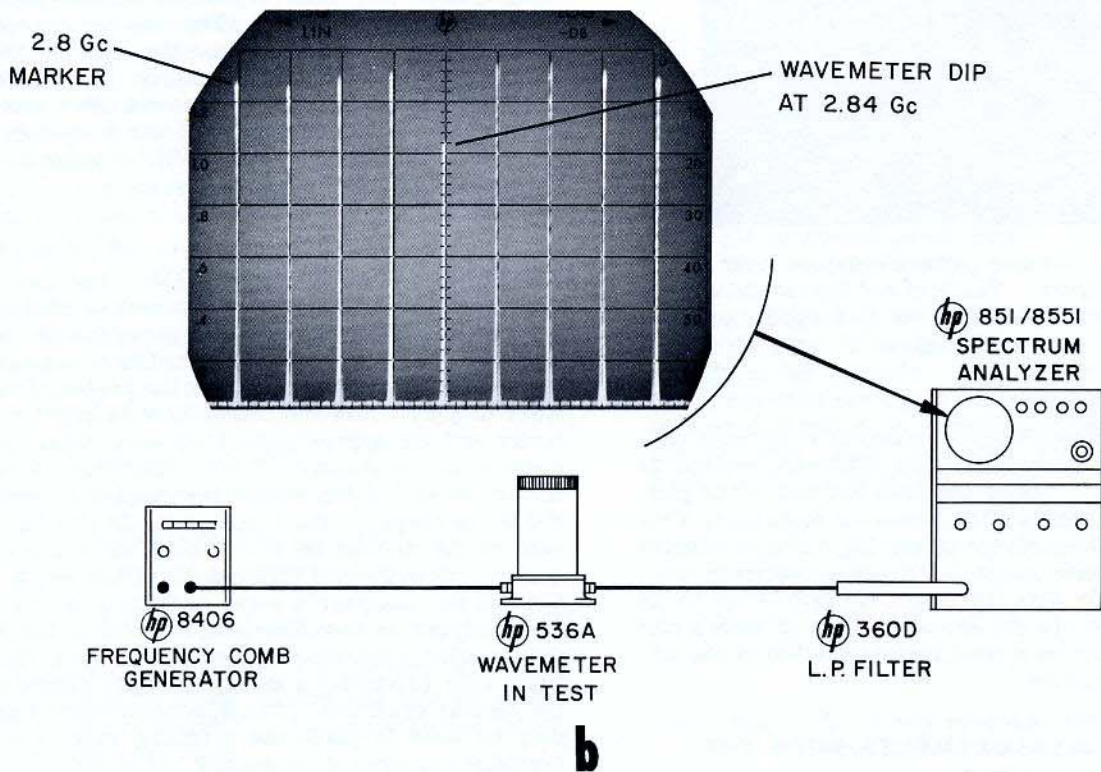
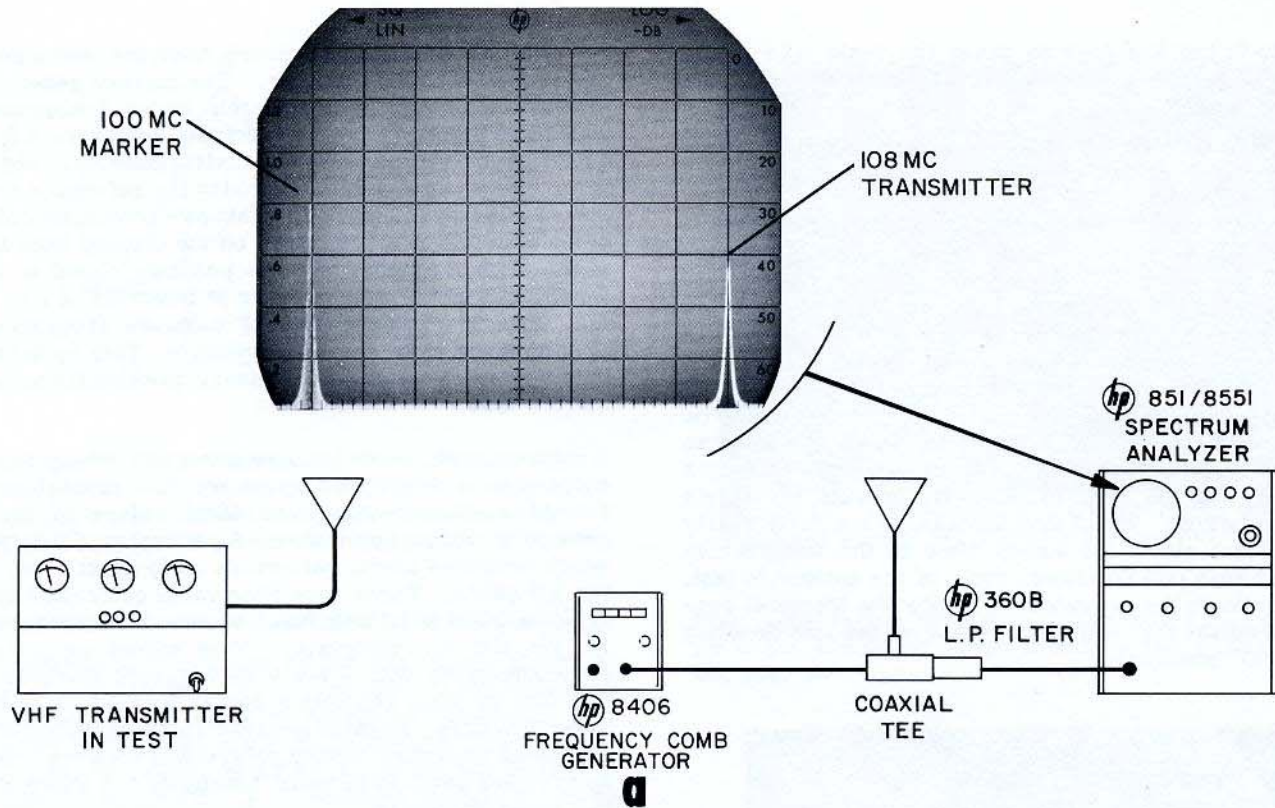
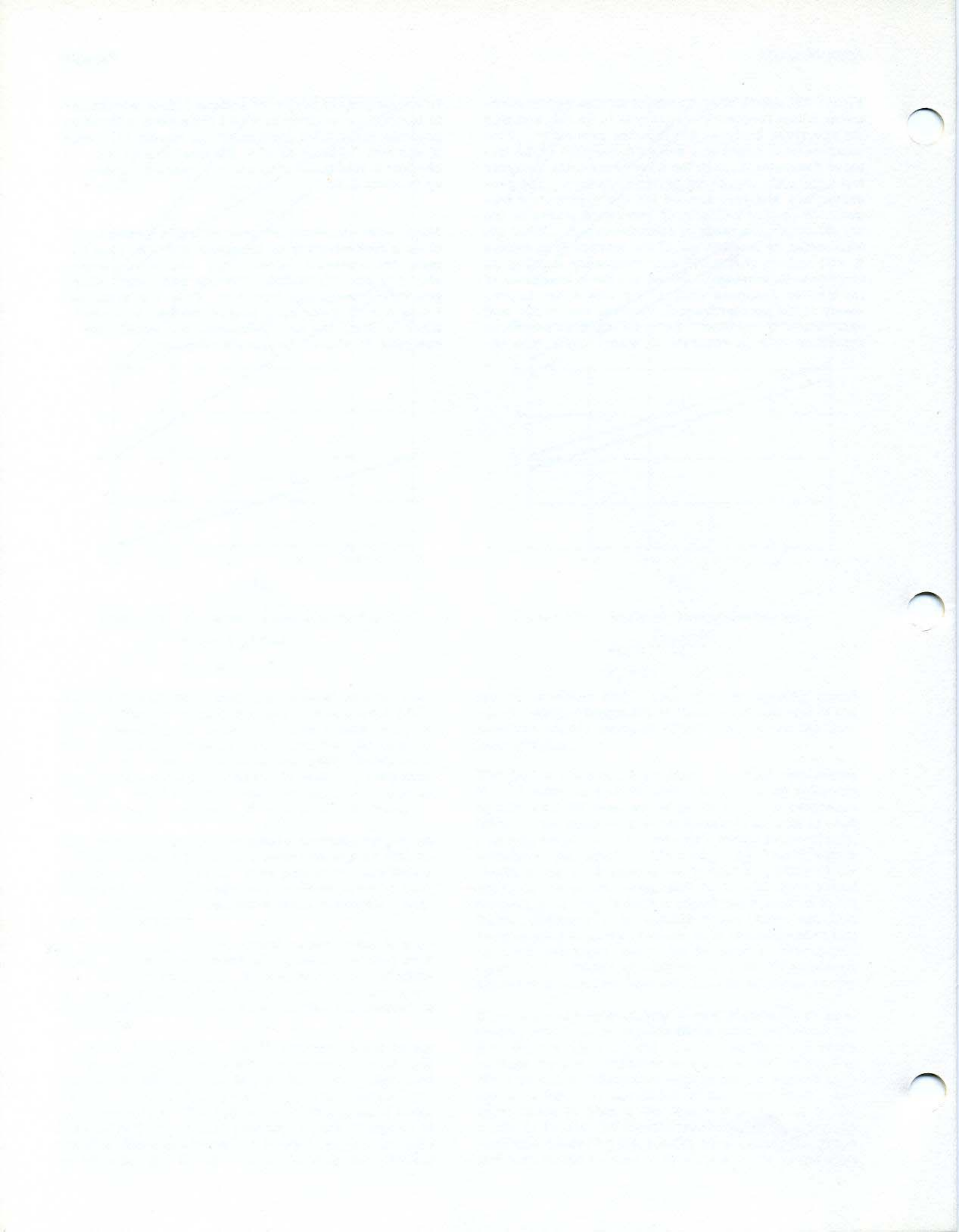

Figure 29. (a) Spectrum Analyzer and high accuracy Marker Generator setup for tuning transmitter frequency.
 (b) Spectrum Analyzer and Marker Generator setup for measuring frequency of passive device. A comb of frequencies may also be applied to an RF filter to display its bandpass characteristics.

Figure 29b shows how to connect an absorption wavemeter whose frequency accuracy is to be checked with the spectrum analyzer and impulse generator. This measurement requires a series connection of the impulse generator through the wavemeter to the analyzer input since the measured device is passive. The generator and analyzer are set for the appropriate frequencies to give a display of reference marks on the screen within the range of the wavemeter. When the wavemeter is tuned to one of the marker frequencies it will absorb that particular frequency causing its amplitude to decrease. When minimum amplitude of the marker response occurs, the wavemeter is precisely at the marker frequency and the wavemeter dial calibration is verified. Since the impulse generator repetition rate is accurate to within .01% it is en-

tirely adequate to verify the accuracy of the wavemeter in test. The repetition rate of 1 Mc makes calibration possible every 1 Mc throughout the wavemeter range if desired. The ϕ G532A Wavemeter may also be checked in this manner as can any passive wavemeter up to about 6 Gc.

Many other possibilities exist with this technique including measurement of bandpass and low-pass filters, transmission wavemeters, and tuned circuits above 10 Mc. Broadband impulse generators which generate frequencies from 1 to 10 Gc are available. Using one of these as a source feeding a bandpass filter in test, the spectrum analyzer would show a complete display of the filter's response.



APPENDIX A
SECTION I

a. WAVEFORM ANALYSIS.

The Fourier integral permits the representation of a function $f(t)$ by the expressions:

$$f(t) = \frac{1}{2\pi} \int_{-\infty}^{\infty} F(\omega) e^{j\omega t} d\omega \quad (1)$$

where

$$F(\omega) = \int_{-\infty}^{\infty} f(t) e^{-j\omega t} dt \quad (2)$$

is the Fourier integral or Fourier transform of $f(t)$. Extensive tables of Fourier transforms are available, and a short table of some of the more important ones is included with this discussion as Appendix A-II.

Several useful properties of Fourier transforms are applicable to spectrum analyzer problems. The first property is that of amplitude modulation. If a carrier represented by $e^{+j\omega_c t}$ is multiplied by a function $f(t)$ using (2)

$$\begin{aligned} F_c(\omega) &= \int_{-\infty}^{\infty} f(t) e^{+j\omega_c t} e^{-j\omega t} dt \\ &= \int_{-\infty}^{\infty} f(t) e^{-j(\omega - \omega_c)t} dt \end{aligned} \quad (3)$$

$$F_c(\omega) = F(\omega - \omega_c)$$

This simply states that the spectrum of a function times a carrier is the spectrum of the function with the origin shifted to the frequency ω_c .

Another useful property is that of filtering and convolution (see Appendix A-II). We can use this property to go from the Fourier transform of a non-recurring transient to the transform of a series of the same transient spaced by a constant time interval. This periodic function can be represented by

$$f_p(t) = \sum_{n=-\infty}^{\infty} f(t - nT) \quad (4)$$

which can, in turn, be represented by

$$f_p(t) = \left[\sum_{n=-\infty}^{\infty} \delta(t - nT) \right] * f(t) \quad (5)$$

where * represents convolution. $\delta(t)$ is the delta or singularity function in time characterized by infinite height, zero width, and unit area. Since convolution in time is equivalent to multiplication in frequency, using pair 6S of Appendix A-II.

$$F_p(\omega) = \frac{1}{T} \left[\sum_{n=-\infty}^{\infty} \delta\left(\omega - \frac{2n\pi}{T}\right) \right] F(\omega) \quad (6)$$

This states that the spectrum of a periodic function is a frequency comb with teeth separated in frequency by the repetition frequency and having areas equal to $1/T$ times the amplitude of the single transient spectrum at the frequency of the impulse.

We will illustrate the use of these first properties by two simple examples:

Example (1) Single Tone AM

$$e(t) = E_o (1 + M \cos \omega_m t) \cos \omega_c t \quad (7)$$

$$\text{here } f(t) = 1 + M \cos \omega_m t \quad (8)$$

$$\cos \omega_c t = \frac{e^{j\omega_c t} + e^{-j\omega_c t}}{2} \quad (9)$$

Using transform pair 5S of Appendix A-II.

$$F(\omega) = 2\pi \left\{ \delta(\omega) + \frac{M}{2} [\delta(\omega + \omega_m) + \delta(\omega - \omega_m)] \right\} \quad (10)$$

using the modulation property

$$\begin{aligned} \frac{E}{E_o} = 2\pi \left\{ \frac{1}{2} \delta(\omega - \omega_c) + \frac{M}{4} [\delta(\omega - \omega_c + \omega_m) + \delta(\omega - \omega_c - \omega_m)] \right. \\ \left. + \frac{1}{2} \delta(\omega + \omega_c) + \frac{M}{4} [\delta(\omega + \omega_c + \omega_m) + \delta(\omega + \omega_c - \omega_m)] \right\} \end{aligned} \quad (11)$$

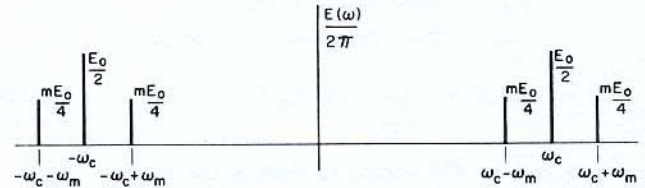

Figure A-1. Single Tone AM Spectrum

Example (2) Rectangular Pulse Train

$$f(t) \begin{cases} E_o, & |t| < \frac{\tau}{2} \\ 0, & |t| > \frac{\tau}{2} \end{cases} \quad \left. \begin{array}{l} \text{periodic with} \\ \text{period } T \end{array} \right\} \quad (12)$$

using pair 7 of Appendix A-II.

$$F(\omega) = E_o \tau \frac{\sin(\omega\tau/2)}{(\omega\tau/2)} \quad (13)$$

$$F_p(\omega) = E_o \frac{\tau}{T} \frac{\sin(\omega\tau/2)}{(\omega\tau/2)} \sum_{n=-\infty}^{\infty} \delta\left(\omega - \frac{2\pi n}{T}\right) \quad (14)$$

This function is illustrated in Figure A-2.

If the pulse train had been used to modulate a carrier $\cos \omega_c t$, the resulting spectrum would have been identical in form to that of Figure A-2 except divided into two parts; one centered about the positive carrier frequency, ω_c , and the other about the negative carrier frequency, $-\omega_c$.

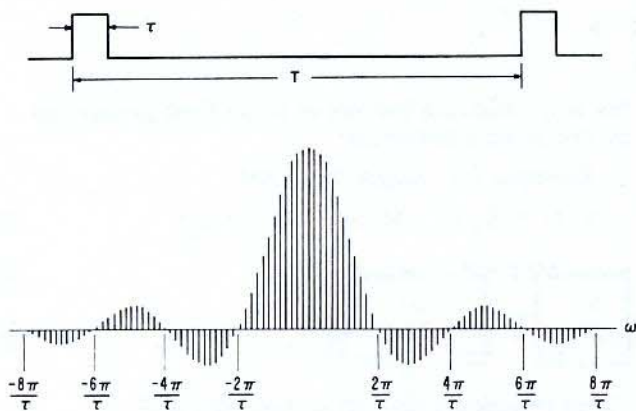

Figure A-2. Rectangular Pulse Train and Spectrum

Single Tone Frequency Modulation

The frequency of a single tone FM signal consists of a constant term plus a sinusoidal term

$$\omega(t) = \omega_0 + \Delta\omega \sin \omega_m t = \frac{d\phi(t)}{dt} \quad (15)$$

- ω_0 - Carrier Frequency
- ω_m - Modulation Frequency
- $\Delta\omega$ - Peak frequency deviation

$$\phi(t) = \omega_0 t + \frac{\Delta\omega}{\omega_m} \cos \omega_m t \quad (16)$$

A single tone FM signal is then of the form

$$y(t) = \cos \phi(t) = \cos \left(\omega_0 t + \frac{\Delta\omega}{\omega_m} \cos \omega_m t \right) \quad (17)$$

$$y(t) = \frac{e^{j\omega_0 t} e^{jM_f \cos \omega_m t} + e^{-j\omega_0 t} e^{-jM_f \cos \omega_m t}}{2} \quad (18)$$

$$M_f = \frac{\Delta\omega}{\omega_m} = \text{index of modulation}$$

Using the identity¹

$$e^{jx \sin \theta} = J_0(x) + 2jJ_1(x) \sin \theta + 2J_2(x) \cos 2\theta + 2jJ_3(x) \sin 3\theta + \dots \quad (19)$$

and the modulation theorem

$$Y(\omega) = \pi \left\{ J_0(M_f) \delta(\omega \pm \omega_0) + \sum_{n=1}^{\infty} J_n(M_f) \left[\delta(\omega \pm \omega_0 \pm N\omega_m) + (-1)^n \delta(\omega \mp \omega_0 \pm N\omega_m) \right] \right\} \quad (20)$$

where

$J_n(M_f)$ is the Bessel function of the first kind, nth order and with argument M_f .

The spectrum is made up of a train of impulse frequency functions having amplitudes given by Bessel Functions and centered about the carrier.

The odd terms (n odd) have odd symmetry about the carrier while the even terms (n even) have even symmetry about the carrier.

A useful asymptotic expression for $J_n(M_f)$ is²

$$J_n(M_f) \rightarrow \frac{C}{\sqrt{M_f}} \cos(M_f - \lambda) \quad (21)$$

$$M_f = \frac{\Delta\omega}{\omega_m} \rightarrow \infty$$

C, λ = constants

In the limit, the various components (including the carrier) oscillate harmonically with amplitudes decreasing with the square root of modulation index.

Two representative FM spectrums are shown in Figure 3. It is interesting to compare Figure 3 with the single tone AM spectrum of Figure 1.

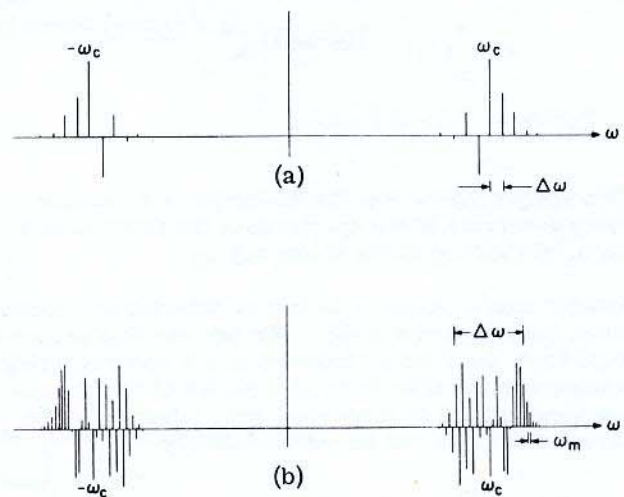

Figure A-3. Single Tone FM (a) $M_f = 1$; (b) $M_f = 10$

Spectrum of a Time Product

Of special interest is a function of the form $y(t) = f(t)g(t)$ where $f(t)$ may be amplitude modulation; $g(t)$ frequency modulation.

Using the product-in-time=convolution-in-frequency theorem

$$y(t) = f(t) g(t)$$

$$Y(\omega) = F(\omega) * G(\omega)$$

¹ Bowman, "Introduction to Bessel Functions", Dover, 1958, p. 89.

² Ibid p. 103.

This is easily interpreted for the case of periodic signals with $f(t)$ a slowly varying function compared to $g(t)$ (or vice versa). Since the spectrum of $f(t)$, periodic function, is a train of impulses, the combination spectrum is a train of spectra of $f(t)$ having an envelope of $G(\omega)$ the spectrum of $g(t)$. This is illustrated in Figure 4 for the case of a pulse train with amplitude modulation.

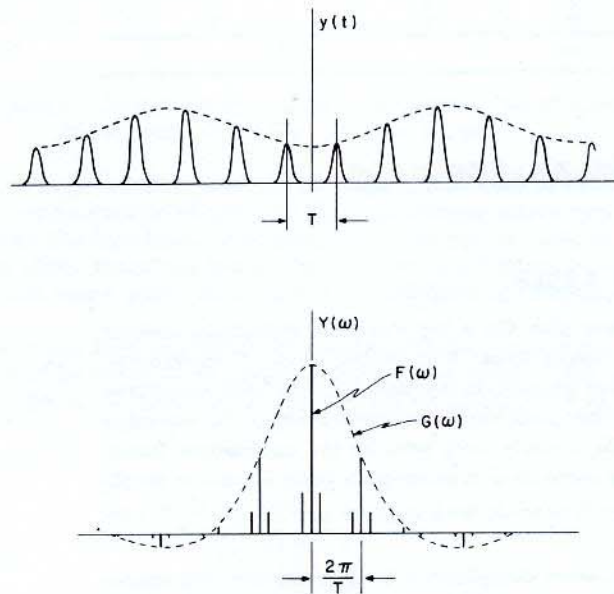

Figure A-4. Spectrum of an Amplitude-Modulated Pulse Train

b. INTERPRETATION OF THE ANALYZER RESPONSE.

Previously, the Fourier transform was defined as

$$F(\omega) = \int_{-\infty}^{\infty} f(t)e^{-j\omega t} dt \tag{2}$$

In general, $F(\omega)$ is complex having a real and an imaginary part

$$F(\omega) = F_{re}(\omega) + j F_{im}(\omega) \tag{22}$$

which may also be expressed in polar coordinates as

$$|F(\omega)| = [F_{re}^2(\omega) + F_{im}^2(\omega)]^{1/2} \tag{23}$$

$$\phi(\omega) = \tan^{-1} \frac{F_{im}(\omega)}{F_{re}(\omega)} \tag{24}$$

A spectrum analyzer of the type described displays only (23), the amplitude spectrum. The phase information is lost. The general time function $f(t)$ then cannot be uniquely determined by the amplitude spectrum alone. An interesting example of this is illustrated by comparing the spectrum of single tone AM with single tone FM of small deviation. The amplitude spectra are almost identical (see Figures A-1 and A-3). As a result, a spectrum analyzer would give virtually the same display for these two radically different functions.

Even though the amplitude spectrum will not give a unique description of the function $f(t)$, it is still very useful for signal and waveform analysis.

APPENDIX A

SECTION II

TABLE OF IMPORTANT TRANSFORMS

EXPLANATION OF THE TABLE

The time functions and corresponding frequency functions in this table are related by the following expressions:

$$F(\omega) = \int_{-\infty}^{\infty} f(t) e^{-i\omega t} dt \quad (\text{Direct transform})$$

$$f(t) = \frac{1}{2\pi} \int_{-\infty}^{\infty} F(\omega) e^{i\omega t} d\omega \quad (\text{Inverse transform})$$

The $1/2\pi$ multiplier in the inverse transform arises merely because the integration is written with respect to ω , rather than cyclic frequency. Otherwise the expressions are identical except for the difference of sign in the exponent. As a result, functions and their transforms can be interchanged with only slight modification. Thus, if $F(\omega)$ is the direct transform of $f(t)$, it is also true that $2\pi f(-\omega)$ is the direct transform of $F(t)$. For example, the spectrum of a $\frac{\sin x}{x}$ pulse is rectangular (pair 6) while the spectrum of a rectangular pulse is of the form $\frac{\sin x}{x}$ (pair 7). Likewise pair 1S is the counterpart of the well-known fact that the spectrum of a constant (d-c) is a spike at zero frequency.

The frequency functions in the table are in many cases listed both as functions of ω and also of p . This is done merely for convenience. $F(p)$ in all cases is found by substituting p for $i\omega$ in $F(\omega)$. (Not simply p for ω as the notation would ordinarily indicate. That is, in the usual mathematical convention one would write $F(\omega) = F\left(\frac{p}{i}\right) = G(p)$ where the change in letter indicates the resulting change in functional form. The notation used above has grown through usage and causes no confusion, once understood.) Thus, in the p -notation

$$F(p) = \int_{-\infty}^{\infty} f(t) e^{-pt} dt \quad f(t) = \frac{1}{2\pi i} \int_{-i\infty}^{i\infty} F(p) e^{pt} dp$$

The latter integral is conveniently evaluated as a contour integral in the p -plane, letting p assume complex values.

The frequency functions have been plotted on linear amplitude and frequency scales, and where convenient, also on logarithmic scales. The latter scales often bring out characteristics not evident in the linear plot. Thus, many of the spectra are asymptotic to first or second degree hyperbolas

on a linear plot. On a log plot these asymptotes become straight lines of slope -1 or -2 (i.e., -6 or -12 db/octave).

The time functions in the table have all been normalized to convenient peak amplitudes, areas or slopes. For any other amplitude, multiply both sides by the appropriate factor. Thus, the spectrum of a rectangular pulse 10 volts in amplitude and 2 seconds long is (from pair 7) $20 \frac{\sin \omega}{\omega}$ volt-seconds.

Again, upon multiplication by a constant having appropriate dimensions, the frequency functions become filter transmissions. Thus, if pair 1 is multiplied by α , the frequency function represents a simple RC cutoff. A one coulomb impulse (pair 1S) applied to this filter would produce an output (impulse response) with the spectrum $\frac{\alpha}{p + \alpha} \times 1$ coulomb, representing the time function $\alpha e^{-\alpha t}$ coulombs (which has the dimensions of amperes). Or a 1 volt step function (pair 2S) would produce the output spectrum $\frac{\alpha}{p + \alpha} \times \frac{1}{p}$ volts, which represents the time function $(1 - e^{-\alpha t})$ volts (pair 4S).

The entries 1S through 6S in the table are singular functions for which the transforms as defined above exist only as a limit. For example, 1S may be thought of as the limit of pair 7 (multiplied by $\frac{1}{\tau}$) as $\tau \rightarrow 0$.

PROPERTIES OF TRANSFORMS

There are a number of important relations which describe what happens to the transforms of functions when the functions themselves are added, multiplied, convolved, etc. These relations state mathematically many of the operations encountered in communications systems: operations such as linear amplification, mixing, modulation, filtering, sampling, etc. These relations are all readily deducible from the defining equations above; but for ready reference some of the more important ones are listed in the Table of Properties (back page).

Again, because of the similarity of the direct and inverse transforms, a symmetry exists in these properties. Thus, delaying a function multiplies its spectrum by a complex exponential; while multiplying the function by a complex exponential delays its spectrum. Multiplying any two functions is

TABLE OF IMPORTANT TRANSFORMS

TIME FUNCTIONS		NO.	FREQUENCY FUNCTIONS (LINEAR SCALES)	(LOG AMPL. - LOG FREQ.)
	$f(t) = \begin{cases} 0, & t < 0 \\ e^{-\alpha t}, & t > 0 \end{cases}$	1	$F(p) = \frac{1}{p + \alpha}$ $F(\omega) = \frac{1}{\alpha + i\omega}$	
	$f(t) = \begin{cases} 0, & t < 0 \\ \alpha e^{-\alpha t} \sin \beta t, & t > 0 \end{cases}$	2	$F(p) = \frac{\alpha}{(p + \alpha)^2 + \beta^2}$ $F(\omega) = \frac{\alpha}{(\alpha + i\omega)^2 + \beta^2}$	
	$f(t) = e^{-\alpha t }$	3	$F(p) = \frac{2\alpha}{\alpha^2 - p^2}$ $F(\omega) = \frac{2\alpha}{\alpha^2 + \omega^2}$	
	$f(t) = \begin{cases} 0, & t < 0 \\ e^{-\alpha t} \sin \beta t, & t > 0 \end{cases}$	4	$F(p) = \frac{\beta}{(p + \alpha)^2 + \beta^2}$ $F(\omega) = \frac{i\omega}{(\alpha^2 + \beta^2) - \omega^2 + i2\alpha\omega}$	
	$f(t) = \begin{cases} 0, & t < 0 \\ e^{-\alpha t} (\cos \beta t - \frac{\alpha}{\beta} \sin \beta t), & t > 0 \end{cases}$	5	$F(p) = \frac{p}{(p + \alpha)^2 + \beta^2}$ $F(\omega) = \frac{i\omega}{(\alpha^2 + \beta^2) - \omega^2 + i2\alpha\omega}$	
	$f(t) = \frac{\sin(\frac{\pi t}{\tau})}{(\frac{\pi t}{\tau})}$	6	$F(\omega) = \begin{cases} \tau, & \omega < \frac{\pi}{\tau} \\ 0, & \omega > \frac{\pi}{\tau} \end{cases}$	
	$f(t) = \begin{cases} 1 - \frac{ t }{\tau}, & t < \frac{\tau}{2} \\ 0, & t > \frac{\tau}{2} \end{cases}$	7	$F(\omega) = \tau \frac{\sin(\frac{\omega \tau}{2})}{(\frac{\omega \tau}{2})}$	
	$f(t) = \begin{cases} 1 - (\frac{t}{\tau})^2, & t < \tau \\ 0, & t > \tau \end{cases}$	8	$F(\omega) = \tau \frac{\sin^2(\frac{\omega \tau}{2})}{(\frac{\omega \tau}{2})^2}$	
	$f(t) = \begin{cases} \sqrt{1 - (\frac{t}{\tau})^2}, & t < \tau \\ 0, & t > \tau \end{cases}$	9	$F(\omega) = \frac{\pi}{2} \tau \frac{2J_1(\omega \tau)}{(\omega \tau)}$	

TIME FUNCTIONS		NO.	FREQUENCY FUNCTIONS (LINEAR SCALES)		(LOG AMPL. - LOG FREQ.)
	$f(t) = e^{-\frac{1}{2} \left(\frac{t}{\alpha}\right)^2}$	10	$F(\omega) = \tau \sqrt{2\pi} e^{-\frac{1}{2}(\tau\omega)^2}$		
	$f(t) = \begin{cases} 0, & t < 0 \\ \alpha e^{-\beta t}, & t > 0 \end{cases}$	11	$F(p) = \frac{\rho}{(p+\alpha)(p+\beta)}$		
	$f(t) = \begin{cases} \cos \omega_0 t, & t < \frac{\pi}{2} \\ 0, & t > \frac{\pi}{2} \end{cases}$	12	$F(\omega) = \frac{\tau}{2} \left[\frac{\sin(\frac{\omega+\omega_0}{2}\tau)}{(\frac{\omega+\omega_0}{2})\tau} + \frac{\sin(\frac{\omega-\omega_0}{2}\tau)}{(\frac{\omega-\omega_0}{2})\tau} \right]$		
	$f(t) = \begin{cases} \frac{1}{\tau}, & t < \frac{\tau}{2} \\ 0, & t > \frac{\tau}{2} \end{cases}$ = $\delta(t)$ (FUNCTION)	1S	$F(p) = F(\omega) = 1$		
	$f(t) = \int_{-\infty}^t \delta(\lambda) d\lambda = \begin{cases} 0, & t < 0 \\ 1, & t > 0 \end{cases}$ = $u(t)$ (UNIT STEP)	2S	$F(p) = \frac{1}{p}$		
	$f(t) = \int_{-\infty}^t u(\lambda) d\lambda = \begin{cases} 0, & t < 0 \\ t, & t > 0 \end{cases}$ = $s(t)$ (UNIT SLOPE)	3S	$F(p) = \frac{1}{p^2}$		
	$f(t) = \begin{cases} 0, & t < 0 \\ 1 - e^{-\alpha t}, & t > 0 \end{cases}$	4S	$F(p) = \frac{\alpha}{p(p+\alpha)}$		
	$f(t) = \cos \omega_0 t$	5S	$F(\omega) = \pi \left[\delta(\omega + \omega_0) + \delta(\omega - \omega_0) \right]$		
	$f(t) = \sum_{-\infty}^{\infty} \delta(t - n\tau)$	6S	$F(\omega) = \frac{2\pi}{\tau} \sum_{-\infty}^{\infty} \delta(\omega - n \frac{2\pi}{\tau})$		

PROPERTIES OF TRANSFORMS

(Continued from first page)

properties, many pairs not in the table can be obtained from those given. For example, the spectrum of $f(t) = (1 - \alpha t) e^{-\alpha t}$ is $\frac{1}{p + \alpha} - \frac{\alpha}{(p + \alpha)^2}$ (by the addition property) $F(p) = \frac{1}{p + \alpha} - \frac{\alpha}{(p + \alpha)^2}$.

equivalent to convolving their spectra; multiplying their spectra is equivalent to convolving the functions, etc.

Many of the pairs listed in the Table of Transforms can be obtained from others by using one or more of the rules of manipulation listed in the Table of Properties. For example, the time

function in pair 8 is $\frac{1}{\tau}$ times the convolution of that in pair 7 with itself. The spectrum should therefore be $\frac{1}{\tau}$ times the product of that in pair 7 with itself, as it indeed is. Further, by using these

TIME OPERATION	FREQ. OPERATION	SIGNIFICANCE
LINEAR ADDITION $af(t) + bg(t)$	LINEAR ADDITION $aF(\omega) + bG(\omega)$	Linearity and superposition apply in both domains. The spectrum of a linear sum of functions is the same linear sum of their spectra (if spectra are complex, usual rules of addition of complex quantities apply). Further, any function may be regarded as a sum of component parts and the spectrum is the sum of the component spectra.
SCALE CHANGE $f(kt)$	INVERSE SCALE CHANGE $\frac{1}{ k } F\left(\frac{\omega}{k}\right)$	Time-Bandwidth invariance. Compressing a time function expands its spectrum in frequency and reduces it in amplitude by the same factor. The amplitude reduces because less energy is spread over a greater bandwidth. For same energy pulse as for $k=1$, multiply both functions by $\sqrt{ k }$. The case where $k=-1$ reverses the function in time. This merely interchanges positive and negative frequencies; so for real time functions, reverses the phase.
EVEN AND ODD PARTITION $\frac{1}{2} [f(t) \pm f(-t)]$	EVEN AND ODD PARTITION $\frac{1}{2} [F(\omega) \pm F(-\omega)]$	Any real function $f(t)$ may be separated into an even part $\frac{1}{2} [f(t) + f(-t)]$ and an odd part $\frac{1}{2} [f(t) - f(-t)]$. The transform of the even part is $\frac{1}{2} [F(\omega) + F(-\omega)]$ which is purely real and involves only even powers of ω . The transform of the odd part is $\frac{1}{2} [F(\omega) - F(-\omega)]$ which is purely imaginary and involves only odd powers of ω . Note: for $f(t)$ real, $F(-\omega) = \overline{F(\omega)}$.
DELAY $f(t-t_0)$	LINEAR ADDED PHASE $e^{-i\omega t_0} F(\omega)$	Delaying a function by a time t_0 multiplies its spectrum by $e^{-i\omega t_0}$, thus adding a linear phase $0 = -\omega t_0$ to the original phase. Conversely a linear phase filter produces a delay of $-\frac{d\theta}{d\omega} = t_0$.
COMPLEX MODULATION $e^{i\omega_0 t} f(t)$	SHIFT OF SPECTRUM $F(\omega - \omega_0)$	Multiplying a time function by $e^{i\omega_0 t}$ "delays" its spectrum, i.e., shifts it to center about ω_0 rather than zero frequency. Ordinary real modulation—by $\cos \omega_0 t$ —produces the time function $\frac{1}{2} (e^{i\omega_0 t} + e^{-i\omega_0 t}) f(t)$ with the spectrum $\frac{1}{2} [F(\omega - \omega_0) + F(\omega + \omega_0)]$.
CONVOLUTION $\int_{-\infty}^{\infty} f(\tau)g(t-\tau)d\tau$	MULTIPLICATION (FILTERING) $F(\omega)G(\omega)$	The spectrum of the convolution of two time functions is the product of their spectra. In convolution one of the two functions to be convolved is reversed left-to-right and displaced. The integral of the product is then evaluated and is a new function of the displacement. Convolution occurs whenever a signal is obtained which is proportional to the integral of the product of two functions as they slide past each other—in other words, in any scanning operation such as in optical or magnetic recording or picture scanning in television. Transform theory states that such scanning is equivalent to filtering the signal with a filter, whose transmission is the transform of the scanning function (reversed in time). Conversely, the effect of an electrical filter is equivalent to a convolution of the input with a time function which is the transform of filter characteristic. This function, the so-called "memory curve" of the filter, is identical with the filter impulse response, aside from dimensions. (Note: the convolution of a time function with a unit impulse gives the same function times the dimensions of the impulse.)
MULTIPLICATION $f(t)g(t)$	CONVOLUTION $\frac{1}{2\pi} \int_{-\infty}^{\infty} F(s)G(\omega-s)ds$	about each component of the (line) spectrum of the train of impulses (see pair 6S). For no overlap, highest frequency in signal to be sampled must be less than half sampling frequency. If this is true original signal spectrum (hence signal) can be recovered by low pass filter (Sampling theorem).
DIFFERENTIATION $\frac{d^n f(t)}{dt^n}$	MULTIPLICATION BY p $p^n F(p)$	a transmission $K \frac{p}{\omega_0}$ where K is dimensionless or has the dimensions of impedance or admittance. Thus the output wave is proportional to the derivative of the input.
INTEGRATION $\int_{-\infty}^t f(\tau)d\tau$	MULTIPLICATION BY $\frac{1}{p}$ $\frac{1}{p^n} F(p)$	The spectrum of the n th derivative of a function is $(i\omega)^n$ times the spectrum of the function. A "differentiating network" has (over the appropriate frequency range) a transmission $K \frac{\omega_0}{p}$, where K is dimensionless or has the dimensions of impedance or admittance. Thus, the output is proportional to the integral of the past impulse response. An "integrating network" has (over the appropriate frequency range) a transmission $K \frac{\omega_0}{p}$.

APPENDIX B

IF AMPLIFIER RESPONSE

Mention was made in the test of the phenomenon of decreased sensitivity and resolution that results when a CW signal is swept by the IF amplifier at a high rate compared to the bandwidth squared. Assuming a Gaussian response for the amplifier, the resulting transient can be determined as follows:

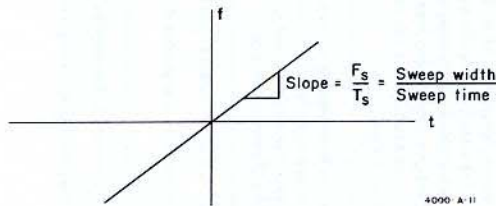

Figure B-1

A sweep frequency signal as illustrated in Figure B-1 can be represented by

$$s(t) = e^{j\pi(F_s/T_s)t^2} \quad (B-1)$$

using pair 10 of Appendix A-II

$$S(\omega) = \tau \sqrt{2\pi} e^{-1/2 (\tau\omega)^2} \quad (B-2)$$

where $\tau = \sqrt{jT_s} / (2\pi F_s)$.

If we assume a Gaussian response,

$$H(\omega) = e^{-1/2 (\omega/\delta)^2} \quad (B-3)$$

the product of $S(\omega) H(\omega)$ gives

$$Y(\omega) = S(\omega) H(\omega) = \tau \sqrt{2\pi} \exp \left[-\frac{1}{2} \left(\tau^2 + \frac{1}{\delta^2} \right) \omega^2 \right] \quad (B-4)$$

The output transient is the inverse transform of this function, again using pair 10

$$y(t) = \frac{\tau}{\sqrt{\tau^2 + \frac{1}{\delta^2}}} \exp \left[-\frac{1}{2} \left(\frac{t^2}{\tau^2 + \frac{1}{\delta^2}} \right) \right] \quad (B-5)$$

Substituting back for τ and simplifying

$$y(t) = \frac{1}{\left[1 - j \frac{2\pi F_s}{T_s \delta^2} \right]^{1/2}} \exp \left[-\frac{1 - j \frac{\delta^2 T_s}{2\pi F_s}}{1 + \left(\frac{T_s \delta^2}{2\pi F_s} \right)^2} \frac{\delta^2 t^2}{2} \right] \quad (B-6)$$

The envelope of $y(t)$ is then

$$y(t) = \frac{1}{\left[1 + \left(\frac{2\pi F_s}{T_s \delta^2} \right)^2 \right]^{1/4}} \exp \left[-\frac{\frac{\delta^2 t^2}{2}}{1 + \left(\frac{T_s \delta^2}{2\pi F_s} \right)^2} \right] \quad (B-7)$$

Note that for low sweep rates

$$\frac{T_s}{2\pi F_s} \gg \frac{1}{\delta^2}$$

$$y(t) = \exp \left[-\frac{1}{2} \left(\frac{2\pi F_s}{\delta T_s} \right)^2 t^2 \right] \quad (B-8)$$

This, as was stated earlier, is a plot of the frequency response of the IF amplifier.

DISTORTION

If the condition on (B-8) is not satisfied, the resulting transient will be altered in both width (time duration) and amplitude. The reduction in amplitude will be

$$\alpha = \frac{1}{\left[1 + \left(\frac{2\pi F_s}{T_s \delta^2} \right)^2 \right]^{1/4}} \quad (B-9)$$

Noting that $\delta = (\pi/\sqrt{\ln 2}) \Delta f$ where Δf is the 3 db bandwidth,

$$\alpha = \frac{1}{\left[1 + \left(\frac{2\ln 2}{\pi} \right)^2 \left(\frac{F_s}{T_s \Delta f^2} \right)^2 \right]^{1/4}} \quad (B-10)$$

A plot of this function in db versus $-F_s/(T_s \Delta f^2)$ is included as Figure B-2.

If we solve for the 3 db time duration Δt from equation (B-8) by setting the function to $1/\sqrt{2}$ and solving for the appropriate Δt , we get

$$\Delta t = \frac{2\sqrt{\ln 2} \delta T_s}{2\pi F_s} \quad (B-11)$$

In a like manner, the 3 db bandwidth of the function (B-7) is

$$\Delta t' = \frac{2\sqrt{\ln 2}}{\delta \pi} \left[1 + \left(\frac{T_s \delta}{2\pi F_s} \right)^2 \right]^{1/2} \quad (B-12)$$

The ratio of these times is

$$\frac{\Delta t'}{\Delta t} = \left[1 + \left(\frac{2\pi F_s}{T_s \delta^2} \right)^2 \right]^{1/2} \quad (B-13)$$

This is the ratio of the effective resolving bandwidth of a spectrum analyzer to the bandwidth of the IF amplifier as a function of sweep rate. Rewritten in terms of 3 db bandwidth Δf .

$$\frac{\Delta f_{\text{eff}}}{\Delta f} = \left[1 + \left(\frac{2 \ln 2}{\pi} \right)^2 \left(\frac{F_S}{T_S \Delta f^2} \right)^2 \right]^{1/2} \quad (\text{B-14})$$

This function is plotted in Figure B-2.

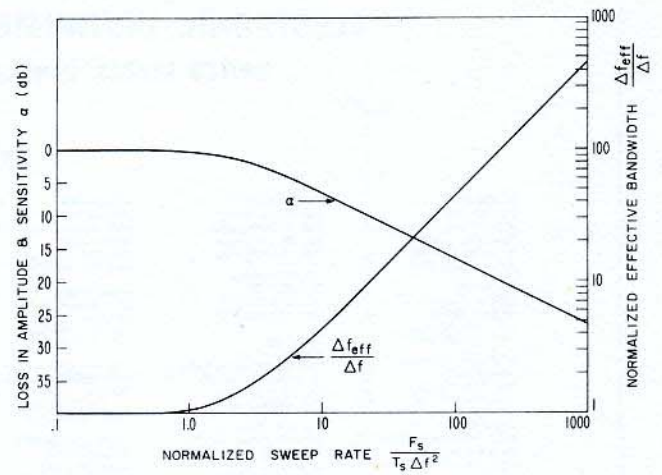

Figure B-2. Sensitivity Loss and Normalized Effective Bandwidth vs Normalized Sweep Rate

- F_S = Sweep Width
- T_S = Sweep Time
- Δf = 3 db IF Bandwidth
- Δf_{eff} = Impulse Bandwidth

