

HAMEG

Instruments

MANUAL

Oscilloscope
HM 604-2 E

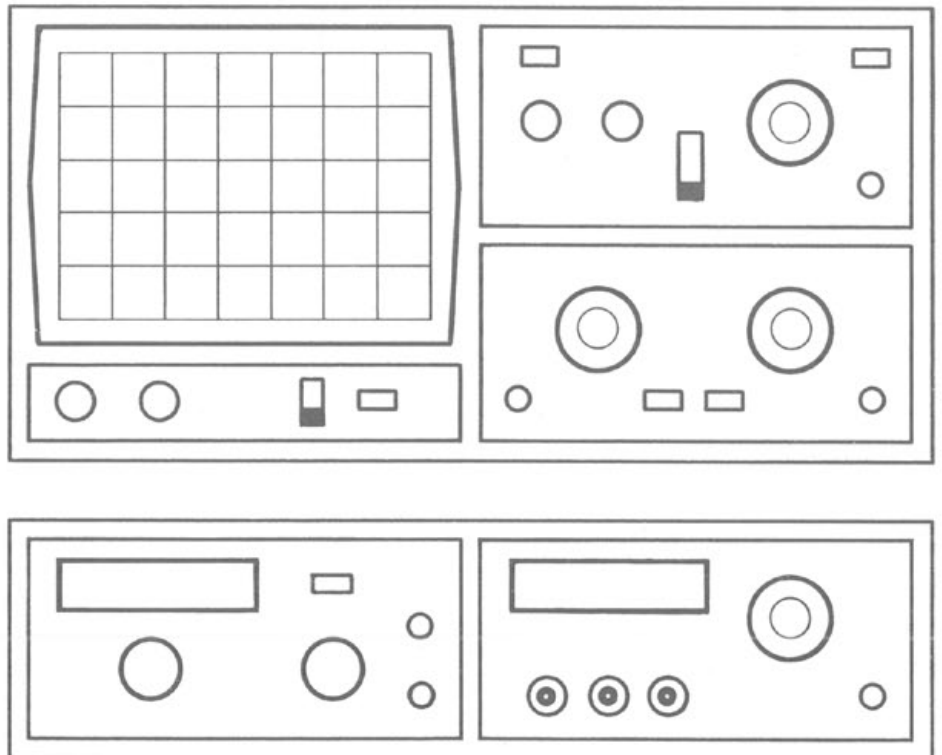

**Oscilloscope datasheet
with technical details** P 1

Operating Instructions

General Information M 1
 Use of tilt handle M 1
 Safety M 1
 Operating conditions M 2
 Warranty M 2
 Maintenance M 2
 Mains/Line voltage change M 2
 Type of Signal M 3
 Amplitude Measurements M 3
 Time Measurements M 4
 Connection of Test Signal M 5
 Operating M 6
 First Time Operation M 7
 Trace Rotation TR M 7
 Attenuator Offset Adjustment M 7
 Use and Compensation of Probes M 7
 Operating Modes of the Y Amplifier M 9
 X-Y Operation M10
 X-Y Phase Measurements M10
 Dual Trace Phase Difference Measurements M10
 Measurement of an amplitude modulation M10
 Triggering and Timebase M11
 Triggering of video signals M11
 Function of variable HOLD OFF control M12
 Sweep Delay / After Delay Triggering M12
 Delay Mode Indication M14
 Component Tester M15
 Miscellaneous M16
 Test Patterns M17

Short Instruction K 1

Front Panel Elements

Folder with Front View K 2

Test Instructions

General T 1
 Cathode-Ray Tube: Brightness, Focus,
 Linearity, Raster Distortions T 1
 Astigmatism Check T 1
 Symmetry and Drift of the Vertical Amplifier T 1
 Calibration of the Vertical Amplifier T 1
 Transmission Performance
 of the Vertical Amplifier T 2
 Operating Modes: CHI/II-TRIG.I/II, DUAL, ADD,
 CHOP., INV.I/II and XY-Operation T 2
 Triggering Checks T 3
 Timebase T 3
 Sweep Delay T 4
 Component Tester T 4
 Trace Alignment T 4
 Miscellaneous T 4

Service Instructions

General S 1
 Instrument Case Removal S 1
 Operating Voltages S 1
 Minimum Brightness S 1
 Astigmatism control S 1

 Block Diagram
 Wiring Diagram
 Circuit Diagrams
 Component Locations

**Oscilloscope
HM 604-2 E**

Specifications

Vertical Deflection

Operating modes: Channel I or Ch. II separate, Channel I and II alternate or chopped (Chopper frequency approx. 0.5MHz).
Sum or difference of Ch. I and Ch. II (with invert buttons for both channels).
XY-Mode via Channel I and Channel II
Frequency range: 2xDC to 60MHz (-3dB)
 Risettime: <5.8ns.
 Overshoot: max. 1%.
Deflection coefficients: 12 calibrated steps from 2mV/div. to 10V/div. in 1-2-5 sequence, $\pm 3\%$ variable 2.5:1 to min. 25V/div.
Input impedance: 1M Ω || 20pF.
 Input coupling: DC-AC-GD.
 Input voltage: max. 400V (DC + peak AC).
Y-output from Ch.I or Ch.II: =50mV_{ref}/div. (50 Ω).
Delay Line: approx. 90ns.

Triggering

With automatic: **10Hz-100MHz** (≤ 0.5 div. height). normal with level control **DC-100MHz**.
 Threshold: external: ≥ 50 mV.
 Slope: positive or negative,
LED-indication for trigger action.
 Sources: Ch.I, Ch.II, altern, Ch.I/Ch.II, line, external
 Coupling: **AC** (10Hz to approx. 20MHz), **DC**, **LF** (DC to 50kHz), **HF** (50kHz to 100MHz).
TV-Sync-Separator for line and frame, pos., neg.
Field Selector for 1. and 2. field.
2nd triggering (Del. Trig.): autom. or slope controlled (independent from slope direction). \pm selection for TV mode.
 Threshold: 1div.; typical 0.5div.
 Trigger bandwidth: ≤ 25 Hz to 60MHz.

Horizontal Deflection

Time coefficients: 23 calibrated steps from 50ns/div. to 1s/div. in 1-2-5 sequence, variable 2.5:1 to min. 2.5s/div.
 Accuracy in calibrated position: $\pm 3\%$.
 with **X-Magnifier x10** ($\pm 5\%$) to 5ns/div..
Hold-Off-time: variable (≥ 5 :1).
Delay: 7 decade steps from 100ns to 0.1s, variable approx. 10:1 to 1s.
Bandwidth X-Amplifier: DC-5MHz (-3dB).
 Input X-Amplifier via Channel II, sensitivity see Ch. II specification.
X-Y phase shift: $< 3^\circ$ below 120kHz.
 Ramp output: approx. 5V positive going.

Component Tester

Test voltage: max. 8.5V_{rms} (open circuit).
Test current: max. 8mA_{rms} (shorted).
Test frequency: 50 - 60Hz (line frequency).

General Information

Cathode ray tube: D14-372 GH / 123 rectangular screen, **internal graticule 8x10div.**
Total acceleration voltage: approx. 13kV.
 Trace rotation: adjustable on front panel.
Calibrator: square-wave generator switchable from approx. 1kHz to 1MHz (t_r approx. 5ns).
 Output voltage: 0.2V and 2V $\pm 1\%$.
Protective system: Safety Class I (IEC 348)
 Line voltage: 110, 125, 220, 240V $\sim \pm 10\%$.
 Line frequency: 50 to 60Hz.
Power consumption: approx. 45 Watt.
 Max. ambient temperature: $-10^\circ\text{C} \dots +40^\circ\text{C}$.
 Weight: approx. 8kg. Colour: techno-brown.
 Cabinet (mm): **W** 285, **H** 145, **D** 380.
 Lockable tilt handle.

Subject to change without notice.

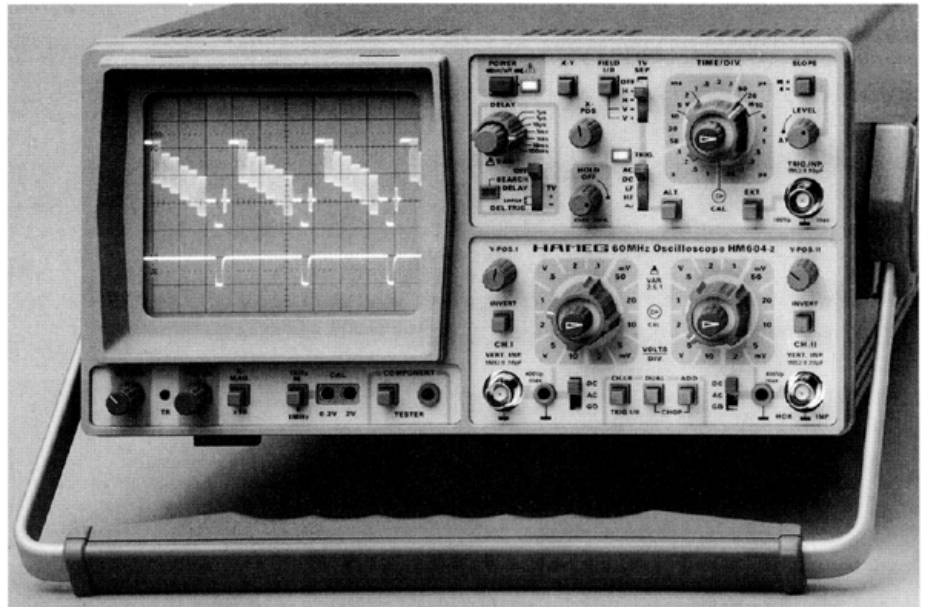

60MHz Universal Oscilloscope HM 604-2

2 Channels, max. 2mV/div., Delay Line, Component Tester.

Time base: 2.5s-5ns/div., including x10 Magnifier & Sweep Delay.

Triggering DC-100MHz, "After-Delay" Trig., TV-Sync-Separator.

Considering the variety of operating and trigger modes, the **HM604-2** has emerged as a real **general purpose oscilloscope**, satisfying a wide range of demanding requirements in laboratory, production, and service. Measurements in the frequency range of up to 100MHz can be displayed due to the exceptional transfer characteristics of the amplifiers, which can be checked at any time with the built-in **1MHz Calibrator**. The instrument's high sensitivity enables stable displays of very small signals (< 2 mV). An analog output is provided for connecting multimeters or counters. Another important feature is the internal **delay line** which allows observation of the leading edge of signals displayed. By virtue of its second time base, the **HM604-2** features a calibrated sweep delay mode allowing the smallest waveform sections to be expanded up to **1000 times**.

The unique feature of the **HM604-2**, however, is the automatic **After-Delay Trigger** mode which ensures extremely stable displays and jitter-free measurements of asynchronous signal sections and bursts, or pulse trains, even in the presence of large amplitude fluctuations. It triggers on any > 5 mm signal slopes without specific "LEVEL" adjustment, independent of slope direction. An **active TV-Sync-Separator** further enhances trigger quality of video frame and line signals. The **field selector**, which is quite uncommon in this price range, allows for individual lines of TV pictures to be displayed without disrupting the normal operation of the circuitry being analyzed.

Users will be particularly impressed by the instrument's outstanding versatility and **ease of operation**. Experienced technicians and engineers will recognize quickly that the **HM604-2** could help them solve many of their future measurement problems.

Accessories supplied

Line cord, Operators Manual
 2 Probes 10:1 HZ51

Optional accessories

50 Ω -feedthrough termination HZ22
 Viewing hood HZ47
 Carrying case HZ96

Operating Instructions

General Information

This oscilloscope is easy to operate. The logical arrangement of the controls allows anyone to become familiar with the operation of the instrument after a short time, however, experienced users are also advised to read through these instructions so that all functions are understood.

Immediately after unpacking, the instrument should be checked for mechanical damage and loose parts in the interior. If there is transport damage, the supplier must be informed immediately. The instrument must then not be put into operation.

Check that the instrument is set to the correct mains/line voltage. If not, refer to instructions on page M2.

Use of tilt handle

To view the screen from the best angle, there are three different positions (C, D, E) for setting up the instrument. If the instrument is set down on the floor after being carried, the handle remains automatically in the upright carrying position (A).

In order to place the instrument onto a horizontal surface, the handle should be turned to the upper side of the oscilloscope (C). For the D position (10° inclination), the handle should be turned in the opposite direction out of the carrying position until it locks in place automatically underneath the instrument. For the E position (20° inclination), the handle should be pulled to release it from the D position and swing backwards until it locks once more.

The handle may also be set to a position for horizontal carrying by turning it to the upper side to lock in the B position. At the same time, the instrument must be moved upwards, because otherwise the handle will jump back.

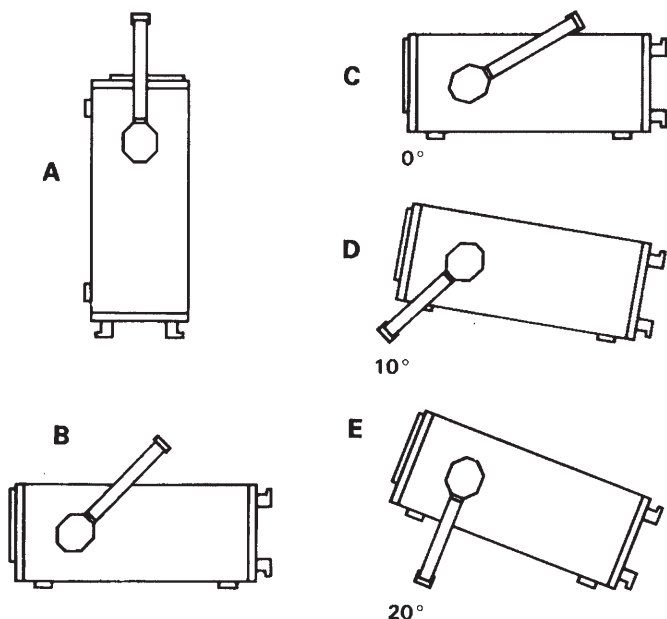

Safety

This instrument has been designed and tested in accordance with **IEC Publication 348, Safety Requirements for Electronic Measuring Apparatus**, and has left the factory in a safe condition. The present instruction manual contains important information and warnings which have to be followed by the user to ensure safe operation and to retain the oscilloscope in safe condition. The case, chassis and all measuring terminals are connected to the protective earth contact of the appliance inlet. The instrument operates according to Safety Class I (three-conductor power cord with protective earthing conductor and a plug with earthing contact). The mains/line plug shall only be inserted in a socket outlet provided with a protective earth contact. The protective action must not be negated by the use of an extension cord without a protective conductor.

Warning! Any interruption of the protective conductor inside or outside the instrument or disconnection of the protective earth terminal is likely to make the instrument dangerous. Intentional interruption of the protective earth connection is prohibited. The mains/line plug should be inserted before connections are made to measuring circuits.

The grounded accessible metal parts (case, sockets, jacks) and the mains/line supply contacts (line, neutral) of the instrument have been tested against insulation breakdown with **2000Vr.m.s. (50Hz)**.

Under certain conditions, 50Hz or 60Hz hum voltages can occur in the measuring circuit due to the interconnection with other mains/line powered equipment or instruments. This can be avoided by using an isolation transformer (Safety Class II) between the mains/line outlet and the power plug of the instrument. When displaying waveforms where the "low-level side of the signal is at a high potential, even with the use of a protective isolation transformer, it should be noted that this potential is connected to the oscilloscope's case and other accessible metal parts. High voltages are dangerous. In this case, special safety precautions are to be taken, which must be supervised by qualified personnel if the voltage is higher than 42V.

Most cathode-ray tubes develop X-rays. However, **the dose equivalent rate falls far below the maximum permissible value of 36pA/kg (0.5mR/h)**.

Whenever it is likely that protection has been impaired, the instrument shall be made inoperative and be secured against any unintended operation. The protection is likely to be impaired if, for example, the instrument

- shows visible damage,
- fails to perform the intended measurements,
- has been subjected to prolonged storage under unfavourable conditions (e.g. in the open or in moist environments),
- has been subject to severe transport stress (e.g. in poor packaging).

Operating conditions

The instrument has been designed for indoor use. The permissible ambient temperature range during operation is +15°C ... +30°C. It may occasionally be subjected to temperatures between +10°C and -10°C without degrading its safety. The permissible ambient temperature range for storage or transportation is -40°C ... +70°C.

The maximum operating altitude is up to 2200m (non-operating 15000m). The maximum relative humidity is up to 80%.

If condensed water exists in the instrument it should be acclimatized before switching on. In some cases (e.g. extremely cold oscilloscope) two hours should be allowed before the instrument is put into operation. The instrument should be kept in a clean and dry room and must not be operated in explosive, corrosive, dusty, or moist environments. The oscilloscope can be operated in any position, but the convection cooling must not be impaired.

The ventilation holes may not be covered. For continuous operation the instrument should be used in the horizontal position, preferably tilted upwards, resting on the tilt handle.

The specifications stating tolerances are only valid if the instrument has warmed up for 30 minutes at an ambient temperature between +15°C and +30°C. Values not stating tolerances are typical for an average instrument.

Warranty

Each instrument runs through a quality test with 10 hour burn-in before leaving the production. Practically every early failure is detected in intermittent operation by this method. However, it is possible that a component fails only after a lengthy operating period. Therefore a **functional guarantee of 2 years** is given for all units. The condition for this is that no modifications have been made in the instrument. In the case of shipments by post, rail or carrier it is recommended that the original packing is carefully preserved. Transport damages and damage due to gross negligence are not covered by the guarantee.

In the case of a complaint, a label should be attached to the housing of the instrument which describes briefly the faults observed. If at the same time the name and telephone number (dialing code and telephone or direct number or department designation) is stated for possible queries, this helps towards speeding up the processing of guarantee claims.

Maintenance

Various important properties of the oscilloscope should be carefully checked at certain intervals. Only in this way is it largely certain that all signals are displayed with the

accuracy on which the technical data are based. The test methods described in the test plan of this manual can be performed without great expenditure on measuring instruments. However, purchase of the new HAMEG scope tester HZ 60, which despite its low price is highly suitable for tasks of this type, is very much recommended.

The exterior of the oscilloscope should be cleaned regularly with a dusting brush. Dirt which is difficult to remove on the casing and handle, the plastic and aluminium parts, can be removed with a moistened cloth (99% water + 1% mild detergent). Spirit or washing benzine (petroleum ether) can be used to remove greasy dirt. The screen may be cleaned with water or washing benzine (but not with spirit (alcohol) or solvents), it must then be wiped with a dry clean lint-free cloth. Under no circumstances may the cleaning fluid get into the instrument. The use of other cleaning agents can attack the plastic and paint surfaces.

Switching over the mains/line voltage

The instrument is set for 220V (240V U.K.) line voltage on delivery. It can be switched over to other voltages at the fuse holder combined with the 3-pole appliance inlet at the rear of the instrument. Firstly the fuse holder printed with the voltage values is removed using a small screw driver and - if required - provided with another fuse. Refer to the table below for the prescribed value of the fuse. Then replace the fuse holder so that the impressed white triangle points to the desired voltage. Here pay attention that the cover plate is also correctly engaged. The use of repaired fuses or short circuiting the fuse holder is not allowed. Damage arising because of this is not covered by the guarantee.

Note: In some countries the nominal line/mains voltage is 230 Volt. Under these conditions the voltage setting should be 240 Volt. This avoids the activation of the internal protective circuit under overvoltage conditions.

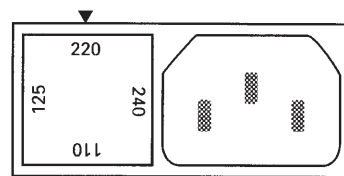

Fuse type: Size **5 x 20mm**; 250V~, C;
IEC 127, Bl. III; DIN 41 662 (possibly DIN 41 571, Bl. 3).
Cutoff: **time lag (T)**.

Line voltage	Fuse rating
110V~±10%:	T 0,63 A
125V~±10%:	T 0,63 A
220V~±10%:	T 0,315A
240V~±10%:	T 0,315A

Type of Signal

All types of signals with a frequency spectrum below 60MHz can be displayed on the HM604. The display of simple electrical processes such as sinusoidal RF and AF signals or ripple poses no problems. However, when examining square or pulse type waveforms, attention must be paid to the harmonic content of such signals. The repetition frequency (fundamental frequency) of the signal must therefore be significantly smaller than the upper limit frequency of the vertical amplifier.

Operating problems can sometimes occur when composite signals are to be displayed, especially if they do not contain any suitable level components and repetition frequency which can be used for triggering. This occurs, for example, with burst signals. To obtain a stably triggered display in these cases, it may be necessary to use Normal Triggering, **HOLD OFF** time control, and/or **TIME/DIV.** variable control.

Video signals are easily triggerable by the aid of the active TV sync separator (**TV SEP.** switch).

For optional operation as a DC or AC voltage amplifier, each channel is provided with a **DC-AC** coupling switch. The **DC** position should only be used with an attenuator probe or at very low frequencies or if the determination of DC voltage content of the signal is absolutely necessary.

However, when investigating very low-frequency pulses, misleading ramp-offs may occur with **AC** coupling. In this case, **DC** operation is to be preferred if the signal voltage is not superimposed on a too high DC voltage level. Otherwise, a capacitor of adequate capacitance must be connected before the input of the vertical amplifier (switched to **DC** coupling). It should be remembered that this capacitor must have a sufficiently high breakdown voltage. **DC** operation is also recommended for the display of logic and pulse signals, particularly if their pulse duty factor changes permanently during operation. Otherwise, the display will move up and down with any change. DC voltages can only be measured in the **DC** position.

Amplitude Measurements

In general electrical engineering, alternating voltage data normally refers to effective values (rms = root-mean-square value). However, for signal magnitudes and voltage designations in oscilloscope measurements, the peak-to-peak voltage (V_{pp}) value is applied. The latter corresponds to the real potential difference between the most positive and most negative points of a signal waveform.

If a sinusoidal waveform, displayed on the oscilloscope screen, is to be converted into an effective (rms) value, the resulting peak-to-peak value must be divided by $2 \times \sqrt{2} = 2.83$. Conversely, it should be observed that sinusoidal

voltages indicated in V_{rms} (V_{eff}) have 2.83 times the potential difference in V_{pp} . The relationship between the different voltage magnitudes can be seen from the following figure.

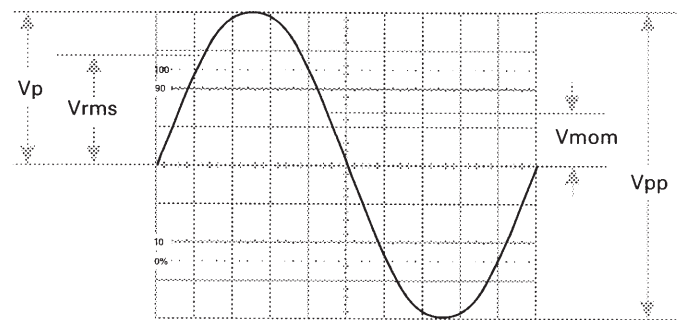

Voltage values of a sine curve

V_{rms} = effective value; V_p = simple peak or crest value;
 V_{pp} = peak-to-peak value; V_{mom} = momentary value.

The minimum signal voltage required at the vertical amplifier input for a display of 1div. is approximately $2mV_{pp}$. However, smaller signals than this may also be displayed. The **deflection coefficients** on the input attenuators are indicated in **mV/div.** or **V/div.** (peak-to-peak value).

The magnitude of the applied voltage is ascertained by multiplying the selected deflection coefficient by the vertical display height in divisions.

If an attenuator probe x10 is used, a further multiplication by a factor of 10 is required to ascertain the correct voltage value.

For exact amplitude measurements the variable control on the attenuator switch must be set to its calibrated detent CAL. When turning the variable control ccw the sensitivity will be decreased by a factor of 2.5.

Therefore every intermediate value is possible within the 1-2-5 sequence.

With direct connection to the vertical input, signals up to **200V_{pp}** may be displayed (attenuator set to **10V/div.**, variable control ccw).

With the designations

H = display height in div.,

U = signal voltage in V_{pp} at the vertical input,

D = deflection coefficient in **V/div.** at attenuator switch, the required quantity can be calculated from the two given quantities:

$$U = D \cdot H$$

$$H = \frac{U}{D}$$

$$D = \frac{U}{H}$$

However, these three values are not freely selectable. They have to be within the following limits (trigger threshold, accuracy of reading):

H between 0.5 and 8div., if possible 3.2 to 8div.,

U between $2mV_{pp}$ and $80V_{pp}$,

D between $2mV/div.$ and $10V/div.$ in 1-2-5 sequence.

Examples:

Set deflection coefficient $D = 50\text{mV/div.} \cong 0.05\text{ V/div.}$,
observed display height $H = 4.6\text{div.}$,
required voltage $U = 0.05 \times 4.6 = 0.23V_{pp}$.

Input voltage $U = 5V_{pp}$,
set deflection coefficient $D = 1V/div.$,
required display height $H = 5:1 = 5\text{div.}$

Signal voltage $U = 220V_{rms} \times 2 \times \sqrt{2} = 622V_{pp}$
(voltage $>80V_{pp}$, with probe $\times 10$: $U = 62.2V_{pp}$),
desired display height $H = \text{min. } 3.2\text{div.}, \text{ max. } 8\text{div.}$,
max. deflection coefficient $D = 62.2:3.2 = 19.4V/div.$,
min. deflection coefficient $D = 62.2:8 = 7.8V/div.$,
adjusted deflection coefficient $D = 10V/div.$

If the applied signal is superimposed on a DC (direct voltage) level the total value (DC + peak value of the alternating voltage) of the signal across the Y-input must not exceed $\pm 400V$ (see figure). This same limit applies to normal $\times 10$ attenuator probes, the attenuation ratio of which allows signal voltages up to approximately $1,000V_{pp}$ to be evaluated. Voltages of up to approximately $2,400V_{pp}$ may be measured by using the HZ53 high voltage probe which has an attenuation ratio of 100:1. It should be noted that its AC_{peak} value is derated at higher frequencies. If a normal $\times 10$ probe is used to measure high voltages there is the risk that the compensation trimmer bridging the attenuator series resistor will break down causing damage to the input of the oscilloscope. However, if for example only the residual ripple of a high voltage is to be displayed on the oscilloscope, a normal $\times 10$ probe is sufficient. In this case, an appropriate high voltage capacitor (approx. 22-68nF) must be connected in series with the input tip of the probe.

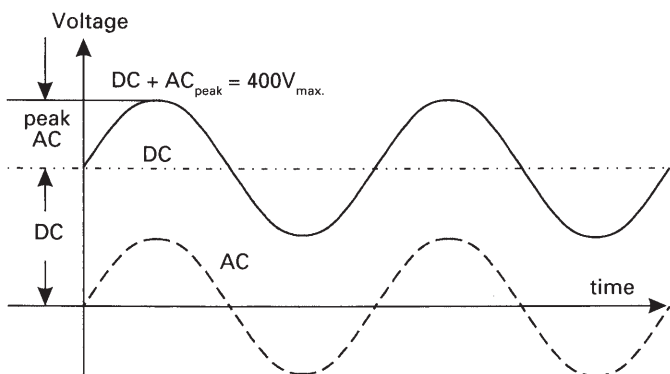

Total value of input voltage

The dotted line shows a voltage alternating at zero volt level. When superimposed a DC level, the addition of the positive peak and the DC voltage results in the max. voltage ($DC + AC_{peak}$).

It is very important that the oscilloscope input coupling is set to **DC**, if an attenuator probe is used for voltages higher than $400V$ (see page M6: Connection of Test Signal).

Time Measurements

As a rule, all signals to be displayed are periodically repeating processes and can also be designated as periods. The

number of periods per second is the recurrence frequency or repetition rate. One or more signal periods or even part of a period may be shown as a function of the adjustment of the **TIME/DIV.** switch. The time coefficients on the **TIME/DIV.** switch are indicated in **s/div.**, **ms/div.**, and **$\mu\text{s/div.}$** Accordingly, the dial is subdivided into three sectors. **The duration of a signal period or a portion of the waveform is ascertained by multiplying the relevant time (horizontal distance in div.) by the time coefficient selected on the TIME/DIV. switch. The time variable control (small knob on the TIME/DIV. switch) must be in its calibrated detent CAL. for accurate measurement** (arrow horizontal and pointing to the right)

With the designations

L = displayed wave length in div. of one period,

T = time in seconds for one period,

F = recurrence frequency in Hz of the signal,

T_c = time coefficient in s/div. on timebase switch

and the relation $F = 1/T$, the following equations can be stated:

$$T = L \cdot T_c \qquad L = \frac{T}{T_c} \qquad T_c = \frac{T}{L}$$

$$F = \frac{1}{L \cdot T_c} \qquad L = \frac{1}{F \cdot T_c} \qquad T_c = \frac{1}{L \cdot F}$$

With X-MAG. $\times 10$ button depressed the T_c value must be divided by 10.

However, these four values are not freely selectable. They have to be within the following limits:

L between 0.2 and 10div., if possible 4 to 10div.,

T between 5ns and 10s,

F between 0.1Hz and 60MHz,

T_c between 50ns/div. and 1s/div. in 1-2-5 sequence (with **X MAG. $\times 10$** in out position), and

T_c between 5ns/div. and 100ms/div. in 1-2-5 sequence (with pushed **X MAG. $\times 10$** button).

Examples:

Displayed wavelength $L = 7\text{div.}$,
set time coefficient $T_c = 0.5\mu\text{s/div.}$,
required period $T = 7 \times 0.5 \times 10^{-6} = 3.5\mu\text{s}$
required rec. freq. $F = 1:(3.5 \times 10^{-6}) = 286\text{ kHz.}$

Signal period $T = 0.5\text{s}$,
set time coefficient $T_c = 0.2\text{s/div.}$,
required wavelength $L = 0.5:0.2 = 2.5\text{div.}$

Displayed ripple wavelength $L = 1\text{div.}$,
set time coefficient $T_c = 10\text{ms/div.}$,
required ripple freq. $F = 1:(1 \times 10 \times 10^{-3}) = 100\text{Hz.}$

TV-line frequency $F = 15\,625\text{Hz}$,
set time coefficient $T_c = 10\mu\text{s/div.}$,
required wavelength $L = 1:(15\,625 \times 10^{-5}) = 6.4\text{div.}$

Sine wavelength **L** = min. 4div., max. 10div.,
 Frequency **F** = 1kHz,
 max. time coefficient $T_c = 1:(4 \times 10^3) = 0.25\text{ms/div.}$,
 min. time coefficient $T_c = 1:(10 \times 10^3) = 0.1\text{ms/div.}$,
set time coefficient $T_c = 0.2\text{ms/div.}$,
required wavelength $L = 1:(10^3 \times 0.2 \times 10^{-3}) = 5\text{div.}$

Displayed wavelength **L** = 0.8div.,
 set time coefficient $T_c = 0.5\mu\text{s/div.}$,
pressed MAG x10 button: $T_c = 0.05\mu\text{s/div.}$,
required rec. freq. $F = 1:(0.8 \times 0.05 \times 10^{-6}) = 25\text{MHz}$,
required period $T = 1:(25 \times 10^6) = 40\text{ns}$.

If the time is relatively short as compared with the complete signal period, an expanded time scale should always be applied (**X MAG x10** button pushed). In this case, the ascertained time values have to be divided by **10**. Very small time intervals at optional points of the signal can be measured more exactly with the aid of the sweep delay. With it, the display and measurement of time intervals, which are smaller than 1% of the full signal period, are possible. The smallest measurable time interval is, on the whole, dependent on the obtainable brightness of the CRT. The limit is an expansion of approximately 1000 times. Using a Viewing Hood HZ47, more expansion is possible, provided that the time coefficient set on the **TIME/DIV.** switch is greater than **5 $\mu\text{s/cdiv.}$** (and using the **X MAG x10** facility) for the signals basic period. Otherwise, the fastest sweep speed determines the greatest possible expansion.

When investigating pulse or square waveforms, the critical feature is the **risetime of the voltage step**. To ensure that transients, ramp-offs, and bandwidth limits do not unduly influence the measuring accuracy, the risetime is generally measured between **10%** and **90%** of the vertical pulse height. For peak-to-peak signal amplitude of **5div.** height, which are symmetrically adjusted to the horizontal center line, the internal graticule of the CRT has two horizontal dotted lines $\pm 2.5\text{div.}$ from the center line. Adjust the Y attenuator switch with its variable control together with the **Y-POS.** control so that the pulse height is precisely aligned with the 0 and 100% lines. The 10% and 90% points of the signal will now coincide with the two lines, which have a distance of $\pm 2\text{div.}$ from the horizontal center line and an additional subdivision of 0.2div. **The risetime is given by the product of the horizontal distance in cm between these two coincidence points and the time coefficient setting.** If magnification is used, this product must be divided by 10. The **fall time** of a pulse can also be measured by using this method.

The figure shows correct positioning of the oscilloscope trace for accurate risetime measurement.

With a time coefficient of **0.05 $\mu\text{s/div.}$** and pushed **X MAG x10** button the example shown in the above figure results in a measured total risetime of

$$t_{\text{tot}} = 1.6\text{div.} \times 0.05\mu\text{s/div.} \times 10 = 8\text{ns}$$

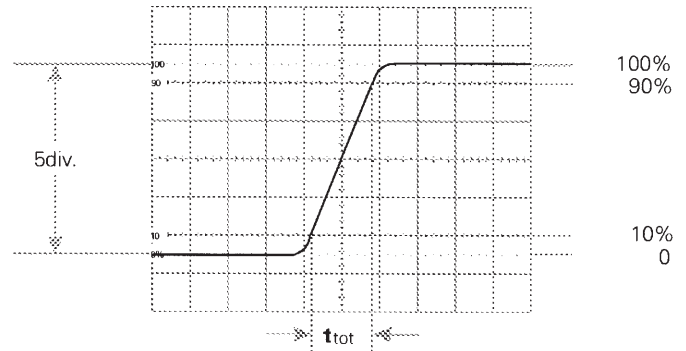

When very fast risetimes are being measured, the risetimes of the oscilloscope amplifier and the attenuator probe have to be deducted from the measured time value. The risetime of the signal can be calculated using the following formula.

$$t_r = \sqrt{t_{\text{tot}}^2 - t_{\text{osc}}^2 - t_p^2}$$

In this t_{tot} is the total measured risetime, t_{osc} is the risetime of the oscilloscope amplifier (approx. 5.8ns), and t_p the risetime of the probe (e.g. = 2ns). If t_{tot} is greater than 42ns, then t_{tot} can be taken as the risetime of the pulse, and calculation is unnecessary.

Calculation of the example in the figure above results in a signal risetime

$$t_r = \sqrt{8^2 - 5.8^2 - 2^2} = 5.1\text{ns}$$

Connection of Test Signal

Caution: When connecting unknown signals to the oscilloscope input, always use automatic triggering and set the **DC-AC** input coupling switch to **AC**. The attenuator switch should initially be set to **10V/div.**

Sometimes the trace will disappear after an input signal has been applied. The attenuator switch must then be turned back to the left, until the vertical signal height is only 3-8div. With a signal amplitude greater than 80V_{pp}, an attenuator probe must be inserted before the oscilloscope's vertical input. If, after applying the signal, the trace is nearly blanked, the period of the signal is probably substantially longer than the set value on the **TIME/DIV.** switch. It should be turned to the left to an adequately greater time coefficient.

The signal to be displayed should be fed to the vertical input of the oscilloscope by means of a shielded test cable, e.g. the HZ32 or HZ34, or by a x10 or x100 attenuator probe. The use of these shielded cables with high impedance circuits is only recommended for relatively low frequencies (up to approx. 50kHz). For higher frequencies, and when the signal source is of low impedance, a cable of matched characteristic impedance (usually 50 Ω) is recommended. In addition, and especially when investigating square or pulse waveforms, a resistor equivalent to the characteristic impedance of the cable must also be connected to the cable directly at the input

of the oscilloscope. When using a 50Ω cable, such as the HZ34, a 50Ω through-termination type HZ22 is available from . When investigating square or pulse waveforms with fast risetimes, transient phenomena on both the edge and top of the signal may become visible if the correct termination is not used. It must be remembered that the 50Ω through-termination will only dissipate a maximum of 2 watts. This power consumption is reached with 10V_{rms} or with 28V_{pp} sine signal.

If a x10 or x100 attenuator probe is used, no termination is necessary. In this case, the connecting cable is matched directly to the high impedance input of the oscilloscope. When using attenuator probes even high internal impedance sources are only slightly loaded by approximately 10MΩ||16pF or 100MΩ||9pF respectively. Therefore, when the voltage loss due to the attenuation of the probe can be compensated by a higher sensitivity setting on the HM604, the probe should always be used. Also it should be remembered that the series impedance of the probe provides a certain amount of protection for the input of the oscilloscope amplifier. It should be noted that all attenuator probes must be compensated in conjunction with the oscilloscope (see: Probe Adjustment, page M8).

If a x10 or x100 attenuator probe is used at voltages higher than 400V, the DC input coupling must always be set. With **AC** coupling, the attenuation is frequency-dependent, the pulses displayed can exhibit ramp-off, DC-voltage contents are suppressed but loads the respective input coupling capacitor of the oscilloscope. The electric strength of which is maximum 400V (DC + peak AC). For the suppression of unwanted DC voltages, a **capacitor** of adequate capacitance and electric strength **may be connected before the input tip of the probe** (e.g. for ripple measurements).

It is important to remember that when low voltage signals are being investigated the position of the ground point on the test circuit can be critical. This ground point should always be located as close as possible to the measuring point. If this is not done, serious signal deformation may result from any spurious currents through the ground leads or test chassis parts. This comment also applies to the ground leads on attenuator probes which ideally should be as short and as thick as possible. For connection of a probe to a BNC socket, a BNC-adaptor should be used. It forms often a part of the probe accessory. Grounding and matching problems are then eliminated.

Hum or interference voltage appearing in the measuring circuit (especially with a small deflection coefficient) is possibly caused by multiple grounding, because equalizing currents can flow in the shielding of the measuring cables (voltage drop between non-fused earthed conductors of other line powered devices, which are connected to the oscilloscope or test object, e.g. signal generators with anti-interference capacitors).

Operating

For a better understanding of these Operating Instructions the front panel picture at the end of these instructions can be unfolded for reference alongside the text.

The front panel is subdivided into three sections according to the various functions. The **INTENS.**, **FOCUS** and **TR** (trace rotation) controls are arranged on the left directly below the screen of the cathode-ray tube (CRT). Continuing towards the right are the horizontal magnification button (**X MAG. x10**), the switch for calibrator frequency selection (**1kHz/1MHz**) and calibrator output sockets 0.2V/2V (**CAL.**). The **COMPONENT TESTER** pushbutton and its measuring socket are located on the right side.

The X-Section, located on the upper right, next to the screen, contains the red **POWER** pushbutton and indicating LED, all controls for timebase (**TIME/DIV.**), triggering (**TRIG.**), horizontal trace position (**X-POS.**), sweep delay (**DELAY**), TV separator (**TV SEP.**) together with the field select button (**FIELD I/II**), the XYmode button (XY), and the knob for holdoff adjustment (**HOLD OFF**).

The lower Y-Section contains the controls for the vertical deflection system. On the right and left in this section are located: vertical input connector, **DC-AC-GD** input coupling slide switch, **Y-POS.** control, **INVERT** pushbutton, attenuator switch with variable control, and ground jack. All these controls and connectors exist in duplicate for each of the Channels I and II. Three pushbuttons for selecting the operating mode are arranged below the attenuator switches: **CHI/II-TRIGI/II**, **DUAL** and **ADD**. These are explained later.

The instrument is so designed that even incorrect operation will not cause serious damage. The pushbuttons control only minor functions, and it is recommended that before commencement of operation all pushbuttons are in the "out" position. After this the pushbuttons can be operated depending upon the mode of operation required.

The HM604 accepts all signals from DC (direct voltage) up to a frequency of at least 60MHz (-3dB). For sinewave voltages the upper frequency limit will be 80MHz. However, in this higher frequency range the vertical display height on the screen is limited to approx. 6div. The time resolution poses no problem. For example, with 100MHz and the fastest adjustable sweep rate (5ns/div.), one cycle will be displayed every 2div. The tolerance on indicated values amounts to ±3% in both deflection directions. All values to be measured can therefore be determined relatively accurately. However, from approximately 25MHz upwards the measuring error will increase as a result of loss of gain. At 40MHz this reduction is about 10%. Thus, approximately 11% should be added to the measured voltage at this frequency. As the bandwidth of the amplifiers differ (normally between 65 and 70MHz), the measured values in the upper limit range cannot be defined exactly.

Additionally, as already mentioned, for frequencies above 60MHz the dynamic range of the display height steadily decreases. The vertical amplifier is designed so that the transmission performance is not affected by its own overshoot.

First Time Operation

Check that the instrument is set to the correct mains/line voltage. (Refer to page M2).

Before applying power to the oscilloscope it is recommended that the following simple procedures are performed:

- Check that all pushbuttons are in the **out** position, i.e. released.
- Rotate the three variable controls with arrows to their calibrated detent.
- Set the variable controls with marker lines to their midrange position (marker lines pointing vertically).
- The **LEVEL** control knob should be on its left stop (**AT**).
- The three lever switches in the X-Section should be set to their uppermost position.
- Both input coupling slide switches for **CH.I** and **CH.II** in the Y-Section should be set to the **GD** position.

Switch on the oscilloscope by depressing the red **POWER** pushbutton. An LED will illuminate to indicate working order. The trace, displaying one baseline, should be visible after a short warm-up period of 10 seconds. Adjust **Y-POS.I** and **X-POS.** controls to center the baseline. Adjust **INTENS.** (intensity) and **FOCUS** controls for medium brightness and optimum sharpness of the trace. The oscilloscope is now ready for use.

If only a spot appears (**CAUTION!** CRT phosphor can be damaged.), reduce the intensity immediately and check that the **X-Y** pushbutton is in the released (out) position. If the trace is not visible, check the correct positions of all knobs and switches (particularly **LEVEL** knob in **AT** position and **DELAY MODE** lever switch to **OFF**).

To obtain the maximum life from the cathode-ray tube, the minimum intensity setting necessary for the measurement in hand and the ambient light conditions should be used.

Particular care is required when a single spot is displayed, as a very high intensity setting may cause damage to the fluorescent screen of the CRT. Switching the oscilloscope off and on at short intervals stresses the cathode of the CRT and should therefore be avoided.

Trace Rotation TR

In spite of Mumetal-shielding of the CRT, effects of the earths magnetic field on the horizontal trace position cannot be completely avoided. This is dependent upon the orientation of the oscilloscope on the place of work. A centred trace may not align exactly with the horizontal center line of the graticule. A few degrees of misalignment can be corrected by a potentiometer accessible through an opening on the front panel marked TR.

Attenuator Offset Adjustment

In spite of careful adjustment in the factory, vertical trace position shift may become visible when switching the attenuator. Such deviations are normally not significant and should only be corrected if more than a half beam width.

The adjustment can be performed for each channel with the aid of a screwdriver inserted in the respective hole marked **DC-BALANCE** at the bottom side of the cabinet.

Before starting the adjustment, the input coupling switch must be set to **GD** position. The trace should be positioned on the middle horizontal line of the graticule. Then the attenuator must be switched constantly between the 2mV/div. and 5mV/div. position while the adjustment is corrected until no trace shift is noticeable.

Use and Compensation of Probes

To display an undistorted waveform on an oscilloscope, the probe must be matched to the individual input impedance of the vertical amplifier.

The HM604s built-in calibration generator provides a squarewave signal with a very low risetime (<5ns), and switch-selectable frequencies of approx. 1kHz and 1MHz at two output sockets below the CRT screen. One output provides **0.2V_{pp} ±1%** for 10:1 probes, and **2V_{pp} ±1%** are present at the other, for 100:1 probes.

When the attenuator switches are set to **5mV/div.** vertical deflection coefficient, these calibration voltages correspond to a screen amplitude of **4div.**

The output sockets have an internal diameter of 4.9mm to accommodate the internationally accepted shielding tube diameter of modern **Modular Probes** and **F-series** slimline probes. Only this type of construction ensures the extremely short ground connections which are essential for an undistorted waveform reproduction of non-sinusoidal high frequency signals.

Adjustment at 1kHz

The C-trimmer adjustment compensates the capacitive loading on the oscilloscope input (approx. 20pF with the HM604). By this adjustment, the capacitive division assumes the same division ratio as the ohmic voltage divider to ensure an equal division ratio for high and low frequencies, as for DC. (For 1:1 probes or switchable probes set to 1:1, this adjustment is neither required nor possible). A baseline exactly parallel to the horizontal graticule lines is a major condition for accurate probe adjustments. (See also Trace Rotation **TR**, page M7.)

Connect the probes (Types HZ51, 52, 53, 54, or HZ36) to **CH.I** input. All pushbuttons should be released (in the out position). Set the input coupling switch to **DC**, the attenuator switch to **5mV/div.**, and the **TIME/DIV.** switch to **0.2ms/div.**, and all variable controls to **CAL.** position.

Plug the probe tip into the appropriate calibrator output socket, i.e. 10:1 probes into the **0.2V** socket, 100:1 probes into the **2.0V** socket.

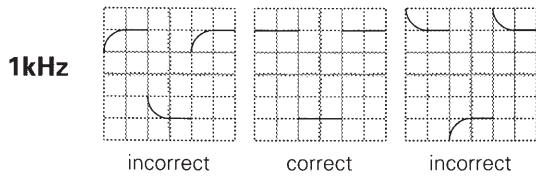

Approximately 2 complete waveform periods are displayed on the CRT screen. Now the compensation trimmer has to be adjusted. Normally, this trimmer is located in the probe head. On the 100:1 probe HZ53, however, it is located in the connecting box at the other end of the cable. Using a small insulated non-metallic screwdriver or trimming tool, the trimmer has to be adjusted slowly until the tops of the squarewave signal are exactly parallel to the horizontal graticule lines. (See Fig. above for 1kHz.) The signal amplitude shown should be $4\text{div.} \pm 0.12\text{div.}$ (= 3%). During this adjustment, the signal edges will remain invisible.

Adjustment at 1MHz

Probes HZ51, 52, and 54 will also allow for HF-adjustments. They incorporate resonance deemphasizing networks (R-trimmer in conjunction with inductances and capacitors) which permit probe compensation in the range of the upper frequency limit of the vertical oscilloscope amplifier. Only this compensative adjustment ensures optimum utilisation of the full bandwidth, together with constant group delay at the high frequency end, thereby reducing characteristic transient distortion near the leading signal edge (e.g. overshoot, rounding, ringing, holes or bumps) to an absolute minimum.

Using the probes HZ51, 52, and 54, the full bandwidth of the HM604 can be utilized without risk of unwanted waveform distortion.

Prerequisite for this HF-adjustment is a squarewave generator with fast risetime (typical 4ns), and low output impedance (approx. 50Ω), providing 0.2V and 2V at a frequency of approx. 1MHz. The calibrator output of the HM604 meets these requirements when the pushbutton 1MHz is depressed.

Connect the probe (HZ51, 52, or 54) to **CH.I** input. Depress the calibrator pushbutton **1MHz**. All other pushbuttons should be released (out position). Set the input coupling switch to **DC**, attenuator switch to **5mV/div**, and **TIME/DIV** switch to **0.1µs/div**. Set all variable controls to **CAL.** position.

Insert the probe tip into the output socket marked **0.2V**. A waveform will be displayed on the CRT screen, with leading and trailing edges clearly visible. For the HF-adjustment now to be performed, it will be necessary to observe the rising edge as well as the upper left corner of the pulse top. The connecting boxes of the HZ51 and HZ54 contain one R-trimmer screw, each, while that of the HZ52 provides three. These R-trimmers have to be

adjusted in such a manner that the beginning of the pulse top is as straight as possible. Overshoot or excessive rounding are unacceptable. This is relatively easy on the HZ51 and HZ54, but slightly more difficult on the HZ52. The rising edge should be as steep as possible, with the pulse top remaining as straight and horizontal as possible.

On the HZ52, each of the three trimmers has a clearly defined area of influence on the waveform shape (see Fig.), offering the added advantage of being able to straighten out waveform aberrations near the leading edge.

HZ51, HZ54

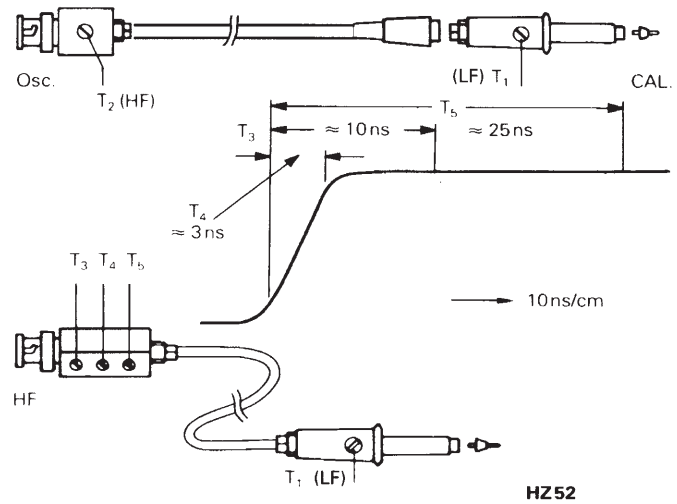

- T₃: alters the middle frequencies
- T₄: alters the leading edge
- T₅: alters the lower frequencies

After completion of the HF-adjustment, the signal amplitude displayed on the CRT screen should have the same value as during the 1kHz adjustment.

Probes other than those mentioned above, normally have a larger tip diameter and may not fit into the calibrator outputs. Whilst it is not difficult for an experienced operator to build a suitable adapter, it should be pointed out that most of these probes have a slower risetime with the effect that the total bandwidth of scope together with probe may fall far below that of the HM604. Furthermore, the HF-adjustment feature is nearly always missing so that waveform distortion can not be entirely excluded.

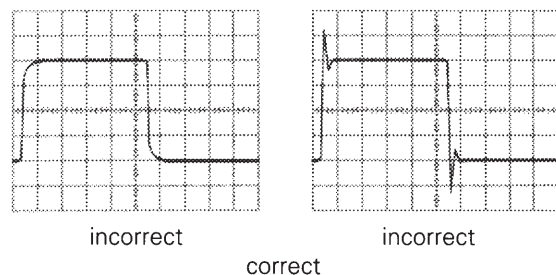

Adjustment 1MHz



The adjustment sequence must be followed in the order described, i.e. first at 1kHz, then at 1MHz. The calibrator frequencies should not be used for timebase calibrations. The pulse duty cycle deviates from 1:1 ratio.

Prerequisites for precise and easy probe adjustments, as well as checks of deflection coefficients, are straight horizontal pulse tops, calibrated pulse amplitude, and zero-potential at the pulse base. Frequency and duty cycle are relatively uncritical. For interpretations of transient response, fast pulse risetimes and low-impedance generator outputs are of particular importance.

Providing these essential features, as well as switch-selectable output-frequencies, the calibrator of the HM604 can, under certain conditions, replace expensive square-wave generators when testing or compensating wideband-attenuators or -amplifiers. In such a case, the input of an appropriate circuit will be connected to one of the **CAL.**-outputs via a suitable probe.

The voltage provided at a high-impedance input ($1\text{M}\Omega/15\text{-}50\text{pF}$) will correspond to the division ratio of the probe used ($10:1 = 20\text{mV}_{\text{pp}}$, $100:1 = \text{also } 20\text{mV}_{\text{pp}}$ from 2V output). Suitable probes are HZ51, 52, 53, and 54.

For low-impedance inputs (e.g. 50Ω), a 1:1 probe can be employed which, however, must be fully terminated with a 50Ω through-termination. A suitable probe type is HZ54, which must be switched to the 1:1 position, and the HF-trimmer in the connecting box turned fully counter-clockwise.

When connected to the **0.2V CAL.** socket, and using the HZ54, this arrangement will provide approx. 24mV_{pp} at 50Ω circuit input.

The voltage given here will have larger tolerances than 1% since operation of a 1:1 probe together with a 50Ω load is very uncommon.

Using the **2V CAL.** socket under similar conditions is only possible with the **HZ54** probe. The potential obtained at the 50Ω input will then be approx. 190mV_{pp} , but with almost twice the risetime. Accurate readings of the available input voltage can be shown directly on the HM604 when connecting a 50Ω through-termination between the BNC plug of the probe and the input of the oscilloscope.

Operating Modes of the Y Amplifier

The required operating modes are selected on three pushbuttons located in the Y-Section. For **Mono** operation all pushbuttons should be in the out position, the instrument is then operating on **Channel I** only.

For **Mono** operation with **Channel II**, the **CHI/II-TRIG.I/II** pushbutton has to be pressed. When the **DUAL** button is depressed, the HM604 is in **Dual** channel operation. In

this mode, the channels are displayed consecutively (alternate mode). This mode is not suitable for the display of very low frequency signals ($<1\text{kHz}$), as the trace will appear to flicker or jump. Under these conditions, the **ADD** button should be depressed additionally selecting chopped mode. In this position, both channels then share the trace during each sweep period. For the display of high frequency signals, the type of channel switching selected is less important.

To select the **add mode** only the **ADD** button should be depressed. The signals on both channels are then added together. If in this mode one channel is **inverted** (pushbutton **INVERT** depressed), then the **difference** between the two channels is displayed. For both of these operating modes, the vertical position of the trace depends on the setting of the **Y-POS.** controls of **both** channels.

Differential measurements techniques allow direct measurement of the voltage drop across floating components (both ends above ground). Two identical probes should be used for both vertical inputs. Using a separate ground connection and **not** connecting the probe or cable shields to the circuit under test avoid ground loops (hum, common-mode disturbances).

X-Y Operation

For **X-Y operation**, the pushbutton in the X-Section marked **X-Y** must be depressed. The X signal is then derived from the **Channel II. The calibration of the X signal during X-Y operation is determined by the setting of the Channel II input attenuator and variable control.** This means that the sensitivity ranges and input impedances are identical for both the X and Y axes. However, the **Y-POS.II** control is disconnected in this mode. Its function is taken over by the **X-POS.** control. It is important to note that the **X MAG. x10** facility, normally used for expanding the sweep, should not be operated in the X-Y mode. It should also be noted that the bandwidth of the X amplifier is approximately 5MHz (-3dB), and therefore an increase in phase difference between both axes is noticeable from 50kHz upwards.

The Y-Input signal may be inverted by using the **INVERT** (channel I) facility.

X-Y Phase Measurements

The X-Y phase measurement method can be used to measure the phase difference between two signals of the same frequency. This provides a method of measurement for signal frequencies up to 120kHz . However, above this frequency the inherent phase difference between the vertical and horizontal system makes accurate measurements difficult. In this mode, one of the sinewave signals provides horizontal deflection (X) while the other signal provides the vertical deflection (Y).

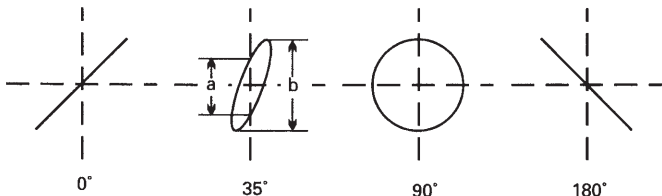

The phase angle between the two signals can be determined from the Lissajous pattern as follows:

$$\sin \varphi = \frac{a}{b}$$

$$\cos \varphi = \sqrt{1 - \left(\frac{a}{b}\right)^2}$$

$$\varphi = \arcsin \frac{a}{b}$$

This simple formula works for angles less than 90°, it is **independent** from both deflection amplitudes on the screen. **Caution!** If a single spot appears (both deflection voltages are missing) reduce the intensity immediately, as a high intensity setting may cause damage to the fluorescent screen of the CRT.

Dual-Trace Phase Difference Measurements

Phase comparison between two signals of the same frequency can be made using the dual-trace feature (**DUAL** button depressed). This method of phase difference measurement can be used up to the frequency limit of the vertical system. To make the comparison, use the following procedure:

Set the Input Coupling switches to the same position, and the **CH.I/II-TRIG.I/II** pushbutton to the channel where the reference signal (Phase 0°) is connected. Select **ALT.** channel switching for frequencies above 1kHz, and **CHOP.** for frequencies below 1kHz. Use probes which have equal time delay to connect the signals to the input connectors. Set the Input Attenuator switches and the CH I and CH II variable controls so that the displays are approximately equal and about five divisions in amplitude. Set the **TIME/DIV.** switch to a sweep rate which displays about one cycle of the waveform. Move the waveforms to the center of the graticule with the **Y-POS.I** and **Y-POS.II** controls. Turn the Variable Time Control until one cycle of the reference signal occupies exactly 10 divisions (see next figure). Each division represents 36° of the cycle.

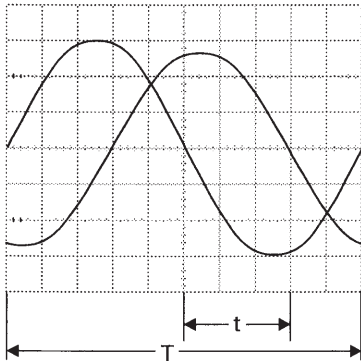

T = Horizontal distance **for one period** (div.)
t = Horizontal distance of zero-crossing points (div.)

Assume a horizontal difference of 3 divisions (**t** = 3div.) and a period of 10 divisions (**T** = 10div.), the phase

difference φ can be calculated using the following formula:

$$\varphi^\circ = \frac{t}{T} \cdot 360^\circ = \frac{3}{10} \cdot 360^\circ = 108^\circ$$

Measurement of an amplitude modulation

The momentary amplitude **u** at time **t** of a HF-carrier voltage, which is amplitude modulated without distortion by a sinusoidal AF voltage, is in accordance with the equation

$$u = U_T \cdot \sin \Omega t + 0,5m \cdot U_T \cdot \cos(\Omega - \omega)t - 0,5m \cdot U_T \cdot \cos(\Omega + \omega)t$$

where U_T = unmodulated carrier amplitude
 $\Omega = 2\pi F$ = angular carrier frequency
 $\omega = 2\pi f$ = modulation angular frequency
m = modulation factor (i.a. $\leq 1 \hat{=} 100\%$).

The lower side frequency **F-f** and the upper side frequency **F+f** arise because of the modulation apart from the carrier frequency **F**.

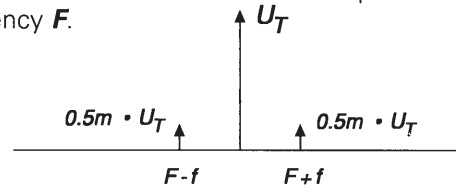

Figure 1
Amplitude and frequency spectrum for AM display (**m** = 50%)

The display of the amplitude-modulated HF oscillation can be evaluated with the oscilloscope provided the frequency spectrum is inside the oscilloscope bandwidth. The time base is set so that several cycles of the modulation frequency are visible. Strictly speaking, triggering should be external with modulation frequency (from the AF generator or a demodulator). However, internal triggering is frequently possible with normal triggering using a suitable **LEVEL** setting and possibly also using the time variable adjustment.

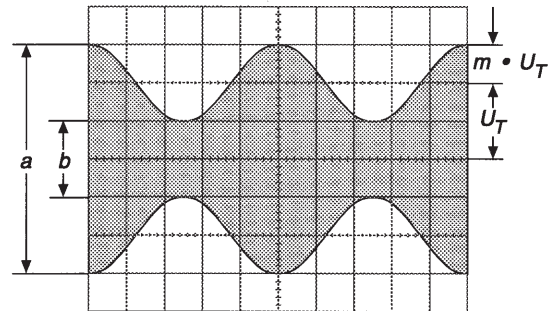

Figure 2
Amplitude modulated oscillation: **F** = 1 MHz; **f** = 1 kHz;
m = 50 %; $U_T = 28.3 \text{ mV}_{\text{rms}}$.

Oscilloscope setting for a signal according to figure 2:
Depress no buttons. **Y: CH. I; 20mV/div; AC.**
TIME/DIV.: 0.2ms/div.

Triggering: **NORMAL** with **LEVEL**-setting; **internal (or external) triggering.**

If the two values **a** and **b** are read from the screen, the modulation factor is calculated from

$$m = \frac{a-b}{a+b} \text{ resp. } m = \frac{a-b}{a+b} \cdot 100 [\%]$$

where **a** = $U_T (1+m)$ and **b** = $U_T (1-m)$.

The variable controls for amplitude and time can be set arbitrarily in the modulation factor measurement. Their position does not influence the result.

Triggering and Timebase

With the **LEVEL** knob in locked position (turned ccw to **AT** position = automatic triggering), a baseline is displayed continuously even when no signal is present. In this position it is possible to obtain stable displays of virtually all uncomplicated, periodically repeating signals above 30Hz. Adjustments of the timebase then are limited to timebase setting.

With normal triggering (**LEVEL** knob not in **AT** position) and **LEVEL** adjustment, triggering of time/div. deflection can be set in any point of a given signal. The triggering range which can be set with the **LEVEL** control depends greatly on the amplitude of the displayed signal. If it is less than 1div, then the range is quite small and performance of settings requires a delicate touch.

If the **LEVEL** control is incorrectly set, no trace will be visible.

In order to obtain a satisfactory stable display, the timebase must be triggered synchronously with the test signal. The trigger signal can be derived from the test signal itself, when internal triggering is selected, or from a frequency related signal applied to the external trigger input.

Triggering can be selected on either the rising or falling edge of the trigger signal depending on whether the **SLOPE +/-** pushbutton (next to **LEVEL**) is in the out or in position. In the out position, triggering from the positive-going edge is selected. The correct slope setting is important in obtaining a display when only a portion of a cycle is being displayed.

With **internal triggering** in the **Mono channel mode** on the Y amplifier, the trigger signal is derived from the respective channel in use. In the **Dual channel mode**, the internal trigger signal may be selected from either **Channel I** or **Channel II** using the **CHI/II-TRIG.I/II** button; in the out position, the trigger signal is derived from Channel I. However, it is always preferable to trigger from the less complicated signal.

With **internal alternate triggering** (**ALT** pushbutton in the X-Section depressed) in the **DUAL** channel alternate mode of the Y amplifier, the trigger voltage is derived **alternately from Channel I and Channel II**. This trigger mode is particularly useful when **two asynchronous signals** are being investigated. Normal triggering should be preferable in this mode. The display of one signal only is not possible on the alternate trigger mode.

For **external triggering**, the **EXT.** pushbutton in the X-Section must be depressed. The sync. signal ($0.05V_{pp}$ - $0.5V_{pp}$) must then be fed to the **TRIG. INP.** input socket.

Coupling mode and frequency range of the trigger signal are selected with the **TRIG.** lever switch in the X-Section

for internal and external triggering, provided that the **TV SEP.** switch is in off position. The HM604 has 4 coupling modes: **AC, DC, LF, HF**. The **AC** coupling mode is mainly used. **DC** trigger coupling is only recommended, when very low frequency signals are being investigated and triggering at a particular value is necessary, or when pulses, which significantly change in duty cycle during observation time, have to be displayed. If **DC** coupling is selected, it is advisable to use the **normal triggering** mode. In the **HF** coupling mode, a **high pass filter** is switched into the trigger amplifier. This filter cuts off the DC content of the trigger signal and the lower frequency range.

In the **LF** coupling mode, a **low-pass filter** is switched into the trigger amplifier. This filter cuts off any amplifier noise and the frequency range of the trigger signal above 50kHz.

For the purpose of **line triggering** (**TRIG.** lever switch in the X-Section) to \sim , a (divided) secondary voltage of the power transformer is used as a trigger signal. This trigger mode is independent of the signal amplitude or display height and allows a display below the (internal) trigger threshold. Line triggering is recommended for all signals which are time-related (multiple or submultiple) to the mains/line frequency or when it is desirable to provide a stable display of a line-frequency component in complex waveforms. Therefore it is especially suited for the measurement of small ripple voltages from power supply rectifiers or of magnetic or static leakage fields in a circuit.

In some countries, the standard power plug has symmetrically arranged plugs (interchanging of **Line** and **Neutral** is possible). In such cases, the **SLOPE +/-** pushbutton may indicate the wrong polarity compared with the display (triggering with falling edge instead of rising edge). For correction, the power plug of the instrument has to be turned.

Triggering of video signals

The built-in active **TV-Sync-Separator** separates the sync pulses from the video signal, permitting the display of distorted video signals either in line (**H** = horizontal) or in frame (**V** = vertical) trigger mode. The **TV** lever switch has five positions: the **OFF** position is for normal operation. The **TV: H+** and **H-** positions (horizontal=line) and the **TV: V+** and **V-** (vertical=frame) positions are used for video triggering. In these four positions the **TRIG.** coupling switch and the **LEVEL** control (in **NORM.** trigger mode) are inoperative. In the **TV: V+** and **V-** positions (frame triggering), a low-pass filter or integrating network is connected into circuit, which forms a trigger pulse sequence with frame frequency from the vertical sync pulses (incl. pre- and postequalizing pulses).

When in **V** mode, it is possible to select field I or II by releasing or depressing **FIELD I/II** pushbutton.

For correct video triggering, the **+** and **-** positions at **V** and **H** must be selected corresponding to the video input signal. If the sync pulses are placed above the picture

content, **H+** or **V+** should be in use. For sync pulses below the picture content of the input signal, correct triggering, without any influence from changing picture contents, will be possible only in **V-** or **H-** setting. The **INVERT** pushbutton only changes the display on the CRT, not the input signal.

In **TV: H** trigger mode, the trigger point lies on the starting edge of a sync pulse if **SLOPE** button is in **+** position. As mentioned before, in **TV: V** mode an integrating network is additionally added to the sync separator which delays the formed trigger pulse by about 50µs.

Video signals are triggered in the automatic mode. Therefore the adjustment of the trigger point is superfluous. The internal triggering is virtually independent of the display height, which may differ from 0.8 to 8div. As opposed to **AT** mode, when in **normal** mode, the screen is blanked without signal at the input (turning the **LEVEL** knob is ineffectual).

Function of var. HOLD-OFF control

If it is found that a trigger point cannot be located on extremely complex signals even after repeated and careful adjustment of the **LEVEL** control in the **Normal Triggering** mode, a stable display may be obtained using the **HOLD-OFF** control (in the X-Section). This facility varies the hold-off time between two sweep periods up to the ratio >5:1. Pulses or other signal waveforms appearing during this off period cannot trigger the timebase. Particularly with burst signals or aperiodic pulse trains of the same amplitude, the start of the sweep can be shifted to the optimum or required moment. After specific use the **HOLD-OFF** control should be re-set into its calibration detent **min.**, otherwise the brightness of the display is reduced drastically.

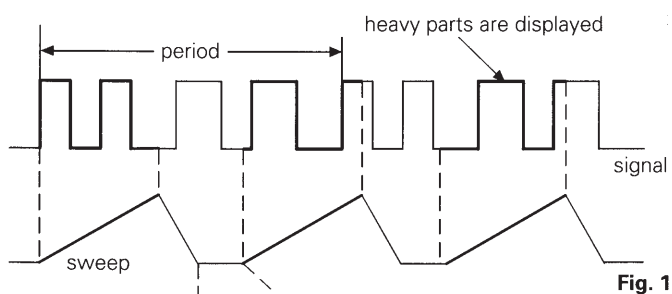

Fig. 1

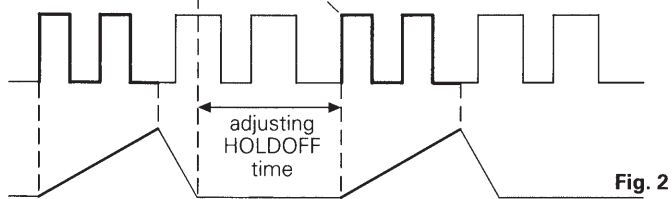

Fig. 2

Fig. 1 shows a case where the **HOLD-OFF** knob is in the **x1** position and various different waveforms are overlapped on the screen, making the signal observation unsuccessful.

Fig. 2 shows a case where only the desired parts of the signal are stably displayed.

Sweep Delay / After Delay Triggering

With the sweep delay, the start of the sweep can be delayed from the trigger point by a selectable time (100ns to maximum 1s). It is therefore possible to start the sweep at practically any point of a waveform. The interval, which follows the start of the sweep, can be greatly expanded by the increase of the sweep speed. From the **5µs/div.** **TIME/DIV.** range downwards to slower sweep speeds, an expansion of at least 100 times, and with the aid of the **X MAG. x10** expansion of 1000 times, is possible. With time coefficients higher than 5µs/div., the maximum expansion increases proportionally. However, with increasing the expansion, the display brightness decreases. Under very high ambient light conditions a Viewing Hood like HZ47 can overcome this problem. It should be noted that there are some difficulties with higher expansions, if the test signal has inherent jitter.

To reduce or eliminate this jitter, expanded parts of a signal can be triggered again "after delay" provided there is another suitable edge (**DEL. TRIG.**).

In **DEL. TRIG.** mode **and TV SEP.** switch in **H** or **V** position, after delay triggering to the next following line is possible. Therefore discrete lines are representable. The slope is appointed by the **TV+** or **TV-** position of the delay switch. When not in TV-trig. mode the susceptibility to interference (**sense**) can be influenced (▲ = normal, ▼ = reduced).

Operation of the sweep delay is relatively easy, as normally only 3 controls in the X-Section need to be used: the **DELAY** operating mode lever switch (**OFF-SEARCH-DELAY-DEL. TRIG.**), the **DELAY** rotary switch (delay time range), and its variable control **VAR. 10:1** (small knob on the **DELAY** switch). The latter, a twenty-turn precision potentiometer with overwind protection, can increase the delay time range tenfold. An LED near the **DELAY** mode switch indicates the operating mode.

For reliable operation of the sweep delay, it is recommended that the following procedure should always be adopted; also reference to the accompanying figures will be of assistance.

Figure 1

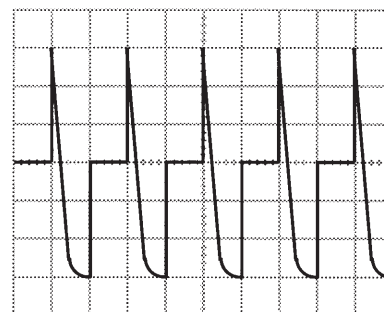

MODE: **NORM.**
 TIME/DIV.: **0.5ms/div.**
 LED: off

Initially, the sweep delay mode lever switch should be set in the **OFF** position. In this mode, the complete waveform under investigation will be displayed as for normal

oscilloscope operation. The mode indicator LED is not illuminated in **OFF** mode. The time coefficient on the **TIME/DIV.** switch is selected so that **1 to 3 basic periods of the signal** are displayed. A larger number unnecessarily decreases the brightness and maximum expansion. The display of only a portion of a period limits the choice of the expanded time interval and possibly complicates the triggering. On the other hand, the range of 1 to 3 basic periods can always be set unconstrainedly with the **TIME/DIV.** switch. In doing so, the **x10 expansion must be switched off temporarily (X MAG. x10 button is in out position)**. In the X-Section, the **HOLD-OFF** control should be set to **min.** and the variable control to **CAL.** The **LEVEL** control is adjusted so that stable triggering is ensured (**TRIG.** LED is illuminated).

The mode switch should now be set to the **SEARCH** position; it will be seen that the start of the display will shift to the right. The amount of shift indicates the exact delay time.

If a display is not obtained in this mode, then a lower delay time range should be selected. For example, when investigating the waveform shown in the figures, a display could not be obtained with a delay time setting of **10ms**, as the display is completely blanked. However, as a result of setting the **DELAY** rotary switch to **0.1µs**, the shifting is not visible. The **DELAY** range switch should then be rotated clockwise until the display starts just prior to the short time interval to be investigated. The precise adjustment to the start is done with the **VAR. 10:1** delay time control. The rotating range of the latter has no stop. On the range limits a certain snapping noise is audible. Initially, this control should be set in the left start position. In the **SEARCH** mode, the LED indicator will flash.

Figure 2

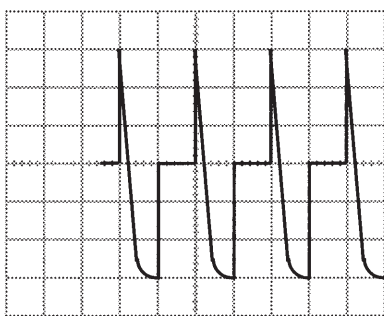

MODE: **SEARCH**
 DELAY range: **1ms**
 TIME/DIV.: **0.5ms/div.**
 LED: flashing

$$\text{Delay time} = 2.5 \text{ div.} \times 0.5 \text{ ms/div.} = 1.25 \text{ ms}$$

In figure 2 it can be seen that the delay time is also measurable as the blanked portion or apparent shift of the start of the trace. This time can be determined by multiplication of (the horizontal shifting in cm) by (the time coefficient set on the **TIME/DIV.** switch).

Now the mode switch can be set to **DELAY**. In this mode, the LED is permanently illuminated. The display will now shift to the left and the trace will commence in the same position as for a normal display; however, the short time interval under investigation now starts on the first or left vertical graticule line.

Figure 3

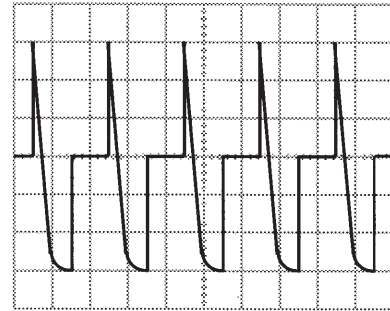

MODE: **DELAY**
 DELAY range: **1ms**
 TIME/DIV.: **0.5ms/div.**
 LED: illuminated

If the timebase sweep speed is increased (rotate **TIME/DIV.** switch clockwise), then the short time interval will be expanded. It may be found that, as the amount of expansion is increased, the trace will tend to shift. If this happens, the **VAR.** delay time control can be readjusted – also subsequently at any time – to enable the exact point of interest to be displayed.

In the example shown in figure 4, it can be seen that an expansion of **x10** was obtained by increasing the timebase sweep speed from **0.5ms/div. to 50µs/div.** Also the precise measurement for the delayed portion of the waveform is possible. In the example, this was found to be **250µs** on multiplication of the horizontal length in div. (of an optional signal section) by the time coefficient just adjusted.

Figure 4

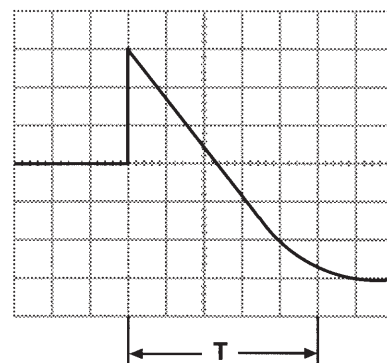

MODE: **DELAY**
 DELAY range: **1ms**
 TIME/DIV.: **50µs/div.**
 LED: illuminated
 Expansion: $0.5 \times 10^{-3} : 50 \times 10^{-6} = 10$
 $T = 5 \text{ div.} \times 50 \mu\text{s/div.} = 250 \mu\text{s}$

Operation of the sweep delay requires a constant trigger point. All signals, which have a constant phase shift between the expanded section and trigger point, pose no problems. This means all electrical signal shapes, which contain signal edges of the same polarity and with triggerable level values, which are constantly repeated with the recurring frequency.

If there is no constant phase shift, the triggering may fail after switching from the **SEARCH** to **DELAY** position or with changing of the time coefficient. It is best to attempt to find a trigger point, which has a constant phase shift up to the signal section to be expanded in the **OFF** mode. With complicated composite signals, the display of the basic period could become superimposed by other signal portions. These disappear as a rule when the sweep is increased. Otherwise, a stable expanded display is obtained by adjusting the **LEVEL** and the variable sweep control or by means of the **HOLD-OFF** control.

Using the **X MAG. x10** button, a *tenfold expansion* of the desired signal section is possible without any change of triggering or timebase. This can be of assistance with complicated or difficult-to-trigger signals.

Operation of the sweep delay needs some experience, particularly with composite signals. However, the display of sections from simple signal waveforms is easily possible. It is recommended to operate only the sequence **OFF-SEARCH-DELAY**, because otherwise location of the short time interval to be investigated will be relatively difficult. The sweep delay facility can be used in the following modes: **Mono**, **Dual**, and **Algebraic Addition ($\pm I+II$)**.

Delay Mode Indication

Both operating modes of the sweep delay are indicated with an LED, located to the right of the DELAY mode lever switch. In **SEARCH** position, the LED will flash. This is an indication of the temporary operating state. The **DELAY** position is indicated by constant lighting of the LED. However, should this be noted, and normal operating mode is required then the change-over of the lever switch to its **OFF** position has been overlooked. This could cause errors in displaying a signal by complete or partial blanking. This indication, therefore, should be closely observed.

Component Tester

General

The HM604 has a built-in electronic Component Tester (abbreviated **CT**), which is used for instant display of a test pattern to indicate whether or not components are faulty. The **CT** can be used for quick checks of semiconductors (e.g. diodes and transistors), resistors, capacitors, and inductors. Certain tests can also be made to integrated circuits. All these components can be tested in and out of circuit.

The test principle is fascinatingly simple. The power transformer of the oscilloscope delivers a sine voltage, which is applied across the component under test and a built-in fixed resistor. The sine voltage across the test object is used for the horizontal deflection, and the voltage drop across the resistor (i.e. current through test object) is used for vertical deflection of the oscilloscope. The test pattern shows a current-voltage characteristic of the test object.

Since this circuit operates with mains/line frequency (50 or 60Hz) and a voltage of 8.5V max. (open circuit), the indicating range of the **CT** is limited. The impedance of the component under test is limited to a range from 20 Ω to 4.7k Ω . Below and above these values, the test pattern shows only short-circuit or open-circuit. For the interpretation of the displayed test pattern, these limits should always be borne in mind. However, most electronic components can normally be tested without any restriction.

Using the Component Tester

The **CT** is switched on by depressing the **COMPONENT TESTER** pushbutton. This makes the vertical preamplifier and the timebase generator inoperative. A shortened horizontal trace will be observed. It is not necessary to disconnect scope input cables unless in-circuit measurements are to be carried out. In the **CT** mode, the only controls which can be operated are **INTENS.**, **FOCUS**, and **X-POS**. All other controls and settings have no influence on the test operation.

For the component connection, two simple test leads with 4mm \varnothing banana plugs, and with test prod, alligator clip or sprung hook, are required. The test leads are connected to the insulated **CT** socket and the adjacent ground socket in the Y-Section. The component can be connected to the test leads either way round.

After use, to return the oscilloscope to normal operation, release the **COMPONENT TESTER** pushbutton.

Test Procedure

Caution! Do not test any component in live circuitry remove all grounds, power and signals connected to the component under test. Set up Component Tester as stated above. Connect test leads across component to be tested. Observe oscilloscope display.

Only discharged capacitors should be tested!

A built-in quick-acting fuse protects the **CT** and the oscilloscope against mis-operation, e.g. device under test not disconnected from mains/line supply. In that case the fuse will blow. For fuse replacement the oscilloscope has to be opened (see service instruction page S1 "Instrument Case Removal"). The fuse is located on the bottom side of the instrument (close to the CT pushbutton). Make sure that only fuses of the specified type are used for replacement: **5x20mm, quick-acting, 250V, C, 50mA** (IEC 127/II or DIN 41661).

Test Pattern Displays

Page M17 shows typical test patterns displayed by the various components under test.

- **Open circuit is indicated by a straight horizontal line.**
- **Short circuit is shown by a straight vertical line.**

Testing Resistors

If the test object has a linear ohmic resistance, both deflecting voltages are in the same phase. The test pattern expected from a resistor is therefore a sloping straight line. The angle of slope is determined by the resistance of the resistor under test. With high values of resistance, the slope will tend towards the horizontal axis, and with low values, the slope will move towards the vertical axis.

Values of resistance from **20Ω** to **4.7kΩ** can be approximately evaluated. The determination of actual values will come with experience, or by direct comparison with a component of a known value

Testing Capacitors and Inductors

Capacitors and inductors cause a phase difference between current and voltage, and therefore between the X and Y deflection, giving an ellipse-shaped display. The position and opening width of the ellipse will vary according to the impedance value (at 50 or 60Hz) of the component under test.

A horizontal ellipse indicates a high impedance or a relatively small capacitance or a relatively high inductance.

A vertical ellipse indicates a small impedance or a relatively large capacitance or a relatively small inductance.

A sloping ellipse means that the component has a considerable ohmic resistance in addition to its reactance.

The values of capacitance of normal or electrolytic capacitors from **0.1μF** to **1000μF** can be displayed and approximate values obtained. More precise measurement can be obtained in a smaller range by comparing the capacitor under test with a capacitor of known value. Inductive components (coils, transformers) can also be tested. The determination of the value of inductance needs some experience, because inductors have usually a higher ohmic series resistance. However, the impedance value (at 50 or 60Hz) of an inductor in the range from 20Ω to 4.7kΩ can easily be obtained or compared.

Testing Semiconductors

Most semiconductor devices, such as diodes, Z-diodes, transistors, FETs can be tested. The test pattern displays vary according to the component type as shown in the figures below.

The main characteristic displayed during semiconductor testing is the voltage dependent knee caused by the

junction changing from the conducting state to the non conducting state. It should be noted that both the forward and the reverse characteristic are displayed simultaneously. This is always a two-terminal test, therefore testing of transistor amplification is not possible, but testing of a single junction is easily and quickly possible. Since the **CT** test voltage applied is only very low (max. 8.5V_{rms}), all sections of most semiconductors can be tested without damage. However, checking the breakdown or reverse voltage of high voltage semiconductors is not possible. More important is testing components for open or short-circuit, which from experience is most frequently needed.

Testing Diodes

Diodes normally show at least their knee in the forward characteristic. This is not valid for some high voltage diode types, because they contain a series connection of several diodes. Possibly only a small portion of the knee is visible. Z-diodes always show their forward knee and, up to approx. 10V, their Z-breakdown, forms a second knee in the opposite direction. A Z-breakdown voltage of more than 12V can not be displayed.



Type:	Normal Diode	High Voltage Diode	Z-Diode 12V
Terminals:	Cathode-Anode	Cathode-Anode	Cathode-Anode
Connections:	(CT-GD)	(CT-GD)	(CT-GD)

The polarity of an unknown diode can be identified by comparison with a known diode.

Testing Transistors

Three different tests can be made to transistors: base-emitter, base-collector and emitter-collector. The resulting test patterns are shown below.

The basic equivalent circuit of a transistor is a Z-diode between base and emitter and a normal diode with reverse polarity between base and collector in series connection. There are three different test patterns:

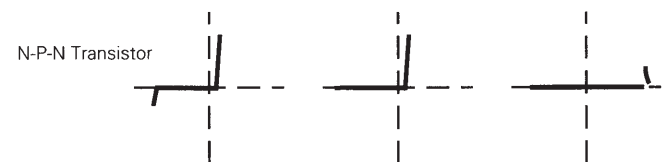

Terminals:	b-e	b-c	e-c
Connections:	(CT-GD)	(CT-GD)	(CT-GD)

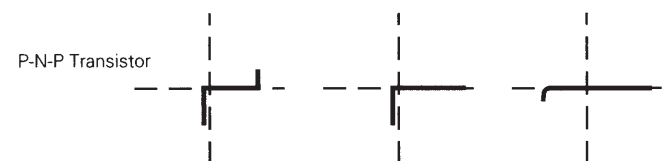

Terminals:	b-e	b-c	e-c
Connections:	(CT-GD)	(CT-GD)	(CT-GD)

For a transistor the figures b-e and b-c are important. The figure e-c can vary; but a vertical line only shows short circuit condition.

These transistor test patterns are valid in most cases, but there are exceptions to the rule (e.g. Darlington, FETs). With the **CT**, the distinction between a P-N-P to a N-P-N transistor is discernible. In case of doubt, comparison with a known type is helpful. It should be noted that the same socket connection (**CT** or ground) for the same terminal is then absolutely necessary. A connection inversion effects a rotation of the test pattern by 180 degrees round about the center point of the scope graticule.

Pay attention to the usual caution with single MOS-components relating to static charge or frictional electricity!

In-Circuit Tests

Caution! During in-circuit tests make sure the circuit is dead. No power from mains/line or battery and no signal inputs are permitted. Remove all ground connections including Safety Earth (pull out power plug from outlet). Remove all measuring cables including probes between oscilloscope and circuit under test. Otherwise the connection of both CT test leads is not recommended.

In-circuit tests are possible in many cases. However, they are not so well-defined. This is caused by a shunt connection of real or complex impedances especially if they are of relatively low impedance at 50 or 60Hz to the component under test, often results differ greatly when compared with single components. In case of doubt, one component terminal may be unsoldered. This terminal should then be connected to the insulated **CT** socket avoiding hum distortion of the test pattern.

Another way is a test pattern comparison to an identical circuit which is known to be operational (likewise without power and any external connections). Using the test prods, identical test points in each circuit can be checked, and a defect can be determined quickly and easily. Possibly the device itself under test contains a reference circuit (e.g. a second stereo channel, push-pull amplifier, symmetrical bridge circuit), which is not defective.

The test patterns on page M17 show some typical displays for in-circuit tests.

Miscellaneous

A positive-going **sawtooth voltage** of approximately **5V_{pp}** coincident with displays sweep time is available at a BNC output connector on the rear panel. This ramp output is marked with \sphericalangle . The load impedance should not be less than 10k Ω ||47pF. If the DC potential of the ramp output is not required, a capacitor should be connected in series with the output. The ramp output can be used for different measuring tasks in combination with the oscilloscope and other instruments, triggering of signal sources, swept-frequency signal generators and so on.

The oscilloscope also contains a **vertical output** with BNC connector marked **Y** on the rear panel. The output voltage is **>50mV_{pp}/div.** display height (into 50 Ω). It is picked off from the vertical amplifier like the trigger signal and it is similarly switchable. Channel **I** or **II** is selected with the **CHI/II-TRIGI/II** pushbutton. With alternate channel switching (**DUAL** button in the Y-Section depressed) and alternate triggering (**ALT.** button in the X-Section depressed), the vertical output is consecutively driven (in time with the sweep period) from Channel I and Channel II. The vertical output is not dependent on the vertical trace position. It does not respond to the adjustment of the **Y-POS.I** and **Y-POS.II** controls and to the depressing one of the **INVERT** buttons. The vertical output is DC coupled and has approximately zero level to ground. The bandwidth of the output is approx. 60MHz (with 50 Ω termination).

The vertical output can be used to increase the input sensitivity of the oscilloscope. However, it must be noticed that a **DC**-offset voltage at the vertical output is unavoidable. Therefore under normal conditions **AC** coupling is recommended. Due to the higher gain more noise is visible.

The measuring signal (e.g. **1mV_{pp}**) is connected to the input of channel I while the attenuator is in the **2mV/div.** position. So the signal is displayed with 0.5 div. height, which is sufficient to enable triggering. The oscilloscope must be set to internal triggering with channel I as trigger source. From the vertical output, the measuring signal should be connected via a coaxial cable (e.g. **HZ34**) and a 50 Ω through termination to the input of channel II. The signal amplitude there is **25mV_{pp}**. The attenuator of channel II should be set to 5mV/div. and the vertical amplifier to **DUAL** mode. The measuring signal is then displayed with a height of approx. **5** divisions.

Single Components

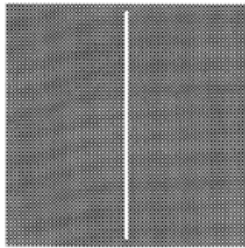

Short circuit

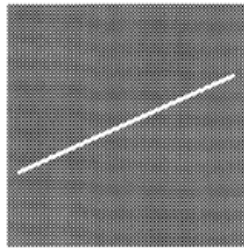

Resistor 510Ω

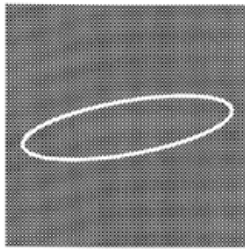

Mains transformer prim.

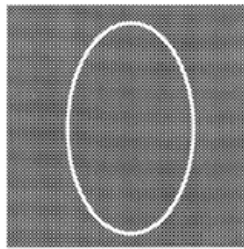

Capacitor 33μF

Single Transistors

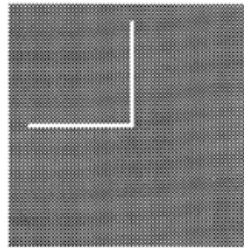

Junction B-C

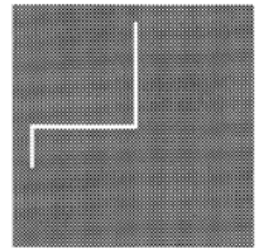

Junction B-E

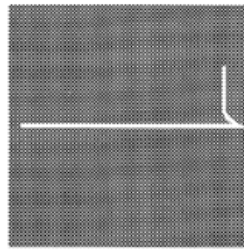

Junction E-C

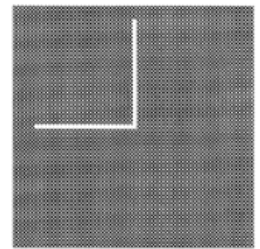

FET

Single Diodes

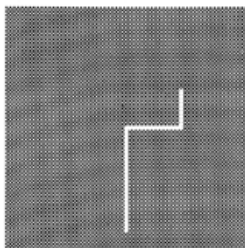

Z-diode below 8V

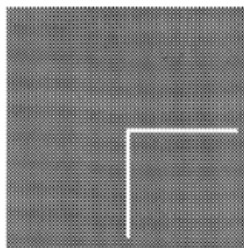

Z-diode beyond 12V

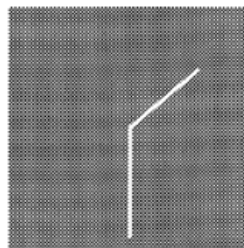

Diode paralleled by 680Ω

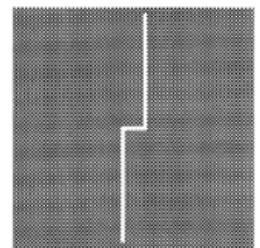

2 Diodes antiparallel

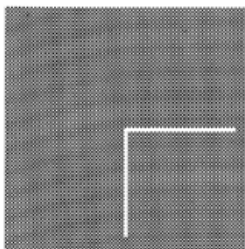

Silicon diode

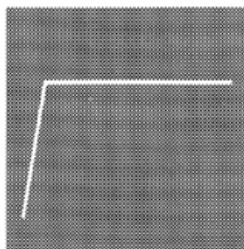

Germanium diode

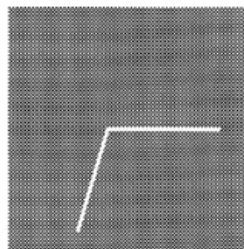

Diode in series with 51Ω

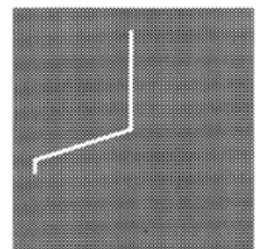

B-E paralleled by 680Ω

In-circuit Semiconductors

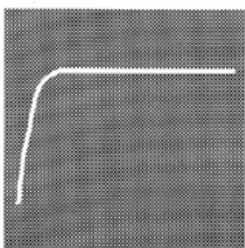

Rectifier

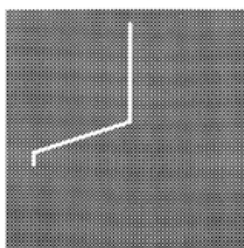

Thyristor, G + A together

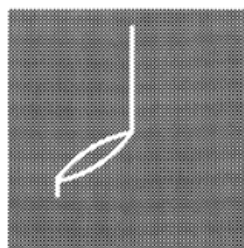

B-E with 1μF+680Ω

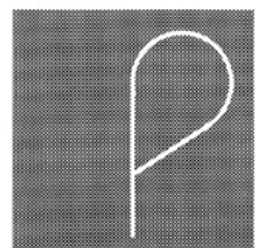

Si.-Diode with 10μF

First Time Operation

Connect the instrument to power outlet. Switch on **POWER** pushbutton. No other button is depressed. LED indicates operating condition.

Case, chassis, and all measuring connectors are connected to the Safety Earth Conductor (Safety Class I).

TRIG. selector switch to **AC, TV SEP.** switch to **OFF, LEVEL** knob in **AT** position (Automatic Triggering). DELAY lever switch to **OFF.** and **HOLD-OFF** control **min.**

Adjust **INTENS.** control for average brightness.

Center trace on screen using **X-POS.** and **Y-POS.I** controls. Then focus trace using **FOCUS** control.

Operating Modes of the Vertical System

Channel I: All pushbuttons in out position.

Channel II: **CH.I/II-TRIG.I/II** button depressed.

Channel I and Channel II: **DUAL** button depressed.

Alternate channel switching: **ADD.** button in out position.

Chopped channel switching: **DUAL and ADD** buttons depressed. Signals <1kHz with **CHOP.**

Channel I+II (sum): **ADD** button depressed only.

Channel -I+II (difference): **ADD and INVERT** (CH.I) buttons depressed.

Channel +I-II (difference): **ADD and INVERT** (CH.II) buttons depressed.

Trigger Modes

Automatic Triggering: **LEVEL** knob in **AT** position. Trace always visible.

Normal Triggering: **LEVEL** turned cw. Trace visible when triggered.

Triggering from positive-going signal edge: **SLOPE +/-** button is in out position.

Triggering from negative-going signal edge: **SLOPE +/-** button depressed.

This facility is important when only a portion of a cycle is being displayed.

Internal triggering: select Channel with button **CH.I/II-TRIG.I/II.**

Internal alternate triggering: **ALT** button is depressed (only with alternate channel switching).

External triggering from **TRIG. INP.** connector: **EXT.** button depressed.

External trigger signal: 50mV-0.5V_{pp}, time-related to vertical input signal.

Line triggering: **TRIG.** selector switch in \sim position.

Trigger coupling selected with **TRIG.** switch **AC-DC-LF-HF.**

Trig. freq. range: **AC** and **DC** to 20MHz, **HF** above 50kHz, **LF** below 50kHz.

Video signals with line freq.: **TV SEP.** switch to **H+** or **H-**.

Video signals with frame freq.: **TV SEP.** switch to **V+** or **V-**.

First or second half of frame selection with **FIELD I/II** switch.

Pay attention to **TRIG.** indication LED!

Measuring

Connect test signal to **CH.I** and/or **CH.II** vertical input connector.

Compensate attenuator probe using **CAL.** square-wave signal.

Select **AC** or **DC** input coupling. **GD:** Y amplifier is disconnected from input and grounded.

Adjust required display height of signal with attenuator switch and variable control.

Select sweep speed with **TIME/DIV.** switch and variable control.

Adjust trigger point with **LEVEL** control.

Calibrated amplitude measurement with attenuator variable control to **CAL.**

Calibrated time measurement with **TIME/DIV.** variable control to **CAL.**

Trigger complex or aperiodic signals using **HOLD-OFF** control in normal trigger mode.

Horizontal x10 expansion: **X MAG. x10** button depressed.

External horizontal deflection: (**X-Y operation**) with **X-Y** button depressed (X input via **CH.II**).

Sweep Delay Operation

OFF: normal oscilloscope operation. DELAY LED not illuminated.

SEARCH: use **DELAY** range switch and **VAR. 10:1** fine control to select point of interest on displayed wave-form. DELAY LED flashing.

DELAY: delayed signal now displayed. Expansion obtained by rotating **TIME/DIV.** switch clockwise. Press **X MAG. x10** button if necessary. DELAY LED illuminated.

DEL TRIG.: After Delay Triggering; together with **TV SEP.:** selection of trigger slope.

Component Tester

Press **COMPONENT TESTER** button. Connect both component terminals to **CT** and ground jacks.

In-circuit test: Circuit under test must be disconnected to battery or power (pull out power plug), signals and ground (earth). Remove all signal connections to HM604 (cable, probe), then start testing.

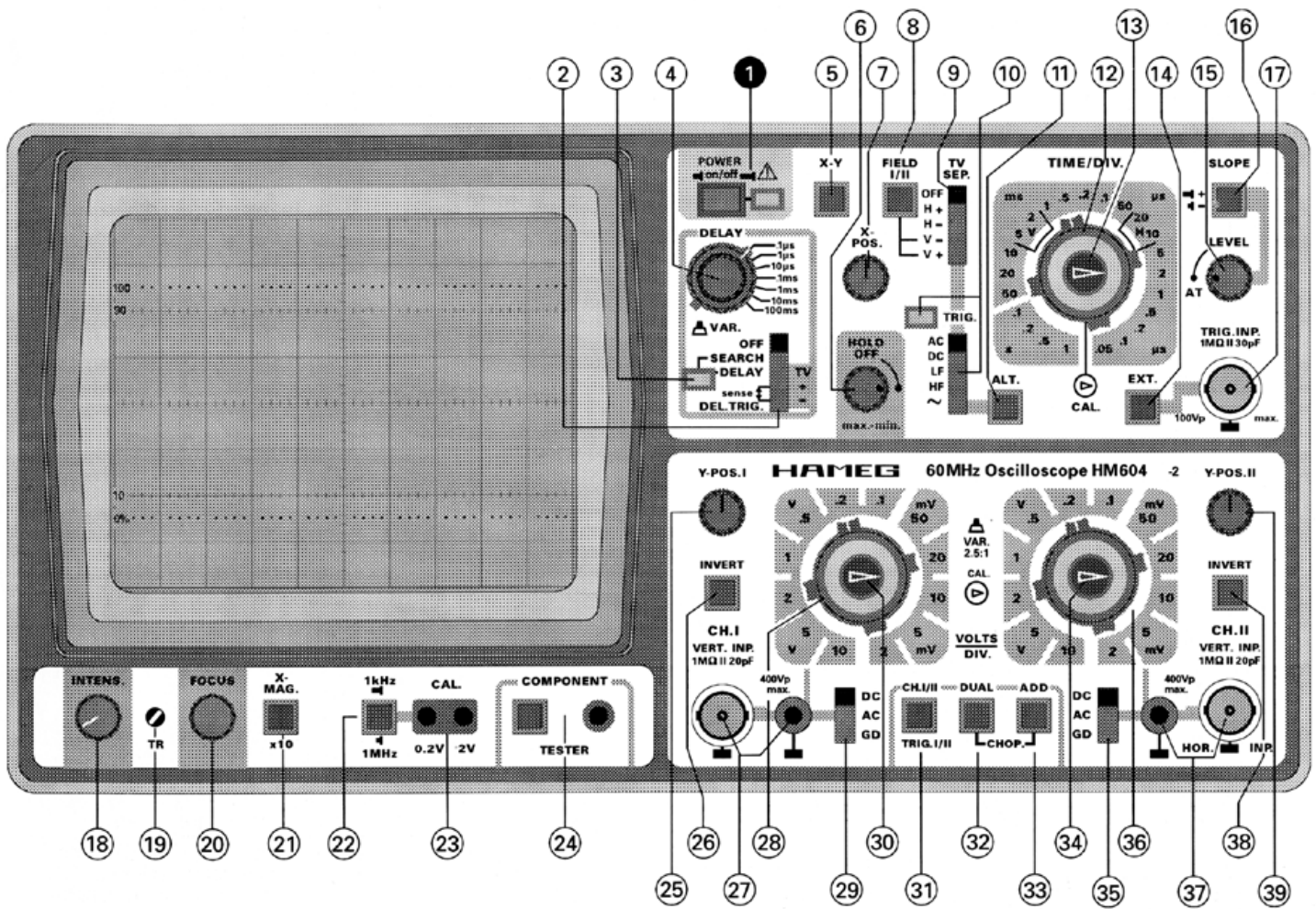

Front Panel Elements HM 604-2

Element	Function	Element	Function
① POWER on/off (pushbutton + LED)	Mains switch; when depressed: on. LED indicates operating condition.	②① X-MAG. x10 (pushbutton)	10 fold expansion in X direction. When depressed, max. resolution = 5ns/div.
② DELAY OFF, SEARCH, DELAY, DEL. TRIG. (TV+/-) (lever switch)	5pos. switch for DELAY mode operation: OFF = normal; SEARCH = delay time select; DELAY = delayed timebase. Turning TIME/DIV. cw = expansion. DEL. TRIG. = additional triggering after delayed time has elapsed. TV+/- = selection of slope from delayed signal when in TV trig. mode.	②② 1kHz – 1MHz (pushbutton)	Selects calibrator frequency. Button released = 1kHz; button depressed = 1MHz.
③ DELAY (LED)	Indicator for DELAY mode: OFF = normal, SEARCH = flashes DELAY = permanently illuminated.	②③ CAL. 0.2V-2V (test sockets)	Calibrator square wave output, 0.2V _{pp} or 2V _{pp} (frequ. adjust ②②)
④ DELAY (7pos. rotary switch, outer knob. Fine adjustment = center pot.)	Coarse adjustment of delay time. Operative only during SEARCH, DELAY and DEL. Trig modes of DELAY lever switch.	②④ COMPONENT TESTER (pushbutton switch and single pole socket)	Switch to convert oscilloscope to component tester mode. Connector for single test lead. Second test lead is connected to chassis ground socket.
⑤ X-Y (pushbutton)	Selects XY operation. Switches off the internal timebase generator and connects channel II to the X amplifier.	②⑤ Y-POS.I (knob)	Controls vertical position of channel I display.
Attention! Phosphor burn-in without signal.		②⑥ INVERT (CHI) (pushbutton)	Inversion of CH. I display. In combination with ADD button ③③ = difference CH. II CH. I. (Does not influence triggering).
⑥ HOLD OFF (knob)	Controls holdoff time between sweeps. Normal position = fully cw.	②⑦ CH. I (BNC connector) Ground (4mm socket)	Channel I signal input. Input impedance 1M Ω 30pF. Separate ground jack.
⑦ X-POS. (knob)	Controls horizontal position of trace.	②⑧ VOLTS/DIV. (12 position rotary switch)	Channel I input attenuator. Selects Y input sensitivity in mV/div. or V/div. in 1-2-5 sequence.
⑧ FIELD/II (pushbutton)	Selects first or second half frame. (only in TV SEP. V+ or V- position).	②⑨ DC – AC – GD (slide switch)	Selects input coupling of CH. I vertical amplifier. DC = direct coupling; AC = coupling via capacitor; GD = signal disconnected from input, Y amplifier input grounded.
⑨ TV SEP. (lever switch)	Switch for TV sync separator. OFF = normal operation, H+/H- = trig. of line (pos. or neg.) V+/V- = trig. of frame (pos. od. neg.)	③⑦ CH. I (BNC connector) Ground (4mm socket)	Channel I signal input. Input impedance 1M Ω 30pF. Separate ground jack.
⑩ TRIG. AC-DC-HF-LF-~ (lever switch; LED indicator)	Trigger selector: AC: 10Hz – 20MHz. DC: 0 – 20MHz. HF: 50kHz – 100MHz. LF: 0 – 50kHz. ~:Internal line triggering. LED illuminated, when timebase is triggered.	③⑧ VOLTS/DIV. (12 position rotary switch)	Channel I input attenuator. Selects Y input sensitivity in mV/div. or V/div. in 1-2-5 sequence.
⑪ ALT. (pushbutton)	Alternating triggering in dual channel mode.	③⑨ DC – AC – GD (slide switch)	Selects input coupling of CH. II vertical amplifier. Similar to ②⑨.
⑫ TIME/DIV. (23 step rotary switch)	Selects time coefficients (speeds) of timebase. from 0.05 μ s/div. to 1s/div.	③⑩ VOLTS/DIV. (12 position rotary switch)	Channel II input attenuator. Selects Y input sensitivity in mV/div. or V/div. in 1-2-5 sequence.
⑬ Variable timebase control (center knob)	Variable adjustment of timebase. Decreases X deflection speed at least 2.5 fold. For time measurements turn to right hand stop.	③⑪ CH. II (BNC connector) Ground (4mm socket)	Channel II signal input. Input impedance 1M Ω 30pF. Separate ground jack.
⑭ EXT. (pushbutton)	Input for external trigger signal. Trigger input signal via ⑰.	③⑫ INVERT (CHII) (pushbutton)	Inversion of Channel II display. Similar to ②⑥.
⑮ LEVEL (knob)	Adjustment of trigger level. Automatic triggering in AT position (knob on left hand stop).	③⑬ Y-POS.II (knob)	Controls vertical position of CH. II display. No function in XY mode.
⑯ SLOPE +/- (pushbutton)	Selection of triggering on positive or negative going edge of signal.		
⑰ TRIG. INP. (BNC connector)	Input for external trigger signal. (Pushbutton ⑭ depressed).		
⑱ INTENS. (knob)	Intensity control for trace brightness.		
⑲ TR (potentiometer adjustment with screwdriver)	Trace Rotation. To align trace with horizontal graticule line. Compensates influence of earths magnetic field.		
⑳ FOCUS (knob)	Focus control for trace sharpness.		
		③⑭ CH I/II-TRIG. I/II (pushbutton)	No button depressed: CH. I only and triggering from channel I. When depressed, channel II only and triggering from channel II. (Trigger selection in DUAL mode).
		③⑮ DUAL (pushbutton)	Button released: one channel only. Button depressed: channel I and channel II in alternating mode. DUAL and ADD buttons depressed: CH. I and CH. II in chopped mode.
		③⑯ ADD. (pushbutton)	ADD depressed only; algebr. addition; In combination with INVERT: difference.
		③⑰ CH. II (BNC connector) Ground (4mm socket)	Channel II signal input. Input impedance 1M Ω 30pF. Separate ground jack.
		③⑱ INVERT (CHII) (pushbutton)	Inversion of Channel II display. Similar to ②⑥.
		③⑲ Y-POS.II (knob)	Controls vertical position of CH. II display. No function in XY mode.

Test Instructions

General

These Test Instructions are intended as an aid for checking the most important characteristics of the HM604 at regular intervals without the need for expensive test equipment. Resulting corrections and readjustments inside the instrument, detected by the following tests, are described in the Service Instructions or on the Adjusting Plan. They should only be undertaken by qualified personnel.

As with the First Time Operation instructions, care should be taken that all knobs with arrows are set to their calibrated positions. None of the pushbuttons should be depressed. **LEVEL** knob out in **AT** position, **TRIG.** selector switch to **AC**, **DELAY** slide switch to **OFF**. It is recommended to switch on the instrument for about 30 minutes prior to the commencement of any check.

Cathode-Ray Tube: Brightness and Focus, Linearity, Raster Distortions

Normally, the CRT of the HM604 has very good brightness. Any reduction of this brightness can only be judged visually. However, decreased brightness may be the result of reduced high voltage. This is easily recognized by the greatly increased sensitivity of the vertical amplifier. The control range for maximum and minimum brightness (intensity) must be such that the beam just disappears before reaching the left hand stop of the **INTENS.** control (particularly when the **X-Y** button is depressed), while with the control at the right hand stop the focus and the line width are just acceptable.

With maximum intensity the timebase fly-back must on no account be visible. Visible display fault without input signal: Bright dot on the left side - **or** - decreasing brightness from left to right or shortening of the baseline. (Cause: incorrect Unblanking Pulse.

It should be noted that with wide variations in brightness, refocusing is always necessary. Moreover, with maximum brightness, no "pumping" of the display must occur. If pumping does occur, it is normally due to a fault in the regulation circuitry for the high voltage supply. The presetting pots for the high voltage circuit, minimum and maximum intensity, are only accessible inside the instrument (see Adjusting Plan and Service Instructions).

A certain out-of-focus condition in the edge zone of the screen must be accepted. It is limited by standards of the CRT manufacturer. The same is valid for tolerances of the orthogonality, the undeflected spot position, the non-linearity and the raster distortion in the marginal zone of the screen in accordance with international standards (see CRT data book). These limit values are strictly supervised by . The selection of a cathode-ray tube without any tolerances is practically impossible.

Astigmatism Check

Check whether the horizontal and vertical sharpness of the display are equal. This is best seen by displaying a

squarewave signal with the repetition rate of approximately 1MHz. Focus the horizontal tops of the square-wave signal at normal intensity, then check the sharpness of the vertical edges. If it is possible to improve this vertical sharpness by turning the **FOCUS** control, then an adjustment of the astigmatism control is necessary. A potentiometer (see Adjusting Plan) is provided inside the instrument for the correction of astigmatism (see Service Instructions). A certain loss of marginal sharpness of the CRT is unavoidable; this is due to the manufacturing process of the CRT.

Symmetry and Drift of the Vertical Amplifier

Both of these characteristics are substantially determined by the input stages of the amplifiers. **The checking and correction of the attenuator offset should be carried out as already described in the Operating Instructions** (page M7).

The symmetry of Channel I and the vertical final amplifier can be checked by inverting Channel I, depress **INVERT** (CHI pushbutton). The vertical position of the trace should not change by more than 0.5div. However, a change of 1div. is just permissible. Larger deviations indicate that changes have occurred in the amplifier.

A further check of the vertical amplifier symmetry is possible by checking the control range of the **Y-POS.** controls. A sine-wave signal of 10-100kHz is applied to the amplifier input. When the **Y-POS.** control is then turned fully in both directions from stop to stop with a display height of approximately **8div.**, the upper and lower positions of the trace that are visible should be approximately of the same height. Differences of up to 1div. are permissible (input coupling should be set to **AC**).

Checking the drift is relatively simple. **Ten minutes after switching on the instrument**, set the baseline exactly on the horizontal center line of the graticule. The beam position must not change by more than **0.5div.** during the following hour. Larger deviations generally result from different characteristics of the FETs in both channel inputs to the Y amplifier. To some extent, fluctuations in drift are caused by offset current on the gate. The drift is too high, if the vertical trace position drifts by more than **0.05div.** on turning the appropriate attenuator switch through all 12 steps. Sometimes such effects occur after long periods of operation.

Calibration of the Vertical Amplifier

Two square-wave voltages of **0.2V_{pp}** and **2V_{pp} ±1%** are present at the output sockets of the calibrator (**CAL.**). If a direct connection is made between the 0.2V output and the input of the vertical amplifier, the displayed signal in the **50mV/div.** position (variable control to **CAL.**) should be **4div.** high (**DC** input coupling). Maximum deviations of 0.12div. (3%) are permissible. If a **x10 probe** is connected between the 2V-output socket and Y input, the same display height should result. With higher tolerances it should first be

investigated whether the cause lies, within the amplifier or in the amplitude of the square-wave signal. On occasions it is possible that the probe is faulty or incorrectly compensated. If necessary the measuring amplifier can be calibrated with an accurately known DC voltage (**DC** input coupling). The trace position should then vary in accordance with the deflection coefficient set.

With variable control at the attenuator switch fully counter-clockwise, the input sensitivity is decreased at least by the factor 2.5 in each position. In the **50mV/div.** position, the displayed calibrator signal height should vary from 4div. to at least 1.6div.

Transmission Performance of the Vertical Amplifier

The transient response and the delay distortion correction can only be checked with the aid of a square-wave generator with a fast risetime (*max. 5ns*). The signal coaxial cable (e.g. HZ34) must be terminated at the vertical input of the oscilloscope with a resistor equal to the characteristic impedance of the cable (e.g. with HZ22). Checks should be made at 100Hz, 1kHz, 10kHz, 100kHz and 1MHz, the deflection coefficient should be set at **5mV/div.** with **DC** input coupling (Y variable control in **CAL.** position). In so doing, the square pulses must have a flat top without ramp-off, spikes and glitches; no overshoot is permitted, especially at 1MHz and a display height of **4-5div.** At the same time, the leading top corner of the pulse must not be rounded. In general, no great changes occur after the instrument has left the factory, and it is left to the operators discretion whether this test is undertaken or not.

Of course, the quality of the transmission performance is not only dependent on the vertical amplifier. **The input attenuators**, located in the front of the amplifier, **are frequency-compensated in each position.** Even small capacitive changes can reduce the transmission performance. Faults of this kind are as a rule most easily detected with a square-wave signal with a low repetition rate (e.g. 1kHz). If a suitable generator with max. output of $40V_{pp}$ is available, it is advisable to check at regular intervals the deflection coefficients on all positions of the input attenuators and readjust them as necessary. A compensated **2:1 series attenuator** is also necessary, and this must be matched to the input impedance of the oscilloscope. This attenuator can be made up locally. It is important that this attenuator is shielded. For local manufacture, the electrical components required are a $1M\Omega \pm 1\%$ resistor and, in parallel with it, a trimmer 3-15pF in parallel with approx. 10pF. One side of this parallel circuit is connected directly to the input connector of the vertical amplifier and the other side is connected to the generator, if possible via a low-capacitance coaxial cable. The series attenuator must be matched to the input impedance of the oscilloscope in the **5mV/div.** position (variable control to **CAL.**, **DC** input coupling; square tops exactly horizontal; no ramp-off is permitted). This is

achieved by adjusting the trimmer located in the 2:1 attenuator. **The shape of the square-wave should then be the same in each input attenuator position.**

Operating Modes: CH.I/II-TRIG.I/II, DUAL, ADD, CHOP., INV.I/II and X-Y Operation

On depressing the **DUAL** pushbutton, two traces must appear immediately. On actuation of the **Y-POS.** controls, the trace positions should have no effect on each other. Nevertheless, this cannot be entirely avoided, even in fully serviceable instruments. When one trace is shifted vertically across the entire screen, the position of the other trace must not vary by more than 0.05div.

A criterion in chopped operation is trace widening and shadowing around and within the two traces in the upper or lower region of the screen. Set **TIME/DIV.** switch to **1 μ s/div.**, depress the **DUAL** and **CHOP.** pushbutton, set input coupling of both channels to **GD** and advance the **INTENS.** control fully clockwise. Adjust **FOCUS** for a sharp display. With the **Y-POS.** controls shift one of the traces to a +2div., the other to a -2div. vertical position from the horizontal center line of the graticule. Do not try to synchronize the chop frequency (500kHz)! Then alternately release and depress the **CHOP.** pushbutton. Check for negligible trace widening and periodic shadowing in the chopped mode.

It is important to note that in the **I+II** add mode (only **ADD** depressed) or the **-I+II** difference mode **INVERT** (**CHI** button depressed in addition) the vertical position of the trace can be adjusted by using **both** the Channel I and Channel II **Y-POS.** controls. If a trace is not visible in either these modes, the overscanning LEDs will indicate the position of the trace.

In X-Y Operation (**X-Y** pushbutton depressed), the sensitivity in both deflection directions will be the same. When the signal from the built-in square-wave generator is applied to the input of Channel II, then, as with Channel I in the vertical direction, there must be a horizontal deflection of **4div.** when the deflection coefficient is set to **50mV/div.** position (variable control set to its **CAL.** position, **X MAG. x10** released). The check of the mono channel display with the **CHI/II** button is unnecessary; it is contained indirectly in the tests above stated.

Triggering Checks

The internal trigger threshold is important as it determines the display height from which a signal will be stably displayed. It should be approx. 0.5div. for the HM604. An increased trigger sensitivity creates the risk of response to the noise level in the trigger circuit. This can produce double-triggering with two out-of-phase traces. Alteration of the trigger threshold is only possible internally. Checks can be made with any **sine-wave voltage** between 50Hz and 1MHz. The **LEVEL** knob should be in **AT** position. Following this it should be ascertained whether the same trigger sensitivity is also present with Normal Triggering (**LEVEL** knob **not** in **AT** position).

On depressing the **SLOPE +/-** button, the start of the sweep changes from the positive-going to the negative-going edge of the trigger signal.

Internally the HM604 should trigger perfectly with sinusoidal signals up to 100MHz at a display height of approx. 0.5div., when the HF trigger coupling mode is set.

For external triggering (**EXT.** button depressed), the **EXT. TRIG.** input connector requires a signal voltage of at least 50mV_{pp}, which is in synchronism with the Y input signal. Checking of TV triggering is possible with a video signal of switchable polarity. A check of both polarities in V and H mode should be made.

The display should not shift horizontally during a change of the trigger coupling from **AC** to **DC** with a sine-wave signal without DC offset.

In the **dual channel mode** (**DUAL** button depressed) **with alternate channel switching and with alternate triggering** (**ALT.** button in the X-Section depressed), two non-frequency related signals (e.g. mains/line frequency signal and calibrator signal) should reliably be triggered internally dependent on the positions of the **CHI/II-TRIG.I/II** pushbuttons. In the dual channel mode with chop channel switching and depressed **ALT.** button, only triggering from Channel I should be possible. Periodical signal blanks (due to the chopper frequency 0.5MHz) should not be visible.

If both vertical inputs are **AC** coupled to the same signal and both traces are brought to coincide exactly on the screen, when working in the **alternate dual channel mode**, then no change in display should be noticeable, when the **ALT.** button is depressed or released.

Checking of the line/mains frequency triggering (50-60Hz) is possible, when the input signal is time-related (multiple or submultiple) to the power line frequency (**TRIG.** selector switch to **LINE**). In this trigger mode, there is no trigger threshold. Even very small input signals are triggered stably (e.g. ripple voltage). For this check, use an input of approx. 1V. The displayed signal height can then be varied by turning the respective input attenuator switch and its variable control.

Timebase

Before checking the timebase it should be ascertained that the **trace length is 10div.** If not, it can be corrected with the potentiometer for sweep amplitude (see Adjusting Plan). This adjustment should be made with the **TIME/DIV.** switch in a mid position (i.e. **5µs/div.**). Prior to the commencement of any check set the time variable control to **CAL.** and the **HOLD-OFF** time control to **min.** The **X MAG. x10** button should be released. This condition should be maintained until the variation ranges of these controls are checked.

If a precise marker signal is not available for checking the **Timebase** time coefficients, then an accurate sine-wave generator may be used. Its frequency tolerance should not be greater than $\pm 1\%$. The timebase accuracy of the HM604 is given as $\pm 3\%$, but as a rule it is considerably better than this. For the simultaneous checking of timebase linearity and accuracy at least 10 oscillations, i.e. **1 cycle every div.**, should always be displayed. For precise determination, set the peak of the first marker or cycle peak exactly behind the first vertical graticule line using the **X-POS.** control. Deviation tendencies can be noted after some of the marker or cycle peaks.

The **20** and **10ms/div.** ranges of the **TIME/DIV.** switch can be checked very precisely with line frequency (**50Hz** only). On the **20ms/div.** range a cycle will be displayed every div., while on the **10ms/div.** range it will be every 2div.

The following table shows which frequencies are required for the particular ranges.

1 s/div. – 1 Hz	0.1 ms/div. – 10kHz
0.5 s/div. – 2 Hz	50 µs/div. – 20kHz
0.2 s/div. – 5 Hz	20 µs/div. – 50kHz
0.1 s/div. – 10 Hz	10 µs/div. – 100kHz
50 ms/div. – 20 Hz	5 µs/div. – 200kHz
20 ms/div. – 50 Hz	2 µs/div. – 500kHz
10 ms/div. – 100 Hz	1 µs/div. – 1MHz
5 ms/div. – 200 Hz	0.5 µs/div. – 2MHz
2 ms/div. – 500 Hz	0.2 µs/div. – 5MHz
1 ms/div. – 1 kHz	0.1 µs/div. – 10MHz
0.5 ms/div. – 2 kHz	0.05 µs/div. – 20MHz
0.2 ms/div. – 5 kHz	

The **time variable control** range can also be checked. The sweep speed becomes slower by turning this variable control counter-clockwise to its left stop. 2.5 cycles at least every **div.** should be displayed (with **X MAG. x10** button released; measurement in the **5µs/div.** range).

When the **X MAG. x10** button is depressed, a marker or cycle peak will be displayed every 10div. $\pm 5\%$ (with variable control in **CAL.** position; measurement in the **5µs/div.** range). The tolerance is better measurable in the **50µs/div.** range (one cycle every 1cm).

Check the ramp output voltage on rear panel (BNC connector marked by \sphericalangle) with a Test Oscilloscope. **Test Scope setting: 1V/div.;** Timebase to one step slower sweep speed than on the HM604 under test. The latter must have no input and no trigger voltage (free-running sweep; input coupling switch to **GD**). The sawtooth voltage is applied with a BNC cable **without termination** from the ramp output connector to the input of the Test Scope. The Test Scope should show a positive-going linear sawtooth with an amplitude of approx. **5V_{pp}**. At the same time the function of the **HOLD-OFF** control **min.-max.** can be checked. The hold-off time variation cannot be measured precisely with this method, because the unblanking pulse of the timebase generator is smaller than the ramp width.

Sweep Delay

When the Sweep DELAY mode lever switch is set to the **OFF** mode, the delay should have no effect on the display of the **1kHz calibration signal**. When the Sweep Delay is set in the **SEARCH** mode (refer to Sweep Delay Operating Instructions), it is possible to check the delay time by means of a distance measurement of the blanked baseline. For this, the DELAY **VAR. 10:1** control must be set to x1 (rotate counterclockwise until a snap noise is audible). When **DELAY** mode is selected, the trace reverts to the full 10cm display without any blanking.

Over the full range of adjustment of the DELAY VAR. 10:1 control, the displayed waveform of the calibration signal should be shifted without any jitter, jumping or intermittent blanking.

Control settings: Connect calibrator socket (0.2V/1kHz) to **CH.I** input connector, **DC** input coupling, deflection coefficient **50mV/div.**, **TRIG.** selector switch to **AC**, time coefficient **1ms/div.**, no pushbutton depressed, all controls in calibrated position, DELAY mode switch in **OFF** position, **LEVEL** knob in **AT** position. Now the calibrator signal is displayed with a signal height of 4div. and approx. 1 cycle per div. After switching to **SEARCH**, the mode indication lamp blinks. Set the **DELAY** range switch to **1ms**. Rotate the DELAY **VAR.** control until the left half of the display is blanked. The delay time is now **5ms**. After switching to **DELAY**, the display is again fully visible. The DELAY mode LED is illuminated continuously. The displayed signal can now be expanded. For this purpose turn the **TIME/DIV.** switch clockwise to **5µs/div.** The expansion is now x200. With the DELAY **VAR.** control, the nearest edge of the calibration signal can be brought in the screen center and checked on the above-mentioned criteria. With x200 expansion, the display brightness normally needs increasing (with **INTENS.** and **FOCUS** control). However, larger expansions than x200 are quite possible, but the decrease of brightness and the jitter restricts the evaluation. When switching to **DEL. TRIG.** positions, every slope is accepted for triggering after the delay time has elapsed. In **TV SEP.** mode condition, the slope can be chosen (+/-).

Component Tester

After pressing the **COMPONENT TESTER** button, a horizontal straight line has to appear immediately, when the **CT** socket is open. The length of this trace should be approx. **8div.** With connection of the **CT** socket to one of the ground jacks in the Y-Section, a vertical straight line with approx. 6div. height should be displayed. The above stated measurements have some tolerances. They are dependent among other things on the mains/line voltage.

Trace Alignment

The CRT has an admissible angular deviation $\pm 5^\circ$ between the X deflection plane D1-D2 and the horizontal center line

of the internal graticule. This deviation, due to tube production tolerances (and only important after changing the CRT), and also the influence of the earth's magnetic field, which is dependent on the instrument's North orientation, are corrected by means of the **TR** potentiometer. In general, the trace rotation range is asymmetric. It should be checked, whether the baseline can be adjusted somewhat sloping to **both sides** round about the horizontal center line of the graticule. With the HM604 in its closed case, an angle of rotation $\pm 0.57^\circ$ (0.1div. difference in elevation per 10div. graticule length) is sufficient for the compensation of the earth's magnetic field.

Miscellaneous

Y output

A check of the **Y** output (rear panel) is possible on the screen using the dual channel mode by means of the calibrator signal. To this a connection is made from the calibrator socket (0.2V/1kHz) to the **CH.I** input connector and – using a BNC-BNC cable and a 50Ω through-termination – a second connection from the **Y** output to **CH.II** input connector. **Settings:** **CH.I** attenuator switch to **50mV/div.**, **CH.II** attenuator switch to **0.1V/div.**, **CH.I** input coupling to **DC**, **CH.II** input coupling to **GD**, **TIME/DIV.** switch to **0.5ms/div.**, automatic triggering (**LEVEL** knob in **AT** position), **TRIG.** selector to **AC**, no button depressed. Now the square-wave signal is visible with **4div.** display height. With **Y-POS.I** control, the tops of the square-wave are adjusted to ± 2 div. from the horizontal center line of the graticule. Then the **DUAL** button has to be pressed. The appearing second trace (without signal) is adjusted to -2 div. using the **Y-POS.II** control. Then the **CH.II** input coupling is set to **DC**. Now the signal across the **Y** output appears with the same phase position as the calibrator signal via Channel I. As well as the DC offset (e.g. $+0.8$ div. $\hat{=} +80$ mV) the amplitude (e.g. 2 div. $\hat{=} 0.2V_{pp}$) of the **Y** output can be measured. In the example, the sensitivity of the **Y** output can be calculated as $0.2V:4div. = 50mV/div.$

Z modulation (optional)

Checking the blanking facility on the **Z** modulation connector (rear panel) is possible with a sine- or square-wave generator. The sine-wave generator requires an output voltage control. The square-wave generator must deliver positive pulses to ground (chassis). Alternatively a small adjustable sine voltage from a (separate) power transformer may be used. For the latter set the **TIME/DIV.** range to e.g. **10ms/div.** With the TIMEBASE variable control, the gap in the baseline can be brought acceptably to a standstill. Line frequency triggering is better (**TRIG.** selector switch to \sim). The length ratio from bright to dark lines on the display is dependent on the sine voltage amplitude. Without a modulating generator, the function of the Z modulation can be checked coarsely by short-circuiting the **Z** connector. Then the baseline is blanked fully.

HAMEG

Oscilloscopes

Multimeters

Counter

Generators

**R- and LC-
Meters**

Curve Tracer

Power Supplies

**Spectrum
Analyzer**

Germany

HAMEG GmbH
Kelsterbacher Str. 15-19
60528 FRANKFURT am Main
Tel. (069) 67 80 510
Telefax (069) 67 80 513

France

HAMEG S.a.r.l
5-9, av. de la République
94800-VILLEJUIF
Tél. (1) 46778151
Telefax (1) 47263544

Spain

HAMEG S.L.
Villarroel 172-174
08036 BARCELONA
Téléf. (93) 4301597
Telefax (93) 3212201

Great Britain

HAMEG LTD
74-78 Collingdon Street
LUTON Bedfordshire LU1 1RX
Tel. (0582) 413174
Telefax (0582) 456416

United States of America

HAMEG, Inc.
1939 Plaza Real
OCEANSIDE, CA 92056
Phone (619) 630-4080
Toll-free (800) 247-1241
Telefax (619) 630-6507

HAMEG, Inc.
266 East Meadow Avenue
EAST MEADOW, NY 11554
Phone (516) 794-4080
Telefax (516) 794-1855

Hong Kong

HAMEG LTD
Flat 1, 4/F.
Crown Industrial Building
106 How Ming St., Kwun Tong
Kowloon, Hong Kong
Tel. 852-7930218
Fax: 852-7635236