

INSTRUCTION MANUAL

**MODEL 150B**

MICROVOLT AMMETER

## **WARRANTY**

We warrant each of our products to be free from defects in material and workmanship. Our obligation under this warranty is to repair or replace any instrument or part thereof (except tubes and batteries) which, within a year after shipment, proves defective upon examination. We will pay domestic surface freight costs.

To exercise this warranty, call your local field representative or the Cleveland factory, DDD 216-248-0400. You will be given assistance and shipping instructions.

## **REPAIRS AND RECALIBRATION**

Keithley Instruments maintains a complete repair service and standards laboratory in Cleveland, and has an authorized field repair facility in Los Angeles.

To insure prompt repair or recalibration service, please contact your local field representative or the plant directly before returning the instrument.

Estimates for repairs, normal recalibrations, and calibrations traceable to the National Bureau of Standards are available upon request.

**TABLE OF CONTENTS**

Section	Page	Section	Page
MODEL 150B SPECIFICATIONS. . . . .	ii	4. MAINTENANCE. . . . .	19
1. GENERAL DESCRIPTION. . . . .	1	4-1. General. . . . .	19
1-1. General. . . . .	1	4-2. Parts Replacement. . . . .	19
1-2. As a Microvoltmeter. . . . .	1	4-3. Mechanical Chopper Replacement. . . . .	19
1-3. As a Null Detector . . . . .	1	4-4. Troubleshooting. . . . .	20
1-4. As an Ammeter. . . . .	1	4-5. Preliminary Troubleshooting Procedures . . . . .	20
2. OPERATION. . . . .	3	4-6. Check Out and Calibration Procedures . . . . .	20
2-1. Mode of Operation. . . . .	3	4-7. Power Supply Check Out and Calibration. . . . .	22
2-2. Battery Operation. . . . .	3	4-8. Amplifier Check Out and Calibration. . . . .	25
2-3. Microvolt and Null Detector Operating Procedures . . . . .	4	5. ACCESSORIES. . . . .	35
2-4. Ammeter Operating Procedures . . . . .	6	5-1. Model 4006 Rack Mounting Kit . . . . .	37
2-5. Zero Suppress Operation. . . . .	6	5-2. Model 4007 Dual Rack Mounting Kit . . . . .	37
2-6. Filter Switch. . . . .	7	5-3. Model 370 Recorder . . . . .	39
2-7. Recorder Outputs . . . . .	7	6. REPLACEABLE PARTS. . . . .	41
2-8. Synchronizing Terminals. . . . .	7	6-1. Replaceable Parts List . . . . .	41
2-9. Differential (Floating) Measurements . . . . .	8	6-2. How to Order Parts . . . . .	41
2-10. Accuracy Consideration . . . . .	8	Model 150B Replaceable Parts List . . . . .	42
2-11. Thermal Noise. . . . .	8	Models 1483, 1484 Replaceable Parts List . . . . .	50
2-12. Input Resistance . . . . .	9	Schematic Diagram 20350E . . . . .	53
2-13. Thermal Emf's. . . . .	9	Schematic Diagram 20357D . . . . .	55
2-14. Shielding. . . . .	10		
2-15. Operating From Source Other Than 117 Volts, 60 cps . . . . .	11	* Change Notice . . . . .	Last page
2-16. Accessories For Input Connections. . . . .	11		
3. CIRCUIT DESCRIPTION. . . . .	13		
3-1. General. . . . .	13		
3-2. Input Circuit. . . . .	13		
3-3. AC Amplifier . . . . .	14		
3-4. Demodulator. . . . .	15		
3-5. DC Amplifier . . . . .	15		
3-6. Zero Suppression . . . . .	15		
3-7. Power Supplies . . . . .	15		
3-8. Battery Charging Circuit . . . . .	17		
		* Yellow Change Notice sheet is included only for instrument modifications affect- ing the Instrument Manual.	

TABLE 1. Model 150B Specifications.

**AS A VOLTMETER AND NULL DETECTOR:**

**RANGE:** 0.3 microvolt ( $3 \times 10^{-7}$  volt) full scale to 1 volt on a zero-center meter. 14 overlapping ranges in 1x and 3x steps.

**ACCURACY:**

**Meter:**  $\pm 2\%$  of full scale on all ranges.

**1-Volt Output Terminals:**  $\pm 1\%$ .

**100-Millivolt Output Terminals:** Adjustable to  $\pm 1\%$ .

**Note:** Accuracy specifications exclude noise and drift.

**ZERO DRIFT:** Less than 0.1 microvolt per 24 hours after 1-hour warm-up with reasonably constant ambient temperature. Long-term drift is non-cumulative.

**INPUT NOISE:** With input shorted, less than 5 nanovolts rms (25 nanovolts peak-to-peak) on the most sensitive range.

With a 10,000-ohm source resistance, less than 14 nanovolts rms (70 nanovolts peak-to-peak) on the most sensitive range.

**INPUT RESISTANCE:**

Range	Input Resistance Greater than, ohms	Maximum Source <sup>1</sup> Resistance, ohms
0.3 $\mu\text{V}$	1 M	10 k
1 $\mu\text{V}$	3 M	30 k
3 $\mu\text{V}$	10 M	100 k
10 $\mu\text{V}$	30 M	300 k
30 $\mu\text{V}$	100 M	1 M
100 $\mu\text{V}$ and above	100 M	1 M

**Note:** <sup>1</sup>Source resistances higher than the recommended maximum will increase noise and rise time.

**ZERO SHIFT WITH SOURCE RESISTANCE:** Less than  $10^{-10}$  volt per ohm.

**LINE FREQUENCY REJECTION\*:** A voltage of power line frequency which is 75 db (p-p/dc) greater than full scale affects reading less than 2% on the most sensitive range (decreasing to 60 db on the 10-microvolt range and to 20 db on the 1-volt range).

**COMMON MODE REJECTION\*:** Greater than 180 db at line frequency or dc.

**RISE TIME (10% to 90%)\*:** Using up to 1000 ohms source resistance, less than 0.5 second on the 30-microvolt and higher ranges, increasing to 3 seconds on the 0.3-microvolt range.

Using maximum source resistance up to 100 kilohms, rise times increase to approximately 3 seconds on the 30-microvolt and higher ranges, 6 seconds on the 10-microvolt and lower ranges.

**ZERO SUPPRESSION:** Up to 10 millivolts available. Stability is such that 100 times full scale may be suppressed.

\***Note:** All specifications are measured with filter in. With filter out, rise times for any source resistance up to maximum are less than 0.5 second on the 30-microvolt and higher ranges, increasing to 3 seconds on the 0.3-microvolt range. With filter out, the rejection ratios are reduced about 30 db.

**AS AN AMMETER:**

**RANGE:**  $3 \times 10^{-10}$  ampere full scale to  $10^{-3}$  ampere on zero-center meter. 14 overlapping ranges in 1x and 3x steps.

**ACCURACY:**

**Meter:**  $\pm 3\%$  of full scale on all ranges.

**1-Volt Output Terminals:**  $\pm 2\%$ .

**100-Millivolt Output Terminals:** Adjustable to  $\pm 2\%$ .

**Note:** Accuracy specifications exclude noise and drift.

**ZERO DRIFT:**  $\pm 2 \times 10^{-11}$  ampere per 24 hours after 1-hour warm-up.

**INPUT NOISE:** Less than  $3 \times 10^{-12}$  ampere peak-to-peak on the most sensitive range.

**INPUT VOLTAGE DROP:** 100 microvolts on the nanoampere ranges, 1 millivolt on the microampere ranges.

**INPUT RESISTANCE:** On the microampere ranges, the input resistance is equal to  $10^{-3}$  divided by the range in amperes. On the nanoampere ranges, it is equal to  $10^{-4}$  divided by the range in amperes.

**GENERAL:**

**ISOLATION:** Circuit ground to chassis ground: Greater than  $10^{10}$  ohms shunted by 0.001 microfarad. Circuit ground may be floated up to  $\pm 400$  volts with respect to chassis ground. On battery operation, may be completely isolated from power line and ground.

**RECORDER OUTPUT (1 volt):**

**Output:**  $\pm 1$  volt dc at up to 1 milliampere for full-scale meter deflection on any range.

**Resistance:** Less than 5 ohms within the amplifier pass band.

**Noise:** Input noise times gain plus modulation products.

**Modulation Products:** Less than 4% peak-to-peak of full scale with input shorted.

**RECORDER OUTPUT (100 mv):**

**Output:**  $\pm 100$  mv adjustable over a 10% span for full-scale meter deflection on any range.

**Output Resistance:** Less than 1000 ohms.

**Noise:** Input noise times gain plus modulation products.

**Modulation Products:** Less than  $\frac{1}{2}\%$  peak-to-peak of full scale with input shorted.

Using this output, response time is at least one second on any range.

**CONNECTORS:** Input: Special Keithley Model 1485. Output: Amphenol 80PC2F Receptacle.

**POWER:**

**Line Operation:** 105-125 volts or 210-250 volts, 60 cps, 25 watts. 50-cps models available.

**Battery Operation:** Rechargeable nickel-cadmium 6-volt battery pack. Over 7 hours continuous operation from full charge; recharges in less than 16 hours from built-in charging circuit.

**DIMENSIONS, WEIGHT:** 7 inches high x  $8\frac{3}{4}$  inches wide x 10 inches deep; net weight, 16 pounds.

**ACCESSORIES SUPPLIED:** Model 1506 Low-Thermal Input Cable (4 feet, low-thermal triaxial cable, alligator clips). Mating output connector. Length of low-thermal solder. Internally mounted nickel-cadmium battery pack, Model 1489.

## SECTION 1. GENERAL DESCRIPTION

1-1. GENERAL. The Keithley Model 150B Microvolt Ammeter is an extremely sensitive instrument which measures voltages from 0.3 microvolt to 1 volt and currents from 0.3 nanoampere to 1 milliampere. It can be used as a voltmeter, null detector or an ammeter with either battery or line power operation.

### 1-2. AS A MICROVOLTMETER.

a. The Model 150B is ideal as a microvoltmeter for measuring semiconductor resistivity, thermopile and thermocouple potentials, Hall effect, contact resistances, biologically generated emf's, electrochemical potentials and strain gauges emf's.

b. The Model 150B has input noise less than 25 nanovolts peak-to-peak; high input resistance and low zero shift; excellent zero stability; very high line-frequency rejection and common mode rejection; battery operation; zero suppression; special low-thermal input circuitry; two available outputs.

c. With these features, the Model 150B permits excellent resolution; maintains measurement accuracy even from high resistance sources; is ideal for long-term measurements; detects dc signals in the presence of large ac voltages and is virtually insensitive to ac or dc voltages applied between circuit and chassis ground; disconnects from power lines for improved isolation; measures small changes in dc signals; reduces temperature and shielding problems; provides outputs where either filtering is needed or fast response or greater output power is needed.

### 1-3. AS A NULL DETECTOR.

a. As a null detector the Model 150B is excellent for use in ratio measurements and in potentiometer and bridge circuits.

b. The Microvolt Ammeter's outstanding features as a null detector are: very good resolution; high line frequency and common mode rejection; isolation from chassis ground to input terminals; battery operation; high input resistance; floating capability; low zero shift; zero suppression.

c. Because of these features the Model 150B has resolution comparable to the maximum usable resolution of most potentiometers and bridges; may be simply connected to the terminals of a null circuit; is very insensitive to common mode voltages developed in the null circuit; can be used in most potentiometer and bridge circuits without off-null loading; accurately detects a null regardless of the setting on most potentiometers and bridges; compensates for thermal emf's generated in the null circuit.

### 1-4. AS AN AMMETER.

a. The Model 150B has general use in research, design and production test facilities. It is useful for making low voltage drop, in-circuit measurements as well as measuring the output of radiation detectors, phototubes and other current generating transducers.

b. The instrument has low voltage drop for measuring currents in very low-voltage circuits; low zero drift for measuring long-term current; excellent floating capabilities for measuring ungrounded sources; and low input noise, giving excellent resolution.

Control	Functional Description	Par.
POWER SUPPLY Switch	Controls mode of operation for power supply	2-1,2-2
RANGE Switch	Selects the full scale voltage or current which is to be measured	2-3,2-4
FUNCTION Switch	Determines whether the Model 150B measures voltage or current; selects input resistance on voltage ranges.	2-3,2-4
ZERO SUPPRESS Controls	Determines the amount of zero suppression	2-5
FILTER Switch	Connects or disconnects a line frequency filter at the input	2-6
INPUT Receptacle	Connection for input cable	2-16

TABLE 2. Model 150B Front Panel Controls. The table briefly describes each control, and indicates the paragraph which contains instructions on the use of the control.

Control	Functional Description	Par.
LINE VOLTAGE Switch	Sets Model 150B for 117 or 234-volt ac power line	2-16
BATTERY FUSE	Quick-Acting, 3/4 amp 3AG or MDL fuse	--
Line Fuse	117-volt: Slow-Blow 1/4 amp 3AG or MDL fuse 234-volt: Slow-Blow 1/8 amp 3AG or MDL fuse	--
Power Cord	Provides ground connection for cabinet; 3-wire power cord with NEMA approved 3-pronged plug	--
1V OUTPUT Receptacle	Power output; provides $\pm 1$ volt at up to one milliampere for a full-scale meter deflection. Fast response.	2-7
100MV OUTPUT Receptacle	Recorder output; provides 100mv, adjustable within 10mv span, for full-scale meter deflection. Filtered.	2-7
100MV ADJUST	Adjusts 100MV OUTPUT within 10mv span	2-7
GND Terminal	Connection to chassis ground	2-3,2-9,2-14
LO Terminal	Connection to circuit low; circuit low will not be at chassis ground unless LO is linked to GND	2-3,2-9,2-14
SYNCHRONIZING Jacks	Eliminates any interaction between two adjacent Model 150B's	2-8

TABLE 3. Model 150B Rear Panel Controls. The table briefly describes each control, and indicates the paragraph which contains instructions on the use of the control.

**SECTION 2. OPERATION**

2-1. MODE OF OPERATION.

a. When the POWER SUPPLY Switch is in the OFF position, the Model 150B will not operate, and the red dot cannot be seen through the switch knob.

b. The Model 150B operates either from an ac power line when the POWER SUPPLY Switch is in the AC position, or from its battery with the Switch in BATTERY position. In either position the red dot can be seen. For most uses the instrument functions well from ac. Use battery operation, however, if the ac power line will create ground loop or isolation problems. Isolation from low to ground is complete for battery operation when the power cord is disconnected; it is greater than  $10^{10}$  ohms shunted by .001 microfarad with the power cord connected. Also, battery operation is useful to reduce modulation products (usually 8 cps) which may appear at the output for certain low-level measurements. (See paragraph 2-14.)

NOTE

Before using the battery operation, thoroughly read paragraph 2-2. Improper battery operation can damage the battery pack and lead to inaccurate measurements.

2-2. BATTERY OPERATION.

a. The Model 150B is supplied with a rechargeable 6-volt, 4 ampere-hour nickel-cadmium battery pack. Do not use the battery more than seven consecutive hours without recharging.

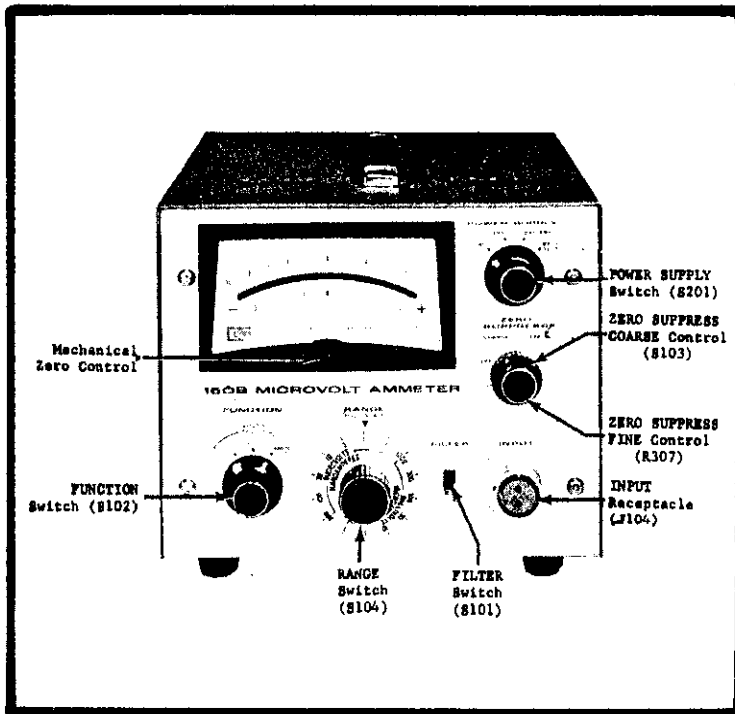

FIGURE 1. Model 150B Front Panel Controls. Circuit designations refer to Replaceable Parts List and schematic diagram.

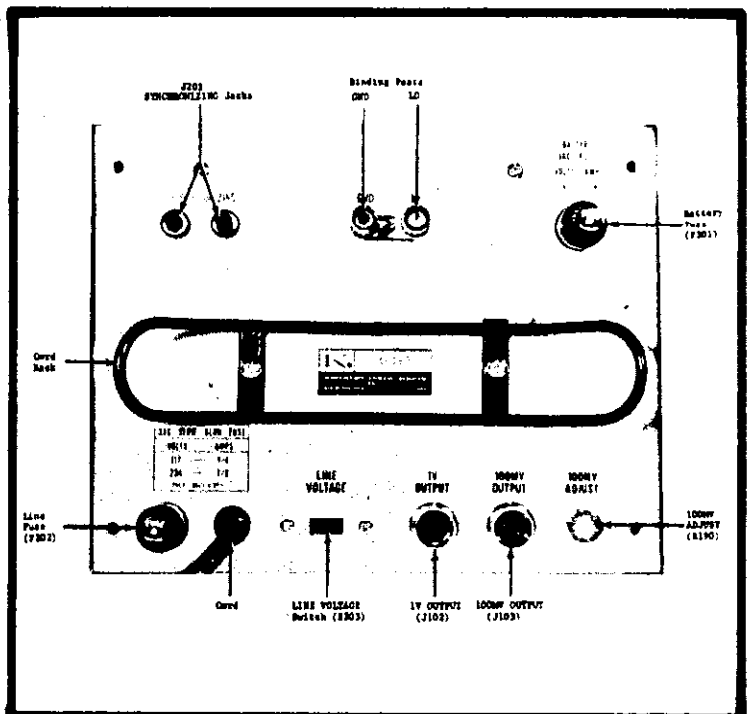

FIGURE 2. Model 150B Rear Panel Controls. Circuit designations refer to Replaceable Parts List and schematic diagram.

## NOTE

Permanent damage to the battery pack may occur if it is used for more than 8 consecutive hours without recharging. At this discharge rate, the number of recharge cycles is greatly reduced. Before using the Model 150B, check the state of the battery charge.

b. Check the battery charge before making a measurement. Hold the POWER SUPPLY Switch in the BATT. TEST position; the red dot will show. In this position the Model 150B shows the state of the battery charge directly on the meter. The minimum acceptable charge is a meter indication of approximately +6 on the upper meter scale.

1. The terminal voltage of a nickel-cadmium battery changes very little from full charge to almost complete discharge. The +6 meter indication for minimum charged terminal voltage will vary a few minor divisions for different batteries. After a few charge-discharge cycles, the exact value of the charged terminal voltage for any individual battery will be apparent.

2. Recharge the battery if needed. Otherwise, battery operation is the same as for the ac power line operating mode; refer to paragraph 2-3.

## NOTE

When the battery is used beyond its capacity, two effects are seen. There is a large shift in zero offset from ac to battery operation. Also, the power supplies do not regulate and high ripple voltages appear at the supply outputs.

c. To recharge the battery, connect the power cord to an ac power line. Turn the POWER SUPPLY Switch to AC or OFF. The battery will be automatically charged in either of these positions. The charging circuit is such that the battery cannot be overcharged.

d. It is suggested that the battery be used during the day and be recharged at night. Leave the instrument always connected to the ac power line; then turn the POWER SUPPLY Switch to OFF at night. After a fully charged battery is used for seven consecutive hours, it will recharge within 16 hours. Leaving the power cord connected has little effect on the isolation:  $10^{10}$  ohms with the low-ground link disconnected. If the battery is used longer than eight hours, it may take considerably longer than 16 hours to recharge.

## 2-3. MICROVOLT AND NULL DETECTOR OPERATING PROCEDURES.

a. Set the front panel controls as follows:

POWER SUPPLY Switch	OFF
RANGE Switch	1000MV
FUNCTION Switch	INPUT R 100K
ZERO SUPPRESS COARSE Control	OFF
FILTER Switch	IN

## NOTE

Make sure the ZERO SUPPRESS COARSE Control is OFF. If it is not, a suppression voltage is introduced, which may cause an error in measurements. See paragraph 2-5 for zero suppression.



- b. Check the voltage shown on the rear panel LINE VOLTAGE Switch; connect the Model 150B to the ac power line. The battery will now be charging.
- c. If the circuit low is to be at ground, put the low-ground link between the LO and GND terminals on the rear panel. The ground terminal (GND) is connected to the chassis and the third wire of the power cord. The low terminal (LO) is connected to circuit ground and the low side of the INPUT Connector.
- d. Turn the POWER SUPPLY Switch to the desired mode of operation, AC or BATTERY. For most stable operation, allow the Model 150B to warm up for 1 hour.
- e. Connect the unknown voltage to the INPUT Receptacle using a Model 1506 or 1507 Low-Thermal Input Cable. (See paragraph 2-16)
- f. Set the FUNCTION Switch to INPUT R OPEN if high input resistance is desired. In this position the Model 150B input resistance varies by range (See Table 4). If the input is left completely open circuit, the meter may drift off scale on any range within a few seconds. Set the FUNCTION Switch to INPUT R 100K if it is desired to maintain on-scale readings as the input circuit is opened. In this position the Microvolt Ammeter measures voltage with 100 kilohms shunting the INPUT Terminals.
- g. Increase the sensitivity of the Model 150B with the RANGE Switch until the meter shows the greatest on-scale deflection.
1. Check the source resistance to make sure that it is within the maximum value specified for the range being used. (See Table 4). If the maximum is exceeded, the Model 150B may not perform within its specifications.
  2. Zero offsets with the ZERO SUPPRESS Controls off will vary with the quality of the circuit's thermal construction. When a Model 1488 Low-Thermal Shorting Plug is connected to the Model 150B INPUT Receptacle, offset should be less than 0.5 microvolt.

Range	Input Resistance Greater Than	Maximum Source Resistance	Minimum Line Frequency Rejection
0.3 microvolt	1 M $\Omega$	10 k $\Omega$	5500:1
1 microvolt	3 M $\Omega$	30 k $\Omega$	---
3 microvolts	10 M $\Omega$	100 k $\Omega$	---
10 microvolts	30 M $\Omega$	300 k $\Omega$	1000:1
30 microvolts	100 M $\Omega$	1 M $\Omega$	---
100 microvolts	100 M $\Omega$	1 M $\Omega$	---
300 microvolts	100 M $\Omega$	1 M $\Omega$	---
1 millivolt through 1 volt	100 M $\Omega$	1 M $\Omega$	30:1

TABLE 4. Model 150B Input Resistance, Maximum Source Resistance, and Minimum Line Frequency Rejection by Range. The rejection is the ratio of impressed peak-to-peak line frequency (50 or 60 cps) voltage at input to the indicated dc voltage. The above line frequency rejections are reduced about 30 db on all ranges with the filter out.

3. Shifts in source resistance may also affect the zero offset, if the source resistance approaches the maximum value given in Table 4. This effect is negligible for source resistances less than 10% of the maximum value.

h. At low levels, spurious emf's may be generated simply by contact between the input leads and the circuit under test. These may be compensated for by the zero suppression circuit. If possible, always leave the instrument connected, and adjust the zero after establishing a zero reference in the apparatus under test. For example, in bridge measurements, disconnect the bridge exciting voltage, or with a phototube, shield the tube from light.

2-4. **AMMETER OPERATING PROCEDURES.** Set the FUNCTION Switch to the AMPS position. Select the range using the RANGE Switch. Make sure low resistance leads are used to connect the source to the Model 150B input to minimize input voltage drop. The maximum allowable current overload on any range is 100 milliamperes. If this is exceeded, or if the maximum input voltage drop is exceeded (see specifications), the current-sensing resistor may be damaged. The Model 150B rise time (10% to 90%) as an ammeter is less than 1 second on the 3-nanoampere and higher ranges, increasing to 3 seconds on the 0.3-nanoampere range.

#### 2-5. ZERO SUPPRESS OPERATION.

a. Purpose: The zero suppression circuit cancels any constant voltage in order to use a more sensitive range to observe a superimposed signal. Stability is such that up to 100 times full scale may be suppressed. For example, the Model 150B can measure changes of less than one microvolt in a 100-microvolt steady signal on its 1-microvolt range.

b. Suppression Voltages Available: The COARSE Control sets the suppression voltage to one of four maximum values. (Refer to Table 5). The FINE Control continuously adjusts the voltage between the positive and negative value of COARSE Control setting. For example, if the COARSE Control is at 3 for a maximum suppression voltage of  $\pm 1.2$  mv, the FINE Control adjustment span is from  $-1.2$  mv to  $+1.2$  mv.

#### c. Operation:

1. Keep the COARSE Control in OFF position. Adjust the RANGE Switch to the range that gives the closest to a full scale meter deflection.

2. Completely turn the FINE Control in the direction opposite to the meter deflection (counterclockwise for positive deflections and clockwise for negative deflections).

3. Increase the COARSE Control setting until the meter needle passes through zero. Adjust the FINE Control for zero deflection.

4. Set the RANGE Switch to a more sensitive range, up to 100 times more sensitive than the original range (four RANGE Switch positions). Readjust the FINE Control to zero, if necessary.

ZERO SUPPRESS COARSE Control Setting	Maximum Suppression Voltage
1	$\pm 3.6$ microvolts
2	$\pm 120$ microvolts
3	$\pm 1.2$ millivolts
4	$\pm 12$ millivolts

TABLE 5. Suppression Voltage by Control Settings. The zero suppression voltage shown is the maximum value,  $\pm 15\%$ , for each COARSE Control setting. The level of suppression voltage for each setting is the same on every voltage range.

## 2-6. FILTER SWITCH.

a. The input filter is adjusted at the factory for 60 cps line frequency, unless 50 cps is indicated on the rear panel of the Model 150B.

b. When the FILTER Switch is at the IN position, a line frequency (Twin-Tee) filter is used at the INPUT. With the Switch at the IN position a higher level (about 30 db) of 60 cps can be tolerated at the INPUT without affecting the accuracy or the sensitivity of the Model 150B. Normally, it is best to leave the FILTER Switch at the IN position for all cases except where the source resistance exceeds 300 kilohms.

c. The filter has a 5-microfarad capacitor. When the FILTER Switch is set to IN, this capacitor is in use and produces an RC time constant. For a source resistance of 300 kilohms or greater, the rise time of the Model 150B is affected by the RC time constant and increases above that given in the specifications.

d. With the Switch set to OUT, the capacitor is not in use. If rise time is important, set the FILTER Switch to the OUT position for source resistances greater than 300 kilohms. However, with the filter out, the line frequency rejection is reduced 30 db on all ranges.

2-7. RECORDER OUTPUTS. The Model 150B has two recorder outputs;  $\pm 1$  volt at up to 1 milliamperes and a filtered  $\pm 100$  millivolts.

a. The  $\pm 1$  volt, 1 milliamperes output is accurate to  $\pm 1\%$  of full scale. Output resistance is less than 5 ohms within the amplifier pass band. This output may be used during either battery or ac operation. If the Model 150B is used for differential measurements, do not ground the recorder connected to the output.

1. When recording with the 1 volt 1 milliamperes output, the Keithley Model 370 Recorder offers complete compatibility with the Model 150B. This output is sufficient to drive the Model 370 without the use of any recorder preamplifiers. The Model 370 allows maximum capability of the Model 150B. It has 1% linearity, 10 chart speeds and can float up to  $\pm 500$  volts off ground. Using the Model 370 with the Model 150B avoids interface problems which may be encountered between a measuring instrument and a recorder.

2. The Model 370 is very easy to use with the Model 150B. All that is necessary is connecting the two units and adjusting an easily accessible control for full-scale recorder deflection. The furnished Model 3701 Input Cable mates with the output connector on the Model 150B. On the most sensitive ranges of the Model 150B, under some conditions, an 8 cps beat may appear. This condition can be eliminated by mounting a 100-microfarad capacitor across pins 14 and 17 in the back of the Model 370 Recorder.

b. The other recorder output is  $\pm 100$  millivolts. This output can be used in conjunction with servo balance recorders. The 100MV ADJUST, which is a screwdriver adjust potentiometer on the rear panel of the Model 150B, is used to adjust the 100MV output over a 10-millivolt span. The resistance of this recorder output is less than 1000 ohms. The 100MV Output Receptacle is filtered to provide less than 1/2% peak-to-peak ac voltages in the output signal. The rise time will be no less than 1 second on any range. This output may be used during either ac or battery operation. If the Model 150B is used for differential measurements, do not ground the recorder connected to the output.

2-8. SYNCHRONIZING TERMINALS. All Model 150Bs have nearly the same chopper frequency. When two or more Model 150Bs are close together, a beat may develop between the instruments due to the slight difference in their chopper frequencies. To eliminate this interaction,

use the two synchronizing terminals on the rear panel of the instrument. These terminals synchronize the chopper frequencies. No polarity is necessary; just connect leads from the terminals of one Model 150B to the same terminals on an adjacent Model 150B.

## 2-9. DIFFERENTIAL (FLOATING) MEASUREMENTS.

a. The Model 150B will measure the difference between two voltages, neither of which is at power line ground. It can be floated up to  $\pm 400$  volts off ground.

### CAUTION

The instantaneous voltage between circuit low and case ground must not exceed  $\pm 400$  volts at any time. The front panel controls are electrically connected to the case. If the power cord is unplugged, and the off-ground voltage exceeds  $\pm 400$  volts, the case may be at any voltage. Use necessary safety precautions.

b. For best results in making differential measurements, follow the steps below:

1. Remove the link from the LO terminal on the rear panel.
2. Connect the source to the input. Make measurements as described in paragraph 2-3. The zero suppress controls may be used for differential measurements.
3. If power line frequency pickup is a problem, use battery operation.
4. When recording from the Model 150B with the LO to GND link removed, be sure to use a recorder which also has LO isolated from GND by a high impedance, and is also capable of withstanding the necessary voltage with respect to ground. The Keithley Model 370 Recorder meets these requirements.

2-10. ACCURACY CONSIDERATIONS. For sensitive measurements — 10 millivolts and below — other considerations besides the instrument affect accuracy. Effects not noticeable when working with higher voltages are very important with microvolt signals. The Model 150B reads only the signal received at its input; therefore, it is important that this signal be properly transmitted from the source. The following paragraphs indicate factors which affect accuracy: thermal noise, input resistance, thermal emf's, shielding and circuit connections.

## 2-11. THERMAL NOISE.

a. The lower limit in measuring small potentials occurs when the Johnson noise, or thermal agitation, becomes evident. The amount of noise present in the source is shown in the following equations.

1. Thermal noise in any ideal resistance can be determined from the Johnson noise equation:

$$E_{\text{rms}}^2 = 4 k T R F \quad \text{Equation 1}$$

where  $E_{\text{rms}}$  is the rms noise voltage developed across the voltage source;  
 T is the temperature in degrees Kelvin;  
 R is the source resistance in ohms;  
 F is the amplifier bandwidth in cps;  
 k is the Boltzmann constant ( $1.38 \times 10^{-23}$  joules/°K).

For an ideal resistance at room temperature (300°K), equation 1 simplifies to

$$E_{\text{rms}} = 1.29 \times 10^{-10} (R F)^{1/2} \quad \text{Equation 2}$$

2. Peak-to-peak meter indications are of more interest than the rms value. Experimentally, the peak-to-peak Johnson noise is about five times the rms value. At room temperature, equation 2 becomes

$$E_{\text{pp}} = 6.45 \times 10^{-10} (R F)^{1/2} \quad \text{Equation 3}$$

where  $E_{\text{pp}}$  is peak-to-peak noise voltage developed across the voltage source.

3. The Model 150B bandwidth,  $F$ , can be estimated from the response speed,  $t_r$ , by:

$$F = 0.35/t_r \quad \text{Equation 4}$$

The response speed varies with the range used and the source resistance. On the 1-microvolt range when the source resistance is less than 33 kilohms, for example, the bandwidth is greater than .07 cps. The maximum specified response speed for this situation is 6 seconds, so the .07-cps bandwidth is a minimum value.

b. In general, good wirewound or low-noise metal-film resistors approximate ideal resistors, and equations 2 and 3 are nearly correct. If the source resistance is composed of other materials, it may be necessary to include other terms in the equations to account for flicker,  $1/f$ , and current noise over and above the thermal noise.

c. As seen in equations 2 and 3, the noise of even low resistance values becomes significant in the microvolt region. The noise in non-ideal resistors is even greater. Therefore, keep the source resistance as low as possible. Other effects of very high source resistance are decreased response speed and added pickup of extraneous voltages.

2-12. INPUT RESISTANCE. The Model 150B is a feedback amplifier; its input resistance is obtained using high feedback factors. When the source resistance exceeds the amplifier's physical input resistance — amplifier input resistance without feedback — the feedback is partially destroyed. Then the instrument may not operate properly. Normally, do not exceed the maximum source resistance listed in Table 4. Higher resistances can be used, but noise, offsets, slow response and instability may result. On the most sensitive ranges, the maximum specified source resistance is consistent with Johnson noise considerations.

#### 2-13. THERMAL EMF'S.

a. Thermal emf's (thermo-electric potentials) are generated by thermal gradients between any two junctions of dissimilar metals. These can be large compared to the signals which the Model 150B can measure.

b. Thermal emf's can cause the following problems:

1. Meter instability or zero offset much higher than expected. Note, though, the Model 150B can have some offset (paragraph 2-3).

2. Meter is very sensitive to ambient temperature differences. This is seen by touching the circuit, by putting a heat source near the circuit, or by a regular pattern of instability, corresponding to heating and air conditioning systems or changes in sunlight.

c. To minimize the drift caused by thermal emf's, use the same metal or metals having the same thermo-electric powers in the input circuit. Gold, silver and low-thermal solder have a thermo-electric power within about  $\pm 0.25 \mu\text{v}/^\circ\text{C}$  of copper. This means a temperature imbalance of  $1^\circ\text{C}$  between these metals would generate a thermal emf of about 0.25 microvolt. At the other extreme, germanium has a thermoelectric power of about  $320 \mu\text{v}/^\circ\text{C}$ , and silicon will develop about  $420 \mu\text{v}/^\circ\text{C}$  against copper. Standard physical handbooks contain tables of thermoelectric powers of materials. Since the Model 150B input circuit is made of pure copper, the best junction is copper to copper. However, copper oxide in the junction will cause thermal emf's on the order of 100 nanovolts per  $^\circ\text{C}$  or less. Also, differences in processing of two pieces of copper can cause thermal emf's of up to 0.2 microvolt per  $^\circ\text{C}$ . The Model 1483 Kit contains all necessary equipment to make very low thermal copper crimp joints. See paragraph 2-16.

d. Besides using similar metals, thermal emf's can be reduced by maintaining constant temperatures. Keep all circuits from open windows, fans, air conditioning vents and similar sources which vary temperature. Minimize thermal gradients by placing all junctions physically close on a large heat sink. Thoroughly clean all copper leads before making a connection. Crimp together the ends of each copper wire; bolt the lugs for each connection point together; mount all stacks of lugs on a thick metal plate having high thermal conductivity. Thermal conductivity between the junctions and the heat sink can be kept at a high level by using mica washers or high conductivity ceramics for electrical insulation.

e. Several other techniques will reduce the effects of thermal emf's. Use the zero suppression circuit to buckout constant voltages. If connections must be soldered, use only cadmium-tin low-thermal solder, such as supplied in the Model 1483 Kit. If cadmium solder is used for connections, make sure the soldering iron used is clean and that it has not been used with regular solder before. Use only Rosin solder flux. If possible, heat sink all cadmium-soldered joints together to reduce thermal emf's. Unlike metals — including regular solder — may be used and low thermal emf's obtained if a well-controlled oil bath or a good heat sink is used. Thermal voltages may be calculated from the thermoelectric power of the materials in the junction and the possible temperature difference between the junctions.

#### 2-14. SHIELDING.

a. Due to its narrow bandwidth and filtering, the Model 150B is quite insensitive to ac voltages superimposed upon a dc signal at the input terminals. However, ac voltages which are large compared with the dc signal — thousands of times greater on the more sensitive ranges — may drive the Model 150B ac amplifier into saturation, increasing the noise and erroneously producing a dc output at the demodulator. Therefore, the circuit should be shielded and the shield connected to the Microvolt Ammeter ground, particularly for low-level sources.

b. Improper shielding can cause the Model 150B to react in one or more of the following ways:

1. Needle jitter or instability, from 10% to 20% of full scale.
2. High offset (dc bias). Changing the power cord polarity or the connection between the LO and GND terminals may affect the amount of offset.
3. Slow response time, sluggish action and/or inconsistent readings between ranges.

c. To minimize pickup, keep the voltage source and the Microvolt Ammeter away from strong ac magnetic sources. Connect all shields together at the low side of the input or

at the LO terminal. The voltage induced due to magnetic flux is proportional to the area of the loop. Therefore, minimize loop areas in the shield connections as well as the input circuitry. Connect the shield at only one point. Run all wires in the circuit along the same path, so the loop area is only the small difference in position of two adjacent wires.

d. Strong third harmonic magnetic fields — 180 cps for 60-cps units — may create an 8-cps beat at the Microvolt Ammeter output and meter. To reduce this effect, turn off all possible nearby sources, such as heavy-duty transformers. Remove the Model 150B and the measuring circuit as far as possible from the magnetic field. If removal does not greatly reduce the beat, magnetic as well as electrostatic shielding around the circuit may be necessary. The ratio of the 8-cps amplitude to the dc output level may be reduced by nearly 1 decade using the 100mv filtered output.

#### 2-15. OPERATING FROM SOURCE OTHER THAN 117 VOLTS, 60 CPS.

a. If the ac power source is 234 volts, use a screwdriver to change the Line Voltage Switch on the back panel. Change the fuse from 1/8 ampere to 1/16 ampere. Use only 250-volt MDL fuses. No other adjustment is necessary.

b. The Model 150B can operate satisfactorily from 60 or 50-cps sources, but the best ac rejection is achieved when the filter is set for the line frequency. For 50-cps ac power sources, change the two resistors in the input filter R147 and R148 (Figure 18). Use Keithley part R132-1273 (R147 and R148) for 50 cps. Some units are, per special order, modified at the factory for 50-cps ac power sources. The filter in these cases is adjusted for 50-cps, and this fact is indicated on the rear panel of the Model 150B.

#### 2-16. ACCESSORIES FOR INPUT CONNECTIONS.

a. The easiest way to connect the voltage source to the Model 150B input is with the Model 1506 Input Cable supplied with the instrument. Use the Cable for temporary setups, for measurements at several points, and when fast connections are needed. The Model 1506, which has alligator clips, connects directly to the INPUT Receptacle.

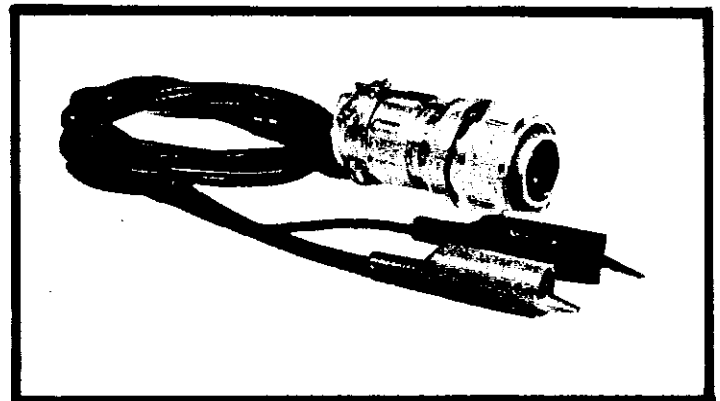

FIGURE 3. Model 1506 Low-Thermal Input Cable.

b. Where more permanent setups are needed, use the Model 1507 Input Cable. It is similar to the Model 1506, except it has spade lugs instead of alligator clips.

c. Use crimp connections with copper wire and lugs for the best low-thermal joints. The Model 1483 Low-Thermal Connection Kit contains a crimp tool, shielded cable, an assortment of copper lugs, copper wire, cadmium solder and nylon bolts and nuts. It is a complete kit for making very low-thermal measuring circuits. The Kit enables the user of the Model 150B to maintain the high thermal stability of the Microvolt Ammeter in his own circuit.

d. The Model 1486 male low-thermal input connector is for connecting custom-made circuits to the Model 150B.

e. Other available accessories are: The Model 1484 Refill Kit, which contains replacement parts for the Model 1483; The Model 1485 female low-thermal input connector to use with the Model 1486 for building shielded low-thermal circuits; Model 1488 Low-Thermal Shorting Plug, which is helpful in testing the Model 150B; Model 1489, which is a replacement nickel-cadmium battery pack.

f. Model 1481 or Model 1482 Input Cable, supplied with the Keithley Models 147 and 148, may be used with the Model 150B. The shielding in these cables, however, is not as good as the shielding in the Models 1506 and 1507 Input Cables. Shielding problems occur with the Models 1481 and 1482 Cables at source resistances greater than 10 kilohms.

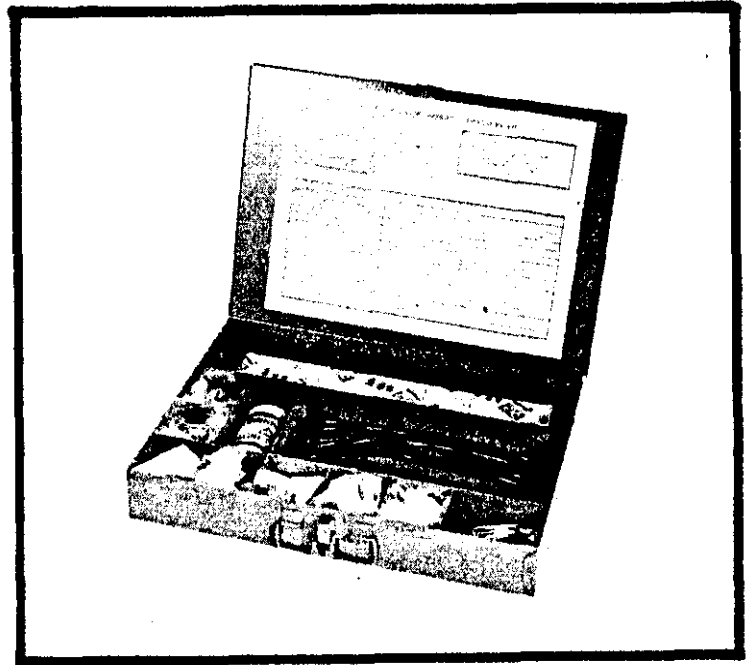

FIGURE 4. Model 1483 Low-Thermal Connections Kit..



### SECTION 3. CIRCUIT DESCRIPTION

#### 3-1. GENERAL.

a. The Model 150B consists of a chopper demodulator system followed by a dc amplifier. Feedback is applied to the whole loop. (See Figure 5).

b. A mechanical chopper converts the dc input signal to a 94-cps signal. The ac signal is amplified, demodulated, dc amplified and applied to the meter and the output. A feedback network samples the signal at the output and compares it to the input. The dc input signal and the feedback signal are compared in the input transformer primary. The transformer increases the voltage-difference signal between the two. The ac amplifier amplifies the difference signal. The ac signal is then demodulated by a saturated transistor switch and enters a dc amplifier, which has a feedback capacitor to filter out the demodulator ripple. The dc amplifier output is connected to the meter, the output terminals and the feedback network. The feedback resistors determine full-scale range. The zero suppress signal is connected to the feedback point in the input circuit.

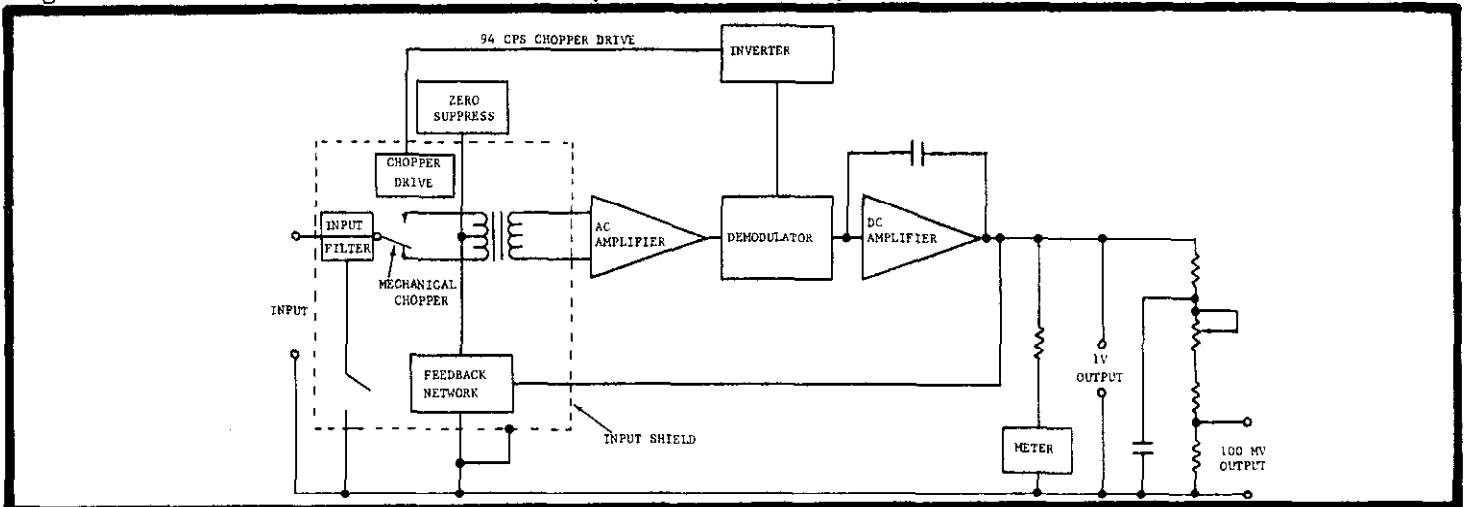

FIGURE 5. Block Diagram of Model 150B Amplifier Circuits.

c. The power source for the Model 150B is either line voltage or the rechargeable battery. Voltage from either source is applied to a regulator, then to an inverter, then to two supplies (which provide large amounts of filtering) and a demodulator and chopper drive. The two supplies furnish power to the amplifier circuits. There is also a battery charging circuit to charge the battery when the line voltage is connected.

#### NOTE

The circuit designations referred to in this section are for Schematic Diagrams 20350E and 20357D found at the back of the manual.

#### 3-2. INPUT CIRCUIT.

a. The dc input signal is connected through the high terminal of the INPUT Receptacle, J104, through the input filter to the center contact of the mechanical chopper, G101. (See Figure 6). The feedback signal is applied to the center tap of the input transformer,

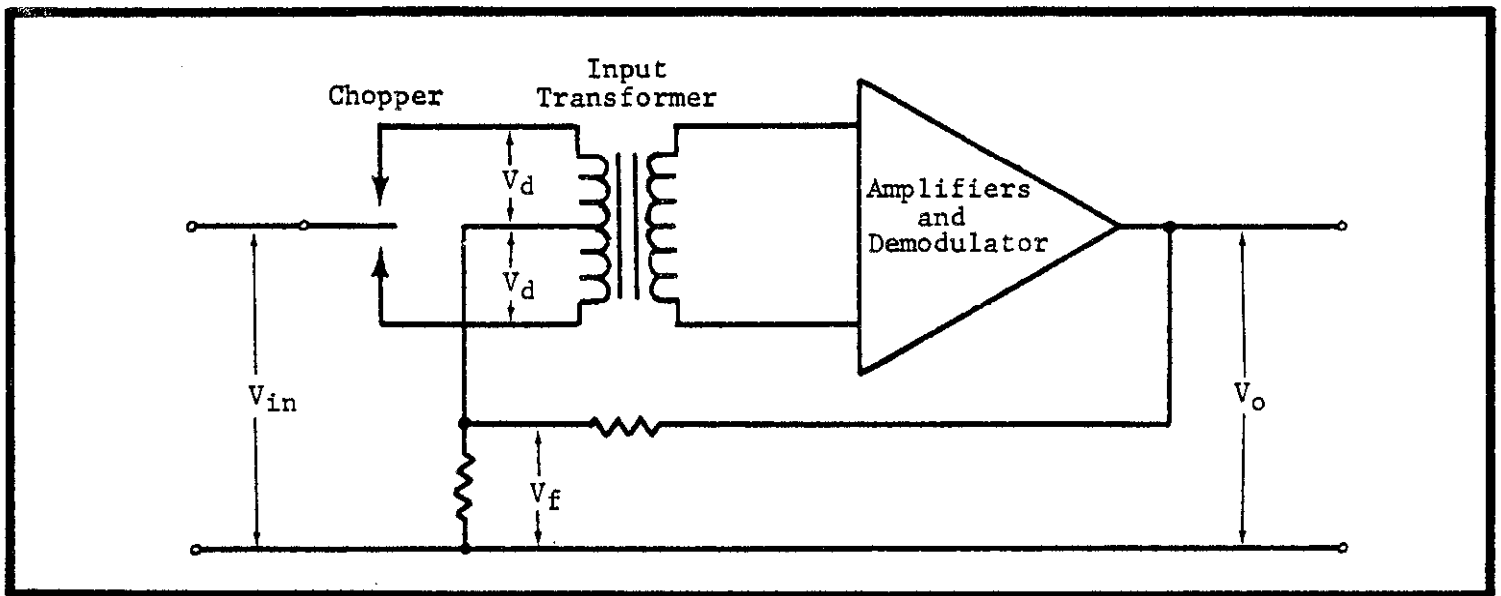

FIGURE 7. Model 150B Input Circuit. The dc input signal,  $V_{in}$ , is applied to the mechanical chopper. The feedback signal,  $V_f$  (the dc amplifier output voltage,  $V_o$ , times the feedback ratio,  $\beta$ ), is applied to the transformer primary. The signal,  $V_d$ , stepped up by the transformer is the difference between the two,  $V_d = V_{in} - V_f$ . When the dc input signal is initially applied to the Model 150B,  $V_f$  is zero and the voltage across the primary is entirely  $V_{in}$ . As the output voltage rises,  $V_f$  increases and  $V_d$  decreases to a small value,  $V_f = V_{in}$ , or  $\beta V_o = V_{in}$ . Only  $\beta$ , which depends upon the RANGE and FUNCTION Switch settings, determines the amplifier gain.

T101. The chopper alternately applies a positive and a negative square-wave signal across each half of the primary. The magnitude of the square wave is proportional to the difference between the dc input and the feedback signal. T101 increases the magnitude of this signal and applies it to the grid of tube VI.

b. The input compartment is designed to insure high thermal stability and to minimize internal ac pickup.

1. Thermal stability is obtained in part by using only copper wire interconnections in the input circuitry. Connections between components are made with low-thermal cadmium solder. Special low-thermal resistors are used in the filter and in the low-level section of the feedback loop. The switches use standard contacts and rotors, gold plated for low thermal emf's and high reliability.

2. The input compartment is shielded against magnetic and electrostatic pickup on all sides. The wires are physically placed to maintain minimum loop area, further minimizing pickup.

c. The feedback network is formed from the output of the dc amplifier back to the center tap of the primary of transformer T101. The RANGE Switch, S104, selects the feedback ratio used for each range.

### 3-3. AC AMPLIFIER.

- a. The ac amplifier circuit amplifies the 94-cps difference signal which corresponds to the dc input signal. The signal is applied to the grid of tube VI and amplified.

Transistor Q101 acts as a constant current source for tube V1, with field effect transistor Q102 providing a high impedance level following the first stage. Transistor Q103 is for impedance matching. Potentiometer R112, between the Q103 emitter and the Q104 base, adjusts the gain to compensate for beta variations. The difference signal is then amplified by transistors Q104 through Q107. Transistors Q106 and Q107 also form a full wave signal for demodulation.

b. The tube type of V1 and the bias of V1 with transistors Q101 and Q102 are selected for low-noise operation at 94 cps. A narrow bandwidth around 94 cps is provided. The frequency to be amplified by the first stage is selected to be 94 cps (TT ADJ Controls, Potentiometers R140 and R143) by a notch filter in a feedback loop around the first stages.

3-4. DEMODULATOR. Transistors Q108 and Q109 in inverted configuration form a transistor switch demodulator. They convert the 94-cps wave from the ac amplifier into a dc voltage with ripple component. Resistors R127 and R128 sum the voltages from each to form a full-wave rectified signal. The secondary of the inverter transformer, T201, furnishes a square-wave drive for the demodulator.

### 3-5. DC AMPLIFIER.

a. The demodulator signal is amplified by two low-drift, high gain silicon transistors, Q110 and Q111, in differential configuration to compensate for temperature drift. Silicon transistors Q112 and Q113 form the second amplifier stage. Total gain is about 500. Diode D102 limits the output current, protecting output transistor Q114.

b. A feedback loop with capacitors C109 and C120 around the dc amplifier acts as an integrator, filtering the ripple component of the demodulated waveform. The effective capacity, which is approximately the value of C109 and C120 times the dc amplifier gain, and the feedback factor (or open-loop gain) of the entire amplifier, V1 to Q114, determine the response speed of the system. The capacitive feedback also reduces the noise in the amplifier outside the system bandpass.

3-6. ZERO SUPPRESSION. The zero suppress circuit provides a regulated voltage from the power supplies to buckout steady background potentials in the input signal. The 10-turn FINE Control, potentiometer R307, is connected between -12 and +12 volt outputs. The rotor of potentiometer R307 is connected to a resistive divider R187, R301, R302 and R303 in the COARSE Switch which further divides the voltage. The suppression voltage is applied directly to the feedback resistor, R165, which acts as another divider in conjunction with R149.

3-7. POWER SUPPLIES (See Figure 7.) The power supply for the Model 150B consists of a regulated supply which operates from the power transformer or a rechargeable battery. The output of this regulator feeds an inverter, two highly filtered supplies with outputs of +12, -12 volts and a drive circuit for the chopper and demodulator. These power all the other Model 150B circuits.

a. The line power, battery and battery charging circuits are controlled through the POWER SUPPLY Switch, S201. When the switch is in AC, the battery is charged and the power supply operates from the power transformer, T202. When the switch is in OFF, the battery charges; all other circuits are off. When the switch is in BATTERY, the power supply operates from the battery; the power transformer is disconnected at its primary windings.

b. The regulated supply is prefiltered with a large capacitor, C211. The supply consists of a series regulator with a darlington pass arrangement made up of Q218, Q212 and Q214. Any variation across the output is referenced by resistors R234 and R238 with zener

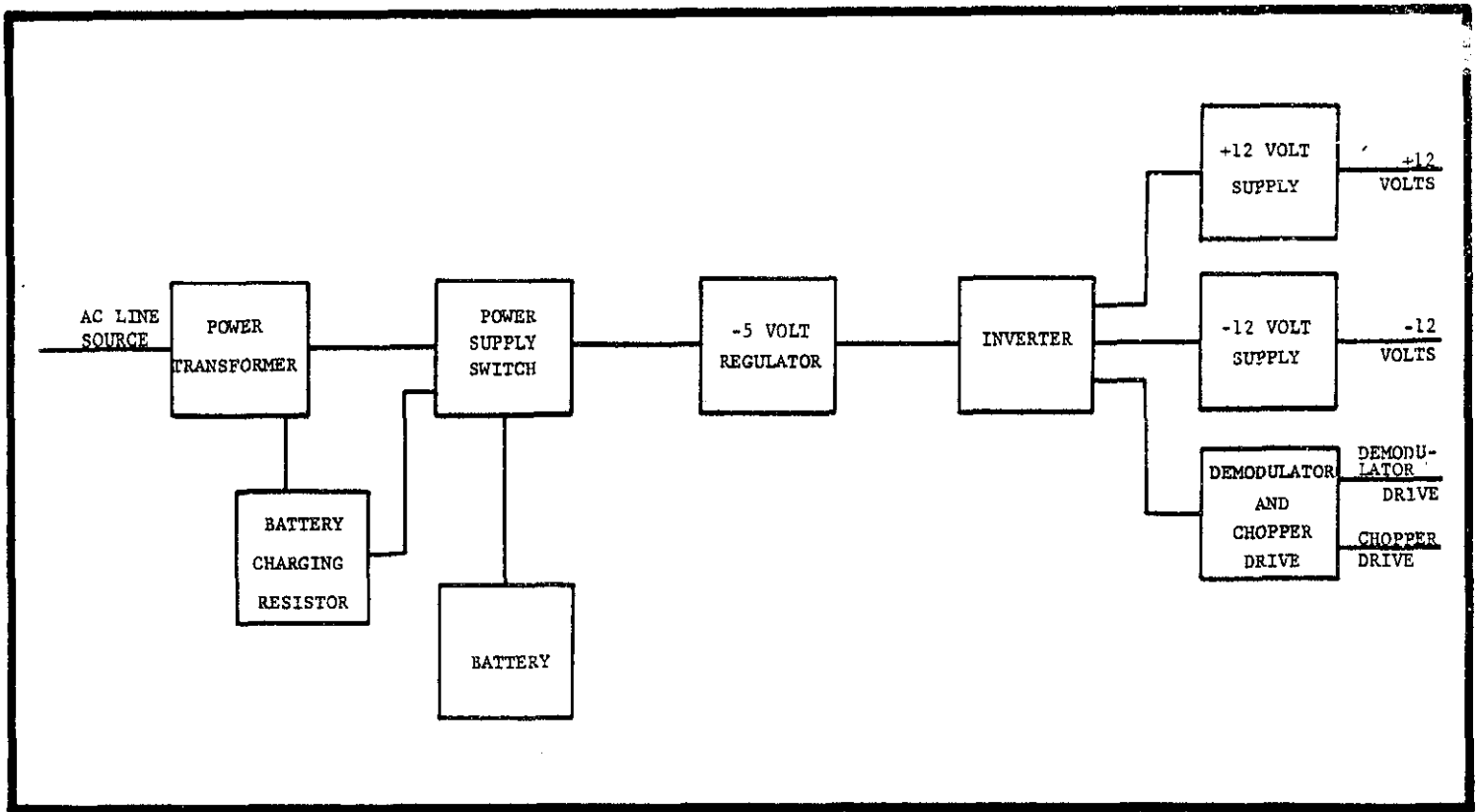

FIGURE 7. Block Diagram of Model 150B Power Supplies.

diode D211 and compensated for by the amplifier consisting of Q215, Q216 and Q217. The output of the supply is adjustable around -5 volts.

c. Voltage from the regulated supply is applied to the inverter circuit. Transistors Q201 and Q202 form a switching network to supply a square-wave voltage to transformer T201. The switching frequency is 94 cps, the same as the carrier frequency. Transformer T201 has a saturable ferrite core. The inverter circuit supplies voltages to the two regulated supplies and the chopper demodulator circuit.

d. The +12 volt supply is a highly filtered voltage taken from the secondary windings of the inverter transformer, T201. Diodes D201 and D202 full wave rectify the signal from the transformer. This signal is filtered by the RC filter, R204 and C203. A Darlington configuration, transistors Q203 and Q204, maintains the low-ripple voltage at the supply output. A current limiting circuit, transistor Q205, protects the pass transistor if the output of the supply is shorted.

e. The -12 volt supply operates in a similar manner to the +12 volt supply.

f. One secondary of the inverter transformer drives transistors Q209 and Q210 through a phase compensating network made up of resistors R220 through R224 and capacitor C210. This phase compensation network compensates for the chopper phase shift. Transistors Q209 and Q210 are alternately cut off and driven into saturation, forming a square wave drive to the demodulator. The drive for the chopper is taken from one-half of the secondary of the inverter transformer that is used to drive the demodulator. Capacitor C213 "rounds off" the square wave to produce a more acceptable chopper drive wave form.

## 3-8. BATTERY CHARGING CIRCUIT.

a. The battery circuit operates when the POWER SUPPLY Switch, S201, is in the AC or OFF position.

b. A charging current from transistor T20<sub>1</sub> is applied to the battery through a half wave rectifier and a series resistor, R228. A fuse is incorporated in this circuit to protect the instrument and the battery. Note, however, that the battery can be damaged if it is used far beyond its capacity. A polarity reversal of a cell may occur, causing heavy circulating currents within the battery.

Instrument	Use
Hewlett-Packard Model 200 CD Oscillator, 5 cps to 600 kc, $\pm 2\%$ accuracy.	TT adjust and Filter adjust calibration.
Hewlett-Packard Model 5512A Electronic Counter, 300-kc counting rate, $\pm 0.1\%$ accuracy.	Monitor oscillator frequency.
Keithley Instruments 1488 Low-Thermal Shorting Plug.	Short Model 150B INPUT Receptacle.
Keithley Instruments Model 1507 Input Cable.	Connecting cable for Model 260 and Model 150B.
Keithley Instruments Model 260 Nanovolt Source.	Signal source for calibrating Model 150B.
Keithley Instruments Model 261 Picoampere Source.	Signal source for calibrating Model 150B.
Keithley Instruments Model 370 Recorder.	Monitor drift.
Keithley Instruments Model 610B Electrometer.	Check plate voltage of tube VI.
Keithley Instruments Model 662 Guarded DC Differential Voltmeter, $\pm 0.01\%$ to 1 millivolt.	Check voltage at output terminals.
RCA Model WV98B Senior Voltohmyst, 11 M $\Omega$ input resistance, $\pm 3\%$ accuracy, 0 to 1500 volts dc.	Check dc voltages throughout circuit.
Tektronix Type 503 Oscilloscope, dc to 450 kc.	Check wave forms for troubleshooting and calibration.

TABLE 6. Equipment Recommended for Troubleshooting and Calibrating the Model 150B. Use these instruments or their equivalents.

## SECTION 4. MAINTENANCE

### 4-1. GENERAL.

a. Section 4 contains the maintenance, troubleshooting and calibration procedures for the Model 150B. It is recommended these procedures be followed as closely as possible to maintain the instrument's specifications.

b. The Model 150B requires no periodic maintenance beyond the normal care required of high-quality electronic equipment. Components operate well below maximum ratings. Principal maintenance is an occasional chopper replacement. (See paragraph 4-3.) Occasional verification of meter calibration (paragraph 4-7) should show any need for adjustment.

### 4-2. PARTS REPLACEMENT.

a. The Replaceable Parts List in Section 6 describes the electrical components of the Microvolt Ammeter. Replace components only as necessary, and use only reliable replacements which meet the specifications. The Model 150B uses no special critical parts except the components listed in Table 7. Make sure parts coded 80164 in the Replaceable Parts List are purchased only from Keithley Instruments or its distributors.

### 4-3. MECHANICAL CHOPPER REPLACEMENT.

a. The mechanical chopper is designed for long life. However, since it is mechanical, it will eventually wear and become noisy. At this point, replacement is necessary.

#### b. Removal Procedures.

1. Disconnect the chopper drive coil at connector J105 (Figure 11). Carefully remove the chopper lugs from the studs mounted on the bottom of the input compartment.

2. Remove the four mounting screws from the bottom of the input compartment. Remove the old chopper.

#### c. Replacement Procedures.

1. Mount the chopper with the four furnished screws.

2. Dress the leads and draw the lugs down on the studs.

Component	Circuit Desig.	Keithley Part No.
Battery pack assembly	BT201	Model 1489
Mechanical chopper assembly and input connector assembly (See paragraph 4-3.)	G101 & J105	20139B
Input transformer assembly	T101	20137B

TABLE 7. Model 150B Pre-assembled Components. These parts have lugs crimped on them and the proper lead length. Use only Keithley parts for replacement.

3. Connect the chopper drive coil at connector J105.

4. Check the instrument for proper operation. Follow paragraph 4-8, subparagraph b, steps 1, 2 and 3.

#### 4-4. TROUBLESHOOTING.

a. The following procedures give instructions for repairing troubles which might occur in the Model 150B. Use these procedures to troubleshoot and use only specified replacement parts. Table 6 lists equipment recommended for troubleshooting. If the trouble cannot be readily located or repaired, contact Keithley Instruments or your Keithley field engineer.

b. Paragraphs 4-6, 4-7 and 4-8 give step-by-step procedures for troubleshooting and checking out the power supply and amplifier circuits. Follow these in the order given. Tables 9 and 12 are troubleshooting tables for these circuits. Also refer to Section 3 to find the more crucial components and to determine their function. The Schematic Diagrams, 20350E, and 20357D, contain the voltages at certain points in the circuit, measured with a Model WV98B Voltohmyst.

#### NOTE

Before troubleshooting inside the Model 150B, check the external circuits (paragraph 4-5). Always check out the power supply circuit before touching the amplifier circuits. The amplifier circuits often appear faulty only because of a defect in the power supply.

#### 4-5. PRELIMINARY TROUBLESHOOTING PROCEDURES.

a. Before troubleshooting, check the outside circuits to the Model 150B. Isolate the Microvolt Ammeter from all external effects:

1. Disconnect all outside circuits from the INPUT and OUTPUT Receptacles, and GND and LO terminals.

2. Connect a low-thermal short across the INPUT Receptacle. The best connector is a Model 1488 Low-Thermal Shorting Plug. The next best is a Model 1506 Input Cable with the clips connected together or the Model 1507 Input Cable with the lugs connected together. Keep the cable as far as possible from ac sources, and avoid a loop where the alligator clips or lugs are connected.

3. Set the ZERO SUPPRESS COARSE Control to OFF.

b. If the battery charge is acceptable (paragraph 2-2), set the POWER SUPPLY Switch to BATTERY. Disconnect the power cord from the power line. Battery operation eliminates many ground-loop connection problems with the test equipment.

c. If ac operation is used, check the Line Voltage Switch for correct position and the Fuse for correct rating.

#### 4-6. CHECK OUT AND CALIBRATION PROCEDURES.

a. To ascertain whether the Model 150B is operating properly, perform an accuracy check of the voltage ranges and current ranges.



1. To check the accuracy of the voltage ranges, follow the procedures of paragraph 2-3. Use the Model 260 as the voltage source and connect the Model 260 to the Model 150B using the 1507 Input Cable. Check each voltage range on the Model 150B by applying a nine-tenths full-scale signal with the Model 260 (i.e. 9 microvolt input signal for the 10 microvolt range; 27 microvolt signal for the 30 microvolt range, etc.). Check each range for both positive and negative polarity. The meter accuracy of the Model 150B is specified to be  $\pm 2\%$  of full scale exclusive of noise and drift.

2. To check the accuracy of the current ranges, follow the procedures of paragraph 2-4. Use the Model 261 as the current source and connect the Model 261 to the Model 150B using the 1507 Input Cable. Check each current range on the Model 150B by applying a nine-tenths full-scale signal with the Model 261 (i.e. 9 nanoampere input signal for the 10 nanoampere range; 27 nanoampere input signal on the 30 nanoampere range, etc.). Check each range for both positive and negative polarity. The meter accuracy of the Model 150B is specified to be  $\pm 3\%$  of full scale exclusive of noise and drift.

3. If any range fails to be within specifications, check to see if the meter is in calibration (paragraph 4-7c). If the meter is in calibration and any range still fails to be within specification, check the indicated resistors in Table 11.

b. The following procedures give the steps to check out and calibrate the Model 150B circuits. If a circuit fails to check out at any point, refer to the circuit's troubleshooting table. Continue as long as the points check out. Use the equipment listed in Table 6.

c. Procedures are given for the power supply and amplifier circuits. These cover the principal adjustments to bring the instrument within specifications.

d. If the Model 150B is not within specifications after performing these checks and calibrations, return the unit to Keithley Instruments for further checkout, or follow the troubleshooting procedures to find the fault.

Control	Circuit Desig.	Fig. Ref.	Refer to Paragraph
V1 Bias adjust	R107	10	4-7, 4-8
Gain control	R112	15	4-8
TT adjust	R140 and R143	15	4-8
Filter adjust	R146	18	4-8
Meter Cal.	R193	17	4-7
Frequency adjust	R235	13	4-7
Current Comp. adjust	R304	10	4-7

TABLE 8. Model 150B Internal Controls. The table lists all the controls, the figure picturing the location, and the paragraph describing the adjustment.

#### NOTE

Make sure the power supply circuit is operating correctly before checking the amplifiers. All circuits depend upon properly functioning power supplies. If taken out of order, the resulting adjustment may be faulty.

TROUBLE	PROBABLE CAUSE	SOLUTION
No voltage at the black and white wire attached to last pin before strut on S103 (point G, Fig. 10).	Blown fuse.	Check for shorted transformer T202 or wiring; then replace fuse.
	D209 or D210 open.	Check components; replace if faulty.
Irregular wave form at pin 8 or 9 (Fig. 8).	Regulator circuit not functioning normally.	Refer to Section 3 to determine the components in the regulator circuit. Check these components and replace if faulty.
Incorrect +12 volt supply voltage, or high ripple on this supply.	Defective Q203 and/or Q204	Check components; replace if faulty.
	Defective C203 and/or C204	Check components; replace if faulty.
	-5 volt regulator not supplying enough voltage to inverter for 94 cps.	Change the value of R204; increase the value if the +12 output is low; decrease it (not below 3.9 kΩ) if the +12 output is high.
Incorrect -12 volt supply voltage, or high ripple on this supply.	Defective Q207 and/or Q208	Check components; replace if faulty.
	Defective C208 and/or C209	Check components; replace if faulty.
	-5 volt regulator not supplying enough voltage to inverter for 94 cps.	Change the value of R219; increase the value if the -12 output is low; decrease it (not below 3.9 kΩ) if the -12 output is high.

TABLE 9. Troubleshooting Table for Power Supply.

4-7. POWER SUPPLY CHECK OUT AND CALIBRATION.

a. All circuits depend upon the -5 volt regulated supply. This supply drives the inverter transformer which, in turn, supplies the -12 and +12 volt outputs. Therefore, the -5 volt supply must be operating correctly before further checks are made. If the power supply fails to check out at any point, refer to Table 9. After clearing the trouble, continue the check.

b. Procedures for Checking Regulated Power Supplies.

1. Connect the Model 1488 Low-Thermal Shorting Plug to the INPUT. Set the Model 150B controls as follows:

POWER SUPPLY Switch	OFF
RANGE Switch	1 MICROVOLT
FUNCTION Switch	INPUT R OPEN
ZERO SUPPRESS COARSE Control	OFF
Line Voltage Switch	Set to line voltage
FILTER Switch	IN

2. Turn the FREQ ADJ Potentiometer, R235 (Figure 13) and V1 BIAS Potentiometer, R107 (Figure 10) completely counterclockwise. This ensures that the tube in the first stage and the chopper will not be damaged.

3. Plug in the power cord.

4. Measure the voltage at the red wire on the POWER SUPPLY Switch front deck. It should be -11 volts dc  $\pm 2$  vdc.

5. Turn the POWER SUPPLY Switch to AC. Use the Type 503 Oscilloscope to check the wave form at pin 8 or 9 of connector J201 on the bottom of PC-120 (Figure 11). Wave form should look like Figure 8.

a) The dc voltage at pin 8 or 9 should be -5 volts  $\pm 0.3$  vdc. This voltage will be present at pin 8 or 9 if the chopper frequency is 94 cps.

b) Check the chopper frequency by connecting the Type 503 Oscilloscope differentially at pins A and D on connector J105 (Figure 11). Measure the oscillator frequency with the Model 5512A Electronic Counter set at 94 cps. Connect the oscillator to the horizontal channel of the Type 503 Oscilloscope and obtain a lissajous pattern. The wave form of the chopper drive should resemble that in Figure 9.

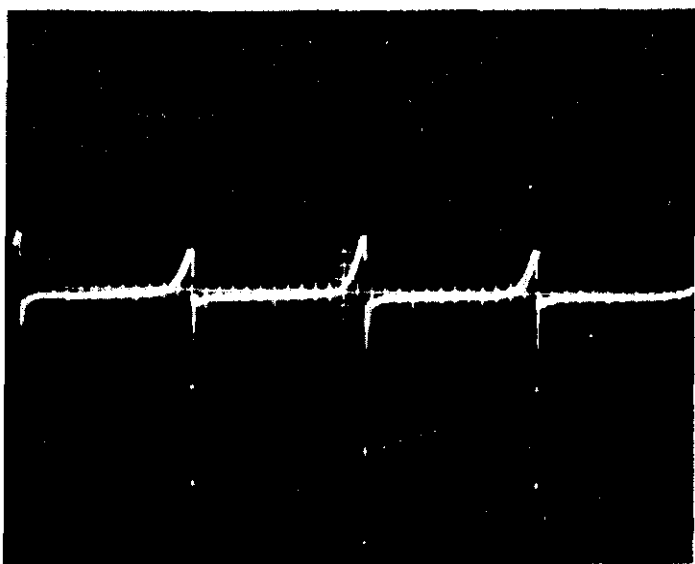

FIGURE 8. Correct -5v Regulated Supply Wave Form at Pin 8 or 9 of Connector J201. See paragraph 4-7. Form was obtained on the 1  $\mu$ v range with the FILTER Switch set to IN. The scale is 0.2v/cm vertical, 2 msec/cm horizontal.

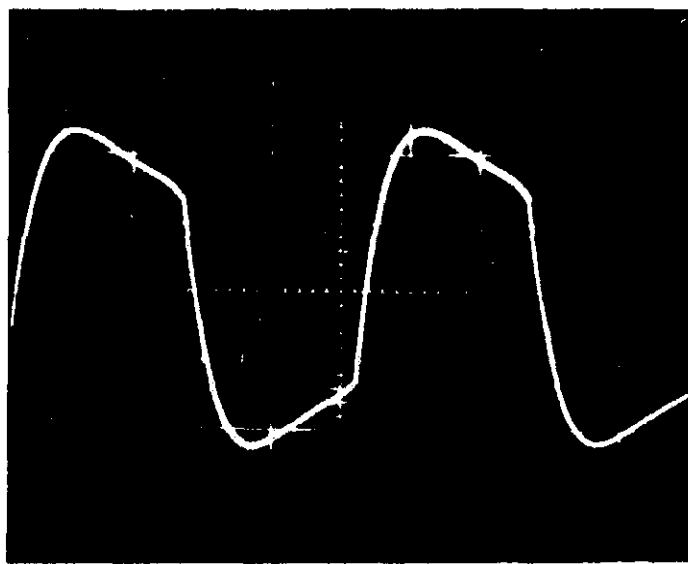

FIGURE 9. Correct Chopper Drive Wave Form at Pins A and D of J105. See paragraph 4-7. Form was obtained on the 1  $\mu$ v range with the FILTER Switch set to IN. The scale is 5v/cm vertical, 2 msec/cm horizontal.

6. Measure the signal levels and ripple with respect to low of the +12 and -12 volt supplies. Table 10 gives the values.

a) To measure the +12 volt supply, connect the Model WV98B Voltmeter at pin 19 of connector J201, Figure 11.

b) To measure the -12 volt supply, connect the Model WV98B Voltmeter to pin 6 of connector J201, Figure 11.

c) To find the ripple on the supplies connect the Type 503 Oscilloscope to pin 19 or 6. The ripple should be less than 2 mv peak-to-peak.

Regulated Power Supply	Test Point, Figure 11	Signal Level, Volts dc	Maximum Ripple, Millivolts Peak-to-Peak	Resistance to Ground, Ohms
+12 volt	pin 19, J201	11 to 12.5	1.5	850 ±100
-12 volt	pin 6, J201	11 to 12.5	2.0	460 ±70

TABLE 10. Signal Level, Maximum Ripple and Resistance for Regulated Power Supplies.

c. Meter Noise Check. Set the Model 150B RANGE Switch to 0.3 MICROVOLT. Short the Model 150B input with the Model 1488 Shorting Plug or some other suitable device. Check the meter noise. The meter noise should be less than 25 nanovolts peak-to-peak. If it is not, then possible sources of noise are transistor Q101, tube V1, the chopper, power supply, and cadmium solder joints.

d. Meter Calibration.

1. Set the Model 150B front panel controls as follows:

POWER SUPPLY Switch	OFF
RANGE Switch	100 MICROVOLTS
FUNCTION Switch	VOLTS (either position)
ZERO SUPPRESS COARSE Control	OFF
ZERO SUPPRESS FINE Control	Approximately centered
FILTER Switch	IN

2. Short the Model 150B input with the Keithley Model 1488 Shorting Plug or some other suitable device.

3. Zero the meter with the Mechanical Zero Control.

4. Turn the POWER SUPPLY Switch to ON and set the ZERO SUPPRESS Control to position 2.

5. Adjust the Model 150B 1V Output to within ±0.1% of full scale as read on the Keithley Model 662 Differential Voltmeter.

6. Adjust the Meter Calibration potentiometer (R193, Figure 17) for a reading of 10 on the Model 150B meter scale.

e. Current Compensation Calibration.

1. Set the Model 150B front panel controls as follows:

POWER SUPPLY Switch	OFF
RANGE Switch	10 MICROVOLTS
FUNCTION Switch	VOLTS, INPUT R 100K
ZERO SUPPRESS COARSE Control	OFF
ZERO SUPPRESS FINE Control	Approximately centered
FILTER Switch	IN

2. Short the Model 150B input with the Keithley Model 1488 Shorting Plug or some other suitable device.

3. Turn the POWER SUPPLY Switch to ON. Allow the Model 150B to warm up for 10 minutes and reach thermal equilibrium.

4. Zero the Model 150B using the ZERO SUPPRESS Controls.

5. Remove the short from the input.

6. Adjust the Current Compensation Adjust (R304, Figure 10) for null. A few tenths of a microvolt instability is to be expected.

#### 4-8. AMPLIFIER CHECK OUT AND CALIBRATION.

a. The check out and calibration of the amplifier circuits is divided into these parts: operational check, gain calibration, TT Adjust calibration, Filter Adjust calibration and drift verification. The operational check does not have to be followed by gain calibration. Use this to check the Model 150B operation. If the amplifiers fail to check out at any point, refer to Table 12. After clearing the trouble, continue the check.

#### NOTE

Check the power supply circuits before adjusting the amplifiers. If extensive changes are made, the amplifier circuit may need recalibration.

b. Operational Check Procedures.

1. Connect the Model 1488 Low-Thermal Shorting Plug to the INPUT RECEPTACLE. Set the front panel controls as follows:

POWER SUPPLY Switch	AC
RANGE Switch	1 MICROVOLT
FUNCTION Switch	INPUT R OPEN
ZERO SUPPRESS COARSE Control	OFF
ZERO SUPPRESS FINE Control	Approximately centered
FILTER Switch	IN

2. On the 1-microvolt range, the meter offset should be less than 0.5 microvolt (50% of full scale). It may be higher if the shorting plug (Model 1488) is not used.

3. Connect the Model 610B Electrometer to the plate of tube V1 (point E, Figure 11). Adjust the V1 BIAS Potentiometer (R107, Figure 10) until the Model 610B reads 7 volts  $\pm 0.1$  volt. If the plate voltage is high and cannot be adjusted down to 7 volts with the V1 BIAS Potentiometer, then decrease the value of resistor R102. If the plate voltage is low and cannot be adjusted up to 7 volts with the V1 BIAS Potentiometer, then

increase the value of resistor R102. Disconnect the Model 610B.

4. Remove the Model 1488 Shorting Plug and leave the Model 150B input open. Set the FUNCTION Switch to INPUT R 100%. Connect the Type 503 Oscilloscope to the Model 150B 1V OUTPUT. Set the oscilloscope amplifier to dc coupling, 0.2 volt/cm, time base to 1 second/cm. Set the Model 150B to the 3-microvolt range. Set the ZERO SUPPRESS COARSE Control to 1 and adjust the ZERO SUPPRESS FINE Control to obtain a 3-microvolt signal. The response time (from 10% to 90% of final value) should be approximately 6 seconds. Adjust Gain Control potentiometer R112 (Figure 15) for this value.

#### c. Gain Calibration Procedures.

1. Connect the Model 260 Source to the Model 150B input with the Model 1507 Input Cable.
2. Connect the Model 662 Differential Voltmeter to the Model 150B 1V OUTPUT Receptacle.
3. Before turning the Model 260 POLARITY Switch to + or -, adjust the ZERO SUPPRESS Controls for zero output at the output terminals. Set the Model 662 to the 5-volt range. Use the Model 662 to determine the zero output.
4. For a given full-scale input signal, measure the output voltage. Check each range and rezero the output using the ZERO SUPPRESS Controls before each check. The output should be 1 volt dc  $\pm 1\%$  for all ranges. If for any range the output is not 1 volt  $\pm 1\%$ , refer to Table 11 and check the resistors for that range. Replace any faulty resistor.

#### d. TT Adjust Calibration.

1. Set the Model 150B front panel controls as follows:

POWER SUPPLY Switch	OFF
RANGE Switch	1 MICROVOLT
FUNCTION Switch	VOLTS (either position)
ZERO SUPPRESS COARSE Control	OFF
ZERO SUPPRESS FINE Control	Approximately centered
FILTER Switch	IN

2. Apply 10 volts peak-to-peak to the input of the 94 cps filter (pin 3 to pin 1 of PC-119, Figure 15) with the Model 200CD Oscillator.
3. Adjust TT ADJ potentiometers R140 and R143 (figure 15) for minimum signal at the output, pin 6 of PC-119. Monitor the output signal with the Model 503 Oscilloscope. The output signal should be about 250:1 less than the input, typically 40 mv or less, and contain very few 94 cps voltages.

#### e. Filter Adjust Calibration.

1. Keep the Model 150B front panel controls the same as in subparagraph d.
2. Apply 10 volts peak-to-peak, 60 cps (or 50 cps if designated on rear panel) to the Model 150B INPUT Receptacle with the Model 200CD Oscillator.
3. Adjust FILTER ADJ potentiometer R146 (Figure 18) for minimum voltage at the output of the filter (junction of resistor R148 to low). Monitor the output with the Model 503

Voltage RANGE	Resistors used in RANGE Switch	Current RANGE	Resistors used in RANGE Switch
0.3 $\mu$ v	R164 through R167	0.3 na	R172, R164, R165, R167, R174
1 $\mu$ v	R164, R165, R167, R168	1 na	R172, R164, R165, R167, R175
3 $\mu$ v	R164, R165, R167, R169	3 na	R172, R164, R165, R167, R176
10 $\mu$ v	R164, R165, R167, R170	10 na	R172, R164, R165, R167, R177
30 $\mu$ v	R164, R165, R167, R171	30 na	R172, R164, R165, R167, R178
100 $\mu$ v	R164, R165, R167, R172	100 na	R172, R164, R165, R167, R179
300 $\mu$ v	R164, R165, R167, R173	300 na	R172, R164, R165, R167, R180
1 mv	R165, R168	1 $\mu$ a	R165, R168, R179
3 mv	R165, R169	3 $\mu$ a	R165, R168, R180
10 mv	R165, R170	10 $\mu$ a	R165, R168, R181
30 mv	R165, R171	30 $\mu$ a	R165, R168, R182
100 mv	R165, R172	100 $\mu$ a	R165, R168, R183
300 mv	R165, R173	300 $\mu$ a	R165, R168, R184
1 v	R165	1000 $\mu$ a	R165, R168, R185

TABLE 11. Range Checkout. If any ranges fail, check the listed resistors.

Oscilloscope. The filter rejection ratio should be about 300:1, typical 30 mv peak-to-peak or less. The output may still contain some live frequency signal.

f. Drift Verification. Make sure the Model 150B cover is on. Short the Model 150B input with the Model 1488 Low-Thermal Shorting Plug. Set the Model 150B RANGE Switch to 0.3 MICROVOLT. Connect the Model 150B to the Model 370 Recorder. After a 1-hour warm-up the drift should be less than 0.1 microvolt per 24 hours. Excessive drift may be indicative of a faulty battery.

TROUBLE	PROBABLE CAUSE	SOLUTION
High zero offset	Short in feedback network.	Make sure lugs do not touch each other or the input compartment.
	Gain adjustment not set correctly.	Adjust GAIN Potentiometer, R112, for a response speed of 6 seconds on the 3 $\mu$ v range. With 100K across the input, see paragraph 4-8b.
Random zero drift, one hundreds of nanovolts or more, sometimes reduced if the cabinet is slapped. Response speed is within specification.	Noisy chopper.	Replace chopper; see paragraph 4-3.
Zero drift greatly affected by slight movement of FUNCTION Switch within a setting.	Dirty FUNCTION or RANGE Switch.	Carefully clean switch contacts and rotors. If this does not cure the problem, return to Keithley Instruments, Inc., for switch replacement.
Zero drift very temperature sensitive.	Contaminated INPUT Receptacle, shorting plug, or connection in input compartment.	Clean INPUT Receptacle with non-metallic abrasive. If contamination goes below plated surface, replace connector. Clean lugs with non-metallic abrasive; be sure to return to posts in original order.
Response speed very slow, possibly offset also high. Cannot adjust to specifications with R112.	Low ac amplifier gain, due to bad active element.	Set to 1-microvolt range, ZERO SUPPRESS COARSE to 1, FINE to an easily readable signal. With oscilloscope, check for square wave at V1 grid, and sine wave at input and output of each succeeding stage. Reduce zero suppression as necessary to prevent saturation. Check dc voltages, V1 through Q107, given on schematic. Replace faulty components.

TABLE 12 (Sheet 1). Amplifier Troubleshooting Table. This table assumes that the Model 150B has a Model 1488 Shorting Plug on the input, and that only test instruments are connected to it.



TROUBLE	PROBABLE CAUSE	SOLUTION
Response speed very slow, possibly offset also high. Cannot adjust to specifications with R112.	Low gain in dc amplifier.	Unsolder and lift one end of R127, R128 and C109. See points M and N, Figure 15. Apply 1 to 100mv to base of Q110 to zero meter. Change input by 1 millivolt; output should shift 0.5 to 1 volt. If not or if more than 100mv is required to zero, check transistors, beginning with Q110 and Q111. Q110 and Q111 are matched for offset. Replace only with parts purchased from Keithley.
	Leaky or shorted C109 and/or C120.	Check; replace if faulty.
Demodulator does not "clamp" during one-half cycle.	Defective Q108, Q109, Q209 or Q210.	Check for square wave at collector of Q209 and Q210 and base of Q108 and Q109. Replace faulty components.
All microvolt ranges out of calibration. The millivolt ranges are good.	R164 or R165 out of tolerance.	Check resistors; replace if faulty.
All ranges are out of calibration.	R165 out of tolerance.	Check resistor; replace if faulty.
One range out of calibration.	Corresponding resistor in Table 11 out of tolerance.	Check resistor; replace if faulty.
When connected in measuring circuit, meter needle oscillates in ac and/or battery operation, even with filter in.	Too much 60 cps at input.	Reduce 60 cps appearing at the input by shielding and grounding as described in paragraph 2-14.

TABLE 12 (Sheet 2). Amplifier Troubleshooting Table. This table assumes that the Model 150B has a Model 1488 Shorting Plug on the input, and that only test instruments are connected to it.

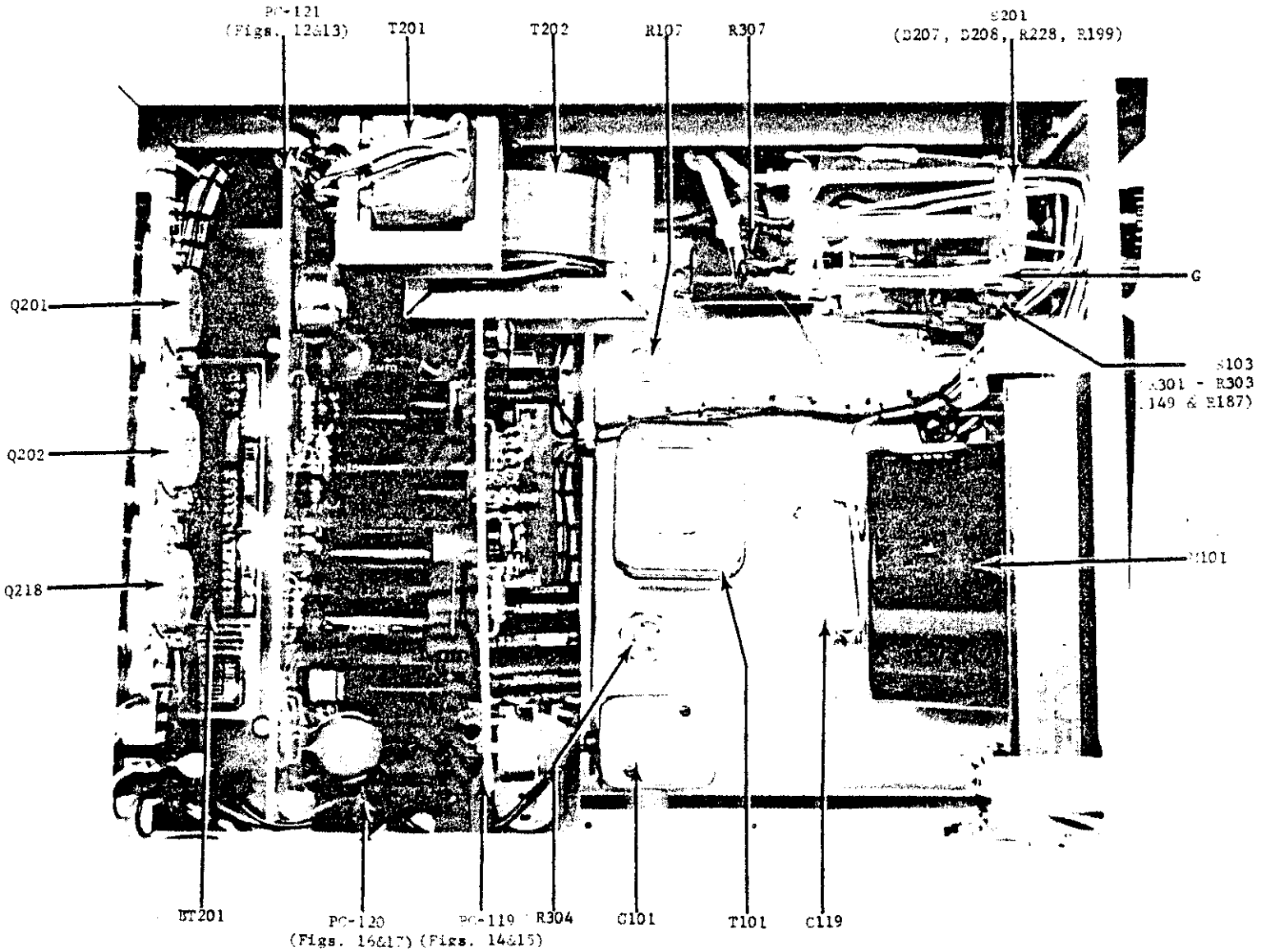

FIGURE 10. Top View of the Model 150B Chassis. Front panel faces right. Location of components, printed circuits and switches is shown. Refer to Replaceable Parts List and schematic diagrams for circuit designations. Figure 11 shows the bottom view.

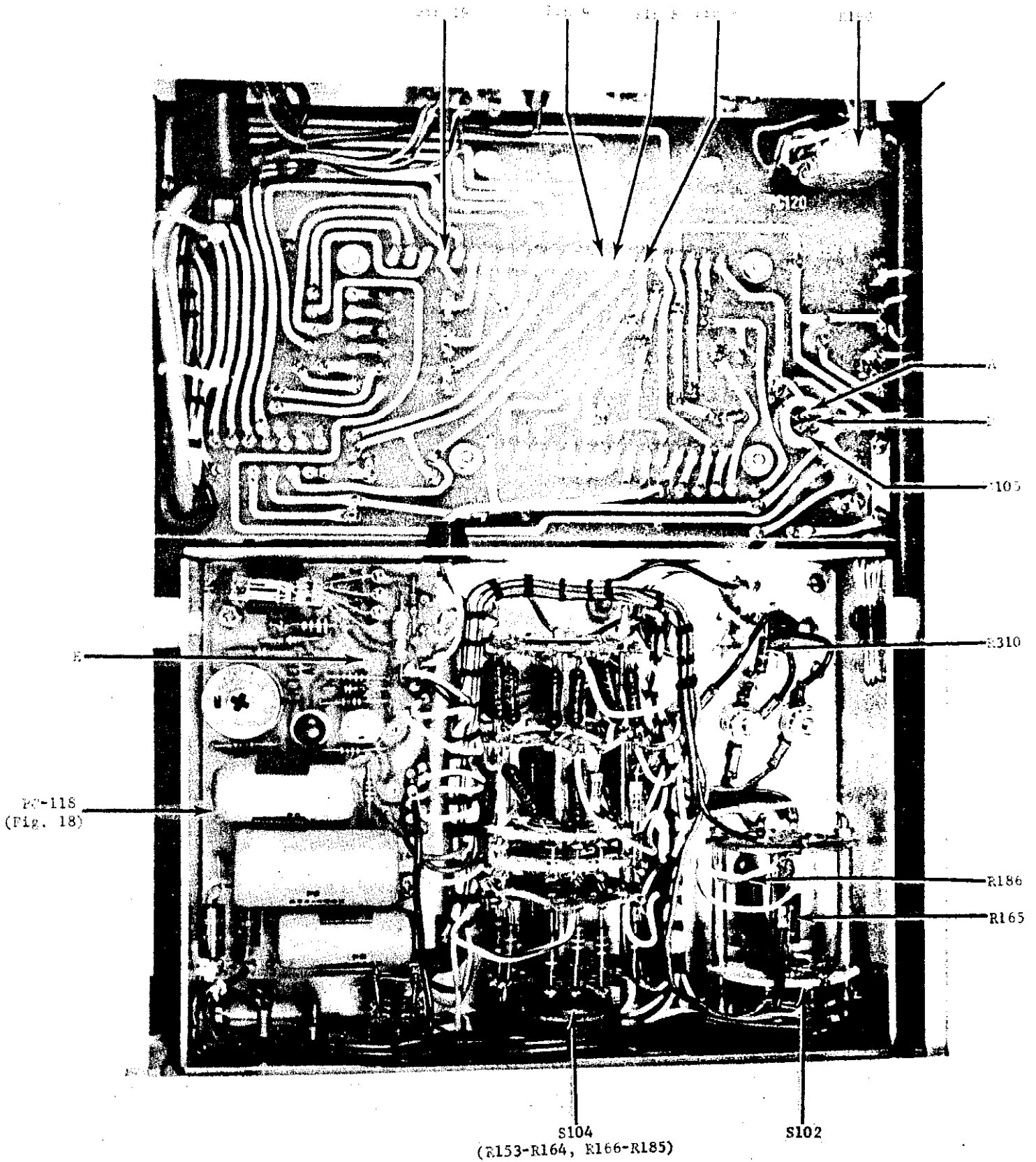

FIGURE 11. Bottom View of the Model 150B Chassis. Front panel faces down. Location of components, printed circuits, switches and test points is shown. Refer to Replaceable Parts List and schematic diagram for circuit designations. Figure 10 shows the top view.

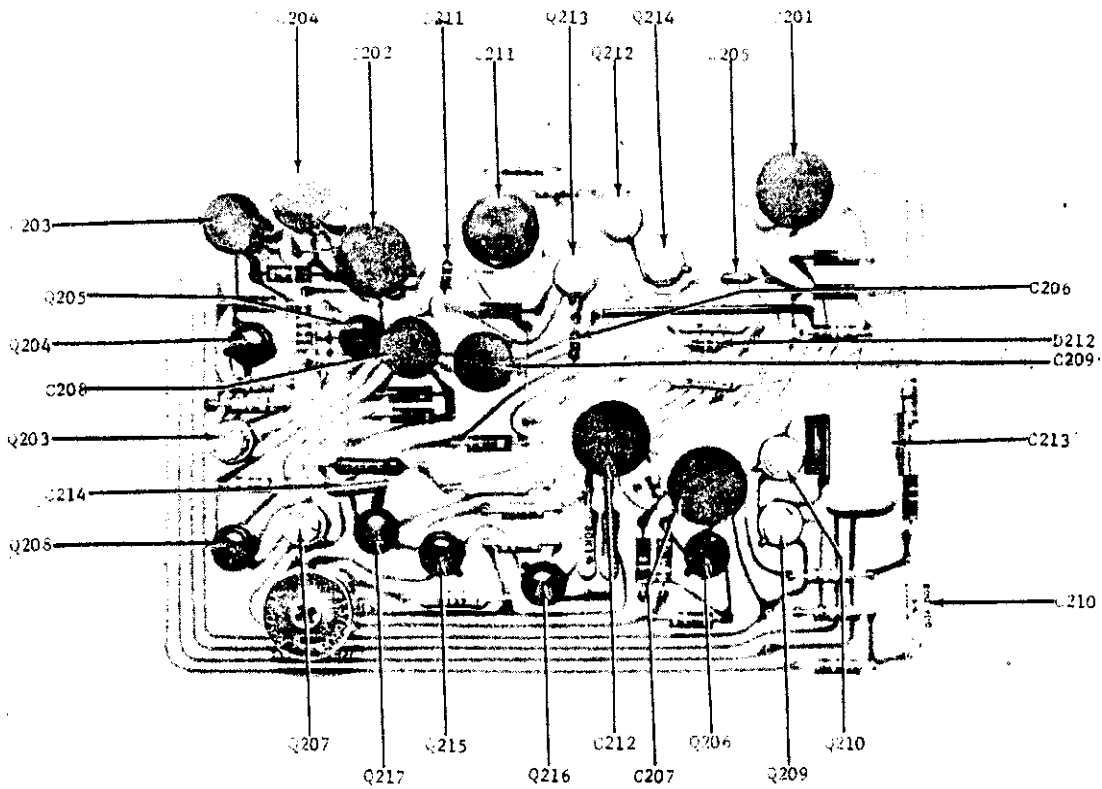

FIGURE 12. Capacitor, Diode and Transistor Locations on PC-121. Refer to Figure 13 for resistor locations.

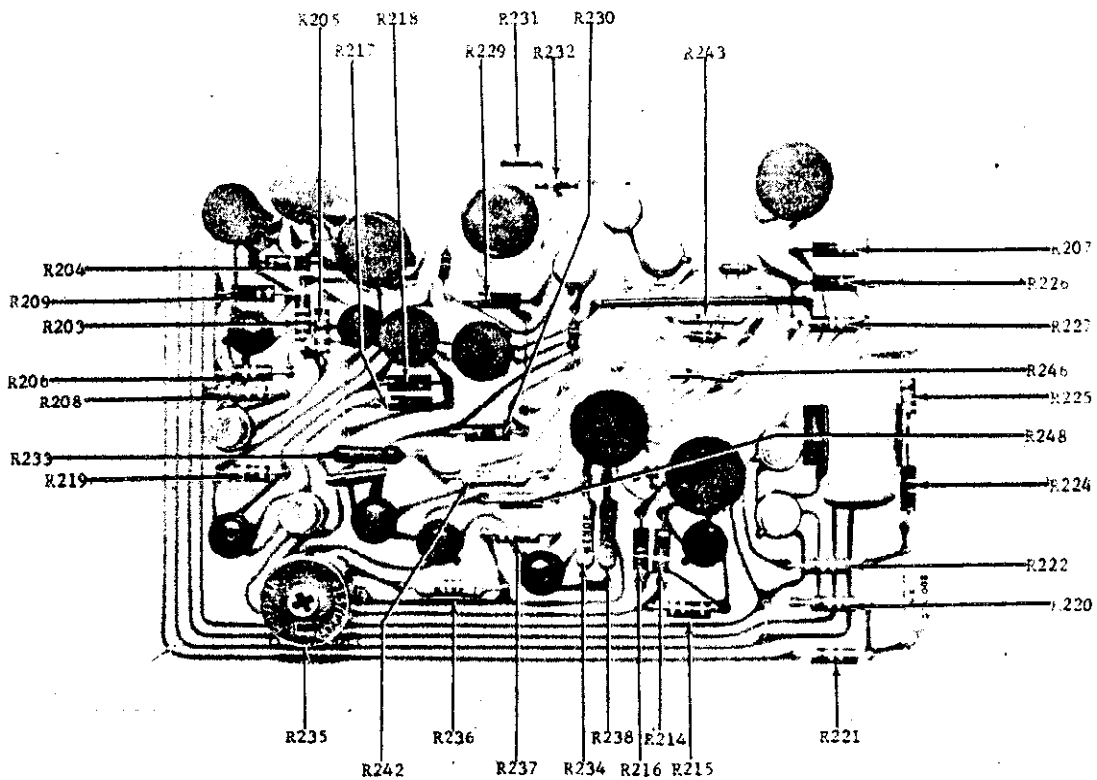

FIGURE 13. Resistor Locations on PC-121. Refer to Figure 12 for capacitor, diode and transistor locations.

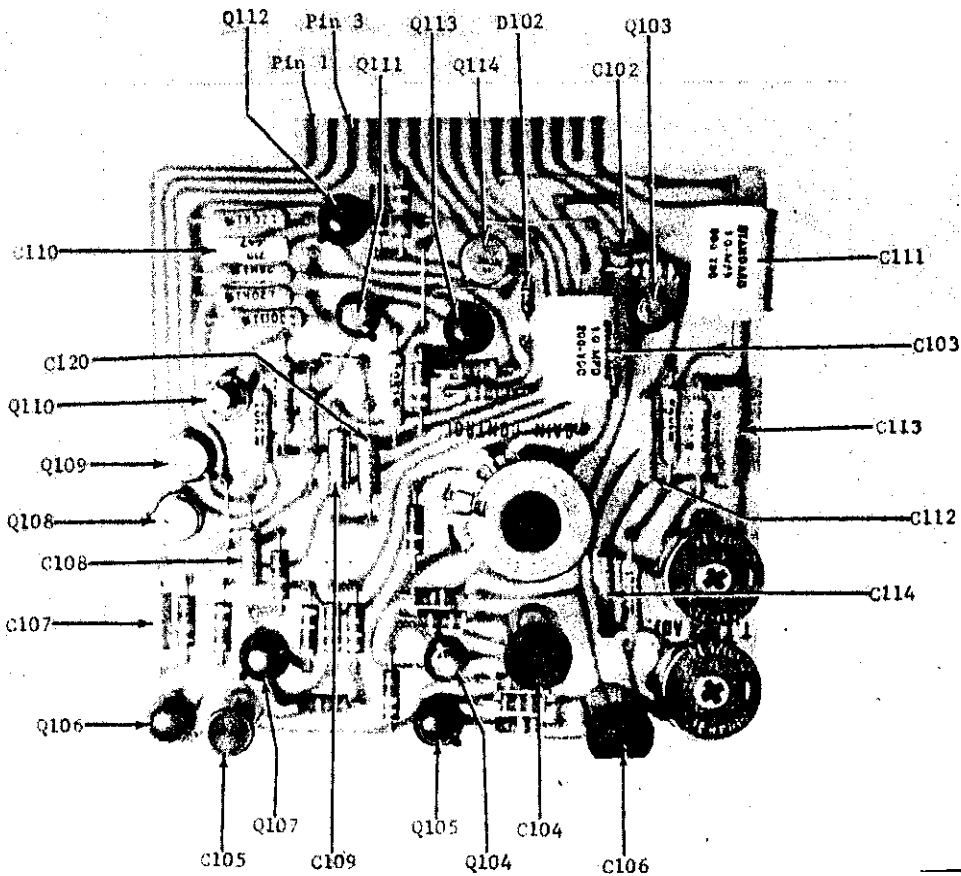

FIGURE 14. Capacitor, Diode and Transistor Locations on PC-119. Refer to Figure 15 for resistor locations and test points M and N.

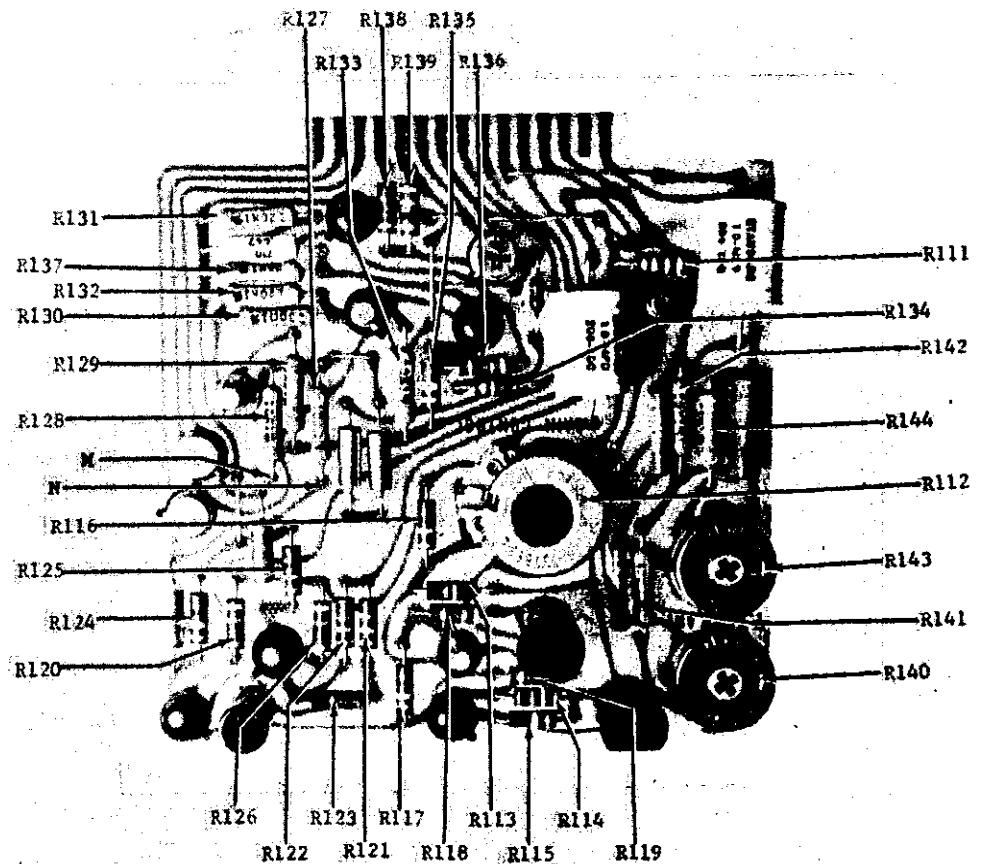

FIGURE 15. Resistor and Test Point Locations on PC-119. Refer to Figure 14 for capacitor, diode and transistor locations.

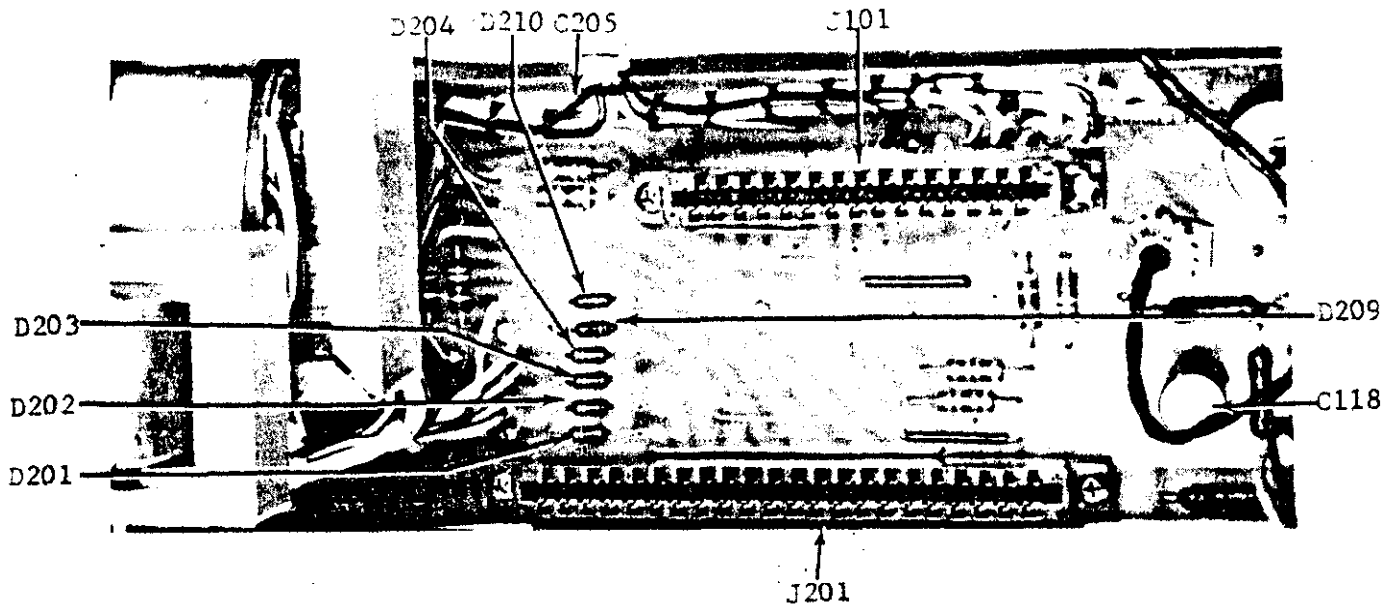

FIGURE 16. Capacitor, Connector and Diode Locations in PC-120. Refer to Figure 17 for resistor locations.

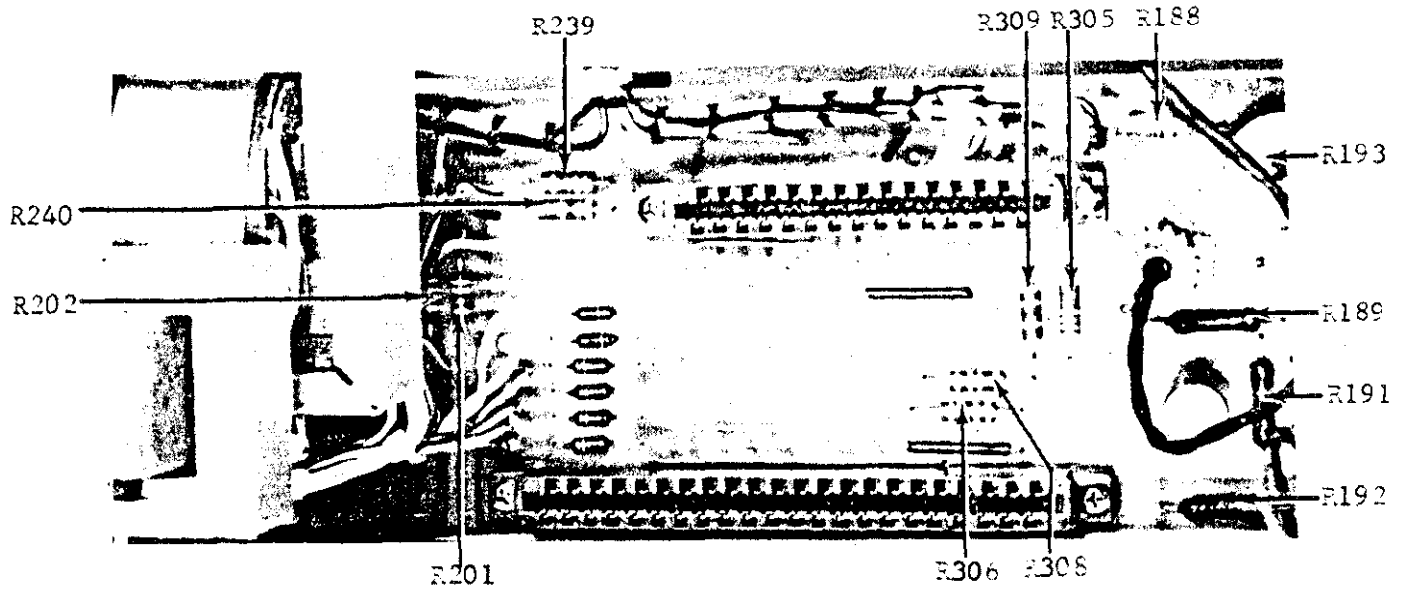

FIGURE 17. Resistor Locations in PC-120. Refer to Figure 16 for capacitor, connector and diode locations.

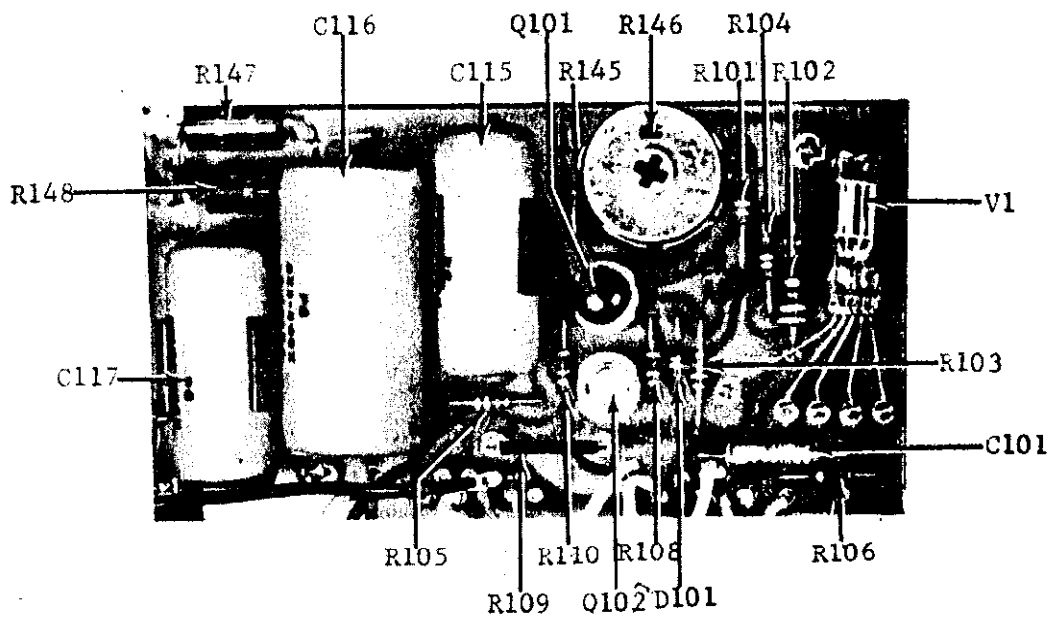

FIGURE 18. Component Locations on PC-118.





## SECTION 5. ACCESSORIES

### 5-1. MODEL 4006 RACK MOUNTING KIT.

a. The Model 4006 Kit converts the Model 150B from a bench model to rack mounting. Rack dimensions are 7 inches high x 19 inches wide x 10 inches deep. The Microvolt Ammeter converts to half-rack size, and the Kit contains a half-rack adapter panel.

b. Procedures. Remove the wrap-around cover on the Model 150B by removing the two corner screws at the bottom of each side. Add the rack mounting parts as shown in Figure 19. Attach in this order: cover (2), rack angle (5), panel support angle (7), rack panel adapter (8), and chassis connecting plate (3).

c. Notice that the cover assembly comes in two sizes, a 13-inch size and a 10-inch size. Use the 10 inch size with the Model 150B. Use the 13-inch size for 13-inch deep Keithley instruments. The rest of the procedure for the 13-inch size is the same as given above for the 10-inch cover.

Item (See Fig. 19)	Description	Keithley Part No.	Quantity
1	Cover Assembly (13 inch)	20015B	1
2	Cover Assembly (10 inch)	20016B	1
3	Chassis Connecting Plate	19154A	1
4	Screw, round head, hex socket, #10 x 1/2	----	4
5	Rack Angle	19147B	1
6	Screw, slotted, #10 x 1/2	----	4
7	Panel Support Angle	19157A	1
8	Rack Adapter Panel	19158A	1

TABLE 13. Parts List for Keithley Model 4006 Rack Mounting Kit.

### 5-2. MODEL 4007 DUAL RACK MOUNTING KIT

a. The Model 4007 Kit converts the Model 150B to rack mounting. The Kit will contain two 10-inch deep instruments, one each 10-inch deep instrument and 13-inch deep instrument, or two 13-inch deep instruments. The Model 150B is a 10-inch deep instrument. Dimensions of the Kit are 7 inches high x 19 inches wide x 10 or 13 inches deep.

b. Procedures. Remove the wrap-around cover on each instrument by removing the two corner screws at the bottom of each side. Assemble the rack mounting parts as shown in Figure 20. Attach as follows when rack adapting two 10-inch instruments or two 13-inch instruments: cover (1 or 2), two rack angles (5), chassis connecting plate (7), and chassis connecting plate (3). Attach as follows when rack adapting one 13-inch deep instrument and one 10-inch deep instrument: cover (1 or 2), two rack angles (5), zee bracket (8), chassis connecting plate (7) and chassis connecting plate (3).

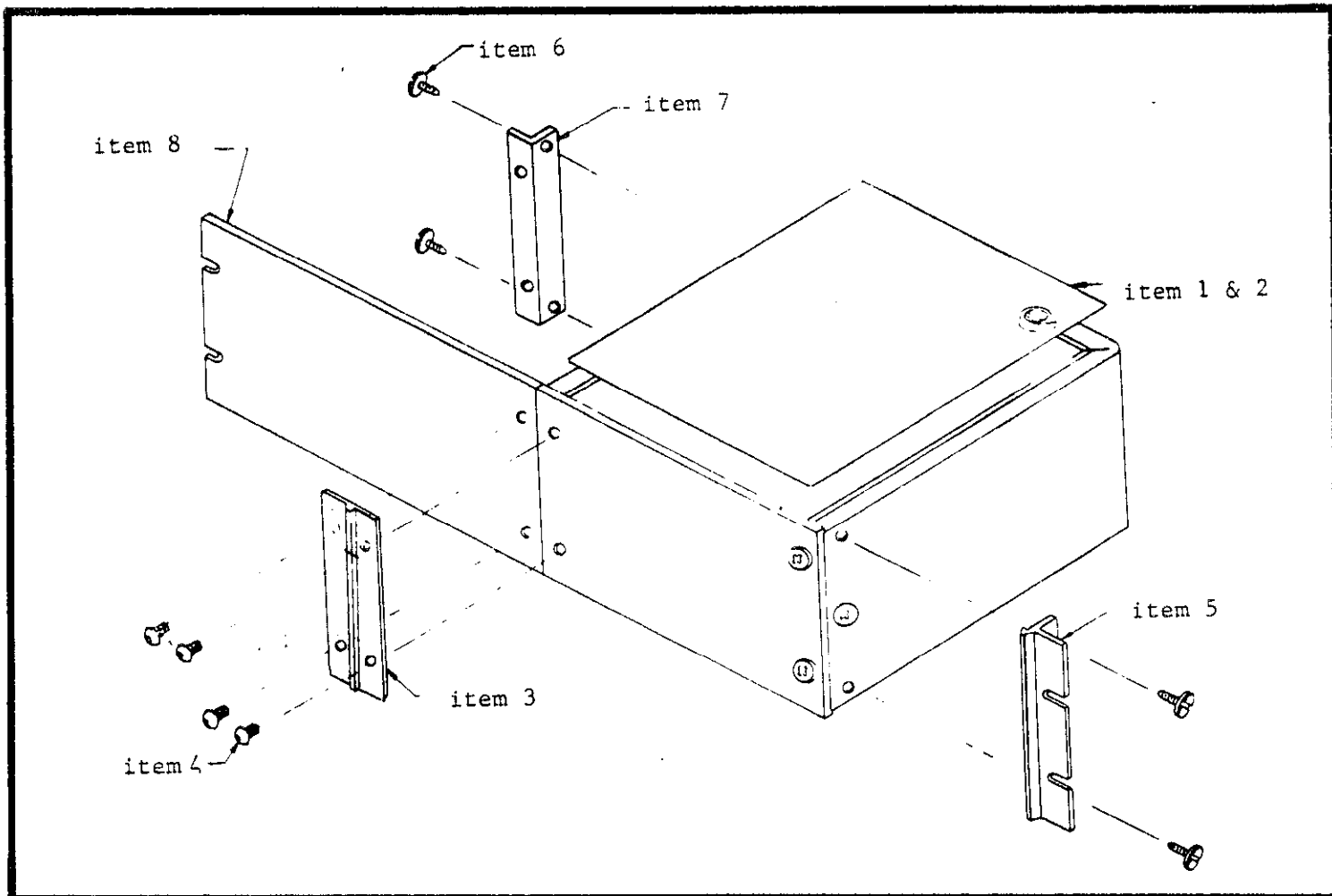

FIGURE 19. Exploded View of Keithley Model 4006 Rack Mounting Kit. Refer to Table 13 for parts list.

Item (See Figure 20)	Description	Keithley Part No.	Quantity
1	Cover (13 inch)	19059C	2
2	Cover (10 inch)	19152B	2
3	Chassis Connecting Plate	19154A	1
4	Screw, round head, hex socket, #10 x 1/2	----	8
5	Rack Angle	19147B	2
6	Screw, slotted, #10 x 1/2	----	4
7	Chassis Connecting Plate	19700A	1
8	Zee Bracket	19167A	1

TABLE 14. Parts List for Keithley Model 4007 Dual Rack Mounting Kit. Two extra covers are included in kit (see paragraph 5-2).

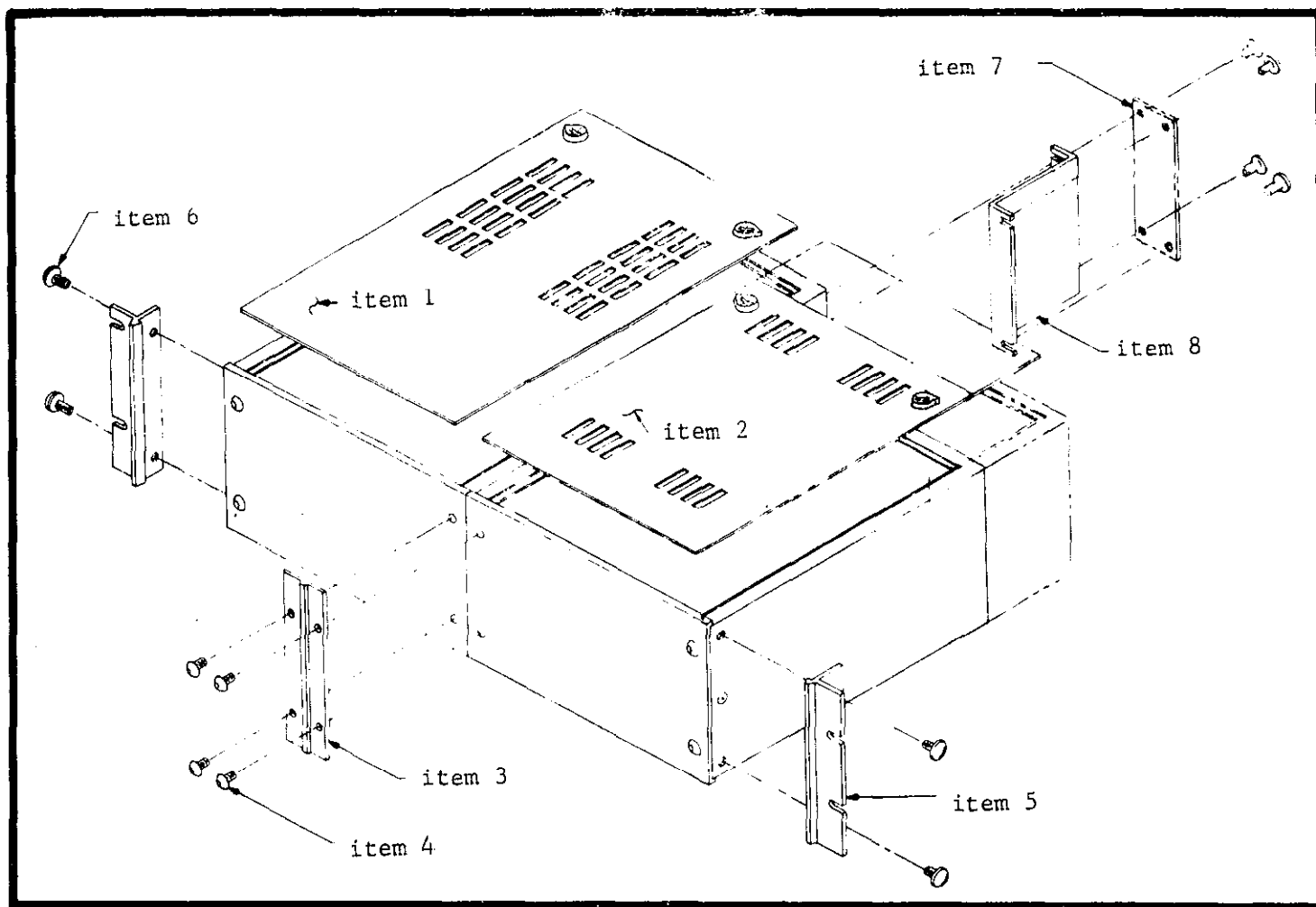

FIGURE 20. Exploded View of Keithley Model 4007 Dual Rack Mounting Kit. Refer to Table 14 for parts list.

### 5-3. MODEL 370 RECORDER.

a. The Model 370 Recorder is uniquely compatible with the Model 150B as well as other Keithley microvoltmeters, electrometers and picoammeters. The Recorder is a high quality economical instrument that epitomizes the performance of the Model 150B, and any other Keithley instrument, even in the most critical applications. The Model 370 can be used with the Model 150B to record dc potentials and currents over the Model 150B's entire range.

b. The Model 150B has the output necessary to drive the Recorder directly (1 volt, 1 milliampere), thus eliminating the need for a pre-amplifier. The Model 370 floats  $\pm 500$  volts off ground, enabling the Model 150B to be used to its specified off-ground voltage. The Recorder is specially shielded to avoid pickup of extraneous signals. The response time of the Model 370 Recorder is 0.5 second; linearity is  $\pm 1\%$  of full scale. Ten chart speeds — from  $3/4$  inch per hour to 12 inches per minute — are selectable with front panel controls. The 6-inch chart has a rectilinear presentation. The Model 370 Recorder has a self-priming inking system. Chart paper and ink refills are easy to install.

c. The Model 370 is very easy to use with the Model 150B. Just connect the Model 150B's 1V OUTPUT Receptacle to the Model 370 with the furnished 3701 Input Cable and adjust an

easily accessible control for full-scale recorder deflection. On the most sensitive ranges of the Model 150B, under some conditions, an 8-cps beat may appear. This condition can be eliminated by mounting a one microfarad capacitor across pins 14 and 17 in the back of the Model 370 Recorder.

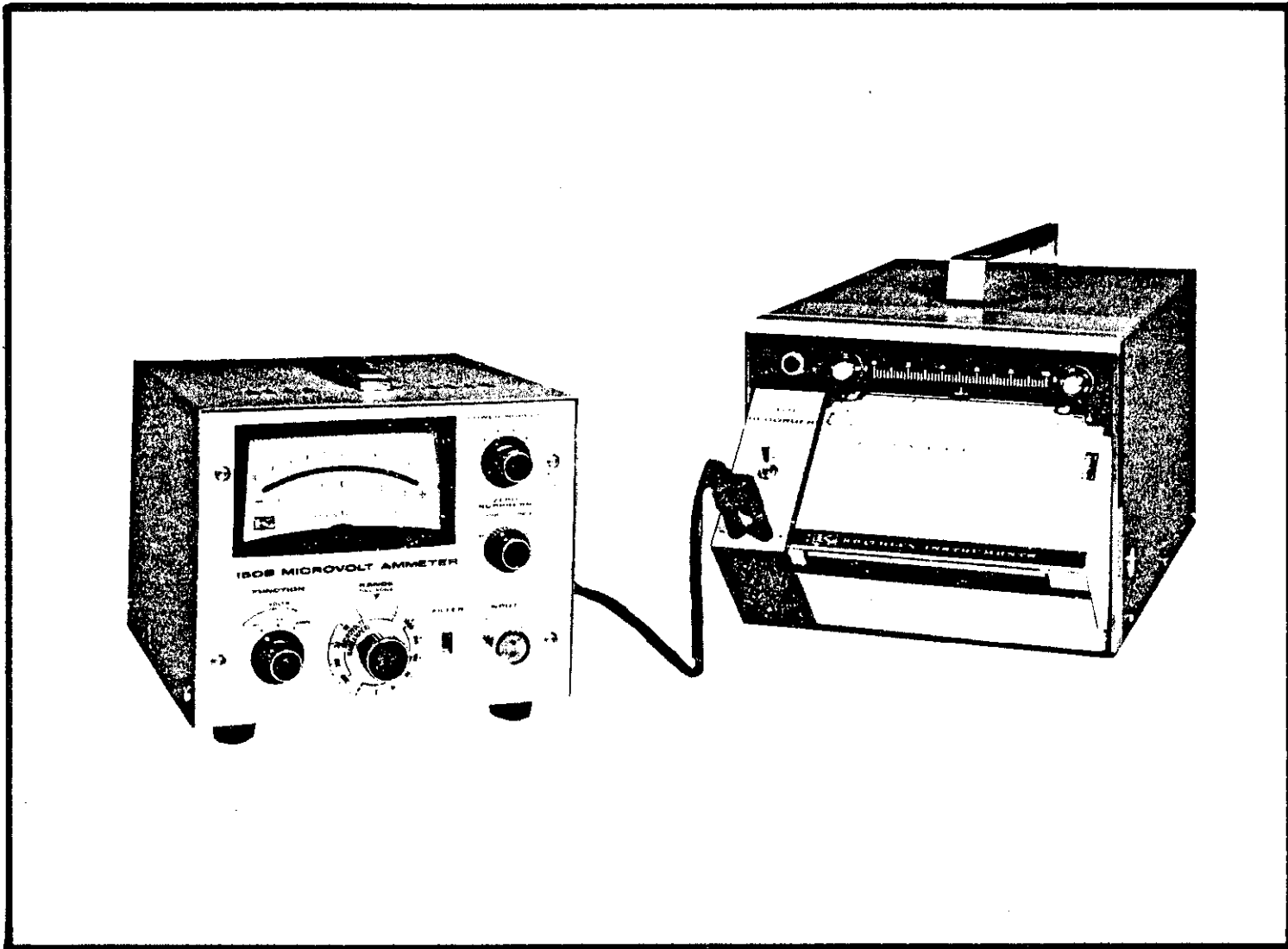

FIGURE 21. Maximum Recording Convenience is Obtained Using the Keithley Model 370, Especially Designed for use with Keithley Microvoltmeters and Other Instruments. The Model 370 can be directly connected to the Model 150B 1-volt output with the Recorder's accessory cable. Response time, floating capability and other specifications of the Model 370 Recorder are completely compatible with those of the Model 150B Microvolt Ammeter.

## SECTION 6. REPLACEABLE PARTS

6-1. REPLACEABLE PARTS LIST. The Replaceable Parts List describes the components of the Model 150B (and its accessories). The List gives the circuit designation, the part description, a suggested manufacturer, the manufacturer's part number and the Keithley Part Number. The last column indicates the figure picturing the part. The name and address of the manufacturers listed in the "Mfg. Code" column are in Table 14.

### 6-2. HOW TO ORDER PARTS.

a. For parts orders, include the instrument's model and serial number, the Keithley Part Number, the circuit designation, and a description of the part. All structural parts and those parts coded for Keithley manufacture (80164) must be ordered through Keithley Instruments, Inc. or its representatives. In ordering a part not listed in the Replaceable Parts List, completely describe the part, its function and its location.

b. Order parts through your nearest Keithley representative or the Sales Service Department, Keithley Instruments, Inc.

amp	ampere	Mfg.	Manufacturer
CerD	Ceramic, Disc	MtF	Metal Film
Comp	Composition	My	Mylar
DCb	Deposited Carbon	$\Omega$	ohm
EAL	Electrolytic, Aluminum	p	pico ( $10^{-12}$ )
ETB	Electrolytic, tubular	Ref.	Reference
ETT	Electrolytic, tantulum	req'd	required
f	farad	$\mu$	micro ( $10^{-6}$ )
Fig	Figure	v	volt
k	kilo ( $10^3$ )	w	watt
M or meg	mega ( $10^6$ ) or megohm	WW	Wirewound
m	milli ( $10^{-3}$ )	WWVar	Wirewound Variable

TABLE 15. Abbreviations and Symbols.

MODEL 150B REPLACEABLE PARTS LIST

(Refer to Schematic Diagrams 20350E and 20357D for circuit designations.)

## CAPACITORS

Circuit Desig.	Value	Rating	Type	Mfg. Code	Mfg. Part No.	Keithley Part No.	Fig. Ref.
C101	10 $\mu$ f	20 v	ETT	05397	K10J20K	C80-10M	18
C102	100 pf	600 v	CerD	72982	ED-100	C22-100P	14
C103	1 $\mu$ f	200 v	My	13050	107-21	C66-1M	14
C104	100 $\mu$ f	15 v	EAL	56289	89D217	C93-100M	14
C105	10 $\mu$ f	15 v	EAL	56289	89D159	C93-10M	14
C106	100 $\mu$ f	15 v	EAL	56289	89D217	C93-100M	14
C107	10 $\mu$ f	20 v	ETT	05397	K10J20K	C80-10M	14
C108	10 $\mu$ f	20 v	ETT	05397	K10J20K	C80-10M	14
C109	*22 $\mu$ f	10 v	ETT	05397	K33J10S	C78-22M	14
C110	.047 $\mu$ f	200 v	My	13050	SM1A	C143-.047M	14
C111	1 $\mu$ f	200 v	My	13050	107-21	C66-1M	14
C112	.033 $\mu$ f	100 v	My	88480	3FR 333-1E	C146-.033M	14
C113	.068 $\mu$ f	100 v	My	88480	3FR 683-1E	C146-.068M	14
C114	.033 $\mu$ f	100 v	My	88480	3FR 333-1E	C146-.033M	14
C115	2.5 $\mu$ f	200 v	My	99120	AZ2-255X	C145-2.5M	18
C116	5 $\mu$ f	200 v	My	99120	AZ2-505X	C145-5M	18
C117	2.5 $\mu$ f	200 v	My	99120	AZ2-255X	C145-2.5M	18
C118	100 $\mu$ f	6 v	EAL	56289	89D	C147-100M	16
C119	100 $\mu$ f	15 v	ETB	72699	TD100-15	C11-100M	10
C120	*27 $\mu$ f	10 v	ETT	80164		C78-27M	14
C201	500 $\mu$ f	15 v	EAL	56289	89D222	C93-500M	12
C202	500 $\mu$ f	15 v	EAL	56289	89D222	C93-500M	12
C203	100 $\mu$ f	15 v	EAL	56289	89D217	C93-100M	12
C204	100 $\mu$ f	15 v	EAL	56289	89D217	C93-100M	12
C205	0.1 $\mu$ f	200 v	My	02777	P-12M	C66-.1M	16
C206	Not used						
C207	500 $\mu$ f	15 v	EAL	56289	89D222	C93-500M	12
C208	100 $\mu$ f	15 v	EAL	56289	89D217	C93-100M	12
C209	100 $\mu$ f	15 v	EAL	56289	89D217	C93-100M	12
C210	0.1 $\mu$ f	200 v	My	13050	SM1A	C47-.1M	12
C211	500 $\mu$ f	25 v	EAL	56289	89D231	C94-500M	12
C212	500 $\mu$ f	15 v	EAL	56289	89D222	C93-500M	12
C213	2 $\mu$ f	200 v	My	99120	AZ2-205X	C120-2M	12
C214	.0033 $\mu$ f	600 v	CerD	72982	ED-.0033	C22-.0033M	12

\*Nominal value, factory adjusted.

## DIODES

Circuit Desig.	Type	Number	Mfg. Code	Keithley Part No.	Fig. Ref.
D101	Silicon	1N645	01295	RF-14	18
D102	Silicon	1N645	01295	RF-14	14
D201	Silicon	1N645	01295	RF-14	16
D202	Silicon	1N645	01295	RF-14	16
D203	Silicon	1N645	01295	RF-14	16
D204	Silicon	1N645	01295	RF-14	16
D205	Silicon	1N645	01295	RF-14	12
D206	Silicon	1N645	01295	RF-14	12
D207	Silicon	1N645	01295	RF-14	10
D208	Silicon	1N645	01295	RF-14	10
D209	Silicon	1N645	01295	RF-14	16
D210	Silicon	1N645	01295	RF-14	16
D211	Zener	1N709	12954	DZ-21	12
D212	Zener	1N709	12954	DZ-21	12

## MISCELLANEOUS PARTS

Circuit Desig.	Description	Mfg. Code	Keithley Part No.	Fig. Ref.
BT201	Battery assembly	80164	Model 1489	10
F201 (117V)	Fuse, slow blow, 3/4 amp, 3AG (Mfg. No. 313.750)	75915	FU-14	2
F201 (234V)	Fuse, slow blow, 3/8 amp, 3AG (Mfg. No. 313.375)	75915	FU-18	
F202 (117V)	Fuse, slow blow, 1/4 amp, 3AG (Mfg. No. 313.250)	75915	FU-17	2
F202 (234V)	Fuse, slow blow, 1/8 amp, 3AG (Mfg. No. 313.125)	75915	FU-20	
---	Fuse holder, 2 req'd (Mfg. No. 342012)	75915	FH-3	
G101	Chopper Assembly	80164	20138B	10
J101	Connector, 15 pin (Mfg. No. PSC4SS 15-12)	03612	CS-175	16
J102	Receptacle, Microphone, 1V OUTPUT (Mfg. No. 80-PC2F)	02660	CS-32	2
---	(F) Plug, Microphone, Mate of J102 (Mfg. No. 80-MC2M)	02660	CS-33	
J103	Receptacle, Microphone, 100M V OUTPUT (Mfg. No. 80-PC2F)	02660	CS-32	2
---	(F) Plug, Microphone, Mate of J103 (Mfg. No. 80-MC2M)	02660	CS-33	

(F) Furnished accessory.

## MISCELLANEOUS PARTS (Cont'd)

Circuit Desig.	Description	Mfg. Code	Keithley Part No.	Fig. Ref.
J104	Receptacle, INPUT	80164	CS-133	1
----	Plug, Special, Mate of J101	80164	Model 1486	
J105**	Receptacle			12
	. Locking Ring (Mfg. No. 126-1430)	02660	CS-165	
	. Receptacle (Mfg. No. 126-1429)	02660	CS-163	
	. Body (Mfg. No. 126-1425)	02660	CS-161	
J105***	Plug			12
	. Nut (Mfg. No. 41-153)	02660	CS-160	
	. Lock Ring (Mfg. No. 126-1428)	02660	CS-164	
	. Plug (Mfg. No. 126-1427)	02660	CS-162	
J201	Connector, 22 pin (Mfg. No. PSC4SS22-12)	03612	CS-182	16
J202	Banana Jack, 2 req'd (Mfg. No. 108-903)	74970	BJ-6B	
---	Binding Post, LO (Mfg. No. DF21BC)	58474	BP-11B	2
---	Binding Post, GND (Mfg. No. DF21GC)	58474	BP-11G	2
---	Shorting Link (Mfg. No. 938-L)	24655	BP-6	2
M201	Meter	80164	ME-14	10
P201	Cord Set, 6 feet (Mfg. No. 4638-13)	93656	CO-5	2
---	Cable Clamp (Mfg. No. SR-5P-1)	28520	CC-4	
S101	Slide Switch, FILTER	80164	SW-45	2
S102	Rotary Switch less components, FUNCTION	80164	SW-214	11
---	Rotary Switch with components, Function	80164	20147B	
---	Knob Assembly, Function Switch	80164	14838A	
S103	Rotary Switch less components, ZERO SUPPRESS COARSE	80164	SW-219	10
---	Rotary Switch with components, Zero Suppress Coarse	80164	20135B	
---	Knob Assembly, Zero Suppress Coarse Switch	80164	18070A	
---	Rotary Switch, Potentiometer, ZERO SUPPRESS FINE	80164	RP42-10K	1,10
---	Knob Assembly, Zero Suppress Fine Switch	80164	16995A	
S104	Rotary Switch less components, RANGE	80164	SW-215	11
---	Rotary Switch with components, Range	80164	20145B	
---	Dial Assembly, Range Switch	80164	19713A	

\*\* Schematic Diagram 20350E

\*\*\* Schematic Diagram 20357D



## MISCELLANEOUS PARTS (Cont'd)

Circuit Desig.	Description	Mfg. Code	Keithley Part No.	Fig. Ref.
S201	Rotary Switch less components, POWER SUPPLY	80164	SW-218	10
---	Rotary Switch with components, Power Supply	80164	20133B	
---	Knob Assembly, Power Supply Switch	80164	18393A	
S202	Not used			
S203	Slide Switch, 117-234 v	80164	SW-151	2
T101	Transformer Assembly	80164	20137B	10
T201	Transformer	80164	TR-93	10
T202	Transformer	80164	TR-95	10

## RESISTORS

Circuit Desig.	Value	Rating	Type	Mfg. Code	Mfg. Part No.	Keithley Part No.	Fig. Ref.
R101	100 k $\Omega$	10%, 1/4 w	Comp	01121	CB	R76-100K	18
R102	*390 $\Omega$	10%, 1/2 w	Comp	01121	EB	R1-390	18
R103	220 k $\Omega$	10%, 1/4 w	Comp	01121	CB	R76-220K	18
R104	10 k $\Omega$	10%, 1/4 w	Comp	01121	CB	R76-10K	18
R105	680 k $\Omega$	10%, 1/4 w	Comp	01121	CB	R76-680K	18
R106	15 $\Omega$	10%, 1/4 w	Comp	01121	CB	R76-15	18
R107	20 $\Omega$	10%, 5 w	WWVar	71450	AW	RP34-20	10
R108	47 k $\Omega$	10%, 1/4 w	Comp	01121	CB	R76-47K	18
R109	*3.9 k $\Omega$	10%, 1/2 w	Comp	01121	EB	R1-3.9K	18
R110	47 k $\Omega$	10%, 1/4 w	Comp	01121	CB	R76-47K	18
R111	33 k $\Omega$	10%, 1/2 w	Comp	01121	EB	R1-33K	15
R112	750 k $\Omega$	1%, 1/2 w	DCb	79727	CFE-15	RP12-750K	15
R113	150 k $\Omega$	10%, 1/2 w	Comp	01121	EB	R1-150K	15
R114	39 k $\Omega$	10%, 1/2 w	Comp	01121	EB	R1-39K	15
R115	3.9 k $\Omega$	10%, 1/2 w	Comp	01121	EB	R1-3.9K	15
R116	100 k $\Omega$	10%, 1/2 w	Comp	01121	EB	R1-100K	15
R117	10 k $\Omega$	10%, 1/2 w	Comp	01121	EB	R1-10K	15
R118	470 $\Omega$	10%, 1/2 w	Comp	01121	EB	R1-470	15
R119	3.9 k $\Omega$	10%, 1/2 w	Comp	01121	EB	R1-3.9K	15
R120	4.7 k $\Omega$	10%, 1/2 w	Comp	01121	EB	R1-4.7K	15
R121	18 k $\Omega$	10%, 1/2 w	Comp	01121	EB	R1-18K	15
R122	18 k $\Omega$	10%, 1/2 w	Comp	01121	EB	R1-18K	15
R123	100 $\Omega$	10%, 1/2 w	Comp	01121	EB	R1-100	15
R124	10 k $\Omega$	10%, 1/2 w	Comp	01121	EB	R1-10K	15
R125	10 k $\Omega$	10%, 1/2 w	Comp	01121	EB	R1-10K	15

\* Nominal value, factory set.

## RESISTORS (Cont'd)

Circuit Desig.	Value	Rating	Type	Mfg. Code	Mfg. Part No.	Keithley Part No.	Fig. Ref.
R126	4.7 k $\Omega$	10%, 1/2 w	Comp	01121	EB	R1-4.7K	15
R127	10 k $\Omega$	1%, 1/2 w	DCb	79727	CFE-15	R12-10K	15
R128	10 k $\Omega$	1%, 1/2 w	DCb	79727	CFE-15	R12-10K	15
R129	50 k $\Omega$	1%, 1/2 w	DCb	79727	CFE-15	R12-50K	15
R130	250 $\Omega$	1%, 1/2 w	DCb	79727	CFE-15	R12-250	15
R131	120 k $\Omega$	1%, 1/2 w	DCb	79727	CFE-15	R12-120K	15
R132	120 k $\Omega$	1%, 1/2 w	DCb	79727	CFE-15	R12-120K	15
R133	50 k $\Omega$	1%, 1/2 w	DCb	79727	CFE-15	R12-50K	15
R134	12 k $\Omega$	10%, 1/2 w	Comp	01121	EB	R1-12K	15
R135	12 k $\Omega$	10%, 1/2 w	Comp	01121	EB	R1-12K	15
R136	470 $\Omega$	10%, 1/2 w	Comp	01121	EB	R1-470	15
R137	25 k $\Omega$	1%, 1/2 w	DCb	79727	CFE-15	R12-25K	15
R138	1.8 k $\Omega$	10%, 1/2 w	Comp	01121	EB	R1-1.8K	15
R139	47 $\Omega$	10%, 1/2 w	Comp	01121	EB	R1-47	15
R140	10 k $\Omega$	20%, 2 w	WW	71450	1NS-115	RP50-10K	15
R141	*47 k $\Omega$	1%, 1/2 w	DCb	79727	CFE-15	R12-47K	15
R142	50 k $\Omega$	1%, 1/2 w	DCb	79727	CFE-15	R12-50K	15
R143	10 k $\Omega$	20%, 2 w	WW	71450	1NS 115	RP50-10K	15
R144	25 k $\Omega$	1%, 1/2 w	DCb	79727	CFE-15	R12-25K	15
R145	*560 $\Omega$	10%, 1/4 w	Comp	01121	CB	R76-560	18
R146	10 k $\Omega$	20%, 2 w	WW	71450	1NS 115	RP50-10K	18
R147	**1060 $\Omega$	1/4%, 1/3 w	WW	01686	7010	R132-1060	18
R148	**1060 $\Omega$	1/4%, 1/3 w	WW	01686	7010	R132-1060	18
R149	300 k $\Omega$	1%, 1/2 w	DCb	79727	CFE-15	R12-300K	10
R150	Not used						
R151	Not used						
R152	Not used						
R153	*1.5 k $\Omega$	10%, 1/2 w	Comp	01121	CB	R1-1.5K	11
R154	*150 $\Omega$	10%, 1/2 w	Comp	01121	CB	R1-150	11
R155	*100 $\Omega$	10%, 1/2 w	Comp	01121	CB	R1-100	11
R156	*8.2 M $\Omega$	10%, 1/2 w	Comp	01121	CB	R1-8.2M	11
R157	*2.7 M $\Omega$	10%, 1/2 w	Comp	01121	CB	R1-2.7M	11
R158	*1 M $\Omega$	10%, 1/2 w	Comp	01121	CB	R1-1M	11
R159	*680 k $\Omega$	10%, 1/2 w	Comp	01121	CB	R1-680K	11
R160	*56 k $\Omega$	10%, 1/2 w	Comp	01121	CB	R1-56K	11
R161	*27 k $\Omega$	10%, 1/2 w	Comp	01121	CB	R1-27K	11
R162	*100 $\Omega$	10%, 1/2 w	Comp	01121	CB	R1-100	11
R163	68 $\Omega$	10%, 1/2 w	Comp	01121	CB	R1-68	11
R164	300 k $\Omega$	1/4%, 1/2 w	MtF	07716	CEC-TO	R127-300K	11
R165	300 $\Omega$	1/4%, 1/3 w	WW	01686	7010	R132-300	11

\* Nominal value, factory set.

\*\* Keithley part number R132-1273 is used for R147 and R148 in units adjusted for 50 cps.

## RESISTORS (Cont'd)

Circuit Desig.	Value	Rating	Type	Mfg. Code	Mfg. Part No.	Keithley Part No.	Fig. Ref.
R166	1 M $\Omega$	1/4%, 1/2 w	MtF	07716	CEC-TO	R127-1M	11
R167	300.6 $\Omega$	1/4%, 1/2 w	MtF	07716	CEC-TO	R127-300.6	11
R168	300 k $\Omega$	1/4%, 1/2 w	MtF	07716	CEC-TO	R127-300K	11
R169	99.7 k $\Omega$	1/4%, 1/2 w	MtF	07716	CEC-TO	R127-99.7K	11
R170	29.7 k $\Omega$	1/4%, 1/2 w	MtF	07716	CEC-TO	R127-29.7K	11
R171	9.7 k $\Omega$	1/4%, 1/2 w	MtF	07716	CEC-TO	R127-9.7K	11
R172	2.7 k $\Omega$	1/4%, 1/2 w	MtF	07716	CEC-TO	R127-2.7K	11
R173	700 $\Omega$	1/4%, 1/2 w	MtF	07716	CEC-TO	R127-700	11
R174	333 k $\Omega$	1%, 1/2 w	MtF	07716	CEC	R94-333K	11
R175	100 k $\Omega$	1%, 1/2 w	MtF	07716	CEC	R94-100K	11
R176	33.3 k $\Omega$	1%, 1/2 w	MtF	07716	CEC	R94-33.3K	11
R177	10 k $\Omega$	1%, 1/2 w	MtF	07716	CEC	R94-10K	11
R178	3.33 k $\Omega$	1%, 1/2 w	MtF	07716	CEC	R94-3.33K	11
R179	1 k $\Omega$	1%, 1/2 w	MtF	07716	CEC	R94-1K	11
R180	333 $\Omega$	1%, 1/2 w	MtF	07716	CEC	R94-333	11
R181	100 $\Omega$	1%, 1/2 w	MtF	07716	CEC	R94-100	11
R182	33.3 $\Omega$	1%, 1/2 w	MtF	07716	CEC	R94-33.3	11
R183	10 $\Omega$	1%, 1/2 w		00327	A20	R126-10	11
R184	3.33 $\Omega$	1%, 1/2 w		00327	A20	R126-3.33	11
R185	1 $\Omega$	0-2%, 1/2 w		00327	A20	R128-1	11
R186	100 k $\Omega$	1%, 1/2 w	DCb	79727	CFE-15	R12-100K	11
R187	3 k $\Omega$	1%, 1/2 w	DCb	79727	CFE-15	R12-3K	10
R188	8.6 k $\Omega$	1%, 1/2 w	DCb	79727	CFE-15	R12-8.6K	17
R189	4.99 k $\Omega$	1%, 1/2 w	MtF	07716	CEC	R94-4.99K	17
R190	1 k $\Omega$	10%, 3 w	WWVar	71450	AW	RP3-1K	2,11
R191	3.33 k $\Omega$	1%, 1/2 w	MtF	07716	CEC	R94-3.33K	17
R192	1 k $\Omega$	1%, 1/2 w	MtF	07716	CEC	R94-1K	17
R193	2 k $\Omega$	20%, 2 w	WW	71450	1NS 115	RP50-2K	17
R194	Not used						
R195	Not used						
R196	Not used						
R197	Not used						
R198	Not used						
R199	100 k $\Omega$	1%, 1/2 w	DCb	79727	CFE-15	R12-100K	10
R201	330 $\Omega$	10%, 1/2 w	Comp	01121	EB	R1-330	17
R202	330 $\Omega$	10%, 1/2 w	Comp	01121	EB	R1-330	17
R203	4.7 $\Omega$	10%, 1/2 w	Comp	01121	EB	R1-4.7	13
R204	*10 k $\Omega$	10%, 1/2 w	Comp	01121	EB	R1-10K	13
R205	470 $\Omega$	10%, 1/2 w	Comp	01121	EB	R1-470	13

\* Nominal value, factory set.

## RESISTORS (Cont'd)

Circuit Desig.	Value	Rating	Type	Mfg. Code	Mfg. Part No.	Keithley Part No.	Fig. Ref.
R206	10 k $\Omega$	10%, 1/2 w	Comp	01121	EB	R1-10K	13
R207	100 $\Omega$	10%, 1/2 w	Comp	01121	EB	R1-100	13
R208	12 k $\Omega$	10%, 1/2 w	Comp	01121	EB	R1-12K	13
R209	100 k $\Omega$	10%, 1/2 w	Comp	01121	EB	R1-100K	13
R210	Not used						
R211	Not used						
R212	Not used						
R213	Not used						
R214	27 $\Omega$	10%, 1/2 w	Comp	01121	EB	R1-27	13
R215	470 $\Omega$	10%, 1/2 w	Comp	01121	EB	R1-470	13
R216	10 k $\Omega$	10%, 1/2 w	Comp	01121	EB	R1-10K	13
R217	12 k $\Omega$	10%, 1/2 w	Comp	01121	EB	R1-12K	13
R218	100 k $\Omega$	10%, 1/2 w	Comp	01121	EB	R1-100K	13
R219	*10 k $\Omega$	10%, 1/2 w	Comp	01121	EB	R1-10K	13
R220	15 k $\Omega$	10%, 1/2 w	Comp	01121	EB	R1-15K	13
R221	15 k $\Omega$	10%, 1/2 w	Comp	01121	EB	R1-15K	13
R222	15 k $\Omega$	10%, 1/2 w	Comp	01121	EB	R1-15K	13
R223	Not used						
R224	15 k $\Omega$	10%, 1/2 w	Comp	01121	EB	R1-15K	13
R225	820 $\Omega$	10%, 1/2 w	Comp	01121	EB	R1-820	13
R226	22 k $\Omega$	10%, 1/2 w	Comp	01121	EB	R1-22K	13
R227	22 k $\Omega$	10%, 1/2 w	Comp	01121	EB	R1-22K	13
R228	56 $\Omega$	5%, 10 w	WW	94310	Val-10	R133-56	10
R229	2.7 k $\Omega$	10%, 1/2 w	Comp	01121	EB	R1-2.7K	13
R230	2.7 k $\Omega$	10%, 1/2 w	Comp	01121	EB	R1-2.7K	13
R231	1.8 k $\Omega$	10%, 1/2 w	Comp	01121	EB	R1-1.8K	13
R232	390 $\Omega$	10%, 1/2 w	Comp	01121	EB	R1-390	13
R233	2.73 k $\Omega$	1%, 1/2 w	DCb	79727	CFE-15	R12-2.73K	13
R234	30 k $\Omega$	1%, 1/2 w	DCb	79727	CFE-15	R12-30K	13
R235	1 k $\Omega$	20%, 2 w	WW	71450	1NS-115	RP50-1K	13
R236	1.4 k $\Omega$	1%, 1/2 w	DCb	79727	CFE-15	R12-1.4K	13
R237	3.3 k $\Omega$	10%, 1/2 w	Comp	01121	EB	R1-3.3K	13
R238	20 k $\Omega$	1%, 1/2 w	DCb	79727	CFE-15	R12-20K	13
R239	680 $\Omega$	10%, 1/2 w	Comp	01121	EB	R1-680	17
R240	47 $\Omega$	10%, 1/2 w	Comp	01121	EB	R1-47	17
R241	Not used						
R242	1.8 k $\Omega$	1%, 1/2 w	DCb	79727	CFE-15	R12-1.8K	13
R243	1 k $\Omega$	1%, 1/2 w	DCb	79727	CFE-15	R12-1K	13
R244	Not used						
R245	Not used						

\* Nominal value, factory set.

## RESISTORS (Cont'd)

Circuit Desig.	Value	Rating	Type	Mfg. Code	Mfg. Part No.	Keithley Part No.	Fig. Ref.
R246	600 $\Omega$	1%, 1/2 w	DCb	79727	CFE-15	R12-600	13
R247	Not used						
R248	2.2 k $\Omega$	10%, 1/2 w	Comp	01121	EB	R1-2.2K	13
R301	10 M $\Omega$	1%, 1/2 w	DCb	79727	CFE-15	R12-10M	10
R302	300 k $\Omega$	1%, 1/2 w	DCb	79727	CFE-15	R12-300K	10
R303	27.3 k $\Omega$	1%, 1/2 w	DCb	79727	CFE-15	R12-27.3K	10
R304	10 k $\Omega$	10%, 5 w	WWVar	71450	AW	RP34-10K	10
R305	47 k $\Omega$	10%, 1/2 w	Comp	01121	EB	R1-47K	17
R306	*470 $\Omega$	10%, 1/2 w	Comp	01121	EB	R1-470	17
R307	10 k $\Omega$	5%, 2 w	WWVar	12697	62JA	RP42-10K	10
R308	*470 $\Omega$	10%, 1/2 w	Comp	01121	EB	R1-470	17
R309	47 k $\Omega$	10%, 1/2 w	Comp	01121	EB	R1-47K	17
R310	10 <sup>9</sup> $\Omega$	20%, 1/2 w	Comp	75042	GBT	R37-10 <sup>9</sup>	11

## TRANSISTORS

Circuit Desig.	Number	Mfg. Code	Keithley Part No.	Fig. Ref.
Q101	S17638	07263	TG-33	18
Q102	U-147		TG-38	18
Q103 *	A1380	73445	TG-32	14
Q104 *	A1380	73445	TG-32	14
Q105	S17638	07263	TG-33	14
Q106	S17638	07263	TG-33	14
Q107	S17638	07263	TG-33	14
Q108	2N1381	01295	TG-8	14
Q109	2N1381	01295	TG-8	14
Q110 *	A1380	73445	TG-32	14
Q111 *	A1380	73445	TG-32	14
Q112	S17638	07263	TG-33	14
Q113	S17638	07263	TG-33	14
Q114	2N1381	01295	TG-8	14
Q201	2N1535	04713	TG-7	
Q202	2N1535	04713	TG-7	
Q203	2N1381	01295	TG-8	12
Q204	S17638	07263	TG-33	12
Q205	S17638	07263	TG-33	12
Q206	S17638	07263	TG-33	12
Q207	2N1381	01295	TG-8	12

\* Nominal value, factory set.

## TRANSISTORS (Cont'd)

Circuit Desig.	Number	Mfg. Code	Keithley Part No.	Fig. Ref.
Q208	S17638	07263	TG-33	12
Q209	2N398A	02735	TG-13	12
Q210	2N398A	02735	TG-13	12
Q211	Not used			
Q212	2N1381	01295	TG-8	12
Q213	2N1381	01295	TG-8	12
Q214	2N1381	01295	TG-8	12
Q215	S17638	07263	TG-33	12
Q216	S17638	07263	TG-33	12
Q217	S17638	07263	TG-33	12
Q218	2N1535	04713	TG-7	

## VACUUM TUBES

Circuit Desig.	Number	Mfg. Code	Keithley Part No.	Fig. Ref.
V1	512AX	80164	EV-512AX	18

MODELS 1483, 1484 REPLACEABLE PARTS LIST

Description	Quantity	Mfg. Code	Keithley Part No.	Used on Kit Model
Crimp Tool for Copper lugs	1	80164	TL-1	1483
#8 Nylon Screws	50	80164	—	1483, 1484
#8 Nylon Hex Nuts	50	80164	—	1483, 1484
Copper Bolt-on Lugs	100	80164	LU-19	1483, 1484
Copper Spade Lugs	100	80164	LU-21	1483, 1484
Copper Hook Lugs	100	80164	LU-22	1483, 1484
Copper Splice Tubes	100	80164	LU-23	1483, 1484
Low-Thermal Cadmium-Tin Solder	10 feet	80164	—	1483, 1484
Copper Alligator Clips (Mfg. No. 6005)	10	76545	AC-9	1483, 1484
Shielded Cable	10 feet	80164	SC-5	1483, 1484
Insulated #20 Copper Wire	100 feet	80164	WS-1	1483, 1484
Non-metallic Abrasive	3 pads	80164	17774A	1483, 1484

00327	Welwyn International, Inc. Cleveland, Ohio	24655	General Radio Co. West Concord, Mass.
01121	Allen-Bradley Corp. Milwaukee, Wis.	28520	Heyman Mfg. Co. Kenilworth, N. J.
01295	Texas Instruments, Inc. Semiconductor-Components Division Dallas, Tex.	56289	Sprague Electric Co. North Adams, Mass.
01686	RCL Electronics, Inc. Riverside, N. J.	58474	Superior Electric Co., The Bristol, Conn.
02660	Amphenol-Borg Electronics Corp. Broadview, Chicago, Illinois	71450	CTS Corp. Elkhart, Ind.
02735	Radio Corp. of America Commercial Receiving Tube and Semiconductor Division Somerville, N. J.	72699	General Instrument Corp. Newark, N. J.
02777	Hopkins Engineering Co. San Fernando, Calif.	72982	Erie Technological Products, Inc. Erie, Pa.
03612	Burndy Corp. Lynwood, Calif.	73445	Amperex Electronic Co. Division of North American Philips Co., Inc. Hicksville, N. Y.
04713	Motorola, Inc. Semiconductor Products Division Phoenix, Arizona	74970	Johnson, E. F., Co. Waseca, Minn.
05397	Union Carbide Corp. Linde Division Kemet Dept. Cleveland, Ohio	75042	International Resistance Co. Philadelphia, Pa.
07263	Fairchild Camera & Instru. Corp. Semiconductor Division Mountain View, Calif.	75915	Littelfuse, Inc. Des Plaines, Ill.
07716	International Resistance Co. Burlington, Iowa	79727	Continental-Wirt Electronics Corp. Philadelphia, Pa.
12697	Clarostat Mfg. Co., Inc. Dover, N. H.	80164	Keithley Instruments, Inc. Cleveland, Ohio
12954	Dickson Electronics Corp. Scottsdale, Ariz.	88480	Mid-West Abrasive Co. Detroit, Mich.
13050	Potter Co. Wesson, Miss.	93656	Electric Cord Co. Caldwell, N. J.
		94310	Tru-Ohm Products Memcor Components Division Huntington, Ind.
		99120	Plastic Capacitors, Inc. Chicago, Ill.

TABLE 16. Code List of Suggested Manufacturers. (Based on Federal Supply Code for Manufacturers, Cataloging Handbook H4-1).







CHANGE NOTICE

September 12, 1967

MODEL 150B MICROVOLT AMMETER

Page ii. Change the ISOLATION specification to:

ISOLATION: Circuit ground to chassis ground: Greater than  $10^9$  ohms shunted by 0.001 microfarad. Circuit ground may be floated up to -400 volts with respect to chassis ground. On battery operation may be completely isolated from power line and ground.