

**KEITHLEY**

# Model 2304A High Speed Power Supply Calibration Manual

A GREATER MEASURE OF CONFIDENCE

---

# WARRANTY

Keithley Instruments, Inc. warrants this product to be free from defects in material and workmanship for a period of 1 year from date of shipment.

Keithley Instruments, Inc. warrants the following items for 90 days from the date of shipment: probes, cables, rechargeable batteries, diskettes, and documentation.

During the warranty period, we will, at our option, either repair or replace any product that proves to be defective.

To exercise this warranty, write or call your local Keithley representative, or contact Keithley headquarters in Cleveland, Ohio. You will be given prompt assistance and return instructions. Send the product, transportation prepaid, to the indicated service facility. Repairs will be made and the product returned, transportation prepaid. Repaired or replaced products are warranted for the balance of the original warranty period, or at least 90 days.

## LIMITATION OF WARRANTY

This warranty does not apply to defects resulting from product modification without Keithley's express written consent, or misuse of any product or part. This warranty also does not apply to fuses, software, non-rechargeable batteries, damage from battery leakage, or problems arising from normal wear or failure to follow instructions.

THIS WARRANTY IS IN LIEU OF ALL OTHER WARRANTIES, EXPRESSED OR IMPLIED, INCLUDING ANY IMPLIED WARRANTY OF MERCHANTABILITY OR FITNESS FOR A PARTICULAR USE. THE REMEDIES PROVIDED HEREIN ARE BUYER'S SOLE AND EXCLUSIVE REMEDIES.

NEITHER KEITHLEY INSTRUMENTS, INC. NOR ANY OF ITS EMPLOYEES SHALL BE LIABLE FOR ANY DIRECT, INDIRECT, SPECIAL, INCIDENTAL OR CONSEQUENTIAL DAMAGES ARISING OUT OF THE USE OF ITS INSTRUMENTS AND SOFTWARE EVEN IF KEITHLEY INSTRUMENTS, INC., HAS BEEN ADVISED IN ADVANCE OF THE POSSIBILITY OF SUCH DAMAGES. SUCH EXCLUDED DAMAGES SHALL INCLUDE, BUT ARE NOT LIMITED TO: COSTS OF REMOVAL AND INSTALLATION, LOSSES SUSTAINED AS THE RESULT OF INJURY TO ANY PERSON, OR DAMAGE TO PROPERTY.

<b>BELGIUM:</b>	Keithley Instruments B.V.	Bergensesteenweg 709 • B-1600 Sint-Pieters-Leeuw • 02/363 00 40 • Fax: 02/363 00 64
<b>CHINA:</b>	Keithley Instruments China	Yuan Chen Xin Building, Room 705 • 12 Yumin Road, Dewai, Madian • Beijing 100029 • 8610-62022886 • Fax: 8610-62022892
<b>FRANCE:</b>	Keithley Instruments Sarl	B.P. 60 • 3, allée des Garays • 91122 Palaiseau Cédex • 01 64 53 20 20 • Fax: 01 60 11 77 26
<b>GERMANY:</b>	Keithley Instruments GmbH	Landsberger Strasse 65 • D-82110 Germering • 089/84 93 07-40 • Fax: 089/84 93 07-34
<b>GREAT BRITAIN:</b>	Keithley Instruments Ltd	The Minster • 58 Portman Road • Reading, Berkshire RG30 1EA • 0118-9 57 56 66 • Fax: 0118-9 59 64 69
<b>INDIA:</b>	Keithley Instruments GmbH	Flat 2B, WILOCRISSA • 14, Rest House Crescent • Bangalore 560 001 • 91-80-509-1320/21 • Fax: 91-80-509-1322
<b>ITALY:</b>	Keithley Instruments s.r.l.	Viale S. Gimignano, 38 • 20146 Milano • 02/48 30 30 08 • Fax: 02/48 30 22 74
<b>NETHERLANDS:</b>	Keithley Instruments B.V.	Postbus 559 • 4200 AN Gorinchem • 0183-635333 • Fax: 0183-630821
<b>SWITZERLAND:</b>	Keithley Instruments SA	Kriesbachstrasse 4 • 8600 Dübendorf • 01-821 94 44 • Fax: 01-820 30 81
<b>TAIWAN:</b>	Keithley Instruments Taiwan	1 Fl. 85 Po Ai Street • Hsinchu, Taiwan, R.O.C. • 886-3572-9077 • Fax: 886-3572-9031

---

# Model 2304A High Speed Power Supply Calibration Manual

©1999, Keithley Instruments, Inc.  
All rights reserved.  
Cleveland, Ohio, U.S.A.  
First Printing, July 1999  
Document Number: 2304A-902-01 Rev. A

---

# Manual Print History

The print history shown below lists the printing dates of all Revisions and Addenda created for this manual. The Revision Level letter increases alphabetically as the manual undergoes subsequent updates. Addenda, which are released between Revisions, contain important change information that the user should incorporate immediately into the manual. Addenda are numbered sequentially. When a new Revision is created, all Addenda associated with the previous Revision of the manual are incorporated into the new Revision of the manual. Each new Revision includes a revised copy of this print history page.

Revision A (Document Number 2304A-902-01) .....July 1999

---

## Safety Precautions

The following safety precautions should be observed before using this product and any associated instrumentation. Although some instruments and accessories would normally be used with non-hazardous voltages, there are situations where hazardous conditions may be present.

This product is intended for use by qualified personnel who recognize shock hazards and are familiar with the safety precautions required to avoid possible injury. Read the operating information carefully before using the product.

The types of product users are:

**Responsible body** is the individual or group responsible for the use and maintenance of equipment, for ensuring that the equipment is operated within its specifications and operating limits, and for ensuring that operators are adequately trained.

**Operators** use the product for its intended function. They must be trained in electrical safety procedures and proper use of the instrument. They must be protected from electric shock and contact with hazardous live circuits.

**Maintenance personnel** perform routine procedures on the product to keep it operating, for example, setting the line voltage or replacing consumable materials. Maintenance procedures are described in the manual. The procedures explicitly state if the operator may perform them. Otherwise, they should be performed only by service personnel.

**Service personnel** are trained to work on live circuits, and perform safe installations and repairs of products. Only properly trained service personnel may perform installation and service procedures.

Exercise extreme caution when a shock hazard is present. Lethal voltage may be present on cable connector jacks or test fixtures. The American National Standards Institute (ANSI) states that a shock hazard exists when voltage levels greater than 30V RMS, 42.4V peak, or 60VDC are present. **A good safety practice is to expect that hazardous voltage is present in any unknown circuit before measuring.**

Users of this product must be protected from electric shock at all times. The responsible body must ensure that users are prevented access and/or insulated from every connection point. In some cases, connections must be exposed to potential human contact. Product users in these circumstances must be trained to protect themselves from the risk of electric shock. If the circuit is capable of operating at or above 1000 volts, **no conductive part of the circuit may be exposed.**

As described in the International Electrotechnical Commission (IEC) Standard IEC 664, digital multimeter measuring circuits (e.g., Keithley Models 175A, 199, 2000, 2001, 2002, and 2010) are Installation Category II. All other instruments' signal terminals are Installation Category I and must not be connected to mains.

Do not connect switching cards directly to unlimited power circuits. They are intended to be used with impedance limited sources. NEVER connect switching cards directly to AC mains. When connecting sources to switching cards, install protective devices to limit fault current and voltage to the card.

Before operating an instrument, make sure the line cord is connected to a properly grounded power receptacle. Inspect the connecting cables, test leads, and jumpers for possible wear, cracks, or breaks before each use.

For maximum safety, do not touch the product, test cables, or any other instruments while power is applied to the circuit under test. ALWAYS remove power from the entire test system and discharge any capacitors before: connecting or disconnecting cables or jumpers, installing or removing switching cards, or making internal changes, such as installing or removing jumpers.

Do not touch any object that could provide a current path to the common side of the circuit under test or power line (earth) ground. Always make measurements with dry hands while standing on a dry, insulated surface capable of withstanding the voltage being measured.

---

The instrument and accessories must be used in accordance with its specifications and operating instructions or the safety of the equipment may be impaired.

Do not exceed the maximum signal levels of the instruments and accessories, as defined in the specifications and operating information, and as shown on the instrument or test fixture panels, or switching card.

When fuses are used in a product, replace with same type and rating for continued protection against fire hazard.

Chassis connections must only be used as shield connections for measuring circuits, **NOT** as safety earth ground connections.

If you are using a test fixture, keep the lid closed while power is applied to the device under test. Safe operation requires the use of a lid interlock.

If a  screw is present, connect it to safety earth ground using the wire recommended in the user documentation.

The  symbol on an instrument indicates that the user should refer to the operating instructions located in the manual.

The  symbol on an instrument shows that it can source or measure 1000 volts or more, including the combined effect of normal and common mode voltages. Use standard safety precautions to avoid personal contact with these voltages.

The **WARNING** heading in a manual explains dangers that might result in personal injury or death. Always read the associated information very carefully before performing the indicated procedure.

The **CAUTION** heading in a manual explains hazards that could damage the instrument. Such damage may invalidate the warranty.

Instrumentation and accessories shall not be connected to humans.

Before performing any maintenance, disconnect the line cord and all test cables.

To maintain protection from electric shock and fire, replacement components in mains circuits, including the power transformer, test leads, and input jacks, must be purchased from Keithley Instruments. Standard fuses, with applicable national safety approvals, may be used if the rating and type are the same. Other components that are not safety related may be purchased from other suppliers as long as they are equivalent to the original component. (Note that selected parts should be purchased only through Keithley Instruments to maintain accuracy and functionality of the product.) If you are unsure about the applicability of a replacement component, call a Keithley Instruments office for information.

To clean an instrument, use a damp cloth or mild, water based cleaner. Clean the exterior of the instrument only. Do not apply cleaner directly to the instrument or allow liquids to enter or spill on the instrument. Products that consist of a circuit board with no case or chassis (e.g., data acquisition board for installation into a computer) should never require cleaning if handled according to instructions. If the board becomes contaminated and operation is affected, the board should be returned to the factory for proper cleaning/servicing.

---

# Table of Contents

<b>1</b>	<b>Performance Verification</b>	
	Introduction .....	1-2
	Verification test requirements.....	1-2
	Environmental conditions .....	1-2
	Warm-up period .....	1-2
	Line power .....	1-3
	Recommended test equipment .....	1-3
	Resistor construction.....	1-3
	Resistor characterization.....	1-4
	Verification limits .....	1-4
	Example limits calculation.....	1-4
	Performing the verification test procedures .....	1-5
	Test summary .....	1-5
	Test considerations.....	1-5
	Setting output values .....	1-5
	Output voltage accuracy.....	1-5
	Voltage readback accuracy .....	1-7
	Compliance current accuracy.....	1-8
	Current readback accuracy .....	1-9
	5A range readback accuracy .....	1-9
	5mA range readback accuracy .....	1-10
	Digital voltmeter input accuracy .....	1-12
<b>2</b>	<b>Calibration</b>	
	Introduction .....	2-2
	Environmental conditions .....	2-2
	Temperature and relative humidity .....	2-2
	Warm-up period .....	2-2
	Line power .....	2-2
	Calibration considerations.....	2-3
	Calibration cycle .....	2-3
	Recommended calibration equipment.....	2-3
	Resistor construction.....	2-4
	Front panel calibration .....	2-5
	Remote calibration .....	2-11
	Remote calibration commands.....	2-11
	Remote calibration display .....	2-12
	Remote calibration procedure .....	2-12

---

Changing the calibration code .....	2-15
Changing the code from the front panel.....	2-15
Changing the code by remote.....	2-15
Resetting the calibration code .....	2-16
Viewing calibration date and count .....	2-16
Viewing date and count from the front panel .....	2-16
Acquiring date and count by remote .....	2-16

## **A Specifications**

Accuracy calculations.....	A-4
Output and compliance accuracy .....	A-4
Readback accuracy .....	A-4
Digital voltmeter input accuracy .....	A-5

## **B Calibration Reference**

Introduction .....	B-2
Command summary.....	B-2
Miscellaneous commands.....	B-3
Detecting calibration errors .....	B-7
Reading the error queue .....	B-7
Error summary.....	B-7
Status byte EAV (Error Available) bit .....	B-7
Generating an SRQ on error.....	B-8
Detecting calibration step completion .....	B-8
Using the *OPC command.....	B-8
Using the *OPC? query.....	B-9
Generating an SRQ on calibration complete .....	B-9

## **C Calibration Program**

Introduction .....	C-2
Computer hardware requirements .....	C-2
Software requirements.....	C-2
Calibration equipment .....	C-2
General program instructions .....	C-3
Program C-1 Model 2304A calibration program .....	C-4



---

# List of Illustrations

<b>1</b>	<b>Performance Verification</b>	
Figure 1-1	4Ω resistor construction and connections .....	1-3
Figure 1-2	4kΩ resistor construction .....	1-4
Figure 1-3	Connections for voltage verification tests .....	1-6
Figure 1-4	Connections for output current and 5A range verification tests .....	1-8
Figure 1-5	Resistor connections for 5mA range verification tests .....	1-11
Figure 1-6	Connections for DVM accuracy verification .....	1-12
<b>2</b>	<b>Calibration</b>	
Figure 2-1	4Ω resistor construction and connections .....	2-4
Figure 2-2	4kΩ resistor construction .....	2-4
Figure 2-3	Connections for voltage calibration .....	2-6
Figure 2-4	Connections for 5A current calibration .....	2-8
Figure 2-5	Connections for 5mA current calibration .....	2-9

---

# List of Tables

<b>1</b>	<b>Performance Verification</b>	
Table 1-1	Recommended verification equipment .....	1-3
Table 1-2	Output voltage accuracy limits .....	1-6
Table 1-3	Voltage readback accuracy limits .....	1-7
Table 1-4	Compliance current accuracy limits .....	1-9
Table 1-5	5A range current readback accuracy limits .....	1-10
Table 1-6	5mA range current readback accuracy limits .....	1-11
Table 1-7	Digital voltmeter input accuracy limits .....	1-13
<b>2</b>	<b>Calibration</b>	
Table 2-1	Recommended calibration equipment .....	2-3
Table 2-2	Front panel calibration summary .....	2-10
Table 2-3	Remote calibration command summary .....	2-11
Table 2-4	Remote calibration summary .....	2-14
<b>B</b>	<b>Calibration Reference</b>	
Table B-1	Remote calibration command summary .....	B-2
Table B-2	Calibration step summary .....	B-6
Table B-3	Calibration error .....	B-7

---

# 1 Performance Verification

## Introduction

Use the procedures in this section to verify that Model 2304A accuracy is within the limits stated in the accuracy specifications. You can perform these verification procedures:

- When you first receive the unit to make sure that it was not damaged during shipment.
- To verify that the unit meets factory specifications.
- To determine if calibration is required.
- Following calibration to make sure it was performed properly.

**WARNING** The information in this section is intended for qualified service personnel only. Do not attempt these procedures unless you are qualified to do so.

**NOTE** *If the power supply is still under warranty, and its performance is outside specified limits, contact your Keithley representative or the factory to determine the correct course of action.*

## Verification test requirements

Be sure that you perform the verification tests:

- Under the proper environmental conditions.
- After the specified warm-up period.
- Using the correct line voltage.
- Using the proper test equipment.
- Using the specified output signals and reading limits.

### Environmental conditions

Conduct your performance verification procedures in a test environment with:

- An ambient temperature of 18° to 28°C (65° to 82°F).
- A relative humidity of less than 70% unless otherwise noted.

### Warm-up period

Allow the Model 2304A to warm up for at least one hour before conducting the verification procedures.

If the unit has been subjected to extreme temperatures (those outside the ranges stated above), allow additional time for the instrument's internal temperature to stabilize. Typically, allow one extra hour to stabilize a unit that is 10°C (18°F) outside the specified temperature range.

Also, allow the test equipment to warm up for the minimum time specified by the manufacturer.

## Line power

The Model 2304A requires a line voltage of 100 to 240V and a line frequency of 50 to 60Hz. Verification tests must be performed within this range.

## Recommended test equipment

Table 1-1 summarizes recommended verification equipment. You can use alternate equipment as long as that equipment has specifications at least four times better than the corresponding Model 2304A specifications. Keep in mind, however, that test equipment accuracy will add to the uncertainty of each measurement.

**Table 1-1**  
*Recommended verification equipment*

Description	Manufacturer/Model	Specifications
Digital Multimeter	Keithley 2001	DC Voltage* 20V: ±22ppm Resistance* 20Ω: ±59ppm 20kΩ: ±36ppm
Precision Resistors (2)	Isotec RUG-Z-2R002	2Ω, 0.1%, 100W**
Precision Resistors (4)	Dale PTF-56 .1%T13	4kΩ, 0.1%, 0.125W***

\*Full-range, 90-day, 23°C ±5°C accuracy specifications of ranges required for various measurement points.

\*\*Connect two 2Ω resistors in series to make single 4Ω resistor. Characterize resistor using 20kΩ range of DMM before use.

\*\*\*Connect four 4kΩ resistors in series-parallel to make 4kΩ resistor. Characterize resistor using 20kΩ range of DMM before use.

## Resistor construction

### 4Ω resistor construction

The 4Ω resistor should be constructed by connecting the two 2Ω resistors listed in Table 1-1 in series. Make test and measurement connections across the combined series equivalent resistance. Figure 1-1 shows resistor construction and connections.

**Figure 1-1**  
*4Ω resistor construction and connections*

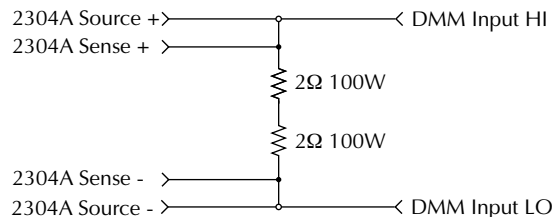

## 4k $\Omega$ resistor construction

The 4k $\Omega$  resistor should be constructed from four 4k $\Omega$  resistors in a series-parallel configuration, shown in Figure 1-2. Again, make test and measurement connections across the combined equivalent series-parallel resistance.

**Figure 1-2**  
*4k $\Omega$  resistor construction*

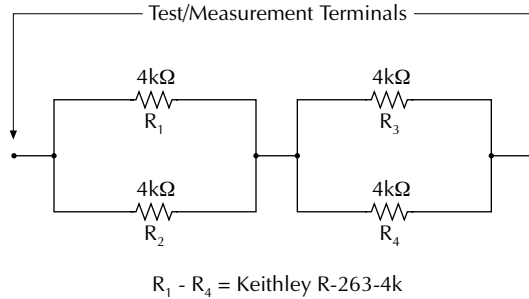

## Resistor characterization

The 4 $\Omega$  and 4k $\Omega$  resistors should be characterized using the 4-wire ohms function of the DMM recommended in Table 1-1 to measure the resistance values. Use the measured resistance values to calculate the actual currents during the test procedures.

## Verification limits

The verification limits stated in the following paragraphs have been calculated using only the Model 2304A accuracy specifications, and they do not include test equipment uncertainty. If a particular measurement falls outside the allowable range, recalculate new limits based both on Model 2304A specifications and corresponding test equipment specifications.

### Example limits calculation

As an example of how verification limits are calculated, assume you are testing the power supply using a 10V output value. Using the Model 2304A voltage output accuracy specification of  $\pm(0.05\%$  of output + 10mV offset), the calculated output limits are:

$$\text{Output limits} = 10\text{V} \pm [(10\text{V} \times 0.05\%) + 10\text{mV}]$$

$$\text{Output limits} = 10\text{V} \pm (0.005 + 0.01\%)$$

$$\text{Output limits} = 10\text{V} \pm 0.015\text{V}$$

$$\text{Output limits} = 9.985\text{V to } 10.015\text{V}$$

---

# Performing the verification test procedures

## Test summary

- DC voltage output accuracy
- DC voltage readback accuracy
- DC current output accuracy
- DC current readback accuracy
- Digital voltmeter input accuracy

If the Model 2304A is not within specifications and not under warranty, see the calibration procedures in Section 2 for information on calibrating the unit.

## Test considerations

When performing the verification procedures:

- Make sure that the test equipment is properly warmed up and connected to the correct Model 2304A terminals on the rear panel. Also, be sure the test equipment is set up for the proper function and range.
- Do not connect test equipment to the Model 2304A through a scanner, multiplexer, or other switching equipment.
- Be sure that the power supply output is turned on before making measurements.
- Allow the power supply output signal to settle before making a measurement.

## Setting output values

When performing the verification procedures, you must set the output voltage and current to specific values.

Use the following general procedure to set output values:

1. Using the DISPLAY key, make sure the unit is in the ACTUAL display mode.
2. Press SET. The LSD (least-significant digit) in the voltage display area will blink, indicating that the unit is in the output setting mode.
3. Use the edit (arrow) keys to adjust the voltage value, then press SET. The LSD for the current value will then blink.
4. Use the edit keys to adjust the current value and press SET. The display will return to the readback mode (no blinking digits).

## Output voltage accuracy

Follow the steps below to verify that Model 2304A output voltage accuracy is within specified limits. This test involves setting the output voltage to specific values and measuring the voltages with a precision digital multimeter.

1. With the power off, connect the digital multimeter to the Model 2304A OUTPUT SOURCE terminals, as shown in Figure 1-3. Be sure to observe proper polarity (SOURCE + to INPUT HI; SOURCE - to INPUT LO).

**Figure 1-3**  
Connections for voltage verification tests

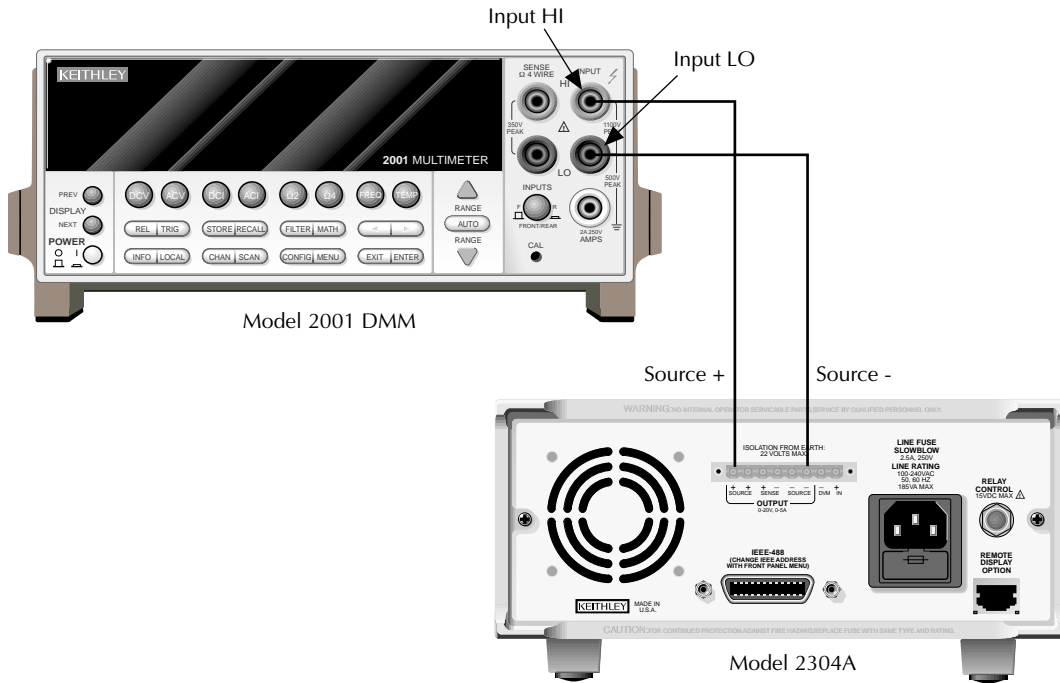

2. Select the multimeter DC volts measuring function and enable auto-ranging.
3. Make sure the Model 2304A output is turned on.
4. Verify output voltage accuracy for each of the voltages listed in Table 1-2. For each test point:
  - Use the SET key to adjust the Model 2304A output voltage to the indicated value. When setting the voltage, set the compliance current to 5A.
  - Allow the reading to settle.
  - Verify that the multimeter reading is within the limits given in Table 1-2.
5. Repeat the procedure for negative output voltages with the same magnitude as those listed in Table 1-2.

**Table 1-2**  
Output voltage accuracy limits

Model 2304A output voltage setting	Output voltage limits (1 year, 18° to 28°C)
5.00V	4.9875 to 5.0125V
10.00V	9.9850 to 10.015V
15.00V	14.9825 to 15.0175V
20.00V	19.9800 to 20.020V



## Voltage readback accuracy

Follow the steps below to verify that Model 2304A voltage readback accuracy is within specified limits. The test involves setting the source voltage to specific values, as measured by a digital multimeter, and then verifying that the Model 2304A voltage readback readings are within required limits.

1. With the power off, connect the digital multimeter to the Model 2304A OUTPUT SOURCE terminals, as shown in Figure 1-3. Be sure to observe proper polarity (SOURCE + to INPUT HI; SOURCE - to INPUT LO).
2. Select the multimeter DC volts measuring function and enable auto-ranging.
3. Make sure actual voltage readings are being displayed (use DISPLAY) and turn on the Model 2304A output.
4. Verify voltage readback accuracy for each of the voltages listed in Table 1-3. For each test point:
  - Use the SET key to adjust the Model 2304A output voltage to the indicated value as measured by the digital multimeter. Note that it may not be possible to set the voltage source precisely to the specified value. Use the closest possible setting and modify reading limits accordingly. When setting the voltage, set the compliance current to 5A.
  - Allow the reading to settle.
  - Verify that the actual voltage reading on the Model 2304A display is within the limits given in the table.
5. Repeat the procedure for negative source voltages with the same magnitudes as those listed in Table 1-3.

**Table 1-3**  
*Voltage readback accuracy limits*

Model 2304A output voltage setting*	Voltage readback limits (1 year, 18° to 28°C)
5.00V	4.988 to 5.012V
10.00V	9.985 to 10.015V
15.00V	14.983 to 15.017V
19.00V	18.981 to 19.019V

\*As measured by digital multimeter. See procedure.

# Compliance current accuracy

Follow the steps below to verify that Model 2304A compliance current accuracy is within specified limits. The test involves setting the compliance current to specific values and determining the actual current by measuring the voltages across a characterized  $4\Omega$  resistor with a precision digital multimeter.

1. With the power off, connect the digital multimeter and  $4\Omega$  resistor to the Model 2304A OUTPUT SOURCE terminals, as shown in Figure 1-4. Be sure to observe proper polarity (SOURCE + to INPUT HI; SOURCE - to INPUT LO). Also be sure to use 4-wire connections from the Model 2304A to the resistor terminals.
2. Select the multimeter DC volts measuring function and enable auto-ranging.
3. Turn on the Model 2304A output.

**Figure 1-4**  
Connections for output current  
and 5A range verification tests

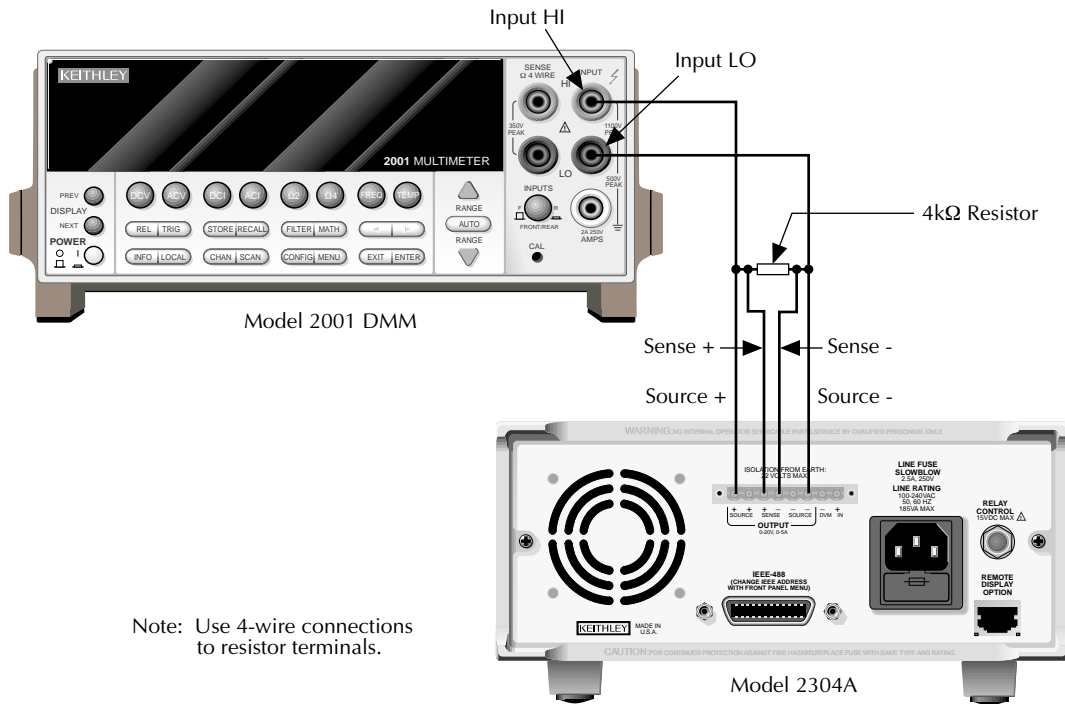

4. Verify compliance current accuracy for the currents listed in Table 1-4. For each test point:
  - Use the SET key to adjust the Model 2304A output voltage to 20V and set the compliance current to the value being tested.
  - Note and record the digital multimeter voltage reading.
  - Calculate the current from the voltage reading and actual 4Ω resistor value ( $I=V/R$ ).
  - Verify that the current is within the limits given in Table 1-4.

**Table 1-4**  
*Compliance current accuracy limits*

Model 2304A compliance current setting	Compliance current limits (1 year, 18° to 28°C)
1.000A	0.993 to 1.007A
2.000A	1.992 to 2.008A
3.000A	2.990 to 3.010A
4.000A	3.989 to 4.011A
5.000A	4.987 to 5.013A

## Current readback accuracy

Follow the steps below to verify that Model 2304A current readback accuracy is within specified limits. The test involves setting the output current to specific values as measured with a resistor and precision digital multimeter.

### 5A range readback accuracy

1. With the power off, connect the digital multimeter and 4Ω resistor to the Model 2304A OUTPUT SOURCE terminals, as shown in Figure 1-4. Be sure to observe proper polarity (SOURCE + to INPUT HI; SOURCE - to INPUT LO). Also, be sure to use 4-wire connections to the resistor terminals.
2. Select the multimeter DC volts measuring function and enable auto-ranging.
3. Using the Model 2304A MENU key, select the 5A readback range. Also make sure actual current readings are displayed (use DISPLAY).
4. Turn on the Model 2304A output.

5. Verify 5A range current readback accuracy for the currents listed in Table 1-5. For each test point:
  - By changing the output voltage with the SET key, adjust the current to the correct value, as determined from the multimeter voltage reading and characterized resistance value. When setting the voltage, be sure to set the compliance current to 5A.
  - Note that it may not be possible to set the output current to the exact value. In that case, set the current to the closest possible value and modify reading limits accordingly.
  - Allow the reading to settle.
  - Verify that the actual current reading on the Model 2304A display is within the limits given in Table 1-5.

**Table 1-5***5A range current readback accuracy limits*

Nominal output voltage	Model 2304A output current*	Current readback limits (1 year, 18° to 28°C)
4V	1.000A	0.9970 to 1.0030A
8V	2.000A	1.9950 to 2.0050A
12V	3.000A	2.9930 to 3.0070A
16V	4.000A	3.9910 to 4.0090A
19V	4.750A	4.7395 to 4.7605A

\*As determined from digital multimeter and 4Ω resistor. See procedure.

## 5mA range readback accuracy

1. With the power off, connect the digital multimeter and 4kΩ resistor to the Model 2304A OUTPUT SOURCE terminals, as shown in Figure 1-5. Be sure to observe proper polarity and connections (4kΩ resistor between SOURCE + and DMM INPUT HI; SOURCE - to DMM INPUT LO).
2. Select the multimeter DC volts measuring function and enable auto-ranging.
3. Using the Model 2304A MENU key, select the 5mA readback range. Also display actual current readings with the DISPLAY key.
4. Turn on the Model 2304A output.
5. Verify 5mA range current readback accuracy for the currents listed in Table 1-6. For each test point:
  - By changing the output voltage with the SET key, adjust the Model 2304A output current to the correct value, as determined from the digital multimeter voltage reading and 4kΩ resistance value. Note that it may not be possible to set the output current to the exact value. In that case, set the current to the closest possible value and modify reading limits accordingly.
  - Allow the reading to settle.
  - Verify that the actual current reading on the Model 2304A display is within the limits given in Table 1-6.

**Figure 1-5**  
Resistor connections for  
5mA range verification tests

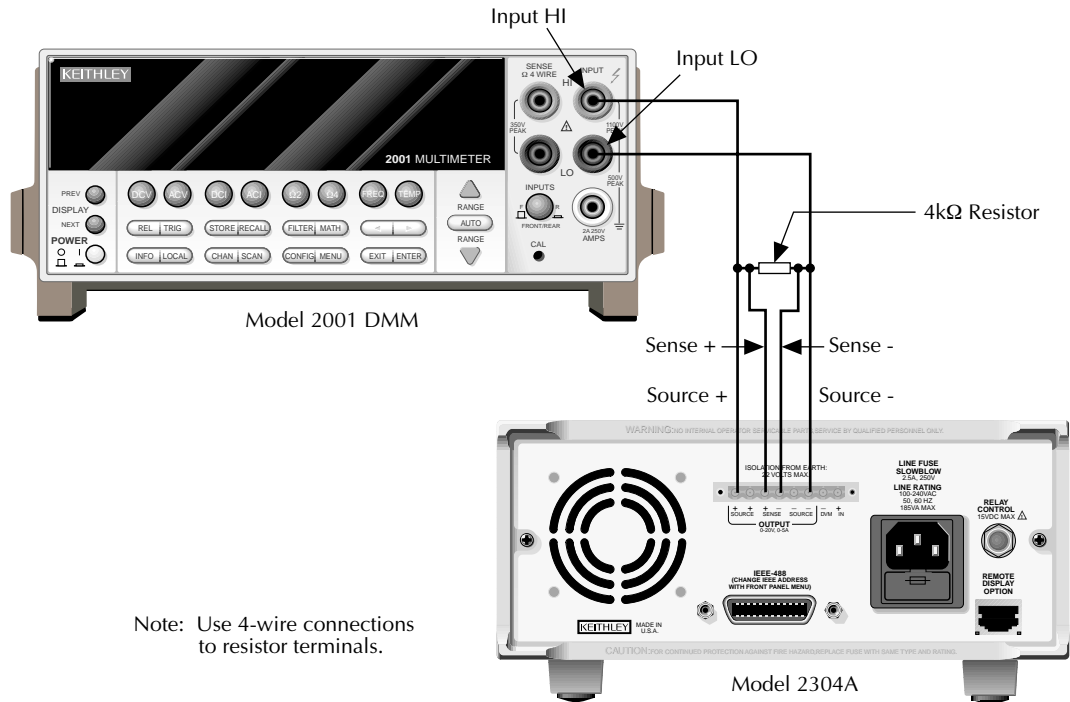

Note: Use 4-wire connections to resistor terminals.

**Table 1-6**  
5mA range current readback accuracy limits

Nominal output voltage	Model 2304A output current*	Current readback limits (1 year, 18° to 28°C)
4V	1.0000mA	0.9970 to 1.0030mA
8V	2.0000mA	1.9950 to 2.0050mA
12V	3.0000mA	2.9930 to 3.0070mA
16V	4.0000mA	3.9910 to 4.0090mA
19V	4.7500mA	4.7395 to 4.7605mA

\*As determined from digital multimeter voltage reading and 4kΩ resistance value. See procedure.

## Digital voltmeter input accuracy

Follow the steps below to verify that Model 2304A digital voltmeter input accuracy is within specified limits. The test involves setting the voltage applied to the DVM input to accurate values and then verifying that the Model 2304A digital voltmeter input readings are within required limits.

1. With the power off, connect the Model 2304A DVM IN terminals to OUTPUT SOURCE terminals and the digital multimeter, as shown in Figure 1-6. Be sure to observe proper polarity (DVM IN + SOURCE + and DMM INPUT HI; DVM IN - to SOURCE - and DMM INPUT LO).
2. Select the DMM DC volts measuring function and enable auto-ranging.
3. Using the DISPLAY key, enable the Model 2304A DVM input.
4. Turn on the Model 2304A source output.

**Figure 1-6**  
Connections for DVM  
accuracy verification

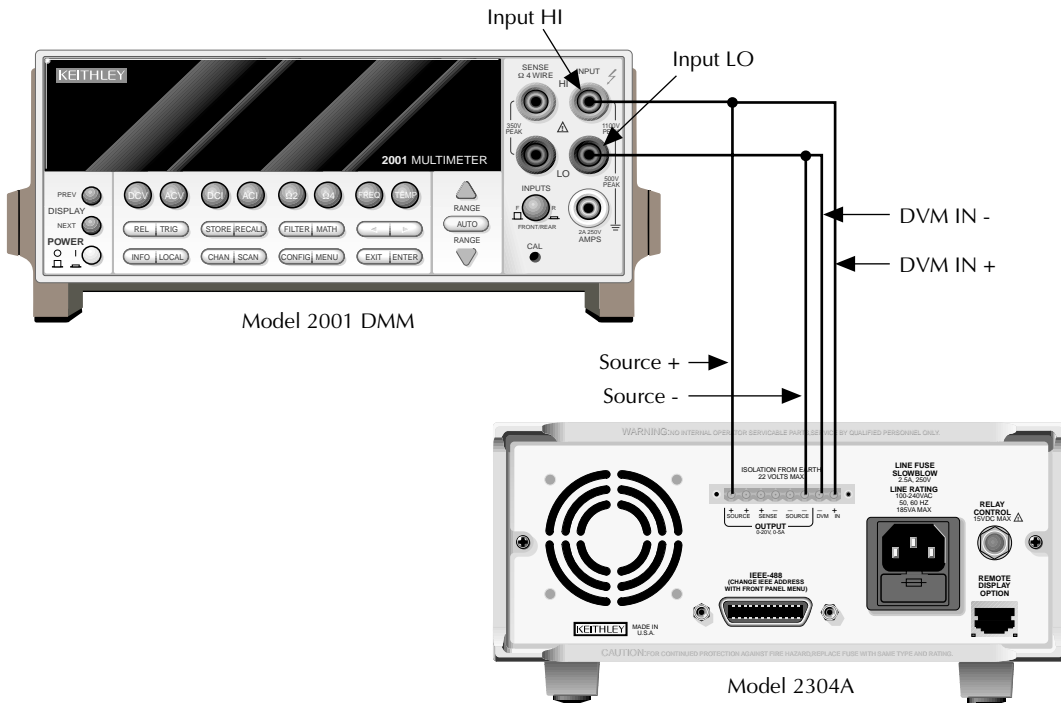

5. Verify digital voltmeter input accuracy for each of the voltages listed in Table 1-7. For each test point:
  - Use the SET key to adjust the voltage to the indicated value as measured by the digital multimeter.
  - Allow the reading to settle.
  - Verify that the voltage reading on the Model 2304A display is within the limits given in Table 1-7.

**Table 1-7**  
*Digital voltmeter input accuracy limits*

<b>Model 2304A voltage output setting*</b>	<b>Digital voltmeter input reading limits (1 year, 18° to 28°C)</b>
+19.00V	+18.981 to +19.019V
-3.00V	-3.019 to -2.981V

\*As measured by digital multimeter. See procedure.

---

# 2 Calibration



## Introduction

Use the procedures in this section to calibrate the Model 2304A. These procedures require accurate test equipment to measure precise DC voltages and currents. Calibration can be performed either from the front panel or by sending SCPI calibration commands over the IEEE-488 bus with the aid of a computer.

**WARNING** The information in this section is intended for qualified service personnel only. Do not attempt these procedures unless you are qualified to do so.

## Environmental conditions

### Temperature and relative humidity

Conduct the calibration procedures at an ambient temperature of 18° to 28°C (65° to 82°F) with a relative humidity of less than 70% unless otherwise noted.

### Warm-up period

Allow the Model 2304A to warm up for at least one hour before performing calibration.

If the instrument has been subjected to extreme temperatures (those outside the ranges stated above), allow additional time for the instrument's internal temperature to stabilize. Typically, allow one extra hour to stabilize a unit that is 10°C (18°F) outside the specified temperature range.

Also, allow the test equipment to warm up for the minimum time specified by the manufacturer.

### Line power

The Model 2304A requires a line voltage of 100 to 240V at line frequency of 50 to 60Hz. The instrument must be calibrated while operating from a line voltage within this range.

# Calibration considerations

When performing the calibration procedures:

- Make sure the test equipment is properly warmed up and connected to the appropriate Model 2304A terminals.
- Always allow the source signal to settle before calibrating each point.
- Do not connect test equipment to the Model 2304A through a scanner or other switching equipment.
- Calibration must be performed in the sequence outlined in this manual or an error will occur.
- If an error occurs during calibration, the Model 2304A will generate an appropriate error message. See Appendix B for more information.

**WARNING** The maximum common-mode voltage (voltage between LO and chassis ground) is 22VDC. Exceeding this value may cause a breakdown in insulation, creating a shock hazard.

## Calibration cycle

Perform calibration at least once a year to ensure the unit meets or exceeds its specifications.

# Recommended calibration equipment

Table 2-1 lists the recommended equipment for the calibration procedures. You can use alternate equipment as long as that equipment has specifications at least four times better than the corresponding Model 2304A specifications.

**Table 2-1**  
*Recommended calibration equipment*

Description	Manufacturer/Model	Specifications
Digital Multimeter	Keithley 2001	DC Voltage* 20V: ±22ppm Resistance* 20Ω: ±59ppm 20kΩ: ±36ppm
Precision Resistors (2)	Isotec RUG-Z-2R002	2Ω, 0.1%, 100W**
Precision Resistors (4)	Dale PTF-56 .1%T13	4kΩ, 0.1%, 0.125W***

\*Full-range, 90-day, 23°C ±5°C accuracy specifications of ranges required for various measurement points.

\*\*Connect two 2Ω resistors in series to make single 4Ω resistor. Characterize resistor using 20Ω range of DMM before use.

\*\*\*Connect four 4kΩ resistors in series-parallel to make single 4kΩ resistor. Characterize resistor using 20kΩ range of DMM before use.

## Resistor construction

### 4Ω resistor construction

The 4Ω resistor should be constructed by connecting the two 2Ω resistors listed in Table 2-1 in series. Make test and measurement connections across the combined series equivalent resistance. See Figure 2-1 for resistor construction and connections.

**Figure 2-1**  
4Ω resistor construction  
and connections

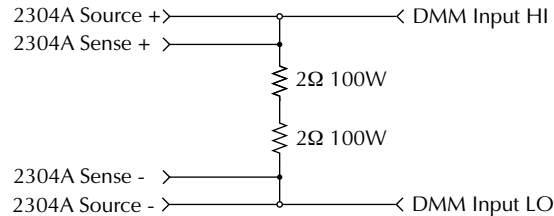

### 4kΩ resistor construction

The 4kΩ resistor should be constructed from four 4kΩ resistors in a series-parallel configuration, as shown in Figure 2-2. Again, make test and measurement connections across the combined equivalent series-parallel resistance.

**Figure 2-2**  
4kΩ resistor  
construction

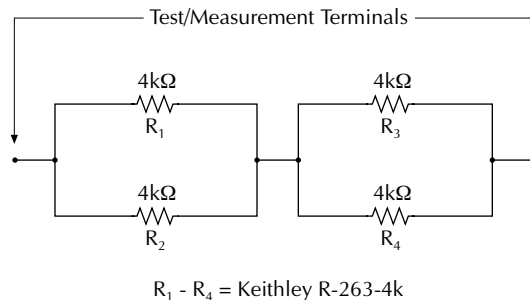

## Resistor characterization

The 4Ω and 4kΩ resistors should be characterized using the 4-wire ohms function of the DMM recommended in Table 2-1 to measure the resistance values. Use the measured resistance values to calculate the actual currents during the calibration procedure.

---

## Front panel calibration

**NOTE** Calibration must be performed in the following sequence or an error will occur. To abort calibration and revert to previous calibration constants at any time during the procedure, press the *MENU* key.

### Step 1: Prepare the Model 2304A for calibration

1. Turn on the Model 2304A and the digital multimeter; allow them to warm up for at least one hour before performing calibration.
2. Press the *MENU* key, choose *CALIBRATE UNIT*, and press *ENTER*. The instrument will display the date last calibrated:  
CALIBRATE UNIT  
LAST ON 02/01/97
3. Press the up arrow key. The instrument will display the number of times it was calibrated:  
CALIBRATE UNIT  
TIMES = 01
4. Press the up arrow key. The unit will prompt you to run calibration:  
CALIBRATE UNIT  
RUN
5. Press *ENTER*. The unit will prompt for the calibration code:  
CALIBRATE UNIT  
Cal Code KI002304
6. Using the edit keys, set the display to the current calibration code and press *ENTER* (default: KI002304). The unit will prompt you as to whether or not to change the code:  
CALIBRATE UNIT  
Change Code NO
7. Be sure *NO* is selected (use the up or down arrow keys), press *ENTER*, and then follow the steps below to calibrate the unit. (See *Changing the calibration code* at the end of this section to change the code.)

## Step 2: Perform calibration steps

**NOTE** The unit will display the most recently calibrated values. Factory defaults are shown in this manual.

1. Connect both the OUTPUT SOURCE and DVM IN terminals to the digital multimeter, as shown in Figure 2-3. (Connect SOURCE + and DVM IN + to DMM INPUT HI; connect SOURCE - and DVM IN - to DMM INPUT LO.)
2. At this point, the Model 2304A will prompt you to set the full-scale output voltage:  
FULL SCALE VOLTS  
SET 19.0000 V

**Figure 2-3**  
Connections for voltage calibration

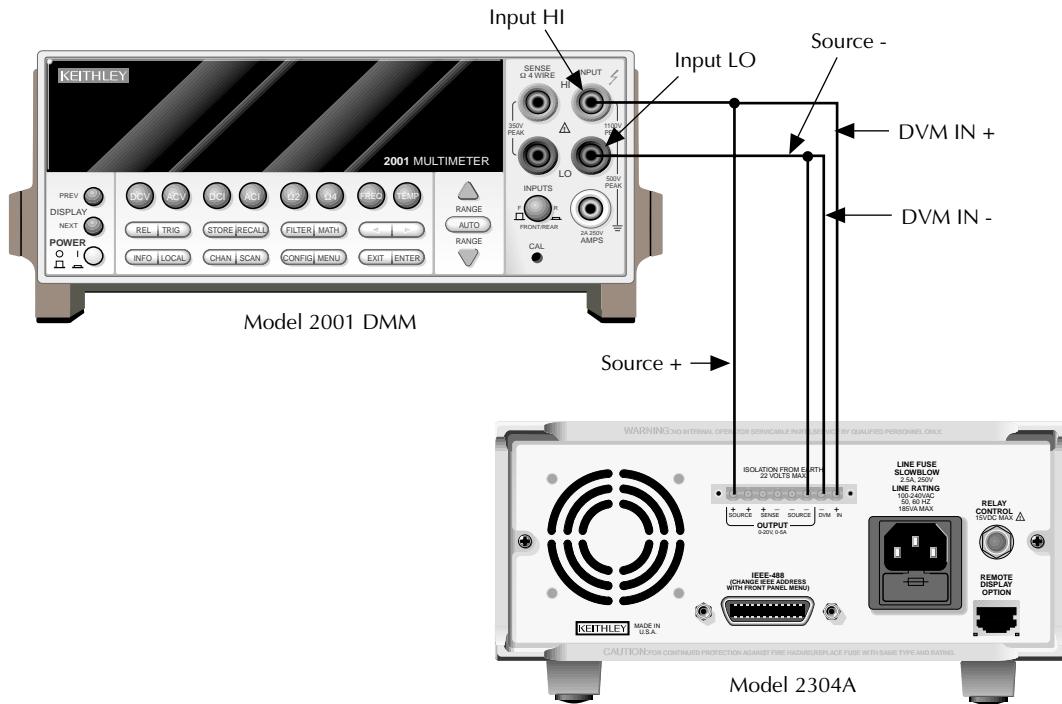

3. Use the edit keys to set the voltage to 19.0000V and press ENTER.

**NOTE** *At this point, the source output is turned on and will remain on until calibration is completed or aborted with the MENU key.*

4. The unit will prompt you for the DMM reading, which will be used to calibrate the full-scale output voltage:  
FULL SCALE VOLTS  
READ1 19.0000 V
5. Using the edit keys, adjust the Model 2304A voltage display to agree with the DMM voltage reading and press ENTER. The unit will prompt for another DMM reading, which will be used to calibrate the full-scale measurement function:  
FULL SCALE VOLTS  
READ2 19.0000 V
6. Using the edit keys, adjust the display to agree with the new DMM voltage reading and press ENTER. The unit will then prompt for DVM full-scale calibration:  
FULL SCALE DVM  
ALL READY TO DO?
7. Press ENTER to complete DVM full-scale calibration.

8. Connect the digital multimeter volts input and  $4\Omega$  resistor to the Model 2304A OUTPUT SOURCE terminals, as shown in Figure 2-4. Be sure to observe proper polarity (SOURCE + to DMM INPUT HI; SOURCE - to INPUT LO).
9. Be sure the digital multimeter DC volts function and auto-ranging are still selected.
10. At this point, the unit will prompt for 5A full-scale calibration output:  
SOURCE 5 AMPS  
SET 1.90000 A
11. Using the edit keys, adjust the set value to 1.9000A and press ENTER. The unit will prompt you for the DMM reading, which calibrates the 5A current limit:  
SOURCE 5 AMPS  
READ1 1.90000 A
12. Note the DMM voltage reading and calculate the current from that reading and the actual  $4\Omega$  resistance value ( $I=V/R$ ). Adjust the Model 2304A current display value to agree with the calculated current value, and press ENTER.

**Figure 2-4**  
Connections for 5A  
current calibration

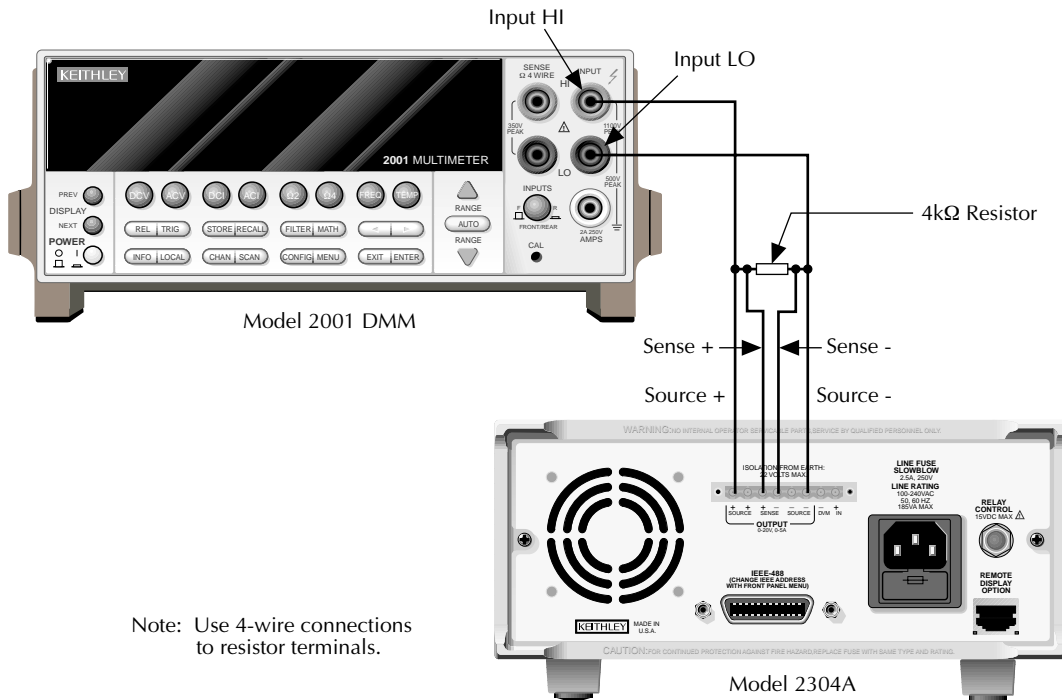

13. The Model 2304A will then prompt for another DMM reading, which is used for 5A measurement calibration:  
SOURCE 5 AMPS  
READ2 1.90000 A
14. Again, calculate the current from the new DMM reading and 4Ω resistor value. Adjust the Model 2304A current display reading to agree with the new current and press ENTER.
15. Disconnect the 4Ω resistor and connect the 4kΩ resistor in its place (see Figure 2-5).
16. Make sure the DMM DC volts function and auto-ranging are still selected.
17. At this point, the unit will prompt to output approximately 5mA for 5mA range full-scale calibration:  
SOURCE 5 mA  
ALL READY TO DO?

**Figure 2-5**  
Connections for 5mA  
current calibration

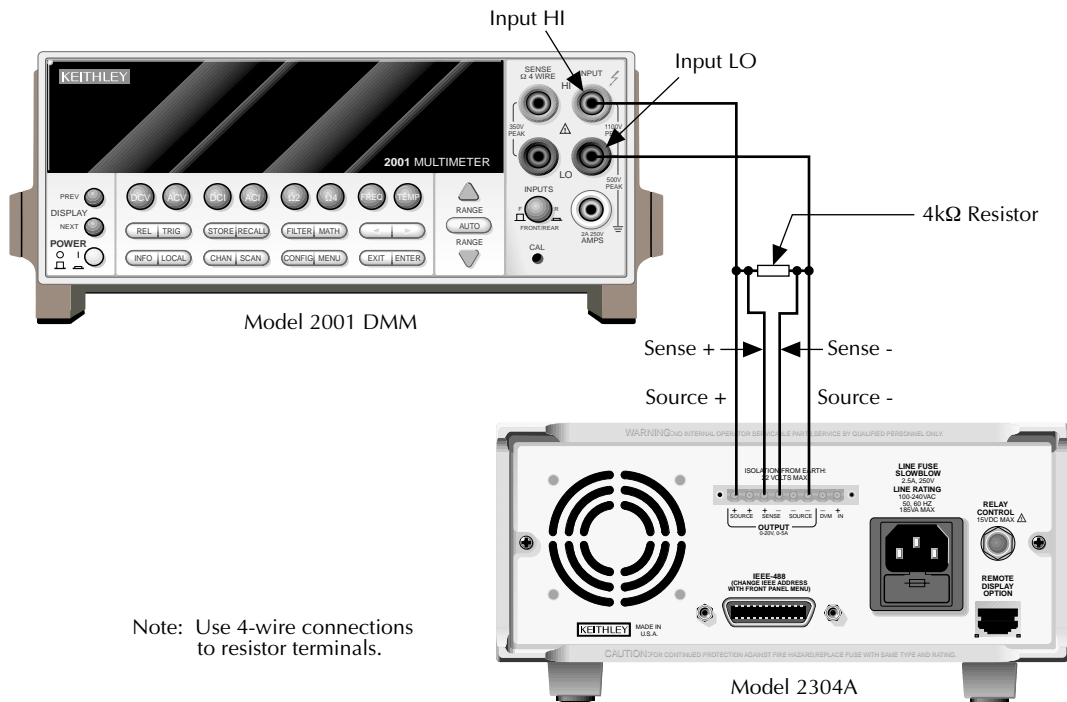

Note: Use 4-wire connections to resistor terminals.



18. Press ENTER to output approximately 5mA. The unit will prompt you for the DMM reading:  
SOURCE 5 mA  
READ1 4.50000 mA
19. Note the DMM voltage reading and calculate the current from that voltage reading and actual 4k $\Omega$  resistance value. Adjust the Model 2304A current display value to agree with that value, and press ENTER.

### Step 3: Enter calibration dates and save calibration

1. After completing all calibration steps, the unit will prompt you to save calibration:  
CALIBRATE UNIT  
Save Cal Data YES
2. To save new calibration constants, select YES with the up arrow key and press ENTER. If you wish to exit calibration without saving new calibration constants, select NO and press ENTER. The unit will then revert to prior calibration constants.
3. The unit will then prompt you to enter the calibration date:  
CALIBRATE UNIT  
Cal Date 02/01/97
4. Using the edit keys, set the calibration date to today's date and press ENTER. The unit will display the following:  
CALIBRATE UNIT  
EXITING CAL
5. Press ENTER to complete the calibration procedure and return to the menu display. Calibration is now complete. Refer to Table 2-2 for a summary of front panel calibration.

**Table 2-2**

*Front panel calibration summary*

Step*	Description	Nominal calibration signal**	Test connections
0	Output 19V	19V	Figure 2-3
1	Full-scale output voltage	19V	Figure 2-3
2	Full-scale measure	19V	Figure 2-3
3	Full-scale DVM	19V	Figure 2-3
4	5A range output current	1.9A	Figure 2-4
5	5A current limit	1.9A	Figure 2-4
6	5A measure	1.9A	Figure 2-4
7	5mA range output current	4.5mA	Figure 2-5
8	5mA measure	4.5mA	Figure 2-5

\*Step numbers correspond to :CAL:PROT:STEP command numbers. See Table 2-3.

\*\*Factory default display values. Unit will display most recently used value.

# Remote calibration

Use the following procedure to perform remote calibration by sending SCPI commands over the IEEE-488 bus. The remote commands and appropriate parameters are separately summarized for each step.

## Remote calibration commands

Table 2-3 summarizes remote calibration commands. For a more complete description of these commands, refer to Appendix B.

**Table 2-3**  
*Remote calibration command summary*

Command	Description
:CALibration	Calibration subsystem.
:PROTected	Cal commands protected by code.
:CODE '<code>'	Unlock cal; changes code if cal is already unlocked. (Default password: KI002304.)
:COUNT?	Query number of times 2304A has been calibrated.
:DATE <yyyy>,<mm>,<dd>	Program calibration year, month, day.
:DATE?	Query calibration year, month, day.
:INIT	Initiate calibration (must be sent before other cal steps).
:LOCK	Lock out calibration. (Abort if calibration is incomplete.)
:SAVE	Save calibration data to EEPROM.*
:STEP0 <nrf>	Output full-scale voltage (19V).
:STEP1 <nrf>	Calibrate output voltage setting using external DMM reading.
:STEP2 <nrf>	Calibrate voltage measuring using external DMM reading.
:STEP3	Perform DVM input full-scale (19V) cal.
:STEP4 <nrf>	Output current (1.9A) for 5A full-scale cal.
:STEP5 <nrf>	Calibrate output current limit using calculated current.
:STEP6 <nrf>	Calibrate 5A measurement range using calculated current.
:STEP7	Output 5mA nominal current for 5mA range full-scale cal.
:STEP8 <nrf>	Calibrate 5mA measurement range using calculated current.

\* Calibration data will not be saved if:

1. Calibration was not unlocked with :CODE command.
2. Invalid data exists. (For example, cal step failed or was aborted.)
3. Incomplete number of cal steps were performed.
4. Calibration was not performed in the proper sequence.

## Remote calibration display

The unit will display the following while being calibrated over the bus.

```
CALIBRATING UNIT  
FROM THE BUS R
```

## Remote calibration procedure

**NOTE** Calibration steps must be performed in the following sequence or an error will occur. You can abort the procedure and revert to previous calibration constants at any time before `:SAVE` by sending the `:CAL:PROT:LOCK` command.

### Step 1: Prepare the Model 2304A for calibration

1. Connect the Model 2304A to the controller IEEE-488 interface using a shielded interface cable.
2. Turn on the Model 2304A and the test equipment. Allow them to warm up for at least one hour before performing calibration.
3. Make sure the IEEE-488 primary address of the Model 2304A is the same as the address specified in the program you will be using to send commands. (Use the MENU key to access the primary address.)
4. Send the following command with the correct code to unlock calibration:  
`:CAL:PROT:CODE '<code>'`  
For example, with the factory default code of KI002304, send:  
`CAL:PROT:CODE 'KI002304'`
5. Send the following command to initiate calibration:  
`:CAL:PROT:INIT`

### Step 2: Perform calibration steps

**NOTE** Allow the Model 2304A to complete each calibration step before going on to the next one. See “Detecting calibration step completion” in Appendix B.

1. Connect both the OUTPUT SOURCE and DVM IN terminals to the digital multimeter, as shown in Figure 2-3. (Connect SOURCE + and DVM IN + to DMM INPUT HI; SOURCE - and DVM IN - to DMM INPUT LO.)
2. Send the following command to output 19V:  
`:CAL:PROT:STEP0 19`

**NOTE** At this point, the source output is turned on and will remain on until calibration is completed or aborted with the `:CAL:PROT:LOCK` command.

3. Note and record the DMM reading, and then send that reading as the parameter for the following command:  
:CAL:PROT:STEP1 <DMM\_Reading>  
For example, if the DMM reading is 19.012V, the command would be:  
:CAL:PROT:STEP1 19.012
4. Note and record a new DMM reading, and then send that reading as the parameter for the following command:  
:CAL:PROT:STEP2 <DMM\_Reading>
5. Send the following command for DVM full-scale calibration:  
:CAL:PROT:STEP3
6. Connect the Model 2304A OUTPUT SOURCE terminals to the DMM volts input and 4 $\Omega$  resistor, as shown in Figure 2-4. Be sure to observe proper polarity (SOURCE + to INPUT HI; SOURCE - to INPUT LO).
7. Make sure the digital multimeter DC volts function and auto-ranging are still selected.
8. Send the following command to output 1.9A for 5A full-scale calibration:  
:CAL:PROT:STEP4 1.9
9. Note and record the DMM voltage reading, and then calculate the current from that reading and 4 $\Omega$  resistor value. Send the following command using that calculated current as the parameter:  
:CAL:PROT:STEP5 <Calculated\_Current>  
For example, with a current value of 1.894A, the command would appear as follows:  
:CAL:PROT:STEP5 1.894
10. Note and record a new DMM voltage reading, and again calculate the current from the voltage and resistance. Send the calculated current value as the parameter for the following command:  
:CAL:PROT:STEP6 <Calculated\_Current>
11. Connect the 4k $\Omega$  resistor in place of the 4 $\Omega$  resistor (see Figure 2-5).
12. Make sure the DMM DC volts function and auto-range are still selected.
13. Send the following command to output approximately 5mA for 5mA full-scale calibration:  
:CAL:PROT:STEP7
14. Note and record the DMM voltage reading, and then calculate the current from the voltage reading and actual 4k $\Omega$  resistance value. Send that current value as the parameter for the following command:  
:CAL:PROT:STEP8 <Calculated\_Current>  
For example, with a current of 4.8mA, the command would be:  
:CAL:PROT:STEP8 4.8E-3

### Step 3: Program calibration date

Use the following commands to set the calibration date:

```
:CAL:PROT:DATE <yyyy>, <mm>, <dd>
```

Note that the year, month, and date must be separated by commas. The allowable range for the year is from 1997 to 2096, the month is from 1 to 12, and the date is from 1 to 31.

### Step 4: Save calibration constants and lock out calibration

Calibration is now complete. You can store the calibration constants in EEROM by sending the following command:

```
:CAL:PROT:SAVE
```

**NOTE** Calibration will be temporary unless you send the SAVE command. Also, calibration data will not be saved if (1) calibration is locked, (2) invalid data exists, or (3) all steps were not completed in the proper sequence. In that case, the unit will revert to previous calibration constants.

Lock out calibration by sending :CAL:PROT:LOCK. Refer to Table 2-4 for a summary of remote calibration.

**Table 2-4**

Remote calibration summary

Step*	Command	Description	Test connections
	:CAL:PROT:CODE 'KI002304'	Unlock calibration.	None
	:CAL:PROT:INIT	Initiate calibration.	None
0	:CAL:PROT:STEP0 19	Full-scale (19V) output.	Figure 2-3
1	:CAL:PROT:STEP1 <DMM_Reading>	Full-scale output cal.	Figure 2-3
2	:CAL:PROT:STEP2 <DMM_Reading>	Full-scale measure cal.	Figure 2-3
3	:CAL:PROT:STEP3	DVM full-scale cal.	Figure 2-3
4	:CAL:PROT:STEP4 1.9	Source full-scale current cal.	Figure 2-4
5	:CAL:PROT:STEP5 <Calculated_Current>	5A current limit cal.	Figure 2-4
6	:CAL:PROT:STEP6 <Calculated_Current>	5A measure cal.	Figure 2-4
7	:CAL:PROT:STEP7	Source 5mA full-scale current.	Figure 2-5
8	:CAL:PROT:STEP8 <Calculated_Current>	5mA range measure cal.	Figure 2-5
	:CAL:PROT:DATE <yyyy,mm,dd>	Program calibration date.	None
	:CAL:PROT:SAVE	Save calibration data.	None
	:CAL:PROT:LOCK	Lock out calibration.	None

\*Step correspond to :STEP commands.

---

# Changing the calibration code

The default calibration code may be changed from the front panel or via remote as discussed below.

## Changing the code from the front panel

Follow the steps below to change the code from the front panel:

1. Press the MENU key, choose CALIBRATE UNIT, and press ENTER. The instrument will display the last date calibrated:  
CALIBRATE UNIT  
LAST ON 02/01/97
2. Press the up arrow key. The instrument will display the number of times it was calibrated:  
CALIBRATE UNIT  
TIMES= 01
3. Press the up arrow key. The unit will prompt you to run calibration:  
CALIBRATE UNIT  
RUN
4. Press ENTER. The unit will prompt you for the calibration code:  
CALIBRATE UNIT  
Cal Code KI002304
5. Using the edit keys, set the display to the present calibration code and press ENTER (Default: KI002304). The unit will prompt you as to whether or not to change the code:  
CALIBRATE UNIT  
Change Code NO
6. Using the up or down arrow key, select YES and press ENTER. The instrument will prompt you to change the code:  
CALIBRATE UNIT  
New Code: KI002304
7. Use the edit keys to set the new code and press ENTER to accept the new code.
8. Press the MENU key to exit calibration and return to the main menu.

## Changing the code by remote

To change the calibration code by remote, first send the present code and then send the new code. For example, the following command sequence changes the code from the 'KI002304' remote default to 'KI\_CAL':

```
:CAL:PROT:CODE 'KI002304'  
:CAL:PROT:CODE 'KI_CAL'
```

You can use any combination of letters and numbers up to a maximum of eight characters.

## Resetting the calibration code

If you lose the calibration code, you can unlock calibration by shorting together the CAL pads, which are located on the digital board. Doing so will also reset the code to the factory default (KI002304).

## Viewing calibration date and count

### Viewing date and count from the front panel

Follow the steps below to view the calibration date and count from the front panel:

1. Press the MENU key, choose CALIBRATE UNIT, and press ENTER. The instrument will display the last date calibrated:  
CALIBRATE UNIT  
LAST ON 02/01/97
2. Press the up arrow key. The instrument will display the number of times it was calibrated:  
CALIBRATE UNIT  
TIMES= 01
3. Press MENU to return to the menu structure.

### Acquiring date and count by remote

Use the :DATE? and :COUNT? queries to determine the calibration date and count respectively. See *Remote calibration procedure* for more details.

---

# A Specifications



---

## DC VOLTAGE OUTPUT (1 Year, 23°C ± 5°C)

### OUTPUT VOLTAGE:

- 0 to +20VDC (for Normal Output Response).
- 0 to +15VDC (for Enhanced Output Response).

**OUTPUT ACCURACY:** ±(0.05% + 10mV).

**PROGRAMMING RESOLUTION:** 5mV.

**READBACK ACCURACY<sup>1</sup>:** ±(0.05% + 10mV).

**READBACK RESOLUTION:** 1mV.

**OUTPUT VOLTAGE SETTling TIME:** 5ms to within stated accuracy.

**LOAD REGULATION:** 0.01% + 2mV.

**LINE REGULATION:** 0.5mV.

**STABILITY<sup>2</sup>:** 0.01% + 0.5mV.

### TRANSIENT RESPONSE TO 1000% LOAD CHANGE:

#### NORMAL MODE:

**Transient Recovery Time<sup>3</sup>:** <50µs to within 100mV of previous level.  
<100µs to within 20mV of previous level.

#### ENHANCED MODE:

**Transient Recovery Time<sup>3,4</sup>:** <40µs to within 100mV of previous level.  
<80µs to within 20mV of previous level.

**Transient Voltage Drop:** <100mV, typical.<sup>3</sup>  
<200mV, typical.<sup>4</sup>

**REMOTE SENSE:** Automatic, 2V max. drop in each lead. Add 2mV to the voltage load regulation specification for each 1V change in the negative output lead due to load current change.

---

## DC CURRENT (1 Year, 23°C ± 5°C)

**OUTPUT CURRENT:** 5A max. (not intended to be operated in parallel).

**COMPLIANCE ACCURACY:** ±(0.16% + 5mA)<sup>5</sup>.

**PROGRAMMED COMPLIANCE RESOLUTION:** 1.25mA.

### READBACK ACCURACY

**5A range:** ±(0.2% + 1mA). **5mA range:** ±(0.2% + 1µA).

### READBACK RESOLUTION

**5A range:** 100µA. **5mA range:** 0.1µA.

### CURRENT SINK CAPACITY:

- 3A max. (for Normal Output Response).
- 1A<sup>6</sup> (for Enhanced Output Response).

**LOAD REGULATION:** 0.01% + 1mA.

**LINE REGULATION:** 0.5mA.

**STABILITY<sup>4</sup>:** 0.01% + 50µA.

---

## DIGITAL VOLTMETER INPUT(1 Year, 23°C ± 5°C)

**INPUT VOLTAGE RANGE:** 0 to +20VDC.

**INPUT IMPEDANCE:** 10<sup>10</sup>Ω typical.

**MAXIMUM VOLTAGE (either input terminal) WITH RESPECT TO OUTPUT LOW:** -3V, +22V.

**READING ACCURACY<sup>1</sup>:** ±(0.05% + 10mV).

**READING RESOLUTION:** 1mV.

---

## DC GENERAL

**MEASUREMENT TIME CHOICES:** 0.01 to 10 PLC<sup>7</sup>, in 0.01PLC steps.

**AVERAGE READINGS:** 1 to 10.

**READING TIME<sup>1,8,9</sup>:** 31ms, typical.

---

## PULSE CURRENT MEASUREMENT OPERATION

**TRIGGER LEVEL:** 5mA to 5A, in 5mA steps.

**TRIGGER DELAY:** 0 to 100ms, in 10 $\mu$ s steps.

**INTERNAL TRIGGER DELAY:** 25 $\mu$ s.

**HIGH/LOW/AVERAGE MODE:**

**Measurement Aperture Settings:** 33.3 $\mu$ s to 833ms, in 33.3 $\mu$ s steps.

**Average Readings:** 1 to 100.

**BURST MODE:**

**Measurement Aperture:** 33.3 $\mu$ s.

**Conversion Rate:** 3600/second, typical.

**Number of Samples:** 1 to 5000.

**Transfer Samples Across IEEE Bus in Binary Mode:** 4800 bytes/ second, typical.

---

## GENERAL

**ISOLATION (low-earth):** 22VDC max.

**PROGRAMMING:** IEEE-488.2 (SCPI).

**USER-DEFINABLE POWER-UP STATES:** 5.

**REAR PANEL CONNECTOR:** 8-position quick disconnect terminal block for output (4), sense (2), and DVM (2).

**TEMPERATURE COEFFICIENT (outside 23°C  $\pm$ 5°C):** Derate accuracy specification by (0.1  $\times$  specification)/°C.

**OPERATING TEMPERATURE:**

0° to 50°C (50W<sup>10</sup> normal response, 25W<sup>10</sup> enhanced response).

0° to 35°C (100W<sup>10</sup> normal response, 75W<sup>10</sup> enhanced response).

**STORAGE TEMPERATURE:** -20° to 70°C.

**HUMIDITY:** <80% @ 35°C non-condensing.

**POWER CONSUMPTION:** 200VA max.

**REMOTE DISPLAY/KEYPAD OPTION:** Disables standard front panel.

**DIMENSIONS:** 89mm high  $\times$  213mm wide  $\times$  360mm deep (3½ in  $\times$  8½ in  $\times$  14⅝ in).

**SHIPPING WEIGHT:** 5.4kg (12 lbs).

**INPUT POWER:** 100V–240V AC, 50 or 60Hz (auto detected at power-up).

**WARRANTY:** One year parts and labor on materials and workmanship.

**EMC:** Conforms with European Union Directive directive 89/336/EEC EN 55011, EN 50082-1, EN 61000-3-2 and 61000-3-3, FCC part 15 class B.

**SAFETY:** Conforms with European Union Directive 73/23/EEC EN 61010-1, UL 3111-1.

**ACCESSORIES SUPPLIED:** User manual, service manual, output connector mating terminal (part no. CS-846).

**ACCESSORIES AVAILABLE:** Model 2304-DISP Remote Display/ Keypad (4.6 in  $\times$  2.7 in  $\times$  1.5 in). Includes 2.7m (9 ft) cable and rack mount kit.

<sup>1</sup> PLC = 1.00.

<sup>2</sup> Following 15 minute warm-up, the change in output over 8 hours under ambient temperature, constant load, and line operating conditions.

<sup>3</sup> Remote sense, at output terminals, 1000% load change; typical.

<sup>4</sup> Remote sense, with 4.5m (15 ft) of 16 gauge wire and 1 $\Omega$  resistance in each source lead to simulate typical test environment, up to 1.5A load change.

<sup>5</sup> Minimum current in constant current mode is 6mA.

<sup>6</sup> 60Hz (50Hz).

<sup>7</sup> PLC = Power Line Cycle. 1PLC = 16.7ms for 60Hz operation, 20ms for 50Hz operation.

<sup>8</sup> Display off.

<sup>9</sup> Speed includes measurement and binary data transfer out of GPIB.

Specifications subject to change without notice.

# Accuracy calculations

The information below discusses how to calculate output, readback, and digital voltmeter input accuracy.

## Output and compliance accuracy

Output and compliance accuracy are calculated as follows:

$$\text{Accuracy} = \pm(\% \text{ of output} + \text{offset})$$

As an example of how to calculate the actual output limits, assume the Model 2304A is sourcing 10V. Compute the output range from output voltage accuracy specifications as follows:

$$\begin{aligned}\text{Accuracy} &= \pm(\% \text{ of output} + \text{offset}) \\ &= \pm[(0.05 \times 10\text{V}) + 10\text{mV}] \\ &= \pm(5\text{mV} + 10\text{mV}) \\ &= \pm 15\text{mV}\end{aligned}$$

Thus, the actual output voltage range is: 10V  $\pm$ 15mV or from 9.985V to 10.015V.

Current compliance calculations are performed in exactly the same manner using the pertinent specifications and compliance current settings.

## Readback accuracy

Readback accuracy is calculated similarly, except of course that voltage or current readback specifications are used. As an example of how to calculate the actual current readback limits, assume the actual current being measured is 1.5A. Using the 5A range current readback specifications, the current readback reading range is:

$$\begin{aligned}\text{Accuracy} &= \pm(0.2\% \text{ of reading} + 200\text{mA offset}) \\ &= \pm[(0.2\% \times 1.5\text{A}) + 200\text{mA}] \\ &= \pm(3\text{mA} + 200\text{mA}) \\ &= \pm 3.2\text{mA}\end{aligned}$$

In this case, the actual current readback reading range is: 1.5A  $\pm$ 3.25mA or from 1.4968A to 1.5032A.

## Digital voltmeter input accuracy

Accuracy of the digital voltmeter can be computed in exactly the same manner. Use the digital voltmeter input accuracy specifications and the applied voltage in your calculations. For example, assume that 5V is applied to the digital voltmeter input. Reading range is:

$$\begin{aligned}\text{Accuracy} &= \pm(\% \text{ of reading} + \text{offset}) \\ &= \pm[(0.05\% \times 5\text{V}) + 10\text{mV}] \\ &= \pm(2.5\text{mV} + 10\text{mV}) \\ &= \pm 12.5\text{mV}\end{aligned}$$

The reading range is: 5V  $\pm$ 12.5mV or from 4.988V to 5.012V.

---

# **B** Calibration Reference

# Introduction

This appendix contains detailed information on the various Model 2304A remote calibration commands, calibration error messages, and methods to detect the end of each calibration step.

Section 2 of this manual covers detailed calibration procedures.

## Command summary

Table B-1 summarizes Model 2304A calibration commands. These commands are covered in detail in the following paragraphs.

**Table B-1**  
*Remote calibration command summary*

Command	Description
:CALibration	Calibration subsystem.
:PROTeCted	Cal commands protected by code.
:CODE '<code>'	Unlock cal; changes code if cal is already unlocked (default password: KI002304).
:COUNt?	Query number of times Model 2304A has been calibrated.
:DATE <yyyy>,<mm>,<dd>	Program calibration year, month, day.
:DATE?	Query calibration year, month, day.
:INIT	Initiate calibration (must be sent before other cal steps).
:LOCK	Lock out calibration. (Abort if calibration is incomplete.)
:SAVE	Save calibration data to EEPROM.*
:STEP0 <nrf>	Output full-scale voltage (19V).
:STEP1 <nrf>	Calibrate output voltage setting using external DMM reading.
:STEP2 <nrf>	Calibrate voltage measuring using external DMM reading.
:STEP3	Perform DVM input full-scale (19V) cal.
:STEP4 <nrf>	Output current (1.9A) for 5A full-scale cal.
:STEP5 <nrf>	Calibrate output current limit using calculated current.
:STEP6 <nrf>	Calibrate 5A measurement range using calculated current.
:STEP7	Output 5mA nominal current for 5mA range full-scale cal.
:STEP8 <nrf>	Calibrate 5mA measurement range using calculated current.

\*Calibration data will not be saved if:

1. Calibration was not unlocked with :CODE command.
2. Invalid data exists. (For example, cal step failed or was aborted.)
3. Incomplete number of cal steps were performed.
4. Calibration was not performed in the proper sequence.

## Miscellaneous commands

Miscellaneous commands are those commands that perform such functions as saving calibration constants, locking out calibration, and programming date parameters.

### **:CODE**

**(:CALibration:PROTeCted:CODE)**

<b>Purpose</b>	To unlock calibration so that you can perform the calibration procedure.	
<b>Format</b>	:cal:prot:code '<code>'	
<b>Parameter</b>	Up to an 8-character ASCII string, including letters and numbers.	
<b>Description</b>	The :CODE command sends the calibration code and enables calibration when performing these procedures via remote. The correct code must be sent to the unit before sending any other calibration command. The default remote code is KI002304.	
<b>Note</b>	<ul style="list-style-type: none"> <li>• The :CODE command should be sent only once before performing calibration. Do not send :CODE before each calibration step.</li> <li>• To change the code, first send the present code and then send the new code.</li> <li>• The code parameter must be enclosed in single quotes.</li> </ul>	
<b>Example</b>	:CAL:PROT:CODE 'KI002304'	Send default code of KI002304.

### **:COUNT?**

**(:CALibration:PROTeCted:COUNT?)**

<b>Purpose</b>	To request the number of times the Model 2304A has been calibrated.	
<b>Format</b>	:cal:prot:count?	
<b>Response</b>	Number of times calibrated.	
<b>Description</b>	The :COUNT? query may be used to determine the total number of times the Model 2304A has been calibrated. The calibration count will also be displayed during the front panel calibration procedure.	
<b>Example</b>	:CAL:PROT:COUNT?	Request calibration count.

## **:DATE**

**(:CALibration:PROTected:DATE)**

<b>Purpose</b>	To program the calibration date.
<b>Format</b>	:cal:prot:date <yyyy>, <mm>, <dd>
<b>Parameter</b>	<yyyy> = 1997 to 2096 <mm> = 1 to 12 <dd> = 1 to 31
<b>Query</b>	:cal:prot:date?
<b>Response</b>	<yyyy>, <mm>, <dd>
<b>Description</b>	The :DATE command allows you to store the calibration date in instrument EEROM for future reference. You can read back the date from the instrument by using the :DATE? query. The calibration date will also be displayed during the front panel calibration procedure.
<b>Note</b>	The year, month, and day parameters must be delimited by commas.
<b>Example</b>	:CAL:PROT:DATE 1997, 11, 20      Send cal date (11/20/97).

## **:INIT**

**(:CALibration:PROTected:INIT)**

<b>Purpose</b>	To initiate calibration.
<b>Format</b>	:cal:prot:init
<b>Description</b>	The :INIT command initiates the calibration process and must be sent before all other commands except :CODE.
<b>Note</b>	The :INIT command should be sent only once at the beginning of the calibration procedure. Do not send :INIT before each calibration step.
<b>Example</b>	:CAL:PROT:INIT      Initiate calibration.



**:LOCK****(:CALibration:PROTected:LOCK)**

<b>Purpose</b>	To lock out calibration.	
<b>Format</b>	:cal:prot:lock	
<b>Description</b>	The :LOCK command lets you lock out calibration after completing the procedure. Thus, :LOCK performs the opposite of sending the code with the :CODE command.	
<b>Note</b>	Sending :LOCK without completing calibration and sending :SAVE will abort calibration and restore previous calibration constants.	
<b>Example</b>	:CAL:PROT:LOCK	Lock out calibration.

**:SAVE****(:CALibration:PROTected:SAVE)**

<b>Purpose</b>	To save calibration constants in EEROM after the calibration procedure.	
<b>Format</b>	:cal:prot:save	
<b>Description</b>	The :SAVE command stores internally calculated calibration constants derived during comprehensive in EEROM. EEROM is non-volatile memory, and calibration constants will be retained indefinitely once saved. :SAVE is sent after all other calibration steps.	
<b>Note</b>	Calibration will be only temporary unless the :SAVE command is sent to permanently store calibration constants. Calibration data will not be saved if: <ol style="list-style-type: none"> <li>1. Calibration was not unlocked by sending the :CODE command.</li> <li>2. Invalid data exists (for example, cal step failed).</li> <li>3. An incomplete number of cal steps were performed.</li> <li>4. Calibration was performed out of sequence.</li> </ol>	
<b>Example</b>	:CAL:PROT:SAVE	Save calibration constants.

## :STEP

(:CALibration:PROTected:STEP<n>)

<b>Purpose</b>	To perform various calibration steps.
<b>Format</b>	:cal:prot:step<n>
<b>Parameter</b>	See Table B-2.
<b>Description</b>	The :CAL:PROT:STEP<n> command performs calibration at the various points listed in Table B-2. See Section 2 for details on test equipment and connections.
<b>Note</b>	Calibration steps must be performed in the order listed in Table B-2 or an error will occur.
<b>Example</b>	:CAL:PROT:STEP0 19      Perform cal step 0 (full-scale output voltage).

*Table B-2  
Calibration step summary*

Command	Description
:CALibration	Calibration subsystem.
:PROTected	Cal commands protected by code.
:STEP0 <nrf>	Output full-scale voltage (19V).
:STEP1 <nrf>	Calibrate output voltage setting using external DMM reading.
:STEP2 <nrf>	Calibrate voltage measuring using external DMM reading.
:STEP3	Perform DVM input full-scale (19V) cal.
:STEP4 <nrf>	Output current (1.9A) for 5A full-scale cal.
:STEP5 <nrf>	Calibrate output current limit using calculated current.
:STEP6 <nrf>	Calibrate 5A measurement range using calculated current.
:STEP7	Output 5mA nominal current for 5mA range full-scale cal.
:STEP8 <nrf>	Calibrate 5mA measurement range using calculated current.

## Detecting calibration errors

If an error occurs during any calibration step, the Model 2304A will generate an appropriate error message. Several methods to detect calibration errors are discussed below.

### Reading the error queue

As with other Model 2304A errors, any calibration errors will be reported in the error queue. Use the `:SYST:ERR?` query to read the error queue.

### Error summary

Table B-3 summarizes calibration errors.

*Table B-3*  
*Calibration error*

Error number	Error message
+400	Voltage zero cal prepare error.
+401	Voltage zero cal output error.
+402	Voltage zero cal measure error.
+403	DVM zero cal error.
+404	Volt full-scale cal prepare error.
+405	Volt full-scale cal output error.
+406	Volt full-scale cal meas error.
+407	DVM full-scale cal meas error.
+408	Open circuit cal error.
+409	5A source cal prepare error.
+410	5A source cal output error.
+411	5A source cal measure error.
+412	5mA source cal prepare error.
+413	5mA source cal measure error.

### Status byte EAV (Error Available) bit

Whenever an error is available in the error queue, the EAV (Error Available) bit (bit 2) of the status byte will be set. Use the `*STB?` query to obtain the status byte, and then test bit 2 to see if it is set. If the EAV bit is set, an error has occurred. You can use the appropriate error query to read the error and at the same time clear the EAV bit in the status byte.

## Generating an SRQ on error

To program the instrument to generate an IEEE-488 bus SRQ (Service Request) when an error occurs, send the \*SRE 4 command. This command will enable SRQ when the EAV bit is set. You can then read the status byte and error queue as outlined above to check for errors and to determine the exact nature of the error.

## Detecting calibration step completion

When sending remote calibration commands, you must wait until the instrument completes the current operation before sending another command. You can use either \*OPC or \*OPC? to determine when each calibration step is completed.

### Using the \*OPC command

Using the \*OPC command is the preferred method to detect the end of each calibration step. To use \*OPC, do the following:

1. Enable operation complete by sending \*ESE 1. This command sets the OPC (operation complete bit) in the standard event enable register, allowing operation complete status from the standard event status register to set the ESB (event summary bit) in the status byte when operation complete is detected.
2. Send the \*OPC command immediately following each calibration command. For example:  
:CAL:PROT:STEP0 19;\*OPC  
Note that you must include the semicolon (;) to separate the two commands, and that the \*OPC command must appear on the same line as the command.
3. After sending a calibration command, repeatedly test the ESB (Event Summary) bit (bit 5) in the status byte until it is set. (Use \*STB? to request the status byte.)
4. Once operation complete has been detected, clear OPC status using one of two methods: (1) use the \*ESR? query, then read the response to clear the standard event status register or (2) send the \*CLS command to clear the status register. Note that sending \*CLS will also clear the error queue and operation complete status.

## Using the \*OPC? query

With the \*OPC? (operation complete) query, the instrument will place an ASCII 1 in the output queue when it has completed each step. To determine when the \*OPC? response is ready, do the following:

1. Repeatedly test the MAV (Message Available) bit (bit 4) in the status byte and wait until it is set. (You can request the status byte by using the \*STB? query.)
2. When MAV is set, a message is available in the output queue, and you can read the output queue and test for an ASCII 1.
3. After reading the output queue, repeatedly test MAV again until it clears. At this point, the calibration step is completed.

## Generating an SRQ on calibration complete

An IEEE-488 bus SRQ (service request) can be used to detect operation complete instead of repeatedly polling the Model 2304A. To use this method, send both \*ESE 1 and \*SRE 32 to the instrument, then include the \*OPC command at the end of each calibration command line, as covered above. Clear the SRQ by querying the ESR (using the \*ESR? query) to clear OPC status, then request the status byte with the \*STB? query to clear the SRQ.

Refer to your controller's documentation for information on detecting and servicing SRQs.

---

# C Calibration Program

## Introduction

This appendix includes a calibration program written in BASIC to help you calibrate the Model 2304A. Refer to Section 2 for more details on calibration procedures, equipment, and connections. Appendix B covers calibration commands in detail.

## Computer hardware requirements

The following computer hardware is required to run the calibration programs:

- IBM PC compatible computer.
- Keithley KPC-488.2 or KPC-488.2AT, or CEC PC-488 IEEE-488 interface for the computer.
- Two shielded IEEE-488 bus cables (Keithley Model 7007).

## Software requirements

To use the calibration program, you will need the following computer software:

- Microsoft QBasic (supplied with MS-DOS 5.0 or later).
- MS-DOS version 5.0 or later.
- HP-style Universal Language Driver, CECHP.EXE (supplied with Keithley and CEC interface cards listed above).

## Calibration equipment

To following calibration equipment is required:

- Keithley Model 2001 Digital Multimeter
- 4 $\Omega$ , 0.1%, 100W resistor
- 4k $\Omega$ , 0.1%, 0.25W resistor

See Section 2 for detailed equipment specifications as well as details on test connections.

## General program instructions

1. With the power off, connect the Model 2304A and the digital multimeter to the IEEE-488 interface of the computer. Be sure to use shielded IEEE-488 cables for bus connections.
2. Turn on the computer, the Model 2304A, and the digital multimeter. Allow the Model 2304A and the multimeter to warm up for at least one hour before performing calibration.
3. Make sure the Model 2304A is set for a primary address of 16. (Use the front panel MENU to check or change the address.)
4. Make sure the digital multimeter primary address is set to 17.
5. Make sure that the computer bus driver software (CECHP.EXE) is properly initialized.
6. Enter the QBasic editor and type in the program below. Be sure to use the actual characterized  $4\Omega$  and  $4k\Omega$  resistor values when entering the FourOhm and FourK parameters.
7. Check thoroughly for errors, then save the program using a convenient filename.
8. Run the program. Follow the prompts on the screen to perform calibration. For test connections, refer to the following figures in Section 2:
  - Voltage connections: Figure 2-3.
  - 5A current connections: Figure 2-4.
  - 5mA current connections: Figure 2-5.



## Program C-1 Model 2304A calibration program

```

' Model 2304A calibration program for use with the Keithley 2001 DMM.
' Rev. 1.2, 4/3/97
' 2304A primary address = 16. 2001 primary address = 17.
OPEN "IEEE" FOR OUTPUT AS #1           ' Open IEEE-488 output path.
OPEN "IEEE" FOR INPUT AS #2           ' Open IEEE-488 input path.
PRINT #1, "INTERM CRLF"                ' Set input terminator.
PRINT #1, "OUTTERM LF"                 ' Set output terminator.
PRINT #1, "REMOTE 16 17"               ' Put 2304A, 2001 in remote.
PRINT #1, "OUTPUT 16;*CLS"             ' Initialize 2304A.
PRINT #1, "OUTPUT 16;*ESE 1;*SRE 32"   ' Enable OPC and SRQ.
PRINT #1, "OUTPUT 17::SYST:PRES"       ' Initialize 2001.
PRINT #1, "OUTPUT 17::FORM:ELEM:READ"  ' Reading only.
C$ = ":CAL:PROT:STEP"                  ' Partial command header.
FourOhm = 4                            ' Use characterized 4 ohm value.
FourK = 4000                            ' Use characterized 4 k ohm value.
CLS
PRINT "Model 2304A Calibration Program"
PRINT #1, "OUTPUT 16::CAL:PROT:CODE 'KI002304'" ' Unlock calibration.
PRINT #1, "OUTPUT 16::CAL:PROT:INIT"        ' Initiate calibration.
GOSUB ErrCheck
GOSUB KeyCheck
FOR I = 0 TO 8                             ' Loop for all cal steps.
IF I = 0 OR I = 4 OR I = 7 THEN           ' Prompt for test connections.
    READ Msg$
    PRINT Msg$
    GOSUB KeyCheck
END IF
I$ = STR$(I): C1$ = C$ + RIGHT$(I$, LEN(I$) - 1)
SELECT CASE I                               ' Build command string.
CASE 0
    Cmd$ = C1$ + " 19 "
CASE 1, 2, 5, 6, 8
    GOSUB ReadDMM
    Cmd$ = C1$ + " " + Reading$
CASE 3, 7
    Cmd$ = C1$
CASE 4
    Cmd$ = C1$ + " 1.9 "
END SELECT
PRINT #1, "OUTPUT 16::"; Cmd$; ";*OPC" ' Send command string to 2304A.
GOSUB ErrCheck
GOSUB CalEnd
NEXT I
LINE INPUT "Enter calibration date (yyyy,mm,dd):"; D$
PRINT #1, "OUTPUT 16::CAL:PROT:DATE"; D$
PRINT #1, "OUTPUT 16::CAL:PROT:SAVE" ' Save calibration constants.
PRINT #1, "OUTPUT 16::CAL:PROT:LOCK" ' Lock out calibration.

```

```

GOSUB ErrCheck
PRINT "Calibration completed."
PRINT #1, "LOCAL 16 17"
CLOSE
END
'
KeyCheck:                                ' Check for key press routine.
WHILE INKEY$ <> "": WEND                  ' Flush keyboard buffer.
PRINT : PRINT "Press any key to continue (ESC to abort program)."
```

DO: I\$ = INKEY\$: LOOP WHILE I\$ = ""

```
IF I$ = CHR$(27) THEN GOTO EndProg      ' Abort if ESC is pressed.
RETURN
'
CalEnd:                                   ' Check for cal step completion.
DO: PRINT #1, "SRQ?"                    ' Request SRQ status.
      INPUT #2, S                        ' Input SRQ status byte.
LOOP UNTIL S                            ' Wait for operation complete.
PRINT #1, "OUTPUT 16;*ESR?"            ' Clear OPC.
PRINT #1, "ENTER 16"
INPUT #2, S
PRINT #1, "SPOLL 16"                    ' Clear SRQ.
INPUT #2, S
RETURN
'
ErrCheck:                                 ' Error check routine.
PRINT #1, "OUTPUT 16;;SYST:ERR?"
PRINT #1, "ENTER 16"
INPUT #2, E, Err$
IF E<> 0 THEN PRINT Err$: GOTO EndProg
RETURN
'
ReadDMM:                                  ' Get reading from DMM.
SLEEP 5
PRINT #1, "OUTPUT 17;;FETCH?"
PRINT #1, "ENTER 17"
INPUT #2, Reading$
IF I = 5 OR I = 6 THEN Reading$ = STR$ (VAL(Reading$) / FourOhm)
IF I = 8 THEN Reading$ = STR$ (VAL(Reading$) / FourK)
RETURN
'
EndProg:                                  ' Close files, end program.
BEEP: PRINT "Calibration aborted."
PRINT #1, "OUTPUT 16;;CAL:PROT:LOCK"
PRINT #1, "LOCAL 16 17"
CLOSE
END
Messages:
DATA "Connect DMM volts input to SOURCE and DVM IN terminals."
DATA "Connect DMM volts input and 4 ohm resistor to SOURCE and SENSE."
DATA "Connect DMM volts input and 4 k ohm resistor to SOURCE and SENSE."
```

---

# Index

:CODE [B-3](#)  
:COUNT? [B-3](#)  
:DATE [B-4](#)  
:INIT [B-4](#)  
:LOCK [B-5](#)  
:SAVE [B-5](#)  
:STEP [B-6](#)

## Numerics

4Ω resistor construction [1-3](#), [2-4](#)  
4kΩ resistor construction [1-4](#), [2-4](#)  
5A range readback accuracy [1-9](#)  
5mA range readback accuracy [1-10](#)

## A

Accuracy calculations [A-4](#)  
Acquiring date and count by remote [2-16](#)

## C

Calibration [2-1](#)  
Calibration considerations [2-3](#)  
Calibration cycle [2-3](#)  
Calibration equipment [C-2](#)  
Calibration Program [C-1](#)  
Calibration Reference [B-1](#)  
Changing the calibration code [2-15](#)  
Changing the code by remote [2-15](#)  
Changing the code from the front panel [2-15](#)  
Command summary [B-2](#)  
Compliance current accuracy [1-8](#)  
Computer hardware requirements [C-2](#)  
Current readback accuracy [1-9](#)

## D

Detecting calibration errors [B-7](#)  
Detecting calibration step completion [B-8](#)  
Digital voltmeter input accuracy [1-12](#), [A-5](#)

## E

Environmental conditions [1-2](#), [2-2](#)  
Error summary [B-7](#)  
Example limits calculation [1-4](#)

## F

Front panel calibration [2-5](#)

## G

General program instructions [C-3](#)  
Generating an SRQ on calibration complete [B-9](#)  
Generating an SRQ on error [B-8](#)

## I

Introduction [1-2](#), [2-2](#), [B-2](#), [C-2](#)

## L

Line power [1-3](#), [2-2](#)

## M

Miscellaneous commands [B-3](#)

## O

Output and compliance accuracy [A-4](#)  
Output voltage accuracy [1-5](#)

## P

Performance Verification [1-1](#)  
Performing the verification test procedures [1-5](#)  
Program C-1 Model 2304A calibration program [C-4](#)

## R

Readback accuracy [A-4](#)  
Reading the error queue [B-7](#)  
Recommended calibration equipment [2-3](#)  
Recommended test equipment [1-3](#)  
Remote calibration [2-11](#)  
Remote calibration commands [2-11](#)  
Remote calibration display [2-12](#)  
Remote calibration procedure [2-12](#)  
Resetting the calibration code [2-16](#)  
Resistor characterization [1-4](#), [2-4](#)  
Resistor construction [1-3](#), [2-4](#)

## S

Setting output values [1-5](#)  
Software requirements [C-2](#)  
Specifications [A-1](#)  
Status byte EAV (Error Available) bit [B-7](#)

## T

Temperature and relative humidity [2-2](#)  
Test considerations [1-5](#)  
Test summary [1-5](#)

---

## U

Using the \*OPC command [B-8](#)

Using the \*OPC? query [B-9](#)

## V

Verification limits [1-4](#)

Verification test requirements [1-2](#)

Viewing calibration date and count [2-16](#)

Viewing date and count from the  
front panel [2-16](#)

Voltage readback accuracy [1-7](#)

## W

Warm-up period [1-2](#), [2-2](#)

---

# Service Form

Model No. \_\_\_\_\_ Serial No. \_\_\_\_\_ Date \_\_\_\_\_

Name and Telephone No. \_\_\_\_\_

Company \_\_\_\_\_

List all control settings, describe problem and check boxes that apply to problem. \_\_\_\_\_

\_\_\_\_\_

Intermittent                       Analog output follows display                       Particular range or function bad; specify \_\_\_\_\_

IEEE failure                       Obvious problem on power-up                       Batteries and fuses are OK

Front panel operational     All ranges or functions are bad                       Checked all cables

Display or output (check one)

Drifts                       Unable to zero                       Unstable

Overload                       Will not read applied input

Calibration only                       Certificate of calibration required                       Data required

(attach any additional sheets as necessary)

Show a block diagram of your measurement including all instruments connected (whether power is turned on or not). Also, describe signal source.

Where is the measurement being performed? (factory, controlled laboratory, out-of-doors, etc.) \_\_\_\_\_

What power line voltage is used? \_\_\_\_\_ Ambient temperature? \_\_\_\_\_ °F

Relative humidity? \_\_\_\_\_ Other? \_\_\_\_\_

Any additional information. (If special modifications have been made by the user, please describe.)

\_\_\_\_\_

Be sure to include your name and phone number on this service form.

Specifications are subject to change without notice.

All Keithley trademarks and trade names are the property of Keithley Instruments, Inc. All other trademarks and trade names are the property of their respective companies.



**Keithley Instruments, Inc.**

28775 Aurora Road • Cleveland, Ohio 44139 • 440-248-0400 • Fax: 440-248-6168  
1-888-KEITHLEY (534-8453) • [www.keithley.com](http://www.keithley.com)

**Sales Offices:**

**BELGIUM:** Bergensesteenweg 709 • B-1600 Sint-Pieters-Leeuw • 02-363 00 40 • Fax: 02/363 00 64  
**CHINA:** Yuan Chen Xin Building, Room 705 • 12 Yumin Road, Dewai, Madian • Beijing 100029 • 8610-6202-2886 • Fax: 8610-6202-2892  
**FINLAND:** Tietäjäsentie 2 • 02130 Espoo • Phone: 09-54 75 08 10 • Fax: 09-25 10 51 00  
**FRANCE:** 3, allée des Garays • 91127 Palaiseau Cédex • 01-64 53 20 20 • Fax: 01-60 11 77 26  
**GERMANY:** Landsberger Strasse 65 • 82110 Germering • 089/84 93 07-40 • Fax: 089/84 93 07-34  
**GREAT BRITAIN:** Unit 2 Commerce Park, Brunel Road • Theale • Berkshire RG7 4AB • 0118 929 7500 • Fax: 0118 929 7519  
**INDIA:** Flat 2B, Willocrissa • 14, Rest House Crescent • Bangalore 560 001 • 91-80-509-1320/21 • Fax: 91-80-509-1322  
**ITALY:** Viale San Gimignano, 38 • 20146 Milano • 02-48 39 16 01 • Fax: 02-48 30 22 74  
**JAPAN:** New Pier Takeshiba North Tower 13F • 11-1, Kaigan 1-chome • Minato-ku, Tokyo 105-0022 • 81-3-5733-7555 • Fax: 81-3-5733-7556  
**KOREA:** FL., URI Building • 2-14 Yangjae-Dong • Seocho-Gu, Seoul 137-130 • 82-2-574-7778 • Fax: 82-2-574-7838  
**NETHERLANDS:** Postbus 559 • 4200 AN Gorinchem • 0183-635333 • Fax: 0183-630821  
**SWEDEN:** c/o Regus Business Centre • Frosundaviks Allé 15, 4tr • 169 70 Solna • 08-509 04 679 • Fax: 08-655 26 10  
**SWITZERLAND:** Kriesbachstrasse 4 • 8600 Dübendorf • 01-821 94 44 • Fax: 01-820 30 81  
**TAIWAN:** 1FL., 85 Po Ai Street • Hsinchu, Taiwan, R.O.C. • 886-3-572-9077 • Fax: 886-3-572-9031