

INSTRUCTION MANUAL

REGULATED DC POWER SUPPLY

PAK - A SERIES

PAK - AM SERIES

APPLICABLE MODELS

PAK6-60A	PAK10-35A	PAK20-18A	PAK35-10A	PAK60-6A
PAK6-120A	PAK10-70A	PAK20-36A	PAK35-20A	PAK60-12A
PAK6-160A	PAK10-100A	PAK20-50A	PAK35-30A	PAK60-18A
PAK6-60AM	PAK10-35AM	PAK20-18AM	PAK35-10AM	PAK60-6AM
PAK6-120AM	PAK10-70AM	PAK20-36AM	PAK35-20AM	PAK60-12AM
PAK6-160AM	PAK10-100AM	PAK20-50AM	PAK35-30AM	PAK60-18AM

KIKUSUI ELECTRONICS CORPORATION

(KIKUSUI PART NO. Z1-750-020)

189.4.5

893363

On Power Supply Source, it is requested to replace the related places in the instruction manual with the following items.

(Please apply the item of \checkmark mark.)

- Power Supply Voltage: to 120 V AC
- Line Fuse: to _____ A
- Power Cable: to 3-core cable (See Fig. 1 for the colors.)

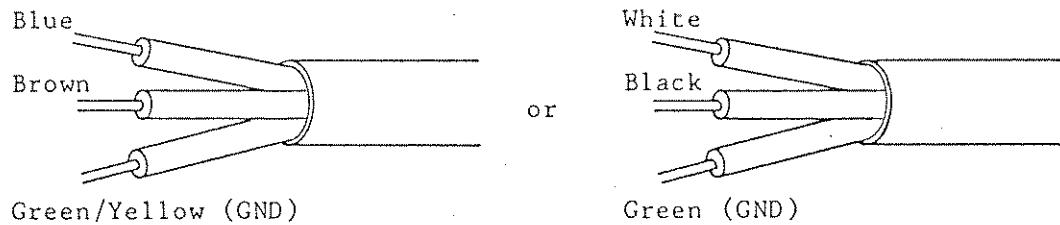
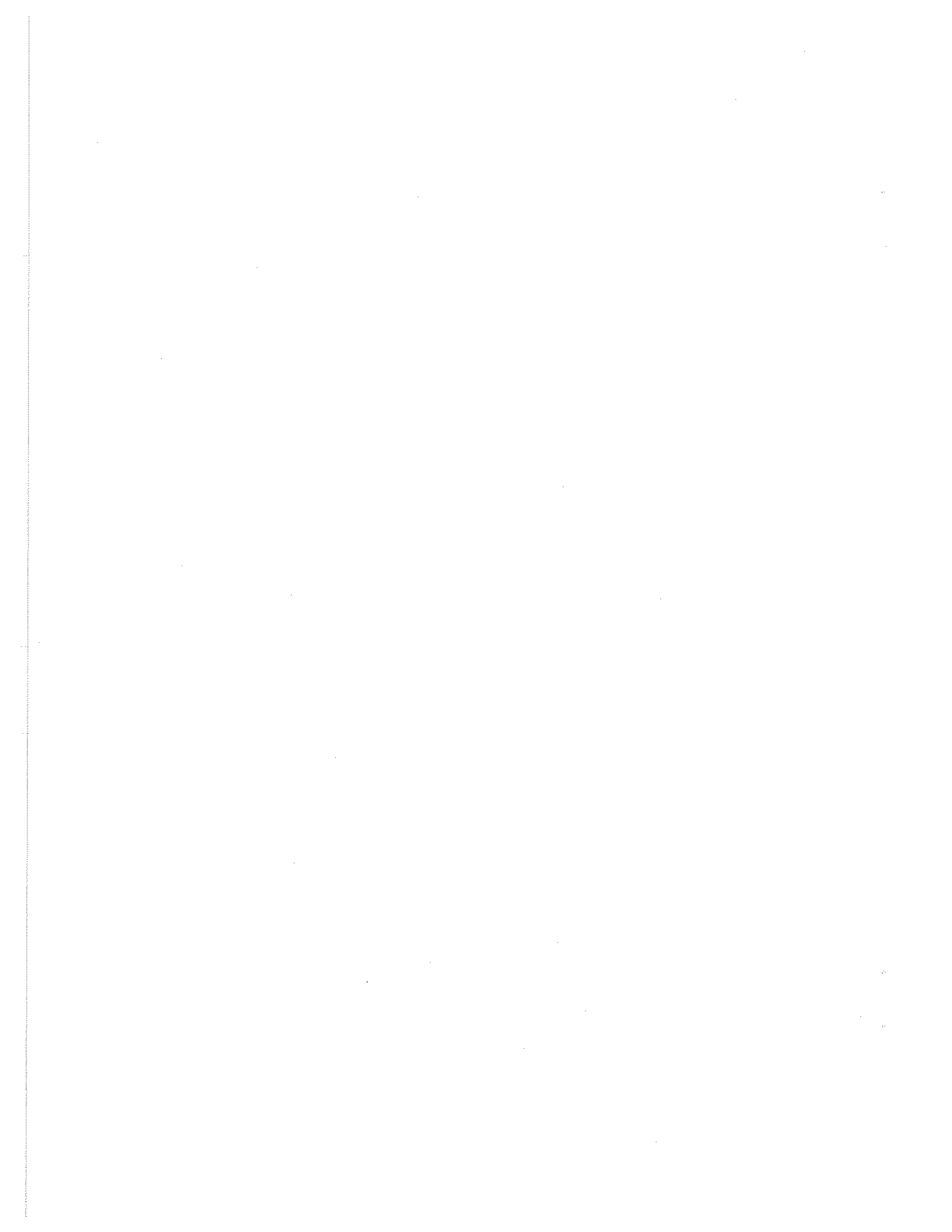

Fig. 1

Please be advised beforehand that the above matter may cause some alteration against explanation or circuit diagram in the instruction manual.

- * AC Plug: In case of Line Voltage 125V AC or more, AC Plug is in principle taken off and delivered, in view of the safety.
(AC Plug on 3-core cable is taken off in regardless of input voltages.)

Before using the instrument, it is requested to fix a suitable plug for the voltage used.



1. GENERAL

1.1 Description

The PAK-A/AM is a high reliability and safty regulated DC power supply for industrial use. It is a switching regulator and provides a high total efficiency, and is extremely compact and light. It is incorporated with various provisions for use as an industrial system component, including a local/remote switchover circuit, remote control signal input circuits, monitor signal output circuits, and protectors.

The advantageous features of the PAK-A/AM Power Supply are as follows:

(1) Compact and light

The sizes and weight of the PAK-A/AM is less than a half to one-third of those of the conventional power supply (those of the corresponding model of Kikusui PAD-L Power Supply).

Thus, the PAK-A/AM can be very advantageously used as a system component. It can be easily handled for maintenace and replacement.

(2) High efficiency

The overall efficiency of the PAK-A/AM is as high as approximately 80%, greatly reducing its Joule loss and increasing its rated output power. When the PAK-A/AM is used as a system component, the overall system cooling provision cost as well as the electicity cost itself will be substantially decreased.

(3) High reliability and safety

The PAK-A/AM has been designed to the highest reliability and safety available based on the full technical assets of Kikusui as a leading manufacturer of measuring instruments and power supplies. The PAK-A/AM is incorporated with protectors against output overvoltage, input overvoltage or overcurrent, and equipment overheat. Trip of any of these protectors will cause the switching drive stop and the input power switch (circuit breaker) turned off.

(4) Provisions for system component

In order to be able to serve as a component of an industrial system, the PAK-A/AM is incorporated with the various features. The PAK-A/AM is available either in a blind type or in an indicating

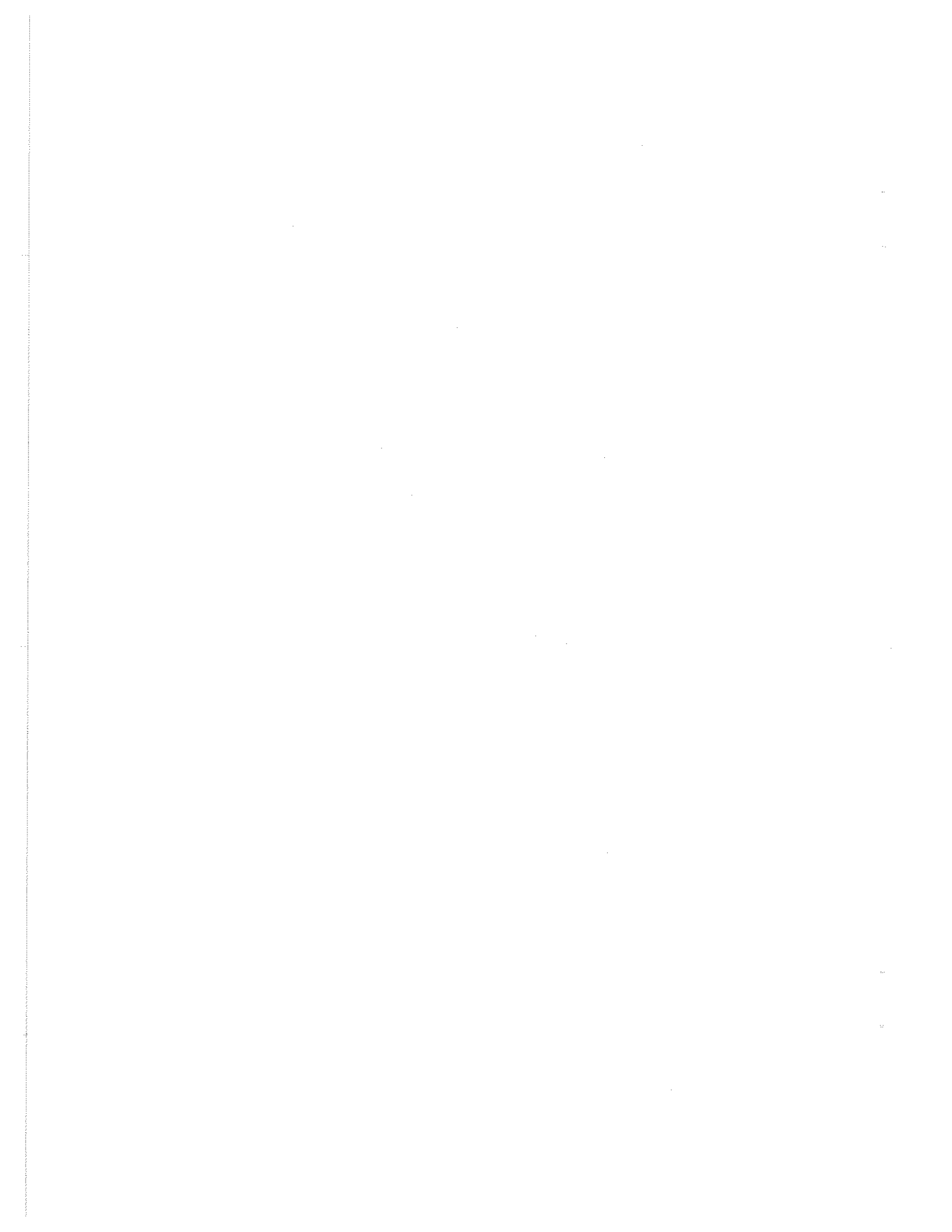

type (with a digital meter). It is incorporated with monitor, status, and control signal output circuits. It is provided with a remote/local selector switch. It employs a front air intake system, to improve the space factor of system components. It can be installed on a rack from the front of the rack.

(5) Fan speed control for low acoustic noise

The revolutionary speed of the cooling fan motor is automatically controlled in proportion to the heat sink temperature. This fan speed control is useful for reducing the thermal stress of power device. Thus, automatically fan speed down when the load is light and/or ambient temperature is low, the PAK-A/AM generates less noise and the air filter is required to be replaced less frequently.

(6) Remote control provisions

In order to be operated as an industrial system component, the PAK-A/AM is incorporated with remote control provisions for continuously-variable control of the output voltage or current with an external voltage or resistance, for on/off control of the output switch with an external contact signal, for turning off of the input power switch, etc.

The indicating model has a digital readout, which operates either as an output voltmeter or ammeter of 3-1/2 digits, as selected with a panel switch. The indicating model has a digital output voltmeter and an ammeter. Both are of 3-1/2 digits.

The PAK-A/AM employs the switching rectification circuit and, therefore, it cannot serve the following types of uses:

- (a) For use at an EMI measuring site or in a shielded room.
- (b) For R & D use which do not tolerate even several millivolts of ripple noise.
- (c) For adjustment of receivers and tuners.

Before starting operating your PAK-A/AM power supply, be sure to read this manual to make you familiar with the PAK-A/AM.

003367

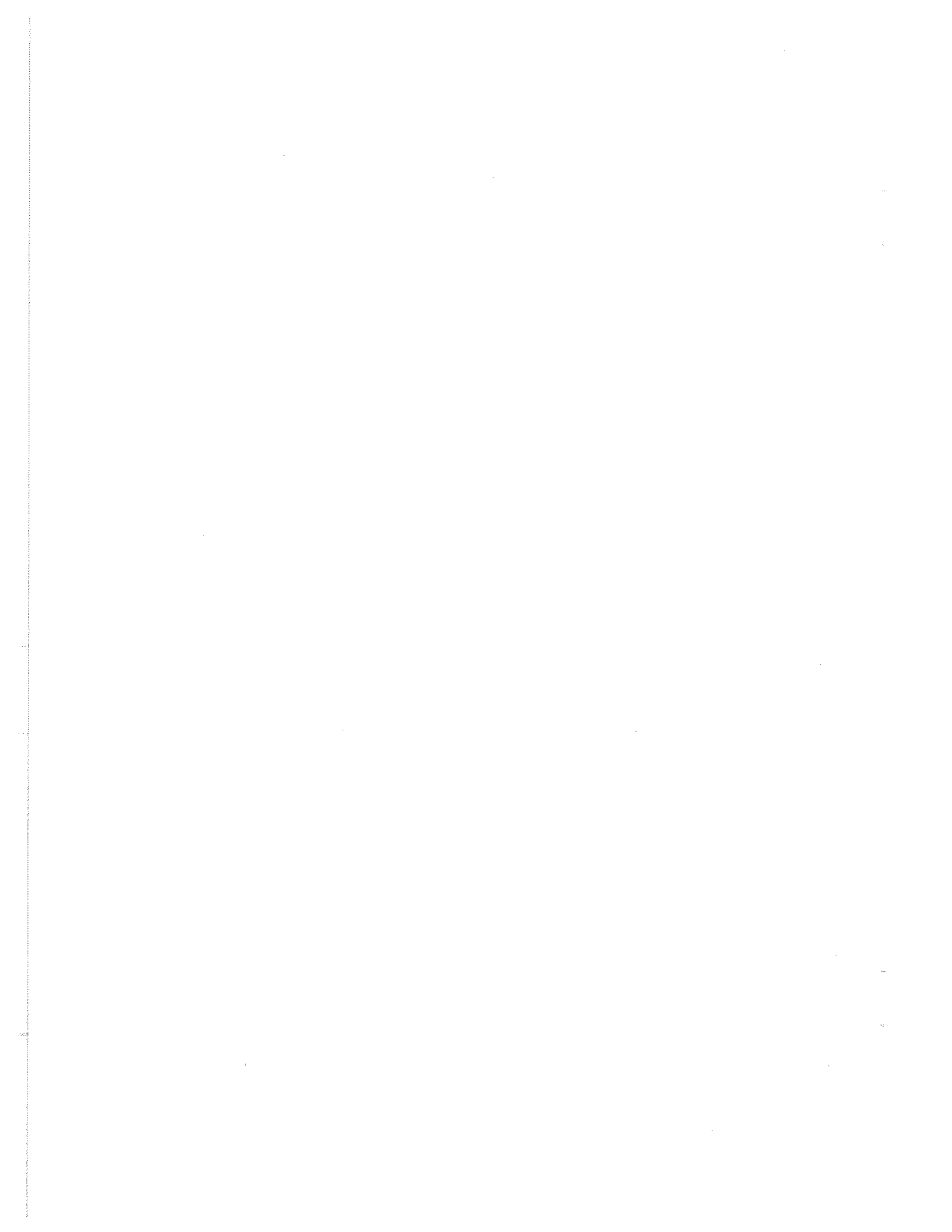

2.2 Input Current vs Output Voltage Characteristics

Input voltage 100V AC 50Hz

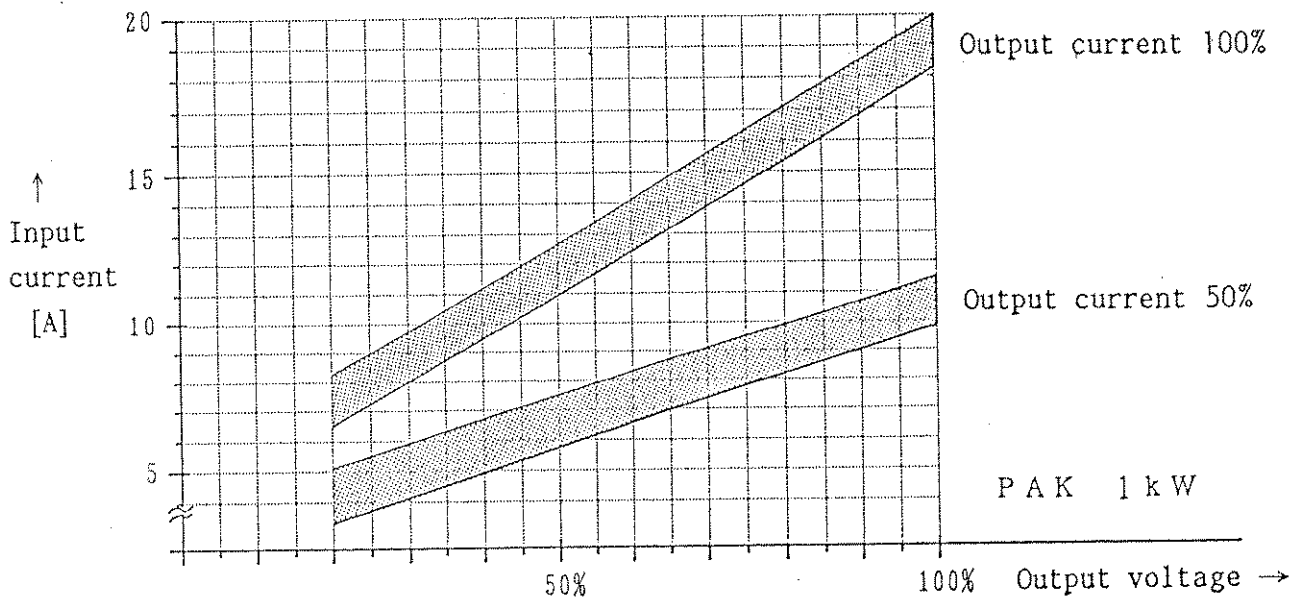
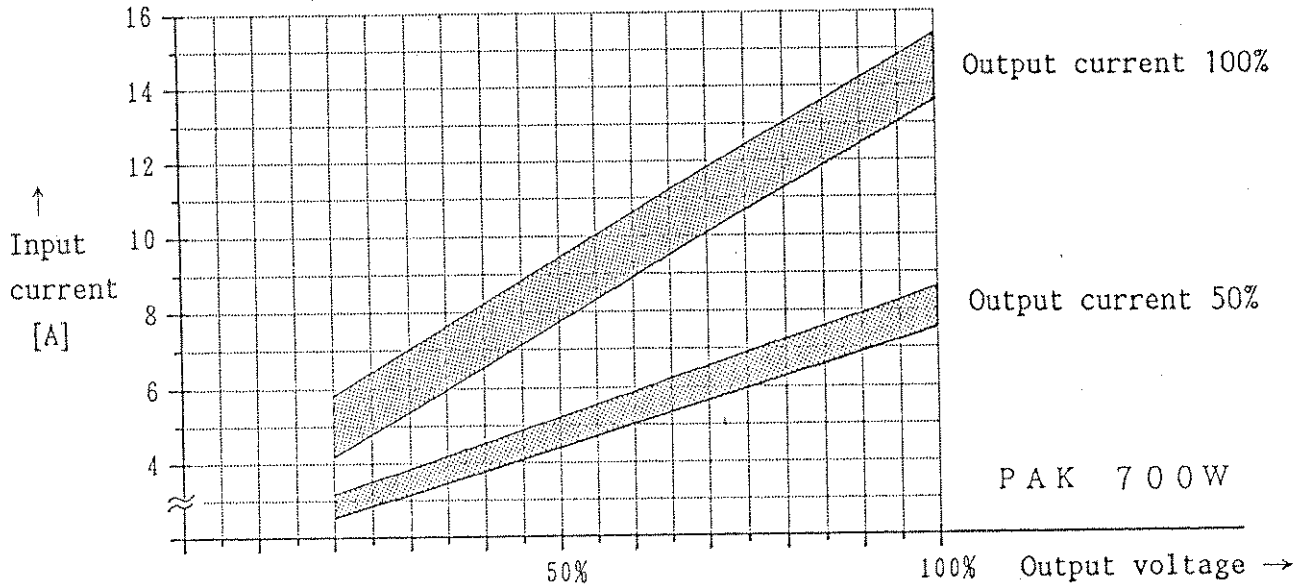
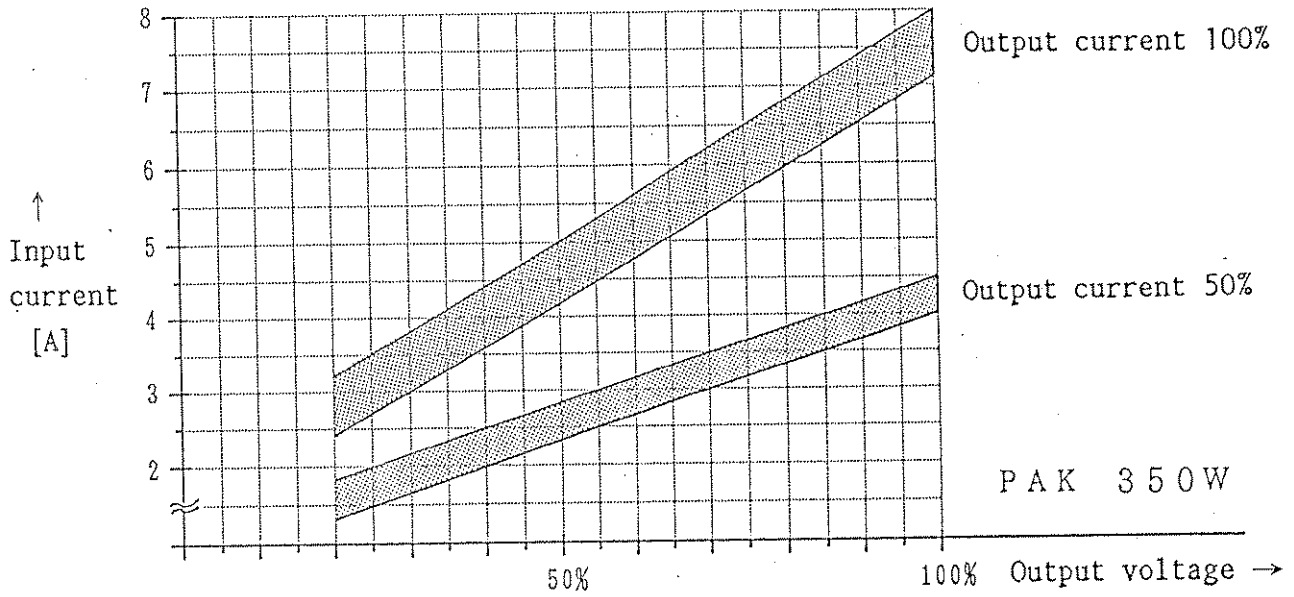

893371

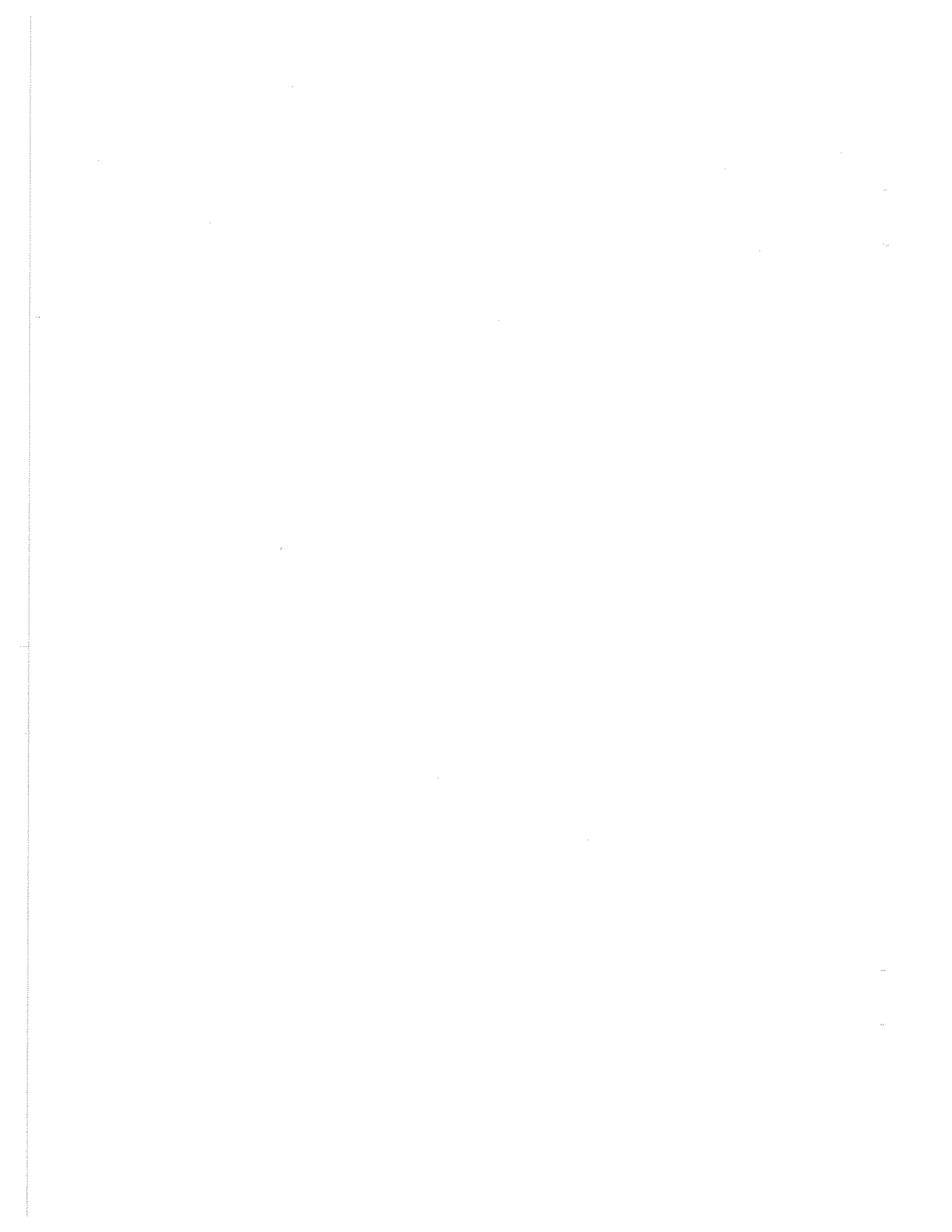

218899

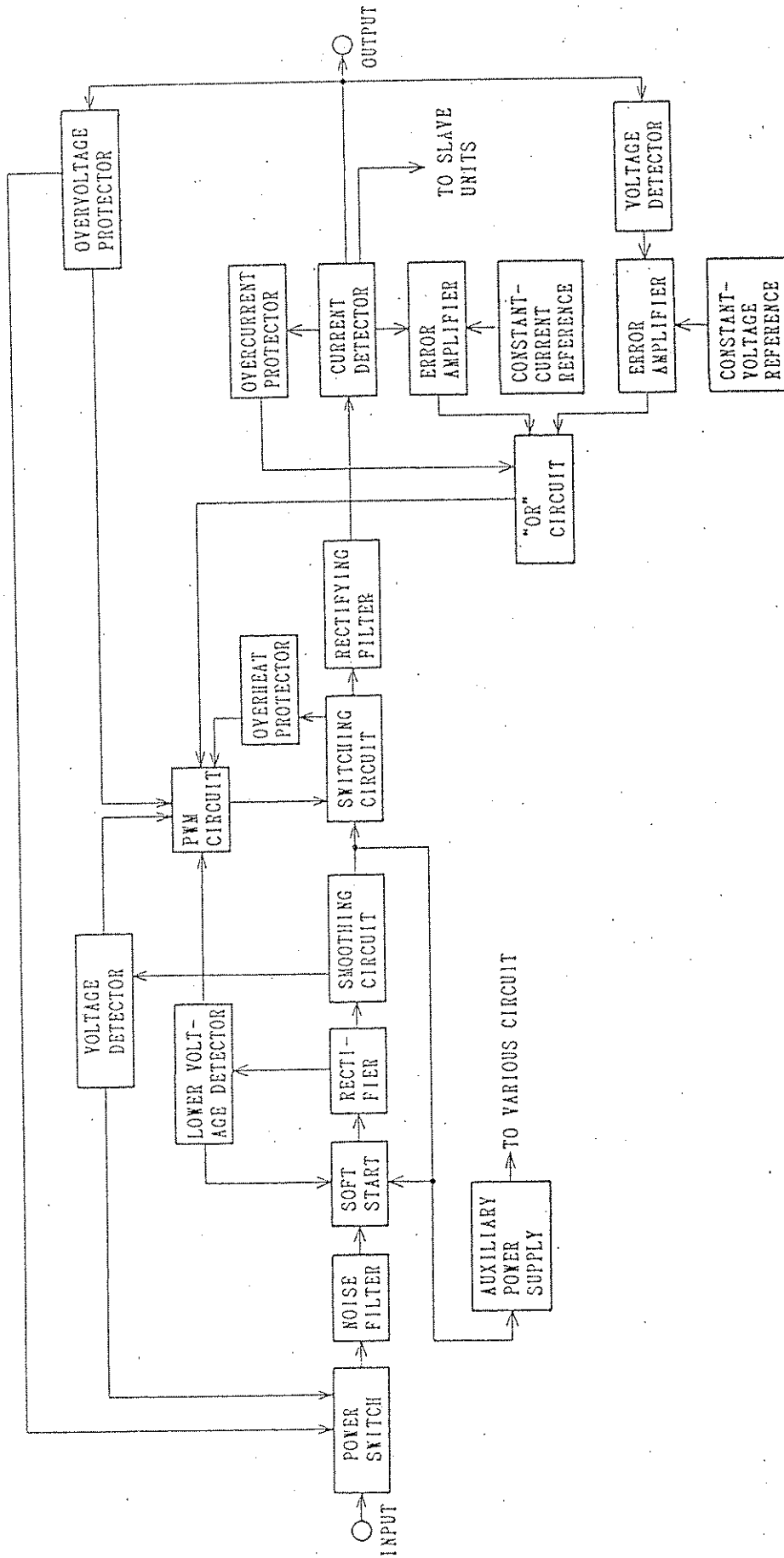

2.3 PAK-A/AM Series Block Diagram

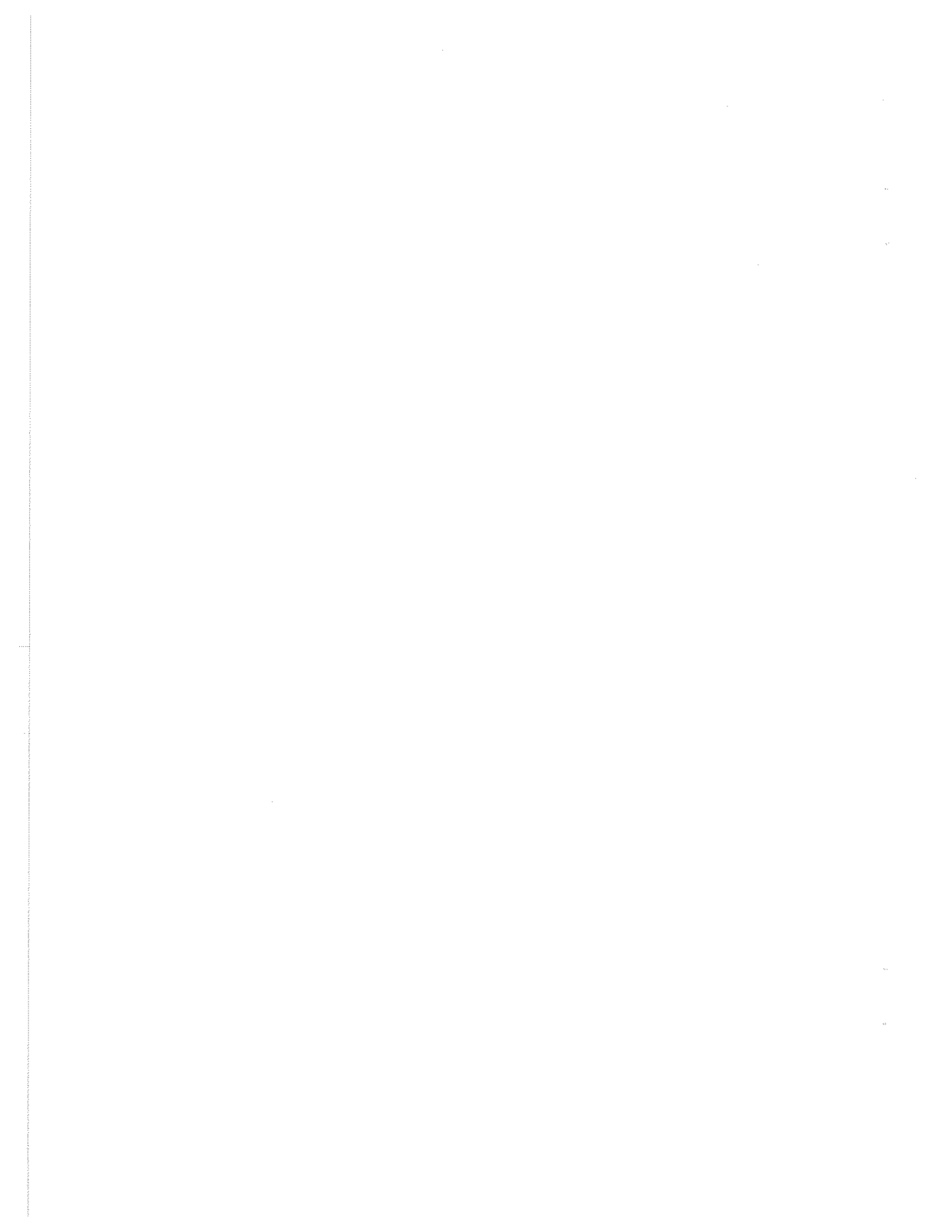

2.4 Mechanical Outline Drawing 1 (Standard type)

(The illustrated ones are those of models with output terminals on the front panel also. The models marked with an asterisk have output terminals on the rear panel only.)

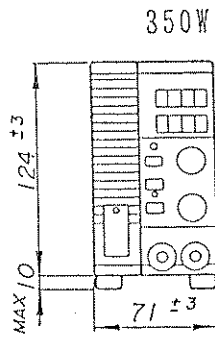

PAK 6-60A *

PAK10-35A *

PAK20-18A

PAK35-10A

PAK60-6A

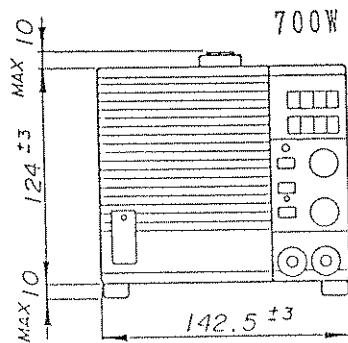
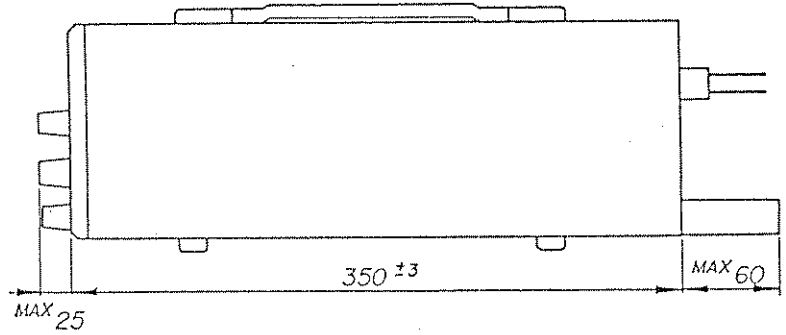

PAK 6-120A *

PAK10-70A *

PAK20-36A *

PAK35-20A

PAK60-12A

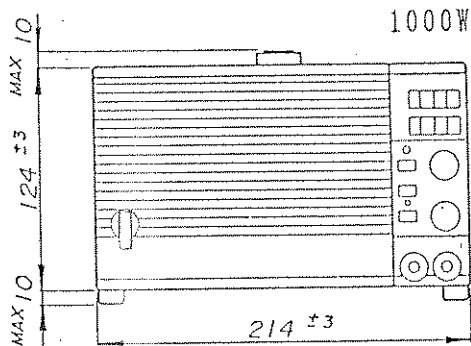

PAK 6-160A *

PAK10-100A *

PAK20-50A *

PAK35-30A

PAK60-18A

Mechanical Outline Drawing 2 (Module type)

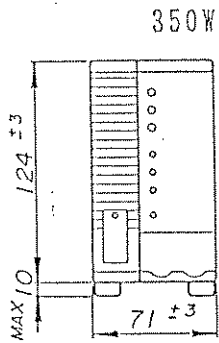

- 350W
- PAK 6-60AM
 - PAK10-35AM
 - PAK20-18AM
 - PAK35-10AM
 - PAK60-6AM

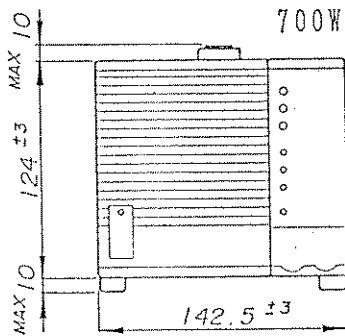
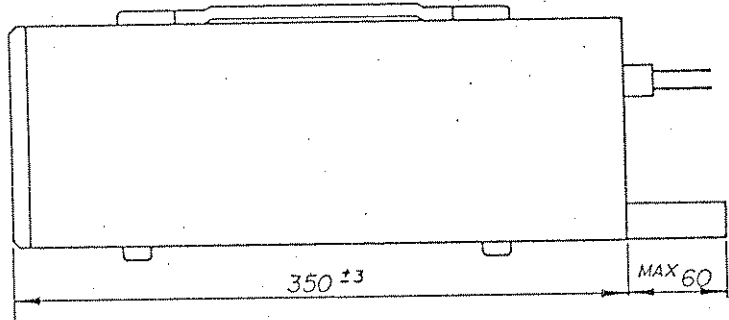

- 700W
- PAK 6-120AM
 - PAK10-70AM
 - PAK20-36AM
 - PAK35-20AM
 - PAK60-12AM

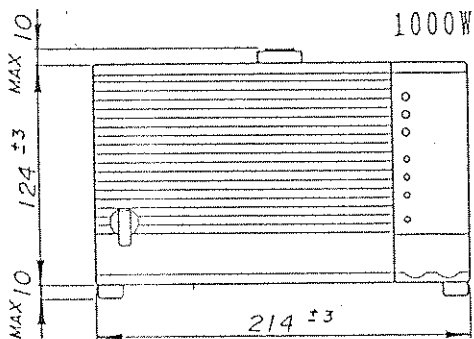

- 1000W
- PAK 6-160AM
 - PAK10-100AM
 - PAK20-50AM
 - PAK35-30AM
 - PAK60-18AM

893374

2.5 Accessories

Name & Parts No.	Description & Notes
Input cable	<ul style="list-style-type: none"> ○ Approx. 2.5 - 3 m long ○ 3-conductor cable <ul style="list-style-type: none"> Green: GND White: LIVE Black: NEUTRAL ○ Accessory cable of 350 W STV, 18 AWG 125 V, 10 A; UL, CCA ○ Plug of 350 W 3P plug + Plug adaptor ○ Cable of 700 W, 1000 W VCTF, 3.5 SQ ○ Plug of 700 W, 1000 W <p>The ratings of the 2P plug adaptor supplied is 125V AC, 15A. When the power requirements are beyond these (e.g. when the power supply is operated with full load or when converted into nominal 200-V AC system), remove the plug and connect the wires directly and securely (e.g. employing press-connected terminals) to an AC line source.</p> <p>Note: ○ Be sure to connect the GND terminal to an earth line. ○ Be sure to fix the terminal cover with the screws.</p>

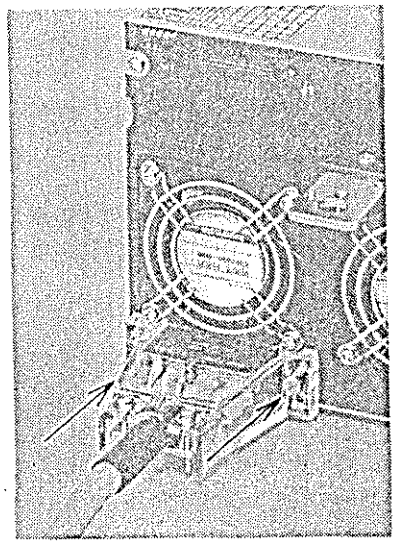
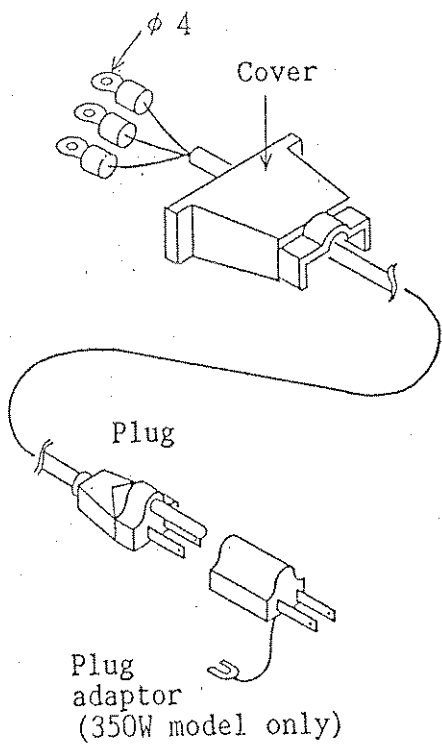

393375

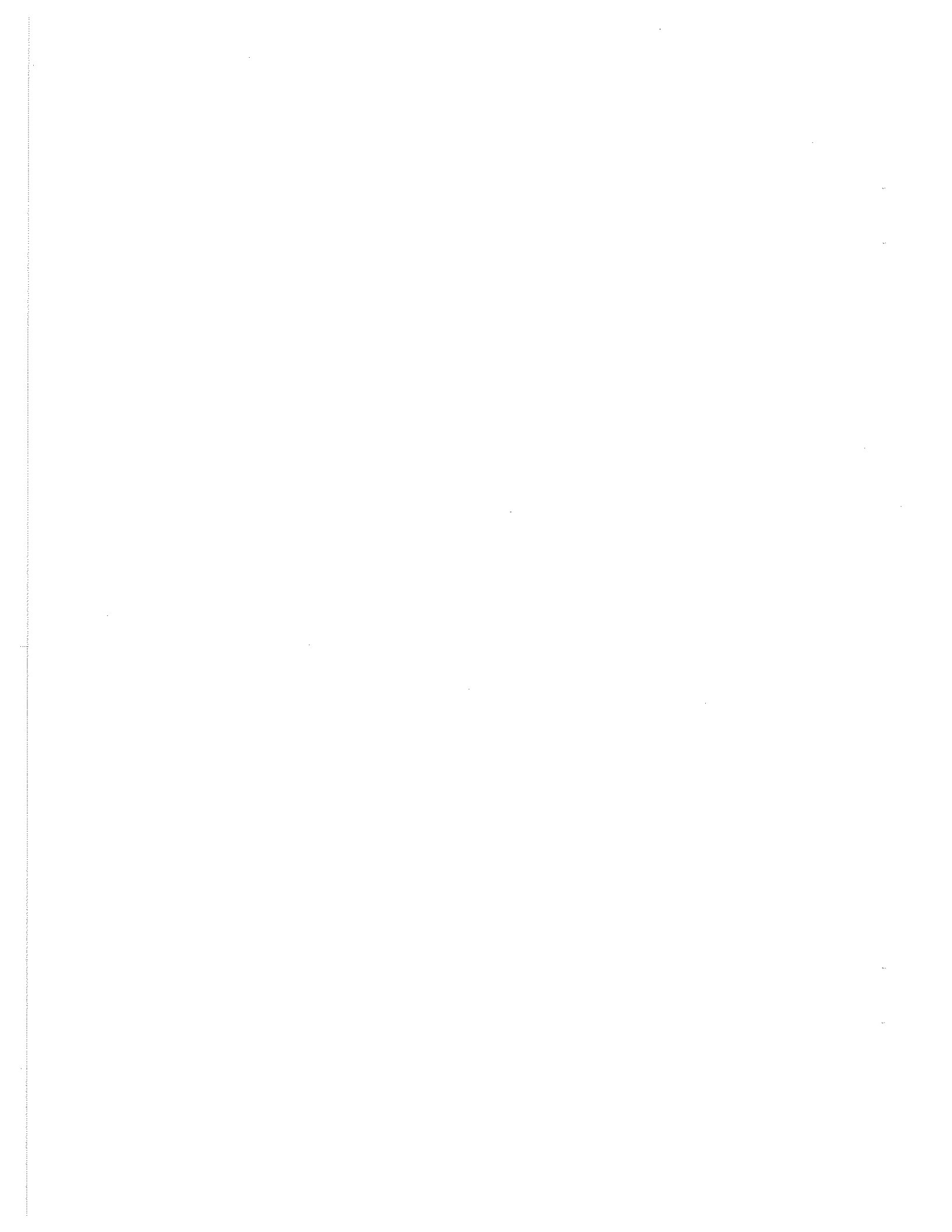

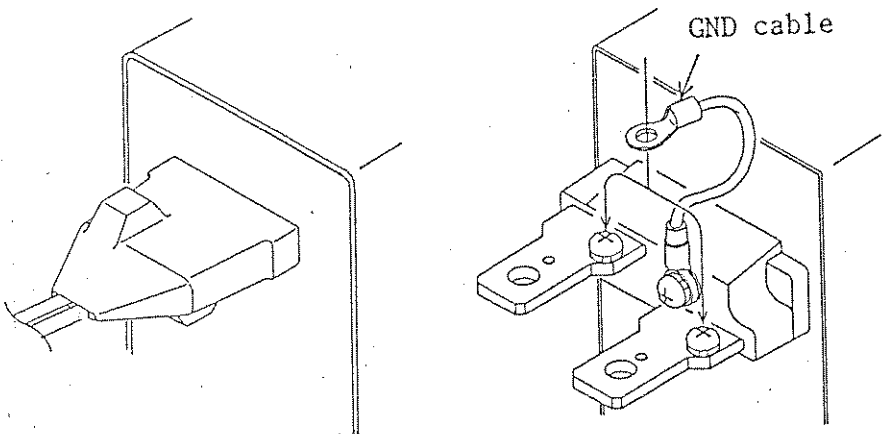
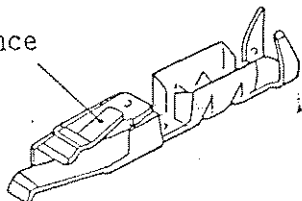
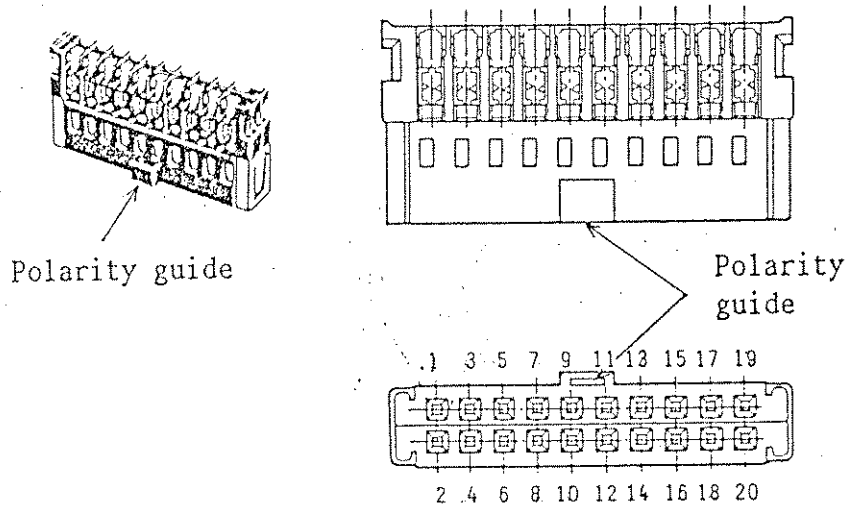
Name & Parts No.	Description & Notes
OUTPUT terminal cover. GND cable	Fix the cover as shown in the figure. 
XG5W-0031 Terminal	 <ul style="list-style-type: none"> ○ Applicable wire gauge AWG 24 (UL-1061) ○ Wires may be connected by soldering when the equipment is used for a temporary purpose (such as for laboratory use). <p>When a high reliability is needed, it is most recommendable to connect the wires using the solderless connecting tool (press type connecting tool) which is available as an optional item.</p> <ul style="list-style-type: none"> ○ Terminal remover (optional) The terminals can be pulled out conveniently by using the terminal remover.
XG5M-T2016 Socket	 <p>Polarity guide</p> <p>Polarity guide</p> <p>1 3 5 7 9 11 13 15 17 19 2 4 6 8 10 12 14 16 18 20</p>

893376

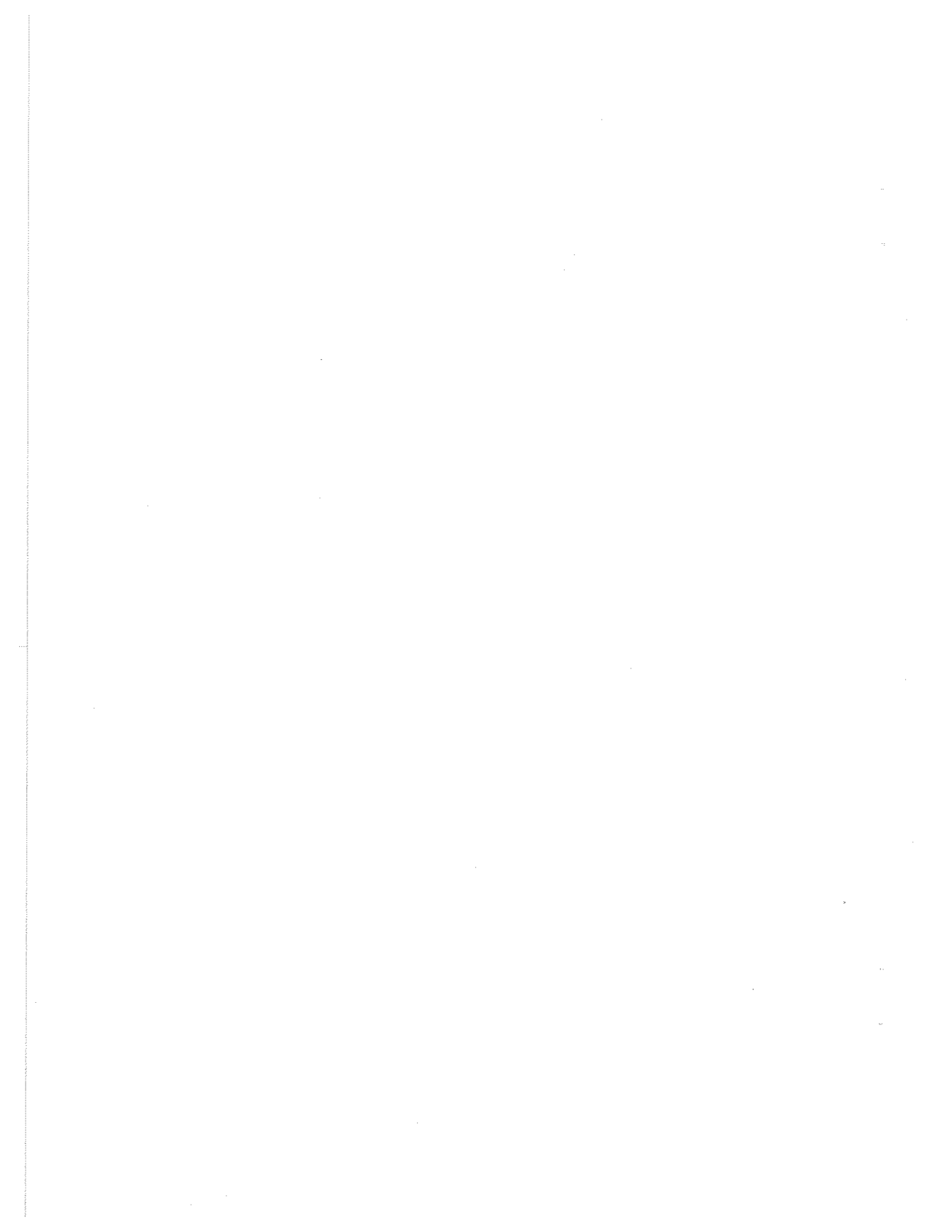

Name & Parts No.	Description & Notes
XG5S-2012 Food cover	<p data-bbox="500 233 834 268">Fixing the hood cover</p> <div data-bbox="581 323 1458 1142"> </div> <p data-bbox="516 1213 1393 1249">To fix the hood cover (split type), proceed as follows:</p> <ol data-bbox="526 1297 1513 1831" style="list-style-type: none"> <li data-bbox="526 1297 1513 1381">(1) Mate the extrusion (A) of one of the halves of hood cover with the indent (B) of the socket. <li data-bbox="526 1436 1513 1520">(2) Mate the indent (D) of the above half of hood cover with the extrusion (C) of the other half of hood cover. <li data-bbox="526 1575 1513 1831">(3) Bind the cable with the cable band. When the amount of cables is less and there remains spaces between cables and the band, fill the spaces with packing stuff (e.g. wound the cables with insulative tape) and fix the cables securely with the cable band so that no mechanical force is directly applied to the pins of the socket.

For the optional tools, see the next page.

893377

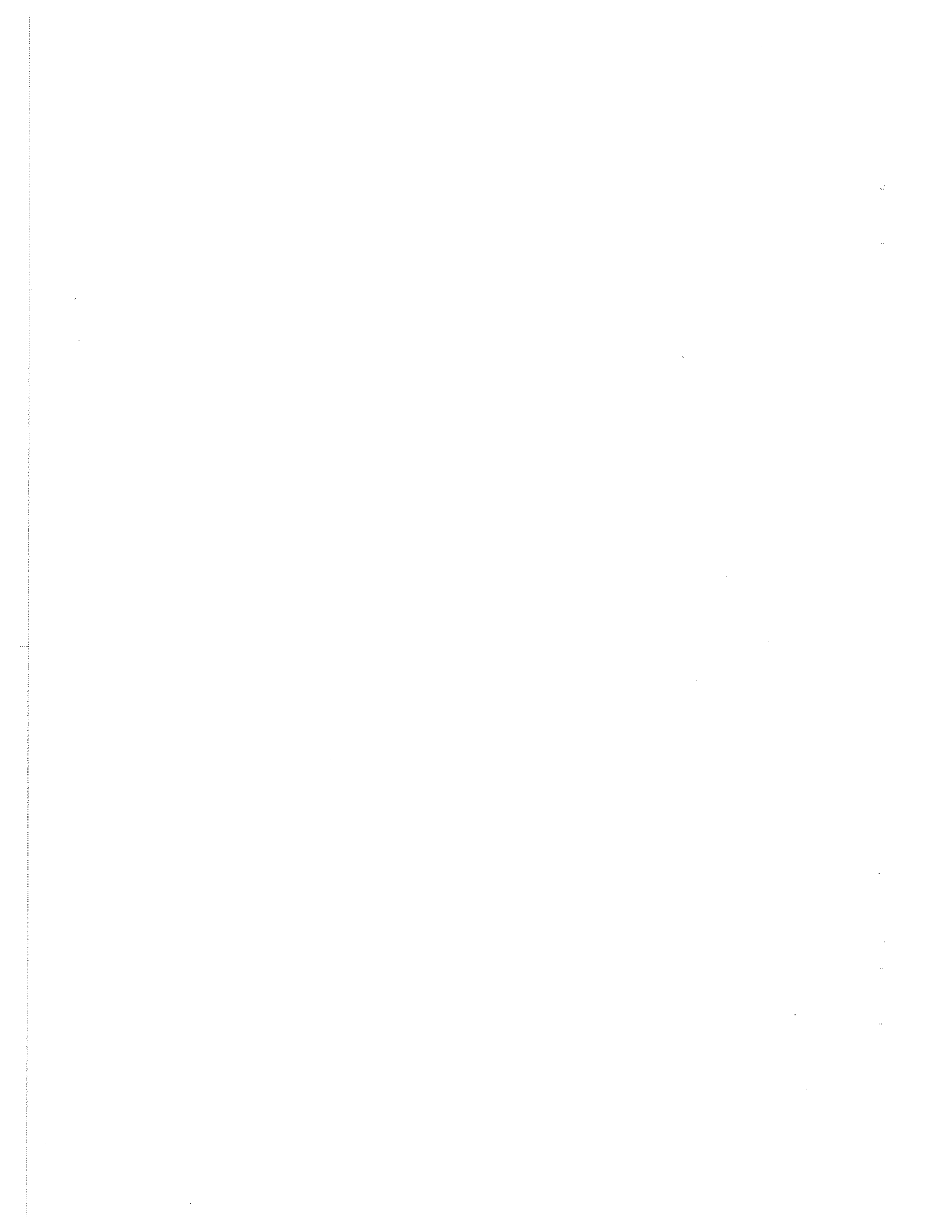

○ Optional Tools (Press-type Terminal Connector and Contact Remover)

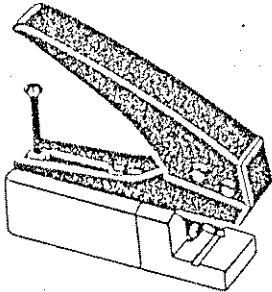
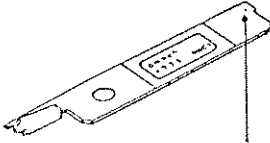
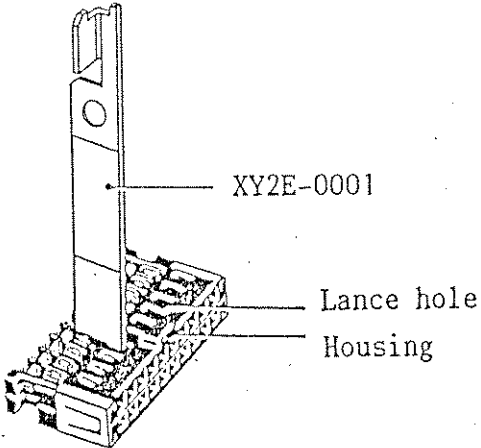
Name & Parts No.	Description & Notes	
<p>XY2B-7006-K</p> <p>Simplified press-type connecting tool</p>		<ul style="list-style-type: none"> ○ For the operation method, refer to the instruction sheet for the tool. ○ Use of the tool is recommendable as it allows secure connections.
<p>XY2E-0001</p> <p>Contact Remover</p>	 <p style="text-align: center;">Lance retainer</p>	<ul style="list-style-type: none"> ○ To use the remover, remove the hood cover.  <p style="text-align: right;">XY2E-0001</p> <p style="text-align: right;">Lance hole</p> <p style="text-align: right;">Housing</p>

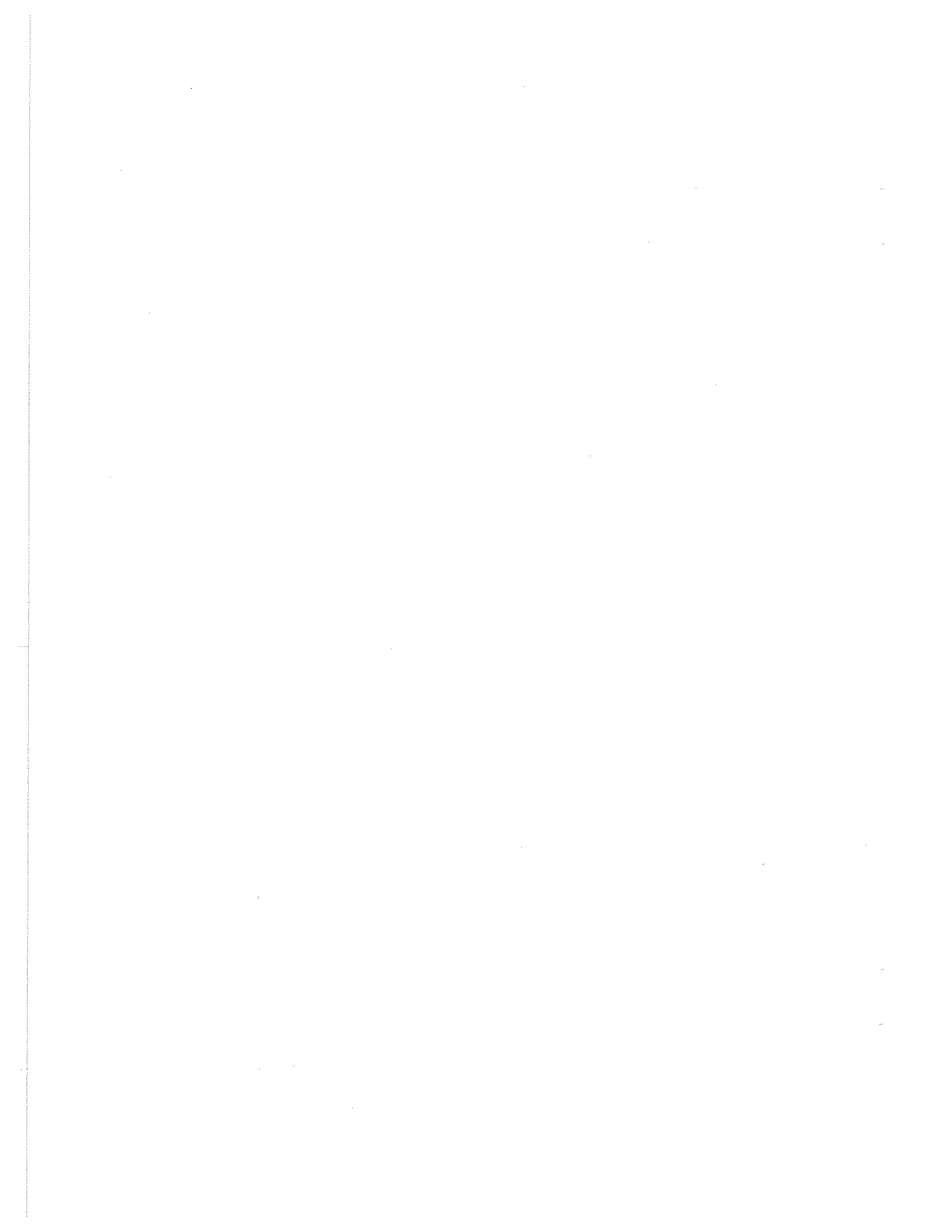

3. OPERATION INSTRUCTIONS

3.1 General Precautions

(1) Unpacking and Repacking

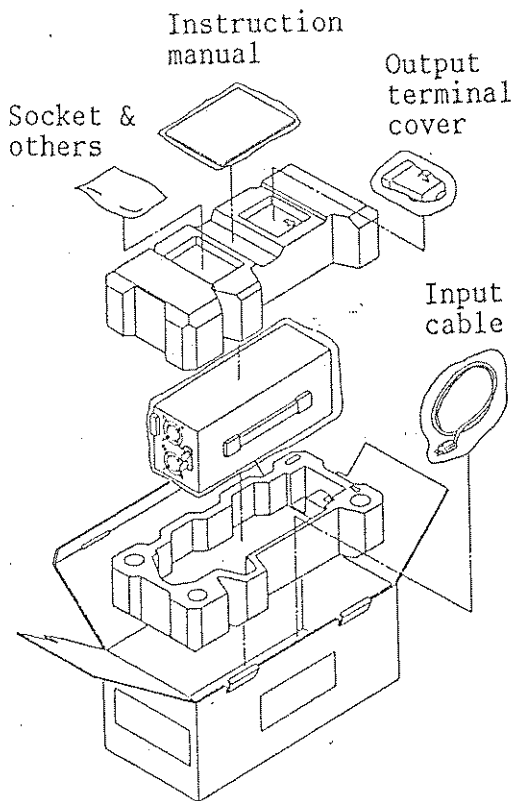

○ When the Power Supply is delivered to you, immediately unpack it and check it for any damage which might have been sustained while in transportation.

○ Check that no accessories are missing. For the accessories which are delivered accompanying the Power Supply, see Section 2.5.

○ For transportation of the Power Supply, be sure to use the dedicated packing materials in which the Power Supply was delivered to you.

○ Before packing the power supply, disconnect the AC cable, load cable, and control signal connector.

○ When no dedicated packing materials are available, consult you Kikusui agent.

(2) AC Input Power

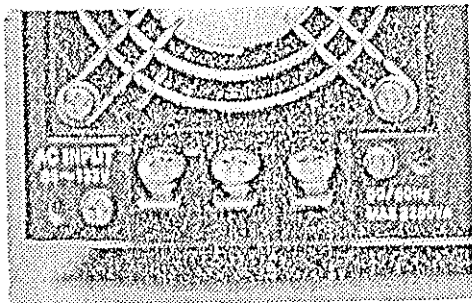

○ Be sure to operate the Power Supply on the correct line voltage. The AC input line voltage range is indicated at the left hand side of the input terminal block.

○ For the AC input power cable, observe the instructions given in Section 2.5.

○ Be sure to connect the GND terminal to an earth line. Also be sure to put back and fix the terminal cover with the screws.

(3) Conditions of Use

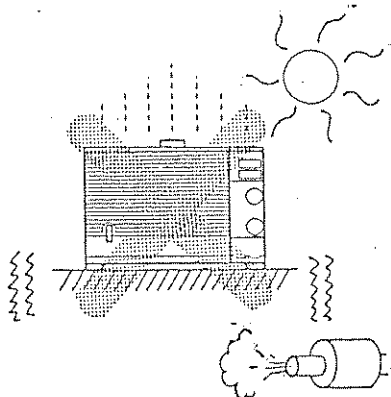

- Pay attention so that the air intake louver is not clogged.
- Pay attention so that the air exit ports are not clogged. Keep a clearance of 30 cm or more at the rear of the Power Supply.
- The place of use of the Power Supply must be reasonably free from heat (direct sunlight), dust, corrosive gas, and mechanical vibration.
- Do not operate high sensitivity devices (e.g. measuring instruments or radio wave receivers) near the power supply.
- Do not put any heavy objects on the power supply.

(4) Ambient Temperature

- The ambient temperature range to meet the performance specifications of the power supply is 0 to 50 °C (32 to 122 °F). If the ambient temperature is outside of this range, the power supply may operate unstably and may be damaged in extreme cases. Note that the semi-conductors and electrolytic capacitors are not resistant against high temperatures (their operating reliabilities and service life expectancies are degraded in general at a rate of to a half per temperature rise of 10 °C (18 °F). Keep the power supply cool.

893330

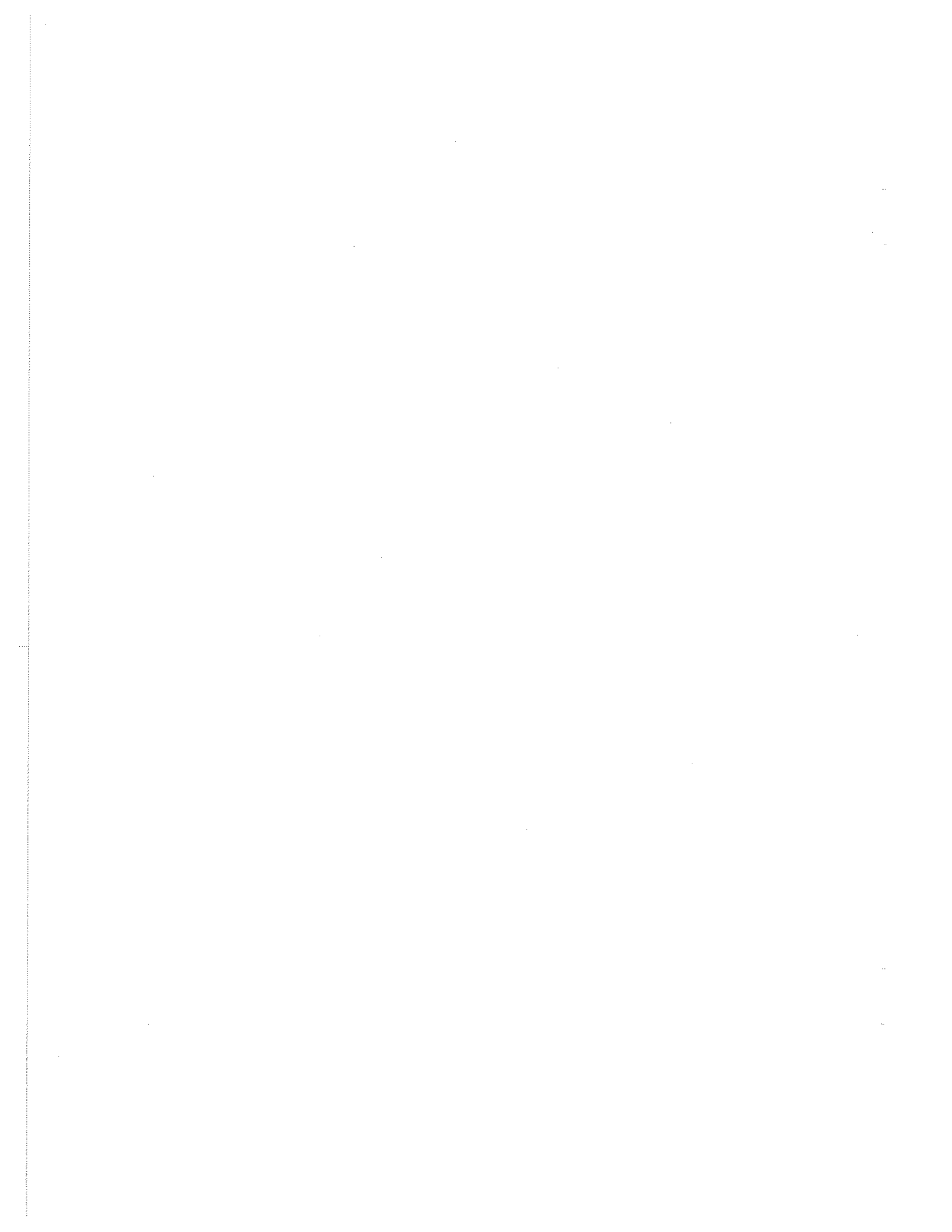

(5) Cleaning of Air Filter

- o Removing the Louver

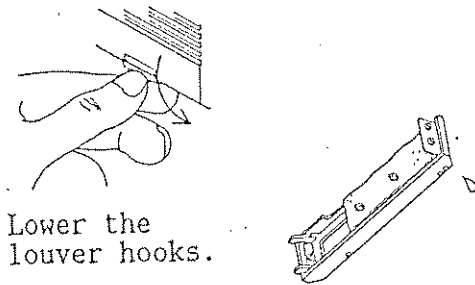

- o Installing the Louver

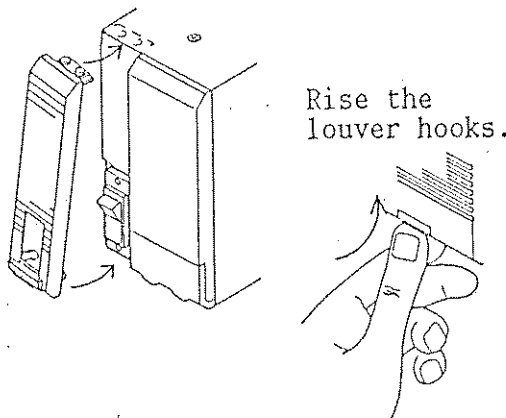

- o If the air filter is clogged, the ventilation air flow will be impeded and equipment temperature may rise and troubles may result. Clean the air filter periodically, sufficiently before they become clogged.

Cleaning the Filter

- o If the filter is dusty, clean it by blowing it with a compressed air (e.g. the exhaust air of a vacuum cleaner).
- o If the filter is badly stained, wash it (together with the louver) with water and then dry it.

(6) Note for Fuse

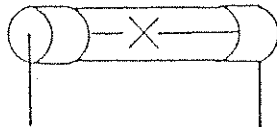

- o When the fuse is blown out, never attempt to replace it for yourself. The blown out fuse means that the internal circuit of the Power Supply has failed. Never attempt to replace the blown out fuse for yourself. Consult your Kikusui agent for repair.

(7) Note for Load

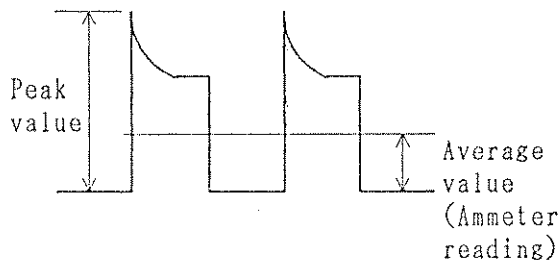

- o Even when the ammeter reading is not greater than the preset limit current, if the load current has peaks higher than the preset limit current, operation of the Power Supply will be driven into the constant-current domain and the output voltage may fall. To avoid this, preset the limit current at a value greater than the peak

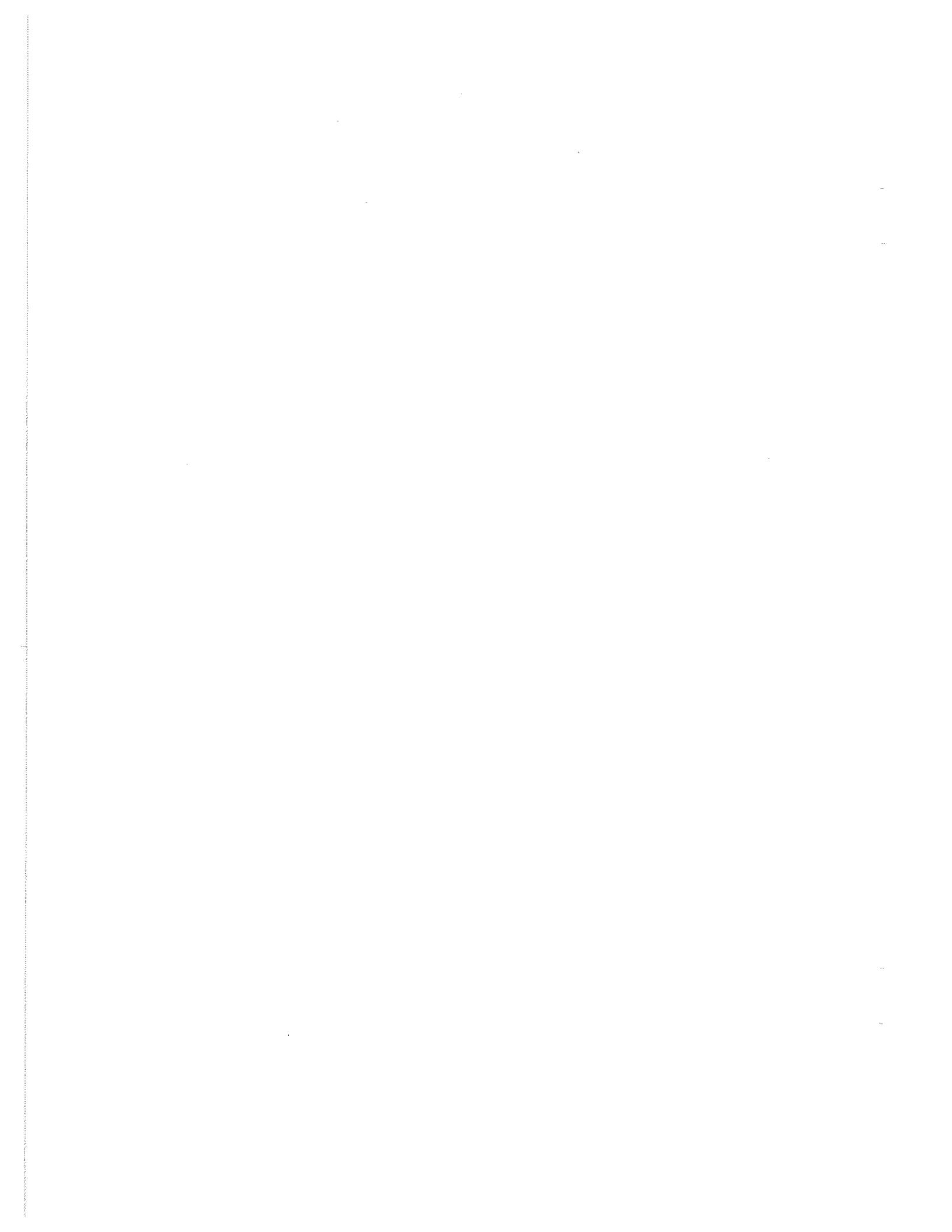

values. For this purpose, a larger output current rating is needed. When the peaks are narrower pulses, however, this purpose can be met simply by connecting a large-capacitance capacitor in parallel to the load.

(8) Regenerative Load

No current flows in the reverse direction.

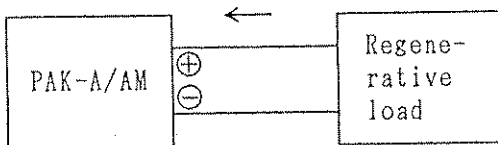

Example of Corrective Setup

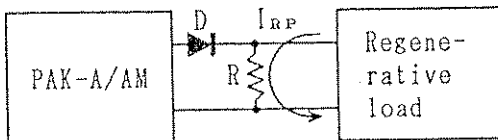

$$R[\Omega] \leq \frac{E_o}{I_{RP}}$$

E_o : Output voltage of Power Supply

I_{RP} : Peak value of reverse current

- The output circuit of the Power Supply can sink no current which could flow from the load to the Power Supply. When the load is a regenerative type, therefore, pay attention so that the regenerative voltage of the load does not exceed the maximum output voltage of the Power Supply.

- As a corrective measure (to ensure that no voltage higher than the rated output voltage of the power supply is fed to its output circuit), connect a resistor in parallel to the load or connect a diode in series to the output circuit of the power supply.

- When I_{RP} is of a narrower pulse waveform, the state may be corrected simply by connecting a large-capacitance capacitor in parallel to the load.

3.2 Layouts and Functions of Panel Items

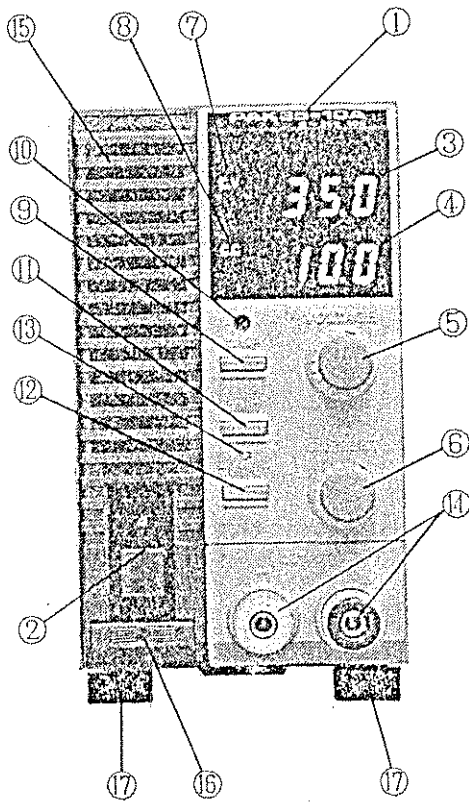

Front view (350 W)

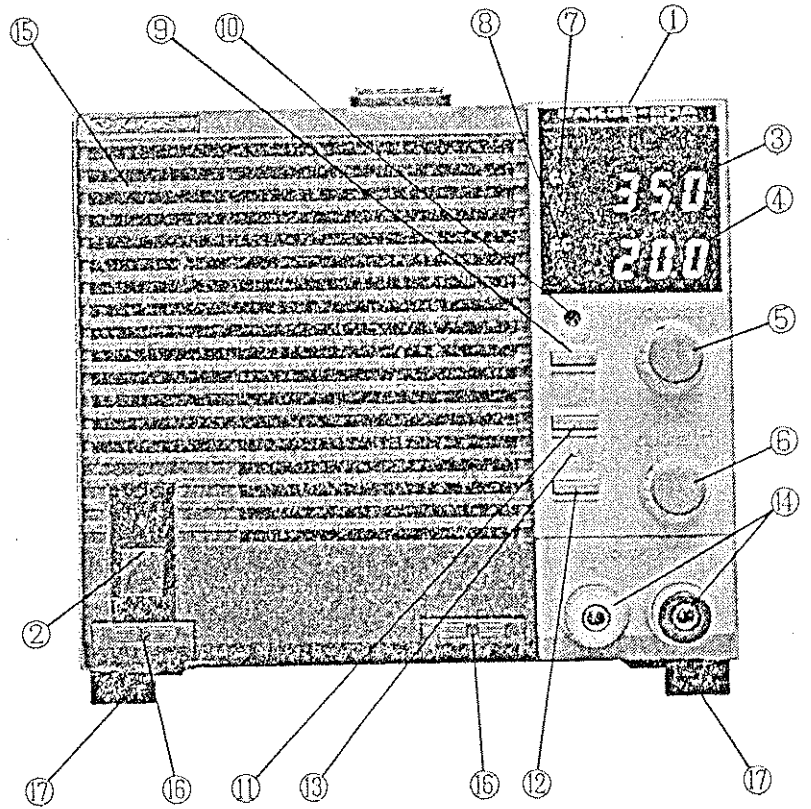

Front view (700 W)

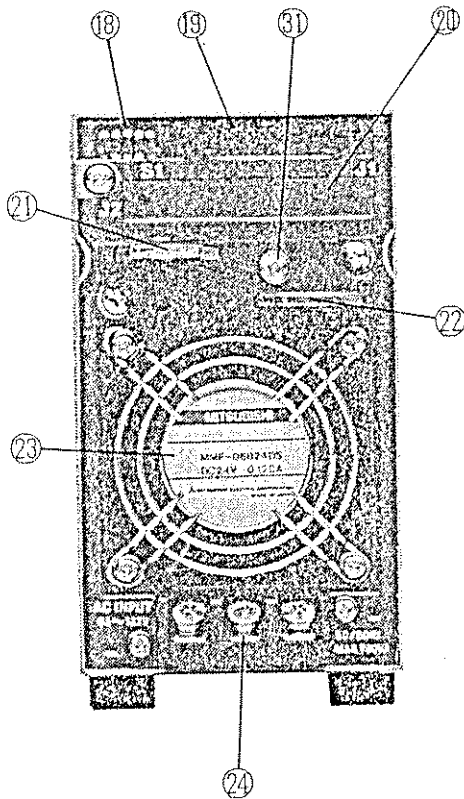

Rear view (350 W)

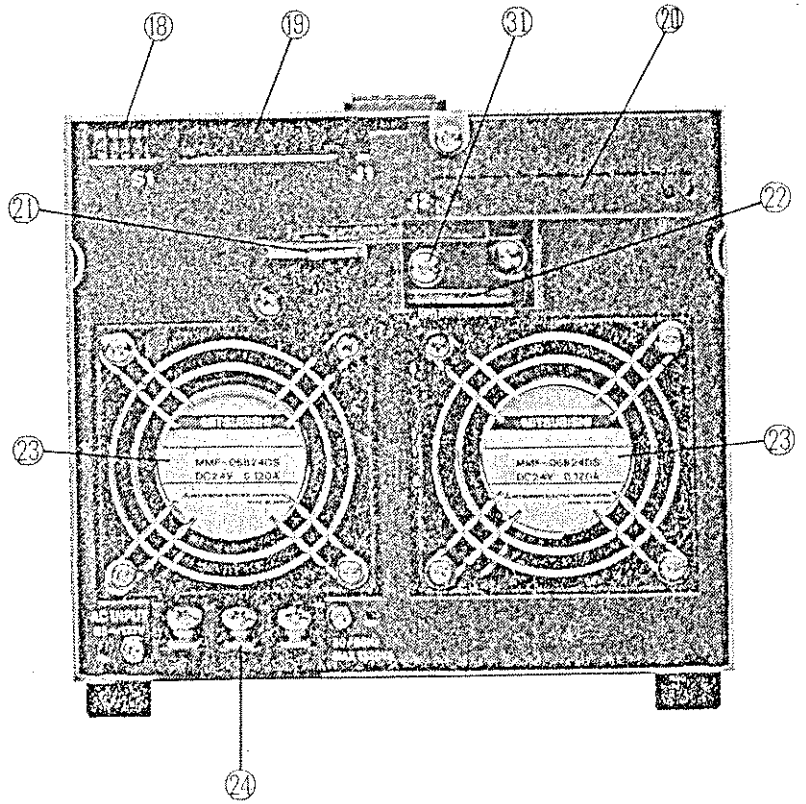

Rear view (700 W)

883333

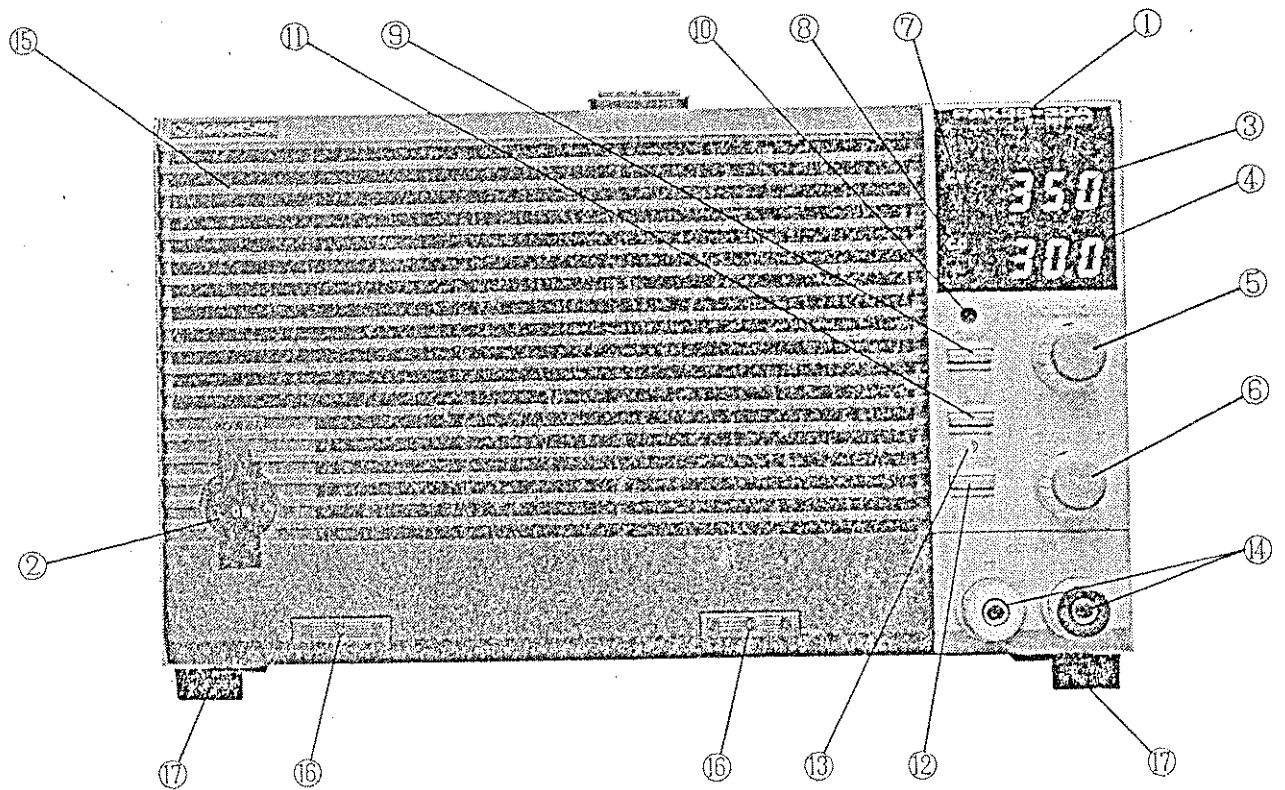

Front view (1000 W)

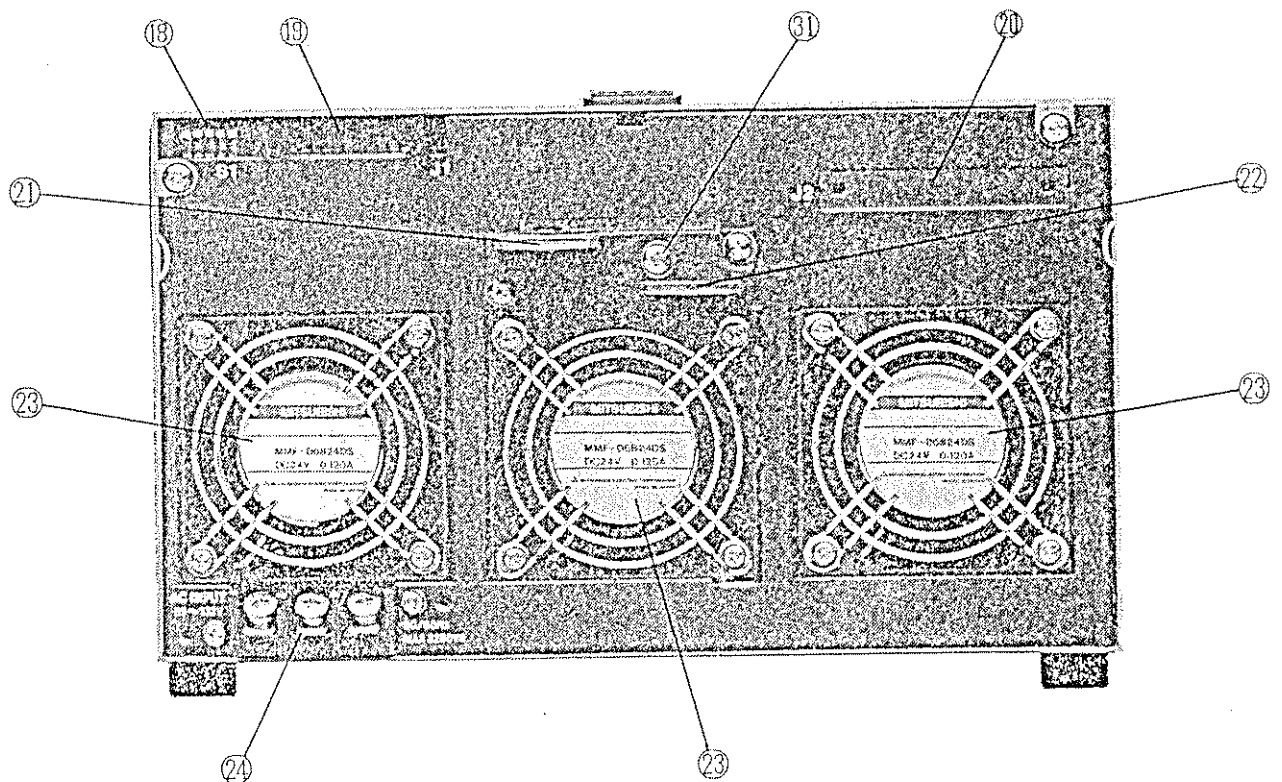

Rear view (1000 W)

633384

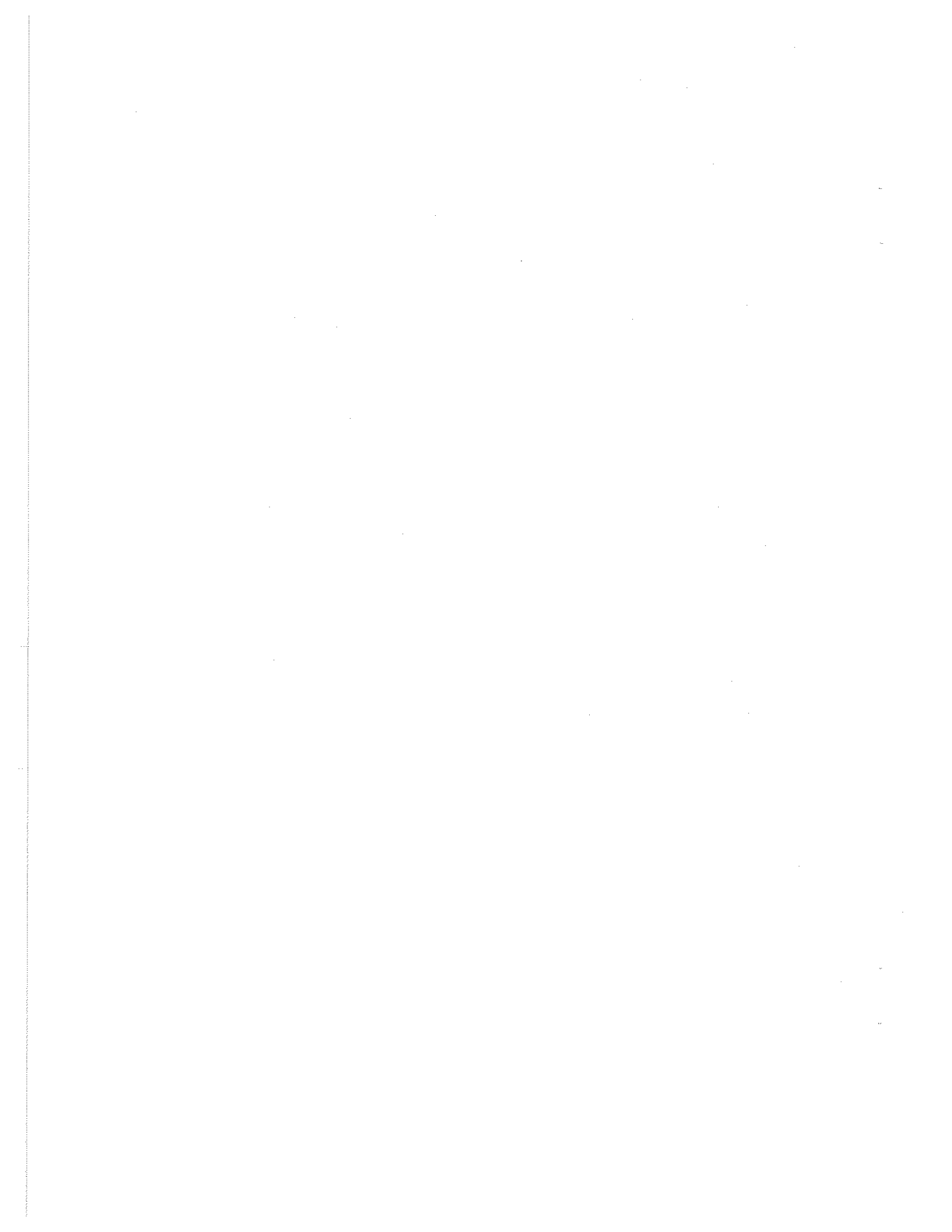

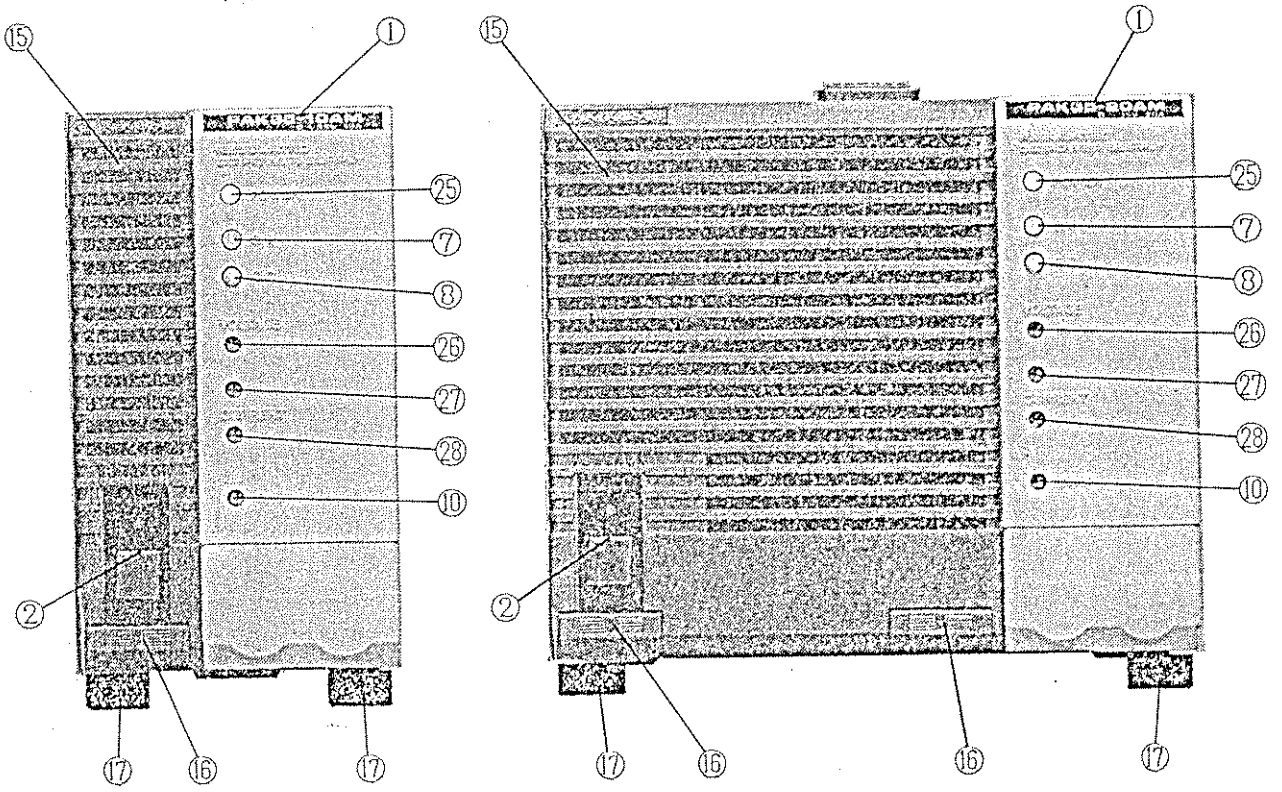

(350 W) Front view of Module Type (700 W)

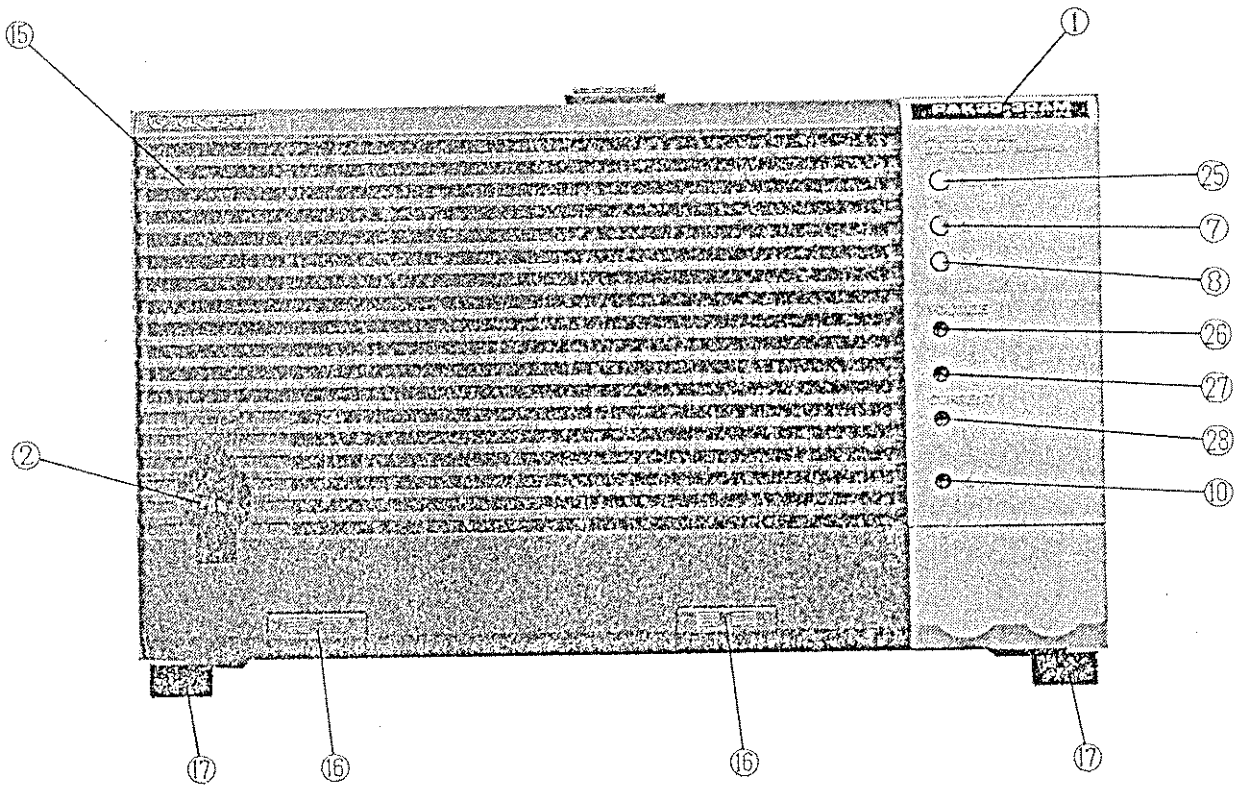

Front view of Module Type (1000 W)

893385

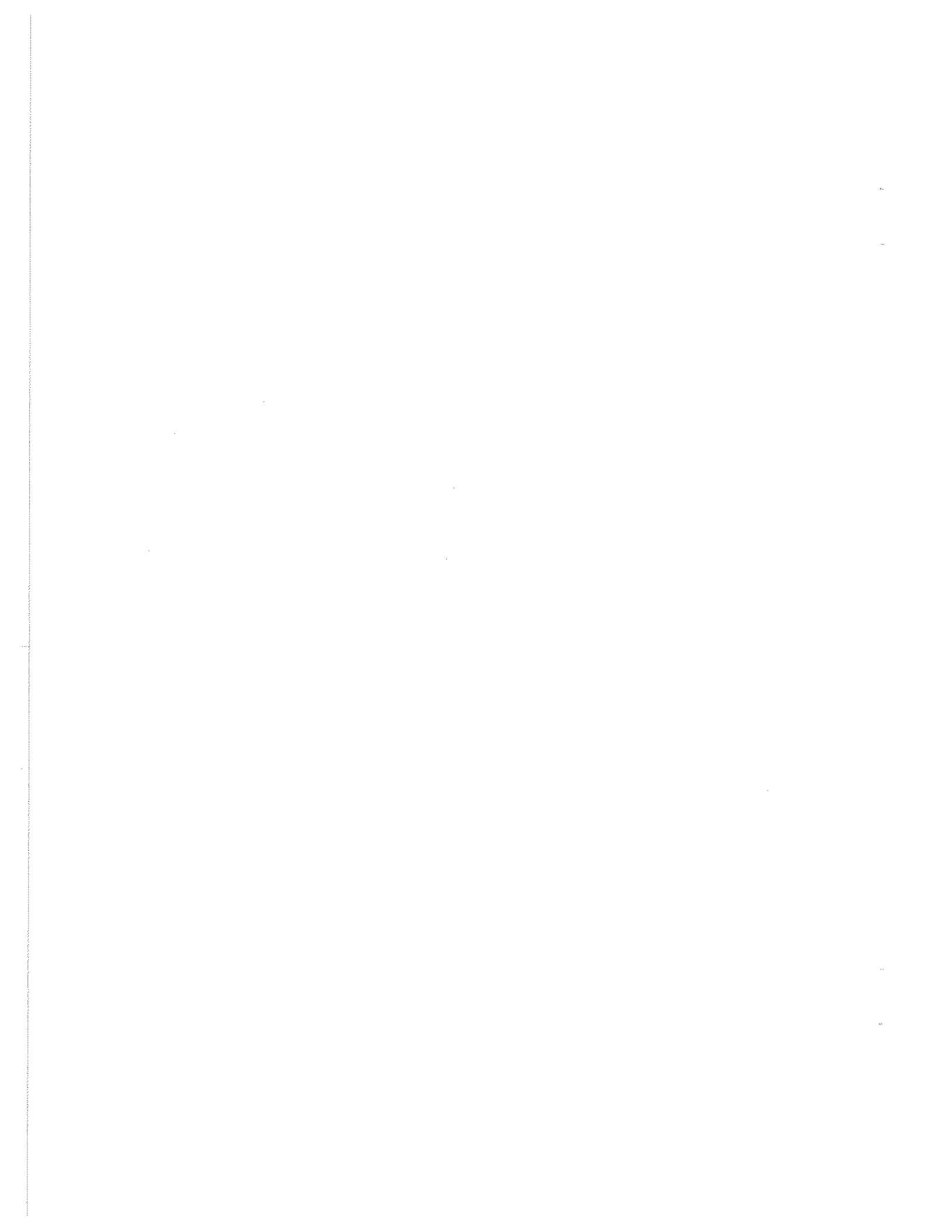

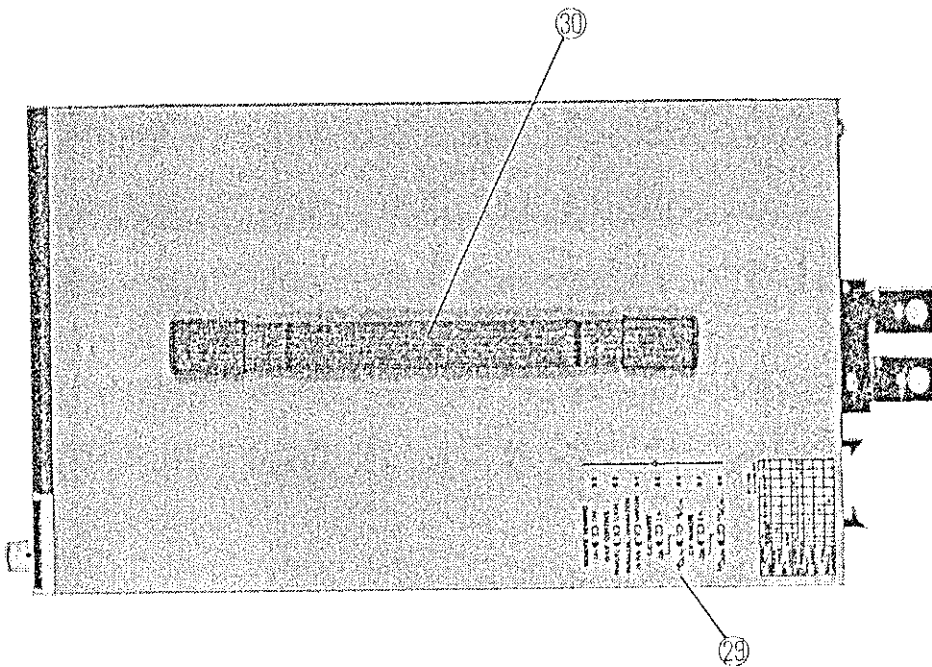
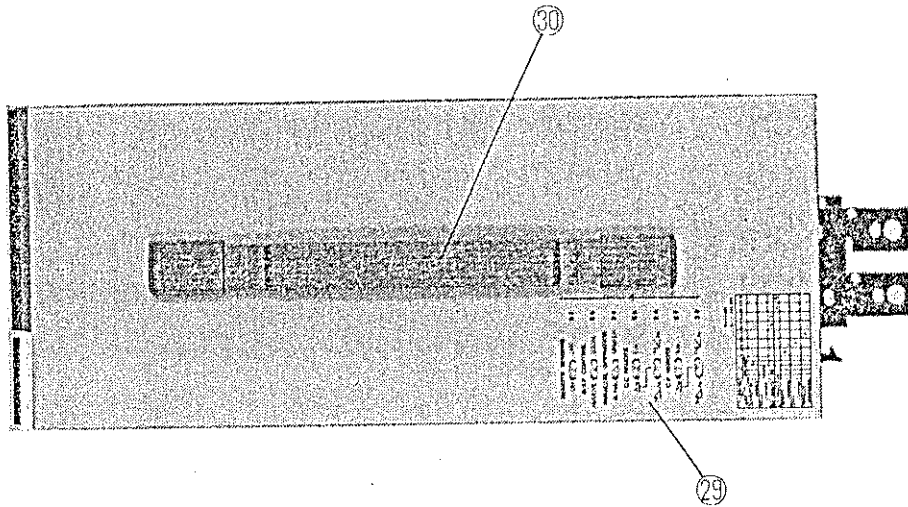
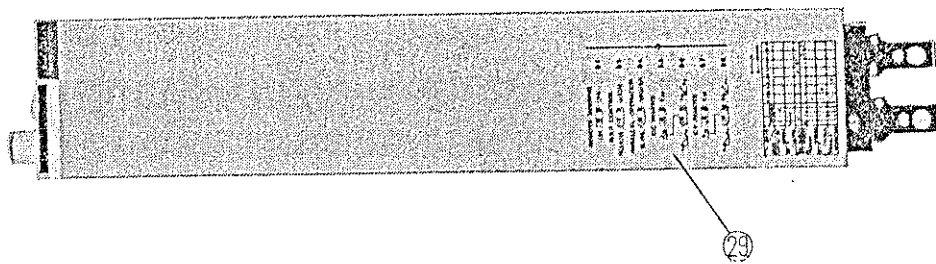

Top view (350 W, 700 W, 1000 W)

893388

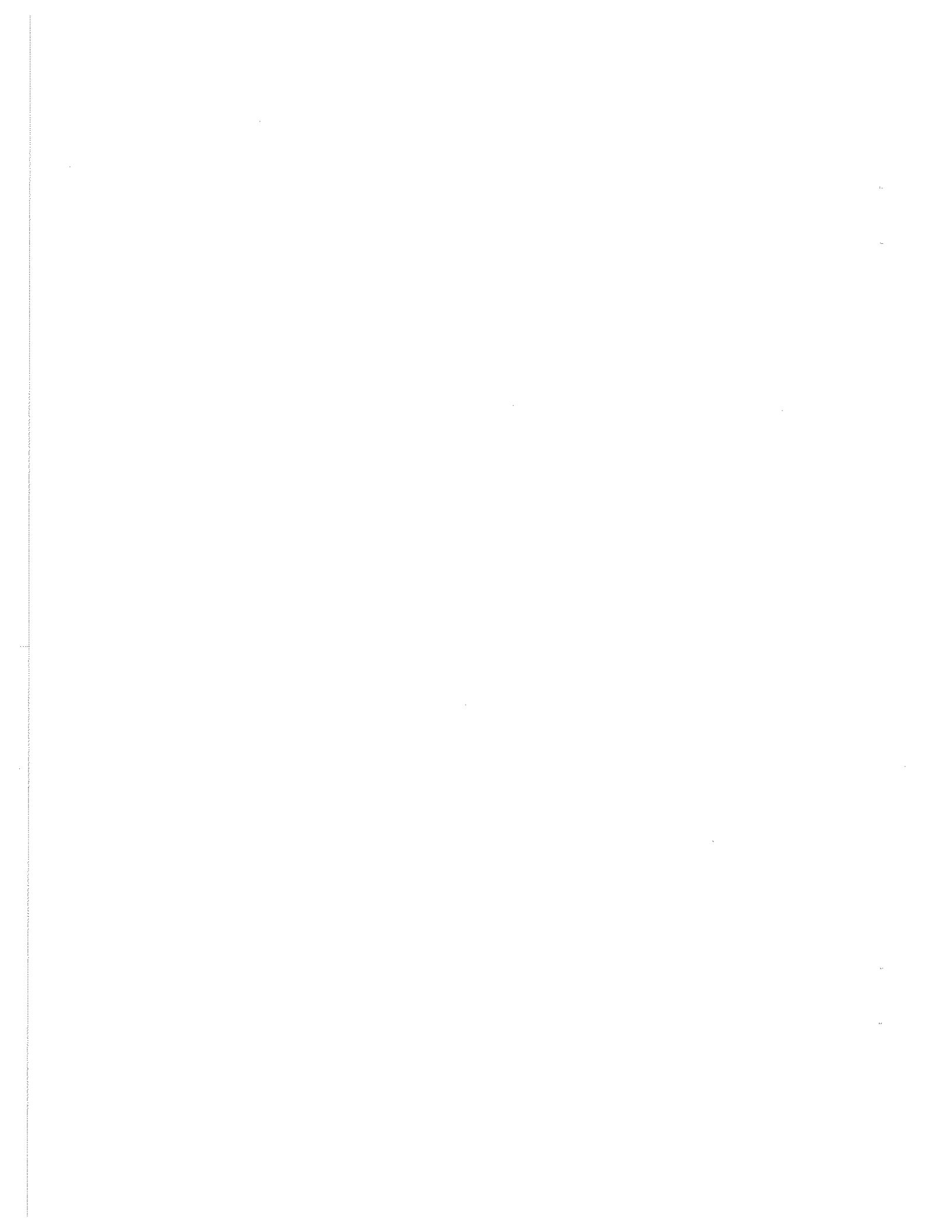

No.	Name	Function
①	Nameplate	○ Indicates the model number.
②	POWER Switch	<ul style="list-style-type: none"> ○ Turns on/off the AC input power. When this switch is thrown to the upper position, the instrument power is turned on. A circuit breaker is used for the switch. The switch is automatically turned off when the input/output over-voltage protector has tripped. ○ It also is possible to turn off the switch with a remote control signal. ○ As an inrush current suppression circuit is incorporated, the power supply actually is started up at approximately 1 second after turning on the switch.
③	Voltmeter	<ul style="list-style-type: none"> ○ Indicates the output voltage. Green LED digital display. ○ When the limit switch is pressed, indicates the limit voltage or OVP trip voltage.
④	Ammeter	○ Indicates the output current, or limit current when the limit switch is pressed.
⑤	VOLTAGE Setting Knob	○ Adjusts the output voltage for constant-voltage operation.
⑥	CURRENT Setting Knob	○ Adjusts the output current for constant-current operation.
⑦	C.V	○ Illuminates to indicate the constant-voltage mode.
⑧	C.C	○ Illuminates to indicate the constant-current mode.
⑨	Preset OVP Switch	○ During the period you keep this switch pressed, the CV meter indicates the OVP trip voltage.
⑩	OVP Trip Voltage Setting Potentiometer	<ul style="list-style-type: none"> ○ Keeping the preset OVP switch depressed, set the OVP trip voltage. ○ The trip voltage should be set at approximately 105 - 110% of the operating voltage.
⑪	Voltage/Current LIMIT Switch	○ During the period you keep this switch pressed, the Voltmeter indicates the limit output voltage and the Ammeter indicates the limit output current.

893387

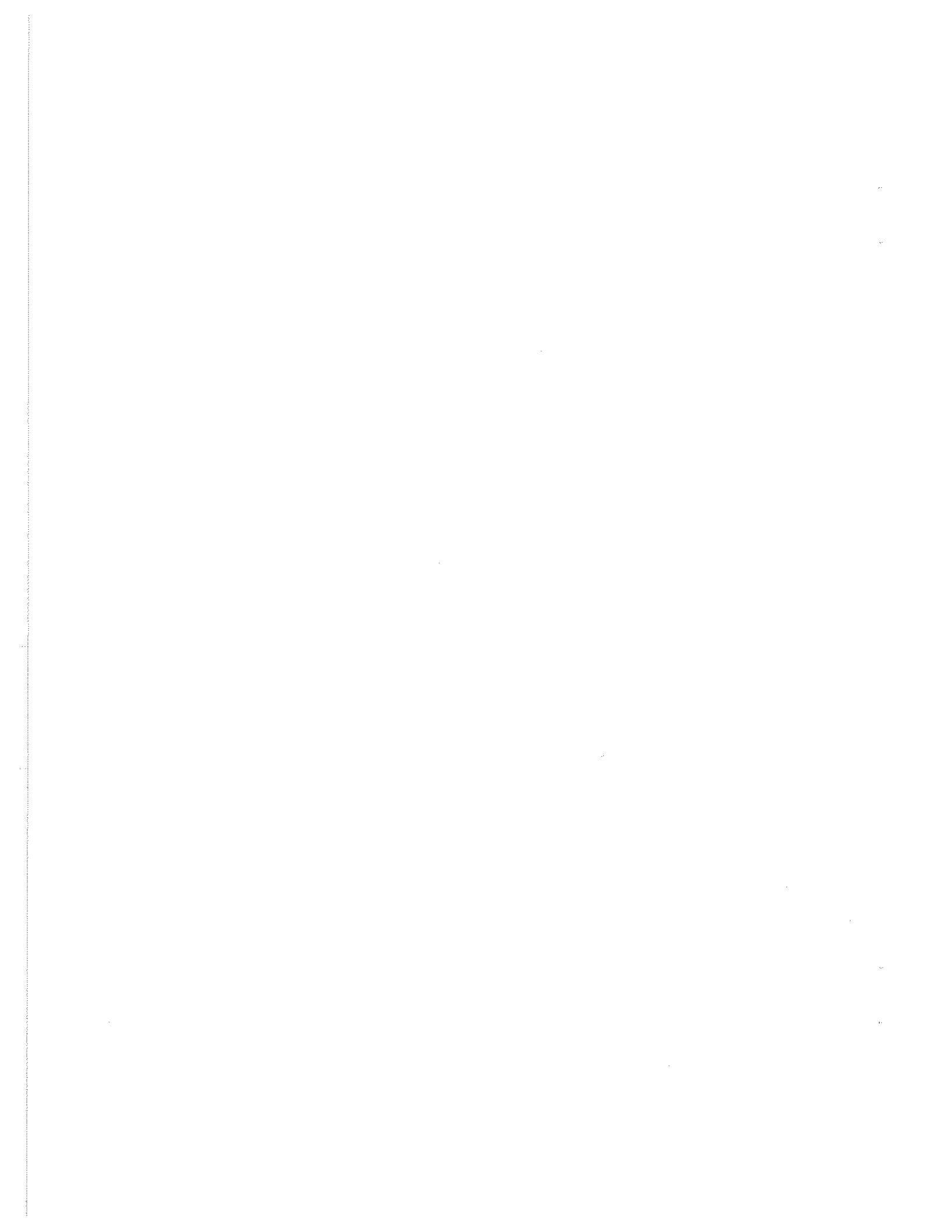

No.	Name	Function									
⑫	OUTPUT Switch	<ul style="list-style-type: none"> ○ Each time as you press the output switch, the output is turned on or off. ○ When the input switch is turned off, the output switch is reset by the automatic reset function. When the input switch is turned on for the next time, the output switch starts by the off state. 									
⑬	OUTPUT Indicator Lamp	<ul style="list-style-type: none"> ○ Illuminates to indicate that the output is on. (Green LED) 									
⑭	Sub-output Terminals Red : "+" White: "-"	<ul style="list-style-type: none"> ○ Allow to deliver the output via the front panel. (The stability is identical with that of the output terminals on the rear panel.) <p>Models which have sub-output terminals:</p> <table style="margin-left: auto; margin-right: auto; border: none;"> <tr> <td style="padding: 0 20px;">PAK20-18A</td> <td style="padding: 0 20px;">PAK35-10A</td> <td style="padding: 0 20px;">PAK60-6A</td> </tr> <tr> <td></td> <td style="padding: 0 20px;">PAK35-20A</td> <td style="padding: 0 20px;">PAK60-12A</td> </tr> <tr> <td></td> <td style="padding: 0 20px;">PAK35-30A</td> <td style="padding: 0 20px;">PAK60-18A</td> </tr> </table>	PAK20-18A	PAK35-10A	PAK60-6A		PAK35-20A	PAK60-12A		PAK35-30A	PAK60-18A
PAK20-18A	PAK35-10A	PAK60-6A									
	PAK35-20A	PAK60-12A									
	PAK35-30A	PAK60-18A									
⑮	Air Intake Louver	<ul style="list-style-type: none"> ○ Allows to intake the cooling air. ○ A filter is provided inside. (Clean the filter periodically.) 									
⑯	Louver Hooks	<ul style="list-style-type: none"> ○ Clamp the louver in position. To detach the louver (e.g. to take out the filter for cleaning), press the hooks downward. 									
⑰	Rubber Studs										
⑱	Control Switch S1	<ul style="list-style-type: none"> ○ Selects functions of remote control with external voltage or resistance signal (ON/OFF-control of output, GP-IB control, etc.). (See Section 3.3.) 									
⑲	Control Signal Connector J1	<ul style="list-style-type: none"> ○ Connects control signals. (See Section 3.3.) 									
⑳	For Control Signal Connector J2	<ul style="list-style-type: none"> ○ Space for GP-IB Controller connector (optional) 									
㉑	Output Terminal "+"	<ul style="list-style-type: none"> ○ Use the supplied bolt and nut. 									
㉒	Output Terminal "-"	<ul style="list-style-type: none"> ○ Use the supplied bolt and nut. 									
㉓	Cooling Fan Motor	<ul style="list-style-type: none"> ○ Cools the power supply. (A temperature proportional type of forced air cooling system) 									

B000000

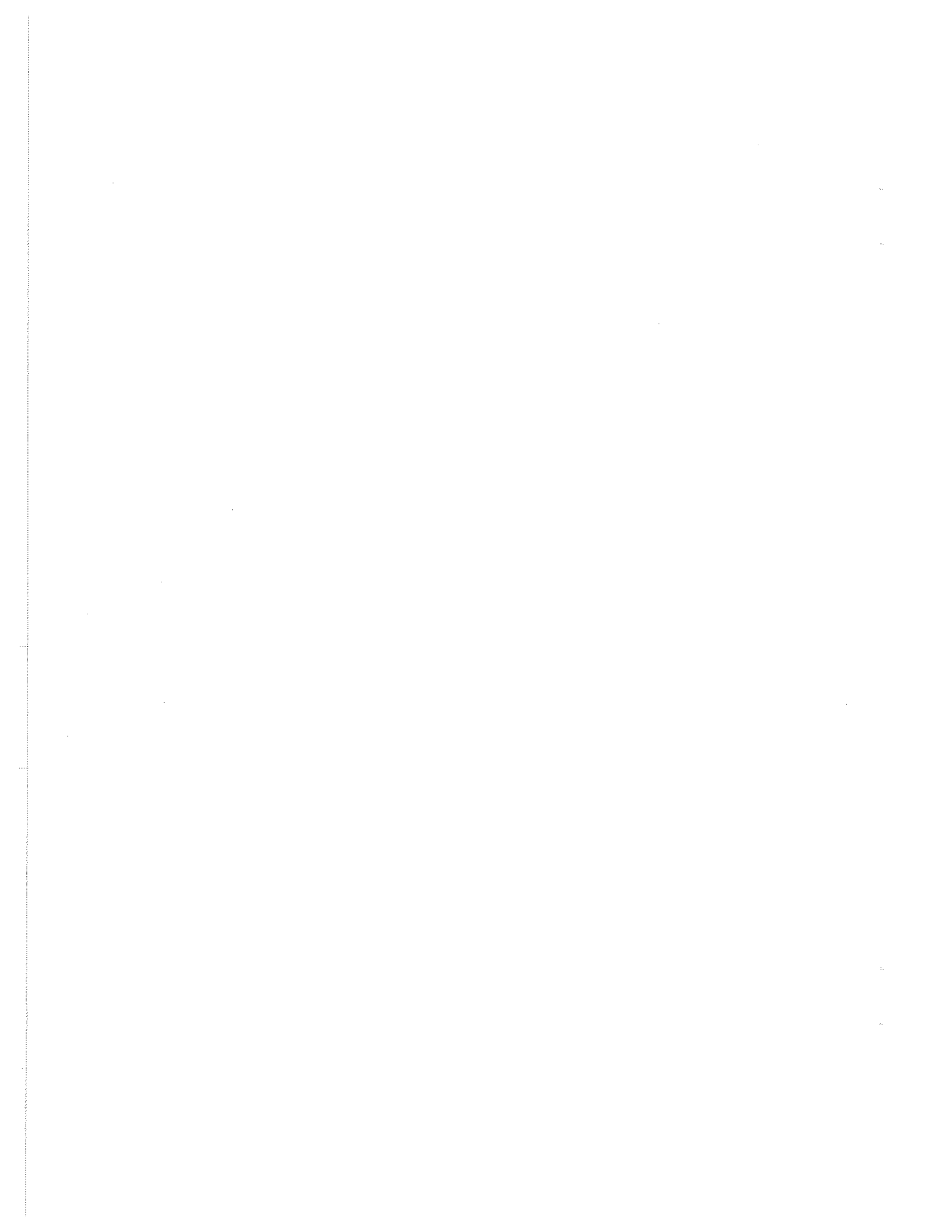

No.	Name	Function
②4	Input Terminals	○ Connects the AC line input power.
②5	Power Indicator Lamp	○ Illuminates to indicate that the AC input power switch is on.
②6	VOLTAGE Control, COARSE	○ Controls coarsely the constant-voltage output. (Potentiometer adjustable with screwdriver)
②7	VOLTAGE Control, FINE	○ Controls finely the constant-voltage output. (Potentiometer adjustable with screwdriver)
②8	CURRENT Control	○ Controls the constant-current output. (Potentiometer adjustable with screwdriver)
②9	Control Switches S2 - S8	○ For the various control actions. (See Section 3.3.)
③0	Handle	
③1	GND	○ Frame ground. When the output is required to be grounded, use the supplied GND cable from the viewpoint of output noise suppression.

893389

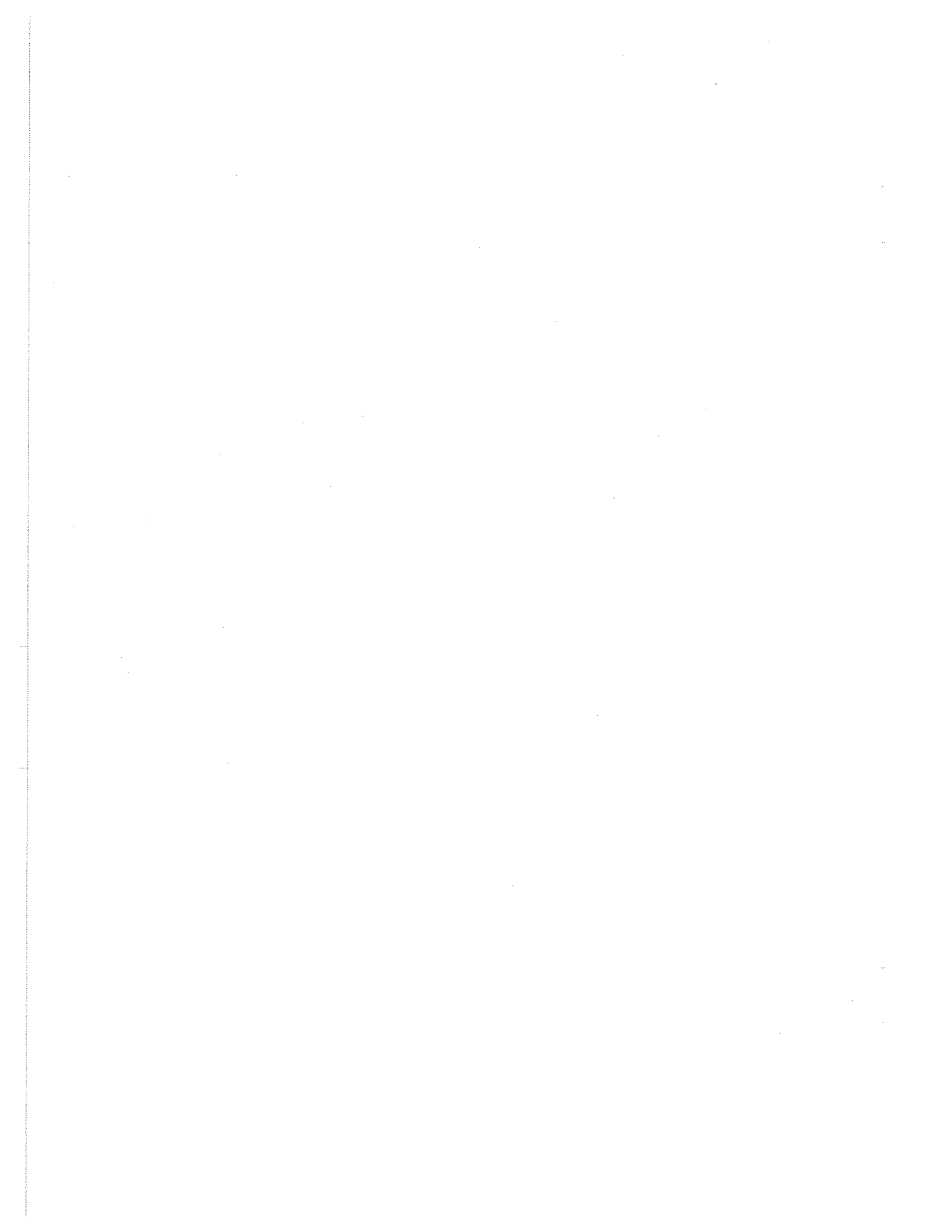

3.3 Remote Sensing and Remote Control

The PAK-A/AM Power Supply allows remote sensing and remote control modes of operation. For this purpose, remote control terminals and switches are provided as shown in Figure 3-1 - 3-3.

Note: Be sure to turn off the POWER switch before making wiring to the remote control terminals or changing the remote control switches (S1 - S9).

3.3.1 Remote Control Terminals and Switches

The remote sensing and control terminals are with a 20-pin MIL-type standard connector as shown in Figures 3-1 and 3-2. The settings of the switches when the power supply is delivered to you are as shown in Figure 3-3.

As viewed from rear of equipment

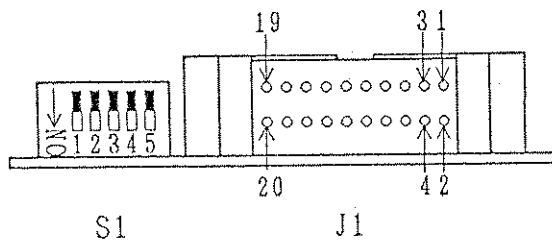

Figure 3-1

Applicable 20P sockets

(OMRON : XG5M-T2016)
 (MATSUSHITA: AXW 120431A)

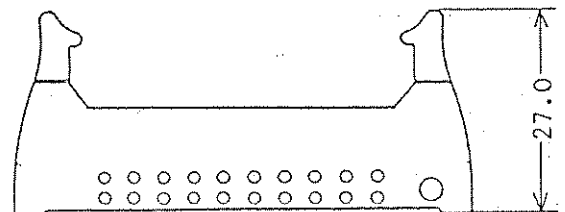

Figure 3-2

Switch setting when equipment is delivered

Switches (S2 - S8) on top panel	Switch S1 on rear panel
REMOTE SENSING ON <input type="radio"/> OFF <input checked="" type="radio"/> S 2 O.V.P CONTROL REMOTE <input type="radio"/> LOCAL <input checked="" type="radio"/> S 3 PARALLEL OPERATION SLAVE <input type="radio"/> MASTER <input checked="" type="radio"/> S 4 C.C REMOTE R-IN <input type="radio"/> E-IN <input checked="" type="radio"/> S 5 R-IN <input type="radio"/> E-IN <input checked="" type="radio"/> S 6 C.V REMOTE R-IN <input type="radio"/> E-IN <input checked="" type="radio"/> S 7 R-IN <input type="radio"/> E-IN <input checked="" type="radio"/> S 8	All switches set to OFF states  S1

Figure 3-3

068890

Function of control terminals

No.	Function
1	Common for analog
2	Common for digital
3	Voltage monitoring
4	+S
5	Remote control of output current with external resistance signal
6	-S
7	Remote control of output voltage with external resistance signal
8	Input for parallel operation signal
9	Input for parallel operation signal
10	Remote control of output current with external voltage/resistance signal
11	Remote control of output voltage with external voltage/resistance signal
12	Remote ON/OFF-control of output
13	Remote control for turning OFF the Power switch
14	C.C mode signal
15	C.V mode signal
16	Common for signal
17	Output signal for parallel operation
18	Current monitoring
19	ON/OFF signal of power switch
20	Alarm signal

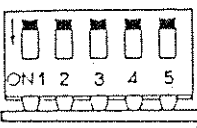
893391

Control Switches S1 - S8

Switch	Mode	Description
S1	OUTPUT SW DISABLE	<ul style="list-style-type: none"> ○ Disables the output switch on front panel. (Refer to Section 3.3.6 (2).) ○ The output switch is fixed in the ON state.
	GP-IB CONTROL	<ul style="list-style-type: none"> ○ Not to be used when in the standard mode of operation. ○ To be turned on when the GP-IB card is put in J2 and the power supply is operated as a member device of a GP-IB programmed control system.
	C.C REMOTE	<ul style="list-style-type: none"> ○ To select remote or local control of output current. ○ As this switch is turned on, operation mode is changed from the local control at front panel to the remote control via terminal J1 on rear panel. This switch should be used in conjunction with switches S5 and S6.
	C.V REMOTE	<ul style="list-style-type: none"> ○ To select remote or local control of output voltage. ○ As this switch is turned on, operation mode is changed from the local control at front panel to the remote control via terminal J1 on rear panel. This switch should be used in conjunction with switches S7 and S8.
S2	REMOTE SENSING	<ul style="list-style-type: none"> ○ To select the remote sensing function to compensate for voltage drop in wiring between power supply and load in order to improve voltage regulation at the load end. (See Section 3.3.2.)
S3	O.V.P CONTROL	<ul style="list-style-type: none"> ○ When the power supply is operated in the local mode, this switch should be set to the LOCAL. ○ When the power supply is operated in the GP-IB mode, this switch selects whether O.V.P setting is to be done locally at the front panel or to be done remotely from the GP-IB controller.
S4	PARALLEL OPERATION	<ul style="list-style-type: none"> ○ To select whether the power supply is to act as a master unit or a slave unit when operated as a member unit of a master/slave control system. <p>Two or three units can be operated in a master slave system. (See Section 3.3.5.)</p>

893392

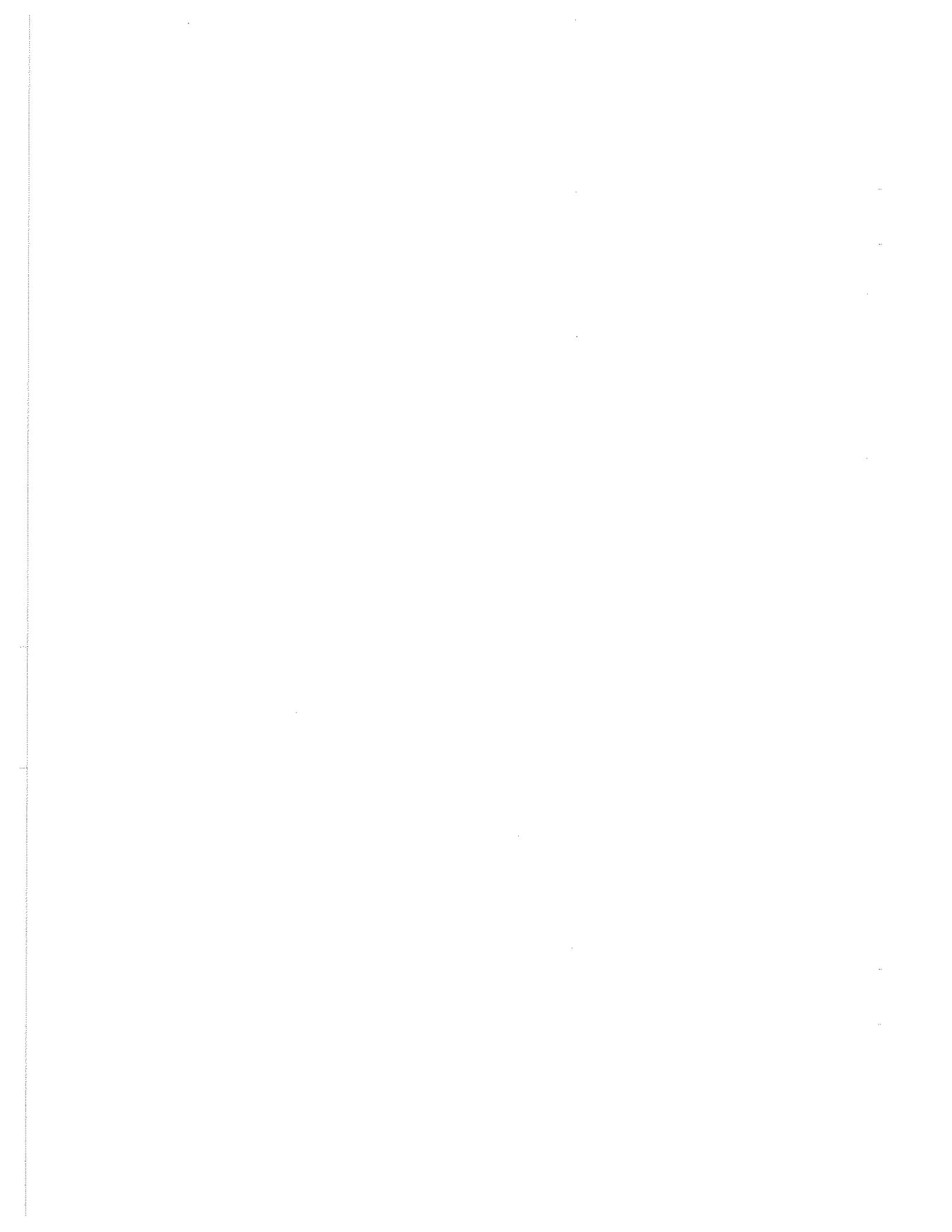

Switch	Mode	Description
S5	C.C REMOTE	○ To select either a voltage signal or a resistance signal for remote control of the output current.
S6		○ When in remote control with a resistance signal, to select a relationship of control signal vs. output current. (See Section 3.3.4.)
S7	C.V REMOTE	○ To select either a voltage signal or a resistance signal for remote control of the output voltage.
S8		○ When in remote control with a resistance signal, to select a relationship of control signal vs. output voltage. (See Section 3.3.2.)

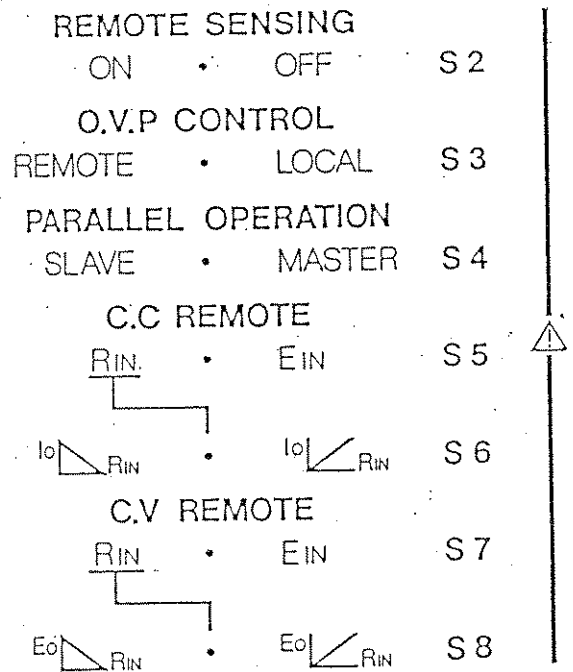

● --- ON
○ --- SELECT

SW NO. MODE	S1					S'2	S3	S4	S5	S6	S7	S8
	1	2	3	4	5							
OUTPUT SW DISABLE				●								
GP-IB CONTROL	●	●	●	○								
C.C REMOTE		●							○	○		
C.V REMOTE	●										○	○
REMOTE SENSING						●						
O.V.P CONTROL							○					
PARALLEL OPERATION								○				

88888888

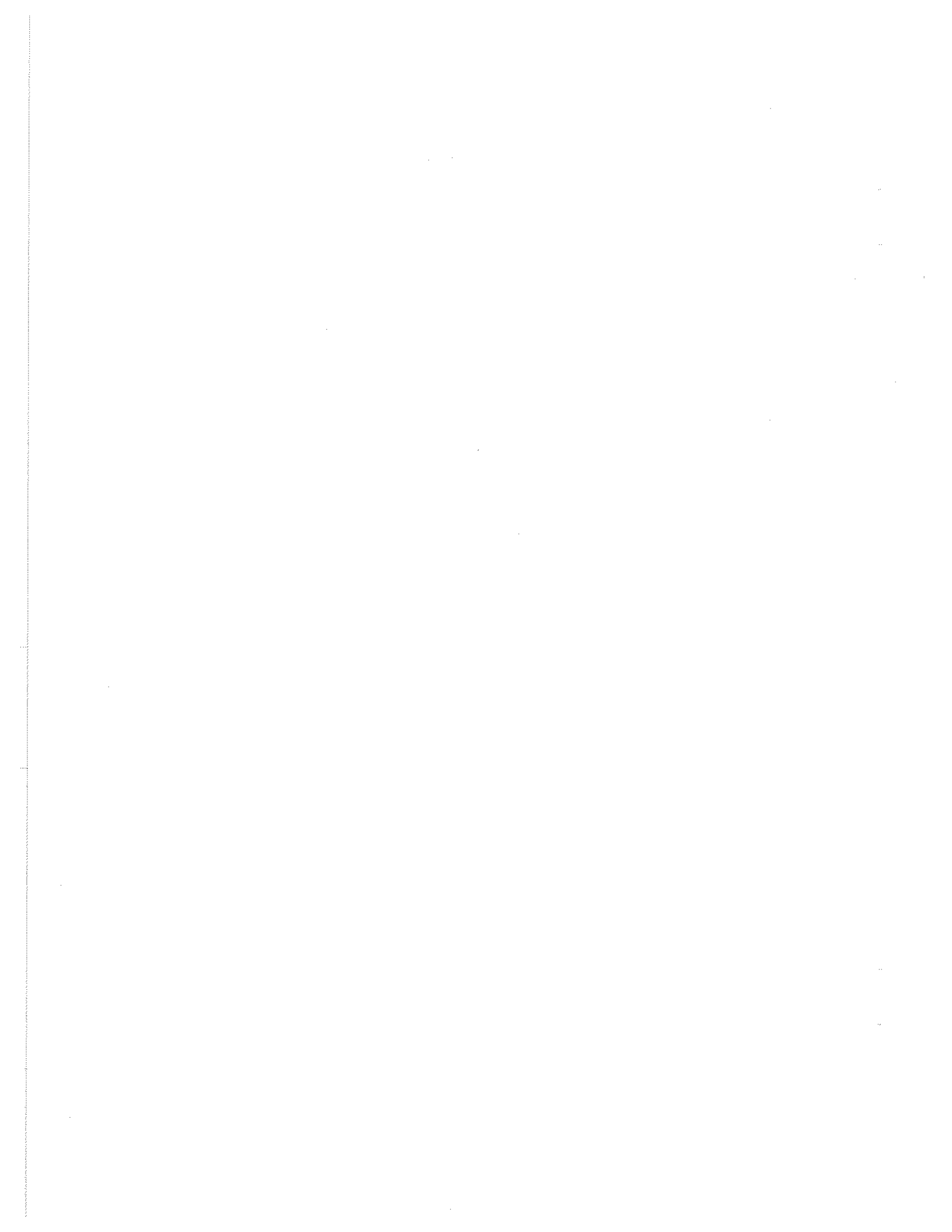

3.3.2 Remote Sensing

The remote sensing mode of operation is employed when the voltage drop in the wiring from the power supply to the load cannot be tolerated. This mode compensates for the voltage drops caused by wire resistances and contact resistances, thereby improving the regulation of the supply voltage at the load end.

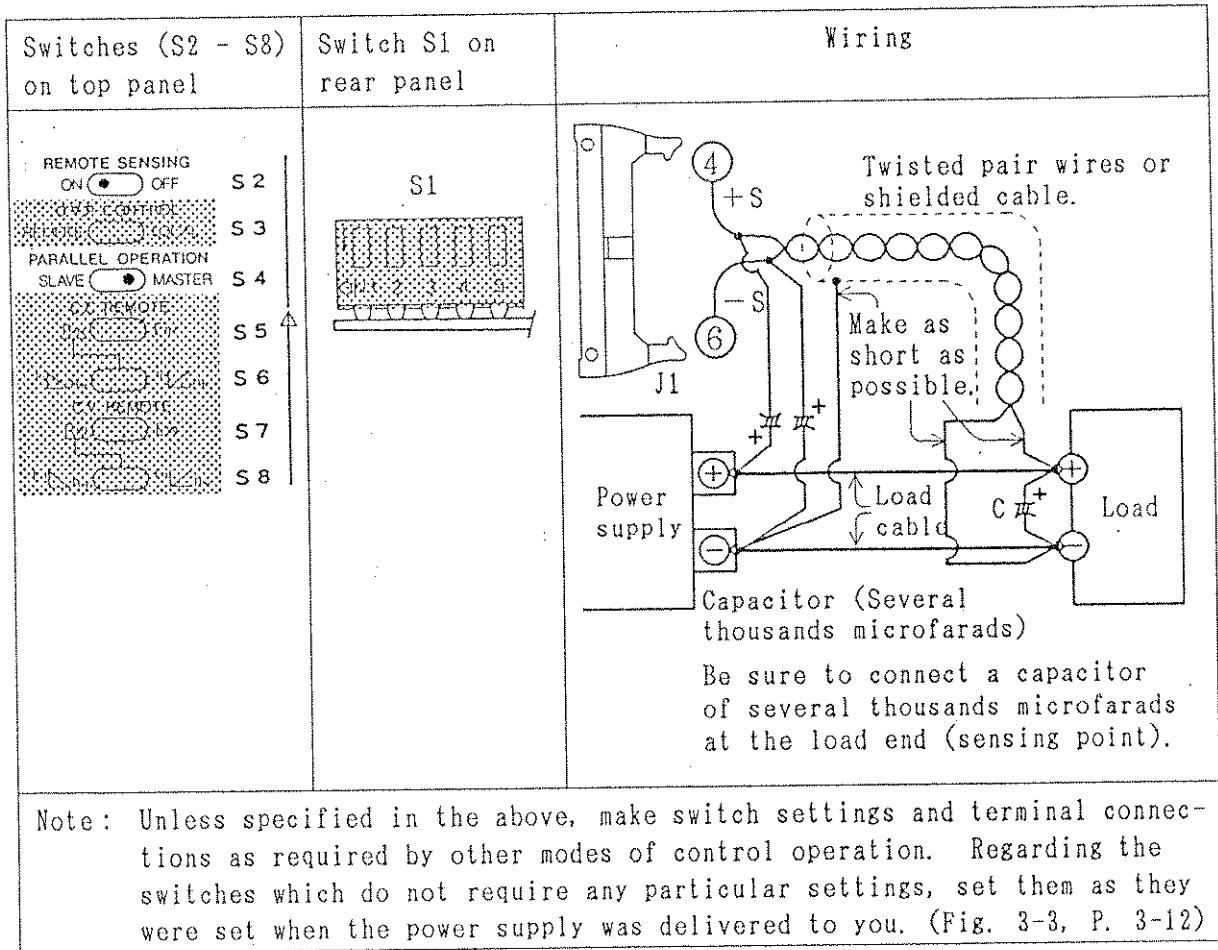

- Notes: (a) With the remote sensing function, a voltage drop of up to approximately 1 volt per one way of electrical wiring from the power supply to the load can be compensated for, when the output voltage of the power supply at its output terminal is within its rated range.
- (b) Be sure to connect to the sensing point an electrolytic capacitor of several thousands microfarads and of a sufficiently high working voltage, in the correct polarity and with a minimal wiring distance.

893394

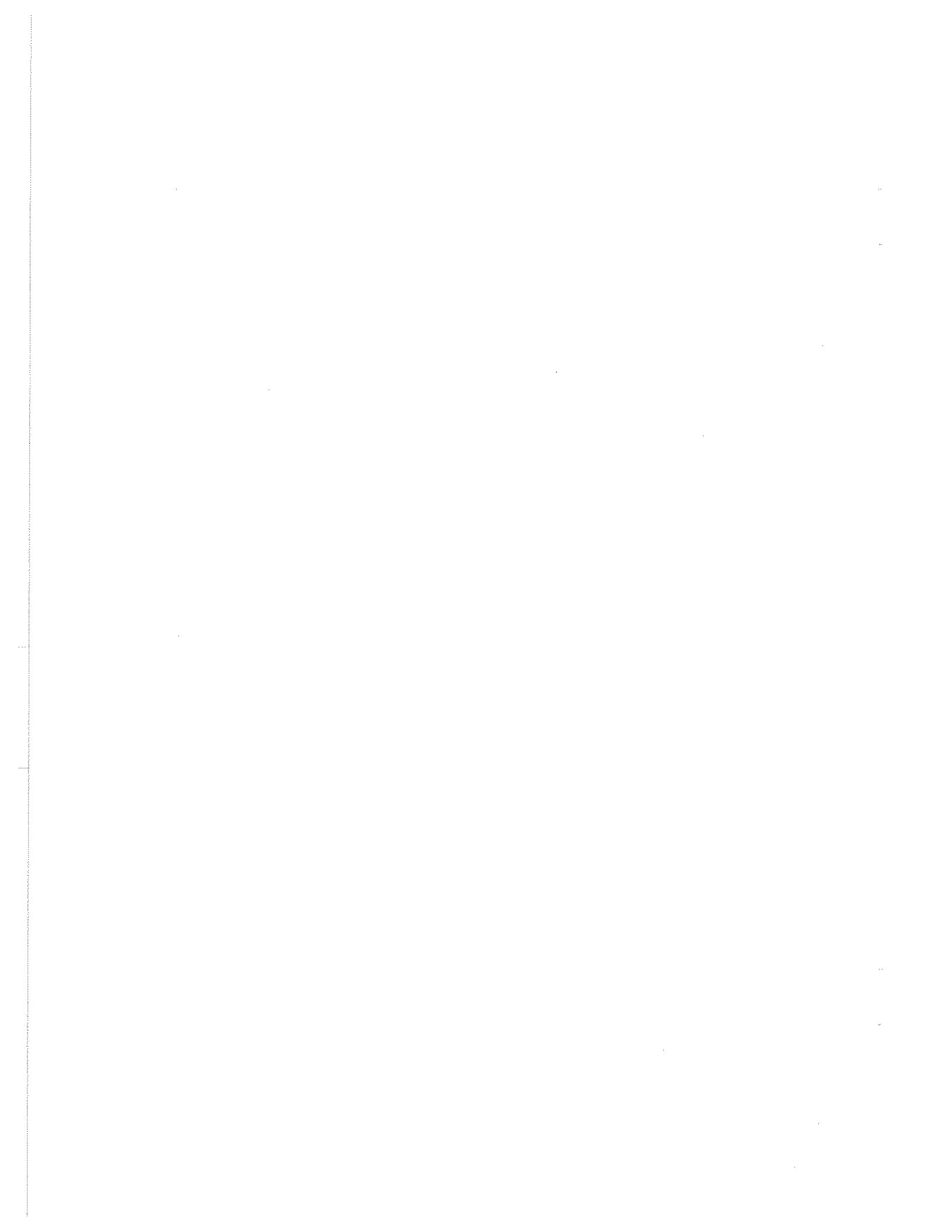

- (c) When the sensing distance is long and voltage regulation at the sensing point is poor, the state may be improved by connecting an electrolytic capacitor of several hundreds microfarads and of a sufficiently high working voltage to each of between "+S" and "OUTPUT +" terminals and between "-S" and "OUTPUT -" terminals, in the correct polarity.
- (d) When two or three units are operated in parallel in a master/slave mode, provide remote sensing for the master unit only.
- (e) For a regenerative load (e.g. a battery), connect the load cable before connecting the sensing cable.
- (f) When controlling the output power by providing an ON/OFF switch in the load cable, provide an ON/OFF switch for the sensing cable also as illustrated below.

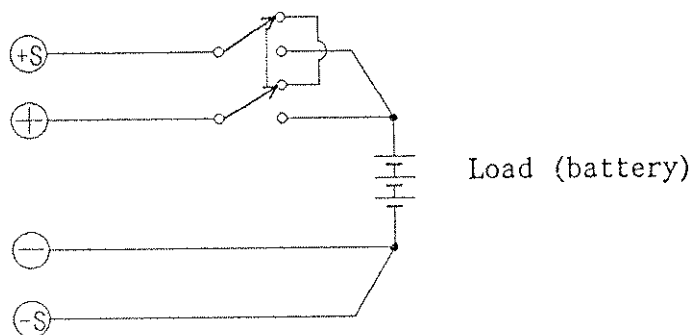

- (f) When the load current changes sharply, regulation of the output voltage may be rather better without any remote sensing.

893395

3.3.3 Remote Control of Output Voltage

The output voltage of the power supply can be remote-controlled with an external voltage or resistance signal as explained in the following:

(1) Remote Control of Output Voltage with Voltage Signal

The output voltage of the power supply can be remote-controlled with an external voltage signal (0 to approx. 10 volts) as explained below.

Switches (S2 - S8) on top panel	Switch S1 on rear panel	Wiring
		<p> $E_o = \frac{E_m \cdot E_{in}}{10}$ </p> <p> $0 \leq E_{in} \leq \text{approx. } 10V$ </p> <p> E_o: Output voltage (V) E_m: Rated voltage (V) E_{in}: Control signal voltage (V) </p>
<p>Note: Unless specified in the above, make switch settings and terminal connections as required by other modes of control operation. Regarding the switches which do not require any particular settings, set them as they were set when the power supply was delivered to you. (Fig. 3-3, P. 3-12)</p>		

Notes: (a) Impedance between ① and ⑩ of J1 is 10kΩ.

A control voltage signal source which allows up 1 mA is needed.

(b) For the remote control voltage signal source E_{in} , use a device which provides a stable, low noise signal (a Kikusui PAB Series Power Supply or an equivalent device).

693396

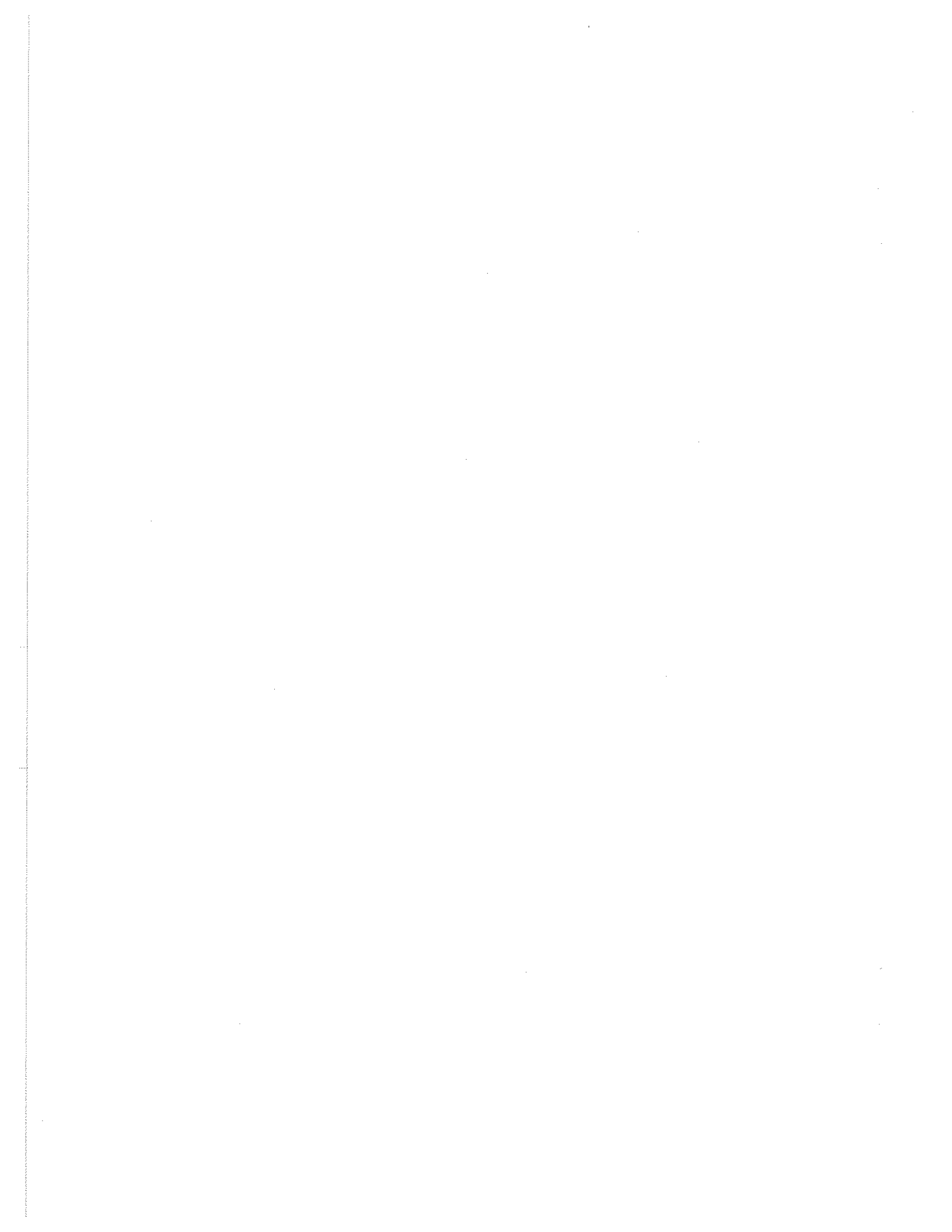

- (c) For wiring from the remote control voltage signal source Ein to the power supply, use a shielded cable or a stranded pair of wires in order to prevent induction noise.
- (d) For Ein, use a voltage signal source which is isolated from other circuits and connect its common line to the "-S" terminal.

*Precaution: Be sure that the signal source is isolated.
If not, the control circuit of the power supply
may be damaged (burnt).*

- (e) Perform full-scale value adjustment and limit value indication calibration as required. (See Section 5.2.)
- (f) Linearity of the power supply output voltage with respect the external control signal voltage is approximately 0.1% (typical), with normal line voltage (100V AC) and normal room temperature.

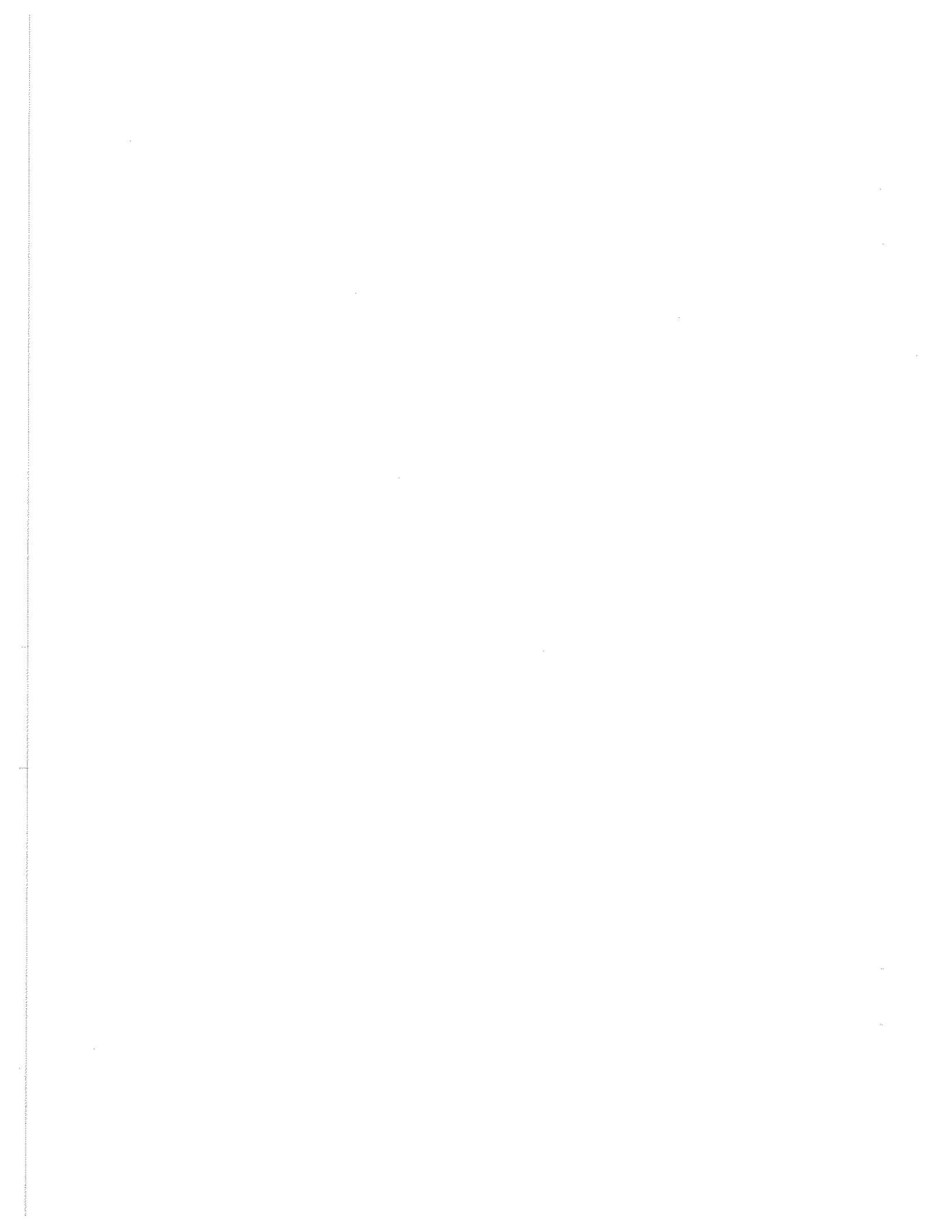

(2) Remote Control of Output Voltage with Resistance Signal I

The output voltage of the power supply can be controlled with an external resistance signal as shown below. The output voltage increases as the control signal resistance increases.

If the equipment is to be driven to the safer side when the resistor (R_{in}) has become open, employ the control method of Item (3) "Method II".

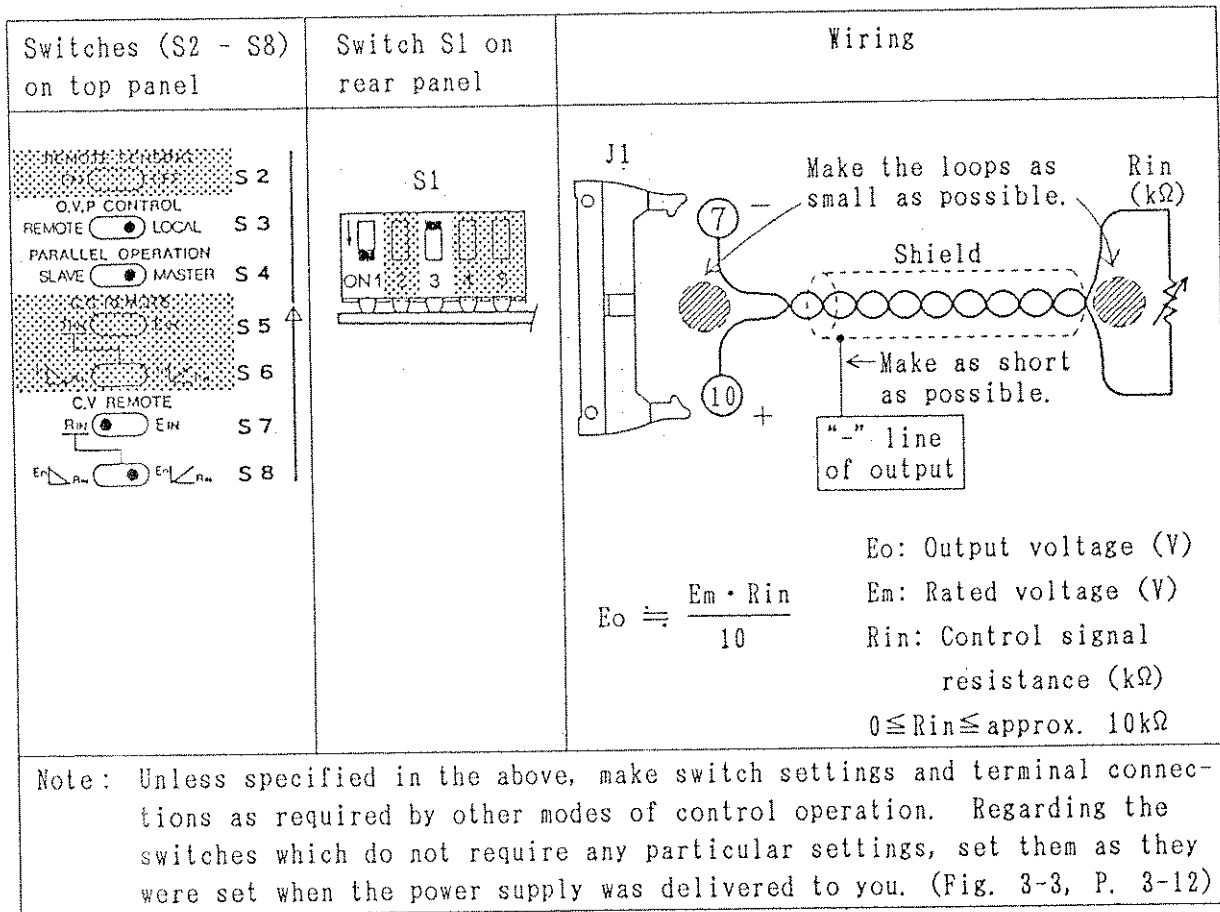

Notes: (a) The current which flows in the control resistor (R_{in}) is constant at approx. 1 mA.

(b) For the resistor (R_{in}), use a quality resistor of 1/2 watt or more, with good temperature coefficient, aging and noise characteristics (such as a metallic film or wire-wound resistor.)

860000

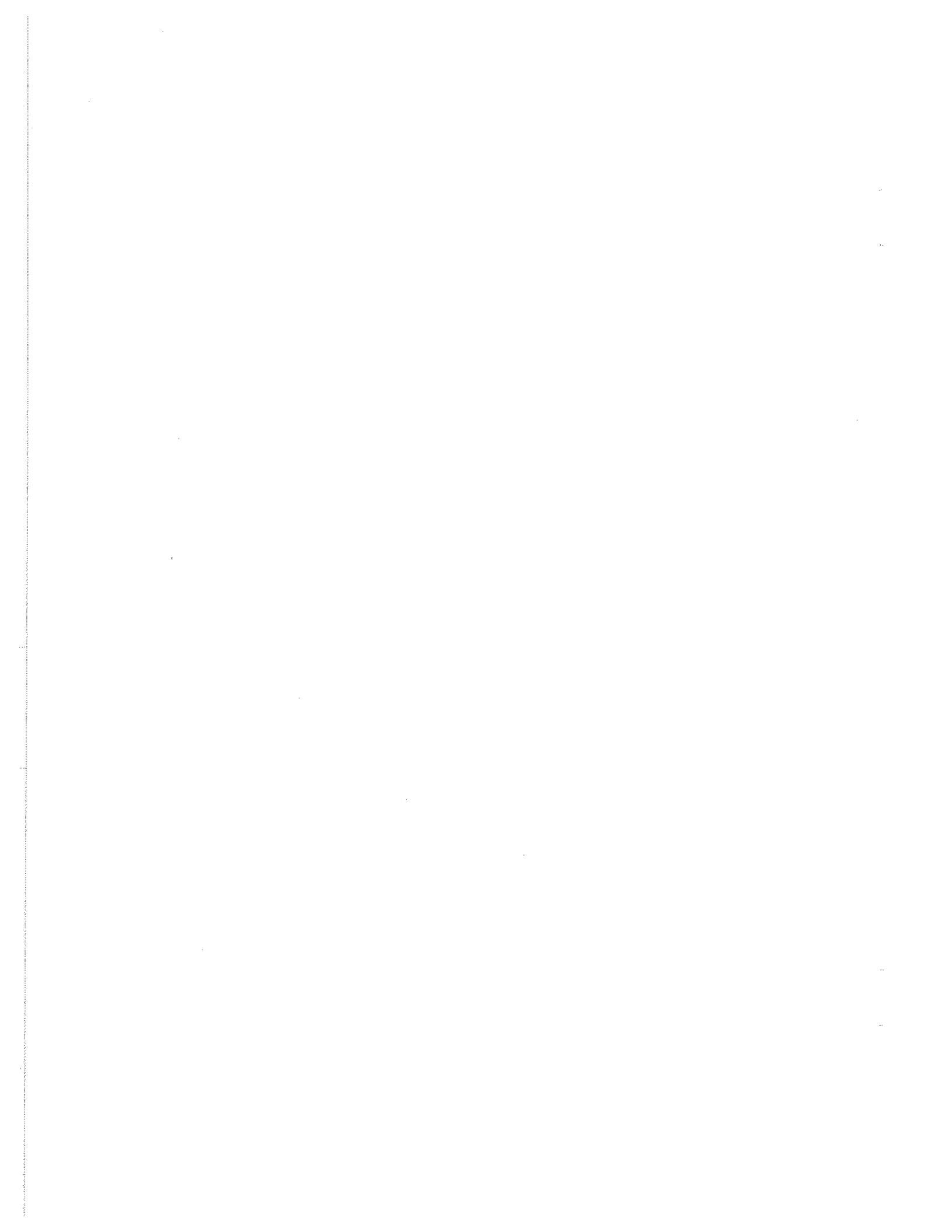

- (c) When the control resistance signal circuit is made open, the power supply output voltage will increase. To protect the load, set the OVP at an appropriate voltage (see Section 3.2 (9) and (10)).
- (d) Connect the shielding wire of the signal cable to the "-" line of the power supply output, using a wire as short as possible.
- (e) Perform full-scale value adjustment and limit value indication calibration as required. (See Section 5.2.)
- (f) Linearity of the power supply output voltage with respect the external control signal resistance is approximately 0.1% (typical), with normal line voltage (100V AC) and normal room temperature.

893399

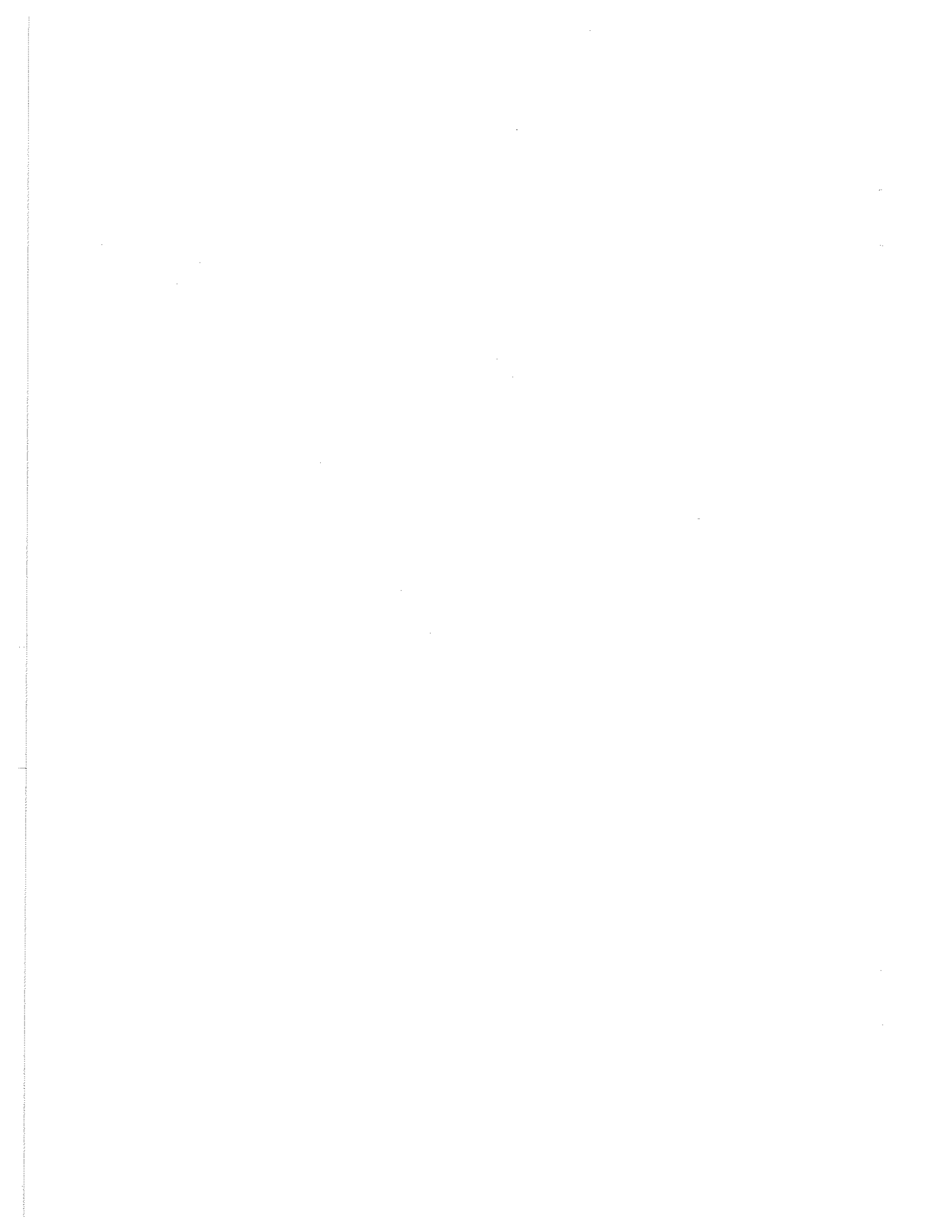

(3) Remote Control of Output Voltage with Resistance Signal II

The output voltage of the power supply can be controlled with an external resistance signal as shown below. The output voltage decreases as the control signal resistance increases.

When the control resistance signal circuit is made open, the power supply output voltage falls to zero, thereby causing no damage to the load.

When the equipment is to be driven to the safer side when the resistor (R_{in}) is shorted (e.g, by water splash), employ the control method of Item (2) "Method I".

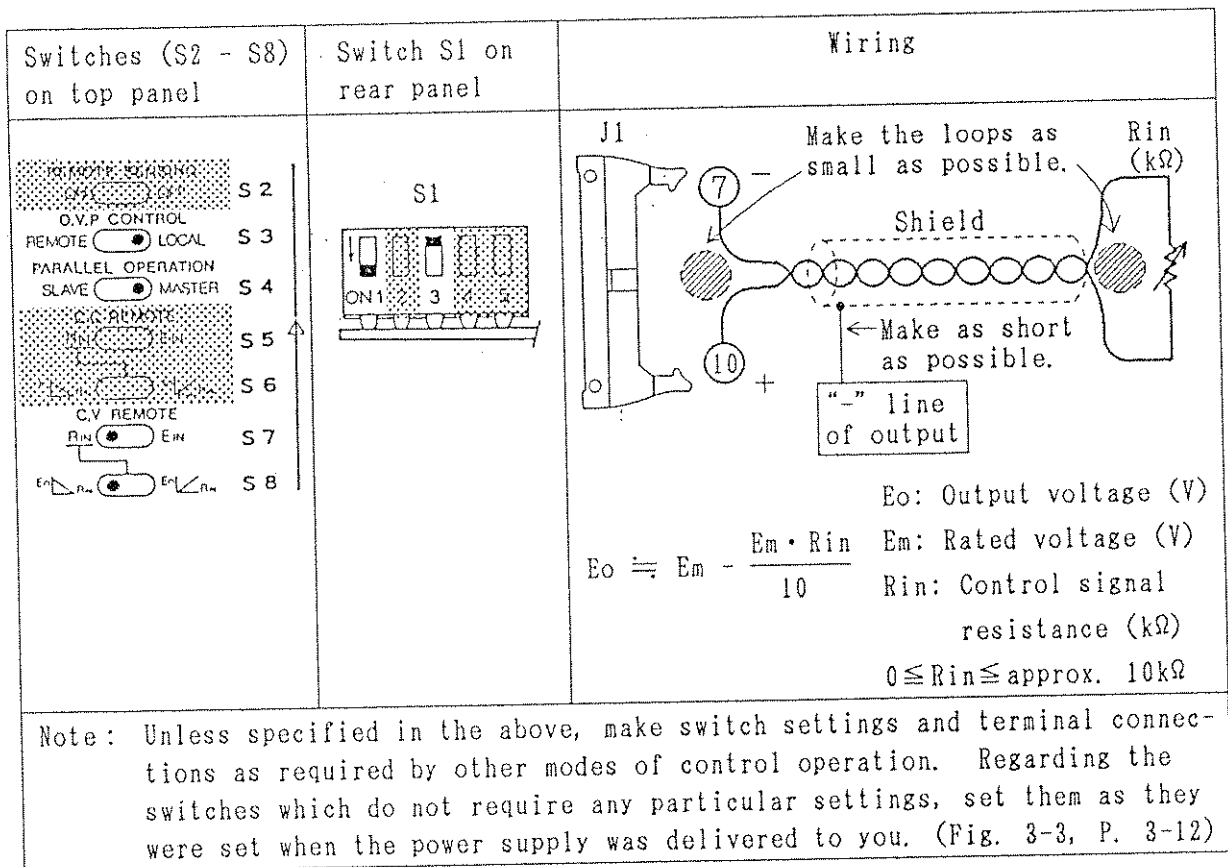

Notes: (a) The current which flows in the control resistor (R_{in}) is constant at approx. 1 mA.

(b) For the resistor (R_{in}), use a quality resistor of 1/2 watt or more, with good temperature coefficient, aging and noise characteristics (such as a metallic film or wire-wound resistor.)

893400

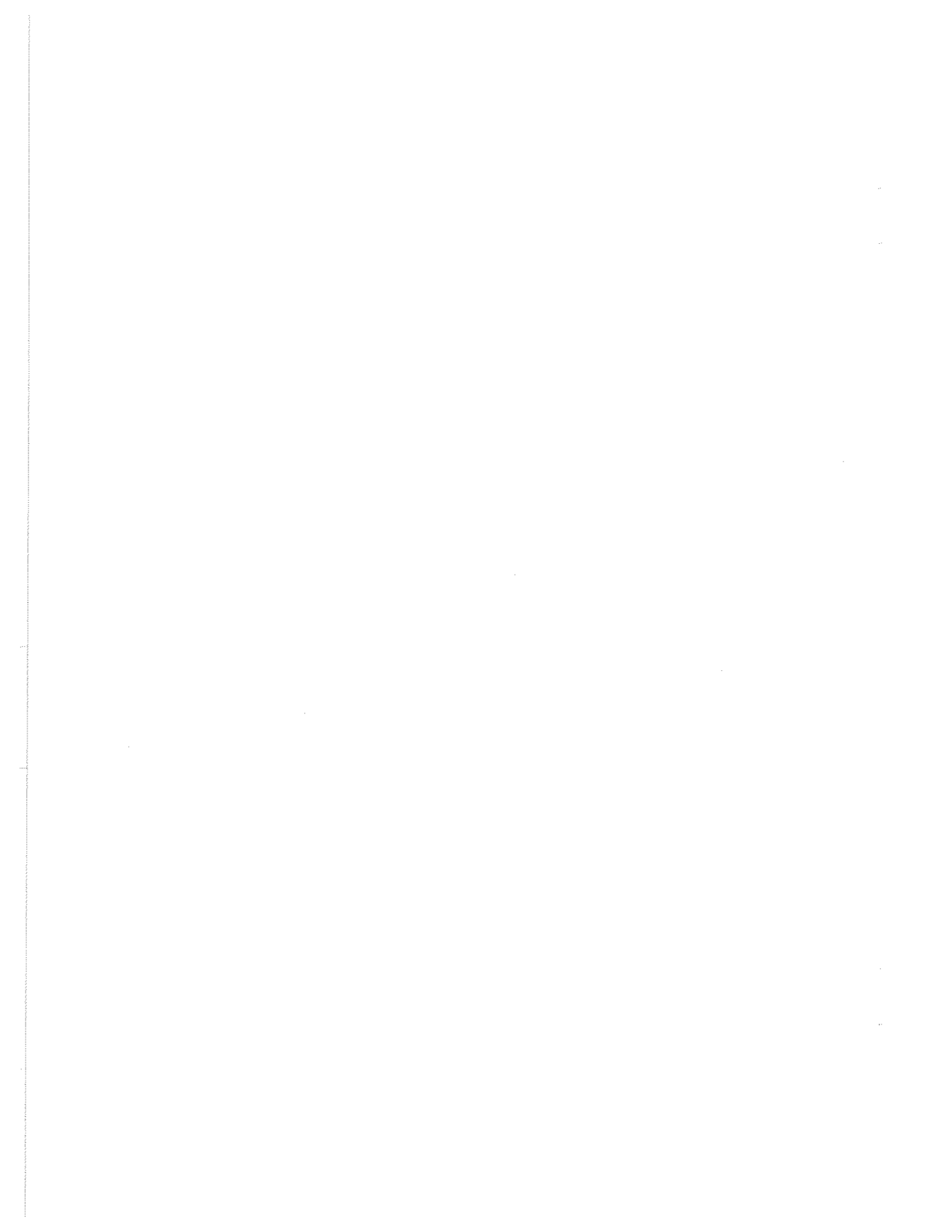

- (c) When the control resistance signal circuit is shorted, the power supply output voltage will increase to the rated voltage. To protect the load, set the OVP at an appropriate voltage (see Section 3.2 (9) and (10)).
- (d) Connect the shielding wire of the signal cable to the "-" line of the power supply output, using a wire as short as possible.
- (e) Perform full-scale value adjustment and limit value indication calibration as required. (See Section 5.2.) Note that, due to tolerances of resistors used in the power supply, the output may not become zero when a resistor of 10 k Ω is used. Use a resistor which can cover additional variable ranges of approximately $\pm 15\%$ of the required controlling resistance range.
- (f) Linearity of the power supply output voltage with respect the external control signal resistance is approximately 0.1% (typical), with normal line voltage (100V AC) and normal room temperature.

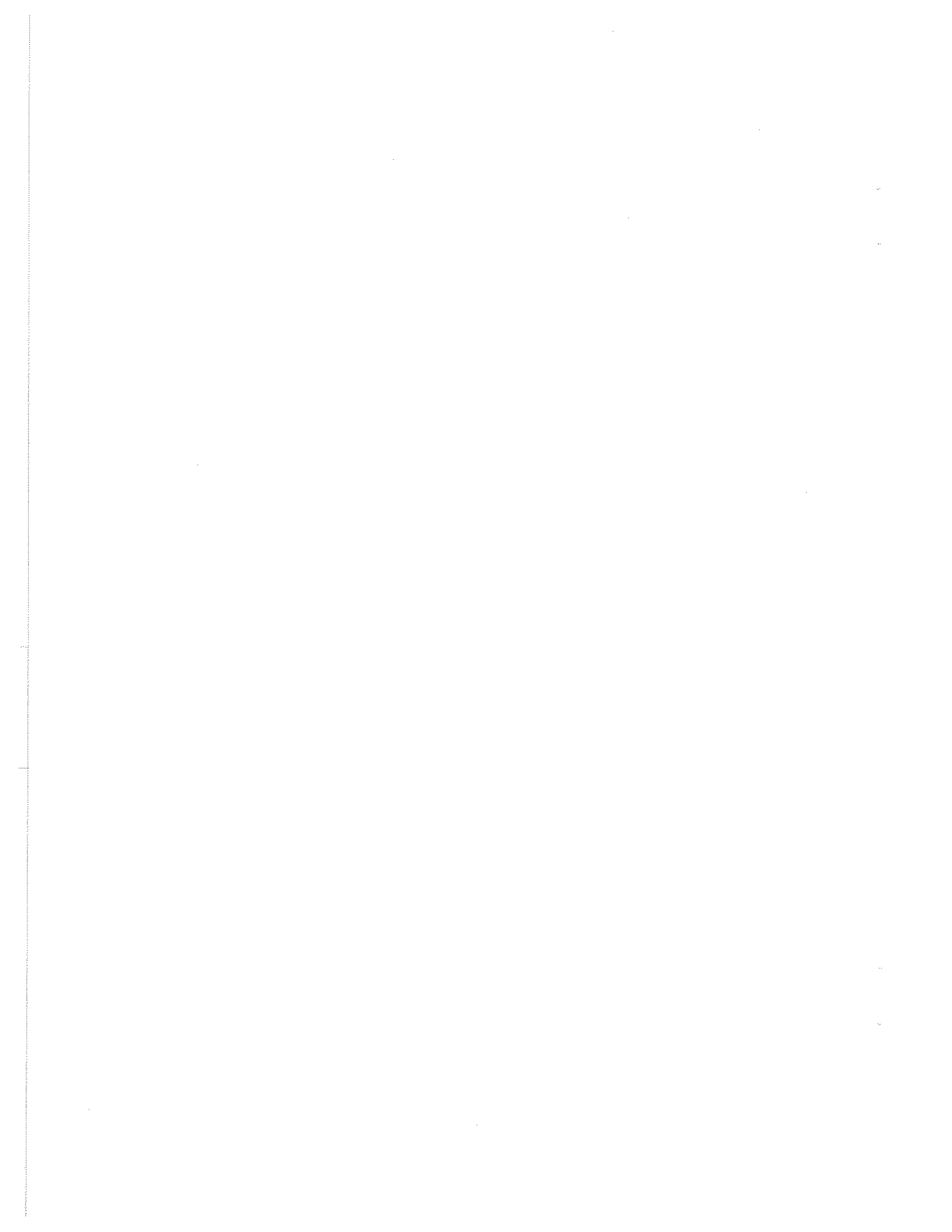

3.3.4 Remote Control of Output Current

The output current of the power supply can be remote-controlled with an external voltage or resistance signal as explained in the following:

(1) Remote Control of Output Current with Voltage Signal

An example of controlling the output current with a remote control voltage signal of 0 - approximately 10 V is explained below.

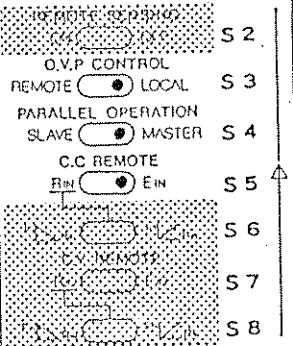
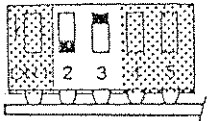
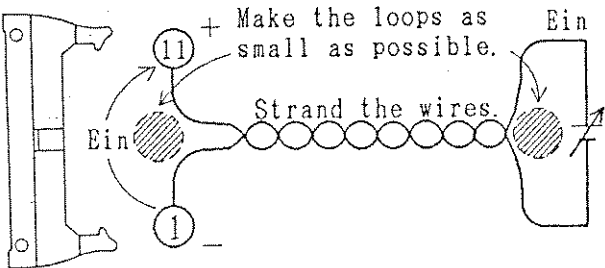
Switches (S2 - S8) on top panel	Switch S1 on rear panel	Wiring
		<p>The common terminal of the control voltage is -S.</p>  <p>$I_o = \frac{I_m \cdot E_{in}}{10}$</p> <p> I_o: Output current (A) I_m: Rated current (A) E_{in}: Control signal voltage (V) $0 \leq E_{in} \leq \text{approx. } 10V$ </p>
<p>Note: Unless specified in the above, make switch settings and terminal connections as required by other modes of control operation. Regarding the switches which do not require any particular settings, set them as they were set when the power supply was delivered to you. (Fig. 3-3, P. 3-12)</p>		

Note: (a) The J1 input impedance between terminal ① and ⑪ is 10kΩ.
A control voltage signal source which allows up 1 mA is needed.

(b) Ripples or other noise components of E_{in} are directly reflected onto the output voltage. For E_{in} , use a quality voltage signal source of less noise.

(c) For control signal wiring, use a shielded cable or a pair of stranded wires. Pay attention to noise especially when the wiring distance is long.

893402

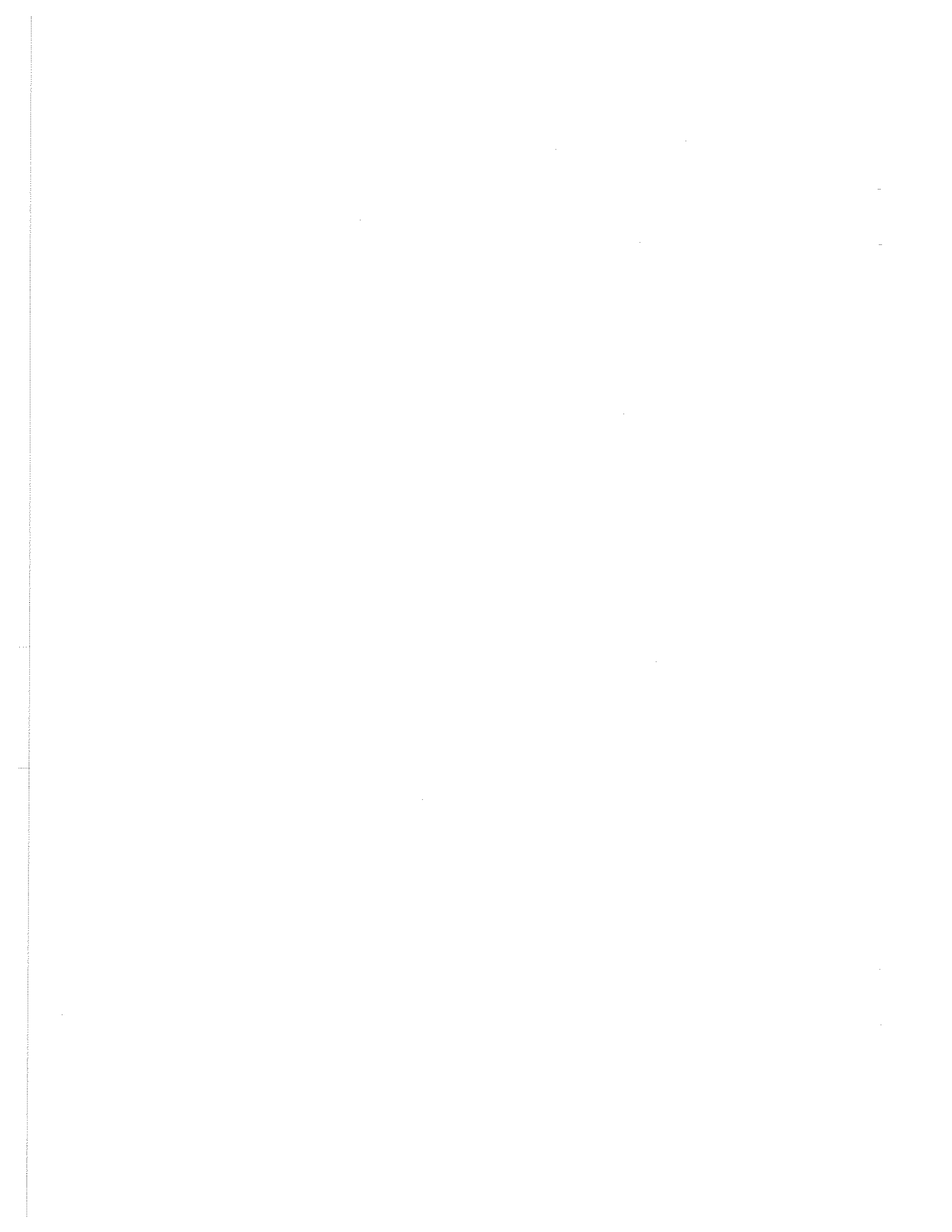

- (d) The external control voltage signal (E_{in}) must be of an isolated type. Note that the power supply may be damaged if the control voltage signal is not of an isolated type. The terminal for the common line of the external control voltage signal is -S.
- (e) Perform full-scale value adjustment and limit value indication calibration as required. (See Section 5.2.)
- (f) Linearity of the power supply output current with respect the external control signal voltage is approximately 0.1% (typical), with normal line voltage (100V AC) and normal room temperature.

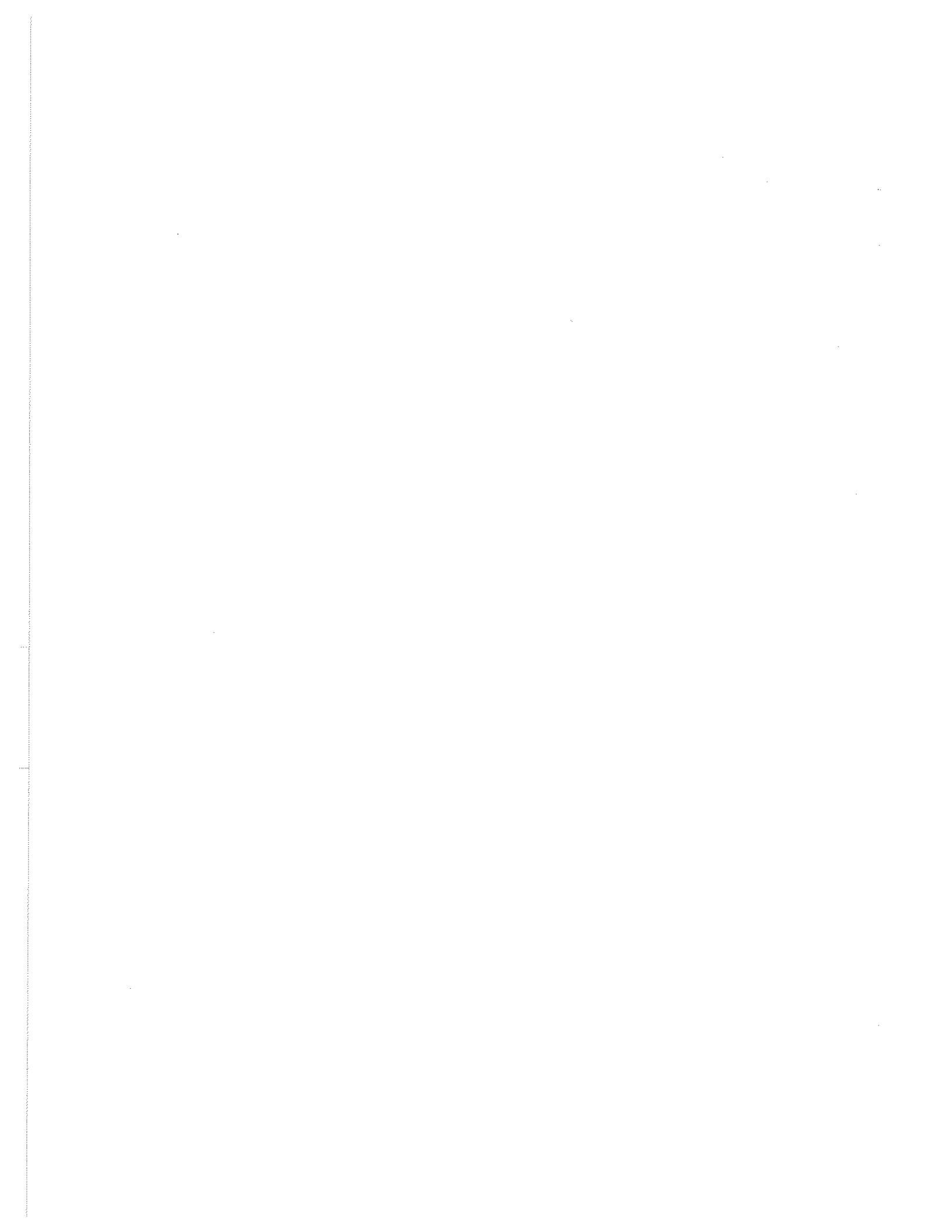

(2) Remote Control of Output Current with Resistance Signal I

The output current of the power supply can be controlled with an external resistance signal as shown below. The output current increases as the control signal resistance increases.

If the equipment is to be driven to the safer side when the resistor (R_{in}) has become open, employ the control method of Item (3) "Method II".

Switches (S2 - S8) on top panel	Switch S1 on rear panel	Wiring
<p>S 2 S 3 S 4 S 5 S 6 S 7 S 8</p>	<p>S1</p>	<p>Make the loops as small as possible.</p> <p>Shield</p> <p>Make as short as possible.</p> <p>"-" line of output</p> <p>J1</p> <p>5</p> <p>11</p> <p>+</p> <p>R_{in}</p> <p>$I_o = \frac{I_m \cdot R_{in}}{10}$</p> <p>$I_o$: Output current (A) I_m: Rated current (A) R_{in}: Control signal resistance (kΩ) $0 \leq R_{in} \leq \text{approx. } 10\text{k}\Omega$</p>
<p>Note: Unless specified in the above, make switch settings and terminal connections as required by other modes of control operation. Regarding the switches which do not require any particular settings, set them as they were set when the power supply was delivered to you. (Fig. 3-3, P. 3-12)</p>		

Notes: (a) The current which flows in the control resistor (R_{in}) is constant at approximately 1mA.

(b) For the resistor (R_{in}), use a quality resistor of 1/2 watt or more, with good temperature coefficient, aging and noise characteristics (such as a metallic film or wire-wound resistor.)

883404

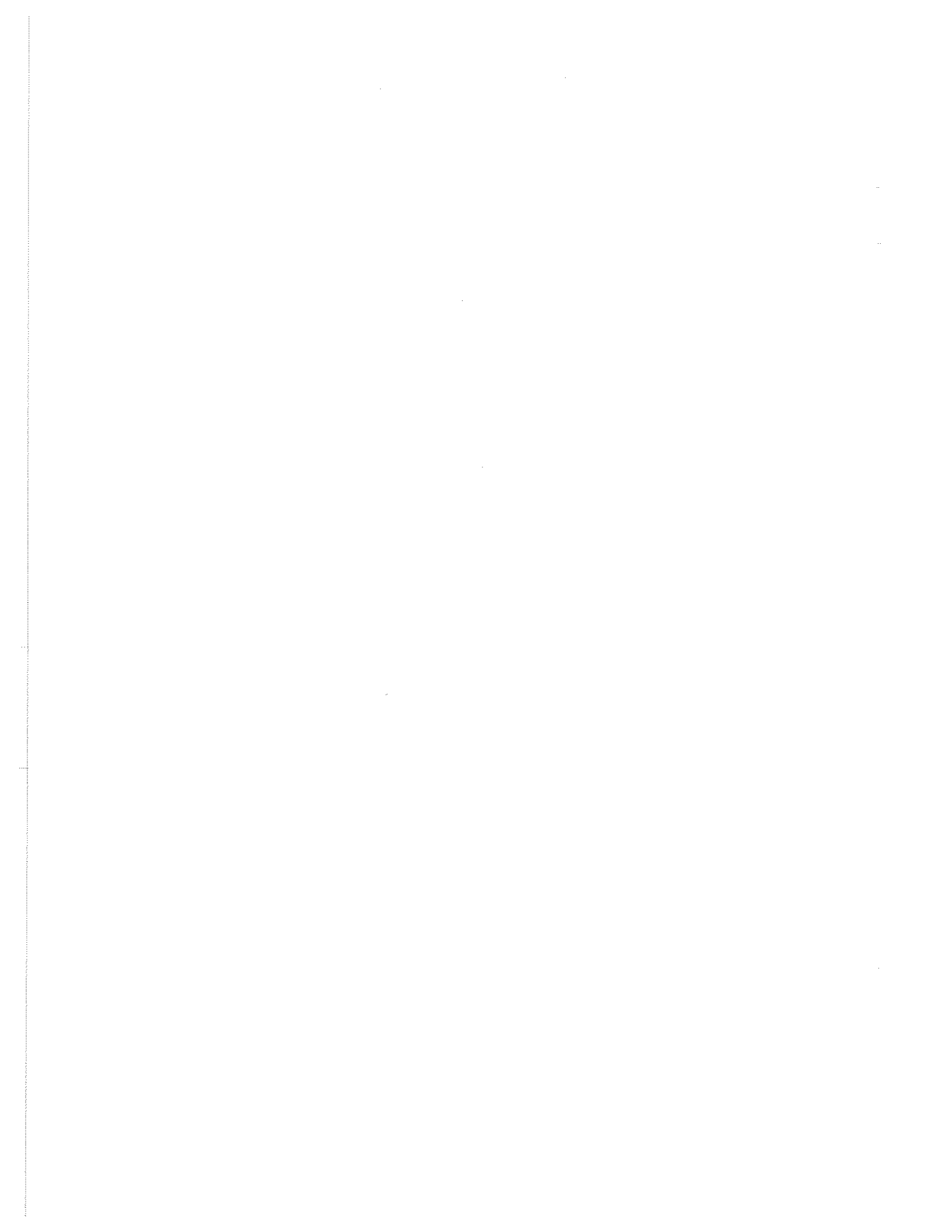

- (c) Note that, if the Rin circuit is made open, the output current is driven into the increasing side.
(The limit circuit trips at approximately 110% of the rated output current of the power supply.)
- (d) Connect the shielding wire of the signal cable to the "-" line of the power supply output, using a wire as short as possible.
- (e) Perform full-scale value adjustment and limit value indication calibration as required. (See Section 5.2.)
- (f) Linearity of the power supply output current with respect the external control signal resistance is approximately 0.1% (typical), with normal line voltage (100V AC) and normal room temperature.

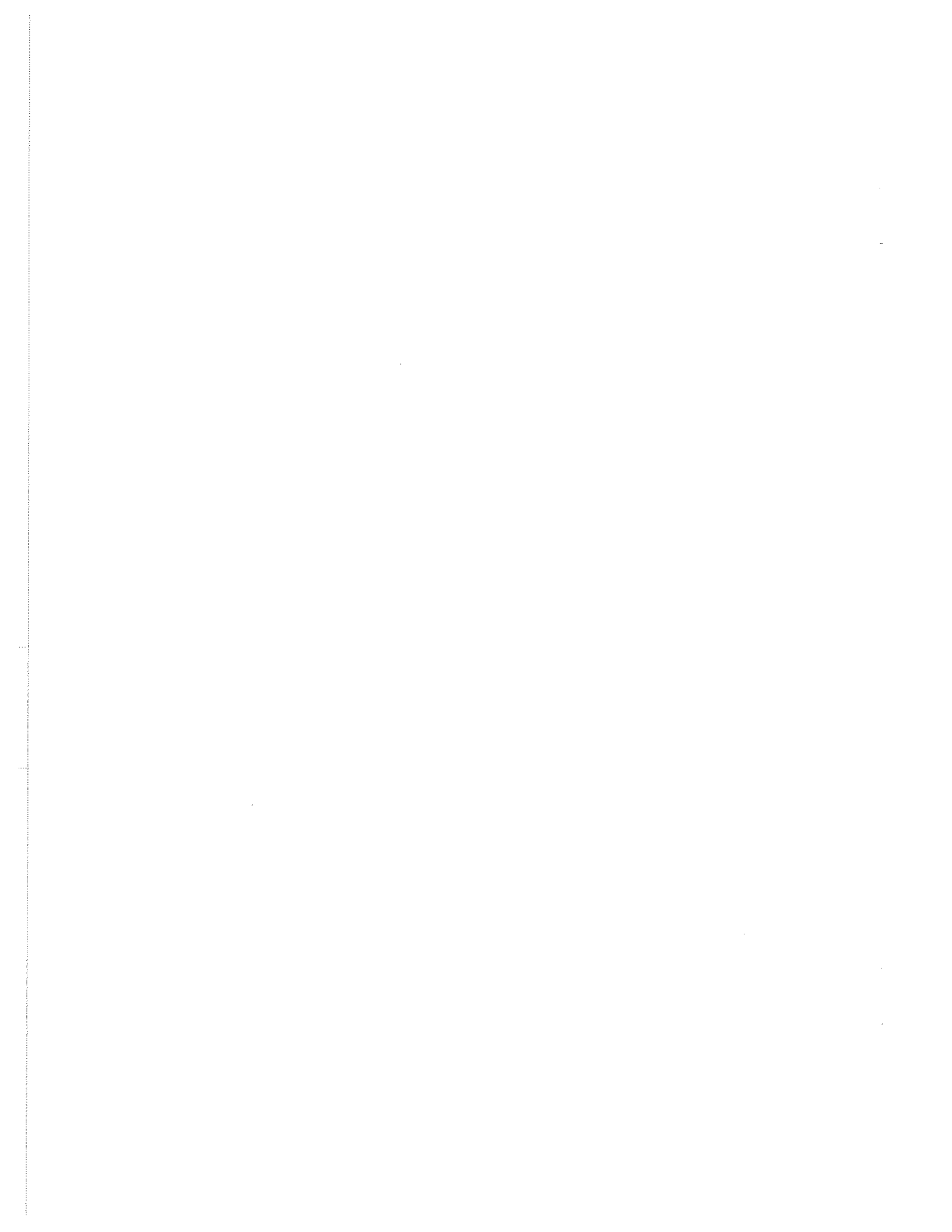

(3) Remote Control of Output Current with Resistance Signal II

The output current of the power supply can be controlled with an external resistance signal as shown below. The output current decreases as the control signal resistance increases.

When the control resistance signal circuit is made open, the power supply output current falls to zero, thereby causing no damage to the load.

When the equipment is to be driven to the safer side when the resistor (R_{in}) is shorted (e.g. by water splash), employ the control method of Item (2) "Method I".

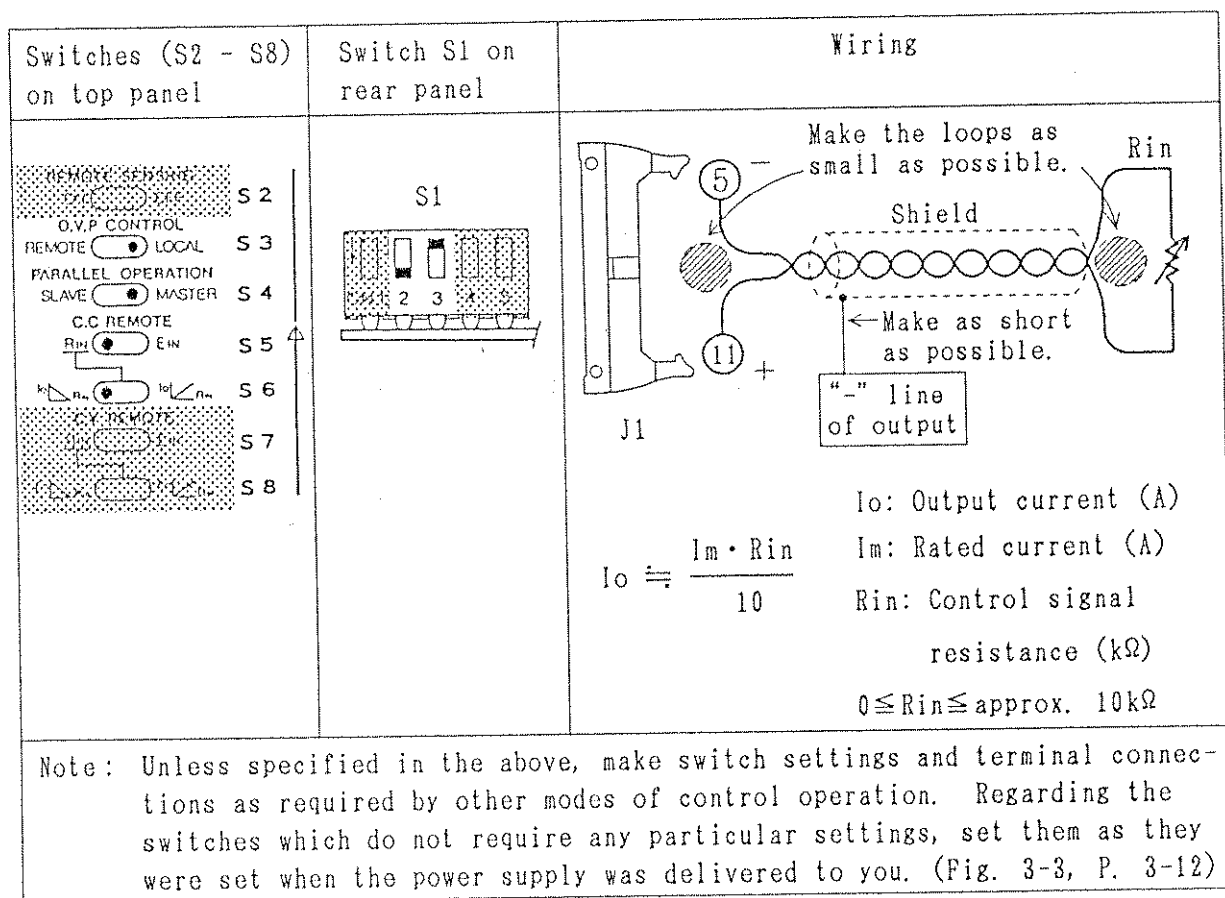

Notes: (a) The current which flows in the control resistor (R_{in}) is constant at approximately $I_m A$.

(b) For the resistor (R_{in}), use a quality resistor of 1/2 watt or more, with good temperature coefficient, aging and noise characteristics (such as a metallic film or wire-wound resistor.)

893406

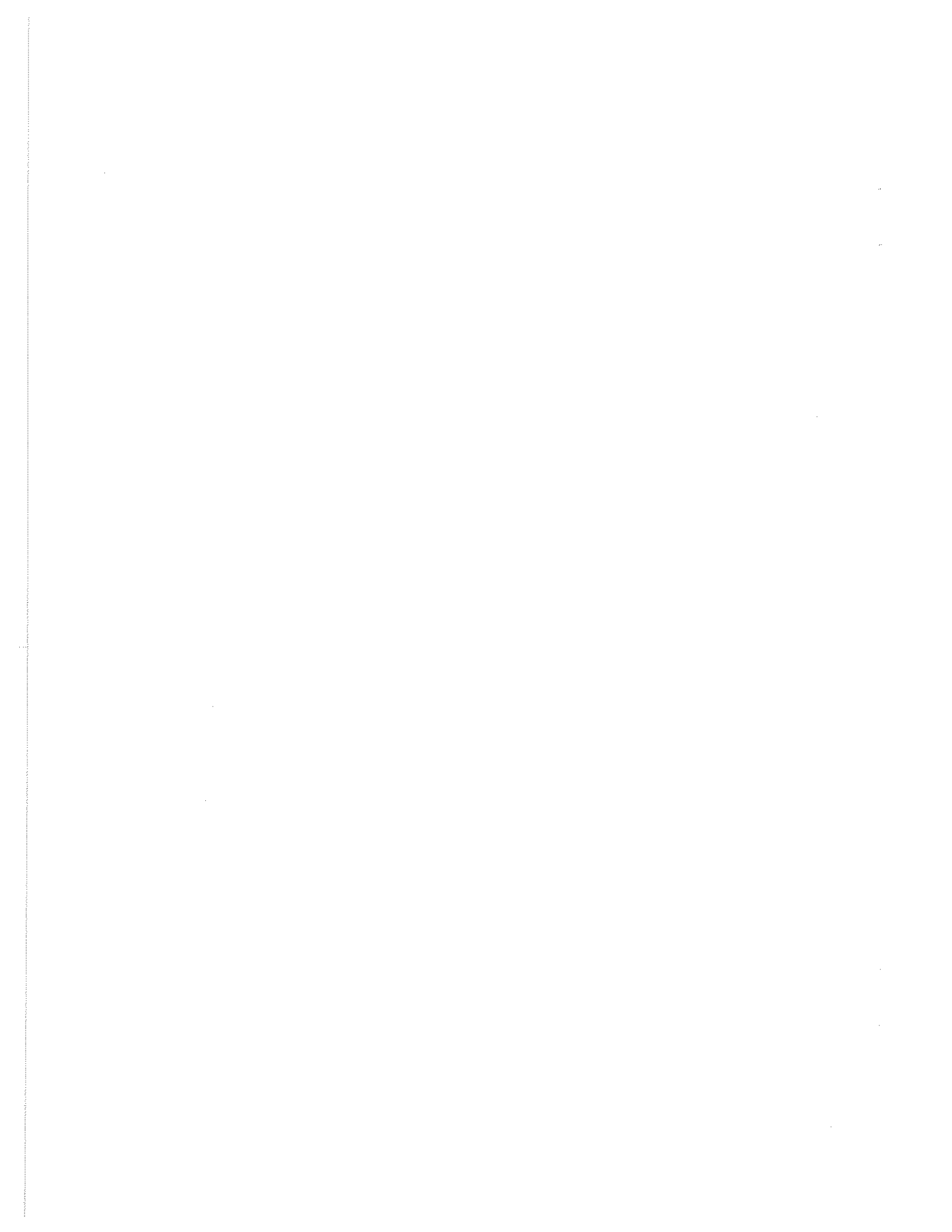

- (c) When the control resistance signal circuit is shorted, the power supply output current will increase to the rated current.
- (d) Connect the shielding wire of the signal cable to the "-" line of the power supply output, using a wire as short as possible.
- (e) Perform full-scale value adjustment and limit value indication calibration as required. (See Section 5.2.) Note that, due to tolerances of resistors used in the power supply, the output may not become zero when a resistor of 10 k Ω is used. Use a resistor which can cover additional variable ranges of approximately $\pm 15\%$ of the required controlling resistance range.
- (f) Linearity of the power supply output current with respect to the external control signal resistance is approximately 0.1% (typical), with normal line voltage (100V AC) and normal room temperature.

888407

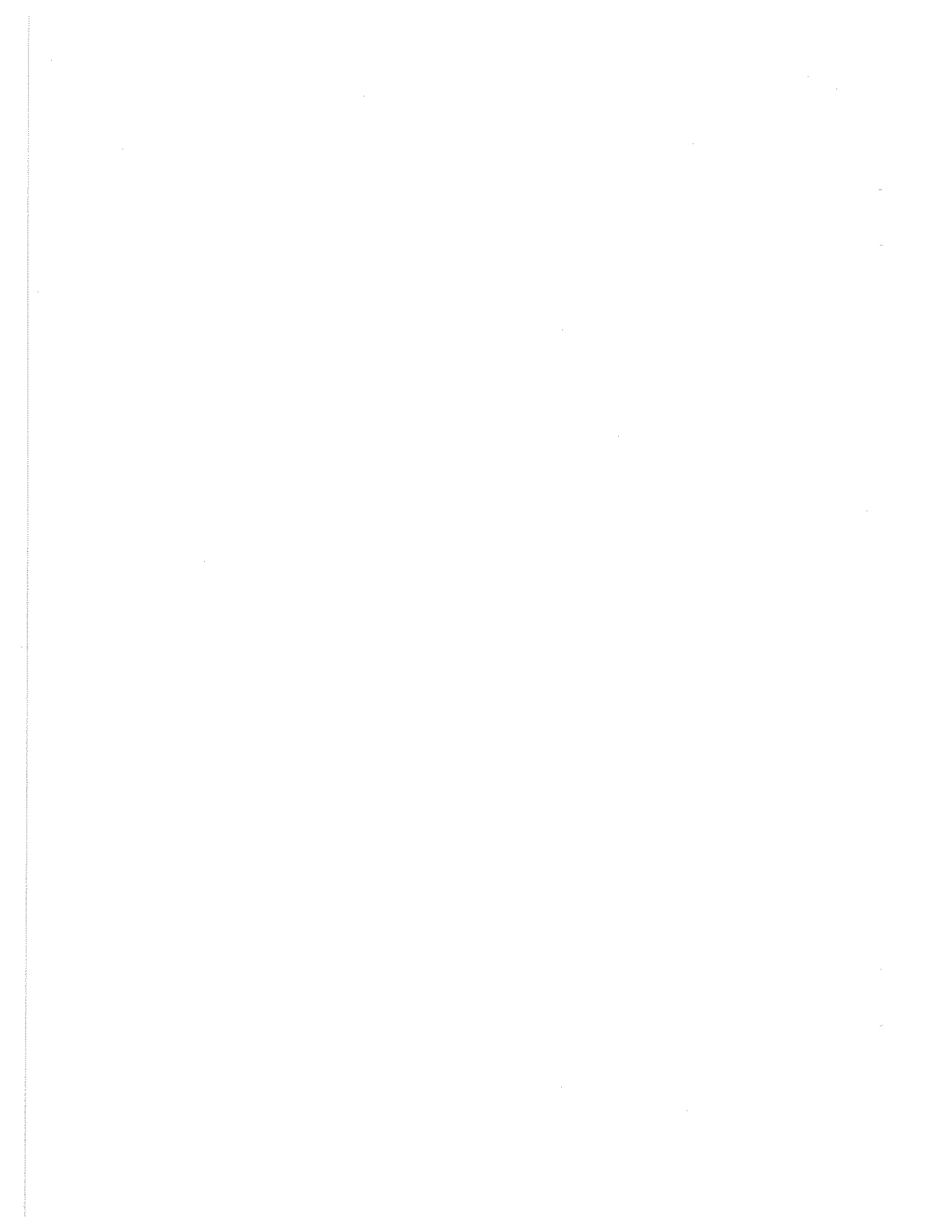

3.3.5 Master/Slave Parallel Operation

Two or three power supply units can be connected in parallel and operated in a master/slave mode, using one of them as a master unit which dictates the operation of all of them.

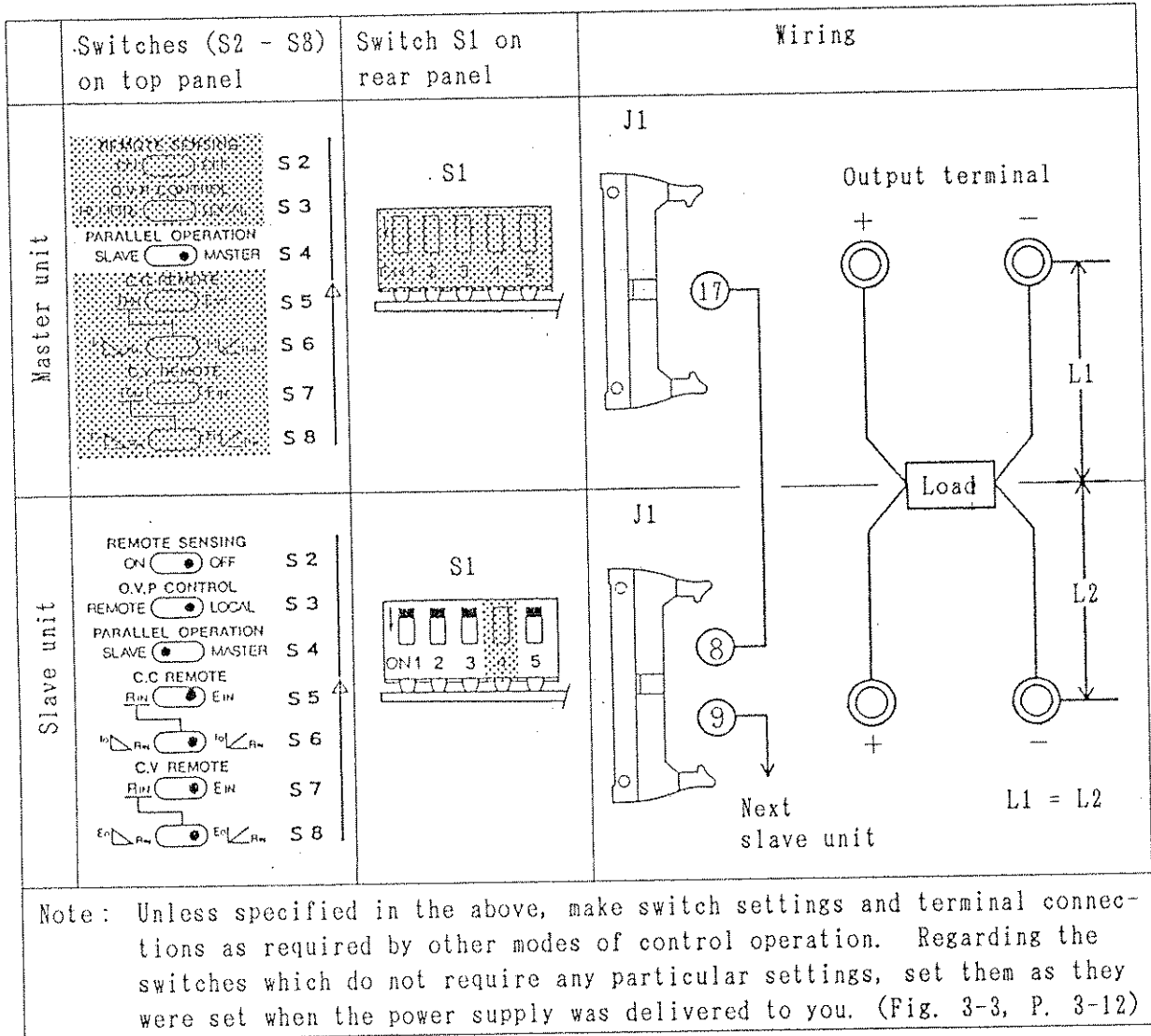

- Notes: (a) For connections from the power supply outputs to the load, use wires of the same gauge and same length (as short as possible).
- (b) Be sure that the "-" output terminals are securely connected.
- (c) The slave units also do not deliver their outputs unless their OUTPUT switches are turned on. For disabling the local operation of the OUTPUT switches of the slave units, see Section 3.3.6.

000408

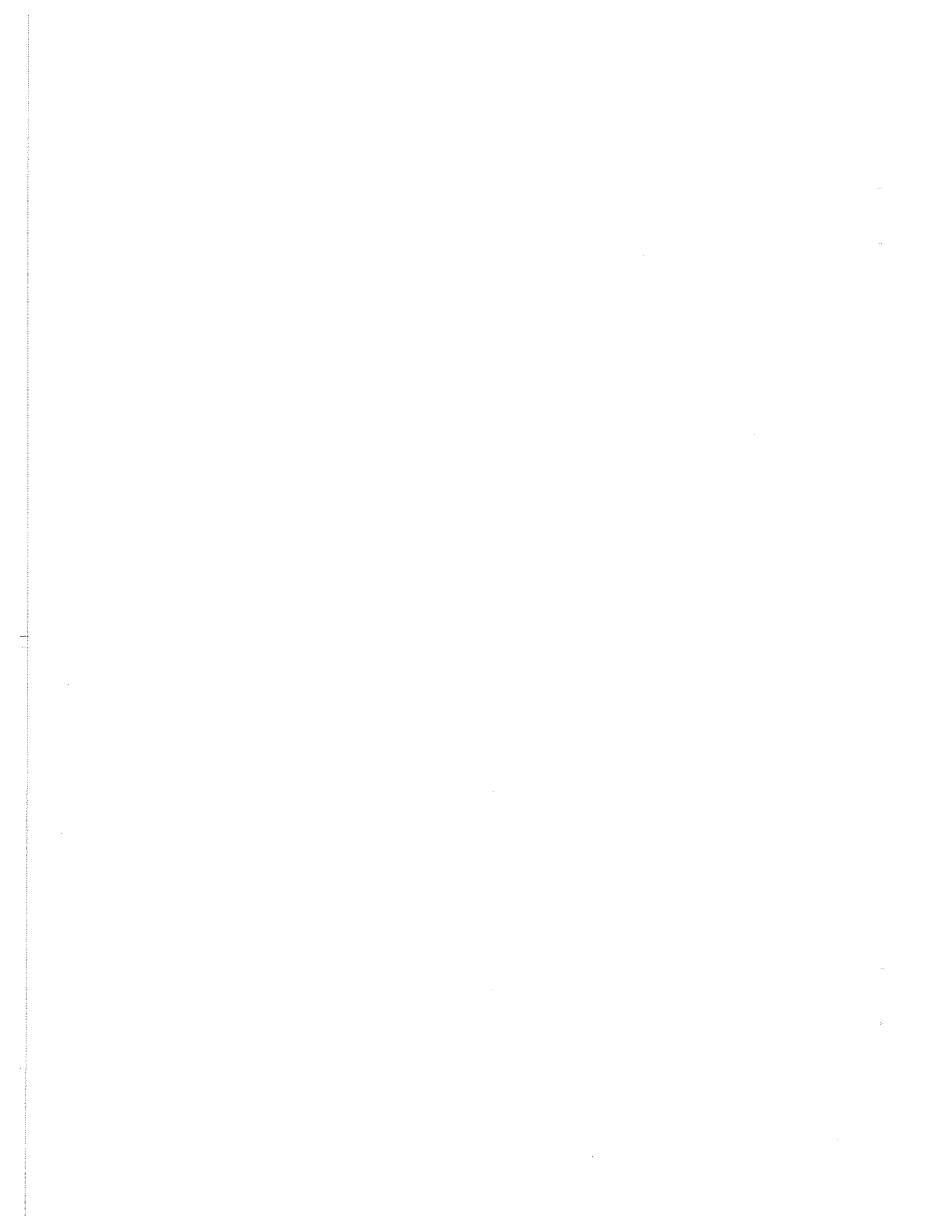

- (d) Set the output voltage of the slave unit(s) at a voltage higher than that of the master unit.
Normally, the slave unit(s) operate in the constant current mode.

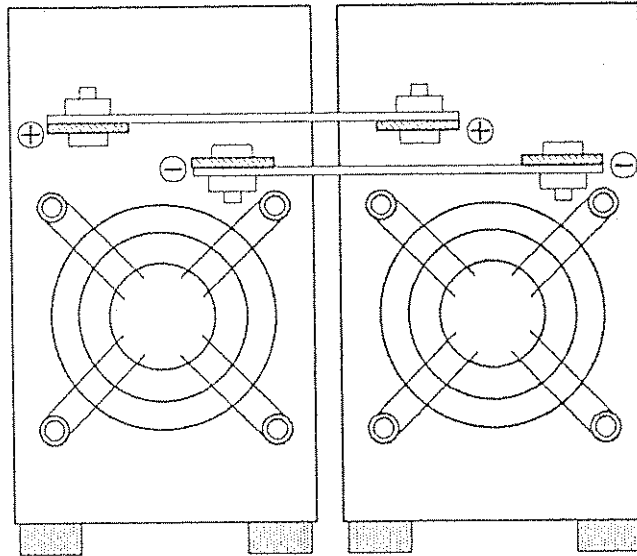

Parallel Connection

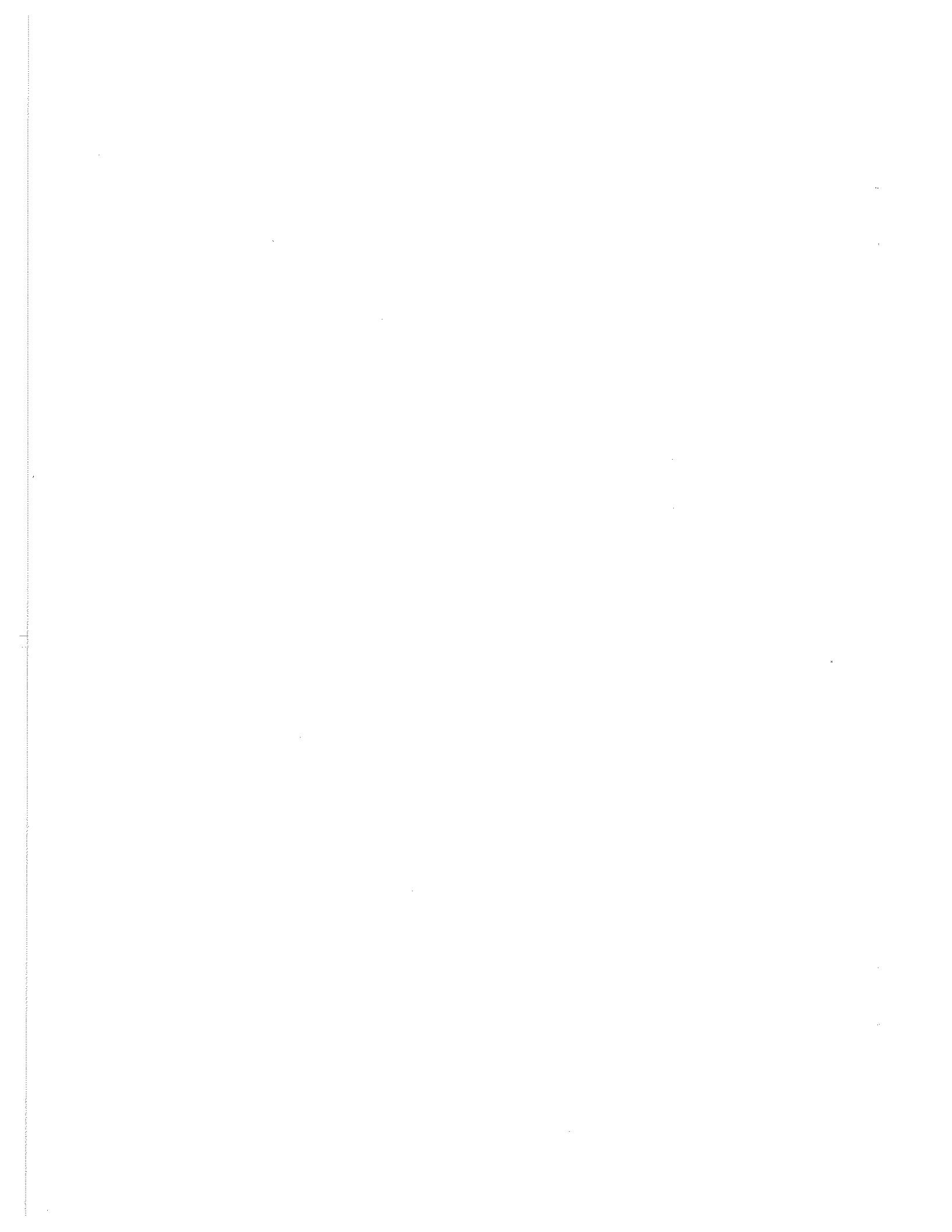

3.3.6 Remote ON/OFF-Control of Output

- (1) The output of the power supply can be on/off-controlled with an external contact signal.

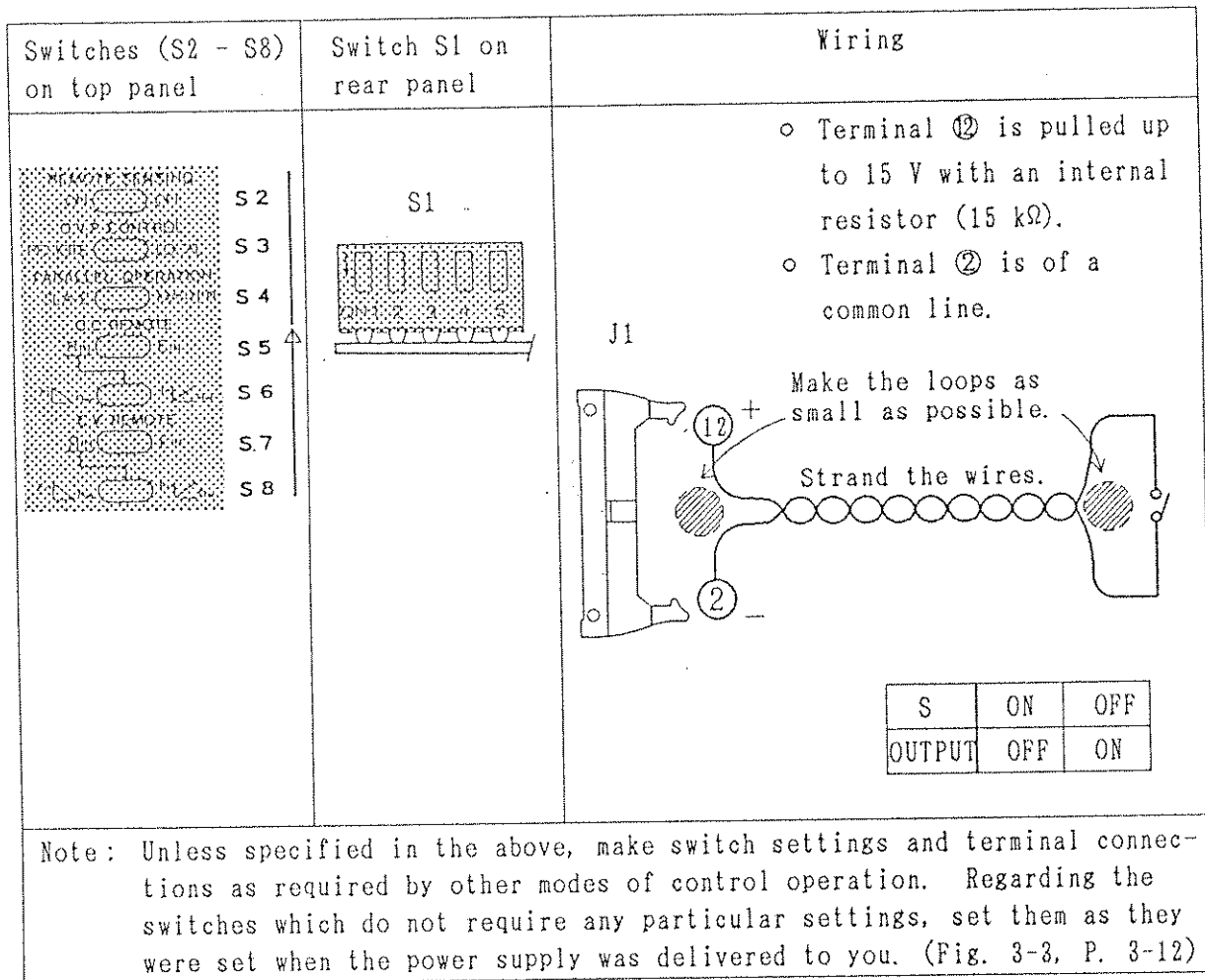

Notes: (a) The ON/OFF-control of the output is with a higher priority given to the OFF control.

The output is not delivered unless all of the front panel output switch (12), the GP-IB control signal, and the remote control signal applied via the rear terminals are ON.

- (b) The current which flows through switch (S) is not greater than 1 mA. The voltage across the switch when it is open is 15 V DC.

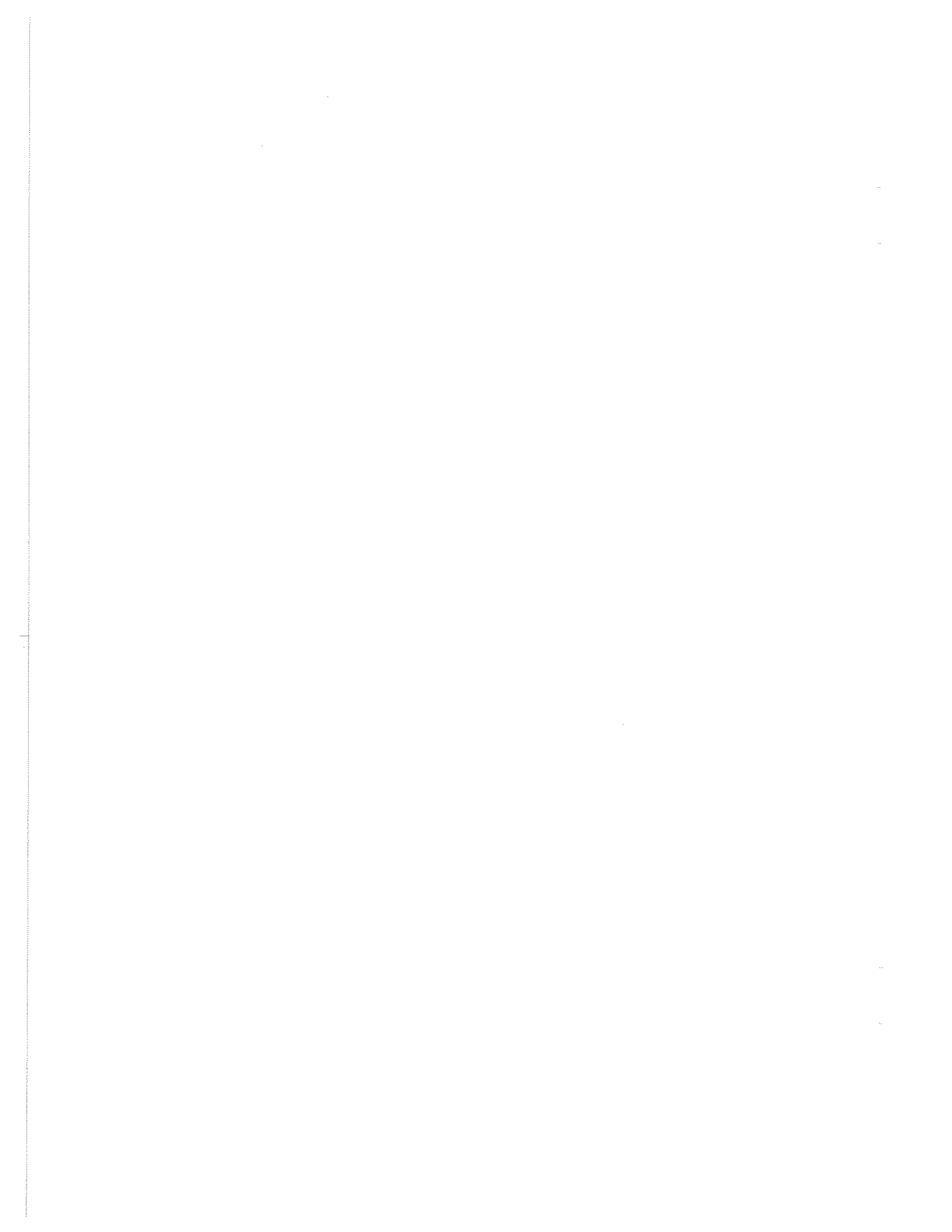

(2) Disabling the OUTPUT switch:

- (a) The OUTPUT switch on the front panel of the power supply can be disabled (held in the ON state) by setting the element switch 4 of S1 in the ON state. The power supply actually is started up at approximately 1 second after turning on the input POWER switch.
- (b) The output can be ON/OFF-controlled with a remote control signal even when 4 of S1 is set to ON.



3.3.7 Remote Control for Turning OFF the POWER Switch

The input POWER switch of the power supply can be turned OFF with an external contact signal.

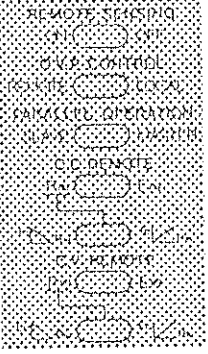
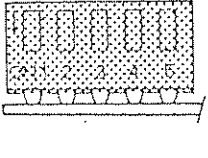
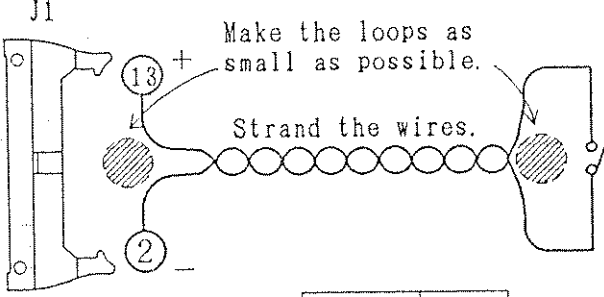
Switches (S2 - S8) on top panel	Switch S1 on rear panel	Wiring				
 <p>S 2 S 3 S 4 S 5 S 6 S 7 S 8</p>	<p>S1</p> 	<ul style="list-style-type: none"> ○ Terminal ⑬ is pulled up to 15 V with an internal resistor (22 kΩ). ○ Terminal ② is of a common line.  <p>Make the loops as small as possible.</p> <p>Strand the wires.</p> <table border="1" data-bbox="1112 1018 1318 1171"> <tr> <td>S</td> <td>ON</td> </tr> <tr> <td>Power Supply Switch</td> <td>OFF</td> </tr> </table>	S	ON	Power Supply Switch	OFF
S	ON					
Power Supply Switch	OFF					
<p>Note: Unless specified in the above, make switch settings and terminal connections as required by other modes of control operation. Regarding the switches which do not require any particular settings, set them as they were set when the power supply was delivered to you. (Fig. 3-3, P. 3-12)</p>						

Note: The current which flows through switch (S) is not greater than 1 mA. The voltage across the switch when it is open is 15 V DC.

883412

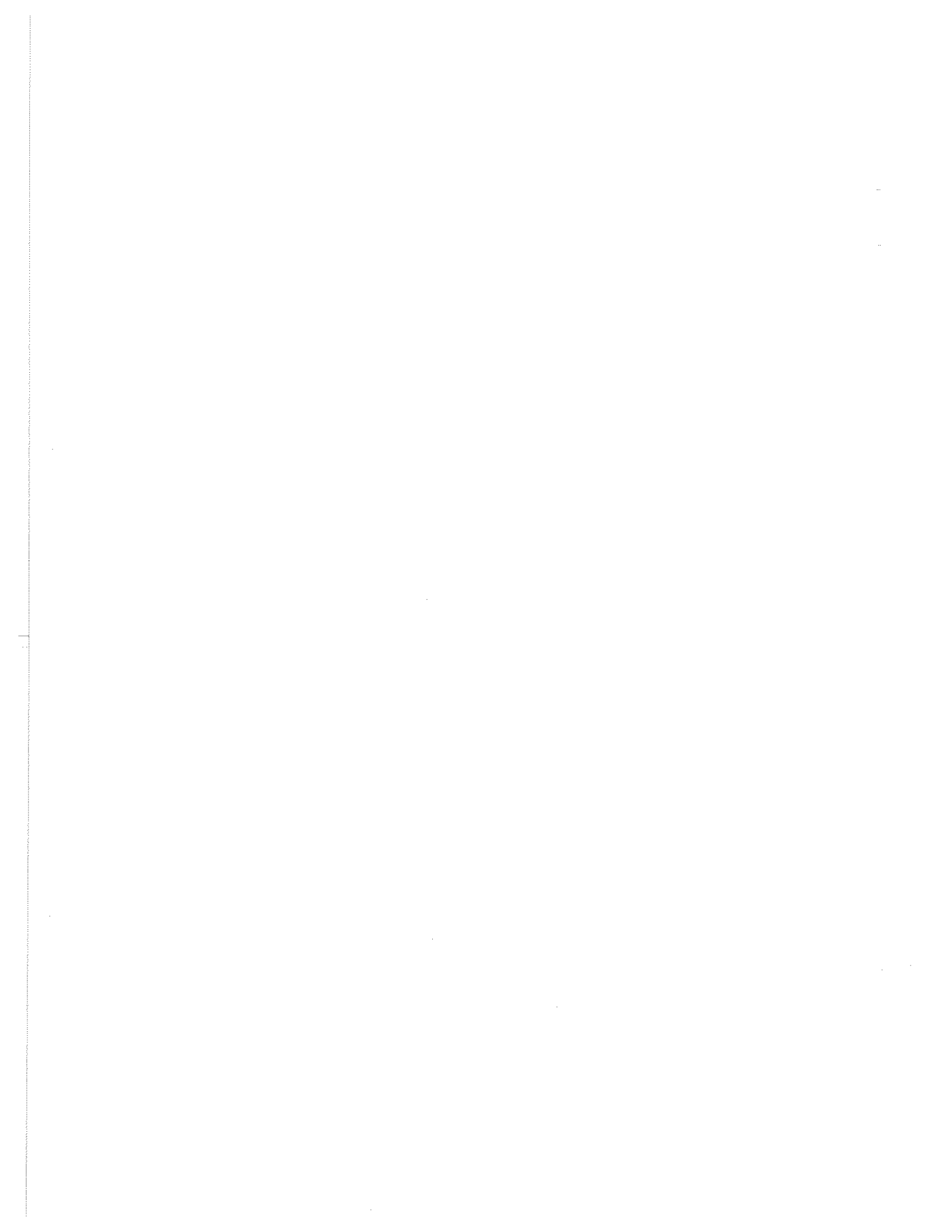

3.3.8 CV Monitor and CC Monitor

(1) Voltage Monitor

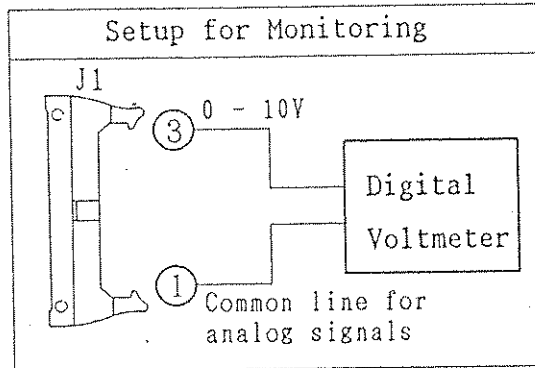

The voltage-monitoring voltage is approximately 0 to 10 V for the output voltage of 0 V to the rated voltage.

(2) Current Monitor

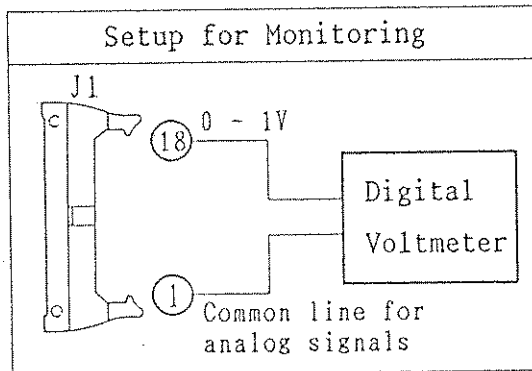

The current-monitoring voltage is approximately 0 to 1 V for the output current of 0 A to the rated current.

Notes: (a) Monitoring is with a voltmeter (not with any waveform display).

(b) The linearity of the monitor signal is approximately 0.1% (typical) when the power supply is operated with 100 V AC at normal room temperature.

(b) The common line of the monitor signal is connected to terminal ①, whose potential is identical with that of terminal ⑤.

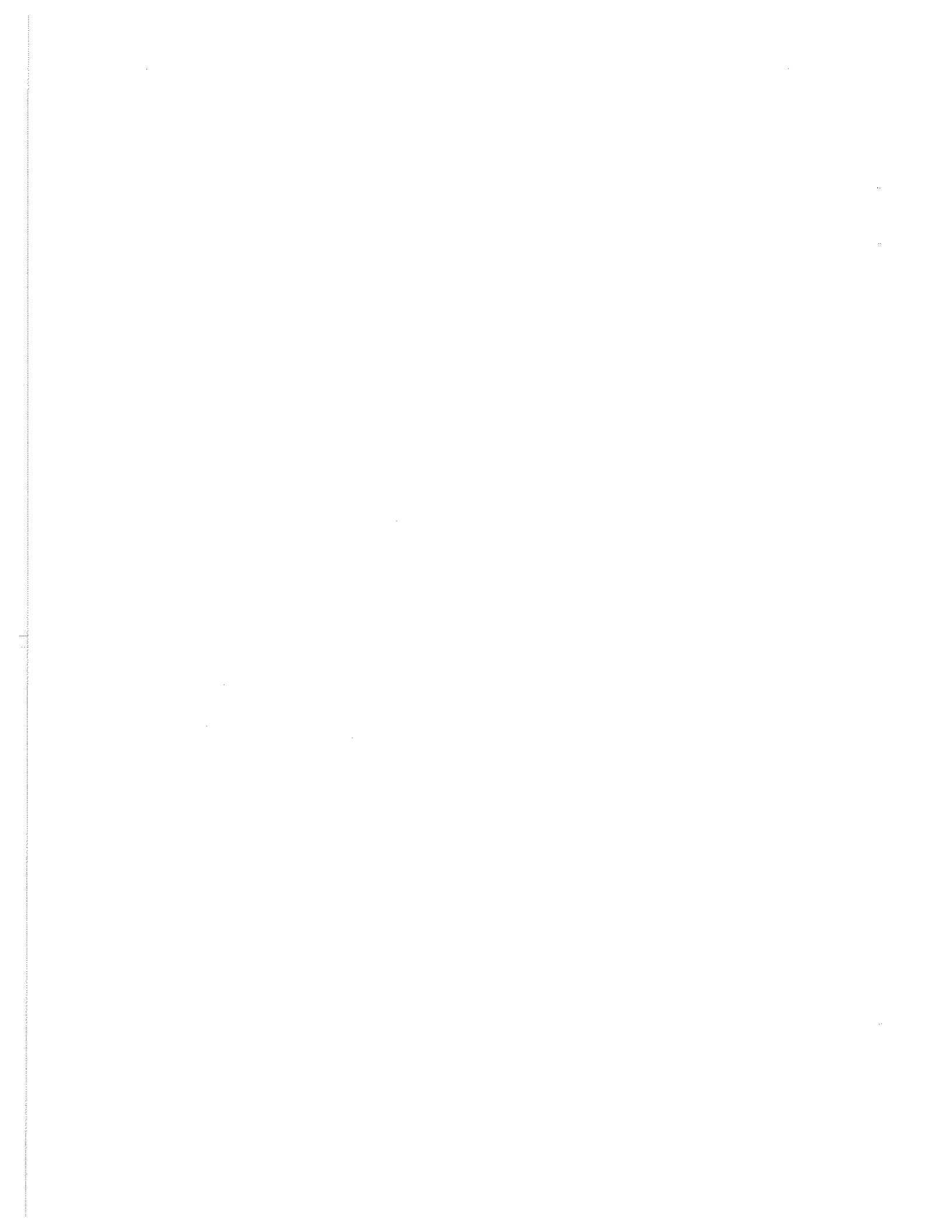

3.3.9 Output Signals

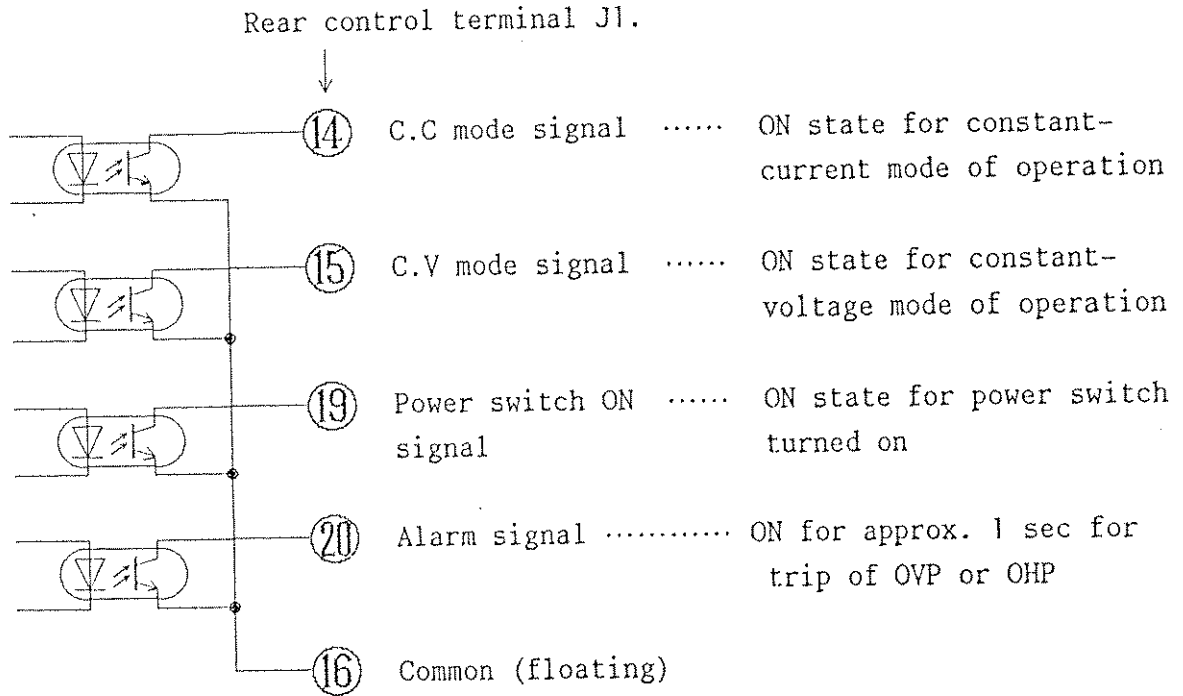

Photon coupled transistor rating
Maximum ratings ($T_a = 25^\circ\text{C}$)

	Parameter	Symbol	TLP521-1	Unit
Photo transistor	Collector-Emitter voltage	V_{CE0}	55	V
	Emitter-Collector voltage	V_{ECO}	7	V
	Collector current	I_c	50	mA
	Collector dissipation (signal circuit)	P_c	150	mW
	Derate collector dissipation derating ($T_a = 25^\circ\text{C}$ or over) (signal circuit)	$\Delta P_c/^\circ\text{C}$	-1.5	mW/ $^\circ\text{C}$
	Operating temperature	T_{opr}	-55 to 100	$^\circ\text{C}$
	Storage temperature	T_{str}	-55 to 125	$^\circ\text{C}$
	Permissible dissipation (signal circuit)	P_t	250	mW
	Permissible dissipation derating ($T_a = 25^\circ\text{C}$ or over) (signal circuit)	$\Delta P_t/^\circ\text{C}$	-2.5	mW/ $^\circ\text{C}$
	Isolation voltage (Note 1)	BV_s	2500	V _{rms}

(Note 1) AC, 1 minute R.H. = 40 to 60%

893414

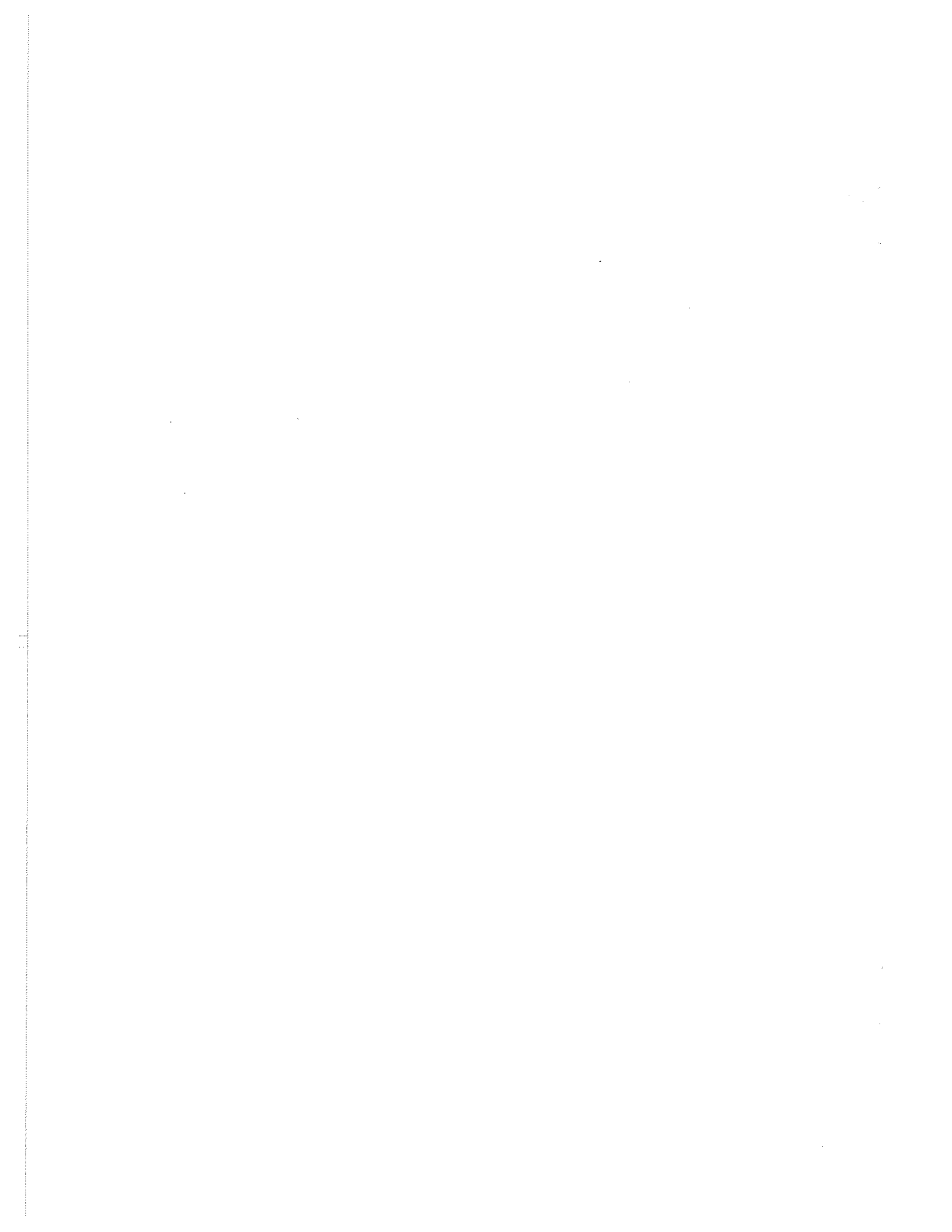

3.3.10 Series Operation and Parallel Operation

(1) Series Operation

Two or more units of PAK-A/PAK-AM Power Supplies can be operated being connected in series to obtain a higher output voltage.

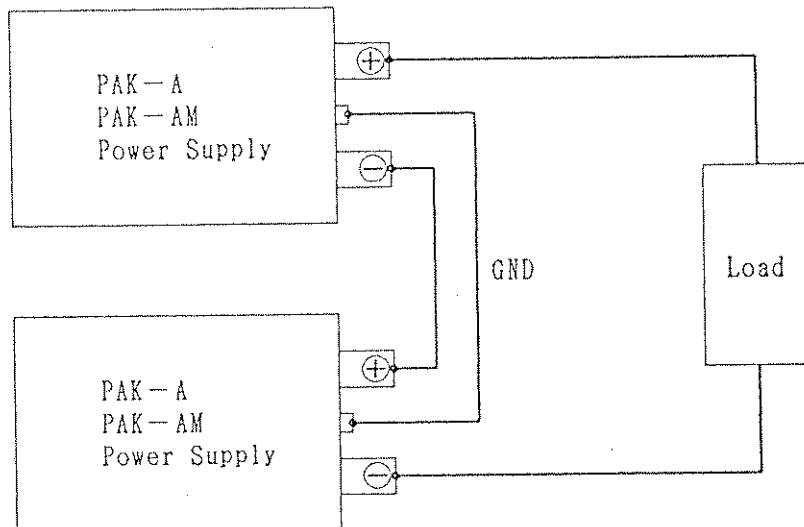

- Notes:
1. The number of power supplies which can be connected in series is restricted by the rated voltage (250V DC) of the power supplies with respect to ground.
 2. To make equal the chassis potentials of all power supplies, connect together the GND terminals of all power supplies and connect the ground line to a line of a potential you may require.
 3. Exercise care so that no current greater than the rated output current of the power supplies is fed. For example, if you connect in series two or more power supplies whose rated output currents are different, a current which is greater than the rated output current of the smaller power supply or supplies may be fed through by the larger power supply or supplies, thereby causing damage or burning of the smaller power supply or supplies. This occurs irrespective of whether the POWER switches or the OUTPUT switches of the smaller power supply or supplies are on or off. It is most recommendable to connect in series the power supplies of the same rated output current only.
 4. To deliver the output after connecting the power supplies in

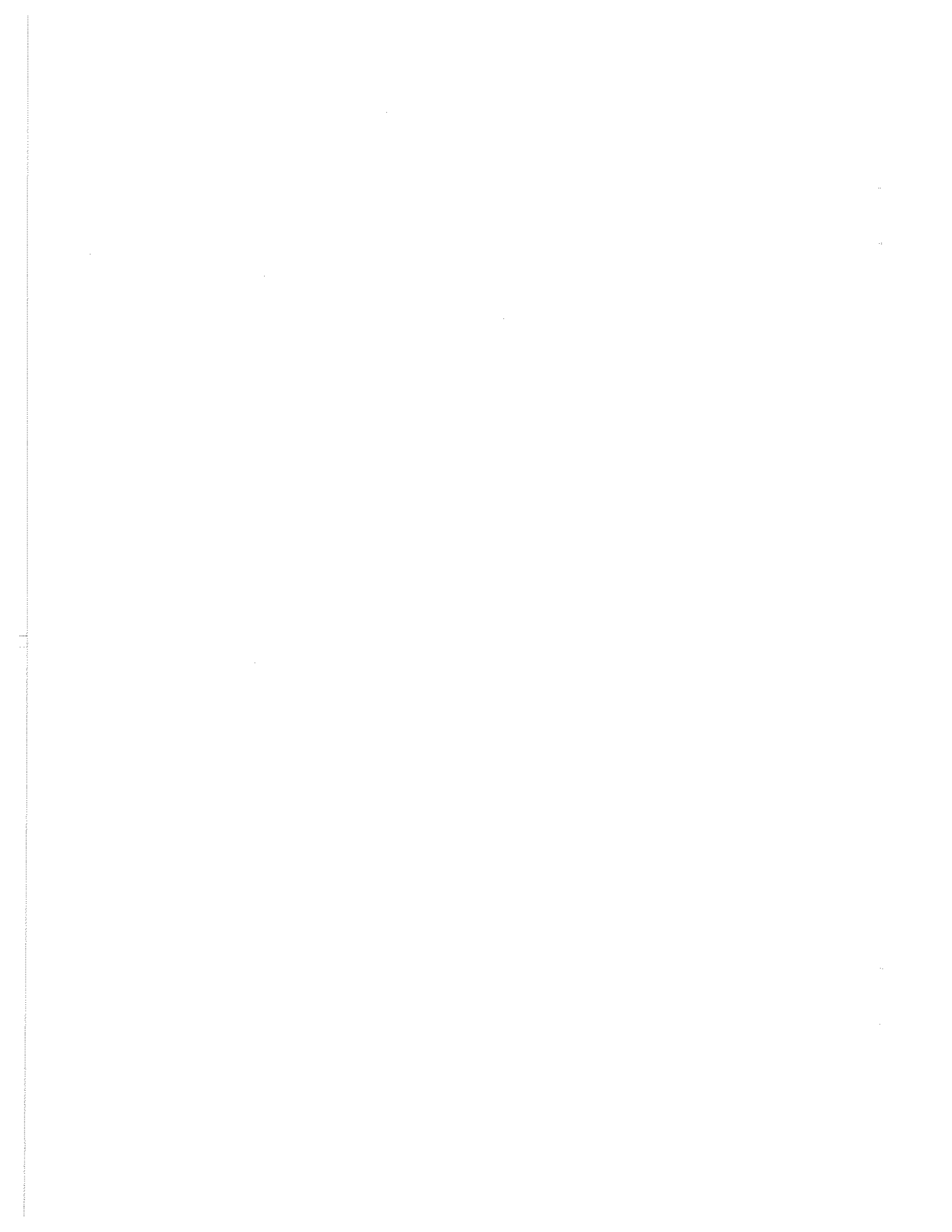

series, turn on the input power switches of all power supplies.

5. The remote sensing mode of operation is unavailable when in the series mode of operation.
6. The master-slave mode of operation is unavailable when in the series mode of operation.

(2) Parallel Operation

Two or more units of PAK-A/PAK-AM Power Supplies can be operated being connected in parallel to obtain a larger output current.

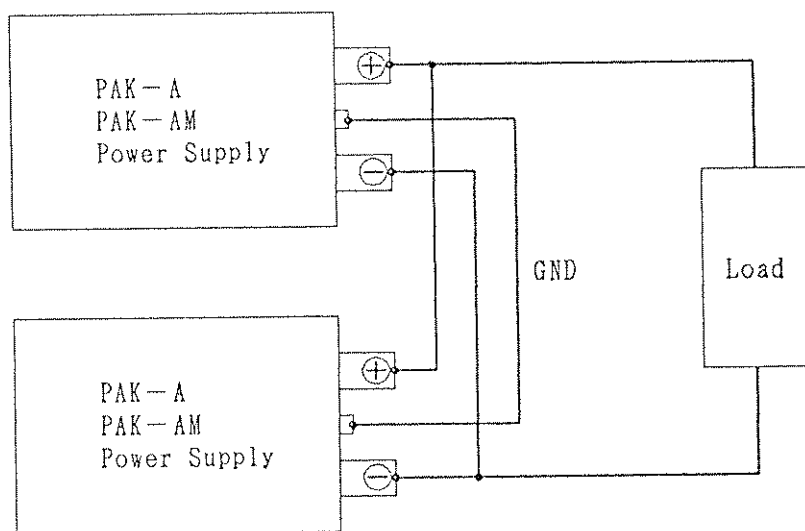

Notes: 1. Exercise care so that no voltage higher than the rated output voltage of the power supplies is applied. For example, if you connect in parallel two or more power supplies whose rated output voltages are different, a voltage which is higher than the rated output voltage of the smaller power supply or supplies may be applied by the larger power supply or supplies, thereby causing damage or burning of the smaller power supply or supplies. This occurs irrespective of whether the POWER switches or the OUTPUT switches of the smaller powersupply or supplies are on or off. It is most recommendable to connect in parallel the power supplies of the same output voltage only.

2. The remote sensing mode of operation is available by employing the master-slave mode of operation described in 3.3.5.

4. RACK ADAPTORS AND BLANK PANELS (OPTIONAL)

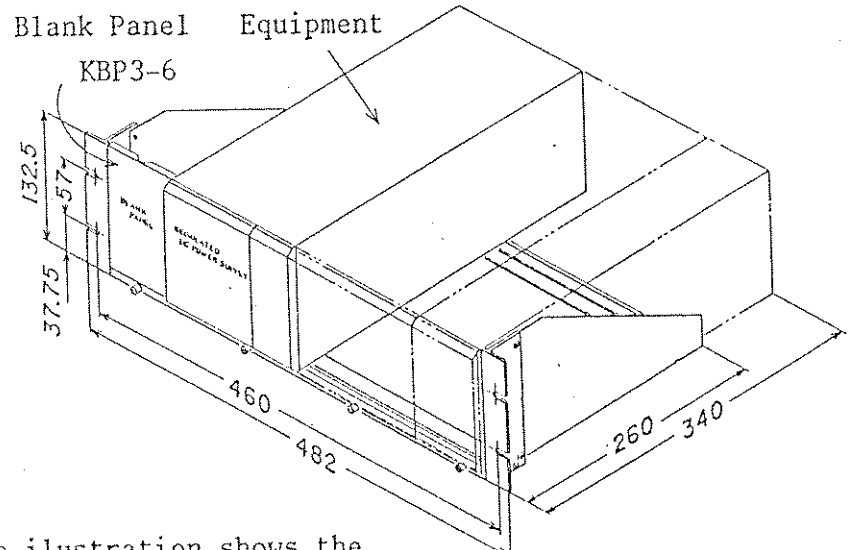
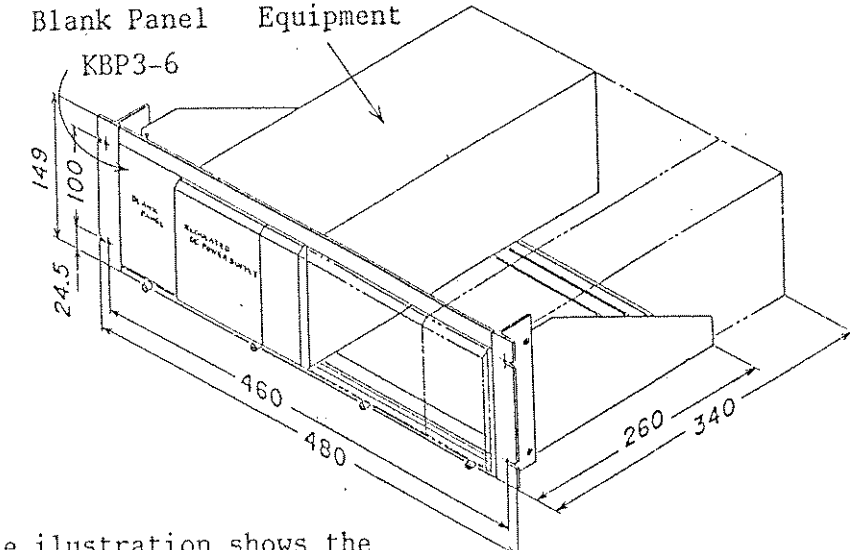
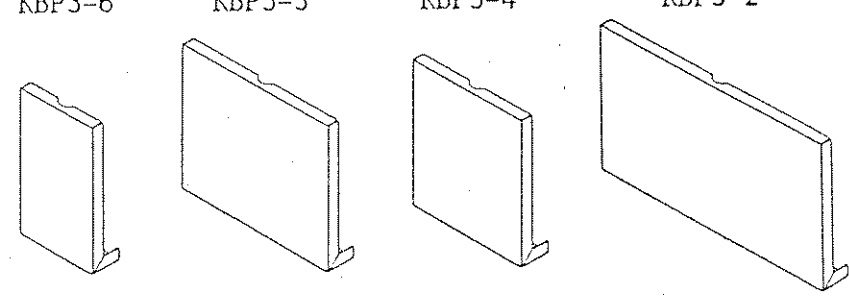
Frame or Panel	Shapes and Dimensions
<p>KRA3 Rack Adaptor (EIA Standard)</p>	 <p>The illustration shows the frame with an equipment installed on it.</p>
<p>KRA150 Rack Adaptor (JIS Standard)</p>	 <p>The illustration shows the frame with an equipment installed on it.</p>
<p>KBP3-6 Blank Panel 1/6 KBP3-3 Blank Panel 1/3 KBP3-4 Blank Panel 1/4 KBP3-2 Blank Panel 1/2</p>	 <p>These panels are only for KRA3 (optional) and KRA150 (optional).</p>

For details, refer to the instruction sheet for the rack mount frame.

893417

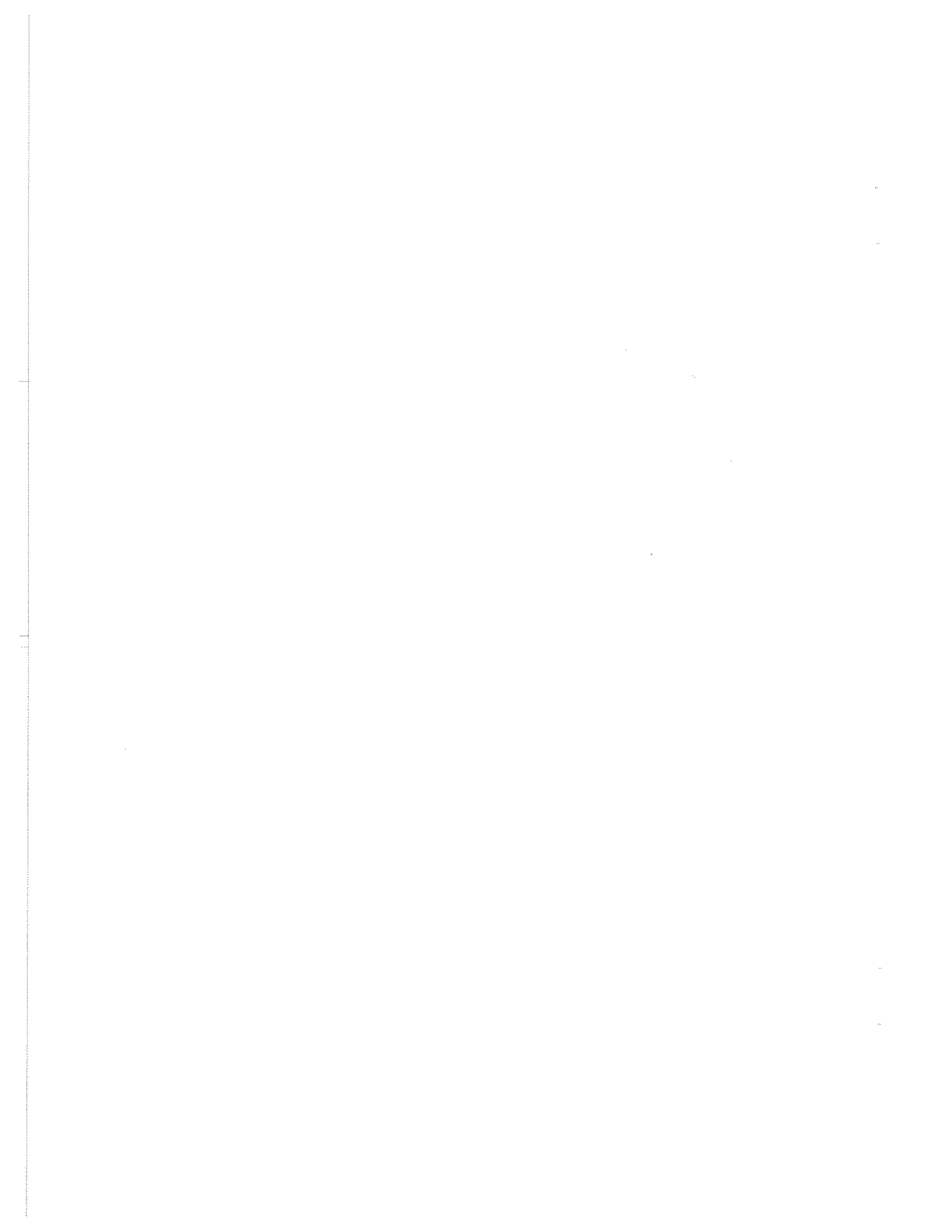

5. MAINTENANCE AND CALIBRATION

It is most recommendable to render maintenance and calibration service for the instrument at certain intervals. The maintenance and calibration items are covered in this section.

5.1 Maintenance

The recommendable maintenance items are as mentioned in the following.

5.1.1 Cleaning the Instrument

- When the panel surfaces have become dirty, wipe them lightly with a cloth moistened with neutral soap or alcohol and then wipe them a dry cloth. Never use benzine, thinner, or other chemical detergent.
- If the air filter is clogged, cooling of the instrument will be degraded and troubles may result. Clean the filter periodically, lest it should be clogged. For the cleaning procedure of the filter, see Section 3.1, Item (5) "Cleaning the Air Filter."
- When dust is collected on the louvers and internal components of the instrument, blow them with compressed air. (The exhaust air of a vacuum cleaner may be used for this purpose.)

5.1.2 Inspecting the AC Power Cord

Inspect the AC power cord of the instrument for damage of the cable sheath, breakage of the plug, and loosening of the plug screw.

5.2 Removing/Installing the Casing

5.2.1 Removing the Casing

To remove the instrument casing, proceed as follows:

- (1) Disconnect the AC power cord from the AC line outlet and leave the instrument in this state for about one minute or more. (This is necessary to let the charges inside the instrument fully discharged.)
- (2) Remove the flush-head screws (M3-6) of the top and bottom panels.
- (3) Remove the screws (M3-6, with lock washers) of the rear panel.
- (4) Remove the casing by pulling it backward of the instrument.

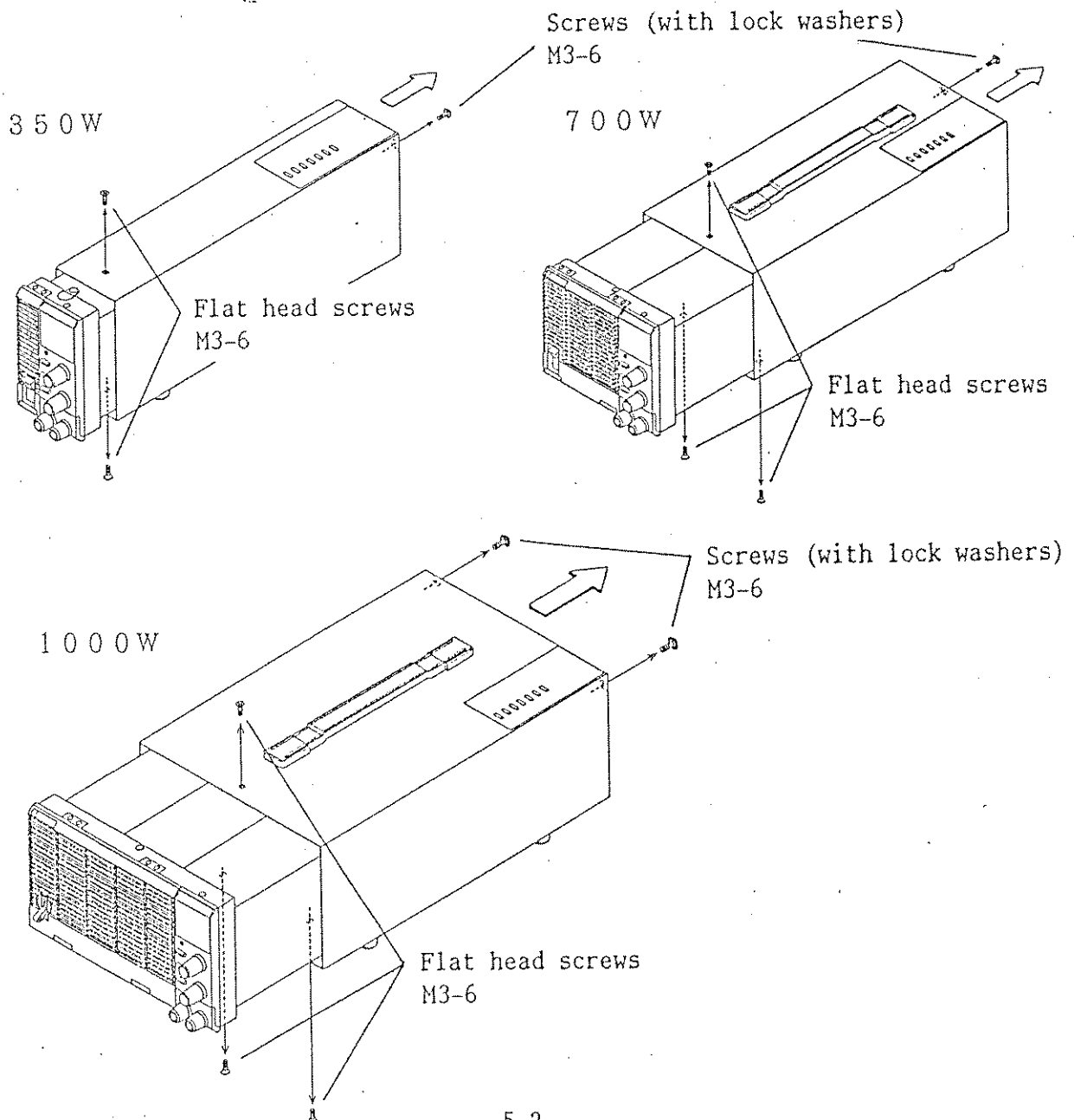

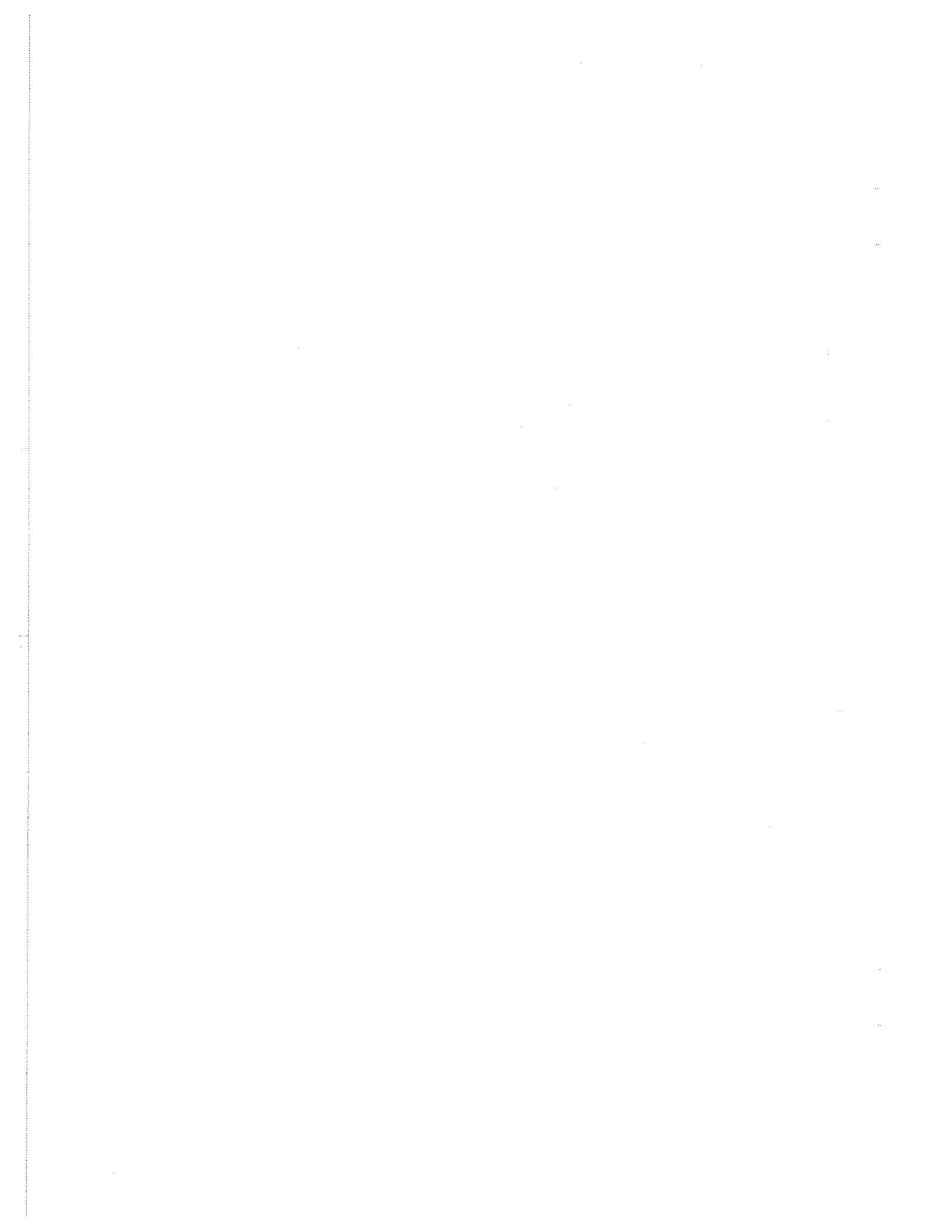

5.2.2 Installing the Casing

To install the instrument casing, proceed as follows:

- (1) Slide the casing onto the instrument from its rear, exercising care so that the casing does not hit the internal components or wiring.
- (2) Fix the screws (M3-6, with lock washers) of the rear panel.
- (3) Fix the flush-head screws (M3-6) of the top and bottom panels.

5.3 Adjustment and Calibration

The adjusting and calibrating procedures of the instrument are described in this section, referring to the Figure 5-1 "Master Control Board." Unless specified otherwise, allow a warm up time of 10 minutes or more before starting adjustment and calibration.

(1) Calibration of Voltmeter

Connect to the instrument output a digital voltmeter (DVM) whose accuracy is 0.02% or better. Calibrate the instrument voltmeter at the rated voltage by adjusting potentiometer RV16.

(2) Adjustment of Output Voltage

Adjust the output voltage in the order of ①, ②, and ③. Be sure to observe this order.

① Offset Adjustment of Output Voltage

This adjustment is to attain the state that the output voltage is zero volts when the input is zero.

Connect to the instrument output a DVM whose accuracy is 0.02% or better. Set the instrument to a state for zero-volt output (turn the control knob fully counterclockwise when in the local operation or apply a zero-volt signal or a zero-ohm signal when in the remote operation), and adjust potentiometer RV5 so that the output becomes zero volts. (When the instrument is delivered with the standard setting, the instrument is with a zero-point offset of a range of -50 mV to -100 mV.)

Next, proceed to Steps ② and ③.

② Full Scale Adjustment of Output Voltage

This adjustment is to set the full-scale output voltage of the instrument.

003421

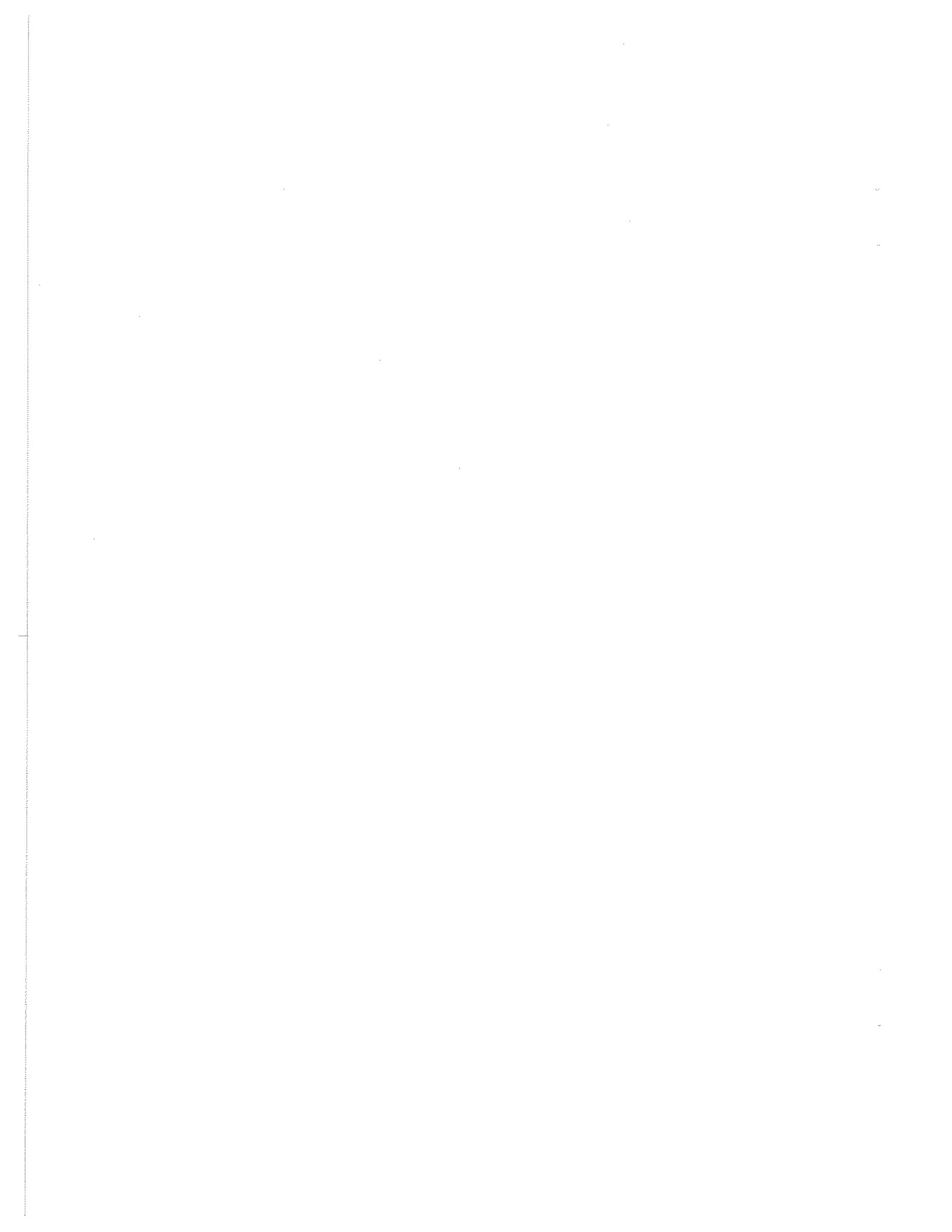

Connect to the instrument output a DVM whose accuracy is 0.02% or better. Set the instrument for a state for full-scale output (turn the control knob fully clockwise when in the local operation or apply a 10-volt or 10-kilo-ohm signal when in the remote operation), and adjust potentiometer RV1 so that the output becomes the full-scale voltage. (when the instrument is delivered with the standard setting, the full-scale output voltage is set at approximately 105% of the rated output voltage.)

Next, proceed to Step ③.

③ Calibration of C.V Limit Indication

Be sure that the voltmeter has been correctly calibrated.

Make the instrument output circuit open at the rated voltage and press the limit switch. In this state, adjust potentiometer RV7 so that the voltmeter indicates the corresponding voltage.

(3) Calibration of Ammeter

Connect to the instrument output a calibration setup (current measuring setup) of an accuracy of 0.1% or better (e.g. a precision shunt resistor and a digital voltmeter). Calibrate the ammeter as follows:

① Zero Calibration of Ammeter

Note: This calibration is not required for Model 350W. For the 350W, proceed to Step ② "Full Scale Calibration of Ammeter."

Set the output current at zero amperes as measured with the calibration setup. Adjust potentiometer RV19 so that the instrument ammeter indicates zero amperes.

② Full Scale Calibration of Ammeter

Be sure that zero calibration of the ammeter has been correctly done as described in Step ①, except for Model 350W. Set the output current at the rated current as measured with the calibration setup, put back the cover (do not neglect this instruction), and allow a warm up

053422

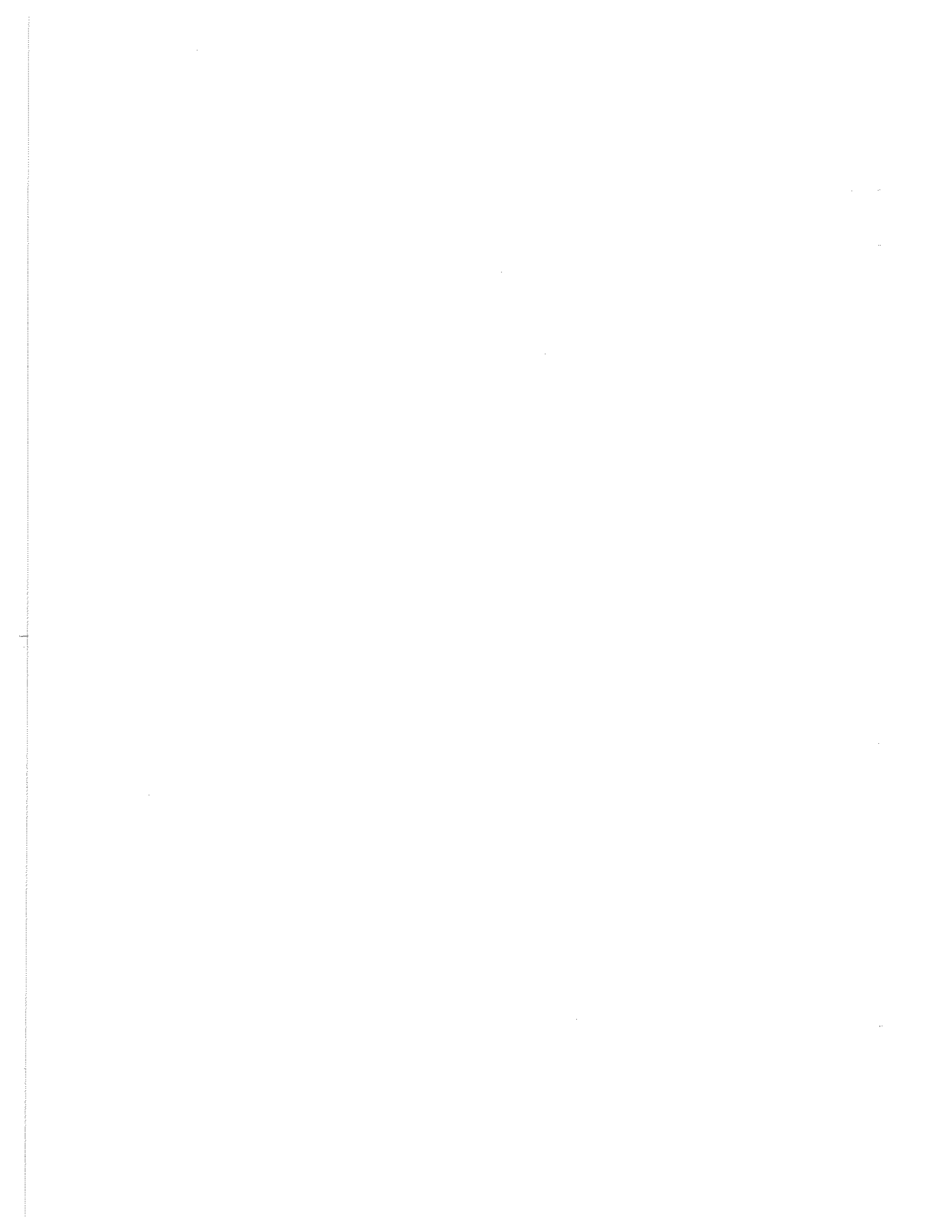

time of approximately 30 minutes (see Precaution 1). Adjust potentiometer RV15 so that the instrument ammeter indicates the rated current conforming with that indicated by the calibration setup.

Precaution 1: Whenever warming up the instrument feeding its output current, be sure to put back the cover. Never feed the output current more than 30 seconds unless the cover is installed.

(4) Adjustment of Output Current

Adjust the Output current in the order of ①, ②, and ③. Be sure to observe this order.

① Offset Adjustment of Output Current

This adjustment is to attain a state that the output current is zero amperes when the input is zero.

Connect to the instrument output a calibration setup (current measuring setup) of an accuracy of 0.1% or better (e.g. a precision shunt resistor and a digital voltmeter). Set the instrument to a state for zero-ampere output (turn the control knob fully counterclockwise when in the local operation or apply a zero-volt or zero-ohm signal when in the remote operation), and adjust potentiometer RV6 so that the output becomes zero amperes. (When the instrument is delivered with the standard setting, the instrument is with a zero-point offset of a range of -0.5 mA to -100 mA.)

Next, proceed to Steps ② and ③.

② Full Scale Adjustment of Output Current

This adjustment is to set the full scale output current of the instrument.

Connect to the instrument output a calibration setup (current measuring setup) of an accuracy of 0.1% or better (e.g. a precision shunt resistor and a digital voltmeter). Set the output current at the full scale current as measured with the calibration setup, put back the

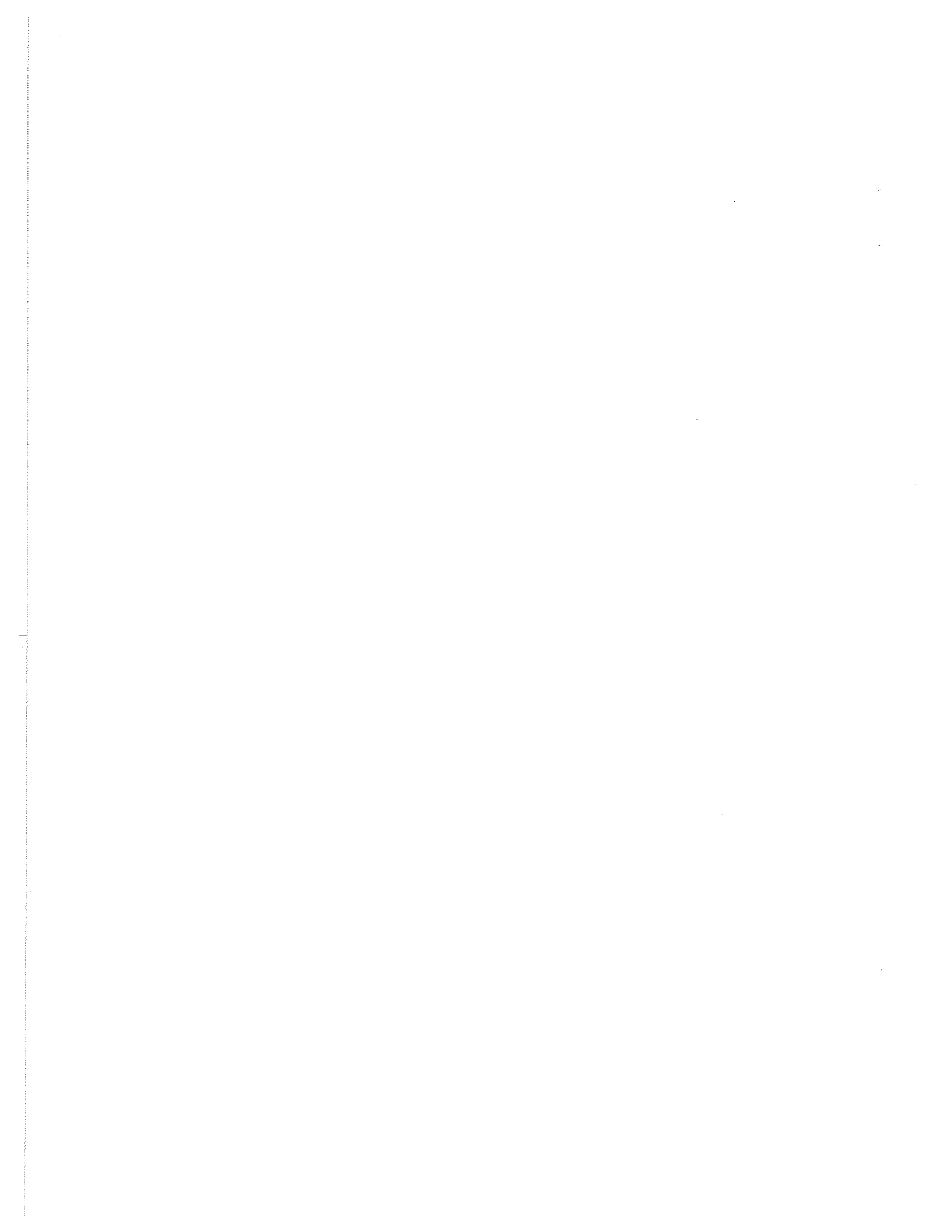

cover (do not neglect this instruction), and allow a warm up period of approximately 30 minutes (see Precaution 1). Adjust potentiometer RV3 so that the calibration setup indicates the full scale value. (When the instrument is delivered with the standard setting, the full scale value is set at approximately 105% of the rated current for local operation with the panel control.)

Next, proceed to Step ③

③ Calibration of C.C Limit Indication

Be sure that the ammeter has been correctly calibrated.

Increase the output current to the rated current of the instrument and press the limit switch. In this state, adjust potentiometer RV8 so that the ammeter indicates the corresponding current.

(5) Calibration of Voltage Monitor

To calibrate the voltage monitor, refer to Section 3.3.8 and proceed as follows:

① Offset Adjustment

Connect to the instrument output a digital voltmeter of accuracy 0.02% or better. Set the output at zero volts as measured with the digital voltmeter. Adjust potentiometer RV13 so that the voltage monitor output signal becomes zero volts.

② Full Scale Adjustment

Connect to the instrument output a digital voltmeter of accuracy 0.02% or better. Set the output at the rated voltage as measured with the digital voltmeter. Adjust potentiometer RV17 so that the voltage monitor output signal becomes 10 volts.

(6) Calibration of Current Monitor

To calibrate the current monitor, refer to Section 3.3.8 and proceed as follows:

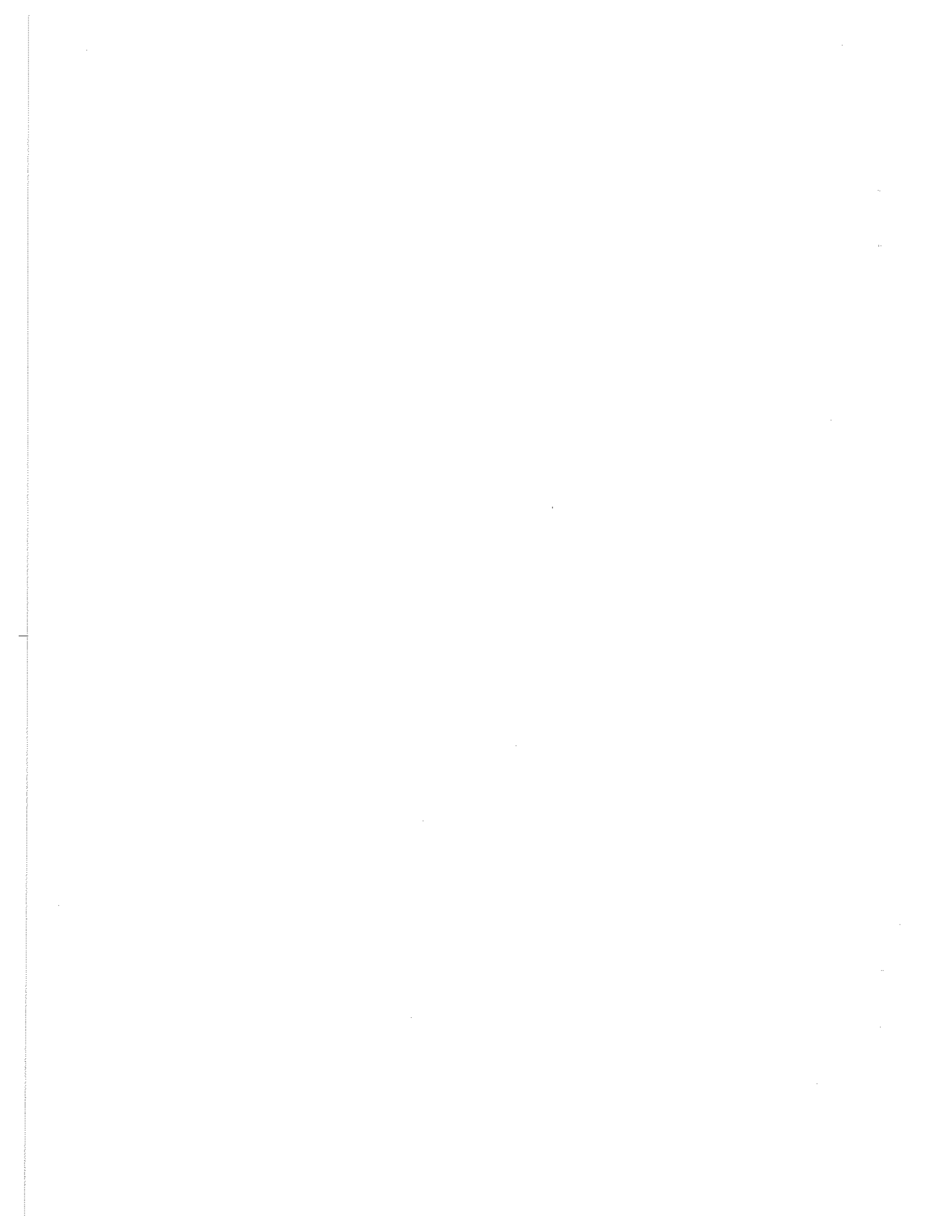

① Offset Adjustment

Connect to the instrument output a calibration setup (current measuring setup) of accuracy 0.1% or better (e.g. a precision shunt resistor and a digital voltmeter). Set the output current at zero amperes. Adjust potentiometer RV11 so that the current monitor output signal becomes zero amperes.

② Full Scale Adjustment

Connect to the instrument output a calibration setup (current measuring setup) of accuracy 0.1% or better (e.g. a precision shunt resistor and a digital voltmeter). Set the output at the rated current, put on the cover (do not neglect this instruction), and allow a warm up period of approximately 30 minutes (see Precaution 1). Adjust potentiometer RV9 so that the current monitor output signal becomes 1 volt.

(7) Calibration of Preset OVP Indication

Connect to the instrument output a digital voltmeter of accuracy 0.02% or better. Set the output at the rated voltage. Slowly turn counter-clockwise the OVP setting knob on the front panel to the point where the OVP trips (the input power switch is turned off). Read the trip voltage on the digital voltmeter. Adjust potentiometer RV18 so that the voltmeter reading when the preset switch is pressed becomes identical with the trip voltage.

Prohibition: The potentiometers other than those mentioned in the above are critical ones. Never attempt to adjust them for yourself.

When you have inadvertently disturbed any of settings of these critical potentiometers, stop using the instrument and consult your kikusui agent for repair.

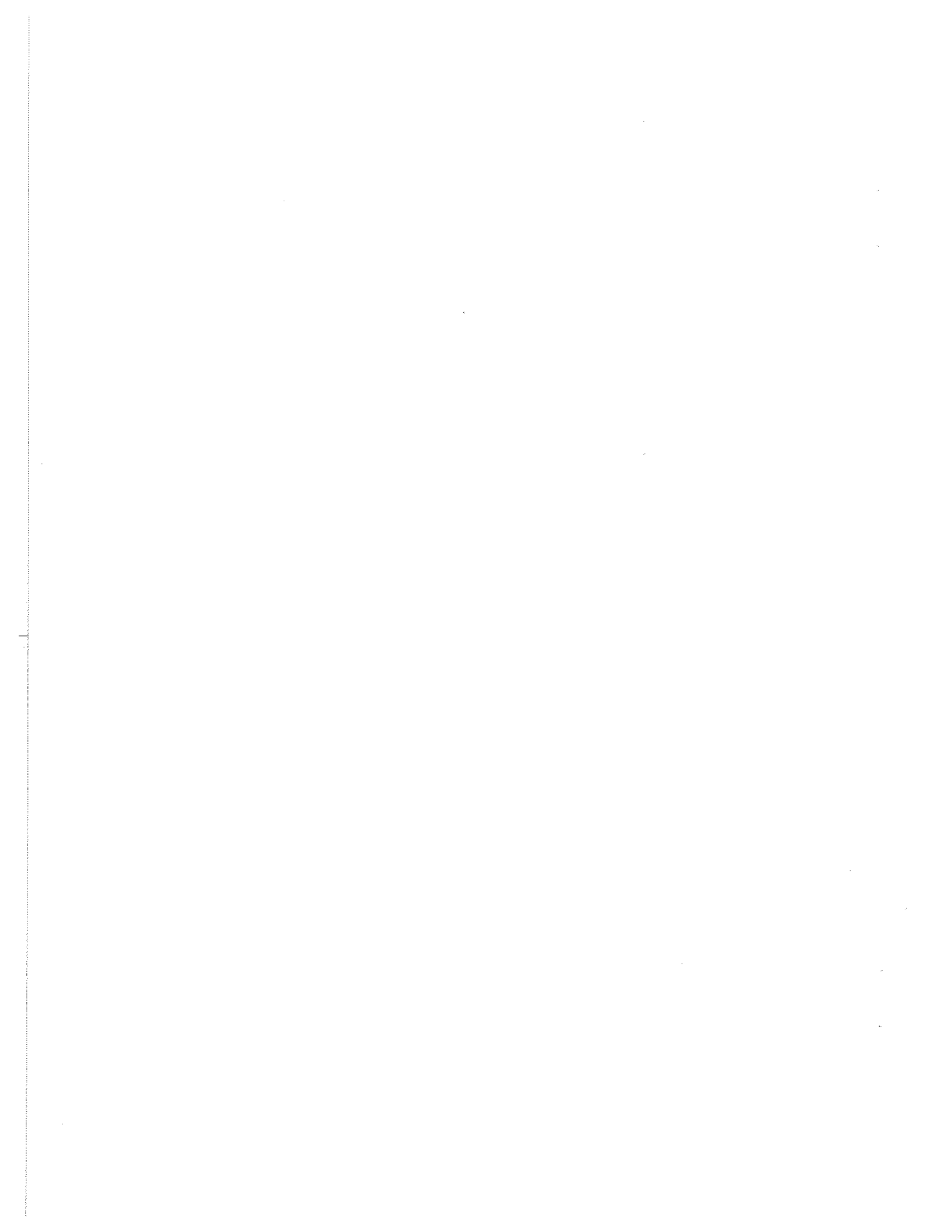

RV16
Voltmeter cal.

RV17
Voltage monitor
full scale adj.

RV3
Output current
full scale adj.

RV1
Output voltage
full scale adj.

RV6
Output current
offset adj.

RV5
Output voltage
offset adj.

RV19
Ammeter zero adj.
* except 350W type

RV13
Voltage monitor
offset adj.

RV18
Preset O.V.P
meter cal.

RV9
Current monitor
full scale adj.

RV11
Current monitor
offset adj.

RV8
C.C limit
meter cal.

RV7
C.V limit
meter cal.

RV15
Ammeter cal.

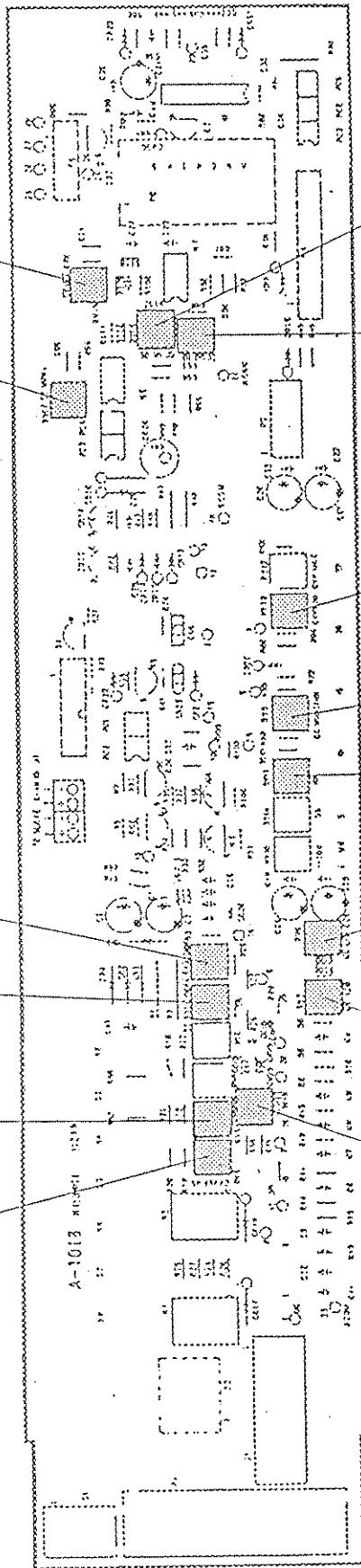

Figure 5-1
Control Circuit
Board A-1018



5.4 Troubleshooting

Simple troubleshooting procedures to be followed by the user are shown in the below table. If the trouble cannot be remedied by following the procedures shown in the table, the power supply may have failed and, if this is the case, please order your Kikusui agent for repair.

Prohibition: The troubleshooting rendered by the user for himself should be limited to the items given in the below table, as a general rule. Note that Kikusui may not accept repair orders if the power supply is unduly repaired or modified by the user for himself.

Symptom	Items to be Checked	Probable Cause
The power supply does not operate at all even when its input POWER switch is turned on.	1. Check that the line power is supplied to the input terminal.	<ul style="list-style-type: none"> ○ Open circuiting of input power cable ○ Wrong connection of input power cable
The power supply displays no indications at all.	2. The above item is in the normal state.	<ul style="list-style-type: none"> ○ Equipment failure
The input POWER switch cannot be turned on.	1. Check that the input voltage is normal.	<ul style="list-style-type: none"> ○ The input voltage is too high.
	2. Check that no alarm signal is generated. (See Section 3.3.9.)	<ul style="list-style-type: none"> ○ Trip of OVP (Note 1)
	3. Check that the input POWER switch is not remote-controlled for OFF. (See Section 3.3.9.)	<ul style="list-style-type: none"> ○ The remote control signal is in the ON state.
	4. The above items are in the normal states.	<ul style="list-style-type: none"> ○ Equipment failure

893427



Symptom	Items to be Checked	Probable Cause
No output is delivered even when the input POWER switch and OUTPUT switch are turned on. The OUTPUT lamp illuminates.	1. Check that the VOLTAGE and CURRENT controls are correctly set.	○ The controls are set at full counterclockwise positions.
	2. Check that the setup for remote control operation is correct.	○ Incorrect setting of switch S1 on rear panel or switch S2 on top panel, or wrong wiring to the control terminals
	3. Check that no alarm signal is generated. (See Section 3.3.9.)	○ Trip of overheat protector (Note 2)
	4. The above items are in the normal states.	○ Equipment failure
The output is unstable.	1. Check that remote-sensing setup is correctly made. (See Section 3.3.2.)	○ Open circuiting or wrong connections of remote-sensing setup ○ Wrong connection of capacitor
	2. Check that remote control operation is correctly done. (See Section 3.3.)	○ Remote control signal voltage or resistance is unstable. ○ Wrong wiring
	3. Check that the input AC line voltage is normal and stable.	○ The input AC line voltage is lower than the specified limit. ○ The input source includes large noise.
	4. The above items are in the normal states.	○ Equipment failure

Note 1 : Correctly set the OVP.

Note 2 : Eliminate the causes of overheating (such as clogging of the intake air filter and blocking of the cooling air outlet), and leave the input POWER switch in the ON state for approximately 15 minutes. In this case, keep the OUTPUT switch in the OFF state.

893428

