

# TABLE OF CONTENTS

## Arbitrary Waveform Generator Users Guide



### 1. General

Installation and Safety	1-3
Getting Started	1-8

### 2. Introductory Tutorial

Creating a simple Arbitrary Waveform	2-1
--------------------------------------	-----

### 3. Waveform Viewing

Waveform Selection	3-3
Display Setup	3-7
Zooming	3-10

### 4. Live Waveform Manipulation

Time Cursors	4-1
Voltage Cursors	4-3
Edit Time	4-5
Duration	4-5
Move Feature	4-6
Delay	4-6
Edit Amplitude	4-8

### 5. Insert Wave

From Scope	5-2
Standard Waves	5-4
Equations	5-7
Other Waves	5-26

### 6. Waveform Editing

Clearing the Display	6-1
Editor Properties and Options	6-3
Insert	6-5
Cut	6-6
Paste	6-9

**Table of Contents**

---

- 7. Sequence Waveforms**
  - Sequence Editor .....7-3
  - Sequence Example .....7-5
  - Group Sequences .....7-11
- 8. Waveform Math**
  - Dual Waveform Math .....8-8
  - Example .....8-8
- 9. Adding Noise to A Waveform**
  - Adding noise on the LW400/LW400A .....9-3
  - Adding Noise on the LW400B .....9-3
  - Controlling Noise .....9-4
- 10. Project Structure**
  - Project Import .....10-5
  - Project Export .....10-7
- 11. Hardcopy**
  - Printers .....11-3
  - Storing Graphics Files .....11-4
  - File Naming .....11-5
- 12. Importing & Exporting Waveform Files**
  - Spreadsheet .....12-9
  - MathCad .....12-10
  - PSpice .....12-12
  - MatLab .....12-13
  - EasyWave File .....12-15
  - LeCroy Scope File .....12-16
  - Other Files .....12-17
  - Exporting Files .....12-18

**13. Setting the Clock**

LW400 Clock .....13-2  
LW400A/B Clock .....13-6  
External Reference—Synchronization .....13-9

**14. Marker**

Programming the Marker .....14-2  
Clocking with the Marker .....14-4

**15. Trigger**

Trigger Setup .....15-1

**16. Interfaces**

Centronics .....16-2  
GPIB .....16-3

**17. Function Generator**

Standard Functions .....17-2

**18. Disk Utilites**

Floppy Disk .....18-1  
Hard Disk .....18-2

**Appendix A: Measurement Functions Description**



**Appendix B: WaveStation Specifications**

**Appendix C: LW400-09A Digital Output Option**



**Warranty**

LeCroy warrants operation under normal use for a period of one year from the date of shipment. Replacement parts and repairs are warranted for 90 days. Accessory products not manufactured by LeCroy are covered by the original equipment manufacturers' warranties.

In exercising this warranty, LeCroy will repair or, at its option, replace any product returned to the factory or an authorized service facility within the warranty period only if the warrantor's examination discloses that the product is defective due to workmanship or materials and the defect has not been caused by misuse, neglect, accident, or abnormal conditions or operations.

The purchaser is responsible for transportation and insurance charges. LeCroy will return all in-warranty products with transportation prepaid.

This warranty is in lieu of all other warranties, express or implied, including but not limited to any implied warranty of merchantability, fitness, or adequacy for any particular purpose or use. LeCroy Corporation shall not be liable for any special, incidental, or consequential damages, whether in contract or otherwise.

**Product Assistance**

Help with installation, calibration, and the use of LeCroy products is available from your local LeCroy office or a LeCroy customer service center.

**Maintenance Agreements**

LeCroy offers a choice of customer support services to meet your individual needs. Extended warranty maintenance agreements let you budget maintenance costs after the initial warranty has expired. Other services such as installation, training, calibration, enhancements and on-site repair are available through specific Supplemental Support Agreements. Contact your local LeCroy office or a LeCroy customer service center for details.

## General Information

---

### RETURN A PRODUCT FOR SERVICE OR REPAIR

If you do need to return a LeCroy product, identify it for us using both its model and serial numbers (see rear of instrument). Describe the defect or failure, and provide your name and contact number. For factory returns, use a Return Authorization Number (RAN), obtainable from customer service. Attach it so that it can be clearly seen on the outside of the shipping package to ensure rapid redirection within LeCroy. Return those products requiring only maintenance to your customer service center.

Within the warranty period, transportation charges to the factory will be your responsibility, while all in-warranty products will be returned to you with transport prepaid by LeCroy. Outside the warranty period, you will have to provide us with a purchase-order number before the work can be done. And you will be billed for parts and labor related to the repair work, as well as for shipping.

You should pre-pay return shipments. LeCroy cannot accept COD (Cash On Delivery) or Collect Return shipments. We recommend using air-freight.

**TIP:** If you need to return your WaveStation, try to use the original shipping carton. If this is not possible, the carton used should be rigid and be packed so that that the product is surrounded by a minimum of four inches, or 10 cm, of shock-absorbent material.

### Software Upgrades

To determine the software revision presently installed:

- 1) press 2nd then  soft key on the front panel.
- 2) press Page Down
- 3) observe SW Rev: line on the display

### To update Revision:

- 1) Turn off instrument power
- 2) Insert floppy disk
- 3) Power on instrument and the firmware will be updated

**Operating Environment**

The WaveStation will operate to its specifications if the environment is maintained within the following parameters:

- Temperature: 5° to 35° C to full specifications,  
0° to 40° C operating, -20° to 70° C non-operating
- Humidity: 10% to 80% non-condensing
- Altitude: < 2000 Meters (6560 ft)
- Operation: Indoor use only

This equipment complies to Safety Standards per EN 61010-1 (Safety Requirements for Electrical Equipment for Measurement, Control, and Laboratory Use). It has been qualified to the following EN 61010-1 categories:







- Installation (Overvoltage) Category II
- Pollution Degree 2.

**Safety Symbols**

Where these symbols or indications appear on the front or rear panels, and in this manual, they have the following meanings:



**CAUTION:** Refer to accompanying documents (for Safety-related information). *See elsewhere in this manual wherever the symbol is present, as indicated in the Table of Contents.*

<p style="text-align: center;"> <b>On</b> (Supply)</p> <p style="text-align: center;"> Alternating Current Only</p> <p style="text-align: center;"> Protective Conductor Terminal</p>	<p style="text-align: center;"> <b>Off</b> (Supply)</p> <p style="text-align: center;"> <b>CAUTION</b>, Risk of electric shock</p> <p style="text-align: center;"> Earth Terminal</p>
--	--

**WARNING**

Denotes a hazard. If a WARNING is indicated on the instrument, do not proceed until its conditions are understood and met.

## Installation and Safety

---



### Warning

**Any use of this instrument in a manner not specified by the manufacturer may impair the instrument's safety protection.**

**The WaveStation has not been designed for use in making direct measurements on the human body. Users who connect a WaveStation directly to a person do so at their own risk.**

### Power Requirements



The WaveStation operates from a 115 V (90 to 132 V) or 230 V (180 to 250 V) AC ( $\sim$ ) power source at 47 Hz to 63 Hz. No voltage selection is required, since the instrument automatically adapts to the line voltage present.

The power supply of the WaveStation is protected against short-circuit and overload by means of one internal 5.0A/250 V  $\sim$ , "T" rated fuse. The fuse is not replaceable by the user.

The WaveStation has been designed to operate from a single-phase power source, with one of the current-carrying conductors (neutral conductor) at ground (earth) potential. Maintain the ground line to avoid an electric shock.

None of the current-carrying conductors may exceed 250 V rms with respect to ground potential. The WaveStation is provided with a three-wire electrical cord containing a three-terminal polarized plug for mains voltage and safety ground connection. The plug's ground terminal is connected directly to the frame of the unit. For adequate protection against electrical hazard, this plug must be inserted into a mating outlet containing a safety ground contact.

### Power On

Connect the WaveStation to the power outlet and switch it on by pressing the power switch located on the front panel. After the instrument is switched on, a self test is performed. The full testing procedure takes approximately 30 seconds, after which time a display will appear on the screen.



Do not exceed the maximum specified input voltage levels. (See appendix B for details.)





**CAUTION**

**Risk of electrical shock: No user serviceable parts inside. Leave repair to qualified personnel.**

**Cleaning And Maintenance**

Maintenance and repairs should be carried out exclusively by a LeCroy technician. Cleaning should be limited to the exterior of the instrument only, using a damp, soft cloth. Do not use chemicals or abrasive elements. Under no circumstances should moisture be allowed to penetrate the WaveStation. To avoid electric shocks, disconnect the instrument from the power supply before cleaning.

**Service Procedure**

Refer any servicing requiring removal of exterior enclosure panels to qualified LeCroy service personnel. Be prepared to describe the problem in detail. Prior to returning a unit please obtain a Return Authorization Number (RAN) from the LeCroy Customer Care Center in New York at (914) 578-6020 or the LeCroy office nearest you.

If the product is under warranty, LeCroy will at its option, repair or replace the LW400 Series at no charge. For repairs after the warranty period, the customer must provide a Purchase Order Number before the service engineer can initiate repairs. The customer will be billed for the parts, labor and shipping..

**Shipping Guidelines**

1. First attach a tag to the instrument which indicates:
  - a. Return Authorization Number
  - b. Purchase Order number
  - c. Owner's name and complete address
  - d. The service required including detailed operational problems
  - e. Person to contact for confirmation (include phone number)
2. Ship the unit in its original packaging.
3. Protect the finish by carefully wrapping the unit in polyethylene sheeting.
4. Place adequate dunnage or urethane foam in the container (approximately 4 inch depth) and place the wrapped unit on it. Allow approximately four inches of space on all four sides and the top of the unit.
5. Fasten the container with packaging tape and/or industrial staples. Address the container to LeCroy's service location and include your return address.

### How To Use This Manual

The LW400 Series arbitrary waveform generator is designed to be operated without having to refer to this manual. This is made possible by the intuitive controls and guiding menus. Most of the arbitrary waveform generator functions are accessed using the Operation Keys clustered around the rotary knob. The other push buttons give access to the useful new features offered by this innovative instrument. A built-in Help library is provided for instant aid in answering questions while operating the AWG.

It is suggested that this manual be used to:

1. Gain an overview of the instrument
2. Familiarize you with the terminology
3. Provide detailed descriptions of the various functions
4. Illustrate the use of the new features of the instrument

Perhaps the best way to use it is to read through the early sections and then browse through the later chapters in order to become familiar with the LW400's capabilities. The Table of Contents is organized so that you can find the right information by locating the things you want to do.

*\*Note: The LW400 Series includes the LW420, LW420A, and LW420B dual channel and the LW410, LW410A, and LW410B single channel arbitrary waveform generators (AWG's). At times the designation LW400 is used to describe features common to all models. At other times specific reference is made to the LW400A and the LW400B Series.*

### WaveStation Arbitrary Waveform Generator

The LeCroy LW400 makes it easy to create and edit waveforms. The LW400 combines complete on board word processor like cut, copy and paste, waveform editing with live waveform feature manipulation and waveform generation. Salient benefits include:

1. 100 psec feature placement resolution
2. 400 MS/s maximum sample clock for each channel

### 3. Sample Clock:

LW400 series sample clock rate is selectable within five decade ranges as described—see chapter 13

LW400A and the LW400B series sample clock is continuously variable from 6 KHz to 400 MHz with a 1 Hz resolution—see chapter 13

4. 100 MHz analog bandwidth
5. Fast Switch Group Sequence mode switches waveforms in < 11 ms minimizing test execution time.
6. 1 channel (LW410/LW410A/LW410B) and 2 channel (LW420/LW420A/lw420B) versions
7. Live update of waveform output
8. Stand alone design, no PC required
9. Waveform Data formats for Spreadsheets, PSpice™, MathCad™, MatLab™, ASCII, and others
10. Up to 1 megabyte of playback memory (256 k standard)
11. Hard Disk of >400 Mbyte standard
12. 3.5" DOS compatible floppy disk for waveforms, sequence, equators, and projects, file transfer and storage
13. GPIB
14. SCPI compatible command set
15. Centronics hard copy interfaces
16. Internal Asynchronous noise source on the LW400 and LW400A series (not available on the LW400B series).

## Getting Started

---

**Accessories Supplied** This Operator's Manual  
Remote Programmers Manual  
Power Cord for country of destination  
Protective Front Cover  
Firmware Installation Disk

**Available Accessories**

LS-RM	Rackmount Kit
LS400-SM	Service Manual
LS-CART	Oscilloscope Cart
LS-TRANS	Hardshell Transit Case
LS-SOFT	Softshell Carrying Bag
DC-GPIB	2 meter GPIB cable

**Options**

LW420-ME2	1 Mbyte Memory
LW410-ME2	1 Mbyte Memory
LW400-HD1	>400 Mbyte HDD
LW400-09A	Digital Output

**Organization**

This manual is organized by application topics (e.g.,VIEWING WAVEFORMS and WAVEFORM EDITING) in order to provide rapid access to those areas of most use. When specific information concerning the operation of a particular push button or control is needed refer to the index of this guide or use the LW400 built-in HELP facility.

**Using the Front Panel Controls**

The "LW400 Getting Started Guide", which follows, describes the basic operation of the LW400 series arbitrary waveform generators. Use it interactively with the tutorial in section 2 for a fast introduction to LW400 operations.

## Getting Started

Welcome to the LeCroy WaveStation LW400 arbitrary waveform generator (AWG) Getting Started Guide. This guide offers a quick overview of basic LW400 operations. The Getting Started Guide is intended for a fast introduction or a brief review, more complete details are available in the following sections of the LW400 Operators Manual.

### The WaveStation Concept

The WaveStation Concept is unique among arbitrary waveform generators in that it is designed to make waveform creation an interactive process. Waveforms can be created and modified continually with an observable, live response at the outputs.

The best place to start when learning to use the LW400 is to look at the conceptual block diagram, shown below.

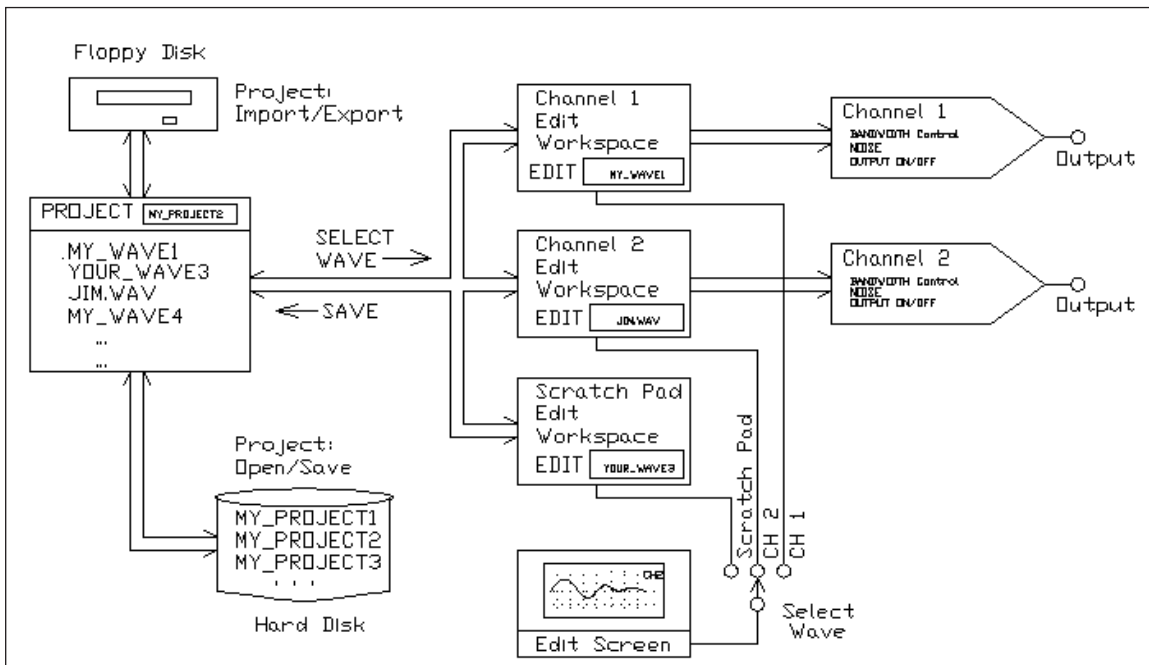

**Figure 1.2 Block Diagram**

## Getting Started

---

Central to the operation of an AWG is waveform creation and modification. This operation is done in the WaveStation's editor which includes 3 workspaces. The channel 1 and channel 2 edit workspaces drive the respective outputs. The connection is direct and permits live updates of the output as the waveform is changed. The scratch pad area is an off-line, utility edit workspace. The EDIT control group on the front panel provides access to operations in the edit work spaces. Waveform selection, creation, and modification are all EDIT functions.

When a workspace is selected the current waveform contents are displayed on the internal CRT display. The VIEW control group provides control of the display parameters, time and voltage cursors, as well as hardcopy operations.

The output operations, like filtering and the addition of additive white noise, are controlled by the CHAN1 and CHAN2 controls.

The SAVE and PROJECT controls are used to move waveforms between the hard disk or floppy disk and the edit workspace. In addition to its waveform file management role PROJECT includes control of system related operations such as the real time clock and control of the remote interfaces.

LW420 Front Panel Layout

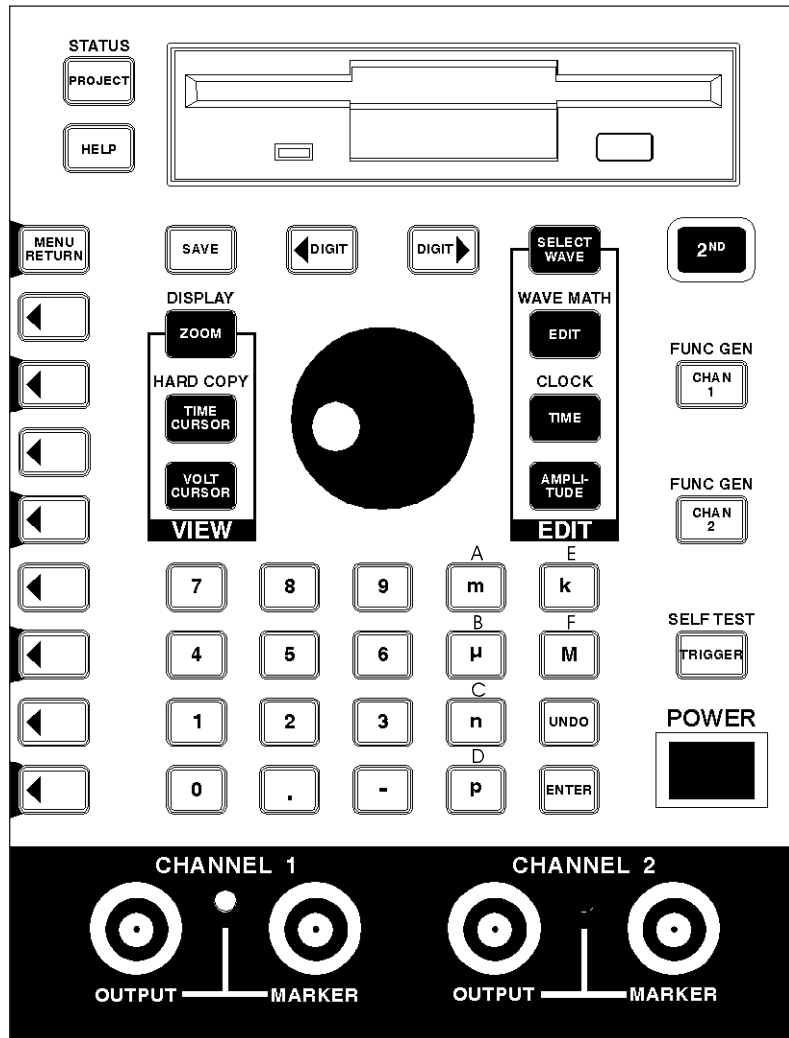

Figure 1.3 Front Panel Layout

*\*Note the front panel of the LW410/LW410A is similar to the LW420/LW420A except that all controls related to channel 2 are removed.*

## Front Panel Controls

The LW400 WaveStation is a menu driven instrument. Push button controls on the front panel bring up related menu's on the CRT display. The LW400 is controlled through the selection and/or entry of the desired parameters in the menus.

1. The controls on the LW400 front panel are divided into functionally related groups. For example:

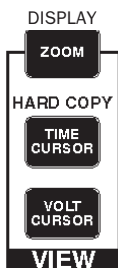

The VIEW Group controls display related functions including hardcopy and the measurement of waveforms on the CRT Screen.

The EDIT Group controls waveform selection, editing, and modification.



The CHAN 1 and CHAN 2 buttons are used to control the channel related elements of the output such as turning channel output on or off, adding noise, or setting the output channel bandwidth.



2. The rotary control knob is used to select menu items or to scroll through numeric parameters within a menu item. The DIGIT select buttons set the rate of change of the rotary knob by selecting the digit of the numeric value to be modified.





## Front Panel Controls

3. The numeric keypad allows precise entry of numeric data into menu fields. Unit multiplier, enter keys p, n,  $\mu$ , m ENTER, k, and M are used to attach the appropriate unit multipliers to the values being entered.
- |   |   |   |       |       |
|---|---|---|-------|-------|
| 7 | 8 | 9 | m     | k     |
| 4 | 5 | 6 | $\mu$ | M     |
| 1 | 2 | 3 | n     | UNDO  |
| 0 | . | - | p     | ENTER |



4. Dedicated controls are permanently labeled to indicate their function.



5. Dual function controls have a secondary function indicated by a red label printed above the control. The second function is accessed by first pressing the red push button labeled “2<sup>ND</sup>” and then pressing the desired button.



6. Information on the function of each front panel button is readily available by pressing the Help button followed by the desired button or softkey.

Sing 0 LeCroy  
CH1 LW420

EDIT

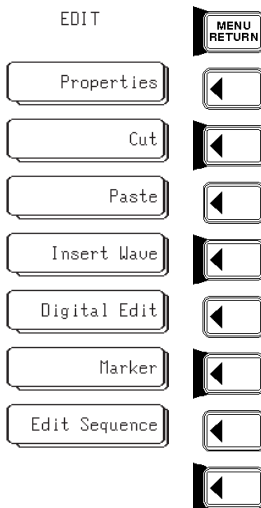

7. The functions of the “Menu” or “Softkeys”, located adjacent to the CRT display, are indicated by menu labels shown on the display.



8. The rotary knob symbol appearing adjacent to a softkey label, on the CRT, indicates that the parameter described in the label may be varied using the rotary knob.



The keypads symbol appearing next to a softkey label, on the CRT, indicates that the parameter described in the label can be entered or changed using the front panel numeric keypad.

9. Softkey labels with a “shadow box” effect, such as the Marker label in the figure above, have additional menu items behind the label. Pressing the corresponding softkey again will list all the choices for that item.

# The Display

## The LW400 Display

The main elements of the LW400 CRT display are shown in the figure below. The display annotation summarizes the current state of the generator including the date and time. Hardcopy capabilities allow the CRT display to be saved to a printer, plotter, or graphics file for notebooks or test procedure documentation.

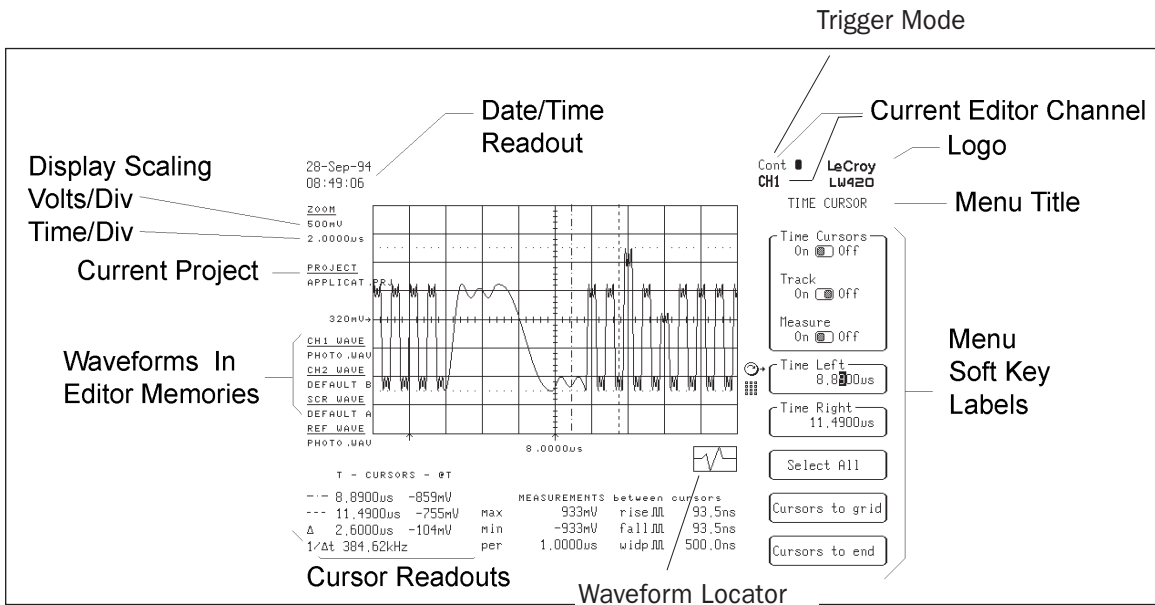

**Figure 1.4**

## Rear Panel Connections

### Rear Panel Connections

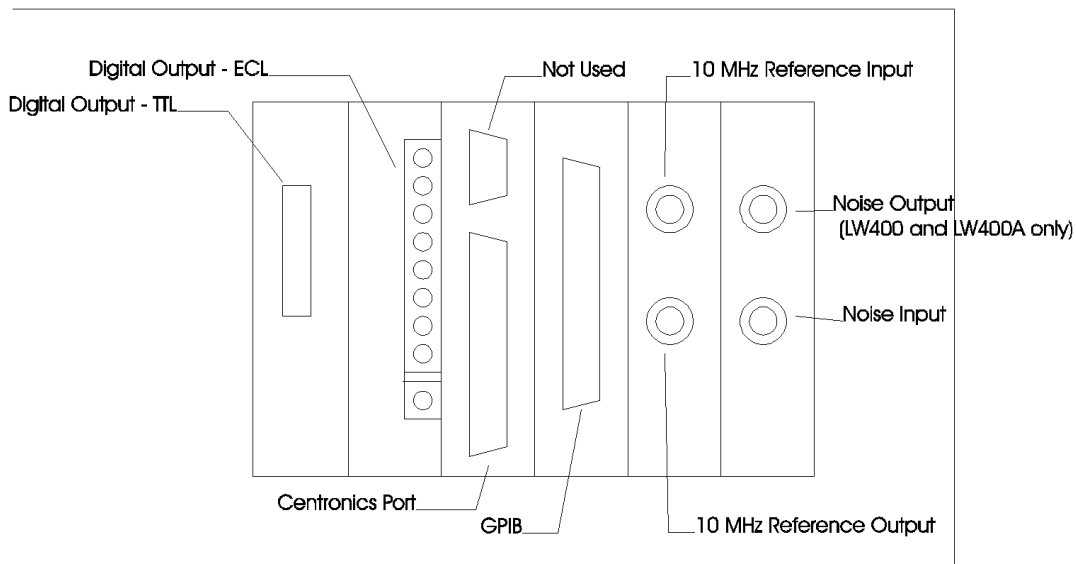

*Note: The digital output connectors for ECL and TTL are not present if the LW400-09A Digital Output option is not installed.*

## LW400 as a Function Generator

### Using the LW400 as a Function Generator

The LW400 includes a function generator mode offering Sine, Square, Triangle, Ramp, Pulse, DC, and Multi-tone waveforms. The frequency of the periodic waveforms can be swept linearly or logarithmically using user entered sweep rate, and start/stop frequencies.



1. Select the function generator mode by pressing the red 2nd button and then selecting the desired channel. The Function Gen menu will be displayed allowing the selection of desired waveform, amplitude, offset, start phase, and frequency by means of the softkeys and/or numeric keypad.
2. Pressing the menu softkey labeled Sweep will alternately turn the frequency sweep on and off as indicated by the toggle switch icon. Pushing the Sweep Param menu key allows control of the sweep parameters.
3. Pressing the Chan 1 (or 2) button on the front panel allows access to the CH1 (or 2) menu.
4. The channel 1 (or 2) output can be turned on or off using the menu key labeled Output.
5. The bandwidth of either channel's output can be controlled in decade steps from 10 kHz to 100 MHz. Bandwidth is automatically selected but the user may choose to override this selection.
6. Gaussian white noise can be added to the signal as a percentage of the peak to-peak signal level.

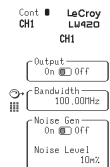
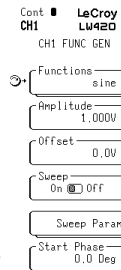

# Generating Arbitrary Waveforms

## Generating Arbitrary Waveforms From Existing Waveform Files

Arbitrary waveforms can be generated from an existing waveform file or from a sequence of files described by a waveform sequence. The EDIT group on the front panel is used to select an existing waveform and output it.



1. Depress the SELECT WAVE button in the EDIT group.
2. Press the menu key corresponding to the waveform label in either Channel 1 or Channel 2. Use the rotary control knob to select the desired waveform filename which will be displayed and simultaneously output, as shown in figure 1.5. It's that simple!
3. The LED indicator next to the CHANNEL 1 (or 2) output connector is green when the waveform is being output and red when it is off. To control the output press the CHAN1 (or 2) button.



4. Push the menu button labeled Output, in the CH1 menu, to toggle the channel 1 output on or off.

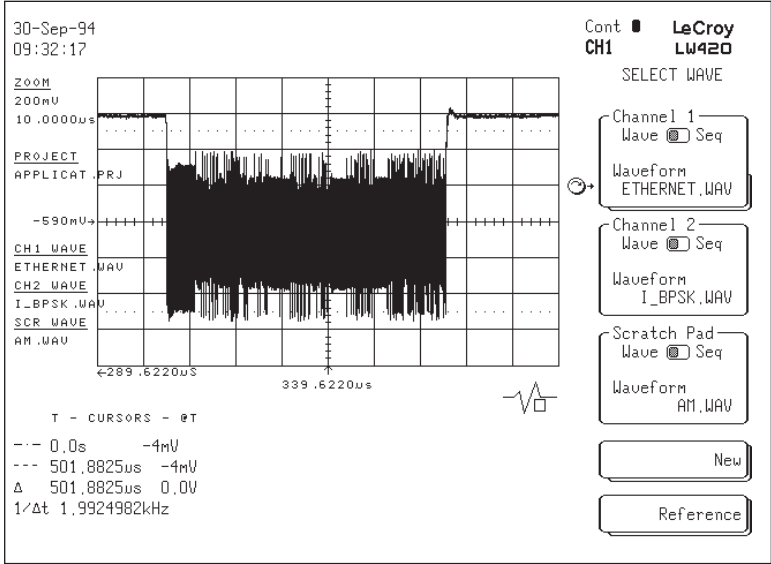
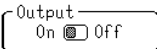

Figure 1.5

## Recalling Other Waveforms

### Recalling Other Waveforms or Sequences

Waveform files and sequences are stored in the LW400's internal hard drive under a dual level file system characterized by a project name and a waveform or sequence filename. This permits multiple users to each have their own set of independent waveform files. To recall a specific waveform you have to select the project it has been stored in and then the waveform or sequence filename.



1. Press the PROJECT button.



2. Push the button labeled Open in the PROJECT menu to see the existing project names.



3. Use the rotary knob to select the desired project, then press the Accept menu key.



4. Use SELECT WAVE, as shown previously, to see the available waveforms.

**Creating a New Arbitrary Waveform Using Standard Waveforms**

The LeCroy WaveStation LW400 offers many techniques for creating arbitrary waveforms. They can be imported from oscilloscopes, or common mathematics programs. They can be created from built in libraries of standard waveforms, or from mathematical equations. A full complement of waveform editing, modification, and array math capabilities allows existing waveforms to be used as sources of new waveforms. Waveforms are created in the currently open project, instructions for creating a new project are found in the following section.

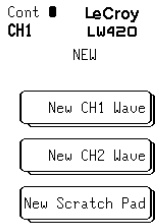

1. Depress the SELECT WAVE button in the EDIT group.



2. Press the menu key marked NEW to create a new waveform name in either channel 1, or channel 2, or scratch pad.

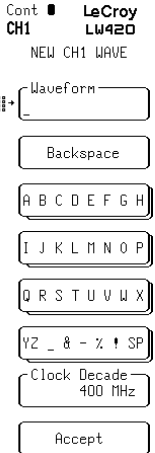

3. Enter the desired waveform name, up to 14 characters long, then press the Accept softkey.

4. Press the front panel EDIT button to access the waveform and sequence edit functions.

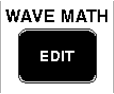

5. Press the softkey labeled Insert Wave to access the waveform sources.

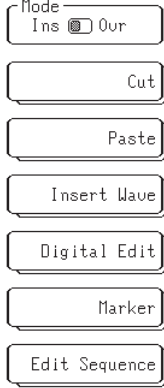
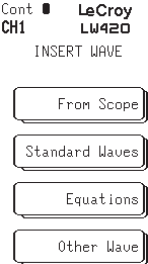

6. The Insert Wave menu allows the choice of acquiring the waveform from a digital oscilloscope, using the standard waves libraries, creating a waveform from an equation, or inserting another waveform.

# New Project

Cont ■ LeCroy  
CH1 LW420  
STANDARD WAVES



7. Press the menu key corresponding to the Standard Waves label. The LW400 will display a menu listing the standard waveform library.

8. The Sine menu, typical of the standard waveform setup menus, shows the waveform parameters that are available to control the standard waveform.

Select the menu softkey adjacent to the desired parameter and then use the rotary knob or the numeric keypad to enter the value needed. After all the parameters have been entered, press the Accept softkey to create the waveform.

Cont ■ LeCroy  
CH1 LW420  
SINE

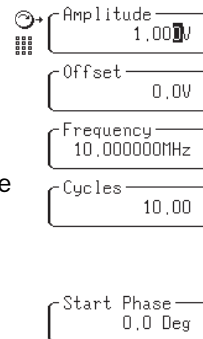

9. The LED indicator next to the CHANNEL 1 (or 2) output connector is green when the waveform is being output and red when it is off. To turn the output on press the CHAN1 (or 2) button.

10. Push the menu button labeled Output, in the CH1 (or 2) menu, to toggle the channel 1 (2) output on or off.

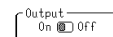

## Starting a New Project

Projects provide individual work and storage areas, especially helpful when multiple users share the AWG. To create a new project:

1. Press the PROJECT button.
2. Press the NEW softkey to enter a new project name, just as the waveform name was entered previously, and then press the Accept menu key.



Cont ■ LeCroy  
CH1 LW420  
PROJECT





### Saving a Waveform

After creating a new waveform it is a good practice to save the waveform to the LW400's internal hard drive. The waveform is stored in the current project with a user assigned filename.

Cont ■ LeCroy  
CH1 LW420  
SAVE

Waveform  
ETHERNET.WAV

Save As

Save Waveform

1. Press the SAVE button on the front panel to display the SAVE WAVEFORM menu. 
2. The name of the currently selected waveform will appear in the menu item labeled Waveform. To save the waveform using this name press the menu key marked Save It.
3. To change the name of the waveform, press the menu key labeled Save As. This will bring up the SAVE AS menu allowing the entry of a new waveform file name. After renaming the waveform press the Accept menu key.

## Display Zoom

### Using Display Zoom

The display zoom controls are used to setup the display horizontal and vertical scaling and position. These controls only affect the display of the waveform and not the waveform itself.

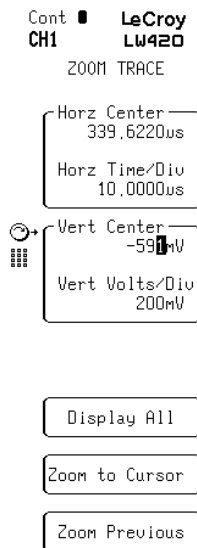

1. Push the front panel ZOOM button to display the ZOOM Trace Menu.
2. Pressing the softkeys labeled Horz Center, Horz Time/Div, Vert Center, and Vert Volts/Div allows the respective display parameter to be set using either the rotary knob or the numeric keypad.
3. Pressing the menu key marked Display All will automatically scale and position the waveform so that all of it is displayed.
4. The Zoom to Cursor menu selection will automatically scale and position the portion of the waveform between the left and right time cursors to fill the display area between 10% and 90% of the horizontal axis.
5. Selecting the Zoom Previous softkey restores the last zoom setting. This is used to quickly toggle between alternate display settings.

# Setup Waveform Display

## Using Display Controls to Setup the Waveform Display

The Display controls are used to setup the type of display, the display Grid Style, and the waveform and grid intensity.

1. The display control menu is accessed by first pressing the red 2<sup>ND</sup> button on the front panel followed by pressing the DISPLAY/ZOOM button.



2. Pushing the menu key labeled Type allows the selection of one of 4 different grid types. Pressing the Type menu key a second time will show all the available selections.

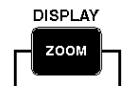
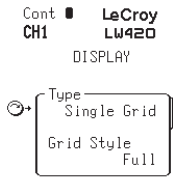

3. In a similar manner, the LW400 display can be setup in any of 3 different grid styles using the Grid Style menu key.

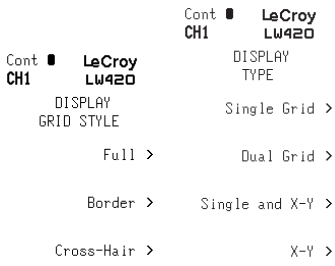

4. Pressing the menu key labeled Intensity allows the intensity of the displayed waveform and its associated annotation to be varied using the rotary control knob or the numeric keypad. The range of intensity values is from 1% to 100%.

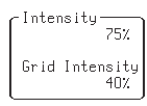

5. Similarly, the Grid Intensity softkey allows the intensity of the selected grid to be varied between 1% and 100% using the keypad or rotary knob.
6. Two system related display functions, the Screen Saver and the Time/Date display, are controlled using the System Preference menu. Since these are seldom used controls. They are grouped with other system related controls within the project group. This is described in the section on setting the system configuration.

# Cursors

## Using Time And Voltage Cursors

The dual time and voltage cursors of the LW400 provide calibrated readout of the time or voltage amplitude of any position on a waveform. Both absolute and relative measurement readouts are shown on the LW400 display. Time cursors also are used to select specific regions, for all edit operations.

The adjacent figure shows both the time and voltage cursors. The waveform values at each cursor are displayed in the cursor readout field in the lower left corner of the CRT screen.

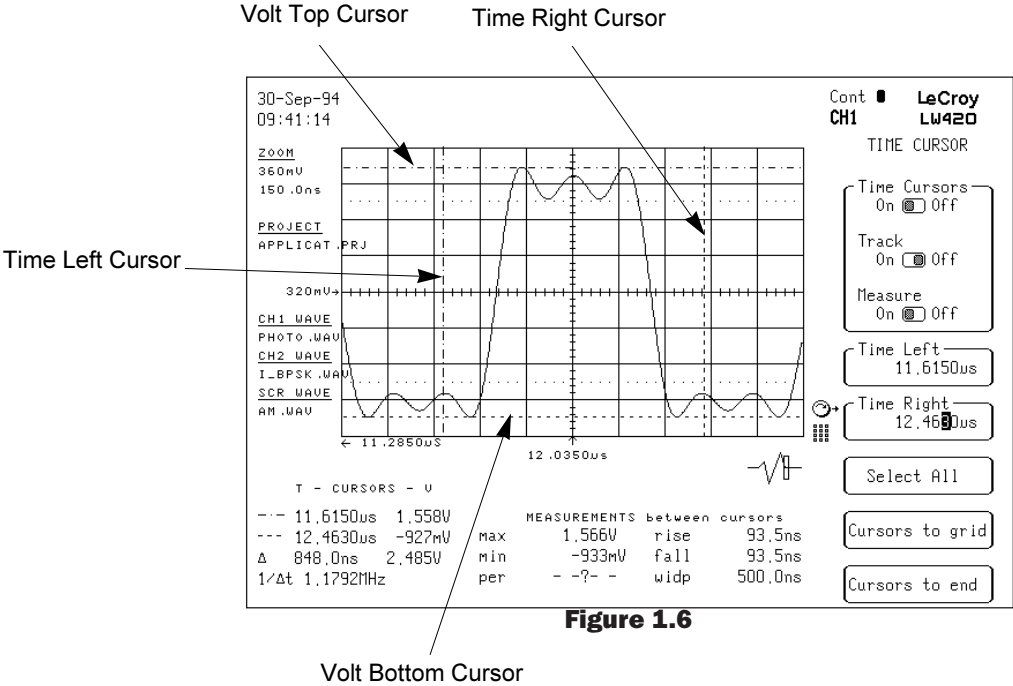

1. Push the TIME CURSOR button on the front panel to HARD COPY  
TIME CURSOR display the TIME CURSOR menu.
2. The menu key marked with Time Cursors toggle switch icon is used to turn the time cursors on and off. The default condition is On.

## Cursors

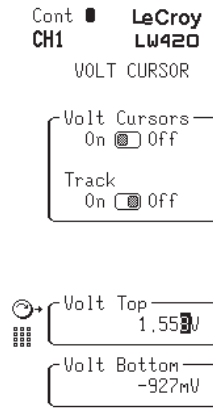
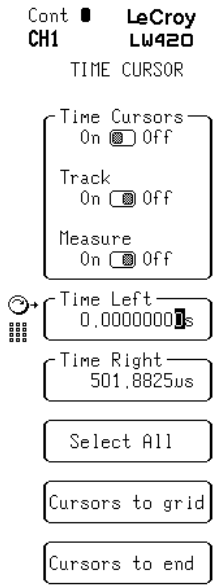

3. In the track mode the right time cursor follows the left time cursor by a constant, user set, Delta. The track mode is controlled by the menu key labeled Track. The track toggle switch icon shows the state of the track mode.
4. The Time Left and Time Right menu keys are used to select and position the respective time cursors using the rotary knob or the numeric keypad. Time Cursor locations are entered in seconds.
5. Pressing the menu key marked Select All will move the left and right time cursors to the beginning and end of the waveform, respectively. *Note that if the waveform extends beyond the display the cursors may seem to disappear.*
6. The Cursors to Grid menu key is used to bring the cursors to fixed positions on the current display. Pressing this menu key will force the left cursor to the 10% point and the right cursor to the 90% point of the display.
7. Depressing the menu key labeled Cursor to end will position both left and right time cursor at the end of the waveform.
8. Press the VOLT CURSOR button on the front panel  to display the VOLT CURSOR menu.
9. The menu key marked with Volt Cursors toggle switch icon is used to turn the time cursors on and off. The default condition of the Voltage Cursor is Off.
10. In the track mode the top voltage cursor follows the bottom voltage cursor by a constant, user set, amplitude difference (Delta). The track mode is controlled by the menu key labeled Track. The track toggle switch icon shows the state of the track mode.

The Volt Top and Volt Bottom menu keys are used to select and position the respective voltage cursors using the rotary knob or the numeric keypad. Volt Cursor locations are entered in units of Volts.

## Cursors

- The Cursors to grid menu key is used to bring the voltage cursors to fixed positions on the current display. Pressing this menu key will force both the top and bottom cursors to first major graticule division inside the upper and lower limits of the display. The figure below shows the positions of both the Time and Volt cursors after pressing the Cursors to grid menu keys.

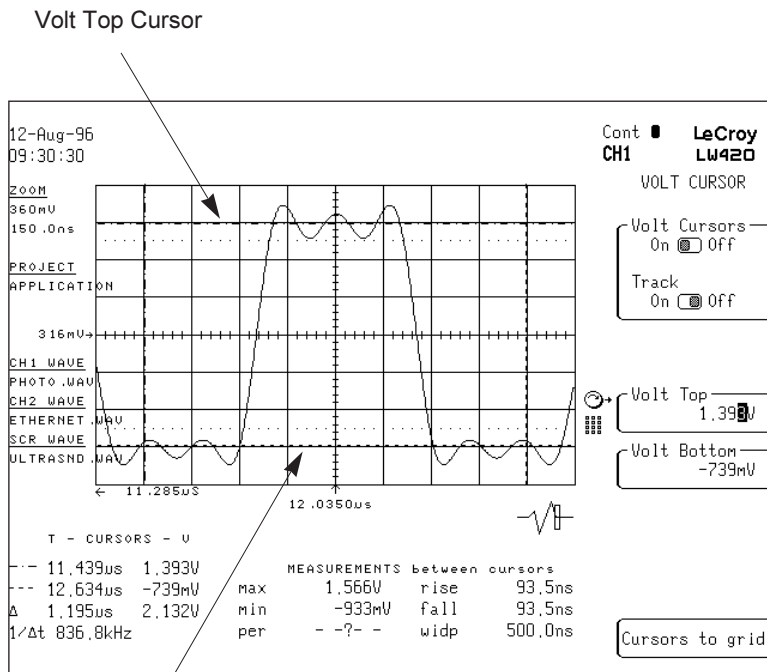
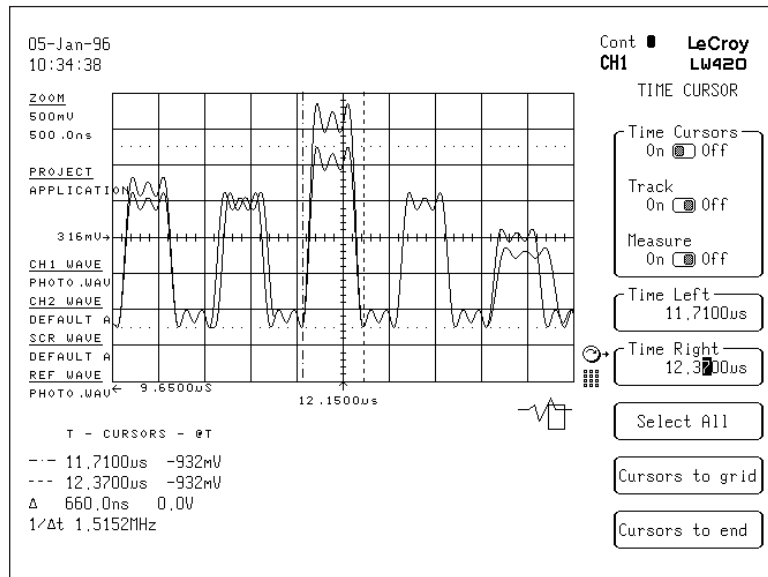

**Figure 1.7**

Volt Bottom Cursor

**Using The Live Waveform Modification Capabilities**

The waveforms from the LW400 can be modified from the front panel while the waveform is being output. "Live" output modification includes the ability to change all or part of a waveform. The amplitude, offset, duration, position, or delay (phase) can be modified as you watch the output on an oscilloscope. Waveform features can be shifted in time by as little as 100 ps. The adjoining screen display provides examples of some of the manipulations possible.



**Figure 1.8**

## Waveform Modification

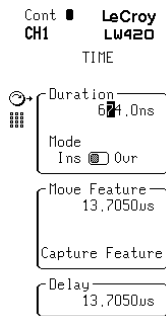

1. Recall or create the waveform that is to be modified.
2. Use the time cursors to bracket the feature or waveform segment to be modified.
3. To delay, move, or modify the duration of the waveform press the TIME button on the front panel to display the TIME menu.
4. Pressing the menu key labeled Duration allows the duration of the waveform feature, between the time cursors, to be varied using the rotary control knob or the numeric keypad.
5. Pressing the menu key marked Mode will change the toggle switch icon, alternating between the insert (Ins) and overwrite (Ovr) modes. If the duration is varied in the insert mode, all waveform data to the right of the feature being changed will move by the same time difference. In the overwrite mode the data to the right of the area being modified will be replaced, if duration is increased. In overwrite mode the overall duration of the waveform remains constant.
6. To move the selected waveform feature, press the menu key labeled Move. The selected area can now be moved horizontally under the control of the rotary knob or the numeric keypad. The LW400 captures and stores the original waveform segment for such calculations. As the selected region is moved signal processing techniques are applied to minimize discontinuities at the boundaries. The Capture Feature menu key allows the user to capture a different reference feature if desired.

The LW400 normally captures the feature for you and there is no need to push this button. This button is only needed to override normal capturing. For instance, if one pulse is moved on top of another and now it is desired to move the two pulses using this button will capture the new feature.



## Modification Capabilities

7. Pressing the menu key labeled Delay allows the selected feature to be delayed in time using the rotary control knob or the numeric keypad. Waveform elements to the right of the selected region will move by the same time delay increment.



8. To change the amplitude related parameters of the selected segment press the AMPLITUDE button on the front panel to display the AMPLITUDE menu.

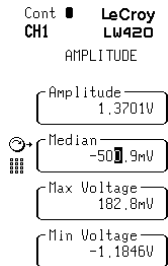

9. Amplitude changes can be entered by controlling the amplitude, median value, maximum, or minimum amplitudes of the selected waveform segment. Pressing the menu key with the desired parameter name allows it to be controlled using the rotary knob or from the numeric keypad.

10. Pressing the UNDO button in the numeric keypad on the front panel will restore the waveform to the state it was in before the AMPLITUDE or TIME menu was entered.



Before the undo operation is executed the LW400 will put up a warning message confirming the operators intent to undo the changes.

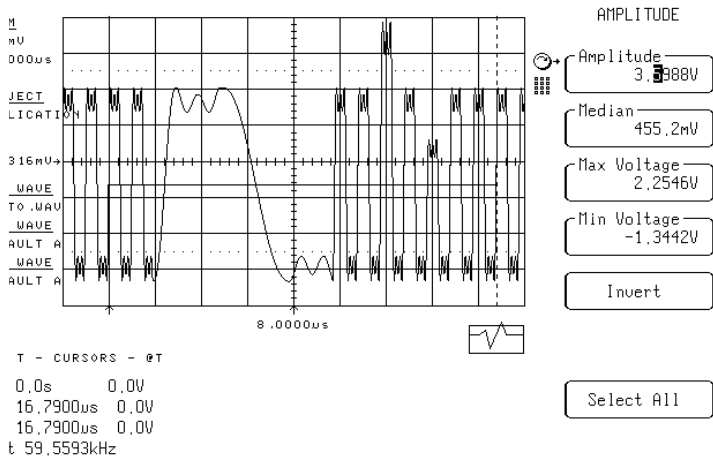
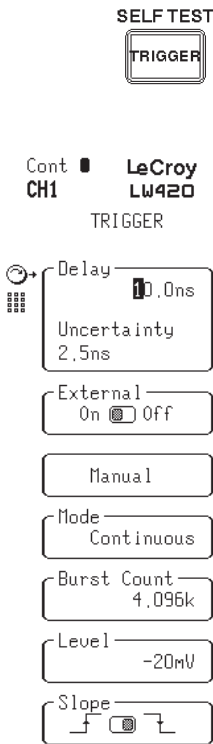

**Figure 1.9**

# Triggering

## Triggering And Markers

The LW400 has 4 triggering modes to provide flexible timing and synchronization of the output waveforms. Each output channel includes a marker output which can be set up to provide a custom timing signal to the device or system using the AWG output waveform. The marker output can produce up to 128 user set edges or a clock output with user set frequency.



1. Press the TRIGGER button on the front panel to display the TRIGGER menu.
2. The trigger modes are selected using the menu key labeled Mode. Pressing this key a second time will show the four available trigger modes.

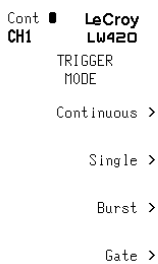

Continuous mode is a free running mode.

Single mode outputs the waveform once for each trigger input.

Burst mode outputs an integer number of repetitions of the waveforms, as set in the Burst Count field of the trigger menu, for each trigger received.

The Gated trigger mode produces and outputs continuously as long as a gating signal, applied to the external trigger input, exceeds the preset trigger level. When the gating signal no longer exceeds the trigger level, the current waveform is output to completion and terminated.

Trigger sources include the external trigger input, manual trigger and trigger via the GPIB interface. The external trigger level and slope are entered in the Level and Slope fields of the TRIGGER menu. The external trigger input is mounted on the front panel. Triggers may also be initiated manually, by pressing the menu key marked Manual.

## Triggering

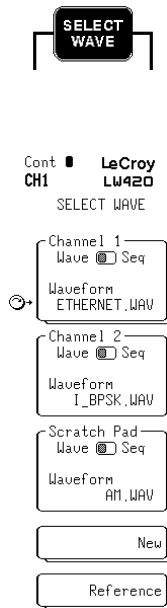

3. Marker outputs, for each channel, offer a very flexible method of providing timing signals synchronous with the output waveform. Each marker is independently programmable with a timing resolution of one sample clock and is associated with a specific waveform. To edit or change the marker, press the SELECT WAVE button and use the SELECT WAVE menu to select or create a new waveform in either Channel 1, 2 or scratch pad.

4. Press the EDIT button on the front panel and select the Marker menu item from the EDIT menu. The MARKER menu will be displayed along with the marker waveform. The following figure shows a typical display using the dual grid display type.

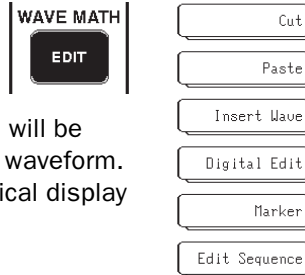

5. The marker Output Level menu key is used to select either TTL or ECL logic levels for the marker signals.

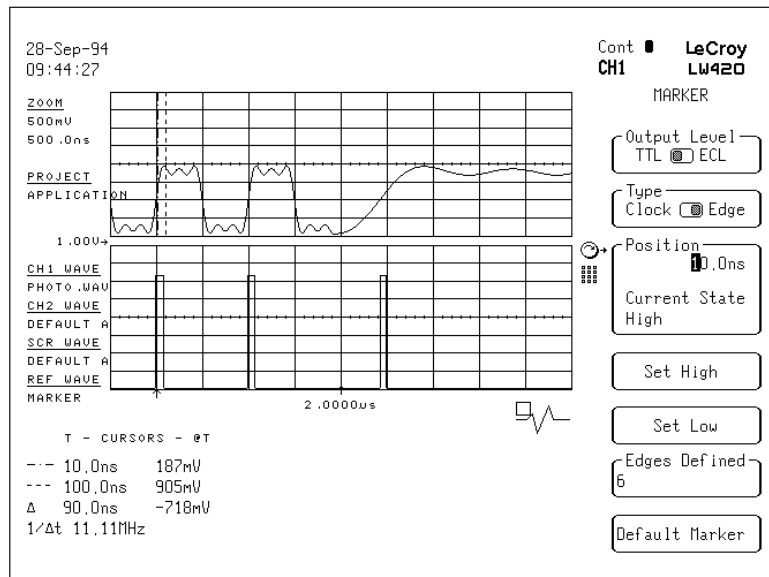

**Figure 1.10**

## Configuration

- The marker Type menu key selects either a periodic clock or edge(s) as a marker type.
- Pressing the Position menu key allows the positioning of a marker edge using the numeric keypad or the rotary knob. The time cursor tracks the position setting. The Set High and Set Low menu keys set the logic state starting at the current cursor position.
- The clock marker type allows the clock frequency to be set by depressing the Frequency menu key. The frequency is settable from 10 Hz - 200MHz using the rotary knob or the keypad.
- Similarly, the delay to the first clock edge is settable from 2.5 ns - 1 s using the First Edge menu field.
- The Default Marker is a positive pulse, with a width of 31 sample clocks and a rising edge one sample clock from the beginning of the waveform.

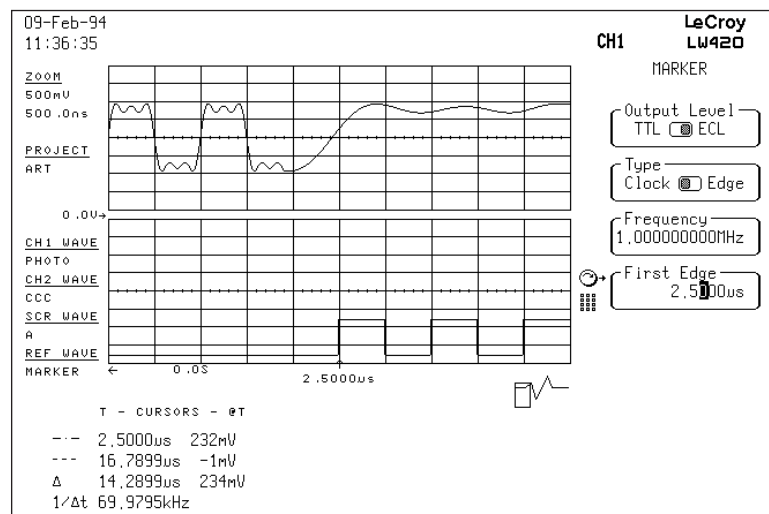

Figure 1.11

## Configuring the LW400

The system parameters of the LW400, including setup of remote interfaces, setting the time/date, and disabling the screen saver, are all user settable.



1. Press the Project button on the front panel to display the Project menu
2. Push the Preferences menu softkey to view the Preferences menu.
3. Select the System softkey to access the System menu.
4. The Logo menu key is used to turn the LW400 logo, in the upper right corner of the display, off and on.
5. The Screen Saver softkey enables or disables the LW400 screen saver feature.
6. The GPIB menu keys provide access to the remote control interface setup menus.
7. Pressing the Set Time/Date menu key will display the Time & Date menu. This menu is used to set up the real time clock.

### PREFERENCES

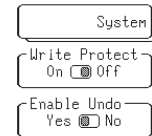

### Cont ■ LeCroy CH1 LW400 SYSTEM

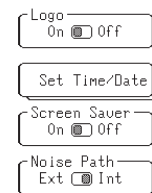

### Cont ■ LeCroy CH1 LW400 TIME & DATE





## Introduction

This tutorial is intended to give the new user of WaveStation his or her first introduction. Further details on all operations are located in the remainder of the operators manual. This introduction is divided functionally into six main categories. They are as follows:

1. Creation of a simple arbitrary waveform
2. Display manipulation and zooming to see more detail
3. Positioning the Cursors
4. “Live” waveform manipulation
5. Simple waveform editing
6. Saving the Waveform

## 1. Creation of a Simple Arbitrary Waveform

### Clearing the display

We will create a waveform that consists of 4.75 cycles of a sine wave followed by ten cycles of a square wave. The first step in the process is to ensure we start with a “clean” slate. The following steps will clear the channel 1 waveform display.

1. Push **Select Wave**
2. Push **New**
3. Push **New CH1 Wave**
4. Use the alphanumeric keys to enter the name “new”, (To enter a letter push the key that contains that letter in the list, then push the key with the letter’s symbol in it. For example, to enter the letter “N” first push the key that contains ‘IJKLMNOP’ then push the “N” key.)

## Tutorial

5. Push **Accept** after entering **New**

We now have a screen that shows no waveforms on it.

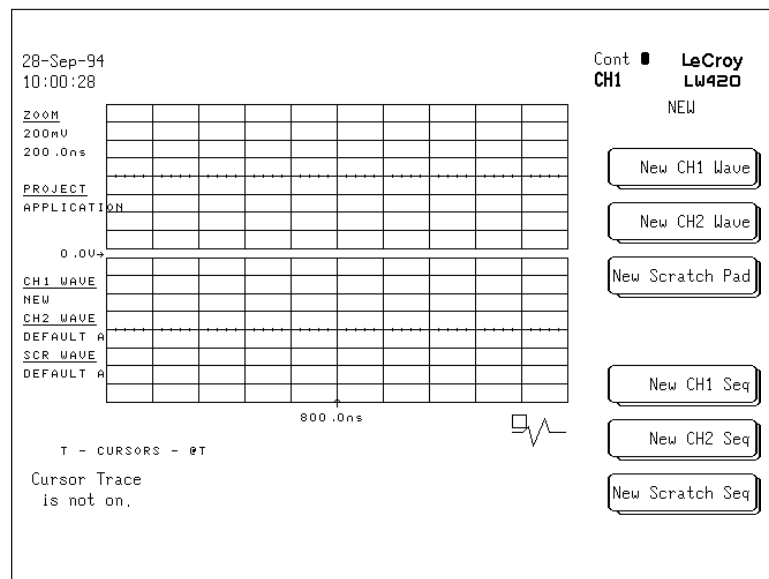

**Figure 2.1 The Blank Screen**

### Creating 4.75 cycles of a sine wave

1. Push **Edit**
2. Push **Insert Wave**
3. Push **Standard Waves**
4. Push **Sine**
5. Push **Cycles**
6. Change the number to "4.75" (Use the keypad to enter 4.75. being sure to push "enter" on the keypad. Alternately use the rotary control to dial in the number "4.75").



7. Verify that all menu selections are as shown in figure 2.2. Make any necessary changes.

8. Push **Accept**

The screen of WaveStation should now show 4.75 cycles of a 10 MHz sine wave. It also shows some additional cycles very faintly. These show how the waveform segment connects to itself in continuous trigger mode. That is the two cycles before and five cycles after the highlighted five cycles are what comes before and after in continuous trigger mode.

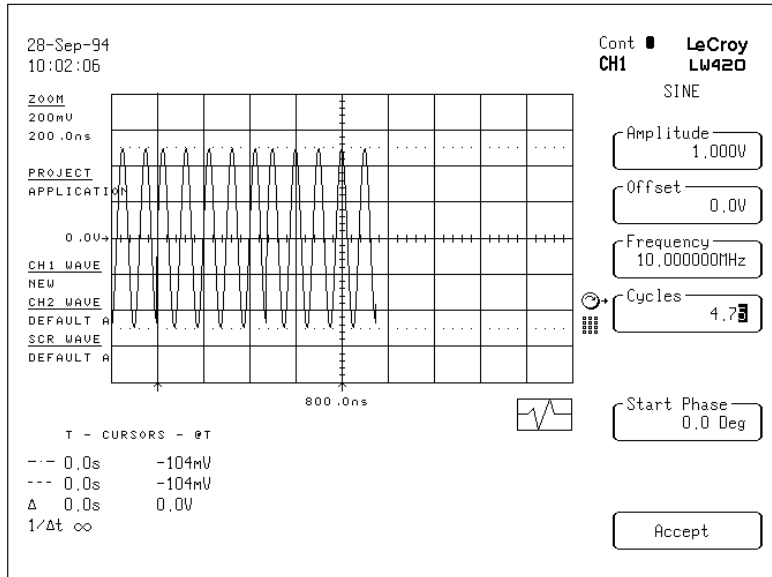

**Figure 2.2 The sine wave**

## Tutorial

### Adding two cycles of a square wave

1. Push **Time Cursor**
2. Push **Cursors to end** (note: both cursors move to the right side of the displayed waveform: all inserting of waves begins at the left cursor location which is now on the right side of the wave - exactly where we want it)
3. Push **Edit**
4. Push **Insert Wave**
5. Push **Standard Waves**
6. Push **Square**
7. Select **Base** and set it for -500 mV (Type "-500" followed by "m" on the numeric keypad)

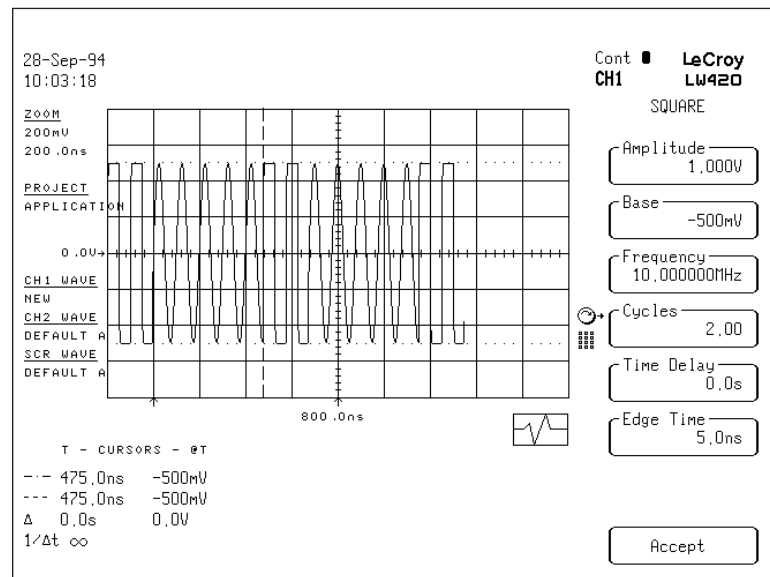
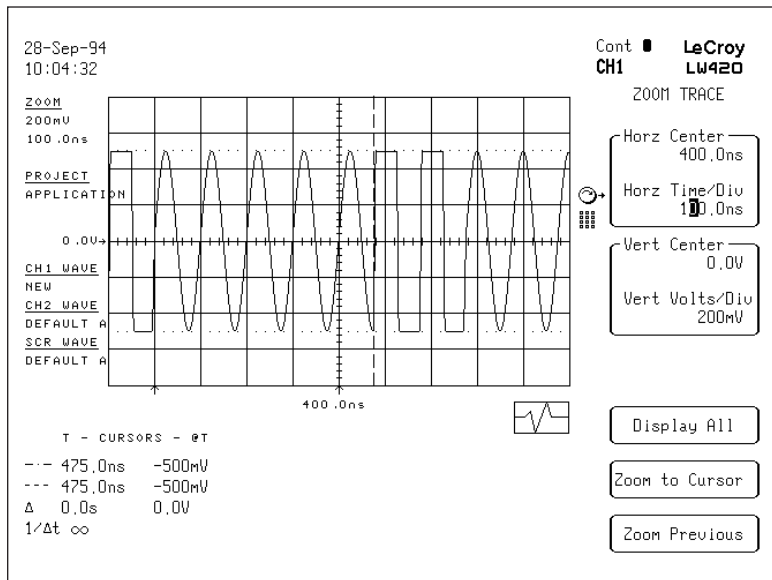

Figure 2.3 Add two cycles of square wave

8. Select **Cycles** and dial in “2” with the Rotary Knob
9. Verify that all menu items match those shown in figure 2.3
10. Push **Accept**

## 2. Zooming to see more detail

1. Push **ZOOM**
2. Push **Horz Center**

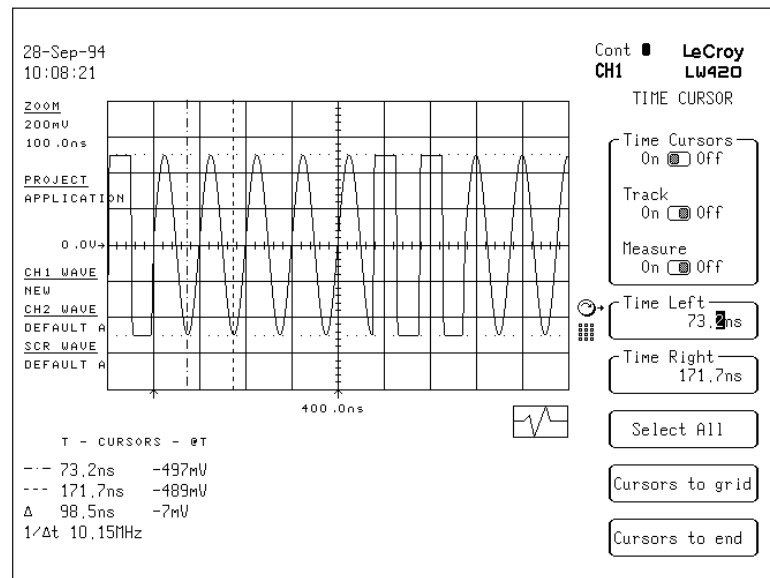

**Figure 2.4 Result of Zooming**

3. Using the Rotary Control dial in 400 nsec
4. Push **Horz Time/Div**
5. Select 100 ns (Use either the Rotary Knob or the numeric keypad”

### 3. Positioning the Cursors

1. Push **TIME CURSOR**
2. Select **Time Left**
3. Turn the Rotary Knob and observe the cursor move
4. Select **Time Right**
5. Turn the Rotary Knob and observe the cursor move
6. Use the Digit keys (above the rotary knob) to change the sensitivity of the cursors
7. Set the cursors around some area of the waveform of interest to you, for example the second cycle of the sine wave



**Figure 2.5 Result of Moving the Time Cursors**

#### 4. Live Waveform Manipulation

1. Push **TIME** in the **Edit** group
2. Select **Duration**
3. Use the Rotary Knob to change the Duration of the area of the waveform you selected
4. Select **Move Feature**
5. Use the Rotary Knob to slide your feature around
6. Select **Duration**
7. Experiment with the difference between the mode **Ins** and **Ovr** (notice overwrite removes data to the right of the region being expanded where as insert extends to total time [length] of the waveform.)

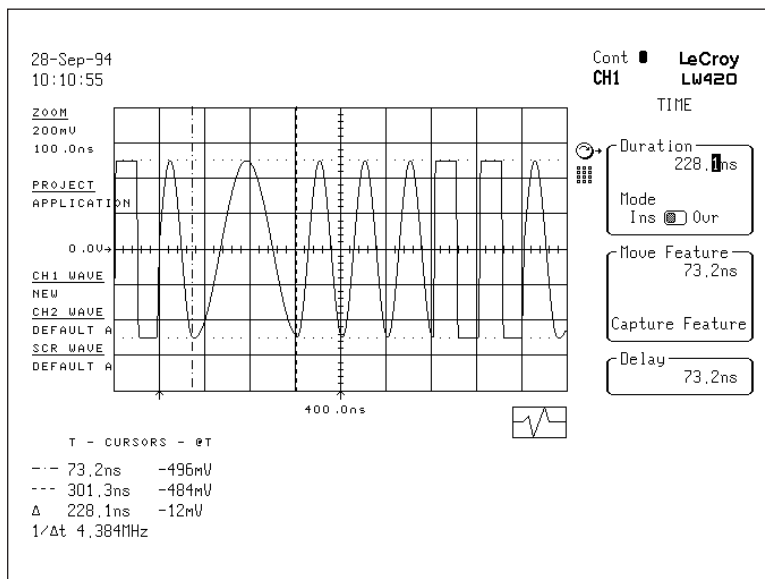
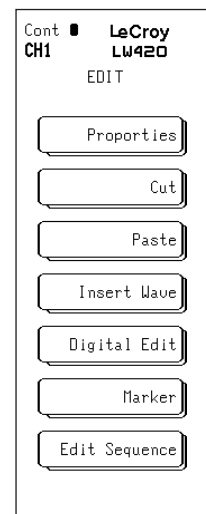

Figure 2.6 Live Waveform Manipulation

## 5. Simple Waveform Editing

The cursors should still be surrounding the “feature” you originally selected although you have probably stretched or compressed it.

1. Push **Edit**—the menu in figure 2.7 will be displayed.
2. Push **Cut**
3. Push **Delete** (your feature disappeared)
4. Push **UNDO** (on the keypad) and answer **OK** (your feature is back)
5. Push **Extract**
6. Push **UNDO** followed by **OK**
7. Push **Copy**
8. Push **Time Cursor**
9. Move the **Time Left** Cursor to a new location
10. Return to the **Edit** Menu (Push **Edit**)
11. Push **Paste**
12. Push **Accept**

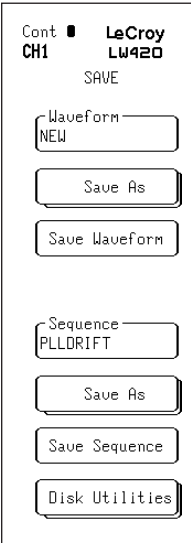

**Figure 2.7**  
**Edit menu**

### 6. Saving Your Creation

- 1. Push **SAVE** button on the front panel—the menu shown in figure 2.8 is displayed.
- 2. Push **Save Waveform**

At this point, the waveform called “NEW” has been saved to the internal hard drive in the current directory or project. For a description of the project and directory structure see the section of the manual entitled “Project Structure”.



**Figure 2.8**  
**Saving the**  
**Waveform**  
**“New”**

## Tutorial

### Final Exercise: Deleting the waveform “New”

1. Push **Project**
2. Push **Delete**
3. Push **What** and select **Waveform**
4. Push **Waveforms** and scroll until **NEW** appears
5. If you wish to delete **NEW** waveform select **Delete**.

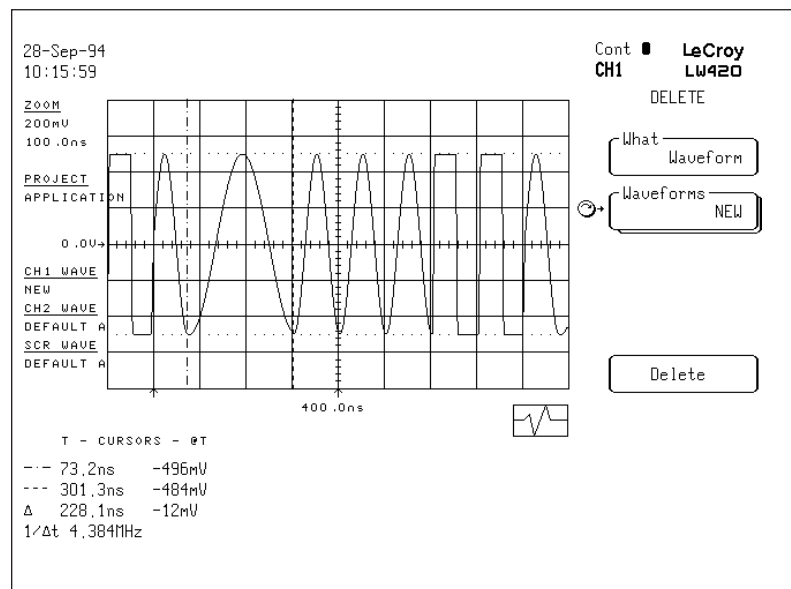

Figure 2.9 Preparing to Delete “New”



## Waveform Viewing

Viewing a waveform can have two different meanings. It can mean viewing a waveform on the screen of the WaveStation, or viewing it on an oscilloscope. BNC to BNC cables are used to connect the AWG to an external oscilloscope such as a LeCroy 9354 digital oscilloscope. In general the signal or waveform appearing on the screen of the AWG is coming out the front panel BNC connectors and there is no further action required on the part of the user. (Except of course to set up the oscilloscope correctly: in the case of all LeCroy oscilloscopes, this means invoking the single keystroke “auto setup”).

The exceptions to this are if the channel being viewed is turned off or if it is the scratch pad editor, which is not connected to an output. If the channel is turned off, the LED between the front panel connector for the channel and the marker will be red indicating no output from that channel. To turn the channel on push the channel select button, such as CHAN 1 and then select output on using the upper grey softkey on the right side of the screen.

It is possible to have a different waveform displayed on the screen of the AWG than the one being viewed on the oscilloscope. For example, the oscilloscope can be connected to the output of channel 1 while the screen of the AWG is displaying the contents of the scratch pad or channel 2. This situation is rectified by pressing the button labeled **SELECT WAVE** and then selecting the desired waveform using the grey softkeys at the right of the display.

## Select Wave

### Triggering an external oscilloscope

In order to produce a stable display on an oscilloscope, it is frequently necessary to use an external trigger. The simplest way to do this is to use the marker output of the WaveStation to trigger the scope. Connect a BNC to BNC cable between the Marker output connector of the appropriate channel on the front of the WaveStation and the external trigger input of the oscilloscope. Set the oscilloscope trigger conditions of the external trigger, DC coupled, negative edge and set the threshold at approximately 300mv (the default marker is a TTL level pulse so, anything above a few hundred millivolts will do). The scope should now trigger and produce a stable display.

If the display is still not stable, make sure that the default marker is enabled. To do this, press **EDIT** and enter the Marker menu and push Default Marker. For further information, see the section of this manual titled MARKER.

### WAVEFORM SELECTION

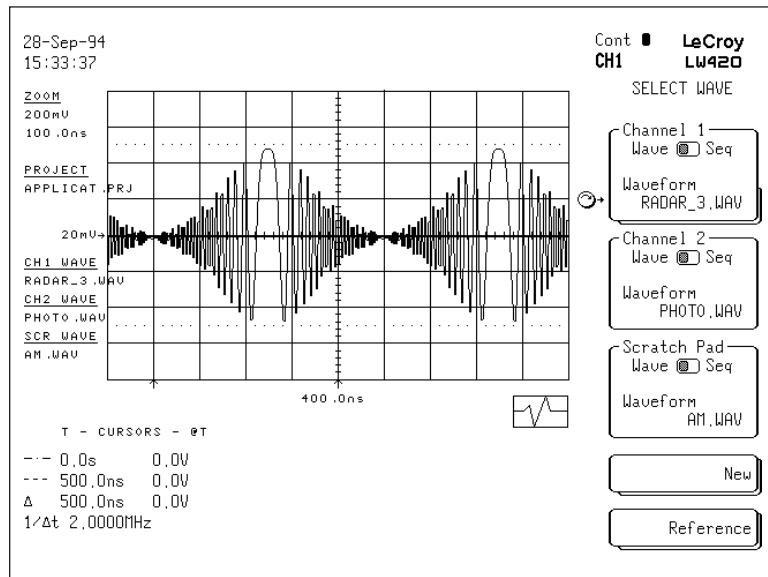

Figure 3.1 Result of Pushing "Select Wave"

**Select Wave**

**GENERAL**

Selecting a waveform generally implies choosing the desired waveform to display or playback from a list of options. It may mean selecting a waveform for editing with “live” feature manipulation by editing one of the channels while it is active. It could also mean editing a waveform in the scratch pad memory so the results of the edit can be viewed without affecting the current state of the output. An additional function is the creation of completely new waveforms. Pushing the button labeled **SELECT WAVE** near the upper right side of the AWG rotary control knob causes the AWG to enter a menu from which these various options can be exercised.

**Help! Where is my waveform? (Changing Projects)**

If the desired waveform does not seem to be available, it is possible that it is stored in a different PROJECT than the one currently active. This may be remedied by pushing the button labeled **PROJECT** on the left of the floppy disk drive and opening the correct project. See the section on Project Structure for a more detailed description of projects and waveform management.

Channel 1	Select <b>Waveform</b> or <b>Sequence</b> for Channel 1
Channel 2	Select <b>Waveform</b> or <b>Sequence</b> for Channel 2
Scratch Pad	Select <b>Waveform</b> or <b>Sequence</b> for the Scratch pad
New	Select a <b>New Wave</b>
Reference	Select A <b>Reference Wave</b>

**Table 3.1 Summary of “Select Wave” menu**

**Channel 1/Channel 2**

In the box labeled channel 1 or channel 2 there are two choices: **Wave/Seq** and **Waveform\***. The former is a toggle switch that chooses whether or not the output of the selected channel is to be a simple waveform or a sequence of waveforms. See the section on Sequence Waveforms for a detailed explanation.

*\*NOTE: For this discussion it is assumed that the toggle switch has been set to **WAVE**.*

## Select Wave

The second choice is **Waveform**. Pushing the associated grey softkey will cause the **Rotary Knob** symbol to attach to the waveform select function. Turning the rotary knob will scroll through the list of available waveforms. Alternately pushing the associated grey softkey again will cause the AWG to display the list of available waveform options on the left side of the screen. The associated softkey can be pushed to select the desired waveform. As described previously, if the waveform desired is not in the list, perhaps it is stored in a different project.

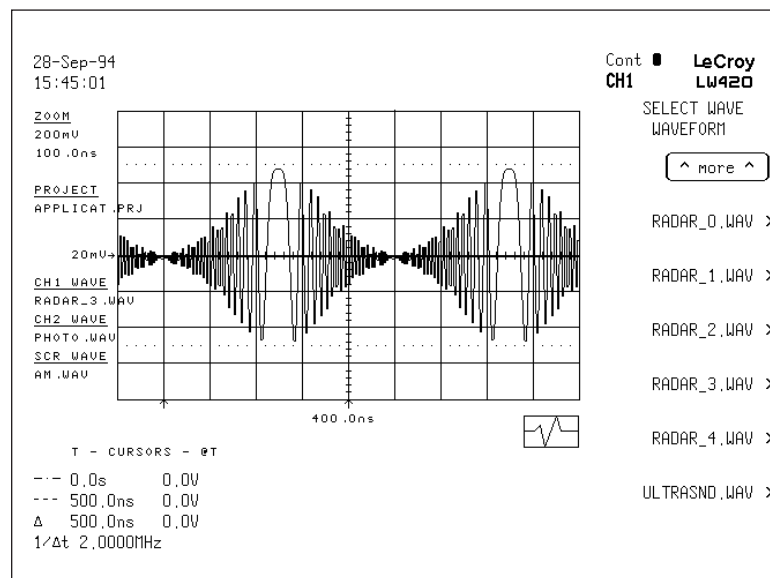

**Figure 3.2 Selecting the Wave from a list**

Notice that after selecting a waveform for channel 1 or 2, the corresponding waveform is now displayed on the screen of the AWG. This waveform is now appearing at the output of the BNC connectors as described above provided the output is enabled.

---

**Scratch Pad**

The **Scratch Pad** has the same selection options as **Channel 1** and **Channel 2**; however, it has a different functionality. The scratch pad is not directly associated with an output channel. It is, as the name implies, a place to experiment with different waveform options before they are committed to an output. Waveforms can be edited in the scratch pad memory without affecting the state of the output of the AWG.

**New**

This is the starting point for creation and naming of a totally new waveform. Pushing the softkey labeled **new** activates a sub menu permitting selection of a **new channel 1 wave**, a **new channel 2 wave** or a **new scratch pad wave** as a new wave. Selecting one of these three options now causes the system to jump to its alphanumeric entry menu and permits the user to assign a unique name to this new waveform.

*Note that alphanumeric entries may also be made via an IBM PC/AT compatible keyboard connected to the Auxilliary Control connector on the rear panel of the LW400. Entries from the keyboard are limited to upper case letters and numbers. The back-space key may be used to delete text.*

# Reference

## Reference

### Selecting the Reference

Often it is desirable to see a reference wave. For example, it may be desirable to edit a waveform while viewing the original version of the waveform as it is being edited. The reference wave provides this ability. In the accompanying figure, a reference wave (bottom trace) is shown simultaneously as the WaveStation user prepares to Edit the active Waveform file (top trace).

Selecting **Reference** from the **SELECT WAVE** menu causes the WaveStation to enter a submenu from which it is possible to choose the reference wave. The choices are the same as for the channel 1 or channel 2 wave. There is an additional selection to **Show Reference**. Answering "yes" permits the reference to be viewed.

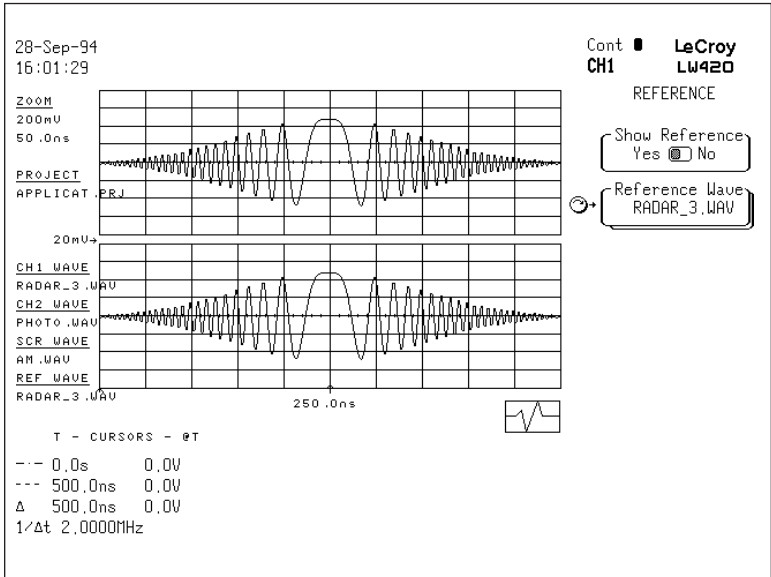

Figure 3.3 Viewing the Reference

# Display

**Splitting the Grid**

To have **two grids** as in the figure, it is necessary to enter the display menu. Push **2nd** followed by **DISPLAY** and under **Type** select **Dual Grid** and push **MENU RETURN**. For further details see the following section on **DISPLAY**.

**Display**

The Display menu is used to setup the type of display, the grid style, and the display intensities. Press the red "2<sup>ND</sup>" button and then **DISPLAY** ( the alternate function of the **ZOOM** button). The **DISPLAY** menu, shown in the adjacent figure, will appear.

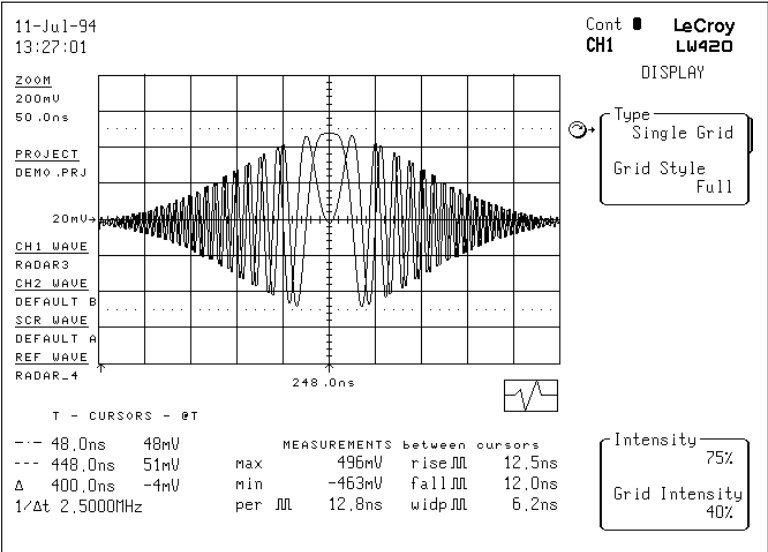

**Figure 3.4 Setting up the display**

## Display

### Type

The four display types available are **Single**, **Dual**, **Single and X-Y**, and **X-Y**. Press the **Type** softkey to enable selecting the display type using the rotary knob. Pressing the softkey a second time will show all the choices along with individual softkeys for selection.

With **Single** grid, the selected waveform, or the selected waveform and the reference waveform can be displayed within the same grid.

The **Dual** grid splits the display into two grids. The selected waveform is displayed within the top grid. The reference waveform, if enabled by **Show Reference** switch in the **REFERENCE** menu, is displayed in the lower grid.

The **Single and X-Y** grid combines an X-Y display and a single display grid. The Reference waveform is plotted as the Y (ordinate) axis, while the Selected Waveform is plotted along the X (abscissa) axis. This arrangement permits waveform phase relationships to be investigated as shown in the accompanying figure.

Similarly, the **X-Y** grid provides a full screen view of the reference waveform plotted against the selected waveform.

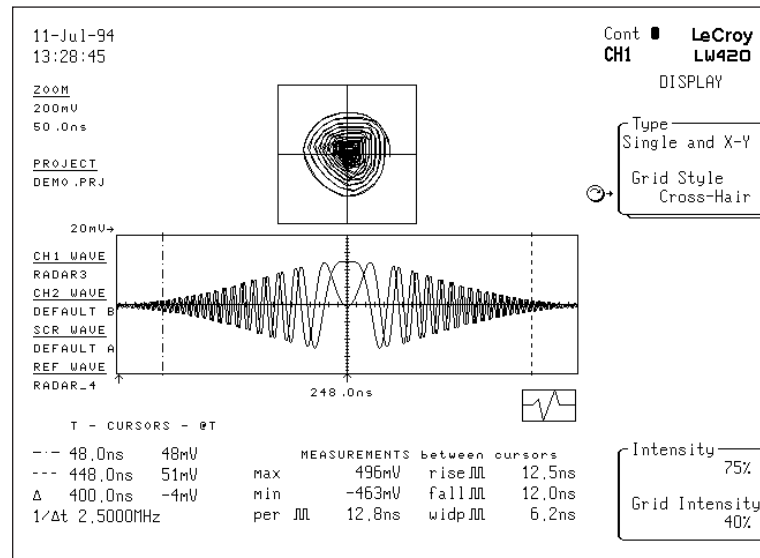

**Figure 3.5 X-Y Single Display**



**Grid Style**

**Full**, **Border**, or **Cross-Hair** grids can be selected by pressing the Grid Style softkey. The **Full** grid includes graticule lines at each major division in the 8 by 10 division display. The Border style eliminates all the grid lines except for an outer border. The **Cross-Hair** grid, as the name implies, consists of a set of perpendicular axes marked with major and minor division increments

**Intensity**

The **Intensity** menu field is used to set the displayed intensity of the waveforms and annotation. When selected, it is adjustable over a range of 1% to 100% using the rotary knob or by numeric entry from the keypad. Likewise, the **Grid Intensity** allows the user to adjust the brightness of the grid lines independently of the waveform traces.

## Zoom

### Zoom

Pushing the operation key labeled **ZOOM** on the left of the rotary control knob activates the menu that permits selection of the displayed time and amplitude scale factors (zoom factor). The ZOOM controls only affect the display of the waveform. The time base and amplitude settings of the waveform are not affected by these settings. There are two major selection fields in this submenu. They are **Horizontal** and **Vertical**. Each section has two additional selections: the value at the center and the appropriate scaling in time or volts per division. Pushing the appropriate grey menu button causes the **rotary control** to attach to the function selected. The rotary control is now used to change the value of the selected function. Whenever the rotary control is used to change a numerical value, the resolution of the digit being controlled can be changed by using the **left** and **right digit** button located above the rotary control.

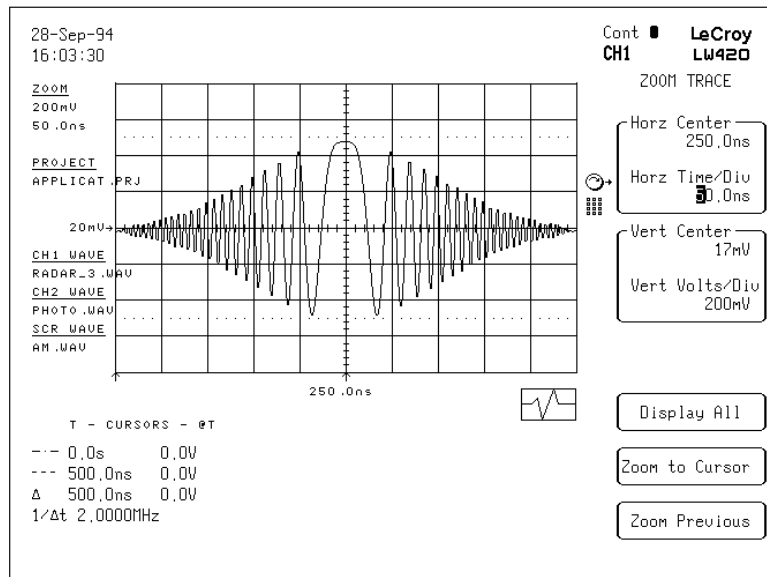

**Figure 3.6 The Zoom Trace Menu**

## Zoom

---

When a selected numerical quantity is lowered or raised until either the low or high limit is reached, an error message is printed on the screen of the AWG. This error message states for example, "Cannot decrement this digit" meaning that either incrementing or decrementing the selected digit will exceed the extreme limit for the field.

### **Display All**

Display All causes the entire waveform to appear on the screen. It has the effect of undoing any expansions that have previously been invoked both in time and in amplitude. This will effect the display only, and not the current waveform or output.

### **Zoom to Cursor**

Zoom to Cursor will cause the region of the waveform between the time cursors to expand and fill the screen between the 10% to 90% horizontal grid line.

### **Zoom Previous**

Toggles between the current and previous **ZOOM** setting.

## Exercise

### Exercise

### Waveform selection and zoom

1. Connect the AWG to an oscilloscope
2. Push Project
3. Push the softkey next to Open
4. Select the project name APPLICAT.PRJ
5. Push Accept
6. Push Menu Return (this step can be skipped)
7. Push Select Wave
8. Push the grey soft key next to Channel 1 Waveform
9. Select PHOTO.wav
10. Push Menu Return (this step can be skipped)
11. Push ZOOM
12. Position Horizontal Center at 12  $\mu$ s
13. Expand Horizontal Time/Div to 200 ns
14. Toggle Display All and Zoom Previous

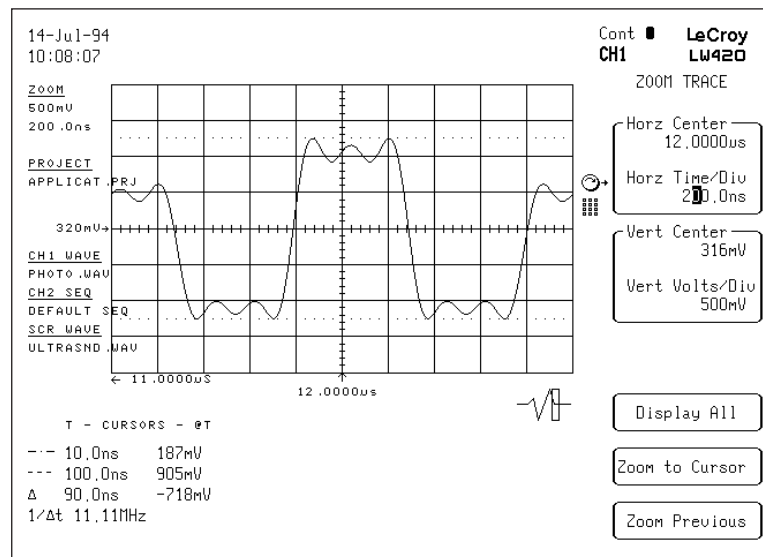

Figure 3.7 The Result of Exercise 1

### Cursor Manipulations

**Live** waveform manipulation means selecting some feature of a waveform and changing it while the output is also modified. This change does not occur in **real time**: there is some delay between feature manipulation in the AWG and a change in the state of the output which is proportional to the size of the area affected.

The first step in “live” waveform manipulation is to use the **time cursors** to select a region of interest in the waveform. This may also involve using the Zoom controls discussed previously. By using Zoom to expand the waveform a detailed examination and selection of waveform elements can be accomplished. This will help assure accurate results of a waveform manipulation of a specific feature.

### Time Cursors

Pressing the **Operation** key labeled **TIME CURSOR** next to the rotary control knob activates the menu depicted in figure 4.1 below. The time cursors consist of two **vertical bars** that can be positioned on either side of a waveform feature in order to manipulate extract or delete that feature when

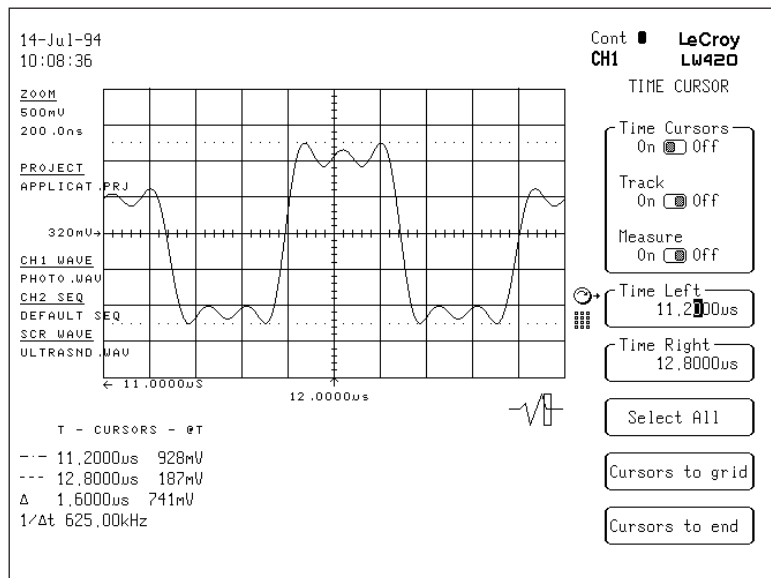

**Figure 4.1 Time Cursor Menu**

## Time Cursor

editing. (See editing waveforms in section 6). The time cursors may not cross one another. Time cursors are used in all editing, functions and measurements. Measurements and Cut editing operations use both cursors while Paste and other Insert operations use the left Cursor.

Time Cursor On/Off	This toggle switch selection turns the timer cursors on or off
Track On/Off	With track set to On, the right cursor moves with left cursor at a fixed time difference (DELTA) when the left cursor is selected and moved.
Measure On/Off	This toggle switch turns the measurements on or off
Time Left	Select this field to move the Time Left Cursor
Time Right	Select this field to move the Time Right Cursor
Delta	Change the delta between the cursors
Select All	Position the cursors to surround the entire waveform
Cursors To Grid	Move the cursors onto the grid (see discussion below)
Cursors To End	Move both cursors to the right end of the waveform

**Table 4.1 Summary of Time Cursor Operations**

### Help ! Where are the Cursors?

When the cursors are first turned on, it is possible that they are not visible on screen. Try pushing the softkey labeled **Cursors to Grid** immediately. The reason the cursors may not be seen initially is they are located on a portion of the waveform that is outside the field of view. This can occur if, for example, the waveform has been previously expanded and recentered using the **ZOOM** controls. Notice it is possible to manipulate the cursors independent of viewing them: the AWG knows where the cursors are even if they are not being displayed. Similarly **Cursors To End** may move the cursors off the screen and outside the field of view if the present state of the expansion is such that the end of the waveform is outside the field of view.

Another reason the cursors may not be visible is because they are located directly over a display gradicule line. Turning the rotary control knob will bring the selected cursor into view.

## Voltage Cursor

### Measure

When the measurements are on they will be displayed in the bottom center of the screen (below the grid). Six measurements will be made: min, max, rise time, fall time, period (PER) and width (WIDP). **Min** will be the minimum amplitude between the **Time Left** and **Time Right** cursors. **Max** will be the maximum amplitude between the **Time Left** and **Time Right** cursors. **Rise time** and **Fall time** will be the first respective qualifying edge after the **Time Left** cursor and are 10% to 90%. **Period** will be the time between two odd numbered 50% crossings beginning with the 1st crossings after the left cursor. **WIDP** is the time between adjacent 50% crossings for the first positive pulse between the cursors. See Appendix A for more detail.

### Voltage Cursors

Pressing the menu selection key labeled **Voltage Cursors** next to the rotary control knob activates the submenu seen in figure 4.2 and summarized in the table below. The voltage cursors consist of **two horizontal bars** that can be positioned up or down along the waveform. The voltage cursors may not cross one another. These cursors are used for making measurements on waveforms.

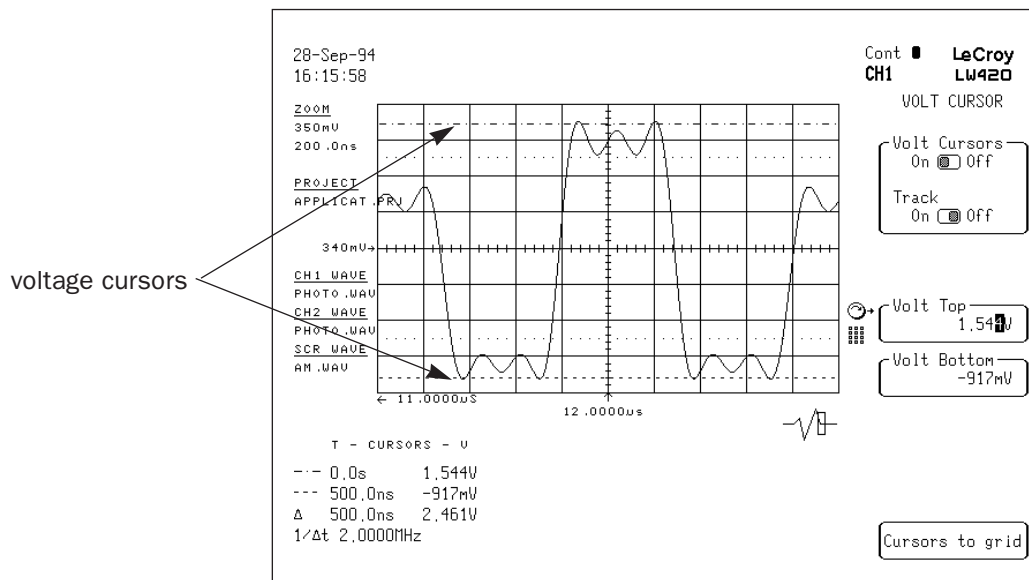

Fig. 4.2 Voltage Cursor Menu

## Voltage Cursor

Volt Cursor On/Off	This toggle turns the voltage cursors on or off
Track On/Off	With Track set to On, the voltage cursors move together at a fixed voltage difference (DELTA) when the top cursor is moved.
Volt Top	Select this field to move the top voltage cursor
Volt Bottom	Select this field to move the bottom voltage cursor
Delta	With track On, this is the voltage difference between the top and bottom cursors
Cursors To Grid	Position the cursors on the grid from their current location

**Table 4.2 Summary of Voltage Cursor Operations**

### “Live” Manipulations

Many Time Editing operations are performed as quickly as possible in response to user input. The LW400 attempts to compute the desired waveform immediately when the state is changed. If the requested state is changed again before the computation is completed, the partially completed computation is discarded and a new attempt to compute the desired waveform is begun.

If the waveform being edited is the active waveform for one of the channels, then it is automatically updated when the new waveform is computed. The output holds a data point from the previous waveform while the new playback image is being loaded. The playback of the new image begins at its first value.



## Time Edit

### Time Edit

Press the **Time** button in the **Edit** group to get the menu of figure 4.3. From this menu the duration of part or all of a waveform can be rescaled, or shifted (delayed) in time. Changing the duration of a region always expands or compresses it horizontally; vertical scaling is not affected.

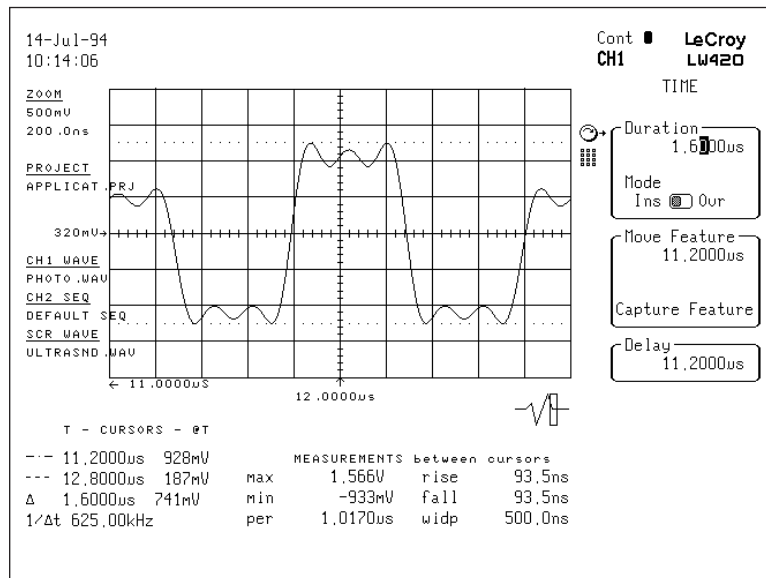

**Fig 4.3 The Edit Time Menu**

### Duration

Stretches and compresses the waveform between the cursors horizontally, in time. The left cursor remains in a fixed position and the right cursor moves to the left or right depending on the direction in which the **rotary knob** is turned. A number for duration can also be entered using the **numeric keypad**. As the right cursor slides in response to the input, the amplitude value at the right cursor remains fixed. The method of insertion depends on the selection of **mode** described below.

*Note that using duration provides a quick way to rescale an entire waveform. Using the **time cursors, select all**, then change duration.*

## Time Edit

---

<b>Mode</b>	In <b>Overwrite Mode</b> the length of the waveform doesn't change as a region is rescaled: as the region expands, data to the right of the region is overwritten; as the region shrinks, amplitude of the right-most point is replicated to keep the waveform length constant. In <b>Insert Mode</b> the waveform size increases and decreases as the region increases and decreases.
<b>Move Feature</b>	Slides the region, or feature, between the cursors over the waveform. As the region slides, the waveform values are linearly superimposed on each other. The precision with which a feature can be placed is 100 psec.
<b>Capture Feature</b>	As a waveform feature is moved the linear addition causes new "features" to be formed. That is for example, a pulse sliding over another pulse and adding to it will cause a new pulse that is the sum of the two. If it is now desired to capture this "new feature" and move it, then press <b>Capture Feature</b> . The memory will now lose the old "feature" and begin to slide the new "feature" in it's place.
<b>Delay</b>	Takes the entire waveform starting with the left cursor and slides it to the right or left by an amount equal to the value in the <b>Delay</b> field. This is done with a maximum precision, or resolution of 100 psec.

### Live Waveform Manipulation

1. Refer back to **Exercise 1** for **Waveform Selection & Zoom**
2. Press **Time Cursor**
3. Position the **Time Left** and **Time Right** Cursor around a small section of the waveform
4. Press **Time** in the **Edit** section
5. Select **Move Feature** and turn the **Rotary Knob**. Observe the effort on the oscilloscope.
6. Push **UNDO** on the keypad and answer **ok**
7. Select **Duration** and turn the **Rotary Knob**. Observe the effort on the oscilloscope.
8. Repeat step 6
9. Select **Delay** and change it with the **Rotary Knob**. Again, observe the effort on the oscilloscope.
10. Repeat step 6 to **Undo** your changes

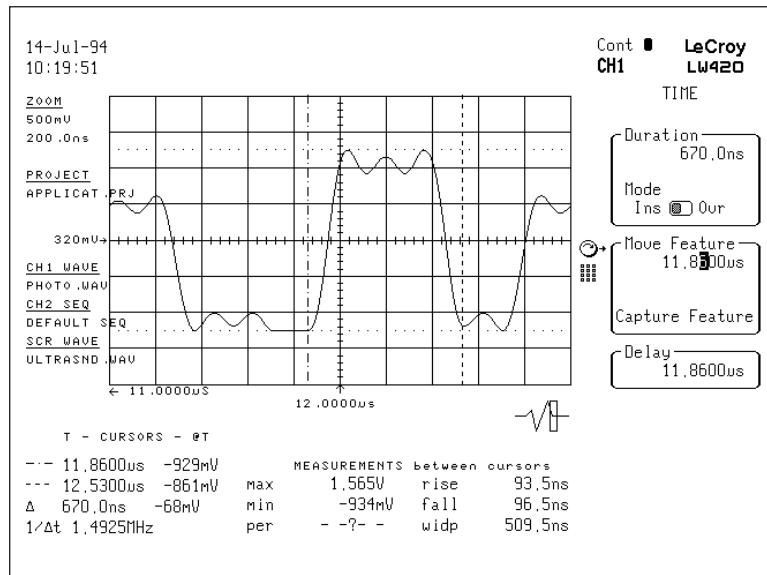

**Fig. 4.4 Moving the feature in PHOTO.WAV**

## Amplitude Edit

### Amplitude Edit

Press the **Amplitude** button in the Edit group to get the menu of figure 4.4. From this menu the amplitude of all or selected portions of the active waveform can be manipulated “live”.

Amplitude	Sets the peak-to-peak amplitude of the waveform between the two cursors with respect to the baseline.* The baseline is the line drawn between the two cursors
Median	Sets the median voltage of the displayed waveform between the time cursors
Max Voltage	Sets the maximum voltage of the displayed waveform between the time cursors
Min Voltage	Sets the minimum voltage of the displayed waveform between the time cursors

**Table 4.3 Summary of the Edit Amplitude menu**

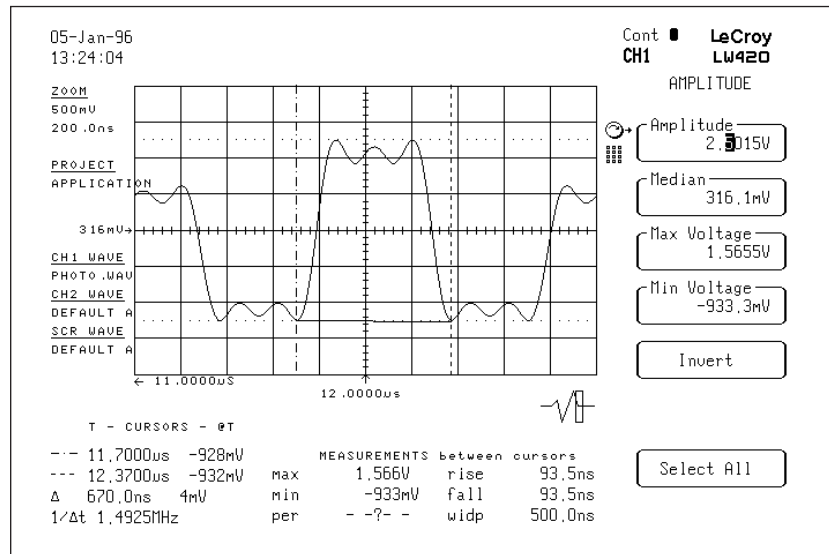
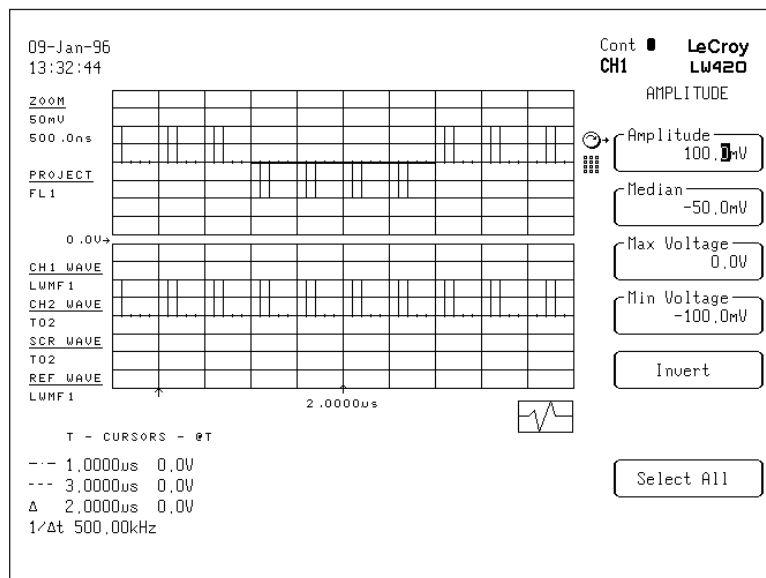

**Figure 4.4 The Edit Amplitude Menu**

*\*Note: The baseline is the reference line shown on the display, connecting the points where two cursors intersect the waveform. If the baseline termination points are not of equal amplitude the baseline will be sloped.*

### Live Waveform Inversion

Waveform inversion (i.e. multiply by -1) is available as an amplitude edit function. As in all of the edit functions, the portion of the waveform between the time cursors is affected by the invert operation. It is possible to invert all or part of the waveform.



**Figure 4.5 The Invert softkey in the Amplitude Edit menu**

In the example shown in the top trace of the accompanying figure, the portion of the waveform between the time cursors has been inverted. The lower trace is the reference waveform, showing the original waveform. Note that the signal is inverted about the edit baseline (the line connecting the points on the waveform intersected by the time cursors). In this example the baseline is set to be 0 Volts.



## Edit Insert Wave Menu

There are many different sources of waveforms available to the user of the LW400 Series Arbitrary Waveform Generator. Waveform files may be transferred directly from a variety of oscilloscopes without the need for an intermediate computer. They may also be transferred from other LeCroy arbitrary function generators. Especially important to current users of LeCroy AFG's is the ability to transfer EasyWave files to the LW400. If a function can be described with an equation, then the built in equation editor should make entry relatively painless. Waveform files may be input in an ASCII format from any source. In addition, a variety of standard functions are available as a starting point for waveform creation.

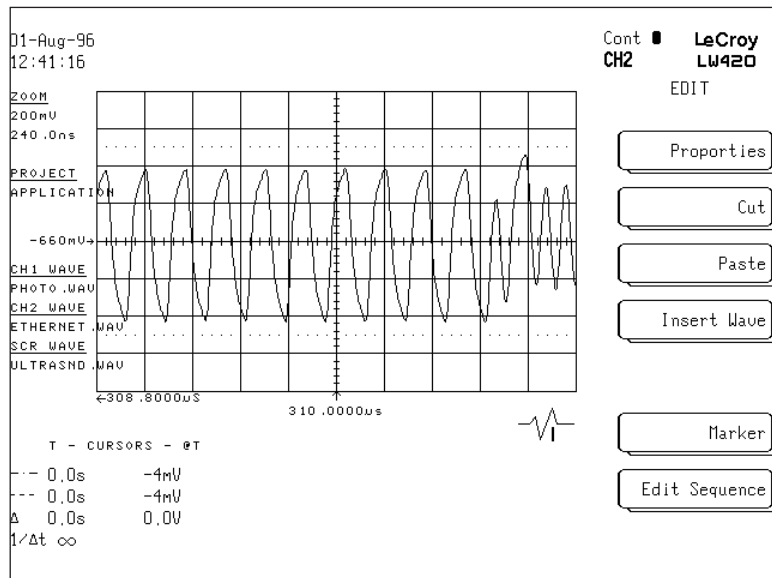

**Fig 5.1 The Edit Wave Menu**

All of these functions can be accessed from Insert Wave, as summarized in table 5.1.

## Insert from DSO

From Scope	Waveforms can be inserted from a variety of scopes (Section 5.1)
Standard Waves	There are a variety of standard waves (Section 5.2)
Equations	The equation editor is described in Section 5.4
Other Waves	Insert other waveforms from current project

**Table 5.1 Summary of Sources from which Waves may be inserted**

DSO Type	Selects from the list of available scopes
Trace Source	Selects which (DSO) Trace to get the waveform from
DSO GPIB Address	Selects the scopes GPIB address (see below)
Preserve Time/Pts	Preserve time resamples the data keeping the waveform duration constant. Preserve points reproduce each sample acquired from the DSO but at the LW400's clock period
Request Control yes/no	Set to yes if LW400 is installed in a system with another GPIB controller on the bus.
Execute	Transfers the waveform from the DSO to the AWG

**Table 5.2 Summary of "Get From Scope" menu options**

**From Scope DSO Type**      This is the type of digital oscilloscope that the waveform will be downloaded from. There are many available choices including oscilloscopes from LeCroy, Hewlett Packard, and Tektronix. Other oscilloscopes may be added by importing an appropriate digital oscilloscope configuration (DSO) file using the Import function in the Project menu.

**GPIB Address**              This command does **not** set the address of the scope or the AWG. It tells the AWG what address the DSO is already set for.



**Insert from DSO**

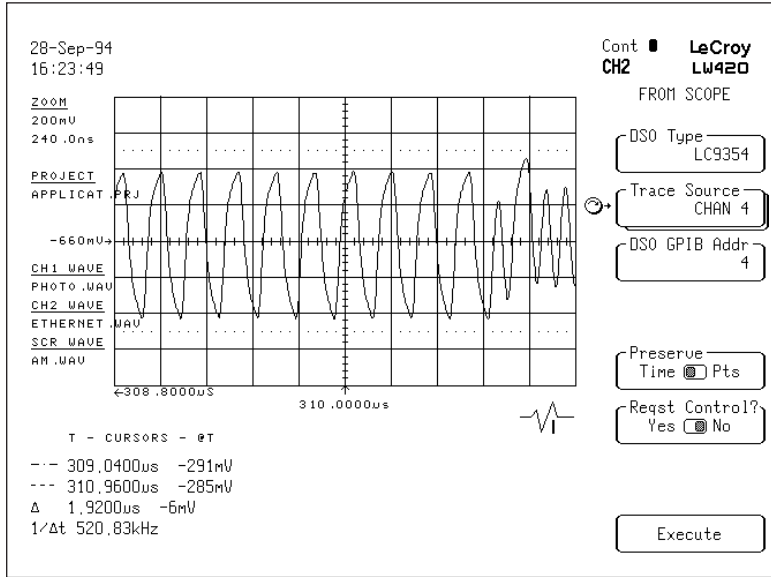

**Figure 5.2 Insert From Scope**

**Preserve Time/Pts**

This choice allows the operator to select between preserving the shape in absolute time of a waveform that is being transferred or to preserve the number of points. For example, suppose a DSO has sampled a waveform at 200 Megasamples/second and the WaveStation is running at a clock speed of 400 Megapoints per second. **Preserving time** means the waveform coming from the scope is resampled to match the faster clock speed of the AWG and thus will have twice as many points.

**Preserving points**, on the other hand, means the reconstructed waveform will have twice the frequency content of the original waveform. This is because the reconstructed waveform will have the same number of points however; since the AWG is going twice as fast as the scope, the new points will be spaced closer together.

The choice to preserve the number of points has the potential to change the frequency content of a signal unless the WaveStation clock is adjusted accordingly but it preserves the exact shape of the waveform.

**Insert from Standard Waves**

**Standard Waves**

A library of standard waves is available. Figure 5.2 shows the menu selections available in the standard waves menu. The tables below summarize the characteristics of these waves.

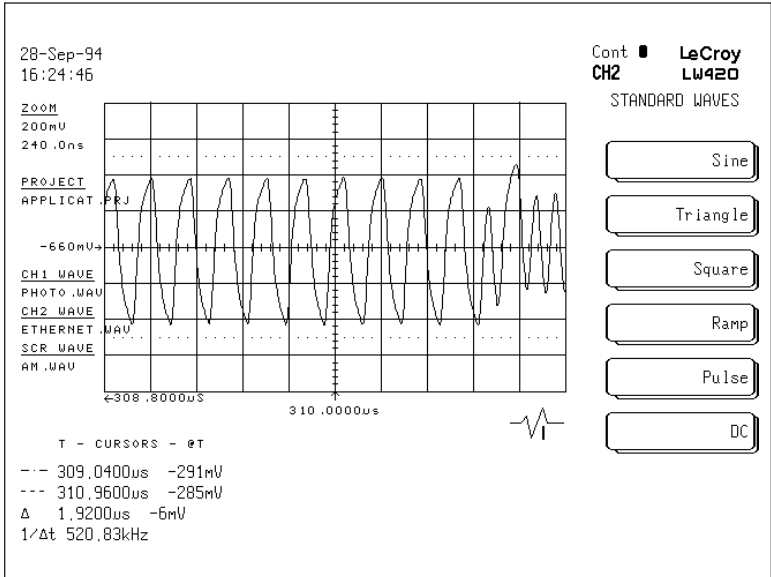

**Figure 5.3 Standard Wave Selection**

Sine

Variable	Range	Resolution	Default Value
Amplitude (peak-to-peak)	0 mV - 10 V	1mV	1 Volt
Offset @ zero phase	+5 V to -5 V	1 mV	0 Volts
Frequency	1 Hz to 100 MHz	1 ppm	10 MHz
Cycles	0.01 to 65 k	1 or 10	10 cycles
Start Phase (see note below)	0 to 360	.05 degree	0 degree

**Insert from Standard Waves**

Triangle

Variable	Range	Resolution	Default Value
Amplitude (peak-to-peak)	0 mV - 10 V	1mV	1 Volt
Offset @ zero phase	+5 V to -5 V	1 mV	0 Volts
Frequency	1 Hz to 25 MHz	1 ppm	10 MHz
Cycles	0.01 to 65 k	1 or 10	10 cycles
Start Phase (see note below)	0 to 360	.05 degree	0 degree

Square

Variable	Range	Resolution	Default Value
Amplitude (peak-to-peak)	0 mV - 10 V	1mV	1 Volt
Base	+5 V to -5 V	1 mV	0 Volts
Frequency	1 Hz to 50 MHz	1 ppm	10 MHz
Cycles	0.01 to 65 k	1 or 10	10 cycles
<sup>1</sup> Time Delay	0 ns to mem. length	1 ns	0 ns
<sup>1</sup> Edge Time (risetime and falltime)	5 nsec to 500 ns	1 ns	5 ns

Ramp

Variable	Range	Resolution	Default Value
Amplitude (peak-to-peak)	0 mV - 10 V	1mV	1 Volt
Offset @ zero phase	+5 V to -5 V	1 mV	0 Volts
Frequency	1 Hz to 25 MHz	1 ppm	10 MHz
Cycles	0.01 to 65 k	1 or 10	10 cycles
Start Position	0 to 100%	1 m %	0.0 %
Invert	on/off		off

1. This range is given for the 400 MS/s clock rate. This range is scaled with the clock rate.

**Insert from Standard Waves**

Pulse

Variable	Range	Resolution	Default Value
Amplitude (peak-to-peak)	0 mV - 10 V	1mV	1 Volt
Base	+5 V to -5 V	1 mV	0 Volts
<sup>1,2</sup> Period	10 ns - 2.5 ms	1 ppm	10 MHz
Cycles	0.01 to 65 k	1 or 10	10 cycles
<sup>1,2</sup> Width	0 to 2.5 ms	1 ns	5 ns
Time Delay	0 to memory length	1 ns	0 ns
<sup>1</sup> Edge Time (risetime and falltime)	5 nsec to 500 ns	1 ns	5 ns

DC

Variable	Range	Resolution	Default Value
Level	+ - 5V	1mV	1Volt
Duration	10 ns to mem length	1ns	10 usec

1. This range is given for the 400 MS/s clock rate. This range is scaled with the clock rate.  
 2. Maximum period and width are related to the length of waveform memory. Numbers quoted are for 1 Mbyte memory.

**Equations**

Any waveform that can be described by an equation using the 11 basic waveform functions, can be entered via the equation editor. This includes simple everyday functions like sine waves and pulses, and extends to very complex mathematical expressions. The equation editor provides an environment for entering, editing and calculating mathematical functions.

This section of the manual describes the equation editor and the associated functions and arguments.

**Waveform  
Equation Notebook**

A separate publication called the “Waveform Equation Notebook” gives examples of many functions and their associated equations. The “Waveform Equation Notebook” is included with this manual section.

## Edit Equation

### Select Line

This field allows a user to select one of the 16 lines in the equation. This is the equation line that is calculated. A valid line number can be entered using the numeric key pad or the rotary knob can be used to move the line cursor. The cursor will not wrap around from line 16 to line 1, it will stop at the extremes.

Duration	This is the duration of the waveform that is calculated
Edit Equation Line	Enter an equation on the selected line
New	Start or name an equation
Open	Get an already existing equation
Save	Save an equation
Calculate	Calculate the equation in the selected line and produce a waveform

**Table 5.3 Summary of “Edit” Equation Options**

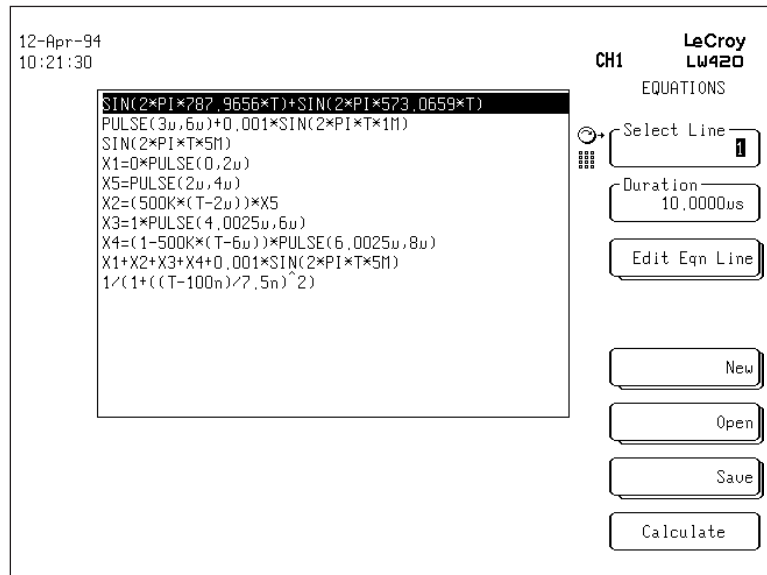

**Figure 5.3 Edit Equations**

### Edit Eqn Line

On entering this menu the select line bar will go away and the text cursor will appear at the beginning of the selected line. When the **Functions**, **Operators**, **Variables**, or **Arguments** field is pressed, the lists are expanded, allowing the user to choose a list item. When the list item is selected (by pressing the softkey next to the item) it will be inserted into the equation. Constants can be placed into the equation by using the numeric key pad. No attempt will be made to make sure that the equation is syntactically correct, it is solely up to the user. If an incorrect equation is calculated, the user will be told there is an error in the equation. References can be made to include other lines of the equation sheet by defining variables. The entire equation will be expanded (internally) but the expanded version must not exceed 1024 characters.

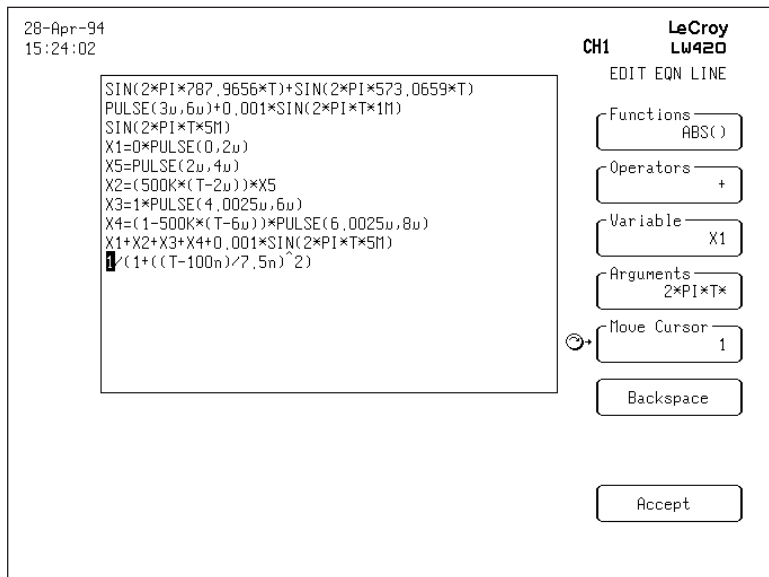

**Figure 5.4 The Equation Editor**

## Edit Equation

### Functions

The following functions can be used in equations; Absolute Value(ABS), Cosine(COS), Exponent(EXP), Integer Floor (FLOOR), Natural Logarithm(LN), Common Logarithm(LOG), Pulse (PULSE), Sine(SIN), Square Root(SQRT), Unit Step(STEP), Tangent(TAN). Since all these functions require a “( )” after the function name, it will automatically be inserted and the cursor will be placed between the parentheses.

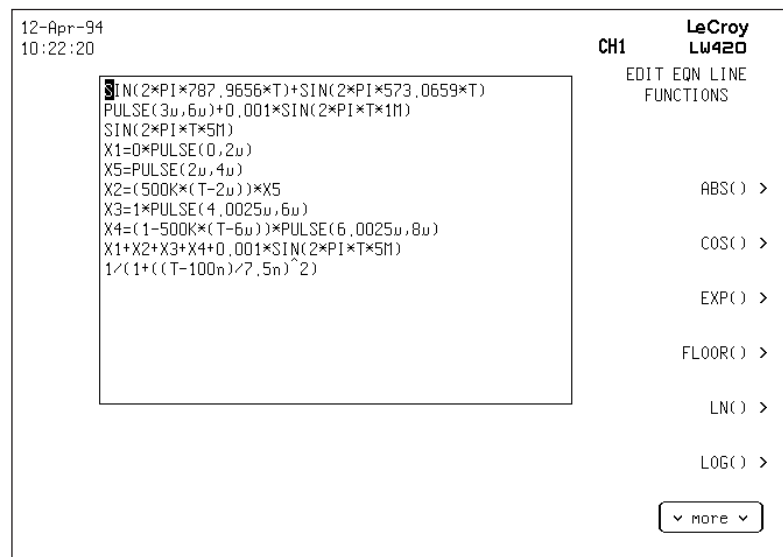

Figure 5.5 The Functions List

### Operators

The available operators are; Add(+), subtract(-), multiply (\*), divide(/), group ( ), comma (,) and raise to a power (^).

### Variables

You can define a variable in the form of X# = <any valid equation including constants>, where # ranges from 1 to 16. These variables can be used in the middle of another equation, e.g. X1 + X2.

### Arguments

Includes: 2\*PI\*T, T, PI, NOISE and GNOISE. NOISE returns a pseudorandom series of values with uniform amplitude distribution. GNOISE returns a pseudorandom sequence with Gaussian distributed amplitude values. *Note: T = 0 at the left cursor.*



## Edit Equation

---

<b>Move Cursor</b>	This field has the rotary knob and numeric keypad attached to it. The text cursor is moved by turning the knob or entering the numeric position desired.
<b>Backspace</b>	Backspace will delete the character to the left of the cursor.
<b>Accept</b>	Enters the selected line and returns the user to the main EQUATION menu and the highlight bar will be restored.  <i>Note: exiting this menu without pressing <b>Accept</b> causes no action to be taken.</i>
<b>New</b>	This field contains the name for a new equation. The number key pad and the keyboard (if present) will be active. It is 14 characters in length and can contain spaces. Entering and accepting a new equation name will close the contents of the equation editor.
<b>Open</b>	A list of available equations to open.
<b>Save</b>	On entry to the menu this field contains the name of the open equation. If a new name is entered in the <b>Save As</b> menu (see below) then this field contains that name.
<b>Save As</b>	This menu acquires the name under which to save the current equation.
<b>Save It</b>	Saves the equation. <i>Note: if the project that the equation belongs to is write protected then the user will be told it's a write protected project and abort the save operation. If a new name was entered for the equation (Save As) then a new equation is created from the current equation. The old equation is closed (no prompt is given if the equation has changed) and the new equation is opened.</i>
<b>Calculate</b>	Calculates the data points of the selected equation and inserts it into the waveform in the <b>INSERT</b> mode. This is the only way to calculate and insert the equation. Exiting this menu without pressing <b>Calculate</b> causes no action to be taken.

## Edit Equations

### Waveform Equation Note book

#### Creating Waveforms From Equations

Equations offer the most precise method of creating a waveform in the LeCroy WaveStation, LW400 Series Arbitrary Waveform Generator. This notebook is intended to provide examples of commonly used waveforms and the equations which describe them. It also provides examples of waveform creation techniques which can be applied more generally.

#### LW400 Equation Functions And Operators

The WaveStation equation editor includes 11 mathematical functions and 9 operators, which are described briefly below.

Functions		
ABS ( )	–	Absolute value, calculates the absolute value, unipolar magnitude, of a function or argument
COS ( )	–	Cosine, calculates the cosine of the argument
EXP ( )	–	Exponential, calculates an exponential, using the base of natural logarithms, e, raised to the power specified in the argument
FLOOR ( )	–	Floor, calculates the integer floor of a function
LN ( )	–	Natural Logarithm, calculates the natural logarithm, base e, of the argument or function
LOG ( )	–	Common Logarithm, calculates the common logarithm, base10, of the argument or function
PULSE ( )	–	Pulse, creates a pulse using edge locations, or functions, specified in the argument
SIN ( )	–	Sine, calculates the sine of the argument
SQRT ( )	–	Square root, calculates the square root of the argument or function
STEP ( )	–	Step Function, creates a unit step at the location specified by the argument or function
TAN ( )	–	Tangent, calculates the tangent of the argument

**Operators**

+	–	Addition
-	-	Subtraction
*	-	Multiplication
/	-	Division
(	-	Mathematical grouping
)	-	Mathematical grouping
,	-	comma – separator for arguments
=	-	equality
^	-	Raise to a power (exponentiation)

**Variables**

The variables X1 - X16 can be used to label the contents of any line on the equation editor. The variable can then be used to replace the contents in another equation.

Example:   X1 = SIN(2\*PI\*10E6\*T)  
               X2 = (1+ 0.75 \* COS(2\*PI\*1E3\*T))  
               X1\*X2

The product X1\*X2 will be computed as follows:

$$X1*X2 = \text{SIN}(2*PI*10E6*T) * (1+ 0.75 * \text{COS}(2*PI*1E3*T))$$

**Arguments**

There are five functional arguments available for use in equations:

- 2\*PI\*T   –   Phase variable for trigonometric functions, in radian seconds
- T       –   Time variable, in seconds
- PI       –   Numerical Constant 3.14159265358979
- NOISE   –   Uniformly distributed random numbers 0-1, mean = 0.5, standard deviation = 0.288
- GNOISE  –   Gaussian distributed random numbers 0-1, mean = 0.5, standard deviation = 0.1667

## Edit Equations

---

### Constants

Numerical constants can be entered from the keypad on the front panel. Use the units multiplier entry keys, p(pico, 1E-12), n (nano, 1E-9),  $\mu$  or u (micro, 1E-6), m (milli, 1E-3), ENTER (units, 1), k (kilo, 1E3), M (Mega, 1E6) to specify the correct multiplier. For example  $7.5 \text{ M} = 7.5 \text{ E}6$  and  $2\text{n} = 2 \text{ E-}9$

### Wave Math

Equations are used in the creation of waveforms from an analytical description. Wave Math is a waveform array processor which operates on entire waveforms, regardless of their source. The operations available in wave math include:

- Smoothing
- Waveform Addition
- Waveform Subtraction
- Waveform Multiplication
- Waveform Division
- Integration
- Differentiation
- Convolution

These operations are available in addition to equation entry but are unique in that they operate on entire waveform. Wave Math operations are covered in a separate section.

### Using The Equation Notebook

In the following examples each waveform type includes a general equation showing the functions, arguments, and variables required. User entered constants are described in general terms. The accompanying waveform includes a specific numerical example. It provides the actual equation used to create the waveform shown.

**Waveform**

**General Equation**

**LW400 Example**

**1. Unit Step**

STEP (T-T<sub>□</sub>)

T<sub>□</sub> - Edge location in seconds

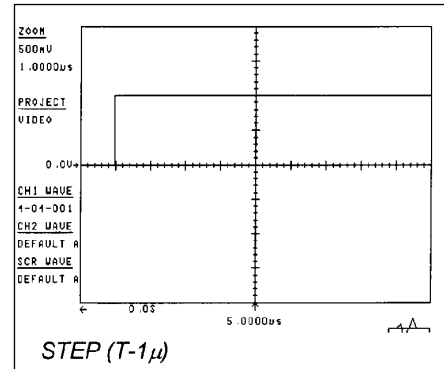

**2. Time Reversed Step (Step Down)**

STEP (T<sub>□</sub>-T)

T<sub>□</sub> - Edge location in seconds

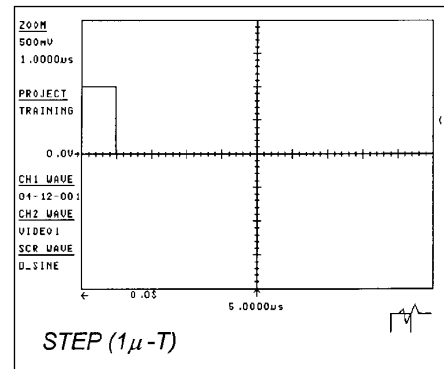

**3. Unit Pulse**

PULSE (T1,T2) or  
STEP (T-T1) - STEP (T-T2)

T<sub>1</sub> - Time of leading edge in seconds

T<sub>2</sub> - Time of trailing edge in seconds

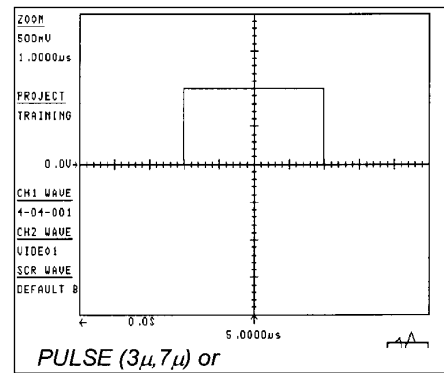

## Edit Equations

### Waveform

### General Equation

### LW400 Example

#### 4. Pulse Train

STEP (SIN (2\*PI\*T\*FS ))  
 FS - Pulse frequency in Hertz

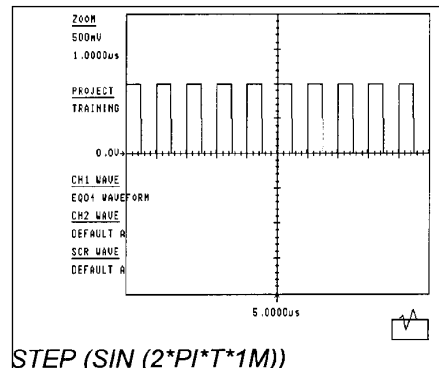

Note: The LW400 function STEP ( ) accepts other functions, f(t), as an argument:

STEP ( f(T)>0 ) = 1  
 STEP ( f(T) <0 ) = 0

#### 5. Tri-level Pulse

PULSE (T<sub>1</sub>,T<sub>2</sub>) - PULSE (T<sub>3</sub>,T<sub>4</sub>)

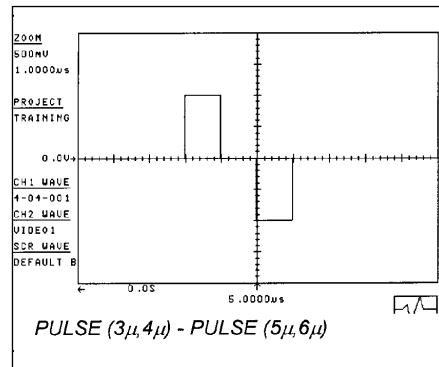

T<sub>1</sub> , T<sub>3</sub> - Time of leading edges in seconds

T<sub>2</sub> , T<sub>4</sub> -Time of trailing edges in seconds

#### 6. Ramp

A \* T

A - Slope of ramp (DV/DT)

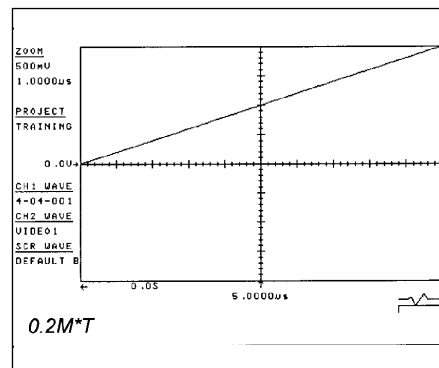

**Waveform**

**General Equation**

**LW400 Example**

**7. Delayed Ramp**

$A * ( T-TD ) * STEP (T-TD )$

A - Slope of ramp (DV/DT)  
 TD - Time delay, seconds

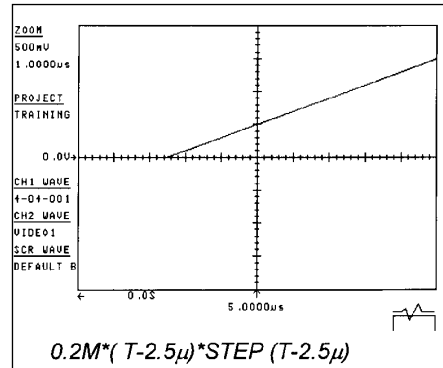

**8. Truncated Ramp**

$A * ( T-TD ) * PULSE ( TD, TL )$

A - Slope of ramp (DV/DT)  
 TD - Time delay, seconds  
 TL - Length of ramp, seconds

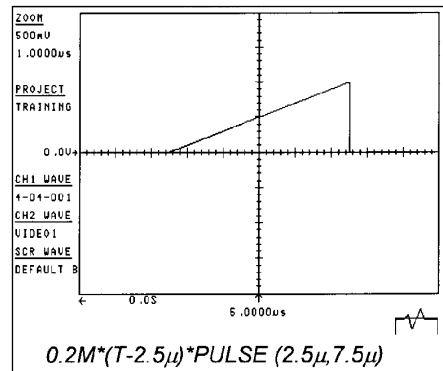

**9. Negative Ramp (Truncated)**

$- A * ( T-TD ) * PULSE ( TD, TL )$

A - Slope of ramp (DV/DT)  
 TD - Time delay, seconds  
 TL - Length of ramp, seconds

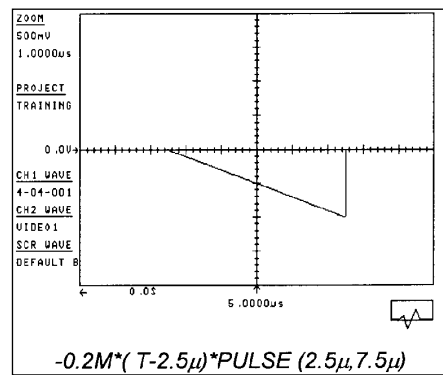

# Equation Notebook

## Waveform

## General Equation

## LW400 Example

**10. Trapezoidal Pulse**  
(with adjustable rise and fall times)

$$X1 = A * (T-T1) * \text{STEP}(T-T1)$$

$$X2 = A * (T-T2) * \text{STEP}(T-T2)$$

$$X3 = A * (T-T3) * \text{STEP}(T-T3)$$

$$X4 = -A * (T-T4) * \text{STEP}(T-T4)$$

A - Edge slope (DV/DT)  
 T<sub>1</sub> - Leading edge start time  
 T<sub>2</sub> - Leading edge end time  
 T<sub>3</sub> - Trailing edge start time  
 T<sub>4</sub> - Trailing edge end time  
 all times in seconds

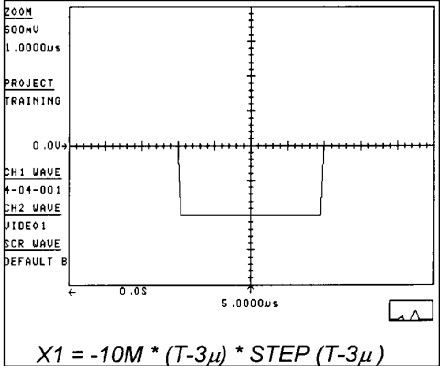

**11. Sine**

$$V * \text{SIN}(2 * \text{PI} * T * \text{FS})$$

FS - Signal frequency, Hertz  
 V - Signal amplitude, V P-P

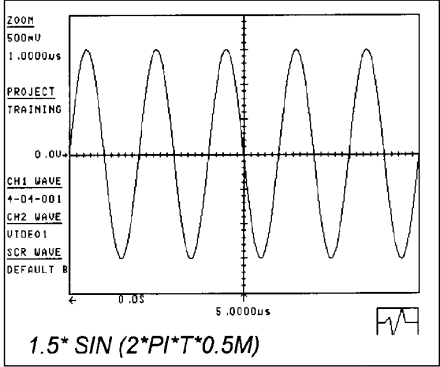

**12. Gated Sine**

$$V * \text{SIN}(2 * \text{PI} * T * \text{FS}) * \text{STEP}(T-TG)$$

FS - Signal frequency, Hertz  
 V - Signal amplitude, V P-P  
 T<sub>g</sub> - Gate start time, seconds

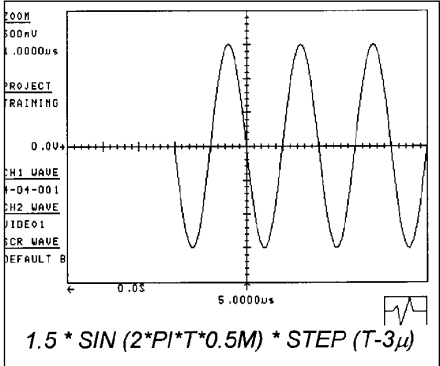



**Edit Equation**

**Waveform**

**General Equation**

**LW400 Example**

**13. Sine Burst**

$$V * \text{SIN}(2 * \text{PI} * T * \text{FS}) * \text{PULSE}(\text{TS}, \text{TE})$$

V - Signal amplitude, V P-P  
 FS - Signal frequency, Hertz  
 TS - Burst start time  
 TE - Burst end time  
 all times in seconds

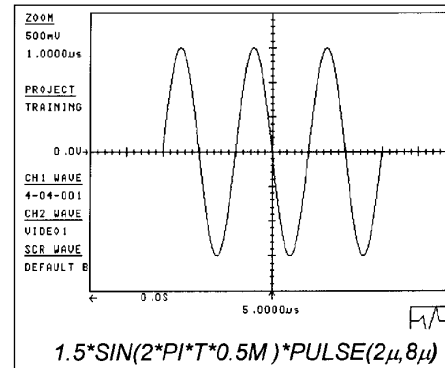

**14. Decaying Exponential**

$$\text{EXP}(-T / \text{TC})$$

T<sub>c</sub> - Time constant, seconds

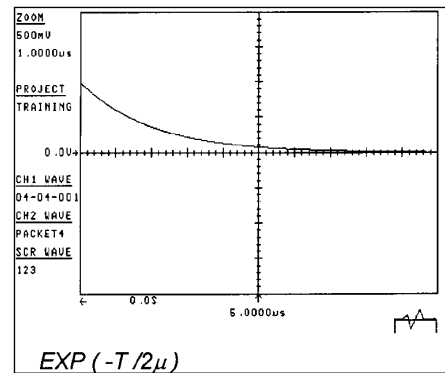

**15. Delayed Exponential Decay**

$$\text{EXP}(-(T - \text{TD}) / \text{TC}) * \text{STEP}(T - \text{TD})$$

T<sub>c</sub> - Time constant, seconds  
 T<sub>D</sub> - Time delay, seconds

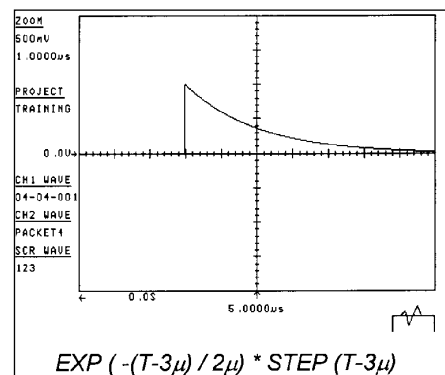

Edit Equation

**Waveform**

**General Equation**

**LW400 Example**

**16. Rising Exponential**

1- EXP (-T/T<sub>c</sub>)  
 T<sub>c</sub> - Time constant, seconds

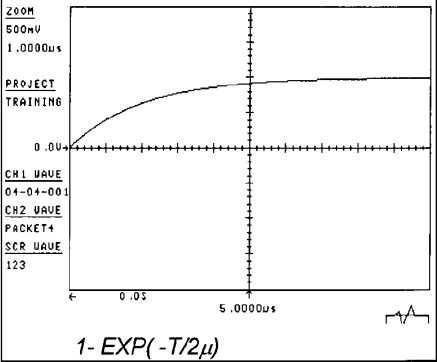

accused

**17. Delayed Rising Exponential**

1-EXP(-(T-T<sub>D</sub>)/T<sub>c</sub>)\*  
 STEP(T-TD)  
 T<sub>c</sub> - Time constant, seconds  
 T<sub>D</sub> - Time delay, seconds

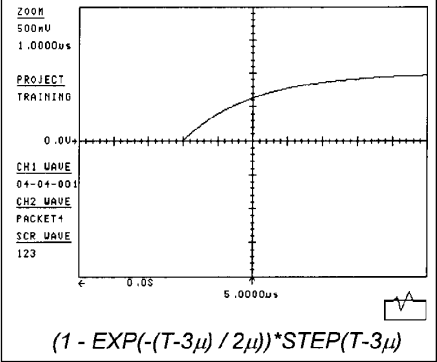

**18. Exponential Pulse With Different Rise And Fall Constants**

X1=(1-EXP(-(T-T<sub>1</sub>)/T<sub>2</sub>))\*  
 PULSE(T<sub>1</sub>, T<sub>3</sub>)  
 X2=(EXP(-(T-T<sub>3</sub>)/T<sub>4</sub>))\*  
 STEP(T-T<sub>3</sub>)  
 X1+X2  
 T<sub>1</sub> - Delay of rising edge  
 T<sub>2</sub> - Time constant of rise  
 T<sub>3</sub> - Delay of falling edge  
 T<sub>4</sub> - Time constant of fall  
 T - Sample period

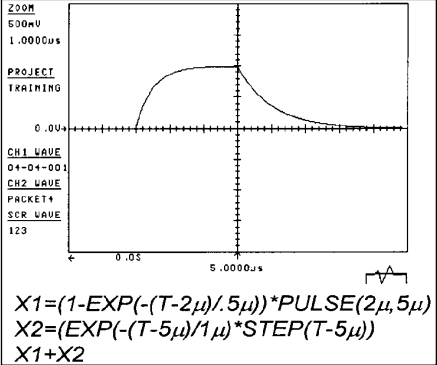

**Waveform**

**General Equation**

**LW400 Example**

**19. Exponentially Damped Sine With Gain**

$$V * \text{EXP}(-T/TC) * \text{SIN}(2 * \text{PI} * T * FS)$$

FS - Signal frequency, Hertz  
 TC - Time constant, seconds  
 V - Signal amplitude, V P-P

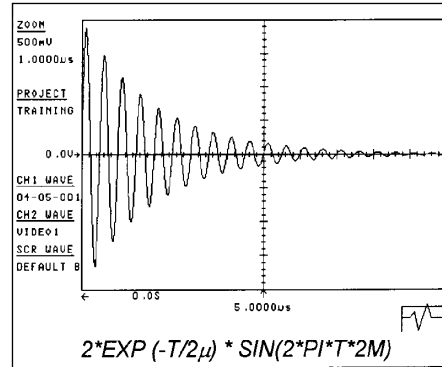

**20. Gaussian Pulse**

$$\text{EXP}(-1/2) * ((T - T_M) / T_s)^2$$

T<sub>M</sub> - Time location of center or "mean" of Gaussian pulse  
 T<sub>s</sub> - Half width of Gaussian point corresponds to standard deviation, s .

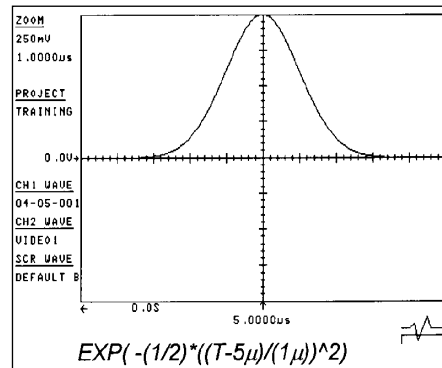

**21. Amplitude Modulation**

$$X1 = \text{SIN}(2 * \text{PI} * T * F_c)$$

$$X2 = (1 + K * f(T))$$

$$X1 * X2$$

f(T) - Modulating waveform, a function of T: e.g  $\text{SIN}(2 * \text{PI} * T * F_M)$   
 F<sub>c</sub> - Carrier frequency, Hertz  
 F<sub>M</sub> - Modulation frequency, Hertz  
 K - Modulation index, 0 < K < 1

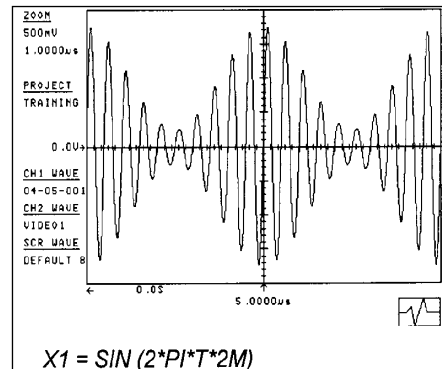

## Edit Equation

### Waveform

### General Equation

### LW400 Example

#### 22. Sine Amplitude Sweep

$$(A * T) * \sin(2 * \pi * T * FS)$$

A - Slope of ramp  
FS - Signal frequency, Hertz

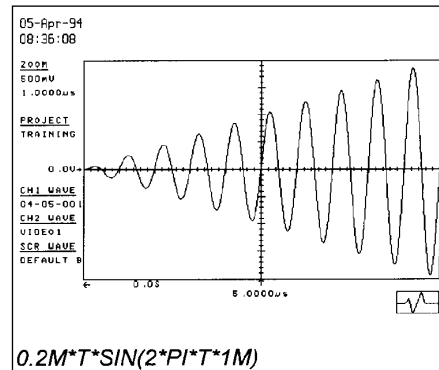

#### 23. Frequency Modulation

$$\sin((2 * \pi * T * FC + (FD / FM) * \int f(t) * \cos(2 * \pi * T * FM)))$$

$F_C$  - Carrier Frequency, Hertz  
 $F_D$  - Frequency Deviation, Hertz  
 $F_M$  - Modulation Frequency

*Note: For frequency modulation the phase argument of the SIN function includes the integral,  $\int f(t)$ , of the desired modulation function,  $f(t)$ : e.g. for sinusoidal  $F_M$   $f(t) = \sin(2 * \pi * FM * T)$  the phase argument contains  $f(t) = \cos(2 * \pi * FM * T) / (2 * \pi * FM)$*

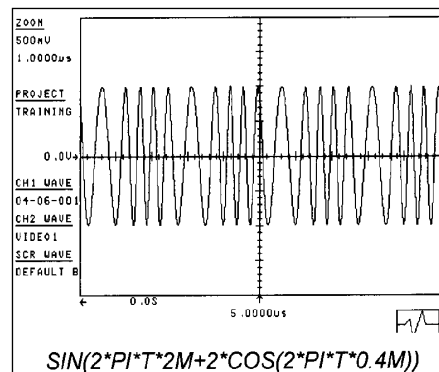

#### 24. Linear Frequency Sweep

$$\sin(\pi * (2 * T * FS + ((FE - FS) / TS) * T^2))$$

$F_S$  - Start frequency, Hertz  
 $F_E$  - End frequency, Hertz  
 $T_S$  - Sweep duration, seconds

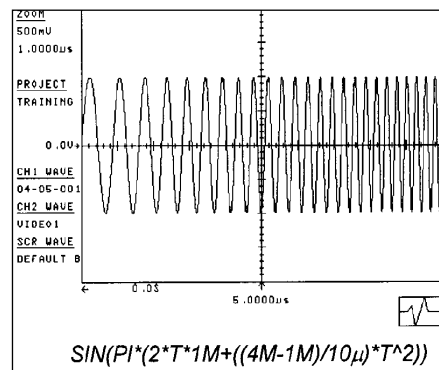

**Waveform**

**General Equation**

**LW400 Example**

**25. Logarithmic Frequency Sweep**

$$X1 = \text{LN}(F_E/F_S)/T_S$$

$$\text{SIN}(2*\text{PI}*((F_S/X1)*\text{EXP}(X1*T)-1)))$$

$F_S$  - Start frequency, Hertz  
 $F_E$  - End frequency, Hertz  
 $T_S$  - Sweep duration, seconds

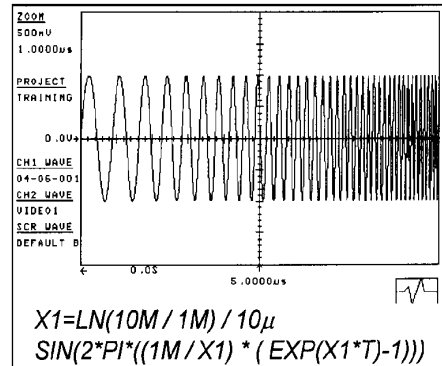

**26. Phase Modulation**

$$\text{SIN}(2*\text{PI}*T*F_C + K * \text{SIN}(2*\text{PI}*T*F_M))$$

$F_C$  - Carrier frequency, Hertz  
 $F_M$  - Modulation frequency  
 $K$  - Peak phase excursion, radians

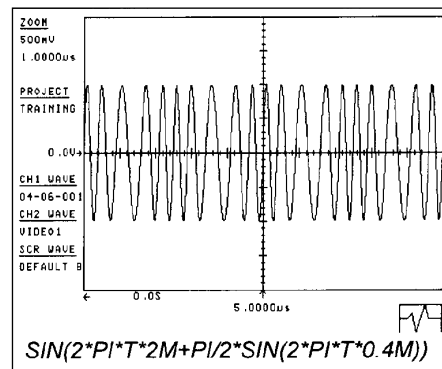

**27. Pulse Width Modulation**

$$X1 = \text{SIN}(2*\text{PI}*T*F_C + K * \text{COS}(2*\text{PI}*T*F_M))$$

$$X2 = \text{SIN}(2*\text{PI}*T*F_C + K * \text{SIN}(2*\text{PI}*T*F_M))$$

$$\text{STEP}(X1) * \text{STEP}(X2)$$

$F_C$  - Pulse frequency, Hertz  
 $F_M$  - Modulation frequency  
 $K$  - Peak phase excursion, radians

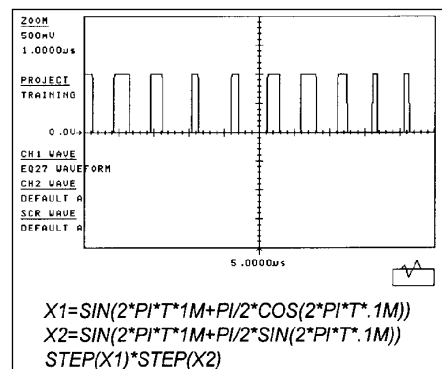

**Edit Equation**

**Waveform**

**General Equation**

**LW400 Example**

**28. Pulse Amplitude Modulation**

$A * T * \text{STEP}(\text{SIN}(2 * \text{PI} * T * F_c))$

A - Slope of ramp, Volts/second  
 F<sub>c</sub> - Pulse frequency, Hertz

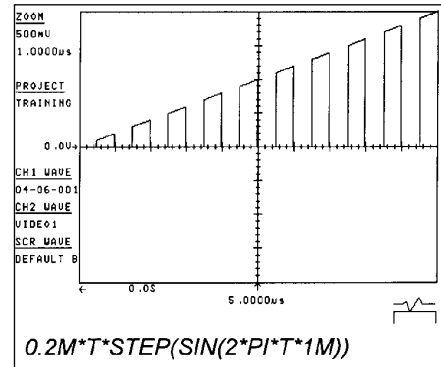

**29. Lorentz Pulse**

$1 / (1 + ((T - TD) / TW)^2)$

TD - Time delay, seconds  
 TW - Half width @ 50% amplitude, seconds

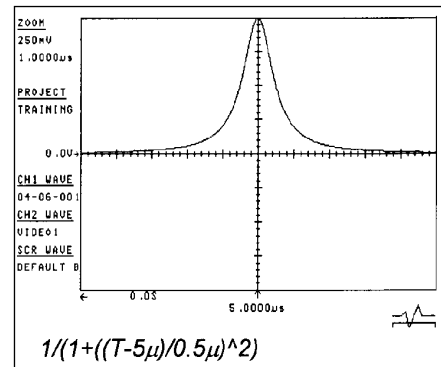

**30. Full Wave Rectified Sine**

$\text{ABS}(\text{SIN}(2 * \text{PI} * T * F_s))$

F<sub>s</sub> - Signal frequency, Hertz

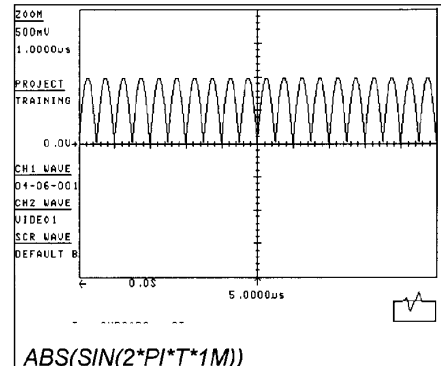

Edit Equation

**Waveform**

**General Equation**

**LW400 Example**

**31. Half Wave Rectified Sine**

$$X1 = \sin(2 * \pi * T * F_s)$$

$$X2 = \text{STEP}(X1)$$

$$X1 * X2$$

$F_s$  - Signal frequency, Hertz

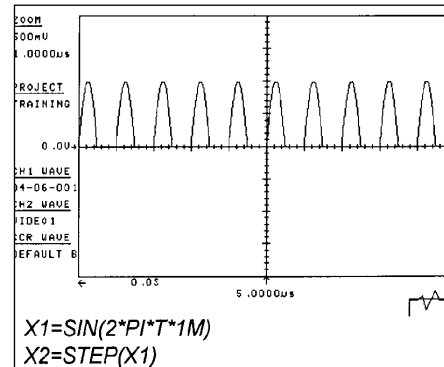

**32. Gated Sine Variable Duty Cycle**

$$X1 = T_D$$

$$X2 = \sin(2 * \pi * T * F_s)$$

$$X3 = \sin(2 * \pi * (T - X1) * F_s)$$

$$\text{STEP}(X2 * X3) * X2$$

$F_s$  - Signal frequency, Hertz  
 $T_D$  - Delay time, seconds

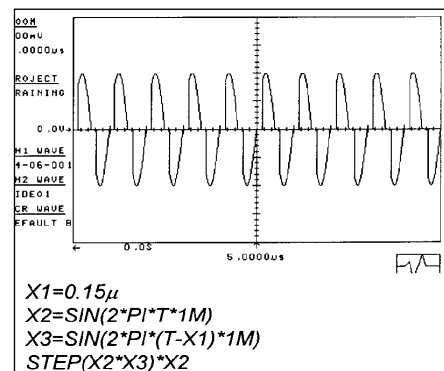

**33. Additive Noise Burst**

$$X1 = \sin(2 * \pi * T * F_s)$$

$$X2 = (\text{NOISE} - .5) * \text{PULSE}(T_1, T_2)$$

$$X1 + X2$$

$F_s$  - Signal frequency, Hertz  
 $T_1$  - Start time of noise burst, seconds  
 $T_2$  - End time of noise burst, seconds

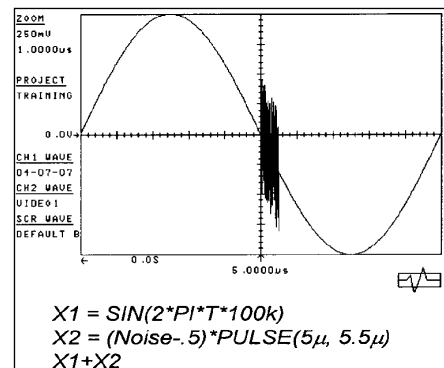

## Other Waves

---

### Other Waves

#### Waveform

A list of available waveforms to insert. These are the waveforms that are stored in the open project. For a discussion of the project structure, see “Project” Section 10 in this manual.

#### Accept

Inserts the waveform in the field **Waveform** starting at the left cursor.

Returns to the main **INSERT** menu

*Note: exiting this menu without pressing **Accept** causes no action to be taken.*



**Getting Started**

Editing operations include the creation and modification of waveforms. The controls within the EDIT section of the front panel provide a complete set of tools for waveform creation as well as “cut” and “paste” editing. In this section we will look at the EDIT functions.

**Clearing The Display**

The easiest way to clear one of the AWG's editors is to select a new waveform. The process was discussed in the tutorial in section 2.

**Exercise 6.1**

1. Push SELECT WAVE
2. Press the NEW softkey in the SELECT WAVE menu
3. Push NEW CH1 WAVE in the NEW menu.
4. Enter the desired waveform name, for instance “New”, then press the Accept softkey.

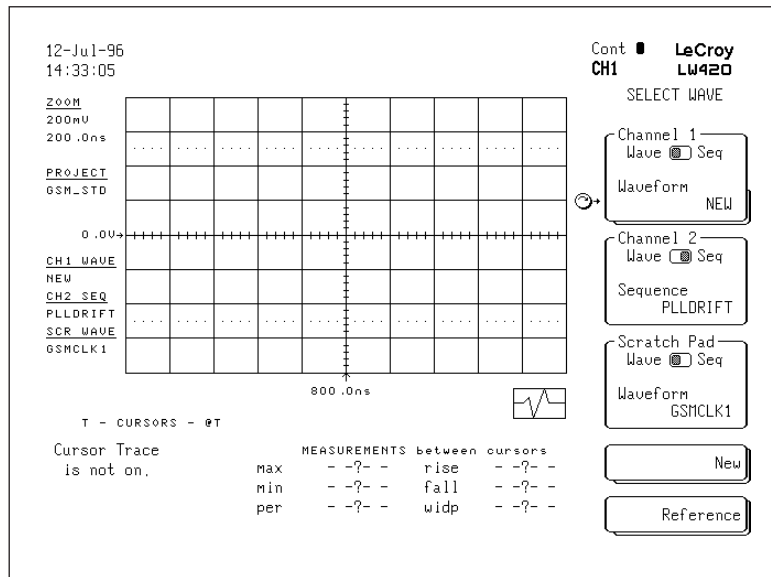
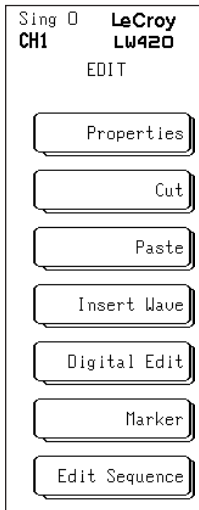

**Figure 6.1 Result of Exercise 1**

## Edit Menu

### The Edit Menu

Pressing the **EDIT** button in the EDIT group on the front panel of the LW400 causes the **EDIT** menu to be displayed:



**Figure 6.2**  
**The Edit Menu**

Softkey Label	Function
Properties	Selects editor options: insert or overwrite and insert before or after the cursor. Also used to select wave options: oversampling yes/no and continuous or single waves.
Cut	Selects Delete, Copy, or Extract operations to remove or copy a selected section of a waveform to the cut buffer.
Paste	Selects Paste operations to copy the contents of the cut buffer to the waveform at the selected insertion point.
Insert Wave	Inserts a waveform segment from a DSO, equation editor, standard function, or another waveform into the current waveform at the selected insertion point.
Digital Edit	Selects digital edit menu. This menu selection only appears if the LW09/LW09A digital option is installed.
Marker	Selects the Marker edit menu used to setup the timing marker(s) associated with the waveform.
Edit Sequence	Selects the sequence editor for creating a composite waveforms and group

**Table 6.1 The Edit Menu Functions**

## The Properties Menu

Pressing the EDIT button in the EDIT group on the front panel of the WaveStation displays the EDIT menu. Select properties to choose the editing insertion technique to be used.

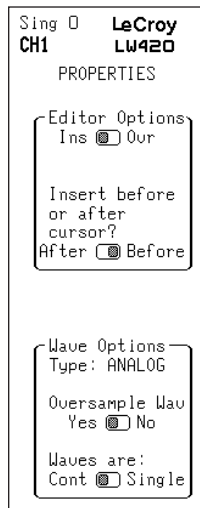

**Figure 6.3**  
**Properties**  
**Menu**

### Editor Options

#### Ins/Ovr

**Overwrite** inserts the new section starting at the left time cursor and overwrites, or replaces, existing sections without increasing the overall duration of the waveform, however it may increase the total duration. It acts the same as the similar function in a word processor.

With **Insert** the new waveform section is inserted at the left cursor and moves all the data to the right of the cursor (not including the point under the left cursor) by the length of the inserted section. Once again, this is similar to insert in a word processor as it pushes the old data out of the way and changes the length accordingly.

#### Insert before or after cursor?

This editor option tells the editor what to do with the cursors after inserting new sections into the waveform. If **Before** is selected, then upon insertion of the new section into the waveform the left cursor is moved to the end of the inserted section—leaving the inserted section before the cursor. If **After** is selected then the left cursor is not moved upon insertion of the new section is into the waveform.

## Edit Properties

---

### Wave options

Waveform options apply to the currently selected waveform. These options are saved with the waveform when the waveform is saved.

### Type

This is an information field only. It displays whether the selected waveform is an ANALOG waveform or a DIGITAL waveform.

### Oversample wave

In order for the LW400 to edit a waveform, the waveform must be oversampled. Many of the editing functions apply signal processing that uses a  $\sin x/x$  interpolator. The interpolator will create significant ringing if the data is not oversampled. If this field is set to Yes then the waveform will be checked for discontinuities and if found they will be fixed by passing the discontinuity through a low pass filter. If **No** is chosen then the data will not be checked for discontinuities. The limitation with this is that no editing operations can be applied to the waveform until it is oversampled. The advantage is oversampling slows the edges by requiring at least two points on every edge. So, by turning oversampling off, faster edges can be achieved.

### Waves are

Use to select if the WaveStation is to consider the waveform a single shot waveform or a continuous waveform (last point wrapped to the first). Continuous waveforms are displayed with the ends wrapped in a dimmer shade on the screen. The WaveStation will check for a discontinuity between the end and the beginning of the waveform. This makes the presumption that when the LW400 reaches the end of the waveform it will jump to the beginning and play the first point. If the waveform is only to be played once (single shot) or, is part of a sequence where wrapping the ends might be an incorrect thing to do, single should be selected for this field.

**Creating A Waveform With Insert Wave**

The **Insert Wave** function can be used, as it was in the tutorial, to create a distinctive waveform to demonstrate editing operations. **Standard Function** sine, square wave, and triangle waves were used to create the waveform shown in figure 6.3.

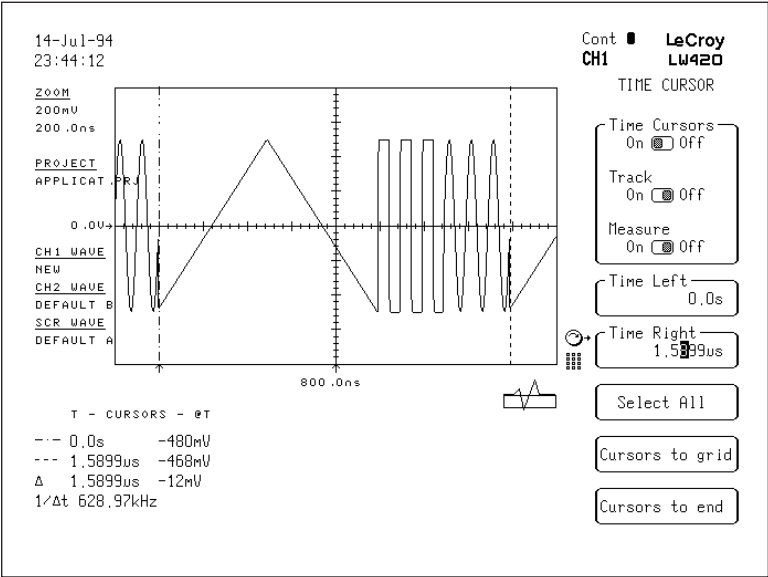

**Figure 6.3 A Waveform Created With Insert Wave**

## Cut

### Cut

The Cut functions include **Delete**, **Copy**, and **Extract** which are described in table 6.2 and cut baseline actions in table 6.3.

Softkey Label	Function
Delete	Erases the section of the current waveform between the time cursors and copies it to the cut buffer. The waveform duration is reduced by the cursor time difference.
Copy	Copies the section of the waveform between the time cursors to the cut buffer without removing it from the original waveform.
Extract*	Erases the section of the current waveform between the time cursors and copies it to the cut buffer. The removed waveform section is replaced by a baseline level.
Baseline	Sets the mode for baseline generation either automatic or manual. Automatic baseline is determined by the value at the left, right, or both cursors as selected by the user in the Attach field. Manual baseline allows user entered values to describe the end points of the baseline.
Attach	Sets the end points of the automatic baseline as the amplitude value of the left, right, or both cursors.

**Table 6.2 Summary of Cut Functions**

Baseline	Attach	Action
Auto	Left	Baseline is set at the amplitude value read at the Time Left cursor
Auto	Right	Baseline is set at the amplitude value read at the Time Right cursor
Auto	Both	Baseline is drawn connecting the amplitudes at the Time Left cursor and the Time Right cursor
Man	Left/Right	Baseline is drawn between the user entered amplitude values specified in the Left and Right entry fields. Automatic baseline is determined by the value at the left, right, or both cursors as selected by the user in the Attach field. Manual baseline allows user entered values to describe the end points of the baseline.

**Table 6.3 Summary of Cut Baseline Settings**

**Delete**

**Delete**

The following figures show the setup for a **Delete** operation on the square wave section of the waveform. Figure 6.4 shows the placement of the time cursors about the section to be deleted. Figure 6.5 shows the result of the deletion. Note that the waveform is shortened by the duration of the deleted section. Pressing the **UNDO** button, located on the front panel, and confirming undo with OK will restore the original waveform.

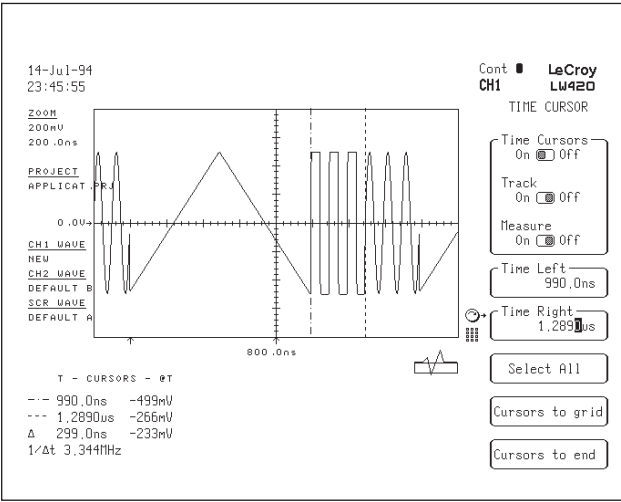

**Figure 6.4 Setup for a Cut—Delete operation**

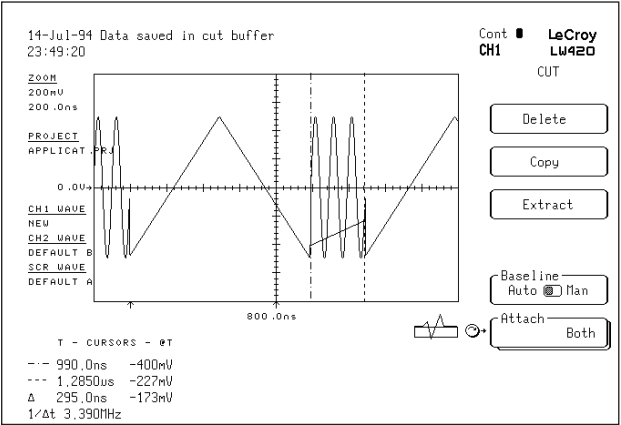

**Figure 6.5 Result of the Delete operation**

## Extract

### Extract

The results of an **Extract** operation are shown in figure 6.6 for the same cursor settings. Note that the waveform retains its original duration and that the “extracted” section is replaced by a baseline. The baseline, created in Auto-Both mode, connects the amplitude value under the time left cursor (-499 mV) to that of the time right cursor(-500 mV). Alternative baseline settings are outlined in table 6.3 shown on page 6-4..

\* Extract is useful in editing small features which occur on a base waveform. For example, adding a “glitch” to a sine wave.

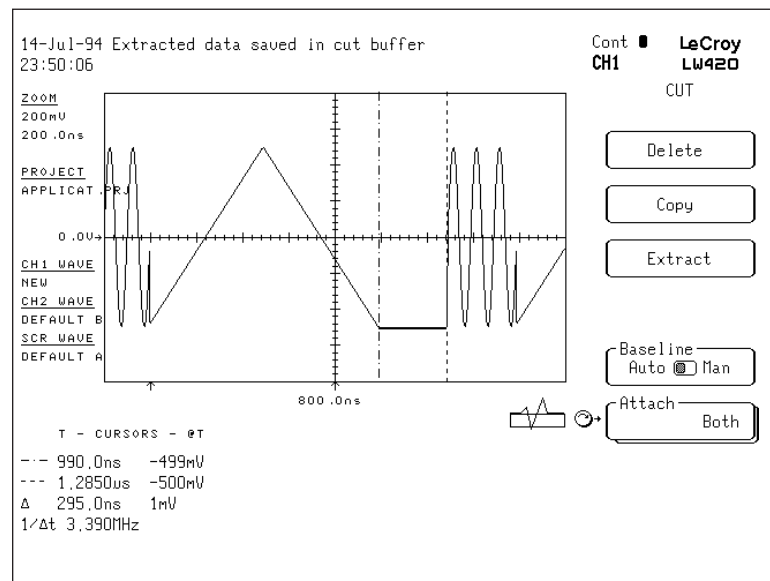

**Figure 6.6 The result of an Extract operation**



**Paste**

**Paste**

**Paste** copies the contents of the cut buffer into a waveform at an insertion point marked by the Time Left cursor. The number of repetitions of the insertion is users selectable from the **PASTE** menu.

The results of the paste operation will change depending on whether the waveform in the cut buffer came from a Cut/Delete, Copy, or a Cut/Extract operation. Examples are shown in figures 6.7 and 6.8.

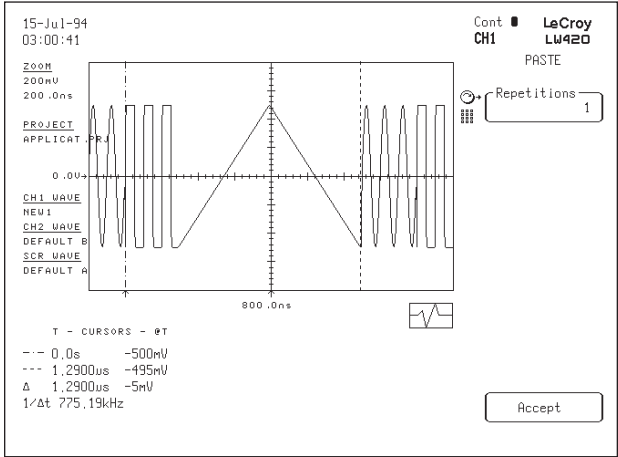

**Figure 6.7 Pasting after a Delete operation**

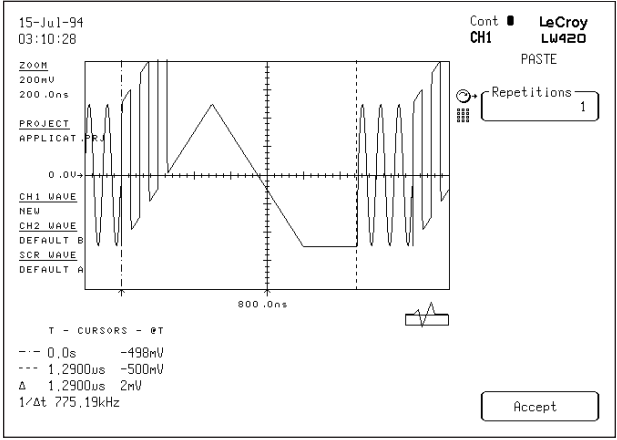

**Figure 6.8 Pasting after an Extract operation**

If the cut buffer was filled as a result of a Copy or Delete operation then the waveform is inserted into, or overwrites, the waveform depending on the edit mode. If the contents of the cut buffer are from an extract operation, they are added to the waveform.



---

## Introduction to Sequences

The Wavestation includes the capability of generating a waveform **sequence**—comprised of waveforms—and a waveform **group** sequence—comprised of sequences. Both types of sequences aid in generating long, complex waveforms. The group sequence mode has the capability of switching from one waveform sequence to the next in less than 5 ms. Both modes are useful for generating certain types of long, complex waveforms while minimizing the amount of memory.

In **sequence** mode—waveform sections that repeat are made into segments that are repeated with loops—effectively generating the waveform using minimal memory. Each waveform and its number of repetitions are stored in a sequence list. The wavestation outputs the waveforms sequentially, the specified number of times.

In **group** sequence mode, waveform sequences are specified in a group list for processing. The first sequence in the list is output until an advance command or a jump command is received. When advance is received the next waveform in the list is output. If a jump command is received, the waveform selected by the jump command is output.

## Sequence Waveforms

### Sequence mode

A **sequence** is the result of concatenating a number of waveform files in a specified fashion. Suppose, for example, it is desired to generate a TV signal. The TV signal is composed of a number of different elements. There is the equalization pulse followed by the vertical synch pulse followed by more equalization pulses then the beginning of the color burst and horizontal synch information followed by video information and so on. This signal can be generated from the smaller parts, or **segments**, by a process called "**linking**". In linking, the individual waveform segments are connected together in the correct order, or sequence, so the composite waveform is a correct representation of the parts in the specified order.

When the individual **segments** are connected together, each segment can be repeated a chosen number of times. This is called **looping**. So for example, the first segment can be looped several times before the next segment is connected or **linked** on. This next segment can then be looped a preset number of times before the third segment is linked on. By continuing this linking and looping process, very long complex waveforms can be generated from a collection of smaller segments.

The looping and linking operation described above is limited only by the amount of available memory and the loop and link counters. The maximum number of loops a given segment can have is 255. The maximum number of links in a given waveform is 512 with 256K of memory installed (standard configuration) and 2048 with the optional 1 Megapoint of memory installed. These are summarized in table 7.1 below.

256K points memory	512 links
1 Meg memory	2048 links
maximum number of loops	255
minimum segment size	64 points
maximum segment size	available memory

**Table 7.1**

## The Sequence Editor

In order to generate a sequence waveform it is necessary to first specify the list of waveform segments in the correct order and with the loop count required. This is done in the sequence editor. Push the **"EDIT"** key followed by the **"Edit Sequence"** softkey that appears at the bottom of the edit menu. From this menu it is a relatively simple task to create and edit sequence files.

### Line

This selects the **line number** to be edited. Notice a line number may be entered using the **numeric keypad**. Alternately the **rotary knob** may be used to scroll down through the available lines. Each line represents a single linking operation. The maximum number of lines in a given sequence file is 512 in a 256K memory machine as discussed above.

### Waveform

This selects the **waveform** file that will be inserted at the current line location as determined above. Activating this menu field by pushing the associated softkey causes the **Rotary Knob** to attach to this field. A second push of the softkey causes a list of available waveform options to be displayed.

### Repetitions

This is the **loop counter** discussed above. Setting this number causes an individual waveform or segment to be repeated by the number of times that this counter is set for. The maximum number of loops a given segment can have is **255**.

If more than 255 repetitions are needed then the waveform can be repeated on multiple lines each with a maximum of 255 repetitions.

### Insert

This is the action key that causes the waveform selected above to be inserted into the sequence file at the location given by **line**. Notice the waveform name is inserted one time independent of the setting of the repetitions or loop counter. Upon waveform generation, these segments will be repeated an appropriate number of times as specified by the repetitions field.

### Block

Activates the Block menu which is used to define a group of lines as a block which can be re-inserted into the sequence at a desired line, or deleted.

## Sequence Editor

---

### Delete

This is an action key that will delete a waveform from a specified line as selected by the line number above.

*Note you do not specify the waveform to delete, rather you specify the line to delete and the waveform already inserted at that line location will be deleted from the link list. This causes the list of waveforms below the selected line to roll upwards one line to fill the gap. That is, if you delete the waveform in line 7 then the waveform in line 8 moves up into line 7 etc. There will be no blank lines in the link list for the sequence file.*

### Group Advance

This softkey is used to activate the Group Advance menu. Group Advance operations are useful with Group Sequences to advance or jump to a selected sequence by pressing the appropriate softkey.

*Note: Group Advance operations are not used with standard Sequence. If a Group Advance operation is invoked on a standard sequence a message will be displayed at the top of the display notifying you with a message similar to "Warning: Ch 1 is not a group sequence".*

### Compile

Compile is an **action key**. It causes the WaveStation to compile the list of waveforms that has been defined by the previous insert operations. This is the act that actually generates the sequence.

## EXAMPLE OF USING THE SEQUENCE EDITOR

### Creating a Waveform Sequence

In the following exercise an EMI waveform will be generated using a waveform sequence.

Figure 7.1 shows a sketch of a typical EMI waveform. The waveform is made up of a 20 pulse burst of 1 ms duration repeated with a 200 ms period. This process continues for 24 cycles. Waveforms like this, with long “dead times” and highly repetitive elements are ideal for generation by sequence mode. The waveform can be created using two waveforms. The first is the

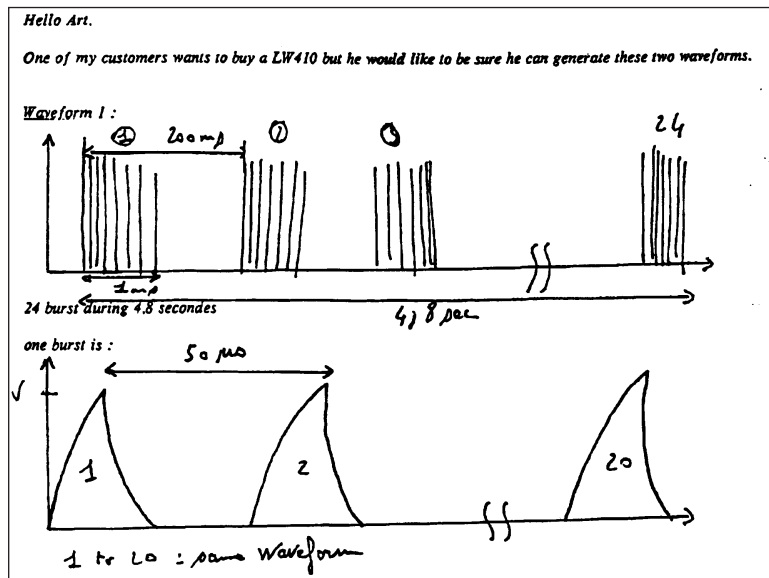

**Figure 7.1**

exponential pulse with a 50 μs period—see figure 7.2. This will be repeated 20 times to make each burst. The second waveform is a 0 V DC level 1 ms long—see figure 7.3. This will be repeated 199 times to create the 199 ms dead time between bursts. Each set of repeated waveforms must be repeated 24 times to complete the waveform.

# Sequence Editor

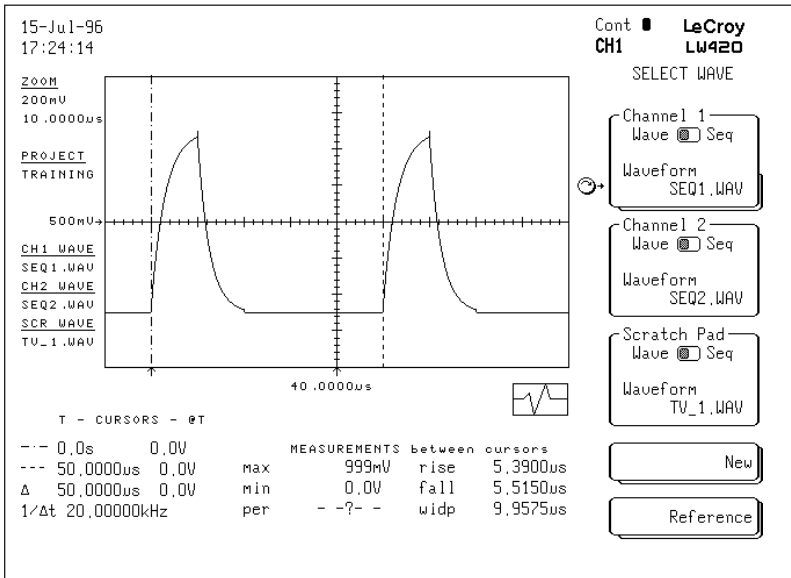

**Figure 7.2 SEQ1 Waveform**

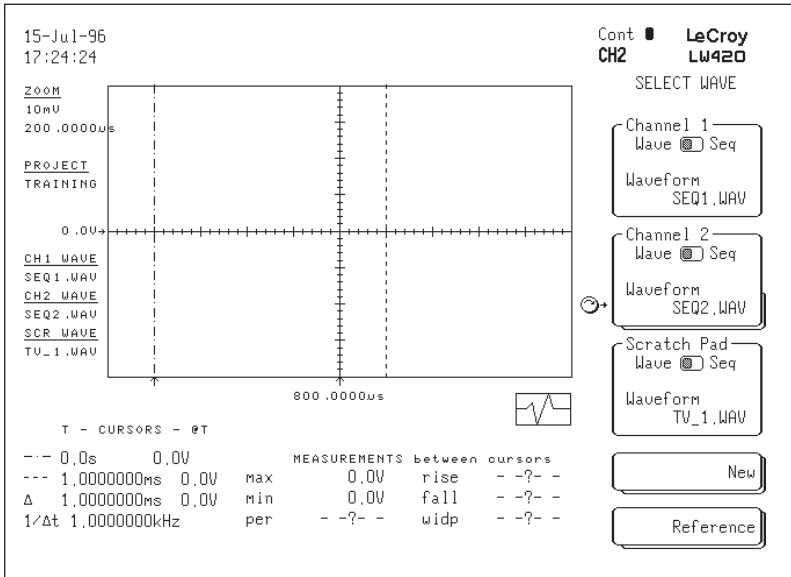
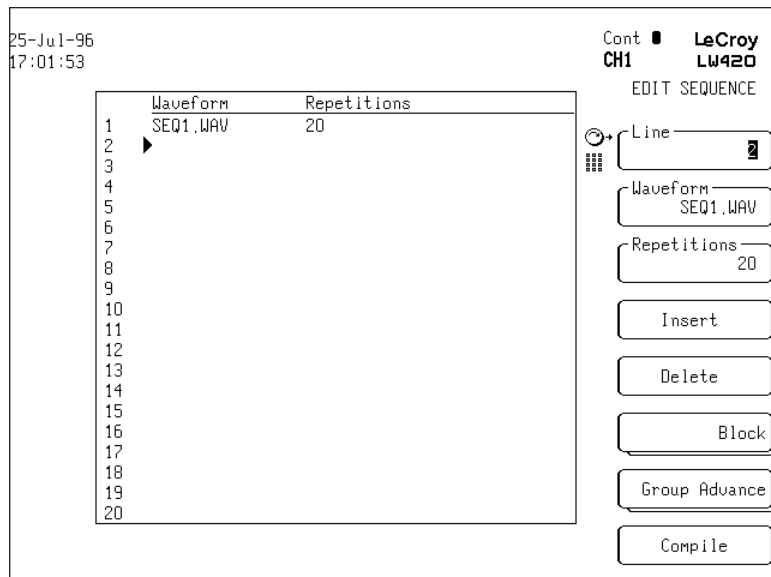

**Figure 7.3 SEQ2 Waveform**



1. The SEQ1 AND SEQ2 waveforms are located in the project Training.. Use the **SELECT WAVE** menu to view each of the waveforms.
2. From the **SELECT WAVE** menu press the softkey **New** to view the **NEW** menu. Select the **New CH1 Seq** item from this menu.
3. The **NEW CH1 SEQ** menu will prompt you to enter a name for the new sequence. Enter the name **SEQ1** and press **Accept**.
4. Press the **EDIT** Key. When the **EDIT** menu appears select **Edit Sequence**. The following figure 7.4 shows the Sequence editor. Enter the waveform and repetitions as shown in the figure, make sure to press the **enter** key in the keypad after entering the numeric information in the repetitions field. When this sequence file is compiled and run, this line instructs the LW400 to output the waveform SEQ1 20 times. When finished entering the data press the **Insert** menu key.

If you make an error in entering any of the information, select the line with the error and press the **Delete** menu key.



**Figure 7.4**

## Sequence Editor

- Continue to Line 2 and select the waveform SEQ2 with 199 repetitions as shown in figure 7.5. Press Insert to add this to the sequence file. This sequence file will generate a burst of 20 SEQ1 waveform repetitions followed by SEQ2 repeated 199 times.

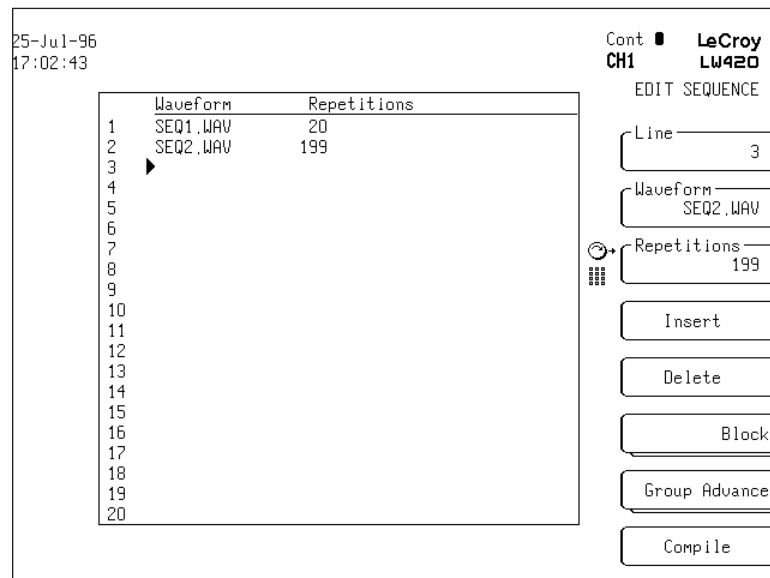

**Figure 7.5**

# Sequence Editor

- 6. This pattern will be repeated a total of 24 times. Continue the entry until all 24 cycles, a total of 48 sequence editor entries, of the waveform are included, as shown in figure 7.6.

25-Jul-96 Cannot decrement this digit  
17:03:52

Cont  LeCroy  
CH1 LW420

BLOCK

	Waveform	Repetitions
1	▶ SEQ1.WAV	20
2	SEQ2.WAV	199
3	SEQ1.WAV	20
4	SEQ2.WAV	199
5	SEQ1.WAV	20
6	SEQ2.WAV	199
7	SEQ1.WAV	20
8	SEQ2.WAV	199
9	SEQ1.WAV	20
10	SEQ2.WAV	199
11	SEQ1.WAV	20
12	SEQ2.WAV	199
13	SEQ1.WAV	20
14	SEQ2.WAV	199
15	SEQ1.WAV	20
16	SEQ2.WAV	199
17	SEQ1.WAV	20
18	SEQ2.WAV	199
19	SEQ1.WAV	20
20	SEQ2.WAV	199

Start Line 1

End Line 2

At Line 1

Insert

Delete

Figure 7.6

## Sequence Editor

To simplify this process, we would normally define lines 1 and 2 as a “Block” and use sequence block edit to copy this pattern 23 more times—see figure 7.7.

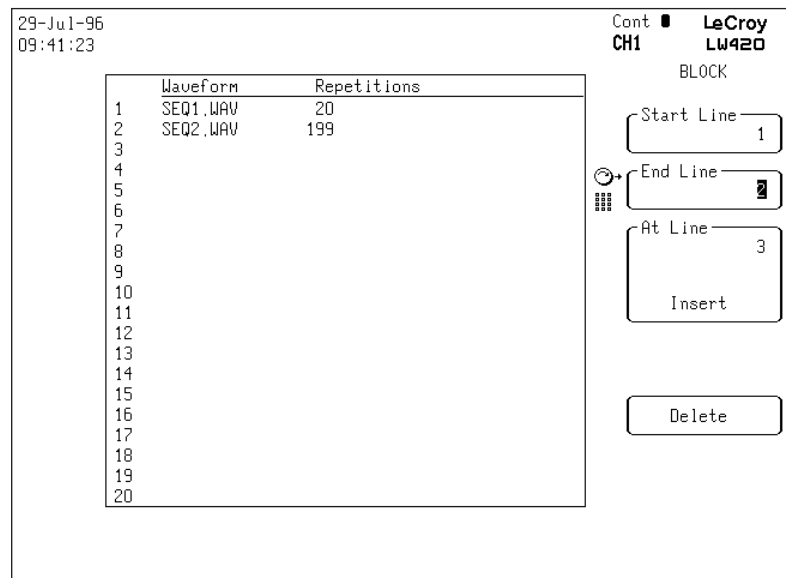

**Figure 7.7**

7. When complete, press the **compile** menu key to assemble and output the waveform.

The sequence mode will combine waveforms created with different clock rates by selecting the optimum clock rate to generate all the waveforms. Any error in waveform duration, incurred by this resampling, is reported in the Error column of the sequence editor. If a common clock was used to generate the waveform segments the error will always be 0.

View the output waveform on the oscilloscope at 0.5 s/div (1 M sample acquisition). Use zoom expansion to inspect the waveform at 0.2 ms/div and 50  $\mu$ s/div.

---

## **Group Sequences**

### **Introduction**

In the Group sequence mode all unique waveforms for all sequences included in the group sequence are loaded into the WaveStation's high speed memory. The sum of the points in the waveforms must be less than 1 Mpoint (Note: that waveforms must start on a 512 point boundary so the actual sum may be less). Once the waveforms are all placed into high speed memory the AWG will start playing the first sequence in the list. See Table 7.1 for a command summary.

The sequence will continue to play (in continuous trigger mode) until a sequence advance (defined below) is initiated from either the front panel or by a remote command. The Wavestation will then immediately advance to the next sequence in high speed memory and play that sequence until another sequence advance is encountered. In addition to the auto advance feature, there is also a command to jump forward or backward to the n'th group in the sequence.

The clock rate for all sequences must be the same. If the waveforms of the sequences are not at the same clock rate, then the fastest clock is chosen and a dialog box will inform the user of this (just like with digital sequences).

## Group Sequence

---

### Creating a Group Sequence

The procedure to create a new **Group Sequence** is similar to that used to create a new **Sequence**.

1. From the **SELECT WAVE** menu press the softkey **New** to view the **NEW** menu. Select the **New CH1 SEQ** item from this menu.
2. Use the appropriate softkey to select **Group** from the **Which Type** sub-menu that is displayed on the **NEW CH1 SEQ** menu.
3. The **NEW CH1 SEQ** menu will prompt you to enter a name for the new sequence and press **Accept**. In this example the name **NEW GROUP SEQ2** was entered—see figure 7.8.
3. Press the **EDIT** Key. When the **EDIT** menu appears select **Edit Sequence** to access the sequence editor—see figure 7.8.
4. The name of the first sequence of the group is then entered on the **EDIT SEQUENCE** menu. Press the **Insert** softkey to enter the sequence name in the group sequence file as shown in figure 7.8.

If you make an error in entering any of the information, select the line with the error and press the **Delete** menu key.

5. Continue to the next line until all sequences in the group are entered.
7. When complete, press the **compile** menu key to assemble and output the waveform. A message will be displayed when the compile is completed successfully— see figure 7.11.

# Group Sequence

Cont  LeCroy  
 CH1 LW420

NEW CH1 SEQ

Which Type  
 Seq  Group

Sequence  
 NEW GROUP SEQ2\_

Backspace

A B C D E F G H

I J K L M N O P

Q R S T U V W X

YZ \_ & - z ! SP

Accept

16-Jul-96  
 15:14:34

```

Sequence
1  DEFAULT SEQ
2  ▶
3
4
5
6
7
8
9
10
11
12
13
14
15
16
17
18
19
20
  
```

Cont  LeCroy  
 CH1 LW420

EDIT SEQUENCE

Line 2

Sequence  
 DEFAULT SEQ

Insert

Delete

Block

Group Advance

Compile

**Figure 7.8**  
**New CH1 SEQ**  
**Menu**

**Figure 7.9 Edit Sequence Menu**

16-Jul-96  
 11:34:24 Sequence Compile completed

```

Sequence
1  DEFAULT SEQ
2  NEW SEQ B
3  SEQ 3
4  ▶
5
6
7
8
9
10
11
12
13
14
15
16
17
18
19
20
  
```

Cont  LeCroy  
 CH1 LW420

EDIT SEQUENCE

Line 4

Sequence  
 SEQ 3

Insert

Delete

Block

Group Advance

Compile

**Figure 7.10 Compiled Group Sequence**

## Group Sequence

### Using Group Sequences

When a **Group** sequence is selected the waveforms contained in the sequences in the group are all placed into high speed memory. Upon completing the waveform loading, the WaveStation will begin playing the first sequence in the list.

The sequence will continue to play (in continuous trigger mode) until a sequence **Advance** or **Jump** is initiated from either the front panel or by a remote command. The sequence pointed to by the **Advance** or **Jump** will then immediately play until another sequence command is issued.

#### ADVANCE ON

Selects the channel the **Advance**, **Jump**, and **Reset** buttons control.

#### ADVANCE

Advances to the next sequence in the list. The current sequence will stop wherever it currently is and the next sequence in the list will begin playing

See the following —figure 7.11—for an example of **ADVANCE**.

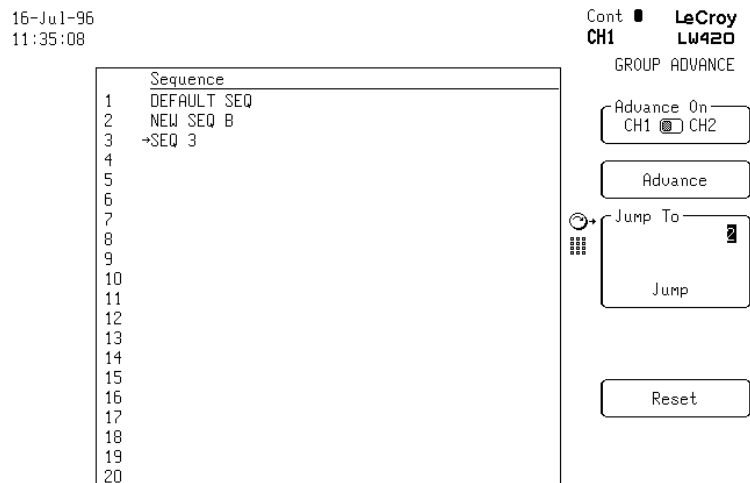

**Figure 7.11 Group Advance Operation**



## Group Sequence

- JUMP TO** Specifies which the sequence to jump to when the **Jump** button is pushed.
- JUMP** Jumps to the sequence specified by the value in **Jump To**. The current sequence will stop wherever it currently is and the sequence specified by the Jump To field will begin playing.
- RESET** Resets to the first sequence in the list—equivalent to a jump to 1. The current sequence will stop wherever it currently is and the first sequence in the list will begin playing.

See the following —figure 7.12—for an example of **JUMP**.

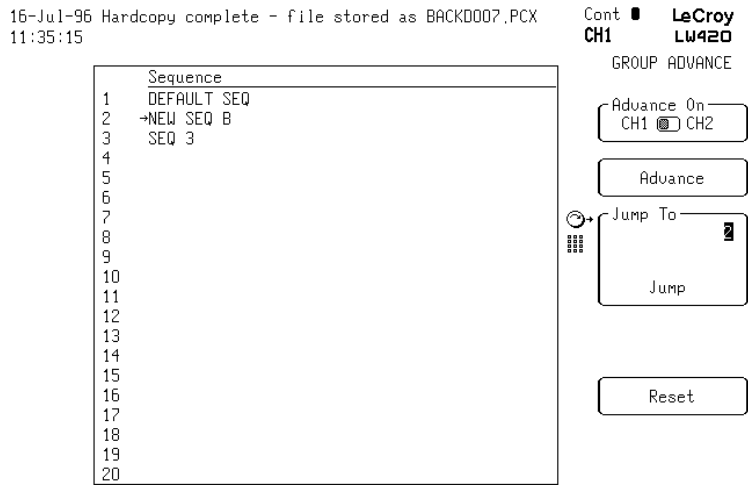

**Figure 7.12 Group Jump Operation**



## WAVEMATH

### Introduction

Wavemath permits the user of the LW400 WaveStation to operate mathematically on complete waveform files. The mathematical operations that are available are summarized in table 8.1. Mathematical operations such as smooth, integrate, and differentiate, that involve a single waveform, operate on the active channel. In other words, to smooth the waveform in channel 1, it must be the active waveform in the **SELECT WAVE** menu. Operations that require two waveforms (add, subtract, multiply, divide, convolve) forces the display to dual grid and a **second source** or reference wave to appear.

### LW400 Math Functions

Function Name	Function Definition
ADD	$F(X) = \text{Active Wave} + \text{Source 2}$
SUBTRACT	$F(X) = \text{Active Wave} - \text{Source 2}$
MULTIPLY	$F(X) = \text{Active Wave} \times \text{Source 2}$
DIVIDE	$F(X) = \text{Active Wave} / \text{Source 2}$
INTEGRATE (DC)	$F(X) = \int (\text{Active Wave} - \text{Median})$
INTEGRATE (AC)	$F(X) = \int (\text{Active Wave})$
DIFFERENTIATE	$F(X) = d/dt (\text{Active Wave})$
SMOOTH	$F(X)$ is an N point moving average of the source
	This is a form of digital filtering which reduces the effective bandwidth of the source.
	Points is user selectable as 3, 5, 7, or 9
Convolve	
$F(x) =$	$\int_{-\infty}^{\infty} f_1(t) f_2(t-\tau) dt$
Where	$f_1(t) = \text{Active Wave}$ $f_2(t) = \text{Source 2}$
<p><i>*Note: Integrate, differentiate, and convolve are normalized to maintain the initial peak to peak amplitude of the waveforms.</i></p>	

**Table 8.1**

# Wavemath

---

**Smoothing Filters**

Smoothing filters are a form of digital filtering that reduces the effective bandwidth of the signal output. The number of smoothing points (3, 5, 7, or 9) is user selectable. The effective bandwidth is provided in the following chart.

**Bandwidth vs.  
Clock Rate and  
Smoothing Points**

Clock Rate	400MS/s	40MS/s	4MS/s	400KS/s	40KS/s
Sample Time	2.5e-9	25e-9	250e-9	2.5e-6	25e-6
Smoothing Points					
3	59.0MHz	5.90MHz	590KHz	59.0KHz	5.90KHz
5	35.4MHz	3.54MHz	354KHz	35.4KHz	3.54KHz
7	25.3MHz	2.53MHz	253MHz	25.3KHz	2.53KHz
9	19.7MHz	1.97MHz	197MHz	19.7KHz	1.97KHz

## Selecting the wave

The following examples describe the use of these operations.

To ensure that the waveform of interest is active, it must be selected. This is described in detail in the section entitled

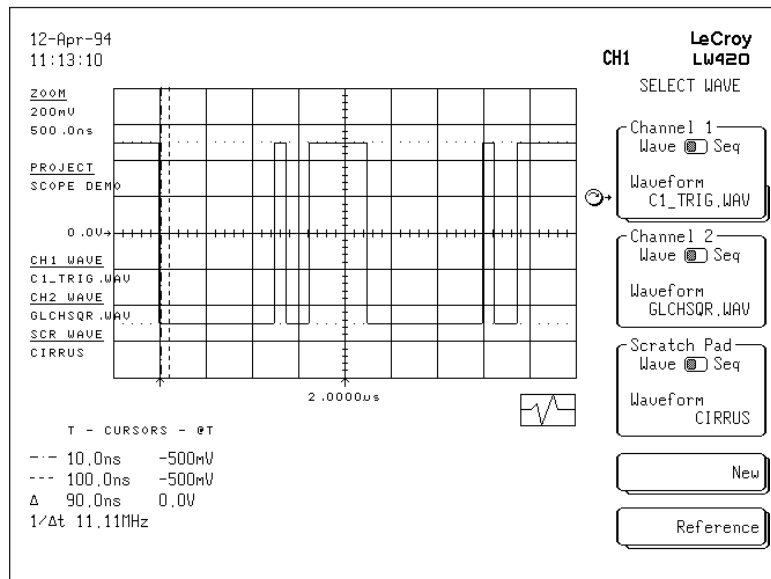

**Figure 8.1 Selecting the wave**

“Waveform Viewing”. The simplest way to tell if the desired waveform is active is to look at the display. If you don’t see your waveform, it is not active. In other words the display always shows the active waveform.

Example: See figure 8.1 above

1. Push **Select Wave**
2. Select **Channel 1 waveform**
3. Select **EQ27 WAVEFORM** (in Project Examples.PRJ)

## Wavemath

---

### Performing Wavemath

Performing Wavemath on this complete waveform is now a very simple operation. The example below details integrating this waveform—See Figure 8.2. Any of the functions that operate on a single waveform can be employed. To integrate this waveform perform the following steps:

1. Push **2nd** followed by **WAVEMATH**
2. Select the operation **Integrate** (This requires using the **Rotary Knob** or pushing the associated softkey and selecting from the list of available functions)
3. *Note: The difference between AC & DC coupling; DC integration is done around zero whereas AC is done around the median of the waveform. Set the coupling to DC*
4. Push **Select All** (*note this assures the entire waveform is selected*)
5. Push **Accept** (This is the action key that causes the mathematical operation to be performed)

## Wavemath

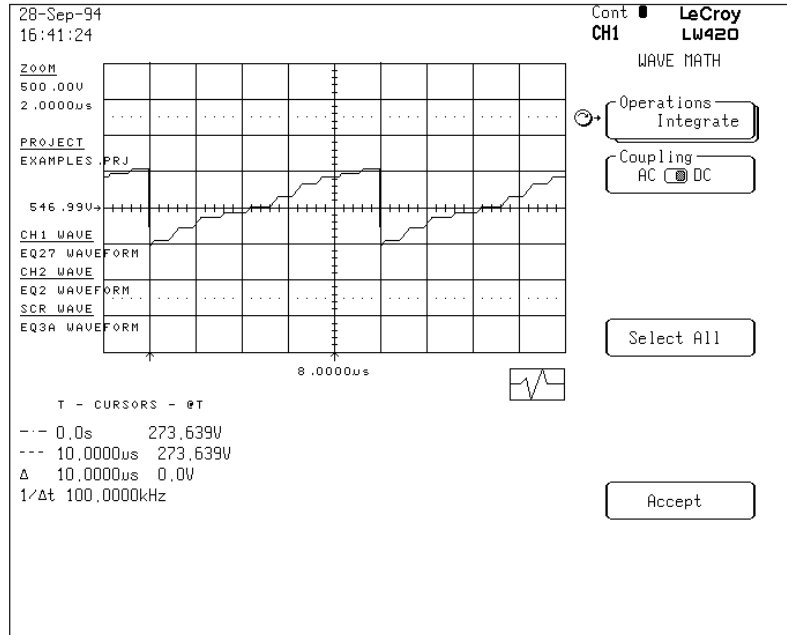

**Figure 8.2 Integrating EQ27 WAVEFORM**

*Note: To undo the result simply push the **UNDO** button in the numeric keypad group and answer **OK**.*

### Operating between the cursors

It is not necessary to operate on entire waveforms. If you want to operate on only a region of a waveform then the region of interest can be isolated by using the time cursors. For example, if you want to integrate only the fourth positive going pulse of the waveform then enter the **TIME CURSOR** menu and bracket the first pulse as shown in figure 8.3. The time cursors in this example have been set to 2.7  $\mu\text{sec}$  for the left cursor and 3.5  $\mu\text{sec}$  for the right cursor. This region is then isolated for the wavemath operation. Refer to the section of the manual on Cursor manipulation for more details. The steps involved are outlined below.

1. Push **Time Cursor**
2. Select **Time Left**
3. Move the left cursor to 2.7  $\mu\text{sec}$
4. Select **Time Right**
5. Move the right cursor to 3.5  $\mu\text{sec}$
6. Return to the Wavemath Menu (**2nd** followed by **Wavemath**)
7. Set the coupling to AC
8. Push **Accept**

As before, it is possible to UNDO this operation by selecting and accepting the **UNDO** command in the numeric keypad.



# Wavemath

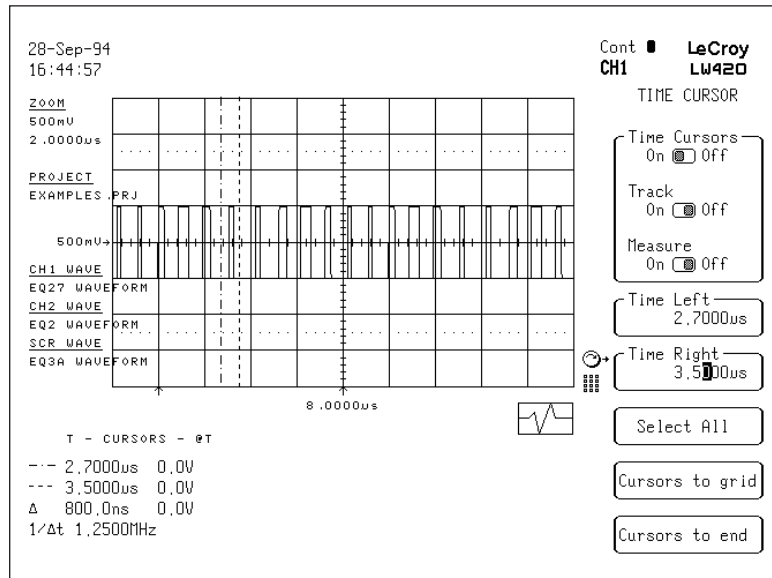

**Figure 8.3 Isolating the fourth pulse for integration**

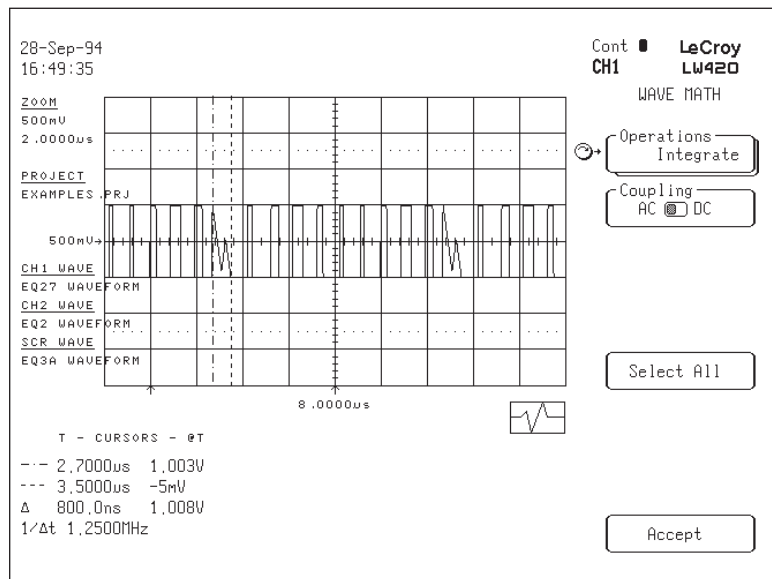

**Figure 8.4 Integrating the fourth pulse**

# Wavemath

## Dual Waveform Math

Suppose we wish to operate on two waveforms with an appropriate mathematical function such as add, subtract, multiply, divide, or convolution. Selecting one of these operations in the **WAVEMATH** menu causes a new field to appear. This field is labeled **Source 2** and is where the selection is made for the second waveform to be used in the wavemath operation.

- 1. Push **2nd** followed by **WAVEMATH**—See figure 8.5
- 2. Select **Convolve**

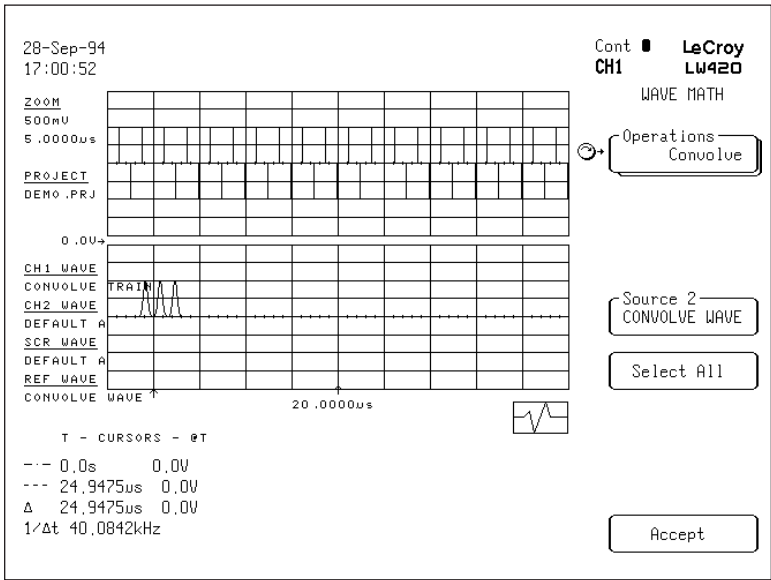
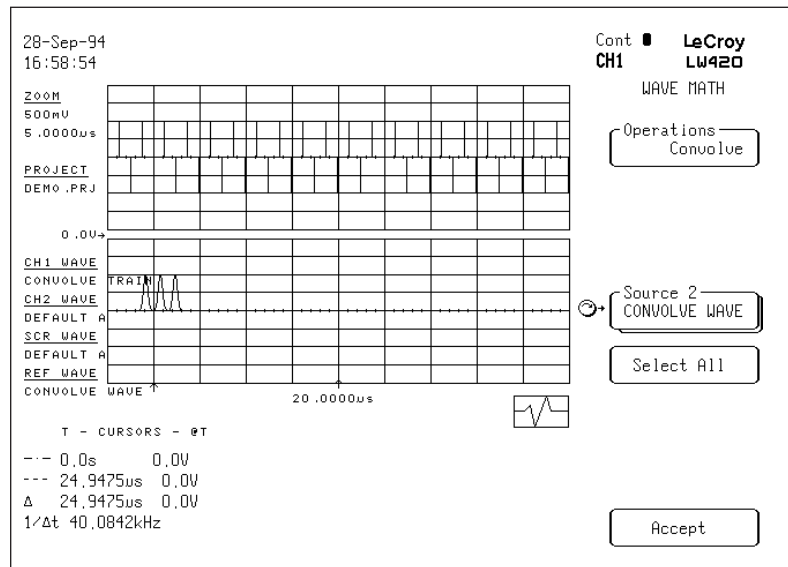

Figure 8.5 Dual Waveform Math

**Practical Example  
of Dual Wave Math**

In this example, the active channel 1 waveform is differentiated NRZ pattern. It is desired to convolve this NRZ pattern with a system impulse response. The impulse response has been previously measured or calculated and imported to the LW400 as a waveform called Convolve Wave and is shown in the bottom half of figure 8.6. Notice when a wavemath function that requires two waveforms is selected, the screen splits so the second waveform can be seen by the user. If the second waveform is not the correct one for the calculation, then push the **Source 2** softkey and select the correct waveform.

As before, **UNDO** can be used to recover if a mistake has been made. It is also possible to use the cursors to bracket or isolate a region of the active waveform to operate on. This operation is the same as described above.



**Figure 8.6 Selecting the second source**

# Wavemath

The final steps are as follows:

1. Push Select All
2. Push Accept

The result of the convolution of the two waveforms is shown on the top trace of the display in figure 8.7.

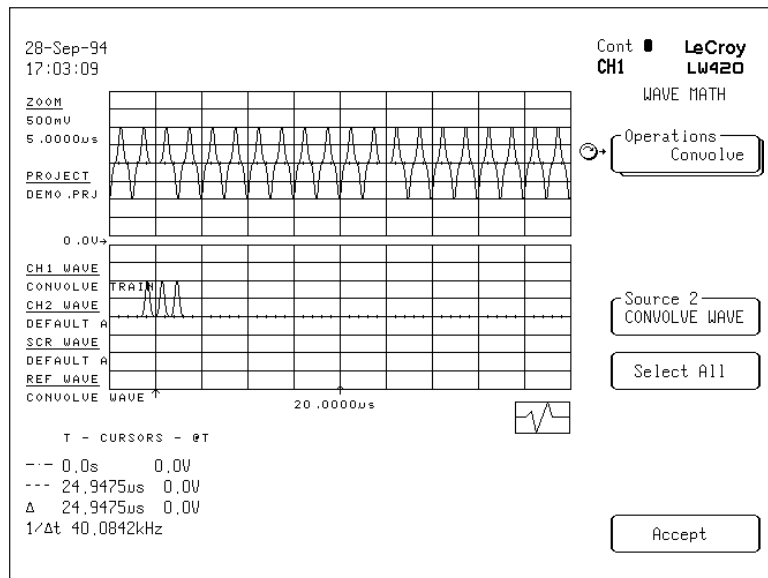

**Figure 8.7 The result of convolving two waveforms**

### Adding Noise To Waveforms

The WaveStation allows users to add controlled amounts of noise to waveforms in two ways. Synchronous pseudorandom noise can be added using equations. Noise created in this way is repeatable and is the same every time the waveform is output.

On LW400 and LW400A models, internally generated, asynchronous noise can be added to the waveform (not available on the LW400B). This noise, uncorrelated with the waveform, is generated by an independent pseudorandom noise generator and summed into the output channels.

The LW400, LW400A, and LW400B models all include a rear panel BNC input for application of an external noise source.

### Synchronous Noise

Synchronous noise is added to waveform equations using either of two noise arguments, **NOISE** or **GNOISE**. Both **NOISE** and **GNOISE** are “white” noise sources; i.e. their signal energy is uniformly

	<b>NOISE</b>	<b>GNOISE</b>
Frequency Distribution	Uniform	Uniform
Amplitude Distribution	Uniform	Gaussian
Amplitude Range	0-1 V	0-1V
Mean	0.5	0.5
Standard Deviation	0.288	0.1667

distributed in the frequency domain. **NOISE** has a uniform amplitude distribution, while **GNOISE** provides a Gaussian amplitude distribution. The statistical characteristics of the noise arguments are summarized in the following table:

The random number generator used in the equation editor creates the same noise sequence each time it is initialized at power up. Subsequent equation calculations, made without cycling power, return different noise sequences. In either case, the noise component added to each sample within the waveform is fixed and cannot be changed without re-calculating. To recreate a waveform with a different set of noise components, simply recalculate the waveform.

## Adding Noise

Figures 9.1 and 9.2 illustrate the use of **GNOISE** in adding noise to a damped sinewave:

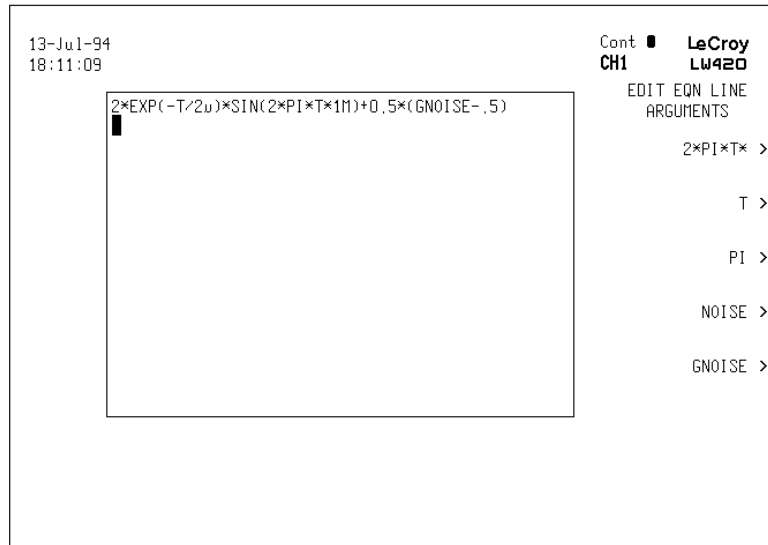

**Figure 9.1 Equation of a Damped Sine with additive noise**

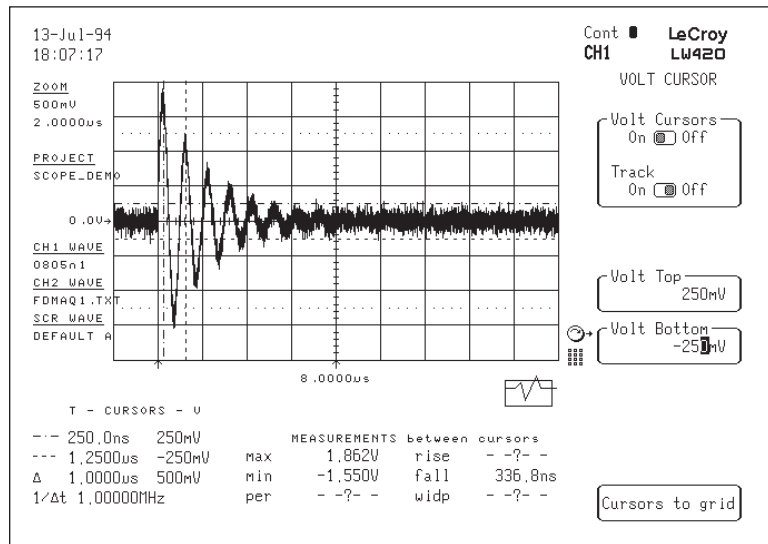

**Figure 9.2 Damped Sine with additive noise**

### Using the noise source on the LW400 and LW400A

The independent pseudorandom noise generator uses a nominal 800 MHz clock source which is asynchronous with the Wavestation's internal timebase. It produces spectrally uniform white noise with a Gaussian amplitude distribution. The pseudorandom pattern length is  $2^{22}$  states. The noise can be added to the output channel(s). The summation point is prior to the gain/attenuation stages so that the signal to noise ratio is fixed regardless of the signal path gain.

Pressing the CHAN1 (or CHAN2 on the LW420 or LW420A) will display the CH1 (CH2) menu which contains the controls for adding noise to the selected channel—see figure 9.3.

### Using an external noise source on the LW400B

The LW400B series does not include the internal noise source however a noise source can be supplied externally through the noise input BNC located on the rear panel. The noise is summed internally and controlled in a way similar to the models that contain the internal noise source—see figure 9.3.

The recommended noise input level is 1.0 V peak to peak with 0.0 V offset.

*Note that since the noise is added independent of the selected waveform creation process it does not appear on the waveform display.*

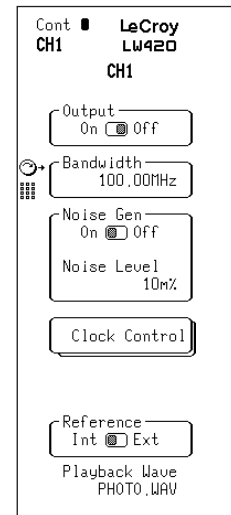

**Figure 9.3**  
**Setting the Asynchronous noise level**

## Adding Noise

---

### Noise Control

Noise may be added to either or both channels in the dual channel models. The noise level is independently adjustable in each channel. The noise level is specified as a percentage of the noise amplitude (in Volts RMS) to the currently selected waveform's amplitude (in Volts peak-to-peak) to a maximum of 9%. This assumes that the AWG's output bandwidth is set to the maximum, 100 MHz, setting.

Example:

For A Signal Amplitude Of 1 Vpp And A Noise Level of 9%

$$V_{\text{NOISE}} = 1 \times 0.09 V_{\text{RMS}} \text{ (Gaussian Noise)}$$

For Gaussian Noise the Peak to Peak Noise is:

$$V_{\text{NOISE}}(\text{P-P}) = 6 V_{\text{NOISE RMS}}$$

*Note: The noise source is uncalibrated, therefore the noise level should be measured and set to your specific requirements. For Gaussian Noise:  $V_{\text{RMS}} = 1$  (sigma) and Peak to Peak =  $6 \times V_{\text{RMS}}$*



**Adding Noise**

**Shaping The Noise on the LW400 and LW400A**

The noise generator output can be routed through an external filter to shape the noise spectrum. The filter, which should have an impedance of 50 Ω, may be connected between the noise output and input BNC connectors in slot 1 on the rear panel.

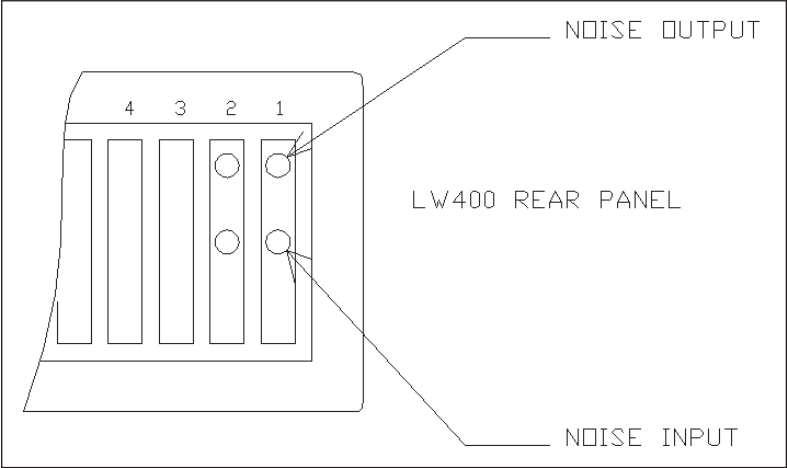
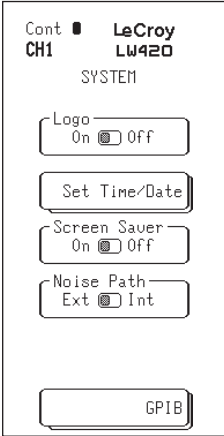

**Figure 9.4 rear panel connections for the noise generator**

The external noise path is selected from the SYSTEM menu as shown in figure 9.5. This can be accessed by pressing the PROJECT button and then selecting the Preferences and System softkeys.

**Note for LW400B Series:**

*The Noise Path Menu box does not appear on the LW400B series. The noise path is always external on the LW400B.*



**Figure 9.5 Selecting the noise path**



The project structure of the WaveStation is intended to provide a logical place to group waveform files and certain system parameters. It is intended to facilitate the use of the instrument in a multi user environment where different users can have their own unique directory of waveforms. Within the user directories, waveform files can be stored along with certain system setup files that define the configuration of the LW400 at start up or initialization.

The project structure can be likened to the file manager in modern computer operating environments such as "windows™" in that it gives the user an easy way to access a hierarchy of directories, called projects in the WaveStation, and to move files into and out of each project directory in WaveStation, as well as between project directories. It also gives the user a way to write protect his or her files should it be necessary.

The multi disk file management capability provides support for importing and exporting large waveforms and projects.

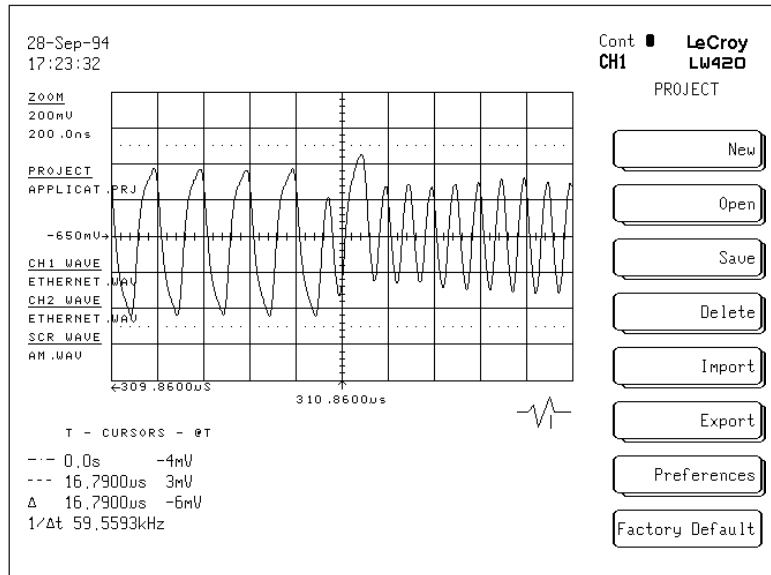
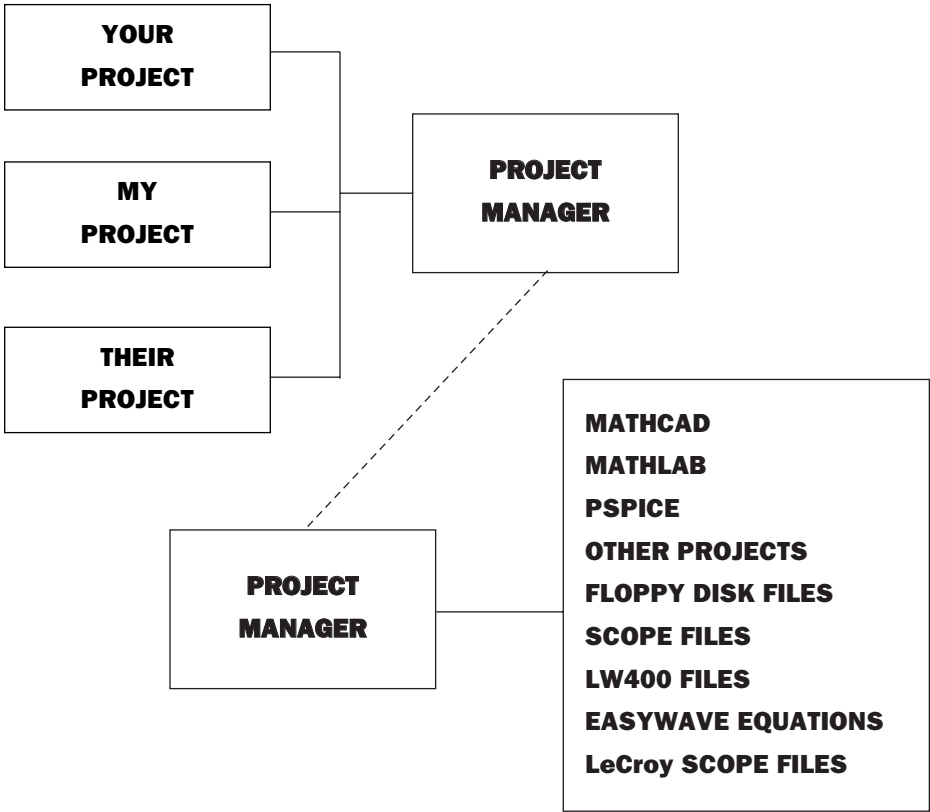

**Figure 10.1 The Project Menu**

## Project Structure

New	Assign a name to a New Project
Open	Choose an existing project from a list and open it
Save	Will save changes to current project or “save as” to change name
Delete	Delete a waveform, sequence, equation or project
Import	Get something from various available sources (see below)
Export	Send something to various available destinations (see below)
Preferences	Sets a myriad of initial conditions (see below)
Factory Default	Set to known state—default settings

**Table 10.1 Selections in the Project menu**



**Figure 10.2 The Role of the Project Manager**

## **Project Menu**

<b>New</b>	This menu is used to create and name a new project.
<b>Open</b>	This menu is used to select an existing project.
<b>Save</b>	On entry to the menu this field contains the name of the open project. If a name is entered in the Save As menu (see below) then this field contains that name.
<b>Save As</b>	This menu is used to change the name under which the current project will be saved.
<b>Save It</b>	Saves the current project. <i>Note: if the project is write protected then the user will be told it's a write protected project and abort the save operation. If a new name was entered for the project (<b>Save As</b>) then a new project is created from the current project. This includes all waveforms, sequences, equations and project preference settings. The old project is closed (no prompt is given if settings have changed) and the new project is opened.</i>

## Project Delete

---

<b>Delete</b>	This is the only place to delete projects, waveforms, sequences, equations, or DSO files. Everything comes in and out of the LW400 through the project menu. The current and default projects may not be deleted. Anything in a write protected project may not be deleted. After delete is pressed then a message appears to verify delete.
<b>What</b>	This field contains the different types of objects that can be deleted; Projects, Waveforms, Sequences, Equations and DSO files. This field dictates what type of objects are shown in the next field. The rotary knob is attached to this field.
<b>Projects</b>	This field contains the objects that can be deleted (dependent on the What field). The label for this field changes in accordance with the What field. If the What field contains Sequence the label will be Sequences. The different labels for this field are: Projects, Waveforms, Sequences, and Equations.
<b>Delete</b>	This is the action softkey that begins the delete operation (dependent on the Are You Sure button) of the object in the fields described above. If the object is write protected it will not be deleted and the appropriate message will be given to the user.

**Import—Refer to section 12 for additional details**

<b>What</b>	The following object types that can be imported into a project: LW4XX Waveform, LW4XX Sequence, LW4XX Equation, LW4XX Project, EasyWave Wave, EasyWave Wad, EasyWave Seq, LeCroyScopeFile, MathCad File, PSpice File, MatLab File, ASCII(Data,Hex,Binary), Spread Sheet File or DSO file.
<b>From</b>	This is the location of the object to be imported. Objects can be imported from other projects, or a floppy disk.
<b>Path/Project</b>	This is the actual path to the objects. The appearance of this field depends on the <b>From</b> field. If the <b>From</b> field displays Another Project, then this field is a list of valid projects. If the <b>From</b> field displays Floppy Disk, then this field is a menu labeled <b>Path</b> . The path submenu permits selection of the floppy disk subdirectory.
<b>Source File</b>	This is the object to be imported. The list contains the objects found in the <b>Project/Path</b> .
<b>Target File</b>	This is the name assigned to the imported object. It will duplicate the name in the <b>Source File</b> field until it is changed with <b>Import As</b> (see below) at which point it will be the name entered.
<b>Import As</b>	Use this menu to enter a new name for the object to be imported.
<b>Options</b>	Pressing the <b>Options</b> softkey displays a menu used to select options to process waveforms during import.
<b>Import</b>	Press the <b>IMPORT</b> softkey to import the object in <b>Source File</b> into the current project with the name in <b>Target File</b> . If it is not an LW4XX object then it will be converted to one because only LW4XX objects are stored in the WaveStation.

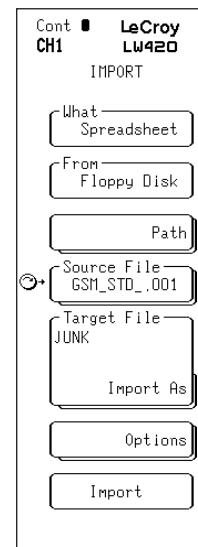

**Figure 10.3  
The Import  
Menu**

## Project Import

### Export

**To** This is the location to export the object to. Objects can only be exported to a floppy disk. Transfers between projects are handled by **Import**.

**Project/Path** This is the actual path to store the object on the floppy disk. The path menu is shown below.

**What** This field specifies what is to be exported, choices are Projects, Waveform, Sequence, Equations, or DSO files.

**Format** This field only appears only if a waveform is being exported. This is the format in which to export the object in. The valid choices are: LW400 Waveform, MathCad, Matlab, spread sheet, or PSpice (PWL)

**Source File** This is the object to be exported. The list contains the objects of the type in the current project.

**Target File** This is the name to be used when the object is exported. It will duplicate the name in the **Source File** field unless it is changed with **Export As** (see below) at which point it will be the name entered.

**Export As** This menu allows the user to enter a new name for the object to be exported.

**Export** This is the action softkey that exports the object in Source File to the disk with the path as dictated by the Project/Path field in the format of the Format field with the name in Target File.

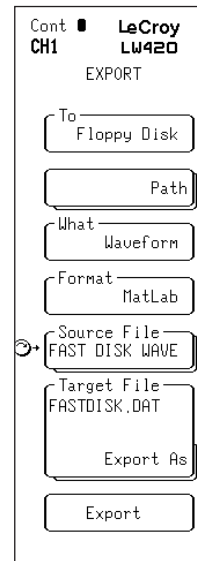
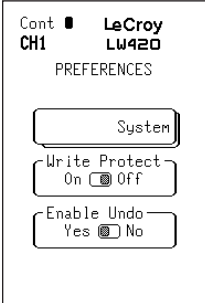

**Figure 10.4**  
**The Export**  
**Menu**



**Preferences**

The preferences menu, shown in the following figure, offers the choice of entering the System preferences menu or enabling Write Protect on the current project.



**Figure 10.5 The Preferences Menu**

**System Menu**

Pressing the **System** softkey will result in display of the SYSTEM menu shown in figure 10.6.

The functions of the SYSTEM menu softkeys are summarized in table 10.2 shown below.

**Write Protect**

This **On/Off** switch write protects the entire project. All waveforms and settings will be write protected. New waveforms, however, may be created, or imported. Waveforms may also be exported. *Note: that any waveform that is created in a write protected project is automatically write protected once it is saved.*

**Enable Undo**

Selecting **Yes/No** with the softkey enables/disables the undo buffer operation. This can speed up menu changes on very long waveforms

Softkey	Function
Logo (ON/OFF)	Turn The LeCroy LW400 logo on or off
Time/Date	Turn real time clock display on or off. Sets time and date.
Screen Saver (ON/OFF)	Enables screen saver
Noise Path (EXT/INT)	Selects internal or external path for asynchronous noise source. The external path is used to supply an external noise source and to filter or “color” the noise. On the LW400B, External is always selected.
GPIB	Used to set GPIB address of the LW400

**Table 10.2**

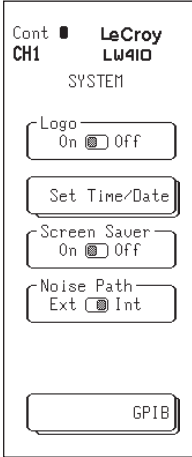
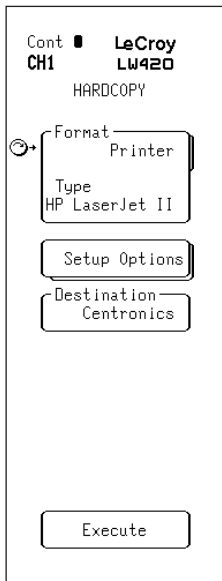

**Figure 10.6 The System Menu**



**Hardcopy**

Many different styles of printers and graphics files are directly supported. The hardcopy setup menu system is accessed by pressing 2nd (red button) followed by the Time Cursor button (HARDCOPY is in red) in the View Group on the front panel next to the Rotary Knob. The menu displayed is shown in figure 11.1. The printer types, formats and options are shown in tables 11.1 and 11.2.



**Figure 11.1**  
**Hardcopy Menu**

Format	Graphics or Printer
Type	Graphics: .PCX., .TIF, .BMP
Type	Printer: Epson MX/FX.LQ, HP LaserJet II and HP ThinkJet
Quality	Proof of Draft (Graphics Only)
Destination	Centronics, Floppy, GPIB (Printer)
Filename	Enter the file name (Floppy only)
Index	Filename.index starting with .000
Auto/Incr index	Yes/No turns on incrementing of the index

**Table 11.1** Hardcopy Options

Size	Presentation (4.26" X 2.66")—Notebook (5.53" X 5.33") (Valid for HP Laser Jet II only).
Quality	Proof/Draft: Valid for Epson LQ, HP ThinkJet, & HP LaserJet only.
Page Feed	On/Off: "On" generates a page feed after the waveform is printed.

**Table 11.2** Setup Options for Printer output only

## Hardcopy

---

### Hardcopy Output

LW400 hardcopy output provides screen images to graphics file or printer. If the output format is capable of high resolution, the output quality can be selected as either proof or draft.

Draft output provides black/white output only: Trace, Grid, and Text, printed as black on white.

Proof output takes advantage of the extra available output resolution to provide a differentiation between trace data and Grid using gray scale intensity.

### Choosing the Port for Hardcopy

If hard copy is to be performed directly to a printer then it is necessary to connect the printer to one of the available output ports. The Centronics or GPIB port are both available as printer destinations.

### File names

The filename will be HCOPY with a 3 digit index. The extension will be .WAV if it is a printer file or the appropriate graphics file format extension if it is a graphics file. Example: HCOPY000.TIF

\* for additional setup information, see the following sections entitled Interface Basics describing these ports and how to configure them.

## Using Hardcopy for Printing

The HARDCOPY softkey menu is shown in figure 11.1. To send a picture of the current display to your printer perform the following steps.

1. Set **FORMAT** to **PRINTER**

2. Set **TYPE** to (As defined below)

Types:	<b>Epson MX/FX</b>	Epson compatible 9 Pin Dot matrix printer
	<b>Epson LQ</b>	Epson compatible 24 Pin Dot matrix printer
	<b>HP Laser Jet II</b>	HP Laser Jet Series II and compatibles (also Laser Jet IV)
	<b>HP ThinkJet</b>	HP ThinkJet Compatible

3. Setup **OPTIONS** (as defined below)

Size:       **Notebook:** 4.2" x 6.0" (10.66 mm x 7.62 mm)  
              **Presentation:** 8.4" x 6.0" (21.33 mm x 15.25 mm)

Page Feed: **On:** Automatic form feed for each page  
              **Off:** Requires manual or externally generated form feed.

Quality:   **Proof:** High quality—gray scale presentation of graphic element.

**Draft:** Fast printing black/white only.

## Storing Hardcopy to a Floppy Disk

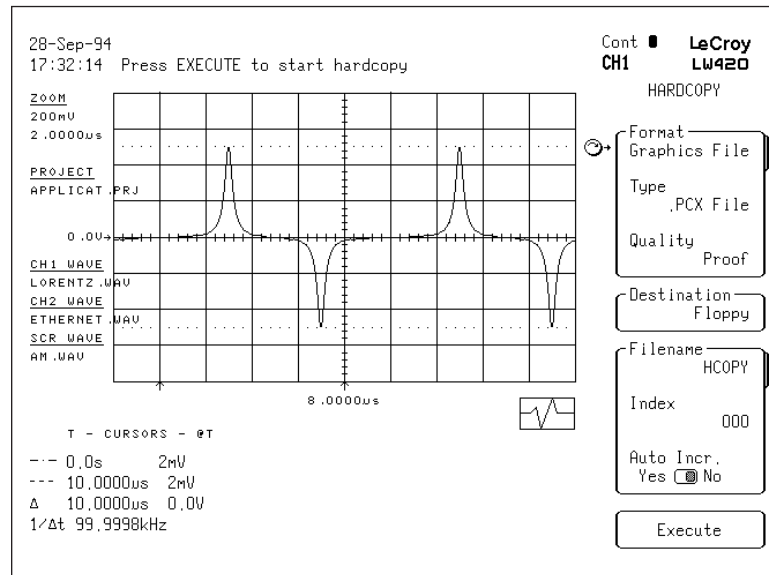

Figure 11.2 Storing to Floppy Disk

In order to use the hardcopy menu to store a screen image to the floppy disk, select destination "floppy" in the hardcopy menu. This menu permits selection of either printer format files or graphics format files. The steps are as follows.

1. Select **2nd** followed by **Hardcopy**
2. Select Format **Printer** or **Graphics file**
3. Select **Type** from the available options
4. Select **setup option** (printer only)
5. Select Index
6. Set Auto Incr. to **yes** or **no**
7. Select **execute**

This final step causes an image of the screen to be stored to the floppy disk in whatever format was selected.

## **File Naming Conventions**

The LW400 uses a standardized scheme for filenames when storing and recalling files from disk.

All files adhere to the DOS convention of an 8 character name and 3 character extension. The default extensions are defined below for each of the data formats supported by LW400.

.PRN	Hardcopy Printer format file
.PCX	PC-Paintbrush compatible graphics file
.BMP	Windows Bit-Map compatible graphics file
.TIF	Tag-Image format compatible graphics file

Many of the Hardcopy file formats supported in LW400 can also accommodate a unique numeric index to facilitate an auto-incrementing filename.

When the auto-increment feature is supported, for a particular file format, a three-digit numeric index is used for the last 3 digits of the 8 character filename.

## **Disk Paths**

The **IMPORT**, **EXPORT**, and **HARDCOPY** system use a default directory (or paths) for all file related operations. The default directory is specified in the **PATHS** menu. This menu is accessible from within the **EXPORT** or **IMPORT** menus, found under **PROJECT**.





## IMPORTING AND EXPORTING WAVEFORM FILES

The LW400 WaveStation provides multiple formats to communicate with other sources of waveform data. By definition, importing and exporting means bringing a waveform file into or out of a current project from either another project or on a floppy disk. The **Import** and **Export** menus are found under the **Project** Menu. In order to Select **Import** or **Export**, push the **Project** key located on the left side of the floppy disk drive on the front panel of the WaveStation. After this select either **Import** or **Export**. In all that follows, Import will be used as an example. The export operation is in general, the inverse of the Import operation.

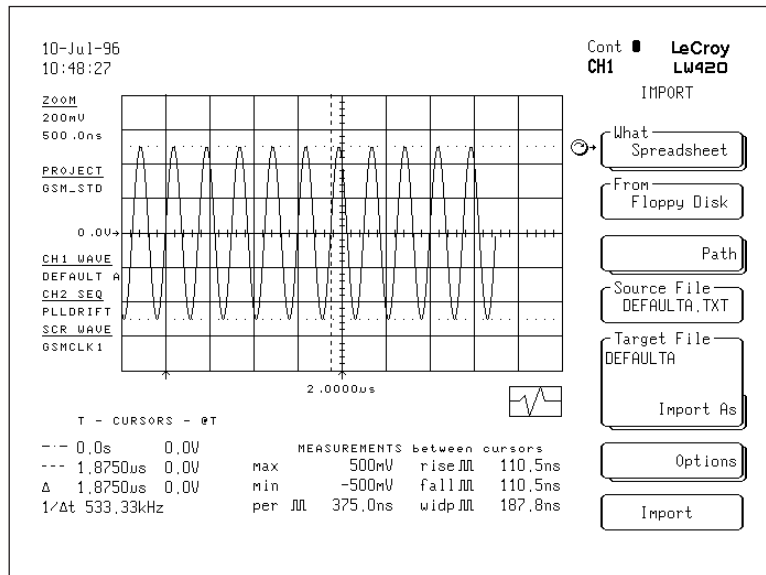

**Figure 12.1 The Import Menu**

## Import

### Information Requested On Import

The Wavestation will prompt the user for time and/or amplitude information if it is not evident from the file being imported or it may need to perform rescaling of the imported data. This may occur for Easywave files without associated setup files, ASCII (.DAT) files, Matlab, or spreadsheet files.

### Time and Amplitude Range Request

When necessary the Wavestation will prompt you to enter new time and/or amplitude information—**Enter New**—or to use the current—**Use Current**—Wavestation settings as shown in figure 12.2.

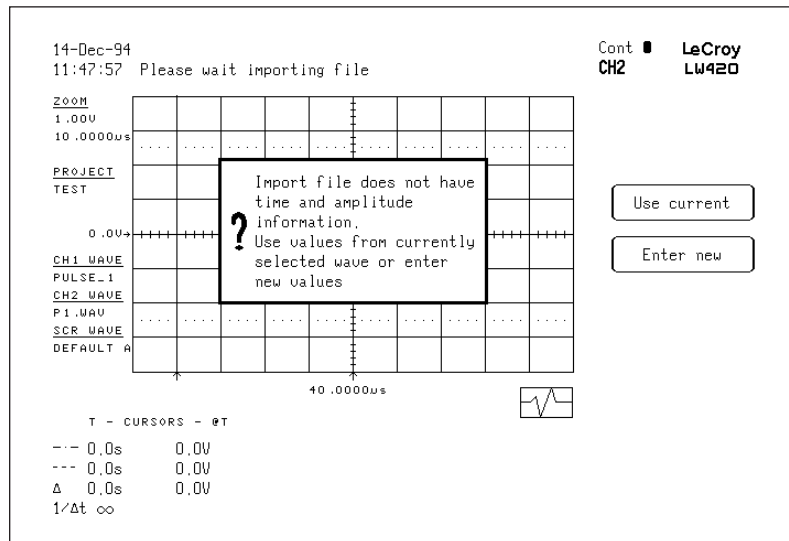

**Figure 12.2 The Time/Amplitude Warning Box**

**Import**

**Time and Amplitude Entry** If **Enter New** was selected—see figure 12.2—the menu shown in figure 12.3 will be displayed, however only the necessary information will be requested. Time is entered as Time/Point and the amplitude range is specified by entering minimum and maximum voltage levels.

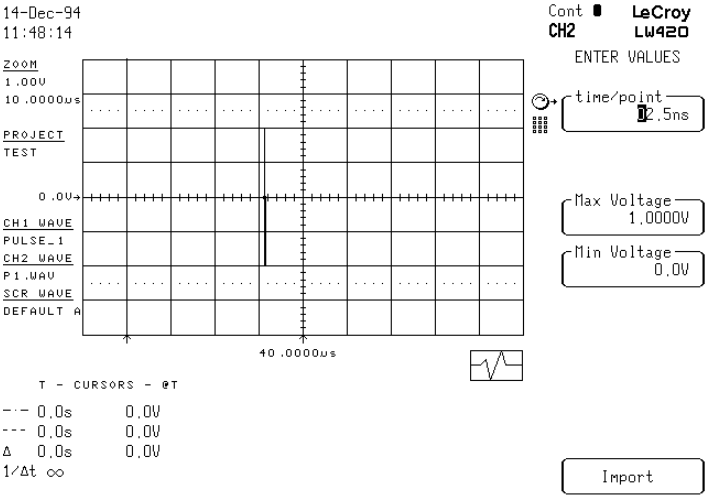

**Figure 12.3 Entering time information**

## Import

### Rescaling

If the Wavestation determines that the data requires rescaling prior to import a prompt will appear as shown in figure 12.4. Two choices are provided for rescaling of the waveform during import:

1. Choosing Preserve Time automatically sets the sample clock to assure that the duration of the waveform generated on the WaveStation equals that of the waveform file imported.
2. Preserve shape assures that the generated waveform has the same shape as the waveform file imported, however the duration of the waveform may not be the same..

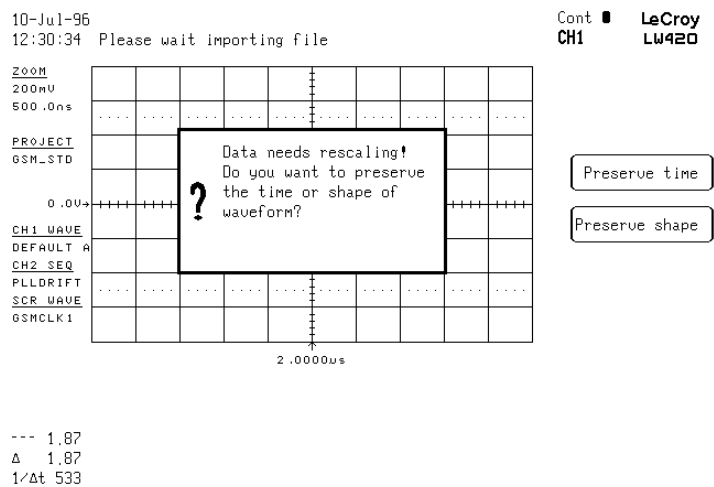

**Figure 12.4 The Rescale Warning Box**

## Import Options

### Oversample Wave

In order to edit a waveform on the WaveStation, the waveform must be sufficiently oversampled. Many of the editing functions utilize signal processing using a  $\sin x/x$  interpolator. The interpolator will create significant ringing if the data is not oversampled. If this field is set to **Yes** then the waveform will be checked for discontinuities and if found they will be fixed by passing the discontinuity through a low pass filter assuring sufficient oversampling.

If **No** is chosen then the data will not be checked for discontinuities. If the data imported is not sufficiently oversampled, editing operations cannot be applied to the waveform until it is oversampled. If you attempt to edit an undersampled waveform, the Wavestation will prompt you with a message allowing you to oversample the waveform. After the waveform has been oversampled, editing operations can be performed.

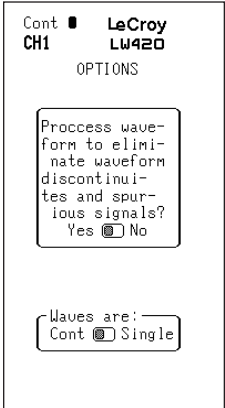

**Figure 12.5**  
**Import Options**  
**Menu**

Advantages of not oversampling are: Faster edges can be achieved since more than one point on an edge is not required; You can import a waveform without modifying the points. This may prove valuable in some situations.

### WAVES ARE

Choose to consider the waveforms imported as a single shot waveform or a continuous waveform (last point wrapped to the first). Continuous waveforms are displayed with the ends wrapped in a dimmer shade on the screen. The discontinuity check will check for a discontinuity between the end and the beginning of the waveform. This makes the presumption that when the Wavestation reaches the end of the waveform it will jump to the beginning and play the first point. If the waveform is only to be played once (single shot) or, is part of a sequence where wrapping the ends might be an incorrect thing to do, single should be selected for this field.

## Import

---

### **Import/Export of Large ASCII Waveforms**

Multi-disk importing is supported for LW4XX waveforms and other files including: Spreadsheet, Mathcad, MatLab, and PSpice formats. When the import function reaches the end of a file for one of these formats you will be prompted, questioning if there is more data or not. If the answer is yes, you will be prompted to select another file. The default name will be the original name of the file being imported but with a .000 extension. The next file extension will be .001, then .002 etc. If this is not the name of the next portion of the waveform the user can enter the name using a standard filename entry menu (like import as menu).

When the Wavestation exports large waveforms the first disk is labeled with a name entered by the user (i.e. user.txt). The next disk will be automatically labeled user.000 then user.001 etc.

**The Import Menu Sources  
of Waveforms to Import**

There are many sources of waveforms to import (export). The list of available options is arrived at by selecting “what” in the Import (Export) menu. Selections include:

LW4XX Waveforms

LW4XX Sequence

LW4XX Equation

LW4XX Project

EasyWave Wave

EasyWave Wad (dual waveform file)

EasyWave Sequence

Spreadsheet (useful for any text file of values)

MathCad

MatLab

PSpice (maximum of four nodes in simulation output)

ASCII Data (integer values between 0 and 255)

LeCroy Scope File

DSO Config File (creat configuration for other scopes)

*Note: units equipped with the LW400-09 digital ouput option will also accept digital EasyWave files, ASCII Hex, and ASCII Binary. See the Appendix covering LW400-09 for additional details.*

## Import

### Import What Menu

The menu shown in figure 12.6 is displayed upon selection of **What** by pressing the softkey on the front panel. The selection of the object type to import, is made by pressing the appropriate softkey.

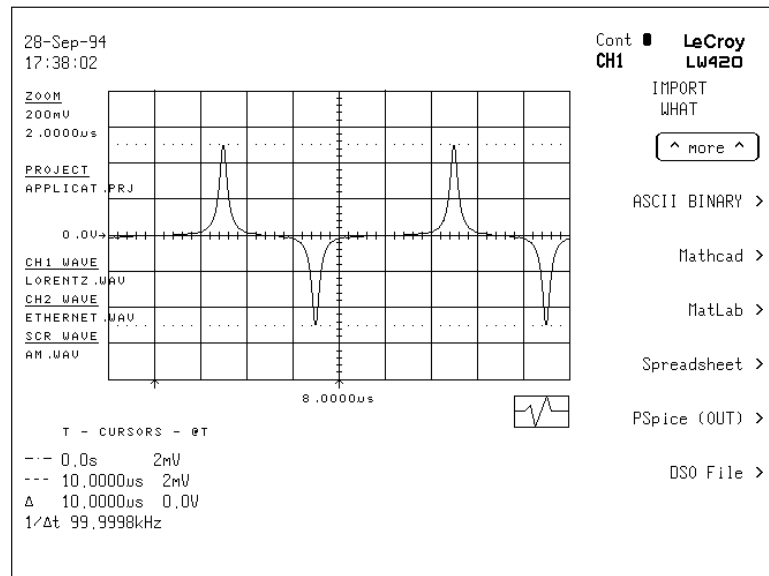

**Figure 12.6 Choices for Import (Export)**



## Communicating With Spread Sheets

### Importing from the spreadsheet to WaveStation

Creating waveforms from data in spreadsheets (such as Microsoft Excel) requires files in comma delimited, ASCII format.

The spreadsheet import selection also enables import of files containing values in one or two columns.

For a file containing two vectors, or arrays, the first array will be assumed to be time and the second array will be amplitude. So, the arrays are read in as "time value, amplitude value".

For a single column or array, it is assumed to be the amplitude array and a question will be asked to prompt you to enter a time value.

Wavestation automatically scales the amplitude to assure the full digitizing range is used. If the peak to peak amplitude is in the range of  $\pm 5.0$  volts the signal amplitude will correspond to that of the data imported. The amplitude can easily be adjusted via the front panel and saved under a name of your choice.

### Exporting From WaveStation to the spreadsheet

If a file is exported from the WaveStation as a spreadsheet file, both amplitude and time values are stored for each waveform point. To import the file into a spreadsheet program enter the spreadsheet and import the file as a text (filename.txt) file.

*Note in Excel™, for example, this also means selecting the comma as the delimiting item. Enter Excel™ and "pull down" the file menu. Select "open". In the "open" dialogue box select "text" and then select "comma". Note these file formats are also compatible with other spreadsheet programs as well as database programs such as Microsoft ACCESS™.*

Refer to your softwares manual for specific instruction regarding importing common delimited ASCII Files.

## Communicating with MathCad

### Importing From MathCad to WaveStation

From MathCad, to prepare a file for importing into the WaveStation it is stored with the WRITEPRN(FILE) command of MathCad. This produces a data file named FILE.PRN. This file will be read directly by the WaveStation. Store the file on a floppy disk and insert the disk into WaveStation. In the figure below, a file named MY\_FILE.PRN has been stored on the floppy disk. It is ready to be imported to WaveStation.

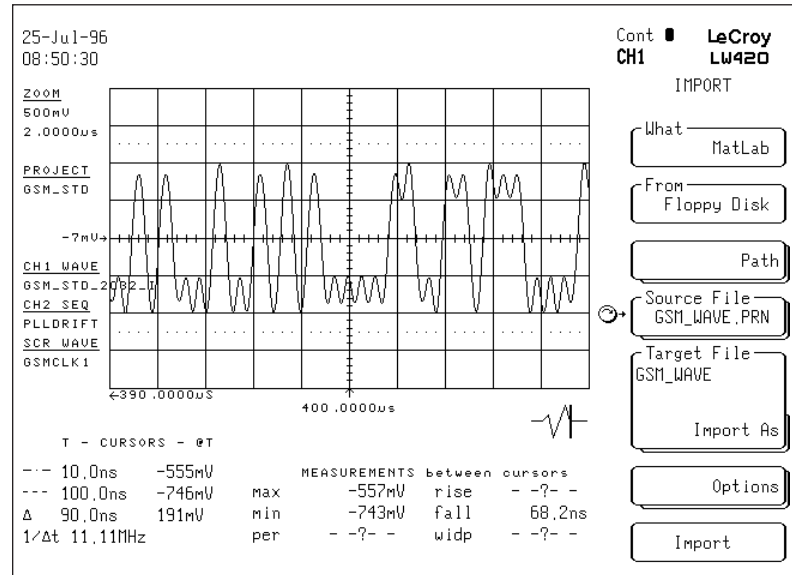

Figure 12.7 Importing From Mathcad

### Exporting from WaveStation to Mathcad

The steps to export a data file from WaveStation to MathCad are as follows:

1. Export a waveform file to a floppy disk using MathCad (.PRN) format—See figure.
2. Storing the desired waveform in MathCad format produces a structured data file with the .PRN extension. Start MathCad and insert the disk containing the MathCad file into the computer.
3. Use associate filename found in the MathCad FILE pull down menu to associate the LW400 file with a MathCad matrix variable, LS\_DATA.
4. Use the READPRN(LS\_DATA) command in MathCad to read the data from the file into matrix LS\_DATA.

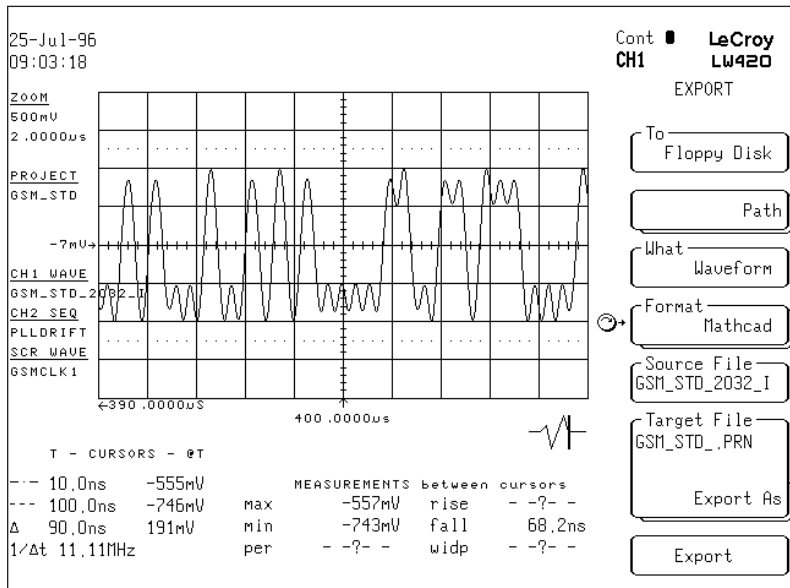

Figure 12.8 Exporting a waveform to Mathcad

## COMMUNICATING WITH PSpICE

PSpice is an analog simulation package that can be used to generate waveforms from circuit models. PSpice has several different methods of generating or storing files. It generates files in piecewise linear format (.PWL) or .OUT format. WaveStation generates .PWL files for exporting to PSpice and accepts .OUT files for importing from PSpice.

### Exporting from WaveStation to PSpice

WaveStation generate files in the .PWL or piece wise linear format. The files so generated are used to describe a voltage source waveform in PSpice and must be included in the Spice net list. The file generated from the WaveStation must be included in the appropriate PSpice directory.

### Importing to WaveStation from PSpice

The PSpice file must be stored as a .OUT file. Up to four nodes can be included in the file. If more than one node is present, WaveStation will ask which node to import. Import begins at the point in the file where the first character is a numeric value. If a line contains a numeric character in the first column prior to this point an import error will occur.

```
**** TRANSIENT ANALYSIS          TEMPERATURE = 27.000 DEG C
*****
TIME          V(1)          V(2)          V(3)          V(4)
0.000E+00     0.000E+00     -6.590E-26    6.590E-26     0.000E+00
1.000E-05     3.139E-01     3.314E-03     1.611E-04     1.158E-03
2.000E-05     6.266E-01     9.882E-02     3.136E-03     3.399E-02
3.000E-05     9.365E-01     3.273E-01     1.027E-02     1.125E-01
4.000E-05     1.243E+00     5.915E-01     1.852E-02     2.034E-01
5.000E-05     1.544E+00     8.678E-01     2.715E-02     2.983E-01
6.000E-05     1.840E+00     1.146E+00     3.584E-02     3.939E-01
7.000E-05     2.128E+00     1.421E+00     4.444E-02     4.885E-0
```

## Communicating With MatLab

MatLab is a matrix oriented mathematical analysis program that is in common use for generating complex waveshapes. MatLab generates two different waveform format files. Either can contain multiple matrices. The first is a standard ASCII file. The second is the .MAT file which is a binary file. Currently WaveStation supports the ASCII file format (identified by a .DAT extension) from MatLab.

### Exporting to MatLab from WaveStation

In order to export a file to MatLab from WaveStation, it is only necessary to export it in MatLab format. The WaveStation exports a one dimensional array of amplitude values. If the wavefile name is "myfile", it will be exported as myfile.dat and can be imported directly into MatLab using the **Load** command.

### Importing from MatLab to WaveStation

#### 1 dimensional arrays

The case of the 1xN or Nx1 array is handled similarly. In MatLab, save the file with the command string "save yourfile.dat arrayname -ascii". This produces a file with name "yourfile" from the MatLab array "arrayname".

Load the floppy disk with this file into the WaveStation and import it directly. In the case of the one dimensional array, only amplitude values are assumed. The timebase that will be associated with this file is the current WaveStation clock setting.

#### Import Steps

1. Push Project
2. Push Import
3. Select What and then MatLab
4. Select From and then Floppy
5. Select Sourcefile and "Yourfile"
6. Push Import

See figure 12.9 at right.

#### 2 dimensional arrays

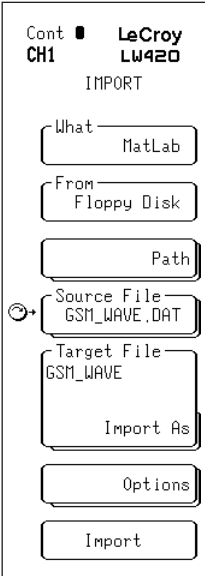

**Figure 12.9**  
**Importing From**  
**MatLab**

**column matrices**

There are two formats for 2 dimensional arrays: column format or row format. In column format (there are 2 columns of n elements each), The WaveStation examines the first two elements of the first column and extracts the timebase. If the first column had values  $x_1, x_2, x_3, \dots$ , then the time step is taken as  $x_2 - x_1 = t$ . If this is an invalid time, then the user is prompted and asked whether to preserve time or shape. Preserving shape will cause the WaveStation to use its current clock setting, whereas preserving time causes WaveStation to resample the waveform thus preserving the overall waveform duration.

**row matrices**

It is possible to save the data file in two arrays that are effectively 2 individual 1xN arrays. The format of the MatLab command is "save yourfile.dat array<sub>1</sub> array<sub>2</sub> -ascii". This produces two individual arrays that can be examined by the WaveStation. In this case, array<sub>1</sub> is assumed to be the time array while array<sub>2</sub> is the amplitude array.

This file is imported into WaveStation just the same as the single array. However this presents an interesting possibility for the informed user. WaveStation will only examine the first values of array<sub>1</sub> to determine the amplitude values. If the remainder of the array is empty, it is of no consequence with one exception. **There must be a third value in the array** which is used solely to determine that it is a row array and not a column array. So in the case of describing the function with two independent arrays, if the values in array<sub>1</sub> are array<sub>1</sub> = (0,t,x) where t is the requested delta time and x is any number, then the correct time information can be passed to WaveStation while achieving a considerable savings in the file size.

## **Communicating With EasyWave**

EasyWave files are directly imported to WaveStation. If the EasyWave file has an associated setting file (filename.set) then the WaveStation will read the time, amplitude and offset information from the settings file. If an EasyWave waveform file has no associated setup file the LW400 will look for a default settings file, IMPORT.SET. If no settings file is present, the WaveStation asks the operator to input a time increment.

## Communicating with LeCroy Digital Oscilloscopes

Any LeCroy digital oscilloscope that has a floppy disk drive can generate a WaveStation compatible file. This file can then be imported into the WaveStation using the file import menu. Use "LeCroy Scope File" from the What field. *Note this is different than the "Get From Scope" command that is implemented in the waveform editor under "Insert Wave" which requires a GPIB cable between the oscilloscope and the WaveStation.*



**Importing ASCII  
Data Files**

ASCII Data files consist of integer values between 0 and 255, encoded as ASCII numbers separated by spaces or commas. The WaveStation will prompt for the voltage range and time per point.

**DSO Configuration  
Files**

DSO configurations file with .DSO extension, are used to describe the key parameters of digital oscilloscopes needed to input waveforms. For more information contact LeCroy for additional information.

## Export

---

### Exporting to Floppy Disk

1. Press Operation key **PROJECT**.
2. Press softkey **EXPORT** then select the destination of the data by selecting **TO** floppy disk.
3. Press softkey **WHAT** and select type of file to be stored.
4. Press the **FORMAT** softkey and select the choices of how the waveform will be stored (LW400 Waveform, MathCad, PSpice, etc.).
5. The **TO** softkey will default to Floppy.
6. Select the source file and **TARGET FILENAMES**.
7. Press **EXPORT** and the waveform will be stored. If more than 1 floppy disk is required you will be prompted to insert additional disks.
8. The **TARGET FILENAME** can be changed to any desired file-name by pressing the **EXPORT AS** menu key and then entering the desired file name.

---

## Sample Clock Introduction

The “LW400A and the LW400B Models” have a sample clock that is continuously variable while the LW400 models have a clock variable over specific decade ranges.

The clock menu is used to set the clock related options for the selected waveform. The menu and range of the clock are different depending on whether or not the continuous clock option is installed. The continuous clock has a range from 6kHz to 400MHz. The standard clock has the following frequency ranges: 355MHz - 400MHz, 35.5MHz - 40MHz, 3.55MHz - 4MHz, 355kHz - 400kHz, 35.5kHz - 40kHz.

There are three parts to this section.

- Refer to the **LW400 Clock Setting** part if you are using an LW410 or LW420.
- Refer to the **LW400A/B Clock Setting** part if you are using an LW410A, LW420A, LW410B, or LW420B.
- The **External Reference part** is common to all models and describes setting up the Wavestation for use with a 10 MHz external clock reference.

## LW400 Clock Setting

### Setting The Sample Clock Rate

When a waveform is created or imported, the LW400 determines the clock rate and number of samples required to generate the waveform with the correct timing and optimum output filtering. Therefore, a logical sample clock rate is associated with every waveform generated in the LW400. Channel 1 is setup as the “master” channel, the waveform in channel 1 determines the physical clock rate for the AWG. Whenever a waveform is selected as the channel 1 waveform the sample clock associated with that waveform is used to set the internal clock rate of the LW400.

There are two methods of changing a waveform’s sample clock rate.

#### Clock Set Method 1

1. Press the **CHAN1** button on the front panel to access the **CH1** menu—figure 13.1.
2. Press the **Clock Control** softkey to access the **Clock Control** menu—figure 13.2.
3. Select the desired value of the **Max Clk Value** or **Clock Rate** in the **Clock Control** menu.

The clock parameter fields in the CH1 menu control the clock hardware of the LW400 directly and affect the waveforms in both channels of the LW400.

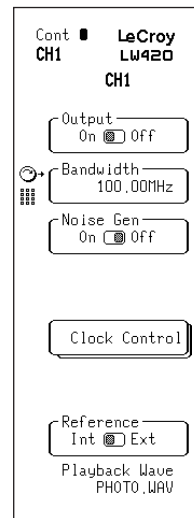

**Figure 13.1  
Clock Selection on CH-1 Menu**

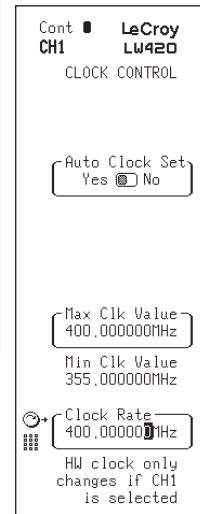

**Figure 13.2  
Setting the Clock Decade and Frequency**

The clock rate is normally set automatically by the LW400. The **Clock Control** menu allows users to override the normal operation of the LW400 and manually set the logical clock rate, associated with the selected waveform. If channel 1 is selected as the active waveform, then the CLOCK menu sets both the logical clock rate of the waveform and the system clock rate. Otherwise, if the scratch pad or channel 2 editor is selected, the CLOCK menu only affects the logical clock rate of the waveform.

**Clock Set Method 2**

The second method of changing the clock setting for the currently selected waveform is as follows:

1. Access the **Clock Control** menu from the front panel by pressing the red “**2ND**” button then the **CLOCK** button (the alternate function of the **TIME** button). The CLOCK menu is shown in figure 13.3.
2. Select the **Max Clk Value** or **Clock Rate** in the **Clock Control** menu.

The menu items associated with setting the clock rate, using either method, are similar and described on pages 13-4 and 13-5.

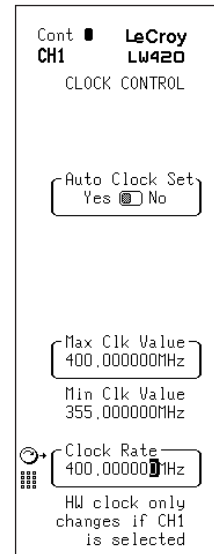

**Figure 13.3 The Clock Menu**

## LW400 Clock Setting

---

### AUTO CLOCK SET

The **Auto Clock Set** selection determines if the sample clock rate can be automatically varied as each new waveform is created or imported or if it is fixed at a single value. If this field is set to **Yes**, the WaveStation automatically selects the best sample rate in order to achieve the required duration. With this field set to **No**, the clock rate is held at the user set frequency and the number of samples is varied to set the waveform duration. In general, the variable clock rate allows more flexibility in achieving the desired waveform duration. In fixed mode, the achievable waveform duration will always be integer multiples of the clock period.

### MAX CLK VALUE

This field is used to set the maximum value for the clock rate. The **Max Clk Value** is a numeric field that can be set to one of the following: 400MHz, 40MHz, 4MHz, 400kHz, or 40kHz to match the available output filters of 100 MHz, 10 MHz, 1 MHz, 100 kHz, 10 kHz respectively.

### MIN CLK VALUE

The **Min Clk Value** is an information field that displays the current minimum clock rate value.

### CLOCK RATE

If **Auto Clock Set** is set to **No**, the clock frequency shown in the **Clock Rate** field is fixed, and will not change unless another frequency is manually selected. If **Auto Clock Set** is set to **Yes**, the current clock frequency is shown in the field. The clock rate can be adjusted when either setting is selected, however, if the LW400 is in auto clock mode then the clock rate may change without notification.

The **Clock Rate** is set using the numeric keypad or the rotary knob. The frequency can be set with a 1 Hz resolution within the decade range—see table 13.1—displayed by the **Max Clk Value** and **Min Clk Value** fields.

*Note that if the LW400-09A digital output option is installed then additional clock ranges are available for use with digital waveforms. See the appendix covering LW400-09A for additional information.*

**Table 13.1 Clock Decades**

Decade	Lower Limit	Upper Limit
400 MHz	355 MHz	400 MHz
40 MHz	35.5 MHz	40 MHz
4 MHz	3.55 MHz	4 MHz
400 kHz	355 kHz	400 kHz
40 kHz	35.5 kHz	40 kHz

**Clock Rate In Dual Channel AWG's**

Waveforms selected in channel 2 of the LW400 are generated using the same sample clock as channel 1. For this reason, if the waveform was created at a different clock rate then a warning message, "Please resample channel 2" will appear. Press the button labeled CHAN 2 to display the CH 2 menu, shown in the accompanying figure. Press the Resample softkey, the waveform in channel 2 is resampled using the currently set clock rate.

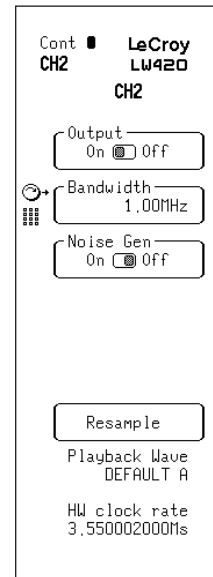

**Figure 13.4 Resampling Channel 2**

## LW400A/B Clock Setting

### LW400A/B Clock Setting

Press the **2nd** then **CLOCK** buttons on the front panel to enter the **CLOCK CONTROL** menu.

#### OPTIMIZE CLOCK (Set to Yes)

This field gives the user a single button to press that sets the clock menu up in a way that will best optimize the clock. Setting **Optimize Clock** to **Yes** on the menu sets **Auto Clock Set** to **Yes** and **Limit Clock** to **Yes**. This causes the LW400A/B to automatically pick the best clock for edit operations and limits that clock to a clock rate that has a matching filter.

The clock can be modified—within the range shown on the menu—by changing the value in the Clock Rate sub-menu shown.

The Maximum clock rate can be changed by changing the value shown in the **Max Clk Value** sub-menu as shown. If a value is selected that is not within an allowable clock decade, the WaveStation will select a value within the decade.

When set for optimized clock, the LW400A/B clock operation is similar to that of the LW400.

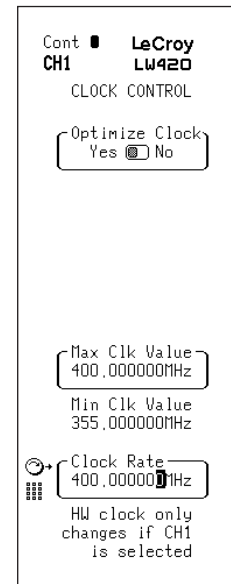

**Figure 13.5**  
**Clock Control**



**OPTIMIZE CLOCK  
(Set to No)**

Setting **Optimize Clock** to **No**—With the continuous clock option—enables full control of the continuously variable clock. With this setting the two menus available are as shown in figure 13.5 and Figure 13.6

**AUTO CLOCK SET**

The **Auto Clock Set** selection determines if the sample clock rate can be automatically varied as each new waveform is created or imported or if it is fixed at a single value. If this field is set to **Yes**, the WaveStation automatically selects the best sample rate in order to achieve the required duration. With this field set to **No**, the clock rate is held at the user set frequency and the number of samples is varied to set the waveform duration. In general, the variable clock rate allows more flexibility in achieving the desired waveform duration. In fixed mode, the achievable waveform duration will always be integer multiples of the clock period.

**LIMIT CLOCK**

The WaveStation has five built in filters that are designed to match the decade ranges of the standard clock. Using one of these clocks and the corresponding filter will produce the best output. Selecting **Yes** in the **Limit Clock to Internal Filter Ranges?** menu, limits the clock that can be set (by both the user and the automatic clock select feature) to only clock ranges that have a corresponding filter—see figure 13.6. If this field is set to **No** then all achievable clock ranges can be set—see figure 13.5.

**MAX CLK VALUE**

The **Max Clk Value** field changes depending on the state of the **Limit Clock** field. This field sets the maximum value for the clock rate. With the **Limit Clock** set to **Yes**—see figure 13.6, this field is a numeric field that can be set to one of the following: 400MHz, 40MHz, 4MHz, 400kHz, or 40kHz to match the available output filters of 100 MHz, 10 MHz, 1 MHz, 100 kHz, 10 kHz respectively.

With **Limit Clock** set to **No**—see figure 13.5, this field is an information box that displays what the Maximum clock rate is and can not be changed.

**MIN CLK VALUE**

This is an information field that displays the current minimum clock rate value.

## LW400A Clock Setting

### CLOCK RATE

If **Auto Clock Set** is set to **No**, the clock frequency shown in the **Clock Rate** field is fixed and will not change unless another frequency is manually selected. If **Auto Clock Set** is set to **Yes**, the current clock frequency is shown in the field. The clock rate can be adjusted when either setting is selected, however, if the LW400 is in auto clock mode then the clock rate may change without notification.

The user can enter the sample clock rate using the numeric keypad or the rotary knob. The frequency can be set with 1 Hz resolution within the range displayed by the **Max Clk Value** and **Min Clk Value** fields.

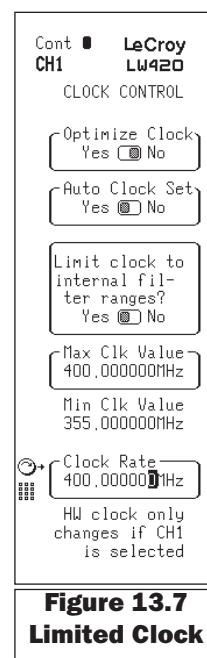
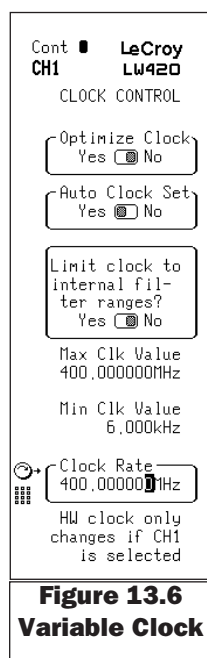

## EXTERNAL REFERENCE

The **external reference** input is an external input that permits WaveStation to be synchronized to other devices. The reference input requires a 10 MHz clock. Input voltage range is 400 mV to 5 dBV pk-pk into 50 ohm. This reference input is phase locked to the internal sample clock.

### Selecting External Reference

The reference selection is made in the **CH1** menu. In order to set the reference to external the following sequence is required.

1. Push **CH1**
2. Select **Ext** using the Reference softkey
3. Push **Menu Return**

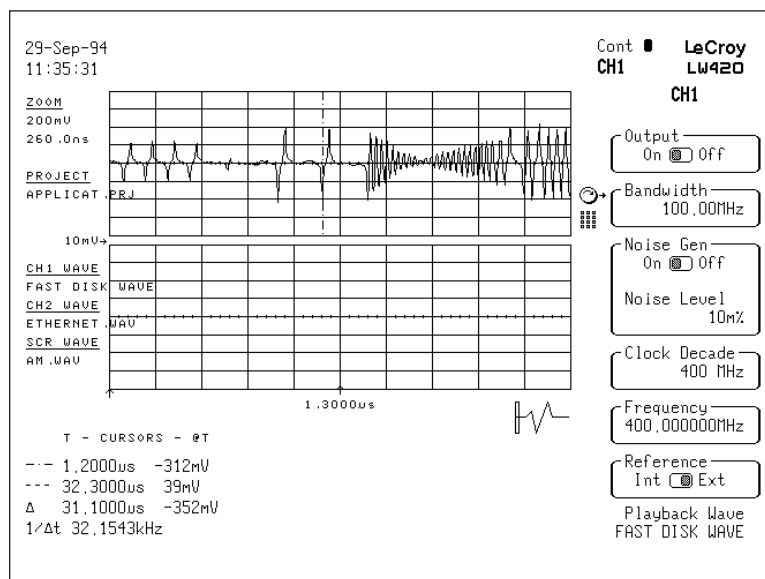

**Figure 13.8 Selecting the External Reference**



**MARKER OUTPUT** The LW400 WaveStation is equipped with a programmable marker output that can be used to synchronize external events to the WaveStation. In the simplest case, the marker is used to trigger some device, say an oscilloscope, at the start of a waveform or waveform segment. The marker is a one bit Digital to Analog converter (DAC) and is fully programmable. There are two marker modes, EDGE and CLOCK. Up to 128 transitions (individual edges) can be defined by the user. The Clock Marker will produce a user selected Square wave “clock”.

### Accessing the Marker

The Marker setup menu is found in the **Edit** group. In order to enter the **Marker** menu push the **Edit** followed by **Marker** softkey. The menu shown in figure 14.1 will appear.

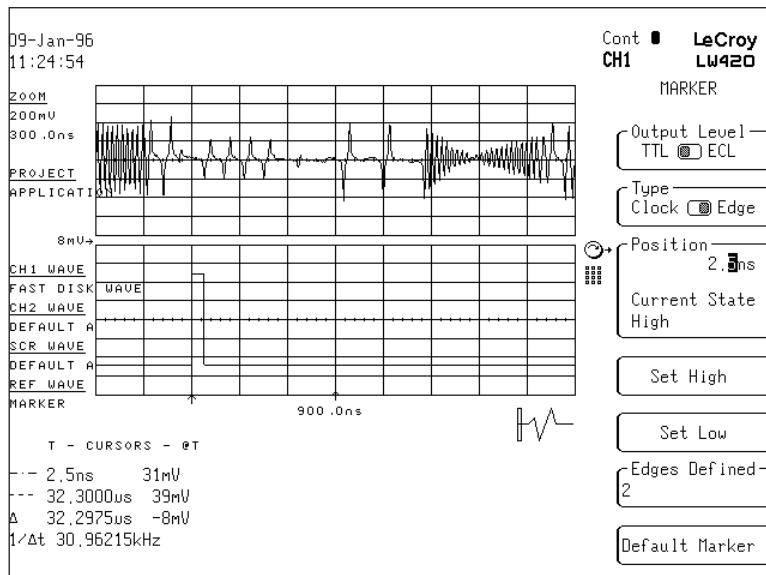

**Figure 14.1 The Marker menu & The Default Marker**

## Marker

---

### Default Marker

The **Default Marker** is to provide a single, positive, TTL level pulse, with a width of 31 Sample Clocks and a rising edge one Sample Clock from the beginning of the output of a waveform. In figure 14.1, the position control is set at 2.5 ns and the current state display is High. Notice the cursor on the top trace located at the beginning of the waveform being generated and the marker on the bottom trace. This is the default marker. This marker can always be generated simply by pushing the softkey labeled **Default Marker** at the bottom of the menu.

### Erasing the Default Marker

The **Default Marker** may be erased by positioning the cursor at 2.5 ns—the rising edge position—as shown in figure 14.1 and pushing the softkey labeled **Set Low**. This will change the transition at 2.5 ns to low and effectively eliminate the default marker. The position is set by activating the position control (pushing the softkey next to **Position**) and entering a value with the numeric keypad or scrolling along with the Rotary Knob until the desired position is reached. *Note: The position of the first edge of the marker is dependent on the sample clock setting. In this example the sample clock is set to 400 MHz resulting in the first edge occurring at 2.5 ns.*

### Programming The Marker

Up to 128 individual transitions may be programmed for the EDGE marker. This is done by scrolling the marker position along to the desired location and alternately pushing the **Set High** and **Set Low** softkeys to change the current marker value from high to low or low to high. For example, suppose in the above figure it is desirable to have a positive TTL pulse that is 250 nsec wide starting at 950 ns. The keystrokes required to achieve this are as follows.

1. Select **Position**
2. Dial the Rotary Knob until position reads 950 ns
3. Push **Set High**
4. Dial the Rotary Knob until it reads 1.20 us
5. Push **Set Low**

Note: See figure 14.2 on them following page.

# Marker

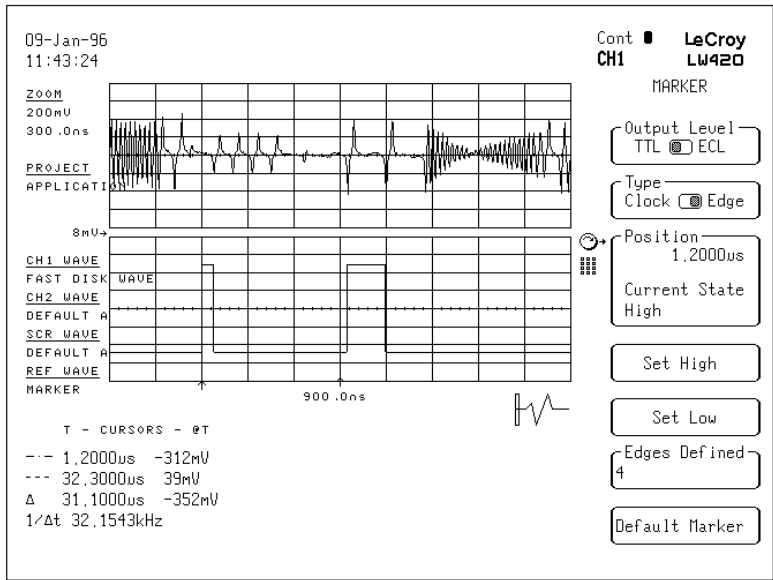

Figure 14.2 Programming The Marker

## Marker

---

### Clocking With The Marker

It is possible to use the marker to clock an external device or event. By pushing the field **Type** in the above menu, clock may be selected. In this case a new field labeled **Frequency** appears. The desired clock frequency may be input subject to certain constraints. The two fundamental constraints on the marker when used as a clock arise from the fact that the marker is associated with a waveform file and can only have frequencies that are even multiples of the current clock frequency. For example, a single marker pulse cannot be longer than the associated waveform file. Also the marker cannot have frequencies that are not even multiples of the clock frequency. For example, if the clock is running at 400 MS/sec, which is 2.5 nsec period then the marker can have a period of 5 nsec, 10 nsec, 15 nsec, 20 nsec, etc. It however, **cannot** have a period of 12.5 nsec or 17.5 nsec.

#### The constraints are summarized as follows.

- Maximum marker clock period**— half the length of the waveform file being generated.
- Allowable marker clock periods**— even multiples of the current clock period.
- Maximum marker clock frequency**— one half of the current clock frequency (200 MHz for 400 MHz).



# Marker

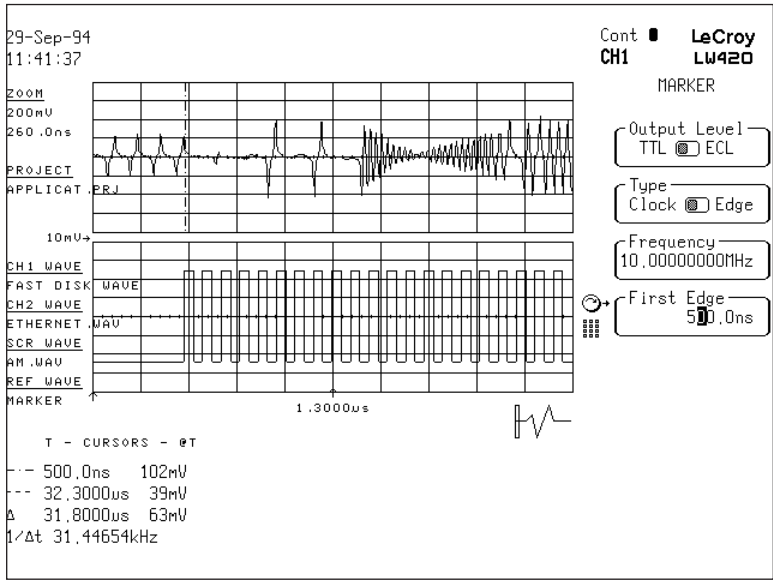
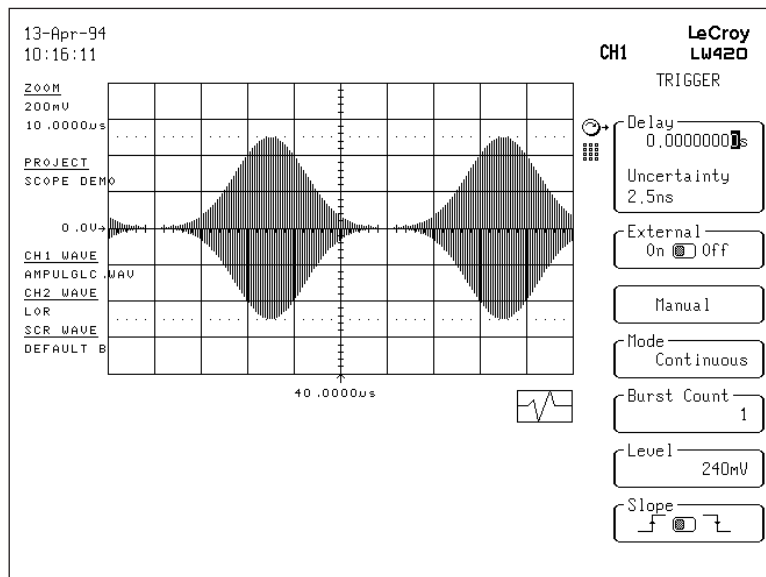

Figure 14.3 Setting The Clock Marker



## The Trigger Setup Menu

The LW400 WaveStation provides many different trigger modes and a great deal of trigger flexibility for the user. The trigger setup menu is accessed via the front panel **Trigger** key located directly above the power switch. The trigger setup menu is shown in the accompanying picture.



**Figure 13.1 The Trigger Setup Menu**

## Trigger Input

The trigger input is a front panel BNC connector located on the lower left side below the CRT. Depending on the trigger mode setting, the WaveStation may be triggered from the external trigger input, or over GPIB. It can also generate its own internal triggers as described on the following page.

## Trigger

### Trigger Modes

There are four trigger modes available. They are:

#### Continuous

The output of WaveStation free runs continuously generating the active waveform(s) provided the channels are turned “on” or “enabled” as described under the channel setup menu.

#### Single

WaveStation generates a complete cycle of the active waveform(s) one time upon receipt of a trigger. The trigger may come from the external input or from pushing the **Manual** trigger softkey in the above menu. It may also come from the GPIB bus. Triggers received while the waveform is still running are ignored.

#### Burst

WaveStation generates the output waveform for the number of cycles entered in the **Burst Count** field in the above menu. The maximum setting for the Burst count is **4096**. Triggers received while the burst is still running are ignored.

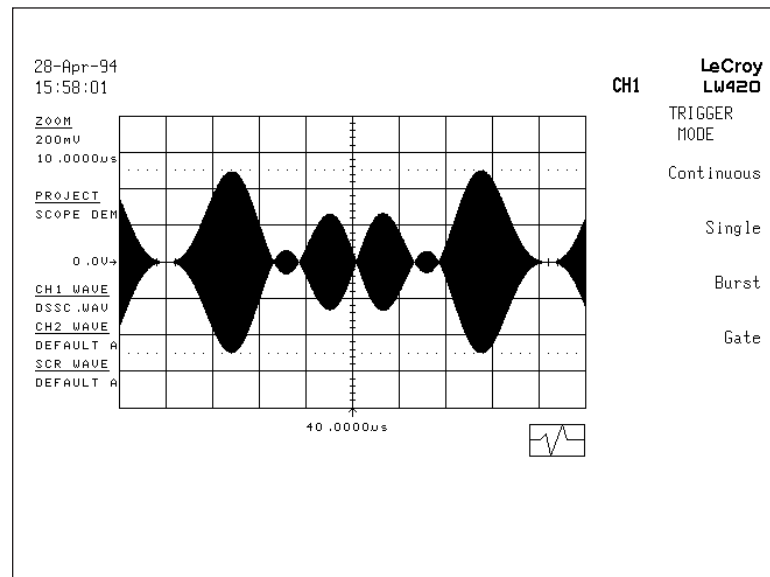

**Figure 13.2 Selecting The Trigger Mode**

## Trigger

**Gate** WaveStation generates the output waveform(s) as long as the external trigger input is held at a voltage level above the **threshold** set in the field titled **Level** as seen in the above menu. The output starts on receipt of a leading edge and terminates at the completion of the cycle following the trailing edge.

**Trigger Delay** The **Delay** field permits entry of the delay time from the trigger point to the start of the output waveform. However, the minimum trigger delay from a rising edge crossing the threshold at the front panel input connector to the beginning of the output of the active waveform is typically 35 nsec  $\pm$  3.5 nsec. This is a unit to unit variation and, once determined for an individual unit, is fixed. There is an additional delay of 5 or 6 clock periods. Therefore the actual **jitter**, or uncertainty, is one clock period. The best case jitter is therefore 2.5 nsec. at the highest clock frequency of 400 MS/sec.

### Trigger Characteristics

Trigger slope	positive or negative
Trigger input impedance	50 ohm $\pm$ 5%
Threshold Range	$\pm$ 2.5 V
Threshold Resolution	20 mV
Threshold Accuracy	100 mV
Threshold Sensitivity	50 mV pk-pk
Minimum Pulse Width	5 nsec
Protection	$\pm$ 5 V



### Retrigger Time

**Retrigger time** is specified by the minimum trigger delay: 35ns  $\pm$  3.5ns + 5 sample clock periods.

For a 400 MS/s clock rate (2.5 ns/point) the minimum delay is 51 ns.



The LW400 has several interfaces. Included are Centronics and GPIB. This section of the manual will cover the setup and use of these interfaces.

1. CENTRONICS
2. GPIB

In addition, the selection of several graphics and data formats are provided to allow for direct compatibility between the oscilloscope data and your application. The type of formats supported include:

#### GRAPHICS

1. .PCX PC Paintbrush
2. .BMP Windows Bit Map
3. .TIF Tagged-Image Format

**Centronics**

---

**Centronics Interface Basics**

The LW400 uses a standard 25 pin (DB-25), D type female connector as the Centronics (Parallel) output port on the rear panel. A standard printer cable is required to convert the DB-25-D connector to the standard 36-pin bale lock connector used on most Centronics (parallel) printers.

<b>Signal Pin LW400</b>	<b>Signal Name</b>	<b>Direction</b>	<b>Description</b>
1. (1)	Strobe	Out	A pulse is output to clock data to the printer
2. (2)	Data 0	Out	Data bits 07 transfer a byte of data to printer
3. (3)	Data 1	Out	
4. (4)	Data 2	Out	
5. (5)	Data 3	Out	
6. (6)	Data 4	Out	
7. (7)	Data 5	Out	
8. (8)	Data 6	Out	
9. (9)	Data 7	Out	
10. (10)	Acknowledge	In	Printer sends a low going pulse to this line to indicate that it has accepted a byte of data from the parallel printer interface
11. (11)	Busy	In	A high on this line indicates the printer cannot receive data
12. (12)	Paper Empty	In	A high on this line indicates the printer is out of paper
13. (13)	Select	In	A high on this indicates the printer is selected
15. (32)	Error	In	A low level on this line indicates that an error has occurred
16. (31)	Reset	Out	A pulse can be output on this line to reset the printer
17.(36)	Select In	Out	A high on this selects the printer
18. 25 (19. 30 & 33)	Ground		



## **GPIB I/O Basics**

The devices on the GPIB network may be connected in any combination of a STAR or LINEAR arrangements. Standard IEEE 488.2 cables must be used to connect all the devices and total length must not exceed 20 meters. The devices must conform to these rules:

1. At least half the devices on the network must be turned on.
2. One network can connect no more than 15 devices (including the controller).
3. One device must be connected for every two meters of cable, assuming one device presents one standard device load.
4. Each device must have a unique bus address.

The LW400 communicates across the GPIB as a Talker or a Listener to receive remote host commands and send responses. The LW400 implements the IEEE 488.2 interface standard as defined by the table on the following page.

The GPIB SETUP softkey menu is obtained by:

1. Pressing the **PROJECT** key.
2. Pressing the **PREFERENCE** key
3. Pressing the **SYSTEM** key
4. Pressing the **GPIB** key.

Address selection is the only setup parameter. Addresses from 1 to 30 may be selected. 1 is the default address setting.

Besides being an Arbitrary Waveform Generator, the WaveStation is also a standard function generator. WaveStation is capable of generating most standard functions such as sines, squares etc. and also some rather nonstandard functions such as multitones and sweeps.

### Activating the Standard Function Generator

The Standard Function Generator is activated by pressing “2nd” followed by either the **channel 1** or **channel 2** select key. The function generator menu is used in a manner that is the same as all other menus in the WaveStation. Pressing the “Functions” softkey will cause the rotary knob to attach to that key making it possible to dial through the list of available standard functions. Alternately a second push of the Functions softkey will present a list of available standard functions to choose from. The tables below summarize the available standard functions and the ranges of the parameters that are selectable by the user.

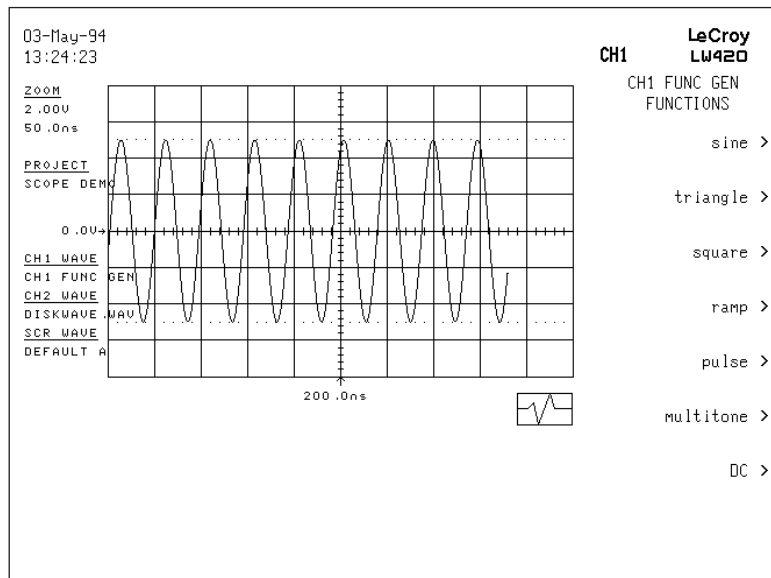

**Figure 17.1 Selecting the Standard Function**

## Function Generator

**Table 17.1 Sine Wave Function Generator**

Variable	Range	Resolution	Default Value
Amplitude (peak to peak)	1 mv - 10 Volts	1 mv	1 volt
Offset @ zero phase	+ 5V to -5V	1 mv	0 volts
Frequency	1 Hz to 100 MHz	1 Hz	10 MHz
Sweep Start Frequency	1 Hz to 100 MHz	1 Hz	1 MHz
SweepStop Frequency	1 Hz to 100 MHz	1 Hz	10 MHz
Sweep Time	1 ns to 1 sec	1 ns	2 ms
Sweep Type	Linear/Natural Log		Linear
Start Phase	0 to 360	.05 degree	0 degrees

**Table 17.2 Triangle Wave Function Generator**

Variable	Range	Resolution	Default Value
Amplitude (peak to peak)	1 mv - 10 Volts	1 mv	1 volt
Offset @ zero phase	+ 5V to -5V	1 mv	0 volts
Frequency	1 Hz to 25 MHz	1 Hz	10 MHz
Sweep Start Frequency	1 Hz to 25 MHz	1 Hz	1 MHz
SweepStop Frequency	1 Hz to 25 MHz	1 Hz	10 MHz
Sweep Time	1 ns to 1 sec	1 ns	2 ms
Sweep Type	Linear/Natural Log		Linear
Start Phase	0 to 360	.05 degree	0 degrees

**Table 17.3 Square Wave Function Generator**

Variable	Range	Resolution	Default Value
Amplitude (peak to peak)	1 mv - 10 Volts	1 mv	1 volt
Base	+ 5V to -5V	1 mv	0 volts
Frequency	1 Hz to 50 MHz	1 Hz	10 MHz
Sweep Start Frequency	1 Hz to 50 MHz	1 Hz	1 MHz
Sweep Stop Frequency	1 Hz to 50 MHz	1 Hz	10 MHz
Sweep Time	1 ns to 1 sec	1 ns	2 ms
Sweep Type	linear/natural log		Linear
Time Delay	0 ns to memory length	1ns	5 ns
Edge Time (risetime and falltime)		5 nsec to 500 ns	1 ns 5ns

## Function Generator

**Table 17.4 Ramp Wave Function Generator**

Variable	Range	Resolution	Default Value
Amplitude (peak to peak)	1 mv - 10 Volts	1 mv	1 volt
Offset @ zero phase	+ 5V to -5V	1 mv	0 volts
Frequency	1 Hz to 25 MHz	1 Hz	10 MHz
Sweep Start Frequency	1 Hz to 25 MHz	1 Hz	1 MHz
Sweep Stop Frequency	1 Hz to 25 MHz	1 Hz	10 MHz
Sweep Time	1 ns to 1 sec	1 ns	2 ms
Sweep Type	Linear/Natural Log		Linear
Start Position	0 to 100 %	.001%	0
Invert	on/off		off

**Table 17.5 Pulse Wave Function Generator**

Variable	Range	Resolution	Default Value
Amplitude (peak to peak)	1 mv - 10 Volts	1 mv	1 volt
Base	+ 5V to -5V	1 mv	0 volts
Period	20 ns to memory length	.1 ns	200 ns
Width	5 ns to mem length	0.1 ns	50 ns
Time Delay	0 to memory length	0.1ns	0
Edge Time (risetime and falltime)		5 ns to 5 ms	1 ns    10

**Table 17.6 Multitone Wave Function Generator**

Variable	Range	Resolution	Default Value
Amplitude (peak to peak)	1 mv - 10 Volts	1 mv	1 volt
Offset @ zero phase	+ 5V to -5V	1 mv	0 volts
Frequency	1 Hz to 100 MHz	1 Hz	10 MHz
Number Of Tones	1 to 10	1 Tone	1
Relative Amplitude	0 to 1	.001	1 volt

**Table 17.7 DC Wave Function Generator**

Variable	Range	Resolution	Default Value
Level	+ - 5 volts	1 mv	1 volt



**Disk Utilities**

Two disk utility functions are available under the **SAVE** menu—see figure 18.1. The disk utility functions are file search and floppy disk format. Disk Utilities are accessed by pressing the **SAVE** button on the front panel and then pressing the **Disk Utilities** softkey.

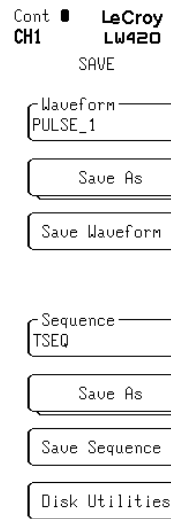

**Fig. 18.1 Disk Utilities Menu**

**Floppy Disk Format**

The LW400 will DOS format 1.44 MByte (high density), 3.5 inch floppy disks. Select Format Floppy from the Disk Utilities menu to begin the formatting process. The format operation is confirmed by a dialog box to prevent erroneous erasure of data.



**Fig. 18.2 Floppy Disk Format Menu**

# Disk Utilities

## Hard Disk File Search Utility

The hard disk file search utility is controlled from the Find File menu. File search will find waveforms, sequences, equations, or all file types, by name, as specified in the What menu field. A wild card character (\*) may be used as a substitute for a group of characters at the beginning or end of any file name.



**Fig. 18.3 Hard Disk File Search**

The result of the file search operation is a report box listing the files found by name, type, and project. Use Page Up and Page Down to view any additional pages.

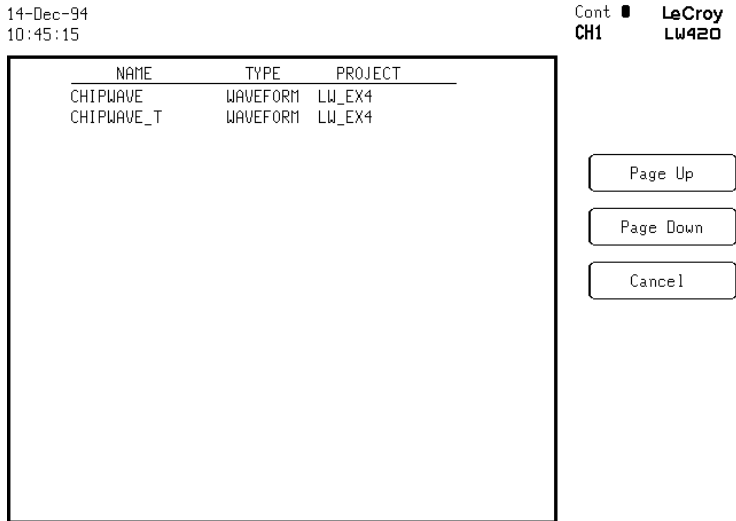

**Figure 18.4 File search results**



APPENDIX A

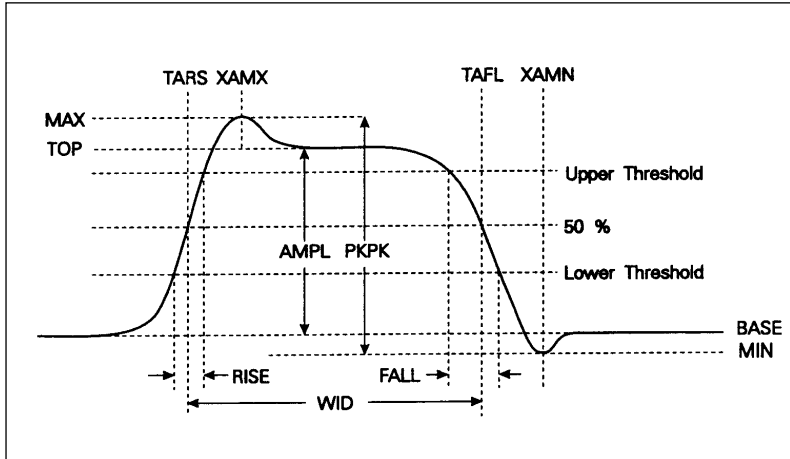

**Figure A-1**

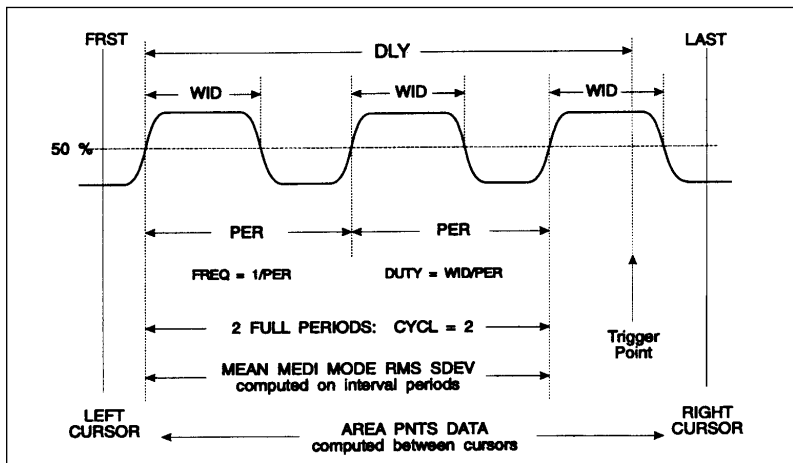

**Figure A-2**

## Appendix A

---

### Measurement Functions Description

#### Introduction

Waveform parameters supported by the LW400 are described in the following pages in alphabetical order. The description of each parameter follows the form shown below. If a section is not needed for a particular parameter, it is omitted.

#### Full Name

#### Abbreviated Name

---

- Description:** This section contains a brief description of the parameter. It is intended to convey the meaning and use of the parameter without getting into technical details.
- Definition:** This is a more technical description of the parameter than the one given above.
- Diagram:** Diagrams referenced by the current parameter are given here. At the end of the section on parameters, there is a single page containing diagrams which help to explain the definitions of the parameters.
- Restrictions:** This indicates conditions necessary for the computation of the parameter.
- Special Cases:** This describes situations in which the parameter may be computed differently depending on the data in the waveform.
- Units:** The units of the parameter are given here.
- Notes:** This section describes any unusual or unexpected behavior of the parameter. It may indicate the differences between this and related parameters.

---

**Fall Time**

**fall**

**Description:** Fall time measures the time between the 10% and 90% values on the falling edges of a waveform. The FALL times of each edge between the cursors are averaged to produce the final result.

**Definition:** Time at Lower Threshold - Time at Upper Threshold averaged over all falling edges.

**Diagram:** Figure A-1

**Restrictions:** The waveform is assumed to have two major levels. For signals in which this is not true, such as triangle or sawtooth waves, FALL may not give results.

**Units:** Seconds

## Appendix A

---

### Minimum Level

---

**min**

**Diagram:** Figure A-1

**Description:** MINIMUM LEVEL measures the lowest point in a waveform. MIN makes no such assumptions that the waveform has two basic levels.

**Definition:** Lowest value in the waveform between the cursors.

**Units:** Volts

---

**Maximum Level**

**max**

**Description:** MAXIMUM LEVEL measures the highest point in a waveform.

**Definition:** Highest value in the waveform between the cursors.

**Diagram:** Figure A-1

**Units:** Volts

## Appendix A

---

### Rise Time

---

rise

- Description:** Rise time measures the time between the 10% and 90% values on the rising edges of a waveform. The RISE times for each rising edge on the screen or between the cursors is averaged to produce the final result.
- Definition:** Time at Upper Threshold - Time at Lower Threshold averaged over each rising edge.
- Diagram:** Figure A-1
- Restrictions:** The waveform is assumed to have two major levels. For signals in which this is not true, such as triangle or sawtooth waves, RISE may not give predictable results.
- Units:** Seconds

---

**Width Positive**

**widp**

<b>Description:</b>	<p>The width of a cyclic signal is determined by examining 50% crossings in the input data. WIDTH POSITIVE searches for a rising edge after the left edge or left cursor. In this case, WIDTH is the time between adjacent rising and falling edges.</p> <p>The widths of all pulses in the waveform are averaged to produce the final result.</p>
<b>Definition:</b>	<p>Width of the first positive pulse, averaged for all similar pulses.</p>
<b>Diagram:</b>	<p>Figures A-1 and A-2</p>
<b>Units:</b>	<p>Seconds.</p>

## Appendix A

---

### Period

**per**

**Description:**

The period of a cyclic signal is measured as the time between every other pair of 50% crossings. Beginning with the first transition defined by the left edge of the graticule or, the left cursor, the period is measured for each pair of transitions. These values are averaged to produce the final result.

**Definition:**

Time between odd numbered 50% crossings beginning with the left most crossing between the cursors, averaged over all such pairs of crossings.

**Diagram:**

Figures A-2

**Units:**

Seconds.



## **LW400/LW400A/LW400B WaveStation Specifications**

### **Generator Mode**

#### **Standard Function Waveforms - 1 Hz Resolution**

Sine, 1 Hz - 100 MHz  
 Square, 1 Hz - 50 MHz  
 Triangle, 1 Hz - 25 MHz  
 Ramp, 1 Hz - 25 MHz  
 Pulse, (period)20 ns - max. memory  
 DC  
 Frequency Sweep Linear / Log  
 Multitone, 1-10 tones, 1 Hz - 100 MHz

### **Arbitrary Functions:**

#### **Waveform Creation**

Interactive Graphical editor on Internal 9" CRT

#### **Standard Functions**

Sine, Square, Triangle, Ramp, Pulse,  
 DC

#### **Equation Editor**

Waveform (array) Math  
 Waveform Import From  
 Digital Oscilloscope  
 Floppy Disk

#### **Waveform Feature Time Resolution:**

100 ps

#### **Available memory:**

256k/ch. standard, 1 Mpoint optional

#### **Minimum segment length:**

64 points

#### **Maximum segment length:**

Up to available memory (1Mpoint when optional memory installed)

#### **Segment length resolution:**

1 point

#### **Number of links:**

512 for 256k memory  
 2048 for 1M memory

### **Internal Noise Generator:**

#### **Available in LW400 and LW400A only**

Independent pseudorandom white noise generator with Gaussian distribution and  $2^{22}$  states

## Appendix B

### Waveform Output Characteristics

**Output channels:**

LW410/LW410A - 1 Channel  
LW420/LW420A - 2 Channel

**Output Impedance:**

50  $\Omega$  ,  $\pm$  5%

**DC Accuracy:**

$\pm$ (2% of setting +40 mV) for output > 500 mV peak-peak  
 $\pm$ (2% of setting +15 mV) for output  $\leq$  500 mV peak-peak

**Vertical resolution:**

8 bits

**Minimum output voltage:**

10 mV p-p into 50  $\Omega$

**Maximum output voltage:**

10 V p-p into 50  $\Omega$

**Offset voltage range:**

$\pm$  5 V into 50  $\Omega$ . The output voltage (signal + offset) must be in the range  $\pm$  5 V into 50  $\Omega$  .

**Offset voltage resolution:**

0.05% of full scale

**Output bandwidth:**

100 MHz (-3dB) (widest bandwidth)

**Total harmonic distortion:**

<5 V p-p <-45 dBc (-50 dBc typical)  
for sinusoidal output  $\leq$ 1MHz

<-35dBc

for sinusoidal output 1 MHz to 20 MHz (<-45 dBc typical)

<-25 dBc

to 50 MHz (<-40 dBc typical) (predominantly 2nd harmonic)

**Spurious & non-harmonic distortion:**

<-60 dBc for frequencies  $\leq$ 1 MHz for output

**Signal-to-noise ratio:**

>40 dB (-45 typical) for output amplitudes >100 mV @ 0 offset

**Transition times:** @ widest bandwidth with band limiting off

**LW400/LW400A/LW400B:** < 6 ns 10%- 90%

**LW400/LW400A/LW400B:** < 5 ns 10%- 90% @ widest bandwidth with band limiting off

**Overshoot and ringing:**

<8% of step size max. 3% typical

**Settling time:**

<50 ns to within 3% of step size @ widest bandwidth

**Inter-channel crosstalk:** <1%**Squarewave Symmetry:** < 6 ppm + 0.5 ns

**Pulse Generator Characteristics:**

Pulse repetition frequency(max): 50 MHz  
 Pulse repetition frequency(min):  
     Limited by Channel memory and clock speed  
 Frequency accuracy:  $\pm 3$  ppm over operating temperature range  
 Pulse width(max): Limited by channel memory and clock speed  
 Pulse width(min): 10 ns  
 Pulse width accuracy:  
      $\pm 3$  ppm + 0.5 ns for widths > 2x the risetime  
 Pulse delay Characteristics:  
     Same as trigger delay with the following exception.  
     pulse time delay resolution = 1 ns

**Ch 1 to Ch 2 skew:**

<1 ns for identical waveforms in each channel (widest bw)



**Output protection:**

$\pm 20$  V

**Output filtering:**

The following filter cutoff frequencies will be available;  
 100 MHz Gaussian, 10 MHz Gaussian, 1 MHz Gaussian, 100 kHz Gaussian, 10 kHz Gaussian

**Sample clock characteristics:**

(with internal 10 MHz reference)

**Maximum sample rate:**

400 MS/second

**Accuracy:**

$\pm 3$  ppm over operating temperature range

**Stability:**

Aging <1 ppm/year

**SSB Phase Noise:**

**LW410/LW420:** <-95 (-100 typical) dBc/Hz @ 10 KHz  
     offset for a 10 MHz sine wave at output

**LW410A/LW420A:** <-90 dBc/Hz @ 10 KHz offset for a 10 MHz sine wave at output

**Resolution:** 1 Hz

**Variable Clock**

**LW400A and LW400B series only**

Variable over range of 6 KHz to 400 MHz

## Appendix B

### Triggering Characteristics



Trigger slope:	Positive or Negative
Trigger input impedance:	$50 \Omega \pm 5\%$
Threshold range:	$\pm 2.5V$
Threshold resolution:	20 mV
Threshold accuracy:	$\pm 100 \text{ mV}$
Threshold sensitivity:	50 mV minimum p-p
Minimum pulse width:	$\leq 5 \text{ ns}$
Protection:	$\pm 5 \text{ V}$

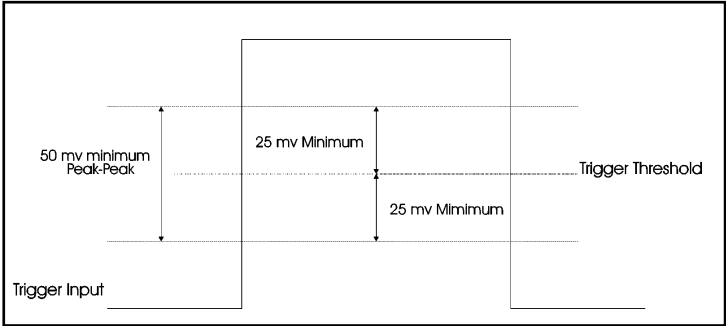

### Trigger Modes

Continuous:

Runs continuously

Single:

Outputs 1 repetition of the waveform for each trigger received. Triggers received while the waveform is still running are ignored.

Burst:

Outputs the selected waveform a programmable number of times in response to a trigger. The maximum number of repetitions for a burst is 4,096. Triggers received while the burst is running are ignored.

Gated:

The waveform starts on the leading edge of the gate signal and stops on completion of the waveform cycle occurring at the trailing edge of the gate signal.

**Trigger Delay**

Minimum(min) delay time:

35 ns  $\pm$ 3.5 ns +5 sample clocks

Maximum delay time:

( $2^{32}-1$ ) sample clocks

Delay resolution:

1 sample clock. The delay will be programmed in units of seconds. When operating from the front panel the resolution (sample clock period) will be shown to the user and the delay will change in increments of that value.

Delay accuracy:

$\pm$  (0.0003% x programmed value)+min delay time+delay jitter

Note: The min delay time is a fixed value for each instrument at the selected sample clock rate. Considering this fact, the time delay at a specific sample clock rate can be measured and used to offset the programmed value to obtain the desired time delay.

offset programmed value = desired value - measured delay

In this case the delay accuracy is:

$\pm$  (0.0003% x offset programmed value)+delay jitter

Delay jitter:

1 sample clock

**Trigger Sources**

Manual:

Front panel pushbutton

External:

Front panel BNC connector

GPIB:

A trigger command may be issued over the GPIB bus

## Appendix B

---

### Auxiliary Inputs



**External 10 MHz reference:** A rear panel input is provided that allows an external reference clock to be input. 400 mV p-p to 5 V p-p into 50  $\Omega$ .

**Noise Input:**  $\pm 500$  mV maximum into 50  $\Omega$ .

### Auxiliary Outputs



**10 MHz reference output:**

Frequency accuracy:  $\pm 3$  ppm

Amplitude (high):  $\geq 1.6$  v into 50  $\Omega$

Amplitude (low):  $\leq 0.2$  v into 50  $\Omega$

**Timing marker:**

1 bit of memory up to 128 transitions definable

Output levels:

ECL or TTL levels

Protection:

Outputs are protected to  $\pm 5$  V

**Digital Output:**

Channel 1 only, 8 bits and clock available from rear panel.

TTL/ECL logic levels simultaneously.

**Noise In/Out:** From rear panel BNC Connectors

### Hard Copy Outputs

Supported Printers include:

Epson MX/FX

Epson LQ

HP LaserJet II

HP ThinkJet

### Programmability

GPIB IEEE 488.2 compatible. Compliant with SCPI programming language. Capable of initiating and controlling waveform transfer from digital oscilloscopes by simply connecting a GPIB cable (no computer required).

**General**



**Temperature:**

5° C to 35° C full specifications;  
0° C to 40° C operating;  
-20° C to 70° C non-operating.

**Humidity:**

10% to 80% relative, non-condensing

**Altitude:**

< 2000 Meters (6560 ft)

**Power:**

90 - 132/180-250 V AC  
47 - 63 Hz  
4 amps @ 115 V AC (20 amps cold start surge)  
2 amps @ 230 V AC (40 amps cold start surge)

The power supply is internally protected against short circuit and overload by means of a single T5.0A/250 V  $\sim$  fuse, which is not replaceable by the user.

**Dimensions (HWD):**

7.67, 14.92, 19.58 (inches)  
19.5, 37.9, 49.7 (cm)

**Weight:**

27.6 lbs (12.5 kilograms)

**Warranty:** One year

**Calibration Interval:** Annually

## Appendix B

---

### **CE Certifications:** CE, UL and cUL

The Wavestation meets requirements of the EMC Directive 89/336/EEC for Electromagnetic Compatibility and Low Voltage Directive 73/23/EEC for Product Safety. See "Declaration of Conformity" certificate for details.

***Warning: This is a Class A product. In a domestic environment this product may cause radio interference, in which case the user may be required to take adequate measures.***

### **UL and cUL Certifications:**

UL Standard: UL 3111-1

Canadian Standard: CSA-C22.2 No. 1010.1-92