

LAG-125
LOW DISTORTION
AUDIO GENERATOR

INSTRUCTION MANUAL



CONTENTS

SECTION		PAGE
1	GENERAL DESCRIPTION	
1.1	Uses	2
1.2	Specifications	2
1.3	Control Functions	3
	1.3.1 Front Panel	3
	1.3.2 Rear Panel	4
2	OPERATION	
2.1	Preliminary Notes	5
2.2	Output Connections	5
2.3	Interconnections	5
2.4	Sine Wave Output	6
	2.4.1 Input/Output Characteristics	6
	2.4.2 Output Meter Readings	6
	2.4.3 Frequency Response	7
	2.4.4 Harmonic Distortion Measurements	8
2.5	Square Wave Output	9
2.6	Burst Output Signals	10
	2.6.1 General	10
	2.6.2 Loudspeaker Testing	11
	2.6.3 Amplifier Testing	12
2.7	Use of the SYNC Connection	13
2.8	Notes on Output Connections	14
3	MAINTENANCE	
3.1	Fuse Replacement	14
3.2	Exposing the Chassis	14
3.3	AC Input Connections	15
3.4	Location of Adjusters	16

FUNCTIONAL BLOCK DIAGRAM

SCHEMATICS

1. GENERAL DESCRIPTION

1.1 Uses

The LAG-125 is particularly designed for measurements and tests of audio and supersonic equipment and circuits. The three different types of output signals will find many applications in testing high fidelity amplifiers, filter networks, and loudspeakers.

FEATURES

- * Wide frequency range, 10Hz to 1MHz, with flat output response.
- * Low distortion sine wave output.
- * Clean-cut square waves for transient response testing and triggering pulse generators.
- * Burst type signals for loudspeaker testing.
- * Calibrated attenuator, and voltmeter for accurate output control.
- * Pushbutton frequency ranging.
- * Frequency synchronization possible from external source.
- * Tilt-up stand for easy operation.

1.2 Specifications

Frequency Range	10Hz – 1MHz in 5 decade ranges.
Frequency Accuracy	Within 3% of dial marking.
Output Functions	
Sine Wave	Output voltage: 3Vrms into 600Ω. Distortion: 0.03% : 500Hz – 20kHz 0.1% : 100Hz – 100kHz 0.5% : 50Hz – 500kHz 1% : 10Hz – 1MHz
Square Wave	Output voltage: 3Vp-p into 600Ω. Overshoot: 2% at maximum output. Sag: 5% at 10Hz. Rise Time: 0.15μs (0.45μs at floating output.)
Burst Signal	Output Voltage: 1.5Vp-p into 600Ω. Gating: 4 cycles at 4 and 12 cycle intervals; 8 cycles at 8 cycle interval. Leakage: Within 2% during off interval at 20kHz.
Frequency Synchronization	
Control	Approx. ±0.5% per volt rms.
Output Data	
Output Impedance	600Ω ±3%; unbalanced and floating.
Response	Flat within ±0.3dB into 600Ω at unbalanced output; to 100kHz at floating output.

Output Control	Total range: -50 to $+10\text{dBm}$ ($2.45\text{mV} - 3.1\text{Vrms}$) with 10dB step attenuator and fine adjuster.
Output Meter	Voltage range: $0 - 1$ and $0 - 3\text{Vrms}$. Decibel range: -10 to $+2\text{dB}$ ($0\text{dB} = 0.775\text{V}$) Accuracy within $\pm 5\%$ f.s.
Power Supply	100, 115 or 230V, as specified, 50/60Hz; approx. 12VA.
Size and Weight	$165(\text{H}) \times 205(\text{W}) \times 250(\text{D})$ mm $6\frac{1}{2}(\text{H}) \times 8(\text{W}) \times 9\frac{7}{8}(\text{D})$ IN approx. 5.5kg. 12.1 LBS.
Accessory, furnished	Output cord, w/plugs and clips 1 ea.

1.3 Control Functions

1.3.1 FRONT PANEL, FIG. 1-1.

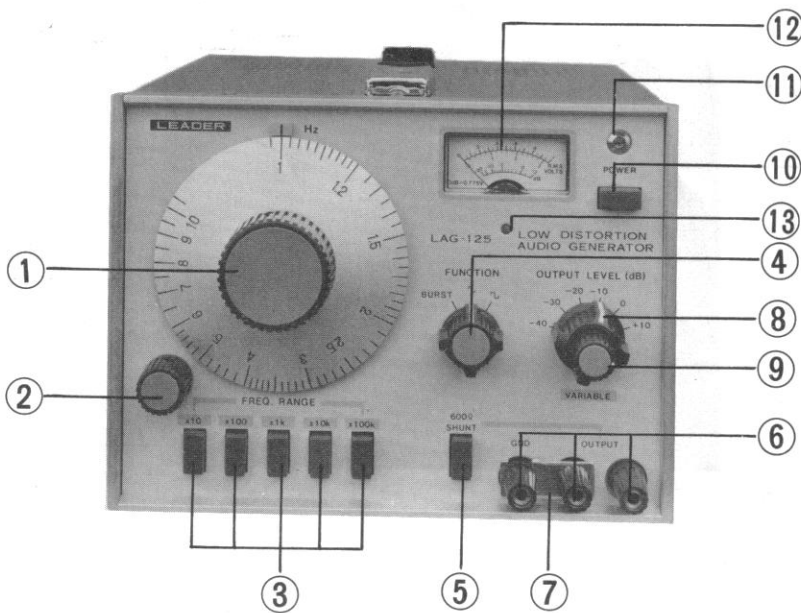

Fig. 1-1 Front panel.

- (1) Frequency dial: Calibrated in Hz, 1 to 10; actual output frequency depends on the setting of the range selector.
- (2) Fine frequency adjuster.
- (3) FREQUENCY RANGE selector: Set the range multiplier for dial markings.
- (4) FUNCTION switch: Selects the type of output signals, sine wave, square wave, and burst [see (14)]

- (5) 600Ω SHUNT switch: Connects a 600Ω load resistor across the output.
- (6) OUTPUT terminals: Black at left is for chassis ground; black at middle is the low potential side of the output; red is the high potential side of the output.
- (7) Shorting link: Connected across the black terminals at the unbalanced output condition (not used when floating output is required).
- (8) OUTPUT LEVEL switch: Adjusts the output in 10dB steps.
- (9) VARIABLE control: For fine adjustment of the output between the 10dB steps.
- (10) POWER switch: Push-push type for turning on the AC power.
- (11) Pilot lamp: Indicates when the power is on.
- (12) Output meter: Calibrated in rms volts with two scales, and dBm (OdB = 0.775V).
- (13) Mechanical zero adjuster for the meter.

1.3.2 REAR PANEL, FIG. 1-2.

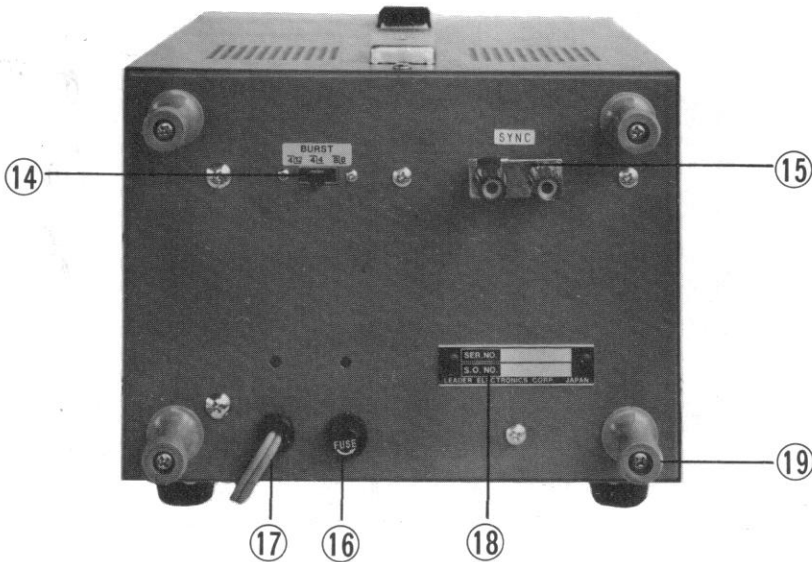

Fig. 1-2 Rear panel functions.

- (14) BURST signal selector: Set the mode of the burst output signals.
- (15) SYNC terminals: For connection to an external frequency synchronizing source.
- (16) FUSE holder: For the AC line fuse.
- (17) AC input cord.
- (18) Label.
- (19) AC cord hooks.

2. OPERATION

2.1 Preliminary Notes

1. When the output is connected to a circuit in which DC voltage is present, always connect a blocking capacitor in series with the "hot" lead. This is to prevent damage to the output circuit. The capacitor should have low reactance at the test frequency and suitable voltage rating.
2. Use short leads for connections. The cord supplied will introduce a loss of less than 0.2dB at 1MHz. A long shielded cable will degrade the high frequency characteristics.
3. When the "floating" output connection is used, the frequency response of $\pm 0.3\text{dB}$ is applicable only up to 100kHz. Further, the square wave rise time will be increased to $0.45\mu\text{s}$ maximum.

2.2 Output Connections

1. Unbalanced:

Connect the shorting link across the two black terminals. Insert the cord lead plugs - black to black and red to red respectively.

The black lead should be used on the ground side on the chassis of the test circuit.

2. Floating:

Remove the shorting link on the black terminals.

Use the middle black terminal and red terminal for the output. If required, connect a lead between the left black terminal and ground side of the chassis.

2.3 Interconnections

The basic interconnections are shown in Fig. 2-1.

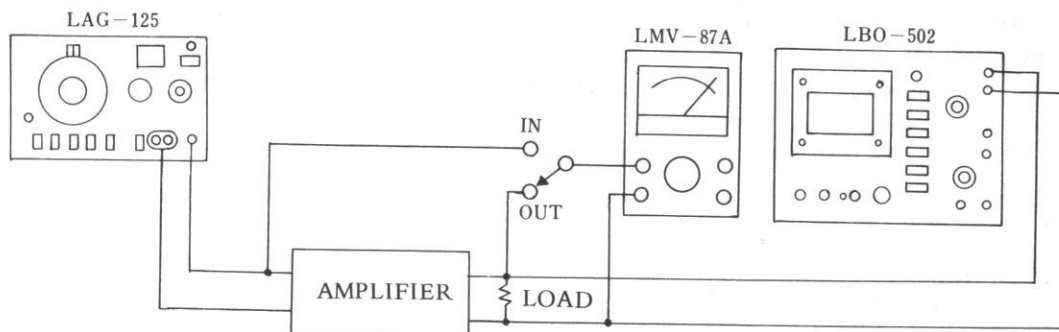

Fig. 2-1 Basic interconnections.

The specified load resistance, R , is connected across the output of the test circuit. It should be non-inductive and have a wattage rating at least twice the expected maximum power output.

In measuring the input/output voltages, an electronic voltmeter is required. The Leader LMV-87A is recommended for the purpose.

An oscilloscope is required when measuring with use of square waves or burst signals. The Leader LBO-301, or LBO-502, is most suited.

2.4 Sine Wave Output

In most amplifier measurements, sine wave signals are used. In this section, typical uses will be described.

2.4.1 INPUT/OUTPUT CHARACTERISTIC

Control settings:

POWER switch at on.

FUNCTION at sine wave.

FREQ RANGE at x1k and dial at "1" for 1kHz.

OUTPUT LEVEL, initially at 40 and fine adjuster set fully counterclockwise.

600Ω SHUNT switch at released position.

The input voltage to the amplifier is gradually increased by advancing the VARIABLE control and lowering the attenuation with the switch towards 0dB. The amplifier output will increase as the input voltage is raised.

When the amplifier is overloaded, there will be no apparent increase in the output and waveform distortion will be observed, i.e., flattening of one or both peaks of the trace.

By noting the input and output voltages, these values are plotted on log-log paper. In this manner, the input voltage range of the amplifier can be easily determined.

When the ration E_{out}/E_{in} is calculated, the voltage gain is given as follows:

$$\text{VOLTAGE GAIN in dB} = 20 \log \frac{E_{out}}{E_{in}}$$

Reference should be made to a decibel table for the dB figures.

The results for voltage gain in dB can be plotted on semi-log paper, using the X-axis for E_{in} and Y-axis for dB.

The power output is calculated from the relation -

$$\text{POWER OUTPUT, } P_o \text{ in WATTS} = \frac{E_{out}^2 \text{ (volts)}}{R \text{ (ohms)}}$$

2.4.2 OUTPUT METER READINGS

The output meter is calibrated to indicate the dB level, or voltage, only at the sine wave function into a 600Ω load.

The range depends on the setting of the OUTPUT LEVEL switch. Other data are shown in the table below.

OUTPUT METER RANGES

OUTPUT LEVEL SETTING	VARIABLE dB RANGE	VARIABLE VOLTAGE RANGE	METER SCALE
+10	0 to +12	0.775 – 3.1 V _{rms}	0 – 3
0	-10 to +2	0.245 – 1.0	0 – 1
-10	-20 to -8	0.0775 – 0.31	0 – 3
-20	-30 to -18	0.0245 – 0.10	0 – 1
-30	-40 to -28	0.00775 – 0.031 (7.75mV – 31mV)	0 – 3
-40	-50 to -38	0.00245 – 0.010 (2.45mV – 10mV)	0 – 1

- NOTES: a. At the +10dB setting, the pointer will go off scale when the load is greater than 600Ω.
- b. For corrections when the load is different than 600Ω, refer to Section 2.8.

2.4.3 FREQUENCY RESPONSE

The frequency response of an amplifier is determined by applying a constant voltage to the amplifier. This voltage is chosen so that the amplifier is operated below the overload point.

Set the reference frequency at 1kHz, or 400Hz, and set the output controls for a suitable output from the amplifier.

Note the input and output voltages.

Set the measuring frequencies with the FREQ RANGE switch and dial to 10Hz, or higher if required.

Since the generator output is practically constant at all frequencies, the input voltage will not require any adjustment. However for the highest accuracy, the input at each frequency can be adjusted to the predetermined value.

The output readings can be simplified by noting the output level in dB at the reference frequency (1kHz or 400Hz). Then at each frequency the dB indication is noted and used in plotting the response curve. (NOTE: Disregard the 0dBm - 0.775V, etc. in this case. The dB readings can be read directly since the voltmeter is connected across a constant impedance.)

The dB readings are added or subtracted from the 1kHz reference level.

Example: Let "dB" at 1kHz - -2dB. Assume that the measured values are as in (A) in the following data.

FREQ (Hz)	20	60	200	600	1K	2K	6K	20K
(A) dB measured	-6	-5	-2	-2	-2	-2	-1	-6
(B) dB	-4	-3	0	0	0	0	+1	-4

The dB figures for (B) are used in plotting on semilog graph paper with the X-axis for frequency and Y-axis for the relative response in dB.

2.4.4 HARMONIC DISTORTION MEASUREMENTS

The low output distortion characteristics of the LAG-125 make it possible to measure the distortion in audio amplifiers.

For the measurements, a harmonic distortion meter, such as the LEADER LDM-170 and a sensitive scope are required. The interconnections are shown in Fig. 2-2.

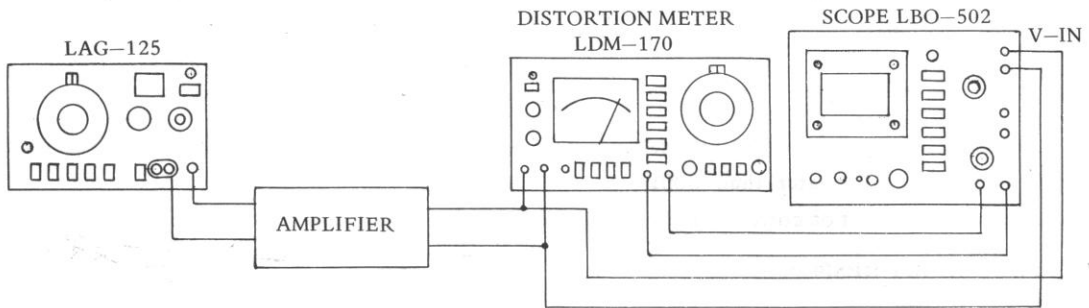

Fig. 2-2 Harmonic distortion measurement.

Connections: SCOPE output of the distortion meter to the horizontal scope input.

Test amplifier output to the distortion meter and also to vertical scope input.

With these connections, the scope will display the lissajous patterns for monitoring the amplifier output. It will be possible to discriminate between the waveform distortion and the noise components. Some examples of the display are shown in Fig. 2-3.

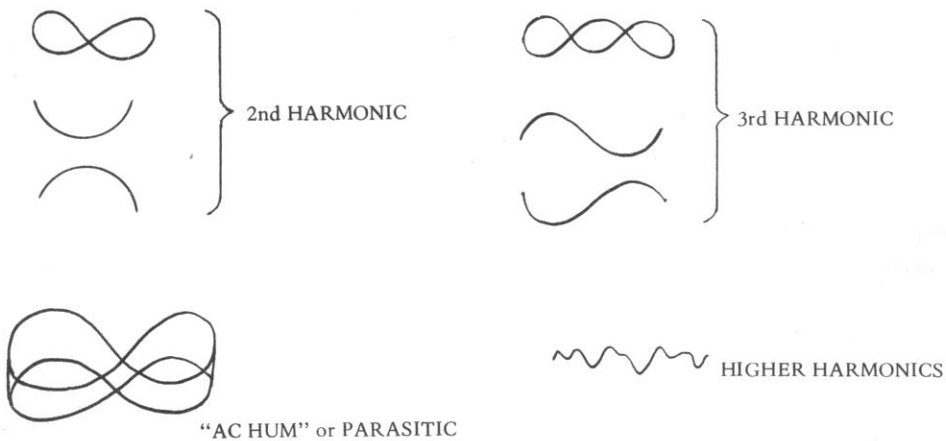

Fig. 2-3 Lissajous patterns.

For accuracy in measurements, especially at low values, it is necessary at the test frequencies and output levels to measure and note the distortion in the LAG-125 signal. This step is required since the distortion meter indicates the total distortion, i.e., amplifier and oscillator outputs.

The distortion is then measured on the meter and noted. The actual amplifier distortion is calculated from the relation -

$$D_A = \sqrt{D_M^2 - D_{OSC}^2} \quad (1)$$

where D_A = Amplifier distortion in %

D_M = Distortion meter indication in %

D_{OSC} = Oscillator distortion in %

In simplified form, (1) may be expressed by -

$$D_A = D_M \sqrt{1 - \left(\frac{D_{OSC}}{D_M}\right)^2} = D_M K \quad (2)$$

The factor, K, for (2) is listed for convenience in the following table.

FACTOR "K" for (2)

D_{OSC}/D_M	K	D_{OSC}/D_M	K
0.90	0.436	0.60	0.80
.85	.526	.50	.866
.80	.60	.40	.916
.75	.661	.30	.954
.70	.714	.20	.978
.65	.758	.10	.995

In general, when the oscillator distortion is less than 1/5 of the amplifier distortion, the meter indication can be used without correction.

2.5 Square Wave Output

Square wave signals are useful in the rough determination of response characteristics of amplifiers at the high and low frequency ends, and also response to signals with fast rise time.

The interconnections are identical with those for sine wave operation with the following exceptions:

FUNCTION switch at square wave.

Use of a good scope, i.e., with fast rise time.

The chart given below shows the waveforms at the amplifier output under different conditions.







NOTES: Output voltage settings are initially made with the OUTPUT LEVEL

adjustments (switch and meter indication) and the FUNCTION switch set at the sine wave position.

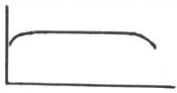
The indicated value will be equal to the peak-to-peak output voltage.

The FUNCTION switch is then set at the square wave position. Disregard the panel meter reading.

If in doubt, check the p-p output voltage with a calibrated scope.

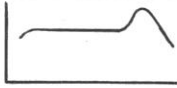
Waveshape	Amplifier Response	Condition
RECTANGULAR 	 FLAT	SATISFACTORY
DROOPING 	 DEFICIENT LOW FREQUENCIES	LOW PRIMARY INDUCTANCE IN OUTPUT TRANSFORMER; INCORRECT VALUES OF THE COUPLING ELEMENTS
PEAKED 	 DEFICIENT HIGH FREQUENCIES	HIGH LEAKAGE INDUCTANCE IN OUTPUT TRANSFORMER OR HIGH DISTRIBUTED CAPACITANCE IN CIRCUIT
RIPPLE 	 RINGING AT HIGH FREQUENCY	MALADJUSTMENT IN THE NEGATIVE FEEDBACK CIRCUIT; INCORRECT CONSTANTS; INSTABILITY

For an amplifier with good characteristics, the response will be flat up to about the 11th harmonic as indicated with sharp square wave displays. As an example, if a 1kHz square wave is reproduced without distortion, the amplifier response is flat to about 11kHz.

NOTES:

- It is advisable to check the input waveform on a scope before application.
- The rise time of the "floating" output connection is 450 μ s maximum.
- Connection from the SYNC output terminals to the scope time base synchronizing input will make adjustments easier when displaying waveforms.

2.6 Burst Output Signals

2.6.1 GENERAL

Three types of the burst signals are available, depending on the setting of the signal selector on the rear panel. The modes are shown in Fig. 2-4.

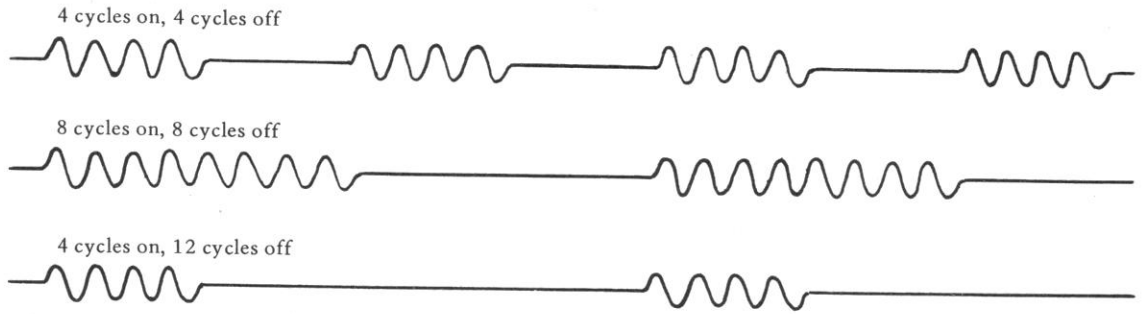

Fig. 2-4 Burst signals.

As shown in Fig. 2-4, the output signal is applied during the on condition and blanked during the off period. The type to be used depends on the application; examples are given below.

NOTES: Output voltage settings are initially made with the OUTPUT LEVEL adjustments (switch and meter indication) and the FUNCTION switch set at sine wave.

When the FUNCTION switch is set at BURST, the actual output (sine wave signal) will be approximately 1/5 of the original setting. Disregard the meter reading.

If in doubt, check the peak-to-peak voltage of the waveform, using a calibrated scope. (Multiply the Vp-p by 0.353 for the rms volt).

2.6.2 LOUDSPEAKER TESTING

Loudspeakers can be tested with the burst signals for their operating characteristics.

The frequency response, cone-support system effects, and other important data can be determined by noting the changes in the output waveforms.

Furthermore, the relationship between the motional and the "static" impedances can be observed. When the loudspeaker is driven with a high impedance source, (a mismatched condition), inefficient damping will be shown by the appearance of spurious waveforms during the off period.

Interconnections for testing are shown in Fig. 2-5.

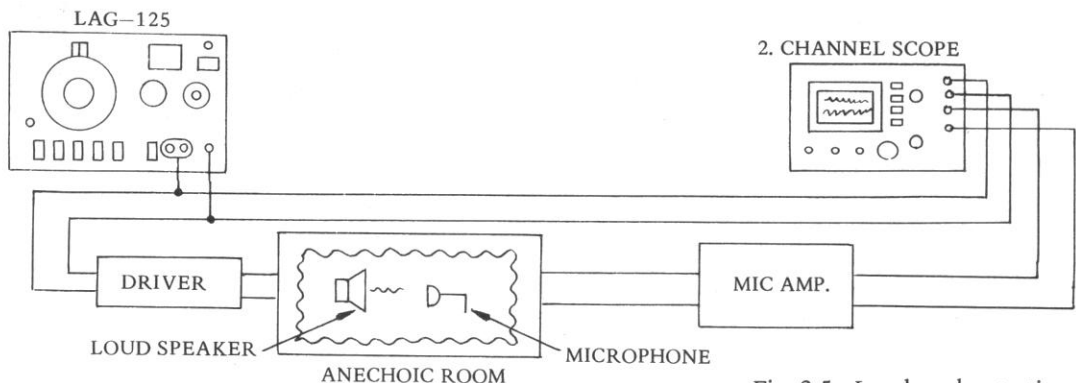
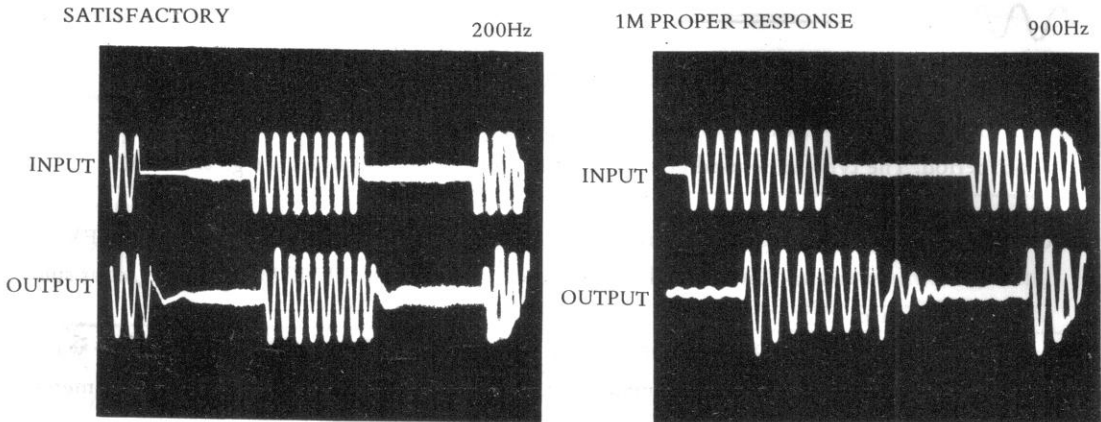

Fig. 2-5 Loudspeaker testing.

A 2-channel scope is most suitable for testing, since the input and output waveforms can be readily compared.

The FUNCTION SWITCH IS SET AT BURST and the type of the signal to be applied is selected by the rear panel switch.

Examples are shown below for use of the test burst signals.



2.6.3 AMPLIFIER TESTING

Generally audio amplifiers have excellent transient characteristics and will not exhibit the same results as loudspeakers. However, burst signals can be used to check amplifier frequency response.

The tests are made with use of a 2-channel scope; the interconnections are shown in Fig. 2-6.

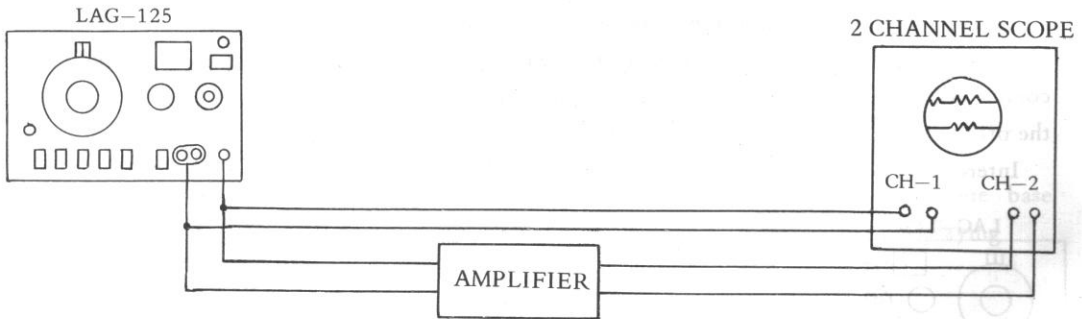





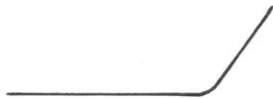

Fig. 2-6 Amplifier testing with burst signals.

The change in the waveshape at the trailing end of the on cycle is observed. The waveshapes and the amplifier conditions are shown in the table below for the 4-on and 4-off signal.

WAVESHAPE	CONDITION	RESPONSE
(1) 	SATIS FACTORY	
(2) 	DEFICIENT LOW FREQUENCIES	
(3) 	DEFICIENT HIGH FREQUENCIES	

It may be added that checks can be made on circuits with time-constant properties. Waveshapes (2) and (3) respectively denote leading and lagging characteristics.

2.7 Use of the SYNC Connection

A. General:

The sync connections, on the rear panel, can be used in several applications as described below. The "input" or "output" impedance is approximately $70k\Omega$.

PRECAUTION

When using the SYNC feature, it is important that the generator output be in the unbalanced condition, i.e.; the two black terminals are shorted. This will prevent instability and other undesirable effects.

B. Control from an external source:

The oscillator frequency can be synchronized with an accurate source over a range of $\pm 0.5\%$ per rms volt input. The control voltage should not exceed $5V_{rms}$ to avoid output distortion.

For example, when the oscillator is set at some point between 995 and 1005Hz, and a signal of exactly 1000Hz is applied, the oscillator will be automatically locked in at 1000Hz. Thus, high accuracy can be achieved with the use of a precision frequency standard.

In another application, a distorted waveform can be "purified", or filtered, by passing it through the oscillator.

C. The SYNC output voltage, approximately $1.5V_{rms}$, should be sufficient to synchronize or trigger the sweep in a scope or to operate a frequency counter. The voltage is not affected by the settings of the output level controls.

2.8 Notes on Output Connections

The output circuit is designed to work into a 600Ω load; level and voltage calibrations are made on this basis.

When the load is higher or lower, the use of a matching pad or transformer is advised.

For loads higher than 600Ω , set the 600Ω SHUNT switch at on. This will prevent the meter from going off-scale at the maximum output condition, i.e., switch at +10 and the adjuster at full clockwise. (The output impedance will be lowered to 300Ω).

For low-power low-impedance circuits, connect a resistor in series with the load to make the total impedance 600Ω .

When testing stereo circuits, equal voltage to two input circuits can be applied with use of a matching pad as shown in Fig. 2-7.

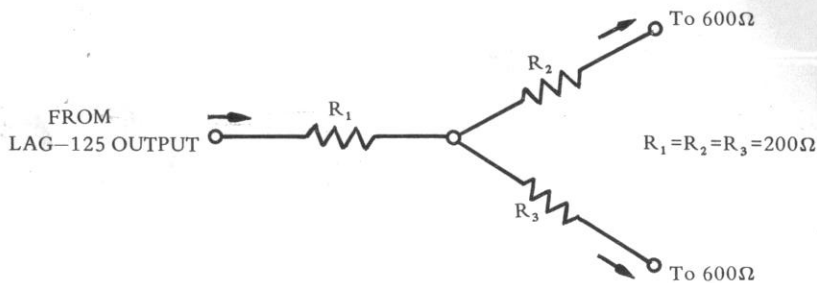

Fig. 2-7 Stereo input pad.

The voltage across the 600Ω loads will be one-half that of the input voltage, or lower by 6dB.

3 MAINTENANCE

3.1 Fuse Replacement

When replacing the AC line fuse (at rear of the case), make certain that the proper rating is used as given below:

<u>LINE VOLTAGE</u>	<u>FUSE RATING</u>
100 - 120	0.5A
200 - 240	0.3A

3.2 Exposing the Chassis

The top and bottom covers are taken off by removing the screws as shown in Fig. 3-1.

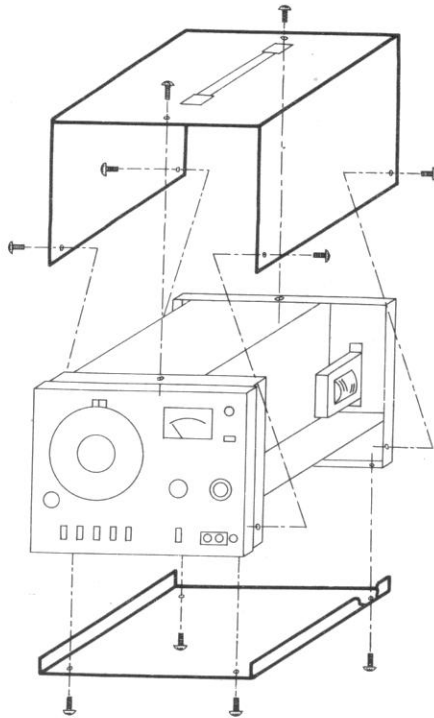

Fig. 3-1 Exposing the chassis

3.3 AC Input Connections

The AC power transformer input is for operation at the voltage initially specified. When changes are to be made, refer to Fig. 3-2.

The transformer is located at the rear of the chassis.

Note that the pilot lamp and series resistor are connected across the 100V terminals.

A) 100V input

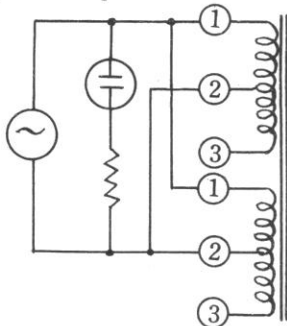

B) 115V input

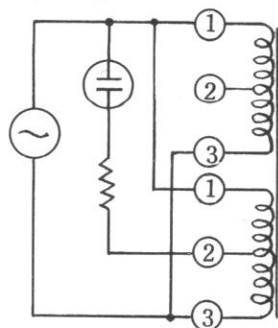

C) 200V input

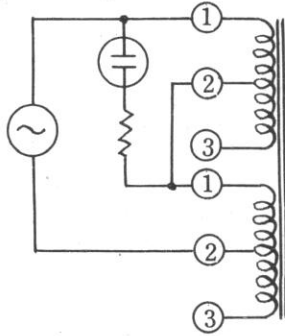

D) 230V input

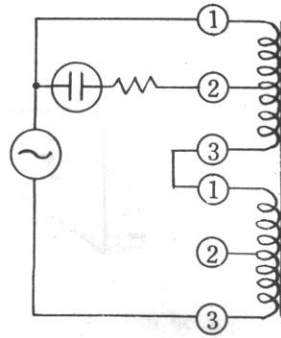
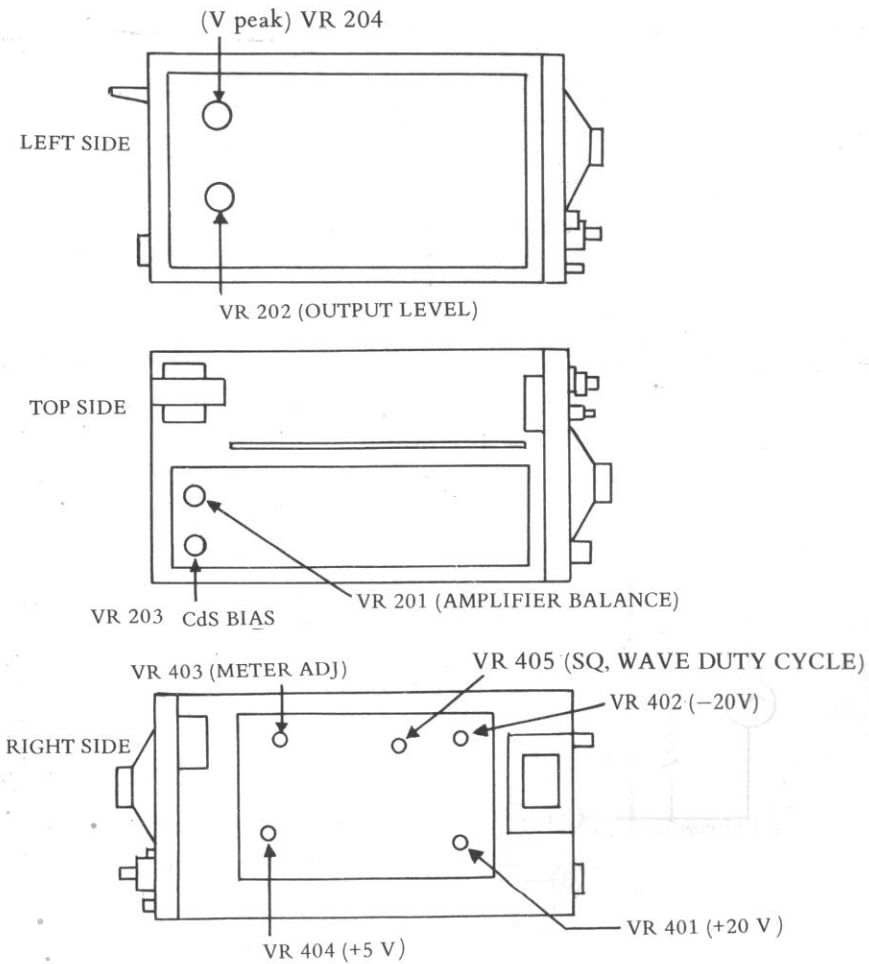
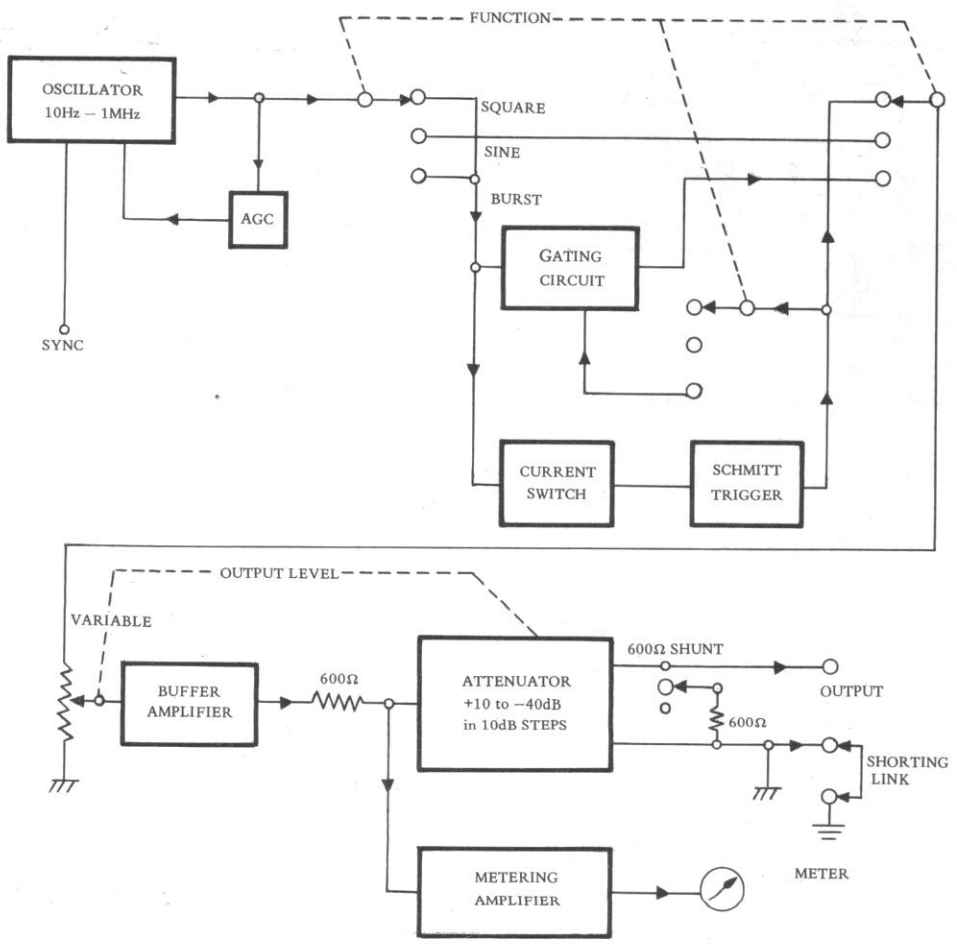
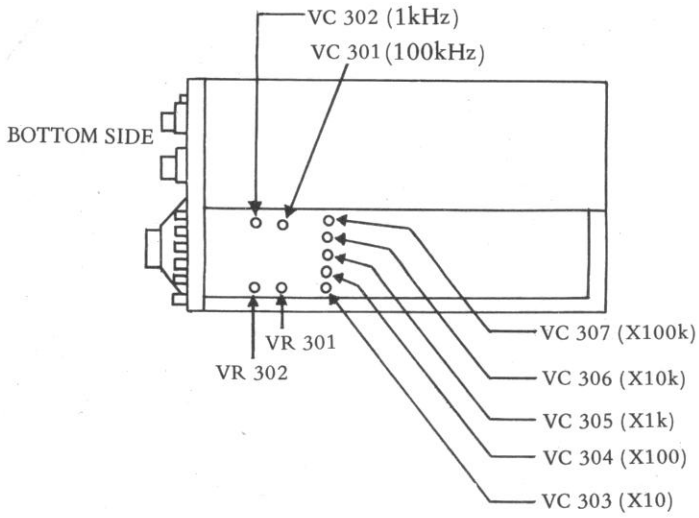
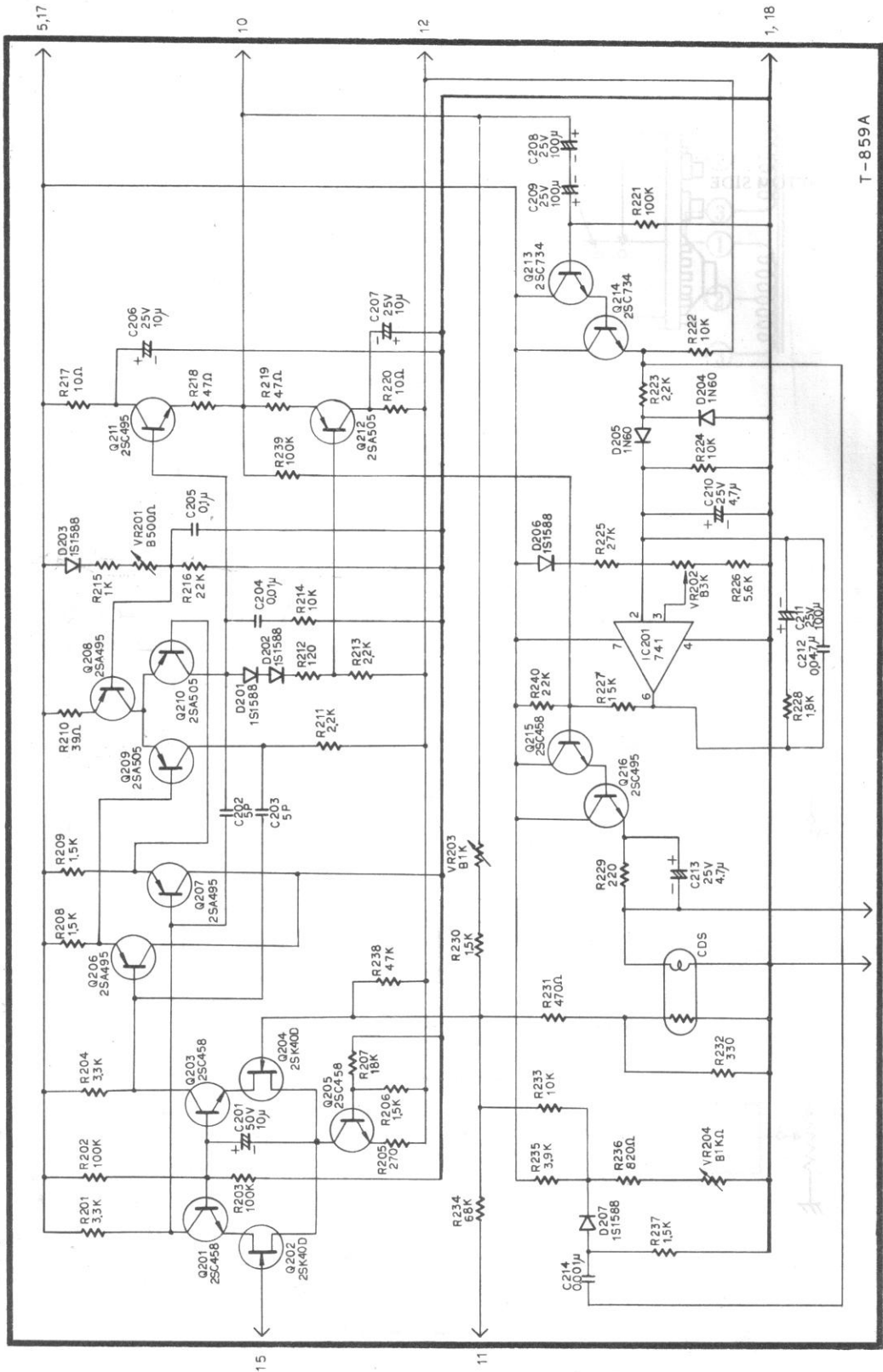

Fig. 3-2 AC input connections.

3.4 Location of Adjusters







SCHEMATIC	Model	LAG 125	0-816	1/3
OSCAMP & AGC	AUDIO GENERATOR	LEADER ELECTRONICS CORP.		

T-859A

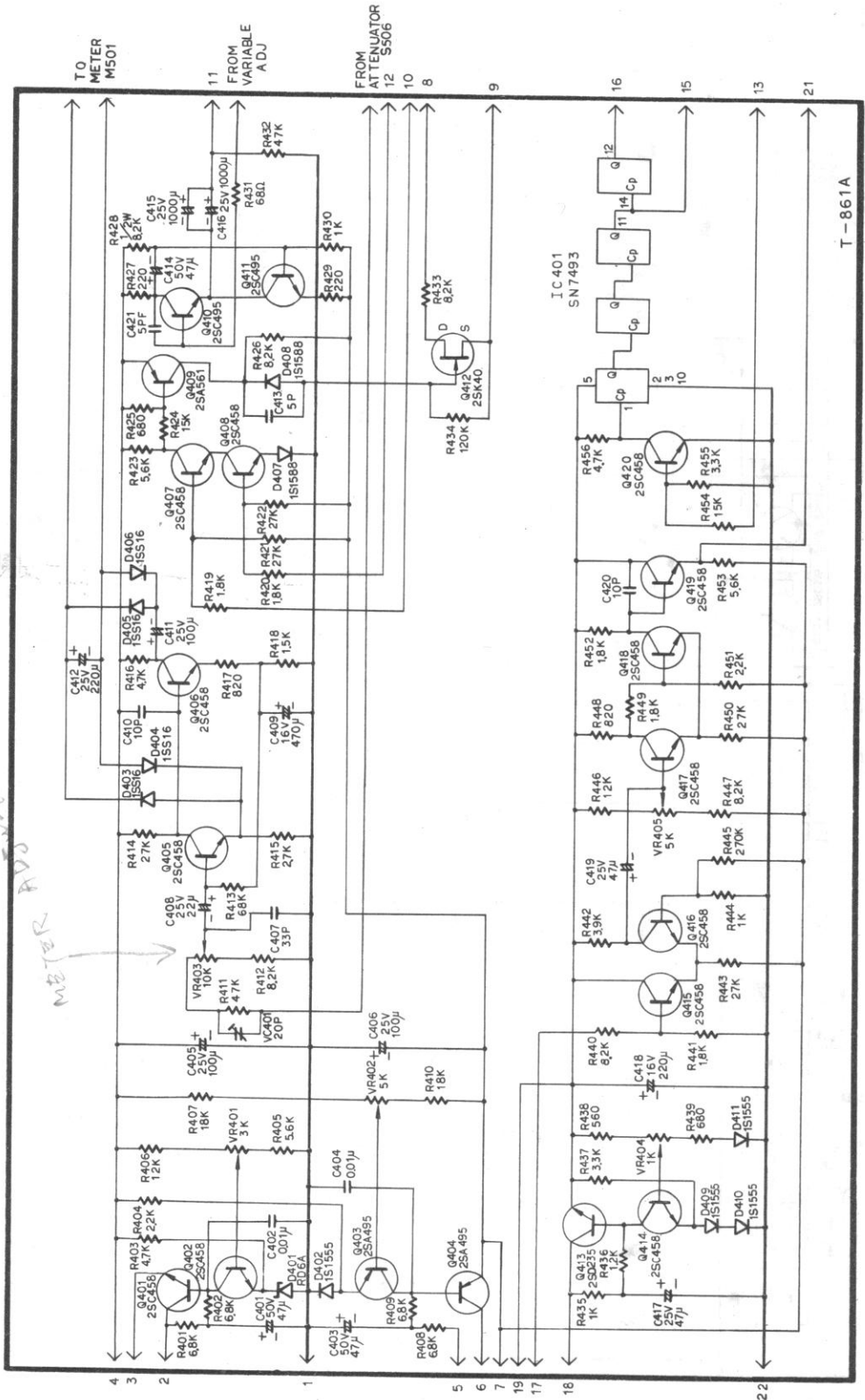

SCHEMATIC	Model	LAG 125	0-816	2/3
MAIN	AUDIO GENERATOR	LEADER ELECTRONICS CORP.		

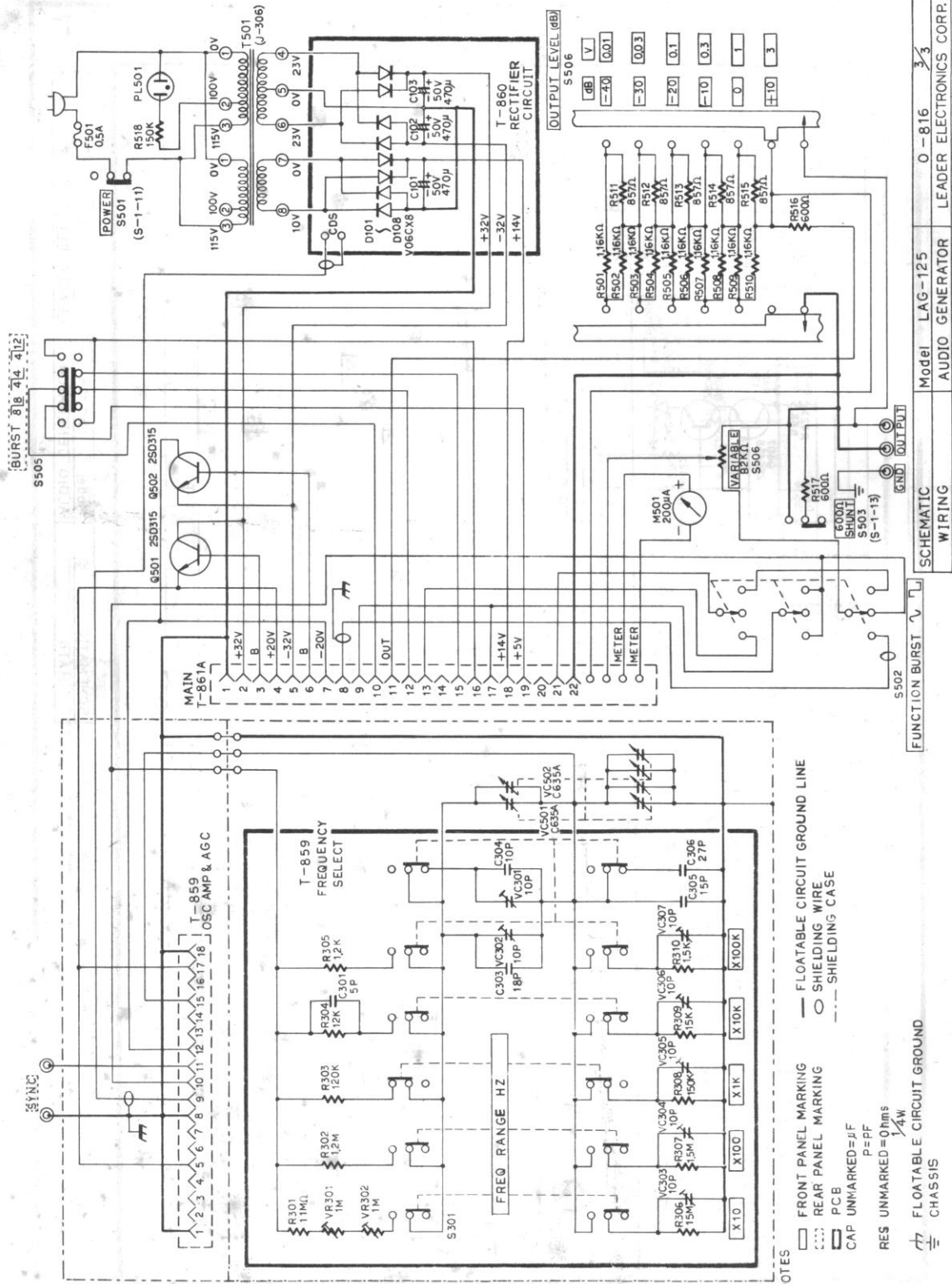

- NOTES
- FRONT PANEL MARKING
 - REAR PANEL MARKING
 - FLOATABLE CIRCUIT GROUND LINE
 - SHIELDING WIRE
 - SHIELDING CASE
 - PCB
 - CAP UNMARKED=10P
 - RES UNMARKED=0rms
 - P=PF
 - 1/4W
 - FLOATABLE CIRCUIT GROUND
 - CHASSIS

SCHEMATIC	Model	LAG-125	0-816	3/3
WIRING	AUDIO GENERATOR	LEADER ELECTRONICS CORP.		

LEADER ELECTRONICS CORP.

2-6-33 TSUNASHIMA HIGASHI, KOHOKU-KU,
YOKOHAMA, JAPAN.

LEADER INSTRUMENTS CORP.

151 DUPONT ST.
PLAINVIEW, N.Y. 11803 U.S.A
TELEPHONE (516) 822-9300