

## WARNING

HIGH VOLTAGE is used in the operation of this equipment. DEATH ON CONTACT may result if personnel fail to observe safety precautions. Know the areas in this equipment containing high voltage. Be careful not to come in contact with the high voltage connections during operation of this equipment.

Do not be misled by the term "Low Voltage." Potentials as low as 25 volts may cause death under adverse conditions.

## WARNING

FLAMMABLE SOLVENTS are used in the maintenance of this equipment. Adequate ventilation should be provided while using isopropyl alcohol. Prolonged breathing of the vapor should be avoided. The solvent is not to be used near heat, sparks, or open flames; it is highly flammable. Since isopropyl alcohol dissolves natural oils, prolonged contact with skin should be avoided. When necessary, use gloves which are solvent-resistant. If the solvent is taken internally, consult a physician immediately.

## WARNING

COMPRESSED AIR is used in the maintenance of this equipment. When used for cleaning, the compressed air source must limit nozzle pressure to no more than 29 pounds per square inch (PSIG). Goggles must be worn when cleaning with compressed air.

## WARNING

Adequate ventilation should be provided while using TRICHLOROTRIFLUOROETHANE. Prolonged breathing of vapor should be avoided. The solvent should not be used near heat or open flame; the products of decomposition are toxic and irritating. Since TRICHLOROTRIFLUOROETHANE dissolves natural oils, prolonged contact with skin should be avoided. When necessary, use gloves which the solvent cannot penetrate. If the solvent is taken internally, consult a physician immediately.

## WARNING

TOXIC HAZARD: Many of the electronic components used in this equipment employ resins and other chemicals which give off toxic fumes on incineration. Appropriate precautions should therefore be taken in the disposal of these items.



# CAUTION



**THIS EQUIPMENT CONTAINS PARTS  
AND ASSEMBLIES SENSITIVE TO  
DAMAGE BY ELECTROSTATIC DISCHARGE (ESD).  
USE ESD PRECAUTIONARY PROCEDURES  
WHEN TOUCHING, REMOVING OR INSERTING  
PRINTED CIRCUIT BOARDS.**

## **ESD CLASS 1**

### NOTE

The symbol for static sensitive devices in military inventory is as depicted in the caution block above. The symbol used in this authenticated manual is 

### GENERAL HANDLING PROCEDURES FOR ESDS ITEMS

- USE WRIST GROUND STRAPS OR MANUAL GROUNDING PROCEDURES
- KEEP ESDS ITEMS IN PROTECTIVE COVERING WHEN NOT IN USE
- GROUND ALL ELECTRICAL TOOLS AND TEST EQUIPMENT
- PERIODICALLY CHECK CONTINUITY AND RESISTANCE OF GROUNDING SYSTEM
- USE ONLY METALIZED SOLDER SUCKERS
- HANDLE ESDS ITEMS ONLY IN PROTECTED AREAS

### MANUAL GROUNDING PROCEDURES

- MAKE CERTAIN EQUIPMENT IS POWERED DOWN
- TOUCH GROUND PRIOR TO REMOVING ESDS ITEMS
- TOUCH PACKAGE OF REPLACEMENTS ESDS ITEM TO GROUND BEFORE OPENING
- TOUCH GROUND PRIOR TO INSERTING REPLACEMENT ESDS ITEMS

### ESD PROTECTIVE PACKAGING AND LABELING

- INTIMATE COVERING OF ANTISTATIC MATERIAL WITH AN OUTER WRAP OF EITHER TYPE 1 ALUMINIZED MATERIAL OR CONDUCTIVE PLASTIC FILM - OR -HYBRID LAMINATED BAGS HAVING AN INTERIOR OF ANTISTATIC MATERIAL WITH AN OUTER METALIZED LAYER
- LABEL WITH SENSITIVE ELECTRONIC SYMBOL AND CAUTION NOTE

## CAUTION

Devices such as CMOS, NMOS, MNOS, VMOS, HMOS, thin-film resistors PMOS, and MOSFET used in many equipments can be damaged by static voltages present in most repair facilities. Most of the components contain internal gate protection circuits that are partially effective, but sound maintenance practice and the cost of equipment failure in time and money dictate careful handling of all electrostatic sensitive components.

The following precautions should be observed when handling all electrostatic sensitive components and units containing such components.

## CAUTION

Failure to observe all of these precautions can cause permanent damage to the electrostatic sensitive device. This damage can cause the device to fail immediately or at a later date when exposed to an adverse environment.

- STEP 1 Turn off and/or disconnect all power and signal sources and loads used with the unit.
- STEP 2 Place the unit on grounded conductive work surfaces.
- STEP 3 Ground the repair operator using a conductive wrist strap or other device using a 1-M series resistor to protect the operator.
- STEP 4 Ground any tools (including soldering equipment) that will contact the unit. Contact with the operator's hand provides a sufficient ground for tools that are otherwise electrically isolated.
- STEP 5 All electrostatic sensitive replacement components are shipped in conductive foam or tubes and must be stored in the original shipping container until installed.
- STEP 6 When these devices and assemblies are removed from the unit, they should be placed on the conductive work surface or in conductive containers.
- STEP 7 When not being worked on wrap disconnected circuit boards in aluminum foil or in plastic bags that have been coated or impregnated with a conductive material.
- STEP 8 Do not handle these devices unnecessarily or remove from their packages until actually used or tested.

**CAUTION : STATIC SENSITIVE COMPONENTS**

Components identified with the symbol  on the circuit diagrams and/or parts lists are static sensitive devices. The presence of such devices is also indicated in the equipment by orange discs, flags or labels bearing the same symbol. Certain handling precautions must be observed to prevent these components being permanently damaged by static charges or fast surges.

- (1) If a printed board containing static sensitive components (as indicated by a warning disc or flag) is removed, it must be temporarily stored in a conductive plastic bag.
- (2) If a static sensitive component is to be removed or replaced the following anti-static equipment must be used.

A work bench with an earthed conductive surface.

Metallic tools earthed either permanently or by repeated discharges.

A low-voltage earthed soldering iron.

An earthed wrist strap and a conductive earthed seat cover for the operator, whose outer clothing must not be of man-made fibre.

- (3) As a general precaution, avoid touching the leads of a static sensitive component. When handling a new one, leave it in its conducting mount until it is required for use.

**WARNING : HANDLING HAZARDS**

This equipment is formed from metal pressings and although every endeavour has been made to remove sharp points and edges care should be taken, particularly when servicing the equipment, to avoid minor cuts.

**WARNING : TOXIC HAZARD**

Many of the electronic components used in this equipment employ resins and other chemicals which give off toxic fumes on incineration. Appropriate precautions should therefore be taken in the disposal of these items.

**RADIO FREQUENCY INTERFERENCE**

This equipment conforms with the requirements of IEC Directive 76/889 as to limits of r.f. interference.

## NOTES AND CAUTIONS

### ELECTRICAL SAFETY PRECAUTIONS

This equipment is protected in accordance with IEC Safety Class 1. It has been designed and tested according to IEC Publication 348, 'Safety Requirements for Electronic Measuring Apparatus', and has been supplied in a safe condition. The following precautions must be observed by the user to ensure safe operation and to retain the equipment in a safe condition.

#### Defects and abnormal stresses

Whenever it is likely that protection has been impaired, for example as a result of damage caused by severe conditions of transport or storage, the equipment shall be made inoperative and be secured against any unintended operation.

#### Removal of covers

Removal of the covers is likely to expose live parts although reasonable precautions have been taken in the design of the equipment to shield such parts. The equipment shall be disconnected from the supply before carrying out any adjustment, replacement or maintenance and repair during which the equipment shall be opened. If any adjustment, maintenance or repair under voltage is inevitable it shall only be carried out by a skilled person who is aware of the hazard involved.

Note that capacitors inside the equipment may still be charged when the equipment has been disconnected from the supply. Before carrying out any work inside the equipment, capacitors connected to high voltage points should be discharged; to discharge mains filter capacitors, if fitted, short together the L (live) and N (neutral) pins of the mains plug.

#### Mains plug

The mains plug shall only be inserted in a socket outlet provided with a protective earth contact. The protective action shall not be negated by the use of an extension lead without protective conductor. Any interruption of the protective conductor inside or outside the equipment is likely to make the equipment dangerous. Before fitting a non-soldered plug to the mains lead, cut off the tinned ends of the mains lead. Otherwise cold flowing of the solder could cause intermittent connections.

#### Fuses

Note that there is a supply fuse in both the live and neutral wires of the supply lead. If only one of these fuses should rupture, certain parts of the equipment could remain at supply potential.

To provide protection against breakdown of the supply lead, its connectors, and filter where fitted, an external supply fuse (e.g. fitted in the connecting plug) should be used in the live lead. The fuse should have a continuous rating not exceeding 6 A.

Make sure that only fuses with the required rated current and of the specified type are used for replacement. The use of mended fuses and the short-circuiting of fuse holders shall be avoided.

OPERATOR'S MAINTENANCE MANUAL  
FOR  
MODULATION METER ME-505B/U  
(MARCONI INSTRUMENTS MODEL 2305)  
(NSN )

CONTENTS

	Page	Volume
Chapter 1. GENERAL INFORMATION	Chap. 1,1	1
2 INSTALLATION	Chap. 2,1	1
3 OPERATION	Chap. 3,1	1
3-1 EXTENDED APPLICATION	Chap. 3-1,1	1
4-1 BRIEF TECHNICAL DESCRIPTION	Chap. 4-1,1	1
4-2 TECHNICAL DESCRIPTION	Chap. 4-2,1	2
5 MAINTENANCE	Chap. 5,1	2
6 REPLACEABLE PARTS	Chap. 6,1	2
7 SERVICING DIAGRAMS	Chap. 7,1	2

SECURITY NOTE

This volume contains details of the unlocking procedures needed before access can be gained to the P2 and P3 groups of second functions. These procedures are not given in the operating manual (Vol. 1). Group P2 functions are concerned with use of the CAL key and with the locking/unlocking of stored batches of control settings. Group P3 functions control the entry or overwriting of basic factory calibration data.

In order to provide for organizations where greater security may be required for the P3 functions, page 5 of Chapter 5, which contains the details, is duplicated in all respects apart from the relevant paragraph and is included with a duplicate page 6 as a separate leaf, pages 5a and 6a. The user should remove one of these leaves before issuing the manual for general use, the choice depending on whether he wishes to withhold the information or not.

Chapter 1

GENERAL INFORMATION

CONTENTS

Para.				
1	Features			
20	Performance data			
20	RF input			
20	Carrier frequency range			
21	Carrier frequency indication			
22	Signal input			
23	Frequency modulation			
24	Phase modulation			
25	Amplitude modulation			
26	Power measurement			
27	Frequency display			
28	Internal frequency standard			
29	Modulation display			
30	Detector modes			
31	Display modes			
32	Modulation bandwidths			
33	De-emphasis			
34	Outputs (front panel)			
35	Distortion			
36	Store/Recall			
37	Rear panel connections			
38	Keyboard second functions			
39	GPIB operation			
40	Psophometer weighting/distortion measurement			
41	Environmental			
41	Rated range of use			
42	Conditions of storage and transport			
43	Safety			
44	Radio frequency interference			
45	Power requirements			
46	Weight and dimensions			
47	Accessories			
47	Supplied accessories			
48	Optional accessories			
49	Principles of measurement			
50	Amplitude modulation			
53	Non-conventional a.m.			
54	AM calibrator			
55	Frequency modulation			
56	Bessel zero calibration technique			
57	Phase modulation			
Fig.				Page
1	50 kHz to 2.3GHz Modulation Meter 2305	...	...	2
2	Typical full a.m. signal symmetrical modulation	..	...	15
3	Asymmetrical modulation	...	...	16



## FEATURES

1. 2305 is a high performance, microprocessor controlled, modulation meter with a comprehensive specification covering the carrier frequency range 50 kHz to 2.3 GHz.
2. Operation may be either local or remote. Local control is obtained via functionally grouped key switches which form the front panel controls and which direct all the instrument functions except those of SUPPLY ON and LF LEVEL.
3. Indication of measured quantities is provided by two l.c.d. 7-segment digital displays : frequency - either of the carrier or of the modulating tone - appears in the 8-digit left-hand display, modulation - in % a.m., kHz or radians deviation - appears in the 4 digit right-hand display.
4. The microprocessor allows maximum flexibility in arranging and controlling the circuit functions and permits remote operation via the GPIB\* when the instrument is fitted with the GPIB interface optional accessory. The 2305 is thus as well suited for stand-alone manual operation as for incorporation in automatic systems with programmed operation and makes few demands on operator skill.

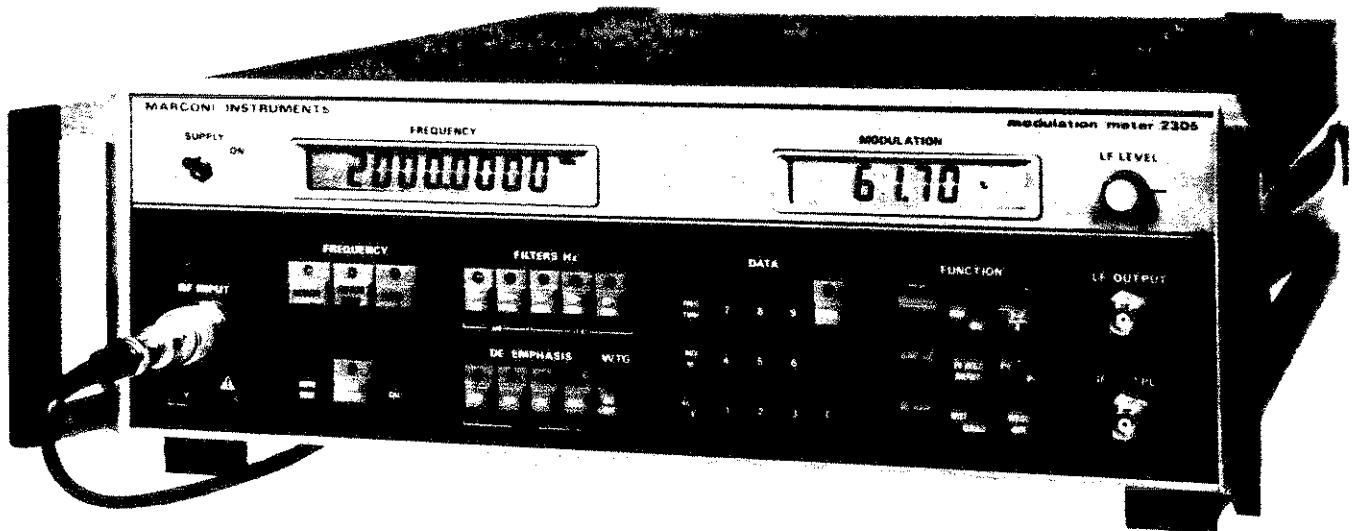

Fig. 1 50 kHz to 2.3GHz Modulation Meter 2305

---

\* GPIB - Marconi Instruments General Purpose Interface Bus in accordance with IEEE Standard 488 - 1978, IEC Publication 625-1 1979 and BS 6146.

5. In its simplest method of operation, the 2305 provides both automatic tuning and control of the ranging circuits, although tuning may be controlled directly by keypad entry of numerical data, and individual ranges may be retained by the use of keyboard second functions<sup>†</sup> if necessary. A HOLD ON/OFF key permits all ranges and functions to be locked in their present states.
6. In both forms of tuning, the local oscillator frequency retains the same sense relationship with signal frequency needed to ensure that positive frequency and phase excursions are always presented as P+.
7. In the CARRIER ERROR mode the instrument will measure small frequency drifts or offsets by continuously subtracting a stored reference value from instantaneous measurements of the carrier. The reference value can be either a numerical entry made via the keypad or a particular instantaneous measurement transferred to store by operation of the CARRIER ERROR key. Two other frequency measurement modes provide for the display of either carrier or modulating frequency.
8. When necessary, an external 10 MHz standard may be used in place of the internal reference which forms the basis for local oscillator frequency synthesis and for frequency measurement. It is also possible to provide for direct substitution of the local oscillator signal by a source of external origin. The changeover in both cases being effected by second function keying.
9. Modulation is normally measured as peak excursions of either the amplitude, frequency or phase of the carrier signal and a choice of detector modes enables the peaks of each polarity either to be measured separately or for their average to be calculated and presented as  $\frac{P+P-}{2}$ . Two additional detector modes offer (1) an averaging detector, and (2) a PEAK HOLD function. The averaging mode (NOISE AVG) is useful when noise is to be measured, and the quantity displayed when in this mode is of the peak value of a sine wave having the same average value. In PEAK HOLD, successive peak samples are examined and store and display are up-dated each time the previous largest sample is exceeded. The PEAK HOLD mode is useful for logging transients and other aspects of modulator system performance under operational conditions. In the a.m. mode, peaks are always measured as P+ and troughs as P-.
10. The 2305 will tune and measure automatically without loss of accuracy on signal levels between -18 dBm and +30 dBm. The sensitivity increases considerably towards the bottom end of the frequency range and a substantial further increase can be obtained by reverting to manual tuning. Input protection is provided above the permitted maximum of +30 dBm. Deep amplitude modulation may reduce the signal level during troughs to a point that is insufficient to ensure proper functioning of the internal frequency counter and auto-tuning may be adversely affected. The effect is only likely to occur with a.m. greater than 90% and, if it happens, the a.m. depth should be temporarily reduced to allow auto-tuning to complete.

---

<sup>†</sup> *Keyboard second functions - A range of operating modes exceeding 16 in number which greatly extend the instrument's use for special purposes including fault diagnosis. The second functions are in 4 groups ranging from those which are directly accessible, through three further groups requiring preliminary unlocking codes of graded complexity.*

11. Frequency deviation can be measured up to a maximum of 500 kHz for modulation frequencies up to 275 kHz. The accuracy attainable varies with modulation frequency and approaches  $\pm 0.5\%$  at 1 kHz.
12. Phase deviation can be measured to a maximum of 500 radians up to 1 kHz modulation frequency. Above this frequency the maximum measurable deviation decreases at 6 dB per octave.
13. Amplitude modulation up to 95% can be measured with accuracies approaching 1%, depending on modulation depth and frequency, up to a maximum modulation frequency of 50 kHz. Useful indications are given for depths up to 99.9%.
14. Measurements of all three types of modulation can be related to any reference level and expressed as dB. The reference quantity may be entered numerically via the keypad or may be a measurement selected from a series and transferred to store by a single key stroke.
15. The post detector bandwidth may be shaped by any one of five built-in filters which cover the varied requirements of mobile radio, broadcasting, telemetry etc. There is also a choice of 3 de-emphasis time constants which may be introduced into the audio output signal in f.m. mode. They may also be introduced into the measurement system by a keyboard second function. External filters may be introduced into the measurement circuit in addition to and independently of any internal selection.
16. Standards of amplitude and frequency modulation are generated within the instrument for calibration purposes. The 2305 automatically runs a self-check routine against these standards after each switch-on and displays pass/fail data. 2305 measurements can be recalibrated against these standards at any time by operation of the CAL key.
17. For systems use or production tests, up to 10 sets of control settings may be stored in non-volatile memory for subsequent recall and use.
18. In its POWER function, the 2305 will normally display the power entering the input terminal in dBm or watts. The measurement is based on peak voltage detection and will indicate peak power on amplitude modulated signals. The range may be extended upward by added external attenuation and a flexible system of power calibration with optional display in watts or dBm can be introduced by second functions.
19. Two major optional accessories extend the instrument's capabilities.
  - (1) The GPIB option enables all the main controls and measurements to be operated and monitored remotely under program control.
  - (2) The Distortion/Weighting Filter option provides single key stroke noise and distortion measurement and contains two standard psophometric weighting networks which may be introduced into the measurement channel.

The measurement performance of the 2305 can be changed by the user to meet special operational needs by keyboard second functions which have their status stored in non-volatile memory. If you are not certain of the state in which the instrument has been left by previous users, you should obtain a second function status display according to the procedure described in Chap. 3, page 15, before attempting any measurements.

## PERFORMANCE DATA

<i>Characteristic</i>	<i>Performance</i>
RF INPUT	
20. <u>Carrier frequency range</u>	<i>500 kHz to 2 GHz for specified Accuracy and usable from</i> 50 kHz - 2.3 GHz Acquisition time on AUTO TUNE is, typically, 500 ms.
21. <u>Carrier frequency indication</u>	8 digit l.c.d. Resolution: 10 Hz below 1 GHz, 100 Hz above 1 GHz, 10 Hz at all frequencies in CARRIER ERROR function.
22. <u>Signal input</u>	
Minimum requirements :	-25 dBm (13 mV) 500 kHz to 500 MHz. -23 dBm (16 mV) 500 MHz to 1000 MHz. -18 dBm (28 mV) 1000 MHz to 1500 MHz. -15 dBm (40 mV) 1500 MHz to 2000 MHz.
Maximum input :	Permitted maximum, 1 W (+30 dBm). Overload trip provides protection against overloads up to 25 W.
Input connector :	Type N female. 50 $\Omega$ nominal.
FREQUENCY MODULATION	
23. Maximum deviation :	(1) Carrier frequencies up to 5.5 MHz. 50 kHz peak deviation at modulation frequencies from 30 Hz to 15 kHz.  (2) Carrier frequencies above 5.5 MHz. 500 kHz peak deviation at modulation frequencies from 30 Hz to 275 kHz.
Range selection :	Selection is automatic for best resolution.
Display :	4 digit l.c.d., in kHz.*
Accuracy : (for carriers >5.5 MHz)	After calibration using internal cali- brator: $\pm 0.5\%$ of reading $\pm 1$ least sig- nificant changing digit at 1 kHz modu- lation frequency measured with 50 Hz to 15 kHz filter selected for deviations above 5 kHz and $\pm 1\%$ of reading $\pm 1$ digit below 5 kHz deviation.
*Note. For all three types of modu- lation measurement, as the quantity displayed increases from 5000 to 6000, the least significant digit will become a fixed zero whatever position the decimal point may happen to be in. The process rever- ses as the quantity falls. Wherever accuracy statements relating to modulation include the qualifica- tion ' $\pm N$ digits', the digits re- ferred to are the least significant of the active digits i.e. XXXN or XXN- as the case may be.	Frequency response relative to 1 kHz : $\pm 0.5\%$ for modulation frequencies from 20 Hz to 20 kHz measured with 10 Hz to 300 kHz filter selected.  $+0.5\%$ , $-1\%$ for modulation frequencies from 20 Hz to 50 kHz.  $+0.5\%$ , $-5\%$ for modulation frequencies from 20 Hz to 275 kHz.

*Characteristic*

*Performance*

Note...

Where necessary, allowance must be made for peak residual noise which will contribute to peak readings.

AM rejection :

Typically, 50% a.m. at 1 kHz will produce an indicated 40 Hz deviation with the 300 Hz to 3.4 kHz filter selected.

Residual f.m. noise :  
(300 Hz to 3.4 kHz bandwidth)

<i>Carrier frequency</i>	<i>FM noise (r.m.s. values)</i>
50 kHz - 50MHz	1.4 Hz
50MHz - 500MHz	15 Hz
500MHz - 1GHz	30 Hz
1GHz - 2.3 GHz	60 Hz
500MHz typically	8 Hz

Typical performance with external low noise 28 MHz to 56 MHz local oscillator:

Below 120 MHz	0.5 Hz
500 MHz	2 Hz
1 GHz	4 Hz

PHASE MODULATION

24. Carrier frequency range :

5.5 MHz to 2 GHz, usable down to 50 kHz.

Maximum deviation :

500 radians for modulation frequencies up to 1 kHz. Decreasing at 6 dB/octave above 1 kHz.

Range selection :

Ranges automatically selected for best resolution.

Accuracy :

After calibration using internal calibrator :  $\pm 2\%$  of reading  $\pm 3$  least significant changing digits at 1 kHz modulation frequency.

Frequency response relative to 1 kHz :  $\pm 2\%$   $\pm 3$  least significant changing digits from 300 Hz to 4 kHz.

Note. Where necessary, allowance must be made for peak residual noise which will contribute to peak readings. Improved accuracy in the measurement of phase modulation may be obtained for single tone modulation by using the FM

*Characteristic*

*Performance*

function. The frequency of the modulating tone may then be displayed in the FREQUENCY window and the  $\phi.m.$  in radians is calculated by dividing this number (in kHz) into the frequency deviation (in kHz) displayed in the MODULATION window. The associated accuracy is comparable with that of the FM measurement.

AMPLITUDE MODULATION

25. Maximum modulation depth :	99.9%.
Modulation frequencies :	30 Hz to 15 kHz for carrier frequencies from 0.5 MHz to 5.5 MHz. 30 Hz to 50 kHz for carrier frequencies from 50 kHz to 2 GHz.
Range selection :	Selection is automatic for best resolution.
Accuracy :	After calibration using internal calibrator : $\pm 1\%$ of reading $\pm 1$ least significant changing digit at 1 kHz modulation frequency and for depths up to 95%. Frequency response relative to 1 kHz : $\pm 1.5\%$ of reading for modulation frequencies from 30 Hz to 50 kHz.
	Notes... (1) These accuracy figures apply with 30 Hz - 50 kHz l.f. filter selected. (2) Where necessary, allowance must be made for peak residual noise which will contribute to peak readings.
FM rejection :	50 kHz peak deviation on carrier frequencies above 5.5 MHz will produce an indication of less than 0.5% a.m. with the 50 Hz to 15 kHz filter selected.
Residual a.m. noise : (300 Hz to 3.4 kHz bandwidth)	Less than 0.02% r.m.s. a.m. With input signals greater than 30 mV (-17 dBm) and the 300 Hz to 3.4 kHz filter selected.

*Characteristic*

*Performance*

POWER MEASUREMENT

26. Range : 10 mW to 1 W (+10 dBm to +30 dBm).  
Accuracy :  $\pm 1$  dB at 800 MHz.  
Frequency response  $\pm 1$  dB from 50 kHz to 1500 MHz, usable up to 2 GHz.  
Input v.s.w.r. : <2.00 from 500 kHz to 1500 MHz.  
Display : Display may be in dBm or W as selected by keyboard second function.  
Temperature range : 0 to 35°C.
27. Frequency display Front panel keys enable the following frequencies to be displayed on an 8 digit l.c.d.

CARRIER

- CARRIER ERROR : Frequency difference between measured carrier frequency and frequency reference in store.

MODULATION

Resolution

- CARRIER : 10 Hz below 1 GHz,  
100 Hz above 1 GHz.  
CARRIER ERROR : All carrier frequencies : 10 Hz.  
MODULATION : 0.1 Hz up to 5 kHz,  
10 Hz above 5 kHz.  
Accuracy :  $\pm 1$  count  $\pm$  frequency standard error.  
(all modes)  
Frequency standard : Front panel indicator shows when external standard is selected.

28. Internal frequency standard

- Frequency change with temperature :  $\leq \pm 0.1$  p.p.m. over the range 0 to 40°C.  
Better than 3 parts in  $10^9$  per day.  
Better than 1 part in  $10^7$  per month.  
Better than 1 part in  $10^6$  per year.
- Ageing rate : Better than 3 parts in  $10^9$  per day.  
Better than 1 part in  $10^7$  per month.  
Better than 1 part in  $10^6$  per year.
- Warm-up time : Within 0.5 p.p.m. of final frequency within 5 min. from switch-on at 20°C ambient.

*Characteristic*

*Performance*

29. Modulation display

In accordance with the function selected, a 4 digit l.c.d. will show the following :

- AM - % modulation depth.
- FM - kHz deviation.
- ϕM - radians deviation.
- POWER - W or dBm as selected.
- Relative (REL) - dB.

30. Detector modes

The following may be selected :

- Average of P+ and P- }  $\frac{P-P}{2}$
- Positive peak P+
- Negative peak P-
- Noise averaging NOISE AVG.  
(calibrated as peak of equivalent sine wave)

31. Display modes

The following may be selected :

- Absolute (ABS) - absolute values of modulation are displayed.
- Relative (REL) - measured modulation is displayed as a ratio in dB to a reference quantity entered and stored in the instrument.
- Peak hold (PK HOLD) - holds and displays the maximum peak occurring in period of observation.  
In power measurement, measures peak power.

32. Modulation bandwidths

Five post detector filter bandwidths may be selected from the front panel :

- 10 Hz to 300 kHz for wide band f.m. measurements.
- 30 Hz to 50 kHz } flat within 0.1 dB.
- 65 Hz to 250 Hz }
- 50 Hz to 15 kHz } nominal
- 300 Hz to 3.4 kHz } -3 dB bandwidths



*Characteristic*

*Performance*

33. De-emphasis

Three de-emphasis time constants may be selected from the front panel :

50  $\mu$ s,  
75  $\mu$ s,  
750  $\mu$ s.

De-emphasis may be introduced into the l.f. output circuit and relative measurements only and does not affect absolute measurements.

34. Outputs (front panel)

IF :

As carrier frequency for input carriers up to 1.5 MHz.

250 kHz nominal for carrier frequencies from 1.5 MHz to 5.5 MHz.

1.5 MHz for carrier frequencies above 5.5 MHz.

100 mV r.m.s. nominal into 50  $\Omega$ .

LF :

Demodulated, filtered and de-emphasized signal is available at BNC socket.

LF LEVEL control adjusts level from 0 to at least 3 V r.m.s. into 600  $\Omega$  for f.m. deviations  $>500$  Hz, a.m.  $>0.5\%$  and c.m.  $>1.5$  rad. at 1 kHz.

35. Distortion

FM :

For modulation frequencies up to 20 kHz,  $<0.15\%$  THD (Total Harmonic Distortion) for deviation up to 100 kHz.  $<0.5\%$  THD for deviation up to 500 kHz.  $<1\%$  THD for modulation frequencies up to 100 kHz.

AM :

$<0.3\%$  THD for modulation depths up to 95% at 1 kHz modulation frequency and  $<1\%$  THD for modulation depths up to 95% and modulation frequencies up to 50 kHz.

Stereo separation :

Better than 50 dB at 1 kHz (typically 54 dB above 100 Hz).

*Characteristic*

*Performance*

36. Store/Recall
- The RCL/STO key used with the numeric keypad allows up to 10 instrument settings to be stored in non-volatile memory for later recall.
37. Rear panel connections
- (1) External filter :
- An external l.f. filter may be connected via a standard stereo jack into the modulation amplifier. Source impedance is low and load impedance is high.
- (2) External local oscillator input :
- An external local oscillator may be connected via a BNC socket and can be switched into circuit in place of the internal oscillator by keyboard action.
- Frequency range 28 MHz to 56 MHz to cover input signals from 26.5 MHz to 2 GHz.
- Input level, 100 mV to 1 V into 50  $\Omega$ .
- (3) Internal frequency standard output :
- 10 MHz output from internal standard available at BNC socket. Output level at least 100 mV into 50  $\Omega$ .
- (4) External frequency standard input :
- 10 MHz external standard input via BNC socket.
- 1 V r.m.s. sine wave into a nominal 100  $\Omega$ .
38. Keyboard second functions
- Group P0 (unprotected) and P1 (first level protected) are concerned with extensions and modifications in operating technique and their use is described in Chapter 3 of this volume. The second and third levels of protection - groups P2 and P3 - control access to basic calibration data stored in the instrument and their description and use is covered in the Service Manual which is available as an optional extra.

*Characteristic*

*Performance*

39. GPIB operation

A GPIB interface is available as an optional accessory which may be supplied fitted, with the instrument, or may be subsequently fitted by the user without the need for special skills or equipment.

All controls except for SUPPLY and LF LEVEL are remotely programmable. Second functions are all programmable, and protected levels can be accessed via the bus directly without prior insertion of the locking code.

The interface complies with the following subsets as defined in IEEE 488 - 1978, IEC 615-1 1979 and BS 6146 : SH1, AH1, T6, TEO, L4, LEO, SRI, RL1, PPO, DC1, CO, E1 - see optional accessories para. 48, page 14.

40. Psophometer weighting/distortion measurement

Incorporation of the optional kit 46883-527G enables the full potential of the 2305 to be realized and the keys controlling weighting (WTG) and distortion measurement (DIST SINAD) to become operational. The kit comprises an assembled circuit board with fitting instructions and may be retro-fitted by a user if fitting was not requested prior to despatch of the 2305.

Distortion measurement

Measurement frequencies :	300 Hz, 500 Hz, 1 kHz, automatically tuned over $\pm 5\%$ .
Fundamental rejection :	greater than 65 dB.
Distortion measurement range :	0.1 to 100%.
SINAD measurement range :	0 to 60 dB.
Measurement accuracy :	$\pm 1$ dB.

Weighting filters

CCITT filter :	Frequency response conforms to CCITT recommendation P53.
CCIR filter :	Frequency response conforms to CCIR recommendation 468-2.

*Characteristic*

*Performance*

ENVIRONMENTAL

41. Rated range of use 0 to 55°C, except power measurement.  
0 to 35°C, power measurement only.
42. Conditions of storage and transport
- Temperature : -40°C to +70°C.
- Humidity : Up to 90% relative humidity.
- Altitude : Up to 2500 m (pressurized freight at  
27 kPa differential i.e. 3.9 lbf/in<sup>2</sup>).
43. Safety Complies with IEC 348.
44. Radio frequency interference Conforms to the requirements of EEC  
directive 76/889.
45. Power requirements AC mains, switchable voltage ranges:  
105 to 110 V }  
115 to 120 V } ±10%  
210 to 220 V }  
230 to 240 V }  
45 to 440 Hz, 70 VA.
46. Weight and dimensions
- Height : 152 mm (6 in).
- Width : 425 mm (16.7 in).
- Depth : 535 mm (21 in).
- Weight : 13.5 kg (29.7 lb).

ACCESSORIES

47. Supplied accessories
- |   |                        |
|---|------------------------|
| Plastic cover                             | Code no.<br>37490-180L |
| AC supply lead                            | 43123-076Y             |
| Operating manual                          | 46881-431P             |
| Jack plug (Con. Tel. Male 3 Free Black A) | 23421-620H             |

48. Optional accessories

Code no.

GPIB Adapter Module	54433-001U
GPIB Lead Assembly	43129-189U
GPIB Manual	46881-365R
Rack Mounting kit	46883-506M
Front Handle kit	46883-511R
Distortion/Weighting Filter kit	46883-527G
Maintenance kit, includes extender board, l.c.d. insertion and extraction tools, board extractor etc.	54711-034U
Service Manual H 52305-900K, Vol. 2	46881-432X
Attenuator 20 W, 50 $\Omega$ , 20 dB	54431-021B
Signal Sniffer. T connector for insertion between transmitter and load with pick-up to give a small signal from the T branch to the modulation meter	54452-011E
Termination 12 W, 50 $\Omega$	54422-011A
Lead coaxial, 50 $\Omega$ , BNC, 1.5m	43126-012S
Lead coaxial, 50 $\Omega$ , type N, 457 mm	43126-026A
IEEE/IEC connector adapter	46883-408K
Stowage Cover kit. Plastic cover with storage space for accessories which clips over the front panel and protects controls during transportation and storage	PB 46883-519Y
Carrying case	46662-086S
Low leakage r.f. coaxial cable with N-type connectors, 50 $\Omega$ , 1 m	54311-095C

## PRINCIPLES OF MEASUREMENT

49. Most modulation measurement is likely to be carried out using steady single tone signals so that the tests can be well defined. For observations on operational systems, the 2305 makes available an i.f. analogue of the input signal that is within the frequency range of most oscilloscopes (IF OUTPUT) and the demodulated tone (LF OUTPUT). The PEAK HOLD function can be used in dynamic measurements to store the largest measurable modulation peak occurring during any period of observation.

Amplitude modulation

50. Amplitude changes are commonly viewed on oscilloscopes because of their unique property for allowing the immediate recognition of fault conditions. Such observations sometimes extend into measurements and it is well to understand that there may be aspects of the signal that will cause inevitable differences between measurements of a.m. signals made on modulation meters and those made on oscilloscopes. In the following paragraphs the reasons for this are examined in more detail.

51. A typical a.m. signal is shown in Fig. 2. In this signal the peaks of modulation are equally spaced about the zero level of the modulating waveform and, consequently, are also symmetrical about the mean - or unmodulated - level of the carrier. With such a signal the 2305 should produce the same reading on both P+ and P- and therefore also on  $\frac{P-P}{2}$ . Any signal may, however, include distortion of the carrier component depending on the nature of the source and whether or not any tuning or filtering at carrier frequency has been given. Harmonics of the carrier will be much reduced by the 2305 which will therefore measure modulation on the fundamental component of the carrier (as displayed in the FREQUENCY window) and this sometimes differs from the amount present on the signal with carrier distortion present. The reason for this is not immediately evident but it is more likely that an oscilloscope will pass some distortion of the carrier than will a tuned modulation meter. Differences can often be detected in these circumstances between successive oscilloscope measurements, based on  $AM = \frac{P - T}{P + T}$ , made with and without initial harmonic filtering. Differences will also arise if the modulation is asymmetrical.

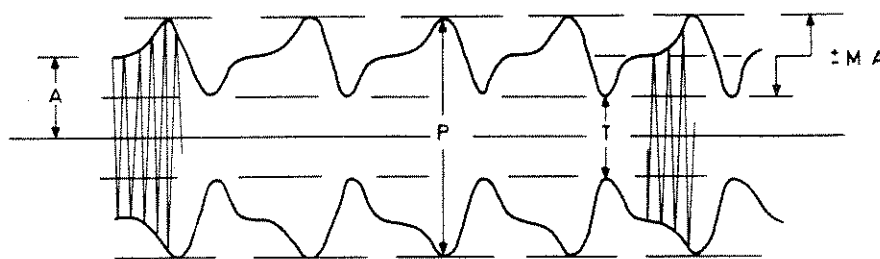

Fig. 2 Typical full a.m. signal symmetrical modulation

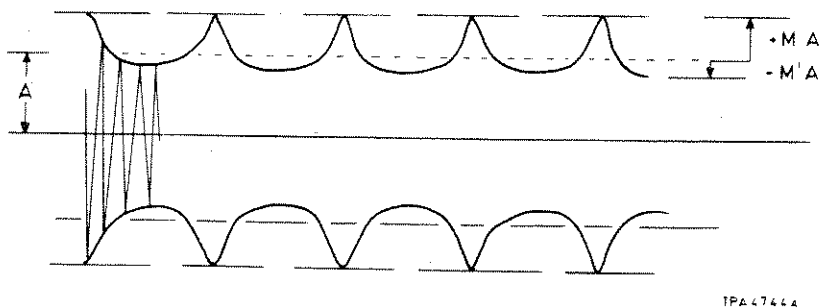

Fig. 3 Asymmetrical modulation

52. The example of a.m. shown in Fig. 3 exhibits gross asymmetry and carrier minima and maxima are very unequally disposed about the mean, unmodulated, level. On such signals the 2305 will measure the quantities  $M$  and  $M'$  shown in the figure, when  $P+$  and  $P-$  are requested, or, their average for  $\frac{P-P}{2}$ . The oscilloscope observer, however, has no reliable way of detecting where the mean level lies and the usual formula employed of a.m. =  $\frac{P - T}{P + T}$  will not, in general, yield the same result as a 2305 measurement of  $\frac{P-P}{2}$ . This can be readily verified by a numerical evaluation of asymmetrical modulation using both formulae. The example shown in Fig. 3 is somewhat extreme, but asymmetry of a few percent of this kind can frustrate an attempt to get agreement between the two measurement methods to within 1%. Any decision as to which measurement is correct requires attention to the definition of the measurement taking the distortion into account.

#### Non-conventional a.m.

53. The term 'amplitude modulation' is sometimes used in connection with signals for which the measurements made by instruments employing the principles of the 2305 are inappropriate. One example is a signal taken from a modulation system in which carrier or sideband suppression has been carried out and to which the normal conventions cannot apply. Another example is the application of the term to the square wave modulation produced by switching modulators in microwave signal sources. The specification for carrier suppression achieved during the 'off' part of the cycle in such modulators is, typically, well in excess of 46 dB (corresponding to 99% a.m.) and so cannot be verified by a modulation meter.

#### AM calibrator

54. The internal a.m. calibrator uses a resistive attenuator pad which is introduced into an i.f. signal deriving from the local oscillator when required. The pad is switched in and out by high impedance FET switches driven from a 1 kHz signal that is precisely square. The attenuation of nominally x5 that is introduced gives a very stable 1 kHz a.m. dependent only on the stability of the resistors in the pad.

Frequency modulation

55. Frequency deviations are translated from the signal frequency to the i.f. The i.f. deviations are then linearly demodulated into a voltage having the frequency of the modulating tone and an amplitude proportional to the deviation. This voltage is then amplified and detected by the same circuits that are used for a.m., the overall gain being sufficiently stable for the metering circuit to be directly calibrated in frequency deviation. The calibration is ultimately referred to the internal frequency standard via the f.m. calibrator in which the local oscillator synthesizer is switched between two pairs of frequencies so simulating two levels of deviation.

Bessel zero calibration technique

56. A well-known method of producing calibrated f.m. signals utilizes the predictable ratios of deviation to modulation signal frequencies at which the carrier or certain sideband signal components disappear. The method is prone to error unless a very pure source of modulating signal is available. An alternative procedure is given in the Service Manual, Chap. 5.

Phase modulation

57. Phase and frequency modulation are related by the expression  $\phi = \frac{fd}{f_m}$ , where  $\phi$  is the carrier phase deviation in radians arising from a modulating tone of frequency  $f_m$ , causing carrier deviation  $f_d$ . A detector of frequency modulation can therefore be turned into a phase demodulator by causing its output to vary as  $\frac{1}{f_m}$  i.e. to roll off at 6 dB/octave. This technique of phase demodulation is used in the 2305 and in other comparable instruments. The permissible full-scale maxima for  $\phi$ .m. cannot, though, be as independent of modulating frequency as in f.m. and a.m. The fixing of a low modulation frequency requirement of 500 radians full-scale defines the corresponding maximum modulation frequency (at which 500 kHz frequency deviation is reached) at 1 kHz. For modulation frequencies above 1 kHz the permissible range maxima must decrease at 6 dB per octave. Below 1 kHz the demodulator gain rises at 6 dB/octave to maintain the 500 rad full-scale maximum until 300 Hz is reached at which point the cut-off frequency of a high-pass filter defines the practical limit for low frequencies. This performance reflects the normal limitations inherent in the design of phase modulated systems and is no disadvantage in practice.





Chapter 2

INSTALLATION

CONTENTS

Para.		
1	Unpacking and repacking	
3	Mounting arrangements	
4	Connecting to supply	
6	Safety testing	
7	GPIB interface	
8	Rack mounting	
9	Front panel handles	
10	External filter	
Fig.		Page
1	Voltage ranges ... ..	2
2	Connections to external filter jack ... ..	4

UNPACKING AND REPACKING

1. Retain the container, packing material and the packing instruction note (if included) in case it is necessary to reship the instrument.
2. If the instrument is to be returned for servicing attach a label indicating the service required, type or model number (on rear label), serial number and your return address. Pack the instrument in accordance with the general instructions below or with the more detailed information in the packing instruction note.
  - (1) Place mains lead in suitable plastic bag and tape it to the instrument rear panel.
  - (2) Place the instrument within its plastic cover.
  - (3) Ensure that the padded fitting is in place within the inner carton and slide the instrument in, rear panel first, leaving the front panel exposed at the open end.
  - (4) Fit the separate front panel protecting cover over the panel and close and seal the inner carton.
  - (5) Place one of the moulded plastic cushions in the bottom of the outer carton and insert the inner carton so that it locates in the cushion recess.
  - (6) Place the remaining plastic cushion over the other end of the inner carton and close and seal the outer carton.
  - (7) Wrap the container in waterproof paper and secure with adhesive tape.
  - (8) Mark the package FRAGILE to encourage careful handling.

Note...

If the original container or materials are not available, use a strong double-wall carton packed with a 7 to 10 cm layer of shock absorbing material around all sides of the instrument to hold it firmly. Protect the front panel controls with a plywood or cardboard load spreader; if the rear panel has guard plates or other projections a rear load spreader is also advisable.

### MOUNTING ARRANGEMENTS

3. Excessive temperatures may affect the instrument's performance; therefore, completely remove the plastic cover, if one is supplied over the case, and avoid standing the instrument on or close to other equipment that is hot.

### CONNECTING TO SUPPLY

4. Before connecting the instrument to the a.c. supply check the position of the two voltage selector switches on the rear panel. A locking plate fixes both switches into one of four possible combinations and only the selected voltage range is displayed when the locking plate is fixed to the back panel. The instrument is normally despatched with the switches selected to 230/240 V. To select a different voltage range remove the locking plate and re-position the switches to the required range as shown in Fig. 1 below and refit the locking plate into its alternative position.

Note...

The a.c. supply fuse may also have to be changed. An indication of the correct fuse rating is given with each displayed voltage range:-

i.e. 1 A-T (1 A time lag)	105 V - 120 V $\pm$ 10%
0.5 A-T (0.5 A time lag)	210 V - 240 V $\pm$ 10%

The fuses are 20 mm x 5 mm cartridge type.

5. The free a.c. supply cable is fitted at one end with a female plug which mates with the a.c. connector at the rear of the instrument. When fitting a supply plug ensure that conductors are connected as follows :

Earth - Green/yellow  
Neutral - Blue  
Live - Brown

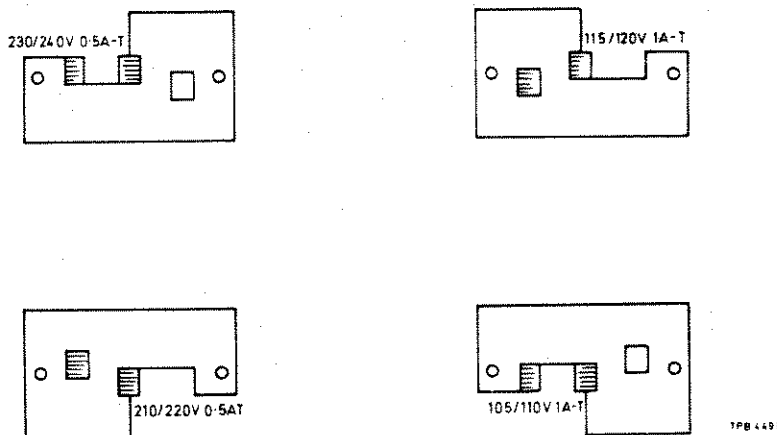

Fig. 1 Voltage ranges (alternative switch and locking plate positions)

## SAFETY TESTING

6. Where safety tests on the a.c. supply input circuit are required, the following procedures can be applied. These comply with BS 4743 and IEC Publication 348. Tests are to be carried out as follows and in the order given, under ambient conditions, to ensure that a.c. supply input circuit components and wiring (including earthing) are safe.

(1) Earth lead continuity test from any part of the metal frame to the bared end of the flexible lead for the earth pin of the user's a.c. supply plug. Preferably a heavy current (about 25 A) should be applied for not more than 5 seconds.

Test limit : not greater than 0.5  $\Omega$ .

(2) 500 V d.c. insulation test from the a.c. supply circuit to earth.

Test limit : not less than 2 M $\Omega$ .

## GPIB INTERFACE

7. The GPIB interface is an optional accessory and can easily be fitted by the user as follows:-

(1) Remove and discard the rectangular cover plate from the left-hand side of the rear panel.

(2) Withdraw the interconnecting lead from inside the instrument and connect this to the GPIB assembly.

(3) Using the four retaining screws provided, secure the GPIB assembly to the rear panel where four pre-positioned captive nuts are fitted. The interface is now ready for GPIB operation.

## RACK MOUNTING

8. The instrument may be mounted in a standard 19 inch rack using the kit 46883-506M available as an optional accessory. Fitting instructions are as follows:-

(1) Remove both top and bottom outer covers, detach and discard front and rear feet on bottom cover.

(2) Detach and discard side trim infills, countersunk screws and screw cups.

(3) Remove the front panel assembly and lay face down protecting the l.c.d's.

(4) If it is required to bring the r.f. input in via the rear panel, carry out steps (5) to (8) otherwise go to step (9).

(5) Remove the r.f. input coaxial socket from the front panel and transfer it to the blanked-off position on the rear panel (see Figs. 2 and 3, pages 4 and 6 in Chapter 3 for precise locations). It is not necessary to remove either of the two coaxial terminals from the r.f. lead in this process. Note that the lead is doubled back on itself for the full depth of the instrument before returning to the miniature bulkhead connector on the r.f. box immediately behind the front panel.

(6) Unscrew the miniature connector and remove the type N r.f. input socket from the front panel by undoing the securing nut. Release the cable from its securing cleats and withdraw it completely from the instrument.

(7) Remove the blanking off grommet from the hole in the rear panel and put it in place of the connector in the front panel. Remove the type N securing nut and washer from the lead by passing them over the miniature connector. Feed the lead back into the instrument by passing the miniature connector through the hole in the rear panel. Replace the washer and nut on the lead by passing them over the miniature connector. Feed the lead fully through the rear panel and assemble the type N connector to the panel.

(8) The lead should be routed down through the recess in the edge of the bulkhead below the new input position. It can then be led diagonally across the base of the power supply, secured in place with a piece of adhesive tape, and returned to the original run of cleats along the bottom of the left-hand side panel and reconnected to the input bulkhead connector on the r.f. box.

(9) Fit the rack brackets in the recesses of the side trims or of the panel handles if these are to be retained, using the 16 mm M4 pan head screws and washers and discarding the plastic trim infills. Finally, refit top and bottom covers.

#### FRONT PANEL HANDLES

9. Front handles are supplied only as optional accessories, fitting instructions are as follows:-

- (1) Remove the side trim infills and side trims. Discard the side trims but retain the screws and washers for re-use.
- (2) Fit the panel handles using the screws and washers previously used to secure the side trims. Ensure that all 4 screws are engaged before any are tightened.
- (3) Refit the side trim infills using the existing screws and washers.

#### EXTERNAL FILTER

10. The connections are shown in Fig. 2. The source impedance is low - a few ohms - and the input impedance is 100 k $\Omega$ .

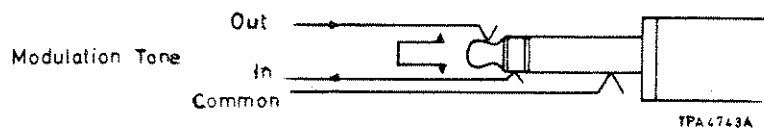

Fig. 2 Connections to external filter jack

Chapter 3

OPERATION

CONTENTS

Para.					
1	Principles of operation				
3	Keyswitch functions				
5	Controls and connectors				
5	Coaxial connectors				
6	Rear panel connections				
7	Front panel controls				
8	Rear panel features				
9	LCD annunciators				
10	Preparation for use				
14	Operating procedures				
15	Modulation measurement				
16	Relative modulation				
17	Modulation frequency measurement				
18	Display ranging				
19	Noise averaging				
21	Correction for noise				
21a	Use of CAL (calibration) key				
22	Input overload protection : trip and reset				
23	Manual frequency tuning				
24	Use of External local oscillator				
25	Distortion measurement and psophometric weighting				
30	Store and recall of control settings				
31	Keyboard second functions				
34	Data entry				
35	Data volatility				
36	Second functions 01 to 15 (Group P0, unprotected)				
37	Second functions 16 to 39 (Group P1, 1st level protected)				
39	Power measurement				
42	Use of power offset mode				
45	Error codes				
48	General Purpose Interface Bus (GPIB) functions				
51	List of 2305 GPIB commands				
52	Talking function				
53	Service requests (SRQ)				
55	SRQ mask				
57	Clear and switch on				
58	GPIB connector contact assignments				
Fig.				Page	
1	2305 controls, shown in standard power-up status	...	...	...	2
2	Front panel controls and connectors	...	...	...	4
3	Rear panel controls and connectors	...	...	...	6
4	Frequency display ..	...	...	...	7
5	Modulation and power display	...	...	...	7
6	Normal and possible fault condition displays occurring during power-up sequence	...	...	...	9
7	GPIB connector assignments	...	...	...	28

## PRINCIPLES OF OPERATION

1. The 2305 is operated locally by functionally grouped keyswitches on the front panel. With the exception of the purely numerical keys on the data keypad which are used for the entry of numerical data, keyswitches have associated lights which by their 'on' state signal that the function controlled by a particular key is active. Dual function keys have dual lights which change over the on state as the controlled functions toggle with successive finger pressures.
2. The operational state of the instrument is indicated by the 'key active' lights together with any display annunciators which may be activated and by the display itself which may be of measured data or, possibly, one of a number of error codes indicating an irregularity of some sort. The simplest of these is the row of 8 dashes in the frequency window shown in Fig. 1 which indicates that the auto-tuning process has not yet produced an acceptable i.f. signal and this is the normal condition for an instrument which has been switched on without a signal connected. It is allocated the error code number 50 but this is the only error code not displayed in numerical form. The standard form of error display utilizes the two central digits in the frequency display. The two display windows are shown in full detail in Fig. 4 and Fig. 5.

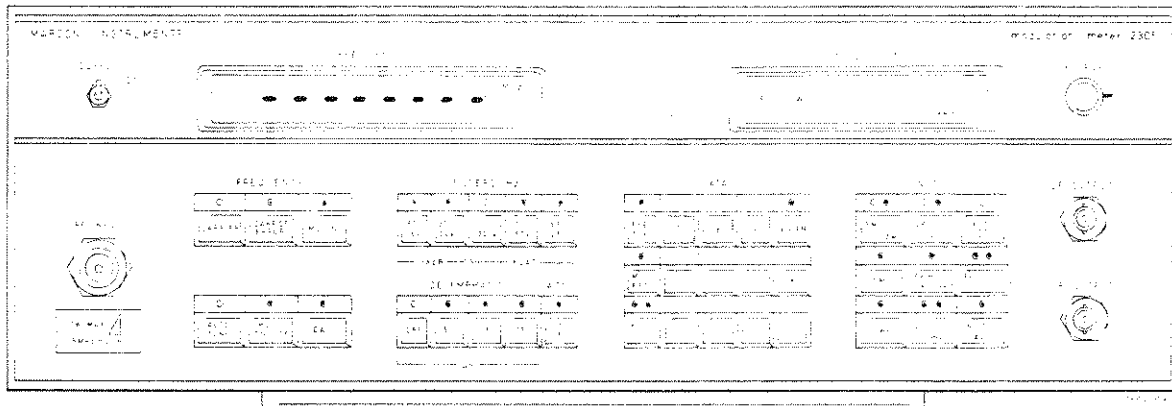

*Fig. 1 2305 controls shown in standard power up status*

The measurement performance of the 2305 can be changed by the user to meet special operational needs by keyboard second functions which have their status stored in non-volatile memory. If you are not certain of the state in which the instrument has been left by previous users, you should obtain a second function status display according to the procedure described in para. 36, page 15 before attempting any measurements.

Keyswitch functions

3. Keyswitch operation is aided by the following considerations.

- (1) Keys which control major functions are coloured orange or green.
- (2) Other function keys having a more subordinate role are coloured grey.
- (3) Data entry keys forming the keypad are black with the exception of the ENTER key which is, uniquely, blue for ease of identification.
- (4) Dual function keys will toggle from one function to the other on successive operations but will only cancel when a key controlling an associated alternative function is operated.
- (5) Those single function keys which are marked ON/OFF will toggle between the two states on successive finger pressures but all others remain active once pressed until a key controlling an alternative function is operated.

(6) Keypad data entry is initiated by the operation of one of the three left-hand director keys. When actuated, FREQ TUNE will cancel the AUTO TUNE function and the MOD REF. key will pre-empt the REL (relative) function on the ABS REL key.

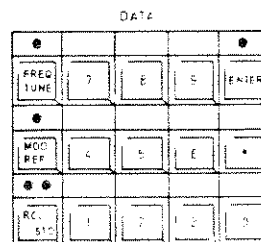

(7) An OFF key is provided with the DE-EMPHASIS selectors which is equivalent to zero de-emphasis. A continuous indication of the main bandwidth state is given by the key active light in the FILTERS group of keys. The maximum bandwidth of 10 Hz to 300 kHz is selected when standard power-up status is entered at switch on. Selection of any other filter requires separate independent choice and action and is unrelated to all other functions apart from that of phase modulation,  $\phi$ .m., which requires special filtering. When  $\phi$ .m. is selected DE-EMPHASIS and FILTERS selections are cancelled, the key active light reverts to the OFF key in the DE-EMPHASIS group and is extinguished on the FILTERS key.

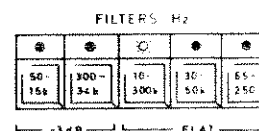
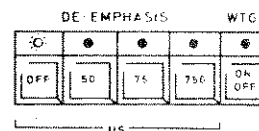

(8) In the event of a mistake occurring during keypad data entry, the keypad register can be cleared by a second operation of the appropriate director key and the sequence can then begin again.

(9) If an illegal command is made, as would happen if a frequency outside the instrument's range was entered, an error code will show in the FREQUENCY display. Error codes also appear if an incoming signal has properties that lie beyond the scope of the instrument or of a range that



has been held in operation. Error code displays remain, blocking normal operation, until the source of the error is corrected. The occasional brief display of error codes during normal use while transient conditions settle down should be ignored.

4. The only controls which are intended for local manual operation and which cannot be operated remotely via the GPIB are :

- SUPPLY ON } front panel
- LF LEVEL } front panel
- STD FREQ ADJ : rear panel access.

## CONTROLS AND CONNECTORS

### Coaxial connectors

5. There are two BNC female connectors on both the front and rear panels (items 20 and 21 and items 3 and 4 respectively). The only other coaxial connector is a 50  $\Omega$  type N female, RF INPUT, which is normally mounted on the front panel (item 2) but which can be transferred to the rear panel and placed in the blanked-off position (item 2) when it is required to rack-mount the instrument (see Chap. 2, page 3 for rack mounting instructions).

### Rear panel connections

6. The 50 - 400 Hz 70 VA a.c. supply receptacle plug (item 6) accepts the a.c. supply input cable supplied with the instrument (code no. 43129-071D). The AUDIO IN-OUT socket (item 5) accepts a standard stereo headphone jack plug, supplied. When the GPIB optional accessory is fitted the receptacle accepts the standard IEEE - 488 connector.

### Front panel controls

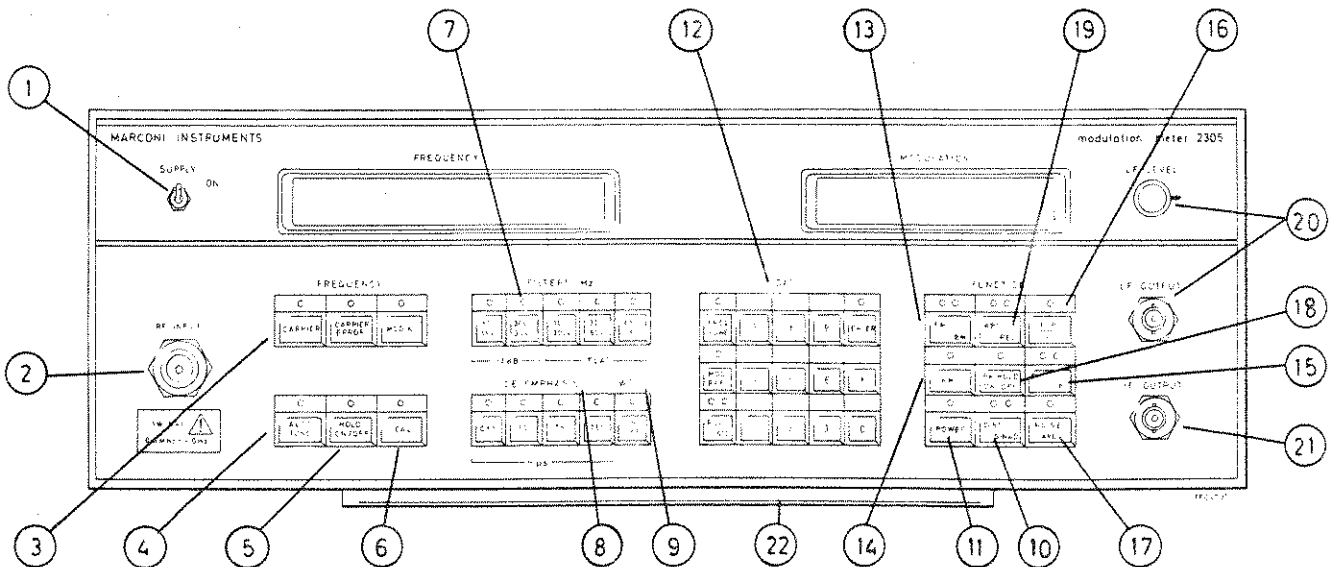

Fig. 2 Front panel controls and connectors

7. (1) SUPPLY switch : sole means of connecting the a.c. supply to the instrument circuits.
- (2) RF INPUT : point of entry for the measurement signal.
- (3) FREQUENCY keys : allow the FREQUENCY display to be used for three separate frequency measurements.
- CARRIER : frequency of input signal carrier.
- CARRIER ERROR : frequency difference between instantaneous measurement of signal carrier and a stored value.
- MODN : frequency of modulation tone (modulation rate).
- (4) AUTO-TUNE : causes instrument to sweep through its tuning range and to lock-on to the largest signal detected.
- (5) HOLD ON/OFF : enables all measurement functions to be frozen in their current states.
- (6) CAL : causes calibration of the modulation measuring circuits to be realigned to the internal a.m. and f.m. standards and sets the signal detection threshold for optimum sensitivity.
- (7) FILTERS : give choice of pass band characteristic.
- (8) DE-EMPHASIS : gives choice of 4 f.m. de-emphasis time constants (including zero).
- (9) WTC - ON/OFF : when DIST SINAD option is fitted, enables whichever of the CCIR, CCITT weighting circuits has been installed by second function action to be introduced by a single stroke of this key.
- (10) DIST SINAD : introduces the optional accessory and presents the distortion of the modulation tone in either form. This key is in-operative if the option is not installed.
- (11) POWER : causes power content of input signal to be displayed in units selected by second function. Measurements may be referred to the input side of externally mounted power attenuators.
- (12) DATA keypad : provides for the entry of numerical data for tuning or reference purposes. ENTER key terminates entry in normal use but precedes two digit number entries for second function operations. When the ENTER key is operated first, its key active light remains ON to indicate that entries are for second functions. Up to 10 sets of control settings may be stored and recalled via RCL/STO in normal operation. In second function mode this key is used to terminate data entry and return to normal mode.
- (13) FM  $\phi$ M : gives choice of angle modulation type for main function, f.m. in kHz,  $\phi$ .m. in radians.
- (14) AM : selects a.m. as main function (%).
- (15) P+, P- : gives choice of peak or trough measurement.
- (16)  $\frac{P-P}{2}$  : causes average of P+ and P- to be displayed.

(17) NOISE AVG : changes from peak responding to average responding modulation measurement. Calibration is the peak value of equivalent sine wave.

(18) PK HOLD, ON/OFF : stores, and holds in display, the largest value appearing during any period of measurement while the key is active.

(19) ABS REL : enables modulation functions to be carried out as an absolute or relative measurement.

(20) LF OUTPUT : filtered, weighted, demodulated signal fully controllable by LF LEVEL control. The index mark corresponds to the overload point and the onset of distortion for signals giving indications approaching the nominal range full scales of 1.5, 5.0, 15 etc.

(21) IF OUTPUT : a buffered output at low impedance.

(22) PULL-OUT CARD : gives summary of operating instructions and error codes which may occur in normal operation.

Rear panel features

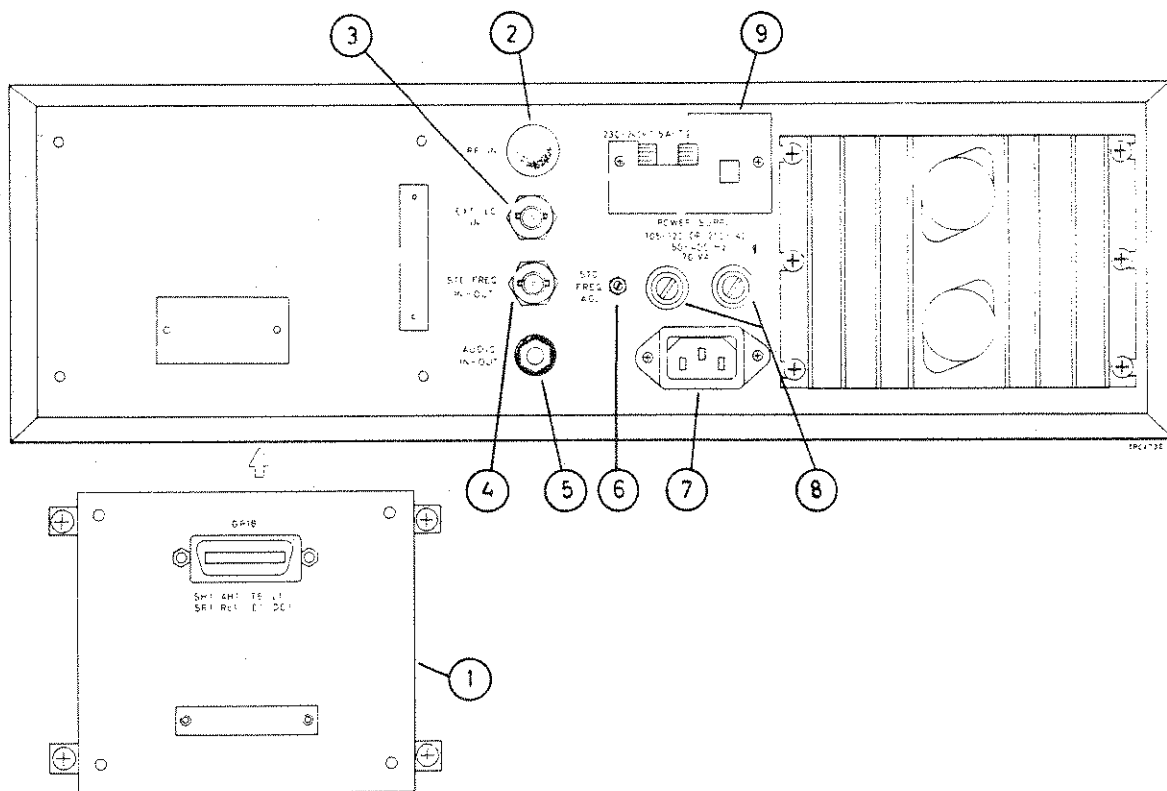
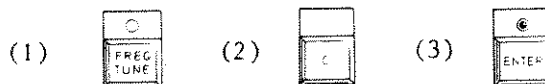

Fig. 3 Rear panel controls and connectors

8. (1) REMOTE CONTROL GPIB INTERFACE, optional accessory.
- (2) Optional position for r.f. input connection.
- (3) EXT. LO IN : connection point for external local oscillator.  
EXT. LO is switched in by the data pad entry sequence :



- (4) STD. FREQ IN-OUT : buffered output point for internal 10 MHz standard when this is in use. Entry point for external standard when switched in by second function keying.
- (5) AUDIO IN-OUT : enables an external filter to be inserted into the audio signal path without disturbance to the internal filters.
- (6) STD FREQ ADJ : screwdriver slot adjuster enables standard frequency to be varied over a range of about  $\pm 5$  p.p.m. to align with an external standard.
- (7) Standard receptacle for mains connector.
- (8) Mains supply fuses.
- (9) Mains supply voltage adjusting switches and locking plate - see Chap. 2, para. 4.

LCD annunciators

9. Annunciators associated with the numerical l.c.d's are activated as necessary to give supporting information with respect to the units of measurement and the functional state of the instrument as shown :

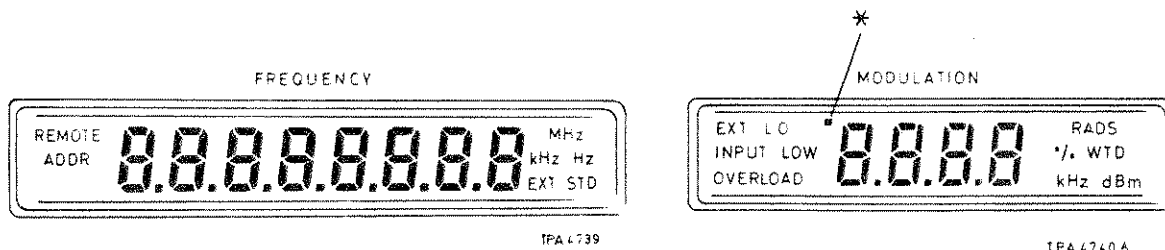

Fig. 4 Frequency display

Fig. 5 Modulation and power display

\* This small elevated 'point' preceding the numbers is activated when SRQ is requested under GPIB operation.

(1) Annunciators, FREQUENCY display.

REMOTE : Instrument has been switched to remote operation following receipt of a command from the bus controller.

ADDR : Instrument has been correctly addressed and is ready for data.

EXT. STD. : Instrument has been switched to accept an external standard frequency signal.

(2) Annunciators, MODULATION display.

EXT. LO. : Instrument has been switched to accept an external local oscillator. The frequency display now shows the i.f.

INPUT LOW } : Signal input outside the instrument's dynamic range.  
OVERLOAD }

WTD : CCIR or CCITT weighting circuit has been introduced. If the SINAD option is not installed, the WEIGHTING key and the annunciator are both inoperative.

dBm, %, RADS, kHz : Units of measurement.

### PREPARATION FOR USE

10. After the 2305 has been properly installed with connection made to a suitable mains supply, switch on. The instrument will now enter a series of self checks and its progress will be monitored on the FREQUENCY display in the way shown in Fig. 6. A fault appearing during memory checks will result in a brief display of a letter H (RAM fault) or P (PROM fault). Such a fault would probably also appear as an operating malfunction and as such would impede progress in the six sets of measurements which now begin on the analogue measuring circuits and are monitored by the gradual advance of the decimal points across the display. When all six sets are complete, nine derived test results are calculated in sequence and each result is compared with a result stored from the same test when made at time of manufacture. A test is failed if the current result differs by more than 5% from the stored reference and will cause the sequence to stop at that point with a display of the test number concerned. If all tests are satisfactory the 2305 will display PASS and then move into its power-up status. This may be the standard power-up status of the instrument as supplied, or it may be any set of operating conditions introduced by both first and second keyboard functions and entered into STORE 0. 'Standard' power-up status confers the following control settings which are considered to be those most commonly required :

FREQUENCY display	- CARRIER
AUTO-TUNE	- ON
FILTERS	- 10 Hz to 300 kHz (maximum bandwidth)
DE-EMPHASIS	- OFF
FUNCTION	- ABS., FM, $\frac{P-P}{2}$

Whether the 2305 powers-up to the standard status or to a special set of operating conditions is determined by the state of second function 24. This may be found from the second function status display described in para. 36 (01) on page 15. For standard power-up status (2305 as supplied) second function 24 will have status 0 and for power-up to store 0 it will have status 1.

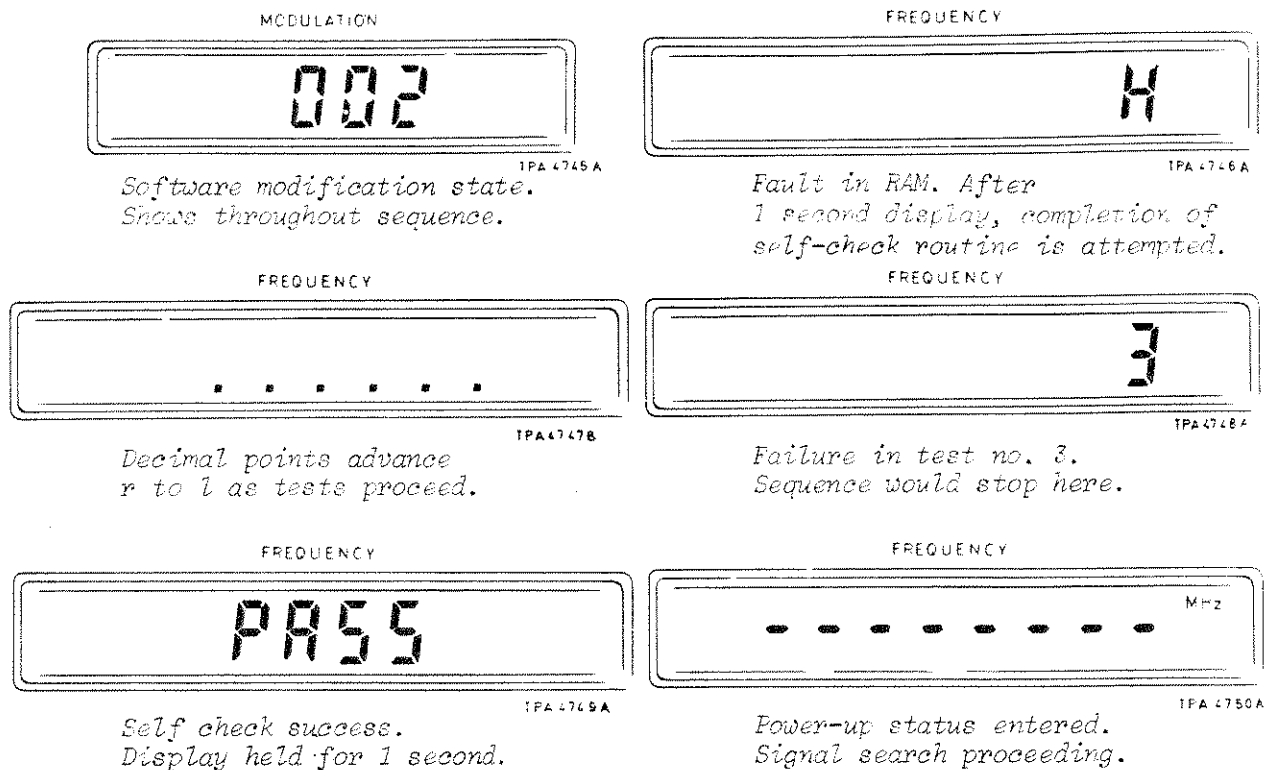

Fig. 6 Normal and possible fault condition displays occurring during power-up sequence

11. The row of 8 dashes that appears across the FREQUENCY display at this stage is an indication that the 2305 is actively searching in the AUTO-TUNE mode but has not yet found a signal. It is also listed under ERROR CODE 50.

12. The PASS indication shows that there has been no abnormal deterioration in the measurement circuits which should not and cannot be calibrated out by operation of the CAL key. Until the next operation of the CAL key, measurements continue on the basis of the recalibration data acquired at the last operation regardless of the number of switch-on sequences that may have occurred between. If a test is failed during self-check, normal operating conditions may be obtained by entering AUTO-TUNE unless the circuit failure concerned has been catastrophic. The level of uncertainty in any measurements made with the 2305 in this state will, however, be undefined.

13. The 3-digit number 001, 002 etc. which also appears in the MODULATION window during the self-check routine is an indication of the software modification state built into the instrument.

#### OPERATING PROCEDURES

14. When, following switch-on, the 2305 enters the standard power-up status and a signal within its dynamic range is connected to the RF INPUT, the 2305 will tune to the signal and display the carrier frequency and any frequency modulation present. The INPUT LOW annunciator will go out. The 2305 can follow drifts in signal carrier frequency up to rates of tens of kHz per second, the limit being dependent on the carrier frequency. If the maximum rate is exceeded as might happen, for example, if a signal generator frequency range was changed, it is possible for the 2305 to be prevented from entering a complete new auto-tuning cycle by an apparent signal acquisition which is, in fact, spurious. The condition is accompanied, typically, by a frequency display that is noisy or grossly in error and by over-ranging in f.m. measurements. To be safe re-enter AUTO-TUNE after changing frequency.

Modulation measurement

15. (1) Select AM, FM or  $\phi$ M as required. The MODULATION display will auto-range as required for maximum resolution. If it is necessary to override the auto-ranging action in order to retain a particular range, it may be done via Second function 36, see page 19.

(2) Select ABS for absolute measurement in :

% AM,

or kHz deviation FM.

or radians  $\phi$ M.

(3) Select  $\frac{P-P}{2}$  and note the reading.

If any modulation assymetry is suspected it may be measured by operating P+ and P- alternately.

(4) Select an alternative FILTER if required.

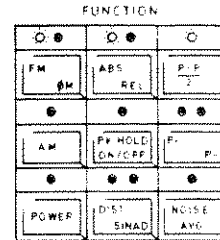
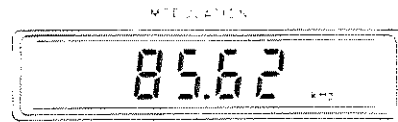

Relative modulation

16. (1) To relate measurements to a pre-determined figure e.g. 25 kHz deviation or 80% a.m. :

Enter MOD REF on the keypad



This action will also activate the

REL function if not already carried out.

Then follow with the numbers of the reference quantity and



In the event of a mistake when making a keypad entry, press



and start again. When AM is selected, the numbers are automatically interpreted as % AM. Similarly, for FM and  $\phi$ M, the unit quantities are known from the FUNCTION that has been selected. The modulation measured will now be displayed in dB relative to the quantity entered. In relative modulation, the signal measured may be shaped by de-emphasis or by the weighting filters if required.

(2) To measure changes in modulation relative to a reference measurement. The 2305 will be in the ABS mode. When the reference measurement is

made, press



. This measurement will then automatically transfer

to store and all subsequent modulation will be expressed as dB referred to this quantity.

Note. A combination of deep a.m. and high modulation frequency may cause difficulty in auto-tuning. Should this occur, reduce the modulation briefly or increase the signal until tuning is achieved.

Modulation frequency measurement

17. Press the



FREQUENCY key. The FREQUENCY display will auto-range

to give the appropriate resolution.

Display ranging



18. The FREQUENCY display makes use of all 8 digits when in CARRIER mode, for frequencies down to 100 MHz. Resolution is, accordingly, 100 Hz for

carrier frequencies of 1 GHz and above and 10 Hz below. Below 100 MHz resolution stays fixed at 10 Hz with suppression of leading zeros. In CARRIER ERROR mode, resolution is 10 Hz at all frequencies. In MODX mode, resolution is 0.1 Hz below 5 kHz and 10 Hz above. The MODULATION display makes use of all four digits independently of the position of the decimal marker, which moves in response to changes in modulation as required by the fixed units kHz, 7 or rads, until the displayed quantity 5000 is exceeded. Before the quantity 6000 is reached the least significant digit becomes a fixed zero leaving 3 useful digits up to the full-scale display of 9990.

#### Noise averaging

19. With the 2305 measuring a modulated signal, turn off the modulation. The least significant digit of the MODULATION display will now be fluctuating in a random manner as the instrument measures the spurious, residual modulation. This is likely to be a larger quantity with an f.m. source than with a.m.

Press  and notice the reduction in fluctuation. Use this key when making signal to noise, relative, measurements. Note that the NOISE AVG calibration is of the peak value of the equivalent sine wave so that both noise and modulation measurements are reduced to quantities of the same kind.

20. This fact may be verified by using a test signal with good quality sinusoidal modulation. When  and  are operated alternately there will be no significant difference in indicated modulation although the detectors will be average and peak responding respectively.

#### Correction for noise

21. A noise measurement can be converted to a relative quantity by pressing



when the 2305 is measuring the total of signal plus noise. If the modulation is now turned off leaving only the noise component, the 2305 will measure this and display it as dB down. If the quantity is too large to be neglected it may be applied as a correction by subtracting the noise fraction from the modulation measurement. As both the measured quantities are peak values, they combine arithmetically.

#### Use of CAL (calibration) key



21a. The 2305 may be put into its recalibration routine at any time by operation of the  key. The instrument will first carry out the self-check routine and only after satisfactory completion of the nine circuit tests will changes be entered into the 'last user calibration' data if any are needed to ensure correct measurement of the internal standards. The 2305 then reverts to its original status. The effect of CAL key operation can be restricted solely to the self-check function if it is required to remove the recalibration capability from operator control. This requires access to second function 40 and the procedure is described in Vol. 2 of this manual. The 2305 is supplied with the recalibration action asserted and its use is necessary in order to obtain the full specified performance. CAL key operation may need to be more frequent when environmental changes occur or when it is necessary to use the 2305 immediately following switch-on. Practical experience in any one set of circumstances having regard to the time available for recalibration and the size of the changes introduced, will probably dictate the frequency of use.



Input overload protection : trip and reset

22. Normal ranging within the 2305 will enable the measuring circuits to accommodate inputs up to 1 W (+30 dBm). Above this level, the OVERLOAD annunciator will light up and at 2 W (+33 dBm) the input protection will introduce an open circuit at the input terminal. The instrument will enter an error mode (07) and will cause the active light on the POWER function key to flash regularly. To reset the instrument, first remove the overload and press the POWER key once.

Manual frequency tuning

23. The non-automatic tuning mode may be required if several signals of comparable strength are present. Select (1)  on the keypad followed by the numerical frequency data in MHz and (2) . The AUTO-TUNE key will have cancelled. The FREQUENCY display will be of the measured signal frequency as before, provided that the numerical entry is close enough to the signal frequency for the i.f. to be within the pass band. Press  to display directly any difference between the measured and the entered frequencies. So long as the signal components remain within the pass band of the i.f. amplifier the CARRIER ERROR mode will monitor drift in the carrier frequency and the modulation measurement circuits will function.

Use of External local oscillator

24. An external low-noise local oscillator within the range 28 to 56 MHz may be substituted for the internal oscillator. Connect the oscillator to the appropriate BNC socket on the rear panel. The input impedance is 50 Ω and a terminal voltage of between 100 mV and 1 V is required.



The MODULATION display will now show EXT LO, the FREQUENCY display will be of the i.f., the Auto-tune process is inhibited and the input signal and external local oscillator are both connected to the sampling gate mixer. The external local oscillator frequency should produce an i.f. of 1.5 MHz ±150 kHz for input signals within the frequency range of 28 MHz to 2 GHz. In order to retain the normal polarity sense in demodulation (positive frequency modulation excursions are measured in the P+ mode) the local oscillator frequency should be chosen from within the permissible range as that which satisfies the relationship.

$$\text{Local oscillator frequency} = \frac{\text{signal frequency} + 1.5 \text{ MHz}}{N}$$

with the smallest possible integral number for N. As there are 36 possible integers for signal frequencies of 2 GHz, falling to 10 for inputs of 560 MHz, it is only signal frequencies in the low hundreds of MHz and below that will require local oscillator frequencies to be substantially more than 10% below the 56 MHz upper limit. It is assumed that, for this particular measurement refinement to be worthwhile, the external local oscillator in question will be based on specially ground quartz crystals and that the possibility of obtaining a valid i.f. display by exciting a spurious response with a variable frequency oscillator does not arise. The displayed i.f. may be allowed to depart from the nominal 1.5 MHz by as much as ±150 kHz without incurring the risk of an increase in measurement uncertainty.



Distortion measurement and psophometric weighting (requires incorporation of options kit 46883-527G)

25. To include a psophometric weighting network in the measurement circuit,

press . Either the CCITT or CCIR network will now be introduced

depending on which has been pre-selected for first function entry by operation of first level protected second function 25. Guidance in this operation is given in a later section devoted to second functions, starting at para. 30. If the options kit has not been installed, error code 06 will be displayed. Weighting is only introduced into relative and distortion measurements. The action of the weighting network or any other filter selected is, however, always present in the LF output signal.

26. To measure distortion, first ensure that the test signal has single tone modulation within  $\pm 5\%$  of one of the three standard frequencies 300 Hz, 500 Hz or 1 kHz. As soon as the signal is tuned and the desired level of modulation

is displayed, operate  or  depending on which form of measurement is wanted. If the modulation frequency is within acceptable limits, fundamental rejection will take place and the distortion factor or SINAD will be calculated and displayed, distortion factor in percent and SINAD in dB.

27. The measurements are based on the usual relationships :

$$\text{Distortion factor} = \frac{\text{Distortion products} + \text{noise}}{\text{Signal} + \text{distortion} + \text{noise}} \times 100 \%$$



where noise is understood to include all components apart from signal and harmonic distortion, and

$$\text{SINAD} = 20 \log \frac{1}{\text{Distortion factor}} \text{ dB}$$

If the error code 59 is displayed, the circuit has failed to produce a frequency notch and the modulation tone should be adjusted to bring its frequency closer to the nominal value.





28. The 2305 average detector is automatically selected for distortion measurement and, in most practical measurement situations, introduces insignificant error in approximating to the r.m.s. response that is theoretically required. The minimum fundamental rejection of 65 dB is compatible with a 0.1% total harmonic distortion measurement and the overall accuracy specification of  $\pm 1$  dB.

29. If the modulation frequency is changed to another standard tone when in DIST/SINAD function, it will be necessary to leave and re-enter the function

by operating another function key, say , followed by  again in order to be certain of obtaining a notch at the new frequency.

Store and recall of control settings

30. To store the 2305's current set of operating conditions, operate

  one of store nos.0-9. These conditions may now be reproduced at any future time by recalling the same store number i.e.   required store no.

when the 2305 will be returned to the same state of operation that it had when the particular store was entered. The data stored therefore includes all keyboard functions, all numerical reference data entered and any 'storable' second functions which may have been introduced. Each time a store is entered existing data is overwritten by the new entry.

## KEYBOARD SECOND FUNCTIONS

31. Second functions are identified by two digit numbers. Numbers from 01 to 52 are allotted although several are spare. The group allocation is as follows :

01 to 15	Unprotected access (group P0)
16 to 39	First level protected (group P1)
40 to 45	Second level protected (group P2)
46 to 52	Third level protected (group P3)

32. To introduce a second function, use the two digit number preceded by the ENTER key. Prior use of the ENTER key in this way causes its active light to come on to indicate the existence of the second function mode. To leave a second function, press any normal function key or use ENTER again.

33. After entry, the second function appears as a 2-digit number in the modulation display. The frequency display may show any of four possible responses :

- (1) No response, i.e. the second function does not exist or is locked.
- (2) Display goes blank and is awaiting the entry of data.
- (3) It shows the current value of some variable, this may be one or more digits with or without decimal points or other symbols such as '-', or 'A'.
- (4) It displays a changing 4-digit number which represents an internal voltage.

### Data entry

34. Once accessed most second functions require a data entry which may be simply a 0 or a 1 or more as in function 02 GPIB address, which is a 2-digit decimal number. On access, the current state of the data is shown on the right-hand side of the frequency display. When new data is entered and is accepted as being in the correct format, it will appear in the left-hand side.

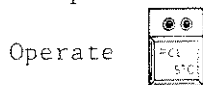

Operate  to store the new data which will then transfer to the right-

hand side of the frequency display, displacing any earlier entries. If the 2305 is in local control, this display will last for 1 second after which the active light on the ENTER key will go out, and the 2305 will return to normal operation. When in REMOTE mode there is no pause for display.

### Data volatility

35. In groups P0 and P1, some second functions have their related data stored in volatile memory so that each switch-on finds these functions in their non-asserted state. The important exceptions are functions covering such items as GPIB address, source of frequency standard, SRQ mask etc. which are stored in non-volatile memory. In a number of cases, data which would normally be volatile may, optionally, be entered into one of the instrument's stores (0-9) together with all the related control settings. Functions belonging to these

groups are identified as 'non-volatile' and 'storable' respectively in the list which follows.

SECOND FUNCTIONS 01 TO 15 (GROUP P0, UNPROTECTED)

36. These functions, which may be entered directly without unlocking are as follows.

SF01 Second function status

In this function, the status of those second functions that are important to the basic operation of the instrument is shown using both the frequency and modulation windows to display the digits concerned, thus :

G G.S C.D.P

W.I.B.M U

where the digits represent the following.

			<i>Second function</i>	<i>Protection</i>
GG (00 to 30)	= GPIB address	-	02	None
S (0/1)	= SRQ enable	-	19	First level
C (0/1)*	= Calibrate mode	-	40	Second level
D (0/1)	= Power-up mode	-	24	First level
P (0 to 3)	= Protection state	-	-	-
W (0/1)	= Weighting filter	-	25	First level
I (0/1)	= ILS filter	-	28	First level
B (0/1)	= 30 kHz B/W	-	27	First level
M (0 to 4)	= Power measurement offset	-	30	First level
Annunciator u				
W	Power units watts	-	29	First level
dBm	Power units dBm	-	29	First level

The second function status display for the 2305 'as supplied' will appear as below :



TPB 4881

SF02 GPIB address (non-volatile)

Any number from 00 to 30 will be accepted. If the GPIB option is not fitted, a double dash - - will appear instead of the 02 code when this function is entered.

SF03 GPIB option : auxiliary output (possible future development)

Enables a 8 bit number to be stored in the 2305 for transmission via an auxiliary output on the GPIB accessory. Enter 8 x 0/1. The auxiliary output is intended for the control of simple apparatus not having full GPIB interface capability.

\* The function of the CAL key may be re-allocated via Second function 40 to perform either the full recalibration process or the self-check routine as introduced automatically during power-up. Instruments are supplied with Second function 40 asserted and the CAL key assigned to the recalibrate mode.

SF04 Select external frequency standard (non-volatile)

Enter 0 for internal, 1 for external. When re-entering this function in order to return to internal, it is necessary to operate the keying sequence slowly if the external source has already been removed.

SF05 Display mixer level

Displays a 4-digit number in the right-hand side of the frequency window being the output from the volts/frequency converter with the mixer level detector connected. The number is not readily calibratable but is useful in fault diagnosis.

SF06 Display IF level

As function 05, but with the IF level detector substituted.

SF07 Display demodulated audio (pre-filter)

As function 05, but with substitution of the detector monitoring the output of the l.f. amplifier (A9) prior to filtering on the A10 board.

SF08 (followed by a selection digit) Voltmeter input

<i>Selection digit</i>	<i>Voltmeter input</i>
0	Peak -ve
1	Peak +ve
2	Averaging detector
3	RF power detector
4	IF level detector
5	Zero reference
6	Mixer level detector
7	Demodulated audio

As function 05, but with the other voltmeter inputs not so far included. Note that when the instrument bases a measurement on any of the volt/frequency conversions, it first supplies a zero voltage input to the converter and notes the magnitude of the offset. This offset is displayed on input 5. The quantities available for display on function 08 are not corrected for this offset but those on functions 05, 06 and 07 are.

SF09 Synthesizer/counter self check

This function exercises the synthesizer control logic and checks the adjustment of the oscillator coils. Any failure in this test would result in the 2305 entering error code 13. The number 13 would then be transmitted via the bus if the 2305 was asked to 'Talk Error' but the only display in the FREQUENCY window would be of a two-digit number representing the particular test in which failure had occurred.

SF10 FM calibrator - wide deviation

This signal will be present at the i.f. output socket on a 1.59375 MHz carrier.

SF11 FM calibrator - narrow deviation

This signal will be present at the i.f. output socket on a 1.50 MHz carrier.

SF12 AM calibrator





The a.m. calibration signal will appear at the i.f. output socket on a 1.50 MHz carrier. Each time this function is entered, the calibrator signal appears for 10 seconds after which the 2305 reverts to normal operation.

Second functions 13 to 15 inclusive are spare.

**SECOND FUNCTIONS 16 TO 39 (GROUP P1, 1ST LEVEL PROTECTED)**





37. Second functions 16 to 18 inclusive are spare.

To unlock the first level of protection

Press and release (1)  (2)  Press  again then 

holding both keys down until a 1 shows in the frequency display. This takes about 5 seconds. Then leave the unlocking mode by pressing  again

(or almost any other function key). The protected second function may now be entered in the same way as an unprotected function. Protection is automatically restored by a supply switch operation or, alternatively, by pressing

(1)  (2)  (3)  (again) and (4)  again - or another function key.

NB. No locking or unlocking action is needed when access to the protected second functions is made via the GPIB.

SF19 SRQ enable

To enable the SRQ, enter 1; to disable the SRQ, enter 0. Disabling will remove any pending SRQ.

SF20,21,22,23 SRQ mask 1, 2, 3, 4 (non-volatile)

Allows any number of error conditions to be masked off from asserting an SRQ. To generate a mask, enter 0 or 1 as necessary (0 = unmasked, 1 = masked) according to the following scheme.

	<i>Error number</i>
Second function 20 :	00* 01 02 03 04 05 06 07
Second function 21 :	08 09 10 11 12 13 14 15
Second function 22 :	48 49 50 51 52 53 54 55
Second function 23 :	56 57 58 59 60 61 62 63

The 0/1 digits enter the FREQUENCY display from the right and the mask is generated by placing a 1 in the same position in a row as the error number to be masked. Unmasked errors attract a 0.

SF24 Power-up mode (non-volatile)

Allows the 2305 to power-up to a particular batch of control settings entered in store 0 instead of the standard power-up status. To default to the standard status enter 0; to recall 0, enter 1.

\* The number 00 is not an error code but is allocated to the 'Ready SRQ'. If 00 is masked, Ready SRQ will not be transmitted.

SF25 Select weighting filter (non-volatile)

To select the filter introduced by the WTG ON/OFF key, enter 0 for CCITT, 1 for CCIR.

SF26 Measure with de-emphasis

To introduce the de-emphasis time constants into the measurement circuit, enter 0 for off, 1 for on.

Note ...

This special requirement should be introduced with care as the de-emphasis will affect all modulation measurements and there is nothing on the front panel to indicate that the introduction has been made. As the function is volatile it will clear to the normal mode as soon as the 2305 is switched off.

SF27 Force 30 kHz bandwidth (storable)

This function causes a 30 kHz low-pass filter that is normally automatically switched out of use when input signal frequencies are above 5.5 MHz, to remain effective for all signals. This enables some channel separation to be carried out within the 2305 as, for example, when high frequency digital information might wind back the ranging in the l.f. amplifier and cause a low frequency voice channel to be lost. The 'forced' bandwidth precedes the l.f. amplifier whereas the panel controlled filters follow it. Enter 0 for 30 kHz off, 1 for 30 kHz in.

SF28 ILS filter (storable)

This function selects the 15 kHz low-pass filter separately from and without any accompanying high-pass section. This provides sufficient high frequency bandwidth for the a.m. ILS signal without admitting an excessive amount of noise. Its special merit is the absence of dispersive effects at the low modulation frequencies employed which would be caused by inclusion of a high-pass section. Enter 1 for on, 0 for off. For AM, select AM and the 10-300 k filter, for FM or to change from AM to FM, select FM and the 50-15 k filter. When the 0-15 k ILS filter has successfully been selected, the l.e.d's in the 50-15 k and 10-300 k filter keys will light simultaneously. Note that when the state of second function 28 is returned to 0, the filter will remain active, with both l.e.d's on, until an alternative filter is selected.

SF29 Power units (non-volatile)

Input power may be displayed either as watts or dBm. Enter 0 for dBm, 1 for watts.

SF30 Power offset modes (storable)

Enter 0 for no offset, 1 - 4 for offset modes as below :

SF31 Enter value (in dB) of added external attenuator (mode 1). (non-volatile)

SF32 Enter power ref. 1 (mode 2). (non-volatile)

SF33 Enter power ref. 2 (mode 3). (non-volatile)

SF34 Enter power ref. 3 (mode 4). (non-volatile)

Mode 1 allows calibration of the extended power range to be derived from a calibration of the external power attenuator.

Modes 2-4 allow calibration of the extended power range to be derived at three standard power levels which can be supplied to the 2305 input with the known values entered for each mode.

Data entered for these modes is all non-volatile. More detailed guidance in the use of power offsets comes in the next section, beginning at para. 42.

SF35 Set input attenuator setting (storable)

Enter 5 for setting 0 dB, 4 for 7 dB, 3 for 14 dB etc. to 0 for 35 dB. Any number greater than 5 restores automatic operation.

SF36 Set switchable gain range setting (storable)

Enter 0 to 5 for settings 0 dB, 10 dB etc. to 50 dB. Any number greater than 5 restores automatic operation.

SF37 Set options board gain setting (storable)

Enter 0, 1 or 2 for settings 0 dB, 10 dB or 20 dB gain. Any number greater than 2 restores automatic operation.

SF38 Set options board notch selection (storable)

Enter setting 0 to 3 for setting required.	0 - No notch, 1 - 300 Hz notch, 2 - 500 Hz notch, 3 - 1 kHz notch.
---	---

Any number greater than 3 restores automatic operation.

SF39 Restore second functions 35, 36, 37 and 38 to automatic operation

When this function is entered, the four setting functions are simultaneously restored to automatic operation.

When any of these second functions is entered, the setting digit corresponding to the range selected at that time in the element concerned will be displayed in the FREQUENCY window. The digit will be accompanied by one of the following letters as appropriate:

A - automatic mode  
H - held mode  
P - set mode

38. Second functions 40 to 52 comprise the groups P2 and P3 which relate to the 2305's fundamental calibration and which have higher levels of protection. Details concerning their use are given in the Service Manual.



Power measurement

39. Power entering the RF INPUT terminal of the 2305 that is within the range 10 mW to 1 W (+10 dBm to +30 dBm) may be measured by operating  .

The measured quantity will then be displayed in the MODULATION window as a 4 digit number in a single fixed measurement range of 1 W or +30 dBm full-scale. Whether the units of measurement are watts or dBm depends on the state of second function 29 which is non-volatile and has to be re-entered if a change of state is required. The discrimination represented by the least significant digit in the display is 1 mW or 0.01 dBm respectively.

40. If an accidental power overload occurs, the input protection relay will trip open to protect the instrument. The tripped state is indicated in 3 ways. The light on the POWER key will flash, the INPUT OVERLOAD annunciator is active and error code 07 shows in the FREQUENCY window. When the overload has been removed, the relay may be reset by a further operation of the POWER key which will also return the alarm indicators to their normal state.

41. If an external power attenuator is connected to the input of the 2305 in order to increase the upper limit of signal power that may be accepted from a source, it is possible to enter calibration data into the instrument so that an r.f. power measurement can be referred to the attenuator input with direct indication given of the power entering that terminal. The calibration is entered as a measured value for the external attenuator (second function 31) or as the value - in watts - of a standard power input to the attenuator. Up to 3 such power calibrations may be stored, via second functions 32, 33 or 34, so enabling particularly good accuracy to be associated with r.f. level in 3 individual sets of test conditions. The method is entitled 'Power offset mode' and requires the use of second functions within the first level of protection which must be unlocked before entries can be made.

Use of power offset mode

42. To enter power offset data, unlock the first level of protection and proceed as follows :

(1) Entry of external attenuator value (second function 31). Operate keyswitch sequence :

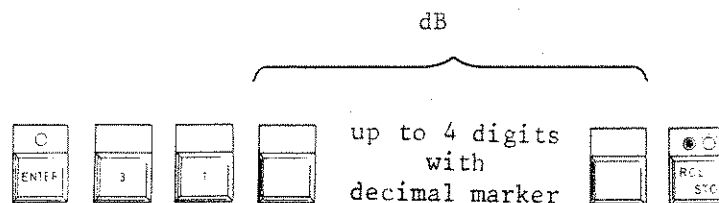

The upper limit for attenuation is 50.00 dB.

(2) Entry of standard power level (second functions 32, 33 and 34)  
Operate keyswitch sequence :

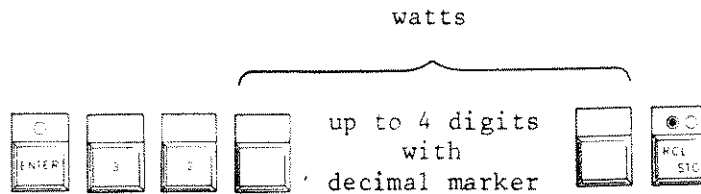

The upper power limit is 999.9 watts.

(3) Register choice of offset mode 1, 2, 3 or 4 with offset mode selector (second function 30). Operate keyswitch sequence :

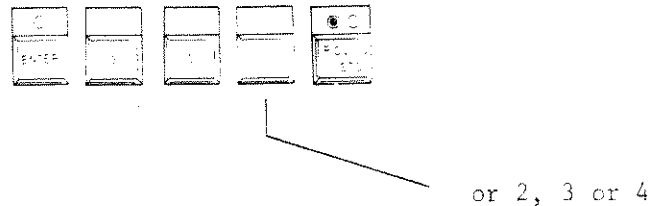

43. The offsets themselves will be in non-volatile memory, but the choice of mode selected for introduction by second function 30 will be volatile. It may be stored, along with other data relating to operating status, in any of the 10 main instrument stores for subsequent recall as a test routine needed for use over an indefinite period. If not stored, the offset will lapse to mode 0 (no offset) when the 2305 is switched off. To retain the offset mode in non-volatile memory :

(1) Verify that the choice of offset mode is correct by entering either of second functions 01 (second function status) or 30 (offset mode). Then leave second function mode.

(2) Set the instrument up to receive and measure the unknown signal with the calibrated external attenuator in position. If the POWER mode is entered the 2305 will now incorporate the selected offset either as dB or as a level correction based on the standard level used in second function 32, 33 or 34 and will display the signal power level. Note that the display units may be either watts or dBm even though the calibration power levels must be entered in watts.

(3) Operate



store no. 0 to 9

All the operating conditions then current will be entered in the selected, non-volatile store including the selected power offset. Any of the other stored offsets may be introduced in similar fashion, together with whatever additional control settings might be required, and entered in an empty instrument store. Note that offset storage does not require the 2305 to be necessarily in the POWER FUNCTION in this process.

44. Calibration of offset modes 2, 3 and 4 is entered in watts but is converted by the microprocessor into an equivalent attenuation in dB linking the two power levels (1) into the external attenuator and (2) as measured in the 2305. In this way the offset mode calculation carried out in each successive measurement is the same for these three modes as for mode 1. If any of second functions 32, 33 or 34 is re-entered after calibration has been assigned, the figures appearing in the right-hand four digits of the FREQUENCY display will be of this calculated equivalent attenuation.

#### ERROR CODES

45. An error code is a two digit number which appears centrally in the FREQUENCY display. It should not be confused with the single digit codes (1 to 9) which appear on the right-hand side of the display during the self-check procedure if a fault is found in any of the measurement circuits. See also para. 10 and Fig. 6 in this chapter. For control purposes errors are divided into two groups according to origin. Errors which arise from an operator's mistake or from a condition in the 2305 are coded 01 to 47. Errors created by a condition of the signal, e.g. frequency out of instrument's range, are given numbers greater than 47. A total of 25 error codes have so far been created.

46. Once an error occurs, further measurement stops until it is cleared. An operator induced error is cleared by the introduction of another function. An error due to an incompatibility in the signal clears as soon as the incompatibility is removed.

47. While the error state persists, GPIB strings are not updated and are preceded by the letter E. If the SRQ is not disabled (second function 19) and the particular error code is not masked, SRQ is asserted for errors coded 47 or less. Signal induced errors (codes greater than 47) do not give rise to an SRQ unless the 2305 is asked to talk frequency or modulation while the error persists.

<i>Error code number</i>	<i>Description</i>
01	Entered data outside limits.
02	Key pressed conflicts with modulation type e.g. de-emphasis with a.m.
03	PEAK HOLD not allowed. (PEAK HOLD is permitted only on ABS measurements).
04	Measurement instruction cannot be changed while HOLD is ON.
05	Illegal numerical entry (e.g. FREQ TUNE or MOD. REF. were not pressed first).
06	Option not fitted.
07	RF input protection tripped. To clear, remove overload and press the POWER function key.
08	Counter error (usually due to external standard being selected but not connected).
09	Unrecognized GPIB character pair.
10	System error - very unlikely - arises from software or hardware fault.
11	Bus error.
12	Calibration tolerance exceeded.
13	Synthesizer/counter self check error.

<i>Error code number</i>	<i>Description (signal incompatibility)</i>
48	Unallocated.
49	
50	No signal applied in AUTO TUNE mode. Displayed as - - - - -
51	Mixer overdriven, e.g. if input attenuator has been held at too low a setting using second function 35.
52	Applied signal carrier frequency appears to be outside range.
53	IF level too high. Automatic operation has been over-ridden.
54	IF level too low. May come on briefly during normal auto-tuning. Try operation of CAL keyswitch in order to optimize detection threshold.

<i>Error code number</i>	<i>Description (signal incompatibility)</i>
55	Modulation over range.
56	Small i.f. error.
57	Large i.f. error. IF errors can be caused by signal drift or, in manual operation, by a revised entry in tuning. A small error (56) will be corrected in automatic mode by slight readjustment. A large error will cause the AUTO TUNE cycle to start over again if this mode is operative.
58	Power display over-range. Occurs when the ranging capability is exceeded. (999.9 W in external attenuator mode.)
59	Cannot select notch. When using Distortion/Weighting Filter, signal frequency is not within $\pm 5\%$ of any of the three design frequencies.
60	Options board over-range. When gain setting is held high by second function intervention.
61	Voltmeter over-range. Could be on any voltmeter function. It may arise from a circuit malfunction including, possibly, the voltmeter itself.

#### GENERAL PURPOSE INTERFACE BUS (GPIB) FUNCTIONS

48. The GPIB interface, offered as an optional accessory, allows the instrument to be coupled to a controller. The essential purpose of the GPIB functions is described below. Further information on the general features and applications of the GPIB system can be obtained from the separate GPIB manual offered as an optional accessory.

49. The 2305 has both talker and listener capabilities. One address is used for both talking and listening and is set via the front panel or via the GPIB using a second function. The instrument can request service (assert SRQ) in certain conditions under the control of an SRQ mask which is set by second function entries.

50. Once addressed via the GPIB, the keyboard is locked out to guard against accidental disruption. Local control can be recovered by operating , unless Local Lockout has been asserted by the controller.

#### SH1: Source handshake (complete capability)

The source handshake sequences the transmission of each data byte from the instrument over the bus data lines. The sequence is initiated when the function becomes active, and the purpose of the function is to synchronize the rate at which bytes become available to the rate at which accepting devices on the bus can receive the data.

AH1 : Acceptor handshake (complete capability)

The acceptor handshake sequences the reading of the data byte from the bus data lines.

T6 : Talker function (no talk only function)

The talker function provides the 2305 with the ability to send device dependent messages over the bus to other devices. The ability of any device to talk exists only when it has been addressed as a talker.

L4 : Listener function (no listen only function)

The listener function provides a device with the ability to receive device dependent messages over the bus. The capability only exists where the device is addressed to listen via the bus by the controller.

SRI : Service request function (complete capability)

The service request function gives the 2305 the capability to inform the controller when it requires attention.

RL1 : Remote/local function (complete capability)

The remote/local function allows the 2305 to be controlled either by the local front panel keys or by device dependent messages over the bus.

DCL : Device clear function (complete capability)

Device clear is a general reset and may be given to all devices in the system simultaneously (DCL). 2305 resets to the power-up mode, in store 0, as supplied from the factory at time of manufacture, that is

Function	-	ABS, FM, $\frac{P-P}{2}$
Auto-tune	-	ON
Filters	-	10 Hz to 300 kHz
De-emphasis	-	OFF
Frequency display	-	CARRIER

E1 : Open collector drivers

The GPIB drivers fitted to 2305 have open collector, rather than tri-state, outputs.

List of 2305 GPIB commands

51. Instructions and data are sent to the 2305 in ASCII format. Instructions take the form of two-character alphanumeric pairs; data is normal ASCII figures and minus sign, plus '.' for decimal marker. When a command is followed by a numerical data string as required, for example, by FT and MR, the string must be terminated in a similar way to that which would be required for a keypad entry, only in this case any of the following punctuation marks should be used : comma, semicolon, <carriage return>, or <line feed>. These may also be used to separate instruction strings, in which case they are ignored. Most of the instructions correspond exactly to front-panel keys; where this would be inconvenient, extra codes are included.

<i>Code</i>	<i>Meaning</i>	<i>Code</i>	<i>Meaning</i>
CF	carrier freq.	PM	phase mod.
CE	carrier error	FM	FM
MF	mod. frequency	AM	AM
AT	autotune	PR	power
H1	hold on	PA	peak-peak/2
H0	hold off	PN	peak negative
CL	calibrate	PP	peak positive
F0	filter 50Hz - 15kHz	AV	noise average
F1	filter 300Hz - 3.4kHz	AE	absolute
F2	filter 10Hz - 300kHz	RL	relative
F3	filter 30Hz - 50kHz	DS	distortion
F4	filter 65Hz - 250Hz	SN	sinad
D0	de-emphasis off	P1	peak hold on
D1	de-emphasis 50 $\mu$ s	P0	peak hold off
D2	de-emphasis 75 $\mu$ s	W0	weighting off
D3	de-emphasis 750 $\mu$ s	W1	weighting on
FT	freqtune	TF	talk frequency
MR	mod. reference	TE	talk error
RC	recall	TM	talk modulation
ST	store	SF	second function
		RS	reset overload trip

Talking function

52. When addressed to talk, the 2305 has three possible responses :

TF talk frequency (carrier or modulation)  
 TM talk modulation (kHz, rad or %)  
 TE talk error (two digits)

Note...

From software version 009 (appearing in the MODULATION window during the self-check routine), it is essential to send TF, TM or TE before each data string is requested.

The data is sent with decimal marker in the following form :

<i>Command</i>	<i>Response</i>
TF	F or E + or - NNNN.NNNNNNN Carrier or modulation frequency. Decimal marker relates to Megahertz. Maximum resolution 0.1 Hz.
TM	M or E + or - NNN.NNN Modulation units corresponding to the decimal marker are : kHz (f.m.) rad (r.m.) % (a.m.) dB (relative modulation) W or dBm (Power function)

The prefix 'E' is sent when the instrument is in error mode.

<i>Command</i>	<i>Response</i>
TE	E NN 2 digit error code

The talk command is sent while the 2305 is still in listening mode and before it is addressed to talk.

#### Service requests (SRQ)

53. When the 2305 service request function is enabled (via Second function 19), attention may be requested for two reasons, first because the instrument has entered an error mode and secondly because of the need to signal to the controller that a status change has been completed and the 2305 is ready for fresh instructions - the 'READY' SRQ.

54. In response to a serial poll, the 2305 will transmit the status byte

b7	b6	b5	b4	b3	b2	b1	b0
0	rsv	abnormal	d4	d3	d2	d1	d0

where b7 : is always 0

b6 : rsv is set for all SRQ

b5 : abnormal, 1 for ERROR SRQ, 0 for READY SRQ

b0 to b4 indicate the error number, thus :

for error no. 01 to 15	} b4 = 0 b0 to b3 hold error no. in binary
for error no. 48 to 63	
	} b4 = 1 b0 to b5 hold error no. in binary

While the 2305 requests service, the small blob at the top left of the left-hand digit in the modulation display is activated.

#### SRQ mask

55. If a selective SRQ response is required it is possible to mask off any particular set of error codes chosen via second functions 20 to 23 and to inhibit the SRQ from being generated should the 2305 enter any of these error states. The READY SRQ can be suppressed in the same way. Note that any SRQ mask is stored in non-volatile memory indefinitely but that the state of second function 19 is volatile and will need to be re-asserted after each switch-on if any SRQ response is required.



Clear and switch on

57. SDC and DCL clear 2305 to the following state:-

- AUTO-TUNE - ON
- FREQUENCY display - CARRIER
- FILTERS - 10 Hz to 300 kHz
- DE-EMPHASIS - OFF
- FUNCTION - ABS, FM,  $\frac{P-P}{2}$

Notes...

- (1) Int/Ext frequency standard selection is unaffected by the SDC and DCL commands.
- (2) The instrument stores are not changed, switching on clears the 2305 to the same status as SDC or DCL or to the control settings in store 0.

(3) To revert from GPIB to front panel control, press the  key.

GPIB connector contact assignments

58. The contact assignment of the GPIB cable connector and the device connector is as shown in Fig. 8 below.

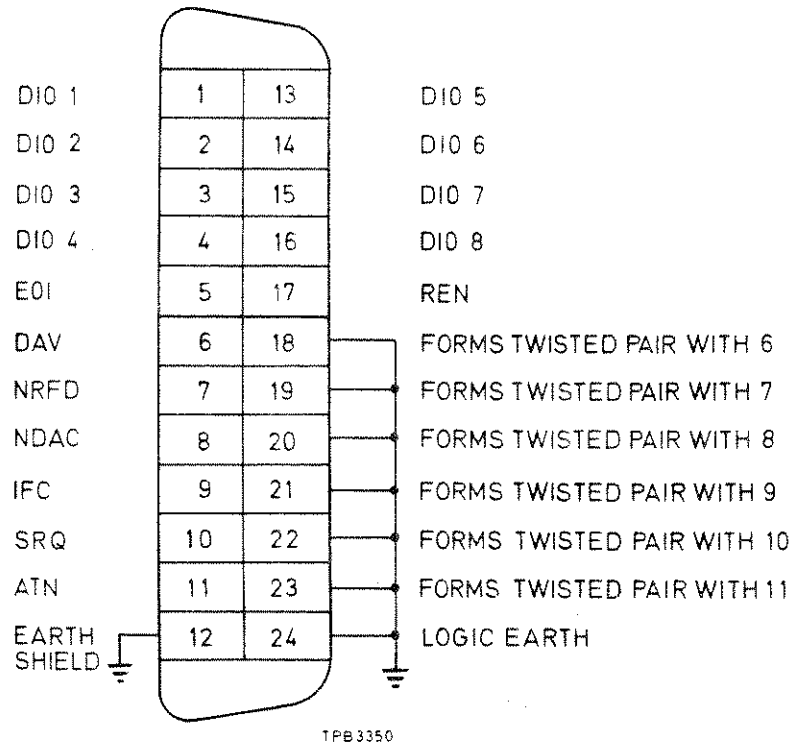

Fig. 8 GPIB connector contact assignments

Chapter 3-1

EXTENDED APPLICATION

CONTENTS

Para.

- 1 LF signal measurements
- 2 Practical details
- 4 Operation

Fig.

	Page
1 External connections to enable the introduction of l.f. signals into 2305 ... ..	2
2 Calibration network to give 5 V full-scale ... ..	2
3 Keys still useful when measuring external l.f. signals ...	3/4

LF signal measurements

1. Although the primary application of the 2305 is in the measurement of modulated r.f. signals, the low frequency measurement circuits in the instrument can usefully be accessed for measurements on low frequency signals such as those originating, for example, in the output stages of receivers. Entry to the l.f. stages is via the rear panel jack socket normally intended for the insertion of external special filters. Reference to Fig. 2 in Chap. 2 and Fig. 2 in Chap. 4-1 will show that if the jack tip connection is ignored, a signal connected between the ring and the sleeve of the jack will be substituted for the internal demodulated signal. Most of the functions of the DATA and FUNCTION keys are still available so that both absolute and relative level measurements can be made including signal to noise ratio. Voltage measurements may be peak or average responding and, if the Distortion/Weighting filter option kit is fitted, the measurements may be weighted and extended to include distortion if required. The signal frequency can be displayed in the FREQUENCY window.

2. Practical details. A jack plug is supplied with the instrument and a suggested method of connection is shown in Fig. 1. If frequent reversion to standard operation is required, as would be the case if l.f. signal measurements formed part of an automatically controlled sequence, the jack plug may be left inserted and the changeover effected by relay contacts as shown. Alternatively, if only occasional use is likely, the switch contacts and the tip wiring can be omitted and the jack inserted manually as required. Any wiring left permanently connected to the 2305 signal path must introduce as little stray capacitance as possible as the l.f. bandwidth may otherwise be reduced.

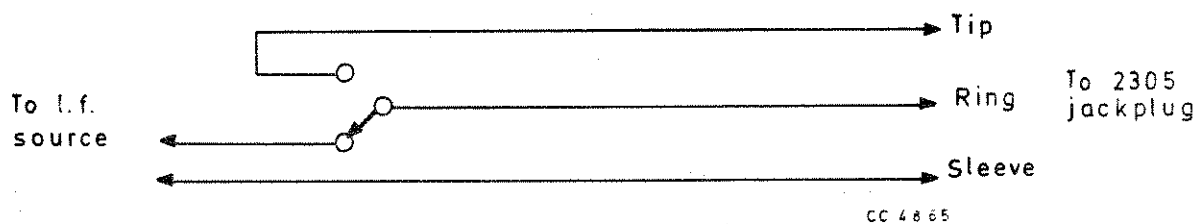

Fig. 1 External connections to enable the introduction of l.f. signals into 2305

3. The 2305 requires a 3 V signal at this point to produce full-scale on the voltmeter. The voltmeter can be made direct reading on a '5' full-scale range by the addition of a simple calibration network of the kind shown in Fig. 2 between the source and the jack connections.

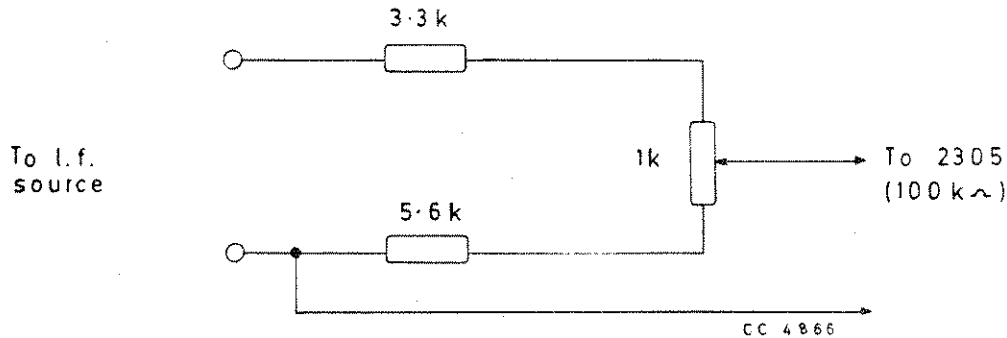

Fig. 2 Calibration network to give 5 V full-scale

#### 4. Operation.

(1) Select FM.

In the absence of an r.f. signal input, the 2305 displays are blanked and the l.f. stages are inhibited. The following keyswitch (or equivalent GPIB command) sequence is therefore required before measurements can begin.









Chapter 4-1

BRIEF TECHNICAL DESCRIPTION

CONTENTS

Para.			
1	Construction		
2	Design outline		
3	Input circuit arrangement		
5	Auto-tuning process		
9	Local oscillator		
10	10 MHz internal reference oscillator		
11	AM detection		
12	Internal calibrator		
14	FM detection		
15	Low frequency circuits		
18	Metering detectors		
19	Voltmeter		
22	Frequency counter and microprocessor		
26	Power supply		

Fig.			Page
1	Internal view of 2305 with front panel folded down ...	...	2
2	2305 Block diagram showing main signal path ..	... ..	7/8

CONSTRUCTION

1. The instrument's component parts may be considered, conveniently, as forming three main groups.

(1) The front panel assembly. This is made up from the keyboard and the display which are directly controlled by the microprocessor.

(2) The rear panel assembly. This comprises the power supply and a card guide. The guide contains the circuit boards for the microprocessor and memories, the counter and voltmeter.

(3) The RF box. This is compartmented and contains most of the analogue signal processing circuits. The circuits are set up and interconnected in response to digital instructions which are latched onto a separate internal bus system so freeing the RF box from the risk of interference which would follow from direct interaction with the microprocessor. The construction may be seen in the photograph in Fig. 1.



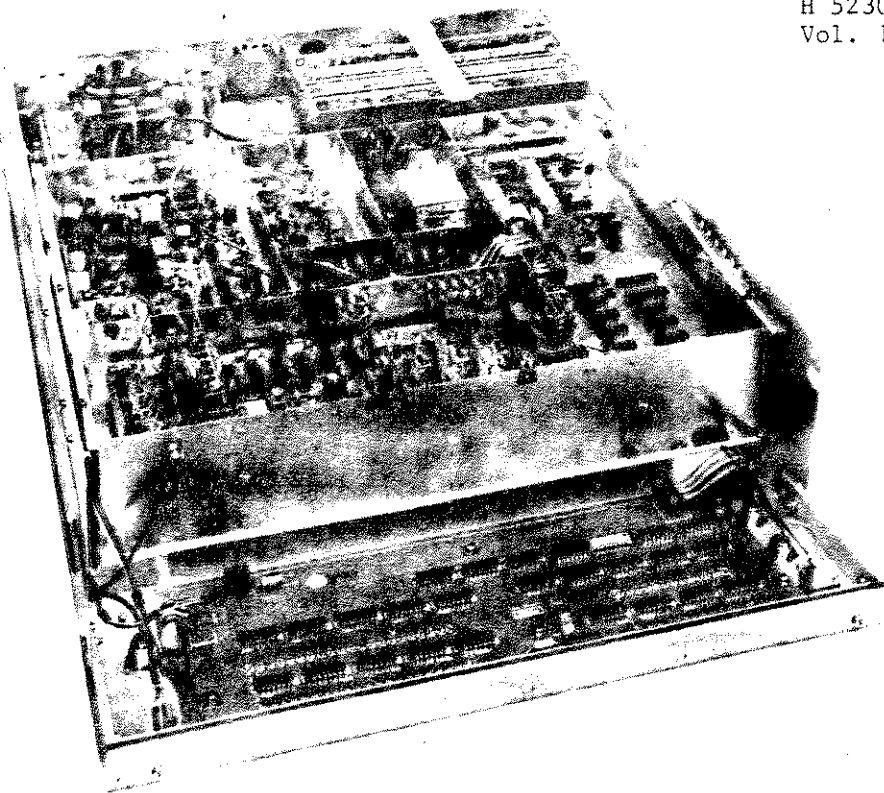

*Fig. 1 Internal view of 2305 with front panel folded down*

## DESIGN OUTLINE

2. The instrument is a low gain superheterodyne amplifier with a synthesizer local oscillator and two separate mixers, a double-balanced ring bridge for signal frequencies below 56 MHz and a sampling gate mixer for frequencies from 56 MHz to 2 GHz. Signals of 1.5 MHz and below pass directly into the i.f. amplifier.

### Input circuit arrangement

3. Reference should be made to the instrument block diagram, Fig. 2, page 7/8. The signal for measurement passes to the input attenuator via a coaxial line relay which isolates the input when it is overloaded. The attenuator has three switchable pads, two of 14 dB and one of 7 dB, which are introduced in 7 dB steps. A diode detector connected immediately after the input protection circuit serves the dual purpose of metering the input power level and, when necessary, of triggering the overload detector circuit. The overload detector shares a circuit board with the l.o. voltage controlled oscillator. When tripped, it causes the INPUT OVERLOADED annunciator in the modulation display to light up and opens the protection relay. The relay can then only be reset by the microprocessor following intervention via the keyboard or GPIB.

4. With no input signal present, the input attenuator is set automatically to zero dB. When a signal appears at the attenuator output, it is detected by the wideband mixer level detector and attenuation will be introduced as required to bring the mixer input within the designed dynamic range. The instrument will then, if not switched to manual over-ride, begin its auto-tuning routine.

### Auto-tuning process

5. In the first stage of auto-tuning, the sampling gate is used as the frequency changer with the local oscillator executing a two-stage search programme designed to produce an i.f. within the range 3 MHz to 11 MHz. A special circuit branching off the main i.f. channel is tuned to receive this band of frequencies and the appearance of a signal here above a standardized threshold causes a level detector to be triggered and information to be passed to the microprocessor that an i.f. exists which is within the frequency range of the internal counter frequency meter. Once the microprocessor receives this 'i.f. present' signal, it causes the signal frequency to be precisely measured and, by noting the effect on the i.f. of a small increment in the local oscillator frequency, it calculates which harmonic of the local oscillator is effective in producing the i.f. The microprocessor then has enough information to calculate the exact input signal frequency and it causes this to be displayed in the FREQUENCY window. It also changes the instructions to the local oscillator and, if necessary, to the binary divider as well so as to produce an i.f. of 1.5 MHz and to ensure that the correct mixer is used.

6. A failure to detect an i.f. signal after this part of the autotune programme has been completed will be interpreted by the microprocessor as meaning that the input signal is 17 MHz or less and it will then cause the signal to bypass the mixers and pass directly to the i.f. After its frequency measurement has been interpreted by the microprocessor the signal will be routed to the balanced mixer if above 1.5 MHz and allowed to pass directly to the i.f. if less.

7. A continued failure to detect an i.f. while the mixer level detector continues to detect an input, will result in the display of error code 52 - frequency out of range.

8. The double-balanced mixer is introduced for signal frequencies below 56 MHz where the rejection contributed by the mixer to the local oscillator and signal frequencies is needed to assist in the proper separation of the i.f. Further assistance is given by the reduction in i.f. from 1.5 MHz to 250 kHz that is made when input signals of less than 5.5 MHz are used. All filter switching and signal routing is carried out by local latching and control in response to data transmitted over the internal bus.

### Local oscillator

9. The l.o. is phase-locked to the required frequency in a loop including the digital phase detector, the programmable divider and a 10 kHz reference frequency. For l.o. frequencies below the bottom limit of the v.c.o. range of 28 to 56 MHz, the binary divider stage is activated so as to reduce the frequency in the required ratio. For signal frequencies above 56 MHz, the sampling gate mixer is used and the l.o. produces a very short sampling pulse at a rate near to a sub-harmonic of the input signal frequency.

### 10 MHz internal reference oscillator

10. The internal oscillator is in a standard oven-controlled enclosure. A sample output appears at the external STD. FREQ. IN-OUT terminal on the rear panel when the instrument is switched to the internal standard and a rear panel-mounted potentiometer enables a fine frequency control to be achieved. An alternative, external, reference may be employed and is

switched in by a keyboard second function. The STD. FREQ. IN-OUT terminal then becomes an input terminal.

#### AM detection

11. The a.m. detector operates with a mean level a.l.c. loop which ensures that peak amplitude excursions of the signal are always measured in relation to the same constant mean value and are therefore proportional to the percentage a.m. The time constants of the a.l.c. loop are switched by the micro-processor in accordance with the lowest modulation frequencies in use so that settling and measurement times are kept to the minimum. Information on the modulation frequency range is deduced from the user's choice of l.f. filter.

#### Internal calibrator

12. For self-calibration purposes the l.o. output is routed to the i.f. circuit. When f.m. calibration is called for, it is produced by modifying the instructions to the programmable divider at a 1 kHz rate. A separate high speed sampling phase detector is used with a 100 kHz reference within the phase-locked loop so that the loop may settle with sufficient speed. The l.o. is switched between either 47 MHz and 49 MHz (1 MHz deviation) or between 46 MHz and 56 MHz (5 MHz deviation). After these frequencies are divided by  $2^5$  in the binary divider, the resulting calibration is at deviations of 31.25 kHz and 156.25 kHz.

13. For a.m. calibration, the l.o. is set to 1.5 MHz and its output is routed via a resistive T-pad giving a nominal  $\pm 5$  voltage ratio. This pad is switched in and out by a bottoming transistor producing nominally 67% a.m. that is dependent almost solely on the properties of the resistors. The precise value of the a.m. is determined during factory calibration and is stored in the instrument's non-volatile memory.

#### FM detection

14. The f.m. detector is supplied via a separate branch of the i.f. amplification system and is designed as a balanced circuit so as to optimize rejection of any residual a.m. that might be present. The detector uses the charge pump principle.

#### Low frequency circuits

15. The audio signals from the modulation detectors, which are related by their amplitude to the amount of modulation, pass into the 50 dB ranging l.f. amplifier and from there to the filter board which contains the switchable filter elements and f.m. de-emphasis circuits all of which are accessed from the keyboard for the appropriate functions. The 6 dB/octave h.f. roll-off characteristic which is introduced automatically when phase modulation is selected, is produced by circuit elements on the filter board. The 2-circuit jack located on the rear panel enables an external filter to be introduced into the audio path at this point.

16. The LF Filter board contains a patching link in its output stage that enables the options board to be connected there, if required. The LF OUTPUT signal originates here so that a signal taken from this outlet will have been conditioned by any filtering and de-emphasis introduced, either internally or externally, and by any function selected on the options board - if fitted.

17. The signal conditioning circuits are normalized to a single mid-band gain level so that the LF OUTPUT mid-band signal level is dependent only on modulation depth but is shaped by the chosen characteristic at other frequencies. The measurement signal, in normal operation, is taken to the voltmeter board without passing through de-emphasis. It is voltage detected, then given analogue to digital conversion and display.

#### Metering detectors

18. The peak detector operates on positive peaks only but is preceded by a switchable, inverting/non-inverting stage which enables either polarity to be measured. When the  $\frac{P-P}{2}$  function is chosen, the microprocessor requests peak measurements of each polarity to be made in turn, then stores the results and calculates the mean value for display. The average detector ensures accurate averaging by converting the l.f. signal into a current source which feeds into leaky capacitor reservoirs. This is followed by an active low-pass filter which completes the averaging process with the longest time constant compatible with an acceptable measurement time.

#### Voltmeter

19. Analogue to digital conversion is carried out as voltage to frequency with frequency then being measured in the internal counter frequency meter and displayed. The converter employs a v.c.o. in a nulling phase-locked loop in which the v.c.o. drives a source of precise, unidirectional pulses. These pulses are supplied to one input of a resistive summing network and the voltage selected for measurement is connected to another. As the summing point is also the nulling point, the v.c.o. frequency is constrained to follow the unknown voltage with accurate proportionality.

20. The voltmeter is also used for the digitization of a range of quantities which are not displayed as part of normal measurement but which are either used by the microprocessor as a part of the control of the automatic processes or which may be accessed for display only as keyboard second functions as aids to fault diagnosis. It is switched between these and any of the normal modulation measurement quantities by on-board switching controlled by local latch/decoders in response to signals on the internal bus.

21. The voltmeter board also contains a multiplying circuit which increases modulation frequencies below 6 kHz by a factor of x100 before passing them to the counter for modulation frequency measurement. This improves the resolution imposed by the 100 ms gate time from 10 Hz to 0.1 Hz and gives the required discrimination at low modulation frequencies without the need to extend gate (and measurement) times or to introduce the complexity of period measurement. The x100 multiplier includes a v.c.o. with a  $\pm 100$  stage in a phase-locked loop. The phase-detector output to the v.c.o., being proportional to frequency, is also used outside the loop with a trigger stage to switch the multiplier in and out as the modulation frequency rises respectively from below to above 6 kHz.

### Frequency counter and microprocessor

22. The counter is based on a l.s.i. custom c.m.o.s. chip with three external scalers which effectively increase the speed of the c.m.o.s. chip. Only two gate times are used - 10 ms and 100 ms. The counter is completely automatic and measures any of 3 signals as directed by the microprocessor. These are : the IF, the demodulated LF signal and the output from the voltmeter voltage to frequency converter.

23. The microprocessor system occupies two boards, one containing the CPU and program memory and the other the I/O ports and EAROM.

24. The microprocessor (type 8085A) is run at about 3 MHz from an oscillator on the board. Up to 7 x 4 kbyte EPROMs of program memory can be accommodated on the board.

25. The interfacing between the instrument data buses, the EAROM and the microprocessor is carried out by two 8155 RAM I/O devices. A -30 V supply for the EAROM is generated by a d.c. - d.c. converter on the board.

### Power supply

26. The 3 supplies for +5 V and  $\pm 15$  V are entirely conventional. A +5 V line to the microprocessor is separately decoupled at the output connector. The mains transformer is a standard item and one secondary winding is not used on the 2305. The consumption is approximately 70 VA.

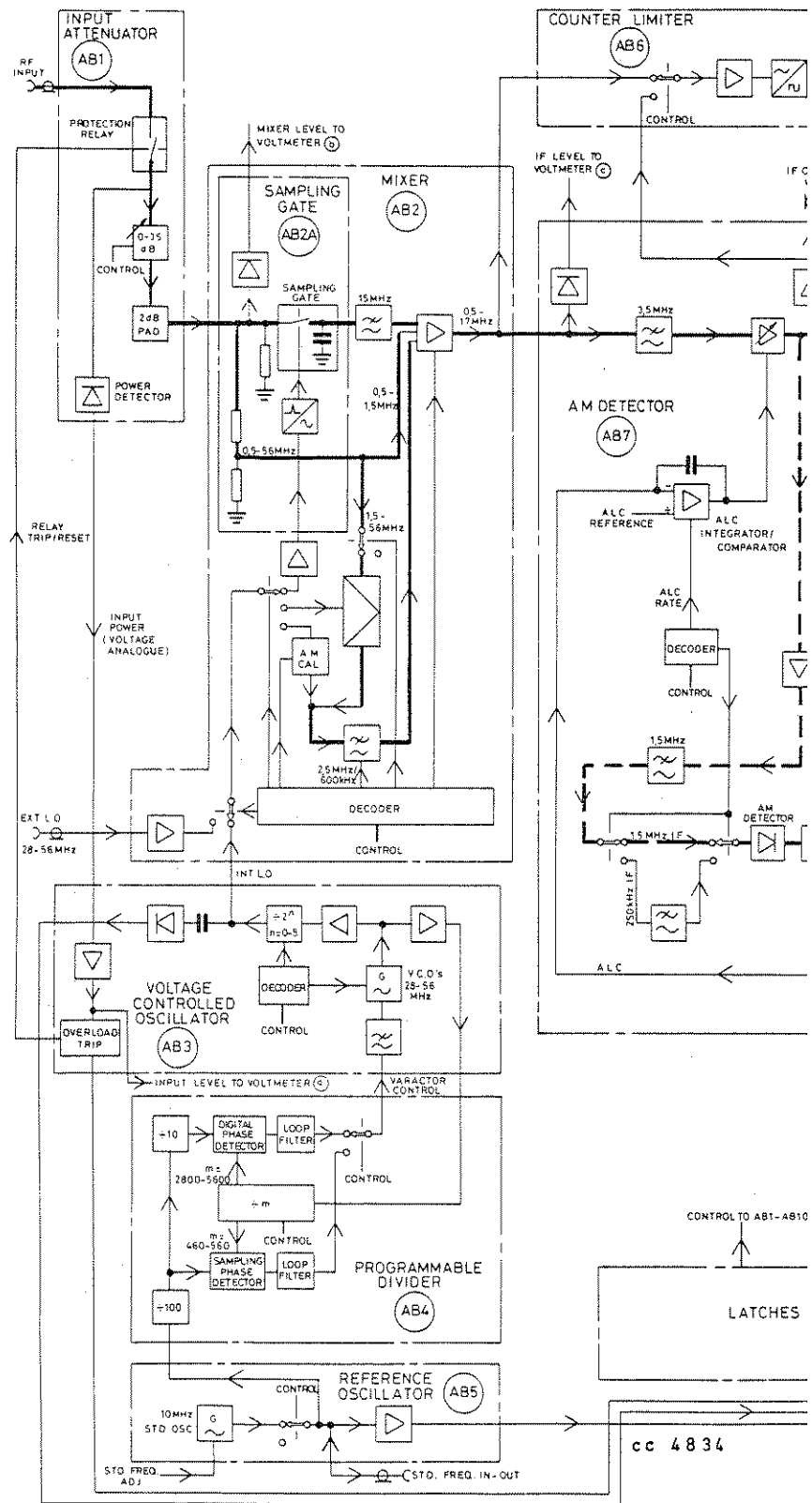

Fig.