

RADIO TEST SET

2965

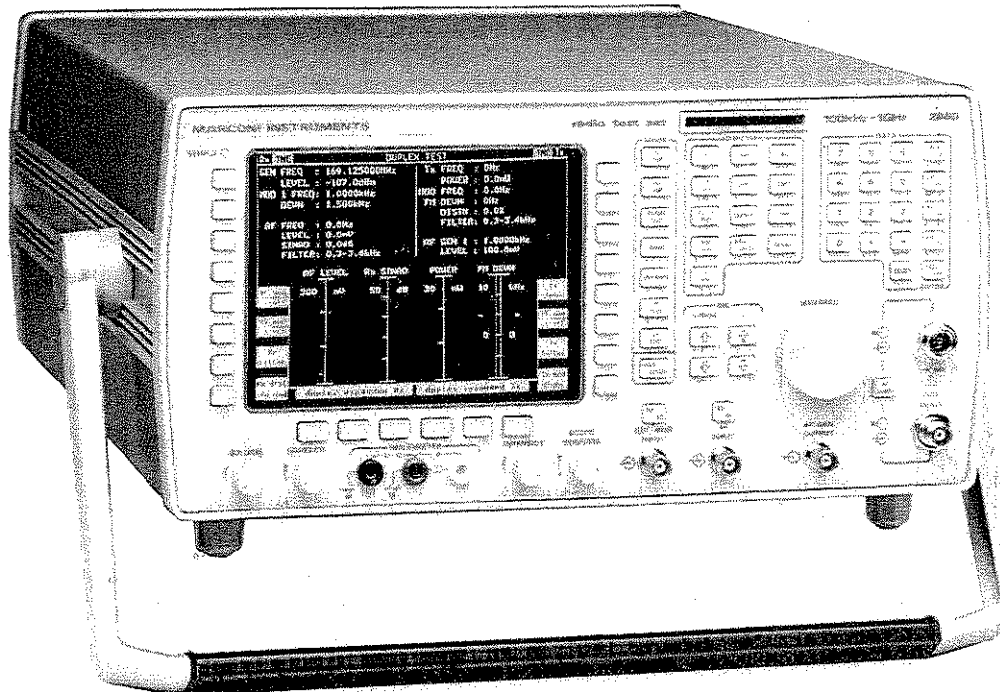

Operating Manual
46842-1000



CUSTOMER QUESTIONNAIRE

Please spare a moment to detach, complete and return the Questionnaire on the next page. Your comments and suggestions will help us improve our products.

If you have had any problems with this product, please contact our Customer Support Help Desk on 01582-33866 at Luton if you are in the UK, or your Local Service Centre if outside the UK. The address and telephone number of your Local Service Centre is listed in this manual.

Please put the completed form in the addressed envelope provided and mail.

End User details

Name		
Company Name		
Company Address		
Country	Post Code	Fax no.
Telephone No		Ext.

Equipment details

Part nos	Serial nos	Software Issues
Name & Address of Purchaser (if different from above)		
Delivery Date	Do you have a Maintenance Contract? <input type="checkbox"/> Yes <input type="checkbox"/> No	

Equipment Condition

Was the equipment in perfect working order when delivered?		<input type="checkbox"/> Yes <input type="checkbox"/> No
If the answer to the above question was 'no', was the problem to do with		
mechanical condition (damaged case etc.)	<input type="checkbox"/>	Severity Critical <input type="checkbox"/> Major <input type="checkbox"/> Minor <input type="checkbox"/>
suspected hardware fault	<input type="checkbox"/>	
suspected software fault	<input type="checkbox"/>	
did not meet its specification.	<input type="checkbox"/>	
Please tick the relevant item and describe below;		Repeatable? Yes <input type="checkbox"/> No <input type="checkbox"/> Occasionally <input type="checkbox"/>
<i>(continue in blank space on previous page if necessary)</i>		

Claim under Guarantee

If you have had problems,

have you already claimed under the Guarantee Yes No

or do you intend to claim under Guarantee? Yes No

Improvements

We should like to receive any suggestions for improvements or applications of this or other products that you may have. Please add them below or include them on an extra sheet.

(continue in blank space on previous page if necessary)

Marconi Instruments Action

	Initial/Date	Initial/Date	Initial/Date
Copy to Comm. Admin.		Distributor contacted	Problem established
Service Dept response		Follow through needed	Cleared

RADIO TEST SET

OPERATING MANUAL

2965

© Marconi Instruments Ltd. 1995

No part of this book may be reproduced or transmitted in any form or by any means, electronic or mechanical, including photocopying, or recorded by any information storage or retrieval system, without permission in writing by Marconi Instruments Ltd.

Printed in the UK

Manual part no. 46882-159J

Issue 7

19 October 1995



About this manual

This manual explains how to use the 2965 Radio Test Set. It applies to test sets fitted with version 5.4x software. With the exception of the section *User options* in Chapter 3, references are made to factory preset settings, prior to any customisation.

Intended audience

People who need to test radio systems and associated equipment.

Structure

Chapter 1

Provides general information concerning the test set's features, performance, and accessories

Chapter 2

Installation instructions

Chapter 3

Operating instructions

Chapter 4

Brief technical description

Chapter 5

Acceptance testing

Index

Document conventions

The following conventions apply throughout this manual:

- | | |
|----------------------|---|
| [RF TEST] | Hard key titles are indicated by normal lettering in square brackets. |
| [<i>Tx filter</i>] | Soft key titles are shown in italic lettering in square brackets. |
| FM DEVN | Messages on the display are shown in this font. |

Associated publications

Other manuals that cover specific aspects of this test set are:-

- **NMT Supplement** (46882-160N) provides testing details for NMT systems
- **AMPS Supplement** (46882-161L) provides testing details for AMPS systems
- **TACS Supplement** (46882-162J) provides testing details for TACS systems
- **MPT1327 Supplement** (46882-163F) provides testing details for MPT systems
- **PMR Supplement** (46882-164G) provides testing details for PMR systems
- **GSM Supplement** (46882-165V) provides testing details for GSM systems
- **Programming Manual** (46882-267V) provides programming information for those wishing to write their own test programs



Contents

Precautions	vii
Precautions	x
Vorsichtsmassnahmen	xii
Precauzioni	xiv
Precauciones	xvi
Chapter 1 GENERAL INFORMATION	1-1
Chapter 2 INSTALLATION	2-1
Chapter 3 OPERATION	3-1
Introduction	3-4
Transmitter testing	3-19
Receiver testing	3-38
Duplex testing	3-47
RF testing	3-64
Audio testing	3-91
Signalling codes testing	3-99
Systems testing	3-123
Help and setting up	3-124
Store and recall facility	3-136
User options	3-138
Chapter 4 BRIEF TECHNICAL DESCRIPTION	4-1
Chapter 5 ACCEPTANCE TESTING	5-1



Precautions

WARNING

CAUTION

Note

These terms have specific meanings in this manual:

WARNING

Information to prevent personal injury.

CAUTION







Information to prevent damage to the equipment.

Note

Important general information.

Hazard symbols

The meaning of hazard symbols appearing on the equipment is as follows:-

Symbol	Nature of hazard	Reference in manual
	Dangerous voltage	Page vii
	Toxic hazard	Page viii
	Fire hazard	Page viii
	Lithium battery	Page viii
	Hot surface	Page viii
	Input overload	Page ix
	Static sensitive	Page ix

Safety

This product has been designed and tested in accordance with BS4743 'Specification for safety requirements for electronic measuring apparatus' and IEC Publication 348 'Safety requirements for electronic measuring apparatus'.

WARNING

Electrical hazards

AC supply voltage

This equipment conforms with IEC Safety Class 1, meaning that it is provided with a protective grounding lead. To maintain this protection, the supply lead must always be connected to the source of supply via a socket with a grounded contact.

Be aware that the supply filter contains capacitors that may remain charged after the equipment is disconnected from the supply. Although the stored energy is within the approved safety requirements, a slight shock may be felt if the plug pins are touched immediately after removal.

Fuses

Note that there are supply fuses in both the live and neutral wires of the supply lead. If only one of these fuses should rupture, certain parts of the equipment could remain at supply potential.

Removal of covers

Disconnect the supply before removing the covers so as to avoid the risk of exposing high voltage parts. If any internal adjustment or servicing has to be carried out with the supply on, it must only be performed by a skilled person who is aware of the hazard involved.

WARNING

Fire hazard

Make sure that only fuses of the correct rating and type are used for replacement.

If an integrally fused plug is used on the supply lead, ensure that the fuse rating is commensurate with the current requirements of this equipment. See under *Performance data* in Chapter 1 for power requirements.

WARNING

Toxic hazards

Some of the components used in this equipment may include resins and other materials which give off toxic fumes if incinerated. Take appropriate precautions, therefore, in the disposal of these items.

WARNING

Beryllia

Beryllia (beryllium oxide) is used in the construction of some of the components in this equipment. This material, if incorrectly handled, could cause a danger to health - refer to the Maintenance part of the Service Manual for safe handling precautions.

WARNING

Lithium

A Lithium battery (or a Lithium battery contained within an IC) is used in this equipment.

As Lithium is a toxic substance, the battery should in no circumstances be crushed, incinerated or disposed of in normal waste.

Do not attempt to recharge this type of battery. Do not short circuit or force discharge since this might cause the battery to vent, overheat or explode.

WARNING

Hot surfaces

Take care when touching the RF input N-type connector after the application of high levels of continuous power. If 50 W is exceeded for a prolonged period, the temperature of the connector can become excessive.

WARNING

Tilt facility

When the instrument is in the tilt position, it is advisable, for stability reasons, not to stack other instruments on top of it.

CAUTION

Input overload

On the RF N-type connector, the input power should not exceed 150 W.
On the RF TNC connector, the input power should not exceed 1 W.

CAUTION

Static sensitive components

This equipment contains static-sensitive components which may be damaged by handling - refer to the Maintenance Manual for handling precautions.

Note

To comply with EN55011[†], this instrument should be used with double screened RF cables.

[†] EN55011 is the European standard: *Limits and methods of measurement of radio disturbance characteristics of industrial, scientific and medical (ISM) radio-frequency equipment.*

Precautions

WARNING

CAUTION

Note

Les termes suivants ont, dans ce manuel, des significations particulières:

WARNING

Contient des informations pour éviter toute blessure au personnel.

CAUTION





Contient des informations pour éviter les dommages aux équipements.

Note

Contient d'importantes informations d'ordre général.

Symboles signalant un risque

La signification des symboles liés à cet équipement est la suivante:

Symbole	Nature du risque	Référence dans le manuel
	Tension dangereuse	Page x
	Danger produits toxiques	Page xi
	Risque lié au feu	Page xi
	Batterie de Lithium	Page xi
	Surfaces chaudes	Page xi

Sécurité

Cet appareil a été conçu et testé conformément aux normes BS4743 "Spécifications des conditions de sécurité pour instruments de mesure électronique" et CEI Publication 348 "Conditions de sécurité pour instruments de mesure électronique".

WARNING

Sécurité électrique

Tension d'alimentation alternative

Cet appareil est protégé conformément à la norme CEI de sécurité class 1, c'est-à-dire que sa prise secteur comporte un fil de protection à la terre. Pour maintenir cette protection, le câble d'alimentation doit toujours être branché à la source d'alimentation par l'intermédiaire d'une prise comportant une borne terre.

Notez que les filtres d'alimentation contiennent des condensateurs qui peuvent encore être chargés lorsque l'appareil est débranché. Bien que l'énergie contenue soit conforme aux exigences de sécurité, il est possible de ressentir un léger choc si l'on touche les bornes sitôt après débranchement.

Fusibles

Notez qu'il y a deux fusibles, l'un pour la phase et l'autre pour le neutre du câble d'alimentation. Si un seul fusible est coupé, certaines parties de l'appareil peuvent rester au potentiel d'alimentation.

Retrait des couvercles

L'appareil doit être débranché avant de retirer les couvercles afin d'éviter tout contact avec les éléments haute tension. Si toutefois un réglage interne ou une réparation nécessitent la présence de l'alimentation, ils devront être effectués par une personne qualifiée et avisée des risques encourus.

WARNING

Risque lié au feu

Lors du remplacement des fusibles vérifiez l'exactitude de leur type et de leur valeur.

Si le câble d'alimentation comporte une prise avec fusible intégré, assurez-vous que sa valeur est compatible avec les besoins en courant de l'appareil. Pour la consommation, reportez-vous au Chapitre 1 "Spécifications".

WARNING

Danger produits toxiques

Certains composants utilisés dans cet appareil peuvent contenir des résines et d'autres matières qui dégagent des fumées toxiques lors de leur incinération. Les précautions d'usages doivent donc être prises lorsqu'on se débarrasse de ce type de composant.

WARNING

Le béryllia

Le béryllia (oxyde de béryllium) entre dans la composition de certains composants de cet appareil. Cette matière peut représenter un danger pour la santé si elle n'est pas manipulée de façon correcte - se référer à la partie "Maintenance" du "Manuel de Maintenance" pour les précautions de manipulation.

WARNING

Lithium

La batterie utilisée dans cet équipement contient du **Lithium**.

Le **Lithium** est une substance toxique; en conséquence, on ne doit l'écraser, l'incinérer ou la jeter dans la "poubelle".

Ne pas essayer de la recharger, ne pas la court-circuiter, une forte décharge rapide risque de provoquer une surchauffe voire l'explosion de celle-ci.

WARNING

Surfaces chaudes

Faire attention, lors de la manipulation d'un connecteur "N", après l'injection de haute puissance en continu sur l'entrée RF de ce connecteur. Si une puissance supérieure à 50 W est envoyée pendant une longue durée, la température du connecteur peut être très élevée.

WARNING

Position inclinée

Lorsque l'appareil est dans une position inclinée, il est recommandé, pour des raisons de stabilité, de ne pas y empiler d'autres appareils.

Vorsichtsmassnahmen

WARNING

CAUTION

Note

Diese Hinweise haben eine bestimmte Bedeutung in diesem Handbuch:

WARNING

dienen zur Vermeidung von Verletzungsrisiken.

CAUTION





dienen dem Schutz der Geräte.

Note

enthalten wichtige Informationen.

Gefahrensymbole

Die Gefahrensymbole auf den Geräten sind wie folgt:

Symbol	Gefahrenart	Im Handbuch
	Gefährliche Spannung	Seite xii
	Warnung vor giftigen Substanzen	Seite xiii
	Feuergefährlich	Seite xiii
	Lithium Batterie	Seite xiii
	Heiße Oberfläche	Seite xiii

Sicherheit

Dieses Gerät wurde in Übereinstimmung mit BS4743 und IEC 348 entwickelt und geprüft.

WARNING

Elektrische Schläge

Wechselspannungsversorgung

Das Gerät entspricht IEC Sicherheitsklasse 1 mit einem Schutzleiter nach Erde. Das Netzkabel muß stets an eine Steckdose mit Erdkontakt angeschlossen werden.

Filterkondensatoren in der internen Spannungsversorgung können auch nach Unterbrechung der Spannungszuführung noch geladen sein. Obwohl die darin gespeicherte Energie innerhalb der Sicherheitsmargen liegt, kann ein leichter Spannungsschlag bei Berührung kurz nach der Unterbrechung erfolgen.

Sicherungen

Es ist zu beachten, daß es Sicherungen in beiden (spannungsführenden und neutralen) Zuleitungen gibt. Wenn nur eine von diesen Sicherungen schmilzt, so bleiben einige Geräteteile immer noch auf Spannungspotential.

Abnahme von Abdeckungen

Die Spannungsversorgung muß vor Abnahme von Gehäuseabdeckungen unterbrochen sein, damit hochspannungsführende Teile gefahrlos zugänglich sind. Falls Abgleiche oder Servicearbeiten unter Spannung notwendig werden, dürfen solche Arbeiten nur von fachkundigem Personal durchgeführt werden, das die Gefahren kennt.

WARNING

Feuergefahr

Es dürfen nur Ersatzsicherungen vom gleichen Typ mit den korrekten Spezifikationen entsprechend der Stromaufnahme des Gerätes verwendet werden. Siehe hierzu die Leistungsdaten (Performance Data) in Kapitel 1.

WARNING

Warnung vor giftigen Substanzen

In einigen Bauelementen dieses Geräts können Epoxyharze oder andere Materialien enthalten sein, die im Brandfall giftige Gase erzeugen. Bei der Entsorgung müssen deshalb entsprechende Vorsichtsmaßnahmen getroffen werden.

WARNING

Beryllium Oxid

Beryllium Oxid wird in einigen Bauelementen verwendet.

Bei inkorrektcr Handhabung kann dieses Material Gesundheitsschäden verursachen. Siehe hierzu die Hinweise zur Handhabung im Service-Handbuch.

WARNING

Lithium

Eine **Lithium**-Batterie ist in diesem Gerät eingebaut.

Da Lithium ein giftiges Material ist, sollte es als Sondermüll entsorgt werden.

Diese Batterie darf auf keinen Fall geladen werden. Nicht kurzschließen, da sie dabei überhitzt werden und explodieren kann.

WARNING

Heiße Oberfläche

Vorsicht bei Berührung der HF Eingangsbuchse Typ N nach Einspeisen hoher Dauerleistung.

Falls über längere Zeit 50 Watt überschritten wird, kann die Temperatur der Buchse über Normal steigen.

WARNING

Schrägstellung

Bei Schrägstellung des Geräts sollten aus Stabilitätsgründen keine anderen Geräte darauf gestellt werden.

Precauzioni

WARNING

CAUTION

Note

Questi termini vengono utilizzati in questo manuale con significati specifici:

WARNING

riportano informazioni atte ad evitare possibili pericoli alla persona.

CAUTION





riportano informazioni per evitare possibili pericoli all'apparecchiatura.

Note

riportano importanti informazioni di carattere generale.

Simboli di pericolo

Significato dei simboli di pericolo utilizzati nell'apparato:

Simbolo	Tipo di pericolo	Riferimento nel manuale
	Tensione pericolosa	Pagina xiv
	Pericolo sostanze tossiche	Pagina xv
	Pericolo d'incendio	Pagina xv
	Batterie al litio..	Pagina xv
	Superfici ad alta temperatura	Pagina xv

Sicurezza

Questo prodotto è stato progettato e provato secondo le norme BS4743 "Specification for safety requirements for electronic measuring apparatus" e la pubblicazione IEC 348 "Safety requirements for electronic measuring apparatus".

WARNING

Pericoli da elettricità

Alimentazione c.a.

Quest' apparato è provvisto del collegamento di protezione di terra e rispetta le norme di sicurezza IEC, classe 1. Per mantenere questa protezione è necessario che il cavo, la spina e la presa d'alimentazione siano tutti provvisti di terra.

Il circuito d'alimentazione contiene dei filtri i cui condensatori possono restare carichi anche dopo aver rimosso l'alimentazione. Sebbene l'energia immagazzinata è entro i limiti di sicurezza, purtuttavia una leggera scossa può essere avvertita toccando i capi della spina subito dopo averla rimossa.

Fusibili

Notare che entrambi i capi del cavo d'alimentazione sono provvisti di fusibili. In caso di rottura di uno solo dei due fusibili, alcune parti dello strumento potrebbero restare sotto tensione.

Rimozione dei coperchi

Prima di rimuovere i coperchi occorre scollegare la spina d'alimentazione onde evitare il rischio di esposizione di parti ad alta tensione. Eventuali operazioni di manutenzione che richiedono la presenza dell'alimentazione dovranno essere eseguite solo da parte di personale specializzato ed a conoscenza dei pericoli coinvolti.

WARNING**Pericolo d'incendio**

Assicurarsi che, in caso di sostituzione, vengano utilizzati solo fusibili della portata e del tipo prescritto.

Se viene usata una spina con fusibili, assicurarsi che questi siano di portata adeguata coi requisiti di alimentazione richiesti dallo strumento. Tali requisiti sono riportati nel cap. 1 "Performance data".

WARNING**Pericolo sostanze tossiche**

Alcuni dei componenti usati in questo strumento possono contenere resine o altri materiali che, se bruciati, possono emettere fumi tossici. Prendere quindi le opportune precauzioni nell'uso di tali parti.

WARNING**Berillio**

Berillio (ossido di berillio) è utilizzato nella costruzione di alcuni componenti di quest'apparato.

Questo materiale, se maneggiato non correttamente, può causare danni alla salute. Far riferimento ai capitoli di manutenzione del Manuale di Servizio per le precauzioni richieste.

WARNING**Litio**

Quest'apparato incorpora una batteria al **litio** o un circuito integrato contenente una batteria al **litio**.

Poiché il litio è una sostanza tossica, la batteria non deve essere mai né rotta, né incenerita, né gettata tra i normali rifiuti.

Questo tipo di batteria non può essere sottoposto né a ricarica né a corto-circuito o scarica forzata. Queste azioni possono provocare surriscaldamento, fuoriuscita di gas o esplosione della batteria.

WARNING**Superfici ad alta temperatura**

Fare attenzione nel toccare il connettore d'ingresso di tipo N dopo aver applicato una potenza elevata e continua. Una potenza superiore a 50 W per tempi prolungati può portare il connettore ad una temperatura molto elevata.

WARNING**Posizionamento inclinato**

Quando lo strumento è in posizione inclinata è raccomandato, per motivi di stabilità, non sovrapporre altri strumenti.

Precauciones

WARNING

CAUTION

Note

Estos términos tienen significados específicos en este manual:

WARNING

contienen información referente a prevención de daños personales.

CAUTION





contienen información referente a prevención de daños en equipos.

Note

contienen información general importante.

Símbolos de peligro

Los significados de los símbolos de peligro que aparecen en los equipos son los siguientes:

Símbolo	Naturaleza del peligro	Referencia en manual
	Voltaje peligroso	Página xvi
	Aviso de toxicidad	Página xvii
	Peligro d'incendio	Página xvii
	Batería de Litio	Página xvii
	Superficies a altas temperaturas	Página xvii

Seguridad

Este producto ha sido diseñado y probado según las normas, BS4743 'Especificaciones de los requisitos de seguridad para instrumentos electrónicos de medida' e IEC publicación 348 'Requisitos de seguridad para instrumentos electrónicos de medida'.

WARNING

Nivel peligroso de electricidad

Tensión de red

Este equipo cumple las normas IEC Seguridad Clase 1, lo que significa que va provisto de un cable de protección de masa. Para mantener esta protección, el cable de alimentación de red debe de conectarse siempre a una clavija con terminal de masa.

Tenga en cuenta que el filtro de red contiene condensadores que pueden almacenar carga una vez desconectado el equipo. Aunque la energía almacenada está dentro de los requisitos de seguridad, pudiera sentirse una ligera descarga al tocar la clavija de alimentación inmediatamente después de su desconexión de red.

Fusibles

Se hace notar que el Equipo está dotado de fusibles tanto en el activo como el neutro de alimentación. Si sólo uno de estos fusibles fundiera, existen partes del equipo que pudieran permanecer a tensión de red.

Para retirar las tapas

Desconectar de red antes de retirar las tapas para evitar el riesgo que supone tener accesibles aquellas partes del equipo expuestas a alta tensión. Aquellas operaciones que requieran tener alimentación con las tapas abiertas para mantenimiento o ajuste deben de ser realizadas por personal cualificado, que esté al tanto de los riesgos implicados.

WARNING

Peligro d'incendio

Asegúrese de utilizar sólo fusibles del tipo y valores especificados como recuento.

Si se utiliza una clavija con fusible incorporado, asegúrese de que los valores del fusible corresponden a los requeridos por el equipo. Ver sección de especificaciones del capítulo 1 para comprobar los requisitos de alimentación.

WARNING

Aviso de toxicidad

Alguno de los componentes utilizados en este equipo pudieran incluir resinas u otro tipo de materiales que al arder produjeran sustancias tóxicas, Por tanto, tome las debidas precauciones en la manipulación de esas piezas.

WARNING

Berilio

Berilio (óxido de berilio) Este material es utilizado en la fabricación de alguno de los componentes de este equipo.

Si se manipula incorrectamente podría causar daños a la salud - En la sección de mantenimiento y reparación encontrará normas de manejo de seguridad.

WARNING

Litio

En este equipo se utiliza una batería de litio (o contenida dentro de un CI).

Dada que el litio es una sustancia tóxica las baterías de este material no deben ser aplastadas, quemadas o arrojadas junto a basuras ordinarias.

No trate de recargar este tipo de baterías. No las cortocircuite o fuerce su descarga ya que puede dar lugar a que la esta emita gases, se recaliente o explote.

WARNING

Superficies a altas temperaturas

Tenga cuidado al tocar el conector de entrada RF tipo N tras la aplicación continuada de altos niveles de potencia. La temperatura del conector puede llegar a ser excesiva si se sobrepasan 50 W durante un periodo prolongado de tiempo.

WARNING

Tener en cuenta con el equipo inclinado

Si utiliza el equipo en posición inclinada, se recomienda, por razones de estabilidad, no apilar otros equipos encima de



Chapter 1

GENERAL INFORMATION

Contents

Introduction	1-1
Features.....	1-1
Performance data	1-5
Accessories	1-17

Introduction

The Radio Test Set 2965 provides a comprehensive measurement system for all types of mobile radio testing applications, including personal mobile radio (simplex and duplex) and cellular systems. It is suitable for making high performance radio system measurements in research and development, production and maintenance.

A high-performance, full-span RF spectrum analyzer with tracking generator is provided. This has features to enable component and sub-unit testing in addition to precision transmitter measurements. A 20 Hz to 40 kHz AF spectrum analyzer is provided to ensure total measurement capability.

The large, bright display has soft keys at each side and beneath it. With the logical layout of the dedicated keys, this allows the many types of measurements of which the test set is capable to be carried out quickly and easily.

An important operating feature is the ability to use several forms of automatic control and interfacing standards. These include IEEE 488.2 and RS-232 remote control as well as a parallel printer port.

Features

The main facilities and features of the test set are listed below. These and the many minor features are explained in the operating instructions at the appropriate points.

1 GHz signal generator

The 2965 contains a high-performance signal generator with an oven-controlled crystal oscillator reference which has an ageing rate of less than 2×10^{-7} /year. It has a fast switching speed and a usable output up to 1.1 GHz. The maximum output is +13 dBm with an accuracy of ± 1.5 dB.

Comprehensive LF generators

There are three modulation and three audio sources internally. These can generate signals between 20 Hz (modulation) or 1 Hz (audio) and 20 kHz in addition to signalling tones and data.

The sources can be combined to produce a single source with a range of 1 Hz to 100 kHz.

Duplex operation

There is provision for simultaneous measurements on a transmitter and a receiver with no limit to the frequency offset between them.

Broad-band power meter

There is an accurate power meter for measurements over the range 1 mW to 150 W with an accuracy of $\pm 7\%$. The accuracy is traceable to international standards.

Selective power meter

Selective power measurements are possible with a sensitivity of -90 dBm. This allows power measurements to be made on selected channels with multiple signals present.

50 W continuous power rating

The test set can handle up to 50 W continuous power on its N-type connector RF in/out port and up to 150 W for short periods of time.

RF power protection

The sensitive TNC connector RF in/out port is protected from accidental overloads up to 10W. This avoids unnecessary repair bills and wasted time.

Full span spectrum analyzer

There is a full-span spectrum analyzer to 1 GHz with centre-span and 80 dB dynamic range. The spurious and harmonic performance of a radio can be measured with auto and user-selected resolution bandwidth.

Tracking generator

This is operative over the full range of the spectrum analyzer. The tracking generator has a variable output level. Measurements can be made on filters and duplexers and in RF circuit development applications. Additionally, offset sweep is available for mixer and IF testing, for both up and down conversions. Doubler ($\times 2$) and divider ($\div 2$) functions are also available.

Fast audio analyzer

There is a comprehensive analyzer for audio input and demodulated RF input signals up to 40 kHz with a minimum span of 50 Hz and a dynamic range of 60 dB. Because it uses an FFT, harmonic and spurious analysis can be performed very quickly. Two markers with full annotation are provided. A stepped audio signal is available up to 20 kHz for audio circuit analysis.

500 kHz digital storage oscilloscope

There is an oscilloscope that is operative up to 500 kHz. It can be used to look at the demodulated audio signal. The trace can be stored and the results can be read over the bus or printed out. There are two markers with full annotation for measuring rise and fall times.

Built-in multimeter

There is provision for measuring voltage, current and resistance, and for continuity testing. The multimeter also has the advantage that it can be controlled over the bus, so can be included in an automatic test system.

Comprehensive range of demodulation and audio filters

A 300 Hz to 3.4 kHz band-pass and 300 Hz, 5 kHz and 20 kHz low-pass filters are provided. In addition to these, CCITT and C-message (CMESS) psophometric filters are provided.

Rx=Tx Key

This is used to set the signal generator frequency to match the transmitter frequency automatically. This saves time and effort when making simplex radio measurements. A duplex offset can also be set for when the transmitter and receiver frequencies are different.

Channel key

It is possible to set up the frequency of the first channel and the channel spacing. Then, instead of having to set a particular frequency, a channel number can be entered.

Display expanded modes

Parts of the display can be expanded to show more information. For example, in duplex testing, the display can be expanded just to show the transmitter or receiver information. This does not affect the operation of the test set. Expanded displays show more information and provides access to more functions. Oscilloscope and analyzer displays can also be expanded to fill the entire screen. This then gives a larger trace for tuning and further adjustment.

Cellular radio options

There are options for testing cellular systems such as TACS and AMPS. Other options cater for testing MPT1327 and other trunked systems.

These are fitted internally, so the size is not increased. A number of automatic test programs are built-in, and bit-level diagnostics are available for protocol analysis.

Test set versions

There are different versions of the test set, as follows:-

Option 1	French language.
Option 2	Spanish language.
Option 3	German language.
Option 9	SSB Receiver fitted.
Option 10	NMT Cellular Radio Test Software fitted.
Option 11	AMPS Cellular Radio Test Software fitted.
Option 12	TACS Cellular Radio Test Software fitted.
Option 13	MPT1327 Trunked Radio Test Software fitted.
Option 14	Private Mobile Radio (PMR) Test Software fitted.
Option 21	GSM Digital Cellular Test Software fitted.

The French, Spanish and German versions are identical to the English version except for the markings on the front and rear panels. On all versions, the screen displays can be set up for any of these languages.

When optional software is fitted, the corresponding Operating Manual Supplement is supplied.

Small lightweight package

With dimensions of 203 mm height x 420 mm width x 600 mm depth, and a weight less than 18 kg, the test set is light and small enough to be carried from place to place. Its small footprint means that it takes up little bench space.

Logical front panel layout

The front panel is laid out with the keys colour coded and grouped by function.

Hard and soft key operation

The main functions are selected by using one of the dedicated hard keys. Subsidiary functions are then selected by using one of the soft keys which are grouped around the edge of the screen.

Using this arrangement, most functions can be accessed without having to go through deep and complicated menu structures. The hard keys can be used for instantaneous return to an upper level.

Rotary variable control

This is particularly useful for both fine tuning and making large adjustments in level and frequency.

Large bright CRT

A high-resolution monochrome graphics screen makes results clear to read.

Screen saver display

A screen saver display can be automatically triggered if any key is not used for a period of time. The moving display will not create screen burn, while indicating that the instrument is active.

Fast high-resolution graphics

Bar charts make finding peaks and nulls much easier than using digital readouts.

VGA output

A VGA colour monitor output is available for when a large display is required (e.g. for educational use or during a demonstration to a large group of people).

GPIB, RS-232 and parallel (Centronics) interfaces

Remote control of the test set is available by using the GPIB (to IEEE 488.2) or RS-232 interface. Automatic testing can be controlled directly from a PC, either locally or remotely.

See the 2965 Programming Manual (46882-267V) for details of remote control.

The Centronics parallel interface can be used to connect to a printer.

Copy function

In transmitter measurements, particularly at high power levels, it could be undesirable to leave the transmitter on for more than a very short period of time. When the transmitter is switched on, the copy function can be used to freeze the results display and to allow the transmitter to be switched off. You can then note the results at leisure and send them to a printer as a screen dump.

Help mode

Help displays are provided to assist you in the case of difficulty or where the Operating Manual may not be available.

Non-volatile registers for front panel settings

For added convenience, the non-volatile memory allows many instrument set-ups to be saved in addition to the storage provided by the memory cards.

Memory cards

Memory cards provide a means of storing instrument set-ups without being restricted by the amount of memory that is available. Once the set-up is saved on the card, the set-up can be recalled on any other 2965. The memory cards can also be used to store sequences of operations for automatic testing. The test set uses the JEIDA 4 and PCMCIA 2 standard (as used in notebook PCs) whose price and availability make it a cost-effective program storage system.

Performance data

Certain characteristics are shown as typical. These provide additional information for use in applying the instrument but they are non-warranted.

In accordance with best practice in electronic measurement, it is recommended that this instrument is allowed to stabilize for thirty minutes after switching on to obtain optimum performance.

RF output and input connectors

Impedance	50 Ω nominal
VSWR	N-type (upper) RF socket:- <1.2 up to 500 MHz <1.3 up to 1 GHz (typically 1.2)
	TNC (lower) RF socket:- Typically <1.3 at 900 MHz

RF signal generator

Frequency	
Range	100 kHz to 1 GHz, usable 90 kHz to 1.1 GHz
Resolution	1 Hz
Indication	10 digit display
Setting	Keyboard entry with increment and decrement keys and rotary variable control
Accuracy	As frequency standard
Output level	
Range	Receiver test and two-port duplex test:- N-type RF socket: -135 dBm to -7 dBm (-17 dBm with AM) TNC RF socket: -115 dBm to +13 dBm (+3 dBm with AM) One-port duplex test:- N-type RF socket -135 dBm to -40 dBm TNC RF socket -115 dBm to -20 dBm
Resolution	0.1 dB
Indication	4 digits and sign (dBm, dB μ V, μ V or mV PD or EMF)
Accuracy	N-type RF socket:- \pm 1 dB up to 575 MHz for levels above -120 dBm \pm 1.5 dB up to 1 GHz for levels above -120 dBm \pm 1.2 dB 575 MHz to 1 GHz over the temperature range 15 to 35°C
Carrier on/off	Keyboard operation, reduces signal generator output to <-120 dBm
Reverse power protection	N-type RF socket:- With the instrument switched on, safe continuous reverse power 50 W, intermittent operation to 150 W. Overload indicated by visual and audible warnings. TNC RF socket:- Protection up to 10 W. Reset available on removal of RF power. Excess power indicated by visual and audible warnings.
Spectral purity	
Residual FM	<6 Hz RMS up to 575 MHz <12 Hz RMS up to 1 GHz CCITT weighted
Residual AM	<0.05% RMS, CCITT weighted
Harmonics	<-30 dBc for levels up to +7 dBm (TNC) <-30 dBc for levels up to -13 dBm (N-type)
Spurious signals	<-45 dBc for carrier frequencies from 100 kHz to 36 MHz <-50 dBc for carrier frequencies from 36 MHz to 1 GHz
SSB phase noise	Better than -114 dBc/Hz up to 575 MHz Better than -108 dBc/Hz up to 1 GHz (20 kHz offset)

RF carrier leakage	<0.5 μ V PD generated at the carrier frequency in a 50 Ω load by a 2-turn loop 25 mm or more from the case with the output level set to <-60 dBm and terminated in a 50 Ω sealed load	
Internal modulation and audio sources	Up to six tone sources can be assigned as three modulation generators and three audio tone generators	
Modulation modes	Internal generators can be assigned to AM, FM or Φ M	
Amplitude modulation, internal		
Frequency range	100 kHz to 400 MHz, usable 90 kHz to 1.1 GHz	
AM depth range	0 to 99%	
Resolution	0.1%	
Indication	3 digits	
Setting	Keyboard entry with increment and decrement keys and rotary variable control	
Accuracy up to 85% AM (1)	For a modulation frequency of:- 1 kHz \pm 4% of setting \pm 1 digit From 30 Hz to 10 kHz \pm 6% of setting \pm 1 digit From 10 kHz to 20 kHz \pm 8% of setting \pm 1 digit	
Distortion	<1% at 1 kHz for modulation depths up to 30%, CCITT weighted <2% for modulation frequencies from 100 Hz to 20 kHz and depths up to 85%	
Modulation frequency range	For carrier frequencies from:- 20 Hz to 15 kHz 100 kHz to 36 MHz 20 Hz to 20 kHz 36 MHz to 400 MHz	
Modulation frequency resolution	0.1 Hz below 10 kHz 1 Hz below 20 kHz	
Amplitude modulation, external input		
Input impedance	Nominally 1 M Ω in parallel with 100 pF	
Frequency range	As internal AM	
Modulation frequency range	As internal AM with AC or DC coupling	
Input sensitivity	2.828 V pk-pk for indicated modulation depth	
Accuracy	As internal AM \pm 2%	
Frequency modulation, internal		
Frequency range	100 kHz to 1 GHz, usable 90 kHz to 1.1 GHz	
Maximum peak deviation	400 kHz at 100 kHz to 36 MHz 40 kHz at 36 to 72 MHz 100 kHz at 72 to 144 MHz 200 kHz at 144 to 288 MHz 400 kHz at 288 to 576 MHz 800 kHz at 576 MHz to 1 GHz	
Resolution	200 Hz at 100 kHz to 36 MHz 20 Hz at 36 MHz to 72 MHz 50 Hz at 72 MHz to 144 MHz 100 Hz at 144 MHz to 288 MHz 200 Hz at 288 MHz to 576 MHz 500 Hz at 576 MHz to 1 GHz <10% of carrier frequency for carrier frequencies <4 MHz	
Indication	4 digits	
Setting	Keyboard entry with increment and decrement keys and rotary variable control	
Accuracy (1)	\pm 3% \pm 1 digit for a modulation frequency of 1 kHz over the range 15 to 35°C (0.1% per °C outside this range). Typically, for modulation frequencies from:- 20 Hz to 5 kHz \pm 3% \pm 1 digit 5 kHz to 20 kHz \pm 7% \pm 1 digit 20 kHz to 75 kHz \pm 10% \pm 1 digit	

Distortion (1)	For modulation frequencies from:- 250 Hz to 5 kHz (deviation 1 to 800 kHz) <0.5% 50 Hz to 20 kHz (deviation 1 to 800 kHz) <1%
Modulation frequency range (2)	MOD1, 2 & 3 20 Hz to 20 kHz MOD4 20 Hz to 100 kHz
Modulation frequency resolution	0.1 Hz
Frequency modulation, external input	
Input impedance	Nominally 1 M Ω in parallel with 100 pF
Frequency range	As internal FM
Modulation frequency range	DC to 100 kHz (DC coupled) 10 Hz to 100 kHz (AC coupled)
Input sensitivity	2.828 V pk-pk for indicated deviation
Accuracy	As internal FM $\pm 2\%$
Phase modulation, internal	
Frequency range	100 kHz to 1 GHz, usable 90 kHz to 1.1 GHz
Maximum peak deviation	80 rad at 100 kHz to 36 MHz 8 rad at 36 to 72 MHz 20 rad at 72 to 144 MHz 40 rad at 144 to 288 MHz 80 rad at 288 to 576 MHz 160 rad at 576 MHz to 1 GHz Peak frequency deviation <10% of carrier frequency for carrier frequencies <4 MHz
Resolution	0.2 rad at 100 kHz to 36 MHz 0.02 rad at 36 MHz to 72 MHz 0.05 rad at 72 MHz to 144 MHz 0.1 rad at 144 MHz to 288 MHz 0.2 rad at 288 MHz to 576 MHz 0.5 rad at 576 MHz to 1 GHz
Indication	4 digits
Setting	Keyboard entry with increment and decrement keys and rotary variable control
Accuracy (1)	$\pm 5\%$ of setting ± 1 digit for modulation frequencies from 250 Hz to 3.4 kHz over the range 15 to 35°C (0.1% per °C outside this range)
Distortion (1)	<1% for modulation frequencies from 250 Hz to 5 kHz (deviation 1 to 160 rad)
Modulation frequency range	250 Hz to 5 kHz
Modulation frequency resolution	0.1 Hz
Phase modulation, external input	
Input impedance	Nominally 1 M Ω in parallel with 100 pF
Frequency range	As internal Φ M
Modulation frequency range	250 Hz to 5 kHz
Input sensitivity	2.828 V pk-pk for indicated deviation
Accuracy	As internal Φ M $\pm 2\%$
(1)	At low modulation levels, the residual AM/FM may become significant.
(2)	Either 3 modulation plus 3 audio generators up to 20 kHz or 1 modulation or 1 audio generator to 100 kHz.

Audio analyzer

Audio voltmeter	
Input impedance	Nominally 1 M Ω in parallel with 100 pF or 600 Ω
Frequency range	DC and 20 Hz to 500 kHz AC only 20 Hz to 500 kHz polarized DC (below 10 Hz)
Level ranges	0 to 10, 0 to 30, 0 to 100, 0 to 300 mV, 0 to 1, 0 to 3, 0 to 10, 0 to 30 V RMS reading (autoranging or fixed)
Level indication	4 digits and a bar chart in V
Level resolution	0.1 mV on 10, 30 and 100 mV ranges 0.3 mV on 300 mV range 1 mV on 1 V range 3 mV on 3 V range 10 mV on 10 V range 30 mV on 30 V range
Level accuracy, DC coupled (3) (4)	$\pm 2\%$ of reading ± 1 mV \pm resolution, DC and 100 Hz to 20 kHz $\pm 4\%$ of reading ± 1 mV \pm resolution, 40 Hz to 100 kHz The audio filter passband error is not included
Level accuracy, AC coupled (3) (4)	$\pm 2\%$ of reading ± 1 mV \pm resolution, 150 Hz to 20 kHz $\pm 4\%$ of reading ± 1 mV \pm resolution, 100 Hz to 100 kHz See also under <i>Environmental; User calibrations</i> on page 1-16.
Residual noise	100 μ V RMS, CCITT weighted
Audio frequency meter	
Range	10 Hz to 500 kHz
Resolution	0.1 Hz from 10 Hz to 5 kHz 1 Hz from 5 to 50 kHz 10 Hz from 50 kHz to 500 kHz
Indication	6 digits
Accuracy	As frequency standard ± 1 digit \pm resolution
Sensitivity	On bar chart, $>25\%$ FSD (DC coupled)
Audio SINAD meter	
Frequency	1 kHz default User selectable to 20 kHz
SINAD range	5 to 50 dB
Resolution	0.1 dB for readings <20 dB 0.2 dB for readings <25 dB
Indication	3 digits and a bar chart, with peak hold
Accuracy (with band pass filter selected)	± 0.5 dB \pm resolution
Sensitivity	100 mV for 46 dB SINAD
Audio distortion meter	
Frequency	1 kHz default. User selectable to 20 kHz
Distortion range	0 to 30%
Resolution	0.1% distortion for readings $>1\%$ 0.2% distortion for readings $<1\%$
Indication	3 digits and a bar chart, with peak hold
Accuracy (with band pass filter selected)	$\pm 5\%$ of reading \pm resolution
Sensitivity	100 mV for 0.5% distortion
Audio S/N meter	
S/N range	0 to 100 dB
Resolution	0.1 dB for readings <50 dB 0.2 dB for readings <70 dB
Indication	3 digits and a bar chart, with peak hold
Accuracy	± 0.5 dB \pm resolution
Sensitivity	2 V for 60 dB 200 mV for 40 dB

Audio oscilloscope	
Operating modes	Single or repetitive sweep
Frequency range	DC to 500 kHz AC coupled 10 Hz to 500 kHz
Glitch catching	>1 μ s
Voltage ranges	2 mV/div to 20 V/div in a 1, 2, 5 sequence
Voltage accuracy	\pm 5% of full scale
Timebase	5 μ s/div to 10 s/div in a 1, 2, 5 sequence
Timebase accuracy	As frequency standard
Trigger mode	Auto trigger
Markers	M1 and M2
Marker indication, level	δ M
Marker indication, time	Δ M
Graticule	10 horizontal by 8 vertical divisions Can be magnified to full screen
Audio FFT analyzer	
Span widths	50 Hz to 50 kHz in a 5, 10, 25 sequence Above 40 kHz, signals are attenuated by 80 dB/octave
Graticule	10 horizontal by 8 vertical divisions Can be magnified to full screen
Reference level	10 mV to 20 V (top of graticule) in a 1, 2, 5 sequence
Level accuracy	\pm 0.3 dB at 100 Hz to 15 kHz Typically \pm 1 dB at 40 Hz to 40 kHz
Vertical scaling	10 dB/division
Dynamic range	60 dB
Max hold	Hold maximum values on multi-sweep traces
Audio sweep	DC to 20 kHz
Markers	M1 and M2
Marker indication, level	M1, M2, δ M
Marker indication, frequency	M1, M2, Δ M
Marker functions	Peak find, ref freq to M1
Audio bar charts	
Displays	AF voltage, SINAD, distortion and S/N
Vertical resolution	1% of full scale
Ranging	Autoranging, range hold or manual selection (up or down). 1, 3, 10 sequence with hysteresis.
Audio filters	
	300 Hz low-pass:- \pm 0.1 dB at <150 Hz relative to 100 Hz \pm 0.2 dB at 150 to 200 Hz relative to 100 Hz
	300 Hz to 3.4 kHz band-pass:- \pm 0.4 dB at 450 Hz to 2.1 kHz relative to 1 kHz
	20 kHz low-pass:- \pm 0.3 dB at <12 kHz relative to 1 kHz Typically -0.9 dB at 15 kHz relative to 1 kHz Typically -3.0 dB at 20 kHz relative to 1 kHz
	CCITT psophometric
	C-MESS

- (3) Audio or modulation filter passband errors not included.
(4) Refer to *Environmental; User calibrations* on page 1-16.

Audio monitor

Demodulated signals and audio signals can be monitored on the internal loudspeaker or through the accessory connector or the BNC sockets on the rear panel

Multimeter

Input terminals	Three 4 mm for Volt/ohm, current and common
Maximum input voltage	375 V with respect to instrument chassis
Voltmeter	
Frequency range	Polarized DC or 40 Hz to 1 kHz
Voltage range	0 to 300 mV, 0 to 3 V, 0 to 30 V, and 0 to 300 V
Crest factor	3:1 maximum at range full scale
Input impedance	Nominally 6 M Ω in parallel with 100 pF
Resolution	0.1% of FSD
Accuracy (4)	$\pm 3\%$ of reading ± 1 mV ± 1 digit
Indication	4 digits and a bargraph, with peak hold
Ammeter	
Frequency range	Polarized DC or 40 Hz to 1 kHz
Current range	0 to 1 A and 0 to 10 A
Resolution	1 mA at <1 A, 10 mA at <10 A
Accuracy	$\pm 5\%$ of reading ± 1 mA ± 1 digit
Indication	4 digits and a bargraph, with peak hold
Resistance meter	
Resistance range	0 to 100 Ω , 0 to 1 k Ω , 0 to 10 k Ω , 0 to 100 k Ω and 0 to 1 M Ω
Resolution	1 Ω at <1 k Ω or 3 digits
Accuracy (4)	$\pm 5\%$ of reading ± 1 Ω ± 1 digit
Continuity test	Continuous tone if reading <10 Ω
Indication	4 digits and a bargraph

(4) Refer to *Environmental; User calibrations* on page 1-16.

RF frequency meter

Range	100 kHz to 1 GHz
Resolution	1 or 10 Hz selectable
Indication	Up to 10 digits
Accuracy	As frequency standard ± 2 Hz \pm resolution
Acquisition time	Nominally <1 s
Dynamic range with automatic tuning	As RF power meter (broad-band)
Frequency range with automatic tuning	10 MHz to 999.9 MHz
Sensitivity with manual tuning, off-air test mode	TNC RF socket:- -100 dBm, depending on the receiver bandwidth
Offset frequency range	± 1 MHz, depending on the receiver bandwidth

RF power meter

Broad-band

Frequency range	100 kHz to 1 GHz
Dynamic range with automatic tuning	N-type RF socket:- 10 mW to 150 W TNC RF socket:- 100 μ W to 0.5 W
Power reading	True mean power in W
Resolution	Better than 1%
Indication	3 digits and a bar chart, with peak hold

Accuracy (4) at 100 kHz to 500 MHz	N-type RF socket:- ±7.5% (0.3 dB) 100 mW to 50 W, ±10% (0.4 dB) 20 mW to 150 W
	TNC RF socket:- ±12% (0.5 dB) at 200 μW to 50 mW
Accuracy (4) at 500 MHz to 1 GHz	N-type RF socket:- ±12% (0.5 dB) 20 mW to 15 W
	TNC RF socket:- ±15% (0.6 dB) 200 μW to 50 mW
Accuracy (4) at 100 kHz to 1 GHz	N-type RF socket:- ±7% (0.3 dB), 0.1 W to 50 W for ambient temperature in the range 15 to 35°C
	TNC RF socket:- ±10% (0.4 dB), 1 mW to 50 mW for ambient temperature in the range 15 to 35°C
Maximum continuous rating	N-type RF socket:- 50 W TNC RF socket:- 0.5 W, overload protected to 10 W
Intermittent rating	N-type RF socket:- 150 W for limited periods, typically 2 minutes at 20°C, typical off to on ratio of 6:1 Overload indicated by audible and visual warnings

Selective

Frequency range	100 kHz to 1 GHz
IF bandwidth	300 Hz to 30 kHz in a 1, 3, 10 sequence and 110 kHz, 280 kHz and 3 MHz
Dynamic range with manual tuning	N-type RF socket:- 0 to +50 dBm (110 kHz IF bandwidth)
	TNC RF socket:- -90 to +20 dBm (110 kHz IF bandwidth)
Accuracy (4)	N-type and TNC RF sockets:- Typically ±2.5 dB
Power reading	Average in dBm
Resolution	Better than 0.1 dB
Indication	3 digits and a bar chart

(4) Refer to *Environmental; User calibrations* on page 1-16.

Modulation analyzer

Dynamic range with automatic tuning	As RF power meter (broad-band)
Sensitivity with manual tuning	N-type RF socket:- -30 dBm at 110 kHz bandwidth
	TNC RF socket:- -50 dBm at 110 kHz bandwidth
Sensitivity with manual tuning, off-air test mode	TNC RF socket:- -101 dBm (2 μV), (better than 10 dB SINAD in 30 kHz IF bandwidth and CCITT weighted), demodulation accuracy maintained on signal >-60 dBm, 30 kHz
Receiver bandwidths	300 MHz to 30 kHz in 1, 3, 10 sequence, plus 110 kHz, 280 kHz and 3 MHz

Demodulation filters	300 Hz low-pass:- ±0.1 dB at <150 Hz relative to 100 Hz ±0.2 dB at 150 to 200 Hz relative to 100 Hz 300 Hz to 3.4 kHz band-pass:- ±0.4 dB at 450 Hz to 2.1 kHz relative to 1 kHz 5 kHz low-pass:- ±0.3 dB at <3.0 kHz relative to 1 kHz 20 kHz low-pass:- ±0.3 dB at <12 kHz relative to 1 kHz Typically -0.9 dB at 15 kHz relative to 1 kHz Typically -3.0 dB at 20 kHz relative to 1 kHz CCITT psophometric C-MESS
Audio output	To an internal loudspeaker, demodulated output socket and accessory connector for an external loudspeaker or headphones
Switching speed	Nominally <1 ms channel to channel up to 50 MHz apart, settling to within 1 kHz of final frequency
Demodulated output	Nominal output impedance <10 Ω, output voltage is range dependent (2 V peak at top of range)
Squelch	A manual squelch control is provided with variable threshold
Amplitude modulation	
Frequency range	100 kHz to 1 GHz
Modulation frequency range	20 Hz to 20 kHz
AM depth range	0 to 99%
Resolution	0.1% AM
Indication	3 digits and a bar chart
Accuracy (1) (3) (4) up to 85% peak AM	±3% of reading ±1% AM at 250 Hz to 5 kHz Typically ±5% of reading ±1% AM at 50 Hz to 15 kHz
Demodulation distortion (1)	<1% at 1 kHz, CCITT weighted
Residual AM	<0.1% AM, CCITT weighted
Frequency modulation	
Frequency range	1 MHz to 1 GHz
Modulation frequency range	20 Hz to 20 kHz
Deviation range	0 to 100 kHz
Resolution	10 Hz below 10 kHz deviation 100 Hz below 100 kHz deviation
Indication	3 digits and a bar chart
Accuracy (1) (3) (4)	±3% ± resolution for modulation frequency of 1 kHz ±5% ± resolution for modulation frequency of 100 Hz to 15 kHz
Demodulation distortion (1)	<0.5% at 1 kHz, CCITT weighted
Residual FM	<25 Hz RMS, CCITT weighted
Phase modulation	
Frequency range	1 MHz to 1 GHz
Modulation frequency range	250 Hz to 5 kHz
Deviation range	0 to 20 rad
Deviation resolution	0.01 rad
Indication	3 digits and a bar chart
Accuracy (1) (3) (4)	±5% ± resolution, 2 to 20 rads At low modulation levels, the residual FM/AM may become significant The audio and modulation filter passband error is not included
Demodulation distortion	<0.5% at 1 kHz (CCITT weighted)

SSB Option

Frequency range	100 kHz to 1 GHz
Demod distortion	As AM demodulation distortion
Sideband selection	USB, LSB or CW

- (1) At low modulation levels, the residual AM/FM may become significant.
- (3) Audio or modulation filter passband errors not included.
- (4) Refer to *Environmental; User calibrations* on page 1-16.

RF spectrum analyzer

Frequency

Frequency range	100 kHz to 1 GHz, usable 30 kHz to 1.05 GHz
Spans	500 Hz/div to 100 MHz/div in a 1, 2, 5 sequence
Resolution bandwidth	300 Hz to 30 kHz in a 1, 3, 10 sequence, 110 kHz, 280 kHz and 3 MHz (manual or automatically selected according to span)
Video bandwidth	Automatic selection 100 Hz, 1 kHz or 3 kHz
Filter shape	Nominally 3 dB/60 dB, 1 : 11 (300 Hz to 30 kHz bandwidth)

Level

Reference level	-100 to +70 dBm (top of graticule)
On-screen dynamic range	80 dB
Vertical dB/div	1, 2, 5, 10 dB
Accuracy (4)	Typically ± 2.5 dB

General features

Sweep speeds	Optimum sweep speed selected according to span and bandwidth
Modes	Single/repeat sweep
Graticule	10 horizontal by 8 vertical divisions
Expanded mode	Occupies full screen for high definition
Markers	M1 and M2
Marker indication, level	M1, M2 and δM
Marker indication, frequency	M1, M2 and ΔM
Marker functions	Peak find, set ref freq to M1
Max hold	Hold maximum values on multi-sweep traces

Tracking generator

Frequency range	100 kHz to 1 GHz
Level range	-135 dBm to +13 dBm
Offset tracking	For mixer, IF, fundamental and 2nd harmonic analysis (up/down $\times 2$ and $\div 2$)

- (4) Refer to *Environmental; User calibrations* on page 1-16.

Audio generators

Also, see under *Internal modulation and audio sources* (page 1-6).

Frequency

Range (2)	AF1, 2 & 3 AF4	1 Hz to 20 kHz 1 Hz to 100 kHz
Setting		Keyboard entry with increment and decrement keys and rotary variable control
Indication		6 digits
Resolution		0.1 Hz
Accuracy		As frequency standard

Level	
Level range	0.1 mV to 5 V RMS (Maximum AF output is 7 V peak with all generators combined)
Setting	Keyboard entry with increment and decrement keys and rotary variable control
Indication	4 digits
Resolution	0.1 mV
Accuracy	±3% ±1 digit, 250 Hz to 5 kHz ±5% ±1 digit, 10 Hz to 20 kHz ±10% ±1 digit, 20 Hz to 75 kHz
Output impedance	Nominally 5 Ω Min load 100 Ω
Protection	Maximum applied voltage 50 V
Signal purity	
Distortion (5)	<0.5% at 1 kHz measured in a 30 kHz bandwidth <1% from 20 Hz to 20 kHz measured in an 80 kHz bandwidth Typically 0.1% for levels >100 mV
Residual noise	<50 μV RMS, CCITT weighted
DC offset	<10 mV
(2)	Either 3 modulation plus 3 audio generators up to 20 kHz or 1 modulation or 1 audio generator to 100 kHz.
(5)	At low audio levels, the residual noise may become significant.

Signalling encoder

Sequential tones	Encodes up to 40 tones. CCIR, ZVEI, DZVEI, EEA, EIA and user-defined standards. Any of the tones can be extended. Continuous, burst and single step modes.
User-defined tones	Up to three frequency plans can be defined and stored within the test set for sequential tones. Any of the standard tone frequency plans can be copied to user-defined and modified. Tone length 10 ms to 1 s. Extended tone length 100 ms to 10 s.
CTCSS tones	Standard tone frequencies can be selected from a menu.
DCS encoder	Generation of digitally-coded squelch.
DTMF encoder	Generation of dual-tone multi-frequency tones.
POCSAG	Generation of POCSAG code CCIR no. 1 Rec. 584. Bit rates 200 to 9600 bit/s

Signalling decoder

Sequential tones	Decodes up to 40 tones. CCIR, ZVEI, DZVEI, EEA, EIA and user-defined standards.
User-defined tones	Up to three frequency plans can be defined and stored within the test set for sequential tones. Any of the standard tone frequency plans can be copied to user-defined and modified. Tone length 10 ms to 1 s. Extended tone length 100 ms to 10 s.
DCS decoder	Decodes digitally-coded squelch.
DTMF decoder	Decodes DTMF tones, duration, frequencies, and twist.

General features

Interfaces

Keyboard and display	Colour-coded keyboard with bright high-resolution CRT
GPIB	Full control of all major instrument functions. Flexibility is further enhanced by Marconi Instruments implementation of IEEE 488.2.
Capability	Complies with the following sub-sets as defined in IEEE 488.1-1978 SH1, AH1, T6, TE0, L4, LE0, SR1, RL1, PP0, DC1, DT1 and E1
Serial interface	EIA RS-232-C for instrument remote control. 9-way D-type connector. Provision is made for a graphics screen dump. A selection of printer drivers is included.
Parallel interface	25-way D-type connector. Provision is made for a graphics screen dump. A selection of printer drivers is included.
Accessory socket	For the connection of various optional accessories. With suitable adapters, compatible with most 2955 series accessories.
Memory card	PCMCIA 2 and JEIDA 4 standard. Facility for the storage of results and set-ups.
Video output	Colour, compatible with most VGA monitors. 15-way sub-miniature D-type connector.

Frequency standard

Internal frequency standard

Frequency	10 MHz
Temperature stability	Better than 5 parts in 10^8 , 5 to 55°C
Ageing rate	Better than 2 parts in 10^7 per year after 1 month continuous use
Warm-up time	<10 minutes to within 2 parts in 10^7 at 20°C

External standard input

Frequencies	1, 2, 5 and 10 MHz
Level	>2 V pk-pk
Input impedance	Nominally 500 Ω

Frequency standard output

Frequency	10 MHz
Level	Nominally 2 V pk-pk loaded with 50 Ω

Power requirements

AC supply

Voltage	88 to 132 V and 188 to 264 V
Frequency	45 to 440 Hz
Power	135 W nominal, 260 W maximum for future options

DC supply

Voltage	11 to 32 V
Power	110 W nominal, 225 W maximum

Electro-magnetic compatibility

Conforms to the requirements of EEC directive 89/336/EEC by complying with standards EN 55011 Class B (RF Emissions).

Conforms to International Standards CISPR 11.

Safety

Complies with IEC 348.

Environmental

Rated range of use

Temperature 0 to 50°C

Humidity Up to 95% relative humidity at 40°C

User calibrations

User calibrations are provided to maintain high accuracy for any ambient temperature (e.g. in ATE racks or in field measurements). Having allowed the instrument to stabilize, running the four user calibrations optimizes the performance at that temperature.

To run the calibrations, see the subsection *Calibrations* in Chapter 3.

A change in temperature of 5°C from the calibration temperature affects the readings as given below. These figures are provided as a guide to typical performance. Typical variations for each 5°C change in temp:-

Power meter:-

Broad-band 2%
Selective 0.5 dB

Spectrum analyzer:-

Selective power 0.5 dB
Level 0.5 dB

Audio analyzer and modulation analyzer filters:-

Audio voltage 0.4%
Demodulation depth and deviation 0.4%

Multimeter:-

Voltage 0.5%
Current, ohms 0.5%

Storage and transport

Temperature -40 to +70°C

Altitude Up to 4570 m (pressurised freight at 27 kPa differential)

Dimensions and weight

Excluding handle, feet and covers

Height 177 mm (6.9 in)
Width 370 mm (14.5 in)
Depth 540 mm (21.2 in)

Including handle, feet and covers

Height 203 mm (7.9 in)
Width 420 mm (16.5 in)
Depth 600 mm (23.6 in)

Weight <18 kg (<39.5 lb)

Accessories

Supplied

46882-159J	Operating Manual
46882-160N	Operating Manual Supplement for NMT (when NMT software is supplied)
46882-161L	Operating Manual Supplement for AMPS (when AMPS software is supplied)
46882-162J	Operating Manual Supplement for TACS (when TACS software is supplied)
46882-163F	Operating Manual Supplement for MPT1327 (when MPT software is supplied)
46882-164G	Operating Manual Supplement for PMR (when PMR software is supplied)
46882-165V	Operating Manual Supplement for GSM (when GSM software is supplied)
43123-076Y	AC Power Supply Cable
46884-651G	Multimeter Cable Kit

Optional

54311-153G	DC Power Supply Cable
54462-025T	Battery Pack
54462-026P	AC Charger for Battery Pack
43129-189U	Cable Assembly, GPIB
46884-560M	Cable Assembly, Parallel to Printer Centronics socket
46884-648G	Cable Assembly, Serial to Printer 25-way D-type socket
46884-649V	Cable Assembly, Serial to PC 25-way D-type socket
46884-650F	Cable Assembly, Serial to PC 9-way D-type socket
43130-596E	Cable Assembly, RF, 1 m, N-type plug and TNC plug
54311-095C	Cable Assembly, RF, 1 m, N-type plugs
54311-071Z	Adapter, TNC plug and BNC socket
54311-092P	Adapter, N-type plug and BNC socket
54421-001N	Telescopic Antenna, BNC
46884-645L	Accessory Socket Adapter (for 2955 accessories)
46884-646J	Accessory Socket 'Y' Adapter
54127-310K	Rack Mounting Kit
37591-634N	Front Dust Cover
54112-158V	Hard Transit Case
54112-157G	Soft Carrying Case
59000-189M	Memory Card, 128 Kbyte - Blank
54431-023A	20 dB AF Attenuator (BNC)
54411-052M	600 Ω Interface Unit (Balanced to Unbalanced Converter and 20 dB Attenuator)
52388-900D	1 GHz Active Probe 2388
54441-012P	Power Supply Unit for 2388
46662-537	Soft Carrying Case for Battery Pack

1 2 3 4 5 6 7 8 9 10 11 12 13 14 15 16 17 18 19 20 21 22 23 24 25 26 27 28 29 30 31 32 33 34 35 36 37 38 39 40 41 42 43 44 45 46 47 48 49 50 51 52 53 54 55 56 57 58 59 60 61 62 63 64 65 66 67 68 69 70 71 72 73 74 75 76 77 78 79 80 81 82 83 84 85 86 87 88 89 90 91 92 93 94 95 96 97 98 99 100

Chapter 2

INSTALLATION

Contents

Ventilation	2-1
Carrying handle	2-1
Power requirements.....	2-2
Power cords.....	2-2
DC power supply	2-2
GPIO port.....	2-2
Parallel port	2-3
Serial port	2-4
External monitor port.....	2-4
Accessory port.....	2-5
Memory cards	2-6
Rack mounting.....	2-6
Routine safety testing and inspection.....	2-7
1. Visual inspection.....	2-7
2. Earth bonding tests.....	2-7
3. Insulation resistance test.....	2-8
Rectification.....	2-8

List of figures

Fig. 2-1 GPIO socket contacts (as seen facing panel)	2-2
Fig. 2-2 GPIO interconnections	2-3
Fig. 2-3 Parallel port socket contacts (as seen facing panel).....	2-3
Fig. 2-4 Serial port plug contacts (as seen facing panel)	2-4
Fig. 2-5 Null modem connections.....	2-4
Fig. 2-6 External monitor socket contacts (as seen facing panel)	2-4
Fig. 2-7 Accessory port plug contacts (as seen facing panel).....	2-5

Ventilation

If the 2965 has a cover, this should be removed before the instrument is connected to the power supply. The instrument is air-cooled through vents with fan assistance. Air is drawn over the heat-producing elements and is expelled by the fan through the rear panel grill.

CAUTION

Over-heating

Do not obstruct the air vents while the instrument is in use. Avoid standing the instrument on or close to other equipment that is hot.

Carrying handle

The carrying handle may be used for tilting the instrument, or may be positioned above or below the instrument for convenience.

The carrying handle may be re-positioned by pressing the boss in the centre of both sides of the handle and moving the handle. On releasing the boss on both sides while moving the handle, it will lock in the next 30 degree position.

CAUTION

To avoid injury, or damage to the instrument, only adjust the handle while the instrument is stood on its rear panel feet.

Power requirements

Power cords

This instrument is provided with a 3-wire (grounded) cordset which includes a moulded IEC 320 connector for connection to the instrument. The cable must be fitted with an approved plug which, when plugged into an appropriate 3-terminal socket outlet, grounds the case of the instrument. Failure to ground the instrument may expose the operator to hazardous voltage levels. Depending upon the destination country, the colour coding of the wires will differ:-

	North America	Harmonised
Line (Live)	Black	Brown
Neutral	White	Blue
Ground (Earth)	Green	Green/Yellow

When the instrument has to be plugged into a Class II (ungrounded) 2-terminal socket outlet, the cable should either be fitted with a 3-pin Class I plug and used in conjunction with an adapter incorporating a ground wire, or be fitted with a Class II plug with an integral ground wire. The ground wire must be securely fastened to ground. Grounding one terminal on a 2-terminal socket will not provide adequate protection.

DC power supply

A Cable Assembly (Part no. 54311-153G) is available as an optional accessory. It is fitted at one end with a 3-way D-type socket which mates with the DC INPUT plug at the rear of the instrument. The socket is gold plated to reduce the voltage drop. The connections are as follows:-

Upper contact	Positive
Middle contact	Ground
Lower contact	Negative

GPIB port

This has a GPIB standard socket which is mounted on the rear panel. See Fig. 2-1.

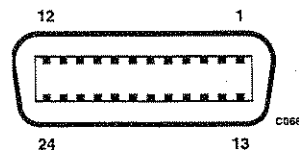

Fig. 2-1 GPIB socket contacts (as seen facing panel)

The functions of the socket contacts are as follows:-

Contact	Function	Contact	Function
1	Data I/O 1	13	Data I/O 5
2	Data I/O 2	14	Data I/O 6
3	Data I/O 3	15	Data I/O 7
4	Data I/O 4	16	Data I/O 8
5	EOI	17	REN
6	DAV	18	Pair with 6
7	NRFD	19	Pair with 7
8	NDAC	20	Pair with 8
9	IFC	21	Pair with 9
10	SRQ	22	Pair with 10
11	ATN	23	Pair with 11
12	Ground shield	24	Logic ground

For connection to other equipment having a 24-way IEEE 488.1 socket, there is a GPIB Cable Assembly (Part no. 43129-189U), which is available as an optional accessory.

The cable assemblies have male-female connectors at both ends. This allows several connectors to be stacked on top of one another and secured by lockscrews.

CAUTION **Stacked connectors**

Do not assemble too large a stack of connectors. This could cause damage.

When stacking connectors to make multiple connections, ensure that excessive strain is not placed on the GPIB socket. Damage can be caused to it resulting in intermittent or faulty connections.

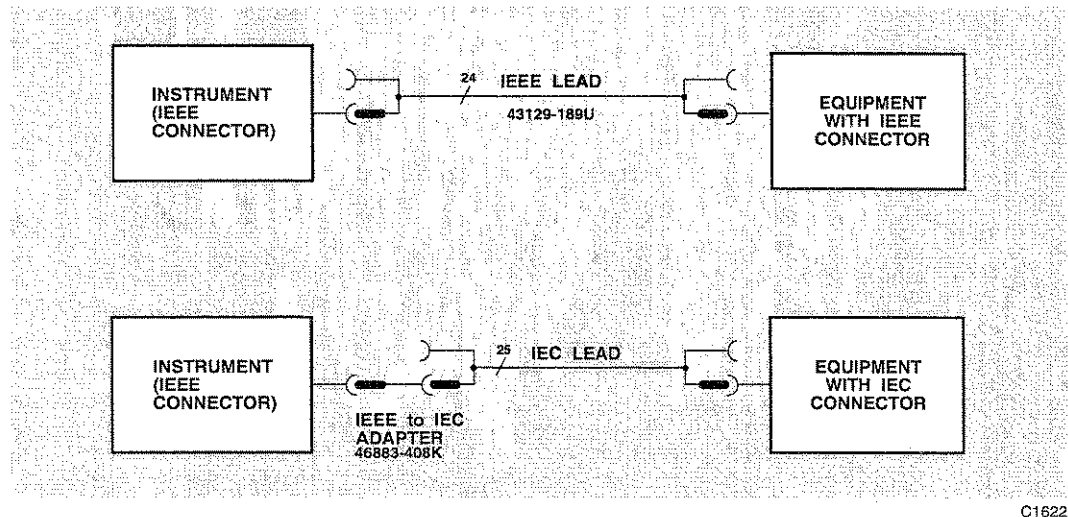

C1622

Fig. 2-2 GPIB interconnections

Parallel port

This has a 25-way D-type socket which is mounted on the rear panel. See Fig. 2-3.

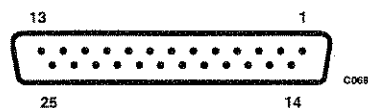

Fig. 2-3 Parallel port socket contacts (as seen facing panel)

The functions of the socket contacts are as follows:-

Contact	Function	Contact	Function
1	Strobe	10	ACK
2	Data 0	11	BUSY
3	Data 1	12	PE
4	Data 2	13	SLCT
5	Data 3	14	AUTOFD
6	Data 4	15	ERROR
7	Data 5	16	INIT
8	Data 6	17	SLCT IN
9	Data 7	18 to 25	Ground

Serial port

The serial port is an RS232 data terminal equipment (DTE) with a 9-way D-type plug mounted on the rear panel. See Fig. 2-4.

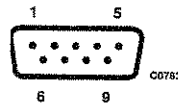

Fig. 2-4 Serial port plug contacts (as seen facing panel)

The functions of the plug contacts are as follows:-

Contact	Function	Contact	Function
1	DCD	6	DSR
2	Rx data in	7	RTS
3	Tx data out	8	CTS
4	DTR	9	RI
5	Ground		

Functions DTR on contact 4 and RTS on contact 7 are held at logic 1.

The use of a NULL MODEM cable assembly and software handshaking is recommended. Hard handshaking is not implemented.

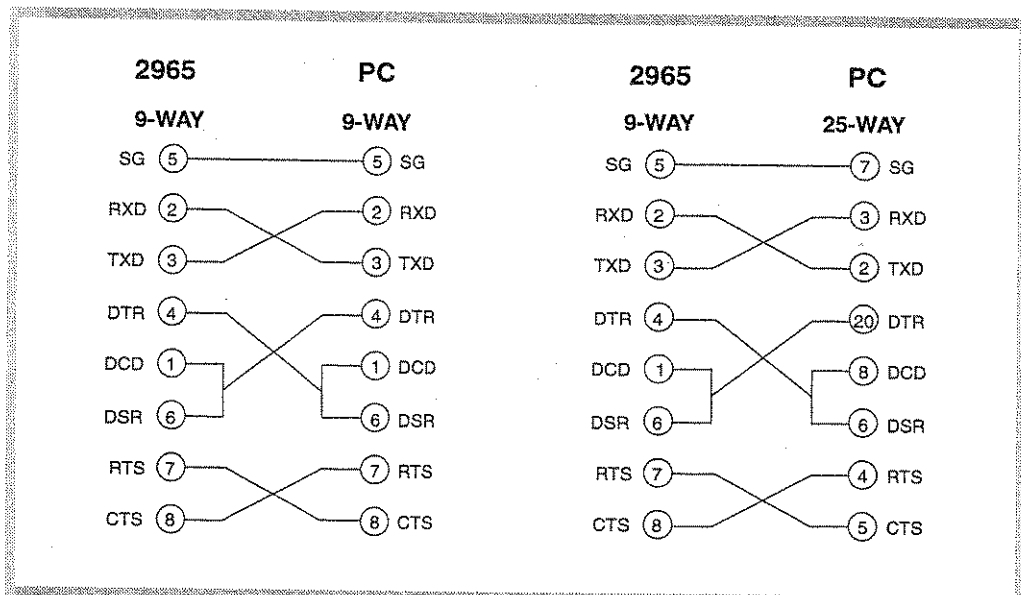

C1674

Fig. 2-5 Null modem connections

External monitor port

This has a 15-way D-type socket which is mounted on the rear panel. See Fig. 2-6.

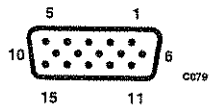

Fig. 2-6 External monitor socket contacts (as seen facing panel)

The functions of the socket contacts are as follows:-

Contact	Function	Contact	Function
1	Video red	9	NC
2	Video green	10	NC
3	Video blue	11	No connection
4	No connection	12	No connection
5	Ground (Red)	13	HSYNC
6	Ground (Green)	14	VSYNC
7	Ground (Blue)	15	No connection

Accessory port

This has a 25-way D-type plug which is mounted on the rear panel. See Fig. 2-7.



Fig. 2-7 Accessory port plug contacts (as seen facing panel)

The table below is included for information only. No inference is made as to the uses to which this connector can be used for connecting any equipment other than approved devices manufactured by Marconi Instruments. The functions of the plug contacts are as shown below.

Pin Nbr	Function	Remarks
1	No connection	For future expansion. Do not use.
2	No connection	For future expansion. Do not use.
3	+12 V	100 mA max.
4	Ground (Logic)	Use with power accessory lines.
5	Acc-SDA	i ² C data.
6	Status 2	Used by 2955 accessories.
7	Logic 3	See Note 1 below.
8	Logic 1	See Note 1 below.
9	Speaker	Maximum load 8 Ω.
10	No connection	
11	Ground (REV PWR)	Used by directional power head.
12	Ground (FWD PWR)	Used by directional power head.
13	No connection	For future expansion. Do not use.
14	No connection	For future expansion. Do not use.
15	No connection	For future expansion. Do not use.
16	-12 V	100 mA max.
17	Acc SCL	i ² C clock.
18	Status 3	Used by 2955 accessories.
19	Status 1	Used by 2955 accessories.
20	Logic 2	See Note 1 below.
21	Logic 0	See Note 1 below.
22	Ground (SPKR)	Speaker ground.
23	REV PWR	Used by directional power head.
24	FWD PWR	Used by directional power head.
25	No connection	For future expansion. Do not use.

Note 1

Programmable in SYSTEMS mode.

Open drain drive pulled up to +5 V with 4K7 Ω. Max sink current, 10 mA for $V_{OL} = 1$ V.

Memory cards

Insert the Memory Card (Part no. 59000-189M) in the slot and push it in to engage the connector.

Format each new Memory Card. For card set-up, see under *Inputs and outputs* in Chapter 3.

For operational information, see under *Store and recall facility* in Chapter 3.

Rack mounting

Introduction

The 2965 can be mounted in a 19-inch rack using the Rack Mounting Kit (Part no. 54127-310K), which is available as an optional accessory. The bracket height is 4U, 176 mm (7 in).

Kit contents

The Rack Mounting Kit consists of the following parts:-

- (a) Side bracket assembly, right-hand (with switch) (1).
- (b) Side bracket assembly, left-hand (no switch) (1).
- (c) Slide assemblies (2) with short rear brackets (2) and long rear brackets (2).
- (d) Screws, pan-head M4 × 10 (10).
- (e) Nut, cage, M6 (12).
- (f) Screws, cheese-head M5 × 16 (8).
- (g) Tapped strip (4).
- (h) Cup washer, M6 (4).
- (j) Screws, pan-head M6 × 16 (4).

Procedure

Assemble the Rack Mounting Kit as follows:-

- (1) If it is necessary to reduce the height of the 2965, detach its four feet by removing their attachment screws.
- (2) Prise off the handle caps. Remove the handle attachment screws. Detach the handle and retain it for future use.
- (3) Offer up each side bracket assembly to the 2965 so that the bracket holes line up with the handle hole and the rear hole. Insert two of the M4 × 10 screws.
- (4) Withdraw the inner slides from the slide assemblies. Offer up each inner slide to the side bracket so that it touches the front of the bracket, the three holes in each line up and the spring latch is at the outside and to the rear. Insert three of the M4 × 10 screws.
- (5) On the front and rear of the rack, fit two cage nuts in adjacent holes at the positions of the two side rails. On the front of the rack, fit two cage nuts 45.5 mm (1.75 in) below and above these pairs of nuts.
- (6) At the front and rear of the rack, using the appropriate bracket at the rear according to the depth, attach the slide outer rails by means of the M5 × 16 screws through the cage nuts into the tapped strips.
- (7) Pull out the middle extenders of the slides. Lift the 2965 into the rack so that the inner slides go into the middle extenders. Press in the spring latches and push the 2965 all the way in.
- (8) Insert the four M6 cup washers and the four M6 × 16 screws in the holes to fix the side brackets to the rack.
- (9) Use the AC cables and the AC switch on the right-hand side bracket. Insert the IEC outlet socket into the equipment's AC inlet plug. See under *Power cords* on page 2-2.

Routine safety testing and inspection

In the UK, the 'Electricity at Work Regulations' (1989) section 4(2) places a requirement on the users of equipment to maintain it in a safe condition. The explanatory notes call for regular inspections and tests together with a need to keep records.

The following electrical tests and inspection information is provided for guidance purposes and involves the use of voltages and currents that can cause injury. It is important that these tests are only performed by competent personnel.

Prior to carrying out any inspection and tests, the instruments must be disconnected from the mains supply and all external signal connections removed. All tests should include the instrument's own supply lead, all covers must be fitted and the equipment supply switch must be in the 'ON' position.

The recommended inspection and tests fall into three categories and should be carried out in the following sequence:-

1. Visual inspection
2. Earth bonding tests
3. Insulation resistance test

1. Visual inspection

A visual inspection should be carried out on a periodic basis. This interval is dependent on the operating environment, maintenance and use, and should be assessed in accordance with guidelines issued by the Health and Safety Executive (HSE). As a guide, this instrument when used indoors in a relatively clean environment would be classified as 'low risk' equipment and hence should be subject to safety inspections on an annual basis. If the use of the equipment is contrary to the conditions specified, you should review the safety re-test interval.

As a guide, the visual inspection should include the following where appropriate:

Check that the equipment has been installed in accordance with the instructions provided (e.g. that ventilation is adequate, supply isolators are accessible, supply wiring is adequate and properly routed).

The condition of the mains supply lead and supply connector(s).

Check that the mains supply switch isolates the instrument from the supply.

The correct rating and type of supply fuses.

Security and condition of covers and handles.

Check the supply indicator functions (if fitted).

Check the presence and condition of all warning labels and markings and supplied safety information.

Check the wiring in re-wireable plugs and appliance connectors.

If any defect is noted this should be rectified before proceeding with the following electrical tests.

2. Earth bonding tests

Earth bonding tests should be carried out using a 25 A (12 V maximum open circuit voltage) DC source. Tests should be limited to a maximum duration of 5 seconds and have a pass limit of 0.1Ω after allowing for the resistance of the supply lead. Exceeding the test duration can cause damage to the equipment. The tests should be carried out between the supply earth and exposed case metalwork, no attempt should be made to perform the tests on functional earths (e.g. signal carrying connector shells or screen connections) as this will result in damage to the equipment.

3. Insulation resistance test

A 500 V DC test should be applied between the protective earth connection and combined live and neutral supply connections with the equipment supply switch in the 'ON' position. It is advisable to make the live/neutral link on the appliance tester or its connector to avoid the possibility of returning the instrument to the user with the live and neutral poles linked with an ad-hoc strap. The test voltage should be applied for 5 seconds before taking the measurement. Marconi Instruments products employ reinforced insulation in their construction and hence a minimum pass limit of 7 M Ω should be achieved during this test.

Where a DC power adapter is provided with the instrument, the adapter must pass the 7 M Ω test limit.

We do not recommend dielectric flash testing during routine safety tests. Most portable appliance testers use AC for the dielectric strength test which can cause damage to the supply input filter capacitors.

Rectification

It is recommended that the results of the above tests are recorded and checked during each repeat test. Significant differences between the previous readings and the measured values should be investigated.

If any failure is detected during the above visual inspection or tests, the instrument should be disabled and the fault should be rectified by an experienced Service Engineer who is familiar with the hazards involved in carrying out such repairs.

Safety critical components should only be replaced with equivalent parts, using techniques and procedures recommended by Marconi Instruments Ltd.

The above information is provided for guidance only. Marconi Instruments products are designed and constructed in accordance with International Safety Standards such that in normal use they represent no hazard to the operator. Marconi Instruments Ltd reserve the right to amend the above information in the course of continuing its commitment to product safety.

Chapter 3

OPERATION

Contents

Introduction.....	3-4
Operating the instrument	3-4
Key groups	3-4
Soft key operation and display	3-4
Modes and displays	3-5
Tx TEST mode.....	3-5
Rx TEST mode.....	3-7
DUPLEX TEST mode.....	3-8
TONES mode.....	3-8
SYSTEMS mode.....	3-9
RF TEST mode	3-9
AF TEST mode	3-10
Controls and connectors	3-11
Front panel.....	3-11
Rear panel.....	3-15
Starting procedure.....	3-17
RF input/output level offsets.....	3-17
Inverse video indications	3-18
Causes of dim-inverse video displays	3-18
Transmitter testing.....	3-19
Transmitter testing - non-expanded.....	3-19
Transmitter testing - expanded	3-25
Oscilloscope	3-25
Spectrum analyzer.....	3-26
Modulation analyzer.....	3-29
Off-air transmitter testing - non-expanded.....	3-32
Off-air transmitter testing - expanded.....	3-37
Oscilloscope	3-37
Spectrum analyzer.....	3-37
Modulation analyzer.....	3-37
Receiver testing	3-38
Receiver testing - non-expanded.....	3-38
Receiver testing - expanded.....	3-42
Oscilloscope	3-42
Audio analyzer.....	3-44
Duplex testing	3-47
Full duplex testing	3-47
Duplex transmitter testing.....	3-51
Duplex transmitter testing - expanded.....	3-57
Oscilloscope	3-57
Spectrum analyzer.....	3-57
Modulation analyzer.....	3-57
Duplex receiver testing.....	3-58
Duplex receiver testing - expanded.....	3-62
Oscilloscope	3-62
Audio analyzer.....	3-62

RF testing	3-64
RF input/output testing - non-expanded	3-64
RF input/output testing - expanded.....	3-69
Oscilloscope	3-69
Spectrum analyzer.....	3-70
Modulation analyzer	3-70
SSB transmitter testing - non-expanded	3-70
SSB transmitter testing - expanded	3-76
Spectrum analyzer.....	3-76
Sideband analyzer	3-78
CW analyzer	3-80
SSB receiver testing - non-expanded	3-83
SSB receiver testing - expanded	3-87
Oscilloscope	3-87
Audio analyzer.....	3-88
Audio testing	3-91
Audio input/output testing - non-expanded.....	3-91
Audio input/output testing - expanded.....	3-96
Oscilloscope	3-96
Audio analyzer	3-96
Audio multimeter testing	3-96
Multimeter display	3-97
Signalling codes testing	3-99
Sequential tones	3-99
CTCSS	3-106
DTMF (dual-tone multi-frequency)	3-108
Introduction	3-108
Connections	3-109
Procedure	3-109
Display (GENERATE/DECODE)	3-114
Display (GENERATE).....	3-115
Display (DECODE).....	3-116
DCS (digitally coded squelch)	3-116
POCSAG pager.....	3-120
Systems testing	3-123
Help and setting up	3-124
Help on topics	3-127
Setting up	3-127
Test options.....	3-128
Inputs and outputs.....	3-132
Miscellaneous	3-133
Default values	3-133
Country.....	3-134
Calibrations	3-134
Demonstration	3-134
Software versions	3-135
Store and recall facility	3-136
Introduction	3-136
Store	3-136
Recall	3-137
User options	3-138
100 kHz audio or modulation generator	3-138
Versatile tracking generator	3-138

List of figures

Fig. 3-1 TRANSMITTER TEST displays	3-6
Fig. 3-2 RECEIVER TEST displays	3-7
Fig. 3-3 DUPLEX TEST displays	3-8
Fig. 3-4 Front panel	3-12
Fig. 3-5 Rear panel.....	3-16
Fig. 3-6 TRANSMITTER TEST display with bar charts	3-20
Fig. 3-7 TRANSMITTER TEST SCOPE expanded display	3-25
Fig. 3-8 TRANSMITTER TEST SPECTRUM ANALYZER expanded display with markers	3-27
Fig. 3-9 TRANSMITTER TEST MOD ANALYZER expanded display.....	3-31
Fig. 3-10 OFF-AIR TRANSMITTER TEST display with bar charts.....	3-33
Fig. 3-11 RECEIVER TEST display with bar charts.....	3-39
Fig. 3-12 RECEIVER TEST SCOPE expanded display with markers on	3-43
Fig. 3-13 RECEIVER TEST AUDIO ANALYZER expanded display with markers	3-45
Fig. 3-14 DUPLEX TEST display with bar charts	3-48
Fig. 3-15 DUPLEX TEST (Tx) display with bar charts	3-53
Fig. 3-16 DUPLEX TEST (Rx) display with bar charts	3-59
Fig. 3-17 RF INPUT/OUTPUT TEST display with bar charts.....	3-65
Fig. 3-18 SSB TRANSMITTER TEST display with bar charts	3-72
Fig. 3-19 SSB TRANSMITTER TEST display with suppression analyzer	3-74
Fig. 3-20 SSB TRANSMITTER TEST SPECTRUM ANALYZER expanded display	3-77
Fig. 3-21 SSB TRANSMITTER LOWER SIDEBAND ANALYZER expanded display.....	3-79
Fig. 3-22 SSB TRANSMITTER CARRIER WAVE ANALYZER expanded display.....	3-82
Fig. 3-23 SSB RECEIVER TEST display with bar charts.....	3-84
Fig. 3-24 SSB RECEIVER AUDIO ANALYZER expanded display with markers.....	3-89
Fig. 3-25 AUDIO INPUT / OUTPUT TEST display with bar charts	3-92
Fig. 3-26 AUDIO TEST MULTIMETER display	3-97
Fig. 3-27 Tx TEST SEQUENTIAL TONES DECODE display.....	3-100
Fig. 3-28 Rx TEST SEQUENTIAL TONES GENERATE display	3-102
Fig. 3-29 Rx TEST CTCSS GENERATE display	3-107
Fig. 3-30 DTMF screens	3-109
Fig. 3-31 Tx TEST DTMF GENERATE/DECODE.....	3-110
Fig. 3-32 Tx TEST DTMF DECODE.....	3-111
Fig. 3-33 Tx TEST DTMF GENERATE	3-112
Fig. 3-34 Rx TEST DTMF GENERATE	3-114
Fig. 3-35 Tx TEST DCS DECODE display	3-117
Fig. 3-36 Rx TEST DCS GENERATE display	3-118
Fig. 3-37 Rx TEST POCSAG PAGER TEST display	3-121
Fig. 3-38 HELP AND SET-UP menu	3-124
Fig. 3-39 HELP AND SET-UP operation	3-125
Fig. 3-40 Normal, doubler and divider testing	3-139
Fig. 3-41 Mixer testing.....	3-140

Introduction

With the exception of the section *User options* (page 3-138), this chapter refers to an instrument with factory preset settings, prior to any customisation.

Operating the instrument

Key groups

The 2965 operation is controlled by six groups of keys:

- (1) Mode keys. These keys permit the selection of the type of testing or operation, and enable appropriate adjustment/selection of test values (e.g. frequency, signal level, etc.).
- (2) Function keys. These keys are the means of selecting the set-up functions appropriate to the mode that has been selected, together with miscellaneous functions. In Rx TEST mode, for example, pressing the [RF GEN] key followed by the [FREQ] key allows the RF generator frequency to be set using the DATA keys.
- (3) Data keys. These keys permit the setting of values and units appropriate to the mode and function key previously pressed.
- (4) Soft keys. These keys around the display are used for operations associated with the display itself. A label for each key in use is shown on the display next to the key. Some soft keys change the display, some provide control of a display feature, and some permit selection from a list of options which are successively displayed as the soft key is successively pressed.
- (5) Input/output keys. These are the [RF SELECT] and the two [AC DC] keys. The [RF SELECT] key permits the TNC and N type RF sockets to be selected for input or output function. The two [AC DC] keys select the type of coupling associated with the EXT MOD INPUT and AF INPUT BNC sockets.
- (6) [INC] keys. These permit frequencies and levels to be incremented by amounts previously set up according to the mode, function and display currently in use.

In addition to the keys provided for instrument control, there are three groups of rotary controls:

- (1) VARIABLE control. This permits frequencies, levels etc. to be set or adjusted.
- (2) VOLUME and SQUELCH controls. These permit the volume and squelch level of the internal speaker to be adjusted. The squelch control also affects some displays in permitting a signal threshold to be adjusted.
- (3) INTENSITY and SCOPE POSITION controls. These controls permit adjustment of display brightness and vertical position respectively.

Soft key operation and display

Soft keys operate in one of three different ways:-

- (1) ON off toggle. Pressing the soft key once switches the soft key's function on, pressing it again switches the soft key's function off. The soft key's legend indicates the current state of the soft key's function. Examples are the Tx TEST mode's [*Tx tune ON off*], and [*gen 1 on OFF*].
- (2) Select from list. Successively pressing the soft key cycles and selects through a list of options. An example is the Tx TEST mode's [*mod type*] soft key, where selection is indicated by the display showing AM DEPTH, Φ M DEVN and FM DEVN. A select from list soft key may introduce additional soft keys to support its function; for example, the Tx TEST mode's [*hold ranges*] and [*auto range*] soft keys.
- (3) Select display. These soft keys are in groups of mutually exclusive keys. On selection of each of these grouped soft keys, the others are reset. After selection, a second key press provides an alternative type of information presentation. These keys are labelled on the display with the function/display that will be selected on the next key-press. Examples are the Tx TEST mode's [*spec ana*], [*mod ana*] and [*scope*] keys.

Modes and displays

This is a summary of the principal features and advantages of each of the many modes and displays that are provided.

Tx TEST mode

In normal transmitter tests, the transmitter is connected directly to one of the RF input connectors.

In the off-air transmitter tests, the transmitter is connected to its antenna. On the 2965, an antenna is fitted to one of the RF input connectors.

Normal

See Fig. 3-1 on page 3-6. In this mode, the 2965 functions as a receiver which measures the following:-

- (a) A transmitter's frequency (or frequency offset) and power.
- (b) The modulation type, frequency, deviation or depth and distortion and/or noise.

The 2965 automatically tunes to the transmitter's frequency. Alternatively, the transmitter can be tuned for minimum or zero offset by manually tuning the 2965. The manually-entered transmitter frequency can be increased or decreased by a previously entered increment.

The 2965 also provides an AF signal for modulating the transmitter. You can select any or all of the three AF generators. Alternatively, the wide range (1 Hz to 100 kHz) generator can be used (see *User options; 100 kHz audio or modulation generator* on page 3-138). Each frequency and level is set independently and each generator can be enabled or disabled. The audio frequencies and levels can be increased or decreased by previously entered increments.

The three AF generators can be configured with the three modulation generators to provide a single LF source with a range of 1 Hz to 100 kHz. This single source can be used as a modulation generator or as a wide range LF generator.

There are seven different stages of display as follows:-

- (a) Primary with bar charts
- (b) Primary with oscilloscope
- (c) Primary with spectrum analyzer
- (d) Primary with modulation analyzer
- (e) Expanded oscilloscope
- (f) Expanded spectrum analyzer
- (g) Expanded modulation analyzer

Off-air

The 2965 functions as a receiver which measures the following:-

- (a) A transmitter's frequency offset and the power that is induced in the antenna
- (b) The modulation type, frequency, deviation or depth and distortion and/or noise

The 2965 is manually tuned to the transmitter's frequency. The transmitter can be tuned for minimum or zero offset. The manually-entered transmitter frequency can be increased or decreased by a previously-entered increment.

The 2965 provides an AF signal as for normal tests.

There are seven different stages of display as for normal tests.

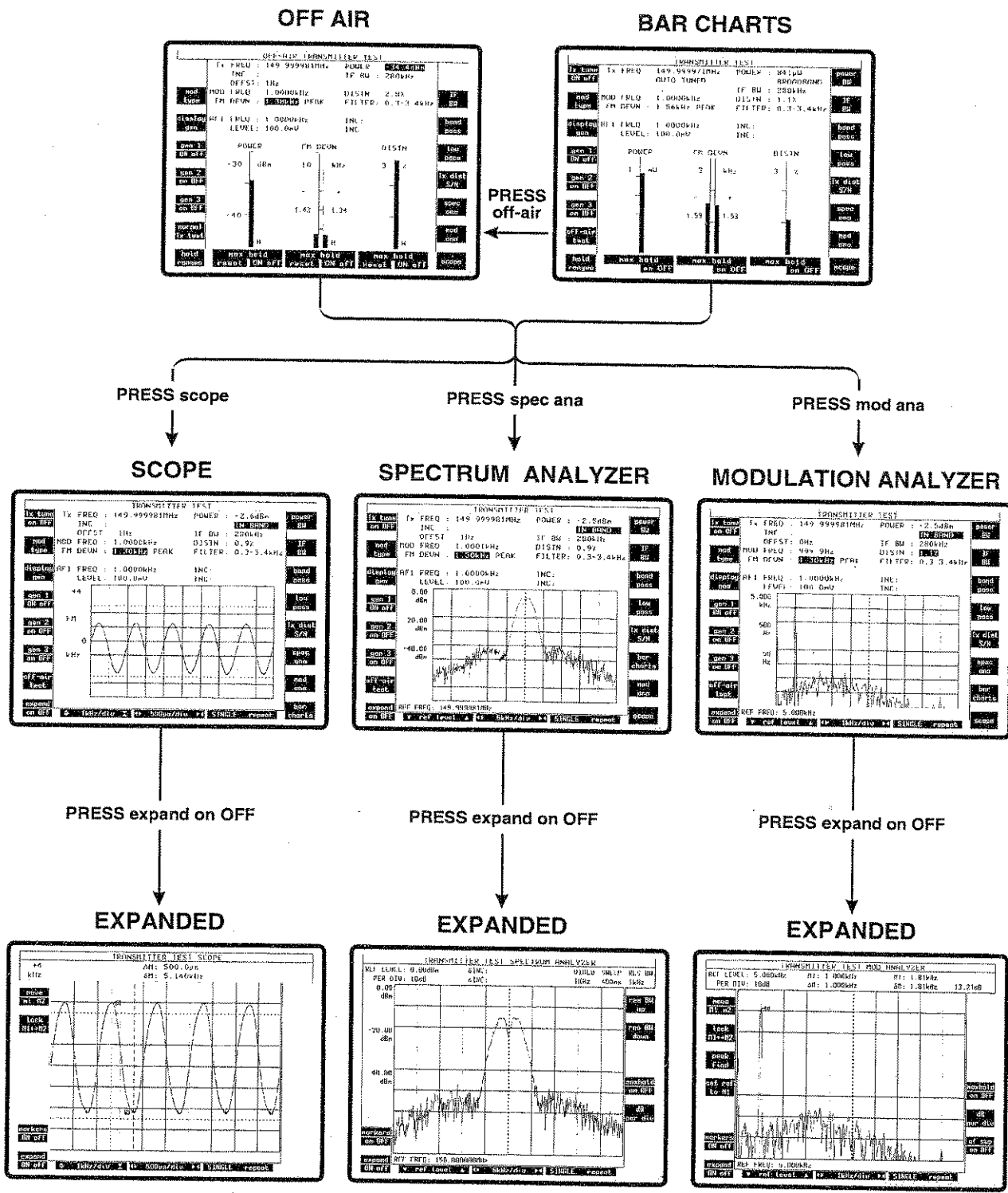

B2723

Fig. 3-1 TRANSMITTER TEST displays

Demodulation measurements

Demodulation measurements can be shown as either peak or RMS values. Switching from one to the other is done via the SET-UP menu; see page 3-129 for further information. The measurement type is displayed next to the value. The default is peak. Note that the RMS measurements are made with a different hardware configuration, not simply calculated from the peak levels.

Rx TEST mode

See Fig. 3-2.

In this mode, the 2965 functions as a transmitter which provides a modulated signal to a receiver. There are three modulation generators and the option of using an external generator. Each frequency and level is set independently and each generator can be enabled or disabled. The RF frequency and level and modulation frequencies and deviations or depths can be increased or decreased by previously entered increments.

The 2965 also measures the level, frequency and distortion and/or noise of the AF signal that has been demodulated by the receiver.

There are five different stages of display as follows:-

- (a) Primary with bar charts.
- (b) Primary with oscilloscope.
- (c) Primary with audio analyzer.
- (d) Expanded oscilloscope.
- (e) Expanded audio analyzer.

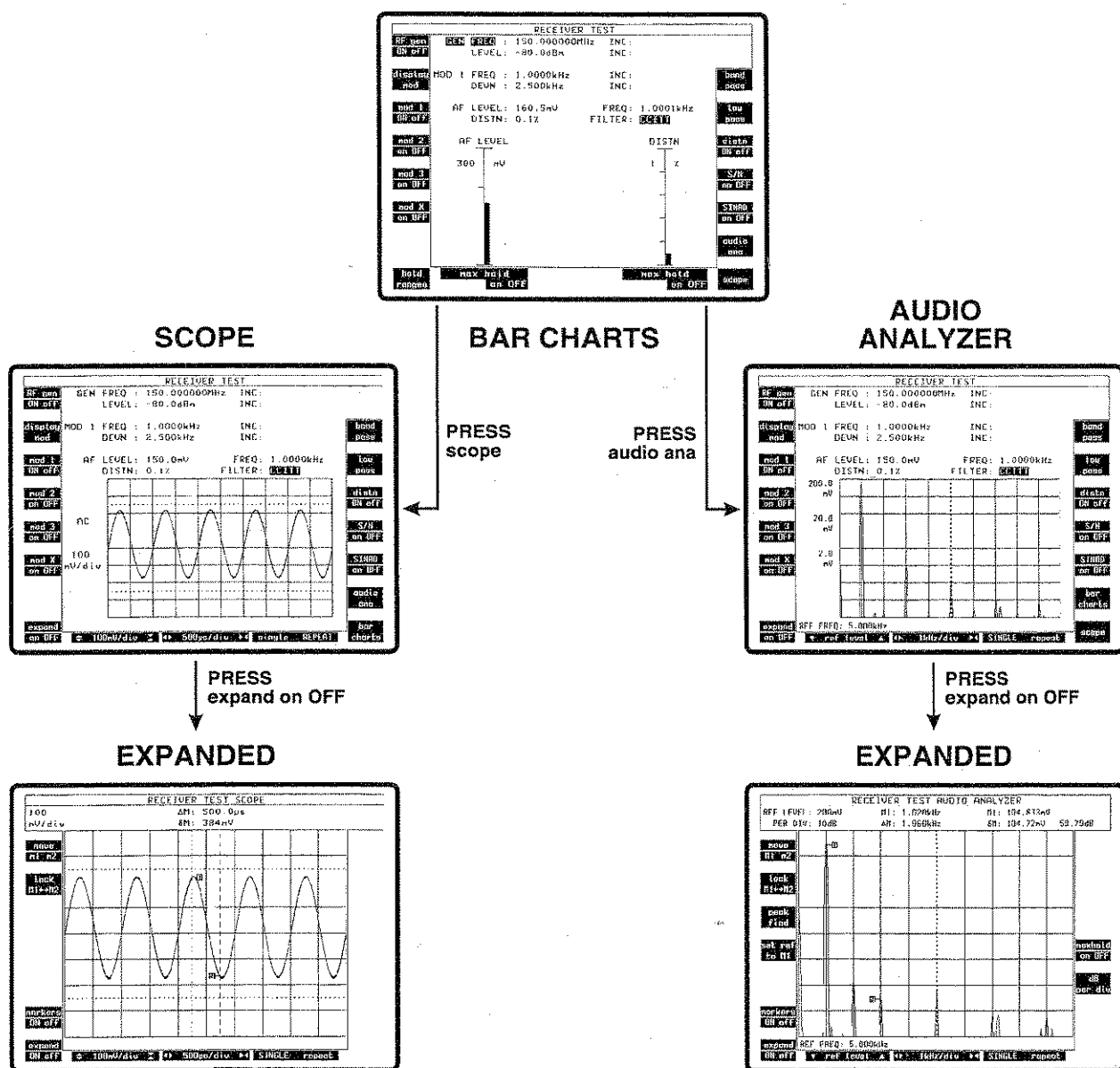

B2724

Fig. 3-2 RECEIVER TEST displays

DUPLEX TEST mode

See Fig. 3-3.

In this mode, the 2965 functions simultaneously as a transmitter (to test a receiver as shown on the left side of the display) and as a receiver (to test a transmitter as shown on the right side of the display). Functioning is the same as in the Tx TEST and Rx TEST modes.

There are thirteen different stages of display as follows:-

- Primary display with bar charts.
- Seven DUPLEX TEST (Tx) displays. These are the same as the primary and expanded displays in the Tx TEST mode.
- Five DUPLEX TEST (Rx) displays. These are the same as the primary and expanded displays in the Rx TEST mode.

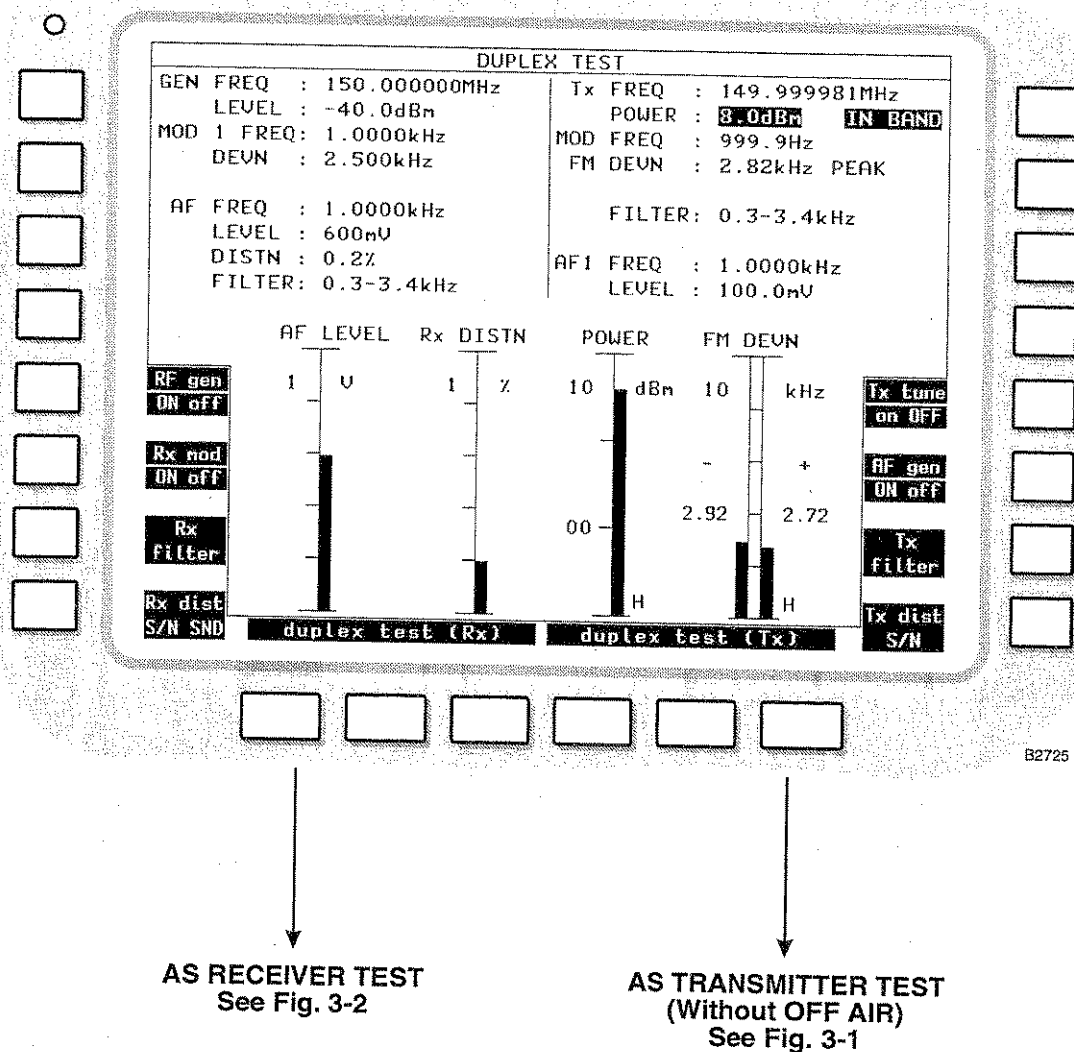

Fig. 3-3 DUPLEX TEST displays

TONES mode

In this mode, the 2965 receives or sends signalling codes as follows:-

- Sequential tones. CCIR, ZVEI, DZVEI, EIA, EEA and user-defined standards.
- DTMF (dual-tone multi-frequency) tones.
- DCS (digitally-coded squelch) signals.

(d) POCSAG radio pager signals.

(e) CTCSS tones.

To test a transmitter, the 2965 functions as a receiver by demodulating the transmitter's RF output signal and then decoding it. The decoded message is shown on the display.

To test a receiver, the 2965 functions as a signal generator which generates an encoded RF signal.

SYSTEMS mode

In this mode, the 2965 functions as a base station for testing cellular or trunked portable transceivers. The following systems options are available:-

(a) NMT-450/900

(b) MULTI-AMPS

(c) MULTI-TACS

(d) MPT 1327

(e) PMR

(f) GSM

The operating instructions for each of these systems options is contained in the appropriate operating supplement. These are supplied with instruments fitted with cellular or trunking system options. They are also supplied when the appropriate software is installed following supply of the test set.

The MI part numbers of these manuals will be found in *About this manual* at the front of this manual.

RF TEST mode

This mode displays a soft key selected menu providing:

(1) RF input/output test.

(2) SSB test.

RF input/output test

This mode is for testing a unit such as a repeater without having extraneous details on the display. It is the same as the DUPLEX TEST mode except as follows:-

(a) The AF settings and measurements are not included in the displays.

(b) The RF frequency and level, and modulation frequencies and deviations or depths, can be increased or decreased by previously entered increments.

SSB test

This optional mode is for testing Single Sideband (SSB) radios. The 2965 is configured as a transmitter or receiver. In the SSB transmitter test mode, the transmitter is connected directly to one of the RF input connectors. In this mode, the 2965 functions as a receiver which measures the following:-

(a) A transmitter's frequency (or frequency offset) and power.

(b) The modulation frequency and distortion.

The 2965 automatically tunes to the transmitter's frequency. Alternatively, the transmitter can be tuned for minimum or zero offset by manually tuning the 2965. The manually-entered transmitter frequency can be increased or decreased by a previously entered increment.

Two AF generators have independent frequency and level settings and are provided to modulate the transmitter.

There are eight different stages of display, as follows:-

- (a) Primary with bar charts.
- (b) Primary with suppression analyzer.
- (c) Primary with spectrum analyzer.
- (d) Primary with sideband analyzer.
- (e) Primary with carrier wave analyzer.
- (f) Expanded spectrum analyzer.
- (g) Expanded sideband analyzer.
- (h) Expanded carrier wave analyzer.

In the SSB receiver mode, the 2965 functions as a transmitter which provides a modulated signal to the radio receiver. The 2965 also measures the level, frequency and distortion of the AF signal that has been demodulated by the receiver.

There are five different stages of display, as follows:-

- (a) Primary with bar charts.
- (b) Primary with oscilloscope.
- (c) Primary with audio analyzer.
- (d) Expanded oscilloscope.
- (e) Expanded audio analyzer.

AF TEST mode

This mode displays a soft key selected menu providing:

- (1) Audio input/output test.
- (2) A full function multimeter.

Audio input/output test

This mode is for testing an item of audio equipment (e.g. an amplifier or filter).

The 2965 provides an AF signal to the unit. You can select any or all of the three AF generators. Alternatively, the wide range (1 Hz to 100 kHz) generator can be used (see *User options; 100 kHz audio or modulation generator* on page 3-138). Each frequency and level is set independently and each generator can be enabled or disabled. The audio frequencies and levels can be increased or decreased by previously entered increments. The three AF generators can be configured with the three modulation generators to provide a single LF source with a range of 1 Hz to 100 kHz. The 2965 measures the level, frequency and distortion and/or noise of the AF signal that is fed from the unit.

Full function multimeter

This mode is for measuring AC and DC volts and amps, resistance, and continuity.

WARNING

Do not connect voltages in excess of 350 V AC or DC, or attempt to measure currents in excess of 10 A.

Controls and connectors

Front panel

See Fig. 3-4 on page 3-12. The numerical references are used throughout this chapter.

CRT screen and soft keys

- (1) Screen. The display shows the functions of the soft keys, instrument settings, measurement results, measurement bar charts and an oscilloscope or analyzer graticule and trace as appropriate for the selected method of operation.
- (2) Soft keys. These are the blank keys at each side and at the bottom of the screen. Their functions are shown as appropriate on the screen. The current selection is shown in inverse video.

Toggle action soft keys. In many cases, soft keys are used to toggle between ON and OFF states. For example, when the RF generator is switched ON, the associated soft key is shown as *[RF gen ON off]*, where ON is highlighted. When the key is pressed, the RF generator is switched OFF, and the soft key changes to *[RF gen on OFF]*, where OFF is highlighted.

Screen saver

The 2965 has a screen saver feature to prevent burn-in on the CRT. This can happen when the instrument is left on for long periods of time, with an unchanging display.

The screen saver display replaces the current display after a preset time during which the front panel controls have not been used and no remote control addressing has taken place.

You have control over the screen saver display pattern, the delay time and whether it is enabled or not. The screen saver has two alternative displays, one called Bouncing Balls, the other Polygons.

These options are controlled from the SET-UP: SCREEN SAVER menu. Access to this menu is via the key sequence [HELP SET-UP], [SET-UP], [MISC], [screen saver]. The soft keys on the left of the screen and their actions are:-

[saver delay] Repeated presses set the delay before the screen saver is initiated. The available delays are from 10 minutes to 60 minutes at 10 minute intervals. The disable option is also included in the choices.

[screen saver] Toggles between the two display patterns.

[saver test] To test the operation of the screen saver. Pressing this key will start the screen saver without waiting for the time delay to elapse.

While the screen saver is running, all measurements and tests are suspended. The screen saver is cancelled by pressing any front panel key, rotating the variable control, removing or inserting a memory card, or by the test set being addressed by the remote controller.

A key press which cancels the screen saver is not decoded as an action but all keys become active on their specified functions thereafter.

MODE keys (blue legends)

- (3) [Tx TEST] key. To select the Tx TEST mode. The first time that this key is used after switching on, the top level TRANSMITTER TEST display appears. After OFF-AIR and/or expanded displays have been selected, the last one re-appears when this key is used again. When one of these has appeared, the top level TRANSMITTER TEST display appears when this key is pressed a second time.
- (4) [Rx TEST] key. To select the Rx TEST mode. The first time that this key is used after switching on, the top level RECEIVER TEST display appears. After expanded displays have been selected, the last one re-appears when this key is used again. When one of these has appeared, the top level RECEIVER TEST display appears when this key is pressed a second time.

- (5) [DUPLEX TEST] key. To select the DUPLEX TEST mode. The first time that this key is used after switching on, the top level DUPLEX TEST display appears. After expanded displays have been selected, the last one re-appears when this key is used again. When one of these has appeared, the top level DUPLEX TEST display appears when this key is pressed a second time.
- (6) [TONES] key. To select signalling codes testing. The first time that this key is used after switching on, a SEQUENTIAL TONES DECODE or GENERATE display appears, depending on the previous mode. After other displays have been selected, the last one re-appears when this key is used again.
- (7) [SYSTEMS] key. To select system testing on a cellular or trunked mobile radio.
- (8) [RF TEST] key. To select the RF TEST mode. The first time that this key is used after switching on, the top level RF INPUT/OUTPUT TEST display appears. After expanded displays have been selected, the last one re-appears when this key is used again. When one of these has appeared, the top level RF INPUT/OUTPUT TEST display appears when this key is pressed a second time.

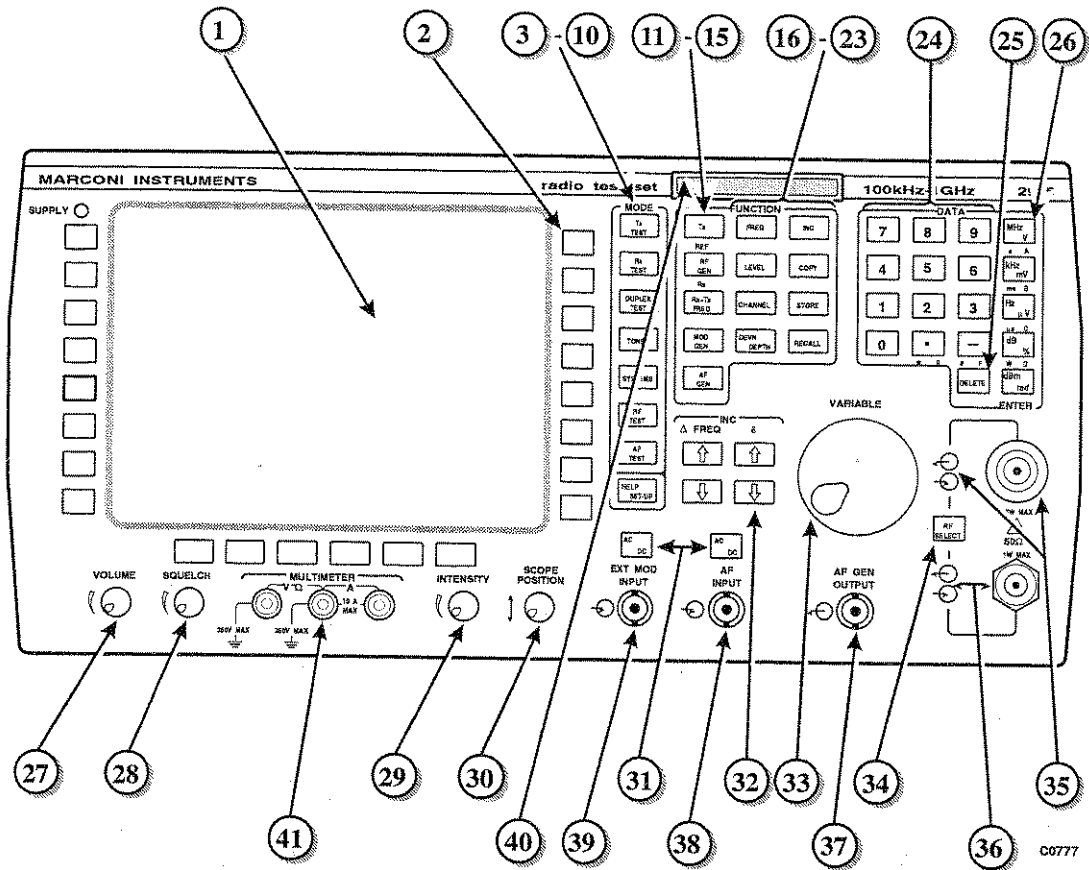

Fig. 3-4 Front panel

- (9) [AF TEST] key. To select the AF TEST mode. The first time that this key is used after switching on, the top level AUDIO INPUT/OUTPUT TEST display appears. After expanded displays have been selected, the last one re-appears when this key is used again. When one of these has appeared, the top level AUDIO INPUT/OUTPUT TEST display appears when this key is pressed a second time.
- (10) [HELP SET-UP] key. To select the HELP AND SET-UP menu for access to pages of help information or to the SET-UP menu.

FUNCTION keys (green legends)

- (11) [Tx] (or [REF]) key. To select the transmitter for manual entering of its frequency by using the DATA keys (24) and (26). Also, to set the transmitter frequency which is used as the REF FREQ in the spectrum analyzer displays. When this key is used, Tx and FREQ appear on the display in inverse video.
- (12) [RF GEN] (or [Rx]) key. To select the internal RF generator prior to using the [FREQ] key (16) and/or [LEVEL] key (17). When this key is used, GEN appears on the display in inverse video.
- (13) [Rx=Tx FREQ] key. To tune the RF generator to the frequency of the transmitter which is connected to the RF N-type socket (35) or the RF TNC socket (36). Therefore, the receiver section of a transceiver can be tested without having to enter the frequency. For use only in the Tx TEST, DUPLEX TEST and RF INPUT/OUTPUT TEST modes with the transmitter on and automatic tuning in operation.
- (14) [MOD GEN] key. To select one of the three internal modulation generators (or the wide range modulation generator), prior to using the [FREQ] key (16) and/or [DEVN DEPTH] key (19). When this key is used, MOD appears on the display in inverse video.
- (15) [AF GEN] key. To select one of the three internal AF generators (or the wide range AF generator), prior to using the [FREQ] key (16) and/or [LEVEL] key (17). When this key is used, AF appears on the display in inverse video.

FUNCTION keys (brown legends)

- (16) [FREQ] key. To precede the entry of a frequency on the DATA keys (24). After the numerical entry, a unit key (26) is used. When reverting to a mode after setting the frequency in another mode, the frequency is as previously set in the current mode or as reset in the other mode according to the selection on the HELP AND SET-UP menu. When this key is used, FREQ appears on the display in inverse video.
- (17) [LEVEL] key. To precede the entry of an RF level or AF level on the DATA keys (24). After the numerical entry, a unit key (26) is used. When reverting to a mode after setting the level in another mode, the level is as previously set in the current mode or as reset in the other mode according to the selection on the HELP AND SET-UP menu. For the modulation generators, this key can be used instead of the [DEVN DEPTH] key (19). When this key is used, LEVEL appears on the display in inverse video.
- (18) [CHANNEL] key. To precede the entry of a channel number on the DATA keys (24) and the [ENTER] key (26). Provided that the channel numbers and increments have been entered on the HELP AND SET-UP menu, this key can be used for tuning instead of the [FREQ] key (16). CHAN and the channel number or FREQ and the frequency appear according to the setting on the HELP AND SET-UP menu.
- (19) [DEVN DEPTH] key. To precede the entry of an FM deviation, AM depth or Φ M deviation on the DATA keys (24). After the numerical entry, a unit key (26) is used. The [LEVEL] key (17) can be used instead. When this key is used, DEVN or DEPTH appears on the display in inverse video.
- (20) [INC] key. To precede the entry of an increment (of frequency, RF level, AF level, FM deviation, AM depth or Φ M deviation) on the DATA keys (24). When this key is used, INC appears on the display in inverse video. After the numerical entry, a unit key (26) is used. Δ (for frequency) and δ (for other parameters) appear alongside the active increments so that using one of the [INC] keys (32) increases or decreases the appropriate settings. Only a single frequency increment and only a single level or deviation or depth increment can be active. Entering a second increment disables the previous increment. On the RECEIVER TEST and DUPLEX TEST (Rx) displays only, when a second increment has been entered and then the first is reselected, its increment re-appears. To activate this increment without changing its value, press the [ENTER] or any unit key (26).

- (21) [COPY] key. To hold the screen or enable the screen to be printed to a printer. Pressing [DELETE] will clear the message window and any other key will re-enable display updates, cancelling the screen hold facility. Pressing [COPY] twice will print the screen in accordance with the parameters set with the key sequence [HELP SET-UP], [SET-UP], [INPUT OUTPUT], [printer options].

The printing of traces within the graticule area is quicker if [SINGLE] is selected or if bar charts are selected after the message disappears.

- (22) [STORE] key. To store the instrument's front panel settings. See under *Store and recall facility* on page 3-136.
- (23) [RECALL] key. To recall the settings that have been stored. See under *Store and recall facility* on page 3-136.

DATA keys (grey legends)

- (24) Numerical keys. For entering numerical data. Two of the keys are for a decimal point (.) and a minus sign (-). These are also used for hexadecimal E and F and also for an asterisk (*) and a hash sign (#). For hexadecimal A, B, C and D, the four upper unit keys (26) are used.
- (25) [DELETE] key. For deleting the previous number or sign.

DATA keys (brown legends)

- (26) Unit keys. For entering the units of frequency (MHz, kHz and Hz) or voltage (V, mV and μ V) and relative level (dB and dBm) or modulation depth percentage (%) or modulation angle (rad). They are also used for times (s, ms, and μ s) and power (W). The four upper keys are also used as numerical keys for hexadecimal A, B, C, and D. The bottom key is also used as the [ENTER] key for numerical entries.

Miscellaneous controls (grey legends)

- (27) VOLUME control. To adjust the level to the loudspeaker which is used for monitoring.
- (28) SQUELCH control. When this is fully anti-clockwise, the modulation meter outputs (loudspeaker, oscilloscope trace, MOD FREQ reading, MOD deviation or depth reading, and DEMOD output signal) are enabled. Turn this control clockwise to increase the carrier threshold below which the modulation meter outputs are disabled. Instead of MOD FREQ, SQUELCHED appears in inverse video.
- (29) INTENSITY control. To adjust the brightness of the display.
- (30) SCOPE POSITION control. To adjust the vertical position of the oscilloscope or analyzer trace.
- (31) [AC DC] keys. To set AC or DC coupling at the AF INPUT socket (38) and EXT MOD INPUT socket (39).
- (32) [INC] keys. To increase or decrease the settings by the increments which have been entered using the [INC] key (20). Δ (for frequency) and δ (for other parameters) appear alongside the appropriate settings.
- (33) VARIABLE control. Analogue control for adjusting the value of the parameter which is shown in inverse video. The rate of change depends on the range.
- (34) [RF SELECT] key. For selecting the RF output and/or input to the RF N-type connector (35) and the RF TNC connector (36). The signal paths are shown by the indicators.

Connectors and indicators

- (35) RF N-type output and input connector and indicators. The N-type socket is for output to a receiver and/or input from a transmitter as set by the [RF SELECT] key (34). See under *Signal generator, RF frequency meter* and *RF power meter* in Chap. 1. The connected signal paths are shown by the indicators.
Note: For information about the RF generator output, see the section *RF input/output level offsets* on page 3-17.

WARNING

Hot surface

Take care when touching the RF N-type connector after continuous power input. If 50 W is exceeded, the temperature of the connector becomes excessive.

CAUTION

Input overload

On the RF N-type connector, the input power should not exceed 150 W.

On the RF TNC connector, the input power should not exceed 1 W.

- (36) RF TNC output and input connector and indicators. TNC socket for output to a receiver and/or input from a transmitter as set by the [RF SELECT] key (34). See under *Signal generator*, *RF frequency meter*, and *RF power meter* in Chapter 1. The connected signal paths are shown by the indicators.
- (37) AF GEN OUTPUT connector. BNC socket for one, two or three AF generator outputs in the range 1 Hz to 20 kHz, or, for the wide range AF generator, 1 Hz to 100 kHz. See under *Audio generators* in Chapter 1. AC or DC coupling is set by the [AC DC] key (31). The connected signal path is shown by the indicator.
- (38) AF INPUT connector. BNC socket for an audio signal. AC or DC coupling as set by the [AC DC] key (31). The connected signal path is shown by the indicator.
- (39) EXT MOD INPUT connector. BNC socket for externally generated modulation signals. See under *Performance data*; *RF signal generator* in Chapter 1. The connected signal path is shown by the indicator.
- (40) Memory Card slot. To store set-ups and sequences of operations. A Memory Card (Part no. 59000-189M) is available as an optional accessory.
- (41) MULTIMETER terminals. Black, red and white posts for 4 mm plugs. Black (–) and red (+) for voltage and resistance measurements. Red (+) and white (–) for current measurements. To measure the power consumption of a unit, connect the unit's power input plug to the black (–) and red (+) terminals and the power supply outlet to the black (–) and white (+) terminals. The power consumption is then the product of the measured voltage and the measured current.

CAUTION

Voltage and current ratings

On the MULTIMETER black, red and white terminals, the voltage with respect to ground should not exceed ± 350 V DC. At the red and white terminals, the input current should not exceed 10 A.

Rear panel

See Fig. 3-5. The numerical references are used throughout this chapter.

- (42) PARALLEL connector. 25-way D-type socket. For connection to a Centronics or parallel type printer or for automatic control of mobile interfaces.
- (43) IF connector. BNC socket. The signal from a transmitter under test is available on this connector at 10.7 MHz.

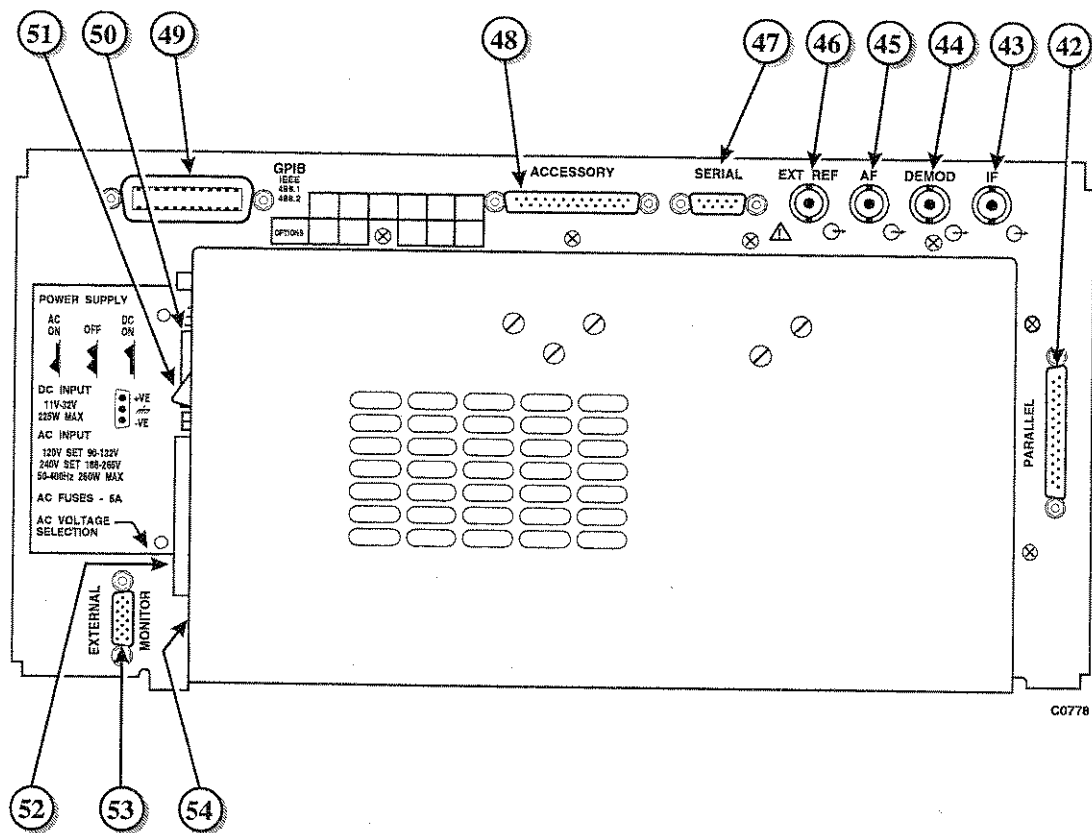

Fig. 3-5 Rear panel

- (44) DEMOD connector. BNC socket. For output of the demodulated signal that is being measured.
- (45) AF connector. BNC socket. For output of the AF signal that is being measured. The output levels at the DEMOD and AF outputs are on fixed ranges only if the respective oscilloscope or FFT mode is selected. When bar charts are displayed, the output levels are always auto-ranging.
- (46) EXT REF connector. BNC socket. To input an external reference signal or output an internal reference signal according to the set-up. See under *Inputs and outputs* on page 3-132.

CAUTION

Reverse power

Change the set-up to the external reference before connecting the external equipment. Otherwise, damage could occur.

- (47) SERIAL connector. 9-way D-type male socket (DTE). For remote control of the 2965 from a terminal or computer using the EIA/TIA-232-C (RS-232) interface. Can also be used for the connection of a printer with a suitable cable.
- (48) ACCESSORY connector. 25-way D-type plug. For external accessories.
- (49) GPIB connector. 24-way IEEE 488.1 socket. For remote control of the 2965 using the GPIB and a GPIB controller.
- (50) DC INPUT connector. 3-way D-type plug. For 11 to 32 V.
- (51) POWER SUPPLY switch. For AC ON (upper half depressed), DC ON (lower half depressed) or OFF (intermediate position).
- (52) AC INPUT connector and fuses. 3-way IEC plug. Two 5 A quick-blow (F) fuses.

- (53) EXTERNAL MONITOR connector. 15-way D-type socket. For VGA monitor unit to duplicate the display on the 2965 but show it in colour.
- (54) AC VOLTAGE SELECTION switch. For 88 to 132 V (120 position) or 188 to 265 V (240 position).

Starting procedure

When the instrument has been installed in accordance with Chapter 2, depress the POWER SUPPLY switch (50) to the appropriate AC ON/DC ON position. After some self testing, one of the following displays appears:-

- (a) The factory default display (DUPLEX TEST).
- (b) The default display that has been saved on the SET-UP : DEFAULT VALUES menu.

For further details on the power-on settings and display, see under *Default values* on page 3-133.

The next steps are dependent on the mode and display that are required. For an introduction to these, see under *Modes and displays*, page 3-5.

For connections and further procedures, refer to the appropriate section for testing the particular unit - transmitter, receiver, RF unit, AF unit, etc.

RF input/output level offsets

The indicated value of RF generator output level and RF input level can be offset so that these values relate to the levels at the remote connector of an external attenuator.

When an offset is effective on the indicated RF generator output level, an asterisk (*) is shown in inverse video to the right of the level on the display.

Similarly, when an offset is effective on the indicated power input level, an asterisk (*) is shown in inverse video to the right of the measured power level on the display.

The level of offset is entered from SET-UP OPTIONS: RF PORT I/O SET-UP. This is reached through the key sequence, [HELP SET-UP], [SET-UP], [TEST OPTIONS], [rf port setup].

Pressing the [set offset] (RF gen level offset) key allows a positive or negative dB value to be entered, within the range ± 40.0 dB, with 1 decimal place resolution.

Pressing the [set offset] (receiver level offset) key allows a positive or negative dB value to be entered, within the range ± 40.00 dB, with 2 decimal place resolution. Any active offsets are effective on the N type RF connector and the TNC RF connector.

Note

Any RF generator level offset that is set on the SET-UP OPTIONS: RF PORT I/O SET-UP menu will be taken into account by automatic test programs in SYSTEMS mode. If the resulting change in RF GEN Level would take it beyond the test set's range, the test program will not attempt to do this. The result is that the default level of -80 dBm will be used, probably leading to the failure of the test.

The message RF gen level out of range will be displayed.

Inverse video indications

In some cases, the display of a measurement result may appear in dim inverse video. The general reason for this is that the measurement hardware is not optimally ranged for the measurement, or the measurement may be invalid due to the measurement setup.

Causes of dim inverse video displays

The three principal causes of dim inverse video displays are:-

- Over-ranged readings
- Instrument function dependency
- Off-tune for SSB suppression measurement

Details of these are given below.

Over-ranged readings

The most likely cause of a dim inverse video indication is that the measurement is over-ranged, that is, the quantity being measured is greater than that which can be measured on the maximum range.

Instrument function dependency

In some cases, ranging hardware may be shared between different functions. For example, if measurement X and measurement Y use the same ranging hardware, but measurement Y controls the ranging hardware, then measurement X may find that it is not optimally ranged for the level of the quantity it is measuring. The result of measurement X is therefore displayed in inverse video.

The following combinations of functions may occasionally produce this situation:-

Controlling function	Slaved function (may use inverse video)
Audio analyzer/scope	Audio noise measurements
Audio analyzer/scope	AF level measurements
Audio noise measurements	AF level measurements
Demod analyzer/scope	Demod noise measurements
Demod analyzer/scope	Demod level measurements
Demod noise measurements	Demod level measurements
Spectrum analyzer reference level	Narrowband power measurement

Off-tune for SSB suppression measurement

When SSB suppression is measured with the 2965 receiver manually tuned, if the measured Tx offset exceeds 30 Hz, the suppression measurement is still operating to specification, but the results are displayed in inverse video to indicate that the measurements may have been compromised by incorrect tuning.

Transmitter testing

Transmitter testing - non-expanded

Connections

Connect the transmitter's RF output connector to the RF N-type socket (35) (or RF TNC socket (36) if preferred for <1 W). Use the [RF SELECT] key (34) to select the appropriate connector, indicated by the lit indicator.

If required, connect the transmitter's AF input connector to the AF GEN OUTPUT socket (37).

WARNING

Hot surface

Take care when touching the RF N-type connector after continuous power input. If 50 W is exceeded, the temperature of the connector becomes excessive.

CAUTION

Input overload

On the RF N-type connector, the input power should not exceed 150 W.

On the RF TNC connector, the input power should not exceed 1 W.

Procedure

Press the [Tx TEST] key (3). One of the TRANSMITTER TEST or OFF-AIR TRANSMITTER TEST displays appears (whichever was last selected). If OFF-AIR display is shown, press the *[normal Tx test]* soft key. If an expanded display has appeared, press the [Tx TEST] key again. The TRANSMITTER TEST display appears. See Fig. 3-6.

In its factory default condition, the 2965 tunes automatically to the strongest frequency component at the RF N-type socket (provided it is > +10 dBm) or TNC socket (provided it is > -10 dBm). Alternatively, the test set can be manually tuned. The set frequency is shown against the Tx FREQ legend, and any offset between this and the measured incoming RF signal is shown against the OFFSET legend.

Enter the required selections and settings on the display as follows:-

- (a) To manually set the test set to the transmitter frequency, press the [Tx] key (11), and then either enter the frequency by using the DATA keys (24) and (26), or use the VARIABLE control (33) to adjust the frequency setting.
- (b) Enter the type of modulation by using the *[mod type]* soft key.
- (c) To select an AF generator, press the [AF GEN] key (15). On the display, AF1, AF2 or AF3 in inverse video shows which of the generators has been selected. To select another generator, press the [1], [2] or [3] key (24) or press the *[display gen]* key repeatedly. (If the wide range AF generator has been enabled, AF4 will be shown in inverse video. See *User options; 100 kHz audio or modulation generator* on page 3-138.) Enter the frequency and level by using the [FREQ] key (16), the [LEVEL] key (17) and the DATA keys (24) and (26). Alternatively, adjust the frequency and level by using the VARIABLE control (33). The output from AF generator 2 is sequential tones when this has been selected on the TONES menu see under *Signalling codes testing* on page 3-99. To enable or disable each AF generator, press the appropriate *[gen on OFF]* (or *[tones on OFF]*) soft key. *[tones on OFF]* is shown instead of *[gen 2 on OFF]* when sequential tones has been selected on the TONES menu.

- (d) To enter an increment for Tx frequency or AF frequency, press the [Tx] key (11) or [AF GEN] key (15), the [FREQ] key (16) and then the [INC] key (20). Enter the increment by using the DATA keys (24) and (26). Δ appears alongside the active increment. To increase or decrease the frequency setting, press the appropriate [INC] key (32). Only a single frequency increment can be active. Entering one for Tx disables one for AF and vice versa.

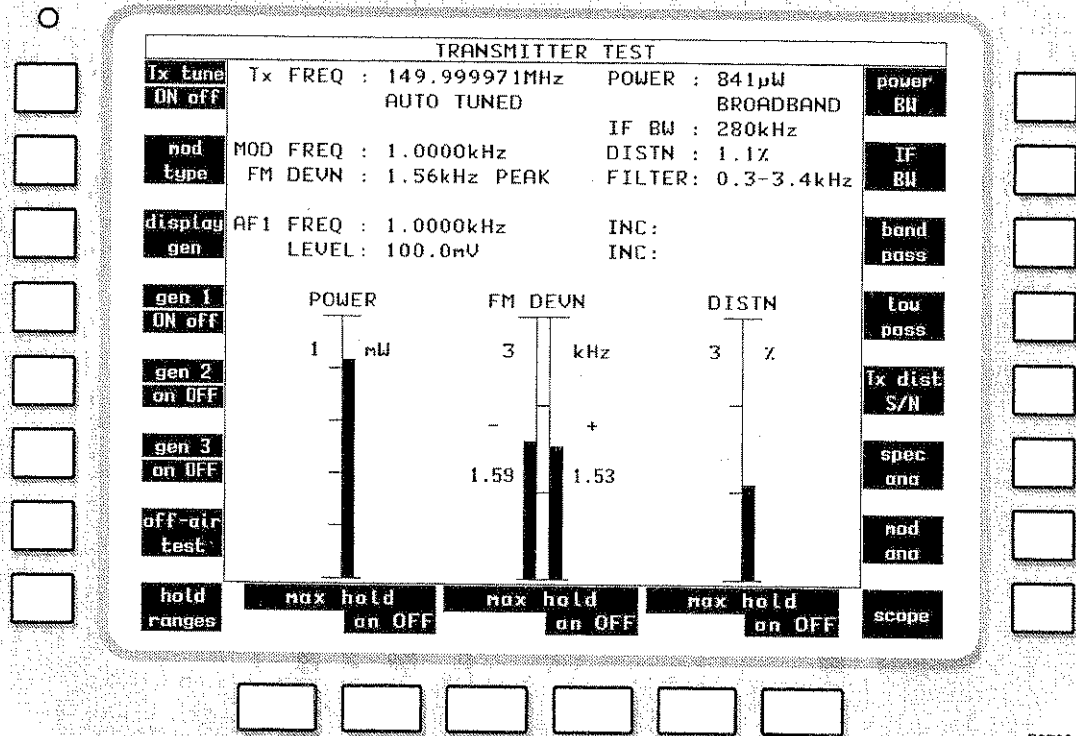

Fig. 3-6 TRANSMITTER TEST display with bar charts

- (e) To enter an increment for AF level, press the [AF GEN] key (15), the [LEVEL] key (17) and then the [INC] key (20). Enter the increment by using the DATA keys (24) and (26). δ appears alongside the active increment. To increase or decrease the level setting, press the appropriate [INC] key (32).

- (f) To select distortion or signal-to-noise measurement, use the [Tx dist S/N] soft key.

Transmitter distortion and signal-to-noise ratio are measured within the bandwidth of the display's FILTER value as set by the [band pass] or [low pass] soft key.

The distortion of the demodulated transmitter is measured at a modulating frequency which is factory preset to 1 kHz. The distortion measurement frequency can be reset using the HELP AND SET-UP mode to either a user-defined frequency or to the frequency of AF GEN 1. Distortion, SINAD or S/N tests cannot be carried out while AF GEN 4 or MOD GEN 4 is enabled.

To change the frequency of measurement, use the key sequence [HELP SET-UP], [SET-UP], [TEST OPTIONS] and [sinad & distn]. For further information, refer to the section *Help and setting up* on page 3-124.

- (g) To select filters, use the [IF BW], [band pass] or [low pass] soft key.

Read off the measurements that are shown on the display in numerical form and as bar charts (using the [bar charts] soft key), oscilloscope display (using the [scope] soft key), spectrum analyzer display (using the [spec ana] soft key) or modulation analyzer display (using the [mod ana] soft key).

For the oscilloscope, spectrum analyzer and modulation analyzer displays, set parameters by using the soft keys as below.

For the spectrum analyzer display, set the reference frequency. Use the [REF] key (11) and then enter the frequency.

When the 2965 tunes automatically, it also selects the optimum spectrum analyzer reference level and, as a result, also selects the input attenuator. This sets the level to the modulation analyzer and to the selective power meter. With manual tuning at low levels, it is necessary to set the spectrum analyzer reference level manually to achieve optimum accuracy. On the TRANSMITTER TEST SPECTRUM ANALYZER display, set the REF LEVEL so that the signal peak is within the top two graticule divisions.

Display

The following settings and measurements are shown:-

- (a) Tx FREQ and INC. The frequency measurement of the transmitter's output through the RF N-type socket (35) (or RF TNC socket (36) if preferred for <1 W) or the transmitter frequency which has been entered manually and any increment. Δ appears alongside when the increment is active.
- (b) OFFST. The difference between the frequency measurement of the transmitter's output and the transmitter frequency which has been entered manually.
- (c) POWER. The power measurement of the transmitter's output. According to which has been selected by using the [power BW] soft key, BROADBAND is shown or IN BAND is shown in inverse video.
- (d) IF BW. The bandwidth for the transmitter IN BAND power measurement as selected by using the [IF BW] soft key.
- (e) MOD FREQ, and FM DEVN, AM DEPTH or Φ M DEVN. The modulation frequency and deviation or depth measurements of the transmitter's output.
- (f) DISTN or S/N. When one of these is enabled, the distortion or signal-to-noise measurement of the demodulated signal from the transmitter's output.
- (g) FILTER. The filter for the demodulated signal from the transmitter's output as selected by using the [band pass] or [low pass] soft key.
- (h) AF1, AF2, AF3 or AF4 FREQUENCY, INC, LEVEL and INC. The settings on one of the AF generators as selected by using the [1], [2] or [3] key (24) after the [AF GEN] key (15) or using the [display gen] soft key. If the wide range AF generator is enabled, the parameters of this are shown. AF2 is not shown when sequential tones has been selected on the TONES menu. When AF1, AF2, AF3 or AF4 is shown in inverse video, the [FREQ] key (16) or the [LEVEL] key (17) can then be used. Δ (for frequency) and δ (for level) appear alongside when the increments are active.

In particular circumstances, the test result may be shown in dim inverse video; refer to the section *Inverse video indications* on page 3-18 for further information.

Bar charts

When the [bar charts] soft key is used, the following measurements are shown:-

- (a) POWER, BROADBAND or IN BAND. The measurement of the transmitter's output through the RF N-type socket (35) (or RF TNC socket (36) if preferred for <1 W).
- (b) FM DEVN, AM DEPTH or Φ M DEVN. The modulation deviation or depth measurement of the transmitter's output.
- (c) DISTN or S/N. When one of these is enabled, the distortion or signal-to-noise measurement of the demodulated signal from the transmitter's output.

The bar charts are auto-ranging except when the [hold ranges] soft key is used. The range designators are then shown in inverse video.

Maximum hold

The soft keys beneath the bar charts allow each measurement presentation to indicate actual levels or maximum levels.

With [*max hold ON*] selected, the bar chart, and the digital readouts of it, will track any rise in the measured level but will not track downward movement. Pressing the [*reset*] key will cause the current level to be displayed before reapplying the maximum hold function. An H is displayed at the lower right of bar charts that are in the 'Maximum Hold' mode.

With [*max hold OFF*] selected, the bar chart and the associated digital readouts, will track any change in the measured level.

Modulation level

The modulation level bar chart is a dual display, showing the positive modulation level on the right and negative modulation level on the left. A digital reading of the indicated level is shown at the side of each bar chart.

The digital reading of modulation level, shown in the top half of the display as FM DEVN, AM DEPTH or Φ M DEVN, is the average of the positive and negative readings.

Oscilloscope

When the [*scope*] soft key is used, the graticule and trace show the levels of the demodulated signal from the transmitter's output through the RF N-type socket (35) (or RF TNC socket (36) if preferred for <1 W). Dotted horizontal lines on the graticule correspond to the 63% (average) levels of full-scale.

Spectrum analyzer

When the [*spec ana*] soft key is used, the graticule and trace show the spectrum of the transmitter's output through the RF N-type socket (35) (or RF TNC socket (36) if preferred for <1 W).

At the bottom of the display, the REF FREQ setting is shown, which corresponds to the central vertical dotted line on the graticule.

Modulation analyzer

When the [*mod ana*] soft key is used, the graticule and trace show the spectrum of the demodulated signal from the transmitter's output through the RF N-type socket (35) (or RF TNC socket (36) if preferred for <1 W).

At the bottom of the display, the REF FREQ setting is shown, which corresponds to the central vertical dotted line on the graticule. In particular circumstances, the test result may be shown in inverse video; refer to the section *Inverse video indications* on page 3-18 for further information.

Soft keys at left side of screen

Eight keys are shown at the left side of the screen, (unless the wide range AF generator/modulation generator has been enabled). The eight keys are:-

- (a) [*Tx tune ON off*] key. To disable automatic tuning or to return to automatic tuning after a transmitter frequency has been set manually.
- (b) [*mod type*] key. To select the type of modulation of the transmitter's output. The options are FM DEVN, AM DEPTH and Φ M DEVN.
- (c) [*display gen*] key. To select the AF generator before or after using the [AF GEN] key (15). Press the key repeatedly to step through 1,2 and 3. AF2 is not available when sequential tones has been selected on the TONES menu. The frequency and level are shown for the selected generator. When the [AF GEN] key is used, AF1, AF2, or AF3 appear in inverse video. The [FREQ] key (16) or the [LEVEL] key (17) can then be used.

- (d) *[gen 1 on OFF]*, *[gen 2 on OFF]* (or *[tones on OFF]*) and *[gen 3 on OFF]* keys. To enable or disable the AF generators. *[tones on OFF]* is shown instead of *[gen 2 on OFF]* when sequential tones has been selected on the tones menu.
- (e) *[off-air test]* key. To select the OFF-AIR TRANSMITTER TEST display.
- (f) *[hold ranges]*, *[auto range]*, *[expand ON off]*, (or *[expand on OFF]*).

When bar charts are displayed, they can be auto-ranging or manually selected. When this key is labelled *[hold ranges]*, pressing it will disable the auto-ranging function and cause the keys beneath the bar charts to become *[range up]* and *[range down]* keys.

When it is labelled *[auto range]*, pressing it will enable the auto-ranging function to the bar charts.

When the spectrum analyzer, modulation analyzer, or oscilloscope function is active, this key becomes *[expand ON off]* or *[expand on OFF]* and will toggle between the expanded and normal mode of each.

When the wide range AF generator/modulation generator has been selected, only six soft keys are shown at the left of the screen. These six keys are:-

- (a) *[Tx tune ON off]* key. As above.
- (b) *[mod type]* key. As above.
- (c) *[afgens 1 to 3]* key. Pressing this key will cause the message ARE YOU SURE? Press key again to continue. Press any other key to cancel. to be displayed.

If the key is pressed again, the wide range AF generator/modulation generator will be disabled and AF generators 1 to 3, and modulation generators 1 to 3, will be enabled. The wide range AF generator/modulation generator can only be enabled again through the HELP AND SET-UP menus.

- (e) *[gen 4 ON off]* key. Repeatedly pressing this key will alternately turn the wide range AF generator on and off. If the wide range MODULATION generator is in the ON condition, pressing this key will turn it off, and turn the wide range AF generator on. But pressing this key to turn the wide range AF generator off will not turn the wide range modulation generator on.
- (f) *[off-air test]* key. As above.
- (g) *[hold ranges]*, *[auto range]*, *[expand ON off]* (or *[expand on OFF]*) key. As above.

Soft keys at right side of screen

Eight keys are shown, as follows:-

- (a) *[power BW]* key. To select the bandwidth for transmitter power measurements. The options are BROADBAND and IN BAND (shown in inverse video). BROADBAND means power within the total bandwidth of the instrument. IN BAND means power at the displayed frequency within the bandwidth which has been selected by using the *[IF BW]* soft key.
- (b) *[IF BW]* key. To select the bandwidth for transmitter power measurements. Values of 300 Hz, 1 kHz, 3 kHz, 10 kHz, 30 kHz, 110 kHz, 280 kHz and 3 MHz are available. Press the soft key repeatedly until the required value is shown on the display.
- (c) *[band pass]* key. This key selects a band-pass filter for inclusion in the AF path from the demodulated output of the transmitter under test to the measuring circuits of the test set. Selecting a band-pass filter will replace a previously selected low-pass filter. Repeated presses will select either the 0.3 to 3.4 kHz band-pass filter or a psophometric weighting filter. When a weighting filter is selected, this is shown in inverse video on the display.

When distortion or SINAD testing is selected, the 0.3 to 3.4 kHz filter is automatically selected.

The choice of CCITT or CMES phometric weighting filter is set by using the [HELP SET-UP], [SET-UP], [TEST OPTIONS], [filter options] and [Psoph Filter] key sequence. See under *Test options* on page 3-128.

- (d) [low pass] key. This key selects a low-pass filter for inclusion in the AF path from the demodulated output of the transmitter under test to the measuring circuits of the test set. Selecting a low-pass filter will replace a previously selected band-pass filter. Repeated presses will select 20 kHz low-pass, 5 kHz low-pass or 300 Hz low-pass. The 20 kHz low-pass and 300 Hz low-pass are show in inverse video when selected.
- (e) [Tx dist S/N] key. To enable or disable distortion or signal-to-noise measurement of the demodulated signal from the transmitter's output. Press the key repeatedly for distortion, S/N or none. When appropriate, DISTN or S/N and a bar chart appear.
- (f) [bar charts], [spec ana], [mod ana] and [scope] keys. To select a bar chart, spectrum analyzer, modulation analyzer or oscilloscope display. The three keys change according to the current selection.

Soft keys at bottom of screen

When the bar charts display has been selected and the [hold ranges] soft key is used, two keys are shown below each bar chart as follows:-

- (a) [range up] key. To increase the range of the bar chart.
- (b) [range down] key. To decrease the range of the bar chart.

When the oscilloscope display has been selected, three pairs of keys are shown, as follows:-

- (a) [▼] and [▲] keys. To increase and decrease, respectively, the level/division of vertical range which is shown
- (b) [▶◀] and [◀▶] keys. To increase and decrease, respectively, the time/division of horizontal range which is shown.
- (c) [single] and [repeat] keys. These two keys select the sweep mode of the oscilloscope. The selected key is highlighted and the legend changes to UPPER CASE. With [REPEAT] selected, the sweep is in repetitive mode. When the [single] key is pressed, the legend changes to [SINGLE], the current sweep is interrupted, and a new sweep is initiated. The waveform will remain visible until overwritten by the next sweep. This can be by another single sweep or by returning to the repetitive mode.

When the spectrum analyzer or modulation analyzer display has been selected, three pairs of keys are shown, as follows:-

- (a) [▼ ref level ▲] keys. To increase and decrease, respectively, the level, deviation or depth that is shown.
- (b) [▶◀] and [◀▶] keys. To increase and decrease, respectively, the frequency/division of the horizontal range that is shown.
- (c) [single] and [repeat] keys. These two keys select the sweep mode of the spectrum analyzer or audio analyzer (see above).

Transmitter testing - expanded

Oscilloscope

Connections

As under *Transmitter testing - non-expanded* on page 3-19.

Procedure

Press the [Tx TEST] key (3). One of the TRANSMITTER TEST or OFF-AIR TRANSMITTER TEST displays appears (whichever was last selected). If it is shown, press the [normal Tx test] soft key. If an expanded display has appeared, press the [Tx TEST] key again. The TRANSMITTER TEST display appears. See Fig. 3-6.

Enter suitable selections and settings as under *Transmitter testing - non-expanded* on page 3-19.

Press the [scope] and [expand on OFF] soft keys. The TRANSMITTER TEST SCOPE expanded display appears. See Fig. 3-7.

For the display, set parameters by using the soft keys as below.

Display

When the [markers on OFF] soft key is pressed, the following measurements are shown:-

- (a) ΔM . The difference of the times at the markers.
- (b) δM . The difference of the levels at the markers.

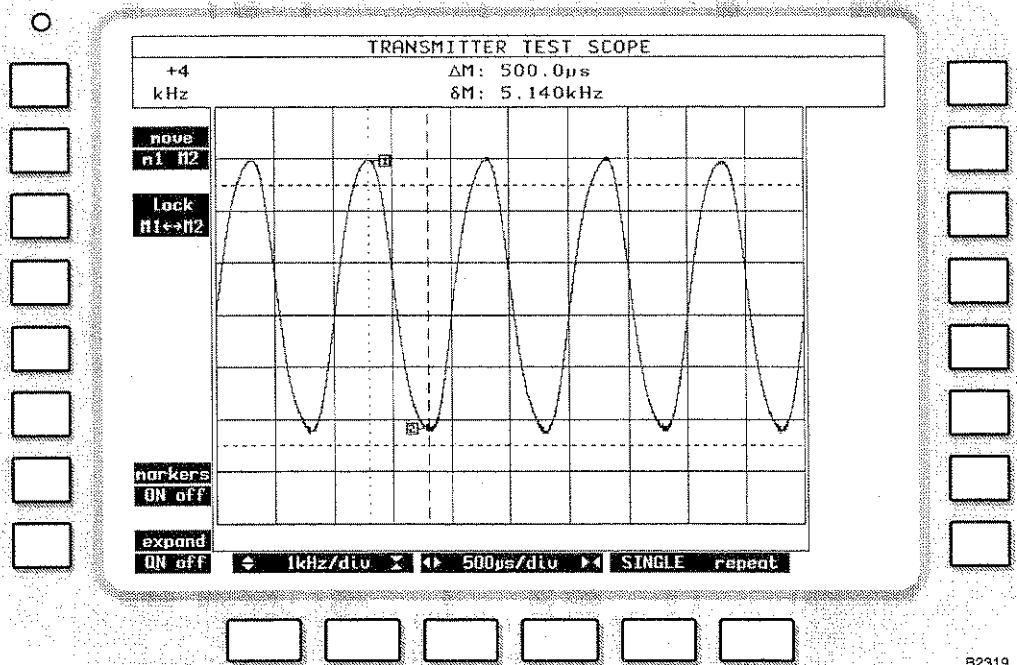

Fig. 3-7 TRANSMITTER TEST SCOPE expanded display

Soft keys at left side of screen





Four keys are shown, as follows:-

- (a) [move m1 m2] key. To show a dotted marker line (M1) or dashed marker line (M2). Each can be moved by rotating the VARIABLE control (33). This key appears only when the [markers on OFF] key is pressed.

- (b) [*lock M1 ↔ M2*] key. To move the two marker lines together. The legend changes to [*unlock M1 ↔ M2*]. This key appears only when the [*markers on OFF*] key is pressed.
- (c) [*markers on OFF*] key. To show the above measurements and soft keys.
- (d) [*expand ON off*] key. To revert to the TRANSMITTER TEST display.

Soft keys at bottom of screen

Three pairs of keys are shown, as follows:-

- (a) [] and [] keys. To increase and decrease, respectively, the level/division of vertical range which is shown.
- (b) [] and [] keys. To increase and decrease, respectively, the time/division of horizontal range which is shown.
- (c) [*single REPEAT*] keys. To initiate a single scan.

Spectrum analyzer

Connections

As under *Transmitter testing - non-expanded* on page 3-19.

Procedure

Press the [Tx TEST] key (3). One of the TRANSMITTER TEST or OFF-AIR TRANSMITTER TEST displays appears (whichever was last selected). If it is shown, press the [*normal Tx test*] soft key. If an expanded display has appeared, press the [Tx TEST] key again. The TRANSMITTER TEST display appears. See Fig. 3-6.





Enter suitable selections and settings as under *Transmitter testing - non-expanded* on page 3-19.

Press the [*spec ana*] and [*expand on OFF*] soft keys. The TRANSMITTER TEST SPECTRUM ANALYZER expanded display appears. See Fig. 3-8.



For the display, set parameters by using the soft keys as below.

Display



The following settings are shown:-

- (a) REF LEVEL. The reference level for the spectrum analyzer which is set with either the ref [] *ref level* [] soft keys or as described below. If an increment has been set as in (b) below, then the reference level can be incremented/decremented by pressing the INC δ [] and [] keys.

The spectrum analyzer's reference level can be adjusted by pressing the [REF] then [LEVEL] function keys to highlight the display's REF LEVEL legend, then entering the required reference level using the DATA keys. Alternatively, the rotary VARIABLE control can be used instead of the numerical DATA keys.

- (b) δ INC. The reference level increment that has been set as described below. The increment is used by pressing the INC δ [] and [] keys.

Reference level increments can be set and/or adjusted by pressing the [REF] then [LEVEL] then [INC] function keys to highlight the display's REF LEVEL INC legend, then entering the required increment setting using the DATA keys, followed by the [dB] DATA key.

- (c) PER DIV. The scaling of the graticule that has been set by using the [*dB per div*] soft key.
- (d) REF FREQ. The spectrum analyzer's reference frequency which can be set as described below. If an increment has been set as in (e) below, then the reference frequency can be incremented/decremented by pressing the INC Δ FREQ [] and [] keys.

The spectrum analyzer's reference frequency can be adjusted by pressing the [REF] then [FREQ] function keys to highlight the display's REF FREQ legend, then entering the required reference frequency using the DATA keys followed by the appropriate [MHz], [kHz] or [Hz] DATA key. The reference frequency can also be adjusted using rotary VARIABLE control instead of the DATA keys.

The reference frequency can be adjusted by two further methods using the marker facilities that are available after pressing the [markers on OFF] soft key:-

1. Press [peak find], [set ref to M1] to set the reference to the strongest signal
2. Select [move M1 m2] and adjust the M1 marker using the rotary VARIABLE control, then press the [set ref to M1] soft key.

Note that increments cannot be adjusted using the [REF FREQ] sequence while the markers are on, though increments already set can be used.

- (e) Δ INC. The reference frequency increment. If an increment has been set as described below, then the reference frequency can be incremented/decremented by pressing the INC Δ FREQ [\uparrow] and [\downarrow] keys.

Reference frequency increments can be set and/or adjusted by pressing the [REF] then [FREQ] then [INC] function keys to highlight the display's REF FREQ Δ INC legend, then entering the required increment using the DATA keys, followed by the appropriate [MHz], [kHz] or [Hz] DATA key.

When the [markers on OFF] soft key is pressed, the following measurements are shown:-

- (a) M1 or M2 frequency. The frequency at the M1 marker (dotted) or M2 marker (dashed) as set by using the [move m1 m2] soft key and the VARIABLE control.
- (b) M1 or M2 level. The level at the above marker.
- (c) Δ M. The difference between frequencies of M1 and M2 markers.
- (d) δ M. The difference between levels of M1 and M2 markers.

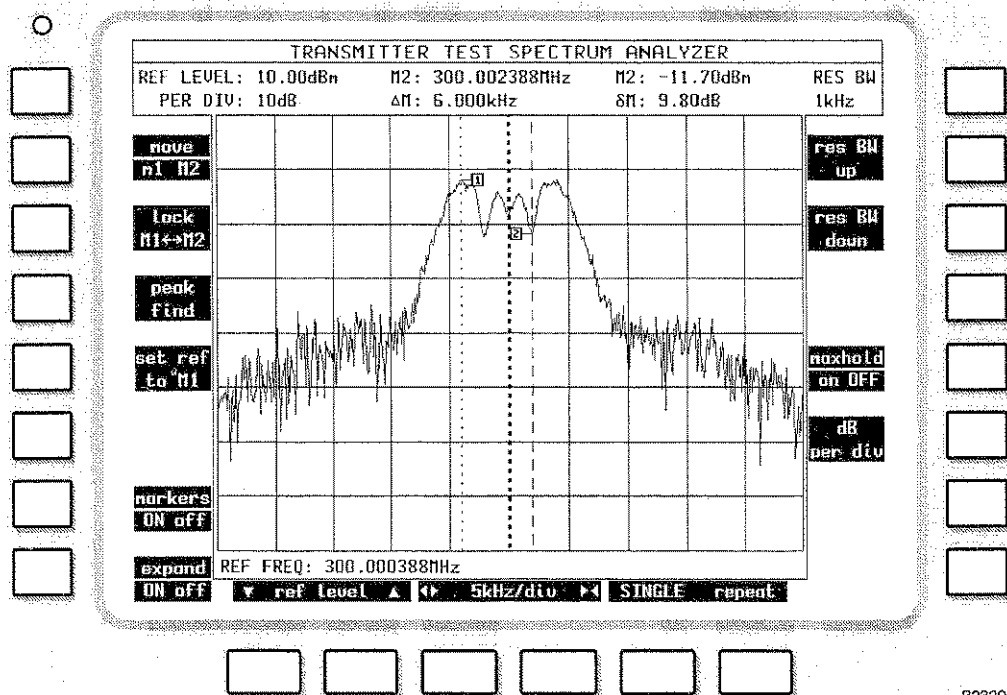

Fig. 3-8 TRANSMITTER TEST SPECTRUM ANALYZER expanded display with markers

Soft keys at left side of screen

Six keys are shown, as follows:-

- (a) *[move m1 m2]* key. To show a dotted marker line (M1) or dashed marker line (M2). Each can be moved by rotating the VARIABLE control (33). This key appears only when the *[markers on OFF]* key is pressed.
- (b) *[lock M1 \leftrightarrow M2]* key. To move the two marker lines together. The legend changes to *[unlock M1 \leftrightarrow M2]*. This key appears only when the *[markers on OFF]* key is pressed.
- (c) *[peak find]* key. To move the dotted marker line (M1) to the frequency at which the level is peak. This key appears only when the *[markers on OFF]* key is pressed.
- (d) *[set ref to M1]* key. To set the reference frequency to that at the position of the dotted marker (M1). This key appears only when the *[markers on OFF]* key is pressed.
- (e) *[markers on OFF]* key. To show the above measurements and soft keys.
- (f) *[expand ON off]* key. To revert to the TRANSMITTER TEST display.

Soft keys at right side of screen

Up to five keys are shown, as follows:-

- (a) *[res BW up]* key. To increase the passband of the resolution bandwidth filtering. This key is not displayed when the resolution bandwidth is set to its maximum, (3 MHz).
- (b) *[res BW down]* key. To decrease the passband of the resolution bandwidth filtering. This key is not displayed when the resolution bandwidth is set to its minimum.
- (c) *[res BW auto]* key. To enable the automatic selection of the resolution bandwidth filtering. This key is not displayed when the automatic selection is active.

The resolution bandwidth is dependent on the frequency span/division setting of the display.

- (d) *[maxhold on OFF]* To hold the display so that frequency components of the current scan are only displayed if they are greater in level than the equivalent frequency components on previous scans.
- (e) *[dB per div]* To set the vertical resolution to 1, 2, 5 or 10 dB per division. This key is shown except when the *[markers on OFF]* soft key is pressed.

The following table shows the resolution bandwidth filter which is selected when in auto mode.

Column A, lists all available span settings.

Column B, shows the video filter which is automatically set with the span setting.

Column C shows the minimum resolution bandwidth filter which may be manually selected with that span setting.

Column D shows the resolution bandwidth filter which is set when auto selection is active.

Column E shows the sweep speed when auto selection of bandwidth filtering is active.

Table 3-1 Spectrum analyzer filtering

Freq/div spans A	Video Filter B	Min Res B/W C	Res'n B'width D	Sweep Speed E
500 Hz	100 Hz	Any	300 Hz	500 ms
1 kHz	1 kHz	Any	300 Hz	500 ms
2 kHz	1 kHz	Any	1 kHz	200 ms
5 kHz	1 kHz	Any	1 kHz	400 ms
10 kHz	3 kHz	Any	3 kHz	200 ms
20 kHz	3 kHz	Any	3 kHz	200 ms
50 kHz	1 kHz	Any	3 kHz	200 ms
100 kHz	3 kHz	1 kHz	10 kHz	200 ms
200 kHz	3 kHz	1 kHz	10 kHz	400 ms
500 kHz	3 kHz	3 kHz	30 kHz	400 ms
1 MHz	3 kHz	3 kHz	30 kHz	400 ms
2 MHz	3 kHz	10 kHz	100 kHz	400 ms
5 MHz	3 kHz	30 kHz	300 kHz	400 ms
10 MHz	3 kHz	30 kHz	300 kHz	500 ms
20 MHz	3 kHz	100 kHz	3 MHz	100 ms
50 MHz	3 kHz	100 kHz	3 MHz	200 ms
100 MHz	3 kHz	100 kHz	3 MHz	400 ms

Soft keys at bottom of screen

Three pairs of keys are shown, as follows:-

- (a) [▼ *ref level* ▲] keys. To increase and decrease, respectively, the reference level of the vertical range.
- (b) [▶ ◀] and [◀ ▶] keys. To increase and decrease, respectively, the frequency/division of horizontal range which is shown.
- (c) [*single REPEAT*] keys. To initiate a single scan.

Modulation analyzer

Connections

As under *Transmitter testing - non-expanded* on page 3-19.

Procedure

Press the [Tx TEST] key (3). One of the TRANSMITTER TEST or OFF-AIR TRANSMITTER TEST displays appears (whichever was last selected). If it is shown, press the [*normal Tx test*] soft key. If an expanded display has appeared, press the [Tx TEST] key again. The TRANSMITTER TEST display appears. See Fig. 3-6.

Enter suitable selections and settings as under *Transmitter testing - non-expanded* on page 3-19.

Press the [*mod ana*] and [*expand on OFF*] soft keys. The TRANSMITTER TEST MOD ANALYZER expanded display appears. See Fig. 3-9.

For the display, set parameters by using the soft keys as below.

Display

The following setting is shown:-

- (a) REF LEVEL. The reference level for the modulation analyzer which is set with either the [▼ *ref level* ▲] soft keys or as described below. If an increment has been set as in (b) below, then the reference level can be incremented/decremented by pressing the INC δ [↑] and [↓] keys.

The modulation analyzer's reference level can be adjusted by pressing the [REF] then [LEVEL] function keys to highlight the display's REF LEVEL legend, then entering the required reference level using the DATA keys. Alternatively, the rotary VARIABLE control can be used instead of the DATA keys.

- (b) δ INC. The reference level increment that has been set as described below. The increment is used by pressing the INC δ [↑] and [↓] keys.

Reference level increments can be set and/or adjusted by pressing the [REF] then [LEVEL] then [INC] function keys to highlight the display's REF LEVEL INC legend, then entering the required increment setting using the DATA keys, followed by the [dB] DATA key.

- (c) PER DIV. The scaling of the graticule that has been set by using the [*dB per div*] soft key.
- (d) REF FREQ. The modulation analyzer's reference frequency which can be set as described below. If an increment has been set as in (e) below, then the reference frequency can be incremented/decremented by pressing the INC Δ FREQ [↑] and [↓] keys.

The modulation analyzer's reference frequency can be adjusted by pressing the [REF] then [FREQ] function keys to highlight the display's REF FREQ legend, then entering the required reference frequency using the DATA keys followed by the appropriate [MHz], [kHz] or [Hz] DATA key. The reference frequency can also be adjusted using rotary VARIABLE control instead of the DATA keys.

The reference frequency can be adjusted by two further methods using the marker facilities which are available after pressing the [*markers on OFF*] soft key:-

Press [*peak find*], [*set ref to M1*] to set the reference to the strongest signal

or

Select [*move M1 m2*] and adjust the M1 marker using the rotary VARIABLE control, then press the [*set ref to M1*] soft key.

Note that increments cannot be adjusted using the [REF FREQ] sequence while the markers are on, though increments already set can be used.

- (e) Δ INC. The reference frequency increment. If an increment has been set as described below, then the reference frequency can be incremented/decremented by pressing the INC Δ FREQ [↑] and [↓] keys.

Reference frequency increments can be set and/or adjusted by pressing the [REF] then [FREQ] then [INC] function keys to highlight the display's REF FREQ Δ INC legend, then entering the required increment using the DATA keys, followed by the appropriate [MHz], [kHz] or [Hz] DATA key.

When the [*markers on OFF*] soft key is pressed, the following measurements are shown:-

- (a) M1 or M2 frequency. The frequency at the M1 marker (dotted) or M2 marker (dashed) as set by using the [*move m1 m2*] soft key and the VARIABLE control.
- (b) M1 or M2 deviation or depth. The modulation at the above marker.
- (c) Δ M. The difference between frequencies of M1 and M2 markers.
- (d) δ M. The difference between levels of M1 and M2 markers (in absolute units and dB).

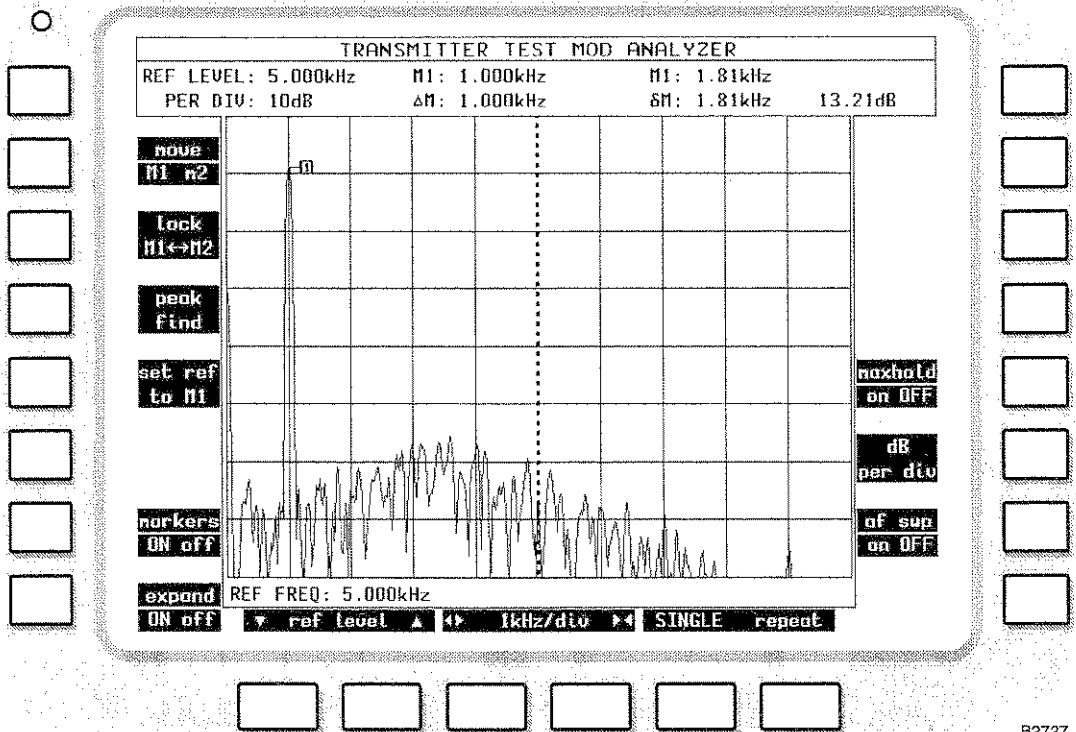

Fig. 3-9 TRANSMITTER TEST MOD ANALYZER expanded display

Soft keys at left side of screen

Five keys are shown, as follows:-

- [move m1 m2]* key. To show a dotted marker line (M1) or dashed marker line (M2). Each can be moved by rotating the VARIABLE control (33). This key appears only when the *[markers on OFF]* key is pressed.
- [lock M1 ↔ M2]* key. To move the two marker lines together. The legend changes to *[unlock M1 ↔ M2]*. This key appears only when the *[markers on OFF]* key is pressed.
- [peak find]* key. To move the dotted marker line (M1) to the frequency at which the modulation is peak. This key appears only when the *[markers on OFF]* key is pressed.
- [set ref to M1]*. To change the REF FREQ: setting to the frequency of marker M1.
- [markers on OFF]* key. To show the above measurements and soft keys.
- [expand ON off]* key. To revert to the TRANSMITTER TEST display.

Soft keys at right side of screen

Three keys are shown, as follows:-

- [maxhold on OFF]* key. To hold the display so that frequency components of the current scan are only displayed if they are greater in level than the equivalent frequency components on previous scans.
- [dB per div]* key. To set the vertical resolution to 1, 2, 5 or 10 dB per division. This key is shown except when the *[markers on OFF]* soft key is pressed.
- [af swp on OFF]* To enable the AF sweep function.

The AF sweep function provides a means of examining the AF frequency response of passive circuits, AF amplifiers or the transmitters.

With the modulation analyzer or audio analyzer mode active, AF gen 2 is repeatedly stepped through the frequency range of the display. The settings of the AF generator is arranged to systematically sample the displayed range at different points on successive sweeps. The frequency range covered by the sweep is from 0 to 20 kHz.

Soft keys at bottom of screen

Three pairs of keys are shown, as follows:-

- (a) [▼ *ref level* ▲] keys. To increase and decrease, respectively, the reference level of the vertical range.
- (b) [▶ ◀] and [◀ ▶] keys. To increase and decrease, respectively, the frequency/division of horizontal range which is shown.
- (c) [*single REPEAT*] keys. To initiate a single scan.

Off-air transmitter testing - non-expanded

Connections

Connect the transmitter to its own antenna.

A Telescopic Antenna (Part no. 54421-001N) is available as an optional accessory. Connect this or another antenna to the RF TNC socket (36).

If required, connect the transmitter's AF input connector to the AF GEN OUTPUT socket (37).

Procedure

Press the [Tx TEST] key (3). One of the TRANSMITTER TEST or OFF-AIR TRANSMITTER TEST displays appears (whichever was last selected). If TRANSMITTER TEST display is shown, press the [*off-air test*] soft key. If an expanded display has appeared, press the [Tx TEST] key again and press the [*off-air test*] soft key. The OFF-AIR TRANSMITTER TEST display appears. See Fig. 3-10.

As required, enter suitable selections and settings, as shown on the display, as follows:-

- (a) Press the [Tx] key (11) and then enter the transmitter's frequency by using the DATA keys (24) and (26). Alternatively, adjust the frequency with the VARIABLE control (33).
- (b) Enter the type of modulation by using the [*mod type*] soft key.
- (c) To select an AF generator, press the [AF GEN] key (15). On the display, AF1, AF2 or AF3 in inverse video shows which of the generators has been selected. To select another generator, press the [1], [2] or [3] key (24) or press the [*display gen*] soft key repeatedly. Enter the frequency and level by using the [FREQ] key (16), the [LEVEL] key (17) and the DATA keys (24) and (26). Alternatively, adjust the frequency and level by using the VARIABLE control (33). The output from AF generator 2 is sequential tones when this has been selected on the TONES menu. See under *Signalling codes testing* on page 3-99. To enable or disable each AF generator, press the appropriate [*gen on OFF*] (or [*tones on OFF*]) soft key. [*tones on OFF*] is shown instead of [*gen 2 on OFF*] when sequential tones has been selected on the TONES menu.
- (d) To enter an increment for Tx frequency or AF frequency, press the [Tx] key (11) or [AF GEN] key (15), the [FREQ] key (16) and then the [INC] key (20). Enter the increment by using the DATA keys (24) and (26). Δ appears alongside the active increment. To increase or decrease the frequency setting, press the appropriate [INC] key (32). Only a single frequency increment can be active. Entering one for Tx disables one for AF and vice versa.
- (e) To enter an increment for AF level, press the [AF GEN] key (15), the [LEVEL] key (17) and then the [INC] key (20). Enter the increment by using the DATA keys (24) and (26). δ appears alongside the active increment. To increase or decrease the level setting, press the appropriate [INC] key (32).

- (f) To select distortion or signal-to-noise measurement, use the *[Tx dist S/N]* soft key.

Transmitter distortion and signal-to-noise ratio are measured within the bandwidth of the display's FILTER value as set by the *[band pass]* or *[low pass]* soft key.

The distortion of the demodulated transmitter is measured at a modulating frequency which is factory preset to 1 kHz. The distortion measurement frequency can be reset using the HELP AND SET-UP mode to either a user-defined frequency or to the frequency of AF GEN 1. Distortion, SINAD or S/N tests cannot be carried out while AF GEN 4 or MOD GEN 4 is enabled.

To change the frequency of measurement, use the key sequence [HELP SET-UP], [SET-UP], [TEST OPTIONS], and *[sinad & distn]*. For further information, refer to the section *Help and setting up* on page 3-124.

- (g) To select filters, use the *[IF BW]*, *[band pass]* and *[low pass]* soft keys.

Read off the measurements that are shown on the display in numerical form and as bar charts (using the *[bar charts]* soft key), oscilloscope display (using the *[scope]* soft key), spectrum analyzer display (using the *[spec ana]* soft key) or modulation analyzer display (using the *[mod ana]* soft key).

For the oscilloscope, spectrum analyzer and modulation oscillator displays, set parameters by using the soft keys beneath the screen.

For the spectrum analyzer display, set the reference frequency. Use the [REF] key (11) and then enter the frequency.

Automatic tuning is not provided in OFF-AIR TRANSMITTER TEST. Set the REF LEVEL so that the signal peak is within the top two graticule divisions.

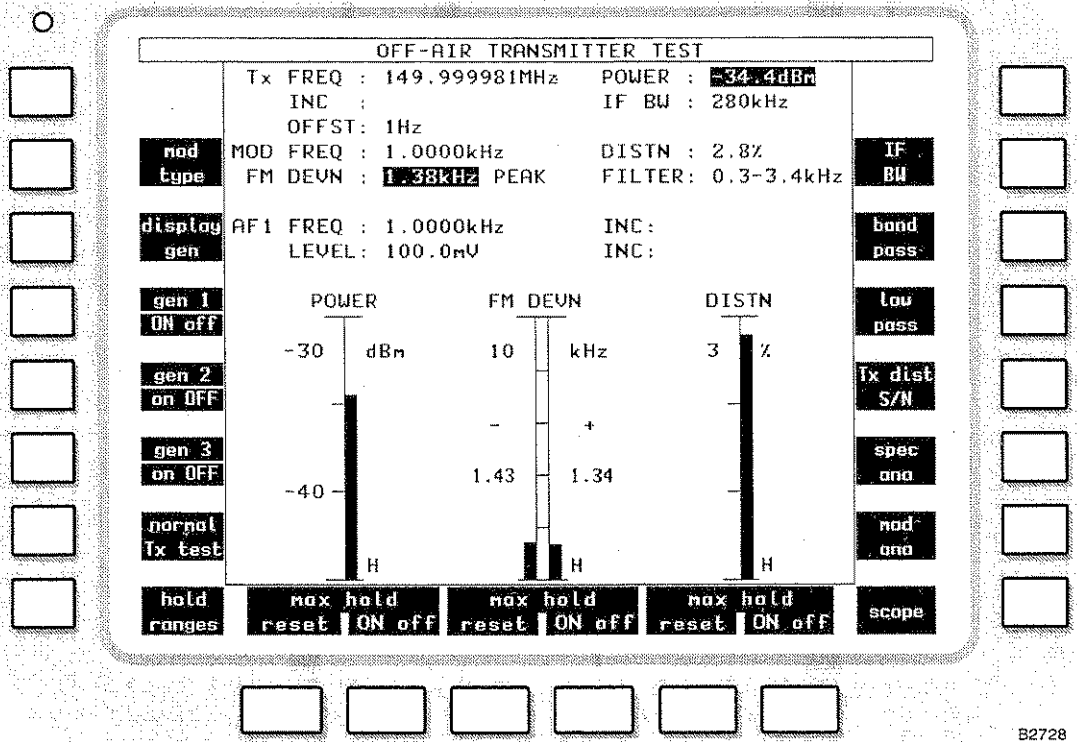

Fig. 3-10 OFF-AIR TRANSMITTER TEST display with bar charts

Display

The following settings and measurements are shown:-

- (a) Tx FREQ and INC. The transmitter frequency which has been entered and any increment.
- (b) OFFST. The difference between the frequency measurement of the transmitter's output and the transmitter frequency which has been entered.
- (c) POWER. The power measurement of the signal which is induced in the antenna.
- (d) IF BW. The bandwidth for the transmitter power measurement as selected by using the *[IF BW]* soft key.
- (e) MOD FREQ and FM DEVN, AM DEPTH or Φ M DEVN. The modulation frequency and deviation or depth measurements of the transmitter's output.
- (f) DISTN or S/N. When one of these is enabled, the distortion or signal-to-noise measurement of the demodulated signal from the transmitter's output.
- (g) FILTER. The filter for the demodulated signal from the transmitter's output as selected by using the *[band pass]* and *[low pass]* soft keys.
- (h) AF1, AF2, AF3 or AF4 FREQUENCY, INC, LEVEL and INC. The settings on one of the AF generators as selected by using the [1], [2] or [3] key (24) after the [AF GEN] key (15) or using the *[display gen]* soft key. If the wide range AF generator is enabled, the parameters of this are shown. AF2 is not shown when sequential tones has been selected on the TONES menu. When AF1, AF2, AF3 or AF4 is shown in inverse video, the [FREQ] key (16) or the [LEVEL] key (17) can then be used.

Bar charts

When the *[bar charts]* soft key is used, the following measurements are shown:-

- (a) POWER IN BAND. The measurement of RF level at the input to RF TNC socket (36).
- (b) FM DEVN, AM DEPTH or Φ M DEVN. The modulation deviation or depth measurement of the transmitter's output.
- (c) DISTN or S/N. When one of these is enabled, the distortion or signal-to-noise measurement of the demodulated signal from the transmitter's output.

The bar charts are auto-ranging except when the *[hold ranges]* soft key is used. The range designators are then shown in inverse video.

Maximum hold

The soft keys beneath the bar charts allow each measurement presentation to indicate actual levels or maximum levels.

With *[max hold ON]* selected, the bar chart and the digital readouts of it, will track any rise in the measured level but will not track downward movement. Pressing the *[reset]* key will cause the current level to be displayed before reapplying the maximum hold function. An H is displayed at the lower right of bar charts that are in the Maximum Hold mode.

With *[max hold OFF]* selected, the bar chart and the associated digital readouts, will track any change in the measured level.

Modulation level

The modulation level bar chart is a dual display, showing the positive modulation level on the right and negative modulation level on the left. A digital reading of the indicated level is shown at the side of each bar chart.

The digital reading of modulation level show in the top half of the display, as FM DEVN, AM DEPTH or FM DEVN, is the average of the positive and negative readings.

Oscilloscope

When the *[scope]* soft key is used, the graticule and trace show the levels of the demodulated signal from the signal which is induced in the antenna.

Spectrum analyzer

When the *[spec ana]* soft key is used, the graticule and trace show the spectrum of the signal which is induced in the antenna.

At the bottom of the display, the REF FREQ setting is shown.

Modulation analyzer

When the *[mod ana]* soft key is used, the graticule and trace show the spectrum of the signal which is induced in the antenna.

At the bottom of the display, the REF FREQ setting is shown.

Soft keys at left side of screen

Seven keys are shown at the left side of the screen, (unless the wide range AF generator/modulation generator has been enabled). The seven keys are:-

- (a) *[mod type]* key. To select the type of modulation of the transmitter's output. The options are FM DEVN, AM DEPTH and Φ M DEVN.
- (b) *[display gen]* key. To select the AF generator before or after using the [AF GEN] key (15). Press the key repeatedly to step through 1,2 and 3. AF2 is not available when sequential tones has been selected on the TONES menu. The frequency and level are shown for the selected generator. When the [AF GEN] key is used, AF1, AF2 or AF3 appear in inverse video. The [FREQ] key (16) or the [LEVEL] key (17) can then be used.
- (c) *[gen 1 on OFF]*, *[gen 2 on OFF]* (or *[tones on OFF]*) and *[gen 3 on OFF]* keys. To enable or disable the AF generators. *[tones on OFF]* is shown instead of *[gen 2 on OFF]* when sequential tones has been selected on the tones menu.
- (d) *[normal Tx test]*. To select the normal TRANSMITTER TEST display.
- (e) *[hold ranges]*, *[auto range]*, *[expand ON off]*, (or *[expand on OFF]*).

When bar charts are displayed, they can be auto-ranging or manually selected. When this key is labelled *[hold ranges]*, pressing it will disable the auto-ranging function and cause the keys beneath the bar charts to become *[range up]* and *[range down]* keys.

When it is labelled *[auto range]*, pressing it will enable the auto-ranging function to the bar charts.

When the spectrum analyzer, modulation analyzer or oscilloscope function is active, this key becomes *[expand ON off]* or *[expand on OFF]* and will toggle between the expanded and normal mode of each.

When the wide range AF generator/modulation generator has been selected, only six soft keys are shown at the left of the screen. These six keys are:-

- (a) *[mod type]* key. As above.
- (b) *[display gen]* key. As above.
- (c) *[afgens 1 to 3]* key. Pressing this key will cause the message ARE YOU SURE?. Press key again to continue. Press any other key to cancel to be displayed.

If the key is pressed again, the wide range AF generator/modulation generator will be disabled and AF generators 1 to 3, and modulation generators 1 to 3 will be enabled. The wide range AF generator/modulation generator can only be enabled again through the HELP AND SET-UP menus.

- (e) [*gen 4 ON off*] key. Repeatedly pressing this key will alternately turn the wide range AF generator on and off. If the wide range MODULATION generator is in the ON condition, pressing this key will turn it off, and turn the wide range AF generator on. But pressing this key to turn the wide range AF generator off will not turn the wide range modulation generator on.
- (f) [*normal Tx test*] key. As above.
- (g) [*hold ranges*], [*auto range*], [*expand ON off*] or [*expand on OFF*] key. As above.

Soft keys at right side of screen

Seven keys are shown, as follows:-





- (a) [*IF BW*] key. To select the IF bandwidth. Values of 300 Hz, 1 kHz, 3 kHz, 10 kHz, 30 kHz, 110 kHz, 280 kHz and 3 MHz are available. Press the soft key repeatedly until the required value is shown on the display.
- (b) [*band pass*] key. To select a band-pass filter for the demodulated signal from the transmitter's output. The options are 0.3 to 3.4 kHz and CCITT or CMES (shown in inverse video). 0.3 to 3.4 kHz is automatically selected when distortion or SINAD testing is enabled. This cancels a previous selection using the [*low pass*] key. CCITT or CMES is set by using the key sequence [HELP SET-UP], [SET-UP], [TEST OPTIONS], [filter options], and [*Psoph Filter*]. See under *Test options* on page 3-128.
- (c) [*low pass*] key. To select a low-pass filter for the demodulated signal from the transmitter's output. The options are 20 kHz LP, 5 kHz LP, 300 Hz LP (shown in inverse video) and NONE (shown in inverse video). This cancels a previous selection using the [*band pass*] key.
- (d) [*Tx dist S/N*] key. To enable or disable distortion or signal-to-noise measurement of the demodulated signal from the transmitter's output. Press the key repeatedly for distortion, S/N or none. When appropriate, DISTN or S/N and a bar chart appear.
- (e) [*bar charts*], [*spec ana*], [*mod ana*] and [*scope*] keys. To select a bar chart, spectrum analyzer, modulation analyzer or oscilloscope display. The three keys change according to the current selection.

Soft keys at bottom of screen





When the bar charts display has been selected and the [*hold ranges*] soft key is used, two keys are shown below each bar chart as follows:-

- (a) [*range down*] key. To increase the sensitivity.
- (b) [*range up*] key. To decrease the sensitivity.

When the oscilloscope display has been selected, three pairs of keys are shown, as follows:-

- (a) [] and [] keys. To increase and decrease, respectively, the level/division of vertical range which is shown.
- (b) [] and [] keys. To increase and decrease, respectively, the time/division of horizontal range which is shown.
- (c) [*single REPEAT*] keys. To initiate a single scan.

When the spectrum analyzer or modulation analyzer display has been selected, three pairs of keys are shown, as follows:-

- (a) Ref level [] and [] keys. To increase and decrease, respectively, the level, deviation or depth which is shown.
- (b) [] and [] keys. To increase and decrease, respectively, the frequency/division of horizontal range which is shown.
- (c) [*single REPEAT*] keys. To initiate a single scan.

Off-air transmitter testing - expanded

Oscilloscope

Connections

As under *Off-air transmitter testing - non-expanded* on page 3-32.

Procedure

Press the [Tx TEST] key (3). One of the TRANSMITTER TEST or OFF-AIR TRANSMITTER TEST displays appears (whichever was last selected). If it is shown, press the *[off-air test]* soft key. If an expanded display has appeared, press the [Tx TEST] key again and press the *[off-air test]* soft key. The OFF-AIR TRANSMITTER TEST display appears. See Fig. 3-10 on page 3-33.

Proceed as under *Transmitter testing - expanded* on page 3-25.

Display

As under *Transmitter testing - expanded* on page 3-25.

Spectrum analyzer

Connections

As under *Off-air transmitter testing - non-expanded* on page 3-32.

Procedure

Press the [Tx TEST] key (3). One of the TRANSMITTER TEST or OFF-AIR TRANSMITTER TEST displays appears (whichever was last selected). If it is shown, press the *[off-air test]* soft key. If an expanded display has appeared, press the [Tx TEST] key again and press the *[off-air test]* soft key. The OFF-AIR TRANSMITTER TEST display appears. See Fig. 3-10.

Proceed as under *Transmitter testing - expanded* on page 3-26.

Display

As under *Transmitter testing - expanded* on page 3-26.

Modulation analyzer

Connections

As under *Off-air transmitter testing - non-expanded* on page 3-32.

Procedure

Press the [Tx TEST] key (3). One of the TRANSMITTER TEST or OFF-AIR TRANSMITTER TEST displays appears (whichever was last selected). If it is shown, press the *[off-air test]* soft key. If an expanded display has appeared, press the [Tx TEST] key again and press the *[off-air test]* soft key. The OFF-AIR TRANSMITTER TEST display appears. See Fig. 3-10.

Proceed as under *Transmitter testing - expanded* on page 3-29.

Display

As under *Transmitter testing - expanded* on page 3-30.

Receiver testing

Receiver testing - non-expanded

Connections

Connect the receiver's RF input connector to the RF TNC socket (36) (or RF N-type socket (35) if preferred). Use the [RF SELECT] key (34) accordingly.

If required, connect the receiver's AF output connector to AF INPUT socket (38). Use the [AC DC] key (31) as required.

Procedure

Press the [Rx TEST] key (4). One of the RECEIVER TEST displays appears (whichever was last selected). If an expanded display has appeared, press the [Rx TEST] key again. The RECEIVER TEST display appears. See Fig. 3-11.

As required, enter suitable selections and settings as follows:-

- (a) Select the RF generator by using the [RF GEN] key (12) and then enter the frequency and level by using the [FREQ] key (16), the [LEVEL] key (17) and the DATA keys (24) and (26). Alternatively, adjust the frequency and level by using the VARIABLE control (33). Instead, the [Rx=Tx FREQ] key (13) can be used in the Tx TEST mode. To enable or disable the RF generator, press the *[RF gen on OFF]* soft key.
- (b) To select a modulation generator, press the [MOD GEN] key (14). On the display, MOD 1, MOD 2, MOD 3, or MOD X (for external) in inverse video shows which of the generators has been selected. To select another generator, press the [1], [2] or [3] key (24) or press the *[display gen]* key repeatedly. To select the external modulation source press the [0] DATA key. This will be shown as MODX. (If the wide range modulation generator has been enabled, MOD4 will be shown in inverse video see *User options; 100 kHz audio or modulation generator* on page 3-138.) Enter the frequency (internal only) and deviation or depth by using the [FREQ] key (16), the [DEVN DEPTH] key (19) and the DATA keys (24) and (26). Alternatively, adjust the frequency and deviation or depth by using the VARIABLE control (33). The output from modulation generator 2 is sequential tones when this has been selected on the TONES menu. The output from modulation generator 3 is CTCSS when this has been selected on the TONES menu. See under *Signalling codes testing* on page 3-99. To enable or disable each modulation generator, press the appropriate *[mod on OFF]* (or *[tones on OFF]* or *[CTCSS on OFF]*) soft key. *[tones on OFF]* is shown instead of *[mod 2 on OFF]* when sequential tones has been selected on the TONES menu. *[CTCSS on OFF]* is shown instead of *[mod 3 on OFF]* when CTCSS has been selected on the TONES menu.
- (c) To enter an increment for RF frequency or modulation frequency, press the [RF GEN] key (12) or [MOD GEN] key (14), the [FREQ] key (16) and then the [INC] key (20). Enter the increment by using the DATA keys (24) and (26). Δ appears alongside the active increment. To increase or decrease the frequency setting, press the appropriate [INC] key (32). Only a single frequency increment can be active. Entering one for RF disables one for modulation and vice versa. When a second increment has been entered and then the first is reselected, its increment re-appears. To activate this increment without changing its value, press the [ENTER] or any unit key (26).

- (d) To enter an increment for RF level or modulation deviation or depth, press the [RF GEN] key (12) and [LEVEL] key (17) or the [MOD GEN] key (14) and [DEVN DEPTH] key (19) and then the [INC] key (20). Enter the increment by using the DATA keys (24) and (26). *d* appears alongside the active increment. To increase or decrease the level or deviation or depth setting, press the appropriate [INC] key (32). Only a single level or deviation or depth increment can be active. Entering one for RF disables one for modulation and vice versa. When a second increment has been entered and then the first is reselected, its increment re-appears. To activate this increment without changing its value, press the [ENTER] or any unit key (26).
- (e) To select distortion, signal-to-noise, or SINAD measurement, use the [*distn on OFF*], [*S/N on OFF*] and [*SINAD on OFF*] soft keys.

Receiver signal-to-noise ratio, distortion, and SINAD are measured within the bandwidth of the display's FILTER value as set by the [*band pass*] or [*low pass*] soft key.

Note: To measure distortion or SINAD *accurately*, you must use one of the bandpass filters. However, low-pass filters can be used for comparative measurements.

The distortion and SINAD of the receiver are measured at an audio frequency that is factory preset to 1 kHz. The measurement frequency can be reset using the HELP AND SET-UP mode to either a user-defined frequency or to the MOD GEN 1 frequency. Distortion, SINAD or S/N tests cannot be carried out while MOD GEN 4 or AF GEN 4 is enabled.

To change the frequency of measurement, use the key sequence [HELP SET-UP], [*SET-UP*], [*TEST OPTIONS*] and [*sinad & distn*]. For further information, refer to the section *Help and setting up* on page 3-124.

- (f) To select a filter, use the [*band pass*] or [*low pass*] soft key.

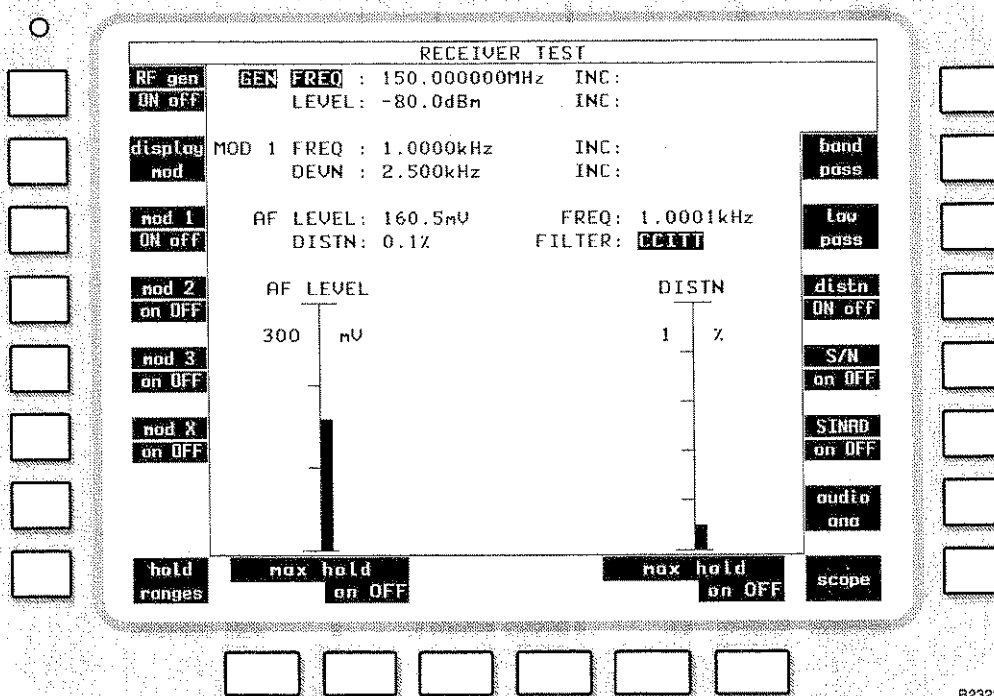

Fig. 3-11 RECEIVER TEST display with bar charts

Read off the measurements that are shown on the display in numerical form and as bar charts (using the [*bar charts*] soft key), oscilloscope display (using the [*scope*] soft key) or audio analyzer (using the [*audio ana*] soft key).

For the oscilloscope and audio analyzer displays, set parameters by using the soft keys as below.

Display

The following settings and measurements are shown:-

- (a) GEN FREQ, INC, LEVEL and INC. The settings of the RF generator. Δ (for frequency) and δ (for level) appear alongside when the increments are active.
- (b) MOD1, MOD2, MOD3, MOD4, or MOD X, FREQ, INC, DEVN (or DEPTH) and INC. The settings of one of the modulation generators as selected by using the [1], [2] or [3] key (24) after the [MOD GEN] key (14) or by using the *[display gen]* soft key. If the wide range modulation generator is enabled, the parameters of this are shown. MOD 2 is not available when sequential tones has been selected on the TONES menu. CTCSS is shown instead of MOD 3 when this has been selected on the TONES menu. When MOD1, MOD2, MOD3 or MOD4 is shown in inverse video, the [FREQ] key (16) or the [DEVN DEPTH] key (19) can then be used. Δ (for frequency) and δ (for deviation or depth) appear alongside when the increments are active.
- (c) AF FREQ and LEVEL. The frequency and level measurements of the receiver's demodulated output through the AF INPUT socket (38).
- (d) DISTN, S/N or SINAD. When one of these soft keys is enabled, the distortion, signal-to-noise or SINAD measurement of the receiver's demodulated output is displayed.
- (e) FILTER. This shows the AF filter that has been selected using the *[band pass]* or *[low pass]* soft keys.

Bar charts

When the *[bar charts]* soft key is used, the following measurements are shown:-

- (a) AF LEVEL. The measurement of the receiver's demodulated output through the AF INPUT socket (38).
- (b) DISTN, S/N or SINAD. When one of these mutually exclusive soft keys is pressed, the distortion, signal-to-noise or SINAD measurement of the receiver's demodulated output is displayed.

The bar charts are auto-ranging except when the *[hold ranges]* soft key is used. When *[hold ranges]* is pressed, range up/down soft-key control is enabled.

Maximum hold

The soft keys beneath the bar charts allow each measurement presentation to indicate actual levels or maximum levels.

With *[max hold ON]* selected, the bar chart and the digital readouts of it, will track any rise in the measured level but will not track downward movement. Pressing the *[reset]* key will cause the current level to be displayed before reapplying the maximum hold function. An H is displayed at the lower right of bar charts that are in the Maximum Hold mode.

With *[max hold OFF]* selected, the bar chart and the associated digital readouts, will track any change in the measured level.

Oscilloscope

When the *[scope]* soft key is used, the graticule and trace show the levels of the receiver's demodulated output through the AF INPUT socket (38).

Audio analyzer

When the *[audio ana]* soft key is used, the graticule and trace show the spectrum of the receiver's demodulated output through the AF INPUT socket (38).

At the bottom of the display the REF FREQ setting is shown, corresponding to the frequency at the vertical dotted line in the centre of the display.

Soft keys at left side of screen

Seven keys are shown at the left side of the screen, (unless the wide range AF generator/modulation generator has been enabled). The seven keys are:-

- (a) *[RF gen on OFF]* key. To enable or disable the RF generator. The output is through the RF TNC socket (36) (or RF N-type socket (35) if preferred) to the receiver under test.
- (b) *[display mod]* key. To select the modulation generator before or after using the [MOD GEN] key (14). Press the key repeatedly to step through 1, 2 and 3. MOD 2 is not available when sequential tones has been selected on the TONES menu. MOD 3 is not available when CTCSS has been selected on the TONES menu. The frequency and deviation or depth are shown for the selected generator. When the [MOD GEN] key is used, MOD1, MOD2 or MOD3 appear in inverse video. The [FREQ] key (16) or the [DEVN DEPTH] key (19) can then be used.
- (c) *[mod 1 on OFF]*, *[mod 2 on OFF]* (or *[tones on OFF]*), *[mod 3 on OFF]* (or *[CTCSS on OFF]*) and *[mod X on OFF]* keys. To enable or disable the modulation generators. *[tones on OFF]* is shown instead of *[mod 2 on OFF]* when sequential tones has been selected on the TONES menu. *[CTCSS on OFF]* is shown instead of *[mod 3 on OFF]* when CTCSS has been selected on the tones menu.
- (d) *[hold ranges]*, *[auto range]* or *[expand on OFF]* key. The soft key function depends on the previous selection. When *[bar charts]* has been selected, this soft key provides *[hold ranges]* or *[auto range]*; when *[hold ranges]* has been selected, the range can be selected using *[range down/up]* soft keys. When either *[audio ana]* or *[scope]* is selected, the *[expand on OFF]* soft key becomes available, to provide an expanded display with the availability of marker handling and measurement facilities.

When the wide range AF generator/modulation generator has been selected, only four soft keys are shown at the left of the screen. These four keys are:-

- (a) *[RF gen ON off]* key. As above.
- (b) *[modgens 1 to 3]* key. Pressing this key will cause the message ARE YOU SURE?. Press key again to continue. Press any other key to cancel to be displayed.

If the key is pressed again, the wide range AF generator/modulation generator will be disabled and modulation generators 1 to 3, and AF generators 1 to 3 will be enabled. The wide range AF generator/modulation generator can only be enabled again through the HELP AND SET-UP menus.

- (c) *[mod 4 ON off]* key. Repeatedly pressing this key will alternately turn the wide range modulation generator on and off. If the wide range AF generator is in the ON condition, pressing this key will turn it off, and turn the wide range modulation generator on. But pressing this key to turn the wide range modulation generator off will not turn the wide range AF generator on.
- (d) *[hold ranges]*, *[auto range]* or *[expand on OFF]* key. As above.

Soft keys at right side of screen

Seven keys are shown, as follows:-

- (a) *[band pass]* key. To select a band-pass filter for the receiver's demodulated output through the AF INPUT socket (38). The options are 0.3 to 3.4 kHz and CCITT or CMESS (shown in inverse video). CCITT or CMESS is set by using the key sequence [HELP SET-UP], [SET-UP], [TEST OPTIONS], [filter options], and [Psoph Filter]. See under *Test options* on page 3-128.
- (b) *[low pass]* key. To select a low-pass filter for the receiver's demodulated output. The options are 20 kHz LP, 300 Hz LP or NONE. This cancels a previous selection using the *[band pass]* key.
- (c) *[dist on OFF]* key. To enable or disable distortion measurement of the receiver's demodulated output. When appropriate, DISTN and a bar chart appear. *[dist ON off]* cancels *[SN ON off]* or *[SINAD ON off]*.





- (d) *[S/N on OFF]* key. To enable or disable signal-to-noise measurement of the receiver's demodulated output. S/N and a bar chart appears. *[S/N ON off]* cancels *[dist ON off]* or *[SINAD ON off]*.
- (e) *[SINAD on OFF]* key. To enable or disable SINAD measurement of the receiver's demodulated output. When appropriate, SINAD and a bar chart appears. *[SINAD ON off]* cancels *[dist ON off]* or *[S/N ON off]*.
- (f) *[bar charts]*, *[audio ana]* and *[scope]* keys. To select a bar chart, audio analyzer or oscilloscope display. The two keys change according to the current selection.

Soft keys at bottom of screen





When the bar charts display has been selected and the *[hold ranges]* soft key is used, two keys are shown below each bar chart as follows:-

- (a) *[range up]* key. To increase the range of the bar chart.
- (b) *[range down]* key. To decrease the range of the bar chart.

When the oscilloscope display has been selected, three pairs of keys are shown, as follows:-

- (a)  and  keys. To increase and decrease, respectively, the level/division of vertical range which is shown.
- (b)  and  keys. To increase and decrease, respectively, the time/division of horizontal range which is shown.
- (c) *[single REPEAT]* keys. To initiate a single scan.

When the audio analyzer display has been selected, three pairs of keys are shown, as follows:-

- (a)  *ref level*  keys. To increase and decrease, respectively, the reference level of the vertical range.
- (b)  and  keys. To increase and decrease, respectively, the frequency/division of horizontal range which is shown.
- (c) *[single REPEAT]* keys. To initiate a single scan.

Receiver testing - expanded

Oscilloscope

Connections

As under *Receiver testing - non-expanded* on page 3-38.

Procedure

Press the [Rx TEST] key (4). One of the RECEIVER TEST displays appears (whichever was last selected). If an expanded display has appeared, press the [Rx TEST] key again. The RECEIVER TEST display appears. See Fig. 3-11 on page 3-39.

Enter suitable selections and settings as under *Receiver testing - non-expanded* on page 3-38.

Press the *[scope]* and *[expand on OFF]* soft keys. The RECEIVER TEST SCOPE expanded display appears. See Fig. 3-12 on page 3-43.

For the display, set parameters by using the soft keys as below.

Display

When the [markers on OFF] soft key is pressed, the following measurements are shown:-

- Vertical sensitivity of oscilloscope.
- ΔM . The difference between frequencies of M1 and M2 markers.
- δM . The difference between levels of M1 and M2 markers.

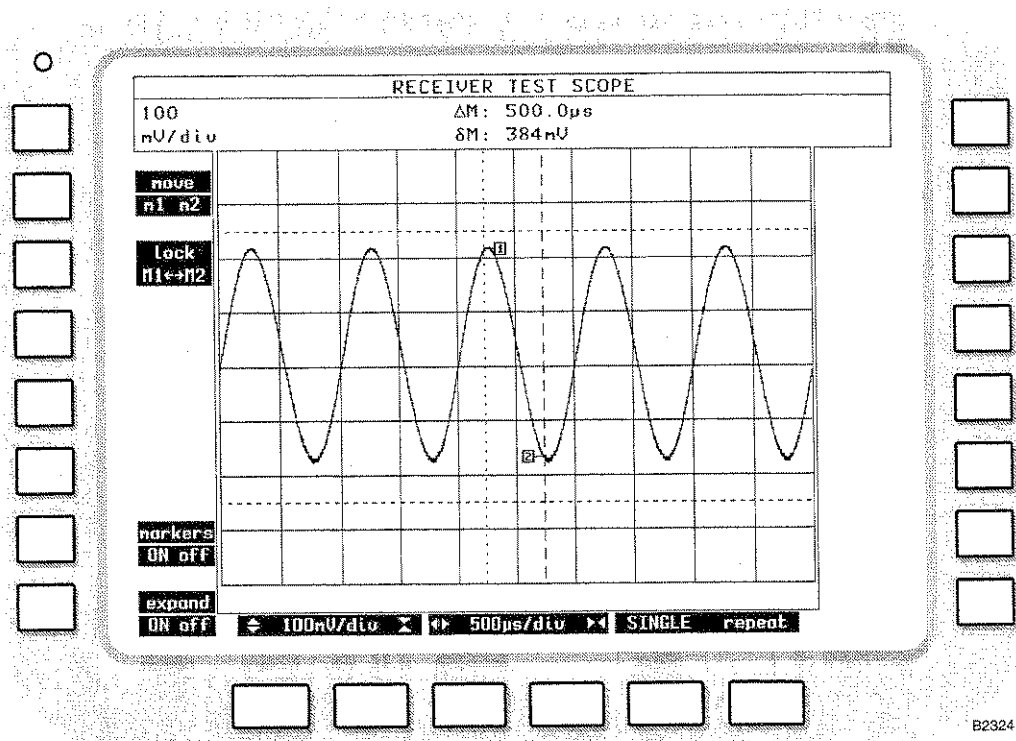

Fig. 3-12 RECEIVER TEST SCOPE expanded display with markers on

Soft keys at left side of screen

Four soft keys are shown after [markers on OFF] is pressed, as follows:-

- [move m1 m2] key. To show a dotted marker line (M1) or dashed marker line (M2). Each can be moved by rotating the VARIABLE control (33). This key appears only when the [markers on OFF] key is pressed.
- [lock M1 ↔ M2] key. To move the two marker lines together. The legend changes to [unlock M1 ↔ M2]. This key appears only when the [markers on OFF] key is pressed.
- [markers on OFF] key. To show the above measurements and soft keys.
- [expand ON off] key. To revert to the RECEIVER TEST display.

Soft keys at bottom of screen

Three pairs of keys are shown, as follows:-

- [▲] and [▼] keys. To increase and decrease, respectively, the level/division of vertical range which is shown.
- [▶◀] and [◀▶] keys. To increase and decrease, respectively, the time/division of horizontal range which is shown.
- [single REPEAT] keys. To initiate a single scan.

Audio analyzer

Connections

As under *Receiver testing - non-expanded* on page 3-38.

Procedure

Press the [Rx TEST] key (4). One of the RECEIVER TEST displays appears (whichever was last selected). If an expanded display has appeared, press the [Rx TEST] key again. The RECEIVER TEST display appears. See Fig. 3-11 on page 3-39.

Enter suitable selections and settings as under *Receiver testing - non-expanded* on page 3-38.

Press the [audio ana] and [expand on OFF] soft keys. The RECEIVER TEST AUDIO ANALYZER expanded display appears. See Fig. 3-13.

For the display, set parameters by using soft keys as below.

Display

The following setting is shown:-

- (a) REF LEVEL. The reference level for the audio analyzer which is set with either the [▼ ref level ▲] soft keys or as described below. The reference level corresponds to the top of the graticule. If an increment has been set as in (b) below, then the reference level can be incremented/decremented by pressing the INC δ [↑] and [↓] keys.

The audio analyzer's reference level can be adjusted by pressing the [REF] then [LEVEL] function keys to highlight the display's REF LEVEL legend, then entering the required reference level using the numeric DATA keys, followed by the [mV] DATA key. Alternatively, the rotary VARIABLE control can be used instead of the numeric DATA keys.

- (b) δ INC. The reference level increment that has been set as described below. The increment is used by pressing the INC δ [↑] and [↓] keys.

Reference level increments can be set and/or adjusted by pressing the [REF] then [LEVEL] then [INC] function keys to highlight the display's REF LEVEL δ INC legend, then entering the required increment setting using the numeric DATA keys, followed by the [mV] DATA key.

- (c) PER DIV. The scaling of the graticule that has been set by using the [dB per div] soft key.
- (d) REF FREQ. The audio analyzer's reference frequency, corresponding to the central vertical dotted line on the graticule, which can be set as described below. If an increment has been set as in (e) below, then the reference frequency can be incremented/decremented by pressing the INC Δ FREQ [↑] and [↓] keys.

The audio analyzer's reference frequency can be adjusted by pressing the [REF] then [FREQ] function keys to highlight the display's REF FREQ legend, then entering the required reference frequency using the numeric DATA keys followed by the appropriate [MHz], [kHz] or [Hz] DATA key. The reference frequency can also be adjusted using the rotary VARIABLE control instead of the numeric DATA keys.

The reference frequency can be adjusted by two further methods using the marker facilities that are available after pressing the [markers on OFF] soft key:-

Press [peak find], [set ref to M1] to set the reference to the strongest signal

or

Select [move M1 m2] and adjust the M1 marker using the rotary VARIABLE control, then press the [set ref to M1] soft key.

Note that increments cannot be adjusted using the [REF FREQ] sequence while the markers are on, though increments already set can be used.

- (e) Δ INC. The reference frequency increment. If an increment has been set as described below, then the reference frequency can be incremented/decremented by pressing the INC Δ FREQ [\uparrow] and [\downarrow] keys.

Reference frequency increments can be set and/or adjusted by pressing the [REF] then [FREQ] then [INC] function keys to highlight the display's REF FREQ Δ INC legend, then entering the required increment using the numeric DATA keys, followed by the appropriate [MHz], [kHz] or [Hz] DATA key.

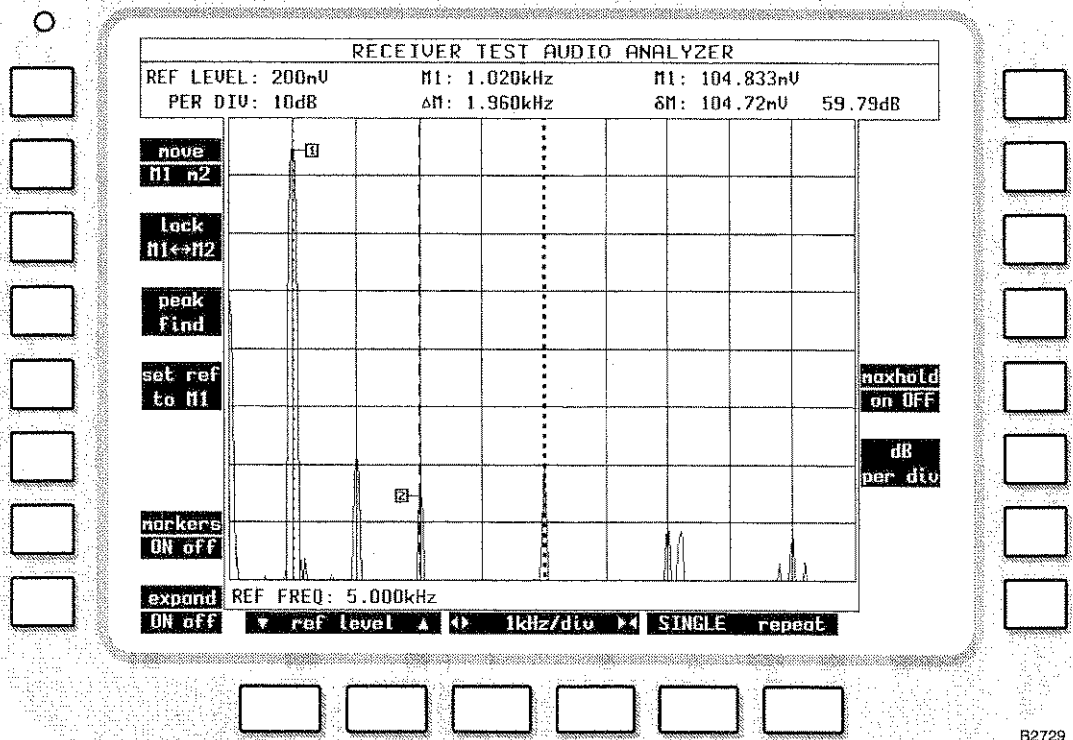

Fig. 3-13 RECEIVER TEST AUDIO ANALYZER expanded display with markers

When the [markers on OFF] soft key is pressed, the following measurements are shown:-

- M1 or M2 frequency. The frequency at the M1 marker (dotted) or M2 marker (dashed) as set by using the [move m1 m2] soft key and the VARIABLE control.
- M1 or M2 level. The level at the above marker.
- Δ M. The difference between frequencies of M1 and M2 markers.
- δ M. The difference between levels of M1 and M2 markers (in absolute units and dB).

Soft keys at left side of screen

Five keys are shown, as follows:-

- [move m1 m2] key. To show a dotted marker line (M1) or dashed marker line (M2). Each can be moved by rotating the VARIABLE control (33). This key appears only when the [markers on OFF] key is pressed.
- [lock M1 \leftrightarrow M2] key. To move the two marker lines together. The legend changes to [unlock M1 \leftrightarrow M2]. This key appears only when the [markers on OFF] key is pressed.
- [peak find] key. To move the dotted marker line (M1) to the frequency at which the level is peak. This key appears only when the [markers on OFF] key is pressed.
- [set ref to M1]. To set REF FREQ to that of M1 marker position.
- [markers on OFF] key. To show the above measurements.

- (f) [*expand on OFF*] key. To revert to the RECEIVER TEST display.

Soft keys at right side of screen

Two keys are shown, as follows:-

- (a) [*maxhold on OFF*] key. To hold the display so that frequency components of the current scan are only displayed if they are greater in level than the equivalent frequency components on previous scans.
- (b) [*dB per div*] key. To set the vertical resolution to 1, 2, 5 or 10 dB per division. This key is shown except when the [*markers on OFF*] soft key is pressed.

Soft keys at bottom of screen

Three pairs of keys are shown, as follows:-

- (a) [*▼ ref level ▲*] keys. To increase and decrease, respectively, the reference level of the vertical range.
- (b) [*► ◀*] and [*◀ ►*] keys. To increase and decrease, respectively, the frequency/division of horizontal range which is shown.
- (c) [*single REPEAT*] keys. To initiate a single scan.

Duplex testing

Full duplex testing

Connections

For two-port duplex, connect the transceiver under test as follows:-

- (a) The receiver's RF input connector to the RF TNC socket (36) (or RF N-type socket (35) if preferred).
- (b) If required, the receiver's AF output connector to AF INPUT socket (38). Use the [AC DC] key (31) as required.
- (c) The transmitter's RF output connector to the RF N-type socket (35) (or RF TNC socket (36) if preferred for <1 W).
- (d) If required, the transmitter's AF input connector to the AF GEN OUTPUT socket (37).

For one-port duplex, connect the transceiver under test as above except for using a single RF socket.

Use the [RF SELECT] key (34) to configure the TNC and/or N-type sockets for the appropriate input/output, indicated by the adjacent front panel lamps.

WARNING

Hot surface

Take care when touching the RF N-type connector after continuous power input. If 50 W is exceeded, the temperature of the connector becomes excessive.

CAUTION

Input overload

On the RF N-type connector, the input power should not exceed 150 W.

On the RF TNC connector, the input power should not exceed 1 W.

When external modulation is to be used, connect the generator to the EXT MOD INPUT socket (39).

Procedure

Press the [DUPLEX TEST] key (5). One of the DUPLEX TEST displays appears (whichever was last selected). If one of the DUPLEX TEST (Tx) or DUPLEX TEST (Rx) displays has appeared, press the [DUPLEX TEST] key again. The DUPLEX TEST display appears. See Fig. 3-14.

In its factory default condition, the 2965 tunes automatically to the strongest frequency component at the RF N-type socket (provided it is >+10 dBm) or TNC socket (provided it is >-10 dBm).

Alternatively the test set can be manually tuned. The set frequency is shown against the Tx .FREQ legend, and any offset between this and the measured incoming RF signal is shown against the OFFSET legend.

Enter the required selections and settings on the display as follows:-

- (a) Select the RF generator by using the [RF GEN] key (12) and then enter the frequency and level by using the [FREQ] key (16), the [LEVEL] key (17) and the DATA keys (24) and (26). Alternatively, adjust the frequency and level by using the VARIABLE control (33). The [Rx=Tx FREQ] key (13) can be used to set the GEN FREQ to the Tx FREQ + OFFSET. The default offset is 0 Hz but can be set as described in *Help and setting up* by pressing [HELP SET-UP], [SET-UP], [TEST OPTIONS], [freq plan].

- (b) When RF frequency and level increments have been entered on the DUPLEX TEST (Rx) display, Δ and δ appear alongside the appropriate settings. Then, to increase or decrease the setting, press the appropriate [INC] key (32). To enable or disable the RF generator, press the [RF gen on OFF] soft key.

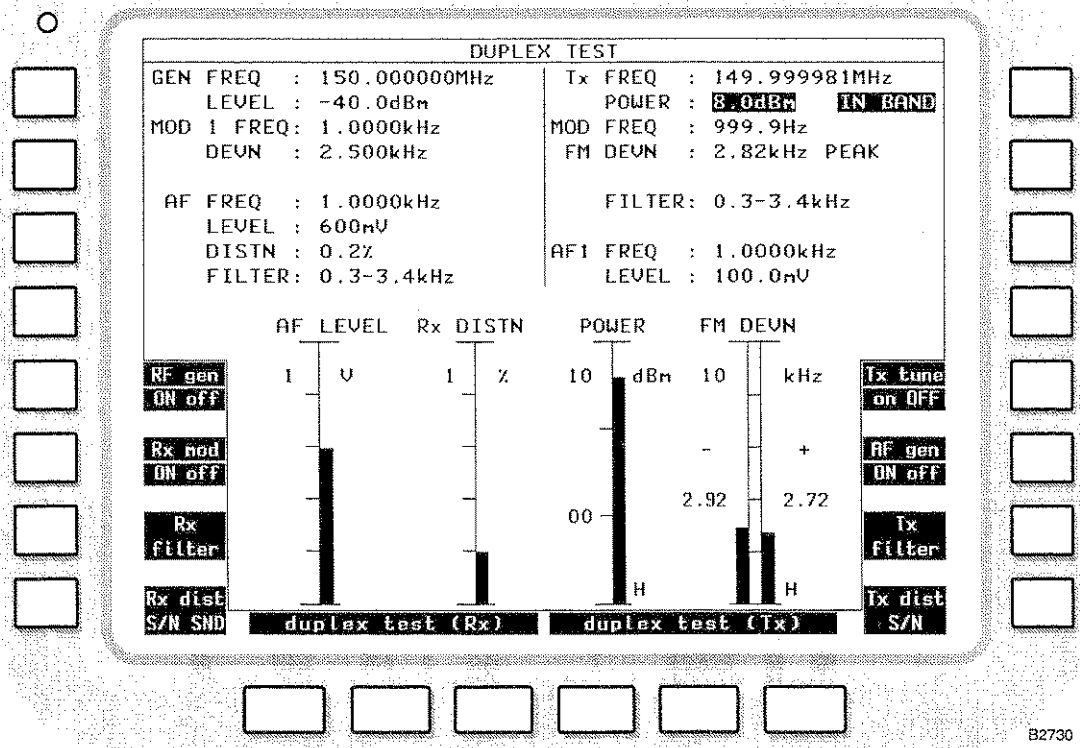

Fig. 3-14 DUPLEX TEST display with bar charts

- (c) To select a modulation generator, press the [MOD GEN] key (14). On the display, MOD 1, MOD 2 or MOD 3 in inverse video shows which of the generators has been selected. (If the wide range modulation generator has been enabled, MOD 4 will be shown in inverse video. See *User options; 100 kHz audio or modulation generator* on page 3-138). Enter the frequency and deviation or depth by using the [FREQ] key (16), the [DEVN DEPTH] key (19) and the DATA keys (24) and (26). Alternatively, adjust the frequency and deviation or depth by using the VARIABLE control (33). The output from modulation generator 2 is sequential tones when this has been selected on the TONES menu. The output for modulation generator 3 is CTCSS when this has been selected on the TONES menu. See under *Signalling codes testing* on page 3-99.
- (d) When modulation frequency and deviation or depth increments have been entered on the DUPLEX TEST (Rx) display, Δ and δ appear alongside the appropriate settings. Then, to increase or decrease a setting, press the appropriate [INC] key (32). To enable or disable the modulation generators which are not OFF, press the [Rx mod on OFF] soft key.
- (e) To manually set the test set to the transmitter frequency, press the [Tx] key (11) and then, either enter the frequency by using the DATA keys (24) and (26), or use the VARIABLE control (33) to adjust the frequency setting.

(f) To select an AF generator, press the [AF GEN] key (15) and press the [1], [2] or [3] key (24). On the display, AF1, AF2 or AF3 in inverse video shows which of the generators has been selected. (If the wide range AF generator has been enabled, AF4 will be shown in inverse video see *User options; 100 kHz audio or modulation generator* on page 3-138.) Enter the frequency and level by using the [FREQ] key (16), the [LEVEL] key (17) and the DATA keys (24) and (26). Alternatively, adjust the frequency and level by using the VARIABLE control (33). The output from modulation generator 2 is sequential tones when this has been selected on the TONES menu. See under *Signalling codes testing* on page 3-99.

(g) To select distortion, signal to noise or SINAD measurement, repeatedly press the [Rx dist S/N SND] and [Tx dist S/N] soft keys until the required selection is displayed.

Distortion, SINAD and signal-to-noise are measured within the bandwidth of the display's FILTER value as set by the [band pass] and [low pass] soft keys.

SINAD and distortion are measured at a frequency which is factory preset to 1 kHz. The measurement frequency can be reset using the HELP AND SET-UP mode to either a user-defined frequency or to the frequency of AF GEN 1. Distortion, SINAD or S/N tests cannot be carried out while AF GEN 4 or MOD GEN 4 is enabled.

To change the frequency of measurement, use the key sequence [HELP SET-UP], [SET-UP], [TEST OPTIONS] and [sinad & distn]. For further information, refer to the section *Help and setting up* on page 3-124.

(h) To select filters, repeatedly press the [Rx filter] and [Tx filter] soft keys, until the required filter is displayed.

Read off the measurements that are shown on the display in numerical form and as bar charts.

When the 2965 tunes automatically, it also selects the optimum spectrum analyzer reference level and the input attenuator. This sets the level to the modulation analyzer and to the selective power meter. With manual tuning at low levels, it is necessary to set these manually to achieve optimum accuracy. On the DUPLEX TEST (Tx) SPECTRUM ANALYZER display, set the REF LEVEL so that the signal peak is within the top two graticule divisions.

Display

In the left half of the display, the following settings and measurements for receiver testing are shown:-

- (a) GEN FREQ and LEVEL. The settings of the RF generator. Δ (for frequency) and δ (for level) appear alongside when increments have been set.
- (b) MOD1, MOD2, MOD3, MOD4 FREQ and DEVN or DEPTH. The settings of one of the modulation generators as selected by using the [1], [2] or [3] key (24) after the [MOD GEN] key. If the wide range modulation generator is enabled, the parameters of this are shown. MOD 2 is not shown when sequential tones has been selected on the TONES menu. When MOD 1, MOD 2 or MOD 3 is shown in inverse video, the [FREQ] key (16) or the [DEVN DEPTH] key (19) can then be used. Each generator can be enabled or disabled in the DUPLEX TEST (Rx) display. The selected generator can be enabled or disabled by using the [Rx mod on OFF] soft key. When a generator is enabled but not selected for display, a warning sign (!) is shown in inverse video. Δ (for frequency) and δ (for deviation or depth) appear alongside when increments have been set.
- (c) AF FREQ and LEVEL. The frequency and level measurements of the receiver's demodulated output through the AF INPUT socket (38).
- (d) DISTN, S/N or SINAD. When one of these is enabled, the distortion, signal-to-noise or SINAD measurement of the receiver's demodulated output.
- (e) FILTER. The filter for the receiver's demodulated output as selected by using the [Rx filter] soft key.

In the right half of the display, the following settings and measurements for transmitter testing are shown:-

- (a) Tx FREQ and POWER. The frequency and power measurements of the transmitter's output. For two-port duplex, this is through the RF N-type socket (35). When IN BAND has been selected by using the *[power BW]* soft key in the TRANSMITTER TEST or DUPLEX TEST (Tx) display, this is shown in inverse video.
- (b) MOD FREQ and FM DEVN, AM DEPTH or Φ M DEVN. The modulation frequency and deviation or depth measurements of the transmitter's output. The type of modulation is that selected by using the *[mod type]* soft key in the DUPLEX TEST (Tx) display.
- (c) DISTN or S/N. When one of these is enabled, the distortion or signal-to-noise measurement of the demodulated signal from the transmitter's output.
- (d) FILTER. The filter for the demodulated signal from the transmitter's output as selected by using the *[Tx filter]* soft key.
- (e) AF1, AF2, AF3 or AF4 FREQ and LEVEL. The settings of one of the AF generators as selected by using the [1], [2] or [3] key (24) after the [AF GEN] key (15). If the wide range AF generator is enabled, the parameters of this are shown. AF2 is not shown when sequential tones has been selected on the TONES menu. When AF1, AF2, AF3 or AF4 is shown in inverse video, the [FREQ] key (16) or the [LEVEL] key (17) can then be used. Each generator can be enabled or disabled in the DUPLEX TEST (Tx) display, by using the appropriate *[gen on OFF]* soft key.

Bar charts

In the left half of the display, the following measurements are shown:-

- (a) AF LEVEL. The measurement of the receiver's demodulated output through the AF INPUT socket (38).
- (b) DISTN, S/N or SINAD. When one of these is enabled, the distortion, signal-to-noise or SINAD measurement of the receiver's demodulated output (with Rx shown) or the demodulated signal from the transmitter (with Tx shown in inverse video), whichever was last selected.

In the right half of the display, the following measurements are shown:-

- (a) POWER. The measurement of the transmitter's output. For two-port duplex, this is through the RF N-type socket (35).
- (b) FM DEVN, AM DEPTH or Φ M DEVN. The modulation deviation or depth measurement of the transmitter's output.

The bar charts are auto-ranging except when *[hold ranges]* soft keys have been used in the *[duplex test (Tx)]* displays. The range designators are then shown in inverse video.

Maximum hold

When an H is displayed at the lower right of a bar chart, the measurement displayed is in the Maximum Hold mode. This cannot be changed unless the appropriate duplex test (Rx) or duplex test (Tx) mode is accessed. See the *Bar chart* sections under *Duplex transmitter testing* and *Duplex receiver testing*.

Soft keys at left side of screen

Four keys are shown, as follows:-

- (a) *[RF gen on OFF]* key. To enable or disable the RF generator.
- (b) *[Rx mod on OFF]* key. To enable or disable the modulation generator which is shown on the display.
- (c) *[Rx filter]* key. To select a filter for the receiver's demodulated output through the AF INPUT socket (38). The options are 0.3 to 3.4 kHz, CCITT (or CMESS; see below), NONE, 20 kHz LP, and 300 Hz LP. 0.3 to 3.4 kHz is automatically selected when distortion or SINAD testing is enabled. CCITT or CMESS is set using the key sequence [HELP SET-UP], [SET-UP], [TEST OPTIONS], [filter options] and [Psoph Filter]. See under *Test options* on page 3-128.

- (d) *[Rx dist S/N SND]* key. To enable or disable distortion, signal-to-noise or SINAD measurement of the receiver's demodulated output. When appropriate, Rx DIST, Rx S/N or Rx SINAD and a bar chart appear.

Soft keys at right side of screen

Four keys are shown, as follows:-

- (a) *[Tx tune ON off]* key. To disable automatic tuning or to return to automatic tuning after a transmitter frequency has been set manually.
- (b) *[AF gen on OFF]* key. To enable or disable the AF generator which has been selected. The output is through the AF GEN OUTPUT socket (37) to the transmitter under test.
- (c) *[Tx filter]* key. To select a filter for the demodulated signal from the transmitter's output. For two-port duplex, this is through the RF N-type socket (35). The options are 0.3 to 3.4 kHz, CCITT (or CMESS; see below), 20 kHz LP, 5 kHz LP, and 300 Hz LP. 0.3 to 3.4 kHz is automatically selected when distortion or SINAD testing is enabled. CCITT or CMESS is set by using the key sequence [HELP SET-UP], [SET-UP], [TEST OPTIONS], [filter options] and [Psoph Filter]. See under *Test options* on page 3-128.
- (d) *[Tx dist S/N]* key. To enable or disable distortion or signal-to-noise measurement of the demodulated signal from the transmitter's output. When appropriate, Tx DISTN or Tx S/N and a bar chart appear.

Soft keys at bottom of screen

Two groups of three keys are shown, as follows:-

- (a) *[duplex test (Rx)]* keys. To change to the DUPLEX TEST (Rx) display.
- (b) *[duplex test (Tx)]* keys. To change to the DUPLEX TEST (Tx) display.

Duplex transmitter testing

Connections

As under *Full duplex testing* on page 3-47.

Procedure

Press the [DUPLEX TEST] key (5). One of the DUPLEX TEST displays appears (whichever was last selected). If an expanded display has appeared, press the [DUPLEX TEST] key again. The DUPLEX TEST display appears (Fig. 3-14 on page 3-48).

Press one of the *[duplex test (Tx)]* soft keys or, if the DUPLEX TEST (Rx) display appeared, press the *[duplex Rx Tx]* soft key. The DUPLEX TEST (Tx) display appears. See Fig. 3-15 on page 3-53.

In its factory default condition, the 2965 tunes automatically to the strongest frequency component at the RF N-type socket (provided it is $>+10$ dBm) or TNC socket (provided it is >-10 dBm).

Alternatively the test set can be manually tuned. The set frequency is shown against the Tx FREQ legend, and any offset between this and the measured incoming RF signal is shown against the OFFSET legend.

Enter the required selections and settings on the display as follows:-

- (a) To manually set the test set to the transmitter frequency, press the [Tx] key (11) and then, either enter the frequency by using the DATA keys (24) and (26), or use the VARIABLE control (33) to adjust the frequency setting.
- (b) Enter the type of modulation by using the *[mod type]* soft key.

- (c) To select an AF generator, press the [AF GEN] key (15). On the display, AF1, AF2 or AF3 in inverse video shows which of the generators has been selected. To select another generator, press the [1], [2] or [3] key (24) or press the *[display gen]* key repeatedly. (If the wide range AF generator has been enabled, AF4 will be shown in inverse video. See *User options; 100 kHz audio or modulation generator* on page 3-138).

Enter the frequency and level by using the [FREQ] key (16), the [LEVEL] key (17) and the DATA keys (24) and (26). Alternatively, adjust the frequency and level by using the VARIABLE control (33).

The output from AF generator 2 is sequential tones when this has been selected on the TONES menu. See under *Signalling codes testing* on page 3-99. To enable or disable each AF generator, press the appropriate *[gen on OFF]* (or *[tones on OFF]*) soft key. *[tones on OFF]* is shown instead of *[gen 2 on OFF]* when sequential tones has been selected on the TONES menu.

- (d) To enter an increment for Tx frequency or AF frequency, press the [Tx] key (11) or [AF GEN] key (15), the [FREQ] key (16) and then the [INC] key (20). Enter the increment by using the DATA keys (24) and (26). Δ appears alongside the active increment. To increase or decrease the frequency setting, press the appropriate [INC] key (32). Only a single frequency increment can be active. Entering one for Tx disables one for AF and vice versa.
- (e) To enter an increment for AF level, press the [AF GEN] key (15), the [FREQ] key (16) and then the [INC] key (20). Enter the increment by using the DATA keys (24) and (26). δ appears alongside the active increment. To increase or decrease the level setting, press the appropriate [INC] key (32).
- (f) To select distortion or signal-to-noise measurement, use the *[dist on OFF]* and *[S/N on OFF]* soft keys.

Transmitter distortion and signal-to-noise are measured within the bandwidth of the display's FILTER value as set by the *[Tx filter]* soft keys.

The distortion of the demodulated transmitter is measured at a modulating frequency which is factory preset to 1 kHz. The distortion measurement frequency can be reset using the HELP AND SET-UP mode to either a user-defined frequency or to the frequency of GEN 1. Distortion, SINAD or S/N tests cannot be carried out while AF GEN 4 or MOD GEN 4 is enabled.

To change the frequency of measurement, use the key sequence [HELP SET-UP], [SET-UP], [TEST OPTIONS] and *[sinad & distn]*. For further information, refer to the section *Help and setting up* on page 3-124.

- (g) To select a filter, use the *[band pass]* and *[low pass]* soft keys.

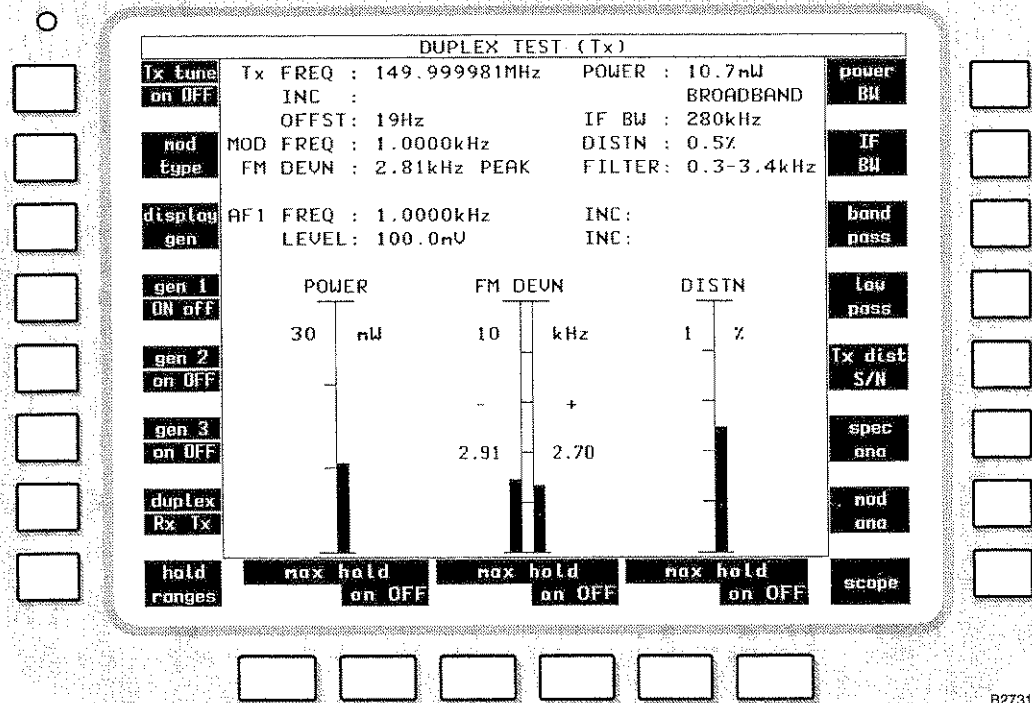

Fig. 3-15 DUPLEX TEST (Tx) display with bar charts

Read off the measurements that are shown on the display in numerical form and as bar charts (using the [bar charts] soft key), oscilloscope display (using the [scope] soft key), spectrum analyzer display (using the [spec ana] soft key) and modulation analyzer (using the [mod ana] soft key).

For the oscilloscope, spectrum analyzer and modulation analyzer displays, set parameters by using the soft keys as below.

For the spectrum analyzer display, set the reference frequency. Use the [REF] key (11) and then enter the frequency.

When the 2965 tunes automatically, it also selects the optimum spectrum analyzer reference level and the input attenuator. This sets the level to the modulation analyzer and to the selective power meter. With manual tuning at low levels, it is necessary to set these manually to achieve optimum accuracy. On the DUPLEX TEST (Tx) SPECTRUM ANALYZER display, set the REF LEVEL so that the signal peak is within the top two graticule divisions.

Display

The following settings and measurements are shown:-

- Tx FREQ and INC. The frequency measurement of the transmitter's output. Alternatively, the transmitter's frequency which has been entered manually and any increment. Δ appears alongside when the increment is active.
- OFFST. The difference between the frequency measurement of the transmitter's output and the transmitter frequency which has been entered manually.
- POWER. The power measurement of the transmitter's output. According to which has been selected by using the [power BW] soft key, BROADBAND is shown or IN BAND is shown in inverse video.
- IF BW. The bandwidth for the transmitter power measurement as selected by using the [IF BW] soft key.

- (e) MOD FREQ and FM DEVN, AM DEPTH or Φ M DEVN. The modulation frequency and deviation or depth measurements of the transmitter's output.
- (f) DISTN or S/N. When one of these is enabled, the distortion or signal-to-noise measurement of the demodulated signal from the transmitter's output.
- (g) FILTER. The filter for the demodulated signal from the transmitter's output as selected by using the *[band pass]* and *[low pass]* soft keys.
- (h) AF1, AF2, AF3 or AF4 FREQ, INC, LEVEL and INC. The settings one of the AF generators as selected by using the [1], [2] or [3] key (24) after the [AF GEN] key (15) or using the *[display gen]* soft key. If the wide range AF generator is enabled, the parameters of this are shown. AF2 is not shown when sequential tones has been selected on the TONES menu. When AF1, AF2, AF3 or AF4 is shown in inverse video, the [FREQ] key (16) or the [LEVEL] key (17) can then be used. Δ (for frequency) and δ (for level) appear alongside when the increments are active.

Bar charts

When the *[bar charts]* soft key is used, the following measurements are shown:-

- (a) POWER. The measurement of the transmitter's output. For two-port duplex, this is through the RF N-type socket (35). According to which has been selected by using the *[power BW]* soft key, BROADBAND is shown or IN BAND is shown in inverse video.
- (b) FM DEVN, AM DEPTH or Φ M DEVN. The modulation deviation or depth measurement of the transmitter's output.
- (c) DISTN or S/N. When one of these is enabled, the distortion or signal-to-noise measurement of the demodulated signal from the transmitter.

The bar charts are auto-ranging except when the *[hold ranges]* soft key is used. The range designators are then shown in inverse video.

Maximum hold

The soft keys beneath the bar charts allow each measurement presentation to indicate actual levels or maximum levels.

With *[max hold ON]* selected, the bar chart and the digital readouts of it, will track any rise in the measured level but will not track downward movement. Pressing the *[reset]* key will cause the current level to be displayed before reapplying the maximum hold function. An H is displayed at the lower right of bar charts that are in the Maximum Hold mode.

With *[max hold OFF]* selected, the bar chart and the associated digital readouts, will track any change in the measured level.

Modulation level

The modulation level bar chart is a dual display, showing the positive modulation level on the right and negative modulation level on the left. A digital reading of the indicated level is shown at the side of each bar chart.

The digital reading of modulation level show in the top half of the display, as FM DEVN, AM DEPTH or FM DEVN, is the average of the positive and negative readings.

Oscilloscope

When the *[scope]* soft key is used, the graticule and trace show the levels of the demodulated signal from the transmitter's output through the RF N-type socket (35) (or RF TNC socket (36) if preferred for <1 W).

Spectrum analyzer

When the *[spec ana]* soft key is used, the graticule and trace show the spectrum of the transmitter's output through the RF N-type socket (35) (or RF TNC socket (36) if preferred for <1 W).

At the bottom of the display, the REF FREQ setting is shown.

Modulation analyzer

When the *[mod ana]* soft key is used, the graticule and trace show the spectrum of the demodulated signal from the transmitter's output through the RF N-type socket (35) (or RF TNC socket (36) if preferred for <1 W).

At the bottom of the display, the REF FREQ setting is shown.

Soft keys at left side of screen

Eight keys are shown at the left side of the screen, (unless the wide range AF generator/modulation generator has been enabled). The eight keys are:-

- (a) *[Tx tune ON off]* key. To disable automatic tuning or to return to automatic tuning after a transmitter frequency has been set manually.
- (b) *[mod type]* key. To select the type of modulation of the transmitter's output. The options are FM DEVN, AM DEPTH and Φ M DEVN.
- (c) *[display gen]* key. To select the AF generator before or after using the [AF GEN] key (15). Press the key repeatedly to step through 1,2 and 3. AF2 is not available when sequential tones has been selected on the TONES menu. The frequency and level are shown for the selected generator. When the [AF GEN] key is used, AF1, AF2 or AF3 appear in inverse video. The [FREQ] key (16) or the [LEVEL] key (17) can then be used.
- (d) *[gen 1 on OFF]*, *[gen 2 on OFF]* (or *[tones on OFF]*) and *[gen 3 on OFF]* keys. To enable or disable the AF generators. *[tones on OFF]* is shown instead of *[gen 2 on OFF]* when sequential tones has been selected on the tones menu.
- (e) *[duplex Rx Tx]* key. To change to the DUPLEX TEST (Rx) display.
- (f) *[hold ranges]*, *[auto range]* or *[expand on OFF]* key. The key changes according to the previous selection. When the *[bar charts]* soft key has been used, to disable or enable auto-ranging. When auto-ranging is disabled, pairs of the soft keys at the bottom of the screen become *[range down]* and *[range up]* and the range designators are shown in inverse video. When the *[spec ana]* soft key has been used, to select the DUPLEX TEST (Tx) SPECTRUM ANALYZER expanded display. When the *[mod ana]* soft key has been used, to select the DUPLEX TEST (Tx) MOD ANALYZER expanded display. When the *[scope]* soft key has been used, to select the DUPLEX TEST (Tx) SCOPE expanded display.

When the wide range AF generator/modulation generator has been selected, only six soft keys are shown at the left of the screen. These six keys are:-

- (a) *[Tx tune ON off]* key. As above.
- (b) *[mod type]* key. As above.
- (c) *[afgens 1 to 3]* key. Pressing this key will cause the message ARE YOU SURE?. Press key again to continue. Press any other key to cancel to be displayed.

If the key is pressed again, the wide range AF generator/modulation generator will be disabled and modulation generators 1 to 3, and AF generators 1 to 3 will be enabled. The wide range AF generator/modulation generator can only be enabled again through the HELP AND SET-UP menus.

- (d) *[gen 4 ON off]* key. Repeatedly pressing this key will alternately turn the wide range AF generator on and off. If the wide range MODULATION generator is in the ON condition, pressing this key will turn it off, and turn the wide range AF generator on. But pressing this key to turn the wide range AF generator off will not turn the wide range modulation generator on.

- (e) *[duplex Rx Tx]* key. As above.
- (f) *[hold ranges]*, *[auto range]* or *[expand on OFF]* key. As above.

Soft keys at right side of screen

Eight keys are shown, as follows:-





- (a) *[power BW]* key. To select the bandwidth for transmitter power measurements. The options are BROADBAND and IN BAND (shown in inverse video). BROADBAND means power within the total bandwidth of the instrument. IN BAND means power at the displayed frequency within the bandwidth which has been selected by using the *[IF BW]* soft key.
- (b) *[IF BW]* key. To select the bandwidth for transmitter power measurements. Values of 300 Hz, 1 kHz, 3 kHz, 10 kHz, 30 kHz, 110 kHz, 280 kHz and 3 MHz are available. Press the soft key repeatedly until the required value is shown on the display.
- (c) *[band pass]* key. To select a band-pass filter for the demodulated signal from the transmitter's output through the RF N-type socket (35). The options are 0.3 to 3.4 kHz and CCITT (or CMESS; see below). 0.3 to 3.4 kHz is automatically selected when distortion or SINAD testing is enabled. This cancels a previous selection using the *[low pass]* key. CCITT or CMESS is set by using the key sequence [HELP SET-UP], *[SET-UP]*, *[TEST OPTIONS]*, *[filter options]* and *[Psoph Filter]*. See under *Test options* on page 3-128.
- (d) *[low pass]* key. To select a low-pass filter for the demodulated signal from the transmitter's output. The options are 20 kHz LP, 5 kHz LP and 300 Hz LP. This cancels a previous selection using the *[band pass]* key.
- (e) *[Tx dist S/N]* key. To select between distortion and S/N measurement (or none) of the demodulated signal from the transmitter's output. When appropriate, a distortion or S/N bar chart appears.
- (f) *[bar charts]*, *[spec ana]*, *[mod ana]* and *[scope]* keys. To select a bar chart, spectrum analyzer, modulation analyzer or oscilloscope display. The three keys change according to the current selection.

Soft keys at bottom of screen





When the bar charts display has been selected and the *[hold ranges]* soft key is used, two keys are shown below each bar chart as follows:-

- (a) *[range up]* key. To increase the range of the bar chart.
- (b) *[range down]* key. To decrease the range of the bar chart.

When the oscilloscope display has been selected, three pairs of keys are shown, as follows:-

- (a)  and  keys. To increase and decrease, respectively, the level/division of vertical range which is shown.
- (b)  and  keys. To increase and decrease, respectively, the time/division of horizontal range which is shown.
- (c) *[single REPEAT]* keys. To initiate a single scan.

When the spectrum analyzer or modulation analyzer display has been selected, each pair of keys is as follows:-

- (a) Ref level  and  keys. To increase and decrease, respectively, the level/division of vertical range which is shown.
- (b)  and  keys. To increase and decrease, respectively, the frequency/division of horizontal range which is shown.
- (c) *[single REPEAT]* keys. To initiate a single scan.

Duplex transmitter testing - expanded

Oscilloscope

Connections

As under *Full duplex testing* on page 3-47.

Procedure

Press the [DUPLEX TEST] key (5). One of the DUPLEX TEST displays appears (whichever was last selected). If an expanded display has appeared, press the [DUPLEX TEST] key again. The DUPLEX TEST display appears (Fig. 3-14 on page 3-48).

Press one of the [*duplex test (Tx)*] soft keys or, if the DUPLEX TEST (Rx) display appeared, press the [*duplex Rx Tx*] soft key. The DUPLEX TEST (Tx) display appears. See Fig. 3-15 on page 3-53.

Proceed as under *Transmitter testing - expanded* on page 3-25.

Display

As under *Transmitter testing - expanded* on page 3-25 except for the heading.

Spectrum analyzer

Connections

As under *Full duplex testing* on page 3-47.

Procedure

Press the [DUPLEX TEST] key (5). One of the DUPLEX TEST displays appears (whichever was last selected). If an expanded display has appeared, press the [DUPLEX TEST] key again. The DUPLEX TEST display appears (Fig. 3-14 on page 3-48).

Press one of the [*duplex test (Tx)*] soft keys or, if the DUPLEX TEST (Rx) display appeared, press the [*duplex Rx Tx*] soft key. The DUPLEX TEST (Tx) display appears. See Fig. 3-15.

Proceed as under *Transmitter testing - expanded* on page 3-25.

Display

As under *Transmitter testing - expanded* on page 3-25 except for the heading.

Modulation analyzer

Connections

As under *Full duplex testing* on page 3-47.

Procedure

Press the [DUPLEX TEST] key (5). One of the DUPLEX TEST displays appears (whichever was last selected). If an expanded display has appeared, press the [DUPLEX TEST] key again. The DUPLEX TEST display appears (Fig. 3-14 on page 3-48).

Press one of the [*duplex test (Tx)*] soft keys or, if the DUPLEX TEST (Rx) display appeared, press the [*duplex Rx Tx*] soft key. The DUPLEX TEST (Tx) display appears. See Fig. 3-15.

Proceed as under *Transmitter testing - expanded* on page 3-25.

Display

As under *Transmitter testing - expanded* on page 3-25 except for the heading.

Duplex receiver testing

Connections

As under *Full duplex testing* on page 3-47.

Procedure

Press the [DUPLEX TEST] key (5). One of the DUPLEX TEST displays appears (whichever was last selected). If an expanded display has appeared, press the [DUPLEX TEST] key again. The DUPLEX TEST display appears (Fig. 3-14 on page 3-48).

Press one of the [*duplex test (Rx)*] soft keys or, if the DUPLEX TEST (Tx) display appeared, press the [*duplex Rx Tx*] soft key. The DUPLEX TEST (Rx) display appears. See Fig. 3-16.

As required, enter suitable selections and settings as follows:-

- (a) Select the RF generator by using the [RF GEN] key (12) and then enter the frequency and level by using the [FREQ] key (16), the [LEVEL] key (17) and the DATA keys (24) and (26). Alternatively, adjust the frequency and level by using the VARIABLE control (33). To enable or disable the RF generator, press the [*RF gen on OFF*] soft key.
- (b) To select a modulation generator, press the [MOD GEN] key (14). On the display, MOD 1, MOD 2, MOD 3 or MOD X (for external) in inverse video shows which of the generators has been selected. To select another generator, press the [1], [2] or [3] key (24) or press the [*display gen*] key repeatedly. (If the wide range modulation generator has been enabled, MOD4 will be shown in inverse video. See *User options; 100 kHz audio or modulation generator* on page 3-138). Enter the frequency and deviation or depth by using the [FREQ] key (16), the [DEVN DEPTH] key (19) and the DATA keys (24) and (26). Alternatively, adjust the frequency and deviation or depth by using the VARIABLE control (33). The output from modulation generator 2 is sequential tones when this has been selected on the TONES menu. The output from modulation generator 3 is CTCSS when this has been selected on the TONES menu. See under *Signalling codes testing* on page 3-99. To enable or disable each modulation generator, press the appropriate [*mod on OFF*] (or [*tones on OFF*] or [*CTCSS on OFF*]) soft key. [*tones on OFF*] is shown instead of [*gen 2 on OFF*] when sequential tones has been selected on the TONES menu. [*CTCSS on OFF*] is shown instead of [*gen 3 on OFF*] when CTCSS has been selected on the TONES menu.
- (c) To enter an increment for RF frequency or modulation frequency, press the [RF GEN] key (12) or [MOD GEN] key (14), the [FREQ] key (16) and then the [INC] key (20). Enter the increment by using the DATA keys (24) and (26). Δ appears alongside the active increment. To increase or decrease the frequency setting, press the appropriate [INC] key (32). Only a single frequency increment can be active. Entering an increment for RF disables an increment previously set for modulation and vice versa. When a second typed increment has been entered and then the first is reselected, its increment re-appears. To activate this increment without changing its value, press the [ENTER] or any unit key (26).
- (d) To enter an increment for RF level or modulation deviation or depth, press the [RF GEN] key (12) and [LEVEL] key (17) or the [MOD GEN] key (14) and [DEVN DEPTH] key (19) and then the [INC] key (20). Enter the increment by using the DATA keys (24) and (26). δ appears alongside the active increment. To increase or decrease the level or deviation or depth setting, press the appropriate [INC] key (32). Only a single level or deviation or depth increment can be active. Entering an increment for RF disables an increment for modulation and vice versa. When a second increment has been entered and then the first is reselected, its increment re-appears. To activate this increment without changing its value, press the [ENTER] or any unit key (26).

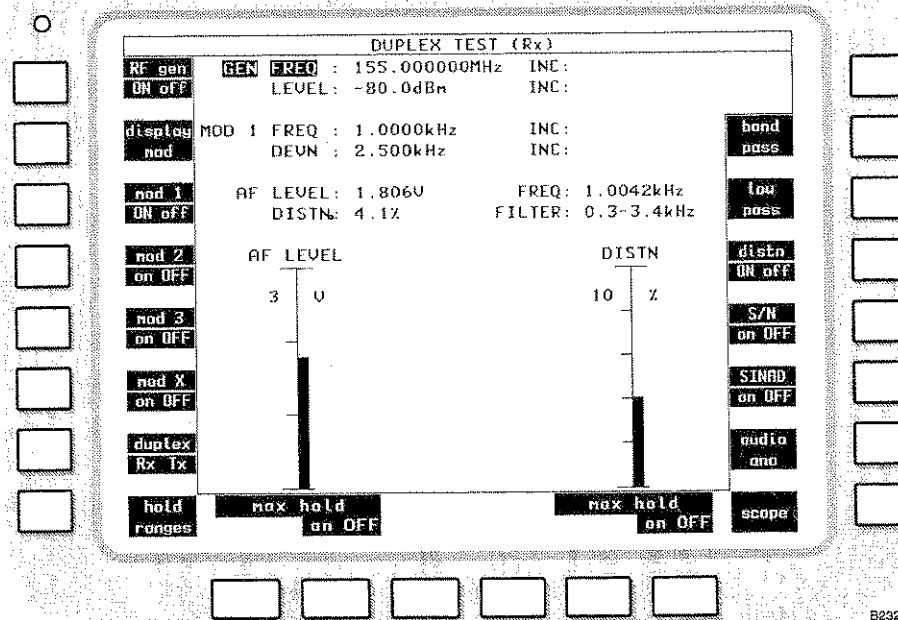

Fig. 3-16 DUPLEX TEST (Rx) display with bar charts

- (e) To select distortion, signal-to-noise or SINAD measurement, use the [distn on OFF], [S/N on OFF] and [SINAD on OFF] soft keys.

The signal-to-noise distortion and SINAD are measured within the bandwidth of the display's FILTER value as set by the [band pass] and [low pass] soft keys.

The distortion and SINAD of the unit under test are measured at an audio frequency that is factory preset to 1 kHz. The measurement frequency can be reset using the HELP AND SET-UP mode to either a user-defined frequency or to the frequency of GEN 1. Distortion, SINAD or S/N tests cannot be carried out while MOD GEN 4 or AF GEN 4 is enabled.

To change the frequency of measurement, use the key sequence [HELP SET-UP], [SET-UP], [TEST OPTIONS] and [sinad & distn]. For further information, refer to the section *Help and setting up* on page 3-124.

- (f) To select a filter, use the [band pass] and [low pass] soft keys.

Read off the measurements that are shown on the display in numerical form and as bar charts (using the [bar charts] soft key), oscilloscope display (using the [scope] soft key) or audio analyzer display (using the [audio ana] soft key).

For the oscilloscope and audio analyzer displays, set parameters by using the soft keys as shown on the previous page.

Display

The following settings and measurements are shown:-

- GEN FREQ, INC, LEVEL and INC. The settings of the RF generator. Δ (for frequency) and δ (for level) appear alongside when the increments are active.
- MOD1, MOD2, MOD3, MOD4 or MOD X, FREQ, INC, DEVN (or DEPTH) and INC. The settings of one of the modulation generators as selected by using the [1], [2] or [3] key (24) after the [MOD GEN] key (14) or using the [display gen] soft key. If the wide range modulation generator is enabled, the parameters of this are shown. MOD 2 is not shown when sequential tones has been selected on the TONES menu. CTCSS is shown instead of MOD 3 when this has been selected on the TONES menu.

When MOD1, MOD2, MOD3 or MOD4 is shown in inverse video, the [FREQ] key (16) or the [DEVN DEPTH] key (19) can then be used. Δ (for frequency) and δ (for deviation or depth) appear alongside when the increments are active.

- (c) AF FREQ and LEVEL. The frequency and level measurements of the receiver's demodulated output through the AF INPUT socket (38).
- (d) DISTN, S/N or SINAD. When one of these is enabled, the distortion, signal-to-noise or SINAD measurement of the receiver's demodulated output.
- (e) FILTER. The filter for the demodulated output through the AF INPUT socket (38) as selected by using the *[band pass]* and *[low pass]* soft keys.

Bar charts

When the *[bar charts]* soft key is used, the following measurements are shown:-

- (a) AF LEVEL. The measurement of the receiver's demodulated output through the AF INPUT socket (38).
- (b) DISTN, S/N or SINAD. When one of these is enabled, the distortion, signal-to-noise or SINAD measurement of the receiver's demodulated output.

The bar charts are auto-ranging except when the *[hold ranges]* soft key is used. The range designators are then shown in inverse video.

Maximum hold

The soft keys beneath the bar charts allow each measurement presentation to indicate actual levels or maximum levels.

With *[max hold ON]* selected, the bar chart and the digital readouts of it, will track any rise in the measured level but will not track downward movement. Pressing the *[reset]* key will cause the current level to be displayed before reapplying the maximum hold function. An H is displayed at the lower right of bar charts that are in the Maximum Hold mode.

Oscilloscope

When the *[scope]* soft key is used, the graticule and trace show the level of the receiver's demodulated output through the AF INPUT socket (38).

Audio analyzer

When the *[audio ana]* soft key is used, the graticule and trace show the spectrum of the receiver's demodulated output through the AF INPUT socket (38).

At the bottom of the display, the REF FREQ setting is shown, corresponding to the frequency at the vertical dotted line in the centre of the display.

Soft keys at left side of screen

Eight keys are shown at the left side of the screen, (unless the wide range AF generator/modulation generator has been enabled). The eight keys are:-

- (a) *[RF gen on OFF]* key. To enable or disable the RF generator. For two-port duplex, the output is through the RF TNC socket (36) to the receiver under test.
- (b) *[display mod]* key. To select the modulation generator before or after using the [MOD GEN] key (14). Press the key repeatedly to step through 1,2, 3 and X (for external). MOD 2 is not available when sequential tones has been selected on the TONES menu. MOD 2 is not available when sequential tones has been selected on the TONES menu. MOD 3 is not available when CTCSS has been selected on the TONES menu. The frequency and deviation or depth are shown for the selected generator. When the [MOD GEN] key is used, MOD1, MOD2 or MOD3 appear in inverse video. The [FREQ] key (16) or the [DEVN DEPTH] key (19) can then be used.

- (c) [*mod 1 on OFF*], [*mod 2 on OFF*] (or [*tones on OFF*]), [*mod 3 on OFF*] (or [*CTCSS on OFF*]) and [*mod X on OFF*] keys. To enable or disable the RF generators. [*tones on OFF*] is shown instead of [*mod 2 on OFF*] when sequential tones has been selected on the TONES menu. [*CTCSS on OFF*] is shown instead of [*mod 3 on OFF*] when CTCSS has been selected on the tones menu.
- (d) [*duplex Rx Tx*] key. To change to the DUPLEX TEST (Tx) display.
- (e) [*hold ranges*], [*auto range*] or [*expand on OFF*] key. The key changes according to the previous selection; when the [*bar charts*] soft key has been used, to disable or enable auto-ranging; when auto-ranging is disabled, pairs of the soft keys at the bottom of the screen become [*range down*] and [*range up*] and the range designators are shown in inverse video; when the [*audio ana*] soft key has been used, to select the DUPLEX TEST (Rx) AUDIO ANALYZER expanded display; when the [*scope*] soft key has been used, to select the DUPLEX TEST (Rx) SCOPE expanded display.

When the wide range AF generator/modulation generator has been selected, only five soft keys are shown at the left of the screen. These five keys are:-

- (a) [*RF gen ON off*] key. As above.
- (b) [*mod gen 1 to 3*] key. Pressing this key will cause the message ARE YOU SURE?. Press key again to continue. Press any other key to cancel to be displayed.

If the key is pressed again, the wide range AF generator/modulation generator will be disabled and modulation generators 1 to 3, and AF generators 1 to 3 will be enabled. The wide range AF generator/modulation generator can only be enabled again through the HELP AND SET-UP menus.

- (c) [*mod 4 on OFF*] key. Repeatedly pressing this key will alternately turn the wide range modulation generator on and off. If the wide range AF generator is in the ON condition, pressing this key will turn it off, and turn the wide range modulation generator on. But pressing this key to turn the wide range modulation generator off will not turn the wide range AF generator on.
- (d) [*duplex Rx Tx*] key. As above.
- (e) [*hold ranges*], [*auto range*] or [*expand on OFF*] key. As above.

Soft keys at right side of screen

Seven keys are shown, as follows:-

- (a) [*band pass*] key. To select a band-pass filter for the receiver's demodulated output through the AF INPUT socket (38). The options are 0.3 to 3.4 kHz and CCITT (or CMESS; see below). 0.3 to 3.4 kHz is automatically selected when distortion or SINAD testing is enabled. This cancels a previous selection using the [*low pass*] key. CCITT or CMESS is set using the key sequence [HELP SET-UP], [SET-UP], [TEST OPTIONS], [*filter options*] and [*Psoph Filter*]. See under *Test options* on page 3-128.
- (b) [*low pass*] key. To select a low-pass filter for the receiver's demodulated output. The options are 20 kHz LP, 300 Hz LP, and NONE. This cancels a previous selection using the [*band pass*] key.
- (c) [*dist on OFF*] key. To enable or disable distortion measurement of the receiver's demodulated output. When appropriate, DISTN and a bar chart appear. [*dist ON off*] cancels a previous selection of [*S/N ON off*] or [*SINAD ON off*].
- (d) [*S/N on OFF*] key. To enable or disable signal-to-noise measurement of the receiver's demodulated output. When appropriate, S/N and a bar chart appear. [*S/N ON off*] cancels a previous selection of [*dist ON off*] or [*SINAD ON off*].
- (e) [*SINAD on OFF*] key. To enable or disable SINAD measurement of the receiver's demodulated output. When appropriate, SINAD and a bar chart appear. [*SINAD ON off*] cancels a previous selection of [*dist ON off*] or [*S/N ON off*].





- (f) *[bar charts]*, *[audio ana]* and *[scope]* keys. To select a bar chart, audio analyzer or oscilloscope display. The two keys change according to the current selection.

Soft keys at bottom of screen





When the bar charts display has been selected and the *[hold ranges]* soft key is used, two keys are shown below each bar chart as follows:-

- (a) *[range down]* key. To increase the sensitivity.
- (b) *[range up]* key. To decrease the sensitivity.

When the oscilloscope display has been selected, three pairs of keys are shown, as follows:-

- (a)  and  keys. To increase and decrease respectively, the level/division of vertical range which is shown.
- (b)  and  keys. To increase and decrease, respectively, the time/division of horizontal range which is shown.
- (c) *[single REPEAT]* keys. To initiate a single scan.

When the audio analyzer display has been selected, three pairs of keys are shown, as follows:-

- (a) Ref level  and  keys. To increase and decrease, respectively, the scaling of vertical range which is shown.
- (b)  and  keys. To increase and decrease, respectively, the frequency/division of horizontal range which is shown.
- (c) *[single REPEAT]* keys. To initiate a single scan.

Duplex receiver testing - expanded

Oscilloscope

Connections

As under *Full duplex testing* on page 3-47.

Procedure

Press the [DUPLEX TEST] key (5). One of the DUPLEX TEST displays appears (whichever was last selected). If an expanded display has appeared, press the [DUPLEX TEST] key again. The DUPLEX TEST display appears (Fig. 3-14 on page 3-48).

Press one of the *[duplex test (Rx)]* soft keys or, if the DUPLEX TEST (Tx) display appeared, press the *[duplex Rx Tx]* soft key. The DUPLEX TEST (Rx) display appears. See Fig. 3-16 on page 3-59.

Proceed as under *Receiver testing - expanded* on page 3-42.

Display

As under *Receiver testing - expanded* on page 3-42 except for the heading.

Audio analyzer

Connections

As under *Full duplex testing* on page 3-47.

Procedure

Press the [DUPLEX TEST] key (5). One of the DUPLEX TEST displays appears (whichever was last selected). If an expanded display has appeared, press the [DUPLEX TEST] key again. The DUPLEX TEST display appears (Fig. 3-14 on page 3-48).

Press one of the [*duplex test (Rx)*] soft keys or, if the DUPLEX TEST (Tx) display appeared, press the [*duplex Rx Tx*] soft key. The DUPLEX TEST (Rx) display appears. See Fig. 3-16.

Proceed as under *Receiver testing - expanded* on page 3-42.

Display

As under *Receiver testing - expanded* on page 3-42 except for the heading.

RF testing

RF input/output testing - non-expanded

Connections

Connect the unit's RF input connector to the RF TNC socket (36) (or RF N-type socket (35) if preferred).

Connect the unit's RF output connector to the RF N-type socket (35) (or RF TNC socket (36) if preferred for <1 W).

Use the [RF SELECT] key (34) accordingly.

WARNING

Hot surface

Take care when touching the RF N-type connector after continuous power input. If 50 W is exceeded, the temperature of the connector becomes excessive.

CAUTION

Input overload

On the RF N-type connector, the input power should not exceed 150 W.
On the RF TNC connector, the input power should not exceed 1 W.

Procedure

Press the [RF TEST] key (8) twice and the RF TEST menu appears. On the RF TEST menu two keys are shown, as follows:-

- (a) [RF IN/OUT]. To select the RF INPUT/OUTPUT TEST display.
- (b) [SSB]. To select the SSB TRANSMITTER TEST display.

Press the [RF IN/OUT] soft key. The RF INPUT/OUTPUT TEST display appears. See Fig. 3-17 on page 3-65.

In its factory default condition, the 2965 tunes automatically to the strongest frequency component at the RF N-type socket (provided it is >+10 dBm) or TNC socket (provided it is >-10 dBm). Alternatively, the transmitter can be manually tuned to indicate frequency offset.

As required, enter suitable selections and settings, as shown on the display, as follows:-

- (a) Select the RF generator by using the [RF GEN] key (12) and then enter the frequency and level by using the [FREQ] key (16), the [LEVEL] key (17) and the DATA keys (24) and (26). Alternatively, adjust the frequency and level by using the VARIABLE control (33). Instead, the [Rx=Tx FREQ] key (13) can be used in the Tx TEST mode. To enable or disable the RF generator, press the [RF gen on OFF] soft key.

- (b) To select a modulation generator, press the [MOD GEN] key (14). On the display, MOD 1, MOD 2, MOD 3 or MOD X (for external) in inverse video shows which of the generators has been selected. To select another generator, press the [1], [2] or [3] key (24) or press the [display gen] key repeatedly. (If the wide range AF generator has been enabled, AF4 will be shown in inverse video. See *User options; 100 kHz audio or modulation generator* on page 3-138). Enter the frequency and deviation or depth by using the [FREQ] key (16), the [DEVN DEPTH] key (19) and the DATA keys (24) and (26). Alternatively, adjust the frequency and deviation or depth by using the VARIABLE control (33). The output from modulation generator 2 is sequential tones when this has been selected on the TONES menu. The output from modulation generator 3 is CTCSS when this has been selected on the TONES menu. See under *Signalling codes testing* on page 3-99. To enable or disable each modulation generator, press the appropriate [mod on OFF] (or [tones on OFF] or [CTCSS on OFF]) soft key. [tones on OFF] is shown instead of [mod 2 on OFF] when sequential tones has been selected on the TONES menu. [CTCSS on OFF] is shown instead of [mod 3 on OFF] when CTCSS has been selected on the TONES menu.

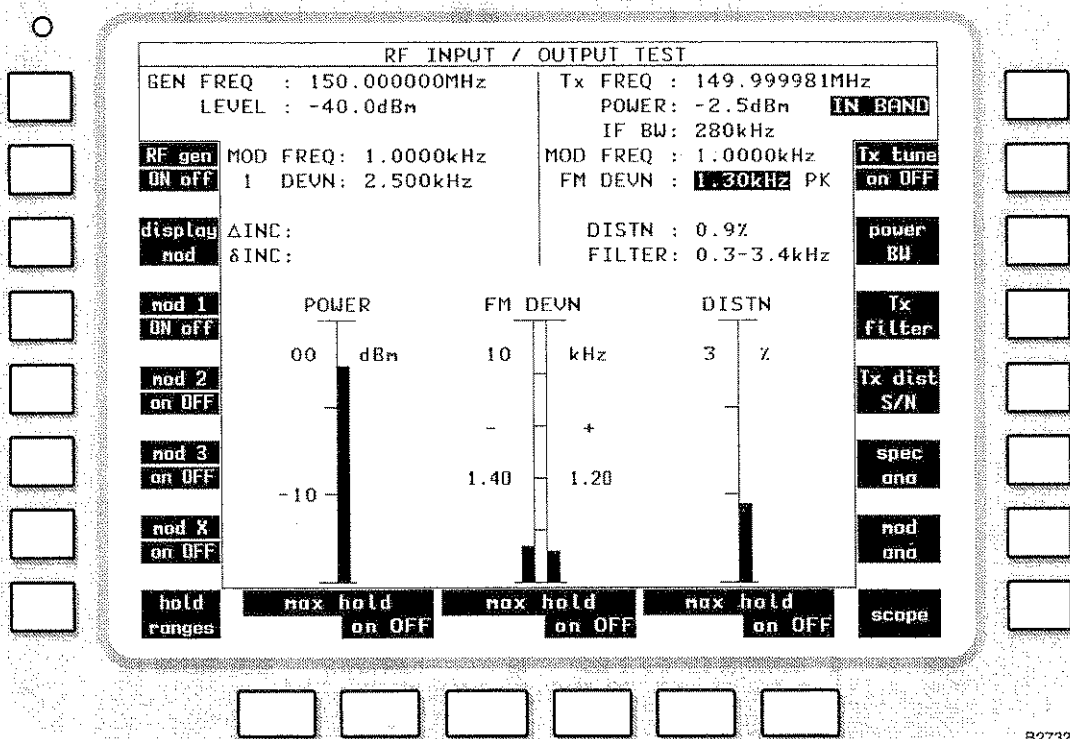

Fig. 3-17 RF INPUT/OUTPUT TEST display with bar charts

- (c) To enter an increment for RF frequency or modulation frequency, press the [RF GEN] key (12) or [MOD GEN] key (14), the [FREQ] key (16) and then the [INC] key (20). Enter the increment by using the DATA keys (24) and (26). Δ appears alongside the active increment. To increase or decrease the frequency setting, press the appropriate [INC] key (32). Only a single frequency increment can be active. Entering one for RF disables one for modulation and vice versa.
- (d) To enter an increment for RF level or modulation deviation or depth, press the [RF GEN] key (12) and [LEVEL] key (17) or the [MOD GEN] key (14) and [DEVN DEPTH] key (19) and then the [INC] key (20). Enter the increment by using the DATA keys (24) and (26). δ appears alongside the appropriate settings. To increase or decrease the frequency, level, deviation or depth setting, press the appropriate [INC] key (32). Only a single level or deviation or depth increment can be active. Entering an increment for RF disables the increment for modulation and vice versa.

- (e) To set the frequency manually, press the [Tx] key (11) and then enter the frequency using the DATA keys (24) and (26). Alternatively, adjust the frequency by using the VARIABLE control (33).
- (f) To select distortion or signal-to-noise measurement, press the [Tx dist S/N] soft key repeatedly.

Transmitter distortion and signal-to-noise are measured within the bandwidth of the display's FILTER value as set by the [Tx filter] soft keys.

The distortion of the demodulated transmitter is measured at a modulating frequency which is factory preset to 1 kHz. The distortion measurement frequency can be reset using the HELP AND SET-UP mode to either a user-defined frequency or to the frequency of GEN 1. Distortion, SINAD or S/N tests cannot be carried out while AF GEN 4 or MOD GEN 4 is enabled.

To change the frequency of measurement, use the key sequence [HELP SET-UP], [SET-UP], [TEST OPTIONS] and [sinad & distn]. For further information, refer to the section *Help and setting up* on page 3-124.

- (g) To select a filter, use the [band pass] or [low pass] soft key.

Read off the measurements that are shown on the display in numerical form and as bar charts (using the [bar charts] soft key), oscilloscope display (using the [scope] soft key), spectrum analyzer display (using the [spec ana] soft key) or modulation analyzer (using the [mod ana] soft key).

For the oscilloscope, and spectrum and modulation analyzer displays, set parameters by using soft keys as below.

For the spectrum analyzer display, set the reference frequency. Use the [REF] key (11) and then enter the frequency.

When the 2965 tunes automatically, it also selects the optimum spectrum analyzer reference level and the input attenuator. This sets the level to the modulation analyzer and to the selective power meter. With manual tuning at low levels, it is necessary to set these manually to achieve optimum accuracy. On the RF TEST SPECTRUM ANALYZER display, set the REF LEVEL so that the signal peak is within the top two graticule divisions.

Display

In the left half of the display, the following settings and measurements for testing the unit's input are shown:-

- (a) GEN FREQ and LEVEL. The settings of the RF generator. This is connected through the RF TNC socket (36) (or RF N-type socket (35) if preferred) to the unit's RF input connector. Δ (for frequency) and δ (for level) appear alongside when the increments are active.
- (b) MOD1, MOD2, MOD3, MOD4 X FREQ and DEVN or DEPTH. The settings of one of the modulation generators is selected by using the [1], [2] or [3] key (24) after the [MOD GEN] key (14) is pressed, or using the [display gen] soft key. If the wide range modulation generator is enabled, the parameters of this are shown. MOD 2 is not shown when sequential tones has been selected on the TONES menu. CTCSS is shown instead of MOD 3 when this has been selected on the TONES menu. When MOD1, MOD2, MOD3 or MOD4 is shown in inverse video, the [FREQ] key (16) or the [DEVN DEPTH] key (19) can then be used. Δ (for frequency) and δ (for deviation or depth) appear alongside when the increments have been set.
- (c) Δ INC and δ INC. The increments of the RF generator's frequency and level or the modulation frequency and deviation or depth. Δ and δ appear alongside the parameters when their increments are active.

In the right half of the display, the following settings and measurements for testing the unit's output are shown:-

- (a) Tx FREQ and POWER. The frequency and power measurements of the unit's output. When IN BAND has been selected by using the *[power BW]* soft key, this is shown in inverse video.
- (b) IF BW. The bandwidth for the unit's output power measurement as selected by using the *[IF BW]* soft key in the TRANSMITTER TEST or DUPLEX TEST (Tx) display.
- (c) MOD FREQ and FM DEVN, AM DEPTH or Φ M DEVN. The modulation frequency and deviation or depth measurements of the unit's output. Set the modulation type, using the soft keys on the left side of the screen, to be the same as that to be measured.
- (d) DISTN or S/N. The distortion or signal-to-noise measurement of the demodulated signal from the unit's output as selected by using the *[Tx dist S/N]* soft key.
- (e) FILTER. The filter for the demodulated signal from the unit's output as selected by using the *[Tx filter]* soft key.

Bar charts

When the *[bar charts]* soft key is used, the following measurements are shown:-

- (a) POWER. The measurement of the unit's output.
- (b) FM DEVN, AM DEPTH or Φ M DEVN. The modulation deviation or depth measurement of the unit's output.
- (c) DISTN or S/N. When one of these is enabled, the distortion or signal-to-noise measurement of the demodulated output.

The bar charts are auto-ranging except when the *[hold ranges]* soft key is used. The range designators are then shown in inverse video.

Oscilloscope

When the *[scope]* soft key is used, the graticule and trace show the levels of the demodulated signal from the equipment's output through the RF N-type socket (35) (or RF TNC socket (36) if preferred for <1 W).

Spectrum analyzer

When the *[spec ana]* soft key is used, the graticule and trace show the spectrum of the unit's output through the RF N-type socket (35) (or RF TNC socket (36) if preferred for <1 W).

At the bottom of the display, the REF FREQ setting is shown.

Modulation analyzer

When the *[mod ana]* soft key has been used, the graticule and trace show the spectrum of the unit's demodulated output.

At the bottom of the display, the REF FREQ setting is shown, corresponding to the frequency at the central vertical dotted line on the display.

Soft keys at left side of screen

Seven keys are shown at the left side of the screen, (unless the wide range AF generator/modulation generator has been enabled). The seven keys are:-

- (a) *[RF gen on OFF]* key. To enable or disable the RF generator. The output is through the RF TNC socket (36) (or RF N-type socket (35) if preferred) to the unit under test.
- (b) *[display mod]* key. To select the modulation generator before or after using the [MOD GEN] key (14). Press the key repeatedly to step through 1,2,3 and X (for external). MOD 2 is not available when sequential tones has been selected on the TONES menu. MOD 3 is not available when CTCSS has been selected on the TONES menu. The frequency and deviation or depth are shown for the selected generator. When the [MOD GEN] key is used, MOD1, MOD2 or MOD3 appear in inverse video. The [FREQ] key (16) or the [DEVN DEPTH] key (19) can then be used.
- (c) *[mod 1 on OFF]*, *[mod 2 on OFF]* (or *[tones on OFF]*), *[mod 3 on OFF]* (or *[CTCSS on OFF]*) and *[mod X on OFF]* keys. To enable or disable the modulation generators. *[tones on OFF]* is shown instead of *[mod 2 on OFF]* when sequential tones has been selected on the TONES menu. *[CTCSS on OFF]* is shown instead of *[mod 3 on OFF]* when CTCSS has been selected on the tones menu.
- (d) *[hold ranges]*, *[auto range]* or *[expand on OFF]* key. The key changes according to the previous selection. When the *[bar charts]* soft key has been used, press *[hold ranges]* or *[auto range]* respectively to disable or enable auto-ranging. When auto-ranging is disabled, pairs of the soft keys at the bottom of the screen become *[range down]* and *[range up]* and the range designators are shown in inverse video. When the *[spec ana]* soft key has been used, press *[expand on OFF]* to select the RF TEST SPECTRUM ANALYZER expanded display. When the *[mod ana]* soft key has been used, press *[expand on OFF]* to select the RF TEST MOD ANALYZER expanded display. When the *[scope]* soft key has been used, press *[expand on OFF]* to select the RF TEST SCOPE expanded display.

When the wide range AF generator/modulation generator has been selected, only four soft keys are shown at the left of the screen. These four keys are:-

- (a) *[RF gen ON off]* key. As above.
- (b) *[modgens 1 to 3]* key. Pressing this key will cause the message ARE YOU SURE?. Press key again to continue. Press any other key to cancel to be displayed.

If the key is pressed again, the wide range AF generator/modulation generator will be disabled and modulation generators 1 to 3, and AF generators 1 to 3 will be enabled. The wide range AF generator/modulation generator can only be enabled again through the HELP AND SET-UP menus.

- (c) *[mod 4 on OFF]* key. Repeatedly pressing this key will alternately turn the wide range modulation generator on and off. If the wide range AF generator is in the ON condition, pressing this key will turn it off, and turn the wide range modulation generator on. But pressing this key to turn the wide range modulation generator off will not turn the wide range AF generator on.
- (d) *[hold ranges]*, *[auto range]* or *[expand on OFF]* key. As above.

Soft keys at right side of screen

Seven keys are shown, as follows:-

- (a) *[Tx tune ON off]* key. To disable automatic tuning or to return to automatic tuning after a unit's output frequency has been set manually.
- (b) *[power BW]* key. To select the bandwidth for output power measurements. The options are BROADBAND and IN BAND (shown in inverse video). BROADBAND means power within the total bandwidth of the instrument. IN BAND means power at the displayed frequency within the bandwidth which has been selected by using the *[IF BW]* soft key in the TRANSMITTER TEST or DUPLEX TEST (Tx) displays.





- (c) *[Tx filter]* key. To select a filter for the demodulated signal from the unit's output. The options are 0.3 to 3.4 kHz, CCITT (or CMESS; see below), 20 kHz LP, 5 kHz LP and 300 Hz LP. 0.3 to 3.4 kHz is automatically selected when distortion or SINAD testing is enabled. CCITT or CMESS is set by using the key sequence *[HELP SET-UP]*, *[SET-UP]*, *[TEST OPTIONS]*, *[filter options]* and *[Psoph Filter]*. See under *Test options* on page 3-128.
- (d) *[Tx dist S/N]* key. To enable or disable distortion or signal-to-noise measurement of the unit's demodulated output. When appropriate, DISTN or S/N and a bar chart appear.
- (e) *[spec ana]*, *[mod ana]*, *[scope]* and *[bar charts]* keys. To select a spectrum analyzer, modulation analyzer, oscilloscope or bar chart display. The three keys change according to the current selection.

Soft keys at bottom of screen





When the bar charts display has been selected and the *[hold ranges]* soft key is used, two keys are shown below each bar chart as follows:-

- (a) *[range down]* key. To increase the sensitivity.
- (b) *[range up]* key. To decrease the sensitivity.

When the oscilloscope display has been selected, three pairs of keys are shown, as follows:-

- (a)  and  keys. To increase and decrease, respectively, the level/division of vertical range which is shown.
- (b)  and  keys. To increase and decrease, respectively, the time/division of horizontal range which is shown.
- (c) *[single REPEAT]* keys. To initiate a single scan.

When the spectrum analyzer or modulation analyzer display has been selected, three pairs of keys are shown, as follows:-

- (a) Ref level  and  keys. To increase and decrease, respectively, the level, deviation or depth of vertical range which is shown.
- (b)  and  keys. To increase and decrease, respectively, the frequency/division of horizontal range which is shown.
- (c) *[single REPEAT]* keys. To initiate a single scan.

RF input/output testing - expanded

Oscilloscope

Connections

As under *RF input/output testing - non-expanded* on page 3-64.

Procedure

Press the *[RF TEST]* key (8) twice and the RF TEST menu appears. On the RF TEST menu press the *[RF IN/OUT]* soft key. The RF INPUT/OUTPUT TEST display appears. See Fig. 3-17 on page 3-65.

Proceed as under *Transmitter testing - expanded* on page 3-25.

Display

As under *Transmitter testing - expanded* on page 3-25 except for the heading.

Spectrum analyzer

Connections

As under *RF input/output testing - non-expanded* on page 3-64.

Procedure

Press the [RF TEST] key (8) twice and the RF TEST menu appears. On the RF TEST menu press the [RF IN/OUT] soft key. The RF INPUT/OUTPUT TEST display appears. See Fig. 3-17.

Proceed as under *Transmitter testing - expanded* on page 3-25.

To select the tracking generator, press the [track on OFF] key.

For more information about the tracking generator, refer to *Versatile tracking generator* on page 3-138.

Display

As under *Transmitter testing - expanded* on page 3-25 except for the heading and as below:-

- (a) TG MODE The current setting of the tracking generator offset mode is shown on the display.

Soft keys at right side of screen

An extra key is shown as follows:-

[track on OFF] key. To turn the tracking generator signal on or off.

Modulation analyzer

Connections

As under *RF input/output testing - non-expanded* on page 3-64.

Procedure

Press the [RF TEST] key (8) twice and the RF TEST menu appears. On the RF TEST menu press the [RF IN/OUT] soft key. The RF INPUT/OUTPUT TEST display appears. See Fig. 3-17.

Proceed as under *Transmitter testing - expanded* on page 3-25.

Display

As under *Transmitter testing - expanded* on page 3-25 except for the heading.

SSB transmitter testing - non-expanded

Connections

Connect the transmitter's RF output connector to the RF N-type socket (35) (or RF TNC socket (36) if preferred for <1 W). Use the [RF SELECT] key (34) to select the appropriate connector, indicated by the lit indicator.

Connect the transmitter's AF input connector to the AF GEN OUTPUT socket (37).

WARNING

Hot surface

Take care when touching the RF N-type connector after continuous power input. If 50 W is exceeded, the temperature of the connector becomes excessive.

CAUTION**Input overload**

On the RF N-type connector, the input power should not exceed 150 W.
On the RF TNC connector, the input power should not exceed 1 W.

Procedure

Press the [RF TEST] key (8) twice and the RF TEST menu appears. On the RF TEST menu, press the [SSB] soft key. The SSB TRANSMITTER TEST display appears. See Fig. 3-18.

In its factory default condition, the 2965 tunes automatically to the strongest frequency component at the RF N-type socket (provided that it is $> +10$ dBm) or TNC socket (provided that it is > -10 dBm). When the 2965 tunes automatically, it also selects the optimum spectrum analyzer reference level and, as a result, also selects the input attenuator. This sets the level to the sideband and CW analyzer. With manual tuning at low levels, it is necessary to set the spectrum analyzer reference level manually to achieve optimum accuracy. With the spectrum analyser displayed, set the REF LEVEL so that the signal peak is within the top two graticule divisions. The transmitter can be manually tuned to indicate frequency offset.

The SSB TEST operates in one of two modes; sideband mode - lower (LSB) or upper (USB), or carrier wave (CW) mode. In the sideband mode, the audio generator AF1 modulates the transmitter to generate a sideband below or above the frequency of the suppressed carrier. In this mode, the auto-tuned Tx FREQ is the frequency of the suppressed carrier and is calculated from the measured sideband frequency, AF1 FREQ and either LSB or USB, whichever is selected. The spectrum of the demodulated transmitter output is displayed on the sideband analyser and relative amplitudes of the LSB, CW and USB are displayed on the suppression analyser.

The carrier wave mode is provided for measuring unmodulated, unsuppressed transmitters. The Tx FREQ is the frequency of the carrier and is measured directly and independent of AF1 FREQ as in normal transmitter testing. In this mode, the sideband and suppression analyzers are replaced by the CW analyzer, which displays the spectrum of the transmitter.

The sideband and CW analyzers display the demodulated transmitter after internal AGC levelling. Provided that the spectrum analyzer reference level is set correctly, the AGC will maintain the largest signal at the top of the sideband or CW analyzer display. This applies irrespective of the transmitter power. Using AF1 and AF2 simultaneously with a 20 dB difference in level will range the highest signal to the top of the analyzer screen and allow the lower level signal to be varied in frequency to measure the transmitter bandwidth. In the expanded sideband analyzer, pressing the [audio sweep] soft key performs this test automatically.

Enter the required selections and settings on the display as follows:-

- (a) To manually set the test set to the transmitter frequency, press the [Tx] key (11) and then, either enter the frequency by using the DATA keys (24) and (26), or use the VARIABLE control (33) to adjust the frequency setting.
- (b) To select an AF generator, press the [AF GEN] key (15). On the display, AF1 or AF2 in inverse video shows which of the generators has been selected. To select the other generator, press the [1] or [2] key (24) or press the [display gen] soft key repeatedly. Enter the frequency and level by using the [FREQ] key (16), the [LEVEL] key (17) and the DATA keys (24) and (26). Alternatively, adjust the frequency and level by using the VARIABLE control (33).
- (c) To enter an increment for Tx frequency or AF frequency, press the [Tx] key (11) or [AF GEN] key (15), the [FREQ] key (16) and then the [INC] key (20). Enter the increment by using the DATA keys (24) and (26). Δ appears alongside the active increment. To increase or decrease the frequency setting, press the appropriate [INC] key (32). Only a single frequency increment can be active. Entering an increment for Tx disables the increment for AF and vice versa.

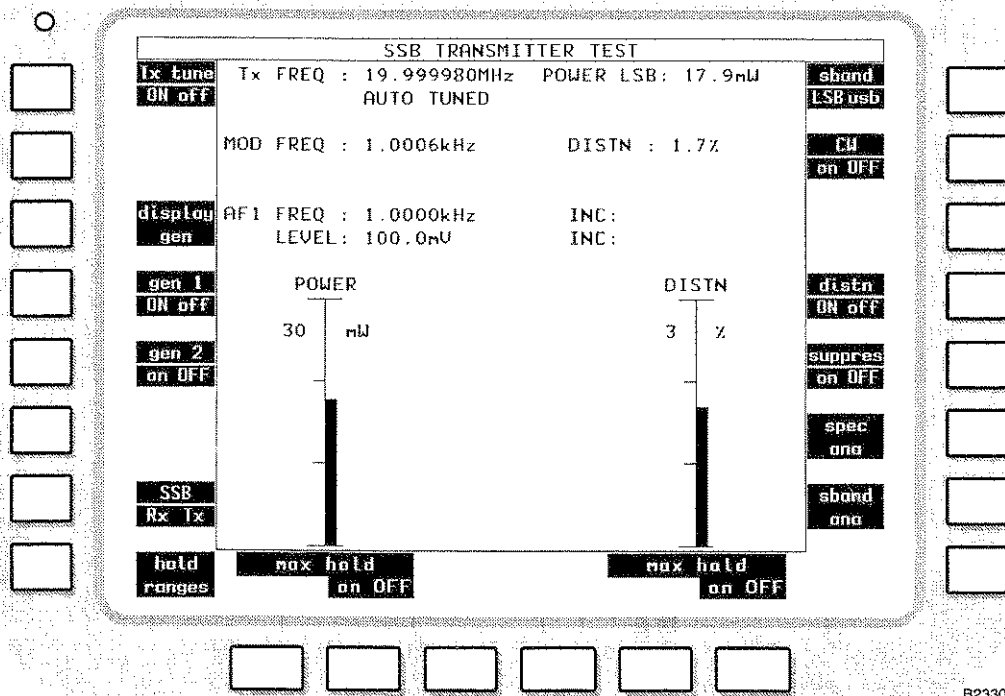

Fig. 3-18 SSB TRANSMITTER TEST display with bar charts

- (d) To enter an increment for AF level, press the [AF GEN] key (15), the [LEVEL] key (17) and then the [INC] key (20). Enter the increment by using the DATA keys (24) and (26). δ appears alongside the active increment. To increase or decrease the level setting, press the appropriate [INC] key (32).
- (e) To select distortion measurement, use the [dist on OFF] soft key.

Transmitter distortion is measured within a 300 Hz to 5 kHz bandwidth.

The distortion of the demodulated transmitter is measured at a modulating frequency which is factory preset to 1 kHz. The distortion measurement frequency can be reset using the HELP AND SET-UP mode to either a user-defined frequency or to the frequency of AF GEN 1.

To change the frequency of measurement, use the key sequence [HELP SET-UP], [SET-UP], [TEST OPTIONS], and [sinad & distn]. For further information, refer to the section *Help and setting up* on page 3-124.

Read off the measurements that are shown on the display in numerical form and as bar charts (using the [bar charts] soft key), spectrum analyzer display (using the [spec ana] soft key), sideband analyzer display (using the [sband ana] soft key), suppression analyzer display (using the [suppres on OFF] soft key) or CW analyzer display (by pressing the [CW on OFF] soft key followed by the [CW ana] soft key).

For the spectrum analyzer, sideband analyzer, suppression analyzer and CW analyzer displays, set parameters by using the soft keys as below.

For the spectrum analyzer display, set the reference frequency. Use the [REF] key (11) and then enter the frequency.

Display

The following settings and measurements are shown:-

- (a) Tx FREQ and INC. The suppressed carrier frequency and increment. The frequency measurement of the transmitter's output through the RF N-type socket (35) (or RF TNC socket (36) if preferred for <1 W) used to calculate the suppressed carrier frequency depending on AF1 FREQ and either LSB or USB, or the measured transmitter frequency in the unmodulated and un-suppressed CW mode, or the transmitter frequency which has been entered manually and any increment. Δ appears alongside when the increment is active.
- (b) OFFST. The difference between the frequency measurement of the transmitter's output and the transmitter frequency which has been entered manually.
- (c) POWER. The power measurement of the transmitter's output.
- (d) MOD FREQ. The modulation frequency measurement of the transmitter's output.
- (e) DISTN. When enabled in LSB or USB mode only, the distortion measurement of the demodulated signal from the transmitter's output.
- (f) AF1 or AF2 FREQUENCY, INC, LEVEL and INC. The settings on one of the AF generators as selected by using the [1] or [2] key (24) after the [AF GEN] key (15) or by using the *[display gen]* soft key. When AF1 or AF2 is shown in inverse video, the [FREQ] key (16) or the [LEVEL] key (17) can then be used. Δ (for frequency) and δ (for level) appear alongside when the increments are active.

Bar charts

When the *[bar charts]* soft key is used, the following measurements are shown:-

- (a) POWER. The measurement of the transmitter's output through the RF N-type socket (35) (or RF TNC socket (36) if preferred for <1 W).
- (b) DISTN. When enabled, the distortion measurement of the demodulated signal from the transmitter's output.

The bar charts are auto-ranging except when the *[hold ranges]* soft key is used. The range designators are then shown in inverse video.

Suppression analyzer

When the *[suppres on OFF]* soft key is used, three bar charts are displayed which show the relative amplitudes of the signals at the LSB, CW and USB frequency. Press the *[sband lsb USB]* soft key and select the same mode as the transmitter under test. This assigns the broad-band power reading to the selected sideband and measures the other two relative to it. See Fig 3-19.

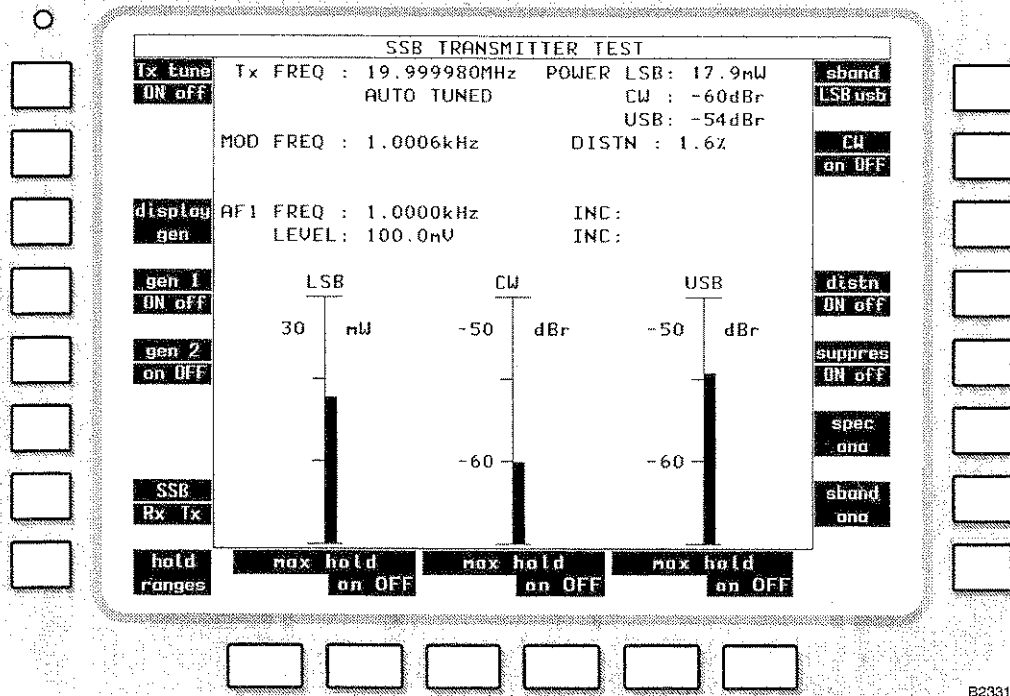

Fig. 3-19 SSB TRANSMITTER TEST display with suppression analyzer

Spectrum analyzer

When the *[spec ana]* soft key is used, the graticule and trace show the spectrum of the transmitter's output through the RF N-type socket (35) (or RF TNC socket (36) if preferred for <1 W).

At the bottom of the display, the REF FREQ setting is shown, which corresponds to the central vertical dotted line on the graticule.

Sideband analyzer

When the *[sband ana]* soft key is used, the graticule and trace show the spectrum of the demodulated signal from the transmitter's output through the RF N-type socket (35) (or RF TNC socket (36) if preferred for <1 W).

At the bottom of the display, the REF FREQ setting is shown, which corresponds to the central vertical dotted line on the graticule.

CW analyzer

The CW analyzer is switched on by pressing the *[CW on OFF]* soft key followed by the *[CW ana]* soft key. The graticule and trace show the spectrum of the signal from the transmitter's output through the RF N-type socket (35) (or RF TNC socket (36) if preferred for <1 W). The CW analyzer and the sideband analyser share the same AGC circuit, which results in the largest signal ranging to the top of the display. When viewing a signal on the CW analyser, the trace shows the RF signal as on the spectrum analyzer rather than the demodulated audio signal as on the sideband analyzer.

At the bottom of the display, the REF FREQ setting is shown, which corresponds to the central vertical dotted line on the graticule.

Soft keys at left side of screen

Five keys are shown, as follows:-

- (a) *[Tx tune ON off]* key. To disable automatic tuning or to return to automatic tuning after a transmitter frequency has been set manually.
- (b) *[display gen]* key. To select the AF generator before or after using the [AF GEN] key (15). Press the key repeatedly to change between 1 and 2. The frequency and level are shown for the selected generator. When the [AF GEN] key is used, AF1 or AF2 appear in inverse video. The [FREQ] key (16) or the [LEVEL] key (17) can then be used.
- (c) *[gen 1 on OFF]*, *[gen 2 on OFF]* keys. To enable or disable the AF generators.
- (d) *[SSB Rx Tx]* key. To switch between the SSB TRANSMITTER AND RECEIVER TEST displays. When switching from SSB TRANSMITTER TEST to SSB RECEIVER TEST, Rx FREQ is set to the Tx FREQ. When switching from SSB RECEIVER TEST to SSB TRANSMITTER TEST, Tx FREQ is set to the Rx FREQ.
- (e) *[hold ranges]*, *[auto range]* or *[expand on OFF]* key. The key changes according to the previous selection.

When the *[bar charts]* soft key has been used, the key is used to disable or enable auto-ranging. When auto-ranging is disabled by pressing *[hold ranges]*, soft keys below the screen become *[range down]* and *[range up]* and the range designators are shown in inverse video.

When the *[spec ana]*, *[sband ana]* or *[CW ana]* soft key has been used, the key changes to *[expand on OFF]*. Press *[expand on OFF]* to select either SSB TRANSMITTER TEST SPECTRUM, SIDEBAND or CARRIER WAVE ANALYZER expanded displays.

Soft keys at right side of screen

Six keys are shown, as follows:-

- (a) *[sband LSB usb]* key. To select either lower or upper sideband mode of operation. This mode is set to the sideband mode of the transmitter under test to avoid errors in Tx, OFFSET and MOD FREQ.
- (b) *[CW on OFF]* key. To select carrier wave mode of operation. This mode is selected when the transmitter under test is generating an unmodulated and unsuppressed carrier.
- (c) *[dist on OFF]* key. To enable or disable distortion measurement of the demodulated signal from the transmitter's output. When appropriate a DISTN bar chart appears.
- (d) *[suppres on OFF]* key. To select a bar chart display showing the relative amplitudes of the LSB, CW and USB signals. The broad-band power measurement is on either the LSB or USB, whichever is selected. Numerical readings appear alongside the power measurement. This mode is not available in CW mode.
- (e) *[bar charts]*, *[spec ana]*, *[sband ana]* and *[CW ana]* keys. To select a bar chart, spectrum analyzer, sideband analyzer or carrier wave analyzer display. The four keys change according to the current selection.

Soft keys at bottom of screen

When the bar charts display has been selected and the *[hold ranges]* soft key is used, two keys are shown below each bar chart as follows:-

- (a) *[range up]* key. To increase the range of the bar chart.
- (b) *[range down]* key. To decrease the range of the bar chart.

When the spectrum analyzer or sideband or carrier wave analyzer display has been selected, three pairs of keys are shown, as follows:-

- (a) Ref level [\blacktriangledown] and [\blacktriangle] keys. To increase and decrease, respectively, the reference level.
- (b) [$\blacktriangleright\blacktriangleleft$] and [$\blacktriangleleft\blacktriangleright$] keys. To increase and decrease, respectively, the frequency/division of the horizontal range which is shown.
- (c) *[single REPEAT]* keys. To initiate a single scan.

SSB transmitter testing - expanded

Spectrum analyzer

Connections

As under *SSB transmitter testing - non-expanded* on page 3-70.

Procedure

Press the [RF TEST] key (8) twice and the RF TEST menu appears. On the RF TEST menu, press the [SSB] soft key. The SSB TRANSMITTER TEST display appears. See Fig. 3-19 on page 3-74.

Enter suitable selections and settings as under *SSB transmitter testing - non-expanded* on page 3-70.

Press the [*spec ana*] and [*expand on OFF*] soft keys. The SSB TRANSMITTER TEST SPECTRUM ANALYZER expanded display appears. See Fig. 3-20 on page 3-77.

For the display, set parameters by using the soft keys as described below.

Display

The following settings are shown:-

- (a) REF LEVEL. The reference level for the spectrum analyzer, which is set with either the [▼ *ref level* ▲] soft keys or as described below. If an increment has been set as in (b) below, then the reference level can be incremented/decremented by pressing the INC δ [↑] and [↓] keys.

The spectrum analyzer's reference level can be adjusted by pressing the [REF] then [LEVEL] function keys to highlight the display's REF LEVEL legend, then entering the required reference level using the DATA keys. Alternatively, the rotary VARIABLE control can be used.

- (b) δ INC. The reference level increment that has been set as described below. The increment is used by pressing the INC δ [↑] and [↓] keys.

Reference level increments can be set and/or adjusted by pressing the [REF], then [LEVEL], then [INC] function keys, to highlight the display's REF LEVEL INC legend, then entering the required increment using the numeric DATA keys, followed by the [dB] DATA key.

- (c) PER DIV. The scaling of the graticule that has been set by using the [*dB per div*] soft key.

- (d) REF FREQ. The spectrum analyzer's reference frequency which can be set as described below. If an increment has been set as in (e) below, then the reference frequency can be incremented/decremented by pressing the INC Δ FREQ [↑] and [↓] keys.

The spectrum analyzer's reference frequency can be adjusted by pressing the [REF] then [FREQ] function keys to highlight the display's REF FREQ legend, then entering the required reference frequency using the numeric DATA keys followed by the appropriate [MHz], [kHz] or [Hz] DATA key. The reference frequency can also be adjusted using rotary VARIABLE control instead of the numeric DATA keys.

The reference frequency can be adjusted by two further methods using the marker facilities that are available after pressing the [*markers on OFF*] soft key; these are:-

1. Press [*peak find*], [*set ref to M1*] to set the reference to the strongest signal.
2. Select [*move M1 m2*] and adjust the M1 marker using the rotary VARIABLE control, then press the [*set ref to M1*] soft key.

Note that increments cannot be adjusted using the [REF FREQ] sequence while the markers are on, though increments already set can be used.

- (e) Δ INC. The reference frequency increment. If an increment has been set as described below, then the reference frequency can be incremented/decremented by pressing the INC Δ FREQ [↑] and [↓] keys.

Reference frequency increments can be set and/or adjusted by pressing the [REF] then [FREQ] then [INC] function keys to highlight the display's REF FREQ Δ INC legend, then entering the required increment using the numeric DATA keys, followed by the appropriate [MHz], [kHz] or [Hz] DATA key.

When the [markers on OFF] soft key is pressed, the following measurements are shown:-

- M1 or M2 frequency. The frequency at the M1 marker (dotted) or M2 marker (dashed) as set by using the [move m1 m2] soft key and the VARIABLE control.
- M1 or M2 level. The level at the above marker.
- Δ M. The difference between frequencies of M1 and M2 markers.
- δ M. The difference between levels of M1 and M2 markers.

Soft keys at left side of screen

Six keys are shown, as follows:-

- [move m1 m2] key. To show a dotted marker line (M1) or dashed marker line (M2). Each can be moved by rotating the VARIABLE control (33). This key appears only when the [markers on OFF] key is pressed.
- [lock M1 \leftrightarrow M2] key. To move the two marker lines together. The legend changes to [unlock M1 \leftrightarrow M2]. This key appears only when the [markers on OFF] key is pressed.
- [peak find] key. To move the dotted marker line (M1) to the frequency at which the level is peak. This key appears only when the [markers on OFF] key is pressed.
- [set ref to M1] key. To set the reference frequency to that at the position of the dotted marker (M1). This key appears only when the [markers on OFF] key is pressed.
- [markers on OFF] key. To show the above measurements and soft keys.
- [expand ON off] key. To revert to the TRANSMITTER TEST display.

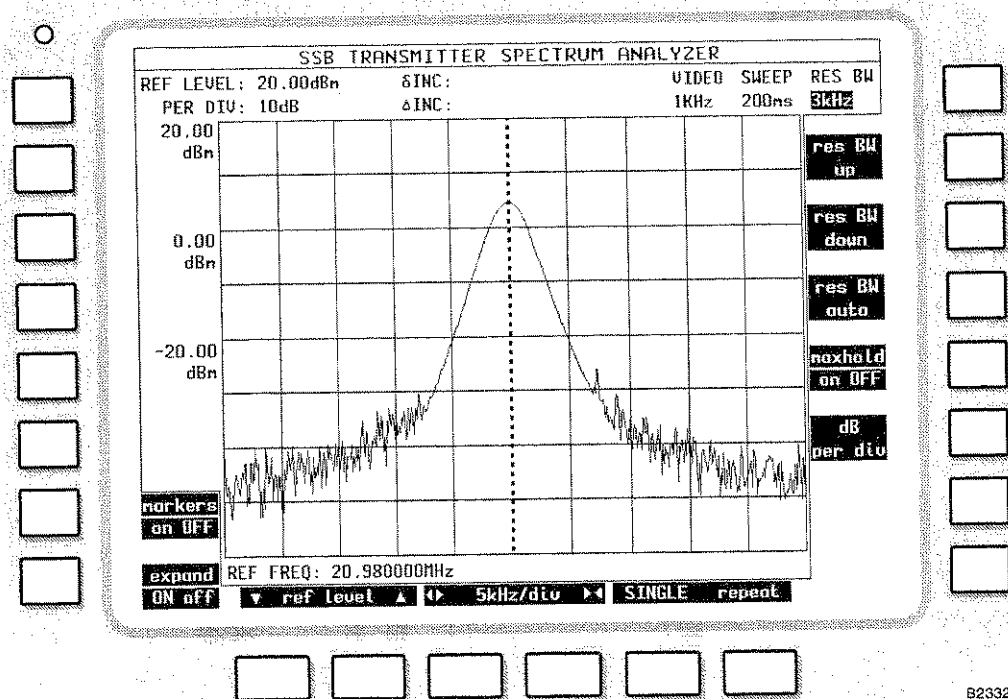

Fig. 3-20 SSB TRANSMITTER TEST SPECTRUM ANALYZER expanded display

Soft keys at right side of screen

Up to five keys are shown, as follows:-

- (a) [*res BW up*] key. To increase the passband of the resolution bandwidth filtering. This key is not displayed when the resolution bandwidth is set to its maximum, (3 MHz).
- (b) [*res BW down*] key. To decrease the passband of the resolution bandwidth filtering. This key is not displayed when the resolution bandwidth is set to its minimum, (300 Hz).
- (c) [*res BW auto*] key. To enable the automatic selection of the resolution bandwidth filtering. This key is not displayed when the automatic selection is active.

The resolution bandwidth is dependent on the frequency span/division setting of the display.

- (d) [*maxhold on OFF*] key. To hold the display so that frequency components of the current scan are only displayed if they are greater in level than the equivalent frequency components on previous scans.
- (e) [*dB per div*] key. To set the vertical resolution to 1, 2, 5 or 10 dB per division. This key is shown except when the [*markers on OFF*] soft key is pressed.

Table 3-1 on page 3-29 gives information on resolution bandwidth filter selection.

Soft keys at bottom of screen

Three pairs of keys are shown, as follows:-

- (a) [*▼ ref level ▲*] keys. To increase and decrease, respectively, the reference level of the vertical range.
- (b) [*► ◀*] and [*◀ ►*] keys. To increase and decrease, respectively, the frequency/division of horizontal range which is shown.
- (c) [*single REPEAT*] keys. To initiate a single scan.

Sideband analyzer

Connections

As under *SSB transmitter testing - non-expanded* on page 3-70.

Procedure

Press the [RF TEST] key (8) twice and the RF TEST menu appears. On the RF TEST menu, press the [*SSB*] soft key. The SSB TRANSMITTER TEST display appears. See Fig. 3-18 on page 3-72.

Enter suitable selections and settings as under *SSB transmitter testing - non-expanded* on page 3-70.

Press the [*sband lsb USB*] soft key to select the same mode as the transmitter under test Press the [*sband ana*] and [*expand on OFF*] soft keys. The SSB TRANSMITTER LOWER SIDEBAND or SSB TRANSMITTER UPPER SIDEBAND ANALYZER expanded display appears. See Fig. 3-21 on page 3-79.

For the display, set parameters by using the soft keys as below.

Display

The following setting is shown:-

- (a) REF LEVEL. The reference level for the sideband analyzer which is set with either the [▼ ref level ▲] soft keys or as described below. If an increment has been set as in (b) below, then the reference level can be incremented/decremented by pressing the INC δ [↑] and [↓] keys.

The sideband analyzer's reference level can be adjusted by pressing the [REF] then [LEVEL] function keys to highlight the display's REF LEVEL legend, then entering the required reference level using the DATA keys. Alternatively, the rotary VARIABLE control can be used instead of the numeric DATA keys.

- (b) δ INC. The reference level increment that has been set as described below. The increment is used by pressing the INC δ [↑] and [↓] keys.

Reference level increments can be set and/or adjusted by pressing the [REF] then [LEVEL] then [INC] function keys to highlight the display's REF LEVEL INC legend, then entering the required increment setting using the numeric DATA keys, followed by the [dB] DATA key.

- (c) PER DIV. The scaling of the graticule that has been set by using the [dB per div] soft key.

When the [markers on OFF] soft key is pressed, the following measurements are shown:-

- (a) M1 or M2 frequency. The frequency at the M1 marker (dotted) or M2 marker (dashed) as set by using the [move m1 m2] soft key and the VARIABLE control.
- (b) M1 or M2 relative levels.
- (c) Δ M. The difference between frequencies of M1 and M2 markers.
- (d) δ M. The difference between levels of M1 and M2 markers.

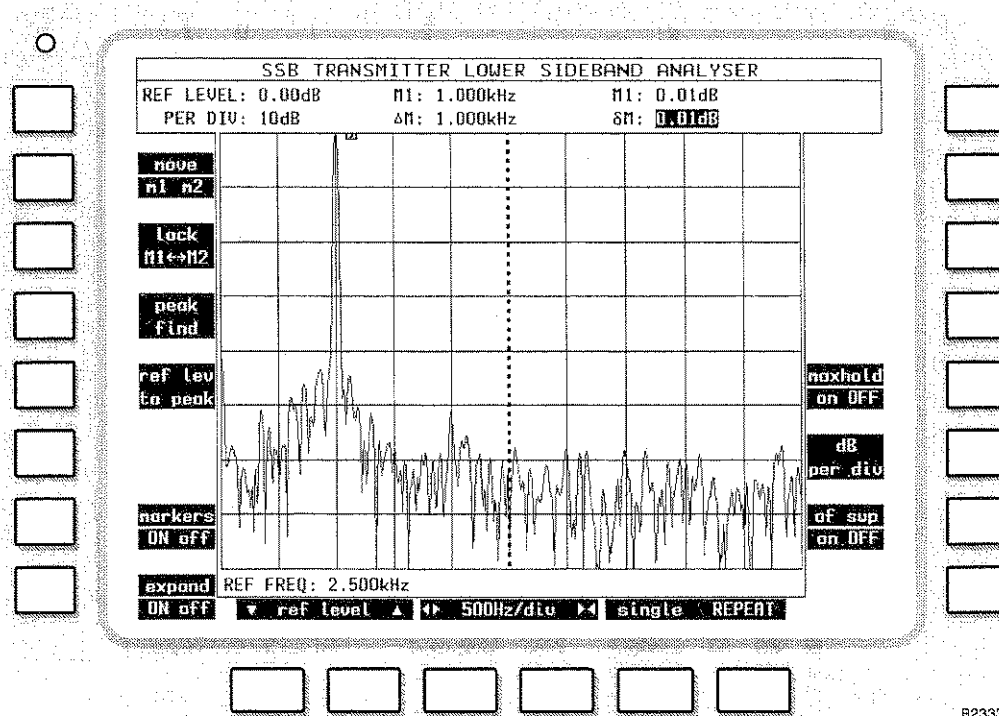

Fig. 3-21 SSB TRANSMITTER LOWER SIDEBAND ANALYZER expanded display

Soft keys at left side of screen

Six keys are shown, as follows:-

- (a) [*move m1 m2*] key. To show a dotted marker line (M1) or dashed marker line (M2). Each can be moved by rotating the VARIABLE control (33). This key appears only when the [*markers on OFF*] key is pressed.
- (b) [*lock M1 ↔ M2*] key. To move the two marker lines together. The legend changes to [*unlock M1 ↔ M2*]. This key appears only when the [*markers on OFF*] key is pressed.
- (c) [*peak find*] key. To move the dotted marker line (M1) to the frequency at which the modulation is peak. This key appears only when the [*markers on OFF*] key is pressed.
- (d) [*ref lev to peak*] key. To move the dotted marker line (M1) to the frequency at which the level is a peak and then move the peak to the top of the display. Set the top of the display annotation to 0 dB. This key appears only when the [*markers on OFF*] key is pressed.
- (e) [*markers on OFF*] key. To show the above measurements and soft keys.
- (f) [*expand ON off*] key. To revert to the SSB TRANSMITTER TEST display.

Soft keys at right side of screen

Three keys are shown, as follows:-

- (a) [*maxhold on OFF*] key. To hold the display so that frequency components of the current scan are only displayed if they are greater in level than the equivalent frequency components on previous scans.
- (b) [*dB per div*] key. To set the vertical resolution to 1, 2, 5 or 10 dB per division. This key is shown except when the [*markers on OFF*] soft key is pressed.
- (c) [*af swp on OFF*] key. To automatically step AF GEN2 which is modulating the transmitter. Set the required AF GEN2 LEVEL before pressing [*af swp on OFF*]. The demodulated frequency response of the transmitter signal is displayed on the sideband analyser.

Soft keys at bottom of screen

Three pairs of keys are shown, as follows:-

- (a) [*▼ ref level ▲*] keys. To increase and decrease, respectively, the reference level of the vertical range.
- (b) [*▶ ◀*] and [*◀ ▶*] keys. To increase and decrease, respectively, the frequency/division of horizontal range which is shown.
- (c) [*single REPEAT*] keys. To initiate a single scan.

CW analyzer

Connections

As under *SSB transmitter testing - non-expanded* on page 3-70.

Procedure

Press the [RF TEST] key (8) twice and the RF TEST menu appears. On the RF TEST menu, press the [*SSB*] soft key. The SSB TRANSMITTER TEST display appears. See Fig. 3-18.

Enter suitable selections and settings as under *SSB transmitter testing - non-expanded* on page 3-70.

Press the [*CW on OFF*] soft key to select the carrier wave mode. This mode is used to measure unmodulated and unsuppressed transmitters. Press the [*CW ana*] and [*expand on OFF*] soft keys. The SSB TRANSMITTER CARRIER WAVE ANALYZER expanded display appears. See Fig. 3-22.

For the display, set parameters by using the soft keys as below.

Display

The following setting is shown:-

- (a) REF LEVEL. The reference level for the CW analyzer which is set with either the [▼ *ref level* ▲] soft keys or as described below. If an increment has been set as in (b) below, then the reference level can be incremented/decremented by pressing the INC δ [↑] and [↓] keys.

The CW analyzer's reference level can be adjusted by pressing the [REF] then [LEVEL] function keys to highlight the display's REF LEVEL legend, then entering the required reference level using the numeric DATA keys, followed by the [dBm] or [dB] DATA key. Alternatively, the rotary VARIABLE control can be used instead of the numeric DATA keys.

- (b) δ INC. The reference level increment that has been set as described below. The increment is used by pressing the INC δ [↑] and [↓] keys.

Reference level increments can be set and/or adjusted by pressing the [REF] then [LEVEL] then [INC] function keys to highlight the display's REF LEVEL INC legend, then entering the required increment setting using the numeric DATA keys, followed by the [dB] DATA key.

- (c) PER DIV. The scaling of the graticule that has been set by using the [*dB per div*] soft key.

- (d) REF FREQ. The CW analyzer's reference frequency which can be set as described below. If an increment has been set as in (e) below, then the reference frequency can be incremented/decremented by pressing the INC Δ FREQ [↑] and [↓] keys.

The CW analyzer's reference frequency can be adjusted by pressing the [REF] then [FREQ] function keys to highlight the display's REF FREQ legend, then entering the required reference frequency using the numeric DATA keys followed by the appropriate [MHz], [kHz] or [Hz] DATA key. The reference frequency can also be adjusted using rotary VARIABLE control instead of the numeric DATA keys.

Note that increments cannot be adjusted using the [REF FREQ] sequence while the markers are on, though increments already set can be used.

- (e) Δ INC. The reference frequency increment. If an increment has been set as described below, then the reference frequency can be incremented/decremented by pressing the INC Δ FREQ [↑] or [↓] keys.

Reference frequency increments can be set and/or adjusted by pressing the [REF] then [FREQ] then [INC] function keys to highlight the display's REF FREQ Δ INC legend, then entering the required increment using the numeric DATA keys, followed by the appropriate [MHz], [kHz] or [Hz] DATA key.

When the [*markers on OFF*] soft key is pressed, the following measurements are shown:-

- (a) M1 or M2 frequency. The frequency at the M1 marker (dotted) or M2 marker (dashed) as set by using the [*move m1 m2*] soft key and the VARIABLE control.
- (b) M1 or M2 relative levels.
- (c) Δ M. The difference between frequencies of M1 and M2 markers.
- (d) dM. The difference between levels of M1 and M2 markers.

Soft keys at left side of screen

Six keys are shown, as follows:-

- (a) [*move m1 m2*] key. To show a dotted marker line (M1) or dashed marker line (M2). Each can be moved by rotating the VARIABLE control (33). This key appears only when the [*markers on OFF*] key is pressed.
- (b) [*lock M1 \leftrightarrow M2*] key. To move the two marker lines together. The legend changes to [*unlock M1 \leftrightarrow M2*]. This key appears only when the [*markers on OFF*] key is pressed.

- (c) *[peak find]* key. To move the dotted marker line (M1) to the frequency at which the modulation is peak. This key appears only when the *[markers on OFF]* key is pressed.
- (d) *[ref lev to peak]* key. To move the dotted marker line (M1) to the frequency at which the level is a peak and then move the peak to the top of the display. Set the top of the display annotation to 0 dB. This key appears only when the *[markers on OFF]* key is pressed.
- (e) *[markers on OFF]* key. To show the above measurements and soft keys.
- (f) *[expand ON off]* key. To revert to the TRANSMITTER TEST display.

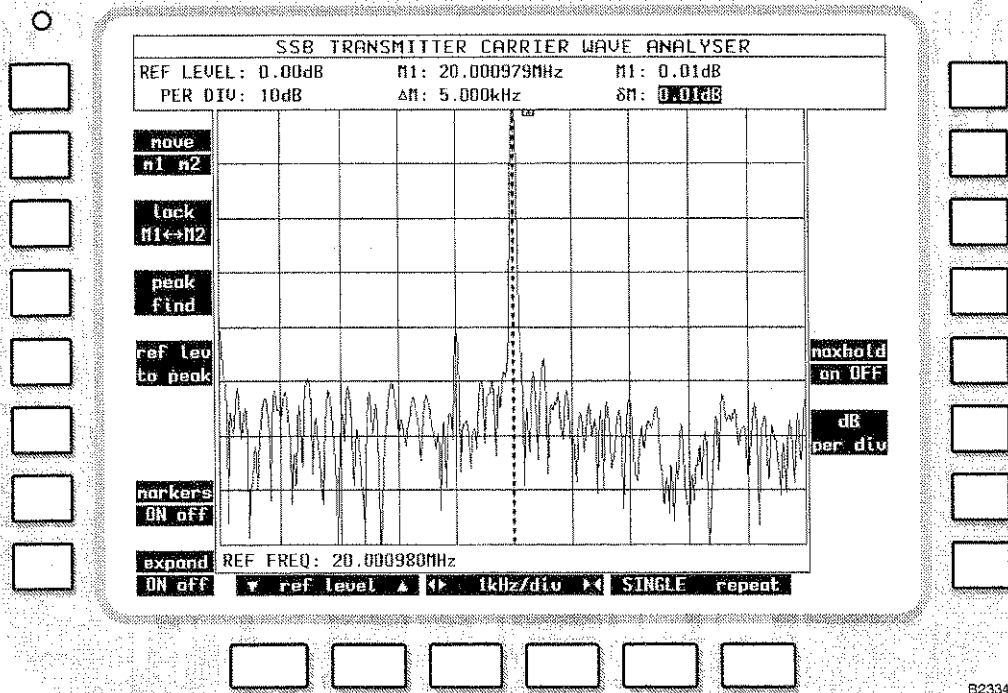

Fig. 3-22 SSB TRANSMITTER CARRIER WAVE ANALYZER expanded display

Soft keys at right side of screen

Two keys are shown, as follows:-

- (a) *[maxhold on OFF]* key. To hold the display so that frequency components of the current scan are only displayed if they are greater in level than the equivalent frequency components on previous scans.
- (b) *[dB per div]* key. To set the vertical resolution to 1, 2, 5 or 10 dB per division.

Soft keys at bottom of screen

Three pairs of keys are shown, as follows:-

- (a) *[▼ ref level ▲]* keys. To increase and decrease, respectively, the reference level of the vertical range.
- (b) *[▶◀]* and *[◀▶]* keys. To increase and decrease, respectively, the frequency/division of horizontal range which is shown.
- (c) *[single REPEAT]* keys. To initiate a single scan.

SSB receiver testing - non-expanded

Connections

Connect the receiver's RF input connector to the RF TNC socket (36) (or RF N-type socket (35) if preferred). Use the [RF SELECT] key (34) accordingly.

Connect the receiver's AF output connector to AF INPUT socket (38). Use the [AC DC] key (31) as required.

Procedure

Press the [RF TEST] key (8) twice and the RF TEST menu appears. On the RF TEST menu, press the [SSB] soft key. The SSB TRANSMITTER TEST display appears. Press the [SSB Rx Tx] soft key. This automatically sets the Rx FREQ to the Tx FREQ and displays the SSB RECEIVER TEST display. See Fig. 3-23.

The SSB RECEIVER TEST operates in either the lower or upper sideband mode as selected by the [*sband LSB usb*] soft key. When the USB sideband mode is selected, a signal is generated above the Rx FREQ by an amount equal to the MOD FREQ and at the specified MOD LEVEL if it is enabled.

As required, enter suitable selections and settings as follows:-

- (a) Set the Rx FREQ (receiver frequency) by using the [RF GEN/Rx] key (12) and then enter the frequency by using the [FREQ] key (16) and the DATA keys (24) and (26). Alternatively, press the [RF GEN/Rx] and the [FREQ] key and adjust it by using the VARIABLE control (33).
- (b) To select the modulation generator, press the [MOD GEN] key (14). On the display MOD appears in inverse video. Enter the frequency or level by using the [FREQ] key (16) or the [LEVEL] key (17) and the DATA keys (24) and (26). Alternatively, press [MOD GEN] and [FREQ] or [LEVEL] keys to make adjustments using the VARIABLE control (33). To enable or disable the modulation generator, press the [*mod on OFF*] key.
- (c) To enter an increment for Rx frequency or modulation frequency, press the [RF GEN/Rx] key (12) or [MOD GEN] key (14), the [FREQ] key (16) and then the [INC] key (20). Enter the increment by using the DATA keys (24) and (26). Δ appears alongside the active increment. To increase or decrease the frequency setting, press the appropriate [INC] key (32). Only a single frequency increment can be active. Entering one for Rx disables the one for modulation and vice versa.
- (d) To enter an increment for the modulation level, press the [MOD GEN] key (14) and [LEVEL] key (17) and then the [INC] key (20). Enter the increment by using the DATA keys (24) and (26). δ appears alongside the active increment. To increase or decrease the level setting, press the appropriate [INC] key (32).
- (e) To select a distortion or SINAD measurement, use either the [*distn on OFF*] or the [*SINAD on OFF*] soft key.

Receiver distortion and SINAD are measured within the bandwidth of the display's FILTER value as set by the [*band pass*] and [*low pass*] soft keys.

The distortion and SINAD of the receiver are measured at an audio frequency which is factory preset to 1 kHz. The measurement frequency can be reset using the HELP AND SET-UP mode to either a user-defined frequency or to the frequency of the GEN 1 signal source.

To change the frequency of measurement, use the key sequence [HELP SET-UP], [SET-UP], [TEST OPTIONS] and [*sinad & distn*]. For further information, refer to the section *Help and setting up* on page 3-124.

- (f) To select a filter, use the [*band pass*] and [*low pass*] soft keys.

Read off the measurements that are shown on the display in numerical form and as bar charts (using the *[bar charts]* soft key), oscilloscope display (using the *[scope]* soft key) or audio analyzer (using the *[audio ana]* soft key).

For the oscilloscope and audio analyzer displays, set parameters by using the soft keys as below.

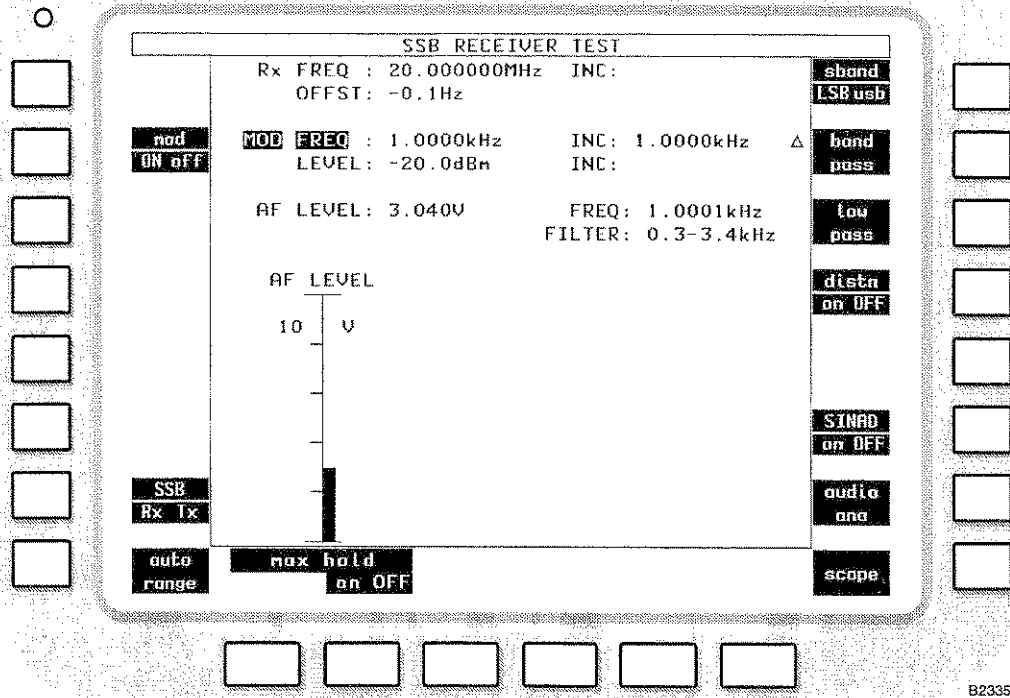

Fig. 3-23 SSB RECEIVER TEST display with bar charts

Display

The following settings and measurements are shown:-

- (a) Rx FREQ and INC. The settings of the suppressed carrier frequency. Δ (for frequency) appear alongside when the increments are active.
- (b) OFFST. The offset frequency is the difference between the MOD FREQ and the measured AF FREQ. It is the difference between the Rx FREQ setting and the frequency of the receiver under test.
- (c) MOD FREQ, INC, LEVEL and INC. The settings of the modulation generator as selected by using the [MOD GEN],[FREQ], [LEVEL] and [INC] keys.
- (d) AF FREQ and LEVEL. The frequency and level measurements of the receiver's demodulated output through the AF INPUT socket (38).
- (e) DISTN or SINAD. When one of these soft keys is enabled, the distortion or SINAD measurement of the receiver's demodulated output is displayed.
- (f) FILTER. The filter for the demodulated output through the AF INPUT socket (38) is selected by using the *[band pass]* and *[low pass]* soft keys. The filter type is displayed.

Bar charts

When the *[bar charts]* soft key is used, the following measurements are shown:-

- (a) AF LEVEL. The measurement of the receiver's demodulated output through the AF INPUT socket (38).
- (b) DISTN or SINAD. When either of these mutually exclusive soft keys is pressed, the distortion or SINAD measurement of the receiver's demodulated output is displayed.

The bar charts are auto-ranging except when the *[hold ranges]* soft key is used. When *[hold ranges]* is pressed, range up/down soft-key control is enabled.

Maximum hold

The soft keys beneath the bar charts allow each measurement presentation to indicate actual levels or maximum levels.

With *[max hold ON]* selected, the bar chart and the digital readouts of it, will track any rise in the measured level but will not track downward movement. Pressing the *[reset]* key will cause the current level to be displayed before reapplying the maximum hold function. An H is displayed at the lower right of bar charts that are in the Maximum Hold mode.

With *[max hold OFF]* selected, the bar chart and the associated digital readouts, will track any change in the measured level.

Oscilloscope

When the *[scope]* soft key is used, the graticule and trace show the levels of the receiver's demodulated output through the AF INPUT socket (38).

Audio analyzer

When the *[audio ana]* soft key is used, the graticule and trace show the spectrum of the receiver's demodulated output through the AF INPUT socket (38).

At the bottom of the display the REF FREQ setting is shown, corresponding to the frequency at the vertical dotted line in the centre of the display.

Soft keys at left side of screen

Three keys are shown, as follows:-

- (a) *[mod on OFF]* key. To enable or disable the modulation generator. The output is through the RF TNC socket (36) (or RF N-type socket (35) if preferred) to the receiver under test.
- (b) *[SSB Rx Tx]* key. To switch between the SSB RECEIVER AND TRANSMITTER TEST displays. When switching from SSB RECEIVER TEST to SSB TRANSMITTER TEST, Tx FREQ is set to the Rx FREQ. When switching from SSB TRANSMITTER TEST to SSB RECEIVER TEST, Rx FREQ is set to the Tx FREQ.
- (c) *[hold ranges]*, *[auto range]* or *[expand on OFF]* key. The soft key function depends on the previous selection. When *[bar charts]* has been selected, this soft key provides *[hold ranges]* or *[auto range]*; when *[hold ranges]* has been selected, the range can be selected using *[range down/up]* soft keys. When either *[audio ana]* or *[scope]* is selected, the *[expand on OFF]* soft key becomes available, to provide an expanded display with the availability of marker handling and measurement facilities.

Soft keys at right side of screen

Seven keys are shown, as follows:-

- (a) *[sband LSB usb]* key. To select either lower or upper sideband mode of operation. This mode is set to the sideband mode of the receiver under test to avoid errors in Rx OFFST and AF FREQ.
- (b) *[band pass]* key. To select a band-pass filter for the receiver's demodulated output through the AF INPUT socket (38). The options are 0.3 to 3.4 kHz and CCITT or CMES (shown in inverse video). CCITT or CMES is set by using the key sequence *[HELP SET-UP]*, *[SET-UP]*, *[TEST OPTIONS]*, *[filter options]* and *[Psoph Filter]*. See under *Test options* on page 3-128.
- (c) *[low pass]* key. To select a low-pass filter for the receiver's demodulated output. The options are 20 kHz LP, NONE or 300 Hz LP. This cancels a previous selection using the *[band pass]* key.
- (d) *[dist on OFF]* key. To enable or disable distortion measurement of the receiver's demodulated output. When appropriate, DISTN and a bar chart appear. *[dist ON off]* cancels *[SINAD ON off]*.
- (e) *[SINAD on OFF]* key. To enable or disable SINAD measurement of the receiver's demodulated output. When appropriate, SINAD and a bar chart appear. *[SINAD ON off]* cancels *[dist ON off]*.
- (f) *[bar charts]*, *[audio ana]* and *[scope]* keys. To select a bar chart, audio analyzer or oscilloscope display. The two keys change according to the current selection.

Soft keys at bottom of screen

When the bar charts display has been selected and the *[hold ranges]* soft key is used, two keys are shown below each bar chart as follows:-

- (a) *[range up]* key. To increase the range of the bar chart.
- (b) *[range down]* key. To decrease the range of the bar chart.

When the oscilloscope display has been selected, three pairs of keys are shown, as follows:-

- (a) $\left[\begin{array}{c} \blacktriangledown \\ \blacktriangle \end{array} \right]$ and $\left[\begin{array}{c} \blacktriangle \\ \blacktriangledown \end{array} \right]$ keys. To increase and decrease, respectively, the level/division of vertical range which is shown.
- (b) $\left[\blacktriangleright \blacktriangleleft \right]$ and $\left[\blacktriangleleft \blacktriangleright \right]$ keys. To increase and decrease, respectively, the time/division of horizontal range which is shown.
- (c) *[single REPEAT]* keys. To initiate a single scan.

When the audio analyzer display has been selected, three pairs of keys are shown, as follows:-

- (a) $\left[\blacktriangledown \text{ ref level } \blacktriangle \right]$ keys. To increase and decrease, respectively, the reference level of the vertical range.
- (b) $\left[\blacktriangleright \blacktriangleleft \right]$ and $\left[\blacktriangleleft \blacktriangleright \right]$ keys. To increase and decrease, respectively, the frequency/division of horizontal range which is shown.
- (c) *[single REPEAT]* keys. To initiate a single scan.

SSB receiver testing - expanded

Oscilloscope

Connections

As under *SSB receiver testing - non-expanded* on page 3-83.

Procedure

Press the [RF TEST] key (8) twice and the RF TEST menu appears. On the RF TEST menu, press the [SSB] soft key. The SSB TRANSMITTER TEST display appears. Press the [SSB Rx Tx] soft key. This automatically sets the Rx FREQ to the Tx FREQ and displays the SSB RECEIVER TEST display. See Fig. 3-23.

Enter suitable selections and settings as under *SSB receiver testing - non-expanded* on page 3-83.

Press the [scope] and [expand on OFF] soft keys. The SSB RECEIVER SCOPE expanded display appears.

For the display, set parameters by using the soft keys as below.

Display

When the [markers on OFF] soft key is pressed, the following measurements are shown:-

- (a) Vertical sensitivity of oscilloscope.
- (b) ΔM . The difference between frequencies of M1 and M2 markers.
- (c) δM . The difference between levels of M1 and M2 markers.





Soft keys at left side of screen

Four soft keys are shown after [markers on OFF] is pressed, as follows:-

- (a) [move m1 m2] key. To show a dotted marker line (M1) or dashed marker line (M2). Each can be moved by rotating the VARIABLE control (33). This key appears only when the [markers on OFF] key is pressed.
- (b) [lock M1 \leftrightarrow M2] key. To move the two marker lines together. The legend changes to [unlock M1 \leftrightarrow M2]. This key appears only when the [markers on OFF] key is pressed.
- (c) [markers on OFF] key. To show the above measurements and soft keys.
- (d) [expand ON off] key. To revert to the RECEIVER TEST display.

Soft keys at bottom of screen

Three pairs of keys are shown, as follows:-

- (a)  and  keys. To increase and decrease, respectively, the level/division of vertical range which is shown.
- (b)  and  keys. To increase and decrease, respectively, the time/division of horizontal range which is shown.
- (c) [single REPEAT] keys. To initiate a single scan.

Audio analyzer

Connections

As under *SSB receiver testing - non-expanded* on page 3-83.

Procedure

Press the [RF TEST] key (8) twice and the RF TEST menu appears. On the RF TEST menu, press the [SSB] soft key. The SSB TRANSMITTER TEST display appears. Press the [SSB Rx Tx] soft key. This automatically sets the Rx FREQ to the Tx FREQ and displays the SSB RECEIVER TEST display. See Fig. 3-23.

Enter suitable selections and settings as under *SSB receiver testing - non-expanded* on page 3-83.

Press the [audio ana] and [expand on OFF] soft keys. The SSB RECEIVER AUDIO ANALYZER expanded display appears. See Fig. 3-24.

For the display, set parameters by using soft keys as below.

Display

The following setting is shown:-

- (a) REF LEVEL. The reference level for the audio analyzer which is set with either the [▼ ref level ▲] soft keys or as described below. The reference level corresponds to the top of the graticule. If an increment has been set as in (b) below, then the reference level can be incremented/decremented by pressing the INC δ [↑] and [↓] keys.

The audio analyzer's reference level can be adjusted by pressing the [REF] then [LEVEL] function keys to highlight the display's REF LEVEL legend, then entering the required reference level using the DATA keys. Alternatively, the rotary VARIABLE control can be used instead of the numeric DATA keys.

- (b) δ INC. The reference level increment that has been set as described below. The increment is used by pressing the INC δ [↑] and [↓] keys.

Reference level increments can be set and/or adjusted by pressing the [REF] then [LEVEL] then [INC] function keys to highlight the display's REF LEVEL INC legend, then entering the required increment setting using the numeric DATA keys, followed by the [dB] DATA key.

- (c) PER DIV. The scaling of the graticule that has been set by using the [dB per div] soft key.
- (d) REF FREQ. The audio analyzer's reference frequency, corresponding to the central vertical dotted line on the graticule, which can be set as described below. If an increment has been set as in (e) below, then the reference frequency can be incremented/decremented by pressing the INC Δ FREQ [↑] and [↓] keys.

The audio analyzer's reference frequency can be adjusted by pressing the [REF] then [FREQ] function keys to highlight the display's REF FREQ legend, then entering the required reference frequency using the numeric DATA keys followed by the appropriate [MHz], [kHz] or [Hz] DATA key. The reference frequency can also be adjusted using rotary VARIABLE control instead of the numeric DATA keys.

The reference frequency can be adjusted by two further methods using the marker facilities which are available after pressing the [markers on OFF] soft key: press [peak find], [set ref to M1] to set the reference to the strongest signal, or press [move M1] soft key and adjust the M1 marker using the rotary VARIABLE control then press the [set ref to M1] soft key. Note that increments cannot be adjusted using the [REF FREQ] sequence while the markers are on, though increments already set can be used.

- (e) Δ INC. The reference frequency increment. If an increment has been set as described below, then the reference frequency can be incremented/decremented by pressing the INC Δ FREQ [\uparrow] and [\downarrow] keys.

Reference frequency increments can be set and/or adjusted by pressing the [REF] then [FREQ] then [INC] function keys to highlight the display's REF FREQ Δ INC legend, then entering the required increment using the numeric DATA keys, followed by the appropriate [MHz], [kHz] or [Hz] DATA key.

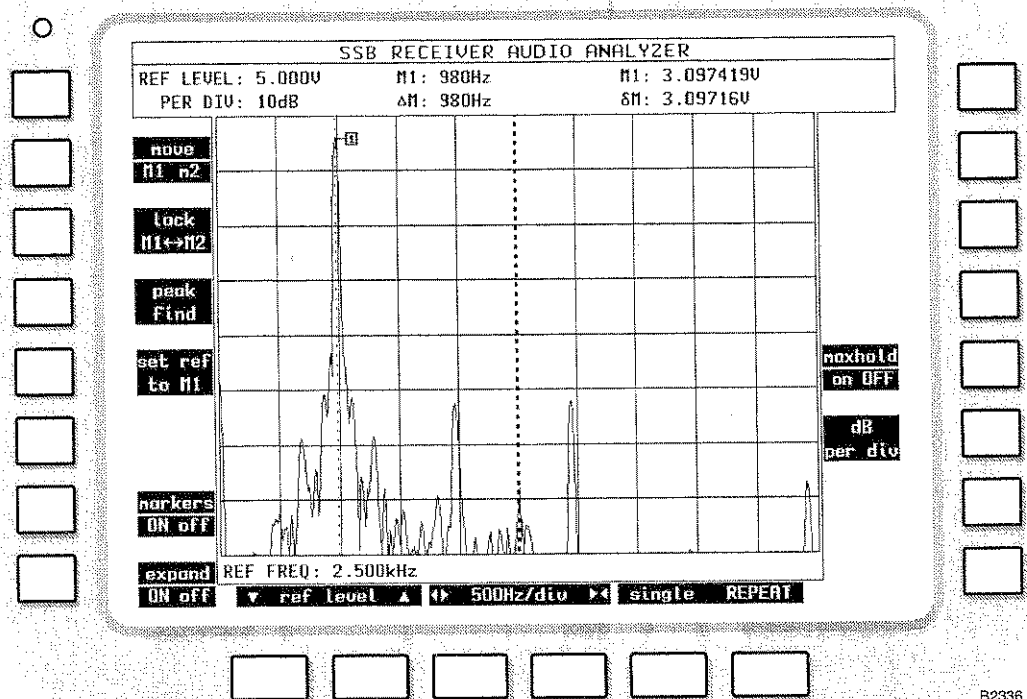

Fig. 3-24 SSB RECEIVER AUDIO ANALYZER expanded display with markers

When the [markers on OFF] soft key is pressed, the following measurements are shown:-

- M1 or M2 frequency. The frequency at the M1 marker (dotted) or M2 marker (dashed) as set by using the [move M1 m2] soft key and the VARIABLE control.
- M1 or M2 level. The level at the above marker.
- Δ M. The difference between frequencies of M1 and M2 markers.
- δ M. The difference between levels of M1 and M2 markers.

Soft keys at left side of screen

Five keys are shown, as follows:-

- [move M1 m2] key. To show a dotted marker line (M1) or dashed marker line (M2). Each can be moved by rotating the VARIABLE control (33). This key appears only when the [markers on OFF] key is pressed.
- [lock M1 \leftrightarrow M2] key. To move the two marker lines together. The legend changes to [unlock M1 \leftrightarrow M2]. This key appears only when the [markers on OFF] key is pressed.
- [peak find] key. To move the dotted marker line (M1) to the frequency at which the level is peak. This key appears only when the [markers on OFF] key is pressed.
- [set ref to M1]. To set REF FREQ to that of M1 marker position.
- [markers on OFF] key. To show the above measurements.
- [expand on OFF] key. To revert to the RECEIVER TEST display.

Soft keys at right side of screen

Two keys are shown, as follows:-

- (a) [*maxhold on OFF*] key. To hold the display so that frequency components of the current scan are only displayed if they are greater in level than the equivalent frequency components on previous scans.
- (b) [*dB per div*] key. To alter the display's vertical sensitivity.

Soft keys at bottom of screen

Three pairs of keys are shown, as follows:-

- (a) [*▼ ref level ▲*] keys. To increase and decrease, respectively, the reference level of the vertical range.
- (b) [*▶ ◀*] and [*◀ ▶*] keys. To increase and decrease, respectively, the frequency/division of horizontal range which is shown.
- (c) [*single REPEAT*] keys. To initiate a single scan.

Audio testing

Audio input/output testing - non-expanded

Connections

Connect the unit's AF input connector to the AF GEN OUTPUT socket (37).

Connect the unit's AF output connector to AF INPUT socket (38). Use the [AC DC] key (31) as required.

Procedure

Press the [AF TEST] key (9) twice and the AUDIO TEST menu appears. On the AUDIO TEST menu, two keys are shown:-

- (a) [AF IN/OUT] key. Press to revert to the AUDIO INPUT/OUTPUT TEST display.
- (b) [MULTIMETER] key. Press to select the AUDIO TEST MULTIMETER display.

Press the [AF IN/OUT] soft key. The AUDIO INPUT/OUTPUT TEST display appears. See Fig. 3-25 on page 3-92.

As required, enter suitable selections and settings as follows:-

- (a) To select an AF generator, press the [AF GEN] key (15). On the display, AF1, AF2 or AF3 in inverse video shows which of the generators has been selected. To select another generator, press the [1], [2] or [3] key (24) or press the [display gen] key for 2 or 3. (If the wide range AF generator has been enabled, AF 4 will be shown in inverse video. See *User options; 100 kHz audio or modulation generator*, on page 3-138). Enter the frequency and level by using the [FREQ] key (16), the [LEVEL] key (17) and the DATA keys (24) and (26). Alternatively, adjust the frequency and deviation or depth by using the VARIABLE control (33). The output from AF generator 2 is sequential tones when this has been selected on the TONES menu. See under *Signalling codes testing* on page 3-99. To enable or disable each AF generator, press the appropriate [gen on OFF] (or [tones on OFF]) soft key. [tones on OFF] is shown instead of [gen 2 on OFF] when sequential tones has been selected on the TONES menu.
- (b) To enter an increment for AF frequency, select the AF generator to be controlled, as in (a) above. Press the [FREQ] key (16) and then the [INC] key. Enter the increment and vice versa. Δ appears alongside the appropriate setting. To increase or decrease the frequency setting, press the appropriate [INC] key (32). Only one AF generator's frequency increment can be active. Entering an increment for AF GEN 1 disables an increment (if set) for AF GEN 2 or 3 and vice versa.
- (c) To enter an increment for AF level, select the AF generator to be controlled, as in (a) above. Press the [LEVEL] key (16) and then the [INC] key. Enter the increment and vice versa. δ appears alongside the appropriate setting. To increase or decrease the level setting, press the appropriate [INC] key (32). Only one AF generator's level increment can be active. Entering one for AF GEN 1 disables the increment for AF GEN 2 or 3 and vice versa.
- (d) To select distortion, signal-to-noise or SINAD measurement, use the [distn on OFF], [S/N on OFF] and [SINAD on OFF] soft keys.

The signal-to-noise, distortion and SINAD are measured within the bandwidth of the display's FILTER value as set by the [band pass] and [low pass] soft keys.

The distortion and SINAD of the unit under test are measured at an audio frequency which is factory preset to 1 kHz. The measurement frequency can be reset using the HELP AND SET-UP mode to either a user-defined frequency or to the frequency of GEN 1. Distortion, SINAD or S/N tests cannot be carried out while AF GEN 4 or MOD GEN 4 is enabled.

To change the frequency of measurement, use the key sequence [HELP SET-UP], [SET-UP], [TEST OPTIONS] and [sinad & distn]. For further information, refer to the section *Help and setting up* on page 3-124.

- (e) To select a filter, use the [band pass] and [low pass] soft keys.

Read off the measurements that are shown on the display in numerical form and as bar charts (using the [bar charts] soft key), oscilloscope display (using the [scope] soft key) or audio analyzer (using the [audio ana] soft key).

For the oscilloscope and audio analyzer displays, set parameters by using the soft keys as below.

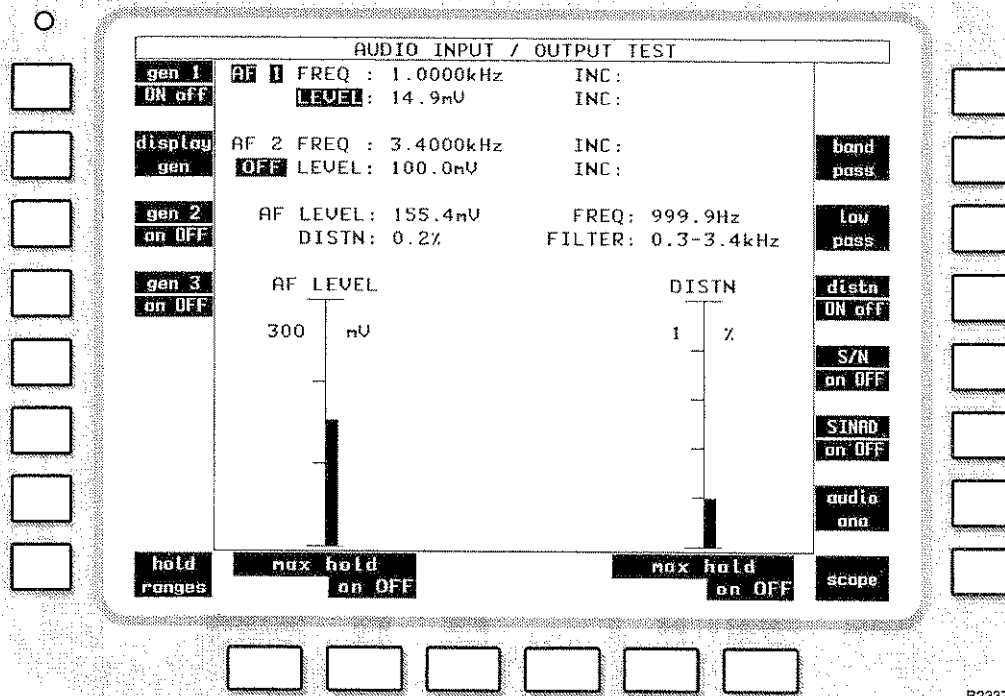

Fig. 3-25 AUDIO INPUT / OUTPUT TEST display with bar charts

Display

The following settings and measurements are shown:-

- AF 1 FREQ, INC, LEVEL and INC. The settings of AF generator 1. When AF1 is shown in inverse video, the [FREQ] key (16) or the [LEVEL] key (17) can then be used. Δ (for frequency) and δ (for level) appear alongside when the increments are active.
- AF 2 or 3 FREQ, INC, LEVEL and INC. The settings of AF generator 2 or 3 as selected by using the [2] or [3] key (24) after the [AF GEN] key (15) or by using the [display gen] soft key. AF 2 is not available when sequential tones has been selected on the TONES menu. When AF2 or AF3 is shown in inverse video, the [FREQ] key (16) or the [LEVEL] key (17) can the be used. Δ and δ appear alongside the appropriate settings.
- AF FREQ and LEVEL. The frequency and level measurements of the unit's output signal through the AF INPUT socket (38).
- DISTN, S/N or SINAD. When one of these is enabled, the distortion, signal-to-noise or SINAD measurement of the unit's output is shown.
- FILTER. The filter for the unit's output through the AF INPUT socket (38) as selected by using the [band pass] and [low pass] soft keys is shown.

Wide range AF generator

If the wide range AF generator is enabled, the parameters relating to it are shown, as AF 4, rather than those relating to AF generators 1 and 2 or 3.

No distortion, SINAD or S/N information is displayed as these test cannot be carried out while AF GEN 4 or MOD GEN 4 is enabled.

Bar charts

When the *[bar charts]* soft key is used, the following measurements are shown:-

- (a) AF LEVEL. The measurement of the unit's output through the AF INPUT socket (38).
- (b) DISTN, S/N or SINAD. When one of these is enabled, the distortion, signal-to-noise or SINAD measurement of the unit's output is displayed.

The bar charts are auto-ranging except when the *[hold ranges]* soft key is used. The range designators are then shown in inverse video.

Maximum hold

The soft keys beneath the bar charts allow each measurement presentation to indicate actual levels or maximum levels.

With *[max hold ON]* selected, the bar chart and the digital readouts of it, will track any rise in the measured level but will not track downward movement. Pressing the *[reset]* key will cause the current level to be displayed before reapplying the maximum hold function. An H is displayed at the lower right of bar charts that are in the Maximum Hold mode.

With *[max hold OFF]* selected, the bar chart and the associated digital readouts, will track any change in the measured level.

Oscilloscope

When the *[scope]* soft key is used, the graticule and trace show the levels of the unit's output through the AF INPUT socket (38). The two horizontal dotted lines on the graticule correspond to 63% of the graticule top and bottom edges.

Audio analyzer

When the *[audio ana]* soft key is used, the graticule and trace show the spectrum of the unit's output through the AF INPUT socket (38).

At the bottom of the display, the REF FREQ setting is shown. This corresponds to the central vertical dotted line on the graticule.

AF 600 Ω accessory. AF level measurements in dBm and dBr

To use the AF 600 Ω optional accessory, the test set must make corrections to the measured AF input levels.

The inclusion of the accessory in the test circuit is indicated to the test set within the SET-UP I/O: BNC SOCKETS screen, accessed by using the key sequence *[HELP SET-UP]*, *[SET-UP]*, *[INPUT OUTPUT]*, *[BNC set-up]*.

Repeatedly pressing the *[AF 600 Ω]* key will alternate the selection between:-

600 Ω Audio Accessory not connected
and
600 Ω Audio Accessory connected

With the 600 Ω facility active, AF level can be shown in dBm or dBr. This is in addition to the normal mV or V readings.

When distortion, SINAD or S/N measurements are not being displayed, pressing the [dB] key will cause the AF input level to be shown as either dBm or dBr. With a level shown in dBm, pressing the [dB] key again will change the reading to 0.0 dBr. Any changes to the AF input level will be shown as a positive or negative dBr level.

The dBr level can be re-referenced at any time by pressing the [dB] key to show the current dBm reading and then again to give 0.0 dBr.

AF level measurements in dBV and dBr

Relative level measurements can be made to the AF input signal when distortion, SINAD or S/N measurements are not being displayed. Pressing the [dB] key will cause the AF input level to be shown as either dBV or dBr, in addition to the normal reading in millivolts or volts.

With a level shown in dBV, pressing the [dB] key again will change the reading to 0.0 dBr. Any changes to the AF input level will be shown as a positive or negative dBr level.

The dBr level can be re-referenced at any time by pressing the [dB] key to show the current dBV reading and then again to give 0.0 dBr.

Soft keys at left side of screen

Five keys are shown at the left side of the screen, (unless the wide range AF generator/modulation generator has been enabled). The five keys are:-

- (a) [*gen 1 on OFF*], [*gen 2 on OFF*] (or [*tones on OFF*]) and [*gen 3 on OFF*] keys. To enable or disable the AF generators. The output is through the AF GEN OUTPUT socket (37) to the unit under test. [*tones on OFF*] is shown instead of [*gen 2 on OFF*] when sequential tones has been selected on the TONES menu.
- (b) [*display gen*] key. To select the AF generator 2 or 3 before or after using the [AF GEN] key (15). Press the key to alternate between 2 and 3. AF 2 is not available when sequential tones has been selected on the TONES menu. The frequency and level are shown for the selected generator. When the [AF GEN] key is used, AF1, AF2 or AF3 appear in inverse video. The [FREQ] key (16) or the [LEVEL] key (17) can then be used.
- (c) [*hold ranges*], [*auto range*] or [*expand on OFF*] key. The key changes according to the previous selection. When the [*bar charts*] soft key has been used, use to disable or enable auto-ranging. When auto-ranging is disabled, pairs of the soft keys at the bottom of the screen become [*range down*] and [*range up*] and the range designators are shown in inverse video. When the [*audio ana*] soft key has been used, press the [*expand on OFF*] soft key to select the Rx TEST EXPANDED AUDIO ANALYZER display. When the [*scope*] soft key has been used, press the [*expand on OFF*] soft key to select the Rx TEST EXPANDED SCOPE display.

When the wide range AF generator has been selected, only three soft keys are shown at the left of the screen. These three keys are:-

- (a) [*gen 4 ON off*] key. Repeatedly pressing this key will alternately turn the wide range AF generator on and off.
- (b) [*afgens 1 to 3*] key. Pressing this key will cause the message ARE YOU SURE?. Press key again to continue. Press any other key to cancel to be displayed.

If the key is pressed again, the wide range AF generator will be disabled and AF generators 1 to 3 will be enabled. The wide range AF generator can only be enabled again through the HELP AND SET-UP menus.

- (c) [*hold ranges*], [*auto range*] or [*expand on OFF*] key. As above.

Soft keys at right side of screen

Seven keys are shown, as follows:-





- (a) *[band pass]* key. To select a band-pass filter for the unit's output through the AF INPUT socket (38). The options are 0.3 to 3.4 kHz and CCITT or CMESS (shown in inverse video). 0.3 to 3.4 kHz is automatically selected when distortion or SINAD testing is enabled. This cancels a previous selection by using the *[low pass]* key. CCITT or CMESS is set by using the key sequence [HELP SET-UP], [SET-UP], [TEST OPTIONS], [filter options] and [Psoph Filter]. See under *Test options* on page 3-128.
- (b) *[low pass]* key. To select a low-pass filter for the unit's output. The options are 20 kHz LP, 5 kHz LP, 300 Hz LP, or NONE. This cancels a previous selection using the *[band pass]* key.
- (c) *[distn on OFF]* key. To enable or disable distortion measurement of the unit's output. When appropriate, DISTN and a bar chart appear. *[dist ON off]* cancels a previous selection of *[S/N ON off]* or *[SINAD ON off]*.
- (d) *[S/N on OFF]* key. To enable or disable signal-to-noise measurement of the unit's output. When appropriate, S/N and a bar chart appear. *[S/N ON off]* cancels a previous selection of *[distn ON off]* or *[SINAD ON off]*.
- (e) *[SINAD on OFF]* key. To enable or disable SINAD measurement of the unit's output. When appropriate, SINAD and a bar chart appear. *[SINAD ON off]* cancels *[distn ON off]* or *[S/N ON off]*.
- (f) *[bar charts]*, *[audio ana]* and *[scope]* keys. To select a bar chart, audio analyzer or oscilloscope display. The two keys change according to the current selection.

Soft keys at bottom of screen





When the bar charts display has been selected and the *[hold ranges]* soft key is used, two keys are shown below each bar chart as follows:-

- (a) *[range down]* key. To increase the sensitivity.
- (b) *[range up]* key. To decrease the sensitivity.

When the oscilloscope display has been selected, three pairs of keys are shown, as follows:-

- (a)  and  keys. To increase and decrease, respectively, the level/division of vertical range which is shown.
- (b)  and  keys. To increase and decrease, respectively, the time/division of horizontal range which is shown.
- (c) *[single REPEAT]* keys. To initiate a single scan.

When the audio analyzer display has been selected, three pairs of keys are shown, as follows:-

- (a) Ref level  and  keys. To increase and decrease, respectively, the reference level of vertical range which is shown.
- (b)  and  keys. To increase and decrease, respectively, the frequency/division of horizontal range which is shown.
- (c) *[single REPEAT]* keys. To initiate a single scan.

Audio input/output testing - expanded

Oscilloscope

Connections

As under *Audio input/output testing - non-expanded* on page 3-91.

Procedure

Press the [AF TEST] key (9). Either the AF TEST menu, or one of the AUDIO INPUT/OUTPUT TEST or AUDIO TEST MULTIMETER displays appears (whichever was last selected). If an AUDIO TEST MULTIMETER or an expanded AUDIO INPUT/OUTPUT TEST display appears, press the [AF TEST] key again. Press the [AF IN/OUT] soft key. The AUDIO INPUT/OUTPUT TEST display appears. (See Fig. 3-25).

Proceed as under *Receiver testing - expanded* on page 3-42.

Display

As under *Receiver testing - expanded* on page 3-42 except for the heading.

Audio analyzer

Connections

As under *Audio input/output testing - non-expanded* on page 3-91.

Procedure

Press the [AF TEST] key (9). Either the AF TEST menu, or one of the AUDIO INPUT/OUTPUT TEST or AUDIO TEST MULTIMETER displays appears (whichever was last selected). If an AUDIO TEST MULTIMETER or an expanded AUDIO INPUT/OUTPUT TEST display appears, press the [AF TEST] key again. Press the [AF IN/OUT] soft key. The AUDIO INPUT/OUTPUT TEST display appears. Proceed as under *Receiver testing - expanded* on page 3-42.

Display

As under *Receiver testing - expanded* on page 3-42 except for the heading.

Audio multimeter testing

Connections

Connect the unit to the MULTIMETER terminals (41) as follows:-

- (a) Voltage, resistance and continuity measurements. Black (-) and red (+).
- (b) Current measurements. Red (+) and white (-).
- (c) Power consumption measurements. The power input plug to black (-) and red (+) and the power supply outlet to black (-) and white (+). The power consumption is then the product of the measured voltage and the measured current.

CAUTION

Voltage and current ratings

On the black and red terminals, the voltage above ground should not exceed 350 V. At the red and white terminals, the input current should not exceed 10 A.

Procedure

Press the [AF TEST] key (9) twice and the AF TEST menu appears. Press the [MULTI METER] soft key. The AUDIO TEST MULTIMETER display appears (Fig. 3-26).

Press the appropriate soft key for the required reading.

Read off the measurement which is shown on the display in numerical form and as a bar chart.

When continuity has been selected, a continuous tone sounds for $<10 \Omega$.

Multimeter display

The voltage, current or resistance measurement is shown at the top of the display.

When resistance or continuity has been selected, OPEN is shown for an open circuit.

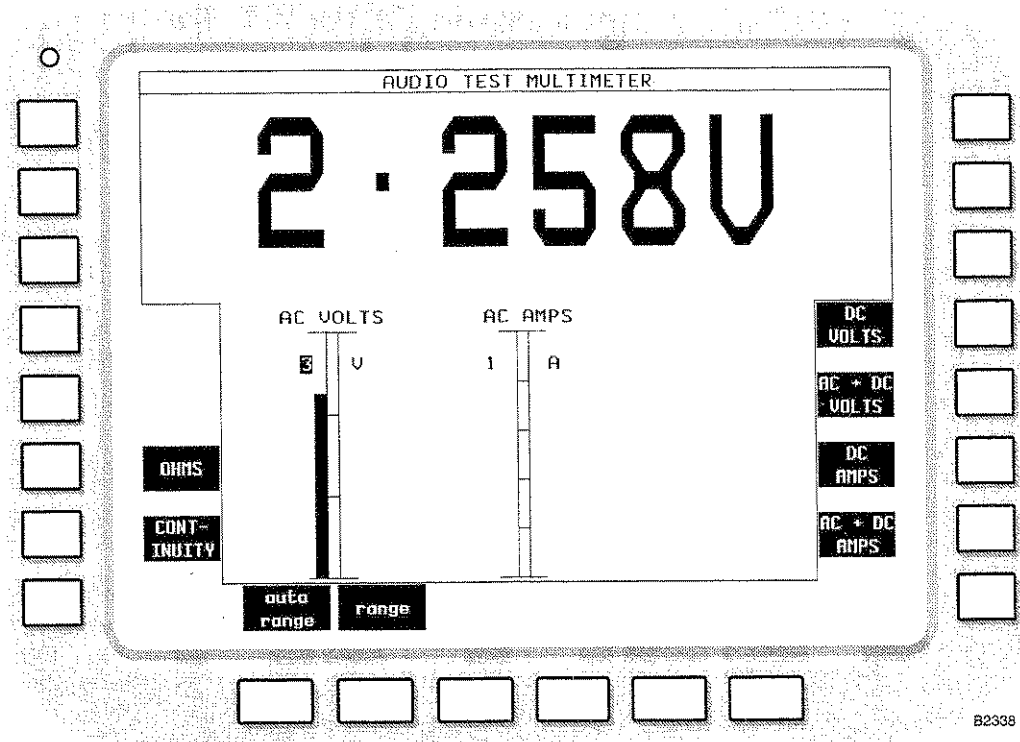

Fig. 3-26 AUDIO TEST MULTIMETER display

Bar charts

The following measurements are shown:-

- DC VOLTS. The measurement when the [DC VOLTS] soft key has been used.
- AC VOLTS. The measurement when the [AC + DC VOLTS] soft key has been used.
- DC AMPS. The measurement when the [DC AMPS] soft key has been used.
- AC AMPS. The measurement when the [AC + DC AMPS] soft key has been used.
- OHMS. The measurement when the [OHMS] soft key has been used.
- CONTINUITY. The measurement when the [CONTINUITY] soft key has been used.

The bar charts are auto-ranging except when the [hold ranges] soft key is used. The range designators are then shown in inverse video.

Soft keys at left side of screen

Two keys are shown, as follows:-

- (a) *[OHMS]* key. To select resistance measurements.
- (b) *[CONTINUITY]* key. To select continuity measurements.

Soft keys at right side of screen

Four keys are shown, as follows:-

- (a) *[DC VOLTS]* key. To select DC voltage measurements.
- (b) *[AC + DC VOLTS]* key. To select AC voltage measurements.
- (c) *[DC AMPS]* key. To select DC current measurements.
- (d) *[AC + DC AMPS]* key. To select AC current measurements.

Soft keys at bottom of screen

When a DC or AC voltage or current measurement has been selected, two keys are shown below the appropriate bar chart as follows:-

- (a) *[hold ranges]* or *[auto range]* key. To disable or enable auto-ranging. When auto-ranging is disabled, the range designator is shown in inverse video. The range can then be changed by successively pressing the *[range]* soft key.
- (b) *[hold max]* or *[range]* key. When auto-ranging is enabled, to hold the maximum measurement. When auto-ranging is disabled, to increment the range.

When a resistance measurement has been selected, two keys are shown below the OHMS bar chart as follows:-

- (a) *[hold ranges]* or *[auto range]* key. To disable or enable auto-ranging. When auto-ranging is disabled, the range designator is shown in inverse video. The range can then be incremented by using the *[range]* soft key.
- (b) *[hold min]* or *[range]* key. When auto-ranging is enabled, the *[hold min]* soft key will hold the maximum reading while allowing the *[reset]* key to be pressed to initiate new maximum readings, while the *[auto]* soft key returns the instrument to auto-ranging. Pressing *[hold ranges]* permits the range to be adjusted manually, with the selected range shown highlighted.

Signalling codes testing

Sequential tones

Introduction

For each of the built-in standards, each tone number has a frequency and duration as follows:-

Tone number	Frequency								
	Hz								
	CCIR 1-5	ZVEI 1	ZVEI 2	ZVEI 3	PZVEI	DZVEI	EEA	EIA	
0	1981	2400	2400	2200	2400	2200	1981	600	
1	1124.6	1060.6	1060.6	970	1060.6	970	1124.6	741	
2	1197	1160	1160	1060.6	1160	1060.6	1197	882.5	
3	1275	1270	1270	1160	1270	1160	1275	1023	
4	1358	1400	1400	1270	1400	1270	1358	1164	
5	1446	1530	1530	1400	1530	1400	1446	1305	
6	1540	1670	1670	1530	1670	1530	1540	1446	
7	1640	1830	1830	1670	1830	1670	1640	1587	
8	1747	2000	2000	1830	2000	1830	1747	1728	
9	1860	2200	2200	2000	2200	2000	1860	1869	
A	2400	2800	885	825	970	2400	2400	2151	
B	930	810	810	740	810	2600	930	2433	
C	2247	970	740	2600	2800	885	2247	2010	
D	991	885	680	885	885	825	991	2292	
E	2110	2600	970	2400	2600	810	2110	459	
Duration	1	100 ms	70 ms	70 ms	70 ms	70 ms	70 ms	40 ms	33 ms
	2	70 ms							
	3	33 ms							
	4	40 ms							
	5	20 ms							
Extended	1	700 ms	700 ms	700 ms	700 ms	700 ms	700 ms	400 ms	330 ms
	2	700 ms							
	3	330 ms							
	4	400 ms							
	5	200 ms							

The level sensitivity for sequential tones decoding does not range automatically; the decode level must be set by the user in the SET-UP OPTIONS: TONES SEQ screen. This can be accessed by pressing the [decode level] key from the SEQUENTIAL TONES DECODE screens (see Fig 3-30). Alternatively, the same screen can be accessed through the HELP AND SET-UP menu using the key sequence [HELP SET-UP], [SET-UP], [TEST OPTIONS], [tones decode] and [SEQ decode].

Refer to the section *Help and setting up* on page 3-124 for further details.

Connections

For testing a transmitter, connect its RF output connector to the RF N-type socket (35) (or RF TNC socket (36) if preferred for <1 W).

WARNING

Hot surface

Take care when touching the RF N-type connector after continuous power input. If 50 W is exceeded, the temperature of the connector becomes excessive.

CAUTION

Input overload

On the RF N-type connector, the input power should not exceed 150 W.
On the RF TNC connector, the input power should not exceed 1 W.

For off-air testing of a transmitter, connect an antenna to the RF TNC socket (36).
 For testing a receiver, connect its RF input connector to the RF TNC socket (36) (or RF N-type socket (35) if preferred).
 Use the [RF SELECT] key (34) accordingly.
 For duplex testing, connect the transceiver as under *Full duplex testing* on page 3-47.
 For RF testing, connect the unit as under *RF input/output testing - non-expanded* on page 3-64.
 For audio testing, connect the unit's AF output connector to AF INPUT socket (38). Use the [AC DC] key (31) as required.

Procedure

Transmitter testing

Press the [Tx TEST] key (3). One of the TRANSMITTER TEST or OFF-AIR TRANSMITTER TEST displays appears (whichever was last selected). If it is shown, press the [normal Tx test] soft key. If an expanded display has appeared, press the [Tx TEST] key again. The TRANSMITTER TEST display appears. See Fig. 3-6.

Key up the transmitter and ensure that the 2965 is correctly tuned to the transmitter's frequency.

Press the [TONES] key (6). One of the tones displays appears (whichever was last selected). If it is shown, press the [SEQU] soft key. When the [TONES] key or both keys are used, the Tx TEST SEQUENTIAL TONES DECODE display appears; see Fig. 3-27. Select a tone standard by pressing one of the soft keys at the bottom of the screen. For CCIR, press the [CCIR VARIANT] soft key repeatedly for variants 1, 2, 3, 4 and 5, which have different tone durations. For ZVEI, press the [ZVEI VARIANT] soft key repeatedly for variants 1, 2, 3 and PZVEI.

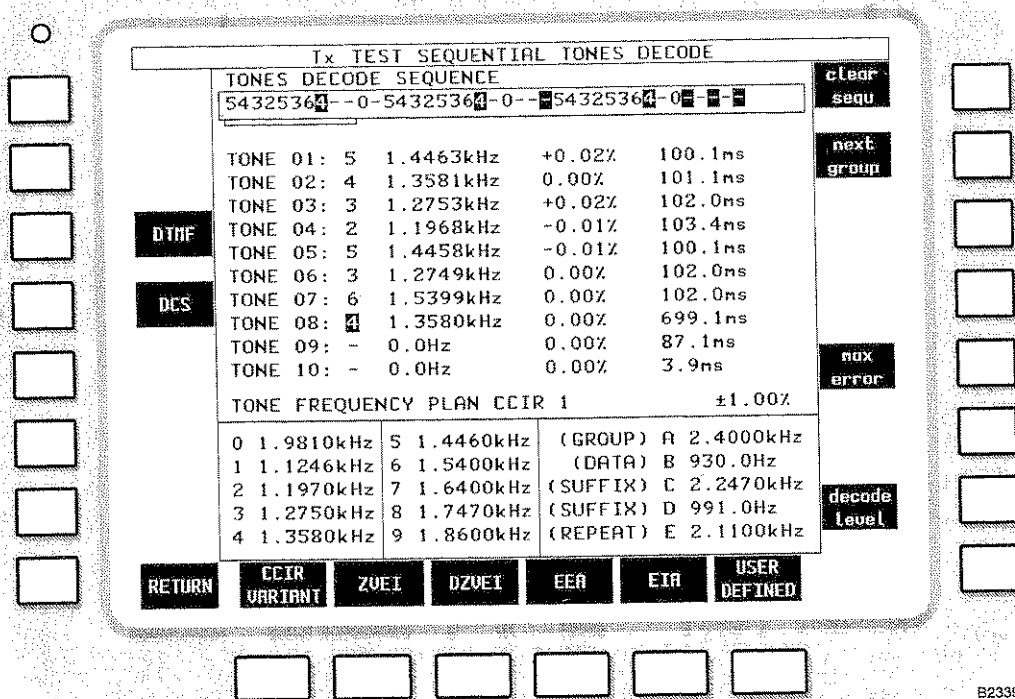

Fig. 3-27 Tx TEST SEQUENTIAL TONES DECODE display

For a user-defined standard, press the [USER DEFINED] soft key. This changes to [USER VARIANT]. The current tone standard is shown on the display. To select another tone standard, press the [USER VARIANT] soft key repeatedly.

On the transmitter, activate a sequence of tones. The sequence of tone numbers appears in the TONES DECODE SEQUENCE box.

Underneath the TONES DECODE SEQUENCE box, the first ten tones are listed with their number, frequency, % error and duration. To list the second, third and fourth group of ten tones, press the *[next group]* soft key repeatedly. The groups are shown by a cursor under the box.

When the % error is greater than the maximum error, it is shown in inverse video. The maximum error is shown above the TONE FREQUENCY PLAN box. To change the maximum error, press the *[max error]* soft key and then use the DATA keys (24) and the [%] key (26).

To select another display, press the *[RETURN]* soft key.

Off-air transmitter testing

Press the [Tx TEST] key (3). One of the TRANSMITTER TEST or OFF-AIR TRANSMITTER TEST displays appears (whichever was last selected). If it is shown, press the *[off-air test]* soft key. If an expanded display has appeared, press the [Tx TEST] key again and press the *[off-air test]* soft key. The OFF-AIR TRANSMITTER TEST display appears. See Fig. 3-10.

Proceed as under *Transmitter testing* above.

Receiver testing

Press the [Rx TEST] key (4). One of the RECEIVER TEST displays appears (whichever was last selected). If an expanded display has appeared, press the [Rx TEST] key again. The RECEIVER TEST display appears. See Fig. 3-11.

Set the RF frequency and RF level as under *Receiver testing - non-expanded* on page 3-38.

Press the [TONES] key. One of the tones displays appears (whichever was last selected). If it is shown, press the *[SEQU]* soft key. When the [TONES] key or both keys are used, the Rx TEST SEQUENTIAL TONES GENERATE display appears. See Fig. 3-28.

Select a tone standard by pressing one of the soft keys at the bottom of the screen. For CCIR, press the *[CCIR VARIANT]* soft key repeatedly for variants 1, 2, 3, 4 and 5 which have different tone durations. For ZVEI, press the *[ZVEI VARIANT]* soft key repeatedly for variants 1, 2, 3 and PZVEI. For DZVEI, press the *[DZVEI]* soft key. For EEA, press the *[EEA]* soft key. For EIA, press the *[EIA]* soft key.

For a user-defined standard, press the *[USER DEFINED]* soft key. This changes to *[USER VARIANT]*. The current tone standard is shown on the display. To select another tone standard, press the *[USER VARIANT]* soft key repeatedly.

To enter the required tone numbers in the TONES GENERATE SEQUENCE box, press the *[change sequ]* soft key, and this soft key changes to *[clear sequ]*. To delete existing numbers, press the *[clear sequ]* soft key. Enter the numbers at the cursor by using the DATA keys (24). To reposition the cursor, use the VARIABLE control (33). While entering the tone sequence, the *[extend tone]* soft key can be used to extend the duration of the tone to 7 or 10 times the normal duration, and such tones are indicated in inverse video in the TONES GENERATE SEQUENCE box. Inter-tone pauses can be inserted using the minus (-) DATA key; extended pauses can be generated by including multiple minus entries. After the last number has been entered, press the [ENTER] key (26) and the *[clear sequ]* soft key changes back to *[change sequ]*.

The method of sending tones can now be selected by repeatedly pressing the *[tone mode]* soft key and the displayed MOD GEN 2 TONE MODE indicates the option selected from CONTINUOUS TONES, TONE BURST or MANUAL/STEP.

When CONTINUOUS TONES or TONE BURST is selected, the tone generation is controlled by the *[tones on OFF]* soft key. When MANUAL/STEP is selected, the *[tone step]* soft key replaces the *[tones ON off]* soft key. The *[tone step]* soft key can be repeatedly pressed to sequentially send the tones displayed in the display's TONES GENERATE SEQUENCE box; the tone selected is indicated by a marker below the selected tone. Alternatively, when MANUAL/STEP is selected, individual tones can be sent using the numeric DATA keys for each tone.

When required, shift all the selected frequencies by up to $\pm\%$ by pressing the [freq shift] soft key and one of the DATA keys 0 to 9 (24) with a minus sign when appropriate.

In the NORMAL MOD GEN 2 mode, the tone frequency is as set on this generator in the Rx TEST mode.

To enter a modulation deviation or depth, press the [MOD GEN] key (14). Then, use the DATA keys (24) and (26).

The frequency of the generated sequential tones can be raised or lowered by $\pm 9.9\%$. Press the [freq shift] soft key, and enter the required frequency shift using the numeric DATA keys and the [%] key. Use the minus key first if the frequencies are to be lowered. The TONE FREQUENCY PLAN will show the new frequencies and a SHIFT legend will be displayed.

To select another display, press the [RETURN] soft key.

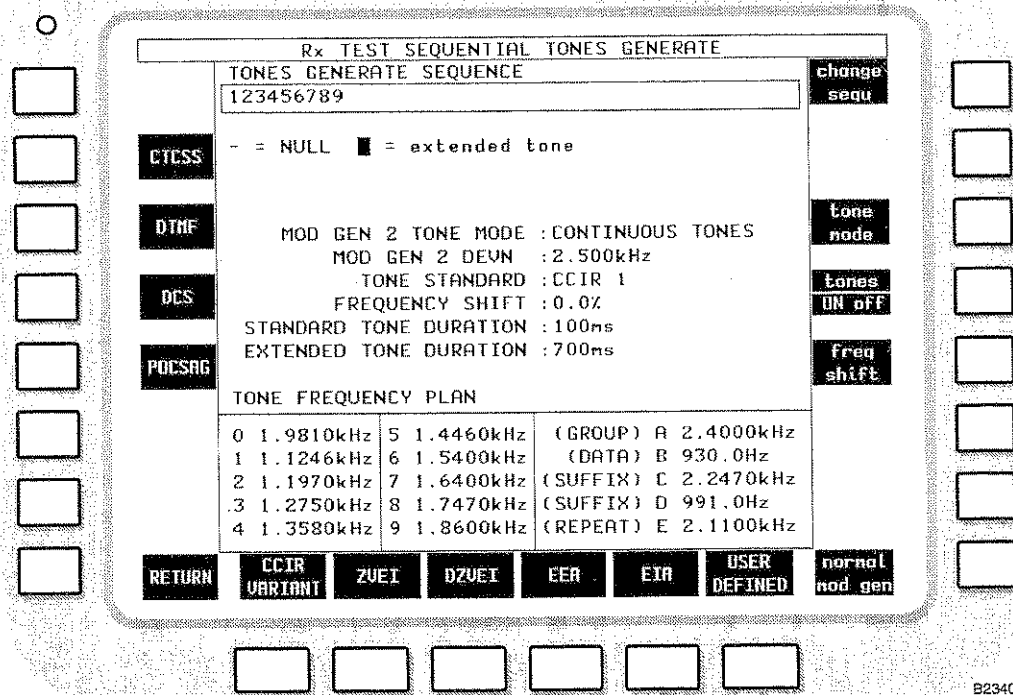

Fig. 3-28 Rx TEST SEQUENTIAL TONES GENERATE display

Duplex testing

Press the [DUPLEX TEST] key (5). One of the DUPLEX TEST displays appears (whichever was last selected). If one of the DUPLEX TEST (Tx) or DUPLEX TEST (Rx) displays has appeared, press the [DUPLEX TEST] key again. The DUPLEX TEST display appears. See Fig. 3-3.

Set the RF frequency and RF level as under *Receiver testing - non-expanded* on page 3-38.

Key up the transmitter and ensure that the 2965 is correctly tuned to the transmitter's frequency.

Press the [TONES] key. One of the tones displays appears (whichever was last selected). Either the [SEQU DECODE] or [SEQU GEN] soft key is shown.

When the [TONES] key alone is used or both the [TONES] key and the [SEQU DECODE] soft key are used, the DUPLEX TEST SEQUENTIAL TONES DECODE display appears. Testing is then the same as under *Transmitter testing* above.

When the [TONES] key alone is used or both the [TONES] key and the [SEQU GEN] soft key are used, the DUPLEX TEST SEQUENTIAL TONES GENERATE display appears. Testing is then the same as under *Receiver testing* above.

To select another display, press the *[RETURN]* soft key.

RF testing

Press the *[RF TEST]* key (8). One of the RF INPUT/OUTPUT TEST displays appears (whichever was last selected). If an expanded display has appeared, press the *[RF TEST]* key again. The RF INPUT/OUTPUT TEST display appears.

Key up the unit and ensure that the 2965 is correctly tuned to the unit's output frequency.

Set the RF frequency and RF level as under *Receiver testing - non-expanded* on page 3-38.

Press the *[TONES]* key. One of the tones displays appears (whichever was last selected). Either the *[SEQU DECODE]* or *[SEQU GEN]* soft key is shown.

When the *[TONES]* key alone is used or both the *[TONES]* key and the *[SEQU DECODE]* soft key are used, the RF TEST SEQUENTIAL TONES DECODE display appears. Testing is then the same as under *Transmitter testing* above.

When the *[TONES]* key alone is used or both the *[TONES]* key and the *[SEQU GEN]* soft key are used, the RF TEST SEQUENTIAL TONES GENERATE display appears. Testing is then the same as under *Receiver testing* above.

To select another display, press the *[RETURN]* soft key.

Audio testing

Press the *[AF TEST]* key (9). One of the AUDIO INPUT/OUTPUT TEST displays appears (whichever was last selected). If an expanded display has appeared, press the *[AF TEST]* key again. The AUDIO INPUT/OUTPUT TEST display appears. See Fig. 3-25.

Press the *[TONES]* key. One of the tones displays appears (whichever was last selected). Either the *[SEQU DECODE]* or *[SEQU GEN]* soft key is shown.

When the *[TONES]* key alone is used or both the *[TONES]* key and the *[SEQU DECODE]* soft key are used, the AF TEST SEQUENTIAL TONES DECODE display appears. Testing is then the same as under *Transmitter testing* above.

When the *[TONES]* key alone is used or both the *[TONES]* key and the *[SEQU GEN]* soft key are used, the AF TEST SEQUENTIAL TONES GENERATE display appears. Testing is then the same as under *Receiver testing* above.

To select another display, press the *[RETURN]* soft key.

Display

Decoding

At the top of the screen, there is the TONES DECODE SEQUENCE box in which the decoded numbers are shown.

At the bottom of the screen, there is the TONE FREQUENCY PLAN box in which tone numbers and their frequencies are shown.

Generating

At the top of the screen, there is the TONES GENERATE SEQUENCE box in which the required tone numbers are shown.

At the bottom of the screen, there is the TONE FREQUENCY PLAN box in which tone numbers and their frequencies are shown.

The following settings are shown:-

- (a) TONE MODE. MANUAL, MANUAL / STEP, TONE BURST, CONTINUOUS TONES or NORMAL MOD GEN 2 according to which has been selected by using the *[tone mode]* and *[normal mod gen]* soft keys.
- (b) MOD GEN 2 DEVN or DEPTH. The modulation that has been set by using the [MOD GEN] key (14) and the DATA keys (24) and (26).
- (c) TONE STANDARD. The standard which has been selected by using one of the soft keys at the bottom of the screen.
- (d) FREQUENCY SHIFT. This is shown in inverse video when the *[freq shift]* soft key is used.
- (e) STANDARD TONE DURATION. The specified time of standard tones.
- (f) EXTENDED TONE DURATION. The specified time of extended tones.

Soft keys at left side of screen

Five keys are shown, as follows:-

- (a) *[CTCSS]* key. To select a CTCSS GENERATE display.
- (b) *[DTMF]* key. To select a DTMF GENERATE display.
- (c) *[DCS]* key. To select a DCS GENERATE display.
- (d) *[POCSAG]* key. To select the Rx TEST POCSAG PAGER TEST display.
- (e) *[RETURN]* key. To return to the previous mode.

Soft keys at right side of screen for decoding

Three keys are shown, as follows:-

- (a) *[clear sequ]* key. To clear the tone numbers in the TONES DECODE SEQUENCE box.
- (b) *[next group]* key. To list another group of ten tones. The cursor under the TONES DECODE SEQUENCE box moves along.
- (c) *[max error]* key. To set the tone frequency % error at which and above which the error is shown in inverse video. Enter the value by using the DATA keys (24) and the [%] key (26).
- (d) *[decode level]* key. To select the sequential tones decode type and level.

Soft keys at right side of screen for generating

Eight keys are shown, as follows:-

- (a) *[change sequ]* or *[clear sequ]* key. When this appears as the *[change sequ]* key, to enter new tone numbers. *[change sequ]* then changes to *[clear sequ]*. Press it to delete all the tone numbers in the TONES GENERATE SEQUENCE box. Tone numbers can be entered by using the DATA keys (24) and the [ENTER] key (26). *[clear sequ]* then changes back to *[change sequ]*. The tone numbers appear in the TONES GENERATE SEQUENCE box.
- (b) *[extend tone]* key. To extend the tone whose number has just been entered. Each extended tone number appears in inverse video. This key appears when the *[change sequ]* soft key is used.
- (c) *[tone mode]* key. To select MANUAL / STEP, TONE BURST or CONTINUOUS TONES. Press this key repeatedly. TONE BURST and CONTINUOUS TONES are available only after a tone sequence has been entered.
- (d) *[tone step]* key. For manual frequency selection only, to select a single frequency. When this key is first used, a triangular cursor appears at the first tone number. For each press, the triangular cursor moves to the next number. After the last number, the triangular cursor restarts at the first number. This key changes to *[tones on OFF]* when TONE BURST or CONTINUOUS TONES is selected.

- (e) *[tones on OFF]* or *[tones ON off]* key. For tone bursts or continuous tones only, to initiate a TONE BURST or CONTINUOUS TONES or to terminate CONTINUOUS TONES. This key appears when the [ENTER] key (26) has been pressed. This key changes to *[tone step]* when MANUAL / STEP is selected.
- (f) *[freq shift]* key. To precede entry of a frequency change by using the DATA keys (24) and the [%] key (26). To cancel the shift, enter 0%. Also used to change user-defined tone durations (see below).
- (g) *[copy std]* or *[enter std]* key. To copy a standard for modification to a user-defined standard. This key appears when the *[USER DEFINED]* or *[USER VARIANT]* soft key is used.
- (h) *[define tone]* key. To enter a standard tone number for modification for a user-defined standard by using the DATA keys (24) and the unit keys (26). This key appears when the *[USER DEFINED]* or *[USER VARIANT]* soft key is used.
- (j) *[normal mod gen]* key. To select the NORMAL MOD GEN 3 mode.

For using modulation generator 2 normally, six keys are shown, as follows:-

- (a) *[change sequ]* key. Not applicable.
- (b) *[extend tone]* key. Not applicable.
- (c) *[tone mode]* key. To select TONE BURST, CONTINUOUS TONES or MANUAL / STEP. Press this key repeatedly. TONE BURST and CONTINUOUS TONES are available only after a tone sequence has been entered.
- (d) *[freq shift]* key. Not applicable.
- (e) *[copy std]* or *[enter std]* key. Not applicable.
- (f) *[define tone]* key. Not applicable.

Soft keys at bottom of screen

Six keys are shown, as follows:-

- (a) *[CCIR]* or *[CCIR VARIANT]* key. To select the CCIR standard. Press this key repeatedly to select CCIR 1, 2, 3, 4 or 5. These have tone durations of 100, 70, 33, 40 and 20 ms and extended tone durations of 700, 700, 330, 400 and 200 ms respectively.
- (b) *[ZVEI]* or *[ZVEI VARIANT]* key. To select the ZVEI standard. Press this key repeatedly to select ZVEI 1, 2 or 3 or PZVEI.
- (c) *[DZVEI]* key. To select the DZVEI standard.
- (d) *[EEA]* key. To select the EEA standard.
- (e) *[EIA]* key. To select the EIA standard.
- (f) *[USER DEFINED]* or *[USER VARIANT]* key. To select a user-defined tone standard. Press this key repeatedly to select USER DEFINED 1, 2 or 3.

User-defined tone durations

Use the following procedure to change the user-defined tone durations:-

- (1) Press the *[USER DEFINED]* or *[USER VARIANT]* soft key to bring up the required user-defined standard.
- (2) Press the *[freq shift]* soft key, which changes to *[std durat'n]*; press this key again, which now changes to *[ext durat'n]*.
- (3) Use the DATA/ENTER keys to enter the required value for the standard tone duration.
- (4) Press the *[ext durat'n]* soft key and use the DATA/ENTER keys to enter the required value for the extended tone duration.

CTCSS

Introduction

Each tone number has a frequency as follows:-

Tone no.	Freq. Hz	Tone no.	Freq. Hz	Tone no.	Freq. Hz	Tone no.	Freq. Hz	Tone no.	Freq. Hz
01	67.0	11	94.8	21	131.8	31	171.3	41	203.5
02	69.4	12	97.4	22	136.5	32	173.8	42	206.5
03	71.9	13	100.0	23	141.3	33	177.3	43	210.7
04	74.4	14	103.5	24	146.2	34	179.9	44	218.1
05	77.0	15	107.2	25	151.4	35	183.5	45	225.7
06	79.7	16	110.9	26	156.7	36	186.2	46	229.1
07	82.5	17	114.8	27	159.8	37	189.9	47	233.6
08	85.4	18	118.8	28	162.2	38	192.8	48	241.8
09	88.5	19	123.0	29	165.5	39	196.6	49	250.3
10	91.5	20	127.3	30	167.9	40	199.5	50	254.1

Connections

For testing a receiver, connect its RF input connector to the RF TNC socket (36) (or RF N-type socket (35) if preferred).

Use the [RF SELECT] key (34) accordingly.

For duplex testing, connect the transceiver as under *Full duplex testing* on page 3-47.

For RF testing, connect the unit as under *RF input/output testing - non-expanded* on page 3-64.

Procedure

Receiver testing

Press the [Rx TEST] key (4). One of the RECEIVER TEST displays appears (whichever was last selected). If an expanded display has appeared, press the [Rx TEST] key again. The RECEIVER TEST display appears. See Fig. 3-11.

Set the RF frequency and RF level as under *Receiver testing - non-expanded* on page 3-38.

Press the [TONES] key. One of the tones displays appears (whichever was last selected). If it is shown, press the [CTCSS] soft key. When the [TONES] key or both keys are used, the Rx TEST CTCSS GENERATE display appears. See Fig. 3-29.

To enter the modulation deviation or depth, press the [MOD GEN] key (14) and then use the DATA keys (24) and (26).

To enter the required tone number, press the [select tone] soft key, use the DATA keys (24) and then press the [ENTER] key (26).

When required, shift all the selected frequencies by up to $\pm\%$ by pressing the [freq shift] soft key and one of the DATA keys 0 to 9 (24) with a minus sign when appropriate.

There are two tone modes. These are CTCSS and NORMAL MOD GEN 3. The current tone mode is shown on the display. To generate a tone, press the [tone on OFF] soft key. CTCSS appears. Press the [tone ON off] soft key to terminate the tone.

For the NORMAL MOD GEN 3 mode, press [normal mod gen] soft key. The tone is then as set on this generator in the Rx TEST mode.

To enter a modulation deviation or depth, press the [MOD GEN] key (14). Then, use the DATA keys (24) and (26).

To select another display, press the [RETURN] soft key.

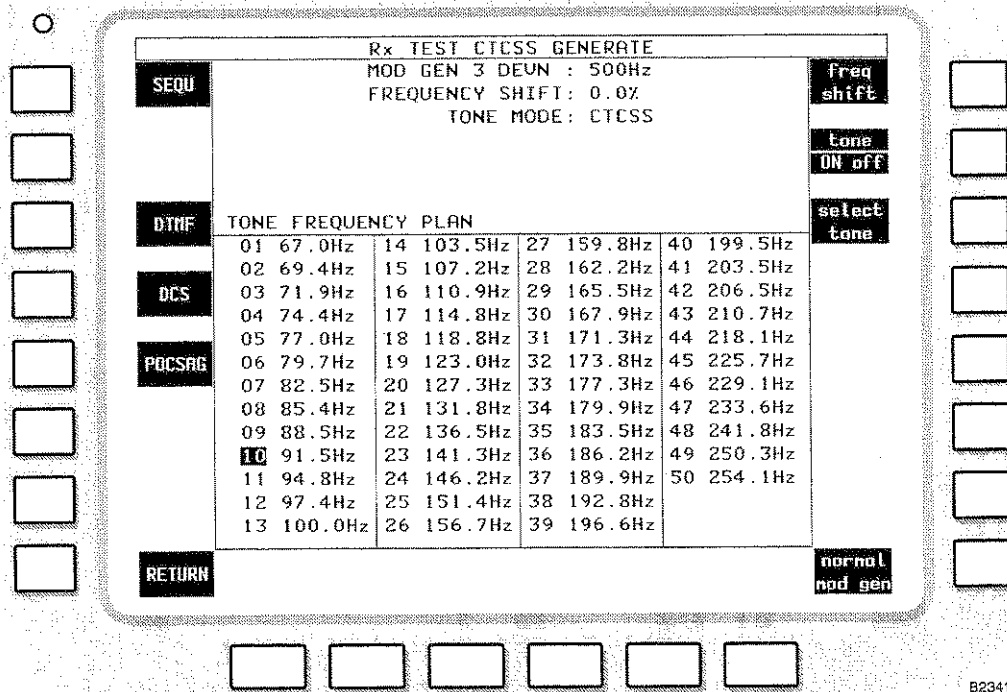

B2341

Fig. 3-29 Rx TEST CTCSS GENERATE display

Duplex testing

Press the [DUPLEX TEST] key. The DUPLEX TEST display appears.

Press the [TONES] key. One of the tones displays appears (whichever was last selected). If it is shown, press the [CTCSS] soft key.

Set the RF frequency and RF level as under *Receiver testing - non-expanded* on page 3-38.

When the [TONES] key alone is used or both the [TONES] key and the [CTCSS] soft key are used, the DUPLEX TEST CTCSS GENERATE/DECODE display appears. Testing is then the same as under *Receiver testing* above.

To select another display, press the [RETURN] soft key.

RF testing

Press the [RF TEST] key. The RF TEST display appears.

Set the RF frequency and RF level as under *Receiver testing - non-expanded* on page 3-38.

Press the [TONES] key. One of the tones displays appears (whichever was last selected). If it is shown, press the [CTCSS] soft key.

When the [TONES] key alone is used or both the [TONES] key and the [CTCSS] soft key are used, the RF TEST CTCSS GENERATE/DECODE display appears. Testing is then the same as under *Receiver testing* above.

To select another display, press the [RETURN] soft key.

Display

At the bottom of the screen, there is the TONE FREQUENCY PLAN box in which tone numbers and their frequencies are shown. The selected tone is shown in inverse video.

The following settings are shown:-

- (a) MOD GEN 3 DEVN. The modulation that has been set by using the [MOD GEN] key (14) and the DATA keys (24) and (26).

- (b) FREQUENCY SHIFT. This is shown in inverse video when the *[freq shift]* soft key is used.
- (c) TONE MODE. CTCSS or NORMAL MOD GEN 3 according to which has been selected by using the *[tone on OFF]* and *[normal mod gen]* soft keys.
- (d) TONE. The tone number that has just been entered prior to pressing the [ENTER] key. This appears when the *[select tone]* soft key is used.

Soft keys at left side of screen

Five keys are shown, as follows:-

- (a) *[SEQU]* key. To select a SEQUENTIAL TONES display.
- (b) *[DTMF]* key. To select a DTMF display.
- (c) *[DCS]* key. To select a DCS display.
- (d) *[POCSAG]* key. To select the Rx TEST POCSAG PAGER TEST display.
- (e) *[RETURN]* key. To return to the previous mode.

Soft keys at right side of screen

Four keys are shown, as follows:-

- (a) *[freq shift]* key. To precede entry of a frequency change by using the DATA keys (24) and the [%] key (26). To cancel the shift, enter 0%.
- (b) *[tone on OFF]* or *[tone ON off]* key. To initiate or terminate generation of a tone.
- (c) *[select tone]* key. To enter a tone number.
- (d) *[normal mod gen]* key. To select the NORMAL MOD GEN 3 mode. This key appears when the *[tone on OFF]* soft key is used.

DTMF (dual-tone multi-frequency)

Introduction

Each number is coded into two simultaneous frequencies as follows:-

Hz	1209	1336	1477	1633
697	1	2	3	A
770	4	5	6	B
852	7	8	9	C
941	*	0	#	D

The DTMF facility for all appropriate test modes is provided by an initial TEST DTMF GENERATE/DECODE display, linked to two displays, one providing a DTMF DECODE facility, and the other a DTMF GENERATE facility. Access to these generate and decode displays is via the *[expanded DTMF generate]* and *[expanded DTMF decode]* soft keys.

The level sensitivity for DTMF decoding does not range automatically; you must set up the decode level on the SET-UP OPTIONS: TONES DTMF screen. This can be accessed by pressing the *[decode level]* key from the DTMF DECODE screens (see Fig 3-30).

Alternatively, the same screen can be accessed through the HELP AND SET-UP menu using the key sequence [HELP SET-UP], *[SET-UP]*, *[TEST OPTIONS]*, *[tones decode]* and *[DTMF decode]*.

Refer to the section *Help and setting up* on page 3-124 for further details.

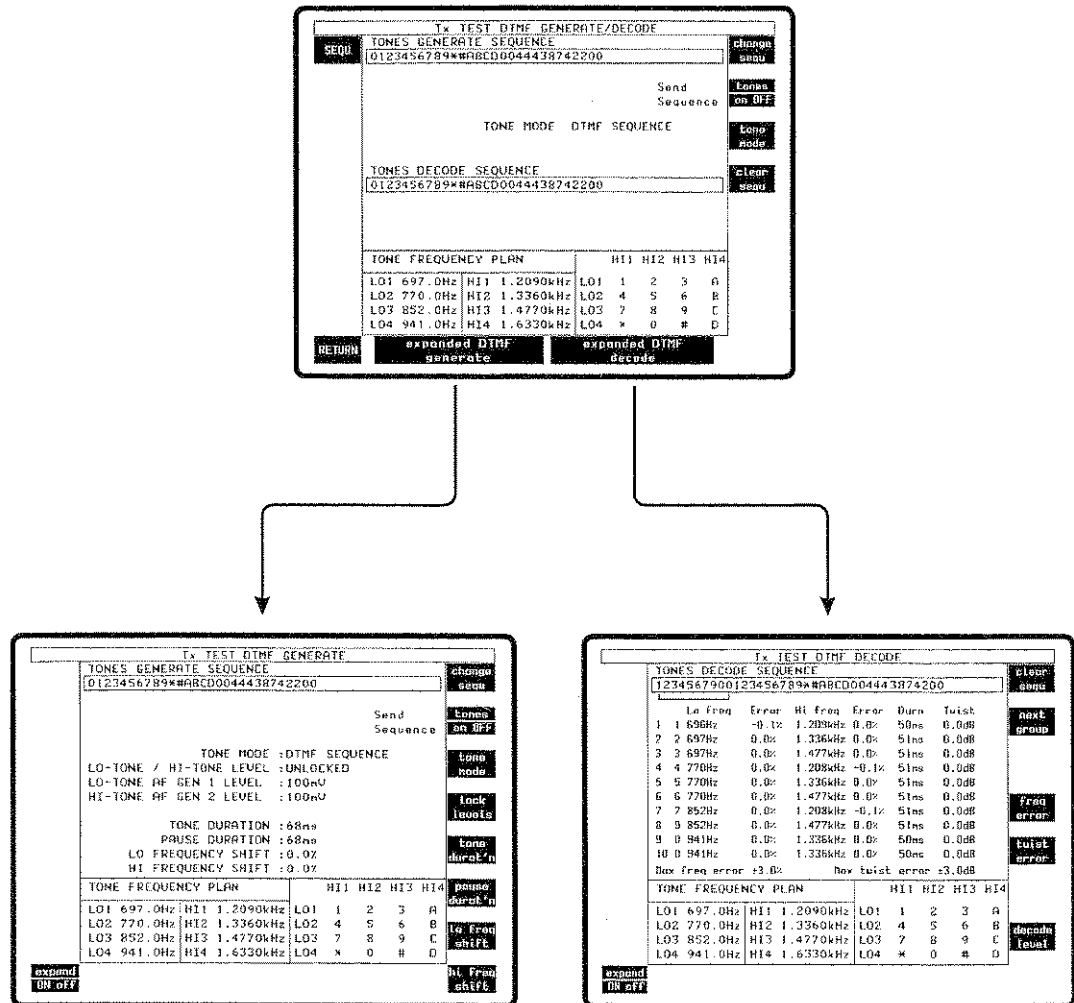

B2028

Fig. 3-30 DTMF screens

Connections

For transmitter testing, connect the transmitter as under *Transmitter testing - non-expanded* on page 3-19.

For receiver testing, connect the receiver as under *Receiver testing - non-expanded* on page 3-38.

For duplex testing, connect the transceiver as under *Full duplex testing* on page 3-47. The AF connections are not necessary in this mode.

For audio testing, connect the unit's AF input connector to the AF GEN OUTPUT socket (37). Connect the unit's AF output connector to the AF INPUT socket (38). Use the [AC DC] key (31) as required.

Procedure

Transmitter testing

Press the [Tx TEST] key (3). One of the TRANSMITTER TEST displays appears (whichever was last selected). If an expanded display has appeared, press the [Tx TEST] key again. The TRANSMITTER TEST display appears. See Fig. 3-6.

Set the RF frequency and RF level as under *Transmitter testing - non-expanded* on page 3-19.

Press the [TONES] key. One of the tones displays appears (whichever was last selected). If it is shown, press the [DTMF] soft key. When the [TONES] key or both keys are used, the Tx TEST DTMF GENERATE/DECODE display appears. See Fig. 3-31. This display permits the entry of a code sequence, and the sending of either the code sequence already entered or individual codes.

To enter the required tone numbers in the TONES GENERATE SEQUENCE box, press the [change sequ] soft key. This changes to [clear sequ]. To delete existing tone numbers, press the [clear sequ] soft key. Enter the tone numbers at the cursor by using the DATA keys (24). To re-position the cursor, use the VARIABLE control (33). Terminating data entry with the [ENTER] key (26) changes [clear sequ] back to [change sequ] and it becomes possible to use the [tone mode] soft key.

To send the tone sequence, press the [tone mode] soft key to select TONE MODE DTMF SEQUENCE and press the [tones on OFF] soft key. To send individual codes press the [tone mode] soft key to select TONE MODE MANUAL DTMF and press individual DATA numeric keys.

Tones returned from the receiver under test are decoded and shown in the TONES DECODE SEQUENCE box.

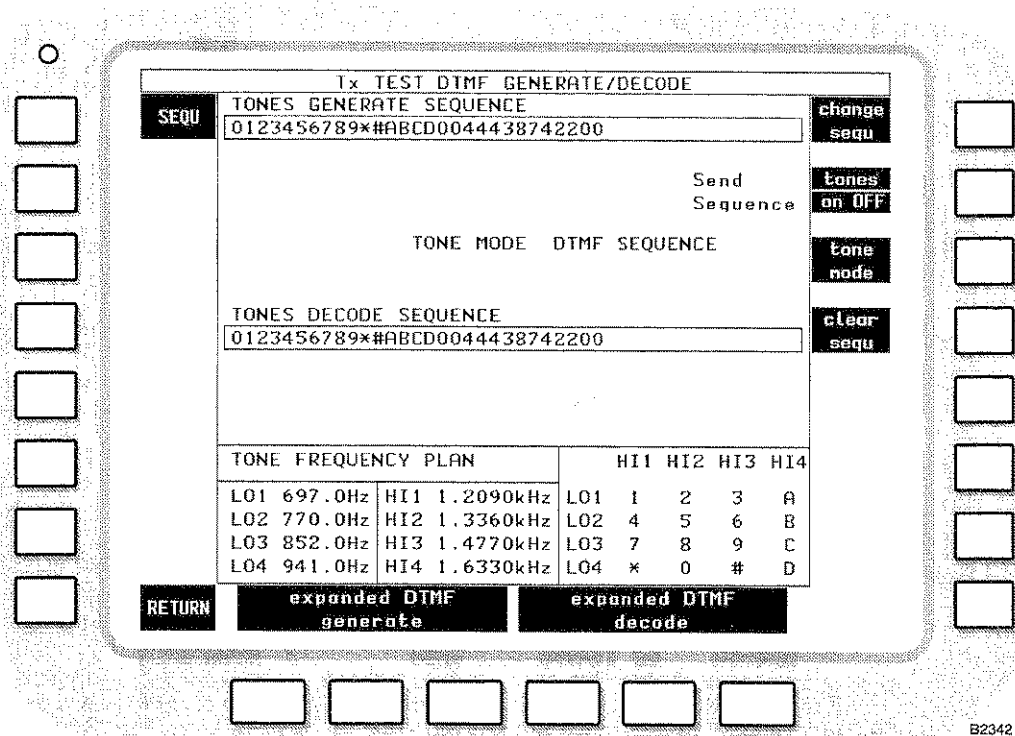

Fig. 3-31 Tx TEST DTMF GENERATE/DECODE

To display detailed information regarding the tones returned from the transmitter, press the [expanded DTMF decode] soft key. A display is shown giving the decoded tone sequence, and tabular details of a group of tones. See Fig. 3-32. The tabular display shows both high and low tones, their frequency error (as a percentage), the duration and twist. If a Max freq error limit has been set (indicated below the table) frequency errors outside the limit are shown highlighted in inverse video in the table. If a Max twist error limit has been set (indicated below the table) the Twist errors outside the limit are shown highlighted in inverse video in the table.

To set a maximum frequency error limit, press the [freq error] soft key and enter the limit using the DATA numeric keys and press the DATA [dB/%] key, and the new limit is displayed.

To set a maximum twist error limit, press the [twist error] soft key and enter the limit using the DATA numeric key and press the DATA [dB/%] key and the new limit is displayed.

Tone sequences with more than ten tones can be examined using the soft key *[next group]*.
 Return to the normal Tx TEST DTMF GENERATE/DECODE display by pressing the *[expand ON off]* soft key.

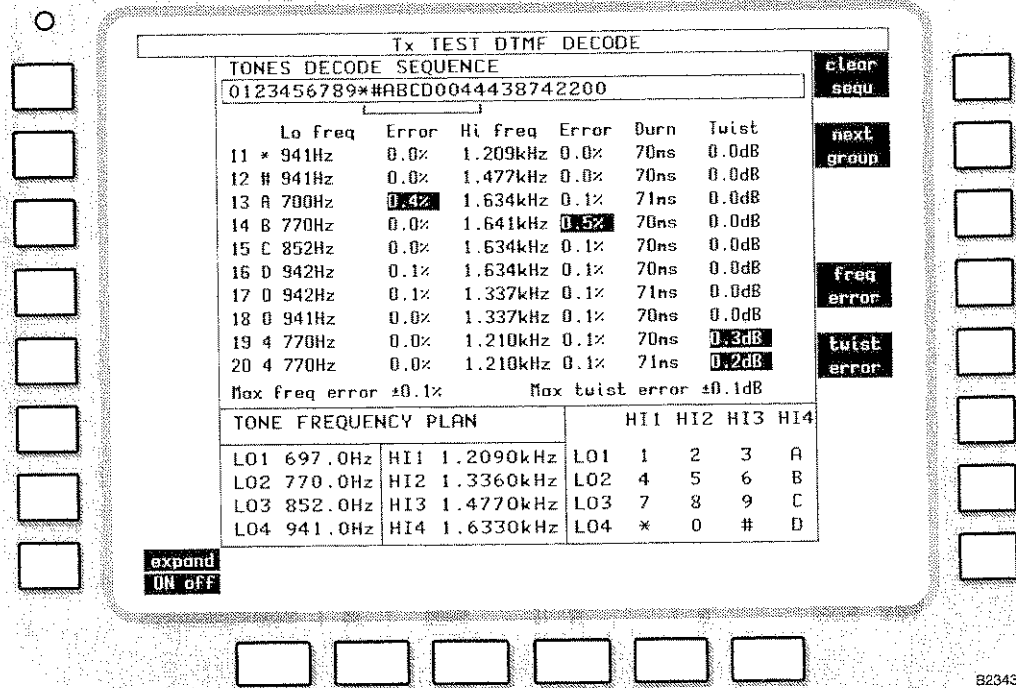

Fig. 3-32 Tx TEST DTMF DECODE

To alter tone parameters for test purposes, press the *[expanded DTMF generate]* soft key to display the Tx TEST DTMF GENERATE screen. See Fig 3-33 on page 3-112. The *[change sequ]*, *[tone mode]* and *[tones on OFF]* soft keys are used in the same way as in the GENERATE/DECODE display.

To enter the AF GEN levels (for each of the two tones), press the [AF GEN] key (15) once (for AF GEN 1 for LO-TONE) or twice (for AF GEN 2 for HI-TONE) and then use the DATA keys (24) and (26).

To enter the required tone numbers in the TONES GENERATE SEQUENCE box, press the *[change sequ]* soft key. This changes to *[clear sequ]*. To delete existing tone numbers, press the *[clear sequ]* soft key. Enter the tone numbers at the cursor by using the DATA keys (24). To reposition the cursor, use the VARIABLE control (33). After the last number, press the [ENTER] key (26). Then, *[clear sequ]* changes back to *[change sequ]* and it becomes possible to use the *[tone mode]* soft key.

To set the LO-TONE / HI-TONE LEVEL to LOCKED or UNLOCKED, press the *[lock levels]* or *[unlock levels]* soft key.

To set the tone duration, press the *[tone durat'n]* soft key. TONE DURATION appears in inverse video. Enter the duration by using the DATA keys (24) and (26).

To create an inter-tone pause, press the minus (-) DATA key (24). Repeat this for multiples of the tone duration. To set the pause duration, press the *[pause durat'n]* soft key. PAUSE DURATION appears in inverse video. Enter the duration by using the DATA keys (24) and (26).

When required shift either the LO-TONE or HI-TONE frequency using the soft keys *[lo freq shift]*, *[hi freq shift]* and the DATA keys. Terminate the entry with the [%] key.

To select another display, press the [RETURN] soft key.

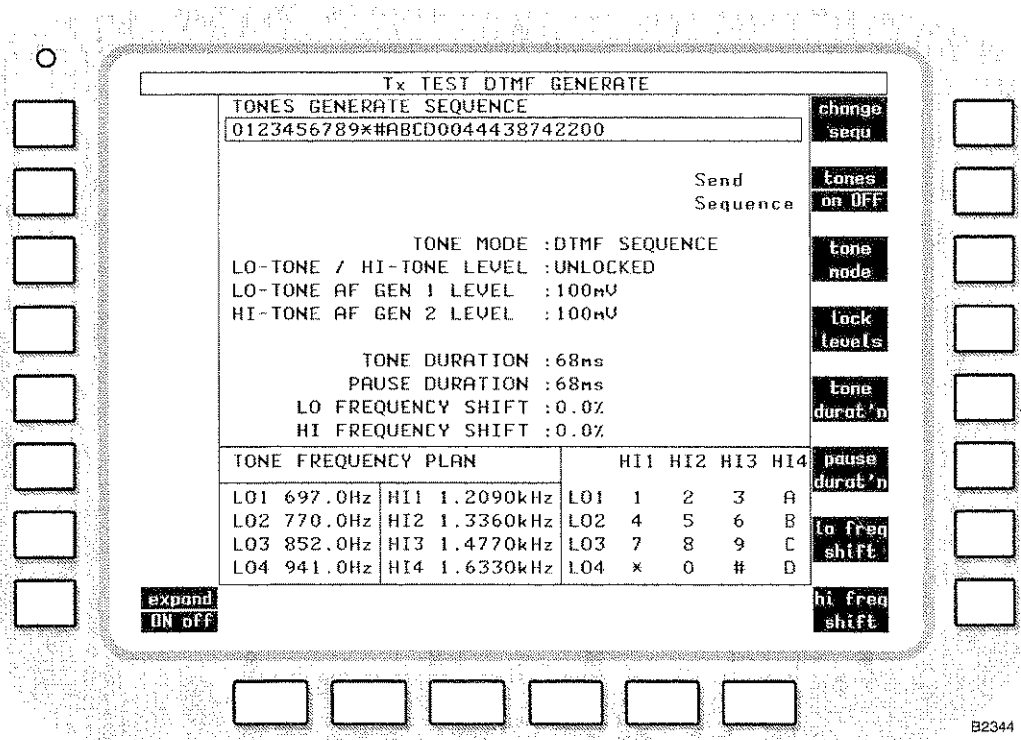

Fig. 3-33 Tx TEST DTMF GENERATE

Receiver testing

Press the [Rx TEST] key (4). One of the RECEIVER TEST displays appears (whichever was last selected). If an expanded display has appeared, press the [Rx TEST] key again. The RECEIVER TEST display appears. See Fig. 3-11.

Set the RF frequency and RF level as under *Receiver testing - non-expanded* on page 3-38.

Press the [TONES] key. One of the tones displays appears (whichever was last selected). If it is shown, press the [DTMF] soft key. When the [TONES] key or both keys are used, the Rx TEST DTMF GENERATE/DECODE display appears. This display permits the entry of a code sequence, and the sending of either the code sequence already entered or individual codes.

To enter the required tone numbers in the TONES GENERATE SEQUENCE box, press the [change sequ] soft key. This changes to [clear sequ]. To delete existing tone numbers, press the [clear sequ] soft key. Enter the tone numbers at the cursor by using the DATA keys (24). To re-position the cursor, use the VARIABLE control (33). Terminating data entry with the [ENTER] key (26) changes [clear sequ] back to [change sequ] and it becomes possible to use the [tone mode] soft key.

To send the tone sequence, press the [tone mode] soft key to select TONE MODE DTMF SEQUENCE and press the [tone on OFF] soft key. To send individual codes press the [tone mode] soft key to select MANUAL DTMF and press individual DATA numeric keys.

Tones returned from the receiver under test are decoded and shown in the TONES DECODE SEQUENCE box.

To display detailed information regarding the tones returned from the receiver, press the [expanded DTMF decode] soft key. A display is shown giving the decoded tone sequence, and tabular details of a group of tones. The tabular display shows both high and low tones, their frequency error (as a percentage), the duration and twist. If a Max freq error limit has been set (indicated below the table) frequency errors outside the limit are shown highlighted in inverse video in the table. If a Max twist error limit has been set (indicated below the table) the Twist errors outside the limit are shown highlighted in inverse video in the table.

To set a maximum frequency error limit press the [*freq error*] soft key and enter the limit using the DATA numeric keys; press the DATA [dB/%] key and the new limit is displayed.

To set a maximum twist error limit press the [*twist error*] soft key and enter the limit using the DATA numeric key and press the DATA [dB/%] key and the new limit is displayed.

Tone sequences with more than ten tones can be examined using the soft key [*next group*].

Return to the normal Rx TEST DTMF GENERATE/DECODE display by pressing the [*expand ON off*] soft key.

To alter tone parameters for test purposes, press the [*expanded DTMF generate*] soft key to display the Rx TEST DTMF GENERATE screen. See Fig. 3-34 on page 3-114. The [*change sequ*], [*tone mode*] and [*tones on OFF*] soft keys are used in the same way as in the GENERATE/DECODE display.

To enter the modulation deviation or depth (for each of the two tones), press the [MOD GEN] key (14) once (for modulation generator 1 for LO-TONE) or twice (for modulation generator 2 for HI-TONE) and then use the DATA keys (24) and (26).

To enter the required tone numbers in the TONES GENERATE SEQUENCE box, press the [*change sequ*] soft key. This changes to [*clear sequence*]. To delete existing tone numbers, press the [*clear sequ*] soft key. Enter the tone numbers at the cursor by using the DATA keys (24). To re-position the cursor, use the VARIABLE control (33). After the last number, press the [ENTER] key (26). Then, [*clear sequ*] changes back to [*change sequ*] and it becomes possible to use the [*tone mode*] soft key.

To set the LO-TONE / HI-TONE LEVEL to LOCKED or UNLOCKED, press the [*lock levels*] or [*unlock levels*] soft key.

To set the tone duration, press the [*tone durat'n*] soft key. TONE DURATION appears in inverse video. Enter the duration by using the DATA keys (24) and (26).

To create an inter-tone pause, press the minus (–) DATA key (24). Repeat this for multiples of the tone duration. To set the pause duration, press the [*pause durat'n*] soft key. PAUSE DURATION appears in inverse video. Enter the duration by using the DATA keys (24) and (26).

When required shift either the LO-TONE or HI-TONE frequency using the soft keys [*lo freq shift*], [*hi freq shift*] and the DATA keys. Terminate the entry with the [%] key.

To select another display, press the [RETURN] soft key.

Duplex testing

Press the [DUPLEX TEST] key. The DUPLEX TEST display appears.

Set the RF frequency and RF level as under *Receiver testing - non-expanded* on page 3-38.

Press the [TONES] key. One of the tones displays appears (whichever was last selected). If it is shown, press the [DTMF] soft key.

When the [TONES] key alone is used or both the [TONES] key and the [DTMF] soft key are used, the DUPLEX TEST DTMF GENERATE/DECODE display appears. The DTMF generate function is the same in duplex and receiver testing. The decode function is the same in duplex and transmitter testing as described above. No audio connections are required.

To select another display, press the [RETURN] soft key.

Audio testing

Press the [AF TEST] key. The AUDIO TEST display appears.

Press the [TONES] key. One of the tones displays appears (whichever was last selected). If it is shown, press the [DTMF] soft key.

When the [TONES] key alone is used or both the [TONES] key and the [DTMF] soft key are used, the AF TEST DTMF GENERATE DECODE display appears. The DTMF generate function is the same in audio and transmitter testing. The decode function is the same in audio and receiver testing as described above. No RF connections are required.

To select another display, press the [RETURN] soft key.

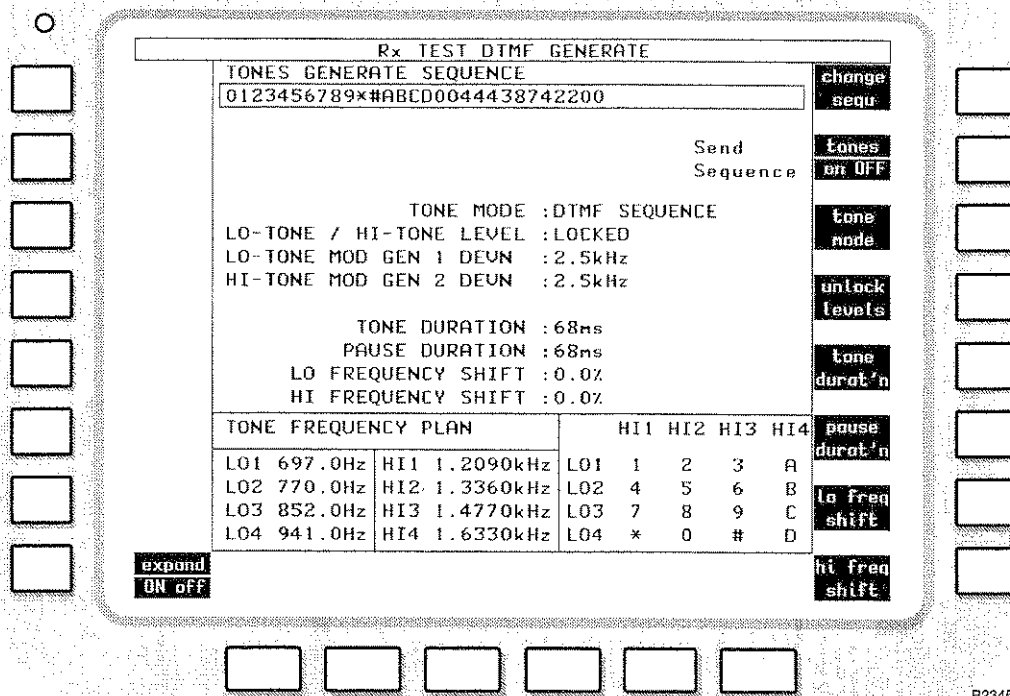

Fig. 3-34 Rx TEST DTMF GENERATE

Display (GENERATE/DECODE)

At the top of the screen, there is the TONES GENERATE SEQUENCE box in which the required tone numbers are entered.

In the centre of the screen, there is the TONES DECODE SEQUENCE box in which the returned codes are displayed.

At the bottom of the screen, there is the TONE FREQUENCY PLAN box in which the tone numbers and their frequencies are shown.

Soft keys at left side of screen

Depending on the mode selected all or a selection of the following keys will be displayed:-

- [SEQU] key. To select a SEQUENTIAL TONES display.
- [CTCSS] key. To select a CTCSS display.
- [DCS] key. To select a DCS display.
- [POCSAG] key. To select the Rx TEST POCSAG PAGER TEST display.
- [RETURN] key. To return to the previous mode.

Soft keys at right side of screen

Depending on the mode selected all or a selection of the following keys will be displayed:-

- [change sequ] or [clear sequ] key. When this appears as the [change sequ] key, to enter new tone numbers. [change sequ] then changes to [clear sequ]. Press it to delete all the tone numbers in the TONES GENERATE SEQUENCE box. Tone numbers can be entered by using the DATA keys (24) and the [ENTER] key (26). [clear sequ] then changes back to [change sequ]. The tone numbers appear in the TONES GENERATE SEQUENCE box.
- [tones on OFF] or [tones ON off] key. To send a DTMF SEQUENCE. Only displayed if the sequence and the mode have been entered correctly.

- (c) *[tone mode]* key. To select a DTMF SEQUENCE or MANUAL DTMF.
- (d) *[clear sequ]* key. To clear the codes received from the transmitter or receiver under test.

Soft keys at bottom of screen

Two keys are shown, as follows:-

- (a) *[expanded DTMF generate]* key. This key causes the appropriate DTMF GENERATE display to be shown, permitting test parameters to be applied.
- (b) *[expanded DTMF decode]* key. This key causes the appropriate DTMF DECODE display to be shown, providing tabular analysis of the codes returned from the transmitter or receiver under test.

Display (GENERATE)

At the top of the screen, there is the TONES GENERATE SEQUENCE box in which the required tone numbers are entered.

At the bottom of the screen, there is the TONE FREQUENCY PLAN box in which tone numbers and their frequencies are shown.

The following settings are shown:-

- (a) TONE MODE. DTMF SEQUENCE or MANUAL DTMF according to which has been selected by using the *[tones mode]* soft key.
- (b) LO-TONE / HI-TONE LEVEL. LOCKED or UNLOCKED according to which has been selected by using the *[lock levels]* or *[unlock levels]* soft key.
- (c) LO-TONE MOD/AF GEN 1 DEVN or DEPTH. The modulation that has been set by using either the MOD GEN (14) or [AF GEN] key (15) and the DATA keys (24) and (26).
- (d) HI-TONE MOD/AF GEN 2 DEVN or DEPTH. The modulation that has been set by using either the MOD GEN (14) or [AF GEN] key (15) and the DATA keys (24) and (26). Press the MOD GEN or [AF GEN] key twice when UNLOCKED has been selected by using the *[unlock levels]* soft key.
- (e) TONE DURATION. The specified time.
- (f) PAUSE DURATION. The specified time.
- (g) LO/HI FREQUENCY SHIFT. Shown in inverse video when the *[freq shift]* soft key is used.

Soft keys at right of screen

Three keys are similar to the GENERATE/DECODE display, with the following additions:-

- (a) *[lock levels]* or *[unlock levels]* key. To select LOCKED or UNLOCKED. LOCKED means that both tone levels are the same. Both are reset by a single entry. UNLOCKED means that the tone levels can be set independently.
- (b) *[tone durat'n]* key. To set the duration of every tone in the sequence.
- (c) *[pause durat'n]* key. To enter the duration of a pause.
- (d) *[freq shift]* key. To precede entry of a frequency change by using the DATA keys (24) and the [%] key (26). To cancel the shift, enter 0%.

Display (DECODE)

At the top of the screen, there is the TONES DECODE SEQUENCE box in which the returned tone numbers are displayed.

At the bottom of the screen, there is the TONE FREQUENCY PLAN box in which the tone numbers and their frequencies are shown.

In the centre of the screen, there is a tabular listing of the various parameters of a selected group of ten tones.

Soft keys at right of screen

These keys are similar to the GENERATE/DECODE display, with the following additions:-

- (a) *[clear sequ]* Clear sequence as described previously.
- (b) *[next group]* Selects the group of ten tones to be shown in tabular form. The cursor indicates the selected group.
- (c) *[freq error]*. Permits a test parameter limit to be set.
- (d) *[twist error]*. Permits a test parameter limit to be set.

DCS (digitally coded squelch)

Connections

For transmitter testing, connect the transmitter as under *Transmitter testing - non-expanded* on page 3-19.

For testing a receiver, connect its RF input connector to the RF TNC socket (36) (or RF N-type socket (35) if preferred).

Use the [RF SELECT] key (34) accordingly.

For duplex testing, connect the transceiver as under *Full duplex testing* on page 3-47.

For RF testing, connect the unit as under *RF testing - non-expanded* on page 3-64.

Procedure

Transmitter testing

Press the [Tx TEST] key (3). One of the TRANSMITTER TEST displays appears (whichever was last selected). If an expanded display appears, press the [Tx TEST] key again. The TRANSMITTER TEST display appears. See Fig. 3-6.

Set the RF frequency and RF level as under *Transmitter testing - non-expanded* on page 3-19.

Press the [TONES] key. One of the tones displays appears (whichever was last selected). If it is shown, press the [DCS] key. When the [TONES] key or both keys are used, the Tx TEST DCS DECODE display appears. See Fig. 3-35.

To enter the bit rate (frequency), press the *[bit rate]* key. BIT RATE appears in inverse video. Then use the DATA keys (24) and the [ENTER] key (26).

To select the bit polarity, press the *[Tx norm invert]* key. NORMAL or INVERT appears.

To set the DCS decode level or to select the DCS decode type, press the *[decode level]* key.

The SET-UP OPTIONS: TONES DCS display appears.

The DCS decode level menu allows selection of the decode type to be used and the decode level of each of the three modulation types.

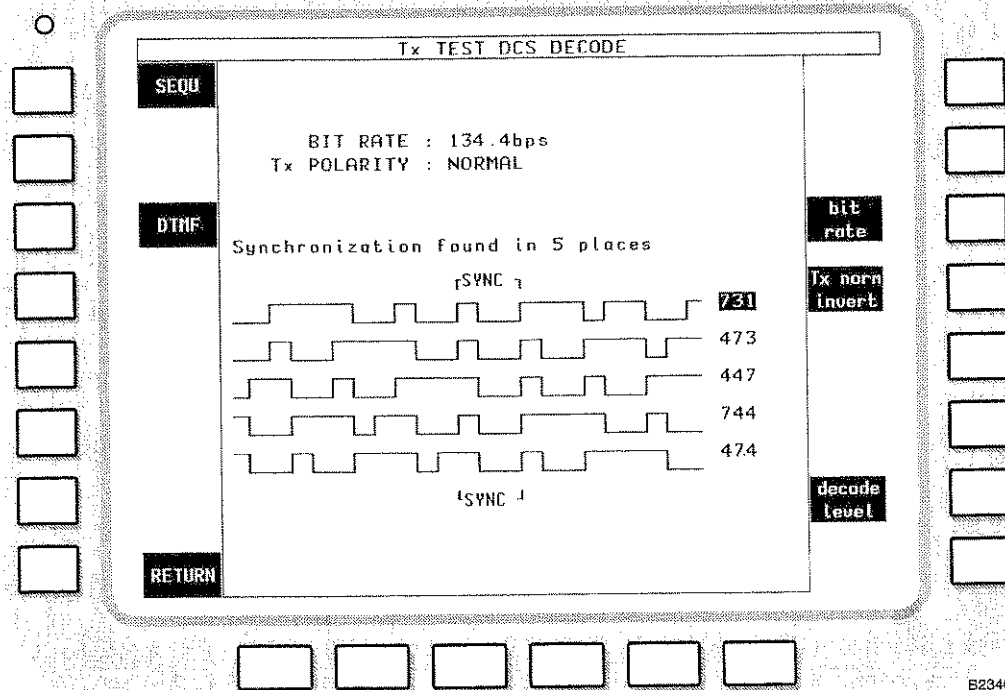

Fig. 3-35 Tx TEST DCS DECODE display

The selections available and the decode levels available for them are given below:-

FM 1 kHz, 3 kHz, 10 kHz, 30 kHz, 100 kHz.

AM 10%, 30%, 100%

PM 1 rad, 3 rad, 10 rad, 30 rad.

Selection is made by repeated presses of the appropriate key.

To commence a test, key the transmitter.

One of two possible message types will be displayed. These are:-

Synchronisation found in n places where n is 0-6

Synchronisation not found

If synchronisation is found in at least 1 place, the decoded data traces will appear on the display, with synchronisation bits aligned in the centre of the screen and the three-digit code to the right of each trace. The code number of a permitted code is shown in inverse video.

If the message states Synchronisation found in 0 places, a pulse train is being received that does not contain the synchronisation code recurring at 23 bit intervals.

If the message states Synchronisation not found, then a DCS signal is not being received by the test set.

The data displays will remain on the screen as long as the data is being received. If the received data changes, the new data is decoded and displayed. If the data signal ceases, then the message Synchronisation not found is displayed and the data clears.

Receiver testing

Press the [Rx TEST] key (4). One of the RECEIVER TEST displays appears (whichever was last selected). If an expanded display has appeared, press the [Rx TEST] key again. The RECEIVER TEST display appears. See Fig. 3-11.

Set the RF frequency and RF level as under *Receiver testing - non-expanded* on page 3-38.

Press the [TONES] key. One of the tones displays appears (whichever was last selected). If it is shown, press the [DCS] soft key. When the [TONES] key or both keys are used, the Rx TEST DCS GENERATE display appears. See Fig. 3-36.

To enter the bit rate (frequency), press the [bit rate] soft key. BIT RATE appears in inverse video. Then, use the DATA keys (24) and the [ENTER] key (26).

To enter the modulation deviation or depth, press the [MOD GEN] key (14) and then use the DATA keys (24) and (26).

To select the bit polarity, press the [Rx norm invert] soft key. NORMAL or INVERT appears.

To enter the required address, press the [code] soft key. DCS CODE appears in inverse video. Enter the 3-digit octal address by using the DATA keys (24) and the [ENTER] key (26).

To generate the signal, press the [DCS on OFF] soft key. The [normal mod gen] soft key appears. Press the [DCS ON off] soft key to terminate the tones.

When the [normal mod gen] soft key is used, the tone is as set on the modulation generator 3 in the Rx TEST mode.

To select another display, press the [RETURN] soft key.

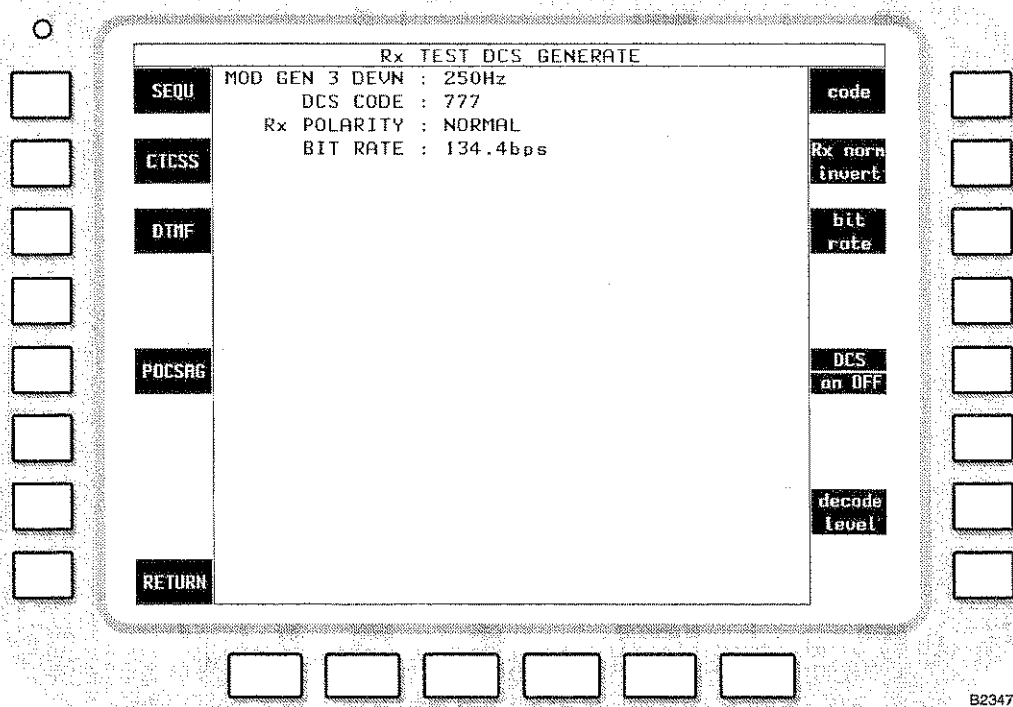

Fig. 3-36 Rx TEST DCS GENERATE display

Duplex testing

Press the [DUPLEX TEST] key. The DUPLEX TEST display appears.

Set the RF frequency and RF level as under *Receiver testing - non-expanded* on page 3-38.

Press the [TONES] key. One of the tones displays appears (whichever was last selected). If it is shown, press the [DCS] soft key.

When the [TONES] key or both keys are used, the DUPLEX TEST DCS GENERATE/DECODE display appears. Testing is then exactly the same as under *Receiver testing* above.

To select another display, press the [RETURN] soft key.

RF testing

Press the [RF TEST] key. The RF TEST display appears.

Set the RF frequency and RF level as under *Receiver testing - non-expanded* on page 3-38.

Press the [TONES] key. One of the tones displays appears (whichever was last selected). If it is shown, press the [DCS] soft key.

When the [TONES] key or both keys are used, the RF TEST DCS GENERATE/DECODE display appears. Testing is then the same as under *Receiver testing* above.

To select another display, press the [RETURN] soft key.

Display

The following settings are shown:-

- (a) MOD GEN 3 DEVN or DEPTH. The modulation that has been set by using the [MOD GEN] key (14) and the DATA keys (24) and (26).
- (b) DCS CODE. The address which has been entered by using the [code] soft key and the DATA keys (24) and the [ENTER] key (26).
- (c) POLARITY. NORMAL or INVERT according to which has been selected by using the [Rx norm invert] soft key.
- (d) BIT RATE. The frequency that has been set by using the [bit rate] soft key and the DATA keys (24) and the [ENTER] key (26).

Soft keys at left side of screen

Five keys are shown, as follows:-

- (a) [SEQU] key. To select a SEQUENTIAL TONES display.
- (b) [CTCSS] key. To select a CTCSS display.
- (c) [DTMF] key. To select a DTMF GENERATE display.
- (d) [POCSAG] key. To select the Rx TEST POCSAG PAGER TEST display.
- (e) [RETURN] key. To return to the previous mode.

Soft keys at right side of screen

Five keys are shown, as follows:-

- (a) [code] key. To enter the DCS address.
- (b) [Rx norm invert] key. To select the bit polarity.
- (c) [bit rate] key. To enter the frequency.
- (d) [DCS on OFF] key. To initiate or terminate generation of the DCS signal.
- (e) [decode level] key. To select the DCS decode type and level.
- (f) [normal mod gen] key. To select the normal modulation generator 3 mode. This key appears when the [DCS on OFF] soft key is used.

The DCS decode level menu allows selection of the decode type to be used and for the decode level of each of the three modulation types.

The selections available and the decode levels available for them are given below:-

FM 1 kHz, 3 kHz, 10 kHz, 30 kHz, 100 kHz
AM 10%, 30%, 100%
PM 1 rad, 3 rad, 10 rad, 30 rad.

POCSAG pager

Connections

For testing a receiver, connect its RF input connector to the RF TNC socket (36) (or RF N-type socket (35) if preferred).

Use the [RF SELECT] key (34) accordingly.

Procedure

Receiver testing

Press the [Rx TEST] key (4). One of the RECEIVER TEST displays appears (whichever was last selected). If an expanded display has appeared, press the [Rx TEST] key again. The RECEIVER TEST display appears. See Fig. 3-11.

Press the [TONES] key. One of the tones displays appears (whichever was last selected). If it is shown, press the [POCSAG] soft key. When the [TONES] key or both keys are used, the Rx TEST POCSAG PAGER TEST display appears. See Fig. 3-37.

Select the RF generator by using the [RF GEN] key (12) and then enter the frequency and level by using the [FREQ] key (16), the [LEVEL] key (17) and the DATA keys (24) and (26). Alternatively, adjust the frequency and level by using the VARIABLE control (33).

To enter an RF level increment, use the [INC] key (20). δ appears alongside the increment. Then, to increase or decrease a setting, press the appropriate [INC] key (32).

To enter a bit rate different from the default value of 512 b/s, press the [bit rate] soft key. BIT RATE appears in inverse video. Enter the bit rate (frequency) by using the DATA keys (24) and the [Hz] key (26).

To enter the modulation deviation, press the [MOD GEN] key (14) and then use the DATA keys (24) and (26).

To select the bit polarity, press the [Rx norm invert] soft key. NORMAL or INVERT appears.

To enter the RADIO IDENTITY code, press the [RIC] soft key. RADIO IDENTITY appears in inverse video. Then use the DATA keys (24) and the [ENTER] key (26).

To select the MESSAGE TYPE as TEXT MESSAGE (11), NUMERIC (00) or ALERT ONLY (01 or 10), press the [alert type] soft key repeatedly. To select the MESSAGE TYPE as NON-STANDARD, press the [message type] soft key.

To select the text message from nine options or the numeric message from three options, press the [select message] soft key repeatedly. The message is shown in the MESSAGE box with the number from 1 to 9 or 1 to 3.

Errors can be introduced in the 32-bit address codeword which is shown in the ERROR PATTERN box. To insert errors, press the [change errors] soft key. This changes to [clear errors]. To delete existing errors, press the [clear errors] soft key. Enter errors at the cursor by using the [error bit] soft key. At each error, E appears in inverse video. To re-position the cursor, use the VARIABLE control (33). After the last error, press the [ENTER] key (26). [clear errors] then changes back to [change errors].

To generate a preamble signal without a subsequent message, press the [pre-amb on OFF] soft key.

To generate the signal, press the [call pager] soft key.

To select another display, press the [RETURN] soft key.

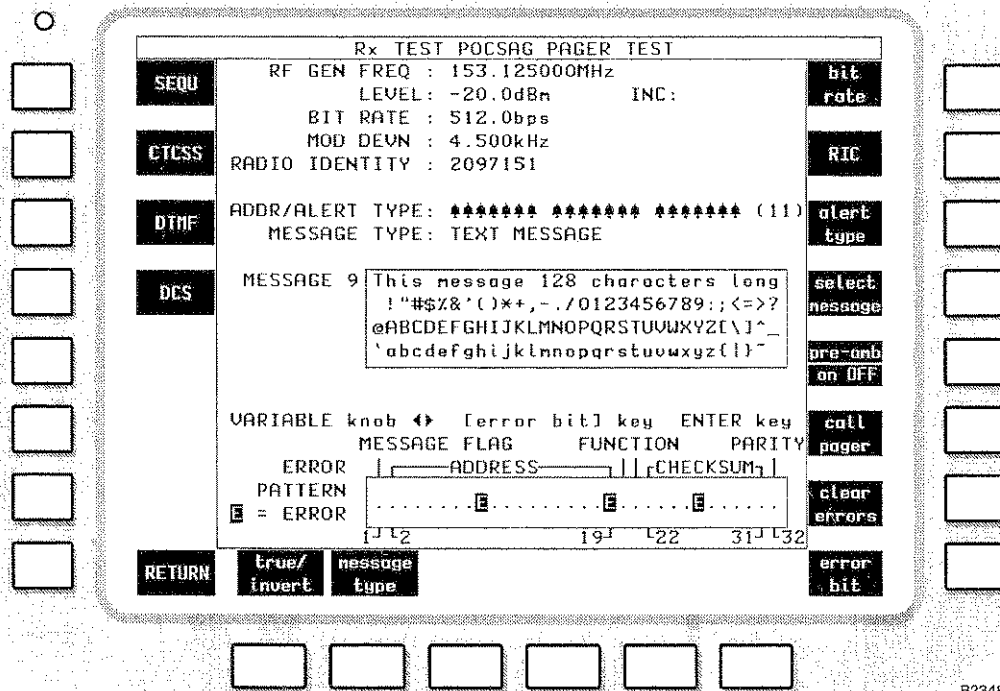

Fig. 3-37 Rx TEST POCSAG PAGER TEST display

Display

In the middle of the screen, there is the message box. The transmitted message is selected by using the [alert type], [select message] and [message type] soft keys. The message is then shown in the box.

At the bottom of the screen, there is the ERROR PATTERN box. Bit errors can be set by using the [error bit] soft key. Each bit error is then shown in the box.

The following settings are shown:-

- (a) RF GEN FREQ, LEVEL and INC. The settings of the RF generator. d appears alongside LEVEL when the increment is active.
- (b) BIT RATE. The frequency that has been set by using the [bit rate] soft key and the DATA keys (24) and the [ENTER] key (26).
- (c) MOD DEVN. The modulation that has been set by using the [MOD GEN] key (14) and the DATA keys (24) and (26). When the polarity is inverted by using the [true/invert] soft key, INVERT appears in inverse video.
- (d) RADIO IDENTITY. The code which has been entered by using the [RIC] soft key and the DATA keys (24) and the [ENTER] key (26).
- (e) ADDR/ALERT TYPE. The ringing mimic for and the number of the message as selected by using the [alert type] soft key.
- (f) MESSAGE TYPE. ALERT ONLY, NUMERIC or TEXT MESSAGE according to which has been selected by using the [alert type] and [message type] soft keys.

Soft keys at left side of screen

Five keys are shown, as follows:-

- (a) *[SEQU]* key. To select a SEQUENTIAL TONES display.
- (b) *[CTCSS]* key. To select a CTCSS display.
- (c) *[DTMF]* key. To select a DTMF GENERATE display.
- (d) *[DCS]* key. To select a DUPLEX TEST DCS GENERATE display.
- (e) *[RETURN]* key. To return to the previous mode.

Soft keys at right side of screen

Eight keys are shown, as follows:-

- (a) *[bit rate]* key. To enter the frequency.
- (b) *[RIC]* key. To enter the radio identity code.
- (c) *[alert type]* key. To select ALERT ONLY (01 or 10), TEXT MESSAGE (11) or NUMERIC (00).
- (d) *[select message]* key. To select one of nine text messages (numbered 1 to 9) or one of three numeric message (numbered 1 to 3) as shown in the MESSAGE box. This key appears when TEXT MESSAGE or NUMERIC has been selected by using the *[alert type]* soft key.
- (e) *[pre-amb on OFF]* key. To initiate or terminate generation of the preamble signal.
- (f) *[call pager]* key. To initiate generation of the pager signal.
- (g) *[change errors]* or *[clear errors]* key. When this appears as the *[change errors]* key, to enter new errors. *[change errors]* then changes to *[clear errors]*. Press it to delete all the errors in the ERROR PATTERN box. Errors can be entered by using the VARIABLE control (33) and the *[error bit]* soft key. Each error is shown by E in inverse video. After the last error, press the [ENTER] key (26). *[clear errors]* then changes back to *[change errors]*.
- (h) *[error bit]* key. When the *[change errors]* soft key has been used, to create an error in the bits in the ERROR PATTERN box at the position of the cursor. The cursor can be moved by using the VARIABLE control (33).

Soft keys at bottom of screen

Two keys are shown, as follows:-

- (a) *[true/invert]* key. To invert bit modulation.
- (b) *[message type]* key. To select a non-standard ALERT ONLY, NUMERIC or TEXT MESSAGE. NON-STANDARD is shown alongside in inverse video.

Systems testing

If a TONES display is on the screen, press the [RETURN] soft key. If a HELP AND SET-UP display is on the screen, press the [return] soft key. Press the [SYSTEMS] key (7).

If the SYSTEMS mode has been used since the last power-on, the display that was last selected re-appears. Otherwise, the SYSTEM SELECTION menu appears. The available systems are as follows:-

Option 10	NMT Cellular Radio.
Option 11	AMPS Cellular Radio.
Option 12	TACS Cellular Radio.
Option 13	MPT1327 Trunked Radio.
Option 14	Private Mobile Radio (PMR).
Option 21	GSM Digital Cellular Radio.

For each system, see the appropriate Operating Manual Supplement. The MI part numbers of these manuals will be found in *About this manual* at the front of this manual.

After a system has been selected, the system continues to operate when other (non-system) modes are selected. The system type is shown in the top left corner of the screen.

To exit from the system, press the [no system] soft key on the SYSTEM SELECTION menu.

Help and setting up

Procedure

Press the [HELP SET-UP] key (10). The HELP AND SET-UP menu appears. See Fig. 3-38.

On the HELP AND SET-UP menu and sub-menus, press the [return] soft key to return to the previous display.

While the HELP AND SET-UP menu or HELP TOPIC menu is displayed, press any of the hard keys on the front panel to display a description of the function of that key.

On each of the displays, repeatedly press the [return] soft key to return to the HELP AND SET-UP menu.

On the HELP AND SET-UP menu, press any of the soft keys to access one of the facilities that are shown.

Display - HELP AND SET-UP menu

Soft keys at left side of screen

One key is shown, as follows:-

[RESET] key. To restore the settings of the front panel controls (except those of the analogue controls) to the state at power-on.

Soft key at right side of screen

Seven keys are shown, as follows:-

- (a) [Copy Screen] key. To send a file of the HELP AND SET-UP menu to a printer. After using this key, press the [COPY] key (21).
- (b) [HELP TOPICS] key. To display the HELP TOPICS menu. See under *Help on topics* below.
- (c) [SET-UP] key. To display the SET-UP menu. See under *Setting up* below.

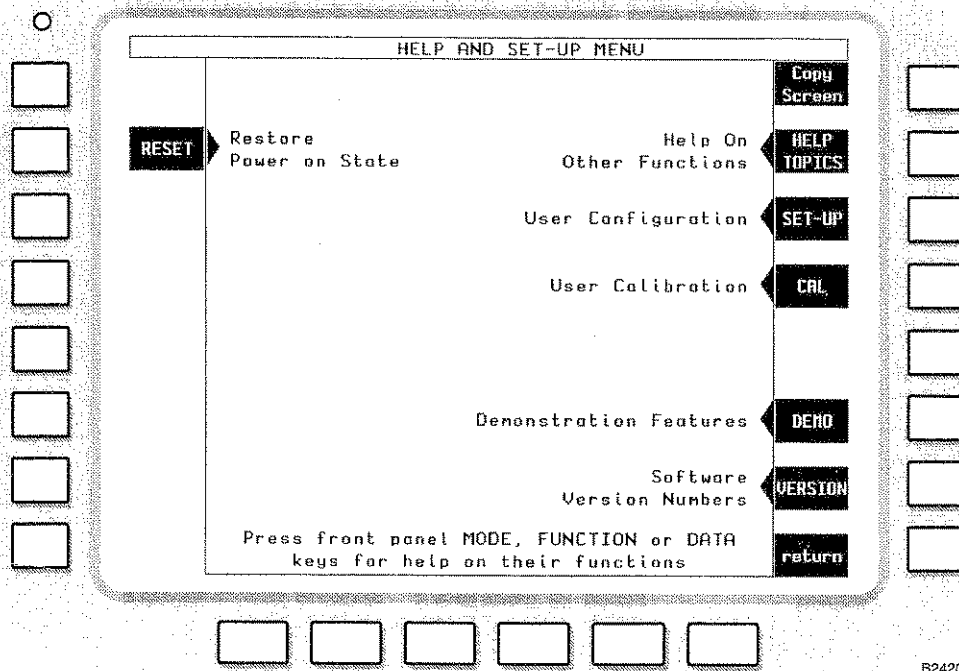

Fig. 3-38 HELP AND SET-UP menu

HELP AND SET UP operation

- (d) *[CAL]* key. To display the CALIBRATION / SELF-TEST menu.
See under *Calibration* below.
- (e) *[DEMO]* key. To display the FEATURE DEMONSTRATIONS menu.
See under *Demonstrations* below.
- (f) *[VERSION]* key. To display the SOFTWARE VERSION NUMBER display.
See under *Software versions* below.
- (g) *[return]* key. To return to the previous display.

While the HELP AND SET-UP menu is displayed, or whenever the *[HELP TOPICS]* soft key has been selected, pressing any of the front panel keys displays help information relating to that key's function.

Fig. 3-39 on page 3-125 shows the HELP AND SET-UP menu structure, permitting you to quickly navigate to any help or set-up option. The figure also shows the settings which may be selected, or (for numeric entries) the method of entry.

Each menu level is shown with the menu title at the top, with the available soft key options below, linked where appropriate to the next menu selected by that soft key.

Where a soft key allows a selection from a list of values, those values are shown, with the top value in the list representing the currently configured value. Where a numeric value is required to be entered, the legend DATA + ENTER or DATA + units is shown. For simplicity, where one of a number of options is selected via a series of soft keys, Fig. 3-39 shows a list rather than individual soft keys linked to options.

The *[return]* soft key operation is not shown on Fig. 3-39.

Help on topics

You can call up help displays for the use of the hard keys and for various topics.

Press the *[HELP SET-UP]* key (10). The HELP AND SET-UP menu appears. See Fig. 3-38.

Press the *[HELP TOPICS]* soft key. The HELP : HELP TOPICS menu appears.

On the HELP TOPICS menu, press the *[return]* soft key to return to the HELP AND SET-UP menu.

On the HELP TOPICS menu, press the soft key for any of the topics that are shown. For each of these, a descriptive display appears.

On each display, press the *[return]* soft key to return to the HELP TOPICS menu.

The top level HELP AND SET-UP menu and all HELP TOPICS sub-menus have a *[Copy Screen]* soft key which causes the current display to be printed; while in these menus pressing the instrument's *[COPY]* function key results in the display of help information relating to the COPY facility, rather than copying the display to the printer.

Setting up

You can configure the 2965 to your own requirements.

Press the *[HELP SET-UP]* key (10). The HELP AND SET-UP menu appears; see Fig. 3-38.

Press the *[SET-UP]* soft key. The SET-UP menu appears.

On the SET-UP menu, press the soft key for any of the subjects that are shown.

On each display, press the *[return]* key to return to the SET-UP menu.

On the SET-UP menu, six soft keys are shown, as follows:-

- (a) *[TEST OPTIONS]* key. To select an option on the SET-UP : TEST OPTIONS menu. See under *Test options* below.
- (b) *[INPUT OUTPUT]* key. To select an option on the INPUT / OUTPUT menu. See under *Inputs and outputs* (page 3-132).
- (c) *[MISC]* key. To select an option on the SET-UP: CUSTOMISE / MISCELLANEOUS menu. See under *Miscellaneous* (page 3-133).
- (d) *[DEFAULT VALUES]* key. To select an option on the DEFAULT VALUES menu. See under *Default values* (page 3-133).
- (e) *[COUNTRY]* key. To select an option on the COUNTRY SPECIFIC PARAMETERS menu. See under *Country* (page 3-134).
- (f) *[return]* key. To return to the SET-UP menu.

Test options

You can determine tuning, modulation and demodulation set-ups.

On the SET-UP menu, press the *[TEST OPTIONS]* soft key. The SET-UP : TEST OPTIONS menu appears.

Press the appropriate soft key and then, on subsidiary menus, press the appropriate soft key once or repeatedly to set each parameter.

On each display, press the *[return]* soft key to return to the previous menu.

On the SET-UP : TEST OPTIONS menu, and on subsidiary menus, the soft keys are as follows:-

Soft key	Soft key	Function
	<i>[tones decode]</i>	To select SET-UP OPTIONS: TONES menu.
	<i>[SEQ decode]</i>	To set sequential tones decode sensitivity.
	<i>[DTMF decode]</i>	To set DTMF decode sensitivity.
	<i>[DCS decode]</i>	To set DCS decode sensitivity.

On the SET-UP OPTIONS: TONES menu, and on subsidiary menus, the soft keys are as follows:-

<i>[SEQ decode]</i>		To set sequential tones receive sensitivities as below.
	<i>[SEQ AF Level]</i>	To set the AF tones minimum decode level to 1, 3, 10, 30, 100 or 300 mV or 1, 3, 10 or 30 V.
	<i>[SEQ FM Level]</i>	To set the Tx tones minimum FM decode level to 1, 3, 10, 30, 100 or 300 kHz.
	<i>[SEQ AM Level]</i>	To set the Tx tones minimum AM decode level to 10, 30 or 100%.
	<i>[SEQ PM Level]</i>	To set the Tx tones minimum F decode level to 1, 3, 10 or 30 rad.
	<i>[Audio Filter]</i>	To set the audio filter to 0.3 to 3.4 kHz, CCITT (or CMESS), 20 kHz LP or 300 Hz LP.
	<i>[Mod Filter]</i>	To set the modulation filter to 0.3 to 3.4 kHz, CCITT (or CMESS), 20 kHz LP, 5 kHz LP or 300 Hz LP.

Soft key	Soft key	Function
[DTMF decode]		To set DTMF receive sensitivities as below.
	[DTMF AF Level]	To set the Rx tones maximum decode level per tone for DTMF decode in AF and Rx TEST mode..
	[DTMF FM Level]	To set the Tx tones maximum FM decode level per tone for DTMF decode in Duplex and Tx TEST modes..
	[DTMF AM Level]	To set the Tx tones maximum AM decode level per tone for DTMF decode in Duplex and Tx TEST modes.
	[DTMF PM Level]	To set the Tx tones maximum PM decode level per tone for DTMF decode in Duplex and Tx TEST modes.
	[Demod Type]	To set the demod type for receiving DTMF in Duplex and Tx TEST modes..
[DCS decode]		To set DCS receive sensitivities as below.
	[DCS FM Level]	To set the Tx tones minimum FM decode level to 1 kHz, 3 kHz, 10 kHz, 30 kHz or 100 kHz.
	[DCS AM Level]	To set the Tx tones minimum AM decode level to 10 %, 30 % or 100 %
	[DCS PM Level]	To set the Tx tones minimum FM decode level to 1 rad, 3 rad, 10 rad or 30 rad.
	[Demod Type]	To set the demod type for receiving DCS in Tx, Duplex & RF modes.

On the SET-UP : TEST OPTIONS menu, and on subsidiary menus, the soft keys are as follows:-

Soft key	Soft key	Function
[misc]		To set miscellaneous options as shown below.
	[Toggle PD/EMF]	To set the RF generator level to PD (loaded) or EMF (unloaded).
	[res'n & rate]	To set the RF counter resolution to 1 or 10 Hz.
	[FM Avg Count]	To set the number of readings (in the range 1 to 31) which are averaged by using the DATA keys (24) and the [ENTER] key (26).
	[AM Avg Count]	To set the number of readings (in the range 1 to 31) which are averaged by using the DATA keys (24) and the [ENTER] key (26).
	[PM Avg Count]	To set the number of readings (in the range 1 to 31) which are averaged by using the DATA keys (24) and the [ENTER] key (26).
	[Demod Noise]	To set the FM noise correction to ON or OFF. The normal setting is ON.
	[Φ Mod correct]	To set the ΦM detector frequency response correction below 1 kHz to ON or OFF. The normal setting is ON.
	[rms or peak]	To set the type of demodulation measurement.

Soft key	Soft key	Function
<i>[sinad & distn]</i>		To set up the frequency and source of the frequency used for receiver and transmitter distortion and SINAD measurements.
Rx DISTN	<i>[Slave Mod Gen]</i>	To select the frequency source at which the receiver and duplex distortion and SINAD testing is done, either USER or GEN1. USER frequency is set as below and is the factory default condition.
	<i>[Mod Freq]</i>	The USER frequency when selected as above is set using the DATA keys. Factory default 1 kHz.
	<i>[Slave AF Gen]</i>	To select the frequency source at which AF TEST distortion and SINAD testing is done, either USER or GEN1. USER frequency is set as below and is the factory default condition.
	<i>[AF User Freq]</i>	The USER frequency when selected as above, set using the DATA keys. Factory default 1 kHz
	<i>[SINAD Window]</i>	Variations of instantaneous audio SINAD measurements that fall outside the displayed SINAD value minus the SINAD window are ignored. Reducing the SINAD window below the 4 dB factory default value will reduce jitter on the displayed average SINAD value. This is of use in Rx sensitivity measurements where some receivers tend to squelch the audio creating measurement problems.
	<i>[Audio SINAD]</i>	The factory default Audio SINAD average count is set to 6. This is the number of instantaneous measurements that are averaged together to form the displayed SINAD value. Increasing this number will reduce the jitter on noisy measurements while at the same time reducing the response time. This is useful for Rx sensitivity measurements at low SINAD levels.
Tx DISTN	<i>[Slave AF Gen]</i>	To select the frequency source at which the transmitter and duplex distortion testing is done, either USER or GEN1. USER frequency is set as below and is the factory default condition..
	<i>[AF User Freq]</i>	The USER frequency when selected as above is set using the DATA keys. Factory default 1 kHz.
	<i>[Slave Mod Gen]</i>	To select the frequency source at which RF TEST distortion testing is done, either USER or GEN1. USER frequency is set as below and is the factory default condition.
	<i>[Mod Freq]</i>	The USER frequency when selected as above is set using the DATA keys. Factory default 1 kHz.

Soft key	Soft key	Function
	[<i>track'g gen</i>]	To select between normal and offset tracking generator modes as described in the <i>User options</i> section of this chapter.
	[<i>normal</i>]	The generator and receiver are at the same frequency.
	[<i>doubler</i>]	The receiver is at twice the frequency of the generator.
	[<i>divider</i>]	The receiver is at half the frequency of the generator.
	[<i>up mixer</i>]	The receiver is higher than the generator with an offset dependent in the mixer LO frequency.
	[<i>down mixer</i>]	The receiver is lower than the generator with an offset dependent on the mixer LO. frequency.
	[<i>mixer freq</i>]	The mixer L.O. frequency is used to calculate the generator frequency together with the up/down mixer mode selection and the receiver frequency.
	[<i>freq plan</i>]	To set the Tx and Rx generator frequency plans as below.
	[<i>Show Chan/Fr</i>]	To determine whether the channel number CHAN or the channel frequency FREQ is shown on displays.
	[<i>Rx=Tx Offset</i>]	To enter the offset frequency by using the DATA keys (24) and (26).
	[<i>Channel Rx</i>]	To enter the RF GEN frequency for channel 1 by using the DATA keys (24) and (26).
	[<i>Channel Step Rx</i>]	To enter the RF GEN frequency increment by using the DATA keys (24) and (26).
	[<i>Channel Tx</i>]	To enter the Tx frequency for channel 1 by using the DATA keys (24) and (26).
	[<i>Channel Step Tx</i>]	To enter the Tx frequency increment by using the DATA keys (24) and (26).
	[<i>filter options</i>]	To set the AF and demodulation filter selections as below.
	[<i>Demod Filters</i>]	To determine whether NONE is included or not included in demodulation filter selections.
	[<i>Psoph Filter</i>]	To determine whether CCITT or CMESS is included in filter selections.
	[<i>af/mod setup</i>]	To select either 3 audio and 3 modulation generators to 20 kHz or 1 generator to 100 kHz which can be assigned to either audio or modulation.
	[<i>af/mod mode</i>]	To select the mode.
	[<i>afgen pad</i>]	Specifies whether or not an external 20 dB pad is connected to the AF GEN OUTPUT socket.
	[<i>rf port setup</i>]	Sets RF I/O functions as shown below.
	[<i>set offset</i>]	Sets RF generator level offset (page 3-17).
	[<i>set offset</i>]	Sets receiver level offset (page 3-17).

Inputs and outputs

You can determine parameters for inputs to and outputs from the 2965.

On the SET-UP menu, press the *[INPUT OUTPUT]* soft key. The SET-UP : INPUT / OUTPUT menu appears.

Press the appropriate soft key and then, on subsidiary menus, press the appropriate soft key once or repeatedly to set each parameter.

On each display, press the *[return]* soft key to return to the previous menu.

On the INPUT / OUTPUT menu, and on subsidiary menus, the soft keys are as follows:-

Soft key	Soft key	Function
<i>[remote options]</i>		To set the type of remote control as below.
	<i>[Remote Input]</i>	To set the Test Set to receive remote commands through the RS232 port, through the GPIB port or through either.
	<i>[Remote Output]</i>	To set the Test Set to transmit remote commands through the RS232 port or through the GPIB port.
<i>[printer options]</i>		To set the printer port and printer type as below.
	<i>[printer port]</i>	To set the output port to parallel or serial.
	<i>[printer driver]</i>	To select Epson FX80, Epson FX100, HP Laserjet (III/IV), compatible, at 100,150, or 300 dots per inch.
<i>[GPIB set-up]</i>		To set the configuration of the IEEE 488.1 communication as below.
	<i>[TALK MODE]</i>	To set the mode to talk only or talker and listener.
	<i>[ADDRESS]</i>	To enter the address number by using the DATA keys (24).
	<i>[EOS Char]</i>	To set the end of string character to decimal 0 or 10, hexadecimal 0 or A.
	<i>[488.1 Spec]</i>	To display the IEEE 488 implementation.
<i>[SERIAL set-up]</i>		To set the configuration of the EIA/RS232 port as below.
	<i>[Baud Rate]</i>	To set the RS 232 port to 75, 150, 300, 600, 1200, 2400, 4800, 9600 or 19200 bit/s.
	<i>[Parity]</i>	To set the parity bit to none, odd or even.
	<i>[Data Bits]</i>	To set the number of data bits to 7 or 8.
	<i>[Stop Bits]</i>	To set the number of stop bits to 1 or 2.
	<i>[Duplex Echo]</i>	To set the echo to on or off.

Soft key	Soft key	Function
[BNC set-up]		To set the configuration of the BNC sockets on the front or rear panel as below.
	[AF 600Ω]	For use with 600Ω Audio accessory. Selecting the [dBm] key (26) whilst measuring AF LEVEL changes the units to dBm.
	[INT/EXT REF]	To use the internal reference and feed the internal reference to the EXT REF socket (46) or to use the external reference which is fed from the EXT REF socket.
[CARD set-up]		To set the operation of the memory card as below.
	[FORMAT CARD]	To format a blank Memory Card (Part no. 59000-189M). When one is present, Format in Progress appears followed by Format Complete.

Miscellaneous

The [MISC] key on the SET-UP menu brings up the SET-UP: CUSTOMISE / MISCELLANEOUS menu. From here you can access the Screen Saver, via the [screen saver], [saver delay] and [saver test] keys. The [option enable] key displays a screen which allows you to enable additional system software, after receiving the relevant enable code from Marconi Instruments.

Screen saver

You can customize the Screen Saver feature to personal preferences.

The period of inactivity that will start the Screen Saver running can be selected. Repeatedly pressing the [saver delay] key will select time delays from 10 minutes to 60 minutes, in 10 minute intervals. A Disabled selection is also included which will, if selected, prevent the Screen Saver starting.

The [screen saver] key toggles between the two display options of Polygons and Bouncing Balls.

The Screen Saver can be started immediately by pressing the [saver test] key.

Option enable

The [option enable] key provides access to a menu listing all of the system software that is available for the specific test set. You should contact a Marconi Instruments Sales or Service centre should you require additional system test facilities.

Default values

The [DEFAULT VALUES] key on the SET-UP menu enables you to select the power-on mode of the instrument. Each time the instrument is switched on, settings are transferred from the Power-On Store to the Working Store. Subsequent key presses or remote commands change the instrument settings in the Working Store.

The Power-On Store can be changed in two ways. The contents of the Working Store are copied to the Power-On Store by pressing the [SAVE DEFAULT] soft key, which saves the current settings and uses them for all subsequent power-ons. Alternatively, the [INIT DEFAULT] soft key copies factory preset values into the Power-On Store to return its power-on settings mode to those set in the factory.

You can set the system parameters to factory preset values. The parameters for all available systems are set to the factory preset values by pressing the [INIT SYSTEMS] soft key. This applies irrespective of whether a system has been selected.

Having selected a system, pressing the *[INIT CURRENT]* soft key will set only the selected systems parameters to the factory preset values. All other system parameters remain unchanged.

Country

You can select the language used on displays.

On the SET-UP menu, press the *[COUNTRY]* soft key. The SET-UP : COUNTRY SPECIFIC PARAMETERS menu appears. On this menu, there are four soft keys, for English, French, German and Spanish. Press the appropriate key.

Press the *[return]* soft key to return to the SET-UP menu.

Calibrations

User calibrations and variations due to ambient temperature are specified in Chapter 1. See under *Performance Data; Environmental; User calibration*. You can initiate calibration of the power meter, spectrum analyzer, audio filters and multimeter. You do this via the CALIBRATION / SELF-TEST menu, accessed as explained below.

If a TONES display is on the screen, press the *[RETURN]* soft key. If a SYSTEMS display is on the screen, press the *[no system]* soft key. Then press the *[Tx TEST]*, *[Rx TEST]*, *[DUPLEX TEST]*, *[RF TEST]* or *[AF TEST]* key.

Press the *[HELP SET-UP]* key (10). The HELP AND SET-UP menu appears (Fig. 3-38 on page 3-124).

Press the *[CAL]* soft key. The CALIBRATION / SELF-TEST menu appears. Do not initiate calibration directly from a TONES or SYSTEMS display.

When any of the calibrations, or a calibration sequence (see below), is run, the message ACTIVE appears on the screen, together with an *[ABORT CAL]* soft key which allows you to abort the operation. When calibration is complete, the message Calibration Complete appears.

The following soft keys are on the left of the CALIBRATION / SELF-TEST menu; press the appropriate soft key to select one of the displayed options.

- (a) *[Power Meter]* key. To initiate calibration of the broad-band power meter.
- (b) *[M'meter Cal]* key. To initiate calibration of the multimeter.
- (c) *[Specana Levels]* key. To initiate calibration of the spectrum analyzer level and the selective power meter.
- (d) *[Audio Filters]* key. To initiate calibration of the audio analyzer and modulation analyzer filters.

On the right of the screen, the following soft keys are present:-

- (a) *[User Cal]* key. To initiate user-defined calibration.
- (b) *[Cal config]* key. To define the calibrations that will be run sequentially if you press the *[User Cal]* key. The default is that all the calibrations are OFF; press one or more of the soft keys to switch ON the associated calibrations.
- (d) *[return]* key. To return to the HELP AND SET-UP menu.

Demonstration

You can call up two demonstration displays.

Press the *[HELP SET-UP]* key (10). The HELP AND SET-UP menu appears (Fig. 3-38 on page 3-124).

Press the *[DEMO]* soft key. The FEATURE DEMONSTRATIONS menu appears.

On the FEATURE DEMONSTRATIONS menu, press the soft key for either of the demonstrations.

Three soft keys are shown, as follows:-

- (a) *[RF over]* key. To show the RF input over-temperature warning message.
- (b) *[char set]* key. To show the character set that is available for displays.
- (c) *[return]* key. To return to the HELP AND SET-UP menu.

Software versions

You can call up information about the software that is fitted to the instrument.

Press the *[HELP SET-UP]* key (10). The HELP AND SET-UP menu appears (Fig. 3-38 on page 3-124).

Press the *[VERSION]* soft key. The SOFTWARE VERSION NUMBERS display appears. The part number, version number and date are shown for A1, A5, A6/2 Application, A6/2 Boot, A7, AE1.

Press the *[return]* soft key to return to the HELP AND SET-UP menu.

Note

If any new software installed in the test set is incompatible with existing software, a message is displayed with details of the incompatibility. Should this happen, contact a Marconi Instruments Sales and Service centre.

Store and recall facility

Introduction

You can store instrument settings, except those associated with analogue controls, internally within the instrument. Settings, system parameters and results can be stored externally on memory cards placed in the memory card slot (40).

The 2965 provides settings stores numbered 0 to 19. Store 0 is automatically copied from the Working Store on power down and is only available in RECALL.

Formatting the memory card provides 15 setting stores numbered 20 to 34, 5 parameters stores and 4 results stores for system users.

CAUTION

Formatting a memory card results in the loss of all data previously stored on the card. Memory cards should be kept away from magnetic fields and extremes of temperature.

Store

If a TONES display is on the screen, press the *[RETURN]* soft key. If a SYSTEMS display is on the screen, press the *[no system]* soft key. Then press the *[Tx TEST]*, *[Rx TEST]*, *[DUPLEX TEST]*, *[RF TEST]* or *[AF TEST]* key.

Press the *[STORE]* key (22). One of the STORE FACILITY menus appears (whichever was last selected). The default is the STORE FACILITY - SETTINGS menu. Do not initiate storage directly from a TONES or SYSTEMS display.

On the left side of the screen, there are two soft keys. If the STORE FACILITY - SETTINGS menu is displayed, these will be *[SYSTEMS PARAMS]* and *[SYSTEMS RESULTS]*. Pressing either of these keys causes that key to disappear and another key, *[SETTING]*, to appear. The functions of these keys are:-

- (a) *[SETTING]* key. To access the STORE FACILITY - SETTINGS menu.
- (b) *[SYSTEMS PARAMS]* key. For use in the SYSTEMS mode. See the appropriate Operating Manual Supplement.
- (c) *[SYSTEMS RESULTS]* key. For use in the SYSTEMS mode. See the appropriate Operating Manual Supplement.

If the STORE FACILITY - SETTINGS menu is not currently being displayed, press the *[SETTING]* soft key.

On the right side of the screen, there are four soft keys. Note that only three of the keys shown in (a), (b), (c), or (d) below will be visible at any one time, depending on which group of stores is currently being displayed.

- (a) *[0 - 9 Int.]* key. To access the menu for internal stores 0 to 9. This key appears when one of the other menu keys is used.
- (b) *[10 - 19 Int.]* key. To access the menu for internal stores 10 to 19.
- (c) *[20 - 29 M. Card]* key. To access the menu for stores 20 to 29 on a Memory Card.
- (d) *[30 - 34 M. Card]* key. To access the menu for stores 30 to 34 on a Memory Card.
- (e) *[ABORT]* key. To return to the original display.

Each menu shows the numbers and titles of the appropriate stores. Enter a store number by pressing DATA keys (24) to save the current settings in the appropriate store. A character set appears and two soft keys are shown - *[NEXT CHAR]* and *[FINISH STORE]*.

If required, change the store title. Otherwise, press the *[FINISH STORE]* soft key.

To change the store title, rotate the VARIABLE control (33) so that the first character appears in inverse video with a cursor underneath it. Press the *[NEXT CHAR]* soft key. Repeat these steps until the title is completed and then press the *[FINISH STORE]* soft key. The original display appears.

Recall

Press the *[RECALL]* key (23). One of the RECALL FACILITY menus appears (whichever was last selected).

On the left side of the screen, the same soft keys as for STORE appear.

If it is shown, press the *[SETTING]* soft key. The RECALL FACILITY - SETTINGS menu appears.

On the right side of the screen, the same soft keys as for STORE appear.

Each menu shows the numbers and titles of the appropriate stores. Enter a store number by pressing DATA keys (24) to recall the settings from the appropriate store. The stored display appears.

User options

100 kHz audio or modulation generator

You can select audio generators AF1, AF2, and AF3 at the same time as modulation generators MOD1, MOD2 and MOD3, or AF4 or MOD4.

Generators 1, 2 and 3 operate up to a maximum frequency of 20 kHz and generator 4 has a maximum frequency of 100 kHz.

Generators AF4 and MOD4 are selected by pressing [HELP SET-UP], [SET-UP], [TEST OPTIONS], [af/mod setup] and [af/mod mode].

Repeatedly pressing the [return] soft key returns to the selected mode. Generator AF4 is available on Tx TEST, AF TEST and DUPLEX TEST and MOD4 is available on Rx TEST, RF TEST and DUPLEX TEST. When in DUPLEX TEST, switching AF4 on switches MOD4 off and switching MOD4 on switches AF4 off.

You can return to generators 1, 2, and 3 by pressing the [afgens 1 to 3] or [modgens 1 to 3] soft keys or via the HELP AND SET-UP menus.

To power up with the 100 kHz generator, select the option and transfer the setting to the Power-On Store via the [HELP SET-UP], [SET-UP], [DEFAULT VALUES], [SAVE DEFAULT] key sequence as described in *Help and setting up* on page 3-124.

Versatile tracking generator

A simple tracking generator has the signal generator output frequency tracking the receiver input frequency exactly. This allows the frequency response of passive elements to be tested.

To allow testing of a system that has frequency translation between its input and output, the signal generator and receiver must be swept independently over different frequency ranges at different rates.

The versatile tracking generator facility of the 2965 allows offset and variable rate tracking to be used for testing frequency doublers (second harmonic analysis), frequency dividers ($\div 2$ sub-harmonic analysis) and mixers (frequency offsets).

For information on selecting the tracking generator mode, see under *Test options* on page 3-128.

For whichever tracking mode you select, the 2965 calculates the sweep parameters for the signal generator from the span and reference frequency that you have selected for the spectrum analyzer.

Description of tracking generator modes

The tracking generator testing setup is shown below. See Fig. 3-40. F_{in} is the input frequency to the unit under test (i.e. signal generator output frequency), F_{out} is the output frequency of the unit under test. The relationship of F_{out} to F_{in} defines the required tracking mode.

Normal

In normal mode, the signal generator and receiver are swept over the same frequency range at the same rate:

$$F_{out} = F_{in}$$

Doubler testing

In doubler mode, the output frequency of the unit under test is twice the input frequency, so the signal generator of the 2965 is sweeping a frequency range that is half that displayed on the spectrum analyzer, centred at half the reference frequency:

$$F_{out} = 2 \times F_{in}$$

Divider testing

In divider mode, the output frequency of the unit under test is half the input frequency, so the signal generator of the 2965 is sweeping a frequency range that is twice that displayed on the spectrum analyzer, centred at twice the reference frequency:

$$F_{out} = F_{in} \div 2$$

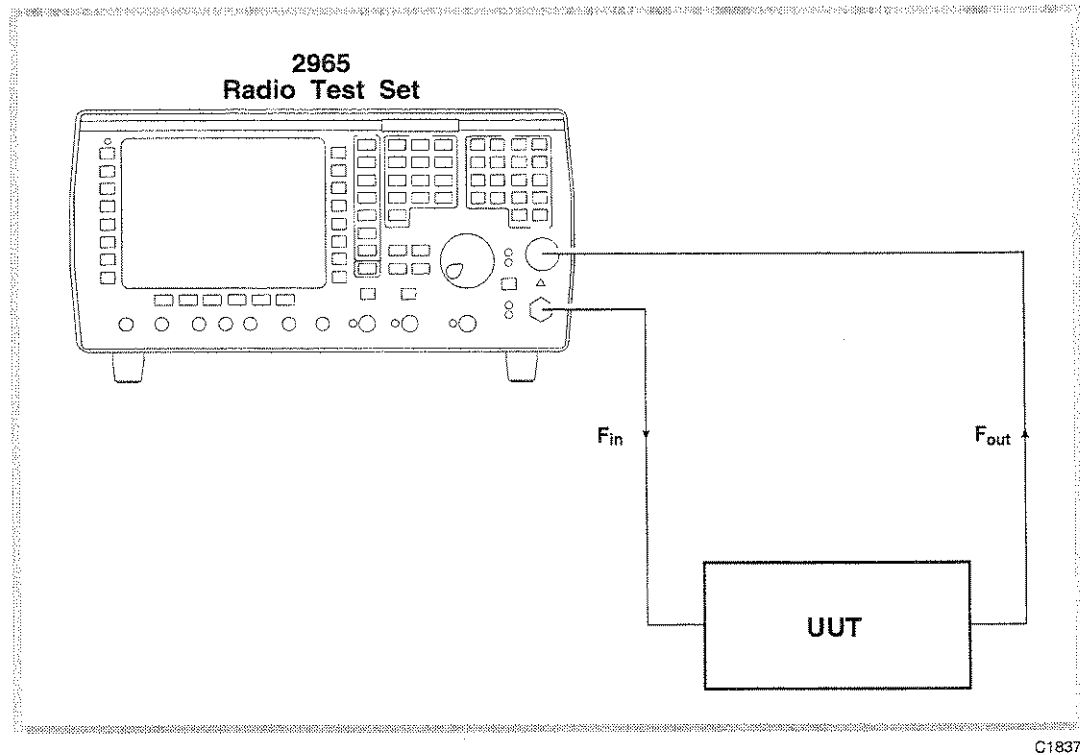

C1837

Fig. 3-40 Normal, doubler and divider testing

Mixer testing

In mixer mode, the output frequency of the unit under test is offset from the input frequency by an amount depending on the mixer LO frequency and whether the unit under test is mixing up or down (these may be set in the TRACKING GENERATOR SET-UP screen). Therefore the signal generator of the 2965 is sweeping a frequency range that is offset from that displayed on the spectrum analyzer, but at the same sweep rate as the spectrum analyzer. The mixer testing setup is shown in Fig. 3-41. F_{LO} is the local oscillator frequency of the mixer.

Note

For the best results, the source for the local oscillator should be phase-locked to the same frequency reference as the 2965.

For up-mixer testing:

$$F_{out} = F_{in} + F_{LO}$$

For down-mixer testing:

$$F_{out} = F_{in} - F_{LO}$$

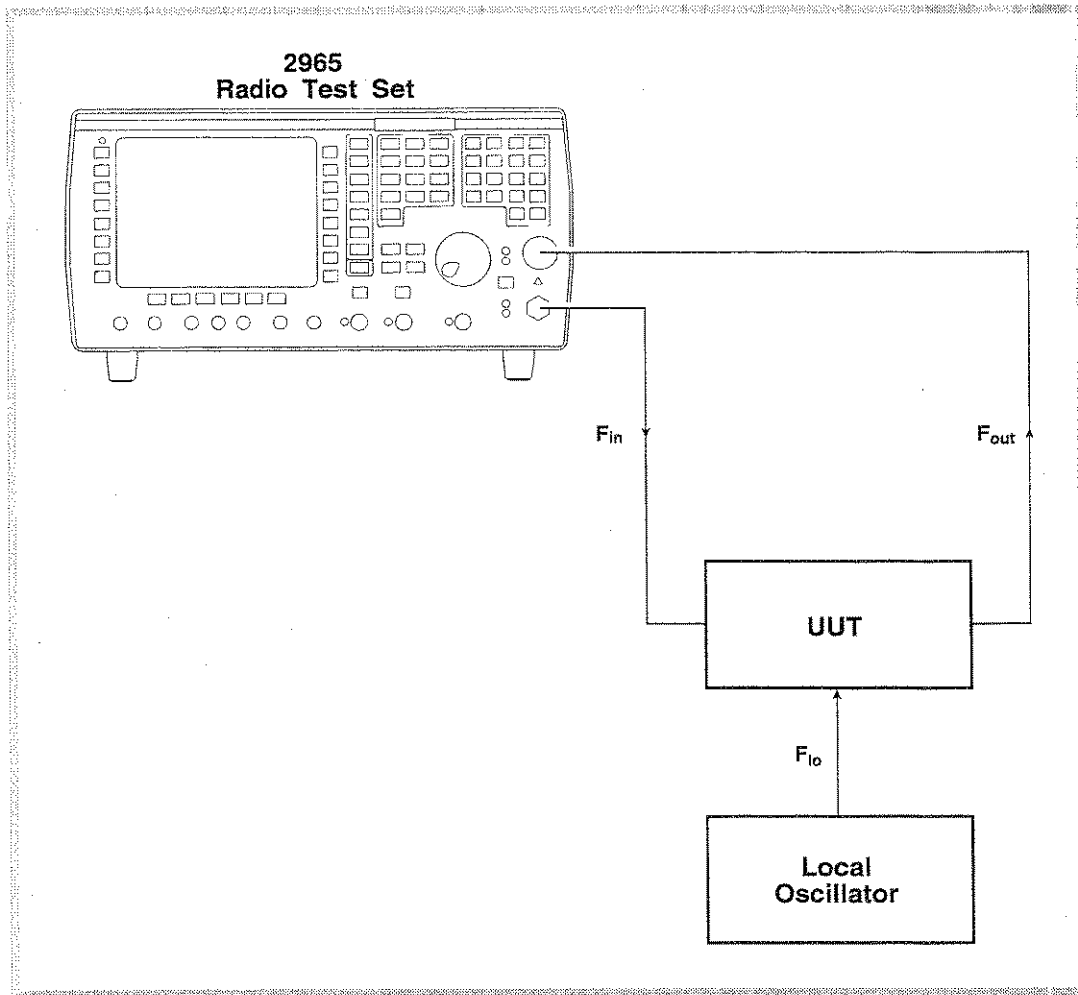

C1838

Fig. 3-41 Mixer testing

Chapter 4

BRIEF TECHNICAL DESCRIPTION

Contents

Introduction	4-1
Control circuits	4-4
Audio and modulation generators.....	4-4
RF signal generator and attenuator.....	4-5
RF output and input switch	4-6
Broad-band power meter	4-6
Receiver.....	4-7
Receiver attenuator and amplifier	4-7
Receiver IF circuits.....	4-7
IF bandwidth filters	4-8
Spectrum analyzer.....	4-8
Selective power meter.....	4-8
IF counter.....	4-9
Modulation analyzer	4-9
Demodulator and filters.....	4-9
Signal processing	4-10
Audio analyzer.....	4-10
Audio filters	4-10
Signal processing	4-10
Common signal processing and CRT circuits	4-10
Peak detectors	4-10
AF counter	4-11
AF voltmeter	4-11
Oscilloscope	4-11
Modulation or audio FFT analyzer	4-12
Distortion and SINAD meter	4-12
Signalling decoding.....	4-12
Multimeter.....	4-12

List of figures

Fig. 4-1 Overall block diagram.....	4-2
Fig. 4-2 Control circuits	4-4
Fig. 4-3 Audio and modulation generators.....	4-5
Fig. 4-4 RF signal generator.....	4-6
Fig. 4-5 Receiver IF circuits	4-7
Fig. 4-6 IF bandwidth filters.....	4-8
Fig. 4-7 Demodulator	4-9
Fig. 4-8 Audio filters.....	4-10
Fig. 4-9 Common signal processing and CRT circuits	4-11

Introduction

The multi-functionality of the 2965 depends on microprocessor control circuits which reconfigure the following circuits according to the task in hand:-

- Common RF output and input circuits.
- Output circuits consisting of RF signal, modulation and audio generators.
- Input circuits consisting of RF receiver and audio analyzer.

Each of these groups is divided into blocks, which are shown in Fig. 4-1, the overall block diagram. There are further levels of block diagrams on the following pages.

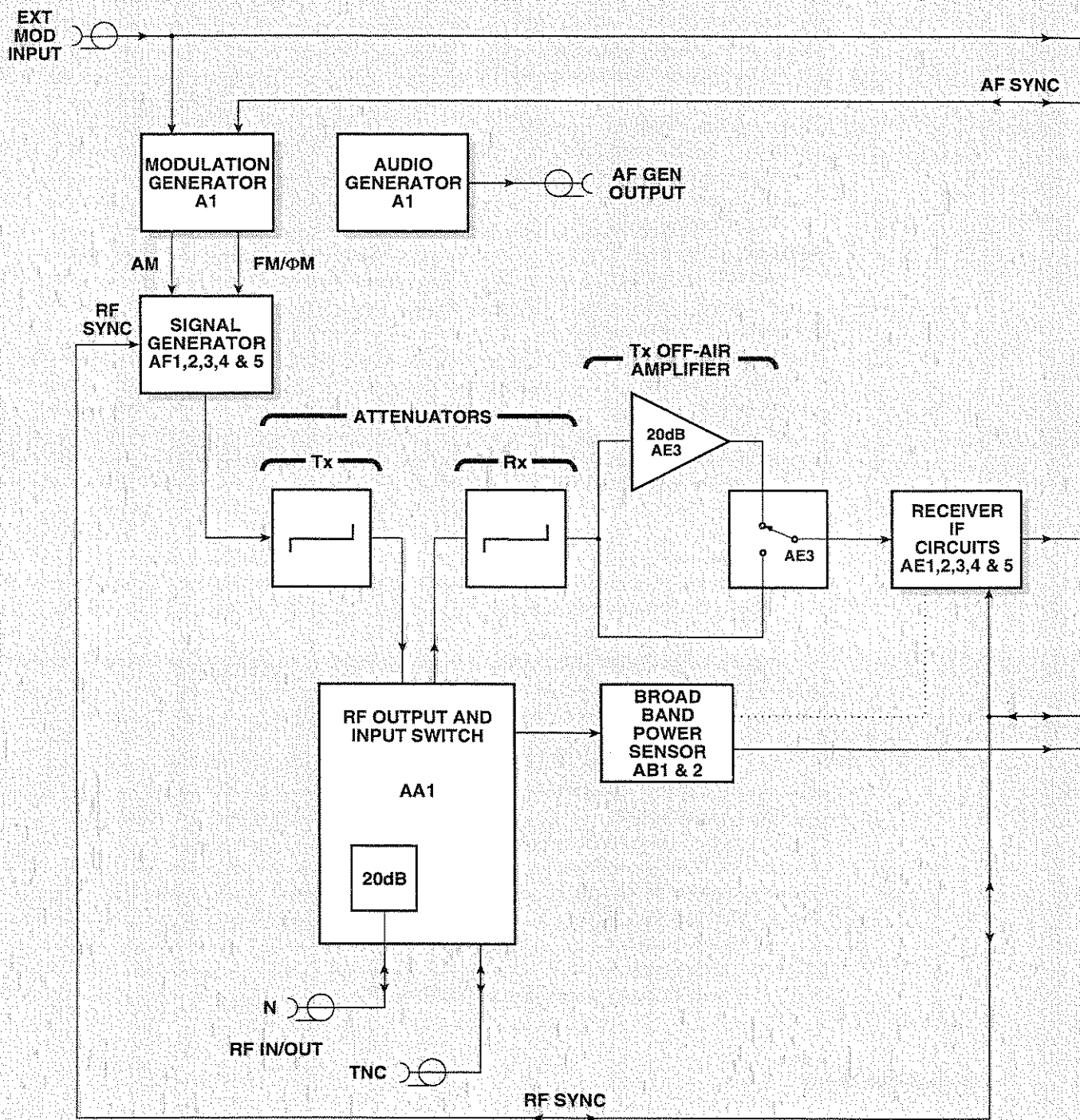

C1769a

Fig. 4-1 Overall block diagram

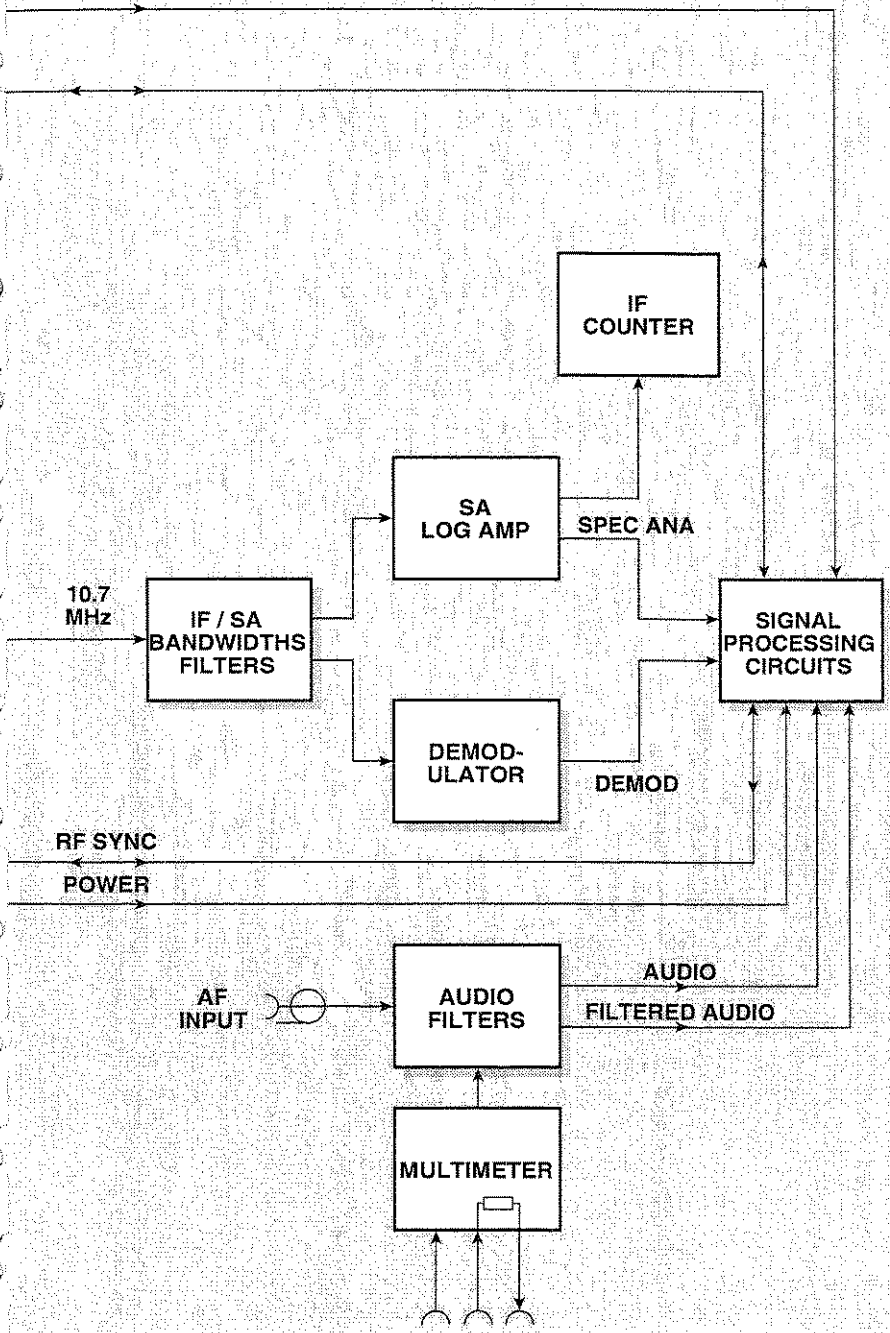

C1475

Control circuits

See Fig. 4-2.

There is a main microprocessor on board A6 which controls the 2965 through slave microprocessors on boards A7, A1, AE1 and A5. In turn, these configure and control a graphics processor on board A5 and specialized digital signal processors (DSPs).

Communication between the main microprocessor, slave microprocessors and DSPs is either through 2-line serial links or through 12-way parallel bridges. In certain conditions, it is necessary to synchronize the slaves to each other (e.g. the spectrum analyzer, the tracking generator and systems signalling). For this, tri-state RF and AF sync lines are used.

The graphics processor and the DSPs run RAM-based programs which are initialized on power-on. The memory is divided into areas for communication and applications. New applications are loaded through the communications routine and replace existing algorithms.

The DSP on board A1 is used for audio, modulation, forward systems signalling tones and POCSAG generation.

The DSP on board A5 is used for audio and demodulation FFT, spectrum analyzer traces, broad-band and in-band power measurements, distortion and SINAD measurements and reverse systems signalling tones decoding.

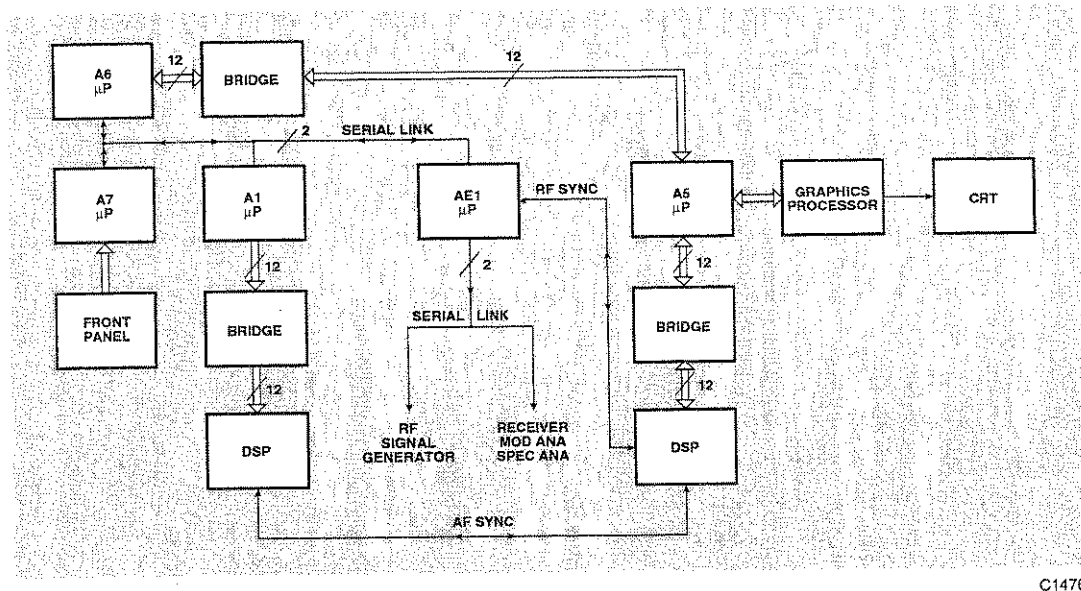

C1476

Fig. 4-2 Control circuits

Audio and modulation generators

See Fig. 4-3.

The DSP on board A1 is configured to simultaneously synthesize three independent audio frequencies on one DAC and three independent modulation frequencies on another DAC. The relative amplitudes of the three signals are set within the DSP while maintaining the highest level signal which is possible at the output of the reconstruction filters.

The frequency range of all the signals is 1 Hz to 20 kHz in 0.1 Hz steps. The phase relationship between any of the signals is not guaranteed. Two signals of the same frequency combine with random phase. Starting with two generators at the same frequency and then offsetting one by 1 Hz shows on the oscilloscope how the phase moves and stops when the offset is removed.

Audio and modulation ranging circuits convert the outputs of the reconstruction filters to the levels which have been set. The audio output buffer provides a low impedance source and reverse power protection.

The signal from the EXT MOD INPUT connector is combined with the internal signal and then this is fed through ranging and switching circuits to the AM, FM or Φ M drive.

The reference level control is applied to the signal generator to control its output level between +13 and -20 dBm.

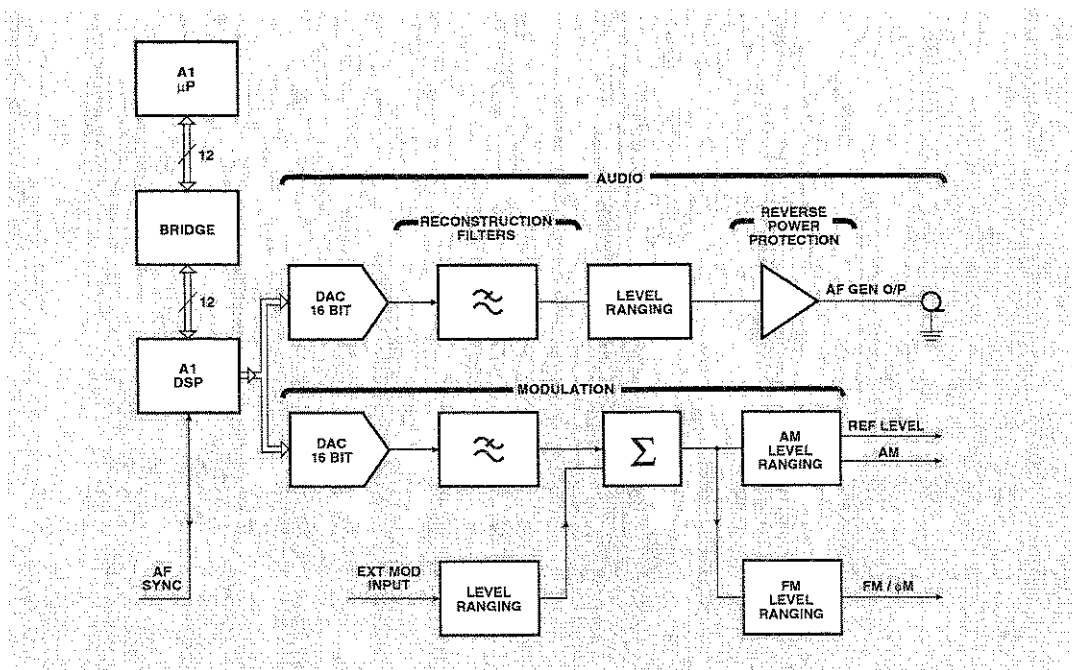

C1477

Fig. 4-3 Audio and modulation generators

RF signal generator and attenuator

See Fig. 4-4.

The frequency range is 100 kHz to 1155 MHz in 1 Hz steps with output levels in the range +13 to -7 dBm. The full frequency range is covered in-bands.

There are three oscillators for 576 to 720, 720 to 912 and 912 to 1155 MHz. The output from the appropriate oscillator is fed through a switch direct to selection filters or through a divider to divide by 2, 4, 8 or 16. The output from the filters is fed direct to AGC circuits or through a stage which mixes it with the output from a 420 MHz oscillator.

On the low band, 840 to 912 MHz from the appropriate oscillator is divided by 2 to give 420 to 456 MHz. This is mixed with 420 MHz to give frequencies below 36 MHz.

Above 36 MHz on other bands, each signal is derived from the appropriate oscillator, divider and filter.

Signals from the modulation generator are applied to give fine control of RF level and modulation depth or deviation. The FM maximum deviation is determined by the signal generator frequency and the divider.

There is an attenuator which has 40 (two), 20 and 10 dB pads to control the output level. The signal level at the output of the AGC circuit compensates for changes of attenuator and input switch losses to maintain the required level at either the N-type or TNC connector.

The RF Sync control line synchronizes the signal generator frequency to the spectrum analyzer frequency when the tracking generator is being used.

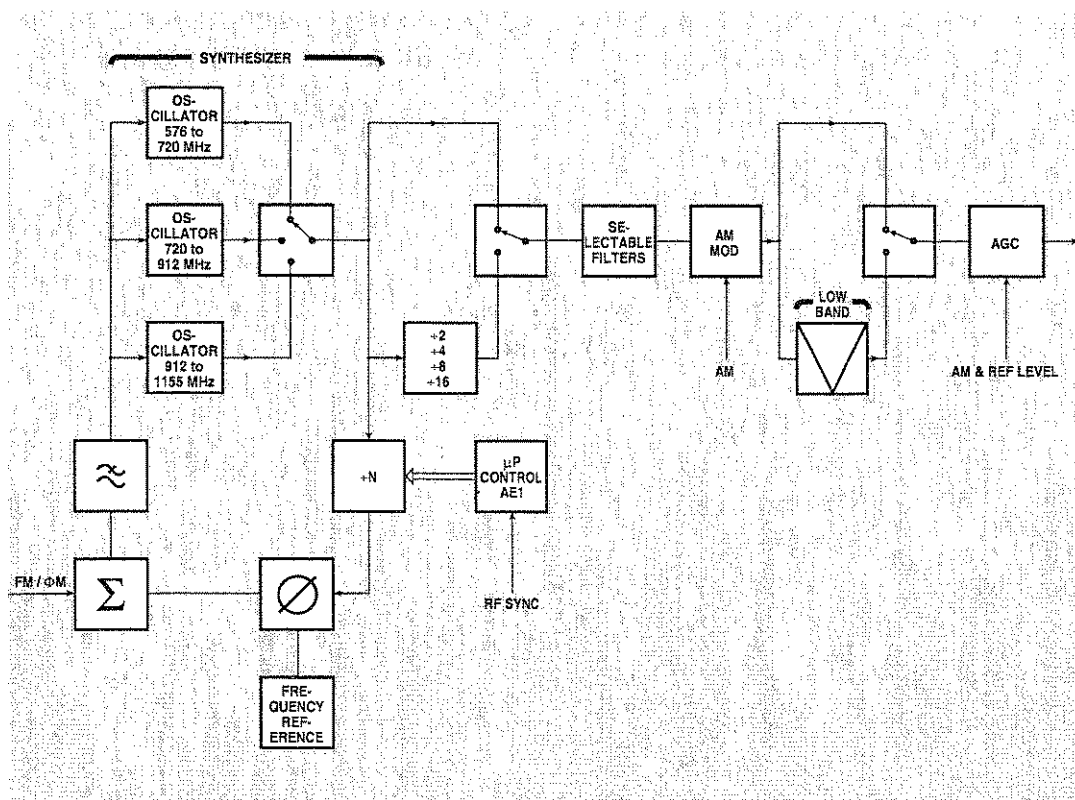

C1749

Fig. 4-4 RF signal generator

RF output and input switch

See Fig. 4-1.

This switch routes signals between any of its six RF ports. Sixteen combinations are used with insertion loss information being stored within the assembly. Some of the combinations are used specifically for internal calibration purposes using a 10 MHz 0 dBm power reference generator.

This switch also provides power overload protection. At the N-type connector, there is a 20 dB load which dissipates power and a heat sensor which trips an overload circuit when appropriate. At the TNC connector, there is a power sensor which trips on overload and simultaneously disconnects the input signal from the rest of the instrument.

Broad-band power meter

See Fig. 4-1, and Fig. 4-9 on page 4-11.

This meter has a broad-band sensor which generates a voltage that is proportional to the input power. A 50 dB dynamic range is achieved by using low noise amplification, filtering and software averaging. Averaging is performed in the DSP on board A5 and the microprocessor on board A6.

When automatic tuning is in operation, the power meter detects the incident power. If it is above the low level threshold of 10 mW at the N-type connector and 100 μ W at the TNC connector, it triggers the search procedure in the main microprocessor. This sets the appropriate receiver attenuator and tunes the frequency of the receiver to the maximum signal level.

Receiver

Receiver attenuator and amplifier

See Fig. 4-1.

There are 40, 20 and 10 dB pads to maintain the correct signal at the input to the receiver. In the normal TRANSMITTER TEST mode and in the RECEIVER TEST, DUPLEX TEST and RF TEST modes, the 10 dB pad remains in circuit. For the OFF-AIR TRANSMITTER TEST display, this pad is removed and a 20 dB amplifier stage is inserted to give maximum receiver sensitivity.

Receiver IF circuits

See Fig. 4-5.

Common circuits are used to process signals for the spectrum analyzer, selective power meter, RF counter and modulation analyzer. An IF of 10.7 MHz is produced by means of three local oscillators and filters. The bandwidth of the second IF filter is 3 MHz.

The first local oscillator operates in the range 1349.3 to 2349.3 MHz with a resolution of 1 Hz. For the spectrum analyzer, the frequency is stepped according to the setting of the horizontal span. For the other readings, the frequency is 1349.3 MHz plus the Tx FREQUENCY. The mixed signal is fed through a 1349.3 MHz filter.

When the spectrum analyzer is operating and the other readings are displayed at the same time, the frequency sweeps for one scan, stays at the tuning frequency while the other readings are displayed, sweeps for the next scan and so on.

The second local oscillator operates at 1280 MHz and is locked to the third local oscillator which operates at 80.0 MHz. The third local oscillator is used as the digital data clock for the microprocessors and DSPs. The output of the third mixer is fed to the 10.7 MHz IF bandwidth filters.

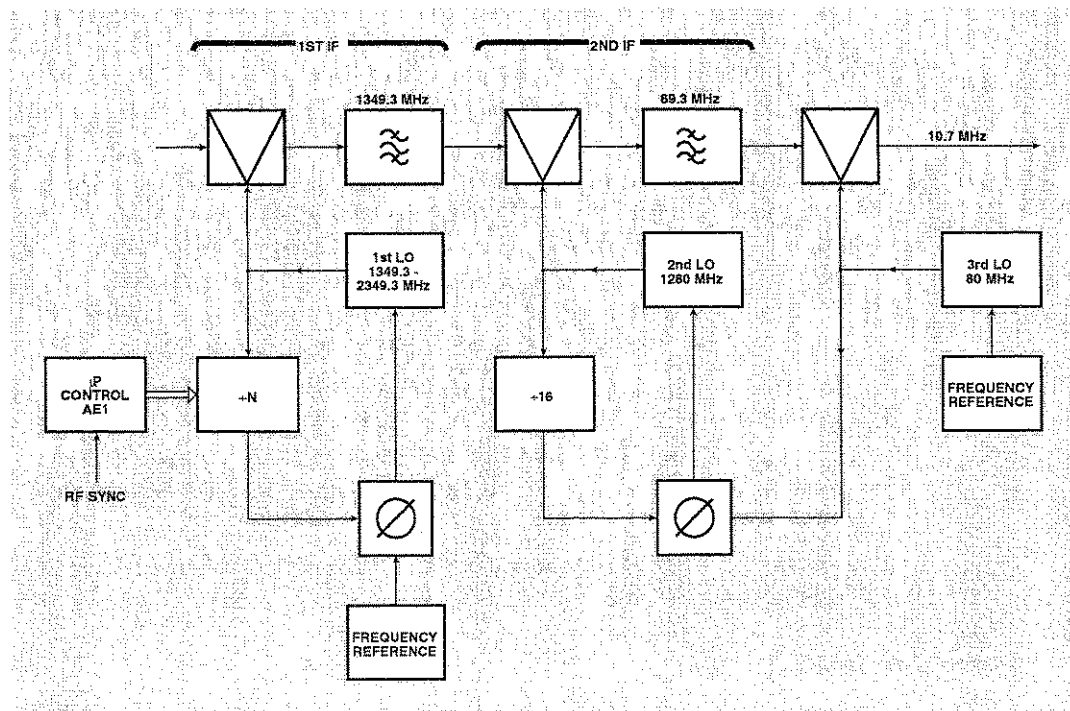

C1756

Fig. 4-5 Receiver IF circuits

IF bandwidth filters

See Fig. 4-6.

The IF bandwidth and the spectrum analyzer resolution bandwidth are determined by ceramic filters which reduce it to 280 or 110 kHz and crystal filters which reduce it to 30, 10, 3 or 1 kHz or 300 Hz. These are selected prior to spectrum analyzer sweeps according to the span/resolution bandwidth and are set to the IF BandWidth for other measurements.

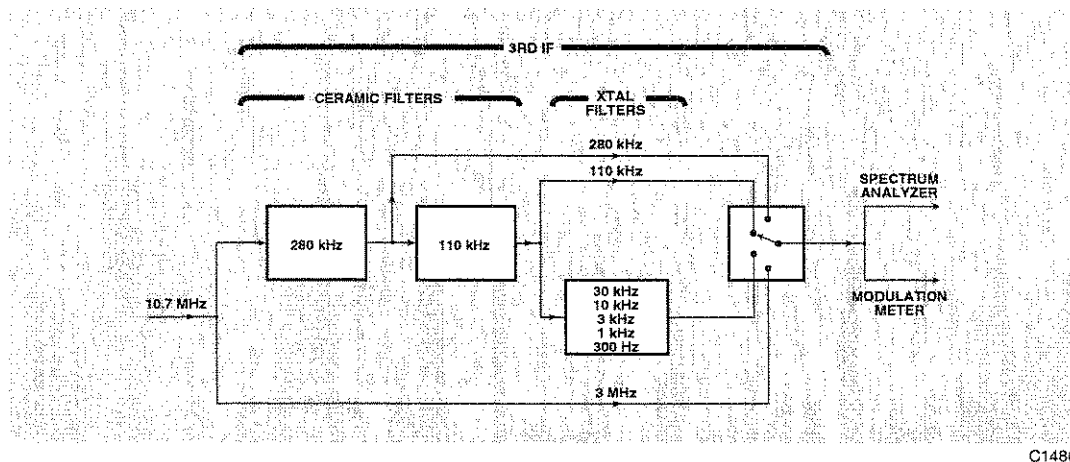

C1480

Fig. 4-6 IF bandwidth filters

Spectrum analyzer

See Figs. 4-1 and 4-9.

Signals from the N-type or TNC connector are routed through the input switch, ranged in the Rx attenuators (according to the spectrum analyzer reference level) and filtered by the resolution bandwidth filters before being applied to a logarithmic amplifier. The output voltage of this amplifier is proportional to the power of the applied signal.

The output signal is routed to a 12-bit ADC. The output from the ADC is processed by the DSP on board A5 which is configured through the bridge by the microprocessor on board A5. The DSP synchronizes reading the ADC with step changes in the frequency of the first local oscillator. The number of steps per trace depends on the span/division and resolution bandwidth. It corrects for logarithmic amplifier linearity, converts to different dB/division, generates trace information and marker information in real time and transfers it over the bridge to be drawn on the graticule by the microprocessor and the graphics processor.

For the small graticule, the first local oscillator dwells at the Tx FREQUENCY between sweeps. During this time, the Tx FREQUENCY, POWER (BROADBAND or IN BAND), MODULATION FREQUENCY, AM DEPTH, FM or Φ M DEVIATION, DISTORTION and SINAD are measured as selected by the user. The DSP is configured to measure the POWER and DISTORTION between sweeps.

For the large graticule, these measurements are suspended, the dwell is removed and the refresh rate increases.

Selective power meter

The reading is the power which is measured in the IF bandwidth at the Tx FREQUENCY. By selecting the IF BandWidth, adjacent signals can be rejected giving frequency selectivity. When modulation is applied to the signal which is being measured, the powers of harmonics outside the IF bandwidth are not included in the measurement.

To illustrate this, apply a signal with 1 kHz modulation frequency and 2 kHz FM deviation. Measure in a 110 kHz bandwidth while the deviation is increased to 3 kHz. There should be no change in power. When the experiment is repeated in a 300 Hz IF BandWidth, the power meter displays the Bessel zero at approximately 2.4 kHz FM deviation.

The same measurement can be obtained on the expanded SPECTRUM ANALYZER display by placing a marker and reading the value of the marker at the TX FREQUENCY. This method is slower as measurements are only taken between sweeps when the receiver first local oscillator tunes to the Tx FREQUENCY.

IF counter

This counter measures signals which are centred on 10.7 MHz. The measurement is used to calculate the Tx FREQUENCY, taking into account the setting of the first local oscillator. The range of the IF counter is half the IF bandwidth. This is the limit which is placed on the Tx FREQUENCY OFFSEt. By selecting the IF bandwidth, two closely spaced signals can be measured to either 1 or 10 Hz resolution. IF counts take place between non-expanded spectrum analyzer and FFT traces.

Modulation analyzer

Demodulator and filters

See Figs. 4-1 and 4-7

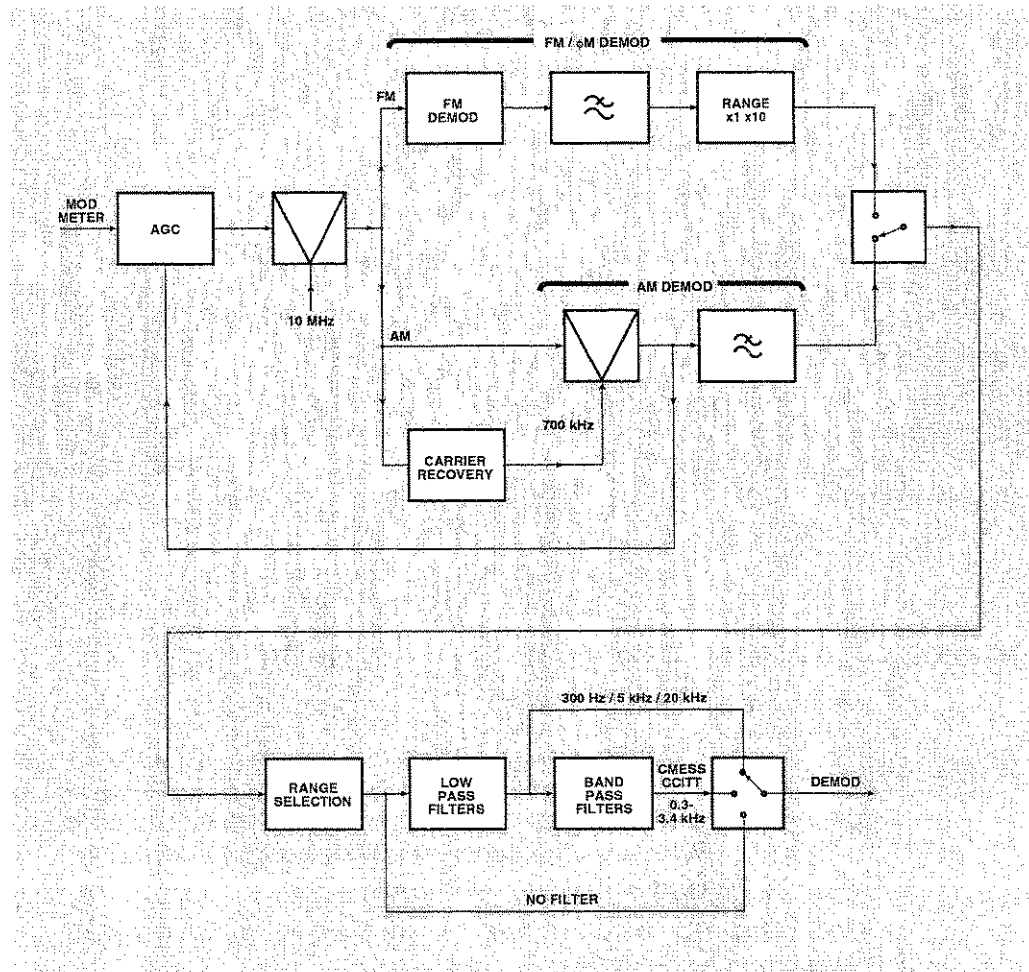

C1481

Fig. 4-7 Demodulator

Signals from the N-type or TNC connector are routed through the input switch, ranged in the Rx attenuators and filtered by the IF bandwidth filters before being applied to a 50 dB AGC loop. Ranging of the receiver attenuators ensures that the signal level is near to the top of its range. The signal is down converted to 700 kHz and then is fed to two demodulators, one to measure the AM depth and the other to measure the FM or Φ M deviation.

For AM, demodulation is by carrier recovery and mixing down to baseband prior to filtering.

For FM, the signal is amplitude-limited and then passed through a demodulation filter. Ranging by a factor of ten depends on whether the deviation is greater than 10 kHz.

One of the two demodulated signals is selected, ranged and fed to the low-pass or band-pass filters which are used to limit the measurement bandwidth and noise.

Signal processing

The output is fed to common signal processing and CRT circuits. See the next section, *Audio analyzer*.

Audio analyzer

Audio filters

See Fig. 4-8.

Under normal audio analysis the signal from the AF INPUT connector is either amplified or attenuated according to its level. There are two outputs. One output is unfiltered and the other passes through band-pass or low-pass filters.

Signal processing

The two outputs are fed to common signal processing and CRT circuits.

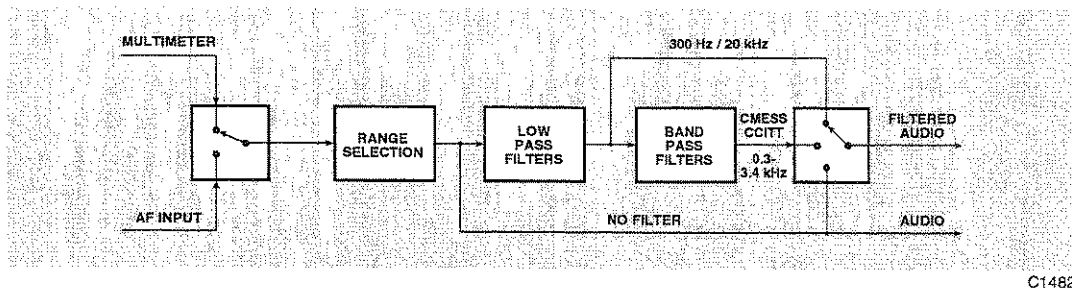

Fig. 4-8 Audio filters

Common signal processing and CRT circuits

See Fig. 4-9.

Peak detectors

The signal from the demodulator is fed to positive and negative peak detectors which measure the peak depth or deviation. The detectors are digital having fast attack and infinite hold times. Resets are applied prior to each measurement.

Distortion measurement, FFT display or scope display can take place simultaneously with peak detection.

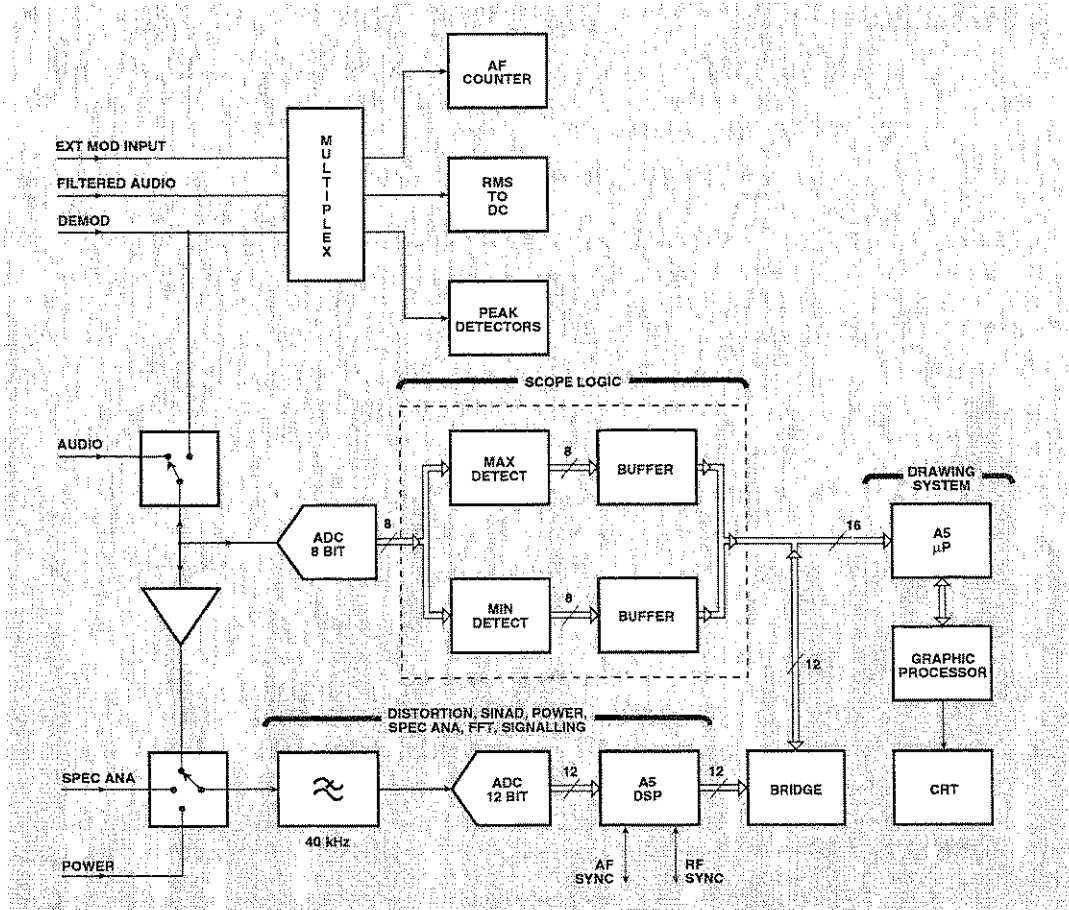

C1483

Fig. 4-9 Common signal processing and CRT circuits

AF counter

The signal from the demodulator or the audio filters is fed to a period counter which measures the duration of one period when the signal is less than 200 Hz.

The measurement is taken over an increasing number of periods as the frequency increases. The measurement duration is 5 ms plus the time to the end of the current period. The frequency is calculated from the overall count duration and the number of periods during the duration.

AF voltmeter

The signal from the audio filters or the EXT MOD INPUT connector is fed to an RMS to DC converter. This measures the voltage or the S/N.

Oscilloscope

The signal from the demodulator or the audio input (unfiltered) is sampled in a 10 MHz 8-bit ADC whose output is fed to a programmable gate array. This contains logic circuits which synchronize the sampling with the timebase, detect maximum and minimum values and prepare the data ready for the microprocessor which draws the trace.

The trace is drawn as either 400 vertical lines on the small graticule or 500 vertical lines on the expanded graticule. Each vertical line requires two points. This makes the maximum transfer of data 1000 points per trace. The trace update rate varies between 7 and 30 updates per second depending on the differences between the old and the new traces.

Modulation or audio FFT analyzer

The signal from the demodulator or the audio input (unfiltered) is band-limited to 40 kHz by feeding it through an anti-aliasing filter. The filtered signal is sampled at 102.4 kHz in the 12-bit ADC which is read directly by the DSP on board A5.

When a trace update is requested by the microprocessor, the DSP starts sampling the signal and performing real time analysis while storing data in the relevant buffers. The data for wide frequency spans is collected quickly but narrow frequency spans with high resolution take longer as in a frequency meter. When the appropriate amount of data is stored, sampling stops and more processing takes place prior to the trace and the marker information being transferred across the bridge. This updates the trace and triggers the microprocessor to request another trace.

For the small graticule, signals are re-routed between traces for POWER (BROADBAND or IN BAND), DISTortioN or SINAD measurements. For the large graticule, these measurements are suspended thus increasing the refresh rate.

For the modulation analyzer, the vertical scale is logarithmic in % or deviation units at 1 decade per 2 divisions.

For the audio analyzer, the vertical scale is logarithmic in voltage units at 1 decade per 2 divisions.

Distortion and SINAD meter

The signal from either the demodulator or the audio filters is routed to the 12-bit ADC and sampled and read by the DSP on board A5. The DSP derives the reading after digital filtering and signal processing. No analogue filters are used.

Signalling decoding

The signal from either the demodulator or the audio filters is routed to the 12-bit ADC and sampled and read by the DSP on board A5. Algorithms perform the data analysis.

Multimeter

See Figs. 4-1 and 4-9.

The multimeter terminals are isolated from the chassis by means of a high impedance differential amplifier which has offset and gain calibration. When the multimeter is selected, the signal from the multimeter terminals is routed through the audio filters to the RMS to DC converter which measures the voltage, current or resistance.

For a current measurement, the voltage across the input resistor is used to calculate the current. For a resistance measurement, a constant current is generated in the load and the resulting voltage is used to calculate the resistance.

Chapter 5

ACCEPTANCE TESTING

Contents

Introduction	5-3
Before starting	5-3
User calibrations	5-3
Default start-up	5-3
Test equipment	5-4
Test results	5-5
RF output tests	5-5
Carrier frequency accuracy	5-5
RF output level	5-6
ALC linearity	5-6
N-type output modes	5-7
TNC output modes	5-7
Attenuator accuracy	5-7
Alternative attenuator functional check	5-8
Spectral purity	5-8
Harmonics, spurious, RF carrier leakage, residual FM	5-8
Amplitude modulation (RF generator)	5-11
Frequency modulation (RF generator)	5-13
AF output tests	5-15
Audio generator output level	5-15
Audio generator signal purity	5-16
Audio generator frequency	5-17
AF input tests	5-17
Audio filters	5-17
Audio counter	5-19
Audio voltmeter	5-20
Audio oscilloscope	5-21
Audio FFT analyzer	5-22
AF distortion and SINAD meter	5-24
Multimeter	5-25
RF input tests	5-27
Modulation analyzer - FM and PM	5-27
Modulation analyzer - AM	5-29
Radio frequency meter	5-31
RF spectrum analyzer	5-32
Narrow-band power meter	5-34
RF broad-band power meter	5-35
Options if fitted	5-37
Options 10, 11, 12, 13, 14, and 21	5-37
Option 9 - SSB	5-37
Acceptance test results tables	5-39

List of figures

Fig. 5-1 Carrier frequency accuracy	5-5
Fig. 5-2 RF output level setup	5-6
Fig. 5-3 Attenuator accuracy setup	5-7
Fig. 5-4 Alternative attenuator functional check	5-8
Fig. 5-5 Carrier harmonics and spurious check	5-9
Fig. 5-6 RF carrier leakage check	5-10
Fig. 5-7 Residual FM checks	5-10

Fig. 5-8 Internal AM accuracy checks	5-11
Fig. 5-9 Internal FM accuracy checks	5-13
Fig. 5-10 FM versus modulation rate	5-14
Fig. 5-11 Audio generator level accuracy checks	5-15
Fig. 5-12 Audio generator signal purity checks	5-16
Fig. 5-13 Audio filter checks	5-18
Fig. 5-14 Audio counter check	5-20
Fig. 5-15 Audio voltmeter level accuracy checks	5-21
Fig. 5-16 Audio oscilloscope check	5-22
Fig. 5-17 Audio FFT analyzer level checks	5-23
Fig. 5-18 Distortion and SINAD meter checks	5-24
Fig. 5-19 Multimeter AC voltage measurement check	5-25
Fig. 5-20 Multimeter ammeter accuracy check	5-27
Fig. 5-21 Modulation analyzer - FM	5-28
Fig. 5-22 Modulation analyzer - AM	5-30
Fig. 5-23 Radio frequency meter	5-31
Fig. 5-24 RF spectrum analyzer checks	5-32
Fig. 5-25 Narrow-band power meter checks	5-34
Fig. 5-26 RF broad-band power meter checks	5-36
Fig. 5-27 RF SSB (Option 9) checks	5-37



Introduction

Test procedures described in this chapter may be simplified and of restricted range compared with those that relate to the generally more comprehensive factory test facilities that are necessary to demonstrate complete compliance with the specifications.

Performance limits quoted are for guidance and should not be taken as guaranteed performance specifications unless they are also quoted in the *Performance data* section of Chapter 1.

When making tests to verify that the instrument meets the stated performance limits, always allow for the uncertainty of the test equipment.

The key presses detailed are based upon version 5.4 software. Some key sequences may differ slightly with earlier software.

Before starting

In line with best practice in electronic measurement, it is recommended that the Unit Under Test (UUT) is allowed to stabilise for thirty minutes after switch on, to obtain optimum performance, before commencing testing. See also *User calibrations* and *Default start-up* below.

User calibrations

User calibrations are provided to maintain high accuracy for any ambient temperature, (for example, in ATE racks or in field measurement). Having allowed the equipment to stabilise, run the four user calibrations, accessed under [HELP SET-UP], [CAL], to optimise the performance at that temperature. These should be run prior to starting the acceptance tests.

A change in temperature over 5°C will change the following readings. These figures are provided as a guide to typical performance.

Function	Measurement	Typical variation
Power Meter	Broad-band power	2.0%
M'meter Cal	Multimeter Volts Multimeter Ohms	0.5% 0.5%
Specana Levels	Selective power Spectrum analyzer level	0.5 dB 0.5 dB
Audio Filters	Audio voltage Demodulation depth and deviation	0.4% 0.4%

Default start-up

To minimise the number of key presses you need to carry out to obtain the correct instrument settings, each section assumes the instrument is being configured from the instrument factory default power-on state. To ensure that this occurs, initially press the following keys:-

[HELP SET-UP], [SET-UP], [DEFAULT VALUES], [INIT DEFAULT], [return], [return], [RESET].

At the beginning of each acceptance test section, the instrument can now be reset to its factory default power-on state by pressing:-

[HELP SET-UP], [RESET]

Test equipment

Description	Minimum specification	Example
Frequency Counter	100 kHz to 1 GHz. 1 Hz resolution. External frequency standard in/out.	MI 2440 or E.I.P.25B
RF Power Meter	±0.1 dB from 100 kHz to 1 GHz.	MI 6960/A/B + 6912 and 6920 sensor
Measuring Receiver	0 dBm to -120 dBm, 2.5 MHz to 1 GHz.	HP 8902A and 11772A sensor
Spectrum Analyzer	100 kHz to 3 GHz, noise floor <-127 dBm.	MI 2383
50 Ω Sealed Load		
2 turn 25 mm Loop		
Low-noise FM Demodulator	Residual FM to be less than 2 Hz up to 1 GHz.	MI 2305 + MI 2041
Modulation Meter	RF I/P 500 kHz to 1 GHz AM measurement accuracy up to 85% depth: ±1% of reading at 1 kHz modulation rate. ±2.5% of reading for modulation rates from 30 Hz to 50 kHz. FM measurement accuracy:- ±0.5% of reading ±1 least significant changing digit, at 1 kHz modulation rate, for deviation >5 kHz.	MI 2305
DVM	1% accuracy:- AC measurement 10 Hz to 100 kHz. DC measurement to 1 mV.	Solatron 7150+
Audio Analyzer	Capable of measuring distortion from 20 Hz to 20 kHz, down to 0.1% in a CCITT bandwidth. AC voltage measurements.	HP 8903B
LF Generator	DC to 500 kHz. External frequency standard in/out. Level accuracy ±0.2 dB or better, 3 mV to 3.5 V RMS.	HP 3325B
RF Synthesizer	500 kHz to 1 GHz. RF level accuracy ±1 dB. AM depth 0 to 85%. Deviation 0 to 100 kHz. Modulation rate 20 Hz to 15 kHz.	MI 2041
Power Splitter	6 dB 50 Ω, 1 MHz to 1 GHz.	WEINSCHEL 1870A
DC PSU	0 to 60 V, 10 A at 10 V.	
Decade Reference Resistor Box	50 Ω to 1M Ω. Accuracy better than 1%.	
Rheostat 0 to 10 Ω 10 A		
DVM Current Shunt	10 A. Accuracy 0.25%. Sensitivity 10 mV/A.	Fluke 80J-10
Calibrated Power Source	3.5% up to 500 MHz. 5% up to 1 GHz.	See broad-band power test

Test results

Test results tables, with provision for recording results of the acceptance tests, are provided at the end of the chapter. It is suggested that copies are made and used, leaving the originals clean.

RF output tests

Carrier frequency accuracy

This check provides a conventional method of checking the RF generator frequency locking circuitry. It will confirm correct operation of the phase lock loop and dividers. Overall accuracy is determined by the instruments internal reference standard. This is checked elsewhere.

Specification

Frequency range:	100 kHz to 1 GHz, usable to 1.1 GHz
Accuracy:	As frequency standard
Resolution:	1 Hz

Test equipment

Description	Minimum specification	Example
Frequency Counter	100 kHz to 1 GHz, 1 Hz resolution, Ext Std In/Out	MI 2440 or EIP 25B

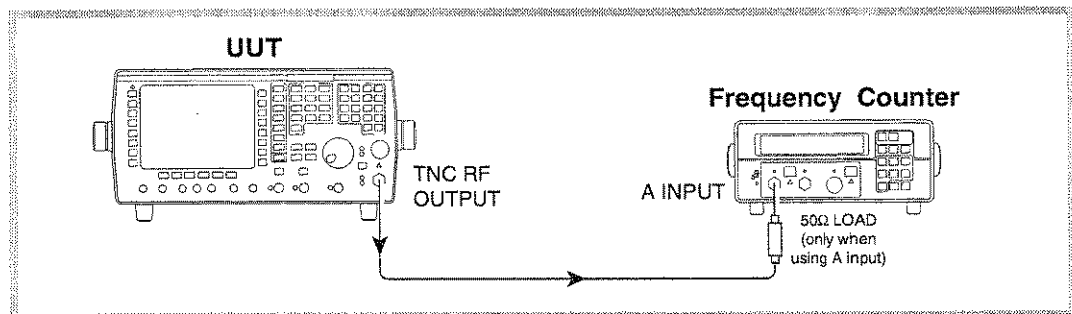

C2525

Fig. 5-1 Carrier frequency accuracy

- (1) Connect the test equipment as shown in Fig. 5-1, connecting to the TNC RF output socket on the UUT and the A input on the Frequency Counter (2440), through the 50 Ω load.
- (2) Lock the reference standards of the instruments together.
- (3) Set the UUT to [Rx TEST], [RF SELECT] TNC output, [RF GEN], [LEVEL] 0 [dBm], [FREQ] 100 [kHz]. All modulation and noise measurements should be switched OFF.
- (4) Set the Frequency Counter to 1 Hz resolution.
- (5) Check that the Frequency Counter reads between 99.999 and 100.001 kHz. This confirms the operation of the RF generator mixed range.
- (6) Repeat for the frequencies shown in Table 5-1 on page 5-39, checking that the Frequency Counter displays the selected frequency, ± 1 Hz. It will be necessary to disconnect the 50 Ω load and reconnect the UUT RF output directly to the B input and C input where indicated.

RF output level

Specification

Level range:	-120 dBm to -7 dBm (N-type socket)
Accuracy:	± 1 dB up to 575 MHz ± 1.5 dB up to 1 GHz

Test equipment

Description	Minimum specification	Example
RF Power Meter	± 0.1 dB from 100 kHz to 1 GHz	MI 6960/A/B + 6912 and 6920 sensor
Measuring Receiver	0 dBm to -120 dBm 2.5 MHz to 1 GHz	HP 8902A and 11772A sensor
Spectrum Analyzer	Noise floor < -127 dBm	MI 2383

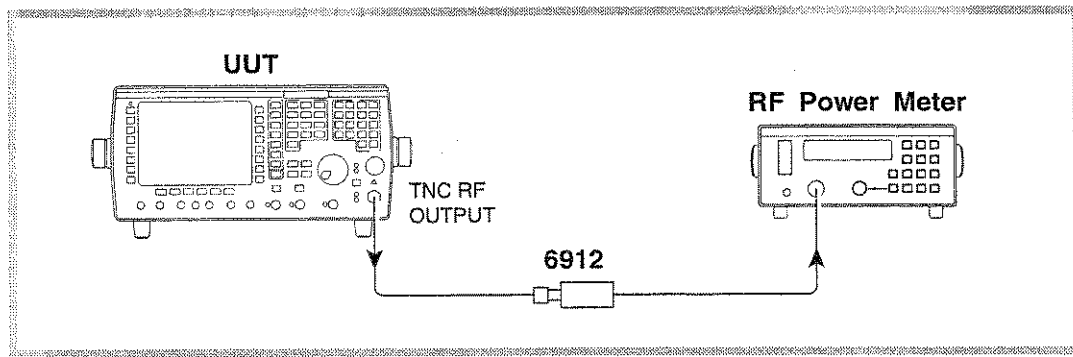

C2526

Fig. 5-2 RF output level setup

- (1) Connect the test equipment as shown in Fig. 5-2, connecting the 6912 sensor to the N-type output socket.
- (2) Set the UUT to [Rx TEST], [RF SELECT] N-type output, [RF GEN], [LEVEL] -7 [dBm], [FREQ] 100 [kHz]. All modulation and noise measurements should be switched OFF.
- (3) Check that the output level is within specification at the frequencies shown in Table 5-2 on page 5-40.

ALC linearity

- (1) Connect the test equipment as shown in Fig. 5-2, connecting the 6912 sensor to the N-type output socket.
- (2) Set the UUT to [RF GEN], [LEVEL] -7 [dBm], [INC] 1 [dB], [FREQ] 2.5 [MHz].
- (3) Increment the RF output of the UUT in 1 dB steps down to -23 dBm as per Table 5-3 on page 5-40, ensuring that the indication on the RF Power Meter is within ± 1 dB of each level set.
- (4) Return the UUT RF level to -7 dBm.
- (5) Set the UUT carrier frequency to 500 MHz and repeat step (3), referring to Table 5-4 on page 5-41.
- (6) Set the UUT carrier frequency to 1000 MHz, return the level to -7 dBm and repeat step (3), referring to Table 5-5 on page 5-41. Check that the indicated level is within ± 1.5 dB.

N-type output modes

- (1) Connect the test equipment as shown in Fig. 5-2, connecting the 6912 sensor to the N-type output socket.
- (2) Refer to Table 5-6 on page 5-42.
- (3) Set the UUT to [DUPLEX TEST], [RF SELECT] two-port duplex (N-type output, TNC input), [RF GEN], [LEVEL] -7 [dBm], [FREQ] 100 [kHz]. All modulation and noise measurements should be switched OFF.
- (4) Check that the level displayed on the RF Power Meter is within ± 1 dB. Repeat with the UUT set to 500 MHz.
- (5) Set the UUT to 1000 MHz and check that the level displayed on the RF Power Meter is within ± 1.5 dB.
- (6) Press the [RF SELECT] key three times. This should set the UUT into 1-port duplex mode on the N-type socket and the RF generator level should also have changed to -40 dBm. Substitute the 6912 sensor by the 6920 sensor and check that the level displayed on the RF Power Meter is -40 dBm ± 1.5 dB. Refer to Table 5-7 on page 5-42.
- (7) Set the UUT to [RF GEN], [FREQ] 500 [MHz] and check that the level displayed on the RF Power Meter is -40 dBm ± 1 dB. Repeat with the UUT set to 10 MHz.

TNC output modes

No claim is made on the output level accuracy of the TNC socket. The following is a functional check to ensure correct internal switching.

- (1) Connect the test equipment as shown in Fig. 5-2, connecting the 6912 sensor to the TNC output socket.
- (2) Set the UUT to [Rx TEST], [RF SELECT] TNC output, [RF GEN], [LEVEL] 13 [dBm], [FREQ] 100 [MHz]. All modulation and noise measurements should be switched OFF.
- (3) Check that the RF Power Meter indicates 13 dBm ± 2.5 dB.
- (4) Set the UUT to [DUPLEX TEST], [RF SELECT] two-port duplex (TNC output, N-type input), [RF GEN], [LEVEL] 13 [dBm], [FREQ] 100 [MHz].
- (5) Check that the RF Power Meter indicates 13 dBm ± 2.5 dB.
- (6) Press the [RF SELECT] key. This should set the UUT into 1-port duplex mode on the TNC socket and the RF generator level should also have changed to -20 dBm. Check that the level displayed on the RF Power Meter is -20 dBm ± 2.5 dB.

Attenuator accuracy

The following test will confirm that the attenuator performs to the published performance specification. In the event of the receiver not being available, an alternative method to functionally test the attenuator is also suggested.

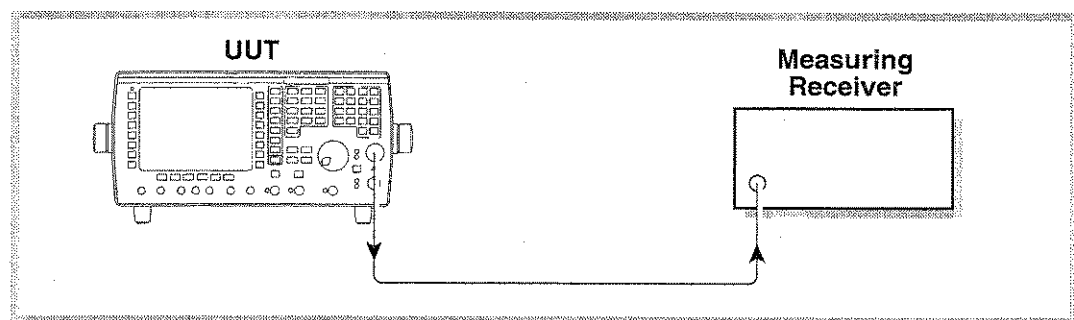

Fig. 5-3 Attenuator accuracy setup

- (1) Connect the test equipment as shown in Fig. 5-3.
- (2) Set the UUT to [RF GEN], [LEVEL] -10 [dBm], [FREQ] 2.5 [MHz].
- (3) Tune the receiver to the frequency set on the UUT RF generator and measure the RF level.
- (4) Decrement the output of the UUT in 10 dB steps down to an RF level of -120 dBm, measuring the RF level at each step.
- (5) Repeat steps (2) to (4) for frequencies of 500 and 1000 MHz.

Alternative attenuator functional check

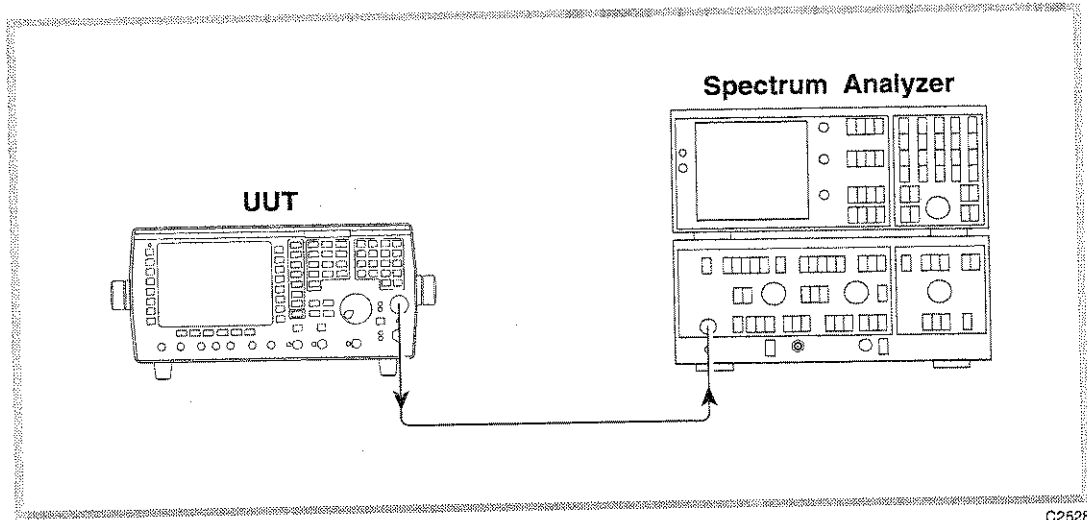

Fig. 5-4 Alternative attenuator functional check

- (1) Connect the test equipment as shown in Fig. 5-4.
- (2) Set the UUT to [Rx TEST], [RF SELECT] N-type output, [RF GEN], [LEVEL] -15 [dBm], [INC] 10 [dB], [FREQ] 251 [MHz]. All modulation and noise measurements should be switched OFF.
- (3) Tune the spectrum analyzer to the signal from the UUT.
- (4) Using the UUT INC δ [↓] key, reduce the level of the UUT output in 10 dB steps down to -125 dBm. At each 10 dB step, ensure the level on the analyzer drops accordingly.

Spectral purity

Harmonics, spurious, RF carrier leakage, residual FM

Specification

Carrier range:	100 kHz to 1 GHz
Harmonics:	Better than -30 dBc for levels up to +7 dBm (TNC), -13 dBm (N-type)
Spurious signals:	Better than -45 dBc for carrier frequencies from 100 kHz to 36 MHz. Better than -50 dBc for carrier frequencies from 36 MHz to 1 GHz.
Carrier leakage:	Less than 0.5 μ V PD generated at the carrier frequency, across a 50 Ω load by a 2 turn 25 mm loop 25 mm from the case, with output level at < -60 dBm and terminated into a sealed 50 Ω load.
Residual FM:	Less than 6 Hz RMS up to 575 MHz (CCITT weighted). Less than 12 Hz RMS up to 1 GHz.

Test equipment

Description	Minimum specification	Example
Spectrum Analyzer	100 kHz to 3 GHz, noise floor better than -125 dBm at 500 MHz.	MI 2383
50 Ω Sealed Load 2 turn 25 mm Loop		
Low-noise FM Demodulator	Residual FM to be less than 2 Hz up to 1 GHz.	MI 2305 + MI 2041

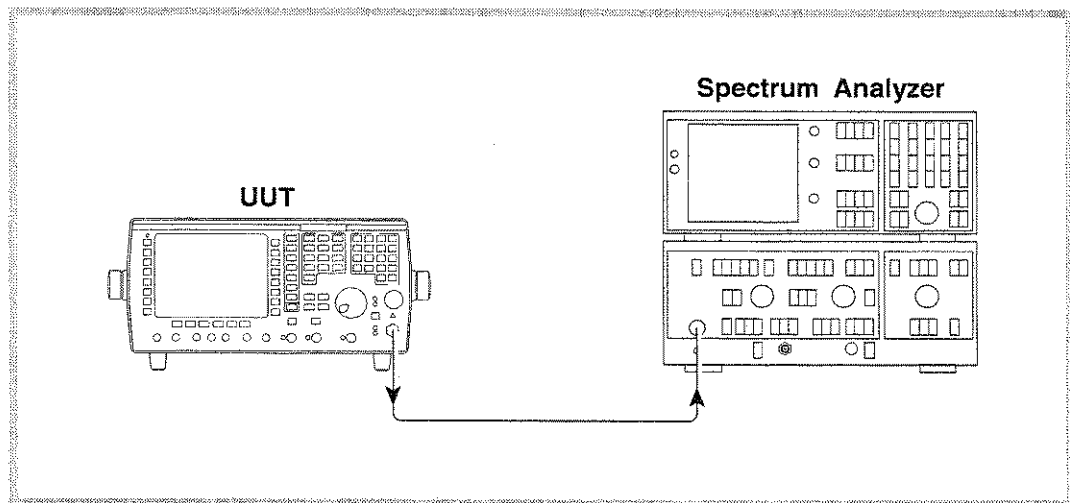

C2529

Fig. 5-5 Carrier harmonics and spurious check

- (1) Connect the test equipment as shown in Fig. 5-5.
- (2) Set the UUT to [Rx TEST], [RF SELECT] TNC output, [RF GEN], [LEVEL] 7 [dBm], [FREQ] 0.1 [MHz]. All modulation and noise measurements should be OFF.
- (3) Tune the Spectrum Analyzer to view the harmonics shown in the columns headed 'Second harmonic' and 'Third harmonic' of Table 5-8 on page 5-42, checking that they are within the above specification.
- (4) Repeat steps (2) and (3) for the remaining frequencies shown in the Table.
- (5) Set the UUT to [Rx TEST], [RF SELECT] TNC output, [RF GEN], [LEVEL] 7 [dBm], [FREQ] 0.1 [MHz].
- (6) Refer to Table 5-9 on page 5-42.
- (7) Use the Spectrum Analyzer to check that any spurious signals are < -45 dBc. Repeat for UUT carrier frequencies of 20 MHz and 35.9 MHz. Repeat for UUT carrier frequencies of 36.1 MHz, 220 MHz, 500 MHz and 1000 MHz checking that any spurious signals are < -50 dBc.

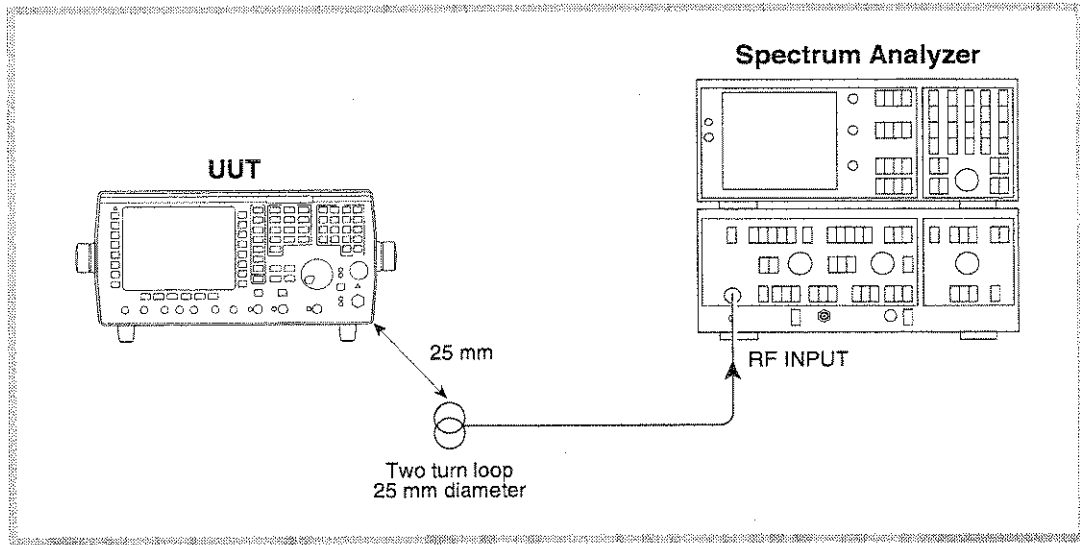

C2744

Fig. 5-6 RF carrier leakage check

- (8) Connect the test equipment as shown in Fig. 5-6, with the 50 Ω load connected to the TNC socket of the UUT.
- (9) Set the UUT to [Rx TEST], [RF SELECT] TNC output, [RF GEN], [LEVEL] -60 [dBm], [FREQ] 501.9873 [MHz].
- (10) Refer to Table 5-10 on page 5-43.
- (11) Tune the Spectrum Analyzer to monitor 501.9873 MHz. Set other Spectrum Analyzer controls to allow the display of signals below -121 dBm. If using the 2383, this can be set to meter mode.
- (12) Hold the loop 25 mm away from the UUT case and check that the level picked up on the Spectrum Analyzer is less than 0.5 μ V PD.
- (13) To confirm the low residual FM of the UUT requires the use of an extremely low-noise FM demodulator. This is achieved by using the MI 2041 low-noise Signal Generator as the local oscillator for the MI 2305. Connect the test equipment as shown in Fig. 5-7.

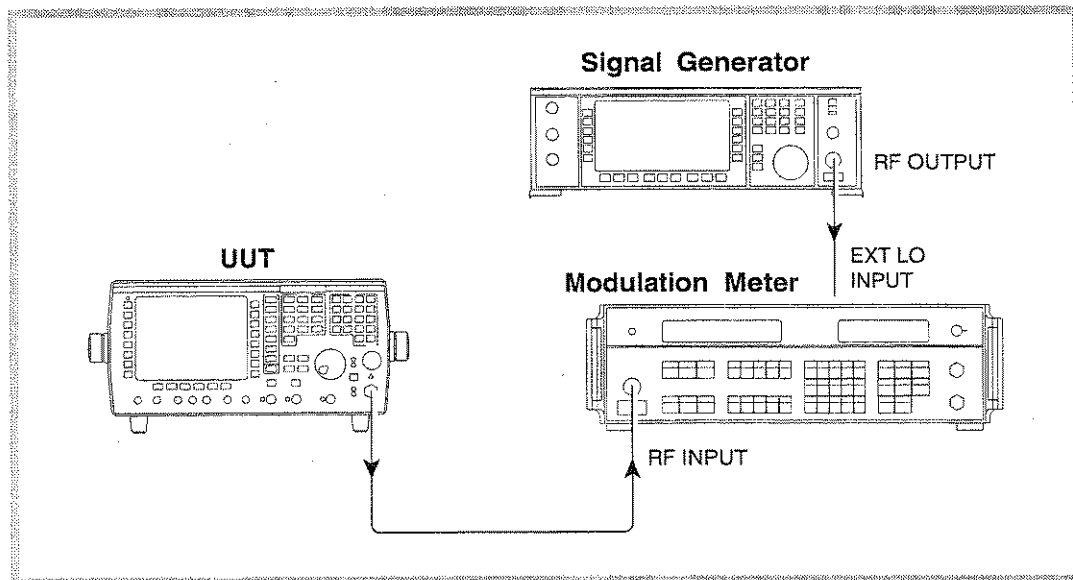

C2531

Fig. 5-7 Residual FM checks

- (14) Set the UUT to [Rx TEST], [RF SELECT] TNC output, [RF GEN], [LEVEL] 0 [dBm], [FREQ] 1000 [MHz]. Switch all modulation generators and noise measurements OFF.
- (15) Set the Signal Generator into low-noise mode 1 and to provide a signal of 55.63889 MHz at 0 dBm.
- (16) Set the Modulation Meter to measure FM in a 300 Hz to 3.4 kHz bandwidth with noise averaging on. Select external LO by pressing FREQ TUNE, 0, ENTER. External LO should now appear in the top left of the modulation window display and the frequency window should display the IF frequency of 1.5 MHz \pm 150 kHz. Check that the residual FM displayed in the modulation window is less than 12 Hz.
- (17) Set the UUT RF generator and the local oscillator to the frequencies shown in Table 5-11 on page 5-43, confirming that the residual FM indicated on the Modulation Meter is within the limits shown in the right hand column.

Amplitude modulation (RF generator)

Specification

Carrier range:	100 kHz to 400 MHz usable to 1.1 GHz
Resolution:	0.1%
Accuracy[†] (up to 85% AM):	\pm 4% of setting \pm 1 digit for modulation at 1 kHz. \pm 6% of setting \pm 1 digit for modulation frequencies from 30 Hz to 10 kHz. \pm 8% of setting \pm 1 digit for modulation frequencies from 10 kHz to 20 kHz
Distortion:	Less than 1% at 1 kHz for modulation depths up to 30% CCITT weighted. Less than 2%, 100 Hz to 20 kHz for modulation depths up to 85%.

[†] At low modulation levels the residual AM/FM may become significant

Test equipment

Description	Minimum specification	Example
Modulation Meter	RF I/P 500 kHz to 400 MHz. AM measurement accuracy up to 85% depth:- \pm 1% of reading at 1 kHz modulation rate. \pm 2.5% of reading for modulation rates from 30 Hz to 50 kHz.	MI 2305

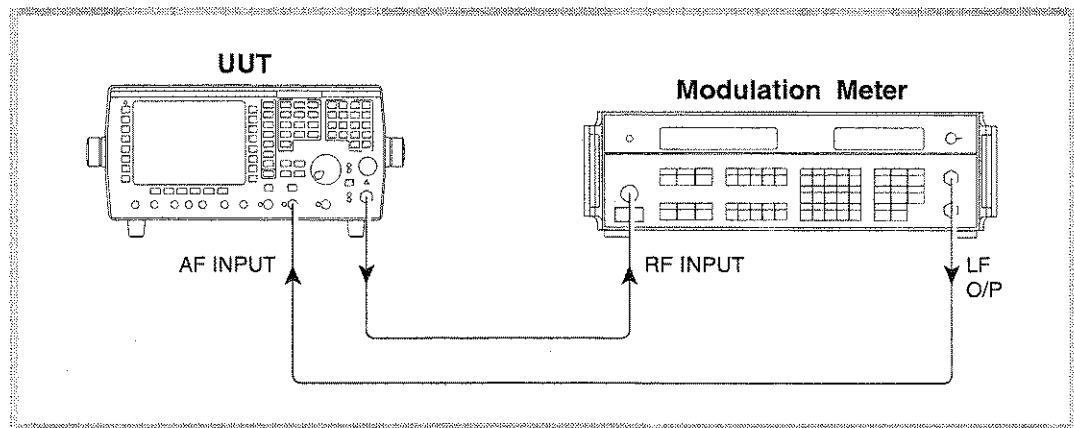

C2532

Fig. 5-8 Internal AM accuracy checks

- (1) Connect the test equipment as shown in Fig. 5-8.
- (2) Refer to Table 5-12 on page 5-43.
- (3) Set the UUT to [Rx TEST], [RF SELECT] TNC output, [RF GEN], [LEVEL] 0 [dBm], [FREQ] 0.5 [MHz], [MOD GEN], [FREQ] 1 [kHz], [DEPTH] 50[%].
- (4) Set the Modulation Meter to monitor AM in a 0.3 to 3.4 kHz bandwidth.
- (5) Check the Modulation Meter for a reading within $\pm 4\%$ of setting ± 1 digit.
- (6) Repeat step (5) but with the UUT RF generator set to the following carrier frequencies:- 10 MHz, 35 MHz, 36 MHz, 100 MHz, then in 50 MHz steps up to 400 MHz.
- (7) Refer to Table 5-13 on page 5-44.
- (8) Set the UUT to [RF GEN], [FREQ] 100 [MHz], [LEVEL] 3 [dBm], [INC] 1 [dB], [MOD GEN], [DEPTH] 70[%] and check the Modulation Meter for a reading within $\pm 4\%$ of setting ± 1 digit. Decrement the RF level by 1 dB and repeat check. Repeat in 1 dB decrements down to -13 dBm.
- (9) Set the UUT to [RF GEN], [LEVEL] 0 [dBm], [MOD GEN], [DEPTH] 5[%].
- (10) Refer to Table 5-14 on page 5-44.
- (11) Check that the Modulation Meter reads within $\pm 4\%$ of setting ± 1 digit. Repeat for UUT AM Depths of 10, 20, 30, 40, 50, 60, 70, 80 and 85%.
- (12) Refer to Table 5-15 on page 5-45.
- (13) Set the UUT to [MOD GEN], [FREQ] 65 [Hz].
- (14) Set the Modulation Meter to monitor AM in a 30 Hz to 50 kHz flat bandwidth.
- (15) Check the Modulation Meter for a reading within $\pm 6\%$ of setting ± 1 digit.
- (16) Repeat step (15) with the UUT set to each of the following mod rates:- 140 Hz, 500 Hz, 2 kHz, 5 kHz and 10 kHz.
- (17) Set the UUT mod rate to 15 kHz and check the Modulation Meter for a reading within $\pm 8\%$ of setting ± 1 digit. Repeat at 20 kHz.
- (18) Set the UUT to [Rx TEST], [RF SELECT] TNC output, [RF GEN], [LEVEL] 0 [dBm], [FREQ] 100 [MHz], [MOD GEN], [DEPTH] 30[%], [FREQ] 1 [kHz] modulation rate.
- (19) Set the Modulation Meter to monitor AM in a 0.3 to 3.4 kHz bandwidth. Connect the LF output from the Modulation Meter to the AF input of the UUT. (The LF level control on the Modulation Meter should be set to the brown marker).
- (20) Refer to Table 5-16 on page 5-45.
- (21) Press the following keys: [HELP SET-UP], [SET-UP], [TEST OPTIONS], [*sinad & distn*]. Toggle the [*Slave Mod Gen*] key until GEN1 is displayed. Press [HELP SET-UP] twice to get back to the RECEIVER TEST screen, then press [*distn ON*].
- (22) Check that the distortion indicated on the UUT display is less than 1%.

Frequency modulation (RF generator)

Specification

Carrier range:	100 kHz to 1 GHz usable to 1.1 GHz.
Maximum deviation/resolution	<p>400 kHz / 200 Hz from 100 kHz to 36 MHz</p> <p>40 kHz / 20 Hz from 36 MHz to 72 MHz</p> <p>100 kHz / 50 Hz from 72 MHz to 144 MHz</p> <p>200 kHz / 100 Hz from 144 MHz to 288 MHz</p> <p>400 kHz / 200 Hz from 288 MHz to 576 MHz</p> <p>800 kHz / 500 Hz from 576 MHz to 1 GHz</p>
Accuracy: †	<p>$\pm 3\% \pm 1$ digit at 1 kHz over the range 10-35 °C (0.1%/ °C outside this range).</p> <p>Typically $\pm 3\% \pm 1$ digit for modulation frequencies from 20 Hz to 5 kHz.</p> <p>Typically $\pm 7\% \pm 1$ digit for modulation frequencies from 5 kHz to 20 kHz.</p> <p>Typically $\pm 10\% \pm 1$ digit for modulation frequencies from 20 kHz to 75 kHz.</p>
Distortion: †	<p>Less than 0.5% for modulation frequencies from 250 Hz to 5 kHz.(deviation 1 kHz to 800 kHz)</p> <p>Less than 1% for modulation frequencies from 50 Hz to 20 kHz (deviation 1 kHz to 800 kHz)</p>

† At low modulation levels the residual AM/FM may become significant.

Test equipment

Description	Minimum specification	Example
Modulation Meter	RF I/P 500 kHz to 1 GHz. FM measurement accuracy $\pm 0.5\%$ of reading ± 1 least significant changing digit at 1 kHz modulation rate for deviation >5 kHz	MI 2305

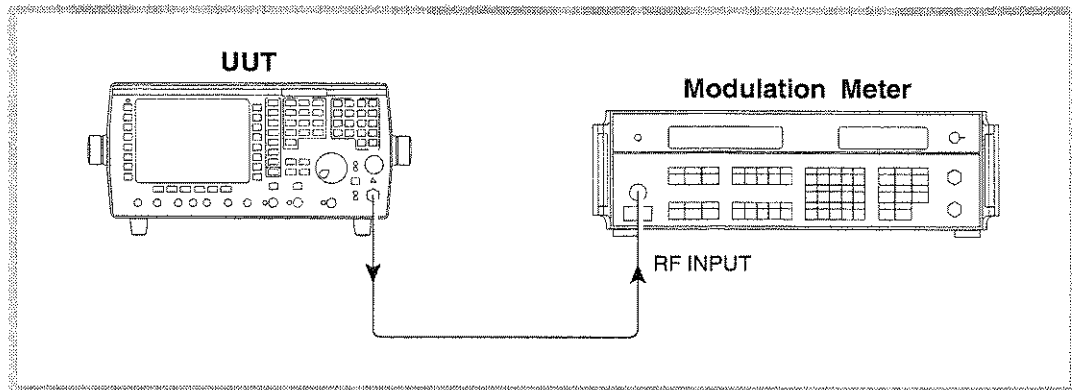

C2533

Fig. 5-9 Internal FM accuracy checks

- (1) Connect the test equipment as shown in Fig. 5-9, connecting to the TNC socket on the UUT.
- (2) Refer to Table 5-17 on page 5-45.
- (3) Set the UUT to [Rx TEST], [RF SELECT] TNC output, [RF GEN], [LEVEL] 0 [dBm], [FREQ] 0.5 [MHz], [MOD GEN] 1, [DEVN] 10 [kHz], [FREQ] 1 [kHz]. All other modulation generators and noise measurements should be switched OFF.

- (4) Set the Modulation Meter to monitor FM in a 50 Hz to 15 kHz bandwidth, noise averaging ON.
- (5) Check the Modulation Meter indicates a reading within $\pm 3\% \pm 1$ digit of the deviation set. Repeat with the UUT set to the remaining carrier frequencies shown in Table 5-17 on page 5-45.
- (6) Refer to Table 5-18 on page 5-46.
- (7) Set the UUT to [RF GEN], [FREQ] 600 [MHz], [MOD GEN], [DEVN] 500 [kHz].
- (8) Check the Modulation Meter indicates a reading within $\pm 3\% \pm 1$ digit of the deviation set. Repeat with the UUT set to the remaining deviations shown in Table 5-18 on page 5-46.
- (9) Connect the test equipment as shown in Fig. 5-10.

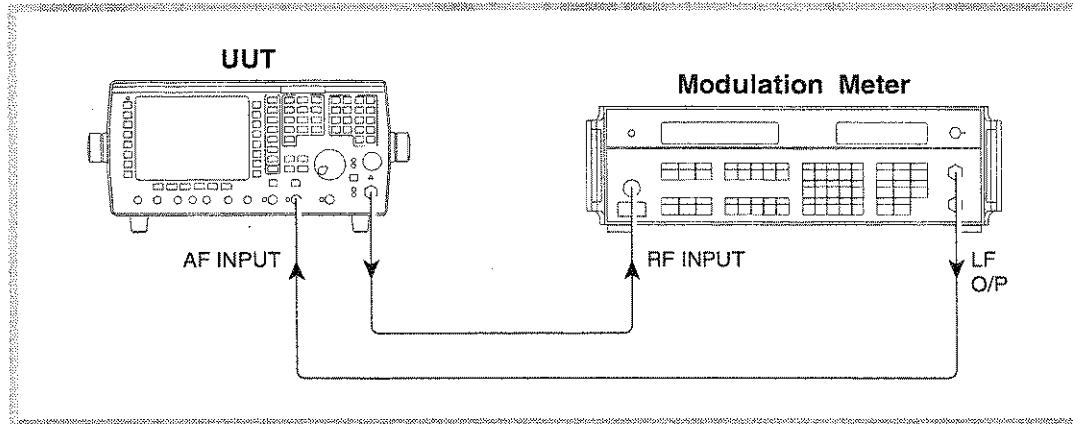

C2532

Fig. 5-10 FM versus modulation rate.

- (10) Set the UUT to [MOD GEN] 1, [DEVN] 10 [kHz], [FREQ] 40 [Hz]. Set the AF filter to 20 kHz LP.
- (11) Select the 30 Hz to 50 kHz filter on the Modulation Meter. Set the LF [LEVEL] control to the brown marker.
- (12) Check that the Modulation Meter reads 10 kHz deviation $\pm 5\% \pm 1$ digit (functional check only) and that the UUT counter reads the modulation frequency set ± 0.5 Hz. Repeat for UUT modulation frequencies of 190 Hz and 4 kHz.
- (13) Repeat step (12) but for modulation frequencies of 10 kHz and 20 kHz, checking the Modulation Meter for a deviation of 10 kHz $\pm 10\% \pm 1$ digit (functional check only).
- (14) Refer to Table 5-19 on page 5-46.
- (15) Set the UUT to [MOD GEN] 1, [FREQ] 1 [kHz], [band pass] 0.3-3.4 kHz. Press the following keys: [HELP SET-UP], [SET-UP], [TEST OPTIONS], [sinad & distn]. Toggle the [Slave Mod Gen] key until GEN1 is displayed. Press [HELP SET-UP] twice to get back to the RECEIVER TEST screen, then press [distn ON].
- (16) Check that the distortion indicated on the UUT display is less than 0.5%.

AF output tests

Audio generator output level

Specification

Level range:	0.1 mV to 5 V RMS
Accuracy:	$\pm 3\% \pm 1$ digit 250 Hz to 5 kHz
	$\pm 5\% \pm 1$ digit 10 Hz to 20 kHz
	$\pm 10\% \pm 1$ digit 20 Hz to 75 kHz

Test equipment

Description	Minimum specification	Example
DVM	1% accuracy 10 Hz to 75 kHz	Solatron 7150+

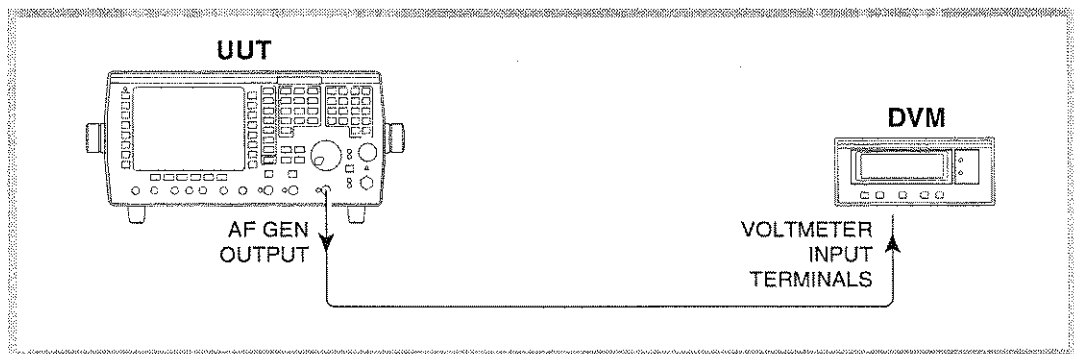

C2534

Fig. 5-11 Audio generator level accuracy checks

- (1) Connect the test equipment as shown in Fig. 5-11, connecting the UUT AF generator output socket to the DVM.
- (2) Set the DVM to measure AC volts RMS.
- (3) Refer to Table 5-20 on page 5-47.
- (4) Set the UUT to [AF TEST], [AF IN/OUT], [gen 1 ON], [FREQ] 1 [kHz], [LEVEL] 5 [V]. (Ensure that AF gen 2 and AF gen 3 are set to 0 mV and OFF).
- (5) Check that the DVM reads the level set $\pm 3\% \pm 1$ digit.
- (6) Repeat with frequencies of 250 Hz and 5 kHz. Set frequencies of 10 Hz, 150 Hz, 10 kHz, 15 kHz and 20 kHz in turn, checking that the DVM reads the level set $\pm 5\% \pm 1$ digit.
- (7) Configure the audio generator as a single generator by pressing the following: [HELP SET-UP], [SET-UP], [TEST OPTIONS], [af/mod setup], then toggle [af/mod mode] until Single Generator to 100 kHz is displayed. Press [HELP SET-UP] twice to get back to the AUDIO INPUT/OUTPUT TEST screen. AF gen 4 should be displayed and be at a frequency of 50 kHz. Set the level to 5 V and check that the DVM reads the level set $\pm 10\% \pm 1$ digit. Repeat with AF gen 4 set to a frequency of 75 kHz.
- (8) Press [HELP SET-UP], [SET-UP], [TEST OPTIONS], [af/mod setup], then toggle [af/mod mode] until Default 6 Generator Mode is displayed. Press [HELP SET-UP] twice to get back to the AUDIO INPUT/OUTPUT TEST screen.

- (9) Set AF gen 1 to 1 kHz and then to the following levels: 20 mV, 500 mV, 1.000 V, 1.512, 2.024, 3.048 and 5 V. Check, in turn, that the DVM reads the level set $\pm 3\% \pm 1$ digit.
- (10) The internal switching of the two lowest audio generator ranges can be functionally checked using the UUT Audio analyzer. Connect the UUT AF GEN OUTPUT to the AF INPUT. Set AF gen 1 level to 90 mV. Select [audio ana] and REF LEVEL 100 mV (the 1 kHz signal should now appear slightly below the top graticule). Set AF gen 1 level to 9 mV (1 mV-9.9 mV range). Check that the 1 kHz signal drops 20 dB (2 divisions) on the Audio analyzer display. Set AF gen 1 to 0.9 mV (0.1-0.9 mV range), checking that the signal drops a further 20 dB (2 divisions) on the display.

Audio generator signal purity

Specification

Distortion:	Less than 0.5% at 1 kHz (30 kHz bandwidth). Less than 1% 20 Hz to 20 kHz (80 kHz bandwidth) Typically 0.1% for levels >100 mV
Residual noise:	Less than 50 μ V RMS (CCITT weighted)
DC offset:	Less than 10 mV

Test equipment

Description	Minimum specification	Example
Audio Analyzer	Capable of measuring distortion from 20 Hz to 20 kHz down to 0.1% and AC measurement in a CCITT bandwidth.	HP 8903B
DVM	DC measurement to 1 mV	Solatron 7150+

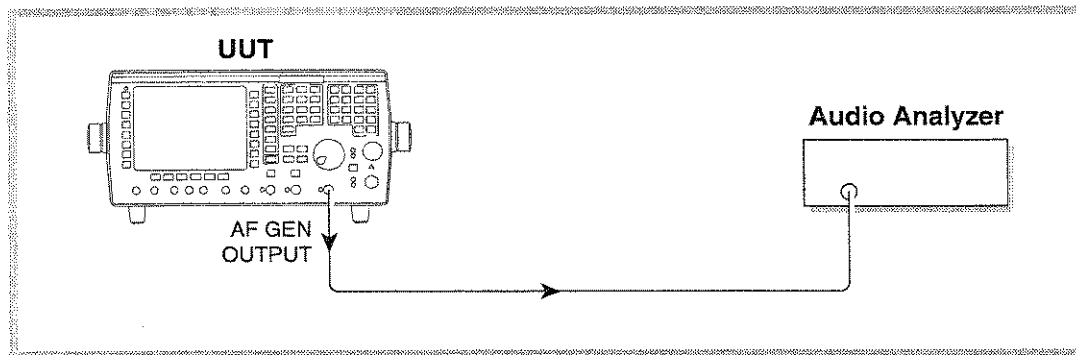

C2535

Fig. 5-12 Audio generator signal purity checks

- (1) Connect the test equipment as shown in Fig. 5-12.
- (2) Refer to Table 5-21 on page 5-47.
- (3) Set the UUT to [AF TEST], [AF IN/OUT], [AF GEN] 1, [FREQ] 1 [kHz] [LEVEL] 5 [V].
- (4) Set the Audio Analyzer to measure distortion with the 30 kHz LP filter selected.
- (5) Check that the distortion indicated is less than 0.5%.
- (6) Repeat step (5) with AF gen 1 level set to 50 mV.
- (7) Set the Audio Analyzer to measure distortion with the 80 kHz LP filter selected.
- (8) Set the UUT to [AF GEN] 1, [LEVEL] 5 [V] and frequencies 20 Hz and 20 kHz in turn. Check that the distortion indicated on the analyzer is less than 1% at these frequencies.

- (9) Set the Audio Analyzer to measure AC volts in a CCITT weighted bandwidth.
- (10) Refer to Table 5-22 on page 5-48.
- (11) Set the UUT to [AF GEN 1], [LEVEL] 1 [mV] and OFF. Set the following frequencies in turn: 1 Hz, 1 kHz, and 20 kHz, checking that the residual noise indicated on the Audio Analyzer is less than 50 μ V.
- (12) Connect the test equipment as shown in Fig. 5-11.
- (13) Set the DVM to measure DC volts.
- (14) Refer to Table 5-23 on page 5-48.
- (15) Set [AF GEN] 1 level to 0 mV and to the following frequencies in turn: 1 Hz, 1 kHz, and 20 kHz, checking that the DC offset indicated on the DVM is less than 10 mV.

Audio generator frequency

The audio generator frequency is derived by digital signal processing and providing this hardware is operational it is only the instrument internal reference frequency that determines the accuracy. The following confirms functionality of the hardware. The instrument reference is checked elsewhere. This check should be carried out after the audio counter has been checked.

Specification

Frequency accuracy: As frequency standard

Test equipment

Description	Minimum specification	Example
None required		

- (1) Connect the UUT AF GEN OUTPUT to the UUT AF INPUT.
- (2) Refer to Table 5-24 on page 5-48.
- (3) Set the UUT to [AF TEST], [AF IN/OUT], [AF GEN] 1, [LEVEL] 1 [V]. Set the audio input filter to 20 kHz LP.
- (4) Set [AF GEN] 1 to the frequencies shown in Table 5-24 on page 5-48, checking that the frequency indicated on the UUT audio counter is within the limits shown in the table.

AF input tests

Audio filters

Specification

Filters:-

300 Hz LP	± 0.1 dB <150 Hz, ± 0.2 dB 150-200 Hz relative to 100 Hz
300 Hz to 3.4 kHz BP	± 0.4 dB 450 to 2100 Hz, relative to 1 kHz.
20 kHz LP	± 0.3 dB less than 12 kHz relative to 1 kHz.
CCITT BP	Recommendation 0.41, CCITT Red Book. Volume 1 V, Fascile 1 V.4.
CMESS BP	Recommendation 0.41, CCITT Red Book. Volume 1 V, Fascile 1 V.4.

Test equipment

Description	Minimum specification	Example
DVM	AC measurement 50 Hz to 300 Hz.	Solatron 7150+

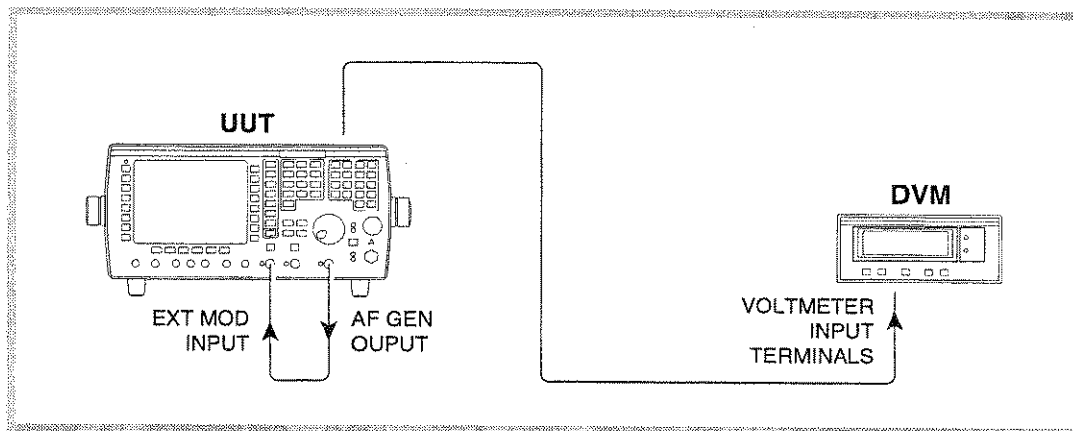

C2536

Fig. 5-13 Audio filter checks

- (1) Connect the equipment as shown in Fig. 5-13, connecting the UUT front panel AF GEN OUTPUT socket to the front panel AF INPUT socket, and the rear panel AF output socket to the external DVM. Set the external DVM to monitor AC volts.
- (2) Refer to Table 5-25 on page 5-49.
- (3) Set the UUT to [AF TEST], [AF IN/OUT], DC-coupled. Press [low pass] to set the audio input filter to NONE. Select [scope] and select the 200 mV/div range.
- (4) Set [AF GEN] 1 to a frequency of 100 Hz and level 500 mV. Adjust the level until the external DVM indicates 1.000 V.
- (5) Press [low pass] until the 300 Hz LP filter is selected. Check that the reading on the external DVM is within 1 V \pm 0.1 dB (0.9885 to 1.0116 V). Make a note of this reading.
- (6) Change [AF GEN] 1 to 50 Hz. Check that the reading on the external DVM is within 1 V \pm 0.1 dB (0.9885 to 1.0116 V). Repeat at 150 Hz.
- (7) Change [AF GEN] 1 to 200 Hz. Check that the reading on the external DVM is within \pm 0.2 dB of the reading noted in step (5).
- (8) Change [AF GEN] 1 to 300 Hz. Check that the reading on the external DVM drops 3 dB \pm 0.5 dB (0.67 to 0.75 V) (functional check only).
- (9) Select the 300 Hz to 3.4 kHz filter on the UUT and set [AF GEN] 1 to 1 kHz. Check that the reading on the external DVM is within 1 V \pm 0.1 dB (0.9885 to 1.0116 V) (functional check only). Adjust [AF GEN] 1 level until the external DVM indicates 1.000 V.
- (10) Change [AF GEN] 1 to 450 Hz. Check that the reading on the external DVM is within 1 V \pm 0.4 dB (0.9550 to 1.0471 V). Repeat at 2100 Hz.
- (11) Change [AF GEN] 1 to 300 Hz. Check that the reading on the external DVM drops 3 dB \pm 1 dB (0.6310 to 0.7943 V). Repeat at 3400 Hz (functional check only).
- (12) Press [low pass] to select filter NONE. Set [AF GEN] 1 to 1 kHz and adjust the level until the external DVM indicates 1.000 V.
- (13) Select the 20 kHz LP filter on the UUT. Check that the reading on the external DVM is within 1 V \pm 0.1 dB (0.9885 to 1.0116 V) (functional check only). Adjust [AF GEN] 1 level until the external DVM indicates 1.000 V.
- (14) Change [AF GEN] 1 to 50 Hz. Check that the reading on the external DVM is within 1 V \pm 0.3 dB (0.9660 to 1.0351 V). Repeat at 12 kHz.

- (15) Press [*low pass*] to select filter NONE. Set [AF GEN] 1 to a frequency of 800 Hz and adjust the level until the external DVM indicates 1.000 V.
- (16) Select the CCITT filter on the UUT. Check that the reading on the external DVM is within $1\text{ V} \pm 0.1\text{ dB}$ (0.9885 to 1.0116 V) (functional check only).
- (17) Change [AF GEN] 1 to the frequencies shown in Table 5-26 on page 5-49. Check that the reading on the external DVM is within the limits shown.
- (18) Press [*low pass*] to select filter NONE. Set [AF GEN] 1 to 1 kHz and adjust the level until the external DVM indicates 1.000 V.
- (19) Select the CMESS filter on the UUT. Check that the reading on the external DVM is within $1\text{ V} \pm 0.1\text{ dB}$ (0.9885 to 1.0116 V) (functional check only).
- (20) Change [AF GEN] 1 to the frequencies shown in Table 5-27 on page 5-49. Check that the reading on the external DVM is within the limits shown in the upper limits column.

Notes:

Depending upon instrument configuration, either the CCITT or CMESS filter will be selectable in the AUDIO INPUT / OUTPUT TEST screen. To alter these, enter the HELP AND SET-UP menu and press [*SET-UP*], [*TEST OPTIONS*], [*filter options*]. Once the required filter is highlighted, press [HELP SET-UP] twice to return to the AUDIO INPUT / OUTPUT TEST screen.

The intrinsic accuracy of the instrument's AF generator is good; however, this should be taken into account when changing frequency by temporarily transferring the DVM to monitor the AF input and readjusting the level if required.

Audio counter

This test confirms the functionality and accuracy of the audio counter hardware. Overall accuracy is governed by the instrument reference frequency. The reference is checked independently elsewhere.

Specification

Frequency range:	10 Hz to 500 kHz
Resolution:	0.1 Hz from 10 Hz to 5 kHz 1 Hz from 5 kHz to 50 kHz 10 Hz from 50 kHz to 500 kHz
Accuracy:	As frequency standard $\pm 1\text{ digit} \pm \text{resolution}$
Sensitivity:	On bar chart greater than 25% FSD

Test equipment

Description	Minimum specification	Example
LF Generator	10 Hz to 500 kHz frequency. Ext Std In/Out. Level accuracy $\pm 0.2\text{ dB}$ or better.	HP 3325B

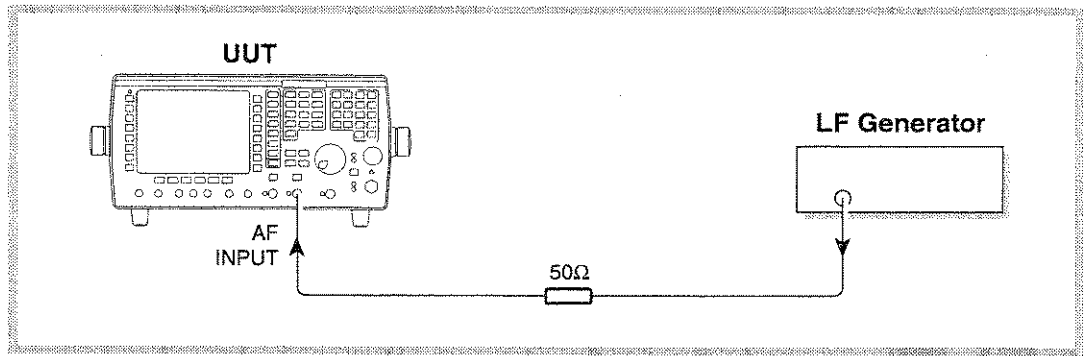

C2537

Fig. 5-14 Audio counter check

- (1) Connect the equipment as shown in Fig. 5-14. The frequency standards of the UUT and LF Generator should be locked together. The 50 Ω load is in circuit because the LF Generator used indicates the level across 50 Ω.
- (2) Refer to Table 5-28 on page 5-50.
- (3) Set the UUT to [AF TEST], [AF IN/OUT]. Set the audio input filter to 20 kHz LP (for the last 3 frequencies no filters should be selected).
- (4) Set the LF Generator to a level of 1 V RMS and to the frequencies shown in Table 5-28 on page 5-50, checking that the frequency indicated on the UUT audio counter is within the limits shown in the table.
- (5) Refer to Table 5-29 on page 5-50.
- (6) On the UUT, set all noise measurements OFF and the bar charts to auto range.
- (7) Set the LF Generator to provide 1 kHz at 2.5 mV RMS, selecting the 0.3-3.4 kHz band-pass filter on the UUT. Check that the UUT audio counter reads the frequency set on the LF Generator.

Audio voltmeter

Specification

Level accuracy: ±2% of reading ±1 mV ±resolution 150 Hz to 20 kHz
(AC-coupled)† ±4% of reading ±1 mV ±resolution 100 Hz to 100 kHz

Level accuracy: ±2% of reading ±1 mV ±resolution DC and 100 Hz to 20 kHz
(DC-coupled)† ±4% of reading ±1 mV ±resolution 40 Hz to 100 kHz

† Audio and modulation filter passband error not included. See *User calibrations* (page 5-3).

Test equipment

Description	Minimum specification	Example
LF Generator	20 Hz to 100 kHz, 7 mV to 3.5 V RMS.	HP 3325B
DVM	AC measurement 20 Hz to 100 kHz.	Solatron 7150+

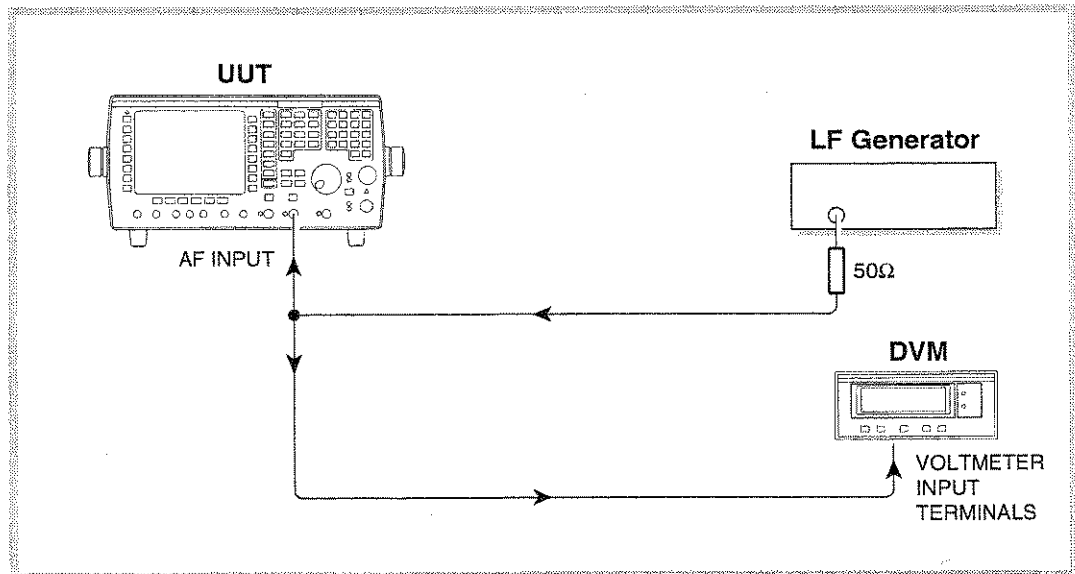

C2538

Fig. 5-15 Audio voltmeter level accuracy checks

- (1) Connect the equipment as shown in Fig. 5-15, connecting to the AF input of the UUT. The 50 Ω load is in circuit because the LF Generator used indicates the level across 50 Ω .
- (2) Refer to Table 5-30 on page 5-51.
- (3) Set the UUT to [AF TEST], [AF IN/OUT]. Set the audio input filter to NONE, AC coupled. All noise measurements should be switched OFF.
- (4) Set the DVM to measure AC volts and the LF Generator to frequency 1 kHz, level 7 mV RMS (adjust until DVM indicates as close to 7 mV as possible). Check that the level indicated on the UUT voltmeter is within $\pm 2\% \pm 1 \text{ mV} \pm \text{resolution}$ of the level indicated on the DVM.
- (5) Repeat step (4) with LF Generator levels of 21 mV, 50 mV, 150 mV, 0.5 V, 1 V, 2 V, 2.8 V, 3.5 V.
- (6) Set the LF Generator to frequency 150 Hz, level 1 V RMS (adjust until DVM indicates as close to 1 V as possible). Check that the level indicated on the UUT voltmeter is within $\pm 2\% \pm 1 \text{ mV} \pm \text{resolution}$ of the level indicated on the DVM.
- (7) Repeat step (6) with LF Generator frequencies of 5 kHz and 20 kHz.
- (8) Set the LF Generator to frequency 100 Hz, level 1 V RMS (adjust until DVM indicates as close to 1 V as possible). Check that the level indicated on the UUT voltmeter is within $\pm 4\% \pm 1 \text{ mV} \pm \text{resolution}$ of the level indicated on the DVM. Repeat this step at 50 kHz and 100 kHz.
- (9) Set the UUT AF input to DC-coupled.
- (10) Set the LF Generator to frequency 100 Hz, level 1 V RMS (adjust until DVM indicates as close to 1 V as possible). Check that the level indicated on the UUT voltmeter is within $\pm 2\% \pm 1 \text{ mV} \pm \text{resolution}$ of the level indicated on the DVM. Repeat this step at 20 kHz.

Audio oscilloscope

Specification

Voltage accuracy:	$\pm 5\%$ of full scale DC to 500 kHz (10 Hz to 500 kHz AC coupled).
Ranges:	2 mV/div to 10 V/div in a 1, 2, 5 sequence.
Graticule:	10 horizontal by 8 vertical.

Test equipment

Description	Minimum specification	Example
LF Generator	DC to 500 kHz, 10 mV to 10 V peak to peak. Accuracy ± 0.2 dB.	HP3325B

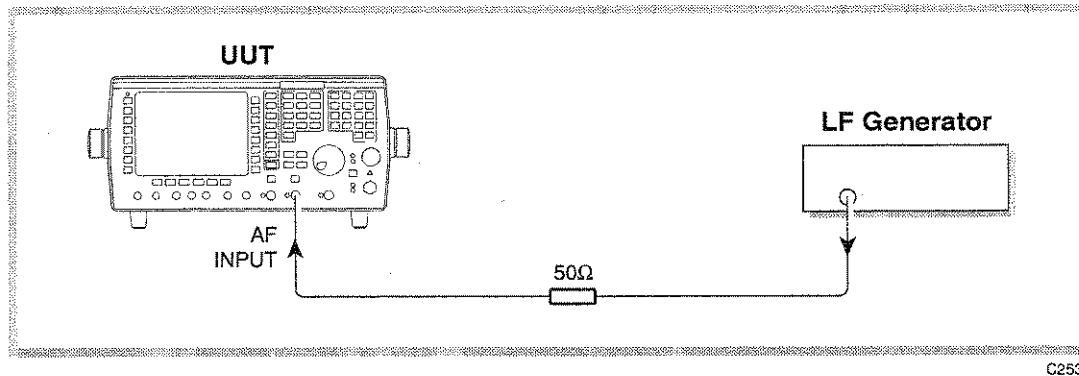

Fig. 5-16 Audio oscilloscope check

- (1) Connect the equipment as shown in Fig. 5-16, connecting to the AF input of the UUT. The 50 Ω load is in circuit because the LF Generator used indicates the level across 50 Ω . (This test relies on the specified level accuracy of the LF Generator being used. If in doubt then a suitable DVM should be used to monitor the level being applied to the UUT.)
- (2) Refer to Table 5-31 on page 5-52.
- (3) Set the UUT to [AF TEST], [AF IN/OUT], [scope], [expand ON]. Set the Oscilloscope timebase to 500 μ S/div.
- (4) Set the LF Generator to provide 1 kHz at each of the levels shown in Table 5-31 on page 5-52, at the same time selecting the relevant vertical deflection [Volts/div] on the UUT. In each case, check that the trace height is within the stated limits.
- (5) Set the UUT to 1 V/div and the AF input to DC coupled. With no signal applied, set the trace onto the centre graticule.
- (6) Set the LF Generator to provide DC only at a level of 2.5 V. Connect this to the UUT and check that the trace moves to within ± 0.4 divisions of the upper dotted graticule. Repeat with the LF Generator set to -2.5 V, checking against the lower dotted graticule.
- (7) Set the UUT to 2 V/div, 50 ms/div.
- (8) Set the LF Generator to provide 10 V pk-pk at each of the frequencies shown in Table 5-32 on page 5-52, at the same time selecting the relevant timebase on the UUT. In each case, check that the trace height is within the stated limits.

Audio FFT analyzer

Specification

Level accuracy: ± 0.3 dB 100 Hz to 15 kHz

Test equipment

Description	Minimum specification	Example
LF Generator	100 Hz to 15 kHz, 7 mV to 3.5 V RMS.	HP 3325B
DVM	AC measurement 100 Hz to 15 kHz.	Solatron 7150+

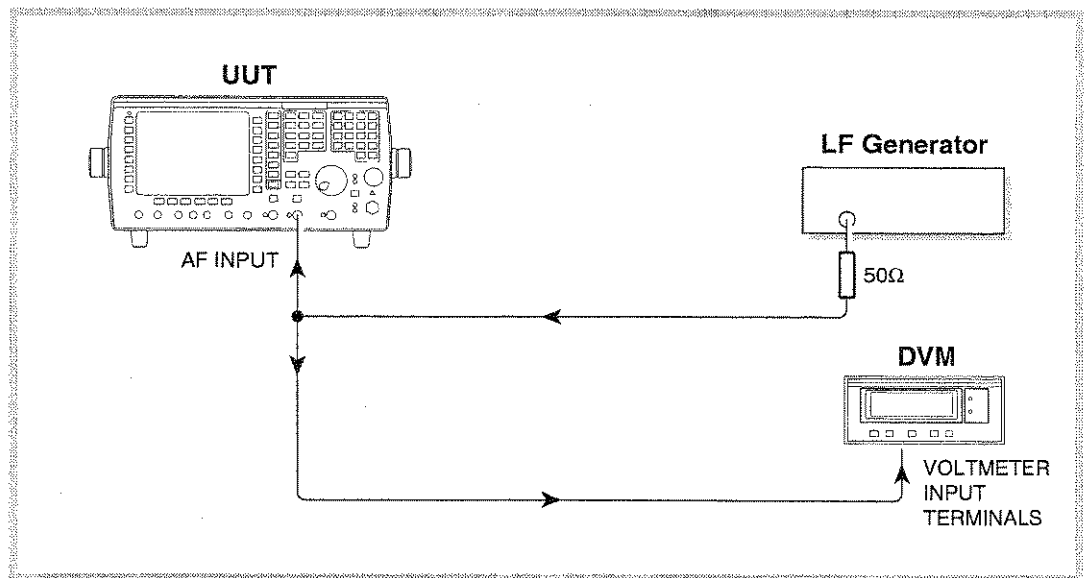

C2538

Fig. 5-17 Audio FFT analyzer level checks

- (1) Connect the equipment as shown in Fig. 5-17, connecting to the AF input of the UUT. The 50 Ω load is in circuit because the LF Generator used indicates the level across 50 Ω .
- (2) Refer to Table 5-33 on page 5-53.
- (3) Set the UUT to [AF TEST], [AF IN/OUT], [audio ana], [expand ON], [REF] [LEVEL] 20 [V], 100 Hz/div, [markers ON], [REF] [FREQ] 1 [kHz].
- (4) Set the DVM to measure AC volts and the LF Generator to frequency 1 kHz, level 3.5 V RMS. Adjust the level to obtain a reading on the DVM as close as possible to 3.5 V.
- (5) Press [peak find] on the UUT Audio analyzer. Marker 1 should now be situated on the peak of the displayed signal.
- (6) Check that the M1 level displayed on the UUT is within ± 0.3 dB of the level displayed on the DVM.
- (7) Repeat steps (5) and (6) but with LF Generator and UUT settings as shown in Table 5-33 on page 5-53.
- (8) Set the LF Generator to 10 mV RMS and UUT [REF] [LEVEL] 10 [mV]. Check that the displayed signal appears at the top graticule. This confirms the lowest range is switching in correctly (functional check only).
- (9) Set the LF Generator to 1 V RMS at 100 Hz and the UUT Audio analyzer to [REF] [LEVEL] 2 [V], 10 Hz/DIV, [REF] [FREQ] 100 [Hz] (adjust the level to obtain a reading on the DVM as close as possible to 1 V).
- (10) Refer to Table 5-34 on page 5-53.
- (11) Press [peak find] on the UUT Audio analyzer. Marker 1 should now be situated on the peak of the displayed signal.
- (12) Check that the M1 level displayed on the UUT is within ± 0.3 dB of the level displayed on the DVM.
- (13) Repeat at 15 kHz.

AF distortion and SINAD meter

Specification

Frequency range:	1 kHz default user selectable to 20 kHz
Distortion meter accuracy:	$\pm 5\%$ of reading \pm resolution
SINAD meter accuracy:	± 0.5 dB. \pm resolution

Test equipment

Description	Minimum specification	Example
DVM	AC measurement 400 Hz to 1 kHz.	Solatron 7150+

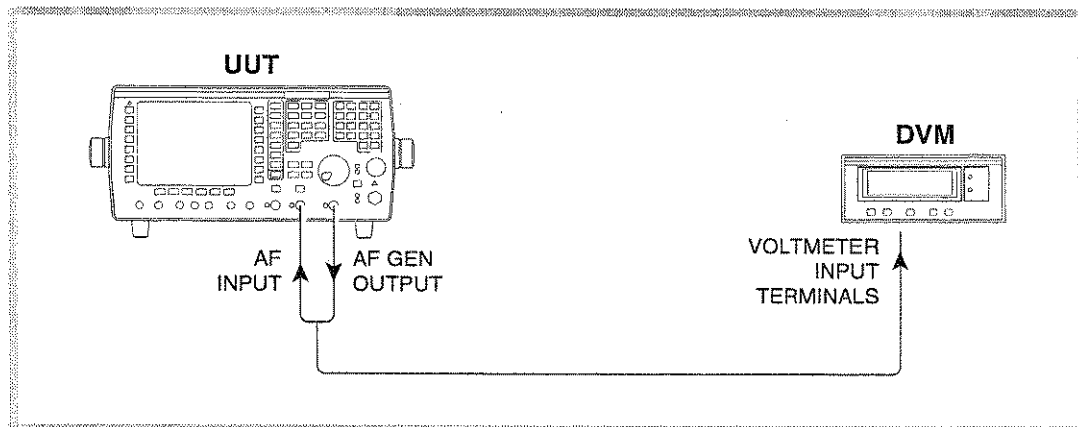

C2539

Fig. 5-18 Distortion and SINAD meter checks

- (1) Connect the equipment as shown in Fig. 5-18, connecting the UUT AF GEN OUTPUT to the UUT AF INPUT and to the external DVM using a T-piece.
- (2) Refer to Table 5-35 on page 5-53.
- (3) Set the UUT to [AF TEST], [AF IN/OUT], [AF GEN] 1, [LEVEL] 2 [V], [AF GEN] 2, [FREQ] 400 [Hz] [LEVEL] 500 [mV], [gen 2 OFF].
- (4) Check the 1 kHz level of AF gen 1 on the DVM and adjust until the DVM indicates as close to 2 V as possible.
- (5) Switch AF gen 1 OFF and AF gen 2 ON.
- (6) Check the 400 Hz level of AF gen 2 on the DVM and adjust until the DVM indicates as close to 500 mV as possible.
- (7) Switch both AF gen 1 and AF gen 2 ON and select [distn ON].
- (8) Check that the distortion meter reads between 23.6% and 26.3% distortion.
- (9) Press [SINAD on OFF] to switch the UUT SINAD meter ON.
- (10) Check that the SINAD meter reads 12 dB ± 0.6 dB.

Multimeter

Specification

AC/DC Volts, level accuracy † $\pm 3\%$ of reading ± 1 mV ± 1 digit.
polarised DC or 40 Hz to 1 kHz:

Resistance accuracy: † $\pm 5\%$ of reading $\pm 1 \Omega$ ± 1 digit.

Ammeter accuracy, $\pm 5\%$ of reading ± 1 mA ± 1 digit.
polarised DC or 40 Hz to 1 kHz:

† Refer to *User calibrations*

Test equipment

Description	Minimum specification	Example
LF Generator	40 Hz to 1 kHz, 7 mV to 3.5 V RMS.	HP 3325B
DVM	AC measurement 40 Hz to 1 kHz.	Solatron 7150+
DC PSU	0 to 60 V, 10 A at 10 V.	
Decade Reference Resistor Box	50 Ω to 1 M Ω . Accuracy better than 1%.	
Rheostat 0 to 10 Ω at 10 A.		
DVM Current Shunt	10 A, 0.25% accuracy. Sensitivity 10 mV/A.	Fluke 80J-10

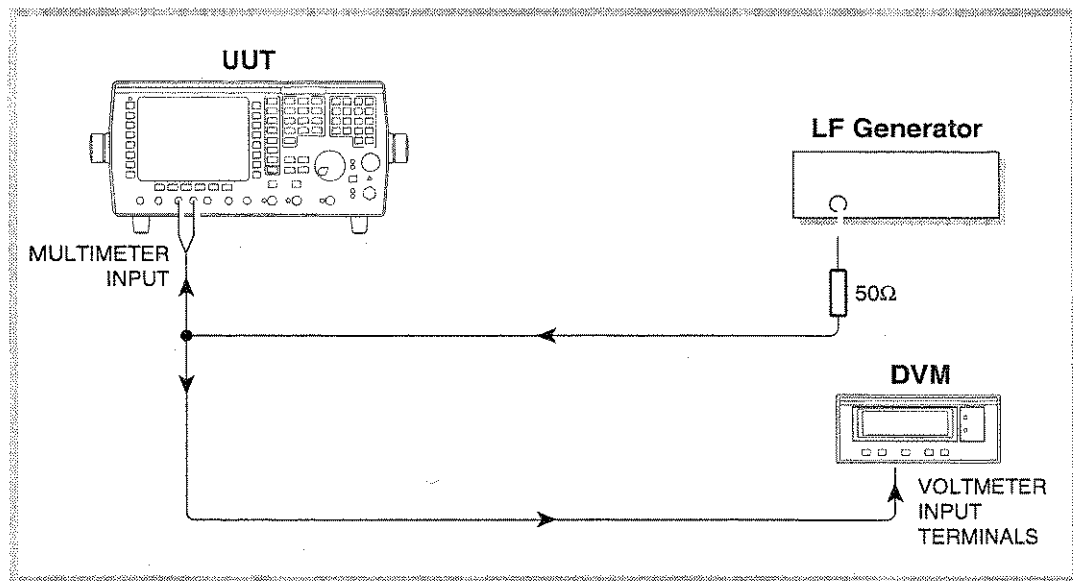

C2540

Fig. 5-19 Multimeter AC voltage measurement check.

- (1) Connect the equipment as shown in Fig. 5-19, connecting the LF Generator and DVM to the MULTIMETER input (red and black terminals).
- (2) Refer to Table 5-36 on page 5-54.
- (3) Set the UUT to [AF TEST], [MULTIMETER], [AC + DC VOLTS].
- (4) Set the DVM to measure AC volts and the LF Generator to frequency 1 kHz, level 10 mV RMS. Check that the level indicated on the UUT voltmeter is within $\pm 3\%$ ± 1 mV ± 1 digit of the level indicated on the DVM.

- (5) Repeat step (4) with LF Generator levels of 20 mV, 50 mV, 100 mV, 150 mV, 200 mV, 500 mV, 750 mV, 1 V, 2 V, 3.5 V.
- (6) Refer to Table 5-37 on page 5-54.
- (7) Set the LF Generator to frequency 80 Hz, level 1 V. Check that the level indicated on the UUT Multimeter is within $\pm 3\% \pm 1 \text{ mV} \pm 1 \text{ digit}$ of the level indicated on the DVM. (Note: At lower frequencies, press *[hold max]* if reading appears unstable).
- (8) Repeat step (7) with LF Generator frequencies of 150 Hz, 250 Hz, 500 Hz, and 750 Hz.
- (9) Remove the LF Generator and 50 Ω load and connect the DC PSU in its place. Set the DVM and the UUT to monitor *[DC VOLTS]*.
- (10) Refer to Table 5-38 on page 5-55.
- (11) Set the DC PSU to provide a voltage of 250 mV. Check that the level indicated on the UUT Multimeter is within $\pm 3\% \pm 1 \text{ mV} \pm 1 \text{ digit}$ of the level indicated on the DVM.
- (12) Repeat step (11) with the DC PSU set to the following voltages: -250 mV, 1 V, -1 V, 2 V, -2 V, 2.8 V, -2.8 V, 4 V, -4 V, 10 V, -10 V, 28 V, -28 V, 32 V, -32 V, 60 V, -60 V.
- (13) Remove the DC supply and DVM. Connect a Decade Reference Resistor Box to the MULTIMETER input (red and black terminals).
- (14) Refer to Table 5-39 on page 5-55.
- (15) Select Ω on the UUT. Set the resistance box to 10 Ω and check that the UUT indicates the resistance set $\pm 5\% \pm 1 \Omega \pm 1 \text{ digit}$.
- (16) Repeat step (15) with the resistance box set to the following: 50 Ω , 90 Ω , 110 Ω , 500 Ω , 900 Ω , 1.1 k Ω , 2 k Ω , 9 k Ω , 11 k Ω , 50 k Ω , 90 k Ω , 110 k Ω , 500 k Ω .
- (17) With the DC PSU turned fully down or off, connect the equipment as shown in Fig. 5-20, connecting to the UUT MULTIMETER input (red and white terminals). The current shunt should be connected to the voltmeter terminals of the DVM.
- (18) Refer to Table 5-40 on page 5-56.
- (19) Select *[DC AMPS]* on the UUT.
- (20) Set the DVM to monitor DC volts and the Rheostat to 10 Ω .
- (21) Turn the DC PSU up to 10 V until the DVM indicates approximately 10 mV (i.e. 1 A at 10 mV/A sensitivity). The UUT should also be displaying approximately 1 A. This indicates that all connections are made correctly before increasing the current.
- (22) Reduce the Rheostat resistance (to approximately 1 Ω) until the DVM indicates as close as possible to 100 mV (i.e. 10 A). If the UUT indicates OVER at this point, back off on the Rheostat to reduce the current slightly.
- (23) Check that the UUT indicates the current displayed on the DVM (every 10 mV is equivalent to 1 A) $\pm 5\% \pm 1 \text{ mA} \pm 1 \text{ digit}$.
- (24) Increasing the Rheostat resistance, repeat step (18) with DVM readings of 50 mV (5 A), 20 mV (2 A).
- (25) Remove the current shunt and connect directly to the DVM ammeter terminals. Set the DVM to monitor DC current.
- (26) Increase the Rheostat resistance until the DVM indicates 1 A. Check that the UUT indicates the current displayed on the DVM $\pm 5\% \pm 1 \text{ mA} \pm 1 \text{ digit}$.
- (27) Reduce the DC PSU voltage to 4 V, then adjust the Rheostat for a reading of 750 mA on the DVM. Check that the UUT indicates the current displayed on the DVM $\pm 5\% \pm 1 \text{ mA} \pm 1 \text{ digit}$.
- (28) Repeat step (27) but adjusting the Rheostat for DVM currents of 500 mA and 100 mA (reduce the DC PSU to 1 V to enable the setting of 100 mA).

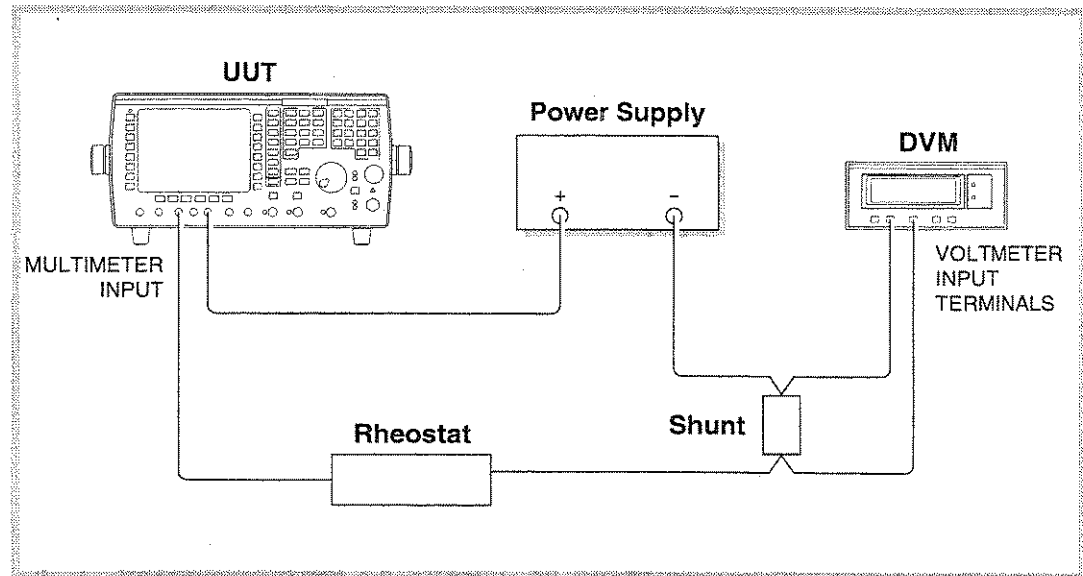

C2541

Fig. 5-20 Multimeter ammeter accuracy check.

RF input tests

Modulation analyzer - FM and PM

Specification

Frequency range:	1 MHz to 1 GHz.
Modulation frequency range:	20 Hz to 20 kHz.
Deviation range:	0 to 100 kHz.
Resolution:	10 Hz below 10 kHz deviation 100 Hz below 100 kHz deviation ²
Accuracy (see Notes 1, 3 & 5):	$\pm 3\% \pm$ resolution for modulation frequency of 1 kHz $\pm 5\% \pm$ resolution for modulation frequencies from 100 Hz to 15 kHz..
Demodulation distortion (1):	Less than 0.5% at 1 kHz (CCITT weighted.)
Residual FM:	Less than 25 Hz RMS (CCITT weighted.)

Notes

- (1) At low modulation levels, the residual AM/FM may become significant.
- (3) Audio and modulation filter passband errors not included.
- (5) Refer to *User calibrations*.

Test equipment

Description	Minimum specification	Example
RF Synthesizer	1 MHz to 1 GHz. Deviation 0 to 100 kHz. Modulation rate 20 Hz to 15 kHz.	MI 2041
Modulation Meter	RF I/P 1 MHz to 1 GHz. FM measurement accuracy $\pm 0.5\%$ of reading ± 1 least significant changing digit at 1 kHz modulation rate for deviation > 5 kHz.	MI 2305
Power Splitter	6 dB 50 Ω , 1 MHz to 1 GHz.	HP 11667A

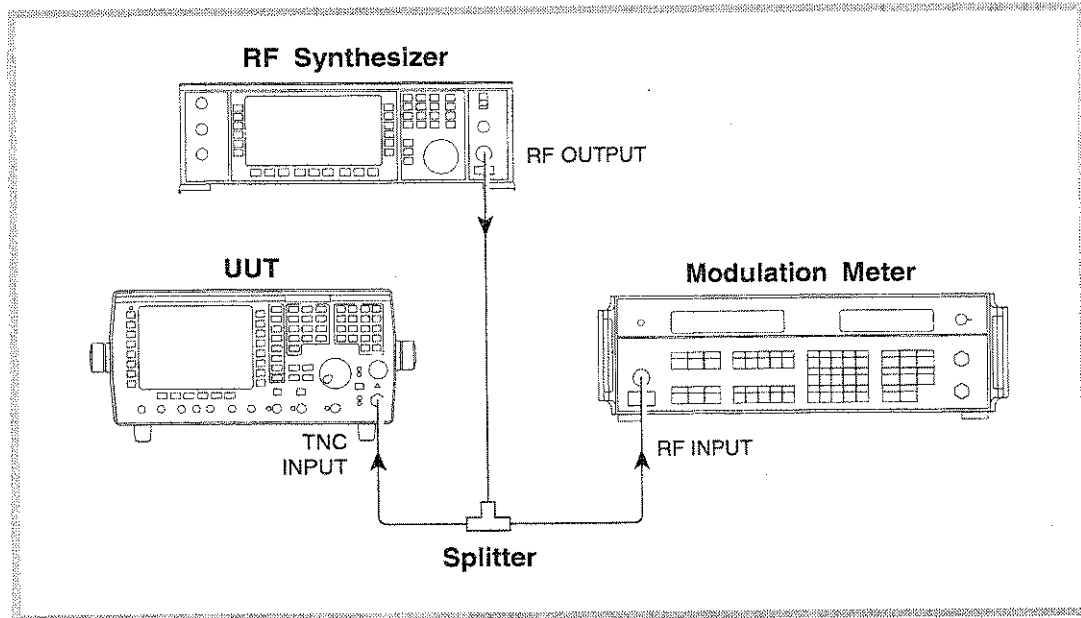

C2542

Fig. 5-21 Modulation analyzer - FM

- (1) Connect the equipment as shown in Fig. 5-21, connecting to the TNC input of the UUT.
- (2) Set the Modulation Meter to monitor FM in a 50 Hz to 15 kHz bandwidth, noise averaging ON.
- (3) Refer to Table 5-41 on page 5-57.
- (4) Set the UUT to [Tx TEST], [RF SELECT] TNC input, [mod type] to FM DEVN, [band pass] to 0.3-3.4 kHz filter. Switch all noise measurements OFF.
- (5) Set the UUT to [TX], [FREQ] 1 [MHz] and set the RF Synthesizer to provide a signal of 1 MHz with 20 kHz deviation at 1 kHz modulation rate. Set the RF level to 6 dBm. (If a MI 2041 is being used, it should be set to normal noise mode.)
- (6) Check that the deviation level indicated on the UUT is within $\pm 3\% \pm$ resolution of the deviation indicated on the Modulation Meter.
- (7) Repeat steps (5) and (6) for RF carrier frequencies of 500 MHz and 1000 MHz.
- (8) Refer to Table 5-42 on page 5-57.
- (9) On the UUT, select the 20 kHz LP filter and [Tx tune ON].
- (10) Set the RF Synthesizer to provide a signal of 300 MHz with 20 kHz deviation at 250 Hz modulation rate. Check that the deviation level indicated on the UUT is within $\pm 8.5\% \pm$ UUT resolution of the deviation indicated on the Modulation Meter. Repeat with a modulation rate of 5 kHz.
- (11) On the Modulation Meter, select the 10 Hz to 300 kHz filter. Set the RF Synthesizer modulation rate to 100 Hz. Check that the deviation level indicated on the UUT is within $\pm 8.5\% \pm$ UUT resolution of the deviation indicated on the Modulation Meter. Repeat with a modulation rate of 12 kHz.
- (12) Select the 0.3-3.4 kHz filter on both the UUT and the Modulation Meter.
- (13) Refer to Table 5-43 on page 5-57.
- (14) Set the RF Synthesizer modulation rate to 1 kHz and set 500 Hz deviation.
- (15) Check that the deviation level indicated on the UUT is within $\pm 3\% \pm$ UUT resolution of the deviation indicated on the Modulation Meter.
- (16) Repeat with the RF Synthesizer set to provide deviations of 1 kHz, 5 kHz, 10 kHz, 50 kHz and 100 kHz.
- (17) Remove the splitter and Modulation Meter and connect the RF Synthesizer directly to the UUT TNC input.

- (18) Refer to Table 5-44 on page 5-57.
- (19) Set the RF Synthesizer to provide a signal of 300 MHz at 6 dBm with 5 kHz deviation at 1 kHz modulation rate.
- (20) On the UUT, select the CCITT band-pass filter and distortion measurement ON.
- (21) Check that the distortion reading on the UUT indicates less than 0.5% then switch Distortion, S/N and SINAD measurement OFF.
- (22) Refer to Table 5-45 on page 5-58.
- (23) Set the UUT to [TX] [FREQ] 10 [MHz] and set the RF Synthesizer to provide a signal of 10 MHz with no modulation. (The MI 2041 should be set to low noise mode.)
- (24) Check the deviation indicated on the UUT display is less than 25 Hz RMS. Repeat steps (23) and (24) for RF carrier frequencies of 500 MHz and 1000 MHz.
- (25) Reconnect the splitter and Modulation Meter.
- (26) Refer to Table 5-46 on page 5-58.
- (27) Return the RF Synthesizer to normal noise mode and set it to provide 300 MHz, 6 dBm with 10 kHz deviation at 1 kHz modulation rate.
- (28) Set the Modulation Meter to monitor FM in a 300 Hz to 3.4 kHz bandwidth, noise averaging ON and adjust the RF Synthesizer deviation until 10.0 kHz deviation is displayed on the Modulation Meter.
- (29) On the UUT, press [TX], [FREQ] 300 [MHz], then select the 0.3-3.4 kHz band-pass filter and [mod type] FM.
- (30) Check that the phase modulation indicated on the UUT is 10 radians $\pm 5\%$ \pm resolution.
- (31) On the UUT, select the CCITT band-pass filter and distortion measurement ON. Check that the UUT distortion meter indicates $<0.5\%$.

Modulation analyzer - AM

Specification

Frequency range:	100 kHz to 1 GHz.
Modulation frequency range:	20 Hz to 20 kHz.
AM depth range:	0 to 99%.
Resolution:	0.1% AM.
Accuracy (up to 85% AM) (see Notes 1, 3 & 5):	$\pm 3\%$ of reading $\pm 1\%$ AM modulation frequencies from 250 Hz to 5 kHz.
Demodulation distortion (1):	Less than 1% at 1 kHz (CCITT weighted).
Residual AM:	Less than 0.1% (CCITT weighted).

Notes

- (1) At low modulation levels the residual AM/FM may become significant.
- (3) Audio and modulation filter passband errors not included.
- (5) Refer to *User calibrations*.

Test equipment

Description	Minimum specification	Example
RF Synthesizer	500 kHz to 1 GHz. AM depth 0 to 85%. Modulation rate 20 Hz to 15 kHz.	MI 2041
Modulation Meter	RF I/P 500 kHz to 1 GHz. AM measurement accuracy $\pm 1\%$ of reading ± 1 least significant changing digit at 1 kHz mod rate for depths up to 85%.	MI 2305
Power Splitter	6 dB 50 Ω , 500 kHz to 1 GHz.	HP 11667A

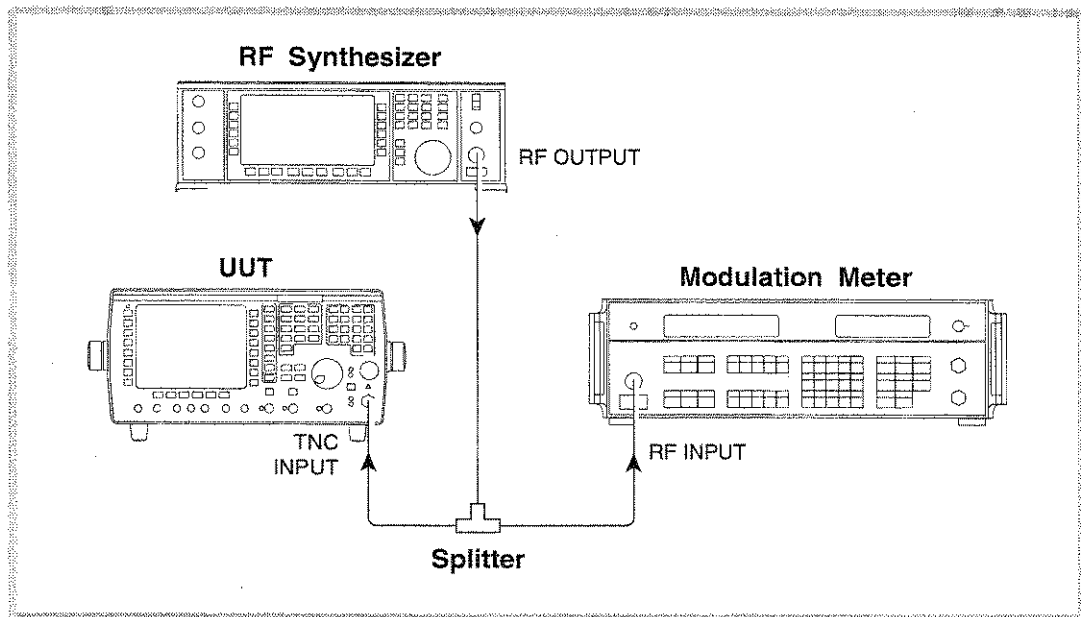

C2542

Fig. 5-22 Modulation analyzer - AM

- (1) Connect the equipment as shown in Fig. 5-22.
- (2) Set the Modulation Meter to monitor AM in a 50 Hz to 15 kHz bandwidth, noise averaging ON.
- (3) Refer to Table 5-48 on page 5-58.
- (4) Set the UUT to [Tx TEST], [RF SELECT] TNC input socket, [mod type] to AM DEPTH, [band pass] 0.3-3.4 kHz filter. Switch all noise measurements OFF.
- (5) Set the UUT to [Tx], [FREQ] 500 [kHz], and set the RF Synthesizer to provide a signal of 500 kHz with 70% AM at 1 kHz modulation rate. Set the RF level to 6 dBm. (If a MI 2041 is being used then it should be set to normal noise mode.)
- (6) Check that the AM depth indicated on the UUT is within $\pm 3\%$ of reading $\pm 1\%$ AM modulation of the depth indicated on the Modulation Meter.
- (7) Repeat steps (5) and (6) for RF carrier frequencies of 500 MHz and 1000 MHz.
- (8) On the UUT, select the 20 kHz LP filter and [Tx tune ON].
- (9) Refer to Table 5-49 on page 5-58.
- (10) Set the RF Synthesizer to provide a signal of 100 MHz with 70% depth at 250 Hz modulation rate. Check that the deviation level indicated on the UUT is within $\pm 6.5\%$ of reading $\pm 1\%$ AM modulation of the depth indicated on the Modulation Meter. Repeat with a modulation rate of 5 kHz.
- (11) Select the 0.3-3.4 kHz filter on both the UUT and the Modulation Meter.
- (12) Refer to Table 5-50 on page 5-59.

- (13) Set the RF Synthesizer modulation rate to 1 kHz and set 5% AM depth.
- (14) Check that the AM depth indicated on the UUT is within $\pm 3\%$ of reading $\pm 1\%$ AM modulation of the depth indicated on the Modulation Meter. Repeat with the RF Synthesizer set to provide depths of 20%, 40%, 60%, and 85%.
- (15) Remove the splitter and Modulation Meter and connect the RF Synthesizer directly to the UUT TNC input.
- (16) Refer to Table 5-51 on page 5-59.
- (17) Set the RF Synthesizer to provide a signal of 100 MHz at 6 dBm with 30% depth at 1 kHz modulation rate.
- (18) On the UUT, select the CCITT band-pass filter and distortion measurement ON.
- (19) Check that the distortion reading on the UUT indicates less than 1%

Radio frequency meter

Specification

Frequency range:	100 kHz to 1 GHz (10 MHz to 999.9 MHz auto tuned)
Resolution:	1 Hz or 10 Hz selectable
Accuracy:	As frequency standard ± 2 Hz \pm resolution
Dynamic range, auto tuned:	10mW to 150W (N-type), 100uW to 0.5W (TNC)
Sensitivity, manually tuned:	-100 dBm (TNC) dependent on receiver bandwidth in OFF AIR test mode

Test equipment

Description	Minimum specification	Example
RF Synthesizer	100 kHz to 1.0 GHz.	MI 2041
RF Power Meter	± 0.1 dB from 10 MHz to 1 GHz.	MI 6960/A/B + 6912 sensor

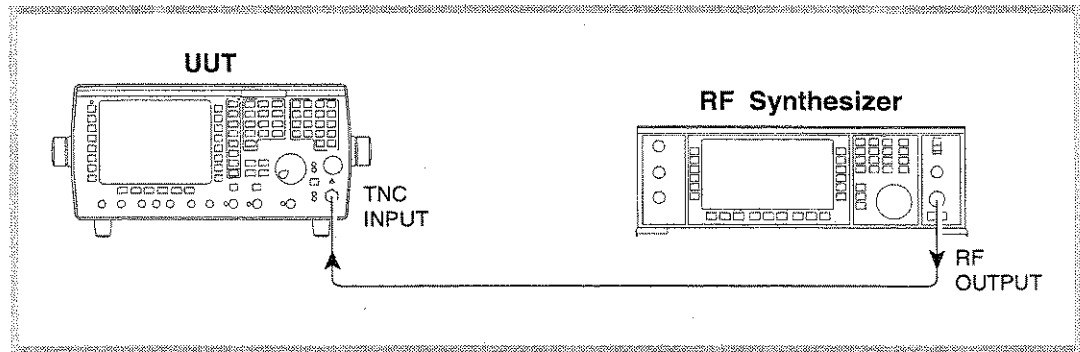

C2543

Fig. 5-23 Radio frequency meter

- (1) Connect the equipment as shown in Fig. 5-23, connecting the incoming signal to the TNC input socket of the UUT. Lock the RF Synthesizer external standard input to the external standard output of the UUT.
- (2) Set the UUT to [Tx TEST], [RF SELECT] TNC input socket. Press [HELP SET-UP], [SET-UP], [TEST OPTIONS], [misc], and toggle [res'n & rate] until 1 Hz is displayed, then press [HELP SET-UP] twice to get back to the Tx TEST display.
- (3) Refer to Table 5-52 on page 5-59.

- (4) On the UUT, enter [Tx] 100 [kHz] and then select [off-air test], toggle [IF BW] to select the 300 Hz IF filter. Set the RF Synthesizer to provide a signal of 100 kHz at an RF level of -100 dBm.
- (5) Check that the offset indicated on the UUT is 0 Hz \pm 2 Hz.
- (6) Repeat steps (4) and (5) for frequencies of 500 MHz and 1.0 GHz.
- (7) On the UUT, press [normal Tx test], and select [Tx tune ON].
- (8) Refer to Table 5-53 on page 5-59.
- (9) Set the RF Synthesizer to provide a signal of 999.9 MHz at a level of -10 dBm. (Check and set this level on the RF Power Meter.) Check that the UUT auto-tunes to the incoming frequency and the Frequency Counter indicates the frequency \pm 2 Hz. Repeat at 500 MHz and 10 MHz.
- (10) Disconnect the external reference from the UUT and connect an external reference with an accuracy of 1 part in 10^9 , or better, to the RF Synthesizer.
- (11) Refer to Table 5-54 on page 5-59.
- (12) Set the RF Synthesizer to provide a frequency of 1000 MHz at a level of 0 dBm.
- (13) Check that the UUT indicates a frequency between 999.999750 MHz and 1000.000250 MHz. The test limits in this step are for guidance and assume that the internal frequency standard has been recently adjusted. Ageing and stability have to be considered when establishing the *real* test limits.

RF spectrum analyzer

Specification

Frequency range:	100 kHz to 1.0 GHz, usable to 30 kHz.
Resolution bandwidth:	300 Hz to 30 kHz in a 1, 3, 10 sequence, DLVs 110 kHz, 280 kHz and 3 MHz
On-screen dynamic range:	80 dB.
Accuracy:	Typically \pm 2.5 dB

Test equipment

Description	Minimum specification	Example
RF Synthesizer	100 kHz to 1 GHz. Level accuracy \pm 0.85 dB.	MI 2041
RF Power Meter	\pm 0.1 dB from 10 MHz to 1 GHz.	MI 6960/A/B + 6912 sensor

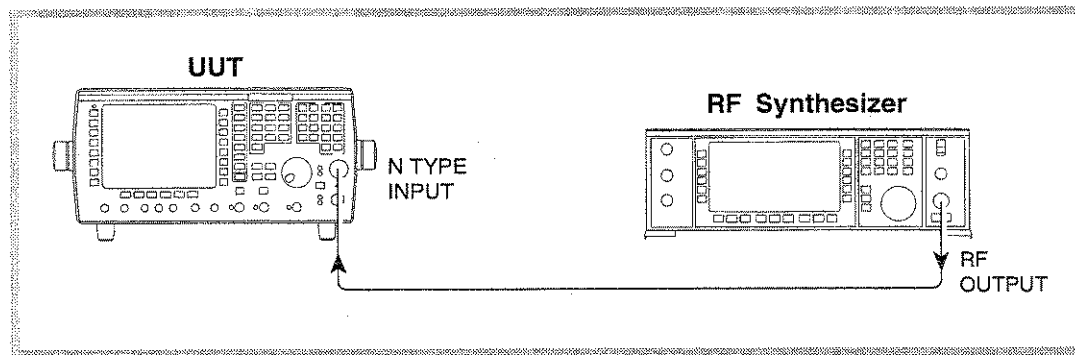

C2544

Fig. 5-24 RF spectrum analyzer checks

The majority of the tests for the spectrum analyzer are designed to test for correct functionality of the spectrum analyzer hardware and are non-warranted. Also, as the spectrum analyzer and narrow-band power meter essentially share the same hardware, some functions such as resolution bandwidth (IF filters) and frequency range are checked under the narrow-band power meter tests.

- (1) Set the UUT to [Tx TEST], [*spec ana*], [*expand ON*], [Tx], [FREQ] 500 [MHz], [*res BW down*] to select a resolution bandwidth of 300 Hz. From power-on, the span/div should be 5 kHz, REF LEVEL 10 dBm, 10 dB/div. If this is not the case, then these settings should be selected.
- (2) Refer to Table 5-55 on page 5-60.
- (3) With nothing connected to the UUT, check that the noise floor has disappeared below the bottom of the screen (80 dB dynamic range).
- (4) Connect the equipment as shown in Fig. 5-24, connecting the incoming signal to the N-type input socket of the UUT. Set the UUT to N-type input if this is not already selected.
- (5) On the UUT, toggle [*res BW up*] to select a resolution bandwidth of 100 kHz and then set 2 MHz span/div.
- (6) Set the RF Synthesizer to provide a signal of 500 MHz at a level of 0 dBm.
- (7) On the UUT, toggle [*markers on OFF*] to switch the markers ON. Press [*peak find*]. Adjust the RF Synthesizer level until M1 digital readout indicates 0.0 dB. The signal trace should now sit 1 division down from the top of the screen. Check that the level set on the RF Synthesizer is 0 dBm \pm 2.5 dB (functional test only). This synthesizer level should be noted as the **REF READING**.
- (8) Reduce the RF Synthesizer REF READING by 10 dB. The trace should drop approximately one graticule division. Check that the M1 digital readout on the UUT is -10 dB \pm 1.5 dB (functional test only).
- (9) Reduce the RF Synthesizer level by a further 10 dB. The trace should again drop approximately one graticule division. Check that the M1 digital readout on the UUT is -20 dB \pm 1.5 dB (functional test only).
- (10) Reduce the RF Synthesizer level by a further 10 dB. The trace should again drop approximately one graticule division. Check that the M1 digital readout on the UUT is -30 dB \pm 1.5 dB (functional test only).
- (11) Reduce the RF Synthesizer level by a further 10 dB. The trace should again drop approximately one graticule division. Check that the M1 digital readout on the UUT is -40 dB \pm 1.5 dB (functional test only). Steps (8) to (11) confirm that there are no fundamental problems with linearity.
- (12) Increase the RF Synthesizer level by 40 dB (back to REF READING) to return the trace to the graticule line 1 division down from the top line. Increase the UUT REF LEVEL in 10 dB steps up to 50 dBm, at each step checking that the signal drops 10 dBm on the display and that the M1 digital readout reads 0 dBm \pm 1.5 dB.
- (13) Increase the RF Synthesizer level by 10 dB and set the UUT span/div to 10 kHz and the resolution bandwidth to 3 kHz. The signal trace should appear approximately 4 divisions down from the top of the display.
- (14) Increase the UUT REF LEVEL in 10 dB steps up to 70 dBm, at each step checking that the signal drops approximately 10 dBm on the display.
- (15) Return the UUT REF LEVEL to +10 dBm and decrease the RF Synthesizer level by 40 dB so that the trace appears 4 divisions down from the top of the display.
- (16) Decrease the UUT REF LEVEL in 10 dB steps to -30 dBm, at each step checking that the signal steps up the display by approximately 1 division. Steps (12) to (16) confirm that the input attenuator is switching in and out correctly.
- (17) Remove the RF Synthesizer signal from the UUT, then select the TNC RF input socket. Press [Tx], [FREQ] 101 [MHz], [Rx TEST], [*RF gen OFF*], [Tx TEST], span/div 500 Hz and REF LEVEL to -50 dBm.

- (18) Press *[maxhold ON]* and wait for approximately 10 seconds, then press *[peak find]*. Check that M1 digital readout gives a noise floor reading of better than -108 dBm (functional test only).

Narrow-band power meter

Specification

Frequency range:	100 kHz to 1.0 GHz
Resolution bandwidth:	300 Hz to 30 kHz in a 1, 3, 10 sequence, plus 110 kHz, 280 kHz and 3 MHz
Accuracy:	Typically ± 2.5 dB

Test equipment

Description	Minimum specification	Example
RF Synthesizer	100 kHz to 1 GHz. Level accuracy ± 0.85 dB.	MI 2041
RF Power Meter	± 0.1 dB from 10 MHz to 1 GHz.	MI 6960/A/B + 6912 + 6920 sensor

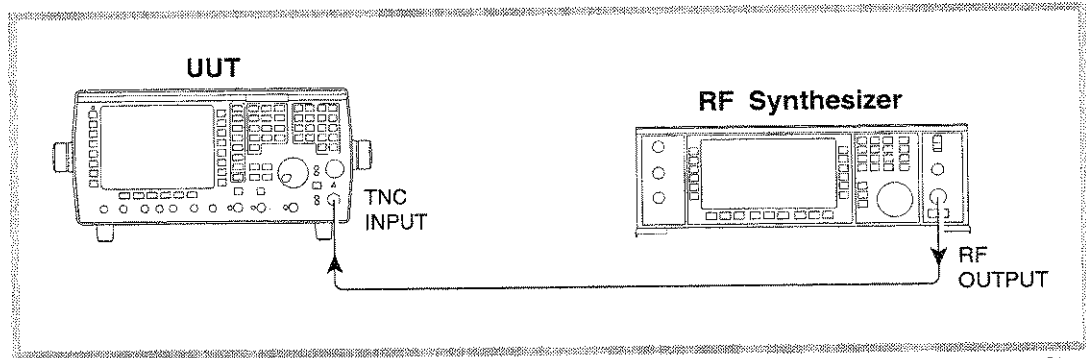

C2543

Fig. 5-25 Narrow-band power meter checks

Note: The narrow-band power meter functions can be optimised by running the spectrum analyzer user calibration (page 5-3). If problems are experienced when carrying out the following checks, try running this user calibration and repeat the checks.

- (1) Connect the equipment as shown in Fig. 5-25, connecting the incoming signal to the TNC input socket of the UUT. (Lock the instrument frequency references standards together for the following checks.)
- (2) Refer to Table 5-56 on page 5-60.
- (3) Set the UUT to *[Tx TEST]*, *[Tx]*, *[FREQ]* 100 [kHz], *[IF BW]* to select 10 kHz, *[power BW]* to select INBAND in inverse video on the display. Set the UUT to TNC input. Select *[spec ana]* and set the REF LEVEL to -10 dBm, then return to bar charts by pressing *[barcharts]*.
- (4) Set the RF Synthesizer to provide a signal of 100 kHz at a level of -20 dBm (confirm this level using the RF Power Meter and the 6912 sensor).
- (5) Check that the UUT narrow-band power meter reads within typically 2.5 dB of the level applied (functional test only).

- (6) Repeat steps (4) and (5) for the following frequencies: 125 MHz, 225 MHz, 525 MHz, 725 MHz, 925 MHz and 1000 MHz. (Remember to manually tune the UUT to each frequency.)
- (7) Manually tune the UUT to 101 MHz and also change the RF Synthesizer signal to 101 MHz.
- (8) On the UUT, step through the IF filters by pressing [IF BW], checking that the variation in level displayed is less than 1 dB (functional test only).

RF broad-band power meter

Specification

Frequency range:	100 kHz to 1.0 GHz
Accuracy 100 kHz to 500 MHz:	±7.5% (0.3 dB), 0.1W to 50W (TYPE N) ±10% (0.4 dB), 20mW to 150W (TYPE N) ±12% (0.5 dB), 200uW to 50mW (TNC)
Accuracy 500 MHz to 1 GHz:	±12% (0.5 dB), 20mW to 150W (TYPE N) ±15% (0.6 dB), 200uW to 50mW (TNC)
Resolution:	Better than 1%

Test equipment

Description	Minimum specification	Example
Calibrated RF Power Source consisting of:-	Accuracy better than 3.5% up to 500 MHz. Better than 5% up to 1 GHz.	See below.
RF Synthesizer	11 MHz to 1 GHz frequency range. RF level 13 dBm.	MI 2041
Power Splitter	6 dB 50 Ω, 11 MHz to 1 GHz.	Weinschel 1870A
RF Amplifier	3W, 40 dB gain, 11 MHz to 1000 MHz.	MI 2177 or AR5W1000 MHz
Attenuator Pads	Values dependent upon amplifier used.	
RF Power Meter	±0.1 dB from 11 MHz to 1 GHz.	MI 6960/A/B + 6912 sensor

- (1) Set the UUT to [Tx TEST]. From power-up, the instrument should already be set to N-type input with auto tune mode ON and the broad-band power meter selected.
- (2) Connect the equipment as shown in Fig. 5-26, connecting to the N-type input socket on the UUT.
- (3) Refer to Table 5-57 on page 5-60.
- (4) Set the calibrated power source to provide a signal at 11 MHz and 20 mW (+13 dBm) to the UUT input. Note the level on the UUT broad-band power meter and check that it is within the stated specification. Repeat at 200 MHz and then in 200 MHz steps up to and including 1000 MHz.
- (5) Set the calibrated power source to provide a signal at 11 MHz and 100 mW (+20 dBm) to the UUT input. Note the level on the UUT broad-band power meter and check that it is within the stated specification. Repeat at 100 MHz and then in 200 MHz steps up to and including 900 MHz.
- (6) Disconnect the calibrated power source from the N-type input and connect to the TNC input. Press [RF SELECT] to select the TNC input.
- (7) Refer to Table 5-58 on page 5-61.

- (8) Set the calibrated power source to provide a signal at 11 MHz and 1 mW to the UUT input. Note the level on the UUT broad-band power meter and check that it is within the stated specification. Repeat at 200 MHz and then in 200 MHz steps up to and including 1000 MHz.
- (9) Set the calibrated power source to provide a signal at 500 MHz and 0.2 mW (-7 dBm) to the UUT input. Note the level on the UUT broad-band power meter and check that it is within the stated specification. Repeat with the calibrated power source set to the following levels: 1 mW (0 dBm), 3.2 mW (5 dBm), 16 mW (12 dBm), 50 mW (17 dBm).

Notes:

- (1) The RF Power Meter/sensor, splitter, and two pads associated with these items, form the calibrated part of the source.
- (2) The attenuator pad values are dependent upon the gain of the amplifier used. They should be chosen so that when the RF Synthesizer is set to its maximum output level, the power arriving at the sensor is below +25 dBm, i.e. not enough to damage the sensor.
- (3) If a calibrated power source is not available, then the UUT power measurement can be verified by using an RF Synthesizer and checking its output level using an external RF Power Meter (at levels suitable to it) before applying the signal to the UUT. It should be noted that no guarantees can be given of the mismatch uncertainties that could be introduced if this method is used.

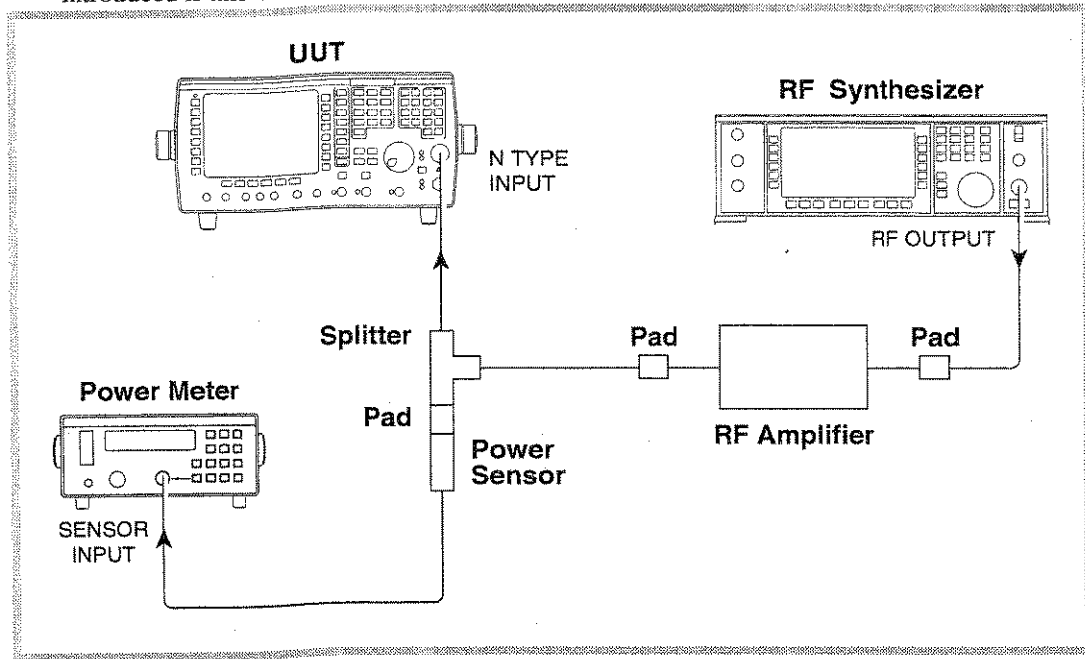

C2545

Fig. 5-26 RF broad-band power meter checks

Options if fitted

Options 10, 11, 12, 13, 14, and 21

- Option 10 - NMT
- Option 11 - AMPS
- Option 12 - TACS
- Option 13 - MPT1327
- Option 14 - PMR TEST
- Option 21 - GSM

The System options make use of the circuitry already tested under the standard instrument tests. Additional testing for these options can be carried out by ensuring that it is possible to call up a fitted option, and then carry out a functional test with a respective mobile for the given option. For details of the connection of a mobile to the UUT, refer to the relevant Operating Manual Supplement for the option concerned.

Option 9 - SSB

Specification

Frequency range:	100 kHz to 1 GHz.
Demod distortion:	As AM demodulation distortion
Sideband selection:	USB, LSB, CW

Test equipment

Description	Minimum specification	Example
RF Synthesizer	100 kHz to 1.0 GHz.	MI 2041
RF Power Meter	± 0.1 dB from 10 MHz to 1 GHz.	MI 6960/A/B + 6912 sensor

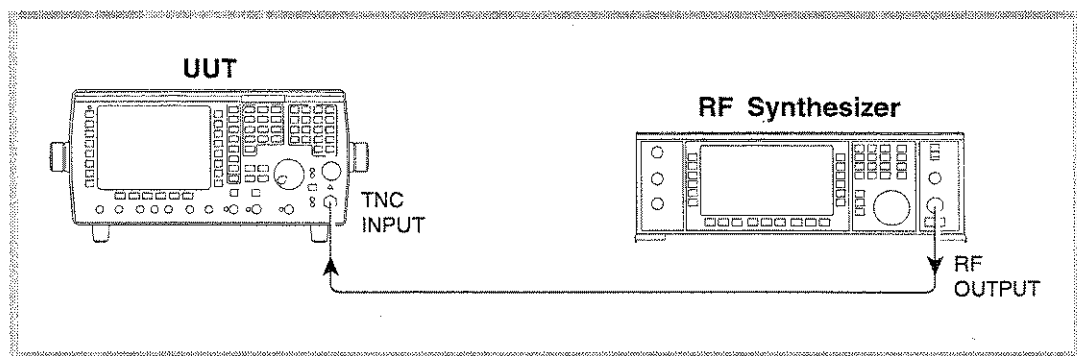

C2543

Fig. 5-27 RF SSB (Option 9) checks

- (1) Connect the equipment as shown in Fig. 5-27, connecting the incoming signal to the N-type input socket of the UUT. Lock the instruments' frequency references together.
- (2) Set the UUT to [RF TEST], [SSB], [Tx tune ON]. On power up, the instrument should have defaulted to the following settings; if this is not the case, then set them:- gen 1 ON, gen 2 OFF, AF1 FREQ 1 kHz, AF1 LEVEL 100.0 mV.
- (3) Set the RF Synthesizer to provide 100.000000 MHz at a level of 10 dBm.
- (4) Check that the UUT auto-tunes to 101.001 MHz ± 10 Hz and that the MOD FREQ displayed is 1 kHz ± 10 Hz and the LSB power reading is 10 mW ± 0.5 mW.

- (5) On the UUT, press [*spec ana*], and set the REF LEVEL to +10 dB. A signal should appear at about +10 dBm.
- (6) On the UUT, press [*sband ana*], [*expand ON*], [*markers ON*], [*peak find*]. Check that marker M1 indicates $-4 \text{ dB} \pm 2 \text{ dB}$.

Acceptance test results tables

For 2965, serial number _____ / _____

RF output tests

Carrier frequency accuracy

Table 5-1 Carrier frequency accuracy

Frequency	Area of UUT checked	2440 range	Lower limit	Upper limit	Result
100.000 kHz	Mixed range	A	99.999	100.001	_____
999.999999 MHz	Oscillator 3 top	B	999.999998	1000.000000	_____
915.000001 MHz	Oscillator 3 bottom	B	915.000000	915.000002	_____
914.999999 MHz	Oscillator 2 top	B	914.999998	915.000000	_____
725.000001 MHz	Oscillator 2 bottom	B	725.000000	725.000002	_____
724.999999 MHz	Oscillator 1 top	B	724.999998	725.000000	_____
560.000001 MHz	Oscillator 1 bottom	C	560.000000	560.000002	_____
188.888888 MHz	} Fractional-N	C	188.888887	188.888889	_____
177.777777 MHz		C	177.777776	177.777778	_____
166.666666 MHz		C	166.666665	166.666667	_____
155.555555 MHz		C	155.555554	155.555556	_____
144.444444 MHz		C	144.444443	144.444445	_____
133.333333 MHz		C	133.333332	133.333334	_____
122.222222 MHz		C	122.222221	122.222223	_____
111.111111 MHz		C	111.111110	111.111112	_____
398.765432 MHz	Divide by 2	C	398.765431	398.765433	_____
198.765432 MHz	Divide by 4	C	198.765431	198.765433	_____
100.765432 MHz	Divide by 8	C	100.765431	100.765433	_____
55.765432 MHz	Divide by 16	C	55.765431	55.765433	_____

RF output level

Table 5-2
RF generator level (-7 dBm) versus frequency (MHz)

Frequency (MHz)	Lower limit (dBm)	Upper limit (dBm)	Result
0.1	-8.0	-6.0	_____
55.0	-8.0	-6.0	_____
100.0	-8.0	-6.0	_____
198.0	-8.0	-6.0	_____
398.0	-8.0	-6.0	_____
560.1	-8.0	-6.0	_____
724.9	-8.5	-5.5	_____
725.1	-8.5	-5.5	_____
914.9	-8.5	-5.5	_____
915.1	-8.5	-5.5	_____
1000.0	-8.5	-5.5	_____

Table 5-3
RF generator ALC linearity @ 2.5 MHz

Level (dBm)	Lower limit	Upper limit	Result
-7	-8.0	-6.0	_____
-8	-9.0	-7.0	_____
-9	-10.0	-8.0	_____
-10	-11.0	-9.0	_____
-11	-12.0	-10.0	_____
-12	-13.0	-11.0	_____
-13	-14.0	-12.0	_____
-14	-15.0	-13.0	_____
-15	-16.0	-14.0	_____
-16	-17.0	-15.0	_____
-17	-18.0	-16.0	_____
-18	-19.0	-17.0	_____
-19	-20.0	-18.0	_____
-20	-21.0	-19.0	_____
-21	-22.0	-20.0	_____
-22	-23.0	-21.0	_____
-23	-24.0	-22.0	_____

Table 5-4
RF generator ALC linearity @ 500 MHz

Level (dBm)	Lower limit	Upper limit	Result
-7	-8.0	-6.0	_____
-8	-9.0	-7.0	_____
-9	-10.0	-8.0	_____
-10	-11.0	-9.0	_____
-11	-12.0	-10.0	_____
-12	-13.0	-11.0	_____
-13	-14.0	-12.0	_____
-14	-15.0	-13.0	_____
-15	-16.0	-14.0	_____
-16	-17.0	-15.0	_____
-17	-18.0	-16.0	_____
-18	-19.0	-17.0	_____
-19	-20.0	-18.0	_____
-20	-21.0	-19.0	_____
-21	-22.0	-20.0	_____
-22	-23.0	-21.0	_____
-23	-24.0	-22.0	_____

Table 5-5
RF generator ALC linearity @ 1000 MHz

Level (dBm)	Lower limit	Upper limit	Result
-7	-8.5	-5.5	_____
-8	-9.5	-6.5	_____
-9	-10.5	-7.5	_____
-10	-11.5	-8.5	_____
-11	-12.5	-9.5	_____
-12	-13.5	-10.5	_____
-13	-14.5	-11.5	_____
-14	-15.5	-12.5	_____
-15	-16.5	-13.5	_____
-16	-17.5	-14.5	_____
-17	-18.5	-15.5	_____
-18	-19.5	-16.5	_____
-19	-20.5	-17.5	_____
-20	-21.5	-18.5	_____
-21	-22.5	-19.5	_____
-22	-23.5	-20.5	_____
-23	-24.5	-21.5	_____

Table 5-6
Two-port duplex @ -7 dBm

Frequency	Lower limit	Upper limit	Result
100 kHz	-8.0	-6.0	_____
500 MHz	-8.0	-6.0	_____
1000 MHz	-8.5	-5.5	_____

Table 5-7 One-port duplex @ -40 dBm

Frequency (MHz)	Lower limit (dBm)	Upper limit (dBm)	Result
1000	-41.5	-38.5	_____
500	-41.0	-39.0	_____
10	-41.0	-39.0	_____

Spectral purity

Table 5-8 Carrier harmonic test points @ +7 dBm

Frequency (MHz)	Second harmonic	Result	Third harmonic	Result	Upper limit (dBm)
0.1	0.2 MHz	_____	0.3 MHz	_____	-23
1.0	2.0 MHz	_____	3.0 MHz	_____	-23
35.0	70.0 MHz	_____	105.0 MHz	_____	-23
561.0	1.122 GHz	_____	1.683 GHz	_____	-23
724.0	1.448 GHz	_____	2.172 GHz	_____	-23
726.0	1.452 GHz	_____	2.178 GHz	_____	-23
914.0	1.828 GHz	_____	2.742 GHz	_____	-23
915.0	1.830 GHz	_____	2.745 GHz	_____	-23
999.0	1.998 GHz	_____	2.997 GHz	_____	-23
399.0	798 MHz	_____	1.197 GHz	_____	-23
199.0	398 MHz	_____	597 MHz	_____	-23
56.0	112 MHz	_____	168 MHz	_____	-23

Table 5-9 Spurious signals (carrier @ +7 dBm)

Carrier frequency (MHz)	Spurious result	Upper limit (dBm)
0.1	_____	-38
20	_____	-38
35.9	_____	-38
36.1	_____	-43
220	_____	-43
500	_____	-43
1000	_____	-43

Table 5-10 RF carrier leakage (carrier @ 501.9873 MHz)

Carrier frequency	Leakage detected	Upper limit
501.9873 MHz	_____	0.5 μ V PD

Table 5-11 Residual FM test points

UUT RF generator frequency (MHz)	LO frequency (MHz)	Result	Limits (Hz)
1000	55.63889	_____	<12
925	54.50000	_____	<12
890	55.71875	_____	<12
730	52.25000	_____	<12
709	54.65385	_____	<12
590	53.77273	_____	<12
502	55.94444	_____	<6
240	48.30000	_____	<6
†20		_____	<6

† This frequency can be measured with the MI 2305 in normal mode of operation, e.g. press AUTO TUNE to switch off the external LO mode.

Amplitude modulation (RF generator)

Table 5-12 RF generator AM versus carrier frequency (50% depth @ 1 kHz rate)

Carrier frequency (MHz)	Lower limit (%)	Upper limit (%)	Result (%)
0.52	47.9	52.1	_____
10	47.9	52.1	_____
35	47.9	52.1	_____
36	47.9	52.1	_____
100	47.9	52.1	_____
150	47.9	52.1	_____
200	47.9	52.1	_____
250	47.9	52.1	_____
300	47.9	52.1	_____
350	47.9	52.1	_____
400	47.9	52.1	_____

Table 5-13

RF generator AM versus carrier level (100 MHz, 70% depth @ 1 kHz rate)

Carrier level (dBm)	Lower limit (%)	Upper limit (%)	Result (%)
3	67.1	72.9	_____
2	67.1	72.9	_____
1	67.1	72.9	_____
0	67.1	72.9	_____
-1	67.1	72.9	_____
-2	67.1	72.9	_____
-3	67.1	72.9	_____
-4	67.1	72.9	_____
-5	67.1	72.9	_____
-6	67.1	72.9	_____
-7	67.1	72.9	_____
-8	67.1	72.9	_____
-9	67.1	72.9	_____
-10	67.1	72.9	_____
-11	67.1	72.9	_____
-12	67.1	72.9	_____
-13	67.1	72.9	_____

Table 5-14 RF generator AM linearity (100 MHz, 0 dBm @ 1 kHz rate)

AM depth set (%)	Lower limit (%)	Upper limit (%)	Result (%)
5	4.7	5.3	_____
10	9.5	10.5	_____
20	19.1	20.9	_____
30	28.8	31.2	_____
40	38.3	41.7	_____
50	47.9	52.1	_____
60	57.5	62.5	_____
70	67.1	72.9	_____
80	76.7	83.3	_____
85	81.5	88.5	_____

Table 5-15 RF generator AM versus mod frequency (100 MHz, 85% depth)

AM frequency (kHz)	Lower limit (%)	Upper limit (%)	Result (%)
0.065	79.8	90.2	_____
0.140	79.8	90.2	_____
0.500	79.8	90.2	_____
2	79.8	90.2	_____
5	79.8	90.2	_____
10	79.8	90.2	_____
15	78.1	91.9	_____
20	78.1	91.9	_____

Table 5-16 RF generator AM versus distortion (100 MHz, 30% depth)

Distortion upper limit (%)	Result
1%	_____

Frequency modulation (RF generator)

Table 5-17 RF generator FM versus carrier frequency (@ 10 kHz devn. 1 kHz rate)

Carrier frequency (MHz)	Lower limit (kHz)	Upper limit (kHz)	Result
0.5	9.69	10.31	_____
39	9.69	10.31	_____
49	9.69	10.31	_____
65	9.69	10.31	_____
81	9.69	10.31	_____
100	9.69	10.31	_____
150	9.69	10.31	_____
200	9.69	10.31	_____
250	9.69	10.31	_____
312	9.69	10.31	_____
400	9.69	10.31	_____
480	9.69	10.31	_____
577	9.69	10.31	_____
719	9.69	10.31	_____
911	9.69	10.31	_____
1000	9.69	10.31	_____

**Table 5-18 RF generator FM linearity checks
(@ 600 MHz carrier frequency 1 kHz rate)**

Deviation frequency (kHz)	Lower limit (kHz)	Upper limit (kHz)	Result
500	484.5	515.5	_____
81.80	79.30	84.30	_____
57.84	56.05	59.63	_____
40.90	39.62	42.18	_____
28.92	28.03	29.81	_____
20.45	19.82	21.08	_____
14.46	14.00	14.91	_____
10.25	9.922	10.58	_____
7.23	6.99	7.47	_____
327.50	317.48	337.53	_____
328.12	318.08	338.16	_____
329.02	318.95	339.09	_____
330.83	320.34	340.96	_____
334.45	324.22	344.68	_____
341.68	331.23	352.13	_____
356.14	345.26	367.02	_____
385.10	373.35	396.65	_____
442.91	429.12	456.70	_____
462.75	448.37	477.13	_____

Table 5-19 RF generator FM distortion.

Modulation frequency (kHz)	Distortion upper limit (%)	Result
1	0.5	_____

AF output tests

Audio generator output level

Table 5-20 Audio generator output level test points

AF generator frequency (Hz)	Level set (mV)	Lower limit (mV)	Upper limit (mV)	Result
1000	5000	4849	5151	_____
250	5000	4849	5151	_____
5000	5000	4849	5151	_____
10	5000	4749	5251	_____
150	5000	4749	5251	_____
10000	5000	4749	5251	_____
15000	5000	4749	5251	_____
20000	5000	4749	5251	_____
50000	5000	4499	5501	_____
75000	5000	4499	5501	_____
1000	20	19.3	20.7	_____
1000	500	484.9	515.1	_____
1000	1000	969	1031	_____
1000	1512	1465.64	1558.36	_____
1000	2024	1962.28	2085.72	_____
1000	3048	2955.56	3140.44	_____
1000	5000	4849	5151	_____

Audio generator signal purity

Table 5-21 Audio generator distortion

AF generator frequency (Hz)	AF generator level (mV)	Distortion upper limit (%)	Result
1000	5000	0.5	_____
1000	50	0.5	_____
20	5000	1.0	_____
20000	5000	1.0	_____

Table 5-22 Audio generator residual noise

AF generator frequency (Hz)	Residual noise upper limit (μ V)	Result
1	50	_____
1000	50	_____
20000	50	_____

Table 5-23 Audio generator DC offset

AF generator frequency (Hz)	DC offset upper limit (mV)	Result
1	10	_____
1000	10	_____
20000	10	_____

Audio generator frequency

Table 5-24 Audio generator frequency

AF GEN 1 setting	Lower limit	Upper limit	Result
15 Hz	14.8 Hz	15.2 Hz	_____
70 Hz	69.8 Hz	70.2 Hz	_____
100 Hz	99.8 Hz	100.2 Hz	_____
500 Hz	499.8 Hz	500.2 Hz	_____
1.0000 kHz	999.8 Hz	1000.2 Hz	_____
1.1111 kHz	1.1109 kHz	1.1113 kHz	_____
2.2222 kHz	2.2220 kHz	2.2224 kHz	_____
3.3333 kHz	3.3331 kHz	3.3335 kHz	_____
4.4444 kHz	4.4442 kHz	4.4446 kHz	_____
5.5550 kHz	5.554 kHz	5.556 kHz	_____
6.6660 kHz	6.665 kHz	6.667 kHz	_____
7.7770 kHz	7.776 kHz	7.778 kHz	_____
8.8880 kHz	8.887 kHz	8.889 kHz	_____
9.9990 kHz	9.998 kHz	10.001 kHz	_____
20 kHz	19.999 kHz	20.001 kHz	_____

AF input tests

Audio filters

Table 5-25 Audio filters

Filter & frequency	Flatness (dB)	Lower limit (V)	Upper limit (V)	Result (V)
300 Hz LP				
100 Hz	±0.1	0.9885	1.0116	_____
50 Hz	±0.1	0.9885	1.0116	_____
150 Hz	±0.1	0.9885	1.0116	_____
200 Hz	±0.2	0.9772	1.0233	_____
0.3-3.4 kHz BP				
450 Hz	±0.4	0.9550	1.0471	_____
2.1 kHz	±0.4	0.9550	1.0471	_____
20 kHz LP				
50 Hz	±0.3	0.9660	1.0351	_____
12 kHz	±0.3	0.9660	1.0351	_____

Table 5-26 Audio CCITT filter

Frequency (Hz)	Expected response (dB)	Lower limit (V)	Upper limit (V)	Result (V)
200	-21	0.0708	0.1122	_____
600	-2	0.7079	0.8913	_____
800	0 (Ref)	Ref	Ref	Ref
1000	+1	1.0000	1.2589	_____
1500	-1.3	0.7674	1.0351	_____
3500	-8.5	0.2985	0.4732	_____
4000	-15	0.1259	0.2512	_____

Table 5-27 Audio CMES filter

Frequency (Hz)	Expected response (dB)	Lower limit (V)	Upper limit (V)	Result (V)
200	-25.1	0.0447	0.0708	_____
400	-11.2	0.2399	0.3020	_____
700	-2.80	0.6531	0.8222	_____
1000	0 (Ref)	Ref	Ref	Ref
1500	-1.2	0.7943	1.000	_____
3500	-7.1	0.3311	0.5248	_____
4500	-22.3	0.0596	0.1189	_____

Audio counter

Table 5-28 Audio counter

LF Generator setting	Lower limit	Upper limit	Result
11 Hz	10.8 Hz	11.2 Hz	_____
70 Hz	69.8 Hz	70.2 Hz	_____
100 Hz	99.8 Hz	100.2 Hz	_____
500 Hz	499.8 Hz	500.2 Hz	_____
1.0000 kHz	999.8 Hz	1000.2 Hz	_____
1.1111 kHz	1.1109 kHz	1.1113 kHz	_____
2.2222 kHz	2.2220 kHz	2.2224 kHz	_____
3.3333 kHz	3.3331 kHz	3.3335 kHz	_____
4.4444 kHz	4.4442 kHz	4.4446 kHz	_____
5.5550 kHz	5.553 kHz	5.557 kHz	_____
6.6660 kHz	6.664 kHz	6.668 kHz	_____
7.7770 kHz	7.775 kHz	7.779 kHz	_____
8.8880 kHz	8.886 kHz	8.89 kHz	_____
9.9990 kHz	9.997 kHz	10.001 kHz	_____
20 kHz	19.998 kHz	20.002 kHz	_____
60 kHz	59.989 kHz	60.011 kHz	_____
100 kHz	99.989 kHz	100.011 kHz	_____
500 kHz	499.989 kHz	500.011 kHz	_____

Table 5-29 Audio counter sensitivity

LF Generator frequency	LF Generator level	UUT filter selection	Lower limit	Upper limit	Result
1 kHz	2.5 mV	0.3 - 3.4 kHz	999.8 Hz	1000.2 Hz	_____



Audio voltmeter

Table 5-30 Audio voltmeter

Frequency	DVM reading (mV)	UUT coupling	UUT lower limit (mV) †	UUT upper limit (mV) †	Result
1 kHz	7	AC	5.76	8.24	_____
1 kHz	21	AC	19.48	22.52	_____
1 kHz	50	AC	47.9	52.1	_____
1 kHz	150	AC	145.7	154.3	_____
1 kHz	500	AC	488	512	_____
1 kHz	1000	AC	978	1024	_____
1 kHz	2000	AC	1956	2044	_____
1 kHz	2800	AC	2740	2860	_____
1 kHz	3500	AC	3419	3581	_____
150 Hz	1000	AC	978	1024	_____
5 kHz	1000	AC	978	1024	_____
20 kHz	1000	AC	978	1024	_____
100 Hz	1000	AC	958	1044	_____
50 kHz	1000	AC	958	1044	_____
100 kHz	1000	AC	958	1044	_____
100 Hz	1000	DC	978	1024	_____
20 kHz	1000	DC	978	1024	_____

† The upper and lower limits in the above table are calculated on the assumption that it was possible to set the exact level. If it is not possible to achieve this, then the limits will need to be calculated for the DVM reading obtained.

Audio oscilloscope

Table 5-31 Oscilloscope accuracy

LF Generator (level pk-pk)	UUT	Trace height lower limit (divisions)	Trace height upper limit (divisions)	Result (divisions)
10 mV	2 mV/div	4.6	5.4	_____
25 mV	5 mV/div	4.6	5.4	_____
50 mV	10 mV/div	4.6	5.4	_____
100 mV	20 mV/div	4.6	5.4	_____
250 mV	50 mV/div	4.6	5.4	_____
500 mV	100 mV/div	4.6	5.4	_____
1 V	200 mV/div	4.6	5.4	_____
2.5 V	500 mV/div	4.6	5.4	_____
5 V	1 V/div	4.6	5.4	_____
10 V	2 V/div	4.6	5.4	_____
10 V	5 V/div	1.6	2.4	_____
10 V	10 V/div	0.6	1.4	_____

Table 5-32 Oscilloscope bandwidth

LF Generator (frequency)	UUT (timebase)	Trace height lower limit (divisions)	Trace height upper limit (divisions)	Result (divisions)
10 Hz	50 ms/div	4.6	5.4	_____
250 Hz	1 ms/div	4.6	5.4	_____
10 kHz	50 us/div	4.6	5.4	_____
100 kHz	10 us/div	4.6	5.4	_____
500 kHz	5 us/div	2.5 (-3 dB)	5.4	_____

Audio FFT analyzer

Table 5-33 FFT analyzer ranges

DVM reading (level RMS)	UUT (REF LEVEL)	Audio Analyzer lower limit †	Audio Analyzer upper limit †	Result
3.5 V	20 V	3.381 V	3.623 V	_____
3 V	10 V	2.898 V	3.106 V	_____
3 V	5 V	2.898 V	3.106 V	_____
2 V	5 V	1.932 V	2.071 V	_____
1 V	2 V	0.966 V	1.035 V	_____
500 mV	1 V	483 mV	518 mV	_____
200 mV	500 mV	193.2 mV	207 mV	_____
100 mV	200 mV	96.6 mV	103.5 mV	_____
50 mV	100 mV	48.3 mV	51.76 mV	_____
20 mV	50 mV	19.3 mV	20.70 mV	_____
15 mV	20 mV	14.49 mV	15.53 mV	_____

Table 5-34 FFT analyzer frequency response

LF Generator (frequency)	UUT (span/div)	DVM reading (level RMS)	Audio Analyzer lower limit †	Audio Analyzer upper limit †	Result
100 Hz	10 Hz	1 V	0.966 V	1.035 V	_____
15 kHz	5 kHz/div	1 V	0.966 V	1.035 V	_____

† The upper and lower limits in Tables 5-33 and 5-34 are calculated on the assumption that it was possible to set the exact level. If it is not possible to achieve this, then the limits will need to be calculated for the DVM reading obtained.

AF distortion and SINAD meter

Table 5-35 Distortion and SINAD meter

Distortion/SINAD set	Lower limit	Upper limit	Result
25%	23.6%	26.3%	_____
12 dB	11.4 dB	12.6 dB	_____

Multimeter

Table 5-36 Multimeter AC level

LF Generator frequency (kHz)	Level set (mV)	Lower limit (mV) †	Upper limit (mV) †	Result (mV)
1	10	8.6	11.4	_____
1	20	18.3	21.7	_____
1	50	47.4	52.6	_____
1	100	95.9	104.1	_____
1	150	144.4	155.6	_____
1	200	192.9	207.1	_____
1	500	483.9	516.1	_____
1	750	726.4	773.6	_____
1	1000	968	1032	_____
1	2000	1938	2062	_____
1	3500	3393	3607	_____

Table 5-37 Multimeter frequency response

LF Generator frequency (Hz)	Level set (mV)	Lower limit (mV) †	Upper limit (mV) †	Result (mV)
80	1000	968	1032	_____
150	1000	968	1032	_____
250	1000	968	1032	_____
500	1000	968	1032	_____
750	1000	968	1032	_____

† The upper and lower limits in Tables 5-36 and 5-37 are calculated on the assumption that it was possible to set the exact level. If it is not possible to achieve this, then the limits will need to be calculated for the DVM reading obtained.

Table 5-38 Multimeter DC

DC level set (mV)	Lower limit (mV) †	Upper limit (mV) †	Result (mV)
250	241.4	258.6	_____
-250	-241.4	-258.6	_____
1000	968	1032	_____
-1000	-968	-1032	_____
2000	1938	2062	_____
-2000	-1938	-2062	_____
2800	2714	2886	_____
-2800	-2714	-2886	_____
4000	3878	4122	_____
-4000	-3878	-4122	_____
10000	9689	10311	_____
-10000	-9689	-10311	_____
28000	27171	28851	_____
-28000	-27171	-28851	_____
32000	31029	32971	_____
-32000	-31029	-32971	_____
60000	58189	61811	_____
-60000	-58189	-61811	_____

† The upper and lower limits in Table 5-38 are calculated on the assumption that it was possible to set the exact level. If it is not possible to achieve this, then the limits will need to be calculated for the DVM reading obtained.

Table 5-39 Resistance meter

Resistance set (Ω)	Lower limit (Ω)	Upper limit (Ω)	Result (Ω)
10	8.49	11.51	_____
50	46.49	48.26	_____
90	84.49	95.51	_____
110	103.4	116.6	_____
500	473.9	526.1	_____
900	853.9	946.1	_____
1100	1043	1157	_____
2000	1898	2102	_____
9000	8548	9452	_____
11000	10439	11561	_____
50000	47489	52511	_____
90000	85489	94511	_____
110000	104399	115601	_____
500000	474899	525101	_____

Table 5-40 Ammeter

Current set (DVM reading)	Lower limit †	Upper limit †	Result
10 A (100 mV)	9.498 A	10.502 A	_____
5 A (50 mV)	4.748 A	5.252 A	_____
2 A (20 mV)	1.898 A	2.102 A	_____
1 A	949.9 mA	1.052 A	_____
750 mA	711.4 mA	788.6 mA	_____
500 mA	473.9 mA	526.1 mA	_____
100 mA	93.9 mA	106.1 mA	_____

† The upper and lower limits in Table 5-40 are calculated on the assumption that it was possible to set the exact level. If it is not possible to achieve this, then the limits will need to be calculated for the DVM reading obtained.

RF input tests

Modulation analyzer - FM and PM

Table 5-41 Modulation analyzer: FM measurement versus carrier frequency (1 kHz rate)

Carrier frequency (MHz)	Deviation (kHz)	Lower limit (kHz) †	Upper limit (kHz) †	Result
1	20	19.3	20.7	_____
500	20	19.3	20.7	_____
1000	20	19.3	20.7	_____

Table 5-42 FM measurement versus modulation rate

Modulation rate	Deviation (kHz)	Lower limit (kHz) †	Upper limit (kHz) †	Result
250 Hz	20	18.2	21.8	_____
5 kHz	20	18.2	21.8	_____
100 Hz	20	18.2	21.8	_____
12 kHz	20	18.2	21.8	_____

Table 5-43 FM measurement versus deviation level (1 kHz rate)

Deviation level	Lower limit (kHz) †	Upper limit (kHz) †	Result
500 Hz	0.475	0.525††	_____
1 kHz	0.96	1.04††	_____
5 kHz	4.84	5.16††	_____
10 kHz	9.69	10.4	_____
50 kHz	48.4	51.6	_____
100 kHz	96.9	103.1	_____

† The upper and lower limits in Tables 5-41, 5-42 and 5-43 are calculated on the assumption that it was possible to set the exact level on the external Modulation Meter. If it is not possible to achieve this, then the limits will need to be calculated for the readings obtained.

†† For the lower deviations, subtract the residual FM reading from the result.

Table 5-44 FM demodulation distortion (1 kHz rate)

Carrier frequency	Deviation	Upper limit	Distortion result
300 MHz	5 kHz	0.5%	_____

Table 5-45 Residual FM

Carrier frequency	Upper limit	Result
10 MHz	25 Hz	_____
500 MHz	25 Hz	_____
1000 MHz	25 Hz	_____

Table 5-46 Phase modulation measurement

Carrier frequency	Phase modulation	Lower limit	Upper limit	Result
300 MHz	10 radians	9.49 radians	10.51 radians	_____

Table 5-47 Phase demodulation distortion (1 kHz)

Carrier frequency	Modulation	Upper limit	Distortion result
300 MHz	10 radians	0.5%	_____

Modulation analyzer - AM

Table 5-48 Modulation analyzer: AM measurement versus carrier frequency (1 kHz rate)

Carrier frequency (MHz)	Depth (%)	Lower † limit (%)	Upper † limit (%)	Result
0.5	70	66.9	73.1	_____
500	70	66.9	73.1	_____
1000	70	66.9	73.1	_____

Table 5-49 AM measurement versus modulation rate

Modulation rate	Depth (%)	Lower † limit (%)	Upper † limit (%)	Result
250 Hz	70	64.4	75.6	_____
5 kHz	70	64.4	75.6	_____

† The upper and lower limits in Tables 5-48 and 5-49 are calculated on the assumption that it was possible to set the exact level on the external Modulation Meter. If it is not possible to achieve this, then the limits will need to be calculated for the readings obtained.

Table 5-50 AM measurement versus AM depth (1 kHz rate)

Depth (%)	Lower † limit (%)	Upper † limit (%)	Result
5	3.85	6.15	_____
20	18.4	21.6	_____
40	37.8	42.2	_____
60	57.2	62.8	_____
85	76.4	88.6	_____

† The upper and lower limits in Table 5-50 are calculated on the assumption that it was possible to set the exact level on the external Modulation Meter. If it is not possible to achieve this, then the limits will need to be calculated for the readings obtained.

Table 5-51 AM demodulation distortion (1 kHz rate)

Carrier frequency	Depth	Upper limit	Distortion result
100 MHz	30%	1%	_____

Radio frequency meter

Table 5-52 Radio frequency meter (@ -100 dBm TNC input, manual tuned)

Carrier frequency	Offset lower limit (Hz)	Offset upper limit (Hz)	Result
100 kHz	-2	2	_____
500 MHz	-2	2	_____
1000 MHz	-2	2	_____

Table 5-53 Radio frequency meter (@ -10 dBm TNC input, auto tuned)

Carrier frequency (MHz)	Lower limit (MHz)	Upper limit (MHz)	Result
999.9	999.899998	1000.000001	_____
500	499.999998	500.000002	_____
10	9.999998	10.000002	_____

Table 5-54 Internal frequency standard

Carrier frequency	Lower limit	Upper limit	Result
1000 MHz	999.999750 MHz	1000.000250 MHz	_____

RF spectrum analyzer

Table 5-55 Spectrum analyzer

Parameter	Limit	Result
Dynamic range	80 dB	_____ (✓)
Linearity	Functional check	_____ (✓)
Input attenuator	Functional check	_____ (✓)
Noise floor	Functional check	_____ (✓)

Narrow-band power meter

Table 5-56 Narrow-band power meter

Parameter	Limit	Result
Accuracy	Typically 2.5 dB (functional check)	_____ (✓)
IF filters	Functional check	_____ (✓)
Input attenuator	Functional check	_____ (✓)
Noise floor	Functional check	_____ (✓)

RF broad-band power meter

Table 5-57 Broad-band power meter (N-type input socket)

Frequency (MHz)	Power applied (mW)	Lower limit (mW)	Upper limit (mW)	Result (mW)
11	20	18.0	22.0	_____
200	20	18.0	22.0	_____
400	20	18.0	22.0	_____
600	20	17.6	22.4	_____
800	20	17.6	22.4	_____
1000	20	17.6	22.4	_____
11	100	92.5	107.5	_____
100	100	92.5	107.5	_____
300	100	92.5	107.5	_____
500	100	92.5	107.5	_____
700	100	88	112	_____
900	100	88	112	_____

Table 5-58 Broad-band power meter (TNC input socket)

Frequency (MHz)	Power applied (mW)	Lower limit (mW)	Upper limit (mW)	Result (mW)
11	1	0.88	1.12	_____
200	1	0.88	1.12	_____
400	1	0.88	1.12	_____
600	1	0.85	1.15	_____
800	1	0.85	1.15	_____
1000	1	0.85	1.15	_____
500	0.2	0.176	0.224	_____
500	1	0.88	1.12	_____
500	3.2	2.81	3.59	_____
500	16	14.08	17.92	_____
500	50	44.0	56.0	_____

INDEX

A

Abnahme von Abdeckungen xiii
Acceptance testing 5-1
Accessories 1-18
Accessory port 2-5
AF counter, brief description 4-11
AF generator
 audio testing 3-89
 duplex testing 3-49, 3-51
 SSB transmitter testing 3-70
 transmitter testing 3-19, 3-32
AF TEST mode 3-10
AF voltmeter, brief description 4-11
AMPS 3-121
Audio analyzer
 audio testing 3-91, 3-94
 brief description 4-12
 duplex testing 3-59, 3-62
 performance data 1-8
 receiver testing 3-40, 3-43
 SSB receiver testing 3-84, 3-86
Audio generators
 brief description 4-4
 performance data 1-14
Audio monitor, performance data 1-10
Audio multimeter testing 3-94
Audio testing
 DTMF 3-112
 expanded 3-94
 non-expanded 3-89
 sequential tones 3-101

B

Bar charts
 audio testing 3-91, 3-95
 duplex testing 3-50, 3-53, 3-59
 receiver testing 3-40
 RF testing 3-66
 SSB receiver testing 3-83
 SSB transmitter testing 3-72
 transmitter testing 3-21, 3-33

Berilio xvii
Berillio xv
Beryllia viii
Béryllia xi
Beryllium Oxid xiii

C

Calibration 3-131
Connectors and indicators 3-14
Control circuits, brief description 4-4
Conventions for soft and hard key labelling iii
Country, language selection 3-131
CRT screen and soft keys 3-11
CTCSS 3-104
Current measurement 3-95
CW analyzer 3-73

D

DATA keys 3-14
DC power supply 2-2
DCS 3-114
Demodulation measurements
 RMS or peak 3-6
Demonstration 3-132
Dimensions and weight 1-17
Displays in inverse video 3-18
Distortion
 audio testing 3-89
 duplex testing 3-49, 3-52, 3-58
 meter, brief description 4-12
 receiver testing 3-39
 RF testing 3-65
 SSB receiver testing 3-82
 SSB transmitter testing 3-71
 transmitter testing 3-20, 3-32
DTMF 3-106
DUPLEX TEST mode 3-8
Duplex testing 3-47
 CTCSS 3-105
 DCS 3-116
 DTMF 3-111
 sequential tones 3-100

E

Electrical hazards vii
Electro-magnetic compatibility 1-16
Elektrische Schläge xii
Environmental performance data 1-17
External monitor port 2-4

F

Feuergefahr xiii
Filters
 duplex testing 3-49, 3-52, 3-58
 receiver testing 3-39
 RF testing 3-65
 SSB receiver testing 3-82
 transmitter testing 3-20, 3-32
Fire hazard viii
Frequency standard, performance data 1-16
Frequency, setting manually 3-65
Front panel 3-11
Full duplex testing 3-47
FUNCTION keys 3-12
Fuses vii
Fusibili xiv
Fusibles x, xvi
G
GPIB port 2-2
H
Help and setting up 3-122
Help on topics 3-125

- I**
- Incremental adjustment
 - frequency
 - duplex testing 3-52, 3-58
 - receiver testing 3-38
 - RF testing 3-64
 - SSB receiver testing 3-82
 - SSB transmitter testing 3-70
 - transmitter testing 3-19
 - frequency and level, duplex testing 3-48
 - level
 - SSB transmitter testing 3-71
 - transmitter testing 3-20, 3-32
 - Inputs and outputs 3-129
 - Interfaces, performance data 1-16
 - Inverse video indications 3-18
- K**
- Keys, soft and hard, conventions for indicating iii
- L**
- Language selection 3-131
 - Lithium viii, xi, xiii
 - Litio xv, xvii
- M**
- Measurement results in inverse video 3-18
 - Memory cards 2-6
 - Miscellaneous controls 3-14
 - MODE keys 3-11
 - Modes and displays 3-5
 - Modulation analyzer
 - brief description 4-9, 4-12
 - duplex testing 3-54, 3-57
 - performance data 1-12
 - RF testing 3-66, 3-69
 - transmitter testing 3-22, 3-29, 3-34, 3-37
 - Modulation generator
 - brief description 4-4
 - duplex testing 3-48, 3-57
 - receiver testing 3-38
 - RF testing 3-64
 - SSB receiver testing 3-82
 - Multimeter 3-94
 - brief description 4-12
 - introduction 3-15
 - performance data 1-10
 - testing with 3-94
- N**
- Nivel peligroso de electricidad xvi
- O**
- Off-air transmitter testing
 - expanded 3-36
 - introduction 3-5
 - non-expanded 3-31
 - signalling codes 3-99
 - Operating the instrument 3-4
- Oscilloscope**
- audio testing 3-91, 3-92, 3-94
 - brief description 4-11
 - duplex testing 3-54, 3-56, 3-59, 3-61
 - receiver testing 3-40, 3-42
 - RF testing 3-68
 - SSB receiver testing 3-84, 3-85
 - transmitter testing 3-22, 3-24, 3-34, 3-36
- P**
- Para retirar las tapas xvii
 - Parallel port 2-3
 - Peak detectors, brief description 4-10
 - Peligro d'incendio xvii
 - Performance data 1-5
 - Pericoli da elettricità xiv
 - Pericolo d'incendio xv
 - POCSAG 3-118
 - Power meter
 - brief description 4-6
 - performance data 1-11
 - Power requirements 1-16, 2-2.
- R**
- Rack mounting 2-6
 - Rear panel 3-15
 - Recalling settings and results 3-133
 - Receiver testing
 - CTCSS 3-104
 - DCS 3-116
 - DTMF 3-110
 - expanded 3-42
 - non-expanded 3-38
 - POCSAG 3-118
 - sequential tones 3-99
 - Receiver, brief description 4-7
 - Removal of covers viii
 - Resistance measurement 3-95
 - Retrait des couvercles xi
 - RF frequency meter, performance data 1-10
 - RF generator 3-38, 3-47, 3-57, 3-63
 - RF output and input connectors 3-14
 - performance data 1-5
 - RF output and input switch, brief description 4-6
 - RF power meter
 - brief description 4-6
 - performance data 1-11
 - RF signal generator
 - brief description 4-5
 - performance data 1-5
 - RF spectrum analyzer
 - performance data 1-13
 - RF TEST mode 3-9
 - RF testing
 - CTCSS 3-105
 - DCS 3-117
 - expanded 3-68
 - non-expanded 3-63
 - sequential tones 3-101

Rimozione dei coperchi xiv

Risque lié au feu xi

Rx TEST mode 3-7

S

Safety Testing vii

Safety testing (routine) 2-7

Safety, compliance 1-16

Sécurité électrique x

Sequential tones 3-97

Serial port 2-4

Setting up 3-125

Sicherungen xii

Sideband analyzer (SSB) 3-73

Signalling codes testing 3-97

Signalling decoding, brief description 4-12

Signalling encoder and decoder, performance data 1-15

Signal-to-noise

audio testing 3-89

duplex testing 3-49, 3-52, 3-58

receiver testing 3-39

RF testing 3-65

transmitter testing 3-20, 3-32

SINAD

audio testing 3-89

duplex testing 3-49, 3-58

meter, brief description 4-12

receiver testing 3-39

SSB receiver testing 3-82

Software versions 3-132

Spectrum analyzer 3-26

brief description 4-8

duplex testing 3-54, 3-56

RF testing 3-66, 3-69

SSB transmitter testing 3-73

transmitter testing 3-22, 3-34, 3-36

SSB

receiver testing

expanded 3-85

non-expanded 3-81

transmitter testing

expanded 3-75

non-expanded 3-69

Starting procedure 3-17

Storing settings and results 3-133

Suppression analyzer (SSB) 3-72

SYSTEMS mode 3-9

Systems testing 3-121

T

TACS 3-121

Technical description 4-1

Test options 3-126

Toggle action soft keys 3-11

Tones

changing user-defined durations 3-104

decoding and generating 3-101

Tones mode 3-8

Tracking generator 3-135

Transmitter frequency 3-32

Transmitter testing

DCS 3-114

DTMF 3-108

expanded 3-24

non-expanded 3-19

sequential tones 3-98

Tx TEST mode 3-5

U

User options 3-135

User-defined tone durations 3-104

V

Voltage measurement 3-95

