

FLUKE®

PM2811-PM2812-PM2813 PM2831-PM2832

Programmable Power Supplies

Users Manual

4822 872 00824

January 1997, Rev. 3, 5/98

© 1997 Fluke Corporation. All rights reserved. Printed in the Netherlands.

All product names are trademarks of their respective companies.

LIMITED WARRANTY & LIMITATION OF LIABILITY

Each Fluke product is warranted to be free from defects in material and workmanship under normal use and service. The warranty period is one year and begins on the date of shipment. Parts, product repairs and services are warranted for 90 days. This warranty extends only to the original buyer or end-user customer of a Fluke authorized reseller, and does not apply to fuses, disposable batteries or to any product which, in Fluke's opinion, has been misused, altered, neglected or damaged by accident or abnormal conditions of operation or handling. Fluke warrants that software will operate substantially in accordance with its functional specifications for 90 days and that it has been properly recorded on non-defective media. Fluke does not warrant that software will be error free or operate without interruption.

Fluke authorized resellers shall extend this warranty on new and unused products to end-user customers only but have no authority to extend a greater or different warranty on behalf of Fluke. Warranty support is available if product is purchased through a Fluke authorized sales outlet or Buyer has paid the applicable international price. Fluke reserves the right to invoice Buyer for importation costs of repair/replacement parts when product purchased in one country is submitted for repair in another country.

Fluke's warranty obligation is limited, at Fluke's option, to refund of the purchase price, free of charge repair, or replacement of a defective product which is returned to a Fluke authorized service center within the warranty period.

To obtain warranty service, contact your nearest Fluke authorized service center or send the product, with a description of the difficulty, postage and insurance prepaid (FOB Destination), to the nearest Fluke authorized service center. Fluke assumes no risk for damage in transit. Following warranty repair, the product will be returned to Buyer, transportation prepaid (FOB Destination). If Fluke determines that the failure was caused by misuse, alteration, accident or abnormal condition of operation or handling, Fluke will provide an estimate of repair costs and obtain authorization before commencing the work. Following repair, the product will be returned to the Buyer transportation prepaid and the Buyer will be billed for the repair and return transportation charges (FOB Shipping Point).

THIS WARRANTY IS BUYER'S SOLE AND EXCLUSIVE REMEDY AND IS IN LIEU OF ALL OTHER WARRANTIES, EXPRESS OR IMPLIED, INCLUDING BUT NOT LIMITED TO ANY IMPLIED WARRANTY OF MERCHANTABILITY OR FITNESS FOR A PARTICULAR PURPOSE. FLUKE SHALL NOT BE LIABLE FOR ANY SPECIAL, INDIRECT, INCIDENTAL OR CONSEQUENTIAL DAMAGES OR LOSSES, INCLUDING LOSS OF DATA, WHETHER ARISING FROM BREACH OF WARRANTY OR BASED ON CONTRACT, TORT, RELIANCE OR ANY OTHER THEORY.

Since some countries or states do not allow limitation of the term of an implied warranty, or exclusion or limitation of incidental or consequential damages, the limitations and exclusions of this warranty may not apply to every buyer. If any provision of this Warranty is held invalid or unenforceable by a court of competent jurisdiction, such holding will not affect the validity or enforceability of any other provision.

Fluke Corporation, P.O. Box 9090, Everett, WA 98206-9090 USA, or
Fluke Industrial B.V., P.O. Box 680, 7600 AR, Almelo, The Netherlands

SERVICE CENTERS

To locate an authorized service center, visit us on the World Wide Web:

<http://www.fluke.com>

or call Fluke using any of the phone numbers listed below:

+1-800-443-5853 in U.S.A. and Canada

+31-402-678-200 in Europe

+1-425-356-5500 from other countries

CONTENS		Page
1	OPERATOR SAFETY	1-1
1.1	INTRODUCTION	1-1
1.2	SAFETY PRECAUTIONS	1-1
1.3	CAUTION AND WARNING STATEMENTS	1-1
1.4	SYMBOLS	1-2
1.5	IMPAIRED SAFETY	1-2
2	INTRODUCTION	2-1
2.1	INTRODUCTION TO YOUR PROGRAMMABLE POWER SUPPLY	2-1
2.2	BASIC OPERATION	2-4
2.2.1	Local operation	2-6
2.2.2	Remote operation	2-7
2.2.3	Sense modes	2-10
2.3	ADVANCED OPERATION	2-12
2.3.1	Output channel interconnections	2-12
2.3.2	Multiple loads	2-13

3	INSTALLATION INSTRUCTIONS	3-1
3.1	INTRODUCTION	3-1
3.2	INITIAL INSPECTION	3-1
3.3	OPERATOR SAFETY INSTRUCTIONS	3-1
3.4	INSTALLATION	3-2
3.4.1	Mechanical installation	3-2
3.4.2	Electrical installation	3-3
3.4.3	Front Connection Unit	3-4
3.5	OUTPUT CONNECTIONS	3-7
3.5.1	Output channel connections	3-7
3.5.2	GPIB connections	3-8
3.5.3	Trigger bus connections	3-8
3.6	ACCEPTANCE TESTS	3-9
3.6.1	Brief check	3-9
3.6.2	Interface check	3-11
3.6.3	Performance Verification	3-12
4	GETTING FAMILIAR WITH THE POWER SUPPLY	4-1
4.1	INITIAL SETUP OF YOUR POWER SUPPLY	4-1
4.1.1	Power up routine	4-1
4.1.2	Instrument identification	4-2
4.2	FRONT PANEL LAYOUT	4-3
4.2.1	Keyboard controls	4-3
4.2.2	Display indicators	4-6
4.3	OUTPUT CHANNEL CONNECTIONS	4-7
4.4	GETTING STARTED	4-8
4.4.1	Selecting an output channel	4-8
4.4.2	Setting an output voltage	4-9
4.4.3	Setting an output current	4-10

5	USING YOUR PROGRAMMABLE POWER SUPPLY	5-1
5.1	INTRODUCTION	5-1
5.2	LOCAL OPERATION	5-2
5.3	REMOTE OPERATION	5-3
5.4	OPERATING FEATURES	5-4
5.5	HOW TO USE THE OPERATING FEATURES	5-7
5.5.1	Output channel characteristics	5-7
5.5.2	Local and remote sensing	5-10
5.5.3	Constant voltage or constant current source	5-13
5.5.4	Store/recall function	5-19
5.5.5	Step functions	5-22
5.6	ADVANCED USE	5-28
5.6.1	Parallel connection of output channels	5-29
5.6.2	Serial connection of output channels	5-32
5.6.3	Parallel connection of loads	5-35
5.6.4	Tips for Remote Sensing Applications	5-36

APPENDIX A	ACCESSORIES	A-1
A.1	Supplied with the instrument	A-1
A.2	Optional	A-1
APPENDIX B	SCPI CONFORMANCE INFORMATION	B-1
B.1	IEEE 488.2-1987	B-1
B.2	SCPI Std 1993.0 Confirmed	B-1
B.3	SCPI approved	B-4
B.4	SCPI syntax and style	B-5
APPENDIX C	ABBREVIATIONS, SYMBOLS & TERMS	C-1
C.1	Abbreviations	C-1
C.2	Glossary of symbols	C-5
C.3	Glossary of terms	C-6
APPENDIX D	APPLICATION FOR PM2812 AND PM2813	D-1
INDEX	I-1

Thank you for purchasing this FLUKE power supply. It has been designed and manufactured to the highest quality standards to give you many years of trouble-free use.

The powerful operating features have been combined with an easy and logical operation so that the full power of this instrument can be used every day. The main operating features are:

- Multiple output, dc power supply
- Output modules with various voltage and current ratings
- Suitable for GPIB as well as benchtop applications
- Conforms to SCPI and IEEE 488.2 standards
- Non volatile memory for 999 settings
- Power down memory (front panel settings)
- Readback of actual voltage and current
- Manual and automatic step function
- Overvoltage and overcurrent protection
- Overtemperature and sense protection
- Coupled protection of output channels
- Closed case calibration facility (protected by password)
- External trigger facilities (auto step)
- Built-in self-test and diagnostics routines

INITIAL INSPECTION

Check the contents of the shipment for completeness and note whether any damage has occurred during transport. If the contents are incomplete, or if there is damage to the instrument or its accessories, notify the FLUKE sales or service office nearest you to facilitate the repair or replacement of the instrument or accessories.

The following items must be included in the shipment:

- Programmable Power Supply
- Reference Manual English
- Operation Manual English, or
Operation Manual German, or
Operation Manual French
- Power Cord
- Two spare fuses
- Two mounting brackets (only for the 19 inch models)

For further information, refer to APPENDIX A, 'Accessories'.

INSIDE THIS MANUAL

This operating manual has been aimed at the experienced user as well as the user new to Programmable Power Supplies. It will help the reader to use and operate the power supply manually (local operation) or from a PC via the GPIB (remote operation).

- 1) OPERATOR SAFETY
Gives full information about safety aspects.
- 2) INTRODUCTION TO YOUR PROGRAMMABLE POWER SUPPLY
Describes what your power supply is and how you can use it.
- 3) INSTALLATION INSTRUCTIONS
Describes the steps necessary to prepare your power supply for use.
- 4) GETTING STARTED WITH YOUR PROGRAMMABLE POWER SUPPLY
Describes how to get started with some commonly used functions of the power supply. A step-by-step tutorial describes how to operate the functions in the local (manual) mode.
- 5) USING YOUR PROGRAMMABLE POWER SUPPLY
Gives functional information about how to use the power supply in the local as well as the remote mode.

Additional information is available in the following appendices:

- A) ACCESSORIES
Gives a functional overview of the accessories that are supplied or can be ordered.
- B) SCPI CONFORMANCE INFORMATION
Gives information about versions of the confirmed and approved SCPI commands and queries.
- C) ABBREVIATIONS, SYMBOLS & TERMS
- D) APPLICATION FOR PM2812 AND PM2813
Gives support information to extend maximum current of the PM2812 or PM2813 by parallel connection of channels

1 OPERATOR SAFETY

Read this page carefully before beginning to install and use the instrument.

1.1 INTRODUCTION

The instrument described in this manual is designed to be used only by qualified personnel.

WARNING: Servicing described in this manual is to be done only by qualified service personnel. To avoid electrical shock, do not service the instrument unless you are qualified to do so.

1.2 SAFETY PRECAUTIONS



For the correct and safe use of this instrument it is essential that both operating and service personnel follow generally accepted safety procedures in addition to the safety precautions specified in this manual. Specific warning and caution statements, where they apply, will be found throughout the manual. Where necessary, the warning and caution statements and/or symbols are marked on the instrument.

1.3 CAUTION AND WARNING STATEMENTS

CAUTION: *Is used to indicate correct operating or maintenance procedures in order to prevent damage to or destruction of the equipment or other property.*

WARNING: Calls attention to a potential danger that requires correct procedures or practices to prevent personal injury.

1.4 SYMBOLS

Symbol	Meaning of symbol
	See explanation in manual
	Earth
	Conformité Européenne

1.5 IMPAIRED SAFETY

Whenever it is likely that safety has been impaired, the instrument must be turned off and disconnected from line power. The matter should then be referred to qualified technicians. Safety is likely to be impaired if, for example, the instrument does not output the expected power or shows visible damage.

2 INTRODUCTION

2.1 INTRODUCTION TO YOUR PROGRAMMABLE POWER SUPPLY

The basic function of your programmable power supply (PPS) is to supply a predefined dc voltage or current in a controlled way through an output channel. Your power supply model can have one, two or three output channels. Unless stated otherwise, the information in this manual applies to all models. For technical and environmental performance specifications, refer to the Reference Manual.

REMOTE OPERATION

The family of Programmable Power Supplies is primarily intended to be used in an automatic system environment programmed via a controller. For that reason the power supplies have been equipped with a GPIB interface and conform to IEEE-488.2 as well as the SCPI 1993.0 standards. For remote operation, refer to the Reference Manual (operating references).

LOCAL OPERATION

The power supplies can be used as bench-top instruments (stand-alone) via their keypads and displays. For local operation, refer to section 4.4 (getting started), section 5.4 (operating features) or the Reference Manual (operating references).

Family overview

PM2811/xyz	Single Output System
PM2812/xyz	Dual Output System
PM2813/xyz	Triple Output System
PM2831/xyz	Single Output System
PM2832/xyz	Dual Output System

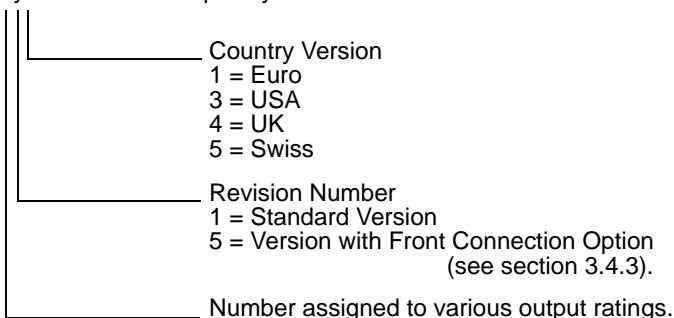

FRONT PANEL

The front panel contains a keypad and LCD for dialogue with the operator. Local operation (manual) of the power supply is done via the keypad. The display is used for passing information to the operator, such as:

- response information for the operator, e.g., ADDRESS 12
- readback information, e.g., an output voltage and current
- status information, e.g., display of the REM text
- error messages, e.g., the OVERCURRENT message

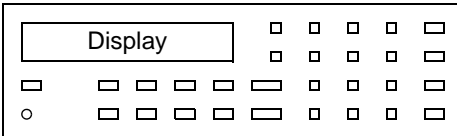

Single front panel (PM2811 only)

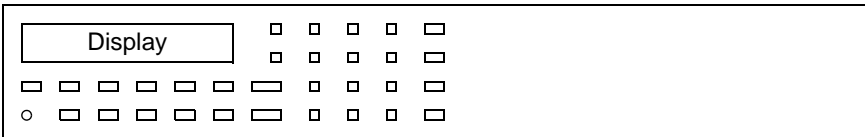

Single, dual and triple output front panel

REAR PANEL

The rear panel contains connectors for the line power input, the output channel(s), the trigger lines, and the GPIB (IEEE 488) interface. A fan provides forced cooling of each output channel. The line power input module also contains the line fuses, line filter, and the power switch.

For remote control, a GPIB (IEEE 488) connector for use with a GPIB controller is provided.

Three SMB connectors for START, STEP, and READY are provided for external triggering of the step mode and recalling stored instrument settings.

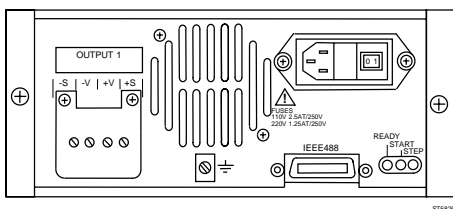

Single rear panel (PM2811 only)

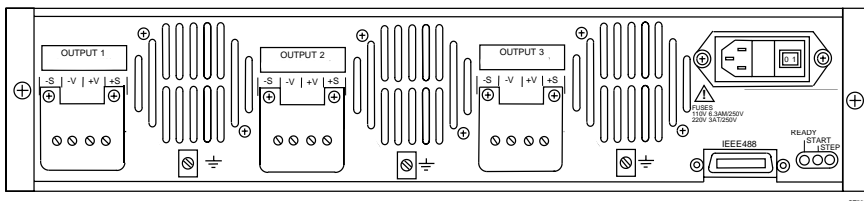

Output rear panel

2.2 BASIC OPERATION

The programmable power supplies offer a combination of programming capabilities and a variety of dc output power ratings that make them ideal for power systems applications. The +V and +S as well as the -V and -S terminals have been connected to each other at the factory.

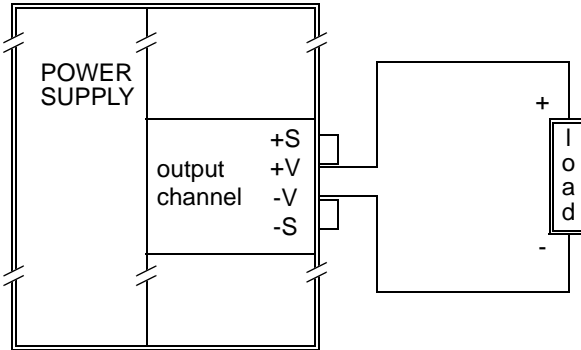

Each output channel can be programmed to the desired dc voltage or dc current (output function). Self-contained measurement and readback capability eliminate the need for using a separate multimeter to externally meter the output channel. The readback voltage and current of the selected output channel can be monitored on the front panel display (measure function). Protective circuitry within the power supply limits or turns off an output channel when an abnormal condition occurs. The following protection features have been implemented:

- OVERVOLTAGE and OVERCURRENT
- UNREGULATED OUTPUT
- OVERTEMPERATURE
- OUT OF SENSE CAPABILITY
- COUPLED PROTECTION (of output channels)

Each output channel can operate as a **constant voltage** source (**CV mode**), or as a **constant current** source or **current sink** (PM283x only) (**CC mode**):

- As a constant voltage source the output voltage remains constant, while the output current changes due to fluctuations of the load.
- As a constant current source the output current remains constant, while the output voltage changes due to fluctuations of the load.

After power on, the programmable power supply performs a self-test. If the selftest is successful, the STANDBY, OPERATE, or CALIBRATION mode will be entered. In the OPERATE mode, an output channel can be in the ENABLED or DISABLED state (only multiple output models).

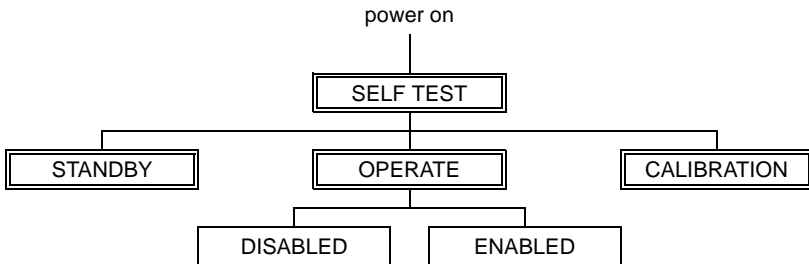

- SELF-TEST** After power on the power supply will test itself. Depending on the Power ON DEFinition (PONDEF), the STANDBY or OPERATE mode is entered. The CALIBRATION mode can be entered manually via the AUX key by pressing it during power up, or remotely via the GPIB controller.
- STANDBY** In this mode the power supply does not output power, i.e., all output channels have been shut off. It is possible, however, to verify or set voltage and current settings.
- OPERATE** In this mode the power supply is able to output a voltage or a current. For multiple output models each individual output channel can be disabled (DISABLED state) or enabled (ENABLED state). It is also possible to verify or set voltage and current settings.
- CALIBRATION** In this mode the power supply can be calibrated. At the end of the calibration, the power supply will enter STANDBY mode.

The following diagram shows the possible output channel states:

	OUTPUT CHANNEL	
	DISABLED	ENABLED
Power supply STANDBY	no power	no power
Power supply OPERATE	no power	power output

2.2.1 Local operation

Using the front panel keys, you can program an output channel voltage or current. On the front panel display you can read back the actual voltage and current of the selected output channel. Operating information about the instrument and the selected output channel, as well as output-specific error messages, are shown on the display in the following ways (see the following figure):

- text
- annunciators, pointing at abbreviations on the front panel right below the display.

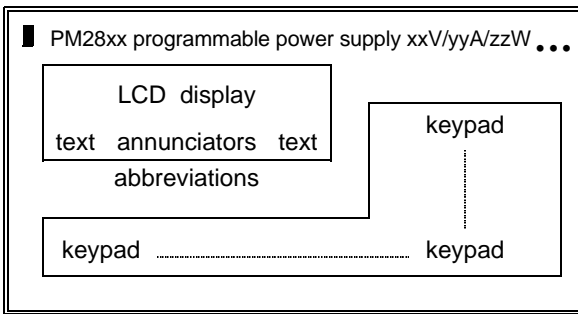

You can use the keypad as follows to control your power supply:

- control interface and general functions via a menu
- switch between the operate and standby mode
- set the supply to local control (if not remotely locked)
- reset the power supply, i.e., return to the 'power on' state
- store/recall/step voltage and current settings (1 to 999) in the instrument's battery backed-up memory (recall memory)

You can use the keypad as follows to control one of the output channels:

- select an output channel (only for multiple output models)
- enable or disable an output channel (only for multiple output models)
- unmask, delay, or display the setting of bits in the fault register
- reset the overvoltage and overcurrent protection

You can use the keypad as follows to perform an output channel setting:

- set or change the output voltage or current
- set the overvoltage trip level
- enable or disable the overcurrent protection

2.2.2 Remote operation

Via the General Purpose Interface Bus (GPIB), you can program your programmable power supply to receive input data and to send output data. An example of input data (listener) is that a voltage and current can be programmed directly to the selected output channel. An example of output data (talker) is the readback voltage and current of the selected output channel.

IEEE 488.2 compatibility

IEEE 488.2 is a standard that is additional and complementary to the IEEE 488.1 standard. Your programmable power supply conforms to the IEEE 488.2 standard. For more information refer to the Reference Manual.

SCPI compatibility

SCPI (Standard Commands for Programmable Instruments) is a command definition standard for programmable test and measurement instruments. Your programmable power supply conforms to the SCPI standard. For more information, refer to the Reference Manual.

The programmable functions have been implemented via the GPIB by means of the following SCPI subsystems:

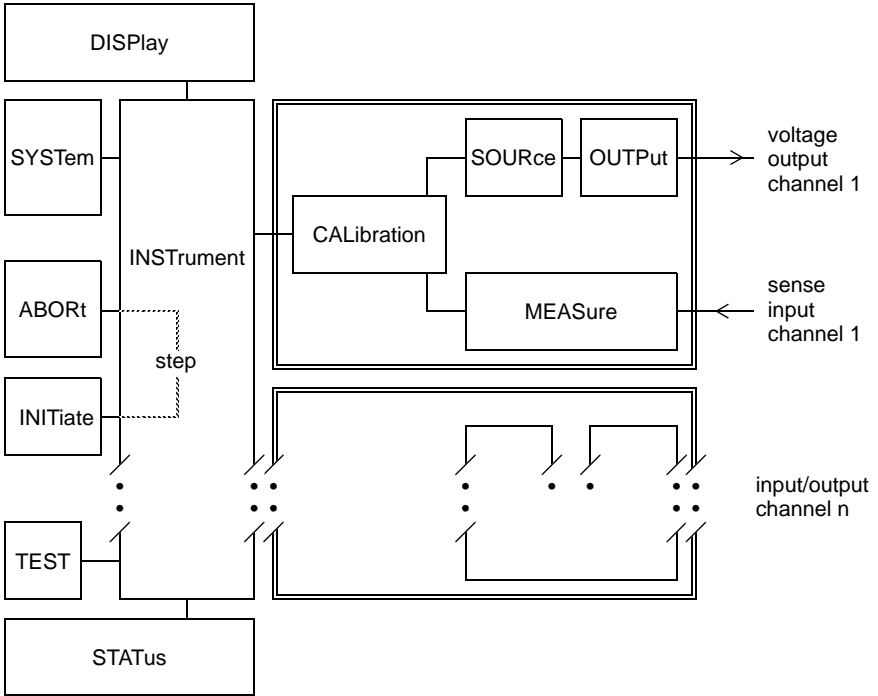

- **ABORt**
This subsystem is used for stopping the step function of the power supply.
- **CALibration**
This subsystem is used for calibration of the instrument. Your power supply can be calibrated without removing the cover or removing the power supply from your rack measurement setup. This feature allows you to calibrate the power supply at its normal operating temperature. The recommended calibration interval is one year. Refer to the Reference Manual for complete calibration details.
- **DISPlay**
This subsystem is used to control the front panel display.
- **INITiate**
This subsystem is used to start up (initiate) the step function of the power supply.
- **INSTRument**
This subsystem is used to control the instrument functions.
- **MEASure**
This subsystem is used to measure (readback) output voltage and output current.
- **OUTPut**
This subsystem is used to control an output channel.
- **SOURce**
This subsystem is used for source and setting functions of an output channel, such as :
 - source definitions
 - voltage (protection) settings
 - current (protection) settings
 - automatic stepping
- **STATus**
This subsystem is used for handling the device-dependent operational and questionable status information.
- **SYSTEM**
This subsystem is used to handle system and control functions, such as:
 - lockout front panel control
 - define the 'power on clear' behavior
 - request for status information
- **TEST**
This subsystem is used to test the instrument.

2.2.3 Sense modes

Each output channel has been provided with a set of four terminals. The inner terminals have been marked as - **V(oltage)** and + **V(oltage)**, while the outer terminals have been marked as - **S(ense)** and + **S(ense)**.

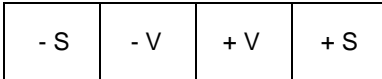

Each output channel can be connected to a load in two different ways:

- through the +V and -V terminals, causing the power supply to operate in its local sense mode.
- through the +V and -V and +S and -S terminals, causing the power supply to operate in its remote sense mode.

Local sensing

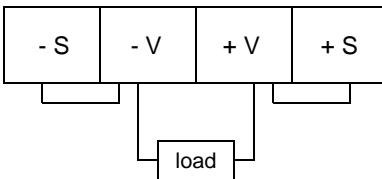

At delivery the sense terminals are interconnected with the voltage terminals. This is called local sensing. If the voltage drop across both of the wires to the load is negligible, the voltage at the load will equal the programmed value.

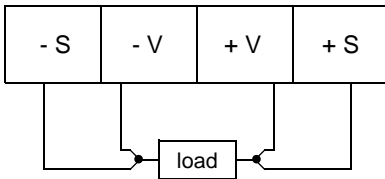
Remote sensing

If the voltage drop across the +V and -V wires to the load is substantial, the voltage at the load will be less than the programmed value. To prevent the voltage at the load from being less than the programmed value, the sense wires must also be connected to the load (remote sensing). This way of sensing allows the power supply to compensate for voltage drops in the wires between the power supply and the load. The sense wires must be connected directly to the load poles.

Note: Long sense wires are susceptible to noise pickup. To minimize noise pickup, twist each pair of sense wires together. Shielding around the sense wires may be necessary in more extreme cases.

2.3 ADVANCED OPERATION

2.3.1 Output channel interconnections

Identical output channels can be connected in the following ways to increase the total output capability:

- In **series** to increase the output voltage capability. Refer to section 5.6.2 "Serial connection of output channels" for more information.

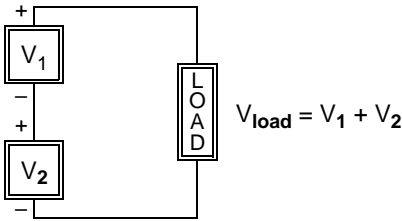

- **Parallel** to increase the output current capability. Refer to section 5.6.1 "Parallel connection of output channels" for more information.

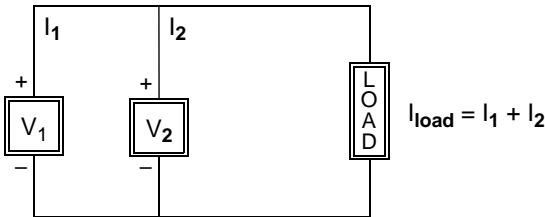

CAUTION: Only output channels with equivalent voltage and current ratings may be connected in series or parallel to prevent damage to one of the channels. For maximum output capacity, refer to section 5.5.1 "Output channel ratings and characteristics". For more information about connections, refer to section 5.6 "Advanced use".

2.3.2 Multiple loads

If more than one load is connected to an output channel, use separate wires to connect each load. This minimizes mutual coupling effects and takes full advantage of the power supply's low output impedance. Each pair of wires should be as short as possible to reduce wire inductance and noise pickup to prevent the loads from mutually influencing each other, due to load fluctuations. The loads must be connected in parallel, not in series.

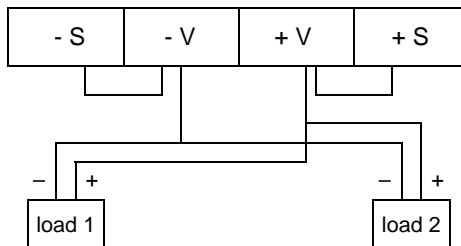

CORRECT: Parallel connection of loads

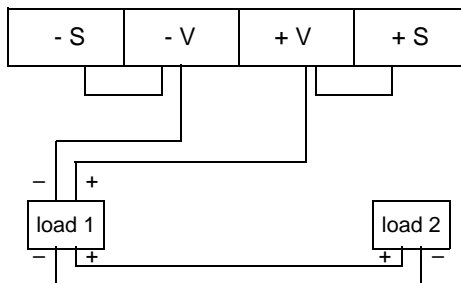

WRONG: Series connection of loads

Note: To prevent noise pickup, you are advised to twist the sense wires and shield them from each other.

In principle there is no restriction about the number of loads that can be connected. Remote voltage sensing is recommended if one load is more sensitive than the other(s); therefore, sense directly at the most sensitive load.

3 INSTALLATION INSTRUCTIONS

3.1 INTRODUCTION

This section contains instructions for the following:

- inspecting the contents of the shipment for completeness and/or damage during transport (initial inspection)
- ensuring the safety of the operator
- installing the power supply
- making the input and output connections
- performing the installation acceptance checks

3.2 INITIAL INSPECTION

Inspect the contents of the shipment for completeness and note whether any damage has occurred during transport. If the contents are not complete, or if there is damage, inform your FLUKE Sales and Service Center so that repair or replacement of the instrument can be arranged.

Pay special attention to the following parts :

- accessories to be supplied (refer to Appendix A).
- front panel keys and display.
- rear panel connectors and terminal blocks.
- cabinet surfaces.

The shipment must contain one power supply plus the accessories supplied. For a complete list of accessories supplied, refer to the INITIAL INSPECTION page in the front of this manual.

3.3 OPERATOR SAFETY INSTRUCTIONS

The instrument has been designed and tested in accordance with IEC Publication 1010 for Class 1 instruments and has been supplied in a safe condition. This Operation Manual contains WARNING and CAUTION statements, that must be followed by the user to ensure safe operation and to keep the instrument in a safe condition.

The instrument described in this manual is to be used by properly trained personnel.

Do not remove the cover or perform any adjustment, maintenance, or repair unless you are qualified to do so and are aware of the hazards involved.

Symbol



Before connecting the instrument to line power, ensure that the power ground is functioning correctly. Before any other connection is made, the instrument must be connected to the earth (ground) conductor via the three-conductor power cord. The power plug must be inserted into a socket outlet provided with ground contact. The grounding protection must not be defeated by use of an extension cord without a ground conductor.

WARNING : Any interruption of the protective conductor inside or outside the instrument or disconnection of the protective ground terminal is likely to make the instrument dangerous. Intentional interruption is prohibited.

The instrument is shipped from the factory with a power cord that has a plug appropriate for the country in which it is sold. If a different power plug or power cord is required, contact your Fluke Sales and Service Center.

CAUTION: *When an instrument is brought from a cold into a warm environment, condensation may cause a hazardous condition; therefore, make sure that the grounding requirements are strictly adhered to.*

3.4 INSTALLATION

3.4.1 Mechanical installation

The instrument is fan cooled and must be installed in a location that allows sufficient space at the three important sides: rear, left, and right. Each side must have a space of at least 1 inch (25 mm). The fan, located at the rear, cools the instrument by drawing air into the openings at the rear and exhausting it through openings on the sides. Each instrument output channel has its own fan.

3.4.2 Electrical installation

Pre-installation checks:

- Read Chapter 1 "OPERATOR SAFETY" before making any connections.
- Before inserting the power plug into the power supply, ensure that the ground conductor is functioning correctly.

Check that this instrument is suitable for the local situation as indicated on the model number plate (sticker) on the rear panel.

NOTE : If the instrument must be wired to conform to local power, contact your FLUKE Sales and Service Center to have it modified.

The power inlet module, located at the rear, is an integral power adapter and includes the power input socket, the holder for the two power fuses and the POWER ON/OFF (1/0) switch. The two power fuses are located behind the flap next to the power input socket.

WARNING: When a fuse must be replaced, the instrument must be turned off and disconnected from the power. Refer to Chapter 2 in the Reference Manual.



3.4.3 Front Connection Unit

Introduction

This section describes the use and capabilities of the Front Connection Unit, mounted underneath the power supply.

The Front Connection Unit provides the interconnections between the rear and front terminals.

The following programmable power supply types have a front connection unit:

- single output model: PM2811/x5z
- dual output model : PM2812/x5z
- triple output model : PM2813/x5z
- single output model: PM2831/x5z
- dual output model : PM2832/x5z

x = Number assigned to various output ratings

z = Country version

Basic operation

Every output channel has been provided with four output terminals, a ground terminal, and a SENSE switch.

FOUR OUTPUT TERMINALS

The inner 2 banana sockets are for the power output, i.e., +V and -V. The outer 2 banana sockets are for the sense input, i.e., +S and -S.

ONE GROUND TERMINAL

The ground (earth)terminal has been connected to the housing for grounding and shielding purposes.

ONE SENSE SWITCH

This switch enables you to select local or remote sensing.

Note: Switching from remote to local or from local to remote may cause a sense break detection. To avoid this, it is advised to switch modes only at power off.

Electrical properties



The maximum voltage between any terminal and ground	: 240 V
The maximum current through an output terminal	: 15 A
The maximum current that may be switched	: 4 A

Local sensing

The SENSE switch is in 'LOCAL' position if S1 is 'closed'.

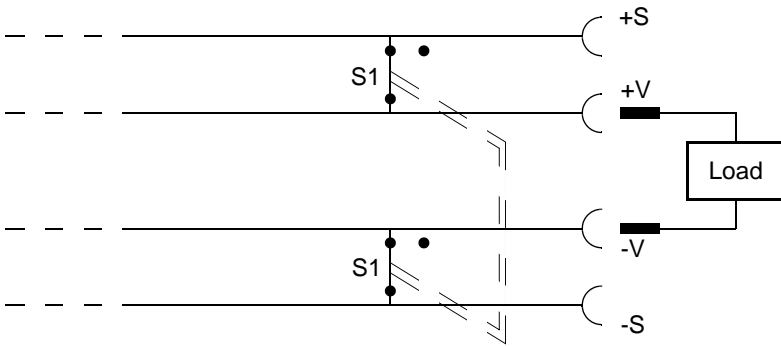

CAUTION: Do not connect a load to the sense terminals +S and -S, because the maximum current through the switch is limited to 4 A. Currents exceeding this limit will damage the switch. Also make sure that the sense wires (used for remote sensing) are disconnected from the sense terminals to prevent current through the sense switches.

Remote sensing

The SENSE switch is in 'REMOTE' position if S1 is 'open'. The sense terminals must be connected to the load.

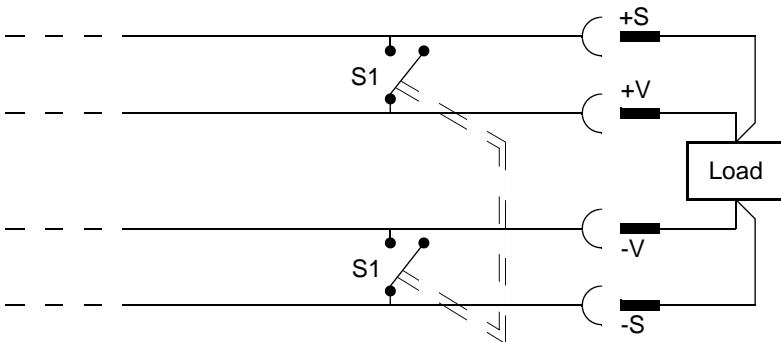

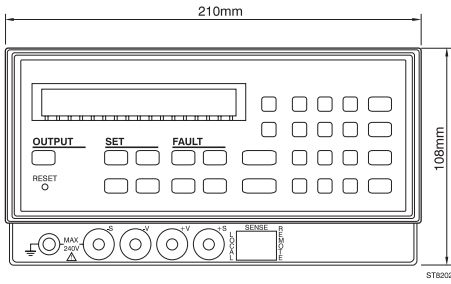

Half size model

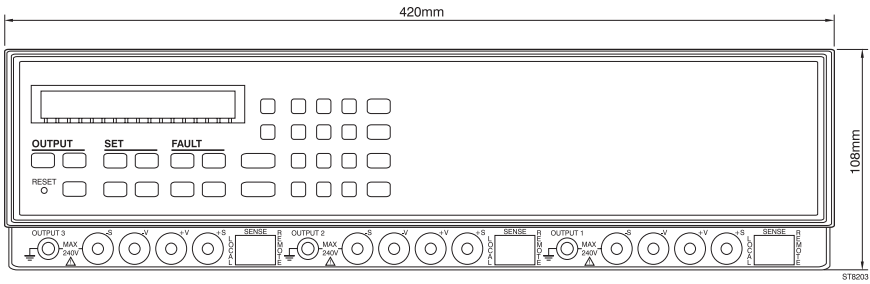

Full size model

3.5 OUTPUT CONNECTIONS

This section describes the following output connections:

- output channel terminals
- GPIB connector
- trigger bus SMB connectors

3.5.1 Output channel connections

The number of the output channels of the various power supplies is indicated in the last figure of the model number (single, dual or triple).

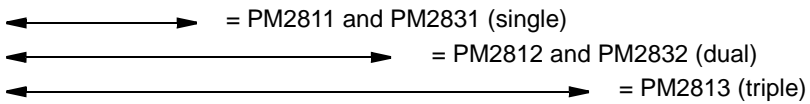

OUTPUT CHANNEL 1	OUTPUT CHANNEL 2	OUTPUT CHANNEL 3
---------------------	---------------------	---------------------

Every output channel connector is identical and consists of four terminals, i.e., two Voltage output terminals and two sense input terminals. A load can be connected in one of the following ways:

- to the + and - voltage terminals (local sensing)
- to the + and - voltage and sense terminals (remote sensing)

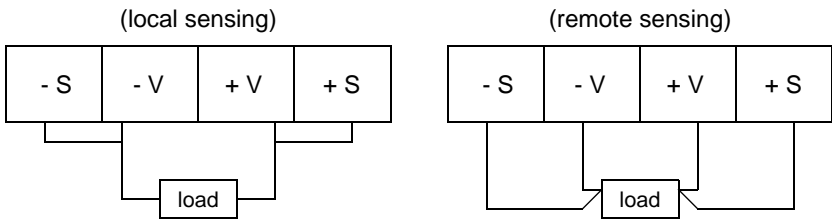

WARNING: To prevent **SHOCK HAZARD**, turn off the power before making rear output channel connections. All wires and straps must be properly insulated, and connected with terminal block screws securely tightened. Before any connection can be made, the plastic terminal block cover must be unscrewed and removed. When the connections have been made, the plastic terminal block cover must be reinstalled again.



3.5.2 GPIB connections

The GPIB (General Purpose Interface Bus) is identical to the IEC 625 or IEEE 488 interface bus. At the rear you will find a 24-pin female connector in which the connector pinning assignment is in accordance with IEEE 488.2 - 1987. An IEEE cable connects your power supply via an IEEE interface board to a controller.

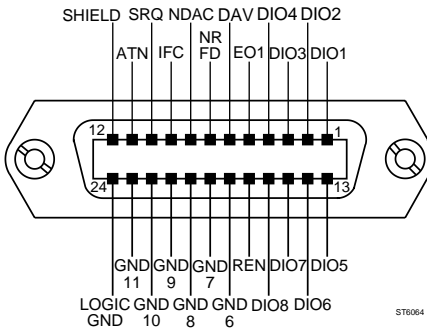

Figure 3.4 IEEE 488/IEC 625 Connections

3.5.3 Trigger bus connections

There are three SMB connectors at the rear: START, STEP, and READY. The modes and functions of the connectors are shown in the following table.

NAME	MODE	FUNCTION
START	input	Enables stepping via the STEP input.
STEP	input	Executes the next step.
READY	output	Indicates whether a step is finished (ready for the next step).

The trigger bus connectors can be used to recall output channel settings from the recall memory. For more information, refer to section 5.5.5 "Step functions".

3.6 ACCEPTANCE TESTS

The acceptance tests give information about the correct operation of the instrument after installation.

The interface test must be performed when using the programmable power supply for remote operation via the Controller/GPIB interface.

3.6.1 Brief check

After turning on your power supply, the following self tests on the hardware parts will be performed automatically:

- ROM test
- RAM test
- GPIB controller test
- Microprocessor timer test
- Communication (D²B) test
- Display controller test
- ADDA output channel(s) test

The tests will not show up on the display unless an error is detected. In the case of a hardware error, the following text + error code is displayed:

ERROR n:ddd n = Indication of the error source.
 ddd = Summation of the decimal values of the individual errors.

The following error codes are possible:

n = 0: Main CPU error

DECIMAL	ERROR DESCRIPTION
128	Display controller failure.
64	Bank switch failure.
32	Not used.
16	D ² B failure.
8	IEEE controller failure.
4	Processor timer failure.
2	RAM failure.
1	ROM failure.

n = 1, 2, or 3: CPU error of output channel 1, 2, or 3

DECIMAL	ERROR DESCRIPTION
128	Not used.
64	ROM checksum error.
32	Configuration checksum error.
16	Calibration checksum error.
8	Checksum error of the default settings.
4	Processor timer failure.
2	Not used.
1	Output channel not responding.

If the display is correct, character # will be displayed on the 16 character positions. Also the text (ENABLED 1 2 3 4 5 6 7 t t t t t t t REM SRQ) will be displayed for 1 second.

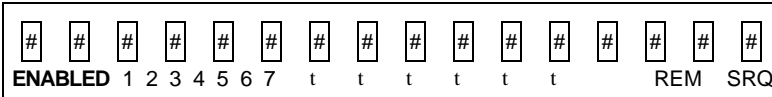

Next, the text INITIALIZING will be displayed for 1 second. If the mode after power on is OPERATE, the readback voltage and current will be displayed if the output is not DISABLED.

If not in OPERATE mode, the display shows STANDBY.

If a failure occurs during one of the tests, inform your FLUKE Sales and Service Center so that repair or replacement of the instrument can be arranged.

These tests take a few seconds to run. The instrument will be ready for use when the message STANDBY or the readback voltage and current appears on the display.

3.6.2 Interface check

To perform the GPIB interface check, the power supply must be connected to the controller via the GPIB; therefore, you need a GPIB interface card + software GPIB drivers + a programming language.

The various parts of the following interface check must be executed sequentially. Your power supply goes into the remote state when the first command is sent via the GPIB. However, the results of programmed commands can still be monitored on the display, e.g., the readback voltage and current. Also the text REM will be displayed in the remote state.

The interface check consists of the following parts:

- Check the GPIB address setting under the AUX menu.
- send → *IDN? Identification query
- read ← PHILIPS,PM28nn/xy,0,Va.b
Notes:
 - *nn = 11, 12, 13, 31 or 32*
 - *x is the model indication*
 - *y is the hardware version*
 - *a.b = the firmware version*
- send → *TST? Read result of power on test.
read ← <response_string>
IF <response_string> = 0 THEN test result is correct
ELSE display controller failure
- send → :TEST:SYSTEM? Selftest power supply query.
read ← <response_string>
IF <response_string> = 0 THEN test result is correct
ELSE the <response_string> = hardware error number
- send → :INST:NSEL 1 Select output channel 1 (only for multiple output models).

send → :TEST:INSTRUMENT? Selftest of the output channel 1.
read ← <response_string>
IF <response_string> = 0 THEN test result is correct
ELSE the <response_string> = hardware error number
Repeat this check for all available output channels.

Note: For meaning of the hardware error numbers, refer to section 3.6.1 "Brief check" or to "Error Messages" in the Reference Manual.

4 GETTING FAMILIAR WITH THE POWER SUPPLY

This chapter will help the user new to programmable power supplies.

4.1 INITIAL SETUP OF YOUR POWER SUPPLY

4.1.1 Power up routine

WARNING: Before you turn on your power supply, make sure that the power input voltage matches the power voltage specifications on the decal on the rear of your power supply. Refer to section 3.4.2 "Installation" for instructions on how to check this.

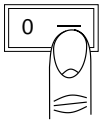

Turn the power on by pressing the switch at the rear. The power supply performs a series of self tests that last about 5 seconds.

Normal self test indications

After the power supply has executed the self tests, all characters and annunciators will be displayed, followed by the message **INITIALIZING**. At the end of the self tests, the supply is in the standby mode (**STANDBY** displayed) or in the operate mode (actual voltage and current displayed).

Self test errors

If a power-on self test fails, all output channels will remain disabled, and the display will indicate the type of failure and the output channel on which it occurred. If this is the case, refer to section 3.6 "Acceptance tests".

4.1.2 Instrument identification

Your power supply can be identified by its model number and version number. At delivery the power supply has a default IEEE device address. To identify your power supply, proceed as follows:

- 1) Start up the identification by pressing:

the **AUX** key as many times as necessary to display the following:

A D D R E S S ■ ■ ■ ■ ■ ■ ■ ■ **a a** ■ ■ ■

Note: The address *aa* is the actual GPIB device address (default = 28).

- 2) Proceed with the identification by pressing:

the **AUX** key again so that the display shows the following:

P M 2 8 n n ■ **V x . x** ■ **y : z z**

Note :

- *PM28nn* is the model number of the power supply.
- *Vx.x* is the firmware version of the power supply.
- *y* is the number of the output channel (1, 2 or 3).
- *zz* is the firmware version of the output channel.

The firmware versions of all output channels can be verified by pressing

SELECT to change Y (output channel number) on the display.

Note: The *SELECT* function is applicable only for multiple output models.

- 3) Finish the identification by pressing: **ENTER**.

4.2 FRONT PANEL LAYOUT

The following sections describe how to use the front panel control keys in combination with the 16-character display and the annunciators concerned. To be able to use the front panel keys, the power supply must be in the local mode. If the supply is in the remote mode (REM text displayed), press **LCL** .

If the power supply does not react after you press the LCL key, this key is disabled remotely by the Local Lockout (LLO) command from the GPIB controller. Pressing the front panel keys when the power supply is in the remote mode, will have no effect on programmed settings. It is, however, possible to view the actual settings on the front panel display, by using the front panel keys SELECT, V, I, OVP, DELAY, UNMASK, DISP, and AUX.

4.2.1 Keyboard controls

The front panel keyboard controls the following power supply functions:

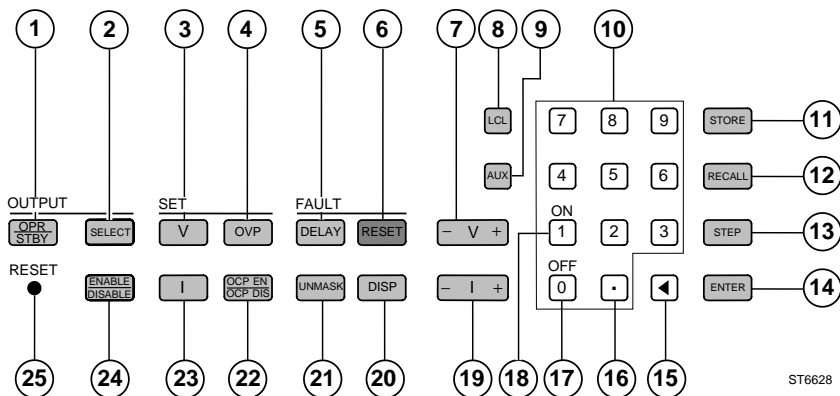

ST6628

FUNCTION

KEY

DESCRIPTION

OUTPUT control



Toggle between OPERATE and STANDBY.



Select an individual channel (applicable only for multiple output models).



















Enable/disable the selected channel (applicable only for multiple output models).

SET output



Verify/set the output voltage of the selected channel.

	(23)		Verify/set the output current of the selected channel.
	(4)		Verify/set the overvoltage trip level of the selected channel.
	(22)		Enable/disable the overcurrent protection of the selected channel.
FAULT handling	(5)		Verify/set the reprogramming delay
	(21)		Verify/set the bit mask of the fault register.
	(20)		Show the contents of the fault register.
	(6)		Reset the overvoltage/overcurrent/fail protection.
Adjust output	(7)		Adjust the output voltage of the selected channel. *)
	(19)		Adjust the output current of the selected channel. *) *) Only in OPERATE mode.
Numeric input	(10)	 ... 	Input a decimal number.
	(17)	 OFF	Turn off key.
	(18)	 ON	Turn on key.
	(16)		Input a decimal point.
	(15)		Erase previous key stroke (backspace) or leave the STEP function.
	(14)		Enter the input value or exit the current function.
Instrument control	(9)	 1)	Step through the following control functions: a) Enter the STEP MENU function (press ENTER). - Set AUTO STEP function on or off. - Program the step TIME INTerval. - Set CONTINUOUS step function on or off. - Define START AT entry of loop sequence. - Define STOP AT entry of loop sequence. b) COUPLE voltage and current PARAMETERS.

- c) COUPLE PROTECTION of all output channels.
- d) Set STANDBY AT Power ON behavior on or off.
- e) Adjust the CONTRAST of the display (0-9).
- f) LOCK the KEYboard ²⁾.
- g) Verify/set the GPIB ADDRESS (0 - 30).
- h) Verify the identity and firmware version of the power supply + its output channel(s).
- i) Verify/set the CALibration access CODE

8 

Switch the power supply to local control.

11 

Store the voltage and current settings of all output channels (999 store addresses).

12 

Recall the stored voltage and current settings from all output channels (999 recall addresses).

13 

Step from one recalled group of settings to the next group of settings.

25 

Pencil point operation push button to reset the power supply while power is on.

- 1) The CALIBRATION mode is entered when you turn on the power supply while pressing the AUX key.
- 2) To unlock the keyboard, press the ENTER key for approximately 5 seconds.

4.2.2 Display indicators

In the OPERATE mode, the display can show up to 16 characters, which are refreshed four times per second.

On the front plate just below the display, a number of status abbreviations, e.g., CV (Constant Voltage), have been placed. Above each status abbreviation an annunciator (▼ sign) can be displayed to indicate the validity of the corresponding status abbreviation.

The enabled output channels (1 to 3) in the OPERATE mode plus the REM and SRQ status abbreviations can also be displayed.

Example of a voltage setting (V_{set}) for output channel 1:

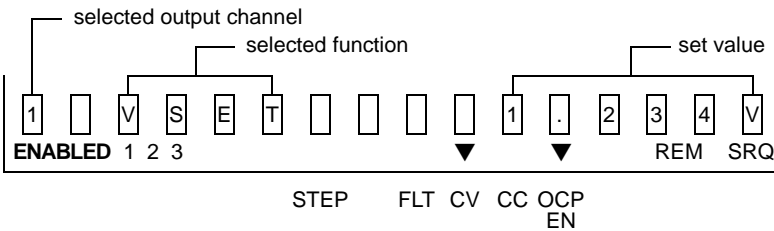

Note: The output channel indication is displayed only for multiple output channel models.

Example of readback data for output channel 2:

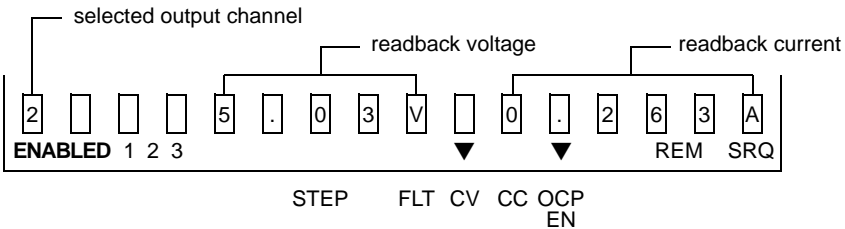

Note: The output channel indication is displayed only for multiple output channel models.

4.3 OUTPUT CHANNEL CONNECTIONS

WARNING: To prevent **SHOCK HAZARD**, turn off the line power before making output channel connections or disable the output channel concerned. All wires and straps must be properly insulated, and connected with terminal block screws securely tightened. Before any connection can be made, the plastic terminal block cover must be unscrewed and removed. When the connections have been made, the plastic terminal block cover must be secured again.



Each output channel has been provided with a set of four terminals. The inner two have been marked as **- V(oltage)** and **+ V(oltage)**, while the outer two have been marked as **- S(ense)** and **+ S(ense)**. At delivery the +V and +S, as well as the -V and -S terminals have been interconnected by straps.

Rear view of an output channel connected to a load:

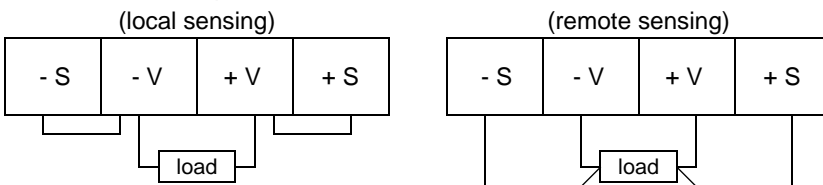

The voltage at the sense terminal(s) equals the programmed value. The voltage at a connected load may differ from the programmed value, because of a voltage drop depending on the resistance of the wires to the load and the current through the load.

If the voltage drop is negligible, the load wires only have to be connected to the +V and -V terminals. This is called 'local sensing'.

However, if the voltage drop is significant, the voltage at the load can differ from the programmed value. To prevent this, the straps between the +V and +S and -V and -S terminals must be removed and the load wires must also be connected to the +S and -S terminals. This is called 'remote sensing'.

Note: The terminals have been shielded with a plastic block cover which must be removed before any connection can be made.

WARNING: To avoid **FIRE HAZARD**, select a wire large enough to carry short-circuit current without overheating. Two factors must be considered when selecting the wire size for load connections:

- Conductor temperature, i.e., the current-carrying capacity.
- Total voltage drop, i.e., the wire length and thickness.

4.4 GETTING STARTED

The various parts of this tutorial must be executed sequentially. Before starting with this tutorial, make sure the power supply is in the local state. If the supply is in the remote state (REM is displayed), press **LCL** . If the REM text does not disappear, the LCL key is disabled remotely by the Local Lockout (LLO) command from the GPIB controller.

If the display shows the measured output voltage and current of one of the output channels, the power supply is in the OPERATE mode. Before starting with the tutorial, set the power supply to the STANDBY mode by pressing the OPR/STBY key.

Notes:

- For multiple output models the selected output channel number *n* will be displayed.
- For a single output model the number *n* will not be displayed.

4.4.1 Selecting an output channel

Make an output channel active as follows.

If you have a single output model, skip the first three lines of the following sequence.

Press **SELECT** to select the desired output channel.

The display then shows the selected output channel.

Press **ENABLE
DISABLE** to enable the selected output (if not already enabled).

The display shows: n **S T A N D B Y** ■ ■ ■ ■ ■ ■ ■ ■
ENABLED n

Press **OPR
STBY** to set the power supply to OPERATE mode.

The display shows: n ■ ■ **x x . x x V** ■ **y y . y y A**
ENABLED n

4.4.2 Setting an output voltage

Do not connect any load. The +V and +S terminals must be interconnected as well as the -V and -S terminals.

- 1) Set the voltage of the selected output channel to 5V by pressing:

The display shows: n **V S E T** **V**

- 2) Enter the output voltage setting by pressing

Check that the display reads approximately 5V. Also check that the CV annunciator is on, indicating that the selected output channel is in the Constant Voltage mode.

- 3) Program the overvoltage trip level to 7V by pressing:

The display shows: n **O V S E T** **V**

- 4) Enter the overvoltage trip level setting by pressing

- 5) Set the voltage of the selected output channel to 8V by pressing:

The display shows: n **V S E T** **V**

- 6) Enter the output voltage setting by pressing , and

check that the display reads: n **O V E R V O L T A G E**

- 7) Set the output voltage to 6V and reset the overvoltage protection by pressing:

Check that the display reads approximately 6V.

- 9) Disable the overcurrent protection and reset the output channel by pressing:



Check that the display reads approximately 0.5A.

Also check that the CC annunciator is on, indicating that the output channel is in the 'Constant Current' mode again.

- 10) Turn off the power supply.
- 11) Remove the jumper wire between the - V(oltage) and + V(oltage) output terminals and reattach the terminal block cover.

5 USING YOUR PROGRAMMABLE POWER SUPPLY

5.1 INTRODUCTION

This chapter contains functional information about using your programmable power supply (PPS). It covers basic information, such as connecting a load to an output channel, and more advanced information such as the following:

- 1) Connecting loads in parallel to an output channel.
- 2) Connecting output channels in series to a load to increase the maximum output voltage or connecting them in parallel to a load to increase the output current.

This chapter also contains information about main operating features and describes how to use those features. You can use your programmable power supply in one of the following ways:

- 1) In a system environment, via a system controller (PC + IEEE interface). This is called "remote operation".
- 2) As a bench-top instrument, using the front panel keys, indicators and display. This is called "local operation".

Each output channel of the power supply is a dc power source with controlled limits for power, voltage, and current. An output channel can operate as a constant voltage (CV) source, as a constant current (CC) source, or as a constant current (CC) sink (PM283x only) depending on voltage/current settings and load conditions. The maximum output voltage or current is limited by the following:

- 1) The maximum voltage and current cannot exceed the output channel-specific limits.
- 2) The product of voltage and current cannot exceed the output channel-specific power limit according to the formula $V_{set} \times I_{set} \leq P_{max}$.

For output limits, refer to section 5.5.1 "Output channel ratings and characteristics".

CAUTION: *You may turn on your power supply if you are sure that the installation instructions as described in Chapter 3 have been followed. The power supply is ready for use within a few seconds after power-up. After a warm-up time of 30 minutes, your power supply meets the specifications listed in the Reference Manual.*

5.2 LOCAL OPERATION

Local operation of your power supply is done through the front panel keys and display. Operational and error information is shown on the display. The keys are used for operator communication and have been placed into functional groups. This makes the functional use of the power supply very easy:

- OUTPUT control : control over the output channels
- SET output : setting a channel output
- FAULT handling : fault handling per output channel
- output adjustment : adjusting a channel output
- numeric control : input of figures or special keys
- instrument control : control over the instrument

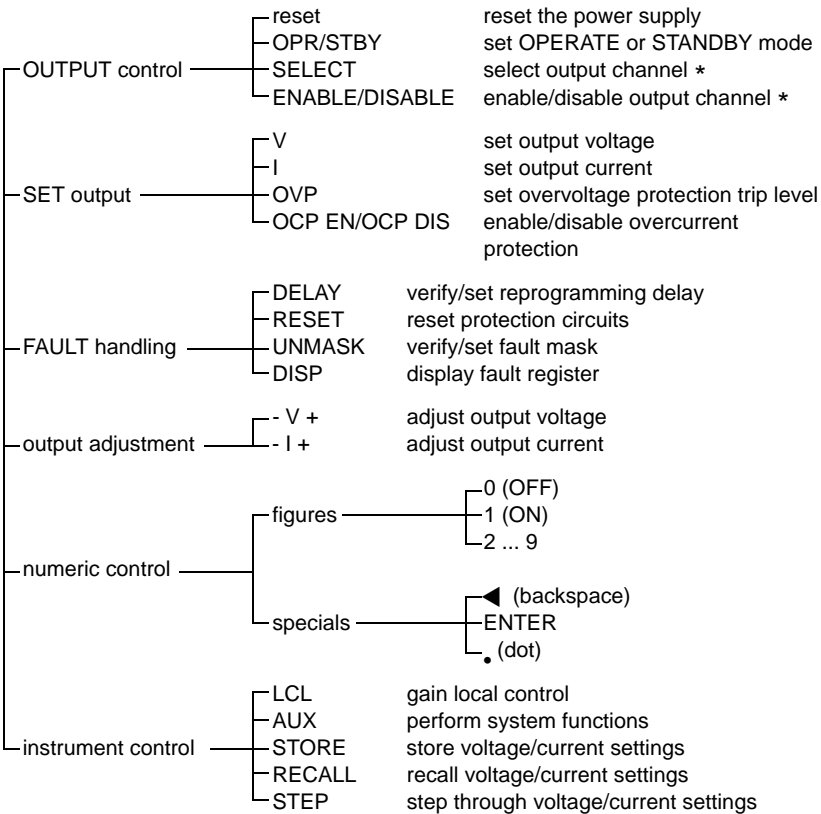

Note: * = applies to multiple output models only.

5.3 REMOTE OPERATION

In the remote mode, pressing the front panel keys will have no effect on programmed settings. It is, however, possible to view the actual settings on the front panel display, by pressing the front panel keys SELECT, V, I, OVP, DELAY, UNMASK, DISP, LCL, and AUX.

SCPI (Standard Commands for Programmable Instruments) is a standardized set of commands to be used for remote control of programmable test and measure instruments. It defines the syntax and semantics that the controller must use to communicate with an instrument, and is implemented in the instrument's firmware.

Please, read the users handbook 'Standard Commands for Programmable Instruments?' to get familiar with the SCPI and IEEE-488.2 standards. This handbook can be ordered at your local Fluke representative. See Appendix A for more information.

5.4 OPERATING FEATURES

Your programmable power supply is equipped with a GPIB interface, which conforms to the IEEE-488.2 standard and the SCPI protocol (Standard Commands for Programmable Instruments). The power supply can be programmed to operate in a remotely controlled instrumentation system via the GPIB.

You can use each output channel of the power supply as a constant voltage source (CV mode), as a constant current source (CC mode), or as a constant current sink (PM283x only). There are three instrument types available:

- single output channel power supply
- dual output channel power supply
- triple output channel power supply

A channel can have various output voltage and output current ratings. The operating structure and operating principles are identical for each instrument type and for each output channel.

The following features have been implemented in each power supply:

- Power on self-test and diagnostics routines.
- Readback capability of the measured voltage and current of each output channel.
- Each output channel offers the ability to sense locally or remotely. For remote sensing, the sense terminals (+S and -S) must be connected to the load instead of the +V and -V output terminals; then the programmed voltage (V_{set}) is guaranteed to be across the load, in spite of the voltage drop in the wires to the load.
- A nonvolatile memory (battery backed up). This enables you to:
 - store and recall voltage and current settings of all output channels (refer to section 5.5.4 "Store/Recall function")
 - save and recall the front panel settings (refer to the common commands *SAV and *RCL).

In this way, stored settings can be recalled, even after a long period of power off.

- Extended STEP possibilities, i.e., the capability to step sequentially through a number of predefined voltage and current settings. This can be done:
 - Manually using the STEP key.
 - Automatically at predefined intervals (internal timer)
 - Externally - by a STEP line trigger via the trigger bus
 - by a trigger via the GPIB interface

You can use this feature to generate test patterns and simulate ramp functions. The following table shows in which operating modes the STEP capabilities can be used:

TRIGGER SOURCE	LOCAL OPERATION	REMOTE OPERATION
MANUAL	STEP key	Not possible
AUTOMATIC	AUX key	:SOURCE:LIST... commands :INIT / :ABORT command
EXTERNAL-STEP line	STEP line	Trigger STEP line trigger
EXTERNAL-GPIB	not applicable	*TRG / GET command

- Closed-case calibration, i.e., your power supply can be calibrated without removing the cover or even without removing the instrument from your system cabinet. This feature allows you to calibrate your power supply at its normal operating temperature. The recommended calibration interval is one year. Refer to section 7.3.3 "Calibration" for complete calibration details.
- Protection circuitry for safe operation of your power supply:
 - by providing protection against OVERTEMPERATURE
 - by reporting an UNREGULATED output channel situation
 - by reporting conflicts in parameter settings
 - by reporting erroneous situations during operation
- Protection circuitry to protect a connected load:
 - against OVERVOLTAGE on each output channel
 - against OVERCURRENT on each output channel
 - against exceeding the sense capability on each output channel
 - with the ability to couple the voltage and current setting of the same output channel (not valid for the linear power supplies)
 - with the ability to couple the protection mechanisms of different output channels of the same power supply

To increase the total output power, connect an output channel to another output channel of the same voltage and current ratings. The connection can be made in series or in parallel. The output channels to be connected can be from the same power supply or from different power supplies; however, the capability of coupling protection mechanisms is only possible for output channels within the same power supply.

The following illustrations show the possible connections.

- SERIES connection to increase the total output voltage capability:

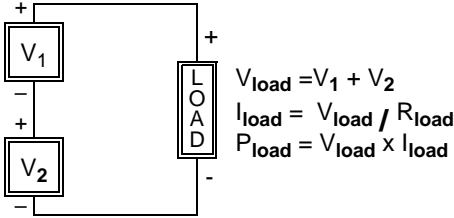

WARNING: To guarantee the safe use of the power supply, the total maximum voltage at each terminal must not exceed 240V with respect to ground.

- Examples:
- 2x 60V/2A = 120V/2A : maximum power = 240W
 - 2x 120V/1A = 240V/1A : maximum power = 240W
 - 2x 8V/15A = 16V/15A : maximum power = 240W

- PARALLEL connection to increase the total output current capability:

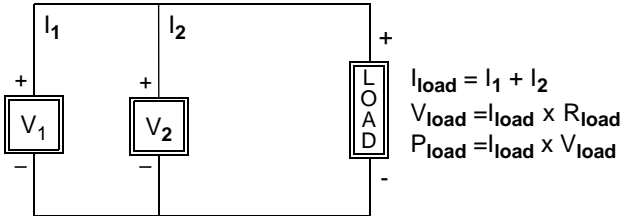

- Examples:
- 2x 60V/2A = 60V/4A : maximum power = 240W
 - 2x 120V/1 = 120V/2A : maximum power = 240W
 - 2x 8V/15A = 8V/30A : maximum power = 240W

CAUTION: Only output channels with equivalent voltage and current ratings may be connected in series or in parallel to prevent that the channel with the lowest ratings will be damaged.

5.5 HOW TO USE THE OPERATING FEATURES

This section contains information about how to use the features of your power supply, such as:

- Dealing with output channel-specific ratings and characteristics.
- Performing local and remote sensing.
- Using an output channel as constant voltage or constant current source.
- Using the memory functions:
 - Store/recall voltage/current settings.
 - Step manually through voltage/current settings.
 - Step automatically through voltage/current settings.

5.5.1 Output channel characteristics

PM2811/12/13

Each individual output channel can supply power according to its output characteristic. Figure 5.5.1 below gives you information about the three possible output channel characteristics. The power output is rated and limited according to the formula: P (power) = U (voltage) \times I (current).

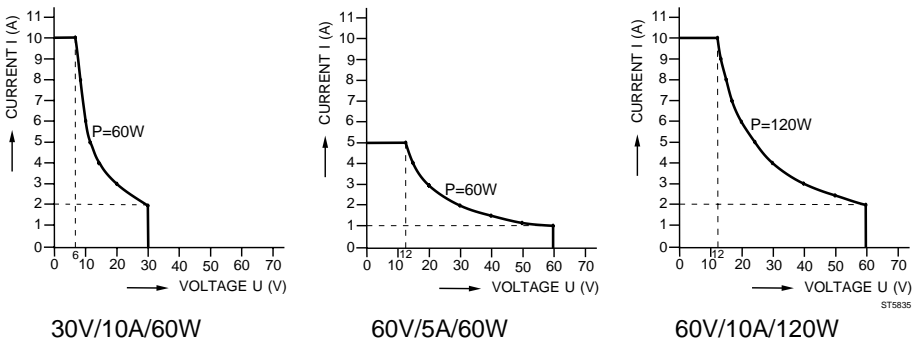

Figure 5.5.1 Output Channel Characteristics

As an example look at the 30V/10A/60W output channel ratings:

- For voltages from 0 to 6V the current can increase to its maximum of 10A. For voltages > 6 to 30V, the current can increase to its maximum along the stated curve, e.g., 20V gives maximum of 3A.
- For currents from 0 to 2A the maximum voltage can be 30V. For currents > 2 to 10A, the voltage can increase to its maximum along the stated curve, e.g., 5A gives a maximum of 12V.

PM2831/32

The following characteristic shows the work area of the output parameters. The linear system power supplies PM2831 and PM2832 can source as well as sink currents. There is, however, only one setting for current. When the power supply is used as a load, the value of the sink current will always track the positive setting.

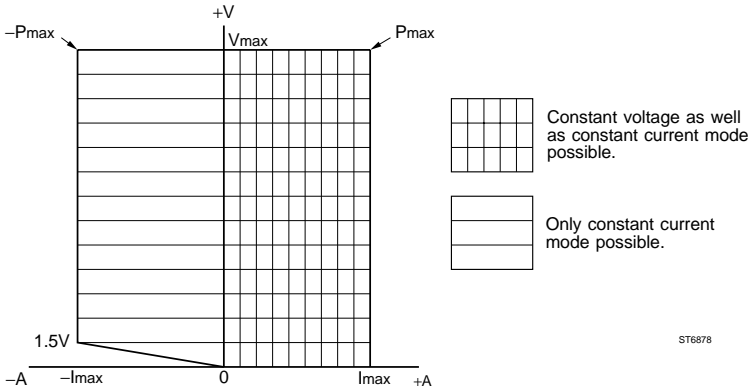

Figure 5.5.2 Output channel characteristics

This characteristic shows that the power supply will output maximum power (only) at V_{max} @ I_{max} and will absorb maximum power at V_{max} @ $-I_{max}$. Overcurrent protection, if enabled, will also work for sink currents that exceed I_{set} . Overvoltage protection will work also for voltages applied from an external source, if the voltage from this source exceeds the overvoltage protection level.

Current sink characteristics PM2831/32

The following figure gives an example that shows the sink characteristics of the power supply. The power supply is used as a constant current load for an external source, where the sink capability of the power supply is demonstrated. Overvoltage protection is set to the maximum level and overcurrent protection is disabled.

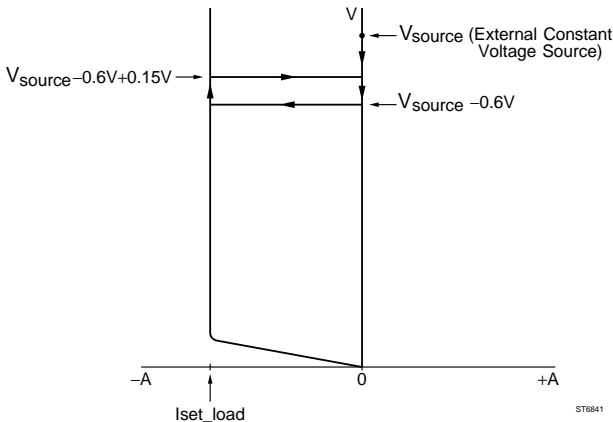

Figure 5.5.3 Current sink characteristics

The power supply and the external source (this may be another power supply) are set to the same output voltage: V_{source} . There is no current flow yet.

The current settings are: $I_{\text{set_source}} > I_{\text{set_load}}$.

The voltage setting of the load is gradually decreased by pressing the -V+ key. The change of the actual voltage setting is not visible on the display, because the display will show the constant voltage applied by the external source. But the voltage setting of the power supply can be made visible at any moment by pressing the V key. When the setting approaches $V_{\text{source}} - 0.6V$, the power supply switches to the constant current (CC) mode at the level of $-I_{\text{set_load}}$. In this situation the negative current of the power supply tracks the programmed (positive) value $I_{\text{set_load}}$. The voltage can be raised by pressing the -V+ key. When the setting approaches $V_{\text{source}} - 0.6V + 0.15V$, the power supply will exit constant current mode and return to the constant voltage mode @ 0A.

5.5.2 Local and remote sensing

All models have the ability to sense the output voltage locally or remotely. The wires between an output channel and the connected load have a resistance, which causes a voltage drop. If the voltage drop is not acceptable, remote sensing must be applied.

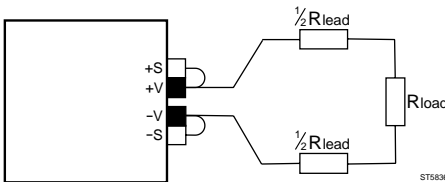

Figure 5.5.4 Voltage drop due to Wire Resistance R_{lead} .

The formula to calculate the voltage drop is $V_{drop} = I_{load} \times R_{lead}$:

- V_{drop} = the total voltage drop of both wires
- I_{load} = the current through the load
- R_{lead} = the total resistance of both wires between the power supply and the load

Figures 5.5.5 and 5.5.6 show the difference between a local and remote connection has been indicated.

CAUTION: *To prevent shock or short-circuit you must set the power supply to the standby mode before making any changes in the output channel connections or you must disable the output channel (only possible for multiple output models).*

All the models and their output channels have the same terminal block (see the following diagram). This means that all output channels have the local or remote sensing feature. The load is supplied with power (voltage and/or current) through the output terminals -V and + V. The readback of the output voltage is done through the input terminals -S and + S.

Local sensing mode:

Local sensing is used when the voltage across the load does not need to compensate for the voltage drop across the load leads. This may be the case when the following conditions exist:

- Short wires between the output channel and the load ($R_{\text{load}} > R_{\text{lead}}$).
- Low current through the connected load.

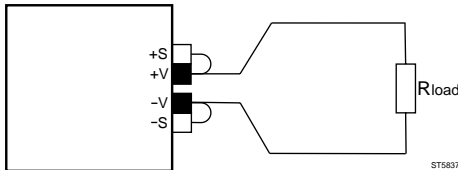

Figure 5.5.5 Connection of a Load in the Local Sense Mode

Remote sensing mode:

Remote sensing is used if the voltage across the load must exactly match the programmed value; remote sensing will namely compensate for the voltage drop across the load leads. This mode will be useful when the following conditions exist:

- Long leads between the output channel and the load ($R_{\text{load}} \leq R_{\text{lead}}$).
- High current through the connected load.

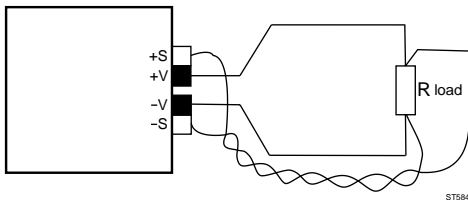

Figure 5.5.6 Connection of a Load in the Remote Sense Mode

Note that with remote sensing, the readback of the load voltage is monitored at the load terminals. When using the remote sensing mode, it is necessary to twist the sense wires to avoid disturbance and noise pickup in the sense input terminals, which might cause instability of the output.

During remote sensing, the power supply can compensate for voltage drops up to a specified minimum value. This is called the remote sense capability (see the Reference Manual, Appendix A). When the voltage drop exceeds this value, sense FAIL may occur. The output voltage and current are then reduced to zero and the display shows the FAIL message.

When the sense leads are disconnected, the power supply goes into the local sense mode, as the V and S terminals are internally interconnected via resistors. Yet you are strongly recommended to interconnect the V and S terminals with the straps if you use the local sense mode, as open sense inputs are sensitive to noise. Moreover, the output specifications are not guaranteed when the sense terminals are open.

Output modules with low voltage ratings may have less sense capability for output voltages in the upper part of the voltage range, e.g. the 8V/15A module for the sense range from 4V to 8V (see the Reference Manual, Appendix A).

For power supplies with a Front Connection Unit, the sense capability is reduced with about 5mV/A per load lead.

5.5.3 Constant voltage or constant current source

Your power supply has been designed according to the automatic crossover principle. This means that each output channel will operate in the Constant Voltage (CV) mode or in the Constant Current CC mode, depending on:

- the programmed output voltage V_{set} and current I_{set}
- the resistance (impedance) of the load R_{load} , connected to the output channel

For a given V_{set} and I_{set} , an output channel is either:

in the CV mode if $\left[R_{\text{load}} > \frac{V_{\text{set}}}{I_{\text{set}}} \right]$ or in the CC mode if $\left[R_{\text{load}} < \frac{V_{\text{set}}}{I_{\text{set}}} \right]$.

In the CV mode the output is a constant voltage, so the current through the load depends on the load resistance (R_{load}).

In the CC mode the output is a constant current, so the voltage across the load depends on the load resistance (R_{load}).

The following picture shows when the output channel goes into the CV or into the CC mode of operation, when connected to a variable resistor R_{load} .

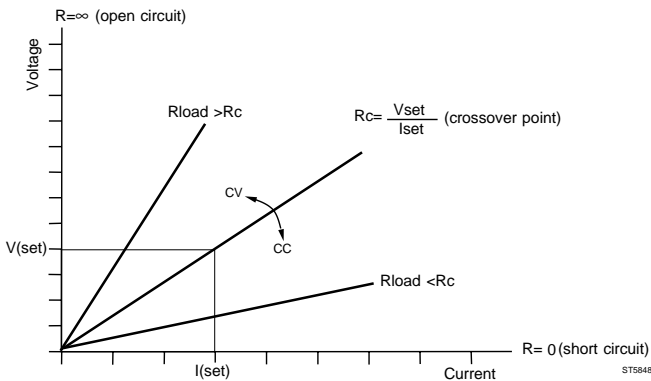

Figure 5.5.7 Power Output Crossover Point

If R_{load} increases ($R_{\text{load}} > R_c$), the output channel goes into the CV mode, reducing the current through the load.

If R_{load} decreases ($R_{\text{load}} < R_c$), the output channel goes into the CC mode, reducing the voltage across the load.

To protect the load against excessive currents, the maximum current I_{set} can be programmed, and the overcurrent protection can be enabled.

To protect the load against excessive voltages, the overvoltage protection level OVP_{set} can be programmed.

LIMITATIONS

The output power is limited by:

- the output specific maximum power P_{max} , according to the formula:
$$I_{\text{set}} \times V_{\text{set}} \leq P_{\text{max}}$$

RESTRICTIONS

The output voltage is restricted by:

- the output specific maximum voltage, or
- the overvoltage protection level OVP_{set}

Note: When the output voltage exceeds the overvoltage protection level, both the output voltage and current are reduced to zero.

The output current is restricted by:

- the output specific maximum current, or
- the programmed maximum current level I_{set}

Note: If the overcurrent protection has been enabled and the output current exceeds the maximum current (I_{set}), the output voltage and current are reduced to zero.

If the overcurrent protection has been disabled, the output current will be kept at its maximum (I_{set}). The consequence is that the output voltage will not reach its programmed value (V_{set}), and the output channel will go into the CC mode.

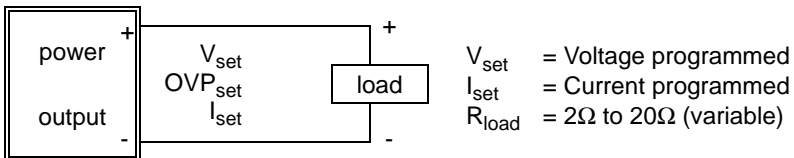
Example for a variable load resistance:

Required: The V_{set} and I_{set} parameter have been coupled for the selected output channel.

- $I_{set} = 1A$ Programmed current becomes 1A.
- $V_{set} = 8V$ Programmed voltage becomes 8V.

The crossover point resistance $R_c = V_{set} / I_{set} = 8\Omega$.

- If R_{load} increases from 8Ω to 16Ω, then $R_{load} > R_c$, so the output channel goes into the CV mode (refer to figure 5.5.7). This means that $V_{load} = 8V$ and I_{load} becomes $8V/16\Omega = 0.5A$.
- If R_{load} decreases from 8Ω to 4Ω, then $R_{load} < R_c$, so the output channel goes into the CC mode (refer to figure 5.5.7). This means that $I_{load} = 1A$ and V_{load} becomes $1A \times 4\Omega = 4V$.

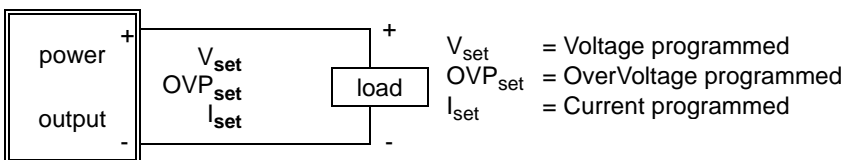
Example for a fixed load resistance:

Required:

- Fixed load resistance $R_{load} = 10\Omega$.
- Overcurrent protection disabled (OCP DIS).
- The V_{set} and I_{set} parameter have not been coupled.

- $I_{\text{set}} = 0.5\text{A}$ Maximum current through the load becomes 0.5A.
- $\text{OVP}_{\text{set}} = 7\text{V}$ Overvoltage protection trip level becomes 7V.

Sequentially the voltages 2V, 4V, 6V, and 8V will be programmed:

- $V_{\text{set}} = 2\text{V}$ $I_{\text{load}} = V_{\text{set}} / R_{\text{load}} = 2\text{V}/10\Omega = 0.2\text{A}$.
The output channel stays in the CV mode.
- $V_{\text{set}} = 4\text{V}$ $I_{\text{load}} = V_{\text{set}} / R_{\text{load}} = 4\text{V}/10\Omega = 0.4\text{A}$.
The output channel stays in the CV mode.
- $V_{\text{set}} = 6\text{V}$ $I_{\text{load}} = V_{\text{set}} / R_{\text{load}} = 6\text{V}/10\Omega = 0.6\text{A}$. However, the maximum output current (0.5A) is going to be exceeded. Therefore, the current through the load becomes 0.5A and the voltage across the load is limited at $0.5\text{A} \times 10\Omega = 5\text{V}$.
The output channel goes into the CC mode.
- $I_{\text{set}} = 1\text{A}$ The maximum current through the load becomes 1A.
 $I_{\text{load}} = V_{\text{set}} / R_{\text{load}} = 6\text{V}/10\Omega = 0.6\text{A}$. The voltage across the load becomes $0.6\text{A} \times 10\Omega = 6\text{V}$.
The output channel goes back into the CV mode.
- $V_{\text{set}} = 8\text{V}$ Now the overvoltage protection trip level OVP_{set} (7V) is going to be exceeded. This will activate the overvoltage protection circuitry, so the output voltage and current will be reduced to zero. Also the message OVERVOLTAGE will be displayed.
- $\text{OVP}_{\text{set}} = 9\text{V}$ The overvoltage protection trip level becomes 9V.
- RESET The overvoltage protection circuitry is reset, and the voltage across the load becomes 8V.
 $I_{\text{load}} = V_{\text{set}} / R_{\text{load}} = 8\text{V}/10\Omega = 0.8\text{A}$.
The output channel remains in the CV mode.

Local control (in CV or CC mode):

The voltage V_{set} can be set using the key and the numeric input keys.
Example:

Press the V key to start the voltage setting.

Press the keys 3, . (dot), 4 and ENTER to enter the setting of 3.4V.

The current I_{set} can be set using the key and the numeric input keys.
Example:

Press the I key to start the current setting.

Press the keys 0, dot (.), 2, 3 and ENTER to enter the setting of 0.23A.

The overvoltage protection level OVP_{set} can be set using the key and the numeric input keys.

Example:

Press the OVP key to initiate the overvoltage setting.

Press the keys 7 and ENTER to enter the overvoltage setting of 7V.

The overcurrent protection can be enabled/disabled using the key.
Example:

Press the OCP EN/OCP DIS key.

IF OCP was enabled THEN OCP is disabled

ELSE OCP is enabled.

IF OCP has been enabled, the annunciator above the text OCP_{EN} will be displayed.

An overcurrent or overvoltage trip protection can be reset by pressing the key. The display of OVERCURRENT or OVERVOLTAGE will also disappear.

In the CV mode, the annunciator above the text CV will be displayed.

In the CC mode, the annunciator above the text CC will be displayed.

Remote control (in CV or CC mode):

The voltage V_{set} can be programmed by the SOURCE subsystem command:

```
[ :SOURce]:VOLTage[:LEVel][:IMMediate][:AMPLitude]
```

The voltage V_{set} can be requested by the SOURCE subsystem query:

```
[ :SOURce]:VOLTage[:LEVel][:IMMediate][:AMPLitude]?
```

The output voltage can be read back by the MEASURE subsystem query:

```
:MEASure[:SCALar]:VOLTage[:DC]?
```

Example:

Send → :VOLT 3.4	Set 3.4V.
Send → :VOLT?	Send request voltage setting.
Read ← set_voltage	Read voltage setting.
Print set_voltage	Display voltage setting.
Send → :MEAS:VOLT?	Send readback query.
Read ← meas_voltage	Read output voltage.
Print meas_voltage	Display measured voltage.

The current I_{set} can be programmed by the SOURCE subsystem command:

```
[ :SOURce]:CURRent[:LEVel][:IMMediate][:AMPLitude]
```

The current I_{set} can be requested by the SOURCE subsystem query:

```
[ :SOURce]:CURRent[:LEVel][:IMMediate][:AMPLitude]?
```

The output current can be read back by the MEASURE subsystem query:

```
:MEASure[:SCALar]:CURRent[:DC]?
```

Example:

Send → :CURR 0.23	Set 0.23A.
Send → :CURR?	Send request current setting.
Read ← set_current	Read current setting.
Print set_current	Display current setting.
Send → :MEAS:CURR?	Send readback query.
Read ← meas_current	Read output current.
Print meas_current	Display measured current.

The overvoltage protection level OVP_{set} can be programmed by the SOURCE subsystem command: `[[:SOURCE]:VOLTage:PROTection[:LEVel]`

The overvoltage protection level OVP_{set} can be requested by the SOURCE subsystem query: `[[:SOURCE]:VOLTage:PROTection[:LEVel]?`

Example:

Send → <code>:VOLT:PROT 7</code>	Set 7V protection level.
Send → <code>:MEAS:PROT?</code>	Send readback query.
Read ← <code>meas_over_voltage</code>	Read overvoltage protection level.
Print <code>meas_over_voltage</code>	Display overvoltage protection level.

The overcurrent protection can be enabled/disabled by the SOURCE subsystem command: `[[:SOURCE]:CURRent:PROTection:STATe`

Example:

Send → <code>:CURR:PROT:STAT ON</code>	Enable overcurrent protection.
Send → <code>:CURR:PROT:STAT OFF</code>	Disable overcurrent protection.

5.5.4 Store/recall function

Your programmable power supply has a recall memory (battery backed up) to be used for storing and recalling voltage and current settings of all output channels. The battery back up feature ensures that the stored values will be kept in memory during power-off. The recall memory consists of 999 addresses, numbered from 1 to 999. A recall memory address contains space for the voltage and current setting of all available output channels.

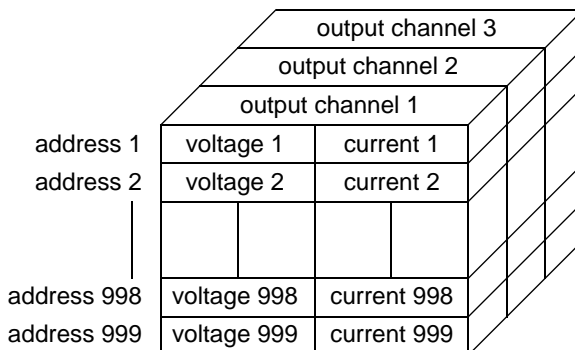

At delivery the contents of all addresses are set to their minimum value. When an address has been filled, its contents can be recalled, so that the settings become actual. The actual settings can be updated in OPERATE and STANDBY modes, but they are only active in the OPERATE mode. When the power supply is in the STANDBY mode, the actual settings will become active as soon as the OPERATE mode is entered.

Note: To remember which locations have been programmed and which have not, keep a record (such as the following) of which locations have been used.

MEMORY ADDRESS	OUTPUT CHANNEL 1		OUTPUT CHANNEL 2	
	VOLTAGE	CURRENT	VOLTAGE	CURRENT
01	2.0	0.00	5.9	0.90
02	1.9	0.10	5.8	0.80
03	1.8	0.20	5.7	0.70
04	etc.	etc.	etc.	etc.

Local control (store/recall):

The voltage V_{set} can be set using the **V** key and the numeric input keys.
 The output voltage can be adjusted using the **V +** key in the OPERATE mode.
 The current I_{set} can be set using the **I** key and the numeric input keys.
 The output current can be adjusted using the **I +** key in the OPERATE mode.
 The actual voltage/current setting can be stored using the **STORE** key.
 The actual voltage/current setting can be recalled using the **RECALL** key.

Example:

- **REQUIREMENTS** : Fill the memory address 23 with 5V/0.3A and the memory addresses 33, 34, and 35 with, respectively, 4V/1A, 3V/1A and 2V/1A for output channel 1.

- **SOLUTION:**

Press **OPR STBY** to make the STANDBY mode active.

For multiple output units, press **SELECT** a number of times until output channel 1 has been selected (see indication 1 on the display).

Press **V** **5** **ENTER** to set the actual voltage at 5V.

Press **I** **•** **3** **ENTER** to set the actual current at 0.3A.

Press **STORE** **2** **3** **ENTER** to store the 5V and 0.3A at memory address 23.

Press

V	4	ENTER
---	---	-------

 to set the actual voltage at 4V.

Press

I	1	ENTER
---	---	-------

 to set the actual current at 1A.

Press

STORE	3	3	ENTER
-------	---	---	-------

 to store the 4V and 1A at memory address 33.

Press

V	3	ENTER
---	---	-------

 to set the actual voltage at 3V.

Press

STORE	3	4	ENTER
-------	---	---	-------

 to store the 3V and 1A at memory address 34.

Press

V	2	ENTER
---	---	-------

 to set the actual voltage at 2V.

Press

STORE	3	5	ENTER
-------	---	---	-------

 to store the 2V and 1A at memory address 35.

Verify the programmed memory addresses, using

RECALL

 and the numeric input keys plus

V

 and

I

 keys, e.g.:

Press

RECALL	2	3	ENTER
--------	---	---	-------

. Press

V

 to verify the voltage of 5V. Press

I

 to verify the current of 0.3A.

Remote control (store/recall):

The recall memory voltage can be programmed using the [:SOURce]:LIST:VOLTage command.

The recall memory current can be programmed using the [:SOURce]:LIST:CURREnt command.

The actual memory address index (1 to 999) can be selected using the [:SOURce]:LIST:INDex[:NSElect] command.

Example:

- REQUIREMENTS : Fill the memory address 23 with 5V/0.3A and the memory addresses 33, 34, and 35 with, respectively, 4V/1A, 3V/1A and 2V/1A for output channel 1.
- SOLUTION:

Send → :INST:STAT OFF	STANDBY mode active.
Send → :INST:NSEL 1	Output channel 1 selected.
Send → :LIST:IND 23	Address 23 selected.
Send → :LIST:VOLT 5	
Send → :LIST:CURR 0.3	5V/0.3A stored at address 23.
Send → :LIST:IND 33	Address 33 selected.
Send → :LIST:VOLT 4,3,2	4V, 3V, and 2V, stored at respectively, the addresses 33, 34, and 35.
Send → :LIST:CURR 1,1,1	1A stored at the addresses 33, 34, and 35.

5.5.5 Step functions

When a list of memory addresses has been filled with voltage and current settings, it can be used in one of the following ways:

1) **AUTO_STEP OFF:**

This will invoke the manual step function, i.e., the next step is initiated by the operator. For instance by manually stepping through a list of predefined voltages and currents, a test pattern of voltage and current settings will be generated. The manual stepping will be executed for all enabled output channels. Refer to section "Manual step function" on this page.

2) **AUTO_STEP ON:**

This will invoke the automatic step function, i.e. the next step is initiated when the interval time has expired. For instance by automatically stepping through a list of sequential voltages and currents, a voltage/current ramp function will be executed. The start and stop address of the sequential list and the interval time between two consecutive steps can be programmed.

Stepping can be done in one of the following ways:

3) **CONTINUOUS_STEP OFF:**

The predefined sequence of memory addresses is executed only once.

4) **CONTINUOUS_STEP ON:**

The predefined sequence of memory addresses is executed continuously, i.e., repeatedly from start to stop address.

Stepping will be executed for all enabled output channels. Refer to section "Automatic step function" on the next page.

Manual step function:

The manual step function can be executed locally, using the STEP key.

The AUTO_STEP function can be set ON or OFF via the STEP MENU under the AUX key.

Example:

- **REQUIREMENTS :**

Step manually through the predefined list of voltage and current settings, stored at the memory addresses 20 to 40. The voltage and current settings must be output for channel 1. Output channel 2 must be disabled.

- SOLUTION:

Press **AUX** **ENTER** to enter the STEP submenu.

Check that the AUTO STEP is OFF, or press the OFF (0) key to set the AUTO STEP function off.

Press **ENTER** to leave the STEP submenu.

Press **SELECT** (only for multiple output models) to select output channel 1.

Press **ENABLE** **DISABLE** to enable output channel 1.

Press **SELECT** (only for multiple output models) to select output channel 2.

Press **ENABLE** **DISABLE** to disable output channel 2.

Press **SELECT** as many times as necessary to select output channel 1 again.

Press **OPR** **STBY** to make the OPERATE mode active.

Press **STEP** to enter the step mode.

Press **2** **0** **ENTER** to select start address 20 of the list.

The display reads: 1 S T E P 2 0

LOOP: Press **V** if you want to see the actual voltage on output channel 1 at the memory address as indicated on the display.

Press **I** if you want to see the actual current from output channel 1 at the memory address as indicated on the display.

Press **STEP** to select the next memory address of the list.

Repeat this loop until step 40 is made active.

ENDLOOP

Press **SELECT** to select output channel 2.

The display reads: 2 S T E P 4 0 D I S

Press **◀** to leave the step mode.

Remark: When the next step is executed, the next voltage and current setting in the list is made active and output on the selected channel.

Automatic step function

Local control (automatic stepping):

The AUTO STEP function, the CONTINUOUS STEP function, the step interval time, the START address, and the STOP address can be set via the **AUX** key.

The automatic step function can be started by pressing the **STEP** key.

Example:

- REQUIREMENTS:

Step automatically through the predefined list of voltage and current settings stored at the memory addresses 20 to 40. When the end of the list is reached, it must be started again at the beginning. The next voltage and current setting must be output for channel 1 at an interval time of 5 seconds.

- SOLUTION:

Press to enter the STEP submenu.

Press to set the AUTO STEP function on.

Press to set the TIME INTerval function.

Press to set the interval time at 5 seconds.

Press to set the CONTINUOUS step function.

Press to set the CONTINUOUS step function on.

Press to set the START AT function.

Press to set the start address of the sequence list at 20.

Press to set the STOP AT function.

Press to set the stop address of the sequence list at 40.

Press to leave the AUX menu.

Press (only for multiple output models) to select output channel 1.

Press to enable output channel 1.

Press to make the OPERATE mode active.

Press to enter the step mode.

Press to select start address 20 of the list.

The display reads : 1 S T E P T O 2 0

Press to initiate the automatic stepping.

- Check that the memory address is automatically incremented every 5 seconds on the display.
- Exit the automatic stepping by pressing the (backspace) key. The last recalled voltage and current setting remain active.

Remote control (automatic stepping):

The actual memory address index (1 to 999) can be selected using the [:SOURce]:LIST:INDEX[:NSElect] command. The selected memory address can be requested by means of the [:SOURce]:LIST:INDEX[:NSElect]? query.

A sequence list of memory addresses can be defined using the [:SOURce]:LIST:SEQUence:STARt and [:SOURce]:LIST:SEQUence:STOP commands.

A sequence list of memory addresses can be reported using the [:SOURce]:LIST:SEQUence:STARt? and [:SOURce]:LIST:SEQUence:STOP? queries.

The length of a sequence list, i.e., the number of voltage and current points, can be requested by the [:SOURce]:LIST:VOLTage:POINts? and [:SOURce]:LIST:CURRent:POINts? queries.

The step interval time can be defined by the [:SOURce]:LIST:TIMer command and can be requested by the [:SOURce]:LIST:TIMer? query.

The source of the next step in the sequence list (the step trigger) can be defined and requested by the [:SOURce]:LIST:SOURce command, respectively the [:SOURce]:LIST:SOURce? query. The following sources are possible:

- If source = TIMer, the internal timer of the power supply is used to count the step interval time.
- If source = EXtErnal or BUS, the active trigger source depends on whether the START line of the trigger bus at the rear of the power supply is active or not. If active, step pulses from the external STEP input will cause the next step to be performed. If not active, the next step will be performed after the *TRG command or after the GET trigger command.

The execution of a sequence list can be started using the :INITiate[:IMMediate] command. The first address is the START address, and the last address is the STOP address.

A sequence list can be executed continuously by means of the :INITiate:CONTInuous command.

The execution of a sequence list can be stopped by means of the :ABORt command. If the execution is stopped, the last recalled voltage and current setting remain active.

Example:

- REQUIREMENTS:

Step automatically through the predefined list of voltage and current settings, stored at the memory addresses 20 through 40. When the end of the list is reached, it must be started again at the beginning. The next voltage and current setting must be output for channel 1 at an interval time of 5 seconds.

- SOLUTION:

Send → :LIST:SOUR TIM The next step is automatically initiated by the internal timer.

Send → :LIST:TIM 5.0 Set the interval time at 5 seconds.

Send → :LIST:SEQ:START 20 Set the start address of the sequence list at 20.

Send → :LIST:SEQ:STOP 40 Set the stop address of the sequence list at 40.

Send → :INST:NSEL 1 Select output channel 1.

Send → :OUTP:STAT ON Enable output channel 1.

Send → :INST:STAT ON Make OPERATE mode active.

Send → :INIT:CONT ON Set the CONTINUOUS step function on.

Send → :INIT Initiate the automatic stepping.

Check the display of the power supply to verify that the memory address is automatically incremented every 5 seconds.

Send → :ABORT Exit the automatic stepping.

Check that the last recalled voltage and current setting remain active.

External step functions

There are three SMB connectors at the rear: START, STEP, and READY.

The modes and functions of the connectors are shown in the following table.

NAME	MODE	FUNCTION
START	input	Enables stepping via the STEP input.
STEP	input	Executes the next step.
READY	output	Indicates whether a step is finished (ready for the next step).

There is a standard GPIB interface connector at the rear. The GPIB interface software supports complete trigger capability.

If the trigger source = TIMER, the internal timer of the power supply is used to count the interval time between two consecutive steps.

If the trigger source = EXTERNAL or BUS, the active trigger source depends on whether or not the START line of the trigger bus at the rear is active.

EXTERNAL STEPPING (via the trigger bus)

If the START line is active (LOW), step pulses from the external STEP input line will cause the next step to be performed.

EXTERNAL STEPPING (via the GPIB)

If the START line is not active (HIGH), the next step will be performed on the receipt of the *TRG command or the GET code via the GPIB.

Note: LOW = 0 to 0.8V and HIGH = 2 to 5V

Trigger bus control:

External stepping via the trigger bus can be done in two ways:

1) In the synchronous mode:

In this mode all three bus signal lines have their own functions.

2) In the asynchronous mode:

In this mode the READY line is externally connected to the START line.

To control the recall memory via the trigger bus, the STEP mode may not be automatic, and the START input line must be pulled LOW. This will enable the STEP line to trigger the next step to be executed (external triggering). Pulling the START line LOW will also disable the manual STEP key.

When enabled, a STEP pulse will trigger the step mechanism. The leading edge of the STEP pulse makes the READY line active (LOW) within 100 nanoseconds. The READY line will be released when the internal processing is finished and the STEP line is HIGH. The internal processing time does not include the reprogramming delay time. It is the responsibility of the user to choose a STEP rate that is not too high for the power supply and its load condition, so that the output can settle within the STEP time.

Note: STEP pulses, received while the READY line is low, will be ignored.

GPIB control:

GPIB control can only be done in the remote mode of operation. An external trigger can be programmed in the following ways:

- Send → *TRG By sending the common command *TRG to the power supply.
- Send → GET By sending the GET (Group Execute Trigger) code over the GPIB interface.

5.6 ADVANCED USE

This section describes how to connect several output channels (with the same ratings) to obtain higher output power through a connected load.

To increase the total output current through a connected load, the output channels must be connected in parallel. Refer to section 5.6.1.

To increase the total output voltage over a connected load, the output channels must be connected in series. Refer to section 5.6.2.

This section also describes the way to connect more than one load to an output channel (multiple loads). Refer to section 5.6.3.

CAUTION: *Only output channels with equivalent voltage and current ratings may be connected in series or in parallel to prevent that the channel with the lowest output ratings will be damaged.*

5.6.1 Parallel connection of output channels

Note: For the PM2812 and PM2813 you can face a number of restrictions when connecting output channels in parallel to a load. Please read Appendix D to get more information of parallel connection of output channels for these instruments.

For the PM2831 and PM2832, parallel connection of output channels is only possible in the source (non-sink) mode

Connecting output channels in parallel provides a greater current capability than can be obtained from a single output channel. In principle, you can put more than two output channels in parallel.

Output channels in parallel configurations can operate in either Constant Voltage (CV) or in Constant Current (CC).

When channels are connected in parallel with the intention of increasing the current capability, it is advised that you set all channels to the same voltage. When the channels have the same power characteristics, set them to the same current value.

In general, you can handle the following procedure.

- Set the power supply to STANDBY before making any connections.
- Connect the channels in parallel.

If a constant voltage is required across the load, proceed as follows.

- Program the voltage setting of all channels equal to the constant voltage required.
- Calculate the maximum current needed for the load (I_{max}). Count with the minimum value of R_{load} .
- Program the current setting of the individual channels so that the sum of the values is equal to I_{max} .
- Now you may set the power supply to the operate mode.

If a constant current is required through the load, proceed as follows.

- Program the current setting of the individual channels so that the sum of the values is equal to the value of the constant current required.
- Calculate the maximum voltage needed to supply the constant current. Count with the maximum value of R_{load} .
- Program the voltage setting of all channels equal to the maximum voltage needed.
- Now you may set the power supply to the operate mode.

If neither constant voltage nor constant current is required, you may program typical values as well.

There are two ways of sensing the load when connecting output channels in parallel: local sensing and remote sensing.

Local sensing (outputs in parallel):

Connecting the load wires directly to the +V and -V terminals of output channel 2 keeps the number and the total length of the load wires to a minimum. The following diagram shows the wiring scheme.

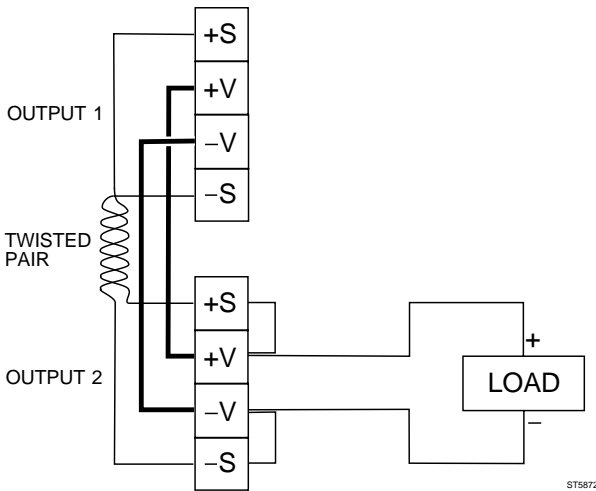

Figure 5.6.1 Local Sensing with Two Outputs in Parallel

CAUTION: To prevent noise pickup, twist the sense wires and shield them from the environment.

Remote sensing (outputs in parallel):

The sense wires are connected from the load to the +S and -S terminals of output channel 2. This compensates for the voltage drop in the wires from the load to the +V and -V terminals. The following diagram shows the wiring scheme.

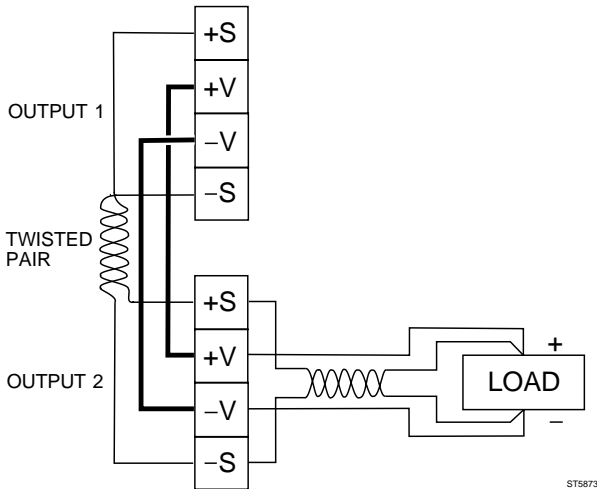

Figure 5.6.2 Remote Sensing with Two Outputs in Parallel

CAUTION: To prevent noise pickup, twist the sense wires and shield them from the environment.

5.6.2 Serial connection of output channels

Connecting output channels in series provides a greater voltage capability than can be obtained from a single output channel. In principle, you can put more than two output channels in series. However, there is the limitation that the total maximum voltage of each terminal may not exceed 240V with respect to the ground.

Output channels in serial configurations can operate in either Constant Voltage (CV) or in Constant Current (CC).

CV OPERATION

For CV operation all output channels must be in the CV mode. Program the current setting of all output channels to the desired current limit point. Then program the voltage setting of each output channel, so that the sum of all voltages equals the total desired operating voltage. The simplest way to accomplish this is to program each output channel to an equal part of the total desired operating voltage, e.g., three output channel settings of 25 V in series provide 75 V.

CC OPERATION

For CC operation the current setting of each output channel must be programmed to the desired operating current. The sum of the voltage settings determines the voltage limit points. As an example, consider two output channels in series (refer also to section 5.6.2.1). Program the voltage setting of both output channels to one half of the total voltage limit point. At load voltages $< 1/2$ of the total voltage limit point, one output channel will operate in the CC mode. At load voltages $> 1/2$ of the total voltage limit point, the output channel that was in the CC mode will change to the CV mode, while the other output channel will regulate the current in the CC mode and provide the balance of the voltage required by the load.

Note that the total voltage over the load is the sum of the individual readback output voltages, provided the load voltage $< 1/2$ of total voltage limit point.

WARNING: To guarantee the safe use of the power supply, the total maximum voltage at each terminal must not exceed 240V with respect to ground.

There are two ways of sensing the load when connecting output channels in series, i.e., local sensing and remote sensing.

Local sensing (outputs in series):

Connect the load wires to the +V terminal of output channel 1 and the -V terminal of output channel 2, and interconnect the -V terminal of output channel 1 and the +V terminal of output channel 2. Connecting the +S of output channel 2 to the -S of output channel 1, while removing the local sense jumper between +S and +V of output channel 2, will compensate for the voltage drop across the wires from output channel 2 to output channel 1. The following diagram shows the wiring scheme.

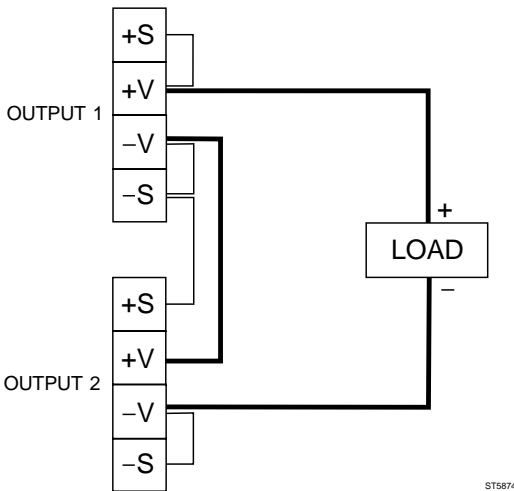

Figure 5.6.3 Local Sensing with Two Outputs in Series

5.6.3 Parallel connection of loads

If more than one load is connected to an output channel, use separate wires to connect each load. This minimizes mutual coupling effects and takes full advantage of the power supply's low output impedance. Each pair of wires should be as short as possible to reduce wire inductance and noise pickup. The loads must be connected in parallel, not in series, so that loads are not mutually influenced by load fluctuations.

It is advised to use a pair of DC distribution terminals (DT) not located at the output channel terminals.

Note: In principle, there is no restriction about the number of loads that can be connected. Remote voltage sensing is recommended if one load is more sensitive than the other(s); therefore, sense directly at the most sensitive load.

Local sensing (loads in parallel):

The following diagram shows the wiring scheme.

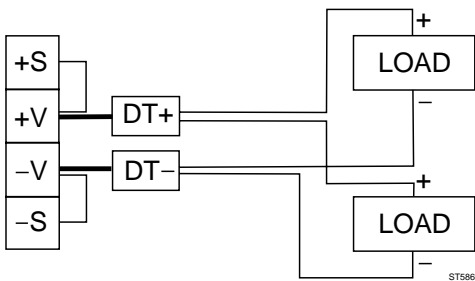

Figure 5.6.5 Local Sensing with Two Loads in Parallel

If local sensing is used, locate the distribution terminals (DT) as near as possible to the output channel terminals.

Remote sensing (loads in parallel):

The following diagram shows the wiring scheme.

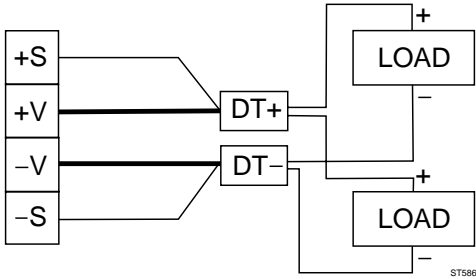

Figure 5.6.6 Remote Sensing with Two Loads in Parallel

If remote sensing is used, locate the distribution terminals (DT) as near as possible to the load terminals.

CAUTION: To prevent noise pickup, twist the sense wires and shield them from the environment.

5.6.4 Tips for Remote Sensing Applications

Prevent Output Noise

It is advised to twist or to shield the sense leads to minimize the pickup of environmental noise. If the sense leads are twisted, run them parallel and close to the load leads. In environments with heavy noise, it may be necessary to shield the sense leads. Connect the shield to ground at the power supply end only.

Prevent Instability

The impedance of the load leads together with the capacitance of the load can form a filter, which may cause a phase shift in the sense feedback loop. This can cause instability or even oscillations, which must be prevented. If there is doubt about the stability of the output, you can check this with an oscilloscope. There are no simple rules to prevent instability for all circumstances, but the following guidelines are valid most often:

1. Use short leads with low resistance for the load and the sense connections.
2. Twist the load leads together to minimize additional inductance.
3. Twist the sense leads together (or shield them) to minimize interference with the environment.
4. Keep the load capacitance as small as possible.

APPENDIX A ACCESSORIES

A.1 Supplied with the instrument

- Reference Manual English : 4822 872 00827
- Operation Manual English : 4822 872 00824, or
Operation Manual German : 4822 872 00825, or
Operation Manual French : 4822 872 00826
- Power Cord EURO : 5322 321 23297, or
Power Cord SWISS : 5322 321 10679, or
Power Cord UK : 5322 321 10681, or
Power Cord USA : 5322 321 10644
- Two spare fuses
- Two mounting brackets (not with PM2811)

A.2 Optional

The following accessories can be ordered via your local Fluke Sales and Service Center.

- 19" Rack mount (with other 19" units) : PM9280/03
- Service Manual PM2811/12/13 : 4822 872 85005
- Service manual PM2831/32 : 4822 872 85004
- Standard Commands for Programmable Instruments : 4822 872 80194

APPENDIX B

SCPI CONFORMANCE INFORMATION

This instrument complies to the SCPI standard version 1993.0. The following classes of commands and queries have been implemented:

B.1 IEEE 488.2-1987

- *CLS
- *ESE
- *ESE?
- *ESR?
- *IDN?
- *OPC
- *OPC?
- *PSC
- *PSC?
- *RCL
- *RST
- *SAV
- *SRE
- *SRE?
- *STB?
- *TRG
- *TST?
- *WAI

B.2 SCPI Std 1993.0 Confirmed

- :ABORT

- :CALIBRATION:STATE
- :CALIBRATION:STATE?
- :CALIBRATION:VALUE
- :CALIBRATION:AUTO

- :DISPLAY:ENABLE
- :DISPLAY:ENABLE?
- :DISPLAY:CONTRAST
- :DISPLAY:CONTRAST?

:DISPLAY:WINDOW:TEXT:DATA
:DISPLAY:WINDOW:TEXT:DATA?

:INITIATE:IMMEDIATE
:INITIATE:CONTINUOUS
:INITIATE:CONTINUOUS?

:INSTRUMENT:SELECT
:INSTRUMENT:SELECT?
:INSTRUMENT:NSELECT
:INSTRUMENT:NSELECT?
:INSTRUMENT:DEFINE
:INSTRUMENT:DEFINE?
:INSTRUMENT:DELETE:NAME
:INSTRUMENT:DELETE:ALL
:INSTRUMENT:CATALOG?
:INSTRUMENT:STATE
:INSTRUMENT:STATE?

:MEASURE:SCALAR:VOLTAGE:DC?
:MEASURE:SCALAR:CURRENT:DC?

:OUTPUT:STATE
:OUTPUT:STATE?
:OUTPUT:PROTECTION:TRIPPED?
:OUTPUT:PROTECTION:CLEAR

:SOURCE:CURRENT:LEVEL:IMMEDIATE:AMPLITUDE
:SOURCE:CURRENT:LEVEL:IMMEDIATE:AMPLITUDE?
:SOURCE:CURRENT:LIMIT:HIGH?
:SOURCE:CURRENT:LIMIT:LOW?
:SOURCE:CURRENT:PROTECTION:TRIPPED?
:SOURCE:CURRENT:PROTECTION:STATE
:SOURCE:CURRENT:PROTECTION:STATE?
:SOURCE:VOLTAGE:LEVEL:IMMEDIATE:AMPLITUDE
:SOURCE:VOLTAGE:LEVEL:IMMEDIATE:AMPLITUDE?
:SOURCE:VOLTAGE:LIMIT:HIGH?
:SOURCE:VOLTAGE:LIMIT:LOW?
:SOURCE:VOLTAGE:PROTECTION:LEVEL
:SOURCE:VOLTAGE:PROTECTION:LEVEL?
:SOURCE:VOLTAGE:PROTECTION:TRIPPED?
:SOURCE:POWER:LIMIT:HIGH?
:SOURCE:FUNCTION:MODE?

:SOURCE:LIST:VOLTAGE
:SOURCE:LIST:VOLTAGE:POINTS?
:SOURCE:LIST:CURRENT
:SOURCE:LIST:CURRENT:POINTS?
:SOURCE:LIST:GENERATION
:SOURCE:LIST:GENERATION?
:SOURCE:LIST:INDEX:NSELECT
:SOURCE:LIST:SEQUENCE:START
:SOURCE:LIST:SEQUENCE:STOP

:STATUS:OPERATION:EVENT?
:STATUS:OPERATION:CONDITION?
:STATUS:OPERATION:ENABLE
:STATUS:OPERATION:ENABLE?
:STATUS:OPERATION:PTRANSITION
:STATUS:OPERATION:PTRANSITION?
:STATUS:OPERATION:NTRANSITION
:STATUS:OPERATION:NTRANSITION?
:STATUS:OPERATION:INSTRUMENT:EVENT?
:STATUS:OPERATION:INSTRUMENT:CONDITION?
:STATUS:OPERATION:INSTRUMENT:ENABLE
:STATUS:OPERATION:INSTRUMENT:ENABLE?
:STATUS:OPERATION:INSTRUMENT:PTRANSITION
:STATUS:OPERATION:INSTRUMENT:PTRANSITION?
:STATUS:OPERATION:INSTRUMENT:NTRANSITION
:STATUS:OPERATION:INSTRUMENT:NTRANSITION?
:STATUS:OPERATION:INSTRUMENT:ISUMMARY:EVENT?
:STATUS:OPERATION:INSTRUMENT:ISUMMARY:CONDITION?
:STATUS:OPERATION:INSTRUMENT:ISUMMARY:ENABLE
:STATUS:OPERATION:INSTRUMENT:ISUMMARY:ENABLE?
:STATUS:OPERATION:INSTRUMENT:ISUMMARY:PTRANSITION
:STATUS:OPERATION:INSTRUMENT:ISUMMARY:PTRANSITION?
:STATUS:OPERATION:INSTRUMENT:ISUMMARY:NTRANSITION
:STATUS:OPERATION:INSTRUMENT:ISUMMARY:NTRANSITION?
:STATUS:PRESET
:STATUS:QUEUE:NEXT?
:STATUS:QUESTIONABLE:EVENT?
:STATUS:QUESTIONABLE:CONDITION?
:STATUS:QUESTIONABLE:ENABLE
:STATUS:QUESTIONABLE:ENABLE?
:STATUS:QUESTIONABLE:PTRANSITION
:STATUS:QUESTIONABLE:PTRANSITION?
:STATUS:QUESTIONABLE:NTRANSITION

:STATUS:QUESTIONABLE:NTRANSITION?
:STATUS:QUESTIONABLE:INSTRUMENT:EVENT?
:STATUS:QUESTIONABLE:INSTRUMENT:CONDITION?
:STATUS:QUESTIONABLE:INSTRUMENT:ENABLE
:STATUS:QUESTIONABLE:INSTRUMENT:ENABLE?
:STATUS:QUESTIONABLE:INSTRUMENT:PTRANSITION
:STATUS:QUESTIONABLE:INSTRUMENT:PTRANSITION?
:STATUS:QUESTIONABLE:INSTRUMENT:NTRANSITION
:STATUS:QUESTIONABLE:INSTRUMENT:NTRANSITION?
:STATUS:QUESTIONABLE:INSTRUMENT:ISUMMARY:EVENT?
:STATUS:QUESTIONABLE:INSTRUMENT:ISUMMARY:CONDITION?
:STATUS:QUESTIONABLE:INSTRUMENT:ISUMMARY:ENABLE
:STATUS:QUESTIONABLE:INSTRUMENT:ISUMMARY:ENABLE?
:STATUS:QUESTIONABLE:INSTRUMENT:ISUMMARY:PTRANSITION
:STATUS:QUESTIONABLE:INSTRUMENT:ISUMMARY:PTRANSITION?
:STATUS:QUESTIONABLE:INSTRUMENT:ISUMMARY:NTRANSITION
:STATUS:QUESTIONABLE:INSTRUMENT:ISUMMARY:NTRANSITION?

:SYSTEM:KLOCK
:SYSTEM:KLOCK?
:SYSTEM:ERROR?
:SYSTEM:SET
:SYSTEM:SET?
:SYSTEM:VERSION
:SYSTEM:VERSION?
:SYSTEM:VERSION 1990.0
:SYSTEM:VERSION 1993.0

B.3 SCPI approved

:SOURCE:CURRENT:LEVEL:IMMEDIATE:AMPLITUDE:AUTO
:SOURCE:CURRENT:LEVEL:IMMEDIATE:AMPLITUDE:AUTO?
:SOURCE:VOLTAGE:LEVEL:IMMEDIATE:AMPLITUDE:AUTO
:SOURCE:VOLTAGE:LEVEL:IMMEDIATE:AMPLITUDE:AUTO?

B.4 SCPI syntax and style

REMARK: It is advised that you use the :SYSTEM:VERSION command to control compatibility of the application program with respect to the SCPI implementation of the programmable power supply used. This is helpful for future SCPI compatibility.

:OUTPUT:PROTECTION:COUPLING:INSTRUMENT
:OUTPUT:PROTECTION:COUPLING:INSTRUMENT?
:OUTPUT:PROTECTION:COUPLING:STATE
:OUTPUT:PROTECTION:COUPLING:STATE?

:SOURCE:CURRENT:PROTECTION:DELAY
:SOURCE:CURRENT:PROTECTION:DELAY?
:SOURCE:LIST:INDEX:NSELECT
:SOURCE:LIST:INDEX:NSELECT?
:SOURCE:LIST:SEQUENCE:START
:SOURCE:LIST:SEQUENCE:START?
:SOURCE:LIST:SEQUENCE:STOP
:SOURCE:LIST:SEQUENCE:STOP?
:SOURCE:LIST:TIMER
:SOURCE:LIST:TIMER?
:SOURCE:LIST:SOURCE
:SOURCE:LIST:SOURCE?

:SYSTEM:UNPROTECT:STATE
:SYSTEM:UNPROTECT:STATE?
:SYSTEM:UNPROTECT:SELECT
:SYSTEM:UNPROTECT:SELECT?
:SYSTEM:UNPROTECT:PWD
:SYSTEM:POCLEAR
:SYSTEM:POCLEAR?
:SYSTEM:VERSION

:TEST:INSTRUMENT?
:TEST:SYSTEM?

APPENDIX C

ABBREVIATIONS, SYMBOLS & TERMS

C.1 Abbreviations

- ac = Alternating current
- ADDA = Analog/Digital - Digital/Analog
- AH = Acceptor Handshake
- AMPL = Amplitude
- ANSI = American National Standards Institute
- AUX = Auxilliary

- BNC = Bayonet Normal Connector

- CAL = Calibration
- CAT = Catalog
- CC = Constant Current
- CLE = Clear
- CLS = Clear screen or Clear status
- CISPR = Comité International Special des Pertubations
Radioélectriques
- COND = Condition
- CONF = Configuration or configure
- CONT = Contrast
- COUP = Coupling
- CP = Coupled Parameters
- CPU = Central Processor Unit
- CSA = Canadian Standards Association
- CURR = Current
- CV = Constant Voltage

- dc = Direct current
- DEF = Define or default
- DEL = Delete or delay
- DEN = Display enable
- DIAG = Diagnostics
- DIS(AB) = Disable
- DISP = Display
- DT = Device Trigger

- EMC = Electro Magnetic Compatibility
- EMI = Electro Magnetic Interference

- EMS = Electro Magnetic Susceptibility
- EN(AB) = Enable
- ERR = Error
- ESB = Event Summary Bit
- ESE = Event Status Enable
- ESR = Event Status Register
- EURO = European
- EVEN = Event
- EXT = External

- FL = Failure
- FLT = Fault
- FUNC = Function

- GEN = Generation
- GET = Group Execute Trigger
- GPIB = General Purpose Interface Bus

- IEC = International Electrotechnical Commission
- IEEE = Institute of Electrical and Electronic Engineers
- IDN = Identification
- IMM = Immediate
- IND = Index
- INIT = Initiate
- INST = Instrument
- INT = Internal
- I/O or IO = Input Output
- ISUM = Instrument summary

- KLOC = Keyboard lock

- LCD = Liquid Crystal Display
- LCL = Local
- LEV = Level
- LIM = Limit
- LRN = Learn
- LSB = Least Significant Bit
- LSD = Least Significant Digit

- MAV = Message available
- MAX = Maximum
- MEAS = Measure(ment)
- MIL = Military

- MIN = Minimum
- MOD = Mode
- MSB = Most Significant Bit
- MSD = Most Significant Digit
- MSS = Master Summary Status
- MTBF = Mean Time Between Failures
- MTTR = Mean Time To Repair

- NRF = Numeric forgiving
- NSEL = Numeric select
- NTR = Negative transition

- OC(P) = Overcurrent (Protection)
- OPC = Operation complete
- OPR = Operate
- OPER = Operation
- OPT = Option
- OUTP = Output
- OV(P) = Overvoltage (Protection)

- PARD = Periodic And Random Deviation
- PC = Personal Computer
- PMT = Program Message Terminator
- PON(C) = Power ON (Clear)
- POW = Power
- pp = peak to peak
- PPS = Programmable Power Supply
- PROT = Protection
- PS = Personal System
- PSC = Power on Status Clear
- PTR = Positive transition
- PWOR = Password

- QUES = Questionable

- RAM = Random Access Memory
- RCL = Recall
- REM = Remote
- RFI = Radio Frequency Interference
- rms = root mean square
- ROM = Read Only Memory
- RQS = Request Service
- RST = Reset

- S = Sense
- SAV = Save
- SCAL = Scalar
- SCPI = Standard Commands for Programmable Instruments
- SEL = Select
- SEQ = Sequence
- SRE = Service Request Enable
- SR(Q) = Service Request
- SOUR = Source
- STAT = State
- STB = Status byte
- STBY = Standby
- STP = Step
- SYST = System

- TC = Temperature Coefficient
- TRG = Trigger
- TRIP = Tripped
- TST = Test

- UK = United Kingdom
- UL = Underwriters Laboratories
- UNPR = Unprotect
- UNR = Unregulated
- USA = United States of America

- VAL = Value
- VDE = Verband Deutscher Elektrotechniker
- VERS = Version
- VOLT = Voltage

- WIND = Window

C.2 Glossary of symbols

- % = percentage
- * = beginning of a common command/query
- , = separation sign for commands/queries
- : = beginning of a subsystem command/query part
- ? = end of a query
- ° = degree (e.g. °C =degree Celsius)
- A = Ampere
- C = Celsius
- d = differentiate, e.g., di (derived current)
- ft = foot
- g = gravity (m/s^2)
- Hz = Hertz
- I = current
- K = Kelvin
- m = meter
- mA = milliampere
- ms = millisecond
- mV = millivolt
- MHz = Megahertz
- OC = Overcurrent
- OV = Overvoltage
- P = Power
- R = Resistance
- s = second
- t = time
- μ = micro, e.g., μs
- U = voltage
- V = Volt
- W = Watt
- Z = Impedance
- [...] = command/query part that may be omitted (default node)
- { ... } = command/query part that can be repeated
- | = sign to indicate a choice (... or ...)

C.3 Glossary of terms

AUTORANGING

A power supply is autoranging if it can supply the maximum rated power over the continuous range of voltage and current.

CALIBRATION MODE

In this mode the power supply can be adjusted to comply with external calibration standards.

DRIFT

The maximum change of the regulated output voltage or current during an 8-hour period (long term drift), following a 30-minute warm-up period (short term drift). All influence and control quantities must remain constant during these periods.

Drift includes both random and periodic deviations over the bandwidth from zero frequency (DC) to the upper frequency limit.

LOAD EFFECT (load regulation)

The load effect is the maximum change in the steady state of the regulated output voltage or current, resulting from a full load change in the load current of a CV supply or in the load voltage of a CC supply.

LOCAL MODE (opposite of the REMOTE mode)

In this mode the power supply can be operated locally via the keypad control keys.

LOCAL SENSING

The voltage is sensed directly at the power supply terminals. The power supply is shipped from the factory with local sensing.

OPERATE MODE (opposite of the STANDBY mode)

In this mode the power supply is able to deliver power.

PARD (ripple and noise)

Periodic And Random Deviation of the DC output voltage or current from its average value over a specified bandwidth. All influence and control quantities must remain constant.

PROGRAMMING ACCURACY

Maximum deviation between the programmed value and the actual output value (at calibration temperature $\pm 2^{\circ}\text{C}$).

PROGRAMMING RESOLUTION

Average programming step size. That is the smallest change that can be obtained either using the front panel keys or a controller.

PROGRAMMING RESPONSE TIME

The maximum time for the output to settle to a programmed value within a settling band, after having finished executing the settle command.

READBACK ACCURACY

Maximum error in the readback value of an output voltage or current (at calibration temperature $\pm 2^{\circ}\text{C}$).

REMOTE MODE (opposite of the LOCAL mode)

In this mode the power supply is programmed remotely from your PC via the GPIB.

REMOTE SENSING

A way of sensing in which a power supply monitors the voltage directly at the load via the extra sensing wires. The resulting circuit action compensates for the voltage drop in the wires to the load up to a maximum of 1 volt total.

SOURCE EFFECT (line regulation)

The maximum change in the steady state of the regulated output voltage or current, resulting from any change in the AC voltage source within the specified values.

STANDBY MODE (opposite of the OPERATE mode)

In this mode the power supply is operable, but the output channels are disabled (no power is supplied).

TEMPERATURE COEFFICIENT

The maximum change in the regulated output voltage or current per degree Celsius following a change in the ambient temperature after a 30 minute warm-up time.

APPENDIX D

APPLICATION FOR PM2812 AND PM2813

The following application support information is meant for the user who wants to extend the maximum current of the PM2812 or PM2813 Power Supply by parallel connection of channels.

PARALLEL CONNECTION OF OUTPUT CHANNELS

When you connect output channels in parallel to a load, be aware of the following:

The 'down programmer'

This is a circuit in the output channel that unloads the internal filter capacitors when the output voltage is set to a lower value, to achieve a short response time. The down programmer will have the same effect on (external) capacitive loads to shorten the response time. The down programmer will sink a fixed current (about 10% of the rated current) as long as the voltage on the channel output is higher than the programmed setting.

The down programmer will influence also the result of parallel connected channels when the channels are set to different voltages. The channel set to the lowest voltage will activate its down programmer, which will behave as a constant current load. This current is not shown by the display or by readback. Then the total current through the load is not equal to the total readback current of the channels.

Example:

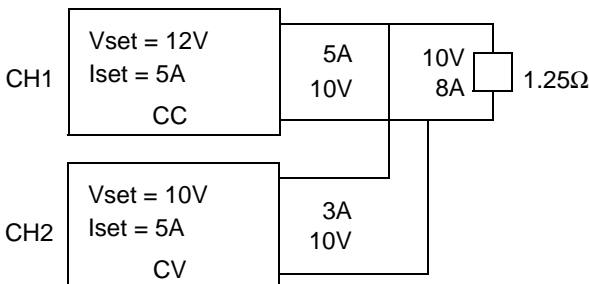

Figure D.1 Channels connected in parallel to a load. CH 1 in Constant Current mode, CH 2 in Constant Voltage mode.

This set-up will cause no problem as CH 1 supplies a constant current (CC) of 5A and CH 2 supplies the additional current needed in constant voltage mode (CV indicator).

A problem will arise when the current needed by the load decreases below 5A, for example when the load resistance increases. This is illustrated by figure D.2.

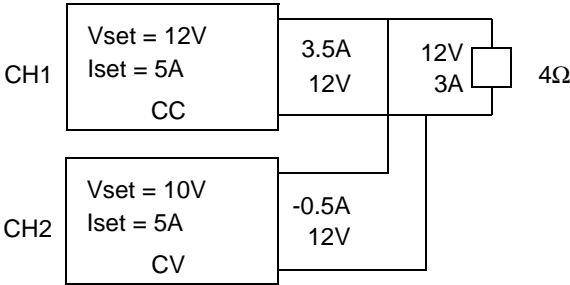

Figure D.2 Channels connected in parallel to a load. Both channels are in Constant Voltage mode.

CH 1 will now enter the Constant Voltage (CV) mode, as the current needed by the load is less than Iset (5A). This implies that the voltage across the load will change to the highest Vset (12V). As Vset of CH 2 is 10V, its down programmer will become active, so that CH 1 will supply 3A plus the current the down programmer of CH 2 will sink. So this set-up is not suitable for load currents, which can be lower than Iset of the Constant Current channel.

For this case there are two solutions. You can set the current of CH 1 to a value below 3A so that CH 1 will enter the Constant Current mode as indicated in Figure D.1. Or, you can set both channels to the same voltage, so that there will be a constant voltage across the load. When the voltages are exactly equal, the down programmer will not become active and the current through the load will be equal to the sum of the currents of the individual channels.

Be careful in using the Standby and Disable modes

Consider the following case. You have connected two channels in parallel. You don't need the second channel to supply current, because the first channel can supply enough current. You disable the second channel to switch it off. The down programmer of this channel will try to sink its output to 0V. As the first channel still supplies a voltage, the down programmer of the second channel will continuously sink current. This causes power dissipation inside the case, which must be prevented as the Power Supply is not designed for this use.

The same is valid for two parallel connected Power Supplies when one Power Supply is set to the Standby mode. The Standby mode, like the Disable mode, will try to sink all outputs to 0V. Then the down programmer can also become active when one Power Supply is still in Operate mode.

Use Coupled Protection for parallel connected channels

When one of the parallel connected channels is shut down by its protection circuit and the other channels are not, the shut down channel will activate its downprogrammer, trying to sink the output to 0V. This causes the same effect as disabling one channel while the others are still enabled.

To prevent this set COUPLE PROT ON for each channel via the AUX key. Disable Overcurrent Protection for the channels that are used in Constant Current mode.

Note: Coupled Protection is possible only for the channels in the same Power Supply.

General advise to program parallel connected channels

Try to prevent that the down programmer of a channel is continuously active. This causes unnecessary dissipation and will diminish the lifetime of the channel.

The best way to prevent the down programmer of a channel to become active is to use at maximum one channel in Constant Voltage mode and all other channels in Constant Current mode. Whether this is possible or not depends on the load requirements. We will handle the following cases:

Case 1: Constant Current.

Case 2: Constant Voltage, Output Current from a fixed minimum value to the maximum.

Case 3: Constant Voltage, Output Current from zero to the maximum.

For all cases it is assumed that there are two or more channels needed to be able to supply the maximum current.

Case 1: Constant Current

If a fixed current is needed, program the current setting of the channels to an equal part of the required current. Program all channels, except one, to the maximum voltage needed plus a small margin to make sure that these channels will stay in the Constant Current mode. Use the one channel to regulate the voltage across the load in the range from 0V to the maximum.

Case 2: Constant Voltage, Output Current from a fixed minimum value to the maximum

The following procedure is useful only if you have one channel that can cover the complete range from the minimum to the maximum and if the other channels together can supply the fixed minimum current.

Program the current setting of the latter channels to an equal part of the minimum value and use these channels in the Constant Current mode. Use the one channel in the Constant Voltage mode. To make sure that the other channels will not leave the Constant Current mode, set their voltage to a value that is a little higher than the Constant Voltage required. Program the current setting of the Constant Voltage channel to a value that is sufficient to supply the maximum additional current required.

If the minimum is 0A or if you don't have one channel that can cover the range from the minimum to the maximum, use the procedure given under Case 3.

Example:

Requirements:

- Load voltage 10V (constant).
- Load current 10A to 15A (variable).
- Protection: Over voltage 11V.
Over current 15A.

Available channel ratings:

- Three channels, all 60V/5A.

Suitable settings:

- Channel 1: Vset = 10.1V, Iset = 5A, OVPset = 11V
- Channel 2: Vset = 10.1V, Iset = 5A, OVPset = 11V
- Channel 3: Vset = 10.0V, Iset = 5A, OVPset = 11V

Set Coupled Protection ON via the AUX key. This will shut down all channels at once, when the protection circuit of any channel becomes active.

Disable Overcurrent Protection of channels 1 and 2 with the OCP EN/OCP DIS key.

Enable Overcurrent Protection of channel 3 with the OCP EN/OCP DIS key.

The channels 1 and 2 operate in the Constant Current mode, and Channel 3 in the Constant voltage mode.

This example will not work if the current through the load decreases below 10A. Then the current contribution of Channel 3 is reduced to 0A, and either Channel 1 or Channel 2 (or both) will enter the Constant Voltage mode (at 10.1V). As there are now at least two channels in Constant Voltage mode, the one with the lowest Vset (Channel 3) will activate its down programmer, sinking about 0.5A. If you are not quite certain about the minimum current required, you are advised to use the procedure given under case 3. Then you must adjust all channels exactly to 10V.

Case 3: Constant Voltage, Output Current from 0A to the maximum

This needs the most care to prevent a down programmer to become active, because all channels must be set exactly to the same voltage. This can best be done at low output currents. Do this as follows. Connect the channels in parallel. Connect a load that allows the required voltage and needs a small current, for example 1% of the required maximum current. Set all channels to the required Constant Voltage value and to an equal part of the required maximum current. If the voltages from all channels are exactly equal, then all channels will supply an equal part of the current. If a channel does not supply current (readback 0.00A), select this channel and use the -V+ button to carefully increase the voltage until the channel starts to supply current.

Check if the other channels still supply current. If not, you may have increased the voltage of one channel too much. If all channels supply current, disconnect the load and connect the real load.

INDEX

19-Inch Rackmount. A-1

A

Acceptance Test 3-9
Accessories A-1
ADDA Output Channel Test 3-9
Automatic Stepping. 2-8
Automatic Step Functions. 5-23
Autoranging C-6

C

CALibration 2-8
Calibration. 2-4
Calibration Mode. C-6
CAUTION 1-1
Channel
 Selecting an Output Channel 4-7
 Setting an Output Channel 4-12
Clear Status 2-6
Communication (D²B) Test 3-6
Constant Current 5-13
Constant Voltage 5-13
Cooling 3-2
Crossover Point 5-13
Current Settings 2-8
Current Sink Characteristics 5-9
Current
 Setting an Output Current 4-9
 Programming an Output Current. 4-14

D

Disabled 2-4
Display Controller Test 3-6
Display Indicators 4-6
Drift C-6

E

EMI Standards	2-14
Enabled	2-4
Environmental Aspects	2-14
External Step Functions	5-26

F

Family Overview	2-1
Fan	3-2
Fault Handling	5-2
Firmware Version	4-2
Fixed Load Resistance	5-15
Front Connection Option	2-1, 3-4
Front Panel	2-2
Front Panel Layout	4-3
Fuses	3-3

G

Getting Started	4-1
GPIB	2-6
GPIB Connections	3-6
GPIB Control	5-28
GPIB Controller Test	3-6
GPIB Device Address	4-2
GPIB (IEEE 488) Connector	2-2
GPIB Interface	2-14

I

Identify	2-6
IEEE 488.1 Standard	2-6
IEEE 488.2 Standard	2-6
Initial Inspection	3-1
Initialization	2-6
Installation Instruction	3-1
Instrument Identification	4-2
Interface Capabilities	5-7
Interface Check	3-11
Instability	5-36

L

Load Effect	C-6
Load Lead Resistance	5-10
Loads in Parallel	5-35, 5-36
Local Sensing	2-9, 5-10, 5-30, 5-33, C-6
Local Mode	C-6
Local Operation	2-1, 5-2
Local Lockout (LLO)	4-3

M

Manual Step Function	5-22
Microprocessor Timer Test	3-6
Multiple Loads	2-13

N

Noise Pickup	2-9, 2-11, 5-36
Nonvolatile Memory	5-4

O

Operate	2-4
Operate Mode	C-6
Output Adjustment	5-2
Output Channel Characteristics	5-37, 5-8
Output Control	5-2
Outputs in Parallel	5-30, 5-31
Outputs in Series	5-33, 5-34
Overcurrent Protection	
Disable Overcurrent Protection	4-11
Enable Overcurrent Protection	4-10
Reset Overcurrent Protection	4-11
Overvoltage	
Programming the Overvoltage Trip Level	4-9
Reset Overvoltage Protection	4-9

P

Parallel Connection of Loads	5-34
Parallel Connection of Output Channels	2-11, 5-29, D-1
PARD	C-6
Performance Verification	3-12
Power Inlet Module	3-4
Power on Status Clear	2-6

Power ON/OFF	3-4
Power Fuses	3-4
Programming Accuracy	C-6
Programming Response Time	C-7
Programming Resolution	C-7

R

RAM Test	3-6
Readback	2-8
Readback Accuracy	C-7
Ready	2-2, 3-6
Rear Panel	2-2
Remote Mode	C-7
Remote Operation	2-1, 5-3
Remote Sensing	2-9, 5-11, 5-31, 5-34, 5-36, C-7
Reprogramming delay	4-4
Reset	2-6
Reset Overcurrent Protection	4-11
Reset Overvoltage Protection	4-9
ROM Test	3-6

S

Safety	1-1
Safety Standards	2-14
SCPI Compatibility	2-7
SCPI Conformance Information	B-1
SCPI Subsystems	2-7
Self Test	2-4
Sense Modes	2-9
Serial Connection of Output Channels	2-11, 5-32
Service Manual	A-1
Service Request (SRQ)	2-6
SET Output	5-2
SMB Cable Set	A-1
SMB Connectors	2-2
Source Definitions	2-8
Source Effect	C-7
Stability	5-36
Standard Event status	2-6
Standby	2-4
Standby Mode	C-7
Start	2-2, 3-6
Status	2-8

Status Byte Register2-6
Status Handling2-6
Step	2-2, 3-6
Function5-22
Stopping2-8
Start up2-8
Store/recall Front Panel Settings2-6
Store/recall Function5-19
Switch3-4
Synchronization2-6
System Functions2-8

T

Temperature Coefficient	C-7
Test	2-6, 2-8, 3-6
Performance Verification3-13
Time interval4-4
Trigger2-6
Trigger Lines2-2
Trigger Bus Control5-27
Trigger Bus Connections3-6
Tutorial	
Local Operation4-8

V

Variable Load Resistance5-15
Verification	
Performance Verification3-12
Voltage	
Programming an Output Voltage4-9
Voltage drop due to Load Lead Resistance5-10
Voltage Settings2-8

W

WARNING1-1
-------------------	------