

PHILIPS

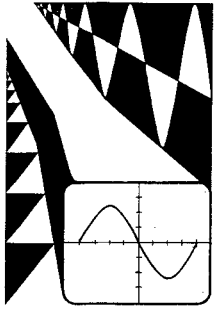

Dual-trace oscilloscope

PM3110/..

9452 031 10...

9499 440 14478

750228/07/07/09



PHILIPS

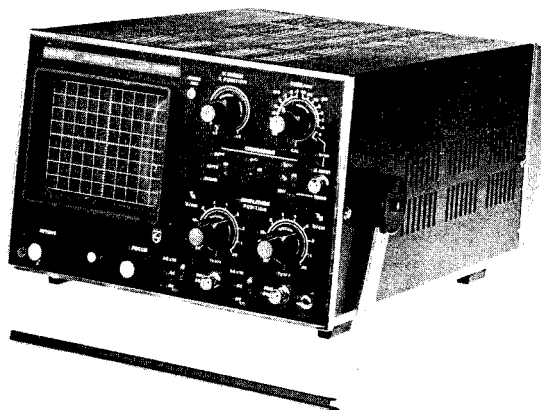

Instruction manual

Anleitung

Handleiding

Notice d'emploi et d'entretien

Dual-trace oscilloscope

Zweikanal-Oszillograf

Dubbelstraal-oscillograaf

Oscilloscope double trace

PM3110/--

9452 031 10...



IMPORTANT

In correspondence concerning this instrument, please quote the type number and serial number as given on the type plate at the bottom of the instrument.

WICHTIG

Bei Schriftwechsel über dieses Gerät wird gebeten, die genaue Typenbezeichnung und die Gerätenummer anzugeben. Diese befinden sich auf dem Leistungsschild an der Unterseite des Geräts.

BELANGRIJK

Vermeld bij correspondentie over dit apparaat steeds het typenummer en het serienummer. Deze nummers zijn aangegeven op het typeplaatje aan de onderzijde van het apparaat.

IMPORTANT**RECHANGE DES PIECES DETACHEES (Réparations)**

Dans votre correspondance et dans vos réclamations se rapportant à cet appareil, veuillez TOUJOURS indiquer le numéro de type et le numéro de série qui sont marqués sur la plaquette de caractéristiques fixée sur la plaque de fond de l'appareil.

Table of contents

ENGLISH

1.	GENERAL INFORMATION	11
1.1.	Introduction	11
1.2.	Technical data	12
1.3.	Accessories	14
1.3.1.	Standard accessories	14
1.3.2.	Optional accessories	14
1.4.	Description of the blockdiagram	14
1.4.1.	Cathode-ray tube	14
1.4.2.	Y-Amplifier: Unit 1A, Unit 1B and Unit 2	14
1.4.3.	X-Channel: Unit 3 and Unit 3A	15
1.4.4.	Z Control (blanking) stage	15
1.4.5.	Square-wave generator	15
1.4.6.	Power supply and d.c. converter	15
2.	DIRECTIONS FOR USE	16
2.1.	Installation	16
2.1.1.	Operating positions	16
2.1.2.	Adjusting to the local mains voltage	16
2.1.3.	Earthing	16
2.2.	Controls and sockets	17
2.3.	Operation	18
2.3.3.	Preliminary settings	18
2.3.2.	Channel selector Y _{A(B)} -OFF	18
2.3.3.	Input coupling	18
2.3.4.	Triggering	18
2.3.5.	Y-Deflection	18
2.3.6.	X-Deflection	19
3.	SERVICE DATA	57

List of figures

1. Front view	11
2. Handle used as tilting bracket	16
3. Adjusting to the local mains voltage	16
4. Controls and sockets	17
5. Block diagram	51
6. Equivalent circuit of the Y preamplifiers and the channel switch	60
7. Equivalent circuit of the Y output amplifier	60
8. Working of Schmitt trigger 305-306	62
9. Removing the knobs	65
10. Adjusting elements on Unit 3	66
11. Adjusting elements on Units 1A, 1B and 2	66
12. Adjusting elements on Unit 4	67
13. Input RC standardizer	71
14. Adapter PM 9051	74
15. Viewing hood	74
16. Multi-purpose camera PM 9380	75
17. Camera adapter PM 9377	75
18. Attenuator probe set PM 9326 (PM 9327)	76
19. Adjusting the attenuator probe	77
20. Attenuator probe set PM 9336 (PM 9336L)	78
21. Probe compensation	79
22. Probe set PM 9335	80
23. Probe clips PM 9333	81
24. Front view showing item numbers	84
25. Top view showing item numbers	84
26. Left-hand side view showing item numbers	84
27. Bottom view showing item numbers	84
28. Lay-out of the mains transformer for versions /06 and onwards	94
29. Printed-wiring board, unit 1A (B)	95
30. Printed-wiring board, unit 2	95
31. Printed-wiring board, unit 3	96
32. Printed-wiring board, unit 4	96
33. Circuit diagram	99

Inhaltsverzeichnis

DEUTSCH

1.	ALLGEMEINES	21
1.1.	Einleitung	21
1.2.	Technische Daten	22
1.3.	Zubehör	24
1.3.1.	Normalzubehör	24
1.3.2.	Zusätzlich lieferbares Zubehör	24
1.4.	Beschreibung des Blockschaltbilds	24
1.4.1.	Sichtteil	24
1.4.2.	Y-Kanal	24
1.4.3.	X-Kanal	25
1.4.4.	Z-Steuerung	25
1.4.5.	Rechteckgenerator	25
1.4.6.	Netzteil und Gleichspannungswandler	25
2.	GEBRAUCHSANLEITUNG	26
2.1.	Vorbereitungen für Inbetriebnahme	26
2.1.1.	Aufstellung	26
2.1.2.	Einstellen auf die örtliche Netzspannung	26
2.1.3.	Erdung	26
2.2.	Anschlüsse und Bedienungselemente	27
2.3.	Bedienung	28
2.3.1.	Vorbereitende Einstellungen	28
2.3.2.	Kanalschalter $Y_{A(B)}$ -OFF	28
2.3.3.	Eingangskopplung	28
2.3.4.	Triggerung	28
2.3.5.	Y-Ablenkung	28
2.3.6.	X-Ablenkung	29
3.	SERVICEANLEITUNG (Nur auf englisch)	57

Bildverzeichnis

1. Frontansicht	21
2. Anwendung des Traggriffs	26
3. Beschaltung des Netztrafos für verschiedene Netzspannungen	26
4. Anschlüsse und Bedienungselemente	27
5. Blockschaltbild	51
6. Grundprinzip des Y-Vorverstärkers und Kanalschalters	60
7. Grundprinzip des Y-Endverstärkers	60
8. Umschaltswelle des Schmitt-Triggers 305, 306	62
9. Abnehmen der Knöpfe	65
10. Abgleichelemente auf Unit 3	66
11. Abgleichelemente auf Unit 1A (B), Unit 2	66
12. Abgleichelemente auf Unit 4	67
13. RC-Eingangsnormale	74
14. Adapter PM 9051	74
15. Faltbare Nebenlichtmaske	74
16. Mehrzweck-Registrierkamera PM 9380	75
17. Adapter PM 9377	75
18. Messkopfsatz (PM 9326, PM 9327)	76
19. Messkopfabgleich	77
20. Messkopfsatz (PM 9336, PM 9336L)	78
21. Messkopfabgleich	79
22. 1:1 Messkopfsatz (PM 9335)	80
23. Miniaturmesskopfpinzetten (PM 9333)	81
24. Frontansicht mit Angabe der mechanischen Ersatzteile	84
25. Ansicht von oben mit Angabe der mechanischen Ersatzteile	84
26. Ansicht von links mit Angabe der mechanischen Ersatzteile	84
27. Ansicht von unten mit Angabe der mechanischen Ersatzteile	84
28. Schaltbild Netztransformator für Ausführungen /06 und folgende	94
29. Printplatte Unit 1A (B)	95
30. Printplatte Unit 2	95
31. Printplatte Unit 3	96
32. Printplatte Unit 4	96
33. Gesamtschaltbild	99

Inhoud

NEDERLANDS

1.	ALGEMEEN	31
1.1.	Inleiding	31
1.2.	Technische gegevens	32
1.3.	Accessoires	34
1.3.1.	Meegeleverde accessoires	34
1.3.2.	Op bestelling leverbare accessoires	34
1.4.	Beschrijving van het blokschema	34
1.4.1.	Elektronenstraalbuis	34
1.4.2.	Vertikale versterker: Unit 1A, Unit 1B en Unit 2	34
1.4.3.	Horizontale versterker: Unit 3 en Unit 3A	35
1.4.4.	Z-modulatie (donkerstuurtrap)	35
1.4.5.	Rechthoekgenerator	35
1.4.6.	Voedingsgedeelte en gelijkspanningsomvormer	35
2.	GEBRUIKSAANWIJZING	36
2.1.	Vorbereidingen voor inbedrijfstelling	36
2.1.1.	Opstelling van het instrument	36
2.1.2.	Instellen op de plaatselijke netspanning	36
2.1.3.	Aarding	36
2.2.	Aansluitingen en bedieningsorganen	37
2.3.	Bediening	38
2.3.1.	Vorbereidende instellingen	38
2.3.2.	Schakelaar Y_A (B)-OFF	38
2.3.3.	Ingangsschakeling	38
2.3.4.	Triggeren	38
2.3.5.	Vertikale afbuiging	39
2.3.6.	Horizontale afbuiging	39
3.	SERVICE GEGEVENS (Alleen in engelse taal)	57

Lijst van figuren

1. Vooraanzicht	31
2. Handgreep als draagsteun	36
3. Aansluitpaneel van de nettransformator voor verschillende netspanningen	36
4. Bedieningsorganen	37
5. Blokschema	51
6. Basisprincipe van de Y-voorversterkers en de kanaalschakelaar	60
7. Basisprincipe van de Y-eindversterker	60
8. Werking Schmitt-trigger TS305, TS306	62
9. Verwijderen van de knoppen	65
10. Afregelorganen op Unit 3	66
11. Afregelorganen op Unit 1A (B) en Unit 2	66
12. Afregelorganen op Unit 4	67
13. Ingangs-RCnormaal	71
14. Aanpassteker PM 9051	74
15. Kijkkoker	74
16. Universele oscillografen-camera	75
17. Aanpasstuk PM 9377	75
18. Meetkopsets PM 9326 en PM 9327	76
19. Afregeling verzwakker-meetkop	77
20. Meetkopsets PM 9336 en PM 9336L	78
21. Afregeling meetkop	79
22. Meetkopset PM 9335	80
23. PM 9333 meetkopklemmen	81
24. Vooraanzicht met verwijzing voor onderdelen	84
25. Bovenaanzicht met verwijzing voor onderdelen	84
26. Linker-zijaanzicht met verwijzing voor onderdelen	84
27. Onderaanzicht met verwijzing voor onderdelen	84
28. Nettransformator voor uitvoeringen /06 en volgende	94
29. Printplaat unit 1A (B)	95
30. Printplaat unit 2	95
31. Printplaat unit 3	96
32. Printplaat unit 4	96
33. Principeschema (totaal) van de PM 3110	99

Table des matières

FRANCAIS

1.	GENERALITES	41
1.1.	Introduction	41
1.2.	Caractéristiques techniques	42
1.3.	Liste des accessoires	44
1.3.1.	Accessoires standard	44
1.3.2.	Accessoires supplémentaires	44
1.4.	Description du schéma synoptique	44
1.4.1.	Tube à rayons cathodiques	44
1.4.2.	Amplificateur vertical: Unit 1A, Unit 1B et Unit 2	44
1.4.3.	Amplificateur horizontal: Unit 3 et Unit 3A	45
1.4.4.	Modulation Z (étage de suppression de faisceau)	45
1.4.5.	Générateur d'impulsions rectangulaires	45
1.4.6.	Alimentation secteur et convertisseur en continu	45
2.	MODE D'EMPLOI	46
2.1.	Préparation à la mise en service	46
2.1.1.	Installation	46
2.1.2.	Adaptation au réseau local	46
2.1.3.	Mise à la terre	46
2.2.	Raccordements et éléments de commande	47
2.3.	Commande	48
2.3.1.	Réglages préliminaires	48
2.3.2.	Sélecteur $Y_{A(B)}$ -OFF	48
2.3.3.	Circuit d'entrée	48
2.3.4.	Déclenchement	48
2.3.5.	Déviation verticale	49
2.3.6.	Déviation horizontale	49
3.	DOCUMENTATION DE SERVICE (Seulement en anglais)	57

Figures

1. Vue avant	41
2. Poignée en tant qu'étrier-support	46
3. Composition du transformateur secteur pour différentes tensions	46
4. Organes de commande	47
5. Schéma synoptique	51
6. Principe de base pour pré-amplificateur Y et sélecteur de canaux	60
7. Principe de base pour amplificateur de sortie Y	60
8. Fonctionnement du déclencheur de Schmitt TS305, TS306	62
9. Retrait des boutons	65
10. Organes de réglage sur Unit 3	66
11. Organes de réglage sur Unit 1A(B) et Unit 2	66
12. Organes de réglage sur Unit 4	67
13. Entrée étalon RC	71
14. Adaptateur PM 9051	74
15. Pare-lumière	74
16. Appareil de photographie d'oscillogrammes	75
17. Adaptateur PM 9377	75
18. Jeu de sondes PM 9326 (PM 9327)	76
19. Réglage de la sonde atténuatrice	77
20. Jeux de sondes PM 9336 et PM 9336L	78
21. Réglage de sonde atténuatrice	79
22. Jeu de sonde PM 9335	80
23. PM 9333 Pincettes miniatures	81
24. Vue avant avec numéros de repère	84
25. Vue du dessus avec numéros de repère	84
26. Vue de gauche avec numéros de repère	84
27. Vue du dessous avec numéros de repère	84
8. Schéma transformateur secteur pour versions /06 et suivantes	94
9. Platine imprimée unit 1A (B)	95
10. Platine imprimée unit 2	95
31. Platine imprimée unit 3	96
32. Platine imprimée unit 4	96
33. Schéma général de principe	99

1. General information

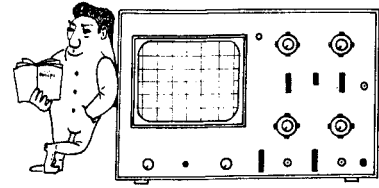

1.1. INTRODUCTION

The dual-trace oscilloscope PM 3110 is, on account of its ease of operation, particularly suitable for radio and television service and for educational and training purposes.

The instrument comprises a large cathode-ray tube with a useful screen area of 8 x 10 cm.

With the exception of the input stages of the two identical Y preamplifiers, the instrument is completely transistorized.

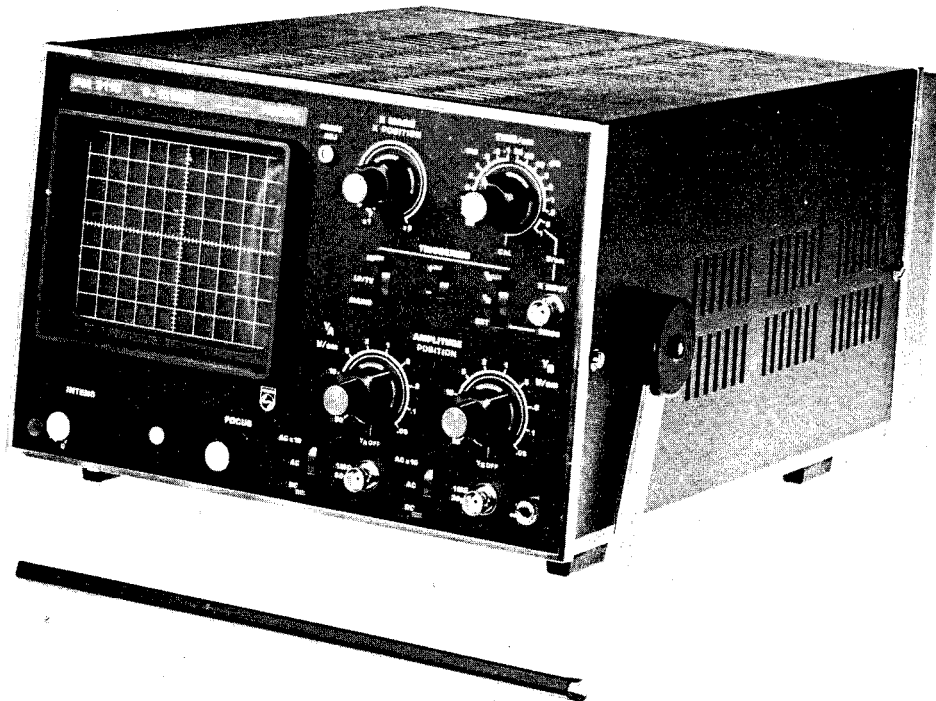

Fig. 1. Front view

1.2. TECHNICAL DATA

Properties expressed in numerical values with tolerances stated are guaranteed by the manufacturer. Numerical values without tolerances are typical values and merely serve as a guide.

Cathode-ray tube

Type	D13 - 480 GH
Screen diameter	13 cm
Useful screen area	8 x 10 cm
Accelerating voltage	-2 kV
Controls	focus, intensity

Y-Amplifier

(These data apply to both channel Y_A and channel Y_B)

Connector	B.N.C.	
Deflection coefficient		
– in positions AC and DC	50 mV/cm to 50 V/cm	} 10 steps in 1-2-5 sequence
– in position ACx10	5 mV/cm to 5 V/cm	
Frequency range (reference trace height 6 cm)		
– in position DC	0 Hz to 10 MHz (-3 dB)	
– in position AC	2 Hz to 10 MHz (-3 dB)	
– in position ACx10	3 Hz to 5 MHz (-3 dB)	
Rise time		
– in position AC and DC	35 ns	
– in position ACx10	70 ns	
Frequency response of trace height	> 8 cm up to 7 MHz	
Magnification		
– linear range	24 cm	
– frequency limit for undistorted display of a sine-wave signal at 24 cm	1 MHz	
Positioning range	> 18 cm	
Linearity error as defined in DIN 43740 *)	< 1 %	
Total measuring error	< 5 % at nominal mains voltage within the temperature range +5 °C to +35 °C	
Input impedance	1 M Ω //30 pF	
Max. permissible input voltage	500 V (d.c. + a.c. peak)	
Operating modes		
Channel Y_A only	Y_B POSITION set to Y_B OFF	
Channel Y_B only	Y_A POSITION set to Y_A OFF	
Channel Y_A and channel Y_B (electronically switched)	Simultaneous display of both channels in chopped or alternated mode as dictated by position of TIME/cm switch: chopped : in pos. 50 to 0.2 ms alternated: in pos. 0.1 ms to 0.5 μ s	
Frequency of the electronic switch	200 kHz	

*) DIN 43740 describes the linearity error as the deviation of the deflection coefficient at 75 % deflection from that at 25 % deflection, expressed as a percentage of the latter and measured in the straight part of the frequency-response curve and from the centre of the screen.

X-Amplifier

Connector	B.N.C.
Deflection coefficient	1 V/cm or 5 V/cm, set by means of TIME/cm switch
Magnification	1x to 5x, continuous control
Frequency range (reference trace width 8 cm)	3 Hz to 1 MHz (-3 dB)
Total error	< 10 %
Input impedance	100 k Ω at 1 V/cm 500 k Ω at 5 V/cm
Max. permissible input voltage	250 V (d.c. + a.c. peak)

Time-base generator

Time coefficient	16 calibrated steps from 0.5 μ s/cm to 50 ms/cm in 1-2-5 sequence A vernier provides uncalibrated, continuous control between the steps (1 : > 2.5)
Error	< 5 % at nominal mains voltage within the temperature range +5 $^{\circ}$ C to +35 $^{\circ}$ C
Linearity error as defined in DIN 43740 *)	< 1 %
Magnification	1x to 5x, continuous control
Positioning range	\pm 5 cm x magnification factor

Triggering

Triggering system	automatic																
External trigger input socket	B.N.C.																
Trigger source	Y _A , Y _B , external																
Polarity	positive and negative (referred to signal peaks)																
Trigger mode																	
HF	normal (triggering by signal peaks)																
LF-TV	triggering by line or frame sync pulses as dictated by the position of the TIME/cm switch: frame: in pos. 50 to 0.2 ms/cm line : in pos. 0.1 ms to 0.5 μ s/cm																
MAINS	triggering by signal with mains frequency and fixed polarity																
Trigger sensitivity																	
	<table style="width: 100%; border-collapse: collapse;"> <thead> <tr> <th style="border-bottom: 1px solid black; width: 33%;"></th> <th style="border-bottom: 1px solid black; width: 33%; text-align: center;">2 Hz</th> <th style="border-bottom: 1px solid black; width: 33%; text-align: center;">100 Hz - 2 MHz</th> <th style="border-bottom: 1px solid black; width: 33%; text-align: center;">10 MHz</th> </tr> </thead> <tbody> <tr> <td>sine wave, internal</td> <td style="text-align: center;">< 2 cm</td> <td style="text-align: center;">< 1 cm</td> <td style="text-align: center;">< 4 cm</td> </tr> <tr> <td>sine wave, external</td> <td style="text-align: center;">< 3 V_{p-p}</td> <td style="text-align: center;">< 1.5 V_{p-p}</td> <td style="text-align: center;">< 3 V_{p-p}</td> </tr> <tr> <td>t.v. signal, internal sync level</td> <td></td> <td style="text-align: center;">< 1 cm</td> <td></td> </tr> </tbody> </table>		2 Hz	100 Hz - 2 MHz	10 MHz	sine wave, internal	< 2 cm	< 1 cm	< 4 cm	sine wave, external	< 3 V _{p-p}	< 1.5 V _{p-p}	< 3 V _{p-p}	t.v. signal, internal sync level		< 1 cm	
	2 Hz	100 Hz - 2 MHz	10 MHz														
sine wave, internal	< 2 cm	< 1 cm	< 4 cm														
sine wave, external	< 3 V _{p-p}	< 1.5 V _{p-p}	< 3 V _{p-p}														
t.v. signal, internal sync level		< 1 cm															
Input impedance for external triggering	100 k Ω																
Max. permissible input voltage	250 V (d.c. + a.c. peak)																

Probe adjustment voltage

PROBE ADJ. output terminal	contact point
Calibration voltage	square-wave voltage of 5 V _{p-p}
Frequency	2.2 kHz

Power supply

Mains voltage	110 V, 128 V, 202 V, 220 V, 238 V
---------------	-----------------------------------

Mains voltage tolerance	+10 %, -15 %
Mains frequency	50 to 60 Hz
Power consumption	47 VA
Ambient temperature	
Reference temperature	+23 °C
Rated range of use	+5 °C to +35 °C
Limit range of operation	-10 °C to +45 °C
Storage and transport conditions	-25 °C to +70 °C

Dimensions

Width	305 mm (overall)
Height	195 mm
Depth	455 mm
Weight	8.5 kg

} (without handle)

1.3. ACCESSORIES**1.3.1. Standard accessories**

A manual

1.3.2. Optional accessories

- B.N.C. - 4 mm adapter	PM 9051
- Passive probe set with 1.15 m cable	PM 9326
- Passive probe set with 2 m cable	PM 9327
- Passive probe set with 1.5 m cable	PM 9336
- Passive probe set with 2.5 m cable	PM 9336L
- Passive probe set (1:1)	PM 9335
- Set of miniature probe clips	PM 9333
- Viewing hood	PM 9366
- Multi-purpose recording camera	PM 9380
- Camera adapter	PM 9377
- Supplementary lens	PM 9373

See also chapter 3.7. "INFORMATION CONCERNING ACCESSORIES"

1.4. DESCRIPTION OF THE BLOCK DIAGRAM (Fig. 5, page 51)**1.4.1. Cathode-ray tube**

The c.r.t. operates with an accelerating voltage of -2 kV. The trace intensity and definition can be adjusted by means of the INTENS. and FOCUS controls.

The INTENS. control incorporates the o/~ mains switch.

1.4.2. Y-Amplifier: Unit 1A, Unit 1B and Unit 2

The oscilloscope has been provided with two identical channels Y_A and Y_B , each comprising the following parts:

- ACx10/AC/DC switch
- Y-AMPLITUDE attenuator with ten calibrated steps
- Impedance transformer (cathode follower)
- Preamplifier. In position ACx10 of the ACx10/AC/DC switch, the sensitivity is increased by a factor 10.

The Y POSITION control allows vertical shifting of the trace; in position Y OFF of this switch, the relevant channel is switched off.

- Channel selector driven by a flip-flop
- Flip-flop, set by the Y_A OFF and Y_B OFF switches and, via the blanking stage, triggered by an astable multivibrator (chopped mode) or the time-base generator (alternated mode).
- Y Final amplifier which amplifies the signal and supplies the deflection voltage for the c.r.t.
- Trigger pick-off stage supplying a signal for internal triggering of the time-base generator

1.4.3. X Channel: Unit 3 and Unit 3A

The time-base generator in the X channel can be triggered with either an external signal or an internal signal obtained from either Y channel.

Bypassing the trigger and time-base circuits allows the X channel to be used as an amplifier for external X deflection signals.

The X channel comprises the following circuits:

- X and trigger preamplifier; in the positions TIME/cm of switch 801 it acts as a trigger-pulse amplifier and in the positions V/cm as preamplifier for external X deflection signals.
The input amplifier has been provided with a +/– polarity switch (803) which enables triggering on the positive- and negative-going edge of the signal.
- $Y_A/Y_B/EXT$ switch to select the trigger source.
- Attenuator allowing the external X deflection signal to be attenuated in two steps
- Peak detector/sync separator which keeps the triggering point at the peaks of the triggering signal.
Three trigger modes can be selected by means of switch 802;
 - HF : triggering by the signal peaks
 - LF-TV: triggering by line or frame sync pulses of a television signal
 - MAINS: triggering by a signal with the mains frequency
- Trigger-pulse shaper supplying pulses with steep edges. The negative-going edges of these pulses start the time-base generator whereas the positive-going ones drive the auto circuit.
- Time-base generator of the constant-current integrator type, comprising the charge capacitors and resistors.
The time coefficients can be selected in twelve steps by means of the TIME/cm switch. Continuous control is possible with TIME/cm potentiometer 609.
- Hold-off circuit which ensures that the time-base generator cannot be started before the flyback is terminated.
- Auto circuit which makes the time-base generator free-running when no trigger pulses are applied.
- X Final amplifier which amplifies the internal sawtooth voltage or the external X deflection voltage before it is applied to the horizontal deflection plates. This stage also contains the horizontal shift control (X POSITION) and the magnification control (X MAGN).

1.4.4. Z Control (blanking) stage

This circuit provides blanking of the c.r.t. during the flyback of the time-base voltage and during the switching time in the chopped mode.

Moreover, this circuit combines the automatic switching signals of the chopper multivibrator and the time-base generator in such a way as to give alternated operation in the positions up to 0.1 ms of the TIME/cm switch, and chopped operation in positions from 0.2 ms onwards.

With external X deflection the instrument also operates in the chopped mode.

1.4.5. Square-wave generator

The square-wave generator supplies a calibration voltage to the PROBE ADJ. contact point. With the aid of this voltage, the square-wave response of an attenuator probe can be optimised.

1.4.6. Power supply and d.c. converter

The power supply provides the d.c. supply voltages and a signal for MAINS triggering. The stabilised d.c. converter supplies the accelerating voltage for the c.r.t.

2. Directions for use

2.1. INSTALLATION

2.1.1. Operating positions

The oscilloscope can be used in any position, provided the air vents in the cabinet are not obstructed. For use in a vertical position, the instrument can be stood on its cable compartment.

The handle can be used as a tilting bracket to operate the instrument in a sloping position. The handle can be folded back over the top of the oscilloscope, after pulling both arm sideways in accordance with Fig. 2.

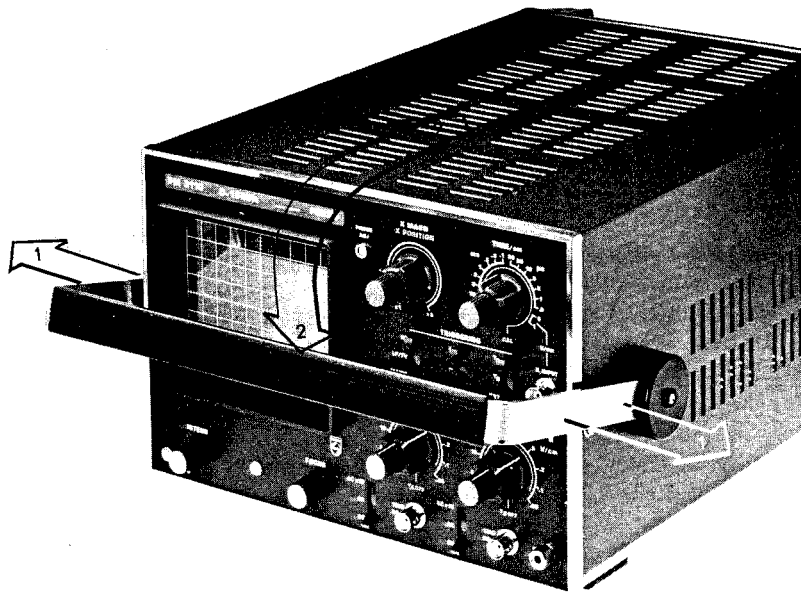
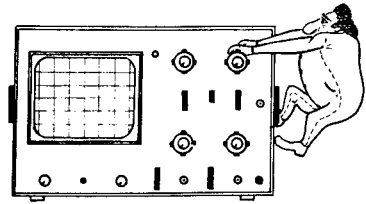

Fig. 2. Handle used as tilting bracket

2.1.2. Adjusting to the local mains voltage

The instrument must be connected to an a.c. mains only. Upon delivery the instrument is adjusted for connection to a 220 V mains.

For operation with mains voltage of 110 V, 128 V, 202 V and 238 V, the mains transformer connections must be appropriately changed:

- remove both screws at either side of the instrument and lift off the cabinet.
- make the relevant connections as shown in Fig. 3.

2.1.3. Earthing

The instrument should be connected to a protective earth in accordance with the local safety regulations. When the instrument is connected to a mains socket with rim-earth contacts, the cabinet is connected to earth via the three-core mains cable. The outer contacts (bushes) of the Y_A , Y_B and X INPUT connectors and earth terminal \perp are in electric contact with the cabinet. Earth terminal \perp can be used as measuring earth.

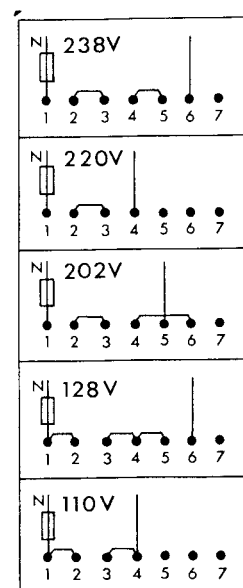

MA 8521

Fig. 3. Adjusting to the local mains voltage

2.2. CONTROLS AND SOCKETS (Fig. 4)

Item	Designation	Function
603	INTENS o/~	Trace intensity control incorporating mains switch
870		Mains voltage indicator
604	FOCUS	Trace definition control
851	PROBE ADJ.	Test point for passive probes
601a	X MAGN.	Magnification control for the X deflection
601b	X POSITION	Horizontal shift control
801	TIME/cm - V/cm	Time coefficient selector incorporating X attenuator
609	TIME/cm CAL.	Vernier control of the time coefficient. The time coefficients are calibrated when this control is in position CAL.
802	HF/LF-TV/MAINS	Trigger mode selector
803	+/-	Trigger polarity switch
804	Y _A /Y _B /EXT.	Trigger source selector
852	X INPUT/TRIGG.	Input for external X or trigger signal
805a	Y _A AMPLITUDE	Step attenuator in channel Y _A
602a	Y _A POSITION Y _A OFF	Vertical positioning control for Y _A trace, incorporating switch to make channel Y _A inoperative
805b	Y _B AMPLITUDE	Step attenuator in channel Y _B
602b	Y _B POSITION Y _B OFF	Vertical positioning control for Y _B trace, incorporating switch to make channel Y _B inoperative
806a	ACx10/AC/DC	Selector for a.c. or d.c. coupling in channel Y _A
806b	ACx10/AC/DC	Selector for a.c. or d.c. coupling in channel Y _B
853	1 MΩ/30 pF	Input socket for channel Y _A
854	1 MΩ/30 pF	Input socket for channel Y _B
855	⊥	Measuring earth terminal

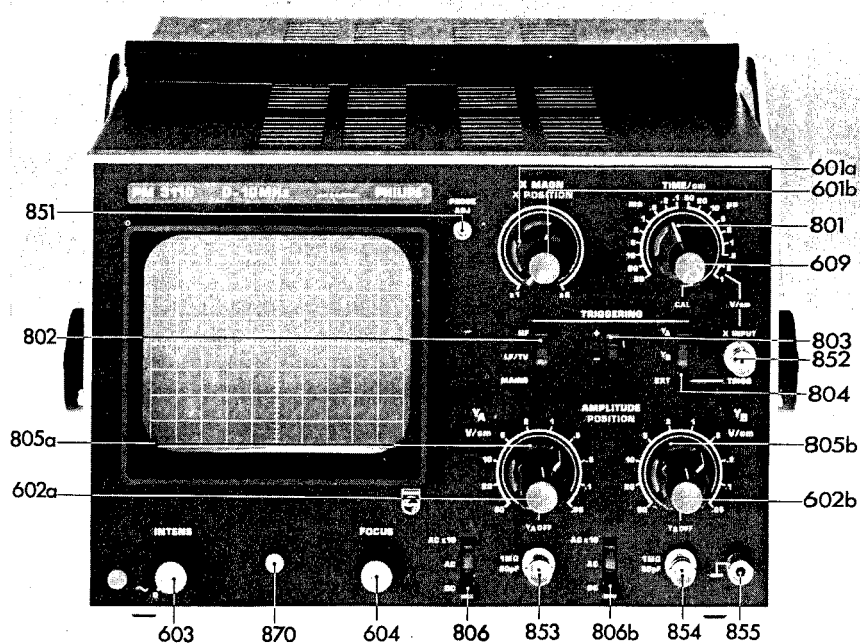

Fig. 4. Controls and sockets

2.3. OPERATION

2.3.1. Preliminary settings

- Connect the instrument to the mains
- Set the controls X POSITION 601b, Y_A POSITION 602a and Y_B POSITION 602b to their mid-positions
- Turn X MAGN. control 601a fully anti-clockwise (position x1)
- Turn TIME/cm vernier control (609) fully clockwise (position CAL)
- Set TIME/cm switch 801 for any time coefficient
- Set HF/LF-TV/MAINS switch 802 to HF
- Set Y_A/Y_B/EXT. switch 804 to either Y_A or Y_B
- Switch on the instrument and set INTENS. control 603 to its mid-position; the traces become visible after approximately 15 seconds.
Lamp 807 indicates that the instrument is switched on.
- Set INTENS. control 603 for an average brightness of the trace
- Set FOCUS control 604 for maximum definition

2.3.2. Channel selector Y_A(B)-OFF

If Y_A (Y_B) POSITION control 602a (602b) is switched to Y_A OFF (Y_B OFF), channel Y_A (Y_B) is inoperative. If neither control is in the OFF position, the instrument operates as a dual-trace oscilloscope.

2.3.3. Input coupling

If ACx10/AC/DC switch 806a (806b) is in position ACx10 or AC, the d.c. component of the input signal is blocked. This is necessary when the a.c. component to be tested is small compared to the d.c. component.

2.3.4. Triggering

Owing to a trigger auto-circuit, the time-base generator is free-running in the absence of a triggering signal so that the trace remains visible on the screen.

The time-base generator may be triggered by the following signal sources:

- either channel Y_A or channel Y_B; therefore, the Y_A/Y_B/EXT. switch 804 must be set accordingly and HF/LF-TV/MAINS switch 802 to either HF or LF-TV
- external signal applied to X INPUT/TRIGG. socket 852; Y_A/Y_B/EXT. switch 804 must be set to EXT. and HF/LF-TV/MAINS switch 802 to HF or LF-TV
- internal signal with the mains frequency; HF/LF-TV/MAINS switch 802 must be set to MAINS.

The trigger polarity is selected with the aid of +/- switch 803. In position +, the time-base generator is started just before the positive peak of the triggering signal and in position – just before the negative peak. In position MAINS of HF/LF-TV/MAINS switch 802, the trigger polarity switch is inoperative. Then the phase can be inverted by reversing the mains plug.

In position LF-TV of HF/LF-TV/MAINS switch 802 the time-base generator is triggered by the line or frame sync pulses of a television signal.

For triggering by line pulses, TIME/cm switch 801 must be in one of the positions 0.2 ms to 50 ms; for frame pulses this switch must occupy one of the positions 0.5 μs to 0.1 ms.

If the peaks of the sync pulses are positive (negative) with respect to the video signal, the trigger polarity switch must be set to position + (–).

The LF-TV position is also very useful when h.f. interference affects triggering of l.f. signals.

In single-trace operation, the blocked channel remains operative and can, therefore, be conveniently used as trigger amplifier, with the following advantages:

In position ACx10 of switch ACx10/AC/DC it is possible to trigger with very small signals.

With larger triggering signals and higher trigger amplification it is possible to trigger on signal levels which lie between the peak and zero levels of the signal; the required gain is selected with the Y AMPLITUDE switch of the relevant channel.

2.3.5. Y-Deflection

The Y-deflection coefficient can be set in ten calibrated steps by means of Y_A AMPLITUDE switch 805a and Y_B AMPLITUDE switch 805b.

In position ACx10 of ACx10/AC/DC switches 806a and 806b the gain is a factor then higher, but the bandwidth is reduced.

The trace can be shifted in vertical direction by means of Y_A and Y_B POSITION controls 602a and 602b.

2.3.6. X-Deflection

X-deflection is effected either internally by the time-base generator or externally by a voltage applied to X INPUT socket 852. X MAGN. control 601a allows a 5x magnification of the trace in X direction. The trace can be shifted in horizontal direction by means of X POSITION control 601b.

2.3.6.1. Time base

The X deflection coefficient can be set in 16 steps by means of TIME/cm switch 801.

TIME/cm control 609 allows a continuous control between the steps. The deflection coefficient is calibrated when X MAGN. control 601a is turned anti-clockwise to position x1 and TIME/cm control 609 clockwise to position CAL.

2.3.6.2. External X-deflection

The time-base generator is switched off when TIME/cm switch 801 is in one of the positions 5 V/cm and 1 V/cm. Then the X deflection is provided by an external signal applied to X INPUT socket 852.

1. Allgemeines

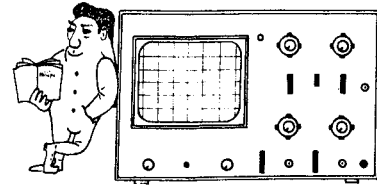

1.1. EINLEITUNG

Der Zweikanal-Oszillograf PM 3110 ist durch seine einfache Bedienbarkeit besonders für die Anwendung im Rundfunk- und Fernseh-Service und für Unterrichtszwecke geeignet.

Das Gerät ist mit einer grossen Elektronenstrahlröhre ausgerüstet, deren ausnutzbares Schirmformat 8 x 10 beträgt.

Mit Ausnahme der Eingangsstufen der beiden identischen Y-Vorverstärker ist das Gerät mit Transistoren bestückt.

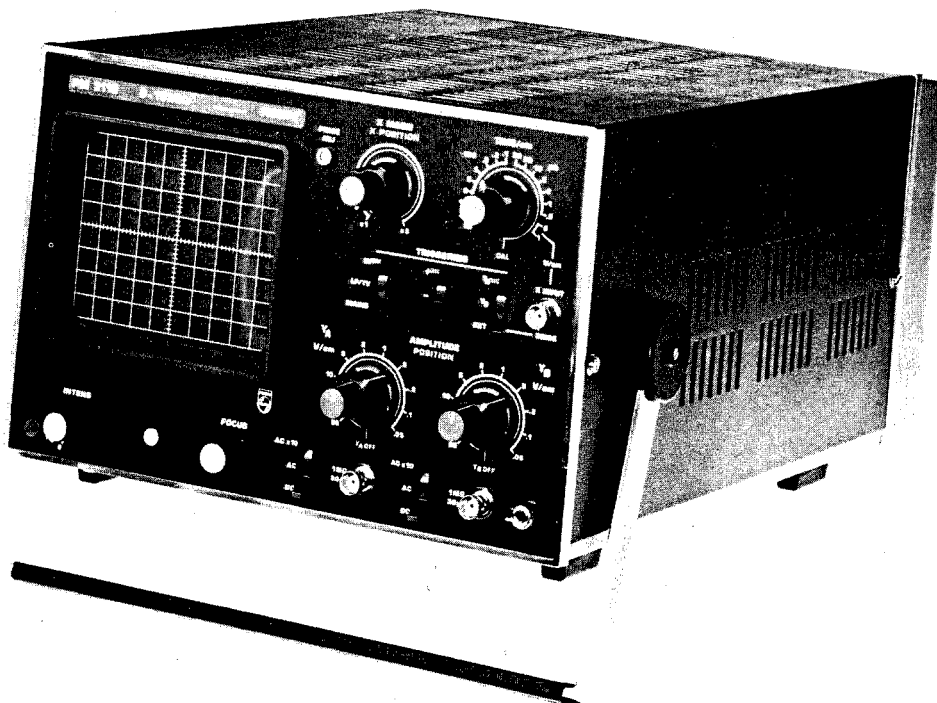

Fig. 1. Frontansicht

1.2. TECHNISCHE DATEN

Die mit einer Fehlergrenze angegebenen Daten sind Garantiewerte. Daten ohne Angabe der Fehlergrenze dienen zur Orientierung, sie entsprechen den Werten eines Durchschnittsgeräts.

Elektronenstrahlröhre

Schirmabmessung	13 cm Ø
Rasterfläche	8 x 10 cm
Beschleunigungsspannung	-2 kV
Einstellungsmöglichkeiten	Fokus, Helligkeit

Y-Verstärker

(Angaben gelten für Kanäle Y_A und Y_B)

Anschluss	BNC-Buchse	
Ablenkkoeffizient		
– in Stellung AC und DC	50 mV/cm bis 50 V/cm	} in 10 Stufen (1-2-5-Folge)
– in Stellung AC x 10	5 mV/cm bis 5 V/cm	
Frequenzbereich		
(Bezugsbildhöhe 6 cm)		
– in Stellung DC	0 Hz bis 10 MHz –3 dB	
– in Stellung AC	2 Hz bis 10 MHz –3 dB	
– in Stellung AC x 10	3 Hz bis 5 MHz –3 dB	
Anstiegszeit		
– in Stellung AC und DC	35 ns	
– in Stellung AC x 10	70 ns	
Frequenzgang der Bildhöhe	> 8 cm bis 7 MHz	
Dehnung		
linearer Aussteuerbereich	24 cm	
Frequenzgrenze für unverzerrte Abbildung eines Sinussignals bei 24 cm Aussteuerung	1 MHz	
Bildverschiebung	> 18 cm	
Linearitätsfehler nach DIN 43740 *)	< 1 %	
Gesamtfehler	< 5 % bei Netznominalspannung im Temperaturbereich +5 bis +35 °C	
Eingangsimpedanz	1 MΩ//30 pF	
Max. zulässige Eingangsspannung	500 V (DC + ACSpitze)	
Betriebsarten:		
Kanal Y_A allein	Y_B POSITION in Stellung Y_B OFF	
Kanal Y_B allein	Y_A POSITION in Stellung Y_A OFF	
Kanal $Y_A + Y_B$, gekoppelt mit Zeitbasisschalter		
Chopper-Betrieb	TIME/cm in Stellung 50 ms bis 0,2 ms	
alternierender Betrieb	TIME/cm in Stellung 0,1 ms bis 0,5 μs	
Schaltfrequenz (Chopper)	200 kHz	

*) Die Definition der Nichtlinearität nach DIN 43740 lautet: "Prozentuale Abweichung des Ablenkkoeffizienten bei 75 % der Aussteuerung von dem bei 25 %, gemessen im waagerechten Teil der Frequenzkennlinie und von der Schirmmitte aus".

X-Verstärker

Anschluss	BNC-Buchse
Ablenkkoeffizient	1 V/cm oder 5 V/cm einstellbar mit Zeitbasisschalter
Dehnung	1 bis 5fach, stetig
Frequenzbereich (Bezugsbildbreite 8 cm)	3 Hz bis 1 MHz -3 dB
Gesamtfehler	< 10 %
Eingangsimpedanz	100 k Ω bei 1 V/cm 500 k Ω bei 5 V/cm
Max. zulässige Eingangsspannung	250 V (DC + AC _{Spitze})

Zeitbasis

Ablenkkoeffizient	0,5 μ s/cm bis 50 ms/cm in 16 kalibrierten Stufen (1-2-5-Folge) stetige Einstellung zwischen den Stufen > 2,5fach, nicht kalibriert
Fehler	< 5 % bei Netzennennspannung im Temperaturbereich +5 bis +35 °C
Linearitätsfehler nach DIN 43740 *)	< 1 %
Dehnung	1 bis 5fach, stetig
Bildverschiebung	\pm 5 cm x Dehnungsfaktor

Triggerung

Anschluss für externe Triggerung	automatisch BNC-Buchse
Quellen	Y _A , Y _B , extern
Polarität	positiv und negativ (bezogen auf die Signalspitzen)

Betriebsarten

HF normal (top triggering)

LF-TV (Bild- und Zeilentriggerung mit
Zeitbasisschalter gekoppelt)

Triggerung auf
Bild : 50 ms/cm bis 0,2 ms/cm
Zeile: 0,1 ms/cm bis 0,5 μ s/cm
Netz, mit fester Polarität

MAINS

Triggerschwelle	2 Hz	100 Hz bis 2 MHz	10 MHz
Sinus, intern	< 2,0 cm	< 1,0 cm	< 4,0 cm
Sinus, extern	U _{SS} < 3,0 V	U _{SS} < 1,5 V	U _{SS} < 3,0 V
TV Signal, intern Synchron-Pegel		< 1,0 cm	

Eingangsimpedanz X INPUT, TRIGG.

100 k Ω

Max. zul. Eingangsspannung

250 V (DC + AC_{Spitze})

Tastkopfabgleich

Ausgang PROBE ADJ.	Tippkontakt
Spannung	U _{Spitze} = 5 V (Rechteck)
Frequenz	2,2 kHz

Stromversorgung

Netzspannung	110, 128, 202, 220, 238 V
Netzspannungstoleranz	+10 %, –15 %
Netzfrequenz	50 bis 60 Hz
Leistungsaufnahme	47 VA

Umgebungsbedingungen

Bezugstemperatur	+23 °C
Toleranzbereich der Temperatur	+5 bis +35 °C
Gebrauchsbereich der Temperatur	–10 bis +45 °C
Grenzbereich der Temperatur für Lagerung und Transport	–25 bis +70 °C

Abmessungen

Breite	305 mm (über alles)
Höhe	195 mm
Tiefe	455 mm
Gewicht	8,5 kg

} (ohne Traggriff)

1.3. ZUBEHOR**1.3.1. Normalzubehör**

Anleitung

1.3.2. Zusätzlich lieferbares Zubehör

– Adapter für BNC auf 4-mm-Stecker	PM 9051
– Messkopfsatz mit Messkopfkabel von 1,15 m	PM 9326
– Messkopfsatz mit Messkopfkabel von 2 m	PM 9327
– Messkopfsatz mit Messkopfkabel von 1,5 m	PM 9336
– Messkopfsatz mit Messkopfkabel von 2,5 m	PM 9336L
– Messkopfsatz (1:1)	PM 9335
– Satz Miniaturmesskopfpinzetten	PM 9333
– Faltbare Nebenlichtmaske	PM 9366
– Mehrzweck-Registrierkamera	PM 9380
– Adapter	PM 9377
– Zusätzlicher Voratzlinse	PM 9373

Siehe auch Abschn. 3.7. "INFORMATION CONCERNING ACCESSORIES"

1.4. BESCHREIBUNG DES BLOCKSCHALTBILDS (Abb. 5, Seite 51)**1.4.1. Sichtteil**

Die Oszillografenröhre wird mit einer Ebschleunigungsspannung von –2 kV betrieben. Die Bildhelligkeit und die Schärfe sind mit den Stellern INTENS. und FOCUS einstellbar.

Der Netzschalter (~, 0) ist mit dem Steller INTENS. gekoppelt.

1.4.2. Y-Kanal

Der Oszillograf hat zwei identische Kanäle Y_A und Y_B . Im einzelnen bestehen diese jeweils aus:

- ACx10, AC, DC-Schalter
- Abschwächer, Schalter Y AMPLITUDE mit zehn kalibrierten Stufen
- Eingangsstufe, als Impedanzwandler

- Vorverstärker. In Stellung ACx10 des Schalters ACx10/AC/DC wird die Empfindlichkeit um den Faktor 10 vergrößert. Mit dem Steller Y POSITION erfolgt eine vertikale Bildverschiebung, in Stellung Y OFF wird der betreffende Kanal gesperrt
- Kanalschalter, er wird von dem Flipflop gesteuert
- Flipflop; wird von den Schaltern Y_A OFF und Y_B OFF gesetzt und über die Z-Steuerung getriggert
- Chopper-Multivibrator, ist ein astabiler Multivibrator, der 400 kHz liefert
- Y-Endstufe; verstärkt das Signal, so dass die volle Ausnutzung der Bildhöhe möglich ist
- Triggertrennstufe, sie dient zur Auskopplung der internen Triggersignale für die Zeitbasisstufe

1.4.3. X-Kanal

Die Zeitbasiseinheit im X-Kanal ist extern oder intern mit Signalen von Kanal Y_A oder Y_B triggerbar. Ausserdem ist durch Umgehung mehrerer Stufen der X-Kanal als Signalverstärker verwendbar.

Im einzelnen besteht der X-Kanal aus:

- Eingangsverstärker; dieser wirkt als Triggerverstärker mit Polaritätsschalter +/– oder als Vorverstärker für X-Betrieb, die Betriebsart ist mit dem Schalter TIME/cm – V/cm wählbar
- Y_A/Y_B/EXT.-Schalter, dient zur Auswahl der Triggersignalquellen
- Abschwächer; dieser gestattet in 2 Stufen die Abschwächung des X-Signals bei Verstärkerbetrieb
- Spitzendetektor/Synchronseparator; enthält eine Klemmschaltung zur Festlegung des Triggerpunktes auf den Scheitelwert des Triggersignals
Drei Betriebsarten sind wählbar:
HF : normale Triggerung (top triggering)
LF-TV : Synchronseparator, selective Triggerung für TV- Bild- und Zeilensignale
MAINS: Triggerung mit Netzfrequenz
- Schmitt-Trigger, dient der Flankenversteilerung, die negativ gerichtete Flanke startet die Zeitbasisstufe und die positiv gerichtete Flanke steuert die Automatik
- Zeitbasisstufe, sie bestimmt den horizontalen Ablenkkoeffizienten. Dieser ist in 12 Stufen mit dem Schalter TIME/cm einstellbar.
- Hold-off; diese Schaltung gewährleistet, dass die Zeitbasisstufe vor Beendigung des Rücklaufs nicht gestartet werden kann
- Automatik, sie bewirkt ein Freilaufen der Zeitbasisstufe, wenn kein Triggersignal am Schmitt-Trigger ansteht
- X-Endstufe, diese verstärkt das Ausgangssignal (Sägezahn) aus der Zeitbasisstufe. Bei Verstärkerbetrieb wird die X-Endstufe über X INPUT und Abschwächer direkt vom Eingangsverstärker gesteuert. Der Steller X MAGN. ermöglicht die Dehnung in X-Richtung, mit dem Steller X POSITION erfolgt eine horizontale Verschiebung

1.4.4. Z-Steuerung

Z-Steuerung; diese verknüpft die automatischen Schaltsignale des Chopper-Multivibrators und der Zeitbasis derart, dass bei Ablenkkoeffizienten bis 0,1 ms/cm alternierender Betrieb und ab 0,2 ms/cm sowie bei externer X-Ablenkung Chopperbetrieb erfolgt. Ausserdem liefert diese Stufe Austastsignale zur Dunkelsteuerung während des Strahlrücklaufs und der Umschaltzeit im Chopperbetrieb.

1.4.5. Rechteckgenerator

Der Rechteckgenerator liefert ein Rechtecksignal an den Tippkontakt PROBE ADJ. zum Abgleich von Abschwächer-Tastköpfen.

1.4.6. Netzteil und Gleichspannungswandler

Das Netzteil liefert die Gleichspannungen und ein Signal für MAINS-Triggerung. In dem stabilisiertem Gleichspannungswandler wird die Beschleunigungsspannung für die Elektronenstrahlröhre erzeugt.

2. Gebrauchsanleitung

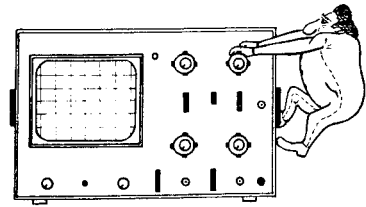

2.1. VORBEREITUNGEN FÜR INBETRIEBNAHME

2.1.1. Aufstellung

Der Oszillograf kann in jeder beliebigen Lage betrieben werden. Die Belüftungsöffnungen des Gehäuses dürfen dabei nicht verdeckt werden. Bei senkrechter Aufstellung dient die Kabeltasche als Fuss. Um das Gerät in Schräglage aufzustellen, wird der Traggriff heruntergeklappt.

Soll der Traggriff in die oberste Stellung gebracht werden, müssen dazu gemäss Fig. 2 beide Griffarme nach aussen gezogen werden.

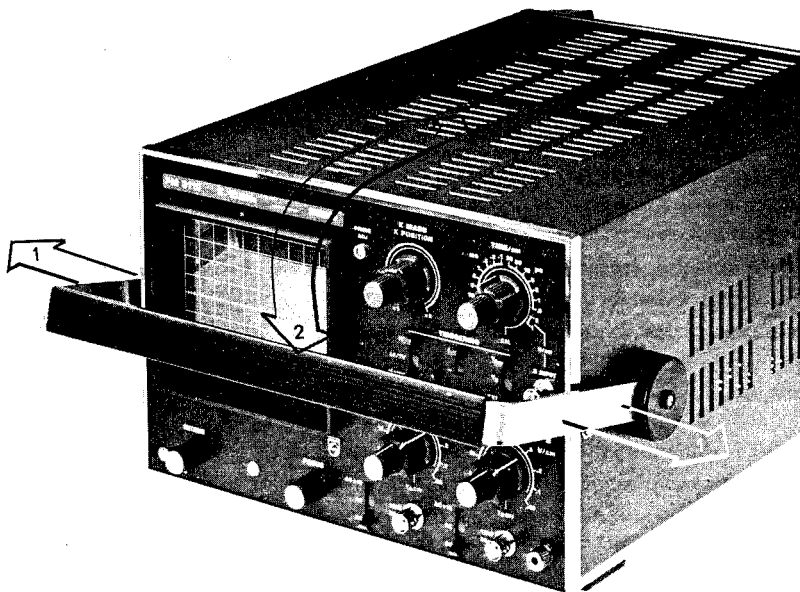

Fig. 2. Anwendung des Traggriffs

2.1.2. Einstellen auf die örtliche Netzspannung

Der Oszillograf darf nur an Wechselspannung angeschlossen werden. Bei Auslieferung ist das Gerät auf eine Netzspannung von 220 V eingestellt. Für den Betrieb mit 110 V, 128 V, 202 V und 238 V muss die Beschaltung des Netztrafos geändert werden:

- Nach Entfernen der zwei Schrauben an den beiden Seiten des Geräts das Gehäuse abnehmen
- Anschlüsse des Netztrafos entsprechend dem eingeklebten Schema umlöten (Fig. 3)

2.1.3. Erdung

Die Schutzerdung des Geräts muss den örtlichen Vorschriften entsprechend vorgenommen werden. Beim Anschluss an eine Schutzkontakt-Steckdose wird das Gehäuse zwangsläufig über das Netzkabel mit Schutzerde verbunden. Mit dem Gehäuse sind die Aussenkontakte der BNC-Buchsen Y_A -Eingang (853), Y_B -Eingang (854) und X INPUT (852) sowie die Klemmbuchse \perp (855) verbunden. Die Buchse \perp (855) ist als Messerdeanschluss verwendbar.

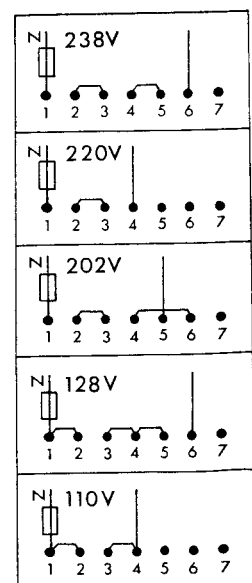

MA 85 21

Fig. 3. Beschaltung des Netztrafos für verschiedene Netzspannungen

2.2. ANSCHLÜSSE UND BEDIENUNGSELEMENTE (Fig. 4)

Pos.	Bezeichnung	Funktion
603	INTENS.	Steller für Bildhelligkeit, kombiniert mit Netzschalter
870		Betriebsanzeigelampe
604	FOCUS	Steller für Bildschärfe
851	PROBE ADJ.	Tippkontakt, Ausgang für Messkopfabgleich
601a	X MAGN.	Steller für Dehnung der X-Ablenkung
601b	X POSITION	Steller für horizontale Bildverschiebung
801	TIME/cm V/cm	Schalter für Ablenkkoeffizient der Zeitbasis kombiniert mit Schalter für X-Abschwächer
609	TIME/cm CAL.	Feinsteller für Ablenkkoeffizient der Zeitbasis in Endstellung CAL ist Schalter TIME/cm (801) kalibriert
802	HF/LF-TV/MAINS	Betriebsartenschalter für Triggerung
803	+/-	Schalter für Triggerpolarität
804	Y _A /Y _B /EXT.	Schalter für Triggerquelle
852	X INPUT/TRIGG.	Eingang für externes X- oder Triggersignal
805a	Y _A AMPLITUDE	Schalter für Y-Abschwächer, Kanal Y _A
602a	Y _A POSITION Y _A OFF	Steller für vertikale Bildverschiebung, Kanal Y _A ; kombiniert mit Schalter Y _A OFF
805b	Y _B AMPLITUDE	Schalter für Y-Abschwächer, Kanal Y _B
602b	Y _B POSITION Y _B OFF	Steller für vertikale Bildverschiebung, Kanal Y _B ; kombiniert mit Schalter Y _B OFF
806a	ACx10/AC/DC	Umschalter für Gleich- oder Wechselspannungskopplung, Kanal Y _A
806b	ACx10/AC/DC	Umschalter für Gleich- oder Wechselspannungskopplung, Kanal Y _B
853	1 M Ω /30 pF	Y-Eingang, Kanal Y _A
854	1 M Ω /30 pF	Y-Eingang, Kanal Y _B
855		Messerdeanschluss

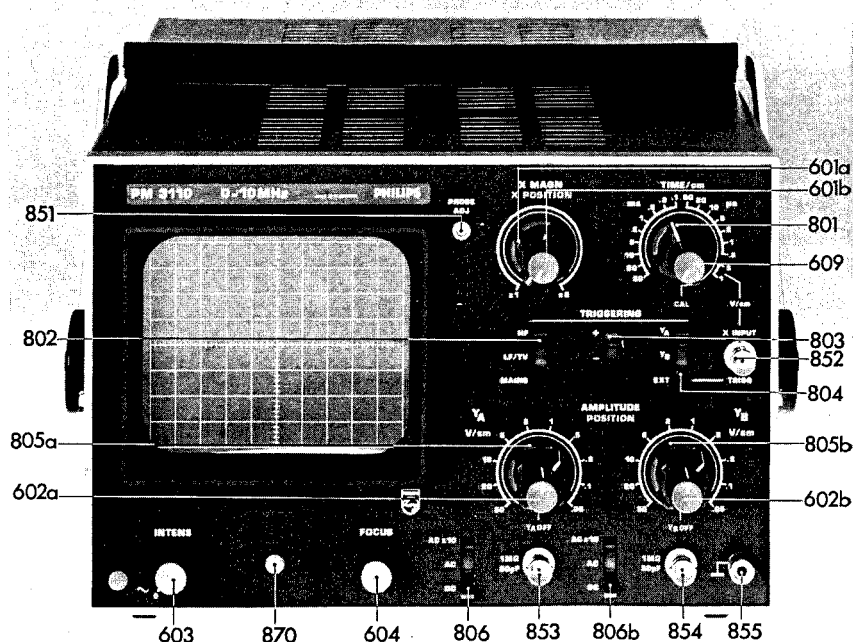

Fig. 4. Anschlüsse und Bedienungselemente

2.3. BEDIENUNG

2.3.1. Vorbereitende Einstellungen

- Gerät an das Netz anschliessen
- Steller X POSITION (601b), Y_A und Y_B POSITION (602a und 602b) in Mittelstellung bringen
- Steller X MAGN. (601a) auf Linksanschlag x1 stellen
- Feinsteller TIME/cm (609) auf Rechtsanschlag CAL. bringen
- Schalter TIME/cm (801) auf eine beliebige Stellung im Bereich 50 ms/cm bis 0,5 μ s/cm stellen
- Schalter HF/LF-TV/MAINS (802) auf HF stellen
- Schalter Y_A/Y_B/EXT. (804) auf Y_A oder Y_B stellen
- Mit Steller INTENS. (603) Gerät einschalten und Steller in Mittelstellung bringen. Die Lampe 870 leuchtet bei eingeschaltetem Gerät. Nach ca. 15 s werden die Zeitlinien sichtbar
- Mit Steller INTENS. (603) die Helligkeit auf einen mittleren Wert einstellen
- Mit Steller FOCUS (604) auf maximale Bildschärfe abgleichen

2.3.2. Kanalschalter

Mit den Stellern Y_A oder Y_B POSITION (602a oder 602b) in Stellung Y_A OFF oder Y_B OFF, Linksanschlag eingerastet, wird der jeweilige Y-Kanal gesperrt (Einkanalbetrieb). Steht keiner der beiden Steller auf Y OFF, arbeitet der Oszillograf im Zweikanalbetrieb.

2.3.3. Eingangskopplung

Mit den Schaltern ACx10/AC/DC (806a oder 806b) erfolgt in Stellung ACx10 und AC eine Abtrennung der Gleichspannungskomponente des Eingangssignals. Dieses ist dann erforderlich, wenn die zu untersuchende Wechselfeldspannungskomponente klein ist gegenüber der Gleichspannungskomponente.

2.3.4. Triggerung

Durch eine Triggerautomatik schwingt der Zeitbasisgenerator frei, wenn kein Triggersignal vorhanden ist, und die Zeitlinien bleiben sichtbar. Folgende Signalquellen dienen zur Triggerung der Zeitbasis:

- wahlweise vom Kanal Y_A oder Y_B; Schalter Y_A/Y_B/EXT. (804) in Stellung Y_A oder Y_B, sowie Schalter HF/LF-TV/MAINS (802) in Stellung HF oder LF-TV.
- externe Quelle an X INPUT; Schalter Y_A/Y_B/EXT. (804) in Stellung EXT., sowie Schalter HF/LF-TV/MAINS (802) in Stellung HF oder LF-TV
- Netzfrequenz (intern); Schalter HF/LF-TV/MAINS (803) in Stellung MAINS

Mit dem Schalter +/– (803) wird die Triggerpolarität gewählt. Die Auslösung Zeitablenkung erfolgt in Stellung + kurz vor dem Erreichen des positiven und in Stellung – kurz vor dem Erreichen des negativen Spitzenwerts des Triggersignals. Bei Triggerung in Stellung MAINS des Schalters 802 ist der Schalter +/– unwirksam. Eine Phasenumkehrung ist durch Umpolen des Netzsteckers möglich.

In Stellung LF-TV des Schalters HF/LF-TV/MAINS (802) erfolgt die Triggerung mit den Synchronimpulsen (Bild oder Zeile) eines Videosignals.

Für Bildimpulse: Schalter TIME/cm (801) im Bereich 0,2 ms/cm bis 50 ms/cm

Für Zeilenimpulse: Schalter TIME/cm (801) im Bereich 0,5 μ s/cm bis 0,1 ms/cm

Sind die Dächer der Synchronimpulse gegenüber der Schwarzschar positiv (negativ), muss der Schalter +/– (803) in Stellung + (–) stehen.

Die Stellung LF-TV ist auch dann von grossem Nutzen, wenn hochfrequente Störungen den Triggervorgang bei niederfrequenten Signalen beeinflussen.

Bei Einkanalbetrieb bleibt der jeweils gesperrte Kanal in Betrieb und lässt sich daher zweckmässig als Triggerverstärker verwenden. Daraus ergeben sich folgende Vorteile:

In Stellung ACx10 kann mit sehr kleinen Signalen getriggert werden. Bei grösseren Triggersignalen und hoher Triggerverstärkung ist es möglich, auf Signalpegeln zu triggern, die zwischen dem Spitzenwert und dem Null-durchgang liegen; die erforderliche Verstärkung wird mit dem Schalter Y AMPLITUDE des entsprechenden Y-Kanals gewählt.

2.3.5. Y-Ablenkung

Der Y-Ablenkoeffizient ist in zehn Stufen mit den Schaltern Y_A AMPLITUDE (805a) und Y_B AMPLITUDE (805b) einstellbar.

In Stellung ACx10 der Schalter ACx10/AC/DC (806a und 806b) ist die Verstärkung zehnmals grösser, dabei wird jedoch die Bandbreite der Y-Verstärker verringert.
Eine vertikale Bildverschiebung erfolgt mit den Stellern Y_A und Y_B POSITION (602a und 602b).

2.3.6. X-Ablenkung

Die X-Ablenkung erfolgt entweder intern mit dem Zeitbasisgenerator oder extern mit einer Signalquelle.
Der Steller X MAGN. (601a) ermöglicht die Dehnung um den Faktor 5. Eine horizontale Bildverschiebung erfolgt mit dem Steller X POSITION (601b).

2.3.6.1. Zeitbasis

Der X-Ablenkkoeffizient ist in 16 Stufen mit dem Schalter TIME/cm (801) einstellbar, eine stetige Einstellung erfolgt mit dem Steller TIME/cm (609). Der Ablenkkoeffizient ist kalibriert, wenn der Steller X MAGN. (601a) auf Linksanschlag x1 und der Steller TIME/cm (609) auf Rechtsanschlag CAL steht.

2.3.6.2. Externe X-Ablenkung

Die interne Zeitablenkung wird abgeschaltet, wenn der Schalter TIME/cm (801) in Stellung 5 V/cm oder 1 V/cm steht. Die Horizontalablenkung erfolgt dann durch eine externe Signalquelle am Eingang X INPUT (852).

1. Algemeen

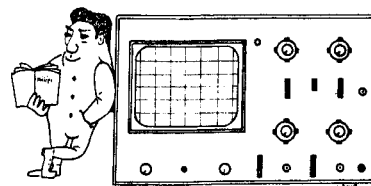

1.1. INLEIDING

De dubbelstraaloscillograaf PM 3110 is door zijn eenvoudige bediening bijzonder geschikt voor onderwijsdoel-einden en radio- en televisieservice.

Het instrument heeft een grote electronenstraalbuis met een nuttige schermoppervlakte van 8 x 10 cm. Met uitzondering van de ingangstrappen van de twee identieke verticale voorversterkers is het apparaat volkomen getransistoriseerd.

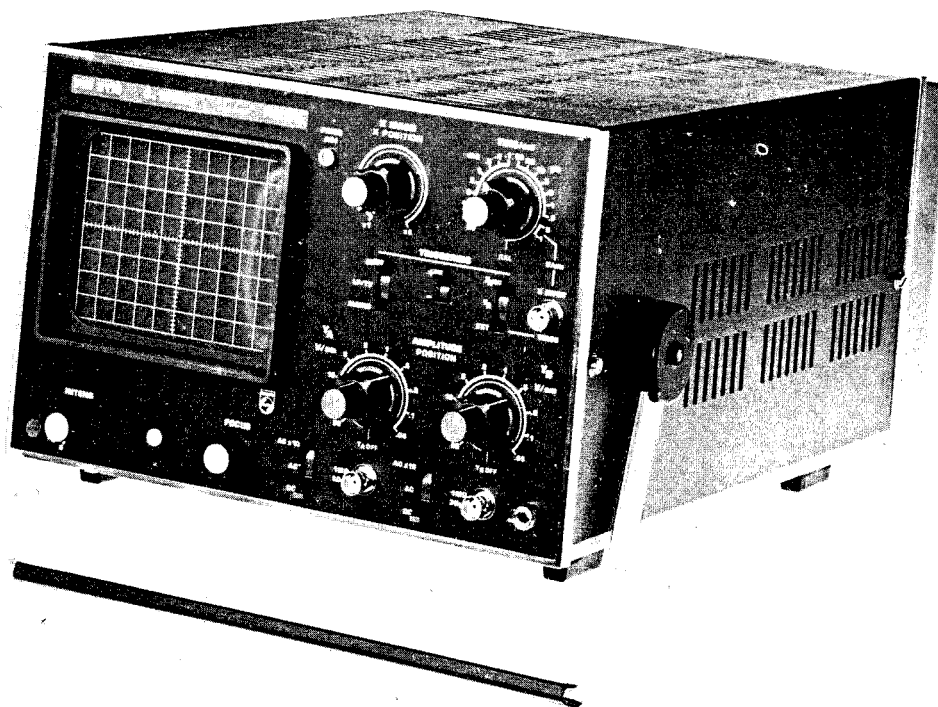

Fig. 1. Vooraanzicht

1.2. TECHNISCHE GEGEVENS

Eigenschappen uitgedrukt in getalwaarden waarbij een tolerantie is aangegeven, worden door ons gegarandeerd. Getalwaarden zonder toleranties geven de eigenschappen van een gemiddeld instrument aan en dienen slechts ter oriëntatie.

Elektronenstraalbuis

Type	D13 - 480 GH
Schermdiameter	13 cm
Nuttig schermoppervlak	8 x 10 cm
Versnellingspanning	-2 kV
Instelmogelijkheden	focus, helderheid

Y-versterker

(gegevens gelden voor de kanalen Y_A en Y_B)

Aansluiting	BNC-bus	
Afbuigcoëfficiënt		
– in stand AC en DC	50 mV/cm - 50 V/cm	} in 10 stappen 1-2-5 volgorde
– in stand ACx10	5 mV/cm - 5 V/cm	
Frequentiebereik (referentie beeldhoogte 6 cm)		
– in stand DC	0 Hz tot 10 MHz (-3 dB)	
– in stand AC	2 Hz tot 10 MHz (-3 dB)	
– in stand ACx10	3 Hz tot 5 MHz (-3 dB)	
Stijgtijd		
– in stand AC en DC	35 ns	
– in stand ACx10	70 ns	
Beeldhoogte als functie van de frequentie	> 8 cm tot 7 MHz	
Vergroting		
– lineair uitsturing bereik	24 cm	
– frequentiegrens voor een onvervormde weergave van een sinussignaal bij een uitsturing van 24 cm	1 MHz	
Beeldverschuiving	> 18 cm	
Lineariteitsfout volgens DIN 43740*)	< 1 %	
Totale meetfout	< 5 % bij nominale netspanning binnen het temperatuurgebied +5 tot +35 °C	
Ingangsimpedantie	1 M Ω //30 pF	
Max. toelaatbare ingangsspanning	500 V (DC + AC _{top})	
Kanaalkeuze		
Kanaal Y_A alleen	Y_B POSITION in stand Y_B OFF	
Kanaal Y_B alleen	Y_A POSITION in stand Y_A OFF	
Kanaal Y_A en kanaal Y_B	Door middel van een kanaalschakelaar (flip-flop) Y_A en Y_B gelijktijdig altemnerend of chopped.	
	Omschakeling is gekoppeld met tijdbasisschakelaar TIME/cm	
“chopped mode”	TIME/cm in stand 50 ms/cm tot 0,2 ms/cm	
“alternated mode”	TIME/cm in stand 0,1 ms tot 0,5 μ s/cm	
schakelfrequentie van kanaalschakelaar	200 kHz	

*) DIN 43740 is omschreven als: het aantal procenten afwijking van de afbuigcoëfficiënt bij 75 % afbuiging betrokken op 25 % afbuiging, gemeten in het rechte deel van de frequentie karakteristiek en vanuit het midden van het scherm.

X-Versterker

Aansluiting	BNC-bus
Afbuigcoëfficiënt	1 V/cm of 5 V/cm, instelbaar met de tijdbasisschakelaar
Vergroting	1- tot 5-voudig, continu regelbaar
Frequentiebereik (referentiebeeldbreedte 8 cm)	3 Hz - 1 MHz, -3 dB
Totale fout	< 10 %
Ingangsimpedantie	100 k Ω bij 1 V/cm 500 k Ω bij 5 V/cm
Max. toelaatbareingangsspanning	250 V (DC + AC _{top})

Tijdbasis-generator

Tijdcoëfficiënten	0,5 μ s/cm - 50 ms/cm in 16 geijkte stappen (volgorde 1-2-5) tussen de stappen onderling continu regelbaar > 2,5 maal, niet geijkt
Meetfout	< 5 % bij nominale netspanning in het temperatuurgebied +5 tot +35 °C
Lineariteitsfout volgens DIN 43740*)	< 1 %
Vergroting	1- tot 5-voudig, continu regelbaar
Beeldverschuiving	\pm 5 cm x de vergrotingsfaktor

Triggering

Aansluiting voor externe triggering	automatisch BNC-bus
Triggerbron	Y _A , Y _B of extern
Polariteit	positief en negatief (met betrekking tot de signaaltoppen)
Trigger werkwijze	
HF	normaal (top triggering)
LF-TV	raster- en lijntriggering met tijdbasisschakelaar gekoppeld: raster: TIME/cm in stand 50 ms/cm tot 0,2 ms/cm lijn : TIME/cm in stand 0,1 ms/cm tot 0,5 μ s/cm
MAINS	Netfrequentie (vaste polariteit)

Triggergevoeligheid

	2 Hz	100 Hz - 2 MHz	10 MHz
sinus, intern	< 2,0 cm	< 1,0 cm	< 4,0 cm
sinus, extern	V _{t-t} < 3,0 V	V _{t-t} < 1,5 V	V _{t-t} < 3,0 V
TV-sigitaal, intern synchroon-niveau		< 1,0 cm	
Ingangsimpedantie X INPUT, TRIGG.	100 k Ω		
Max. toelaatbareingangsspanning	250 V (DC + AC _{top})		

Afregelingsspanning voor meetkop

PROBE ADJ.	tipkontakt
Spanning	V _{t-t} = 5 V (blokspanning)
Frequentie	2,2 kHz

Voeding

Netspanning	110, 128, 202, 220, 238 V
Netspanningstolerantie	+10 %, -15 %

Netfrequentie	50 tot 60 Hz
Opgenomen vermogen	47 VA

Bedrijfsomstandigheden

Temperatuur waarbij het instrument afgeregeld is	+23 °C
Temperatuur waarbij de opgegeven toleranties gelden	+5 tot +35 °C
Temperatuur waarbij het apparaat bruikbaar is zonder dat de opgegeven toleranties gelden	−10 tot +45 °C
Uiterste temperatuur waarbij het apparaat mag worden opgeslagen en getransporteerd	−25 tot +70 °C

Afmetingen

Breedte	305 mm
Hoogte	195 mm
Diepte	455 mm
Gewicht	8,5 kg

} (zonder handgreep)

1.3. ACCESSOIRES

1.3.1. Meegeleverde accessoires

Handleiding

1.3.2. Op bestelling leverbare accessoires

– Aanpassingsteker (BNC naar 4-mm-banaansteker)	PM 9051
– Meetkopset met 1,15 m meetkopkabel	PM 9326
– Meetkopset met 2 m meetkopkabel	PM 9327
– Meetkopset met 1,5 m meetkopkabel	PM 9336
– Meetkopset met 2,5 m meetkopkabel	PM 9336L
– Meetkopset (1:1)	PM 9335
– Set miniatuur meetkop clips	PM 9333
– Kijkkoker	PM 9366
– Universele camera voor oscillografen	PM 9380
– Aanpasstuk (oscillograaf-camera)	PM 9377
– Voorzetlens voor universele camera	PM 9373

Zie ook hoofdstuk 3.7. "INFORMATION CONCERNING ACCESSORIES"

1.4. BESCHRIJVING VAN HET BLOKSCHEMA (Fig. 5, blz. 51)

1.4.1. Elektronenstraalbuis

Deze buis wordt met een versnellingsspanning van -2 kV gevoed. Helderheid en scherpte zijn instelbaar met de instelorganen INTENS en FOCUS. De netschakelaar $\sim/0$ is met instelorgaan INTENS gekoppeld.

1.4.2. Vertikale versterker: Unit 1A, Unit 1B en Unit 2

De oscillograaf heeft twee identieke kanalen Y_A en Y_B die elk afzonderlijk bestaan uit:

- schakelaar ACx10/AC/DC
- Verzwakkerschakelaar (Y AMPLITUDE) met tien geijkte standen
- Ingangstrap als impedantieomvormer

- Voorversterker. In stand ACx10 van schakelaar ACx10/AC/DC wordt de gevoeligheid met een faktor 10 vergroot. Met potentiometer Y POSITION wordt het beeld vertikaal verschoven, in stand Y OFF wordt het desbetreffende kanaal geblokkeerd.
- Kanaalschakelaar; deze wordt door een flip-flop bediend.
- Flip-flop; deze wordt via de Z-modulatie door een astabiele-multivibrator (chopped mode) of door de tijdbasisgenerator (alternated mode) getriggerd, verder kan de flip-flop met de schakelaars Y_A OFF en Y_B OFF worden ge"set".
- Y-eindtrap; versterkt het signaal en levert de afbuigspanning voor de beeldbuis.
- Triggerscheidingstrap; via deze trap wordt een signaal (Y_A, Y_B) afgenomen bestemd voor het vormen van interne triggersignalen voor de tijdbasisgenerator.

1.4.3. Horizontale versterker: Unit 3 en Unit 3A

De tijdbasisgenerator in de X-Versterker kan zowel door extern signaal als intern met een signaal afgeleid van kanaal Y_A of Y_B gestart worden.

Bovendien is door het uitschakelen van de tijdbasisgenerator de horizontale versterker te gebruiken als versterker voor externe X-afbuig signalen.

De X-versterker bestaat uit:

- Ingangsversterker; in de standen TIME/cm van schakelaar 801. Werkt deze als triggerversterker voor de tijdbasisgenerator en in de standen V/cm als voorversterker voor de horizontale versterker. Bovendien heeft ingangsversterker een keuzeschakelaar +/- (803) waarmee het mogelijk is op de positief gaande of op de negatief gaande flank van het te meten signaal te triggeren.
- Schakelaar Y_A/Y_B/EXT.; dient voor het kiezen van de triggerbronnen.
- Verzwakker; deze maakt het mogelijk het externe signaal dat voor X-afbuiging aan de horizontale-versterker wordt toegevoerd te verzwakken (2 stappen).
- Topdetector/synchronisatiescheider; deze dient voor het vastleggen van de triggerpunt op de topwaarde van het trigger signaal.

Met schakelaar 802 is te kiezen uit drie trigger mogelijkheden nl.:

HF : normale triggering (top triggering)

LF-TV : synchronisatiescheider, selectieve triggering voor raster- en lijnsignalen.

MAINS: Triggering met netfrequentie

- Schmitt-trigger (impulsvormer); deze levert een blokspanning waarvan de negatief gaande flank de tijdbasisgenerator start en de positief gaande flank de triggerautomaat stuurt.
- Tijdbasisgenerator; deze is van het stroombron-integrator type. Hierin zijn de laadcondensatoren en weerstanden opgenomen, die met schakelaar TIME/cm worden gekozen. Continueregeling van de tijdcoëfficiënten geschiedt met potentiometer TIME/cm (609).
- Hold-off-schakeling; deze waarborgt dat de tijdbasisgenerator niet voor het einde van de terugslag kan worden gestart.
- Triggerautomaat; zorgt voor vrijlopen van de tijdbasisgenerator wanneer aan de Schmitt-Trigger geen triggersignalen worden toegevoerd.
- X-Eindtrap; deze dient om de interne zaagtandspanning of een externe afbuigspanning te versterken alvorens deze aan de horizontale afbuigplaten wordt toegevoerd. In de schakeling zijn ook de horizontale verschuivingsregelaar (X POSITION) en de vergrotingsregelaar (X MAGN.) opgenomen.

1.4.4. Z-modulatie (donkerstuurtrap)

Deze trap levert impulsen voor het donkersturen van de e.s.b. gedurende de terugslag van de zaagtand en gedurende de tijd dat de elektronenstraal tussen Y_A en Y_B heen en weer schakelt.

Bovendien levert deze trap impulsen aan de flip-flop welke de kanaalschakelaar bedient.

1.4.5. Rechthoekgenerator

Levert een blokspanning welke kan dienen voor het afregelen van een verzwakker-meetkop.

De blokspanning is aangesloten op tipkontakt PROBE-ADJ.

1.4.6. Voedingsgedeelte en gelijkspanningsomvormer

Het voedingsgedeelte levert de verschillende gelijkspanningen en een signaal voor MAINS-triggering.

In de gestabiliseerde gelijkspanningsomvormer wordt de hoogspanning voor de elektronenstraalbuis opgewekt.

2. Gebruiksaanwijzing

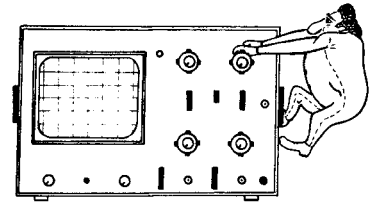

2.1. VOORBEREIDINGEN VOOR INBEDRIJFSTELLING

2.1.1. Opstelling van het instrument

De oscillograaf kan in elke willekeurige stand worden gebruikt. Het apparaat dient zo te worden opgesteld dat vrije luchtcirculatie gewaarborgd is.

Bij verticale opstelling kan de kabelbak als voet dienen. Om het apparaat schuin te zetten moet de handgreep naar beneden worden geklapt. Wil men de handgreep in de bovenste stand zetten, dan moeten de beide armen volgens fig. 2 naar buiten worden getrokken.

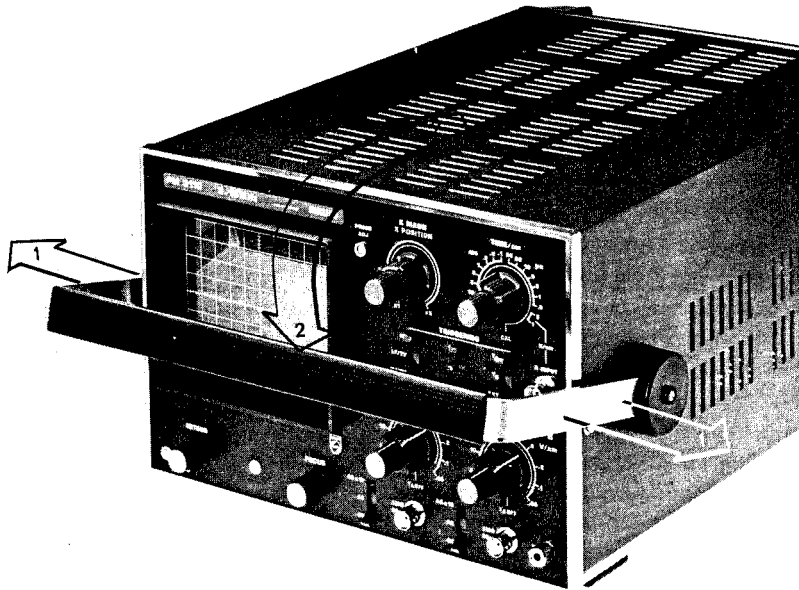

Fig. 2. Handgreep als draagsteun

2.1.2. Instellen op de plaatselijke netspanning

De oscillograaf mag alleen op wisselspanning worden aangesloten. Bij aflevering is het apparaat ingesteld op een netspanning van 220 V. Voor gebruik op netspanningen van 110 V, 128 V, 202 V en 238 V moeten verschillende aansluitdraden van de nettransformator worden omgeschakeld. Dit geschiedt als volgt:

- De kap na het verwijderen van de twee schroeven aan beide kanten van het apparaat afnemen.
- De aansluitdraden van de nettransformator volgens het ingeplakte schema omsolderen (zie ook fig. 3.).

2.1.3. Aarding

Het apparaat moet volgens de plaatselijk geldende voorschriften worden geaard. Bij aansluiting op een wandkontaktdoos met randaarde is het chassis automatisch via het 3 aderige netsnoer met aarde verbonden. De buitencontacten van de BNC-ingangsbussen Y_A , Y_B (853, 854) en X INPUT (852) en de klembus \perp (855) zijn met het chassis verbonden. Klembus \perp (855) is als meetaardeaansluiting te gebruiken.

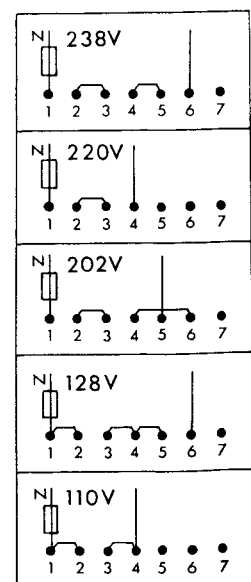

MA 8521

Fig. 3. Aansluitpaneel van de nettransformator voor verschillende netspanningen

2.2. AANSLUITINGEN EN BEDIENINGSORGANEN (Fig. 4)

Pos.	Omschrijving	Functie
603	INTENS - \sim/o	Instelorgaan voor helderheid, gekombineerd met netschakelaar
870		Netspannings-indicatielampje
604	FOCUS	Instelorgaan voor beeldscherpte
851	PROBE ADJ.	Tipkontakt, uitgang afregelspanning meetkop
601a	X MAGN.	Instelorgaan voor vergroting van de X-afbuiging
601b	X POSITION	Instelorgaan voor horizontale beeldverschuiving
801	TIME/cm V/cm	Stappenregeling van de tijdbasis afbuigcoëfficiënten; gekombineerd met 2 verzwakker standen om de externe spanning te verzwakken voor externe triggering resp. X-afbuiging
609	TIME/cm	Continu regeling van de tijdbasis afbuigcoëfficiënten; in eindstand CAL. is schakelaar TIME/cm (801) geijkt.
802	HF/LF-TV/MAINS	Keuzeschakelaar triggerwijze
803	+/-	Keuzeschakelaar triggerpolariteit
804	Y _A /Y _B /EXT.	Keuzeschakelaar triggerbron
852	X INPUT/TRIGG.	Ingangsbuss voor een externe triggerspanning resp. X-afbuigspanning
805a	Y _A AMPLITUDE	Stappenregeling van de verticale afbuigcoëfficiënten kanaal Y _A
602a	Y _A POSITION Y _A OFF	Instelorgaan voor verticale beeldverschuiving Kanaal Y _A ; gekombineerd met schakelaar Y _A OFF
805b	Y _B AMPLITUDE	Stappenregeling van de verticale afbuigcoëfficiënten kanaal Y _B
602b	Y _B POSITION Y _B OFF	Instelorgaan voor verticale beeldverschuiving Kanaal Y _B ; gekombineerd met schakelaar Y _B OFF
806a	ACx10/AC/DC	Keuzeschakelaar voor gelijk- of wisselspanningskoppeling, Kanaal Y _A
806b	ACx10/AC/DC	Keuzeschakelaar voor gelijk- of wisselspanningskoppeling, Kanaal Y _B
853	1 M Ω /30 pF	Ingangsbuss Y-versterker voor Kanaal Y _A
854	1 M Ω /30 pF	Ingangsbuss Y-versterker voor Kanaal Y _B
855	\perp	Meetaardaansluiting

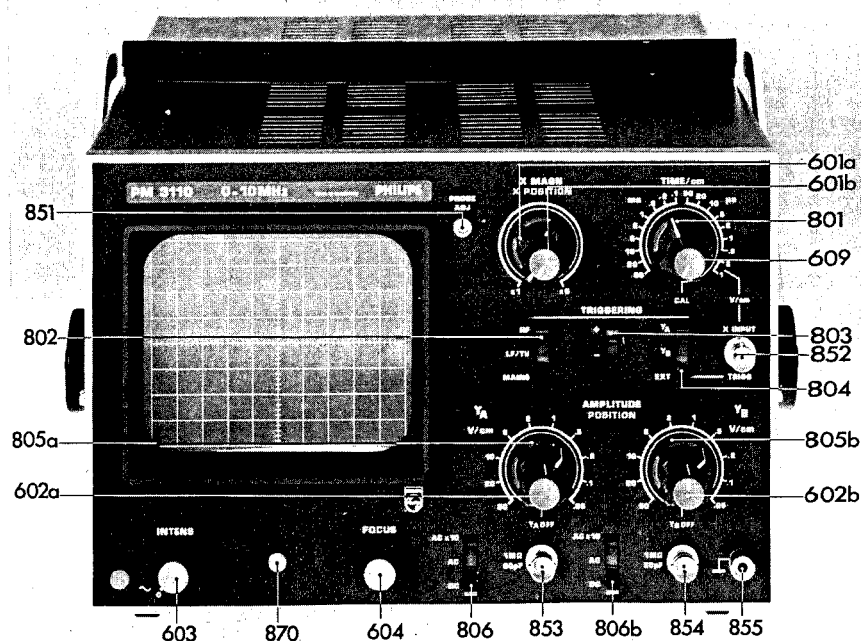

Fig. 4. Bedieningsorganen

2.3. BEDIENING

2.3.1. Voorbereidende instellingen

- Sluit het instrument aan op de netspanning.
- Zet de knoppen X POSITION (601b), Y_A en Y_B POSITION (602a en 602b) in de middenstand.
- Draai knop X MAGN. (601a) geheel linksom (stand x1).
- Draai continueregelaar TIME/cm (609) geheel rechtsom (stand CAL).
- Zet schakelaar TIME/cm (801) in een willekeurige stand in het gebied 50 ms/cm tot 0,5 μ s/cm.
- Zet schakelaar HF/LF-TV/MAINS (802) op HF.
- Zet schakelaar Y_A/Y_B/EXT. (804) op Y_A of Y_B.
- Met knop INTENS (603) het instrument inschakelen; knop daarna in de middenstand zetten. Lampje 870 brandt wanneer het apparaat is ingeschakeld.
Na ca. 15 sec. worden de beeldlijnen zichtbaar.
- Met knop INTENS (603) de helderheid op een gemiddelde waarde instellen.
- Met knop FOCUS (604) op maximale beeldscherpte afregelen.

2.3.2. Schakelaar Y_A(B)-OFF

Wanneer de knop Y_A of Y_B POSITION (602a of 602b) geheel linksom wordt gedraaid (stand Y_A OFF of Y_B OFF) is het desbetreffende Y-kanaal geblokkeerd (gebruik als éénstraal oscillograaf).

2.3.3. Ingangsschakeling

Met de schakelaars ACx10/AC/DC (806a of 806b) in stand ACx10 en AC wordt van het zichtbaar te maken signaal de gelijk en wisselspanningskomponent van elkaar gescheiden. Dit is noodzakelijk, wanneer de te onderzoeken wisselspanningskomponent klein is t.o.v. de gelijkspanningskomponent.

2.3.4. Triggering

De triggerautomaat zorgt ervoor, dat, wanneer er geen triggersignaal aanwezig is, de tijdbasisgenerator vrijloopt en een tijdbasis lijn zichtbaar blijft. De volgende signaalbronnen kunnen dienen voor het triggeren van de tijdbasisgenerator:

- naar keuze met kanaal Y_A of Y_B: schakelaar Y_A/Y_B/EXT. (804) in stand Y_A of Y_B en schakelaar HF/LF-TV/MAINS (802) in stand HF of LF-TV
- externe bron aan X INPUT; schakelaar Y_A/Y_B/EXT. (804) in stand EXT. en schakelaar HF/LF-TV/MAINS (802) in stand HF of TV
- netfrequentie (intern); schakelaar HF/LF-TV/MAINS (802) in stand MAINS.

Met de schakelaar +/- (803) wordt de triggerpolariteit gekozen. De tijdbasisafbuiging vindt plaats in stand + vlak voor het bereiken van de positieve, in stand – vlak voor het bereiken van de negatieve topwaarde van het triggersignaal. In stand MAINS van schakelaar 802 (triggering op de netfrequentie) is schakelaar +/- buiten werking. Door het omkeren van de netstekker kan de fase 180° worden omgedraaid.

In de stand LF-TV van de schakelaar HF/LF-TV/MAINS (802) vindt de triggering met de synchronisatieimpulsen (raster of lijn) van een videosignaal plaats.

Voor rasterimpulsen: schakelaar TIME/cm (801) in het gebied 0,2 ms/cm tot 50 ms/cm

Voor lijnimpulsen : schakelaar TIME/cm (801) in het gebied 0,5 μ s/cm tot 0,1 ms/cm.

Wanneer het videosignaal positieve synchronisatie-impulsen heeft (dus een negatief videosignaal), dan moet schakelaar +/- (803) in stand + staan en in de stand – als het signaal negatieve synchronisatie-impulsen heeft. De stand LF-TV heeft ook grote voordelen, wanneer hoogfrequentie storingen het triggeren bij laagfrequente signalen beïnvloeden.

Bij gebruik als eenstraal oscillograaf blijft het dan geblokkeerde kanaal toch in werking en kan als triggerversterker worden gebruikt. Dit heeft volgende voordelen:

In stand ACx10 kan worden getriggerd op signalen met een geringe amplitude.

Bij grotere triggersignalen en een hogere triggerversterking is het mogelijk op niveaus te triggeren die liggen tussen de topwaarde en de nuldoorgang van het signaal, de juiste versterking wordt met de schakelaar Y AMPLITUDE van het overeenkomstige Y-kanaal gekozen.

2.3.5. Vertikale afbuiging

De Y-afbuigcoëfficiënt kan met de schakelaars Y_A AMPLITUDE (805a) en Y_B AMPLITUDE (805b) in tien geijkte stappen worden ingesteld.

In stand ACx10 van de schakelaars ACx10/AC/DC (806a en 806b) is de versterking 10x groter dan in stand AC. De bandbreedte van de Y-versterkers wordt echter verminderd.

Met de instelorganen Y_A en Y_B POSITION (602a en 602b) wordt het beeld in verticale richting verschoven.

2.3.6. Horizontale afbuiging

X-afbuiging kan plaats vinden: intern door een zaagtandspanning opgewekt in de tijdbasisgenerator of extern, door een signaal aan ingangsbus X-INPUT toe te voeren. Met instelorganen X MAGN. (601a) is het mogelijk, het beeld in de X-richting 5 maal te vergroten. Met X POSITION (601b) wordt het beeld in horizontale richting verschoven.

2.3.6.1. Tijdbasisgenerator

De horizontale afbuigcoëfficiënt is met schakelaar TIME/cm (801) in 16 geijkte stappen instelbaar, continue regeling vindt plaats met knop TIME/cm (609).

De afbuigcoëfficiënt is geijkt, wanneer knop X MAGN. (601a) uiterst links (in stand x1) en knop TIME/cm (609) uiterst rechts (in stand CAL.) wordt gedraaid.

2.3.6.2. Externe horizontale afbuiging

De interne tijdbasisgenerator wordt automatisch uitgeschakeld, wanneer schakelaar TIME/cm (801) in stand 5 V/cm of 1 V/cm staat. Een externe signaalbron aan ingang X INPUT (852) zorgt dan voor de horizontale afbuiging.

1. Généralités

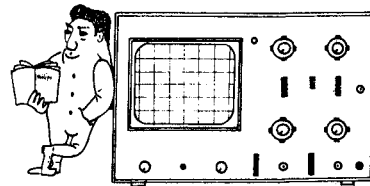

1.1. INTRODUCTION

L'oscilloscope à deux faisceaux PM 3110 est, du fait de sa grande maniabilité, particulièrement apte à l'entretien de radios et de télévisions, ainsi qu'à des fins d'enseignement.

L'appareil est muni d'un grand tube à rayons cathodiques, dont l'écran utile est de 8 x 10 cm.

Exception faite des étages d'entrée des deux pré-amplificateurs verticaux, l'appareil est complètement transistorisé.

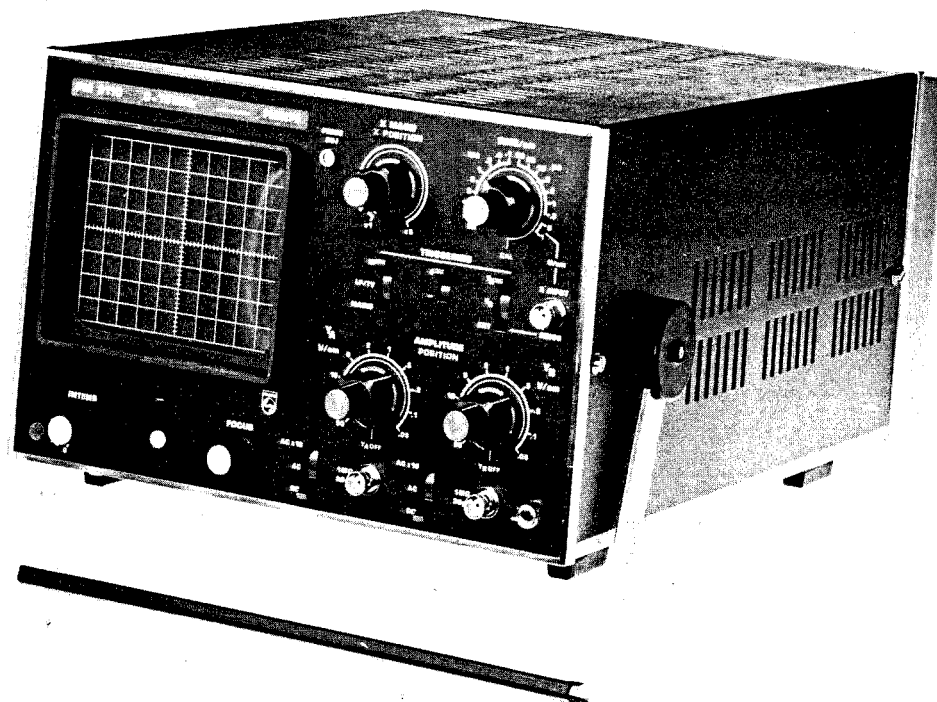

Fig. 1. Vue avant

1.2. CARACTERISTIQUES TECHNIQUES

Seules les valeurs avec tolérances sont garanties par l'usine. Les valeurs sans indication de tolérance ne sont mentionnées qu'à titre informatif et correspondent aux caractéristiques d'un appareil moyen.

Tube à rayons cathodiques

Type	D13 - 480 GH
Diamètre d'écran	13 cm
Surface utile de l'écran	8 x 10 cm
Tension de accélération	-2 kV
Possibilités de réglage	focalisation, luminosité

Amplificateur Y

(ces données sont également valables pour les canaux Y_A et Y_B)

Prise	connecteur BNC	
Coefficient de déviation		} en 10 étages étalonnés progression 1, 2, 5
– en position AC et DC	50 mV/cm à 50 V/cm	
– en position ACx10	5 mV/cm à 5 V/cm	
Gamme de fréquence (hauteur d'image de référence 6 cm)		
– en position DC	0 Hz à 10 MHz (-3 dB)	
– en position AC	2 Hz à 10 MHz (-3 dB)	
– en position ACx10	3 Hz à 5 MHz (-3 dB)	
Temps de montée		
– en position AC et DC	35 ns	
– en position ACx10	70 ns	
Hauteur d'image en fonction de la fréquence	> 8 cm jusqu'à 7 MHz	
Agrandissement		
– gamme d'agrandissement linéaire	24 cm	
– fréquence limite pour représentation d'un signal sinusoïdal sans déformation et pour agrandissement linéaire de 24 cm	1 MHz	
Décadrement	> 18 cm	
Faute de linéarité conformément à DIN 43740*)	< 1 %	
Dérive totale	< 5 % pour tension secteur nominale dans une gamme de température de +5 à +35 °C	
Impédance d'entrée	1 MΩ//30 pF	
Tension maximale d'entrée admise	500 V (crête AC + DC)	
Modes de fonctionnement		
Canal Y _A	Y _B POSITION en position Y _B OFF	
Canal Y _B	Y _A POSITION en position Y _A OFF	
Canal Y _A et canal Y _B	Couplés simultanément en fonctionnement alternant ou avec chopper par un sélecteur de canaux (flip-flop). La permutation se fait à l'aide du commutateur de base de temps TIME/cm.	
fonctionnement avec chopper	TIME/cm en position 50 ms/cm à 0,2 ms/cm	
fonctionnement alternant	TIME/cm en position 0,1 ms/cm à 0,5 μs/cm	
Fréquence de commutation du sélecteur de canaux	200 kHz	

*) La norme DIN 43740 est définie comme étant la différence procentuelle du coefficient de déviation mesurée sur la partie droite de la caractéristique de fréquence, à partir du milieu de l'écran, lorsqu'on compare une déviation de 75 % à une déviation de 25 %.

Amplificateur X

Prise	connecteur BNC
Coefficient de déviation	1 V/cm ou 5 V/cm, à régler avec le commutateur de base de temps
Agrandissement	1 à 5 fois en réglage continu
Gamme de fréquence (largeur d'image de référence 8 cm)	3 Hz à 1 MHz, -3 dB
Dérive totale	< 10 %
Impédance d'entrée	100 k Ω à 1 V/cm 500 k Ω à 5 V/cm
Tension maximale d'entrée admise	250 V (crête AC + DC)

Base de temps

Coefficient de temps	0,5 μ s/cm à 50 ms/cm en 16 échelons étalonnés (progression 1, 2, 5) Réglage continu entre les échelons > 2,5 fois pas étalonnés
Dérive	< 5 % pour tension secteur nominale dans une gamme de température de +5 à +35 °C
Faute de linéarité conformément à DIN 43740*)	< 1 %
Agrandissement	1 à 5 fois, en réglage continu
Décadrage	\pm 5 cm x facteur d'agrandissement

Déclenchement

Prise pour déclenchement externe	connecteur BNC												
Source	Y _A , Y _B ou externe												
Polarité	positive et négative (par rapport aux crêtes de signal)												
Modes de déclenchement	normal (déclenchement à la crête) déclenchement de trame et de ligne couplé avec le commutateur de base de temps: déclenchement de trame: 50 ms/cm à 0,2 ms/cm déclenchement de ligne : 0,1 ms/cm à 0,5 μ s/cm fréquence secteur (polarité fixe)												
HF													
LF-TV													
MAINS													
Seuil de déclenchement	<table> <thead> <tr> <th>2 Hz</th> <th>100 Hz à 2 MHz</th> <th>10 MHz</th> </tr> </thead> <tbody> <tr> <td>< 2,0 cm</td> <td>< 1,0 cm</td> <td>< 4,0 cm</td> </tr> <tr> <td>V_{CC} < 3,0 V</td> <td>V_{CC} < 1,5 V</td> <td>V_{CC} < 3,0 cm</td> </tr> <tr> <td></td> <td>< 1,0 cm</td> <td></td> </tr> </tbody> </table>	2 Hz	100 Hz à 2 MHz	10 MHz	< 2,0 cm	< 1,0 cm	< 4,0 cm	V _{CC} < 3,0 V	V _{CC} < 1,5 V	V _{CC} < 3,0 cm		< 1,0 cm	
2 Hz	100 Hz à 2 MHz	10 MHz											
< 2,0 cm	< 1,0 cm	< 4,0 cm											
V _{CC} < 3,0 V	V _{CC} < 1,5 V	V _{CC} < 3,0 cm											
	< 1,0 cm												
Impédance d'entrée X INPUT, TRIGG.	100 k Ω												
Tension maximale d'entrée admise	250 V (crête AC + DC)												

Adjustage de sonde

PROBE ADJ.	point de contact
Tension	V _{CC} = 5 V (rectangulaire)
Fréquence	2,2 kHz

Alimentation

Tension secteur	110, 128, 202, 220, 238 V
Tolérance de tension secteur	+10 %, -15 %

Fréquence secteur	50 à 60 Hz
Consommation	47 VA

Conditions de travail

Température de référence	+23 °C
Gamme de température dans laquelle les tolérances sont valables	+5 à +35 °C
Gamme de température dans laquelle l'appareil peut être utilisé sans que les tolérances soient valables	-10 à 45 °C
Limite de température pour emmagasinage et transport	-25 à +70 °C
Dimensions	
Largeur	305 mm
Hauteur	195 mm
Profondeur	455 mm } sans poignée
Poids	8,5 kg

1.3. LISTE DES ACCESSOIRES

1.3.1. Accessoires standard

- Notice d'emploi et d'entretien

1.3.2. Accessoires supplémentaires (sur commande)

– Adaptateur pour BNC de 4 mm	PM 9051
– Jeu de sondes avec câble de 1,15 m	PM 9326
– Jeu de sondes avec câble de 2 m	PM 9327
– Jeu de sonde avec câble de 1,5 m	PM 9336
– Jeu de sonde avec câble de 2,5 m	PM 9336L
– Jeu de sonde (1:1)	PM 9335
– Pincettes miniatures pour probes	PM 9333
– Pare-lumière	PM 9366
– Appareil de photographie d'oscillogrammes	PM 9380
– Adaptateur (oscilloscope - PM 9380)	PM 9377
– Lentille adaptatrice	PM 9373

Voir également chapitre 3.7. "INFORMATION CONCERNING ACCESSORIES"

1.4. DESCRIPTION DU SCHEMA SYNOPTIQUE (Fig. 5, page 51)

1.4.1. Tube à rayons cathodiques

Celui-ci est actionné par une tension de accélération de -2 kV.

La clarté et la netteté de l'image sont respectivement réglables à l'aide des potentiomètres INTENS et FOCUS. Le commutateur secteur \sim/\circ est couplé avec le potentiomètre INTENS.

1.4.2. Amplificateur vertical: Unit 1A, Unit 1B et Unit 2

L'oscilloscope possède deux canaux identiques Y_A et Y_B , lesquels sont composés des éléments suivants:

- Commutateur ACx10/AC/DC.
- Commutateur d'atténuation Y AMPLITUDE à 10 échelons étalonnés.
- Etage d'entrée en tant que convertisseur d'impédance.

- Pré-amplificateur. En position ACx10 du commutateur ACx10/AC/DC, la sensibilité est augmentée d'un facteur 10. Le potentiomètre Y POSITION permet de décadrer verticalement; en position Y OFF, le canal correspondant est bloqué.
- Sélecteur de canaux commandé par flip-flop.
- Flip-flop; il est déclenché par un multivibrateur astable par l'intermédiaire de la commande Z (chopper) ou par le générateur de base de temps (alternant).
Il peut de plus être actionné par les commutateurs Y_A OFF et Y_B OFF.
- Etage de sortie Y; il amplifie le signal et produit la tension de déviation pour le tube à rayons cathodiques.
- Etage intermédiaire de déclenchement; par son intermédiaire un signal (Y_A , Y_B) est prélevé.
Il sert à former des signaux internes de déclenchement pour le générateur de base de temps.

1.4.3. Amplificateur horizontal: Unit 3 et Unit 3A

Le générateur de base de temps dans l'amplificateur X peut être démarré par un signal externe ou interne dérivé du canal Y_A ou Y_B .

De plus, si l'on déclenche le générateur de base de temps, l'amplificateur horizontal peut être utilisé comme amplificateur de signaux externes de déviation X.

L'amplificateur X est composé des éléments suivants:

- Amplificateur d'entrée; en positions TIME/cm du commutateur 801, il fonctionne comme amplificateur de déclenchement pour le générateur de base de temps. En position V/cm, il fonctionne comme pré-amplificateur pour l'amplificateur horizontal. De plus, l'amplificateur d'entrée est pourvu d'un sélecteur de polarité +/- (803) qui permet de déclencher le flanc positif ou le flanc négatif du signal à mesurer.
- Sélecteur $Y_A/Y_B/EXT$; il sert à choisir les sources de déclenchement.
- Atténuateur; il permet d'atténuer en deux phases le signal externe conduit à l'amplificateur horizontal pour déviation X.
- Détecteur de crêtes - séparateur synchrone; il sert à établir le point de déclenchement sur la valeur de crête du signal de déclenchement.
Il y a trois modes de déclenchement, correspondant à trois positions du commutateur 803:
HF : déclenchement normal (déclenchement à la crête)
LF-TV : séparateur synchrone, déclenchement sélectif pour signaux de trame et de ligne
MAINS: déclenchement avec fréquence secteur
- Déclencheur de Schmitt (conformateur d'impulsions); il produit une tension rectangulaire dont le flanc négatif démarre le générateur de base de temps et dont le flanc positif commande le circuit automatique.
- Générateur de base de temps: du type intégrateur de source de courant. Il est composé de condensateurs et de résistances à choisir avec le commutateur TIME/cm. Le potentiomètre TIME/cm (609) permet le réglage continu des coefficients de temps.
- Unité de blocage; cette unité empêche le démarrage du générateur de base de temps avant le retour du spot.
- Circuit automatique; il permet le fonctionnement libre de la base de temps, lorsque le déclencheur de Schmitt n'est pas alimenté en signaux de déclenchement.
- Etage de sortie X; il sert à amplifier la tension interne en dents de scie ou la tension externe de déviation avant d'être conduite aux plaques de déviation horizontale.
Ce circuit comprend également le régulateur de décadrage horizontal (X POSITION) et le potentiomètre d'agrandissement (X MAGN).

1.4.4. Modulation Z (étage de suppression de faisceau)

Cet étage produit les impulsions nécessaires à obscurcir le tube cathodique pendant le retour de la dent de scie et pendant la permutation $Y_A - Y_B$ du tube.

De plus cet étage produit des impulsions pour flip-flop de commande du sélecteur de canaux.

1.4.5. Générateur d'impulsions rectangulaires

Celui-ci produit un signal rectangulaire pour ajustage d'une sonde atténuatrice.
Cette tension se trouve sur le point de contact PROBE ADJ.

1.4.6. Alimentation et convertisseur en continu

L'alimentation produit les tensions continues et un signal pour déclenchement MAINS. La haute tension pour tube cathodique est produite dans le convertisseur en continu.

2. Mode d'emploi

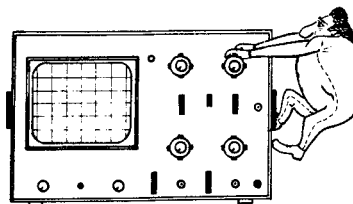

2.1. PREPARATION A LA MISE EN SERVICE

2.1.1. Installation

L'oscilloscope peut être utilisé dans toutes les positions et en tout lieu, à condition que la circulation de l'air environnant soit garantie.

En position verticale, le casier pour câble sert de base. Pour placer l'appareil en position inclinée, rabattre la poignée vers le bas. Pour mettre la poignée en position supérieure, tirer les deux bras conformément à la figure 2.

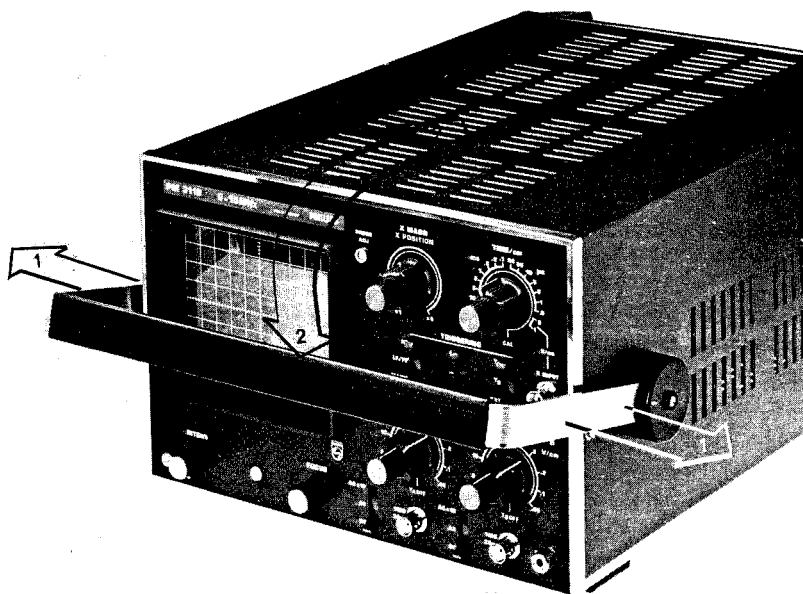

Fig. 2. Poignée en tant qu'étrier-support

2.1.2. Adaptation au réseau local

L'oscilloscope ne peut être branché que sur une tension alternative. A la livraison, l'appareil est réglé sur une tension secteur de 220 V. Cependant, l'appareil peut aussi fonctionner sur les tensions 110 V, 128 V, 202 V et 238 V, mais dans ces cas, il faut adapter le circuit du transformateur secteur.

Pour ce faire, procéder comme suit:

- Après retrait des vis des deux côtés de l'appareil, déposer le couvercle.
- Intervenir les soudures du transformateur selon le schéma collé (voir également fig. 3).

2.1.3. Mise à la terre

L'appareil doit être mis à la terre conformément aux règles de sécurité locales.

En cas de branchement à une prise murale à ergot de terre, le châssis est automatiquement relié à la terre par le câble secteur à trois conducteurs. La masse des connecteurs d'entrée Y_A (853), Y_B (854) et X INPUT (852) ainsi que la prise de terre (855) sont reliés au châssis.

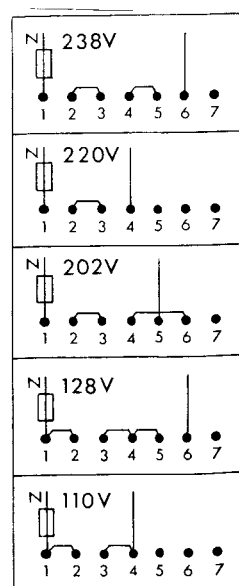

MA 85 21

Fig. 3. Composition du transformateur secteur pour différentes tensions

2.2. RACCORDEMENTS ET ELEMENTS DE COMMANDE (Fig. 4)

Rep.	Désignation	Fonction
603	INTENS \sim/\circ	Potentiomètre de luminosité combiné avec commutateur secteur
870		Lampe témoin
604	FOCUS	Potentiomètre pour netteté d'image
851	PROBE ADJ.	Point de contact, sortie pour réglage de sonde
601a	X MAGN.	Potentiomètre pour agrandissement de déviation
601b	X POSITION	Potentiomètre pour décadrage horizontal
801	TIME/cm V/cm	Régulateur par échelons pour coefficients de déviation de la base de temps, combiné avec deux positions atténuateur afin d'atténuer la tension externe pour déclenchement externe et déviation X
609	TIME/cm	Régulateur continu pour coefficients de déviation de la base de temps; en position CAL le commutateur TIME/cm (801) est étalonné
802	HF/LF-TV/MAINS	Sélecteur de mode de déclenchement
803	+/-	Sélecteur de polarité de déclenchement
804	Y _A /Y _B /EXT	Sélecteur de source de déclenchement
852	X INPUT/TRIGG	Douille d'entrée pour tension externe de déclenchement et tension de déviation X
805a	Y _A AMPLITUDE	Régulateur par échelons des coefficients de déviation verticale canal Y _A
602a	Y _A POSITION Y _A OFF	Potentiomètres pour décadrage vertical Canal Y _A ; combiné avec commutateur Y _A OFF
805b	Y _B AMPLITUDE	Régulateur par échelons des coefficients de déviation verticale canal Y _B
602b	Y _B POSITION Y _B OFF	Potentiomètres pour décadrage vertical Canal Y _B ; combiné avec commutateur Y _B OFF
806a	ACx10/AC/DC	Sélecteur continu/alternatif, canal Y _A
806b	ACx10/AC/DC	Sélecteur continu/alternatif, canal Y _B
853	1 M Ω /30 pF	Douille d'entrée amplificateur Y pour canal Y _A
854	1 M Ω /30 pF	Douille d'entrée amplificateur Y pour canal Y _B
855	\perp	Terre de mesure

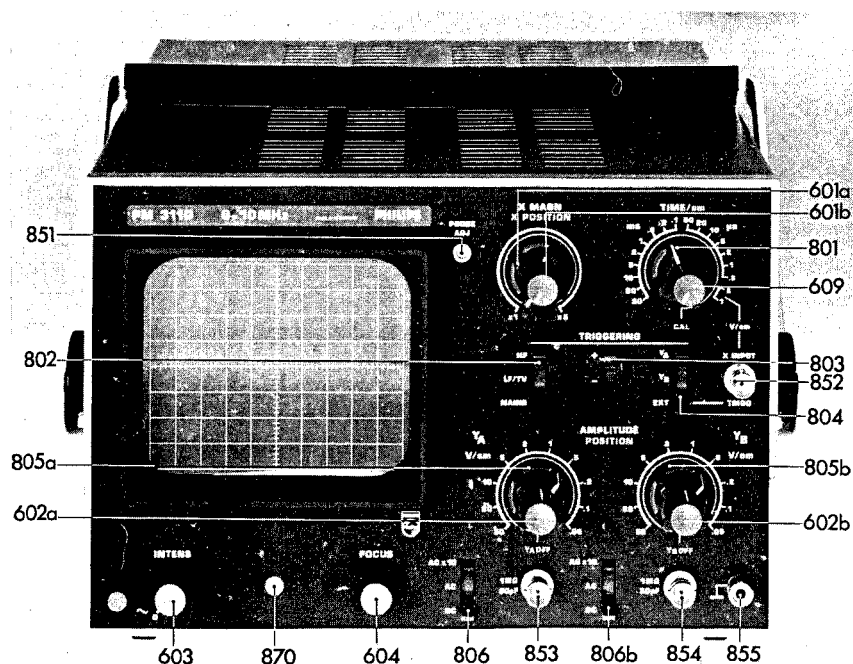

Fig. 4. Organes de commande

2.3. COMMANDE

2.3.1. Réglages préliminaires

- Brancher l'appareil au secteur.
- Mettre les potentiomètres X POSITION (601b), Y_A et Y_B POSITION (602a et 602b) en position médiane.
- Tourner le potentiomètre X MAGN. (601a) complètement vers la gauche (position x1).
- Tourner le régulateur fin TIME/cm (609) complètement vers la droite (position CAL).
- Mettre le commutateur TIME/cm (801) en position adéquate dans la gamme 50 ms/cm à 0,5 μs/cm.
- Mettre le sélecteur HF/LF-TV/MAINS (802) sur HF.
- Mettre le sélecteur Y_A/Y_B/EXT (804) sur Y_A ou Y_B.
- Enclencher l'appareil avec le potentiomètre INTENS (603); ensuite, mettre ce potentiomètre en position médiane. La lampe 870 s'allume lorsque l'appareil est enclenché. Les lignes sont visibles après environ 15 secondes.
- Régler la luminosité sur une valeur moyenne avec le potentiomètre INTENS (603).
- Régler la netteté d'image au maximum avec le potentiomètre FOCUS (604).

2.3.2. Sélecteur Y_A(B)-OFF

Lorsque les potentiomètres Y_A ou Y_B POSITION (602a ou 602b) sont tournés complètement vers la gauche (positions Y_A OFF ou Y_B OFF), le canal Y correspondant est bloqué. L'oscilloscope fonctionne alors en monocanal.

2.3.3. Circuit d'entrée

En positions ACx10 et AC des commutateurs ACx10/AC/DC (806a ou 806b) le continu et l'alternatif du signal à visualiser sont séparés. Cette séparation est nécessaire lorsque le composant alternatif à tester est petit par rapport au composant continu.

2.3.4. Déclenchement

Le générateur de base de temps oscille librement et les lignes de temps restent visibles par l'action du circuit automatique de déclenchement, et ce lorsqu'il n'y a pas de signal de déclenchement.

Les sources de signaux suivantes servent au déclenchement du générateur de base de temps:

- canal Y_A ou Y_B; commutateur Y_A/Y_B/EXT (804) en position Y_A ou Y_B et sélecteur HF/LF-TV/MAINS (802) en position HF ou LF-TV
- source externe sur X INPUT; commutateur Y_A/Y_B/EXT (804) en position EXT et sélecteur HF/LF-TV/MAINS (802) en position HF ou LF-TV
- fréquence secteur (interne); sélecteur HF/LF-TV/MAINS (802) en position MAINS.

La polarité de déclenchement est réglable avec le sélecteur +/- (803). La déviation de temps a lieu en position + ou - peu avant d'atteindre la crête positive ou négative du signal de déclenchement.

En position MAINS du sélecteur 802 (déclenchement sur secteur), le sélecteur +/- est déclenché.

Un déphasage de 180° est possible en permutant les pôles de la fiche secteur.

En position LF-TV du sélecteur HF/LF-TV/MAINS (802), le déclenchement se fait avec les impulsions synchrones (trame ou ligne) d'un signal vidéo.

Pour les impulsions de trame: commutateur TIME/cm (801) dans la gamme 0,2 ms/cm à 50 ms/cm.

Pour les impulsions de ligne: commutateur TIME/cm (801) dans la gamme 0,5 μs/cm à 0,1 ms/cm.

Lorsque les impulsions du signal vidéo sont positives (signal vidéo négatif), le sélecteur +/- (803) doit être en position +. Par contre, si ces impulsions sont négatives, le sélecteur 803 doit être en position -.

La position LF-TV présente également de grands avantages lorsque des dérangements de haute fréquence influencent le déclenchement à basse fréquence.

En fonctionnement monocanal, le canal bloqué reste en service et peut être utilisé en tant qu'amplificateur de déclenchement. Cette fonction présente les avantages suivants:

En position ACx10 le déclenchement peut se faire sur des signaux à faible amplitude.

Avec des signaux plus forts et en cas d'amplification plus importante, il est possible de déclencher des signaux dont la valeur se situe entre crête et zéro. Choisir l'amplification correspondante avec le commutateur Y AMPLITUDE du canal Y correspondant.

2.3.5. Déviation verticale

Le coefficient de déviation Y est réglable en 10 échelons étalonnés avec les commutateurs Y_A AMPLITUDE (805a) et Y_B AMPLITUDE (805b).

En position ACx10 des commutateurs ACx10/AC/DC (806a et 806b), l'amplification est dix fois plus grande qu'en position AC; par contre, la largeur de bande des amplificateurs Y est réduite.

Le décadrage vertical se fait à l'aide des potentiomètres Y_A et Y_B POSITION (602a et 602b).

2.3.6. Déviation horizontale

La déviation X peut se faire soit de manière interne, en excitant une tension en dents de scie dans le générateur de base de temps, soit de manière externe, en appliquant un signal à l'entrée X INPUT.

Les potentiomètres X MAGN. (601a) permet d'agrandir 5 fois l'image dans le sens horizontal, tandis que X POSITION (601b) permet le décadrage horizontal.

2.3.6.1. Générateur de base de temps

Le coefficient de déviation horizontale est réglable en 16 échelons étalonnés avec le commutateur TIME/cm (801), le réglage continu étant obtenu à l'aide du potentiomètre TIME/cm (609).

Le coefficient de déviation est étalonné lorsque le potentiomètre X MAGN. (601a) est tourné complètement vers la gauche (position x1) et le potentiomètre TIME/cm (609) complètement vers la droite (position CAL.).

2.3.6.2. Déviation horizontale externe

Le générateur de base de temps interne est automatiquement interrompu lorsque le commutateur TIME/cm (801) se trouve en position 5 V/cm ou 1 V/cm. La déviation horizontale s'obtient en appliquant un signal de source externe à l'entrée X INPUT (852).

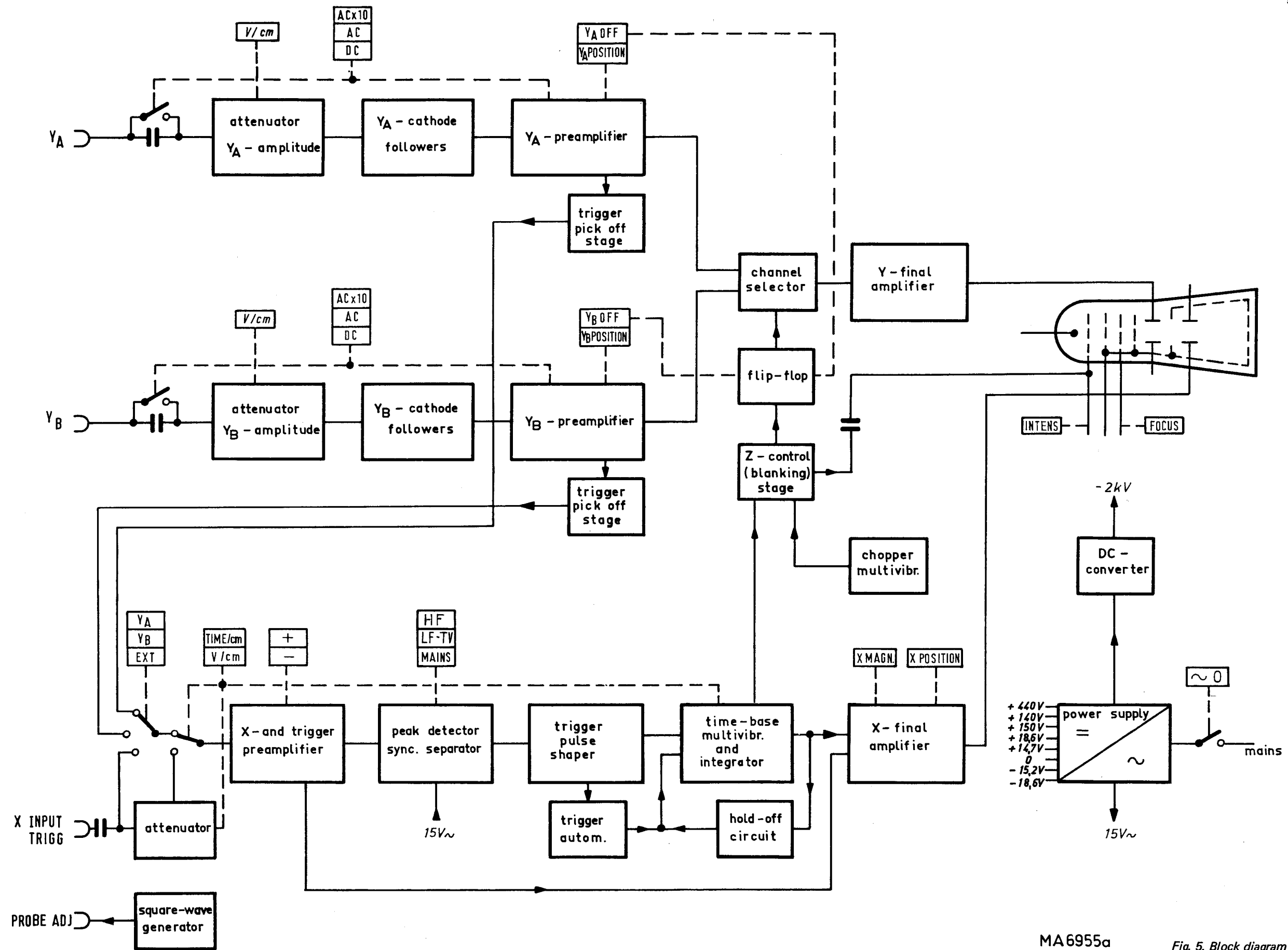

MA 6955a

Fig. 5. Block diagram

Table of contents

3.	SERVICE DATA	57
3.1.	Circuit description	57
3.1.1.	Attenuators: Unit 1A and Unit 1B	57
3.1.2.	Vertical amplifier: Unit 2	57
3.1.3.	Horizontal amplifier: Unit 3 and Unit 3A	62
3.1.4.	Power supply: Unit 4	64
3.2.	Dismantling	65
3.2.1.	Removing top cover and handle	65
3.2.2.	Removing the bottom plate	65
3.2.3.	Removing the knobs	65
3.2.4.	Removing bezel and measuring graticule	65
3.3.	Adjusting elements and their functions	67
3.4.	Checking and adjusting	68
3.4.1.	Power supply (Unit 4)	68
3.4.2.	Cathode-ray tube (310)	68
3.4.3.	X Adjustment (Unit 3)	68
3.4.4.	Triggering	69
3.4.5.	Y Amplifier, channel A (B) (Unit 2)	70
3.4.6.	PROBE ADJ.	72
3.4.7.	AC/DC Mode	72
3.4.8.	Y POSITION and Y OFF switch	72
3.5.	Replacing components	72
3.5.1.	Replacing the fuse	72
3.5.2.	Replacing ECC83 valves 301/U2 and 351/U2	72
3.6.	Information for assistance in fault finding	72
3.6.1.	Mains transformer 752	72
3.6.2.	Voltage levels and waveforms	73
3.7.	Information concerning accessories	74
3.7.1.	Adapter PM 9051	74
3.7.2.	Viewing hood PM 9366	74
3.7.3.	Multi-purpose camera PM 9380	75
3.7.4.	Adapter PM 9377	75
3.7.5.	Attenuator probe sets PM 9326 and PM 9327	76
3.7.6.	Attenuator probe sets PM 9336 and PM 9336L	78
3.7.7.	1:1 Probe set PM 9335	80
3.7.8.	Set of miniature probe clips PM 9333	81
3.8.	Parts list	82
3.8.1.	Mechanical parts (including a few electrical parts)	82
3.8.2.	Electrical parts	86
3.8.3.	Parts list of probe sets	93

3. Service data

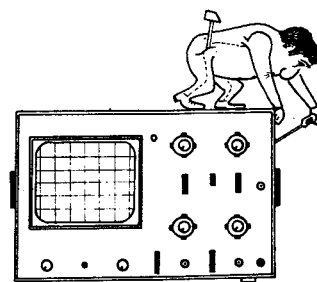

3.1. CIRCUIT DESCRIPTION (Fig. 33)

3.1.1. Attenuators: Unit 1A and Unit 1B

Units 1A and 1B are identical.

The input signal can be applied either direct (DC) or via a blocking capacitor (AC) to attenuator 805a or 805b as dictated by ACx10/AC/DC switch 806a or 806b; in position ACx10 the input sensitivity is increased by a factor ten.

The attenuators consist of five sections which are, via Y_A AMPL. switch 805a and Y_B AMPL. switch 805b, interconnected in such a way that a total of ten deflection coefficients are obtained.

The attenuator sections are frequency compensated by trimmers 504, 508, 512, 517 and 521 so that the input impedance of 1 M Ω //30 pF sockets 853 and 854 is the same in all position of step attenuators 805a and 805b. The input capacitance is adjusted to the same value for all attenuator positions by means of trimmers 502, 506, 510, 515 and 518.

3.1.2. Vertical amplifier: Unit 2

The oscilloscope comprises two identical vertical amplifiers, one for channel Y_A and one for channel Y_B , the former of which is described. The corresponding elements for channel Y_B are given in brackets.

3.1.2.1. Input stage

The input stage is equipped with a double triode 301 (351) and is connected so as to form a pushpull amplifier. One system of the valve acts as an impedance converter (cathode follower) with a high input and a low output impedance, thus the next stage is voltage driven. Resistor 604 (654) protects the valve from too high an input voltage.

Diodes 407, 408 and 402 (457, 458 and 452) limit the output voltage of the cathode follower so as to protect the next stage. Normally these diodes are blocked.

The other system of the valve reduces the d.c. drift of the amplifier because variations of the d.c. levels on the cathodes of the push-pull amplifier cancel out.

A d.c. voltage is used for the heater supply of the valve.

3.1.2.2. Preamplifier

The preamplifier comprises three stages and will be discussed with the aid of the equivalent circuit shown in Fig. 6.

The first stage with transistors 311 and 312 (361 and 362) is a differential amplifier stage which balances the preamplifier. The large degree of negative feedback via resistor 611 (661) stabilises the gain and increases the output impedance of this stage. The transfer ratio (ratio of alternating output current and alternating input voltage) virtually equals the reciprocal value of the feedback resistor.

In position ACx10 of ACx10/AC/DC switch 807 (808) resistors 612 and 613 (662 and 663) shunt feedback resistor 611 (661) thus reducing its value by a factor of ten. Consequently, the gain of the stage increases by the same factor.

Basically, the first stage is a voltage-to-current converter. Its output current, which is proportional to the input signal, is applied to terminals 3 and 4 of the second stage.

Select-in-test resistor 638 (688) allows adjusting of the operating point of the first stage.

The second stage with transistors 313 and 314 (363) and (364) is an amplifier with negative shunt-feedback via resistors 616 and 618 (666 and 668). As a result of this feedback method, the in- and output impedance is low (virtually the reciprocal value of the mutual conductance of the transistor). As the input impedance is low and the stage is driven by a current, the voltage difference between terminals 3 and 4 is small. The magnitude of the amplified voltage across terminals 5 and 6 is chiefly determined by resistors 616 and 618 (666 and 668). The output voltage across terminals 5 and 6 causes feedback currents to flow through these resistors.

Consequently, the currents through terminals 3 and 4 are practically balanced. The base currents i_B are negligible in relation to the feedback currents. The second stage is basically a current-to-voltage converter.

The gain of the first two stages (between terminals 5-6 and 1-2) is 4x in positions AC and DC of ACx10/AC/DC switch 807 (808).

This gain is slightly lower than the theoretical value that can be found using the approximation formula:

$$\begin{aligned} \text{gain} &= \frac{\text{feedback resistance 616} + 618}{\text{feedback resistance 611}} \\ &= \frac{12 \text{ k}\Omega + 12 \text{ k}\Omega}{5.1 \text{ k}\Omega} = 4.7 \end{aligned}$$

In position ACx10 of the ACx10/AC/DC switch, the gain is 40.

Capacitors 505 and 508 (555 and 558) and trimmer 509 (559) correct the frequency response at high frequencies. Y_A and Y_B POSITION potentiometers 602a and 602b allow a zero-line shift of approximately three times the screen height.

The third stage of the preamplifier comprises transistors 315 and 316 (365 and 366) and is basically a voltage-to-current converter like the first stage.

The overall gain of the preamplifier is adjusted by means of potentiometer 627 (677). Resistor 629 (679) and capacitor 510 (560) correct the frequency response.

3.1.2.3. Trigger pick-off stage

The triggering signal is obtained from the collector of transistor 314 (364) and applied to the trigger-pulse shaper via emitter follower 317 (367).

The emitter voltage of transistor 317 (367) and the input signal are in phase with one another.

3.1.2.4. Channel switch

The switch consisting of diodes 405 and 406 (455 and 456) connects the preamplifier output of the input of the final amplifier (terminals 7 and 8 in Fig. 6). The anode potential of these diodes is approximately +6.8 V. They are conductive and do not affect the collector currents of transistors 315 and 316 (365 and 366), as long as diodes 403 and 404 (453 and 454) are blocked. The latter diodes are blocked if their cathode potential is approximately 0 V.

Diodes 403 and 404 (453 and 454) are conductive if their cathode potential is about +9.5 V.

Then the collector currents of transistors 315 and 316 (365 and 366) are short-circuited and no signal reaches the final amplifier.

Diodes 403 and 404 (453 and 454) are driven by the output voltage of a flip-flop.

3.1.2.5. Flip-flop

The flip-flop acts as driver stage for the channel switch and comprises transistors 371 and 372.

It is equipped with two set inputs controlled by the Y OFF switch, and a trigger input. The trigger pulses for the latter are, in the alternated mode, obtained from the sawtooth generator and in the chopped mode from the chopper multivibrator.

Transistors 371 and 372 are simultaneously driven on their base via diodes 461 and 464. The transistor which was cut off up to then starts conducting and this condition is maintained via feedback resistors 705 and 706. At the same time, the transistor which was conducting is cut off.

Y OFF switches 602a and 602b determine the potential on the set inputs in such a way that the collector potentials of transistors 371 and 372 approximately +9.5 V when the switch contacts are open.

If the instrument is used as a single-trace oscilloscope, the blocked channel remains operative and can be used as trigger amplifier.

3.1.2.6. Y Output amplifier

The equivalent circuit of the output amplifier is shown in Fig. 7. The cascode circuits with transistors 373-375 and 374-376 form together basically a current-to-voltage converter which is supplied with a constant current from current source 377-378.

The gain between terminals 11-12 and 5-6 is 75x. The cascode circuits have such a form of negative feedback via resistors 709 and 710, that both input and output impedance are low. Owing to the low input impedance and the constant current drive of the stage, the voltage difference between terminals 9 and 10 is small.

The output voltage across terminals 11 and 12 is chiefly determined by resistors 709 and 710. This voltage causes feedback currents to flow through resistors 709 and 710. Consequently, the currents through terminals 9 and 10 are practically balanced. The base current i_B of transistors 373 and 374 are negligible in relation to the feedback currents.

The collector current of transistors 377 and 378 is kept constant by means of zener diodes 465 and 466 together with emitter resistors 717 and 718.

The Y deflection plates as well as the feedback resistors 709 and 710 have been connected to the emitters of transistors 377 and 378 in stead of to the output of the constant-current source.

As a result of this, the stray capacitances can be charged and discharged faster so that the bandwidth of the Y amplifier is enlarged.

Diodes 467 and 468 protect transistors 377 and 378 from too high a negative base-emitter voltage.

Capacitors 578 and 579 improve the h.f. behaviour of the current sources. Capacitors 575 and 576 correct the frequency response at high frequencies.

The connection cable to the Y deflection plates is matched with the output of the final amplifier by means of resistors 722 and 723 ($150 \Omega + 150 \Omega = 300 \Omega$). The anode and the screening of the c.r.t. obtain the average potential of the Y output voltage via resistors 720 and 721. This obviates an astigmatism adjustment.

Resistors 711 and 712 limit the driving range of the Y amplifier.

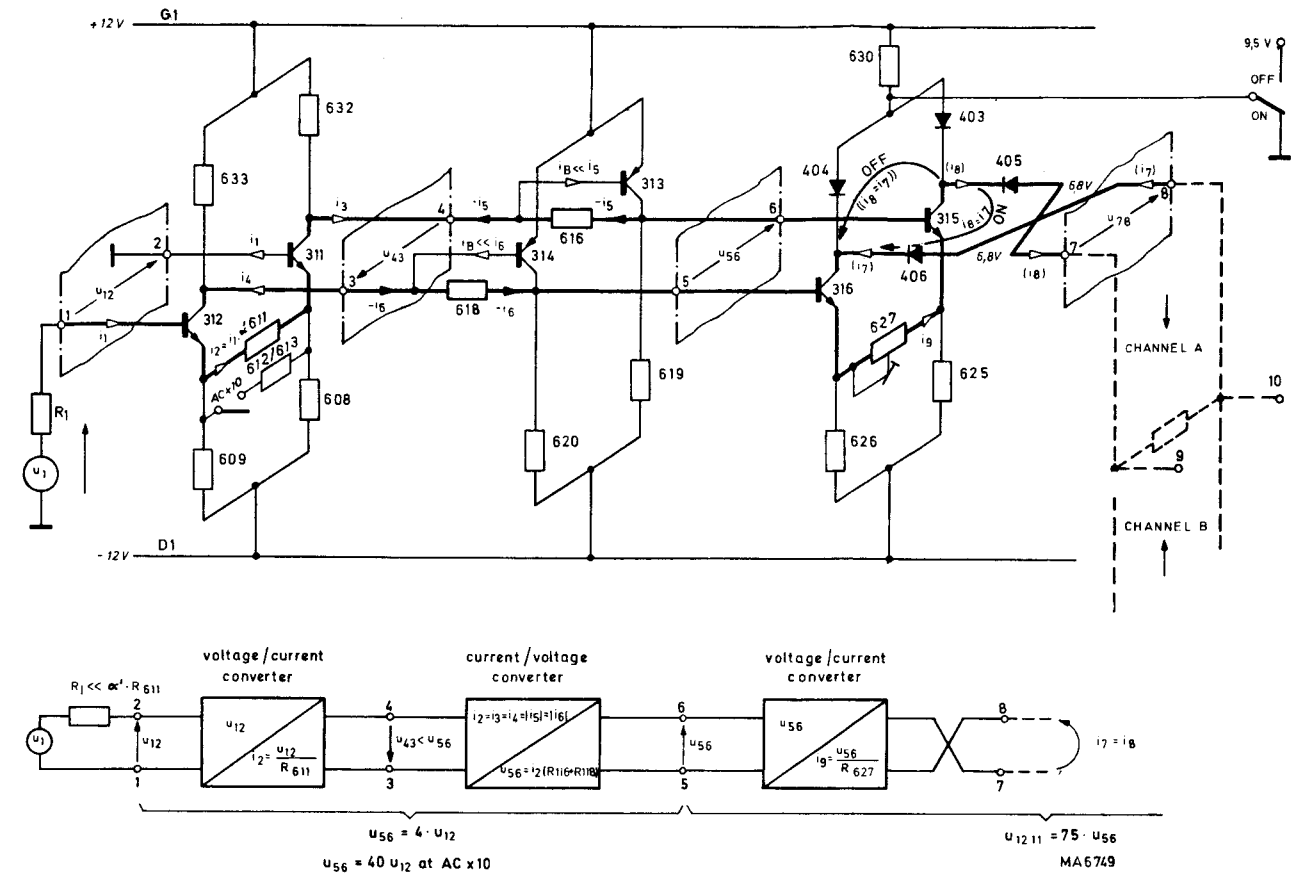

Fig. 6. Equivalent circuit of the Y preamplifiers and the channel switch

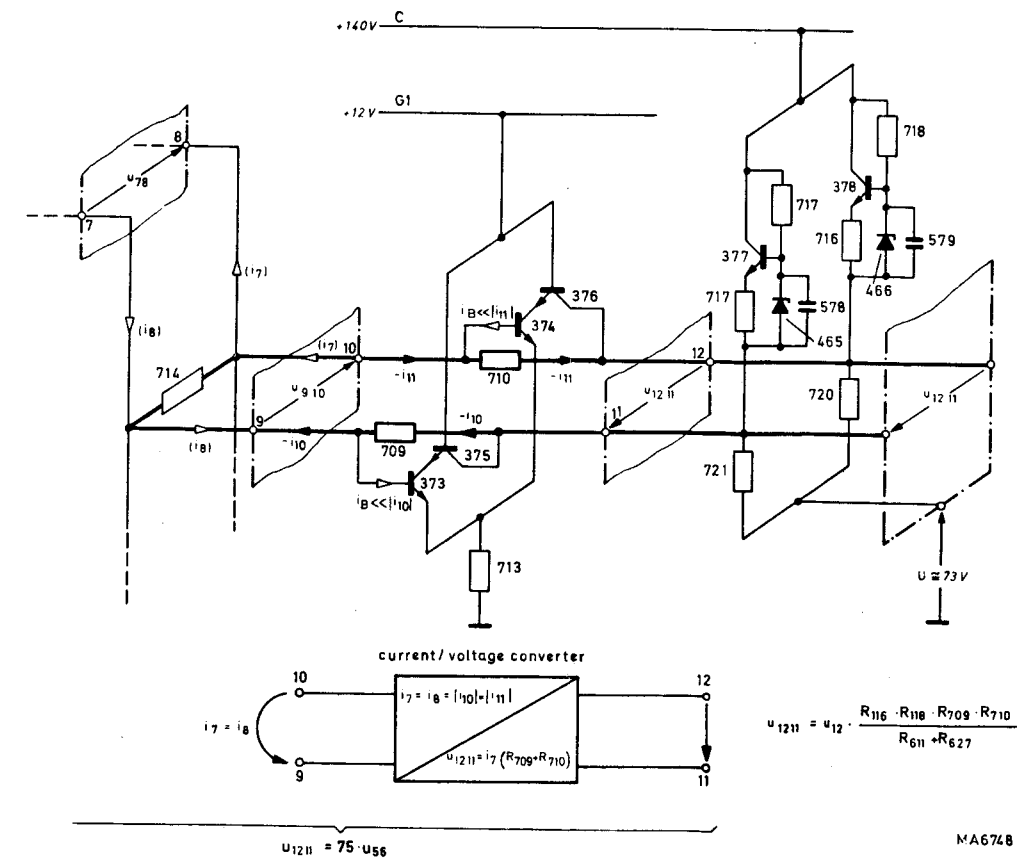

Fig. 7. Equivalent circuit of the Y output amplifier

3.1.3. Horizontal amplifier: Unit 3 and Unit 3A

3.1.3.1. Input amplifier and attenuator

The input amplifier comprises transistors 301 and 302 and is used both as trigger amplifier and as X amplifier. Both stages are basically current-to-voltage converters the gain of which is chiefly determined by resistors 604/U3 and 610/U3. The second stage (transistor 302) is used as phase inverter. The collector voltages of transistors 301 and 302 are equal in amplitude and opposite in phase. The +/– switch 803 allows selection of one of these voltages thus enabling triggering on the positive- or negative-going edge of the signal. The amplitudes of the collector voltage are equalized by means of potentiometer 607/U3.

In the external triggering mode, transistor 301 is protected from overloads by resistor 601/U3 and diodes 401, 402, 403 and 404.

For external X deflection, transistor 301 is protected by resistor 601/U3A and the same diodes; resistor 602/U3A reduces the gain by a factor of five.

3.1.3.2. Peak detector and sync separator

The peak detector consists of a clamping circuit followed by a switching stage with transistor 304.

The clamping circuit comprises emitter follower 303, capacitor 503 and diode 405. The positive half-cycles of the triggering signal at the emitter of transistor 303 charge capacitor 503 via diode 405 to the peak value of the triggering signal.

As a result of this, the anode of diode 405 and, thus, the base of transistor 304 will attain a potential of approximately 0 V.

Via the leakage in capacitor 503, the reverse resistance of diode 405, the input impedance of transistor 304, and resistor 616/U3, capacitor 503 can be discharged a little. This results in a positive potential of approximately 1 V on the anode of diode 405 and the base of transistor 304 during the peaks of the triggering signal.

The switching stage is conductive when the base of transistor 304 is positive with respect to its emitter. The emitter is biased at -0.7 V by resistor 619/U3 and diode 406/U3, so that the transistor will be conductive during the positive peaks of the triggering signal. When transistor 304 is cut off, its collector voltage is determined by resistors 617/U3 and 618/U3. This voltage level lies above the hysteresis gap of the next Schmitt-trigger with transistors 305 and 306 (Fig. 8).

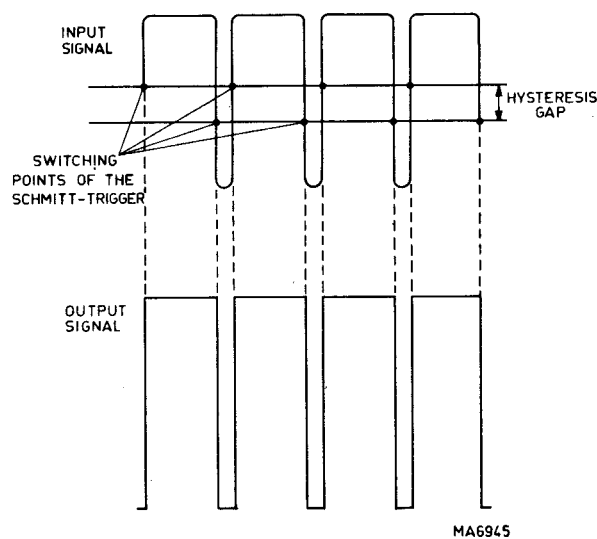

Fig. 8. Working of Schmitt-trigger 305-306

If transistor 304 (switching stage) is conductive, the collector voltage of this transistor is approximately +2 V. This voltage level lies below the hysteresis gap of the Schmitt-trigger.

In position LF-TV of HF/LF-TV/MAINS switch 802 the peak detector operates as sync separator. Then switching stage 304 is driven in such a way that it is only conductive during the peaks of the sync pulses. The frame and line sync pulses are separated by means of capacitors 505/U3 and 506/U3a, together with TIME/cm switch 801. In positions 0.2 ms to 50 ms of TIME/cm switch 801, triggering takes place on the frame sync pulses and in positions 0.5 μ s to 0.1 ms on the line sync pulses.

The LF-TV position may also be useful when l.f. signals (up to approx. 17 kHz) are used for triggering, as possible h.f. interferences are suppressed by capacitor 505/U3.

In position HF of HF/LF-TV/MAINS switch 802 the maximum bandwidth of the stage is available; it is, therefore, important to set the switch to this position when h.f. signals are used for triggering.

In position MAINS of HF/LF-TV/MAINS switch 802 transistor 304 is cut off and Schmitt-trigger 305-306 is, via voltage divider 622/623/U3, driven by a signal with the mains frequency.

3.1.3.3. Trigger-pulse shaper

The Schmitt-trigger with transistors 305 and 306 (Fig. 8) is a trigger pulse shaper which supplies trigger pulses with the same frequency as the input signal. Emitter follower 307 matches the output of the Schmitt-trigger and the high load by the auto-circuit.

3.1.3.4. Time-base generator and hold-off circuit

The time-base generator comprises constant-current source 311-312 driven by sweep-gating multivibrator 309-310. For the explanation of the circuit we start with the following condition of the sweep-gating multivibrator: transistor 309 cut off, transistor 310 conductive. Then the collector voltage of transistor 310 is approximately +7 V.

As the Zener voltage of diode 409 (appr. 7.2 V) and the collector voltage of 310 are of opposite polarity, the base voltage of transistor 312 is slightly negative so that this transistor is cut off.

As long as transistor 312 remains cut off, current source 311 charges capacitor 514 and, dependent on the position of TIME/cm switch 801, either capacitor 501 or 502 with a constant current.

This results in a linearly increasing voltage across these capacitors. This sawtooth voltage is available on the emitters of emitter followers 313 and 314. The emitter voltage of transistor 313 is applied to the horizontal amplifier, via TIME/cm switch 801. The emitter voltage of transistor 314 is fed back to sweep-gating multivibrator 309-310, via resistor 638/U3.

If the sawtooth voltage has reached a certain level, the sweep-gating multivibrator switches over to the condition: transistor 309 conductive, transistor 310 cut off. Then the collector voltage of transistor 310 is approximately +12 V. The difference between this voltage and the zener voltage of diode 409 is about 4.5 V. Consequently, the base potential of transistor 312 becomes so positive that the transistor is hard on, and the fly-back takes place.

As long as transistor 312 is conductive, the time-base capacitors are discharged via this transistor. Upon arrival of a negative pulse on the base of transistor 309, the sweep-gating multivibrator switches over to condition: transistor 309 cut off, transistor 310 conductive.

The feedback circuit also comprises the hold-off capacitors 503/U3A, 504/U3A and 512/U3 which prevent starting of the time-base generator before the time-base capacitors have been entirely discharged.

Potentiometers 647/U3 and 648/U3 allow adjustment of the time coefficients in the ranges 50 ms/cm to 1 ms/cm and 0.5 ms/cm to 0.5 μ s/cm.

The magnitude of the charging current of the time-base capacitors and, thus, the time-coefficient is determined by resistors 603/U3A to 608/U3A. Continuous control of the charging current is possible with the TIME/cm control 609/U3A.

3.1.3.5. Trigger auto-circuit

In the absence of a triggering signal transistor 304 is continuously conductive. Then the collector voltage of this transistor drives pulse shaper 305-306 in such a way that transistor 305 is cut off and 306 is conductive. The collector voltage of transistor 306 is then approximately 6 V. Capacitor 508/U3 is charged to this potential via emitter follower 307 and diode 407. Consequently, the average d.c. potential at the top of voltage divider 631...635 drops from 11 V (when the time base is not free-running) to 6 V and the d.c. base potential of emitter follower 308 drops accordingly. This results in a drop of the average d.c. base level of transistor 309 in the sweep-gating multivibrator 309-310.

The sawtooth voltage which is fed back via transistor 314 and superimposed on this level can now exceed both limits of the hysteresis gap of transistor 309. The time-base generator is then free-running, i.e. the described cycle is repeated periodically.

N.T.C. Resistor 634 stabilises the temperature of voltage divider 631-632-633-635/U3.

The d.c. level of the trigger auto-circuit can be adjusted with potentiometer 632/U3.

3.1.3.6. X Output stage

The working of the X output amplifier is basically identical to that of the Y amplifier.

Transistor 317 acts as a constant-current source in the emitter circuit of transistors 315 and 316.

These transistors form a differential amplifier, one input of which is driven by the sawtooth generator.

The other input is driven by a d.c. voltage from X POSITION potentiometer 601b, allowing trace shift in horizontal direction.

The gain of the differential amplifier can be preset by potentiometer 659/U3; continuous control is possible with X MAGN. potentiometer 601a.

The voltage gain is obtained by means of the cascode circuits 318-320 and 319-321.

Resistors 662, 663, 669, 679 and 680/U3 stabilise and couple the amplifier stages.

3.1.3.7. Chopper multivibrator

The chopper multivibrator is an astable emitter-coupled multivibrator comprising transistors 322/U3 and 323/U3. The marking and spacing intervals of the generated signal differ strongly and are chiefly determined by the unequal emitter resistances. The frequency of the signal is approximately 400 kHz.

3.1.3.8. Blanking stage

The blanking stage suppresses the electron beam during the flyback of the sawtooth and during the switching from channel Y_A to channel Y_B in the chopped mode. The stage comprises transistors 326/U3 and 327/U3 in cascode arrangement.

Via coupling diodes 412/U3 and 413/U3, the blanking stage is driven by either the time-base generator or the chopper multivibrator. This depends on the position of TIME/cm switch 801.

The blanking stage supplies a positive voltage of approximately 100 V with negative-going pulses of a large amplitude. Capacitor 513/U4 blocks the d.c. component of this signal. Diodes 405/U4 and 406/U4 suppress the positive pulses, so that the Wehnelt cylinder receives only negative pulses.

The c.r.t. is cut off during the time that the Wehnelt cylinder is kept at a negative potential by these pulses.

3.1.3.9. Square-wave generator

The square-wave generator is an astable emitter-coupled multivibrator comprising transistors 328/U3 and 329/U3. The generated signal has a mark-to-space ratio of 1:1 and a frequency of approximately 2 kHz.

Diode 415 clips the signal so as to obtain a well-defined square wave of approximately 5 V_{p-p}.

3.1.4. Power supply: Unit 4

3.1.4.1. Unstabilised d.c. voltages

Rectifier 412 supplies the voltage for the Y output amplifier and the blanking stage (voltage C).

The voltage doubler with diodes 411 and 413 and capacitors 524 and 525 supplies the voltage for the X output amplifier (voltage B) and also, via resistor 618 (voltage A) the Y and X input stages.

Rectifier 410 supplies a positive and a negative voltage for the heater supply of the Y input valves.

The use of d.c. voltages prevents hum phenomena.

3.1.4.2. Stabilised high-voltage supply

The d.c. converter is a controlled sine-wave oscillator with voltage tripler. The oscillator circuit formed by coil 751 and capacitors 501, 502 and 503 is connected between emitter and collector of transistor 303. The a.c. voltage generated in oscillator coil 751 is approximately 700 V at a frequency of approximately 50 kHz. This voltage is rectified and trebled by diodes 402, 403 and 404 and capacitors 505, 506 and 507, and smoothed by RC filter 607-510.

The control voltages for the intensity of the electron beam and its focussing are taken off from the voltage divider with resistors 608, 603, 610, 604, 611, 612, 613 and 614.

The control ranges of potentiometers INTENS 603 and FOCUS 604 are determined by potentiometer 608/U4. The driving voltage for the control amplifier with transistors 301 and 302 is adjusted with potentiometer 613. Diode 401 acts as reference source. The ripple component of the output voltage is fed back via the capacitive voltage divider with capacitors 507 and 508. This gives an extra driving signal for the control amplifier so that the high voltage is additionally smoothed and stabilised.

Diodes 405 and 406 suppress the positive pulses of the blanking signal.

3.2. DISMANTLING

IMPORTANT – In this instrument very high voltages are generated so that you must take due care when you are working on the interior of the instrument.

- Switch off the instrument at least one minute before you start replacing parts.

3.2.1. Removing top cover and handle

- Remove the two screws at either side of the instrument
- Lift off the cover

The handle has been fitted to the cover with a screw and nut at either end of the handle bracket.

3.2.2. Removing the bottom plate

- Remove the four screws on the bottom plate
- Lift off the bottom plate

3.2.3. Removing the knobs

3.2.3.1. Single knobs

The knobs can be pulled off the shaft.

3.2.3.2. Double knobs (Fig. 9)

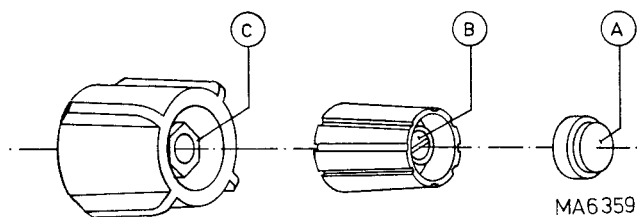

Fig. 9. Removing the knobs

- Remove cap A
- Slacken screw B
- Pull the inner knob off the shaft
- Slacken nut C
- Pull the outer knob off the shaft

3.2.4. Removing bezel and measuring graticule

The bezel can be pulled off after slightly pressing its long sides together. Subsequently, the contrast filter and the measuring graticule can be removed.

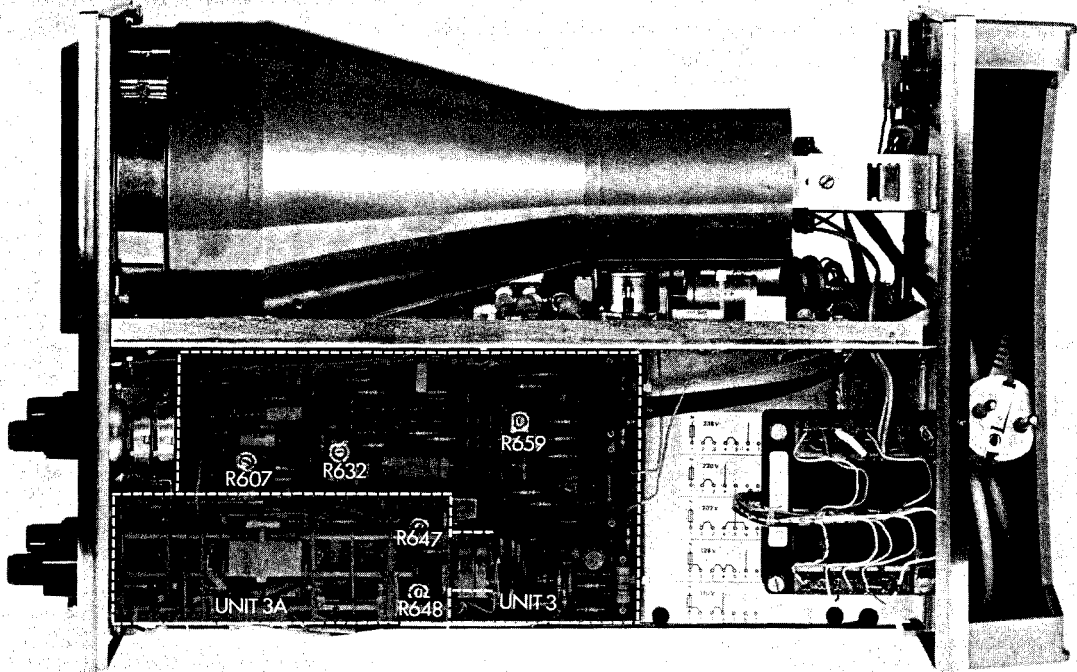

Fig. 10. Adjusting elements on Unit 3

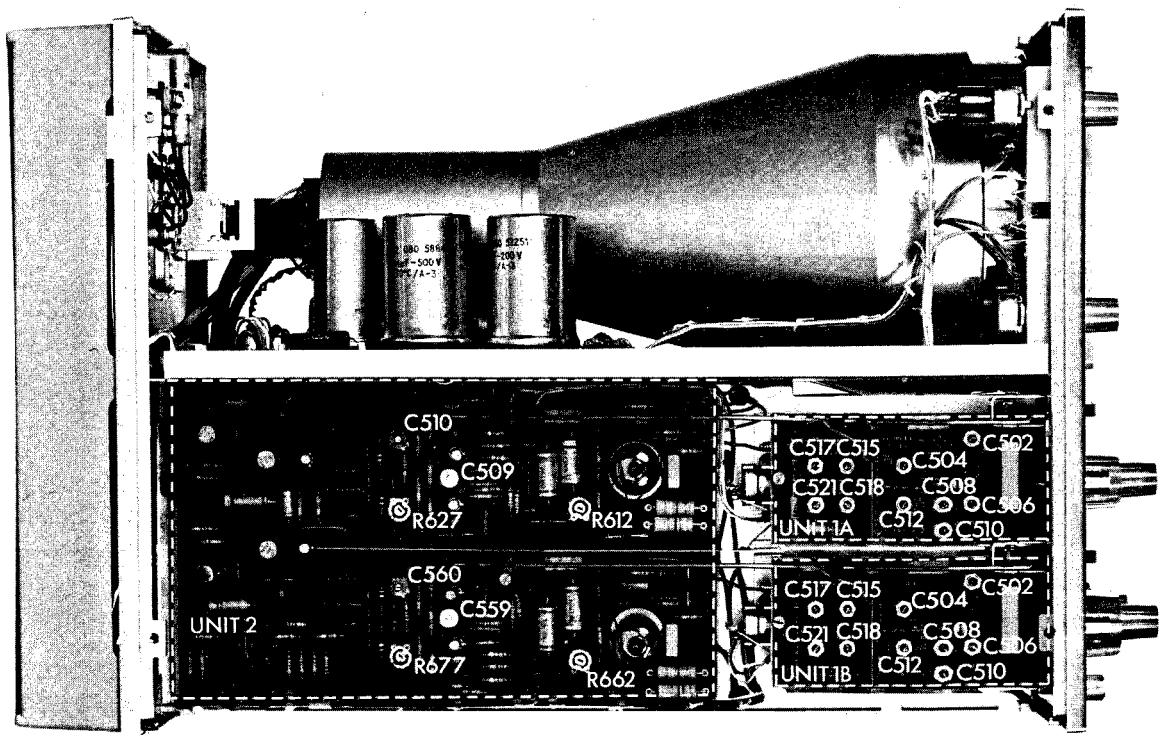

Fig. 11. Adjusting elements on Units 1A, 1B and 2

3.3. ADJUSTING ELEMENTS AND THEIR FUNCTIONS

<i>Adjusting element</i>	<i>Section</i>	<i>Adjustment</i>	<i>Fig.</i>
Potentiometer 613/U4	3.4.2.	C.r.t.	12
Potentiometer 608/U4	3.4.2.	C.r.t.	12
Potentiometer 607/U3	3.4.3.2.	Gain	10
Potentiometer 659/U3	3.4.3.2.	X Magnification	10
Potentiometer 632/U3	3.4.3.3.	Stability	10
Resistor 631/U3	3.4.3.3.	Stability	10
Potentiometer 647/U3	3.4.3.4.	Time base	10
Potentiometer 648/U3	3.4.3.4.	Time base	10
Potentiometer 627/U2, 667/U2	3.4.5.2.	Y Gain	11
Trimmer 509/U2, 510/U2 559/U2, 560/U2	3.4.5.3.	Frequency response	11
Resistor 638/U2, 688/U2	3.4.5.4.	Y Position	11
Potentiometer 612/U2, 662/U2	3.4.5.5.	ACx10	11
Trimmer 517/U1A (B) 515/U1A (B) 521/U1A (B) 518/U1A (B) 504/U1A (B) 502/U1A (B) 508/U1A (B) 506/U1A (B) 512/U1A (B) 510/U1A (B)	3.4.5.6.	Attenuator	11

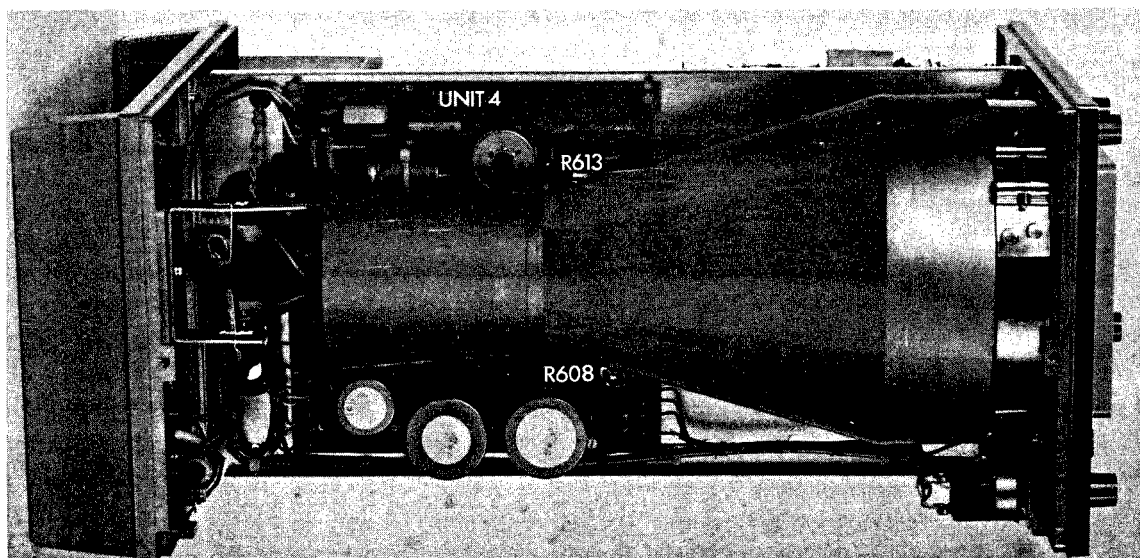

Fig 12. Adjusting elements on Unit 4

3.4. CHECKING AND ADJUSTING

The tolerances given in the following text apply to newly adjusted instruments only. Therefore, they may differ from the values stated in chapter 1.2.

All adjusting elements are tabulated together with their functions and positions in chapter 3.3.

3.4.1. Power supply (Unit 4)

- Connect the instrument to the mains via an ammeter (moving-iron instrument)
- Check that the mains current is approximately 220 mA at a mains voltage of 220 V.
- Check the d.c. and hum voltages in accordance with the following table:

<i>Contacts</i>	<i>Nominal value</i>	<i>Tolerance</i>	<i>Hum voltage</i>
3-1	+150 V	±2 %	≤ 0.3 V _{p-p}
4-1	+140 V	±2 %	≤ 3 V _{p-p}
7-1	+440 V	±2 %	≤ 10 V _{p-p}
8-1	– 18.6 V	±2 %	≤ 1.5 V _{p-p}
11-1	+ 18.6 V	±2 %	≤ 1.5 V _{p-p}
12-1	– 15.2 V	±3 %	≤ 0.12 V _{p-p}
13-1	+ 14.7 V	±3 %	≤ 0.12 V _{p-p}

3.4.2. Cathode-ray tube (310)

- Display a time-base line using INTENS. potentiometer 603.
- Check that the voltage between contact U4/16 and earth (⊥) is $-1.95 \text{ kV} \pm 50 \text{ V}$ (use a d.c. voltmeter with an internal resistance $> 50 \text{ M}\Omega$). If necessary readjust potentiometer 613/U4.
- Lower the mains voltage by 15 %.
- Focus the beam with FOCUS potentiometer 604.
- Set INTENS. potentiometer 603 for maximum intensity
- Adjust potentiometer 608/U4 in such a way that the voltage between contact U4/16 and earth (⊥) is not influenced ($< 1 \%$).
- Check that the trace runs parallel to the graticule. If necessary, slacken the collet and turn the c.r.t. to the correct position.
- Readjust the mains voltage to its nominal value.
- Check that the zero line does not drift more than 2 mm per hour after warming up.

3.4.3. X Adjustment (Unit 3)

3.4.3.1. Checking the operating point of the output stage

- Interconnect contacts U3/15 and U3/16 by means of two series-connected $100 \text{ k}\Omega$ resistors.
- Check that the voltage at the centre tap is $+143 \text{ V} \pm 10 \%$ (use a d.c. voltmeter with an internal resistance $\geq 100 \text{ M}\Omega$).

3.4.3.2. Gain and X MAGN.

- Apply a sawtooth voltage to Y_A input socket 853.
- Apply a 1/2T square-wave voltage of 1.6 V_{p-p} , frequency 2 kHz, to X input socket 852.
- Set TIME/cm switch 801 to position 1V/cm.
- Set X MAGN. potentiometer 601a to position x5.
- Check that the trace width is 8 cm. If necessary, readjust potentiometer 607/U3.
- Increase the square-wave voltage to 8 V_{p-p} .
- Set TIME/cm switch 801 to position 5 V/cm.
- Check that the trace width is $8 \text{ cm} \pm 4 \%$.
- Set TIME/cm switch 801 to position 1 V/cm.
- Set X MAGN. potentiometer 601a to position x1.
- Check that the trace width is 8 cm. If necessary, readjust potentiometer 659/U3.
- Remove the input voltages

3.4.3.3. Stability

- Set potentiometer X MAGN. (601a) to position x1.
- Set switch TIME/cm (801) to position 10 μ s/cm.
- Set potentiometer TIME/cm (609) to position CAL.
- Set switch HF/LF-TV/MAINS (802) to position HF.
- Set switch +/- (803) to position +.
- Set switch Y_A/Y_B/EXT (804) to position EXT.
- Set switch Y_A AMPLITUDE (805a) to position 0.1 V/cm.
- Set switch ACx10/AC/DC (806a) to position DC.
- Remove top cover and handle of the oscilloscope (see point 3.2.1. of the manual).
- Apply a sine-wave voltage of 10 V_{pp}, 1 kHz to input socket X (852).
- Connect the negative pole of an earth-free d.c. voltage source of 2,5 V to input socket Y_A (853) and the positive pole to contact U3/34.
- Turn potentiometer 632/unit 3 fully clockwise.
- Shift the starting point of the displayed line onto the vertical centre axis by means of X POSITION potentiometer 601b.
- Shift the line 2 cm below the horizontal centre axis by means of Y_A POSITION potentiometer 602a.
- Turn potentiometer 632/unit 3 anti-clockwise until the line displayed is shifted 130 mV \pm 10 % upwards; if necessary, change the value of resistor 631/unit 3.
- Remove the voltage sources.

3.4.3.4. Time base and X POSITION

- Set X MAGN. potentiometer 601a to position x1.
- Set TIME/cm potentiometer 609 to position CAL.
- Apply needle pulses to Y_A input socket 853.
Pulse interval : equal to the time coefficient set with TIME/cm switch 801
Frequency error: \ll 1 %
Amplitude : equivalent to 4 cm trace height
- Check that the length of the time-base line is \geq 10 cm in all the time positions of the TIME/cm switch.
- Align the pulses with the graticule lines by means of X POSITION potentiometer 601b.
- Set TIME/cm switch 801 to position 5 ms/cm.
- Check that the 8 centre periods have a total width of 8 cm. If necessary, readjust potentiometer 647/U3.
- Set TIME/cm switch 801 to position 20 μ s/cm.
- Check that the 8 centre periods have a total width of 8 cm. If necessary, readjust potentiometer 648/U3.
It could be possible that a higher resistance value for potentiometers 647 and 648 is required, in this case the connection wires from unit 3 (contacts 28 and 29) to unit 3A have been replaced by resistors 750/unit 3A (2 k Ω).
- Check the error of the time coefficients in the other positions of TIME/cm switch 801:
 $<$ 3 % within \pm 4 cm on the X axis
 \leq 5 % at the edge of the screen
- Check that the control range of TIME/cm potentiometer 609 is at least 1:2.5
- Turn X POSITION potentiometer 601b fully both ways. It must be possible for both the start and the end of a 10 cm wide trace to be shifted to as far as the centre of the graticule.
Tolerance: \pm 5 mm.
- Remove the input signal

3.4.4. Triggering

- Apply a video signal of 625 lines (or, on French standard, 819 lines) to Y_A input socket 853.
Trace height of the synchronising pulses: 1 cm.
- Set HF/LF-TV/MAINS switch 802 to position LF-TV
- Set +/- switch 803 to position + when the video signal is negative and to position – when it is positive.
- Check that the time-base generator is triggered by the line-synchronising pulses in positions 0.1 ms/cm to 0.5 μ s/cm of TIME/cm switch 801, and by the frame-synchronising pulses in positions 50 ms/cm to 2 ms/cm.
- Apply a sine-wave voltage with the mains frequency to Y_A input socket 853. Adjust for a trace height of 2 cm.
- Apply a sine-wave voltage of 6 V with the mains frequency to TRIGG. socket 852.
- Set HF/LF-TV/MAINS switch 802 to position HF.
- Set Y_A/Y_B/EXT. switch 804 to position Y_A.
- Check that there is a stationary display of a sine-wave voltage with the mains frequency.

- Set $Y_A/Y_B/EXT.$ switch 804 to position Y_B .
- Check that there is a zero line displayed (delayed).
- Apply the input voltage from the Y_A input socket 853 to Y_B socket 854.
- Check that there is a stationary display of a sine-wave voltage with the mains frequency.
- Set $Y_A/Y_B/EXT.$ switch 804 to position $EXT.$
- Check that there is a stationary display of a sine-wave voltage with the mains frequency.
- Set $+/-$ switch 803 to position $+$.
- Check that the trace starts with a positive-going slope.
- Set $HF/LF-TV/MAINS$ switch 802 to position $MAINS$.
- Check that there is a stationary display of a sine-wave voltage with the mains frequency.
- Remove the input signals.
- Apply a sine-wave voltage with a frequency of 10 Hz to Y_A input socket 853. Adjust for a trace height of 1 cm.
- Set $Y_A/Y_B/EXT.$ switch 804 to position Y_A .
- Set $HF/LF-TV/MAINS$ switch 802 to position HF .
- Check that there is a stationary display of a sine-wave voltage with a frequency of 10 Hz.
- Increase the frequency of the input signal to 10 MHz. Adjust for a trace height of 3 cm.
- Check that there is a stationary display of a sine-wave voltage of 10 MHz.
- Remove the input signal.

3.4.5. Y AMPLIFIER, CHANNEL A (B) (UNIT 2)

3.4.5.1. Checking the operating point of the output stage

- Check that the voltage between contact U2/13 and earth (\perp) is $+74\text{ V} \pm 10\%$ (use a d.c. voltmeter with an internal resistance $\geq 100\text{ M}\Omega$).

3.4.5.2. Y Gain

- Set $ACx10/AC/DC$ switch 807 (808) to position DC .
- Set $Y_A (Y_B)$ AMPLITUDE switch 805a (805b) to position 0.05 V/cm.
- Apply a square-wave voltage of 300 mV_{p-p} , frequency 2 kHz, rise time 300 ns, to $Y_A (Y_B)$ input socket 853 (854).
- Check that the trace height is 6 cm. If necessary, readjust potentiometer 627/U2 (677/U2).
- Check that the deviation of the Y gain at mains voltage fluctuations of -15% and $+10\%$ is less than 1 % in positions DC and AC of $ACx10/AC/DC$ switch 806a (806b), and less than 3 % in position $ACx10$.
- Readjust the mains voltage to its nominal value.

3.4.5.3. Frequency response

- Apply a square-wave voltage of 300 mV_{p-p} , frequency 1 MHz, rise time between 10 and 50 ns, to $Y_A (Y_B)$ input socket 853 (854).
- Adjust trimmer 509/U2 (559/U2) and 510/U2 (560/U2) for optimum square-wave response.
Maximum permissible overshoot: 2 %.
- Apply a sine-wave voltage of 400 mV_{p-p} , frequency 10 MHz to $Y_A (Y_B)$ input socket 853 (854).
- Check that the trace height is at least 5.6 cm.

3.4.5.4. Y POSITION

- Apply a sine-wave voltage of 1.2 V_{p-p} , frequency 1 MHz, to $Y_A (Y_B)$ input socket 853 (854)
- Turn $Y_A (Y_B)$ POSITION potentiometers 602a (602b) fully both ways and check that the peaks of the signal can be displayed without distortion within the measuring graticule. If necessary, select a different value for resistor 638/U2 (688/U2).
- Remove the input voltage.

3.4.5.5. ACx10 Adjustment, hum voltages

- Set $ACx10/AC/DC$ switch 807 (808) to position $ACx10$.
- Set $Y_A (Y_B)$ AMPLITUDE 805a (805b) to position 0.05 V/cm.
- Apply a square-wave voltage of 30 mV_{p-p} , frequency 2 kHz, rise time 300 ns, to $Y_A (Y_B)$ input socket 853 (854).

- Check that the trace height is 6 cm. If necessary, readjust potentiometer 612/U2 (662/U2).
- Decrease the frequency of the input signal to 10 Hz.
- Check the lower frequency limit by means of a droop test. The frequency limit should be lower than 2.5 Hz which corresponds to a droop of less than 46 % with respect to the peak value.
- Remove the input signal.
- Check that the deflection due to hum does not exceed 2 mm (peak-to-peak).

3.4.5.6. Attenuator (Units 1A and 1B)

- To equalize the input capacitance in all positions of the Y_A (Y_B) AMPLITUDE switch 805a (805b), an input RC standardizer is connected in series with Y_A (Y_B) input socket 853 (854). The input RC standardizer consists of the parallel circuit of a $1\text{ M}\Omega$ resistor and a 3-60 pF trimmer (Fig. 13) and is adjusted as indicated in the following table.
- Connect a square-wave generator (rise time 100 ns, internal resistance $< 1\text{ k}\Omega$) to Y_A (Y_B) input socket 853 (854). Adjust amplitude and frequency in accordance with the following table.
- Adjust the trimmers mentioned in the table for optimum square-wave response.

Y_A (Y_B) AMPLITUDE switch 805a (805b) to position	ACx10/AC/DC switch 806a (806b) to	Generator e.m.f.	Generator frequency (r.t. 100 ns)	Use input RC standardizer	Trimmer on UNIT 1A (1B) to be adjusted
0 V/cm	AC	600 mV	10 kHz	no	517
0.2 V/cm	AC	1.2 V	10 kHz	no	521
0.5 V/cm	AC	3 V	10 kHz	no	504
1 V/cm	AC	6 V	10 kHz	no	515
2 V/cm	AC	12 V	10 kHz	no	518
5 V/cm	AC	30 V	10 kHz	no	508
50 V/cm	ACx10	30 V	10 kHz	no	512
0.1 V/cm	AC	1.2 V	2 kHz	yes	trimmer
0.5 V/cm	AC	6 V	2 kHz	yes	502
5 V/cm	ACx10	6 V	2 kHz	yes	506
50 V/cm	ACx10	60 V	2 kHz	yes	510

} square-wave response
} trimmer in standardizer
} input capacit.

- Remove input voltage.

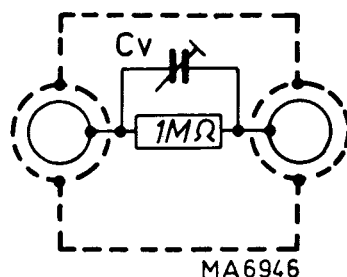

Fig. 13. Input RC standardizer

3.4.5.7. Cross talk

- Set ACx10/AC/DC switches 806a and 806b to position DC.
- Set Y_A and Y_B AMPLITUDE switches 805a and 805b to position 0.05 V/cm.
- Apply a sine-wave voltage of 0.8 V_{p-p} , frequency 10 MHz, to Y_A input socket 853.
- Check that the trace height on channel B due to cross talk does not exceed 0.2 cm (p-p).
- Connect the input signal to Y_B input socket 854.
- Check that the trace height on channel A due to cross talk does not exceed 0.2 cm (p-p).

- Increase the input voltage to 1.6 V_{p-p}.
- Decrease the frequency of the input signal to 1 MHz.
- Check that the trace height on channel A due to cross talk does not exceed 0.8 cm (p-p).
- Connect the input signal to Y_A input socket 853.
- Check that the trace height on channel B due to cross talk does not exceed 0.8 cm (p-p).

3.4.6. PROBE ADJ.

- Set ACx10/AC/DC switch 806a to position AC.
- Set Y_A AMPLITUDE switch 805a to position 1 V/cm.
- Apply the voltage of PROBE ADJ. socket 851 to Y_A input socket 853 with the aid of a 1:1 probe.
- Check that the trace height is 5 cm ± 10 % and that the frequency of the displayed waveform is 2 kHz ± 15 %.

3.4.7. AC/DC Mode

- Set Y_A and Y_B AMPLITUDE switches 805a and 805b to position 0.05 mV/cm.
- Apply a 500 V d.c. voltage to Y_A and Y_B input sockets 853 and 854.
- Set ACx10/AC/DC switches 806a and 806b from position DC to position AC.
- Check that the d.c. voltage is disconnected.
- Remove the input voltages.

3.4.8. Y POSITION and Y OFF switch

- Set Y_A POSITION potentiometer 602a to position Y_A OFF.
- Check that the channel A trace disappears.
- Set Y_B POSITION potentiometer 602b to position Y_B OFF.
- Check that the channel B trace disappears.

3.5. REPLACING COMPONENTS

The opening of parts or removal of covers is likely to expose live conductors. The instrument should, therefore, be disconnected from all voltage sources before any opening of parts or removal of covers is started.

During and after dismantling, bear in mind that capacitors in the instrument may still be charged, even if it has been separated from all voltage sources.

After replacing components it may be necessary to readjust the relevant circuit in accordance with chapter 3.4. CHECKING AND ADJUSTING.

3.5.1. Replacing the fuse

Thermal fuse 880 is fitted on top of the mains transformer. After unsoldering both connection wires, the fuse can be pulled out of the transformer.

The fuse can be replaced without removing the transformer from the instrument.

3.5.2. Replacing ECC83 valves 301/U2 and 351/U2

Replacement valves should be aged for 100 hours at an anode voltage of 140 V and an anode current of 1 mA.

3.6. INFORMATION FOR ASSISTENCE IN FAULT FINDING

3.6.1. Mains transformer 752

The winding data and the open output voltages of the mains transformer are indicated in Fig. 28.

3.6.2. Voltage levels and waveforms

The d.c. voltage levels in circuit diagram Fig. 33 have been measured with a PHILIPS Multimeter P817.

During the measurements no signal was applied to the input sockets Y_A and Y_B , and X MAGN. potentiometer 601a was set to position x1.

The waveforms have been recorded under the following conditions:

- HF/LF-TV/MAINS switch 804 to position HF.
- +/- Switch 803 to position +.
- $Y_A/Y_B/EXT.$ switch 804 to position Y_B .
- X MAGN. potentiometer 601a to position x1.
- TIME/cm potentiometer 609 to position CAL.
- Y_A and Y_B POSITION potentiometers 602a and 602b to mid position
- ACx10/AC/DC switches 806a and 806b to position AC.
- Y_B AMPLITUDE switch 805b to position 1 V/cm.
- TIME/cm switch 801 to position 0.1 ms/cm, with the exception of waveform  at the chopper multivibrator output (collector of transistor 323/U3) which has been measured with TIME/cm switch 801 set to position 0.2 ms/cm.
- A sine-wave voltage of 6 V_{p-p}, frequency 2 kHz, applied to Y_B input socket 854.

NOTE: All indicated voltage values should be regarded as typical values.

3.7. INFORMATION CONCERNING ACCESSORIES

3.7.1. Adapter PM 9051 (Fig. 14)

This is an adapter to make a BNC socket suitable for connection of two 4mm banana plugs..



Fig. 14. Adapter PM 9051

3.7.2. Viewing hood PM 9366 (Fig. 15)

This hood shields the tube face from external light when the intensity of the light produced by the oscilloscope screen is low e.g. when observing phenomena with a low repetition frequency and a short rise time.

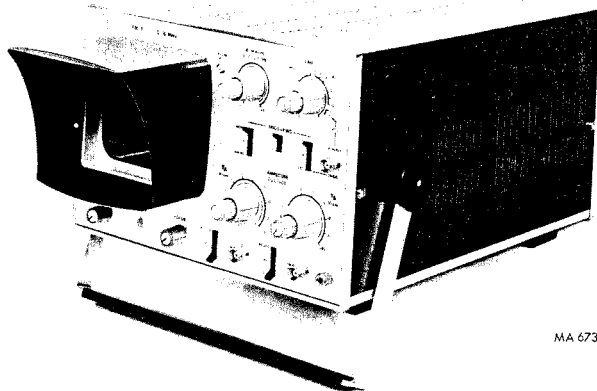

Fig. 15. Viewing hood

3.7.3. Multi-purpose camera PM 9380 (Fig. 16)

Camera PM 9380 has been designed to photograph oscilloscope displays in a quick and simple way. It incorporates the Polaroid instant photographic process which has the advantage that you can see the picture only a few moments after you took it.

The PM 9380 comprises:

- a camera body
- a lens unit
- a carrying case
- a manual

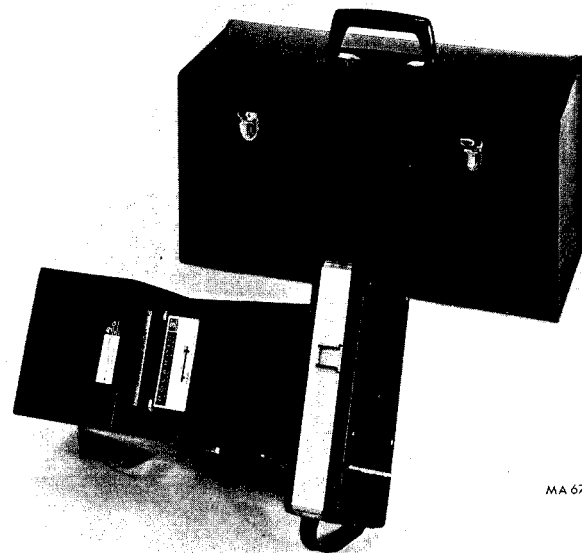

MA 6740

Fig. 16. Multi-purpose camera PM 9380

3.7.4. Adapter PM 9377 (Fig. 17)

This adapter forms the connection between camera PM 9380 and oscilloscope PM 3110. The dimensions of the adapter are such, that the camera is automatically focussed when the camera-adapter combination is held against the oscilloscope.

NOTE: Together with this adapter, supplementary lens PM 9373 must be used.



MA 6741

Fig. 17. Camera adapter PM 9377

3.7.5. Attenuator probe sets PM 9326 and PM 9327 (Fig. 18)

These passive probe sets are equal but for the length of the probe cable, which is 1,15 m for the PM 9326 and 2 m for the PM 9327.

The sets consist of:

1 probe cable	Fig. 18, item 1
1 earth lead 15 cm	Fig. 18, item 2
1 earth lead 30 cm	Fig. 18, item 3
1 measuring probe 1:1 (black)	Fig. 18, item 4
1 test pin	Fig. 18, item 5
1 test hook	Fig. 18, item 6
1 attenuator probe 1:10 (grey)	Fig. 18, item 7
1 test clip	Fig. 18, item 8
1 box	Fig. 18, item 9

For ordering numbers of these parts, see list 3.8.3.1.

The measuring probe and the earth lead can be simply pulled from the cable. The test clip, test pin and test hook are screwed on to the measuring probe.

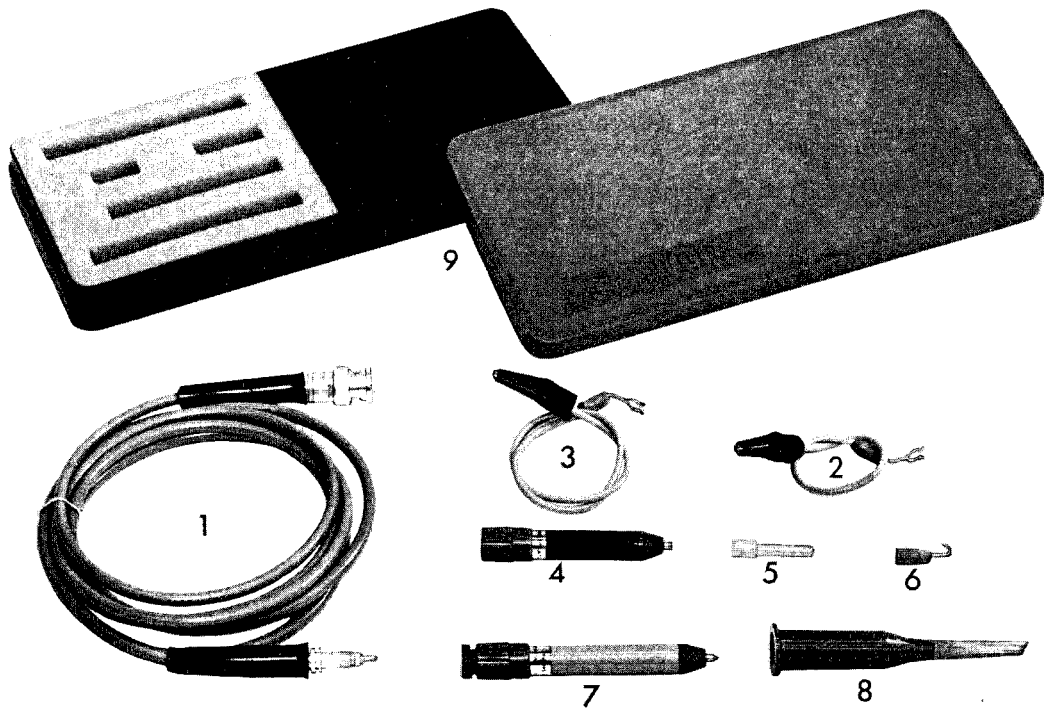

Fig. 18. Attenuator probe set PM 9326 (PM 9327)

3.7.5.1. Technical data

Attenuation	1:10 \pm 3 %
Input impedance	10 MOhm//10 pF
Max. permissible input voltage	1000 V _{p-p}

Maximum d.c. component 500 V with the blocking capacitor included into the circuit.

3.7.5.2. Adjustment (Fig. 19)

- Unscrew the probe locking nut by turning it anti-clockwise
- Rotate the probe body to change the capacitance while watching the display for the desired waveform
- When compensation is completed, carefully turn the locking nut clockwise, to lock it without disturbing the adjustment

The attenuator probe causes distortion if it has not been properly adjusted.

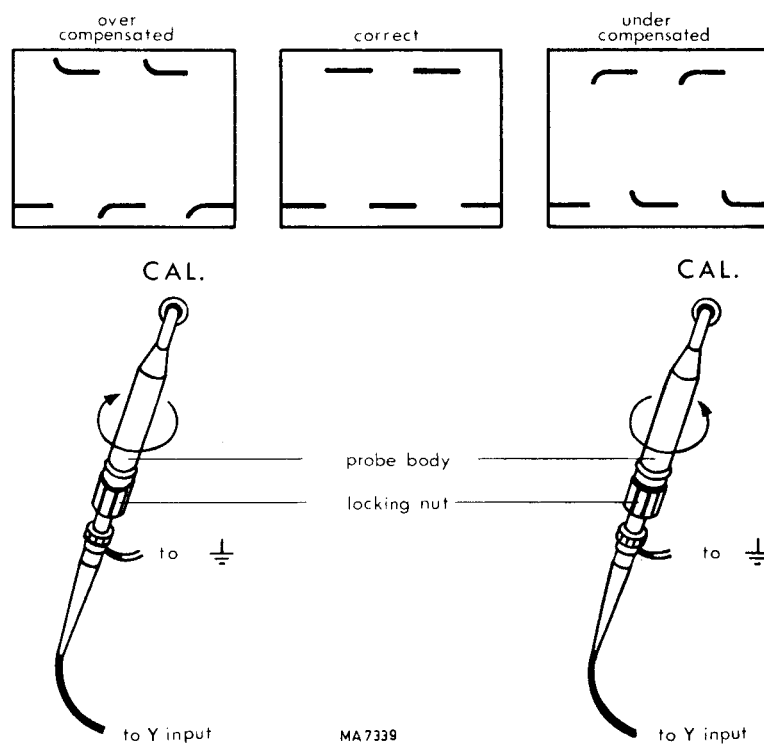

Fig. 19. Adjusting the attenuator probe

3.7.6. Attenuator probe sets PM 9336 and PM 9336L (Fig. 20)

The PM 9336 is a 10x attenuator probe, designed for oscilloscopes up to 25 MHz, having a BNC input jack and 10 to 35 pF input capacitance, paralleled by 1 M Ω . The PM 9336L is a similar probe with a cable length of 2.5 m.

The set consist of:

1 probe assembly	Fig. 20, item 1
5 soldering terminals	Fig. 20, item 2
1 test hook	Fig. 20, item 3
2 spare test hook sleeves	Fig. 20, item 4
1 protective cap	Fig. 20, item 5
1 probe holder	Fig. 20, item 6
2 probe tips	Fig. 20, item 7
1 earthing cord	Fig. 20, item 8
1 box	item 9

For ordering numbers of these parts, see list 3.8.3.2.

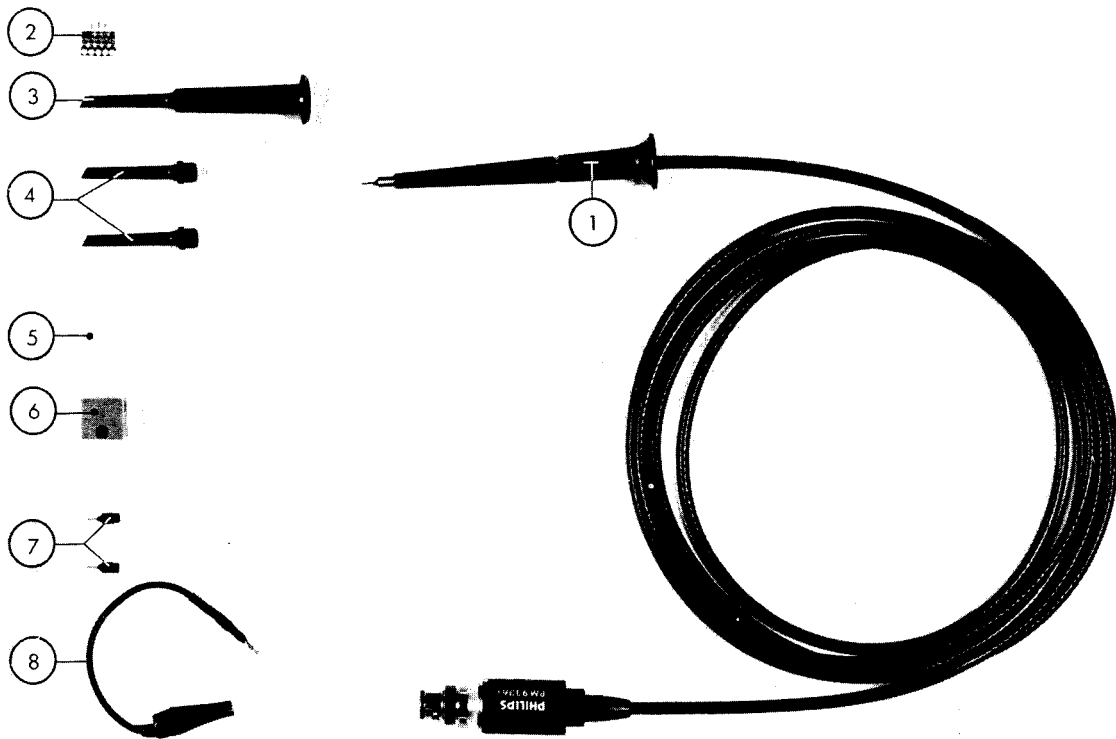

Fig. 20. Attenuator probe set PM 9336 (PM 9336L)

3.7.6.1. Technical data

Attenuation	1:10 \pm 3 %
Input resistance	PM 9336 10 M Ω \pm 2 % PM 9336L 10 M Ω \pm 2 %
Input capacitance	PM 9336 11 pF \pm 1 pF PM 9336L 14 pF \pm 1 pF
Maximum allowable input voltage	500 V (D.C. + A.C. peak)

3.7.6.2. Adjustment (Fig. 21)

The measuring probe has been adjusted and checked by the factory. However, to match the probe to your oscilloscope, the following manipulation is necessary.

Connect the measuring pin to socket CAL of the oscilloscope.

A trimmer can be adjusted through a hole in the compensation box to obtain optimum square-wave response.

See the following examples

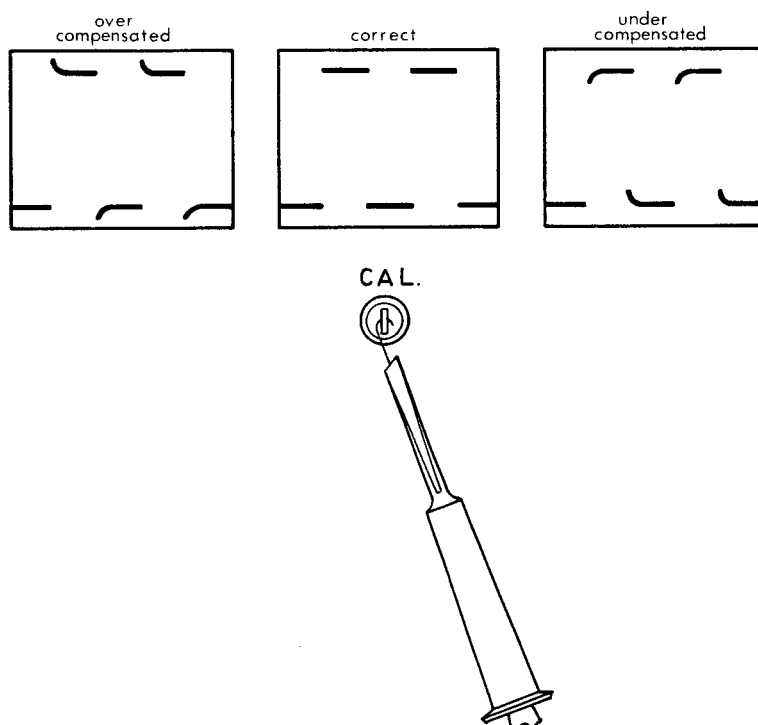

MA 8329

Fig. 21. Probe compensation

3.7.7. 1:1 Probe set PM 9335 (Fig. 22)

The PM 9335 is a passive probe without signal attenuation for use with oscilloscope, counters and voltmeters having a high input impedance and a BNC input socket.

The cable design is such that the reflections due to the instrument's capacitive load are absorbed.

The useful frequency range of this probe is restricted to d.c. and l.f. applications (up to 10 MHz).

The set consist of:

- | | |
|---------------------------|-----------------|
| 1 test hook | Fig. 22, item 1 |
| 2 spare test hook sleeves | Fig. 22, item 2 |
| 2 spare probe tips | Fig. 22, item 3 |
| 1 protective cap | Fig. 22, item 4 |
| 1 earthing lead | Fig. 22, item 5 |
| 1 probe holder | Fig. 22, item 6 |
| 1 probe assembly | Fig. 22, item 7 |
| 1 box | item 8 |

For ordering numbers of these parts, see list 3.8.3.3.

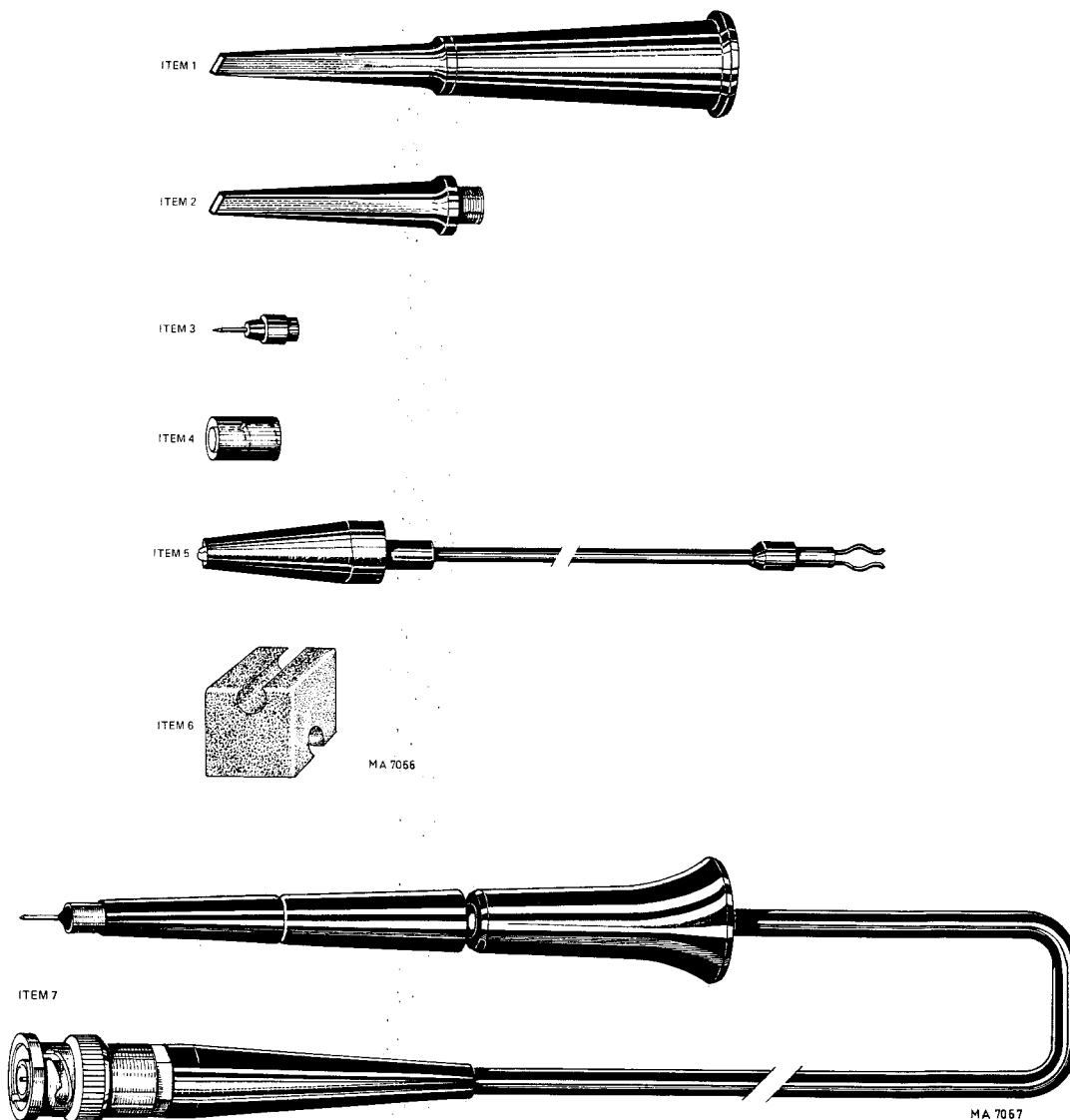

Fig. 22. Probe set PM 9335

3.7.7.1. Technical data

Attenuation	1:1		
Input resistance	1 MOhm		
Input capacitance	45 ± 5 pF + input cap. of measuring instrument		
Max. allowable input voltage			
D.C.	500 V		
A.C. peak-to-peak	500 V divided by frequencies in MHz or 500 V whichever is smaller		
A.C. peak + D.C.	500 V		
Dimensions	L	W	H
probe body	105		mm
cable	1.5		m
box	230	104	24 mm

3.7.8. Set of miniature probe clips PM 9333

PM 9333 Set of eagle clips especially designed to probe difficult to reach signal sources, all types of wrapped wiring etc.

Each set contains:

- 10 eagle clips fitting the probes PM 9335 - PM 9336 and PM 9336L
- 10 adapter pieces fitting the probes PM 9326 and PM 9327
- 10 adapter pieces fitting the micro-miniature probe PM 9352



Fig. 23. Probe clips PM 9333

3.8. PARTS LIST

3.8.1. Mechanical parts (including a few electrical parts)

<i>Item</i>	<i>Fig.</i>	<i>Qty</i>	<i>Order number</i>	<i>Description</i>
1	24	1	5322 450 74007	Text plate
2	24	1	5322 498 40323	Handle, complete
3	24	1	5322 268 10031	Contact plug
4	24	1	5322 325 80058	Grommet
5	24	1	5322 414 34081	Knob 23 mm dia., shaft 6 mm dia.
6	24	4	5322 414 34083	Knob 14.5 mm dia., shaft 4 mm dia.
7	24	3	5322 414 34081	Knob 23 mm dia., shaft 6 mm dia.
8	24	4	5322 414 74016	Cover for knob (blue)
9	24	5	5322 411 50258	Switch lever
10	24	1	5322 267 10004	BNC socket
11	24	1	5322 268 20051	Earth terminal
12	24	2	5322 267 10004	BNC socket
13	24	2	5322 413 30346	Knob 14.5 mm dia., shaft 6 mm dia.
14	24	2	5322 414 74014	Cover for knob (grey)
	24	2	5322	Shaft filling piece ^{*)}
15	24	1	5322 381 10116	Lens
16	24	4	5322 462 40201	Foot
17	24	2	5322 498 70043	Cover for handle
18	24	1	5322 450 60088	Measuring graticule
19	24	1	5322 480 30096	Contrast filter
20	24	1	5322 455 84042	Bezel
21	27	1	5322 290 60187	Terminal strip
22	25	1	5322 462 70826	Mains cable container
23	25	14	5322 255 40006	Transistor spacer TO5
24	25	2	5322 255 40053	Heat sink (for BF179)
25	25	1	5322 255 40073	Transistor spacer TO18
26	25	3	5322 277 30516	Slide switch (802, 803, 804)
27	25	1	5322 492 40377	Spring
28	27	6	5322 404 50375	Printed-wiring board clamp
29	25	1	4822 526 10016	Ferroxcube bead
30	27	4	5322 277 30411	Slide switch (806a, 806b, 807, 808)
31	27	2	4822 255 70139	Valve support (for ECC83)
32	25-27	5	5322 255 40054	Heat sink (for BFY50, BF178)
33	26	1	5322 255 70159	Valve support (for D13-480GH)
34	25	1	5322 131 20036	C.R.T. Type D13-480GH
35	25	1	5322 321 10073	Mains cable
36	25	1	5322 216 54085	Unit 3, complete
37	25	1	5322 105 30067	Unit 3A, complete
39	28	1	5322 146 34046	Mains transformer (752)
40	25-28	1	5322 252 20001	Thermal fuse
41	27	2	5322 131 80018	Valve ECC83
42	27	1	5322 134 20102	Neon tube
43	27	2	5322 105 30066	Unit 1A (B), complete
44	27	1	5322 216 50213	Unit 2, complete
45	26	1	5322 158 20341	Coil (751)
46	26	1	5322 216 50214	Unit 4, complete
47	25	1	5322 121 44028	Suppressing capacitor

^{*)} To match the flat-face shaft to the round bushing of the knob.

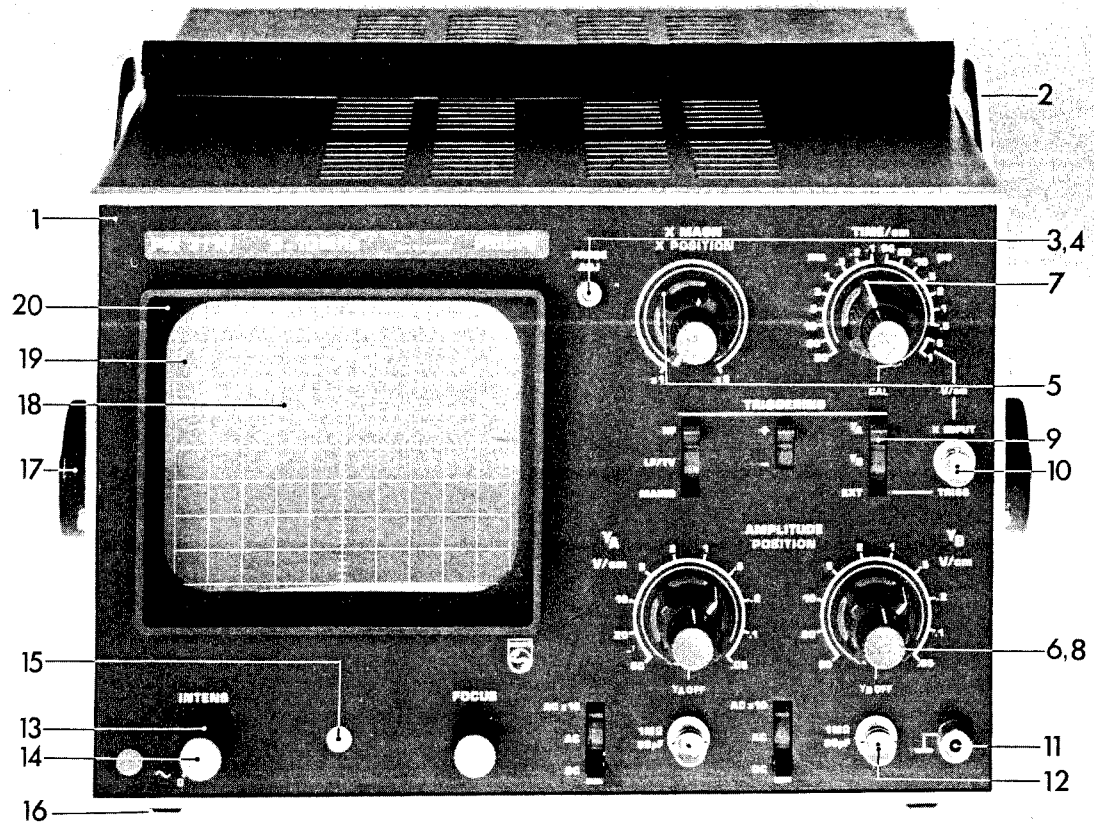

Fig. 24. Front view showing item numbers

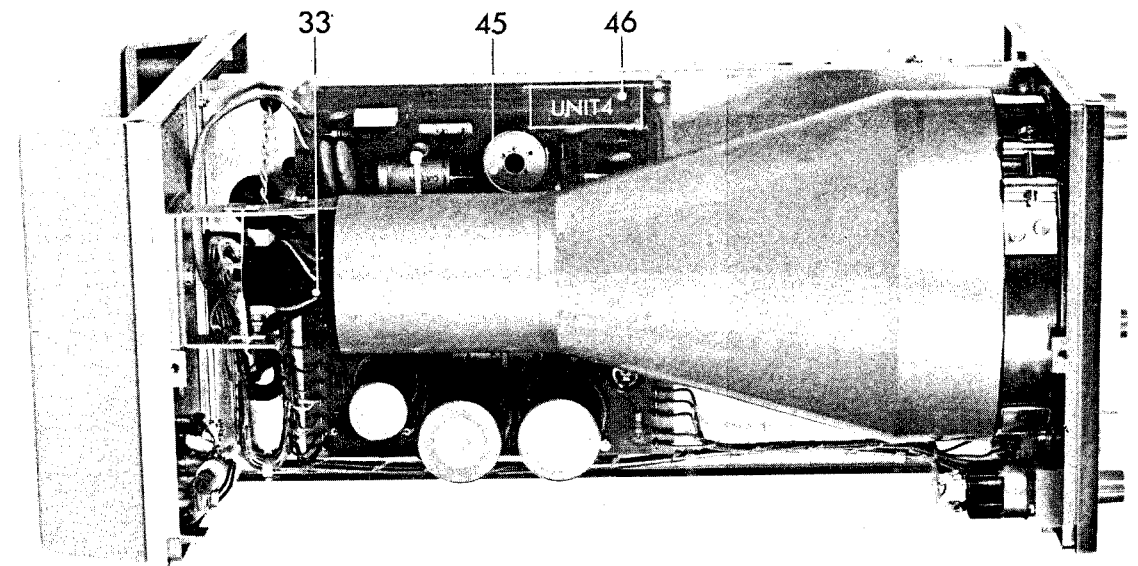

Fig. 26. Left-hand side view showing item numbers

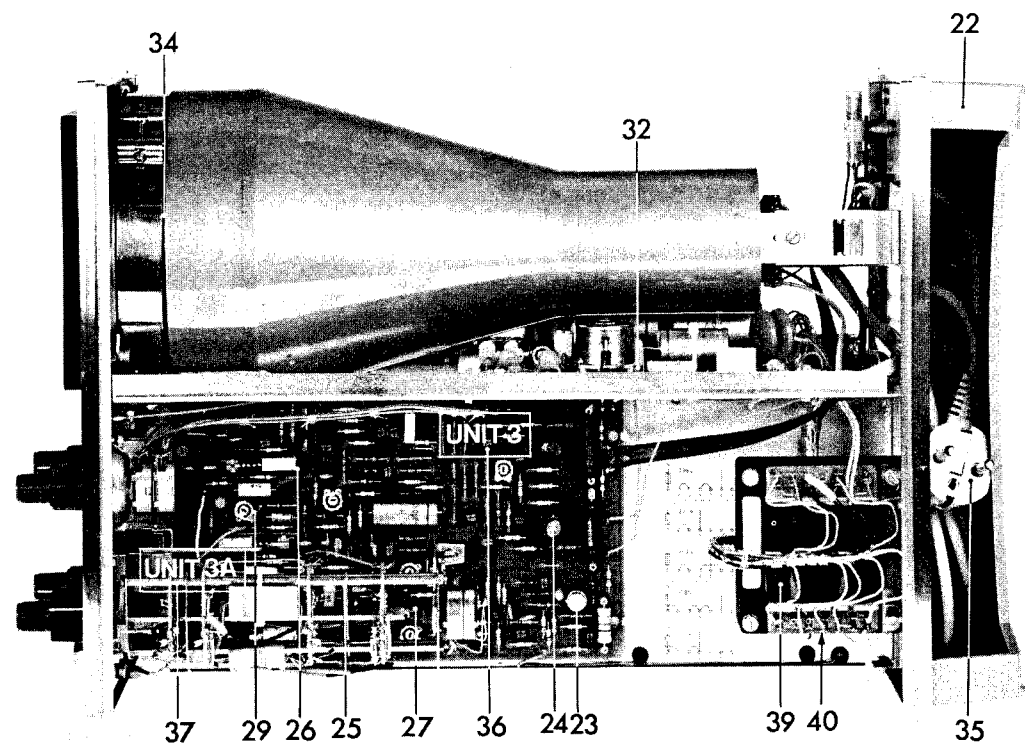

Fig. 25. Top view showing item numbers

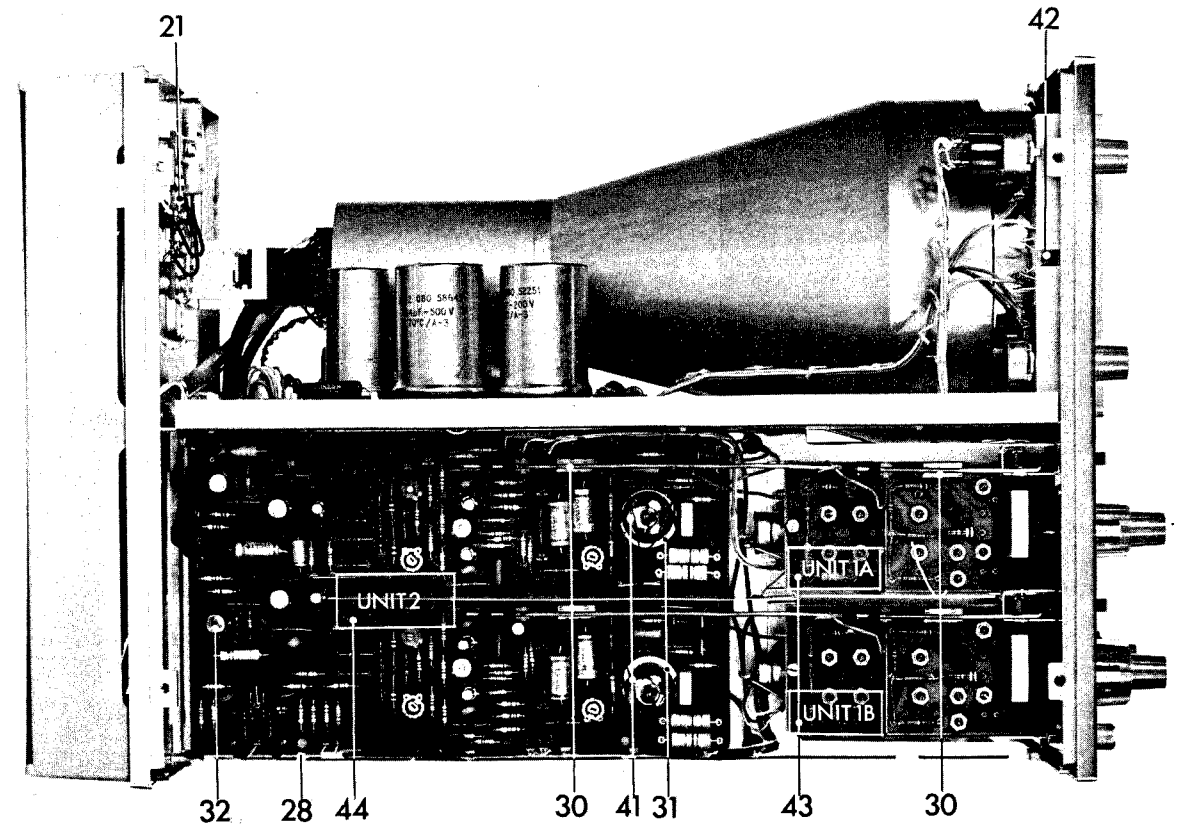

Fig. 27. Bottom view showing item numbers

3.8.2. Electrical parts



















This parts list does not contain multi-purpose and standard parts. These components are indicated in the circuit diagram by means of identification marks. The specification can be derived from the survey below.

Diese Ersatzteilliste enthält keine Universal- und Standard-Teile. Diese sind im jeweiligen Prinzipschaltbild mit Kennzeichnungen versehen. Die Spezifikation kann aus nachstehender Übersicht abgeleitet werden.

In deze stuklijst zijn geen universele en standaardonderdelen opgenomen. Deze componenten zijn in het principschema met een merkteken aangegeven. De specificatie van deze merktekens is hieronder vermeld.

La présente liste ne contient pas des pièces universelles et standard. Celles-ci ont été repérées dans le schéma de principe. Leurs spécifications sont indiquées ci-dessous.

Esta lista de componentes no comprende componentes universales ni standard. Estos componentes están provistos en el esquema de principio de una marca. El significado de estas marcas se indica a continuación.

	Carbon resistor E24 series Kohleschichtwiderstand, Reihe E24 Koolweerstand E24 reeks Résistance au carbone, série E24 Resistencia de carbón, serie E24	} 0,125 W	} 5%		Carbon resistor E12 series Kohleschichtwiderstand, Reihe E12 Koolweerstand E12 reeks Résistance au carbone, série E12 Resistencia de carbón, serie E12	} 1	} $W \leq 2,2 M\Omega, 5\%$ $> 2,2 M\Omega, 10\%$
	Carbon resistor E12 series Kohleschichtwiderstand, Reihe E12 Koolweerstand E12 reeks Résistance au carbone, série E12 Resistencia de carbón, serie E12			} 0,25 W $\leq 1 M\Omega, 5\%$ $> 1 M\Omega, 10\%$			
	Carbon resistor E24 series Kohleschichtwiderstand, Reihe E24 Koolweerstand E24 reeks Résistance au carbone, série E24 Resistencia de carbón, serie E24	} 0,5 W $\leq 5 M\Omega, 1\%$ $> 5 M\Omega, 2\%$ $> 10 M\Omega, 5\%$			Wire-wound resistor Drahtwiderstand Draadgewonden weerstand Résistance bobinée Resistencia bobinada	} 0,4 - 1,8 W	} 0,5%
	Carbon resistor E12 series Kohleschichtwiderstand, Reihe E12 Koolweerstand E12 reeks Résistance au carbone, série E12 Resistencia de carbón, serie E12		} 0,5 W $\leq 1,5 M\Omega, 5\%$ $> 1,5 M\Omega, 10\%$		Wire-wound resistor Drahtwiderstand Draadgewonden weerstand Résistance bobinée Resistencia bobinada		
	Wire-wound resistor Drahtwiderstand Draadgewonden weerstand Résistance bobinée Resistencia bobinada	} 10 W		} 5%			
	Tubular ceramic capacitor Rohrkondensator Keramische kondensator, buistype Condensateur céramique tubulaire Condensador cerámico tubular		} 500 V			Polyester capacitor Polyesterkondensator Polyesterkondensator Condensateur au polyester Condensador polyester	} 400 V
	Tubular ceramic capacitor Rohrkondensator Keramische kondensator, buistype Condensateur céramique tubulaire Condensador cerámico tubular	} 700 V			Flat-foil polyester capacitor Miniatur-Polyesterkondensator (flach) Platte miniatuur polyesterkondensator Condensateur au polyester, type plat Condensador polyester, tipo de placas planas	} 250 V	
	Ceramic capacitor, "pin-up" Keramikkondensator "Pin-up" (Perltyp) Keramische kondensator "Pin-up" type Condensateur céramique, type perle Condensador cerámico, versión "colgable"		} 500 V		Paper capacitor Papierkondensator Papierkondensator Condensateur au papier Condensador de papel		} 1000 V
	"Microplate" ceramic capacitor Miniatur-Scheibenkondensator "Microplate" keramische kondensator Condensateur céramique "microplaca" Condensador cerámico "microplaca"	} 30 V			Wire-wound trimmer Drahttrimmer Draadgewonden trimmer Trimmer à fil Trimmer bobinado		
	Mica capacitor Glimmerkondensator Micakondensator Condensateur au mica Condensador de mica		} 500 V		Tubular ceramic trimmer Rohrtrimmer Buisvormige keramische trimmer Trimmer céramique tubulaire Trimmer cerámico tubular		



For multi-purpose and standard parts, please see PHILIPS' Service Catalogue.

Für die Universal- und Standard-Teile siehe den PHILIPS Service-Katalog.

Voor universele en standaardonderdelen raadplege men de PHILIPS Service Catalogus.

Pour les pièces universelles et standard veuillez consulter le Catalogue Service PHILIPS.

Para piezas universales y standard consulte el Catálogo de Servicio PHILIPS.

3.8.2.1. Resistors

Item	Fig.	Order number	Value (Ω)	Description
601a	4	5322 102 10136	10 k	Double potentiometer
601b	4		10 k	
603	4	5322 101 ⁴⁰⁰⁶⁵ 40073	470 k	Potentiometer with switch
604	4	5322 101 20421	2.2 M	Potentiometer

Item	Order number	Value (Ω)	Watt/70 °C	%	Description
------	--------------	--------------------	------------	---	-------------

UNIT 1A, UNIT 1B

602	5322 101 44003	4.7 k			Potentiometer with switch
610	5322 111 20321	900 k	0.5	1	Carbon
611	5322 116 50461	111 k	0.5	1	Carbon
612	5322 111 20331	990 k	0.5	1	Carbon
613	5322 116 50229	10.1 k	0.5	1	Carbon
614	5322 111 20317	1.0 M	0.5	1	Carbon
615	4822 111 20018	1.0 k	0.5	1	Carbon
617	5322 111 20329	500 k	0.5	1	Carbon
618	5322 111 20317	1.0 M	0.5	1	Carbon
619	5322 111 20318	750 k	0.5	1	Carbon
620	5322 116 50122	333 k	0.5	1	Carbon
621	5322 111 20317	1.0 M	0.5	1	Carbon

UNIT 2

607	5322 116 54079	36 k	0.33	2	Carbon
608	5322 116 50109	56 k	0.33	2	Carbon
609	5322 116 50109	56 k	0.33	2	Carbon
610	5322 116 54079	36 k	0.33	2	Carbon
611	5322 116 50158	5.1 k	0.5	1	Carbon
612	5322 100 10075	100 k			Potentiometer
613	5322 116 50086	220	0.5	1	Carbon
614	5322 116 50801	9.1 k	0.33	2	Carbon
615	5322 116 50801	9.1 k	0.33	2	Carbon
616	5322 116 50119	12 k	0.5	1	Carbon
618	5322 116 50119	12 k	0.5	1	Carbon
625	5322 116 50537	9.1 k	0.5	1	Carbon
626	5322 116 50537	9.1 k	0.5	1	Carbon
627	4822 100 10038	470			Potentiometer
628	5322 116 50097	680	0.5	1	Carbon
657	5322 116 54079	36 k	0.33	2	Carbon
658	5322 116 50109	56 k	0.33	2	Carbon
659	5322 116 50109	56 k	0.33	2	Carbon
660	5322 116 54079	36 k	0.33	2	Carbon
661	5322 116 50158	5.1 k	0.5	1	Carbon
662	5322 100 10075	100 k			Potentiometer
663	5322 116 50086	220	0.5	1	Carbon
664	5322 116 50801	9.1 k	0.33	2	Carbon
665	5322 116 50801	9.1 k	0.33	2	Carbon
666	5322 116 50119	12 k	0.5	1	Carbon
668	5322 116 50119	12 k	0.5	1	Carbon
675	5322 116 50537	9.1 k	0.5	1	Carbon
676	5322 116 50537	9.1 k	0.5	1	Carbon
677	4822 100 10038	470			Potentiometer
678	5322 116 50097	680	0.5	1	Carbon

<i>Item</i>	<i>Order number</i>	<i>Value (Ω)</i>	<i>Watt/70 °C</i>	<i>%</i>	<i>Description</i>
709	5322 116 50184	33 k	0.5	1	Carbon
710	5322 116 50184	33 k	0.5	1	Carbon
711	5322 116 50927	36 k	0.5	1	Carbon
712	5322 116 50927	36 k	0.5	1	Carbon
714	5322 110 60104	750	0.33	5	Carbon
715	5322 116 50554	750	0.5	1	Carbon
716	5322 116 50554	750	0.5	1	Carbon
UNIT 3					
602	5322 116 50594	120 k	0.5	1	Carbon
604	5322 116 50107	43 k	0.5	1	Carbon
605	5322 116 50858	200 k	0.5	1	Carbon
607	4822 100 10035	10 k			Potentiometer
608	5322 116 50106	39 k	0.5	1	Carbon
609	5322 116 50106	39 k	0.5	1	Carbon
610	5322 116 50109	56 k	0.5	1	Carbon
613	5322 116 50107	43 k	0.33	2	Carbon
614	5322 116 50109	56 k	0.33	2	Carbon
617	5322 116 50463	10 k	0.5	1	Carbon
618	5322 111 20019	3 k	0.5	1	Carbon
619	5322 116 50219	5.6 k	0.5	1	Carbon
624	5322 116 50517	180	0.5	1	Carbon
625	5322 116 50293	1.5 k	0.5	1	Carbon
626	5322 111 20022	3.9 k	0.5	1	Carbon
627	5322 116 50152	8.2 k	0.5	1	Carbon
628	5322 116 50584	620	0.5	1	Carbon
631	5322 110 60138	15 k	0.33	5	CR25
632	5322 100 10036	4.7 k			Potentiometer
634	4822 116 30058-18	1.3 k		20	N.T.C. carbon
640	5322 116 50097	680	0.33	2	Carbon
641	5322 116 50088	270	0.33	2	Carbon
642	5322 116 50103	3.9 k	0.33	2	Carbon
643	5322 116 54064	2.0 k	0.33	2	Carbon
647	4822 100 10029	2.2 k			Potentiometer
648	4822 100 10029	2.2 k			Potentiometer
655	5322 116 50152	8.2 k	0.5	1	Carbon
656	5322 116 51056	11 k	0.5	1	Carbon
657	5322 116 50532	2.2 k	0.5	1	Carbon
658	5322 116 50584	620	0.5	1	Carbon
659	5322 100 10052	100 k			Potentiometer
660	5322 116 50671	2.61 k	0.4	1	Metal film
661	5322 116 50671	2.61 k	0.4	1	Metal film
667	4822 111 20038	15 k	0.5	1	Carbon
668	5322 111 20019	3 k	0.5	1	Carbon
669	5322 116 50657	6.8 k	0.5	1	Carbon
670	5322 116 50158	5.1 k	0.5	1	Carbon
675	5322 116 50275	130 k	0.5	1	Carbon
676	5322 116 50275	130 k	0.5	1	Carbon
677	5322 112 30147	33 k	7	5	Wire wound
678	5322 112 30147	33 k	7	5	Wire wound
693	5322 111 20019	3 k	0.5	1	Carbon
694	5322 116 50114	160 k	0.5	1	Carbon
705	5322 116 50226	1.3 k	0.33	2	Carbon

<i>Item</i>	<i>Order number</i>	<i>Value (Ω)</i>	<i>Watt/70 °C</i>	<i>%</i>	<i>Description</i>
UNIT 3A					
601	5322 111 20034	100 k	0.5	1	Carbon
602	5322 116 50305	390 k	0.5	1	Carbon
603	5322 111 20034	100 k	0.5	1	Carbon
604	5322 116 50332	20 k	0.5	1	Carbon
605	5322 116 50332	20 k	0.5	1	Carbon
606	5322 116 50463	10 k	0.5	1	Carbon
607	5322 116 50941	2 k	0.5	1	Carbon
608	5322 116 50941	2 k	0.5	1	Carbon
609	5322 101 40078	10 k			Potentiometer with switch
611	5322 110 60161	100 k	0.33	5	Carbon
750	5322 110 60115	2 k	0.33	5	Carbon

UNIT 4

608	5322 101 10064	220 k			Potentiometer
613	5322 100 10086	22 k			Potentiometer
618	5322 112 30147	33 k	7	5	Wire wound

Note: Due to delivery problems of certain carbon resistors, these have been replaced by metal film resistors at the factory. When replacing one of these metal film resistors, the part as indicated in the parts list or in the circuit diagram of the manual can be used.

3.8.2.2. Capacitors

<i>Item</i>	<i>Order number</i>	<i>Value</i>	<i>Volt</i>	<i>%</i>	<i>Description</i>
501	5322 121 40013	1.0 μ F	250	20	Polyester
502	5322 121 44028	10 nF	250		Suppressor
UNIT 1A, UNIT 1B					
501	4822 121 40105	100 nF	630	20	Polyester
502	5322 125 60037	0.8-6 pF	500		Trimmer
504	5322 125 60037	0.8-6 pF	500		Trimmer
506	5322 125 60037	0.8-6 pF	500		Trimmer
508	5322 125 60037	0.8-6 pF	500		Trimmer
510	5322 125 60037	0.8-6 pF	500		Trimmer
512	5322 125 60037	0.8 pF	500		Trimmer
513	4822 121 50474	2.7 nF	63	5	Polystyrene
515	5322 125 60037	0.8-6 pF	500		Trimmer
517	5322 125 60037	0.8-6 pF	500		Trimmer
518	5322 125 60037	0.8-6 pF	500		Trimmer
521	5322 125 60037	0.8-6 pF	500		Trimmer
UNIT 2					
501	5322 121 40327	4.7 nF	400	10	Polyester
503	4822 124 20405	470 μ F	6.3		Electrolytic
504	4822 124 20405	470 μ F	6.3		Electrolytic
505	4822 122 40019	1.0 pF	400	0.25 pF	Ceramic
507	5322 122 30043	10 nF	40	-20/+100	Ceramic
508	4822 122 40019	1.0 pF	400	0.25 pF	Ceramic
509	4822 125 50061	1.4-5.5 pF	100		Trimmer
510	5322 125 54001	4-30 pF	50		Trimmer
511	4822 122 40007	22 pF	400	5	Trimmer
512	5322 122 34008	10 pF	400	5	Ceramic

<i>Item</i>	<i>Order number</i>	<i>Value</i>	<i>Volt</i>	<i>%</i>	<i>Description</i>
551	5322 121 40327	4.7 nF	400	10	Polyester
553	4822 124 20405	470 μ F	6.3		Electrolytic
554	4822 124 20405	470 μ F	6.3		Electrolytic
555	4822 122 40019	1.0 pF	400	0.25 pF	Ceramic
557	5322 122 30043	10 nF	40	-20/+100	Ceramic
558	4822 122 40019	1.0 pF	400	0.25 pF	Ceramic
559	4822 125 50061	1.4-5.5 pF	100		Trimmer
560	5322 125 54001	4-30 pF	50		Trimmer
561	4822 122 40006	18 pF	400	-5	Ceramic
562	5322 122 34008	10 pF	400	5	Ceramic
571	5322 122 40086	68 pF	400	10	Ceramic
572	5322 122 40086	68 pF	400	10	Ceramic
573	4822 122 40018	15 pF	400	5	Ceramic
574	4822 122 40018	15 pF	400	5	Ceramic
575	5322 122 40084	0.47 pF	400	0.25 pF	Ceramic
576	5322 122 40084	0.47 pF	400	0.25 pF	Ceramic
577	4822 124 20362	22 μ F	25		Electrolytic
578	5322 122 30043	10 nF	40	-20/+100	Ceramic
579	5322 122 30043	10 nF	40	-20/+100	Ceramic
580	4822 124 20032	4.7 μ F	250		Electrolytic

UNIT 3

501	5322 124 20355	10 μ F	25		Electrolytic
502	4822 124 20362	22 μ F	25		Electrolytic
503	5322 124 20355	10 μ F	25		Electrolytic
504	5322 122 30002	150 pF		2	Ceramic
505	5322 121 50373	5.6 nF	63	1	Polystyrene
507	4822 122 40083	39 pF	400	5	Ceramic
508	4822 124 20523	680 μ F	10		Electrolytic
510	4822 122 40005	33 pF	400	5	Ceramic
511	5322 122 40078	1.5 nF	400	-20/+50	Ceramic
512	5322 121 50373	5.6 nF	63	5	Polystyrene
513	4822 122 40011	10 pF	400	5	Ceramic
514	4822 121 50413	470 pF	125	1	Polystyrene
515	5322 122 30103	22 nF	40	-20/+100	Ceramic
516	5322 121 50368	820 pF	125	5	Polystyrene
517	4822 122 40006	18 pF	400	5	Ceramic
518	4822 122 40018	15 pF	400	5	Ceramic
519	5322 122 40084	0.47 pF	400	0.25 pF	Ceramic
520	5322 121 40231	150 nF	100	10	Polyester
521	5322 122 10107	100 nF	30	-20/+80	Ceramic
522	5322 122 40078	1.5 nF	400	-20/+50	Ceramic

UNIT 3A

501	4822 121 40266	4.7 μ F	100	10	Polyester
502	5322 121 50375	47 nF	63	1	Polystyrene
503	4822 124 20351	6.4 μ F	40		Electrolytic
504	5322 121 40094	68 nF	100	10	Polyester
505	4822 120 10036	2.2 pF	250	0.5 pF	Ceramic
506	4822 122 10052	220 pF	400	5	Ceramic
507	5322 121 50368	820 pF	125	5	Polyester

<i>Item</i>	<i>Order number</i>	<i>Value</i>	<i>Volt</i>	<i>%</i>	<i>Description</i>
UNIT 4					
501	5322 122 20018	100 pF	2000	10	Ceramic
502	5322 121 40197	1.0 μ F	100	20	Polyester
503	5322 121 40257	330 nF	100	20	Polyester
504	5322 121 40197	1.0 μ F	100	20	Polyester
505	5322 122 50044	1.0 nF	3000	-20/+50	Ceramic
506	5322 122 50044	1.0 nF	3000	-20/+50	Ceramic
507	5322 122 50044	1.0 nF	3000	-20/+50	Ceramic
510	5322 122 30134	10 nF	3000	-20/+50	Ceramic
511	5322 121 40175	470 nF	100	10	Polyester
512	4822 121 50044	1.0 nF	3000	-20/+50	Ceramic
513	5322 122 30134	10 nF	3000	-20/+50	Ceramic
521	5322 124 20597	2200 μ F	40		Electrolytic
522	5322 124 20597	2200 μ F	40		Electrolytic
523	5322 124 20598	470 μ F	63		Electrolytic
524	5322 124 40059	100 μ F	300		Electrolytic
525	5322 124 40116	64 μ F	500		Electrolytic
526	5322 124 40078	250 μ F	200		Electrolytic

3.8.2.3. *Semi-conductors*

<i>Item</i>	<i>Type</i>	<i>Order number</i>	<i>Description</i>
UNIT 2			
Transistors			
311, 312	BF194	5322 130 40303	Silicon transistor
313, 314	AF121/07	5322 130 40385	Germanium transistor
315, 316	BF196	5322 130 40376	Silicon transistor
361, 362	BF194	5322 130 40303	Silicon transistor
363, 364	AF121/07	5322 130 40385	Germanium transistor
365, 366	BF196	5322 130 40376	Silicon transistor
367, 371, 372	BF194	5322 130 40303	Silicon transistor
373, 374	BSX20	5322 130 40417	Silicon transistor
375, 376, } 377, 378 }	BF336	4822 130 40908	Silicon transistor
Diodes			
401 } 451 }	GZ11214A	5322 130 34127	Selected diode pair
402	BZX79-C6V2	5322 130 30766	Silicon zener diode
403 up to 408	BAX13	5322 130 40182	Silicon diode
452	BZX79-C6V2	5322 130 30766	Silicon zener diode
453 up to 458	BAX13	5322 130 40182	Silicon diode
461 up to 464	BAX13	5322 130 40182	Silicon diode
465, 466	BZX79-C6V2	5322 130 30766	Silicon zener diode
467, 468	BAX13	5322 130 40182	Silicon diode
UNIT 3			
Transistors			
301, 302	BF196	5322 130 40376	Silicon transistor
303, 304, } 305, 306 }	BF194	5322 130 40303	Silicon transistor
307	BSW33	5322 130 40538	Silicon transistor
308, 309, 310	BF194	5322 130 40303	Silicon transistor
311	BC159	5322 130 40508	Silicon transistor
312	BSX20	5322 130 40417	Silicon transistor
313	BC148C	4822 130 40361	Silicon transistor
314	BC148	5322 130 40318	Silicon transistor
315, 316, 317	BF194	5322 130 40303	Silicon transistor
318, 319	BC148C	4822 130 40361	Silicon transistor
320, 321	BF338	5322 130 44108	Silicon transistor
322 up to 326	BF194	5322 130 40303	Silicon transistor
327	BF336	4822 130 40908	Silicon transistor
328, 329	BF194	5322 130 40303	Silicon transistor
Diodes			
401 up to 407	BAX13	5322 130 40182	Silicon diode
408	AAZ17	5322 130 30283	Germanium diode
409	BZX79-C7V5	5322 130 30666	Silicon zener diode
410	AAZ17	5322 130 30283	Germanium diode
411 up to 415	BAX13	5322 130 40182	Silicon diode
416, 417	GZ11214A	5322 130 34238	Silicon zener diode

Item	Type	Order number	Description
UNIT 4			
Transistors			
301	BC158	5322 130 40476	Silicon transistor
302	BC148C	4822 130 40361	Silicon transistor
303	BFY50	5322 130 40294	Silicon transistor
Diodes			
401	BZX79-C6V2	5322 130 30766	Silicon zener diode
402, 403, 404	BYX10	5322 130 30195	Silicon rectifier diode
405, 406	BAX13	5322 130 40182	Silicon diode
407	ZY150	5322 130 34094	Silicon zener diode
410	BY164	5322 130 30414	Rectifier
411, 412, 413	BYX10	5322 130 30195	Silicon rectifier diode

3.8.3. Parts list of probe sets

3.8.3.1. Parts of attenuator probes PM 9326 and PM 9327 (Fig. 18)

Item	Qty	Ordering number	Description
1	1	5322 320 10042	Probe cable 2 m for PM 9327
1	1	5322 321 20087	Probe cable 1.15 m for PM 9326
2	1	5322 321 20096	Earth lead 15 cm
3	1	5322 321 20134	Earth lead 30 cm
4	1	5322 266 20015	Measuring probe 1:1 (black)
5	1	5322 268 10029	Test pin
6	1	5322 268 10039	Test hook
7	1	5322 210 70044	Attenuator probe 1:10 (grey)
8	1	5322 264 20016	Test clip
	1	5322 111 20155	Resistor

3.8.3.2. Parts of attenuator probes PM 9336 and PM 9336L (Fig. 20)

Item	Qty	Ordering code	Description
1	1	5322 320 14004	Cable assembly PM 9336 (1,5 m)
1	1	5322 320 14013	Cable assembly PM 9336L (2,5 m)
2	1	5322 255 44026	Soldering terminal
3	1	5322 264 20024	Test hook
4	1	5322 264 20028	Test hook sleeve
5	1	5322 532 60535	Protective cap
6	1	5322 256 94034	Probe holder
7	1	5322 268 14017	Probe tip
8	1	5322 321 20223	Earthing cord
9	1	5322 600 34002	Box

3.8.3.3. Parts of probe set PM 9335 (Fig. 22)

Item	Qty	Ordering number	Description
1	1	5322 264 20024	Test-hook
2	1	5322 264 20028	Test-hook sleeve
3	1	5322 268 14017	Probe tip
4	1	5322 532 60535	Protective cap
5	1	5322 321 20223	Earth lead
6	1	5322 265 94034	Probe holder
7	1	5322 320 14005	Probe assembly
	1	5322 600 34002	Box

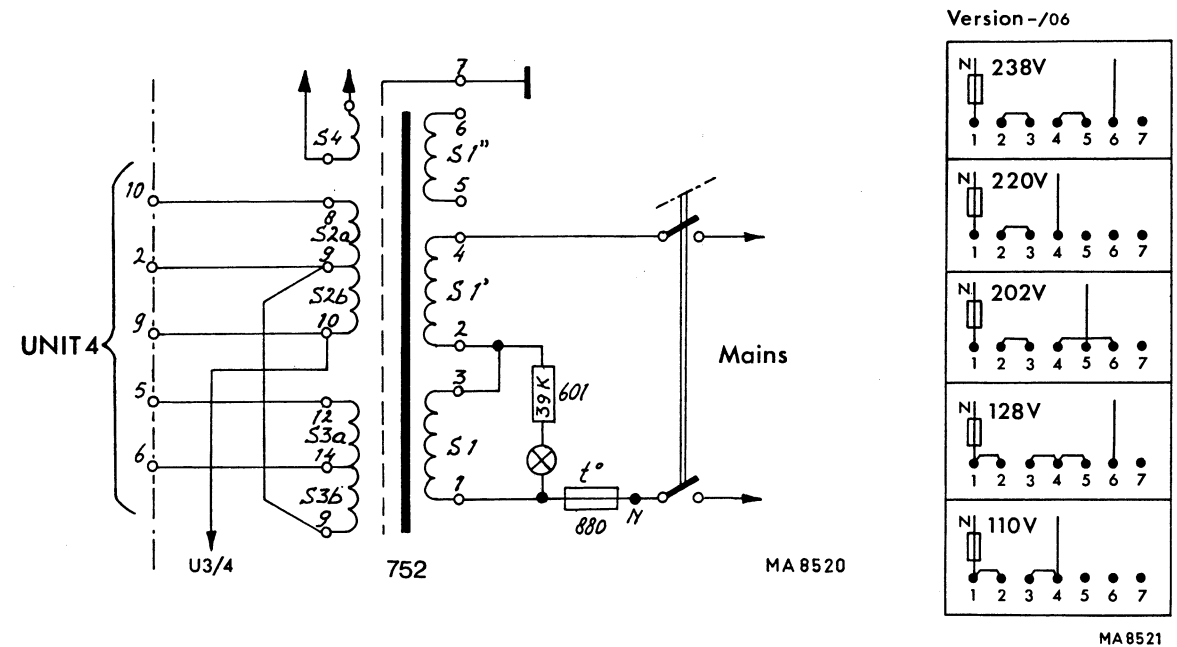
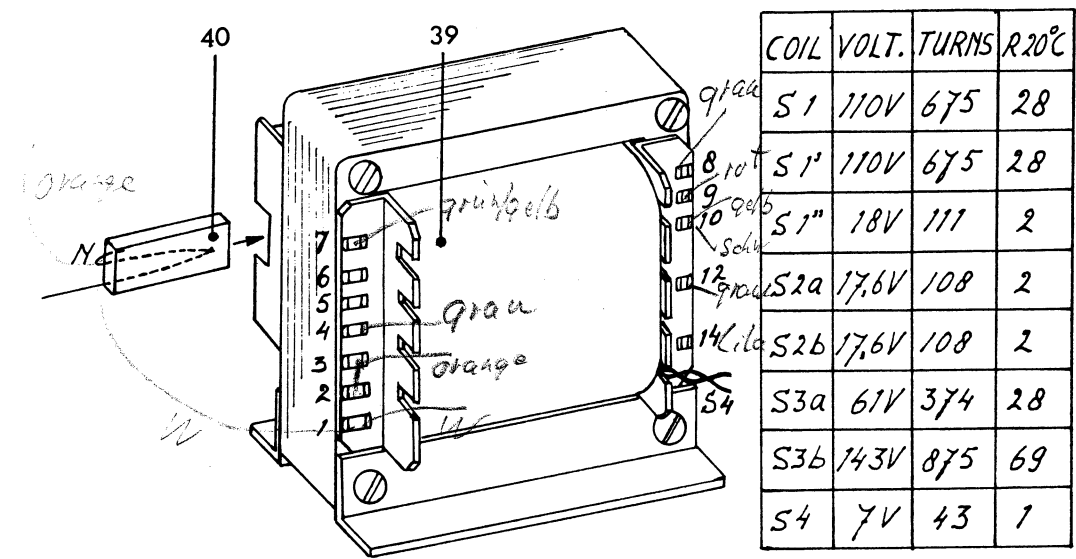

Fig. 28. Lay-out of the mains transformer

If some PM 3110 oscilloscopes (serial numbers LO9001 ... LO9535) are adapted to mains voltages of 110 V or 128 V, the pilot lamp will not light up when the instrument is switched in.

This can be cured by disconnecting the orange wire from soldering lug 2 of the transformer and reconnecting it to lug 3 (refer to Fig. 1).

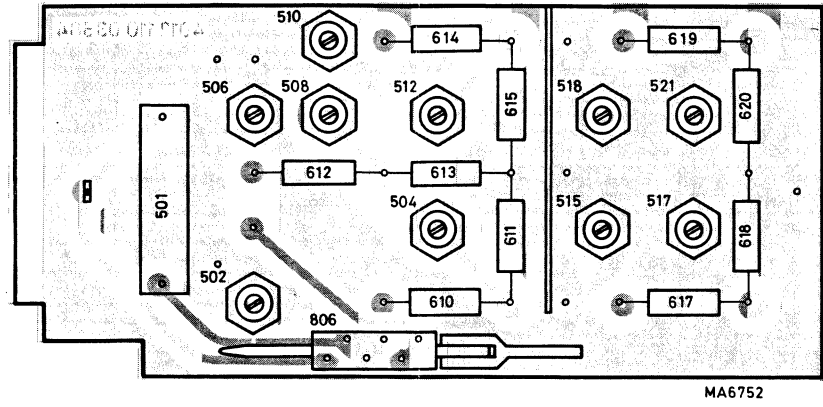

Fig. 29. Printed-wiring board, unit 1A (B)

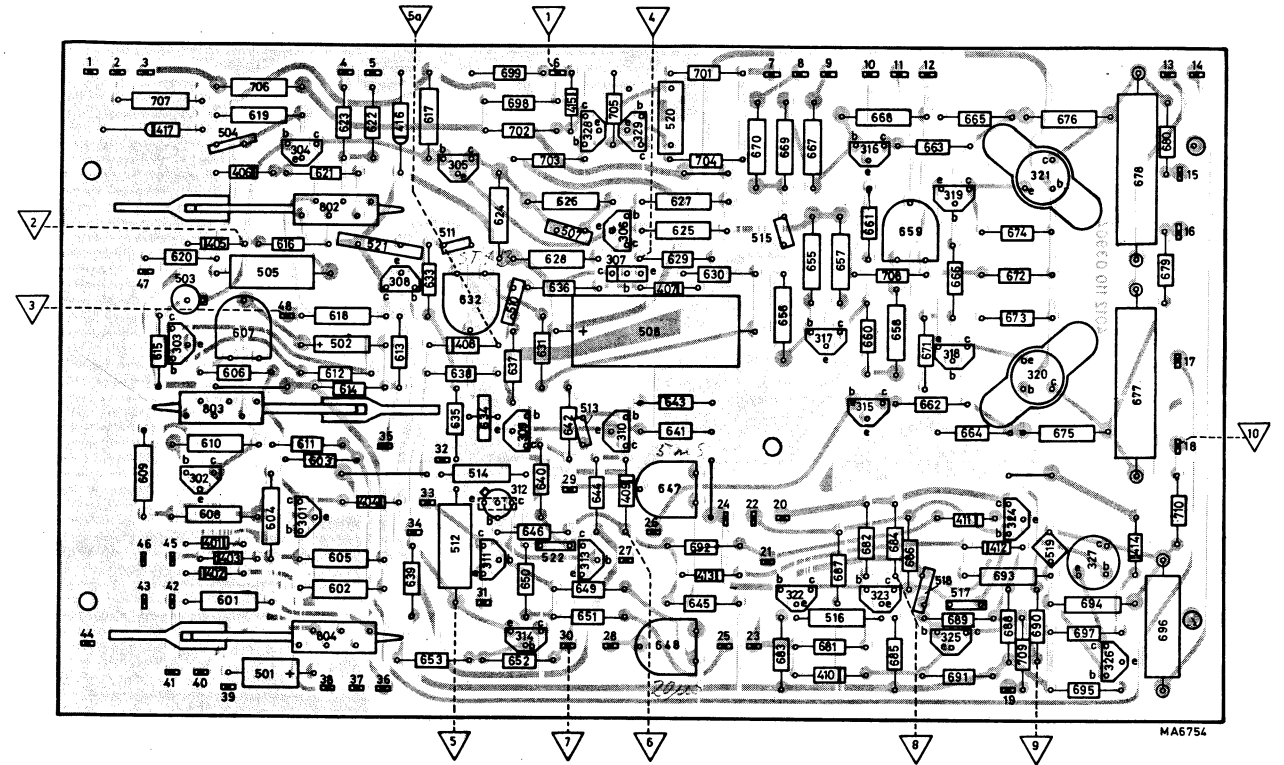

Fig. 31. Printed-wiring board, unit 3

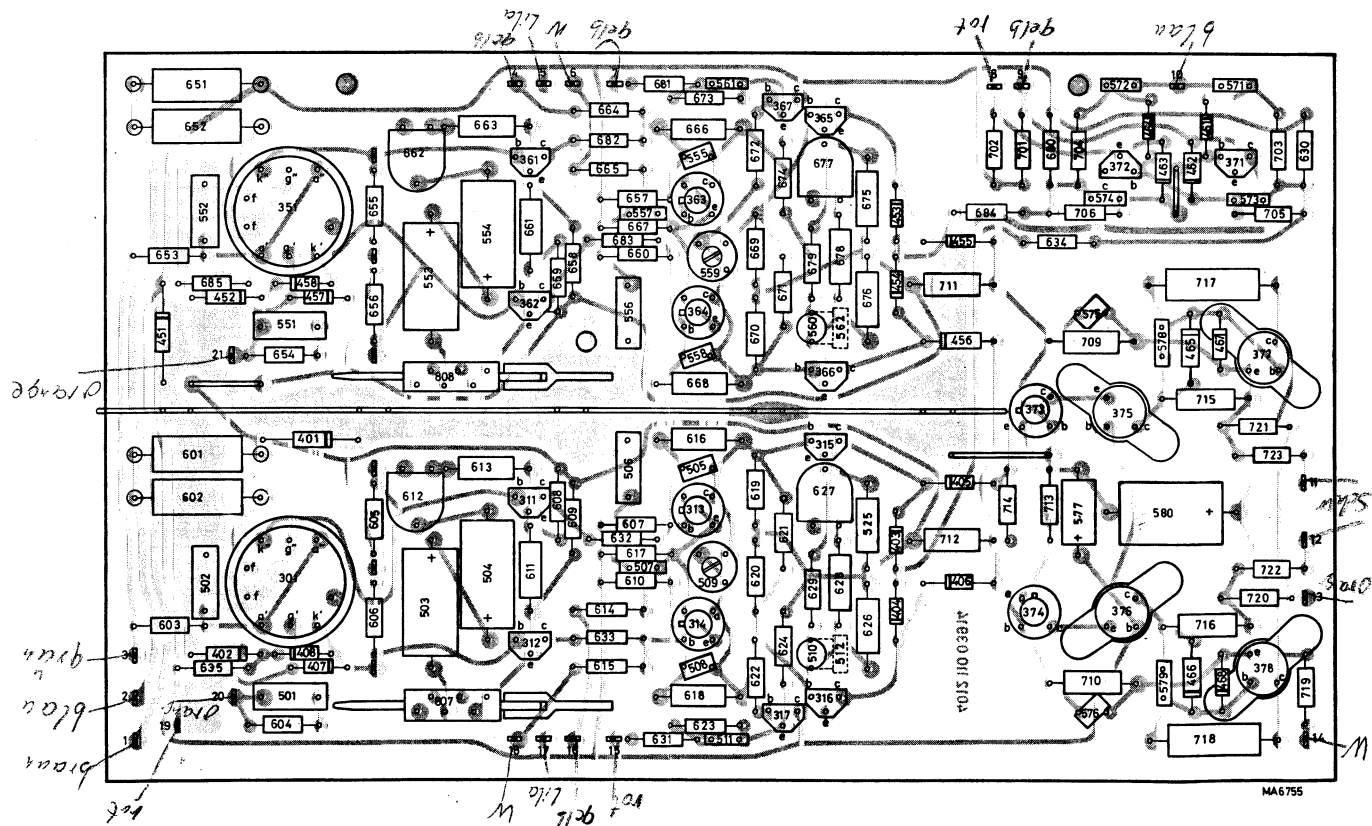

Fig. 30. Printed-wiring board, unit 2

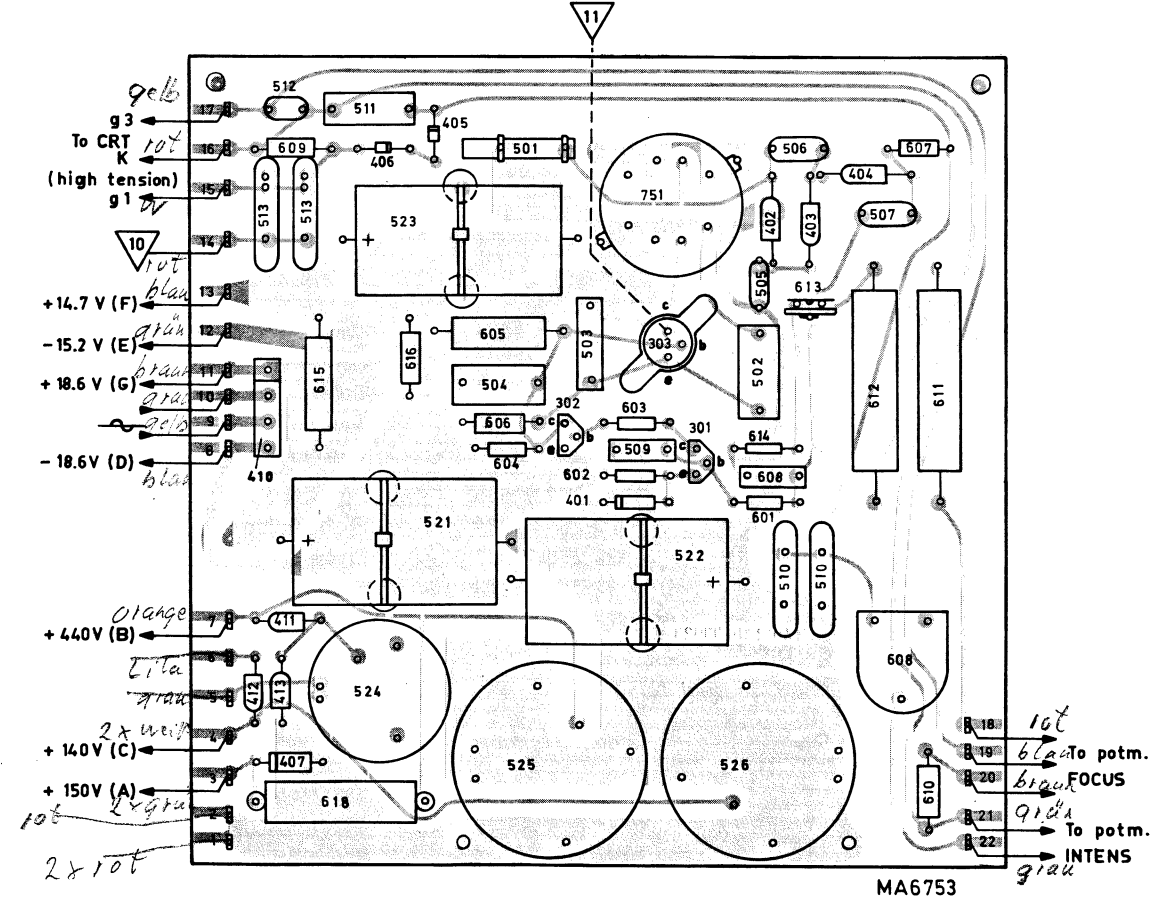
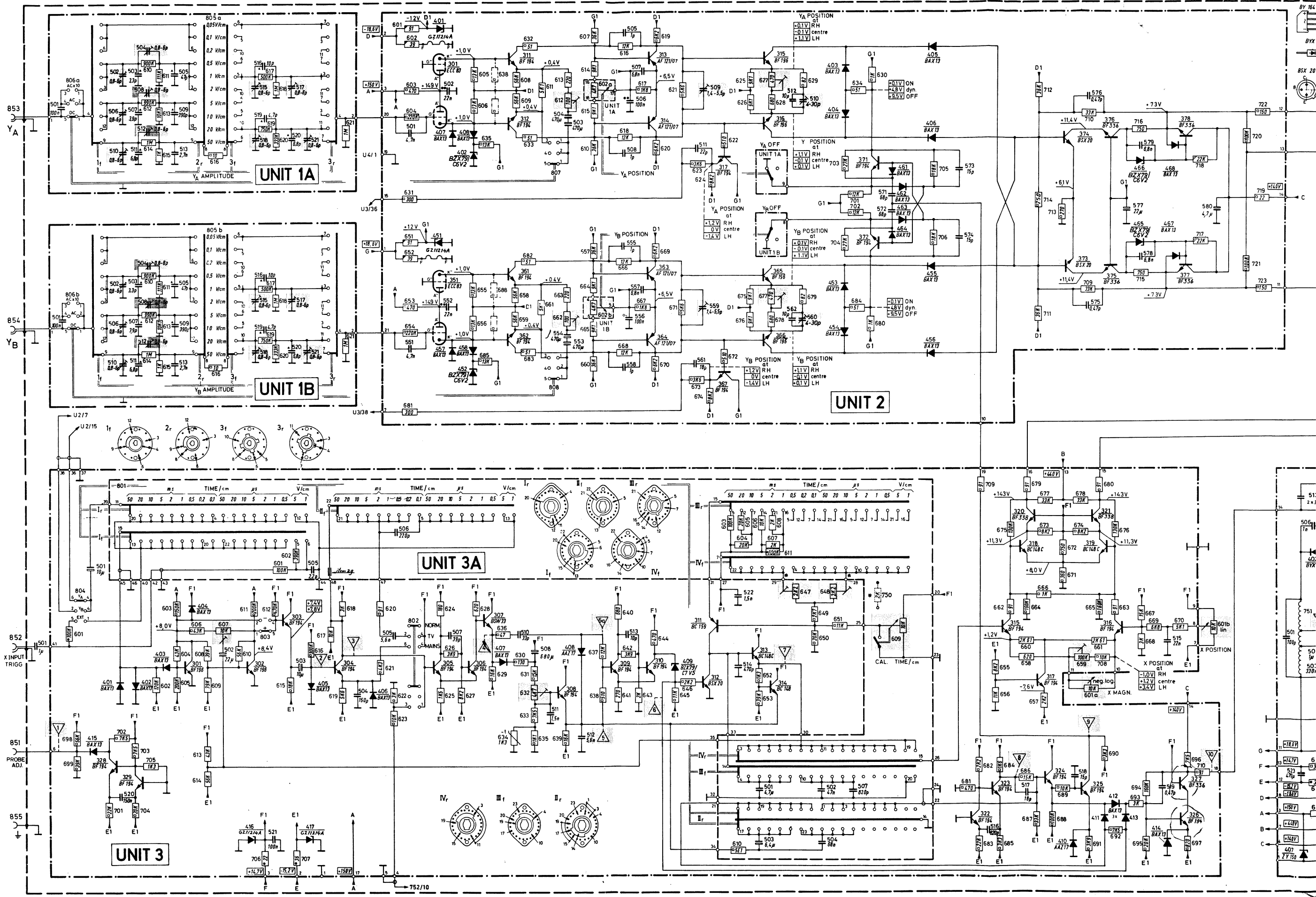
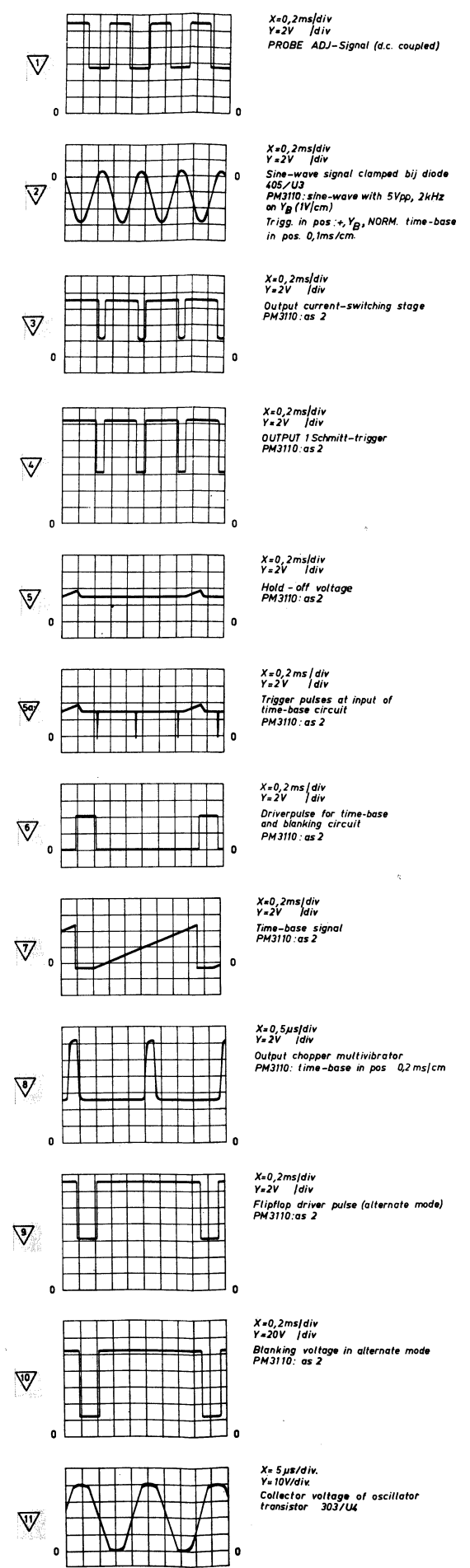
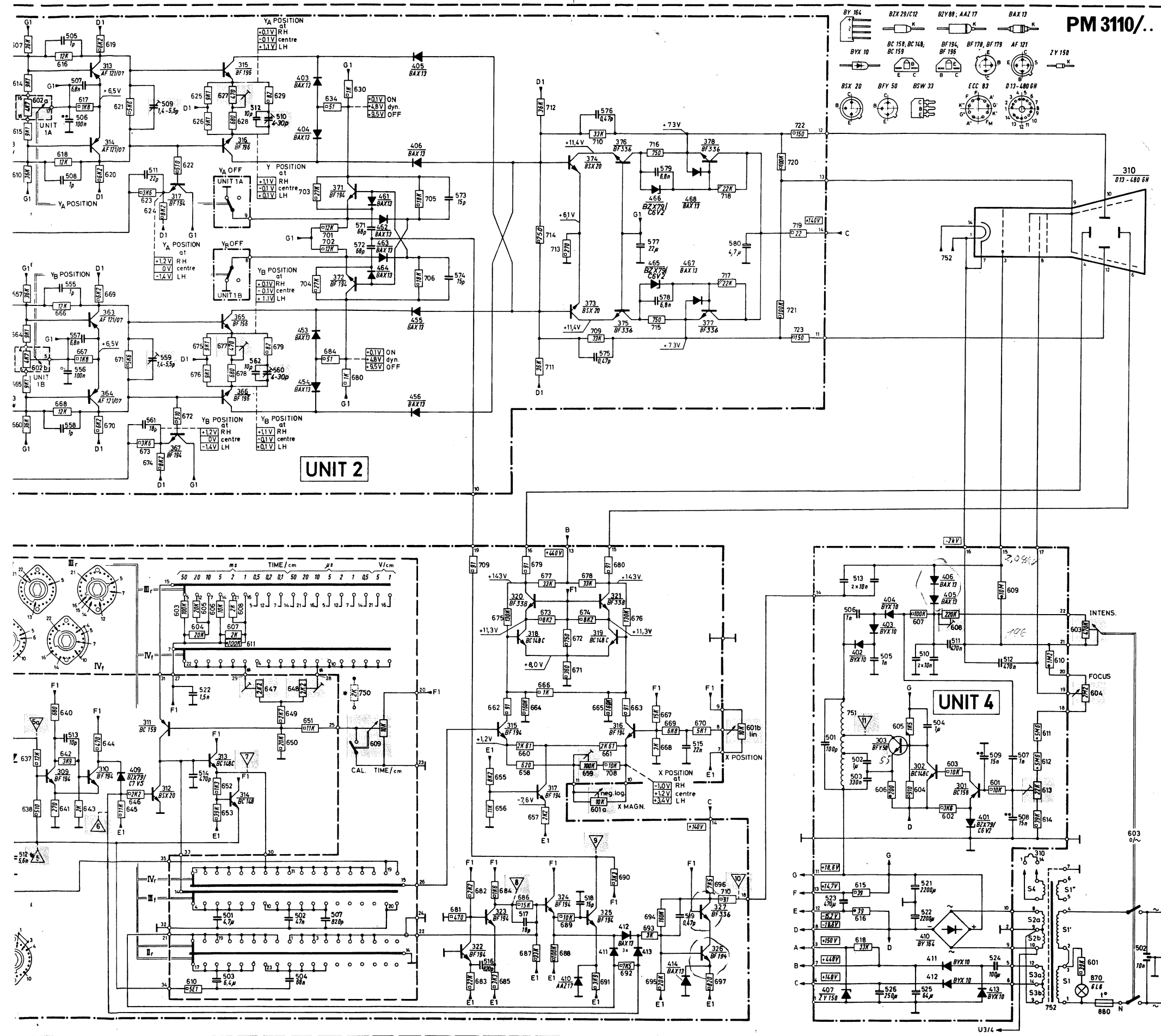

Fig. 32. Printed-wiring board, unit 4





MA8986 Fig. 33. Circuit diagram

QUALITY REPORTING

CODING SYSTEM FOR FAILURE DESCRIPTION

The following information is meant for Philips service workshops only and serves as a guide for exact reporting of service repairs and maintenance routines on the workshop charts.

For full details reference is made to Information G1 (Introduction) and Information Cd 689 (Specific information for Test and Measuring Instruments).

LOCATION

□□□□

Unit number

e.g. 000A or 0001 (for unit A or 1; not 00UA or 00U1)

or: Type number of an accessory (only if delivered with the equipment)

e.g. 9051 or 9532 (for PM 9051 or PM 9532)

or: Unknown/Not applicable

0000

CATEGORY

□

- 0 Unknown, not applicable (fault not present, intermittent or disappeared)
- 1 Software error
- 2 Readjustment
- 3 Electrical repair (wiring, solder joint, etc.)
- 4 Mechanical repair (polishing, filing, remachining, etc.)
- 5 Replacement
- 6 Cleaning and/or lubrication
- 7 Operator error
- 8 Missing items (on pre-sale test)
- 9 Environmental requirements are not met

COMPONENT/SEQUENCE NUMBER

□□□□□

Enter the identification as used in the circuit diagram, e.g.:

GR1003	Diode GR1003
TS0023	Transistor TS23
IC0101	Integrated circuit IC101
R0....	Resistor, potentiometer
C0....	Capacitor, variable capacitor
B0....	Tube, valve
LA....	Lamp
VL...	Fuse
SK....	Switch
BU....	Connector, socket, terminal
T0....	Transformer
L0....	Coil
X0....	Crystal
CB....	Circuit block
RE....	Relay
ME....	Meter, indicator
BA....	Battery
TR....	Chopper

Parts not identified in the circuit diagram:

990000	Unknown/Not applicable
990001	Cabinet or rack (text plate, emblem, grip, rail, graticule, etc.)
990002	Knob (incl. dial knob, cap, etc.)
990003	Probe (only if attached to instrument)
990004	Leads and associated plugs
990005	Holder (valve, transistor, fuse, board, etc.)
990006	Complete unit (p.w. board, h.t. unit, etc.)
990007	Accessory (only those without type number)
990008	Documentation (manual, supplement, etc.)
990009	Foreign object
990099	Miscellaneous

Sales and service all over the world

Alger: Sadetel; 41 Rue des Frères Mouloud Alger; tel. 656613-656607

Argentina: Philips Argentina S.A., Cassila Correo 3479, Buenos Aires; tel. T.E. 70, 7741 al 7749

Australia: Philips Electrical Pty Ltd., Philips House, 69-79 Clarence Street, Box 2703 G.P.O., Sydney; tel. 2.0223

België/Belgique: M.B.L.E. Philips Bedrijfs-apparatuur, 80 Rue des Deux Gares, Bruxelles; tek 02/13.76.00

Bolivia: Industrias Bolivianas Philips S.A. -A Jón postal 2964 La Paz tel. 50029

Brasil: S.A. Philips Do Brasil; Avenida Paulista 2163; P.O. Box 8681; Sao Paulo S.P.; tel 81-2161.

Burundi: Philips S.A.R.L., Avenue de Grèce, B.P. 900, Bujumbura

Canada: Philips Electronic Industries Ltd., Scientific and Electronic Equipment Division, Philips House, 116 Vanderhoof Avenue, Toronto 17 M 4G 2J1. tel. (416)-425-5161.

Chile: Philips Chilena S.A., Casilla 2687, Santiago de Chile; tel. 94001

Colombia: Industrias Philips de Colombia S.A., Calle 13 no. 51-03, Apartado Nacional 1505, Bogota; tel. 473640

Costa Rica: Philips de Costa Rica Ltd., Apartado Postal 4325, San José; tel. 210111

Danmark: Philips Elektronik Systemer A/S Afd. Industri & Forskning; Strandlodsvej 4 2300-København S; Tel (0127) AS 2222; telex 27045

Deutschland (Bundesrepublik): Philips Elektronik Industrie GmbH, 2000 Hamburg 73, Meindorferstraße 205; Postfach 730 370; tel. 6797-1

Ecuador: Philips Ecuador S.A., Casilla 343, Quito; tel. 239080

Egypt: Ph. Scientific Bureau 5 Sherif Str. Cairo - A.R. Egypt P.O. Box 1807; tel. 78457-57739

Eire: Philips Electrical (Ireland) Ltd., Newstead, Clonskeagh, Dublin 14; tel. 976611

El Salvador: Philips de El Salvador, Apartado Postal 865, San Salvador; tel. 217441

España: Philips Ibérica S.A.E., Avenida de America, Apartado 2065, Madrid 17; tel 2462200

Ethiopia: Philips Ethiopia (Priv. Ltd. Co.), P.O.B. 2565; Cunningham Street, Addis Ababa; tel. 48300

Finland: Oy Philips Ab, Postboks 10255, Helsinki 10; tel. 10915

France: Philips Industrie, Division de la S.A. Philips Industrielle et Commerciale 105 Rue de Paris, 93 002 Bobigny; tel. 830-11-11

Ghana: Philips (Ghana) Ltd., P.O.B. M 14, Accra; tel. 66019

Great Britain: Pye Unicam Ltd., York Street, Cambridge; tel. (0223) 58866

Guatemala: Philips de Guatemala S.A., Apartado Postal 238, Guatemala City; tel. 64857

Hellas: Philips S.A. Hellénique, 54, Ave Syngrou, Athens; tel 230476, P.O. Box 153

Honduras: Hasbun de Honduras Apartado Postal 83, Tegucigalpa; tel. 2-9121...5

Hong kong: Philips Hong Kong Ltd., P.O.B. 2108, St. George's Building, 21st floor, Hong Kong; tel. 5-249246

India: Philips India Ltd., Shivsagar Estate, Block "A", Dr. Annie Besant Road, P.O.B. 6598, Worli, Bombay 18; tel. 370071

Indonesia: P. T. Philips Development Corporation, Jalan Proklamasi 33, P.O.B. 2287, Jakarta; tel. 51985-51986

Iran: Philips Iran Ltd., P.O.B. 1297, Teheran; tel. 662281

Iraq: Philips Iraq W.L.L. Munir Abbas Building 4th Floor; South Gate. P.O. box 5749 Baghdad; tel. 80409

Island: Heimilistaeki SF, Saetún 8, Reykjavik; tel. 24000

Islas Canarias: Philips Ibérica S.A.E., Triana 132, Las Palmas; Casilla 39-41, Santa Cruz de Tenerife

Italia: Philips S.p.A., Sezione PIT; Viale Elvezia 2, 20052 Monza; tel. (039) 361-441; telex 35290

Kenya: Philips (Kenya) Ltd., P.O.B. 30554, Nairobi; tel. 29981

Malaysia: Philips Malaya Sdn Bhd. P.O. Box 332, Kuala Lumpur; Selangor W. Malaysia; tel. 774411

Mexico: Philips Comercial S.A. de C.V., Uruapan 7, Apdo 24-328, Mexico 7 D.F.; tel. 25-15-40

Nederland: Philips Nederland B.V., Boschdijk, Gebouw VB, Eindhoven; tel. 793333

Ned. Antillen: N.V. Philips Antillana, Postbus 523, Willemstad; tel. Curaçao 36222-35464

New Zealand: Philips Electronical Industries (N.Z.) Ltd., Professional and Industrial Division, 70-72 Kingsford Smith Street, P.O.B. 2097, Lyall Bay, Wellington; tel. 73-156

Nigeria: Philips (Nigeria) Ltd., 6 Ijora Causeway, P.O.B. 1921, Lagos; tel. 45414/7

Nippon: Nihon Philips Corporation, P.O.B. 13, World Trade Center, 32nd Floor, Tokyo 105; tel. (03) 435-5211

Norge: Norsk A.S. Philips, Postboks 5040, Oslo; tel. 463890

Österreich: Oesterreichische Philips Industrie GmbH, Abteilung Industrie Elektronik, Triesterstrasse 64, A-1101 Wien; tel. (0222) 645511/31

Pakistan: Philips Electrical Co. of Pakistan Ltd., El-Markaz, M.A. Jinnah Road, P.O.B. 7101, Karachi; tel. 70071

Paraguay: Philips del Paraguay S.A., Casilla de Correo 605, Asuncion; tel. 8045-5536-6666

Perú: Philips Peruana S.A., Apartado Postal 1841, Lima; tel. 326070

Philippines: Philips Industrial Development Inc., 2246 Pasong Tamo P.O.B. 911, Makati

Rizal D-708; tel. 889453 to 889456

Portugal: Philips Portuguesa S.A.R.L., Av. Eng. Duarte Pacheco, 6 - Lisboa - 1

Rwanda: Philips Rwanda S.A.R.L., B.P. 449, Kigali

Saudi Arabia: A. Rajab and A. Silsilah P.O. box 203 Jeddah - Saudi Arabia; tel. 5113-5114

Schweiz-Suisse-Svizzera: Philips A.G., Binzstrasse 15, Postfach 8027, Zürich; tel. 051-442211

Singapore: Philips Singapore Private Ltd. P.O. Box 340; Toa Payoh Central Post Office; Singapore 12; tel. 538811

South Africa: South African Philips (Pty) Ltd., P.O.B. 7703, 2, Herb Street, New Doornfontein, Johannesburg; tel. 24-0531

Sverige: Svenska A.B. Philips, Fack, Lidingövägen 50, Stockholm 27; tel. 08/635000

Syria: Philips Moyen-Orient S.A. Rue Fardoss 79 Immeuble Kassas and Sadate B.P. 2442 Damas; tel. 18605-21650

Taiwan: Yung Kang Trading Co. Ltd., San Min Building, Gnd Floor, 57-1 Chung Shan N Road, 2 Section, P.O.B. 1467, Taipei; tel. 577281

Tanzania: Philips (Tanzania) Ltd., Box 20104, Dar es Salaam; tel. 29571

Thailand: Philips Thailand Ltd., 283, Silom Road, Bangkok; tel. 36980, 36984-9

Turkey: Türk Philips Ticaret A.S., Posta Kutusu 504, Beyoglu; Gümüssüyu Caddesi 78/80 Istanbul 1 Turkye

Uganda: Philips Uganda Ltd. p.o. Box 5300 Kampala; tel. 59039

Uruguay: Industrias Philips del Uruguay, Avda Uruguay 1287, Montevideo; tel 915641 Casilla de Correo 294

U.S.A.: Philips Test and Measuring Instruments Inc.; 400 Crossways Park Drive, Woodbury, N.Y. 11797; tel. (516) 921-8880

Venezuela: C.A. Philips Venezolana, Apartado Postal 1167, Caracas; tel. 360511

Zaire: Philips S.Z.R.L., B.P. 1798, Kinshasa; tel. 31887-31888-31693

Zambia: Philips Electrical Ltd., Professional Equipment Division, P.O.B. 553 Kitwe; tel. 2526/7/8; Lusaka P.O. Box 1878

750101

For information on change of address:

N.V. Philips
Test and Measuring Instruments Dept.
Eindhoven - The Netherlands

For countries not listed:

N.V. Philips PIT Export Dept.
Test and Measuring Instruments Dept.
Eindhoven - The Netherlands



Technische Service-Mitteilung

Nr: 028

IE/AMT Nr. 005 Oszillografen	Betrifft: <u>Zweikanal-Oszillograf PM 3110/02</u> Zenerdioden BZX 70/C 12														
SHW/Sch/St Tel. 245 Hamburg, den 4.1.72	<p>Die Zener-Dioden 401 und 451 (Einheit 2) sowie 416 und 417 (Einheit 3), bisher vom Typ BZX 29/C 12, wurden, da nicht verfügbar, durch BZX 70/C 12 ersetzt.</p> <p>Aus bisher unbekanntem Gründen neigen einige dieser BZX 70/C 12-Dioden zu Ausfallerscheinungen.</p> <p>Wir möchten Sie darauf hinweisen, alle in die Werkstatt kommenden PM 3110/02 auf einwandfreie Funktion dieser Zener-Dioden zu prüfen.</p> <p style="text-align: center;">PEI - Hauptabteilung Service und Montage</p> <p style="text-align: center;"><i>(Stieglitz)</i> (Stieglitz)</p> <p style="text-align: center;"><i>(Schäfer)</i> (Schäfer)</p> <table border="1" data-bbox="1136 1646 1466 2027"><tr><td colspan="2" style="text-align: center;">TB BERLIN</td></tr><tr><td colspan="2" style="text-align: center;">Empf. 28. JAN. 1972</td></tr><tr><td>Ans:</td><td></td></tr><tr><td>Herrn:</td><td></td></tr><tr><td>„</td><td></td></tr><tr><td>„</td><td></td></tr><tr><td>erl.:</td><td></td></tr></table>	TB BERLIN		Empf. 28. JAN. 1972		Ans:		Herrn:		„		„		erl.:	
TB BERLIN															
Empf. 28. JAN. 1972															
Ans:															
Herrn:															
„															
„															
erl.:															
Verteiler: IE/AMT Alle PEI-Servicestellen FB's und TB's PEI-Dokumentation															