

Legend:

- Relay symbol
- Switch symbol
- Motor symbol
- Power source symbol
- Terminal block symbol

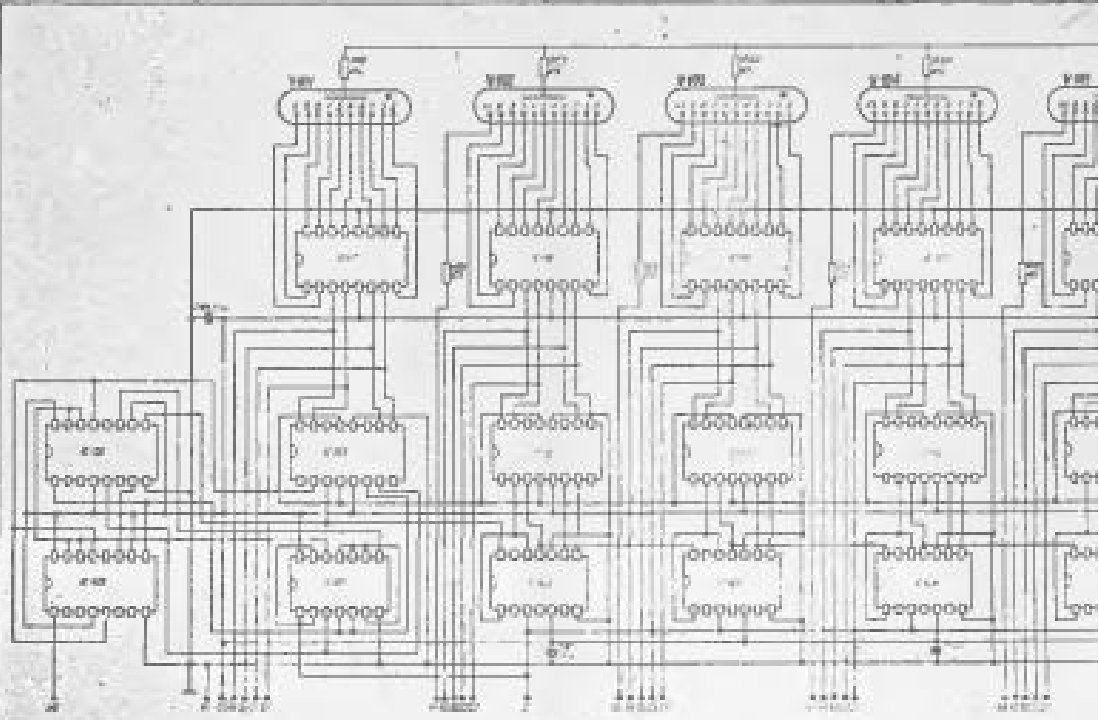

201 - 2010000

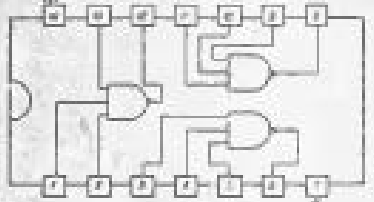

202 - 2010000

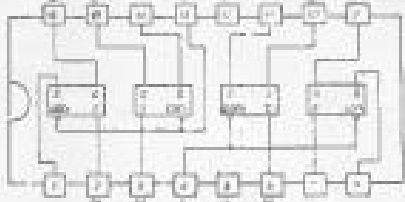

203

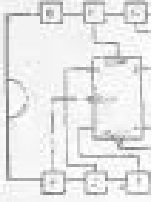

204 - 2010000

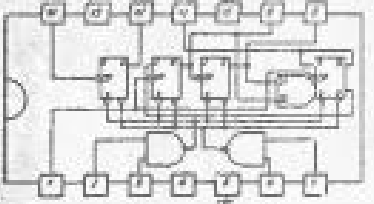

205 - 2010000

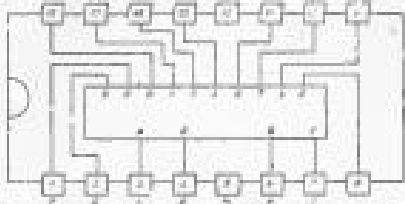

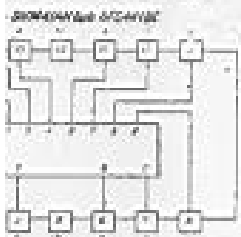
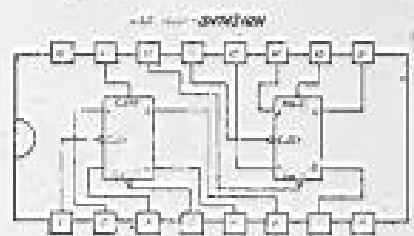
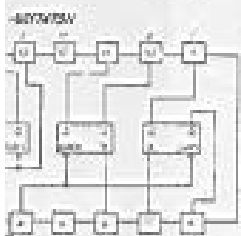
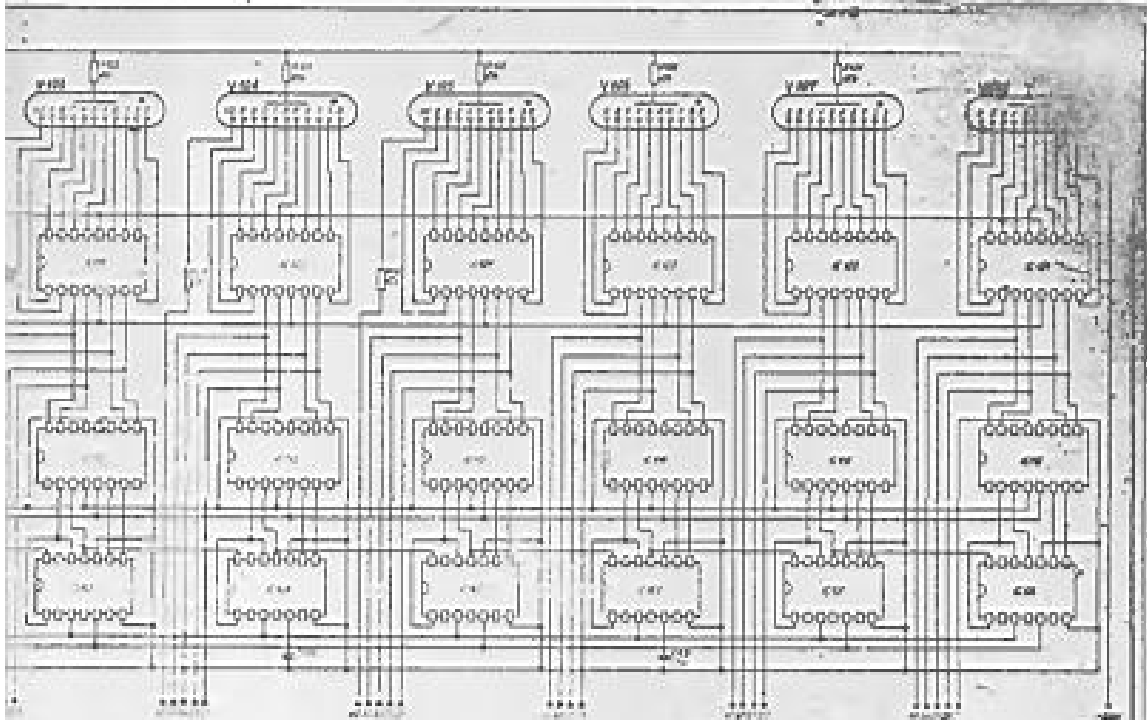

ZOPAN License Counter 100-100

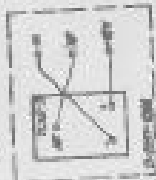

Generator winding

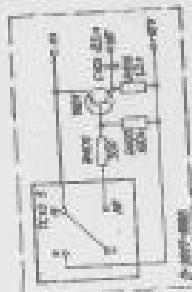

Generator winding

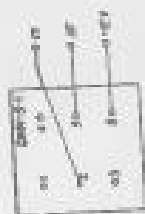

Generator winding

Generator winding	Generator winding
Generator winding	Generator winding
Generator winding	Generator winding
Generator winding	Generator winding
Generator winding	Generator winding

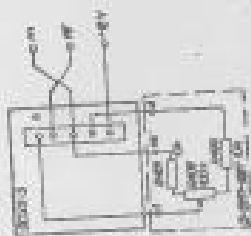

Generator winding

Generator winding
Standard generator

ZUPAN

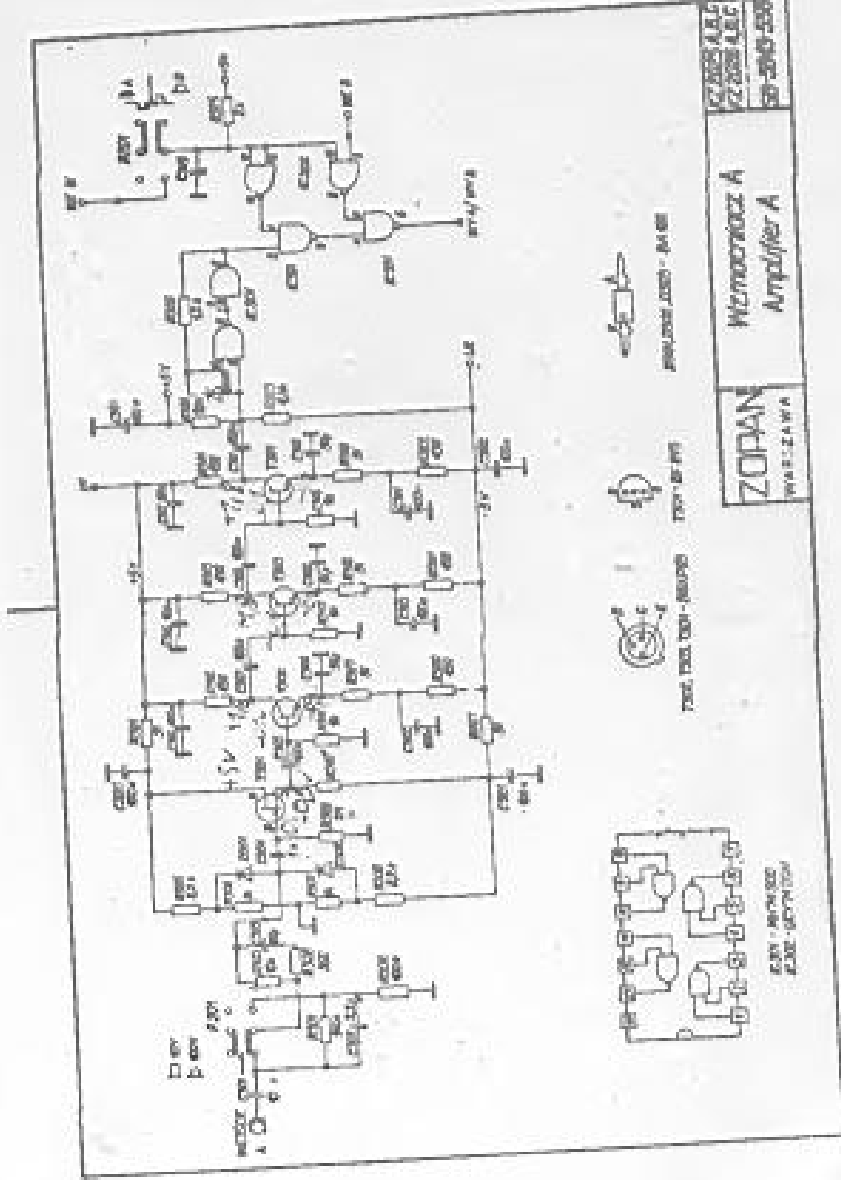

6X4 - 6X4 tube
 6X5 - 6X5 tube
 1000µF - 1000µF capacitor
 100µF - 100µF capacitor
 100kΩ - 100kΩ resistor
 100Ω - 100Ω resistor
 100V - 100V transformer
 220V - 220V transformer
 250V - 250V transformer

ZORAN
 WARSZAWA
 Muzmorozov A
 Amplifier A



6200 - 62000 - 620000

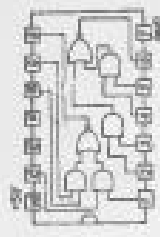

6200 - 620000

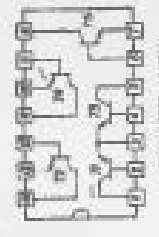

6200 - 62000 - 620000



6200 - 62000 - 620000



6200 - 62000
6200 - 620000
6200 - 6200000



6200 - 62000 - 620000
6200 - 620000 - 6200000

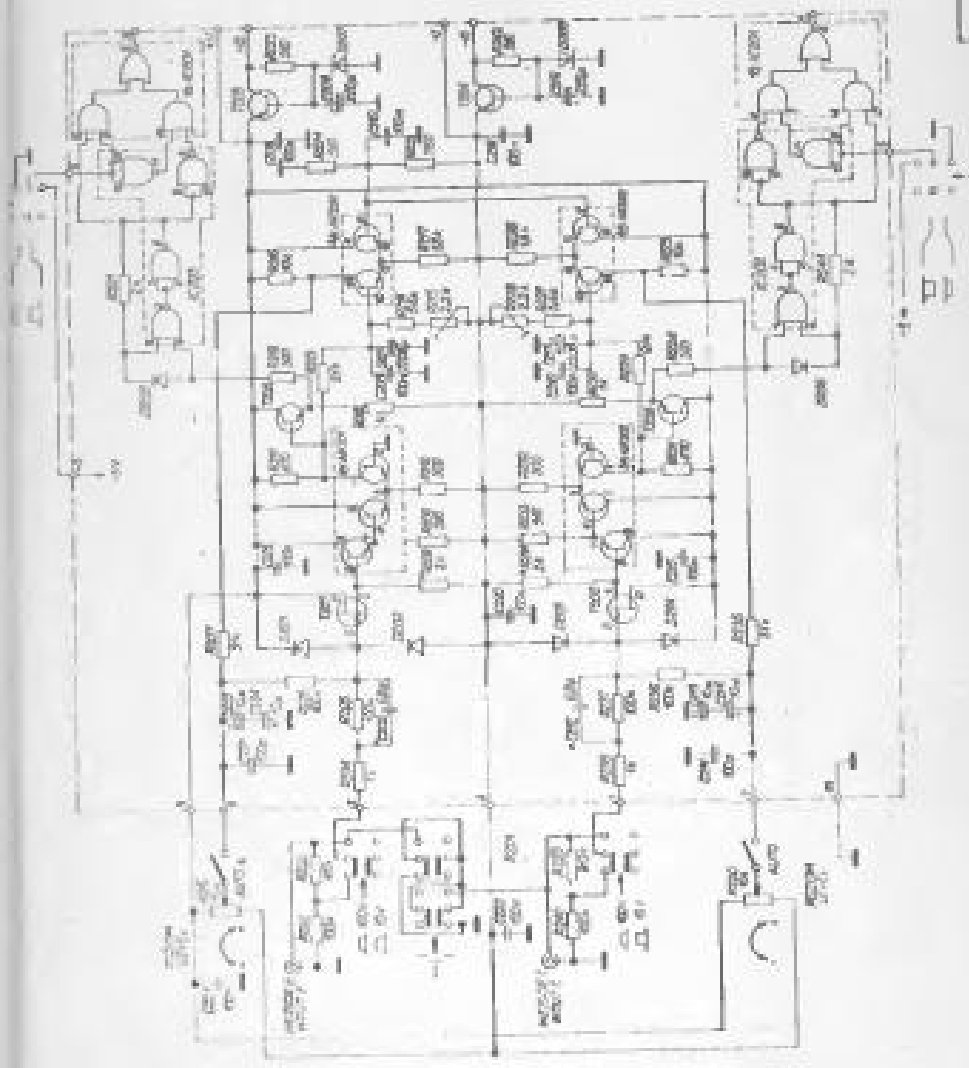

ZODAN
Wzmocniacz BIC
Amplifier BIC

KLASA AK
KLASA BK
94-940-558

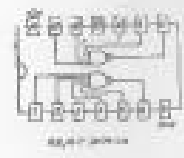
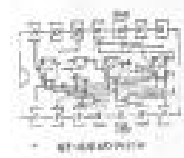
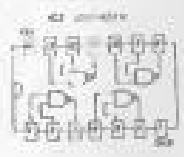
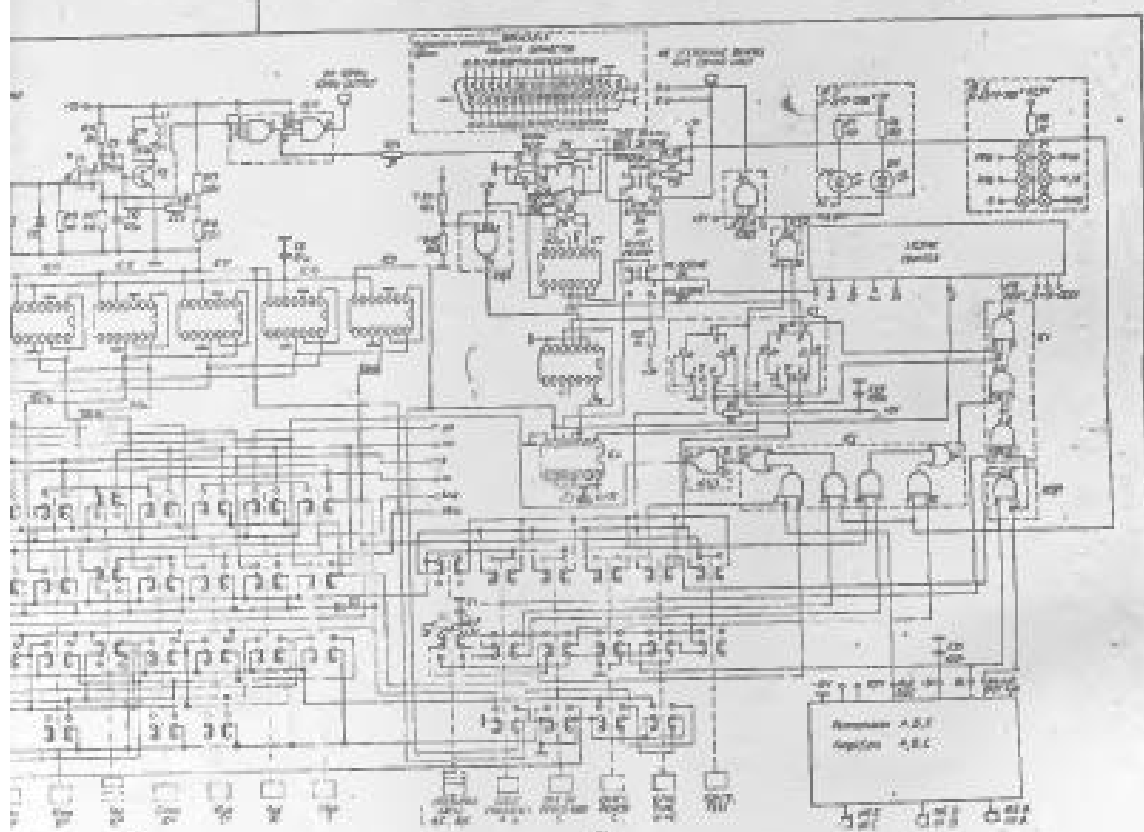

Relay	1	2	3	4	5
100	100	100	100	100	100
101	101	101	101	101	101
102	102	102	102	102	102
103	103	103	103	103	103

ZOPAN Digitalmeter - customer
 ZOPAN
 Frequency-line Digital Meter
 Mikroprozessor
 ALPINE
 50-600-500