



ROHDE & SCHWARZ

SMDU

RADIOTELEPHONE TEST ASSEMBLY SMDU

0.14 to 1050 MHz

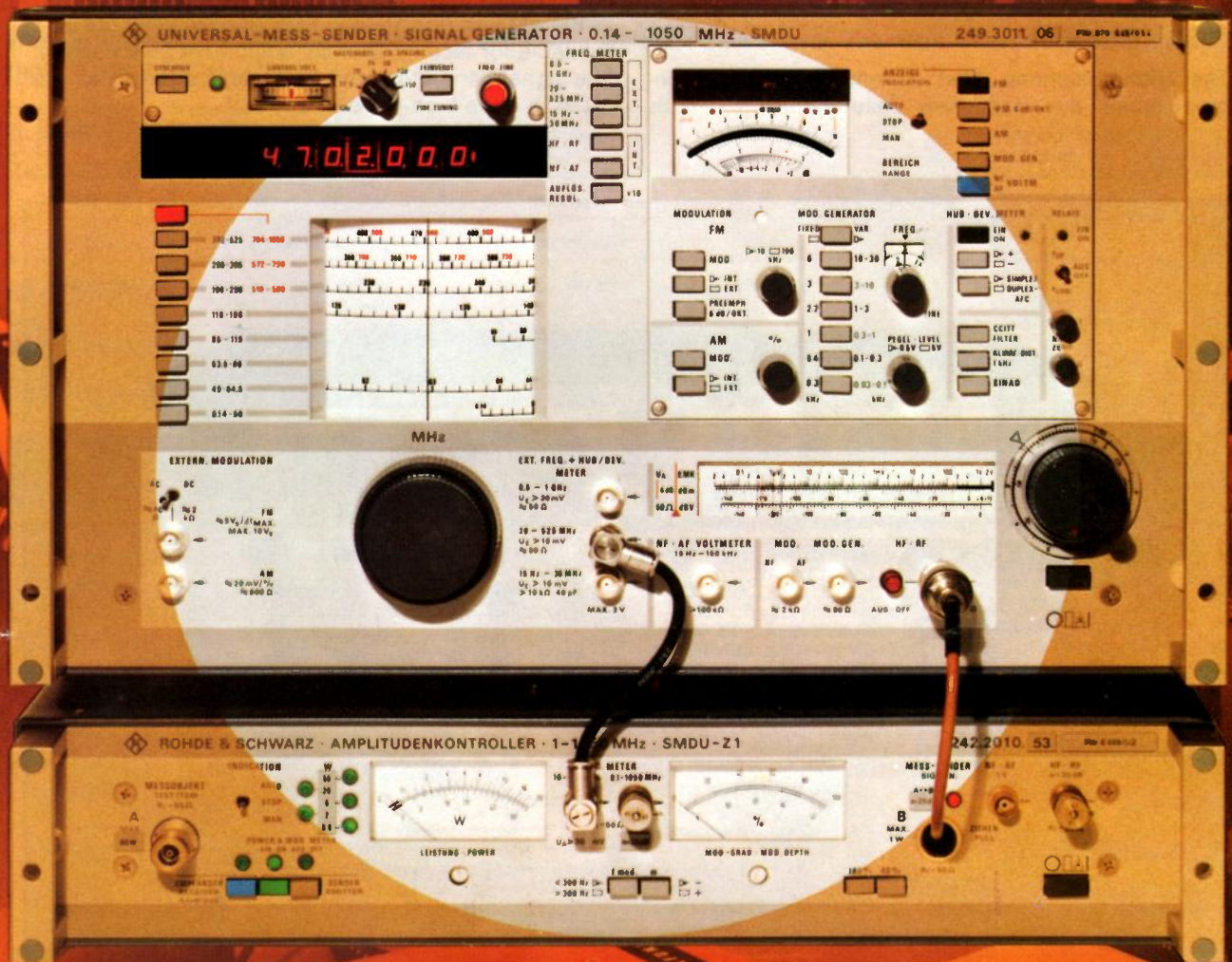

RADIOTELEPHONE TEST ASSEMBLY SMDU

0.14 to 1050 MHz (525 MHz without options)

The accurate, value-for-money test system combining versatility with operating ease

- Optimum spectral purity for two-source measurements according to CEPT, EIA and BPO standards
- Suitable for AM/FM radiotelephones in all power ranges
- Rapid and precise measurements in accordance with all standard test methods

The ideal system for every application

The Radiotelephone Test Assembly SMDU incorporates all the necessary instruments for both

receiver and transmitter testing and is available in a number of versions.

For testing FM radiotelephones, the RT Test Set SMDU 249.3011.56 is recommended. This brings all the necessary equipment together in a single cabinet and, like all the other versions, can be extended for frequencies up to 1050 MHz by means of options.

Test assemblies for purposes other than RT testing, or for combined measurements, can be built up from one of the basic SMDU models (which already contain various different instruments), options and add-on units such as the power test adapter (for FM) or the AM unit (for AM and FM). Special units are also available for testing avionics equipment (see page 4). The signal generators and their application areas are listed in table 1 on page 3.

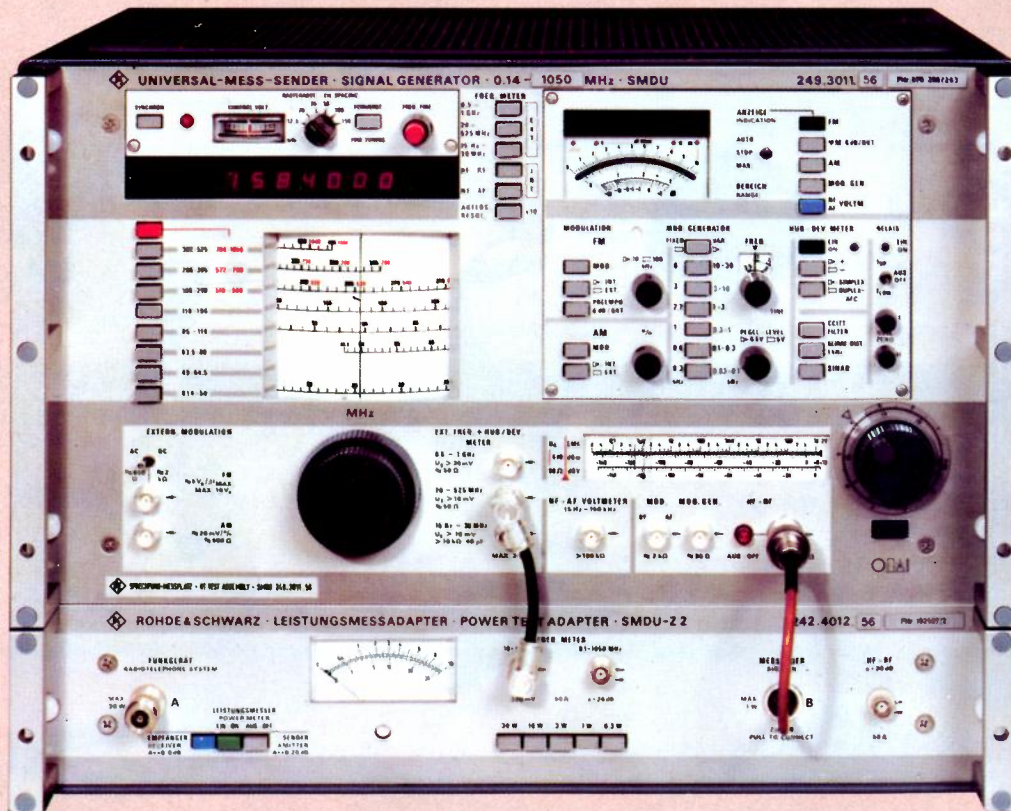

Figure 1 SMDU 249.3011.56 test assembly for FM radiotelephones in a single cabinet

Application	Model	Further information in data sheet
AM/FM radiotelephones	Radiotelephone model 249.3011.06	
AM radiotelephones and stereo broadcast receivers (in combination with CB sets)	Radiotelephone model 249.3011.09	
AM/FM radiotelephones, airborne VOR/ILS and communication equipment	Radiotelephone and air-navigation model 249.3011.07	249 311
Airborne VOR/ILS and communication equipment	Air-navigation model 249.3011.08	249 301 and 249 311
Low-cost signal generator	Standard model 249.3011.02	249 301
General-purpose signal generator	Universal model 249.3011.04	249 301

All models are suited for use as the interfering source in two-source measurements

Table 1 The models in the SMDU signal-generator family and their applications in radio engineering

Models SMDU 02, 04 and 08 are described in detail in separate data sheets. The main characteristics of these models are given in table 2.

Model	Modulation specially suited for	Modulation generator	Output	Autoranging modulation meter and AF voltmeter
SMDU 02	—	0.4 and 1 kHz	1 V	no
SMDU 04	Stereo broadcasting	15 Hz to 150 kHz	5 mV to 1 V	yes
SMDU 08	Stereo broadcasting and VOR/ILS signals	15 Hz to 150 kHz	5 mV to 1 V	yes

Table 2 Characteristics of general-purpose signal-generator models SMDU 02, 04 and 08

Options

All models of the SMDU can be fitted with the following five mutually independent options. The options can be ordered together with the signal generator or added later as required.

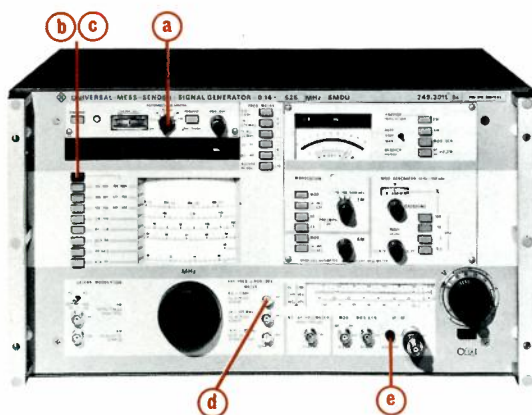

Figure 2 SMDU models 04 and 08

► Synchronizer SMDU-B1 249.6340.02 a

This option is fitted as standard equipment in the Radiotelephone Test Assembly SMDU 249.3011.56.

Long-term frequency stability is improved to that of a synthesizer while the high spectral purity of a free-running oscillator is maintained. Operation is greatly simplified by the **channel-stepping facility** with switch-selected steps of 12.5, 20, 25, 50, 100 or 150 kHz and by the wide-range, high-resolution **electronic fine tuning**.

► 1.05-GHz Frequency Range Ext. SMDU-B3 249.9484.02 b

Extends the frequency range of the RF generator to 1.05 GHz without sacrificing frequency stability, high spectral purity or RF-output-level accuracy. Digital display of internal frequency up to 1.05 GHz; option SMDU-B4 is not required.

► 1.05-GHz Frequency Doubler SMDU-B5 275.1312.02 c

Low-cost option for doubling the frequency range of the RF generator to 1.05 GHz. Subharmonics and harmonics are at least 20 dB below the carrier level. Does not affect frequency stability or accuracy of RF output level. Frequency displayed digitally (option SMDU-B4 not required).

► 1-GHz Frequency Meter SMDU-B4 250.0012.02 d

Extends the range of the counter to 1 GHz for external signals. Sensitivity: 30 mV.

► Overload Protection SMDU-B2 249.7346.02 e

This option is fitted as standard equipment in the Radiotelephone Test Assemblies SMDU 06, 07, 09 and 56. It protects the RF output of the signal generator against externally applied power of up to 50 W.

Add-on units

Model SMDU 249.3011.56 is supplied as a fully equipped Radiotelephone Test Assembly. The remaining models can be equipped for radiotelephone and air-communication equipment testing by combining them with a number of add-on units. For special applications, such as antenna testing and sequential-tone measurements, further instrumentation is available (see pages 7 and 15).

▶ POWER TEST ADAPTER SMDU-Z2 242.4012.52

This unit permits matched connection of the radiotelephone to the test assembly, further signal generators (for multi-source measurements) and to an analyzer. It also permits switchover between receiver and transmitter measurements without reconnection of the cables. The **power test adapter**, which is standard equipment in the SMDU 56, is a particularly economic way to provide these essential functions.

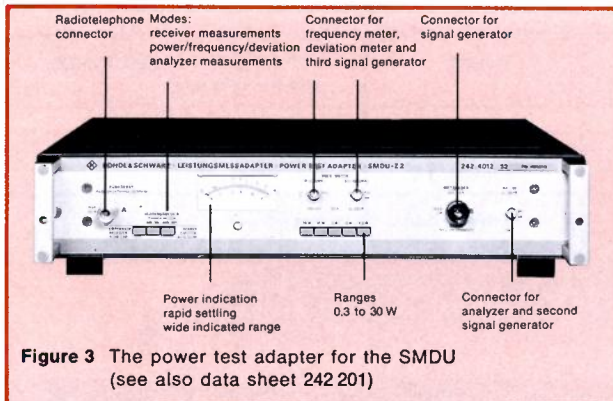

Figure 3 The power test adapter for the SMDU (see also data sheet 242 201)

▶ AM UNIT SMDU-Z1

242.2010.53 (60-W model)
242.2010.52 (30-W model)

The AM unit makes for even greater operating ease and provides the additional function of modulation-depth measurement. The AM unit is available in 30-W and 60-W models, and differs from the power test adapter through the additional features shown in figure 4. Also provided are recorder outputs for the carrier voltage and the modulation depth. In both cases a DC output voltage of $1\text{ V} \pm 3\%$ corresponds to full scale on the front-panel meter.

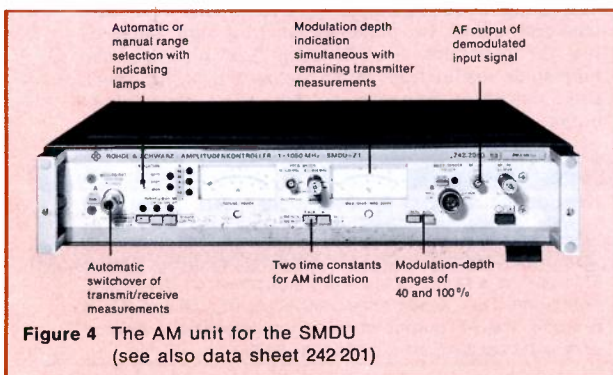

Figure 4 The AM unit for the SMDU (see also data sheet 242 201)

▶ VOR/ILS UNIT SMDA-Z 214.3115.02

The VOR/ILS unit is for use in all measurements on VOR/ILS receivers according to the ARINC and RTCA recommendations (see data sheet 249 311).

▶ VOR/ILS UNIT SMDA-Z 214.3115.10

This model of the VOR/ILS unit includes a decade DDM (difference in depth of modulation) switch. The switch can be set in steps of 0.001 DDM.

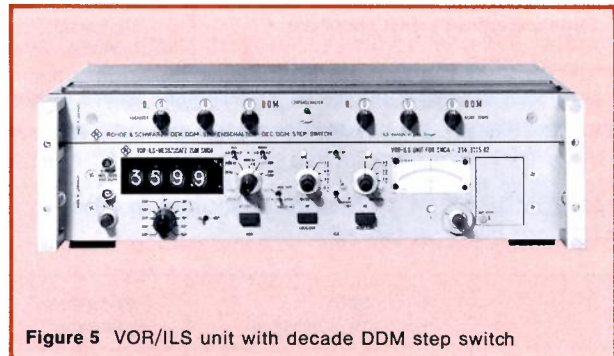

Figure 5 VOR/ILS unit with decade DDM step switch

■ TEST ASSEMBLY FOR AIRBORNE VOR/ILS AND COMMUNICATION EQUIPMENT

The outstanding advantage of this test assembly for air-navigation receivers is the built-in monitoring facility. The complete system for testing VOR/ILS receivers thus comprises an AF generator, an RF generator and a monitor. Other features of the test assembly are self-test and calibration facilities by means of which the accuracy of the modulation-depth, DDM-null and VOR-phase measurements can be checked and restored as necessary (see data sheet 249 311).

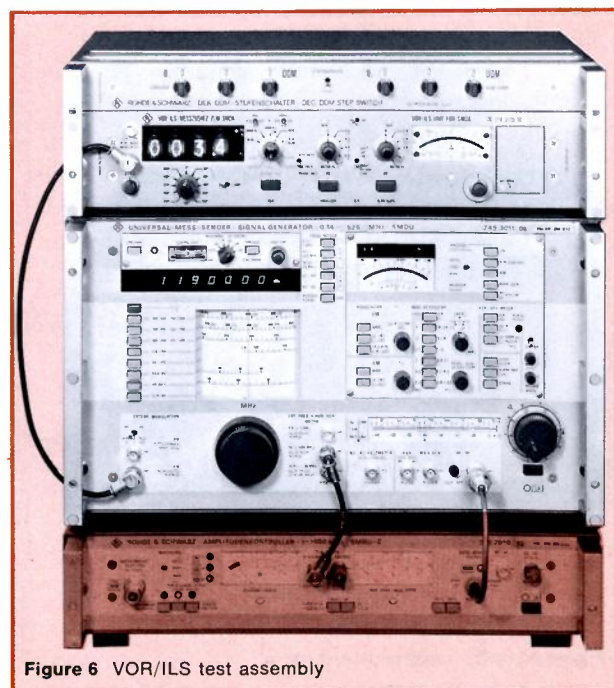

Figure 6 VOR/ILS test assembly

High-accuracy, cost-effective radiotelephone test assembly

This third generation of radiotelephone test assemblies is the result of many years' experience in the field. The Radiotelephone Test Assembly SMDU is ideal for all measurements in development, test department, production and servicing. Its low price makes the SMDU an attractive solution in all such applications. The convenient operating controls and the provision of semi-automated test routines make for great rationalization of the measurement process. Even in measurements involving a number of error sources is the overall accuracy of the result assured. Thus, for example, in the measurement of SINAD sensitivity according to the method of CEPT, the errors of level meter, deviation meter and voltmeter, range switch-over and SINAD filter are all taken into account. The worst-case error in making this measurement with the SMDU is less than 3 dB, less than half that of the test sets normally used. Since the AF voltmeter uses a true rms rectifier, as specified in the test method, no additional error is thereby introduced.

Although it would be possible to manufacture cheaper test assemblies by not taking account of these measurement specifications, the use of such equipment, even for servicing purposes, would be of dubious value. Where required, the SMDU incorporates instruments of an accuracy found previously only in specialized, separate units. The test assembly is already in use by many national authorities with responsibility for radio traffic. The SMDU 06, for example, is registered with the Deutsche Bundespost under the number 27609415, and the AM Unit SMDU-Z1 under the number 276094155.

■ COST EFFECTIVENESS

The SMDU combines the necessary measurement

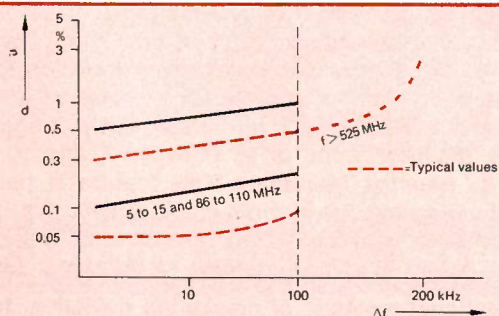

FM modulation distortion measured with a distortion-free modulating signal of 15 Hz to 53 kHz as a function of frequency deviation

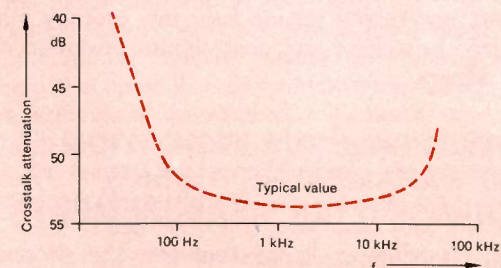

Channel crosstalk in stereo modulation as a function of modulation frequency

Figure 7 FM modulation distortion and crosstalk of SMDU 09

accuracy with an attractive price. The test assembly makes use of many of the subassemblies of the signal-generator family of the same name, thereby gaining the advantage of advanced design techniques and permitting high-volume production and automated testing. The SMDU is conceived in such a way as to permit the multiple use of many subassemblies and the cost-saving fulfilment of varying measurement requirements through the creation of different models of the basic signal generator. The possibility of later extension by the incorporation of options has also been foreseen from the design stage. Thus, for example, the SMDU 09 is suitable for testing high-quality stereo-broadcast receivers combined with Citizens' Band radiotelephones for use in cars.

■ WIDE FREQUENCY AND LEVEL RANGES

The test assembly has a frequency range of 0.14 to 525 MHz which may be extended to 1050 MHz by the addition of option SMDU-B3 or SMDU-B5. This range covers all present and planned radiotelephone bands as well as many other services, and is also adequate for broadband measurements.

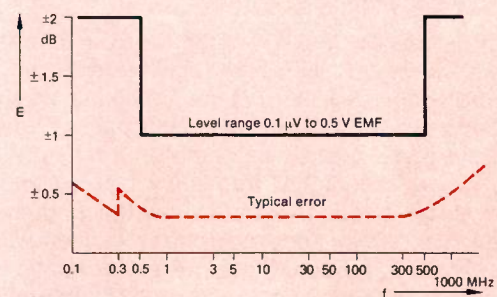

Figure 8 Level inaccuracy as a function of frequency

The extremely wide range of the output-signal level (0.05 μV EMF to 2 V EMF) covers all possible requirements, from the testing of high-sensitivity receivers to overdriving, blocking and similar situations where a high voltage is necessary. The excellent level accuracy throughout the entire frequency range is illustrated in figure 8.

■ HIGH SPECTRAL PURITY

The high spectral purity of the output signal allows

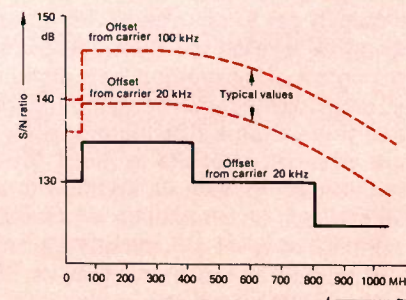

Figure 9 Signal-to-noise ratio with 1-Hz measuring bandwidth for various carrier offsets as a function of carrier frequency

even the maximum output level to be used for critical receiver measurements (see back page of data sheet). Such situations occur during, for example, dynamic adjacent-channel and image-frequency measurements, as well as in intermodulation, crossmodulation and blocking investigations. The use of very steep filters in the Frequency Extension SMDU-B3 guarantees high suppression of spuria even up to 1.05 MHz. All SMDU models are suitable for use as the interfering generator in multi-source measurements, the low cost of the standard model (SMDU 02) making it particularly attractive for this rôle.

Operating ease

TUNING

The SMDU can be tuned through its entire frequency range without having to reverse the direction of rotation of the tuning knob. This feature, together with the combined digital/analog scale and the optimized gearing of the coarse/fine tuning drive, permits much quicker frequency setting than a row of decade switches.

Rapid frequency setting is particularly valuable when searching for signal and interference frequencies which are not precisely known.

When the optional Synchronizer SMDU-B1 is incorporated (standard with the Radiotelephone Test Assembly SMDU 249.3011.56) the tuning can be simply stepped to the next channel (channel spacing selected by a front-panel switch) by slightly turning the fine-tuning knob. The digital frequency display and the control-range indicator clearly show the step change in frequency. When the synchronizer is used without fine tuning the frequency can be set in multiples of the chosen channel spacing throughout the entire frequency range; when fine tuning is selected synchronized adjustment of the frequency to any intermediate value is also possible. The tuning range is always more than $\pm 60\%$ of the selected channel spacing. The coarse/fine electronic tuning permits very accurate frequency setting, the sensitivity being 0.1% of the channel spacing per revolution of the tuning knob. The output frequency of the signal generator is indicated on the digital frequency counter at all times, including during synchronized operation.

LEVEL SETTING

The single-range output attenuator permits the signal level to be quickly set to any value with no jumps and without having to reverse the direction of rotation of the setting control. This method has distinct advantages over other arrangements using coarse range switches and fine variable attenuators. Above all, the single-range attenuator results in much faster measurement of parameters such as sensitivity, adjacent-channel selectivity, intermodulation and crossmodulation. The continuous level adjustment also eliminates all problems related to the measurement of squelch performance or AGC response.

The calibrated, 10 dB/turn scale on the rotary attenuator knob permits rapid and accurate setting of specific level changes such as 6 or 10 dB. The main

scale is arranged horizontally for ease of reading. It is marked in all the level scales necessary to permit measurements according to all standard test methods without any need for conversions.

AF GENERATOR AND MODULATION

The modulation controls are provided, where appropriate, with coarse and fine adjustments to permit exact setting in all operating modes. Together with the autoranging feature of the meter and the mode indicator lamps, this makes for very simple operation and rapid measurements.

FREQUENCY MEASUREMENTS

The direct-reading seven-digit frequency meter has sufficient accuracy and resolution for use even on frequency processing stages whose errors are magnified in the final frequency as a result of frequency multiplication.

A mixer incorporated in the test assembly beats the signal from the test item with the synchronized output of the signal generator. The resulting difference frequency can be monitored on headphones or displayed by the digital frequency meter, a technique which is often valuable when adjusting circuits such as crystal oscillators.

The high sensitivity of the frequency meter (typically a few millivolts) permits non-interacting, non-contact measurements using loops, probes or antennas. Remote frequency measurements on mobile transmitters are also possible.

FREQUENCY-DEVIATION MEASUREMENT

In the deviation meter, the signal is first mixed with the main oscillator frequency and then with the output of a second, automatically tuned oscillator. There is no need for separate tuning during deviation measurements on simplex and duplex systems as long as the signal generator is tuned to the receive frequency of the radiotelephone or to between 4 and 10 MHz from its transmit frequency. This feature is particularly time-saving when multi-channel sets are being tested. Even spurious deviation can be measured thanks to the low internal noise of the meter circuit.

Conventional methods of measuring deviation during relay operation of a radiotelephone require an independent deviation meter. The new technique used in the SMDU cancels the effect of the signal-generator FM during the mixing process, thereby making the time-consuming and costly extra deviation meter unnecessary.

SIMULTANEOUS INDICATION OF PARAMETERS DURING TRANSMITTER MEASUREMENTS

During transmitter measurements the frequency, power and frequency deviation/modulation depth are all indicated simultaneously. With the AM unit, the power-measurement range is selected automatically. No additional adjustments are required on changing the channel frequency, thus making it possible to record the test results.

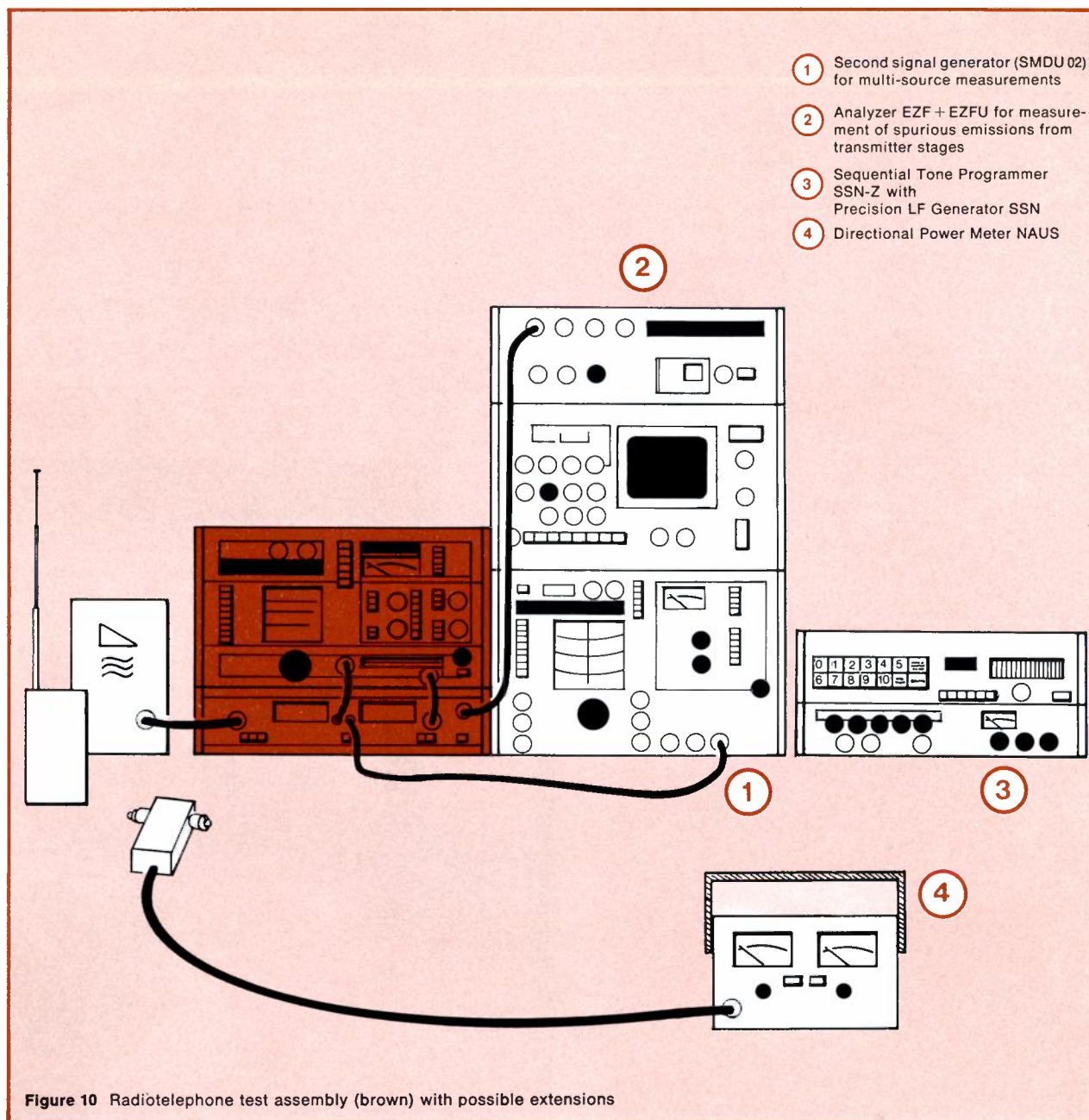

Figure 10 Radiotelephone test assembly (brown) with possible extensions

Extending the test assembly

The Radiotelephone Test Assemblies SMDU incorporate all the instruments required for normal servicing (see block diagram on page 12).

In practical situations, the investigation of poor radio communications involves further measurements for checking the special, interference-determining items of the equipment specifications. Consideration must also be given to the possibility that working conditions alone are responsible for the disturbed communication. It is therefore advantageous that test assemblies, even when used only for servicing, may be easily extended to permit, for example, two-source measurements. An important parameter such as adjacent-channel selectivity can only be measured using a two-source technique. Thanks to the direct connections for a second signal generator and an analyzer, extension of the SMDU Radiotelephone Test Assembly is very straightforward. For special measurement prob-

lems, a comprehensive range of additional equipment can also be supplied (see page 15).

RECORDING FACILITIES

Printing or recording of the results of all transmission measurements is made possible through the provision of a number of test outputs:

BCD output of the digital frequency meter, DC output of the indication on the meter associated with the modulation generator, AC output from the deviation meter, DC outputs proportional to the carrier voltage and the modulation depth at the AM unit SMDU-Z1.

Further equipment, such as a suitable digital voltmeter as A/D converter, or a D/A converter for charting the frequency, may be added to the recorders.

Operating controls

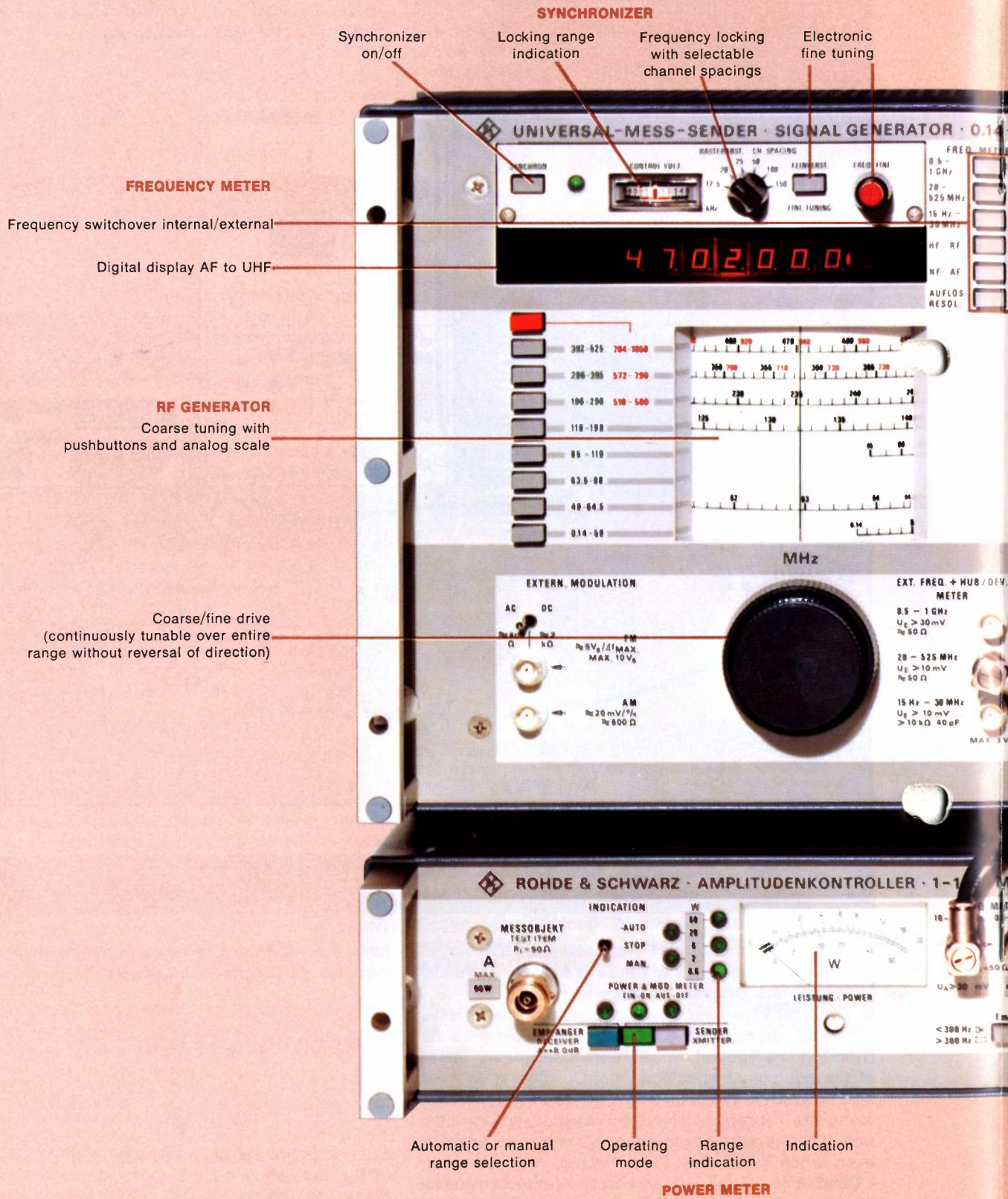
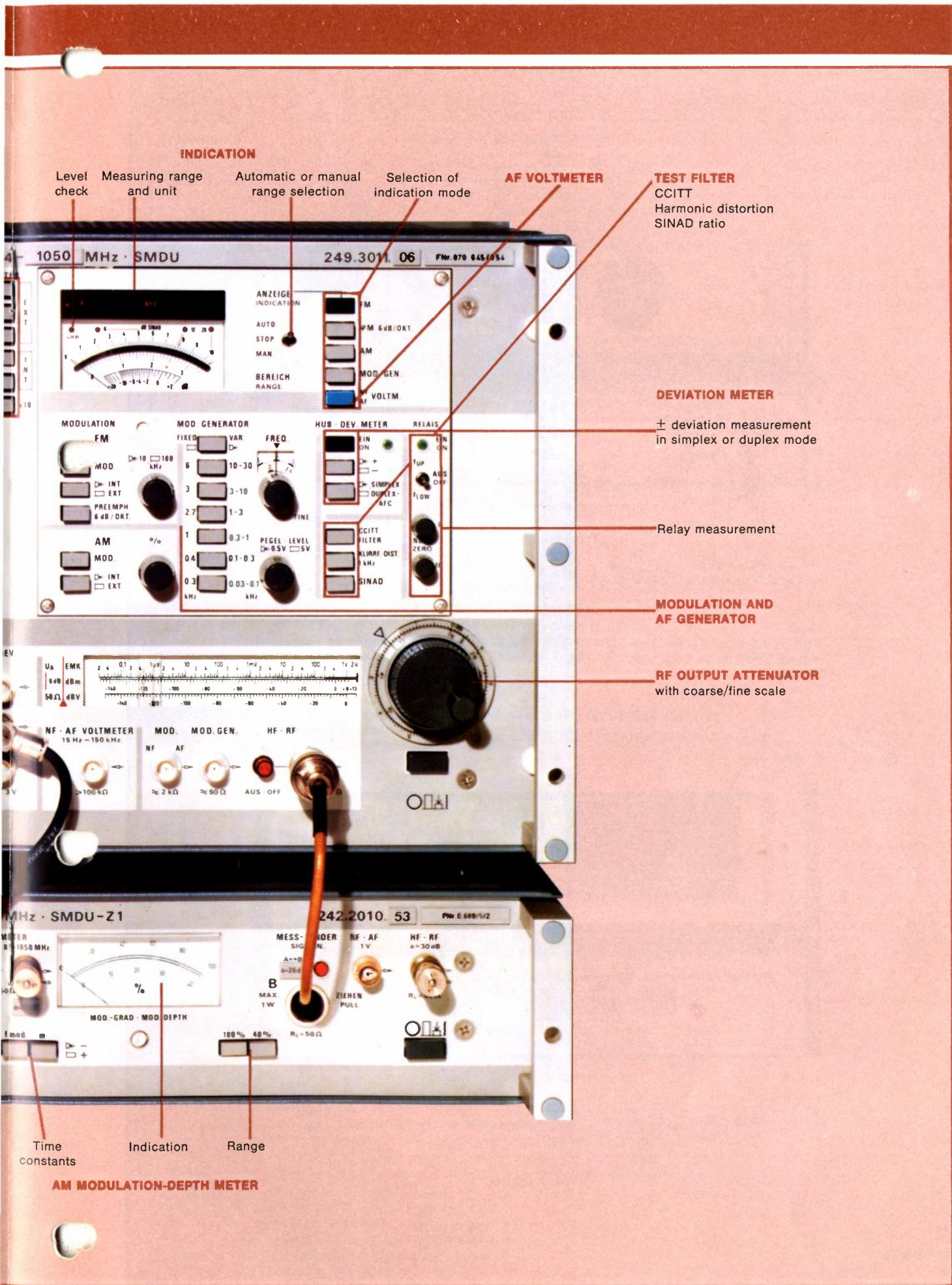

Figure 11 SMDU Radiotelephone Test Assembly with AM Unit SMDU-Z1



INDICATION

Level check Measuring range and unit Automatic or manual range selection Selection of indication mode

AF VOLTMETER

TEST FILTER

CCITT
Harmonic distortion
SINAD ratio

DEVIATION METER

± deviation measurement
in simplex or duplex mode

Relay measurement

MODULATION AND AF GENERATOR

RF OUTPUT ATTENUATOR
with coarse/fine scale

AM MODULATION-DEPTH METER

Time constants Indication Range

Test connectors

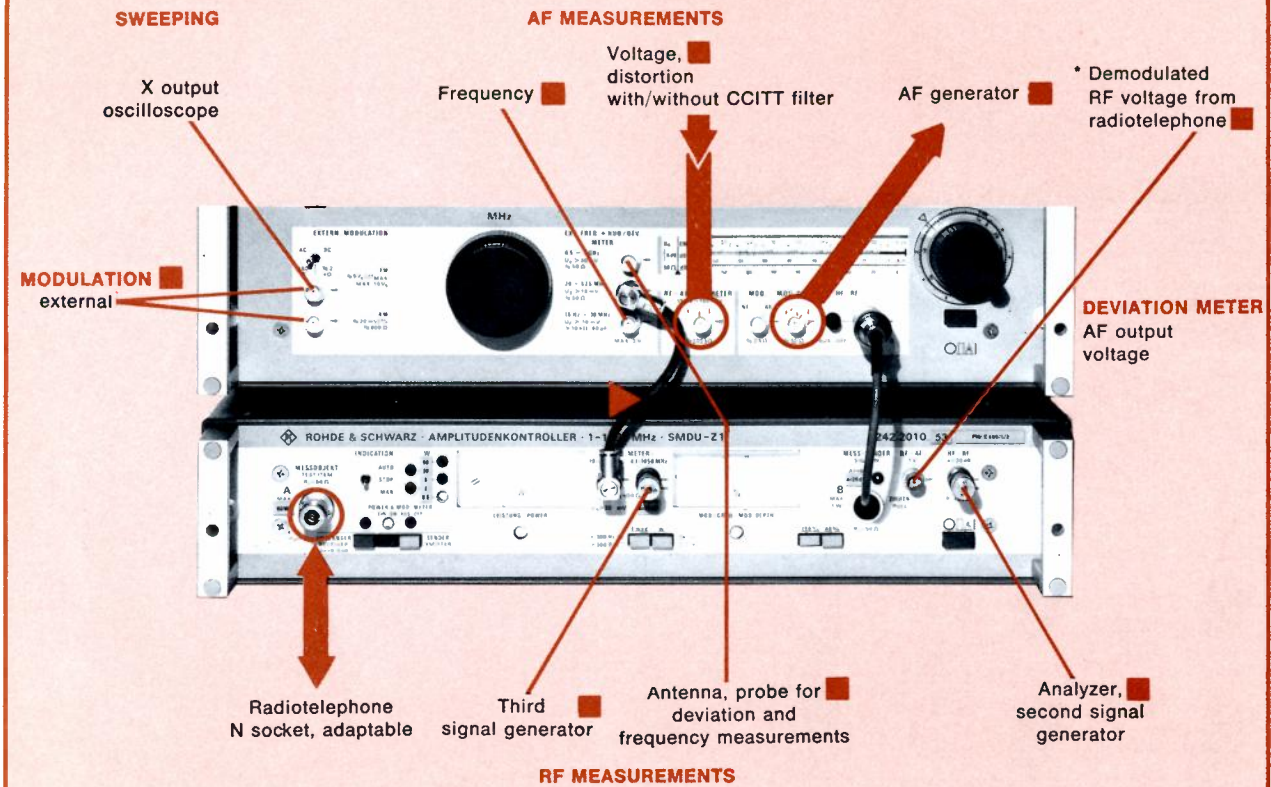

RF MEASUREMENTS

Note

For all standard measurements requiring only one signal generator only the connectors marked are used. Connectors fitted to the AM unit but not to the power test adapter are marked *.

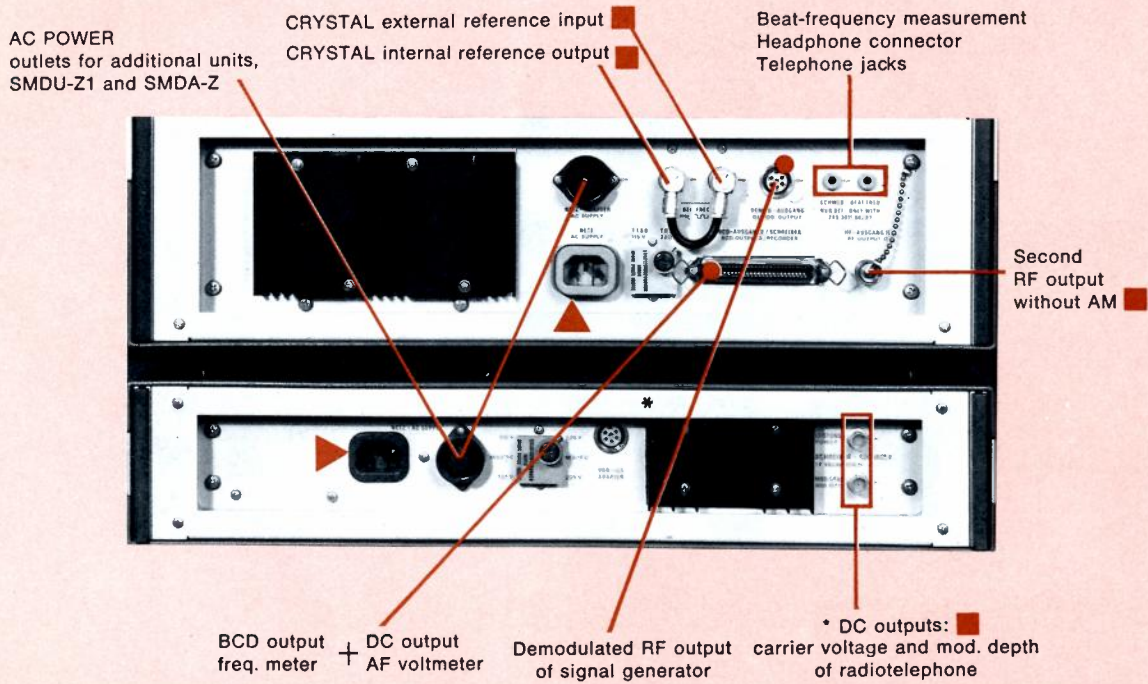

RECORDING

- BNC sockets
- Connector for supplied accessories
- Mating connectors, see bottom of page 11

Figure 12

Applications

Application	Remarks	Extension
Transmitter measurements Frequency accuracy Transmit-frequency offset Power Frequency deviation Setting of deviation limiting Amplitude/frequency response Harmonic distortion Call-tone measurement Modulation depth (assembly with SMDU-Z1) Limiting	Automatic overload protection of signal generator Immediate display on digital frequency meter Rapid crystal adjustment without annoying detuning Frequency difference can be displayed on SMDU Simultaneous indication of frequency, power and deviation Semi-automatic tuning Close tolerances permit full deviation of radiotelephone to be used Continuously tunable AF generator Direct indication of distortion at 1 kHz 1-Hz resolution Measurement simultaneous with indication of power and frequency Direct indication of distortion at 1 kHz May be evaluated together with distortion measurement	Headphones (optional)
Receiver measurements Sensitivity Frequency accuracy and bandwidth Limiter action Squelch action Amplitude/frequency response Harmonic distortion	S/N and SINAD measurements, with CCITT weighting or unweighted High resolution on digital frequency meter (10 or 100 Hz), wide-range electronic fine tuning Single-range output attenuator No problems with squelch hysteresis thanks to single-range attenuator May be measured with frequency or phase modulation Direct distortion measurement at 1 kHz	
Measurements on duplex sets Duplexer loss Receiver sensitivity Relay operation	No additional instruments required Power indication with simultaneous sensitivity measurement Automatically tuned deviation meter for relay operation	
Special transmitter measurements Spurious emissions Recording of frequency, power, modulation, distortion Remote frequency and deviation measurement Measurements on sequential tones	Direct connection of analyzer Test outputs provided Measurements possible up to distances of approx. 50 m Detailed investigations on sequential-tone demodulators	Analyzer, e. g. EZF-EZFU Recorders, A/D and D/A converters Antenna, probe Sequential Tone Programmer SSN-Z and Precision LF Generator SSN
Special receiver measurements Same-channel suppression Adjacent-channel selectivity Spurious responses Intermodulation Desensitization (blocking) Spurious emissions Narrow-band sweeping (± 100 kHz)	High signal-to-noise ratio and spurious suppression permit measurement of even the most extreme values Channel-stepping makes tuning of adjacent channel very easy, direct connection for second signal generator Direct connection to test assembly Checking of IF stages	Second signal generator SMDU 02 (standard): low-cost, high-quality solution Analyzer Oscilloscope
Measurements on AF section	Complete level-measuring set with AF generator and voltmeter	
Cables and connectors (to be ordered separately, see also data sheet 902 100) RF connecting cable 100.6945.05 (BNC connector, 0.5 m) RF connecting cable 100.6945.10 (BNC connector, 1 m) RF connecting cable 100.6945.20 (BNC connector, 2 m) RF connecting cable 100.7670.10 (50 Ω , N male connector, 1 m) Connector for DEMOD. OUTPUT FO 018.5356 Connector for 50-pole recorder output FM 018.5904		

System configuration

The list below gives the instruments which are incorporated in the SMDU Radiotelephone Test Assemblies. The version SMDU 249.3011.56 consists of the signal generator, with synchronizer option, and the power test adapter in a common case.

INTEGRATED INSTRUMENTS

AM/FM signal generator

0.14 to 525 MHz (1050 MHz with option) with high spectral purity, stability and accuracy.

Synchronizer (option)

For crystal-accurate frequencies. Permits channel stepping and electronic fine tuning by up to 150 kHz.

Digital frequency meter

15 Hz to 525 MHz (1 GHz with option). Displays the RF and AF frequencies of the signal generator and the test item.

Mixer

Generates the beat frequency between the radiotelephone output and the signal generator output for frequency-offset measurements and the like.

Deviation meter

Features semi-automatic tuning to the transmit frequency in simplex, duplex and relay operation of the radiotelephone. Suitable for frequency and phase modulation; separate measurement of positive and negative deviation peaks. Automatic rms weighting of spurious deviation.

Power meter

10 mW to 30 W (60 W). Autoranging on AM unit.

Power RF attenuator and R/T switchover

For matching the radiotelephone transmitter to the deviation, frequency and power meters. Automatic switchover between transmitter and receiver measurements with AM unit.

Multi-way distributor

For connection of further signal generators and an analyzer.

Modulation-depth meter (with AM unit)

AF generator

30 Hz to 30 kHz plus six standard frequencies for modulation of the signal generator or the radiotelephone. Also suitable for general AF measurements.

AF voltmeter

Autoranging in all indication modes.

Psophometer

For signal-to-noise ratio measurements. Weighting according to CCITT.

SINAD-ratio meter

Automatic indication of the standard SINAD ratio (6, 12 or 20 dB) falling within the selected measurement range.

Distortion meter

Measurement at 1 kHz, range 0.5 to 50%. CCITT filter may be introduced.

Automatic overload protection

Protects the signal generator against reverse power flow should the talk button of the radiotelephone be accidentally pressed.

Recorder outputs

BCD output of frequency, analog output of meter indications.

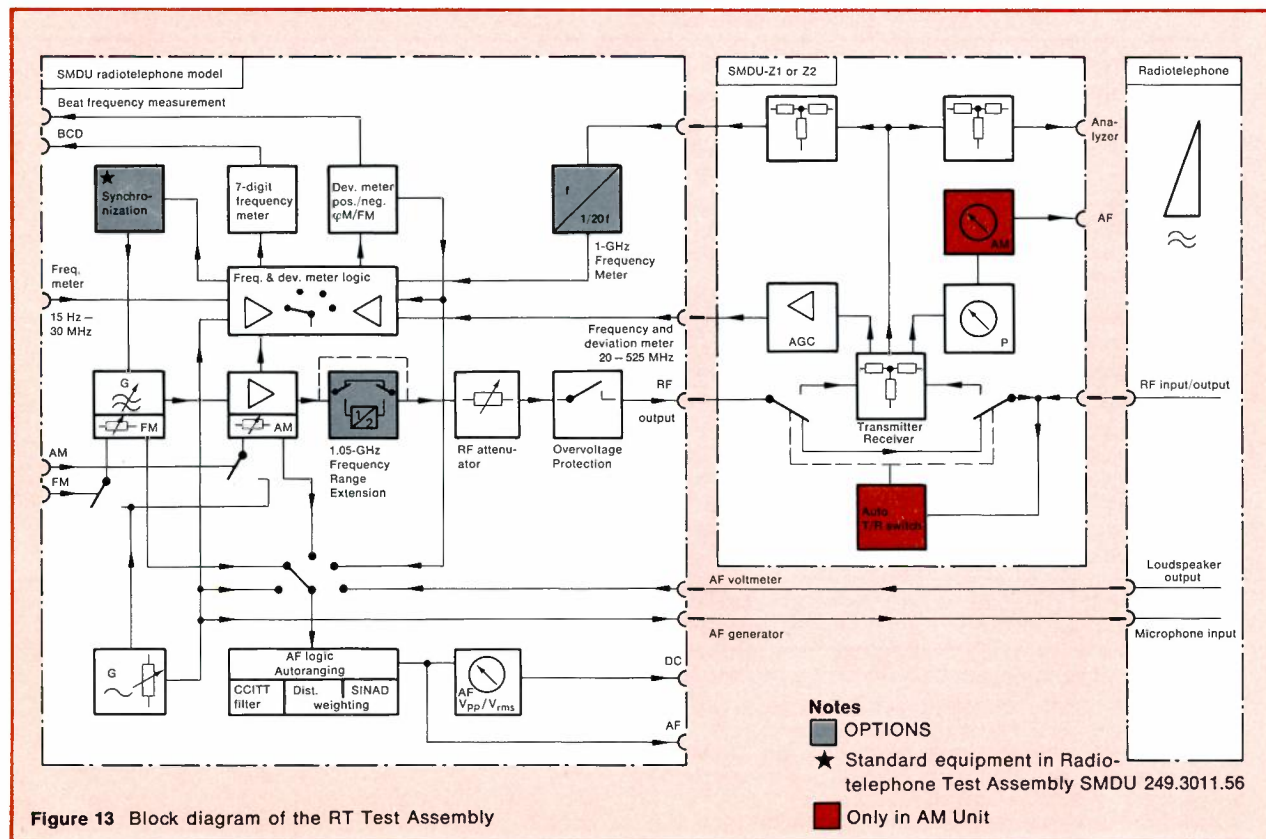

Figure 13 Block diagram of the RT Test Assembly

Specifications

Frequency

without options 0.14 to 525 MHz
 with option 0.14 to 1050 MHz

Reference crystal, internal or external 10 MHz, aging 5×10^{-8} /month

Resolution of display

0.14 to 50 MHz	50 to 800 MHz	800 to 1050 MHz
1 or 10 Hz	10 or 100 Hz	0.1 or 1 kHz

Tuning modes and frequency instability

	Free-running unsynchronized		With synchronizer ¹⁾			
			locked		with fine tuning	
Channel spacings	none		12.5/20/25/50/100/150 kHz		12.5/20/25/50/100/150 kHz +0, -1 %	
Tuning range	unlimited		steps equal to channel spacing		20 to 160 kHz according to channel spacing	
Warmup time	10 min	3 h	15 min	1 h	15 min	1 h
Measuring interval	5 min	10 min	10 min	1 h	10 min	1 h
Temperature change	none		1 °C 1 °C		1 °C 1 °C	
0.14 to 200 MHz	< 3 kHz	< 1.5 kHz	} < $5 \times 10^{-8} + 10$ Hz		} < 100 Hz < 5×10^{-7}	
200 to 525 MHz	< 4 kHz	< 3 kHz				
525 to 1050 MHz	< 8 kHz	< 6 kHz				

Spectral purity

Signal-to-noise ratio with 1 Hz measuring bandwidth approximately 140 dB; see figure 9 on page 5.

Frequency MHz	Harmonics suppression (< 1 V EMF) dB	Spurious suppression dB		Spurious frequency deviation Hz		Spurious depth of amplitude modulation	
		< 200 MHz from carrier	> 200 MHz from carrier	CCITT weighting (0.3 to 3 kHz)	CCIR weighting (20 Hz to 15 kHz)	CCITT weighting	CCIR weighting
0.14 to 50	> 26 (typ. 30)	> 90	> 90 (typ. 100)	< 7	< 20 (typ. 10)	< 10^{-4}	< 3×10^{-4}
50 to 395	> 35 (typ. 40)	> 110	> 110	< 7	< 20 (typ. 10)		
395 to 525	> 35 (typ. 40)	> 110	> 90	< 10	< 40 (typ. 20)		
525 to 1050 ²⁾	> 26 (typ. 30)	> 110	> 70	< 20	< 60 (typ. 30)		
525 to 1050 ³⁾	> 20 (typ. 26)	> 100	> 20 (typ. 30)	< 20	< 60 (typ. 30)		

Incidental AM for FM with $f_{mod} = 1$ kHz < 1 % (typ. 0.5 %) at 100 kHz deviation (for $f > 1$ MHz)

Incidental synchronous φ M for 30 % AM depth

	0.14 to 20 MHz	20 to 110 MHz	110 to 525 MHz
Modulation index $\Delta f/f_{mod}$	< 0.02 (typ. 0.01)	< 0.1 (typ. 0.05)	< 0.2 (typ. 0.1)

RF output of signal generator N female connector, adaptable⁴⁾ (Dezifex A base)
 Output EMF or power 0.05 μ V to 2 V or -139 to +13 dBm
 Source impedance 50 Ω
 VSWR for levels < 0.2 V EMF < 1.2 ($f < 525$ MHz); < 1.4 ($f > 525$ MHz)
 Output voltage error (total error)
 0.4 to 525 MHz < ± 1 dB
 remainder of range < ± 2 dB } for 0.1 μ V to 0.5 V EMF

Overload protection switches off the RF output if excessive RF power or DC voltage is applied
 Maximum permissible power 50 W
 Maximum permissible DC voltage 50 V

RF output II (on rear panel) without AM, > 20 mV into 50 Ω
 Connector BNC female

Frequency meter (7-digit readout)

Frequency range	Voltage range *	Maximum input *	Resolution	Gate time	Input impedance *
15 Hz to 30 MHz	10 mV to 3 V	10 V	1 or 10 Hz	1 or 0.1 s	10 k Ω 20 pF
20 to 525 MHz	10 mV to 3 V **	10 V	10 or 100 Hz	1 or 0.1 s	50 Ω
500 to 1000 MHz ⁵⁾	30 mV to 1 V	3 V	10 or 100 Hz	2 or 0.2 s	50 Ω

Permissible noise voltage * 5 mV_{pp}

* Data valid for direct signal input. When signal is fed via SMDU-Z1 or Z2 measurement range of power meter applies.

** < 2 V up to 30 MHz and > 15 mV above 470 MHz.

1) With option SMDU-B1 2) With option SMDU-B3 3) With option SMDU-B5 4) With the aid of screw-in assemblies the user can easily adapt this connector to other systems; see data sheet 902.100.

5) With option SMDU-B4

Specifications

Power meter	SMDU-Z2	SMDU-Z1 (30 W)	SMDU-Z1 (60 W)
Measurement ranges	0.05 to 0.3/1/3/10/30 W	0.05 to 0.3/1/3/10/30 W	0.1 to 0.6/2/6/20/60 W
Error limits up to 500 MHz		\pm (6 % of rdg + 1.5 % of fsd)	
up to 1000 MHz		\pm (8 % of rdg + 1.5 % of fsd)	
Modulation-depth meter			
Measurement ranges		0 to 40 % / 0 to 100 %	
Input power	0.1 to 30 W		0.2 to 60 W
Modulation frequency		25 Hz to 10 kHz	
Error limits		\pm (4 % of rdg + 1.5 % of fsd)	
Power attenuator			
Attenuation in receiver/transmitter measurements	0 + 0.6 dB / 20 \pm 1.3 dB		0 + 0.6 dB / 26 \pm 1.3 dB
RF connector (for analyzer, additional sources)			
Input / output attenuation / VSWR		30 \pm 0.8 dB / 1.3	
General data			
Connectors		see page 10	
Nominal/shelf temperature range		+10 to +45 °C / -40 to +70 °C	
Power requirements		115/125/220/235 V \pm 10 % (100 to 120 VA), 47 to 420 Hz	
Front-panel markings		German + English	
Vibration testing		according to VDE 0411	
Order designations	Dimensions (W×H×D) mm	Weight kg	Accessories supplied
Compact test assembly			
▶ Radiotelephone Test Assembly * SMDU 249.3011.56	492×401×434	37	Power cable 025.2365.00
Single instruments for combination as test assembly			
▶ Signal Generator SMDU Radiotelephone model 249.3011.06	492×296×434	28	Power cable 025.2365.00
▶ Signal Generator SMDU Radiotelephone model, stereo-compatible 249.3011.09	492×296×434	28	Power cable 025.2365.00
▶ Signal Generator SMDU Radiotelephone and air-navigation model 249.3011.07	492×296×434	28	Power cable 025.2365.00
▶ Synchronizer SMDU-B1 249.6340.02 (including synchronizer front panel)	175×33×235 163.5×33×80	1.2	
▶ 1.05-GHz Frequency Range Extension SMDU-B3 249.9484.02	185×208×60	1.0	
▶ 1-GHz Frequency Meter SMDU-B4 250.0012.02	62×225×33	0.4	
▶ 1.05-GHz Frequency Doubler SMDU-B5 275.1312.02	115×208×60	0.6	
▶ AM Unit SMDU-Z1 242.2010.52 (30-W model)	492×118×434	0.8	Power cable 025.2365.00 2 terminations 244.7677.00 Free plug 018.5356.00 RF connecting cable 242.3680.00 for connection to frequency meter of SMDU
▶ AM Unit SMDU-Z1 242.2010.53 (60-W model)	492×118×434	8.5	
▶ Power Test Adapter SMDU-Z2 242.4012.52	492×118×434	8.0	
* The single-cabinet compact test assembly consists of the SMDU 06 with option SMDU-B1 and the SMDU-Z2.			
Recommended extras			Data sheet
● Directional Power Meter 25 to 1000 MHz, Z = 50 Ω			
NAUS 3			
Dezifix B or N connectors (range 20 mW to 30 W)	288.8610.55		288 861
NAUS 4			
N connectors (range 50 mW to 110 W)	289.9010.54		288 861
● Standard Frequency Receiver XKD 200 kHz	100.5678.03		444 822
Sensitivity 2 μ V			
● Analyskop EZF min. resolution 70 Hz/50 Hz	100.8831.25/100.8831.52		150 910
● UHF Tuner EZFU for 30 to 1400 MHz/2700 MHz	210.0011.04/210.0011.02		
● Sequential Tone Programmer SSN-Z 1 to 9999 Hz	274.0012.92		274 001
● Precision LF Generator SSN	204.8014.52		204 801
● High-power Attenuator RBU 10 dB/50 Ω for 100 W	100.8654.15		200 001
● Three-port Junction Box DVU 3 (N connectors, 50 Ω)	100.5203.03		474 410
● Four-port Junction Box DVU 4 (N connectors, 50 Ω)	201.4018.03		201 401
for large-signal, multi-source measurements up to 1.5 GHz			
● Coupling Head SMDA-Z (N connector) with isolating capacitor	124.7558.50		
● Cables and connectors			see pages 10 and 11

140 dB/Hz for selectivity measurements

Receiver input
selectivity

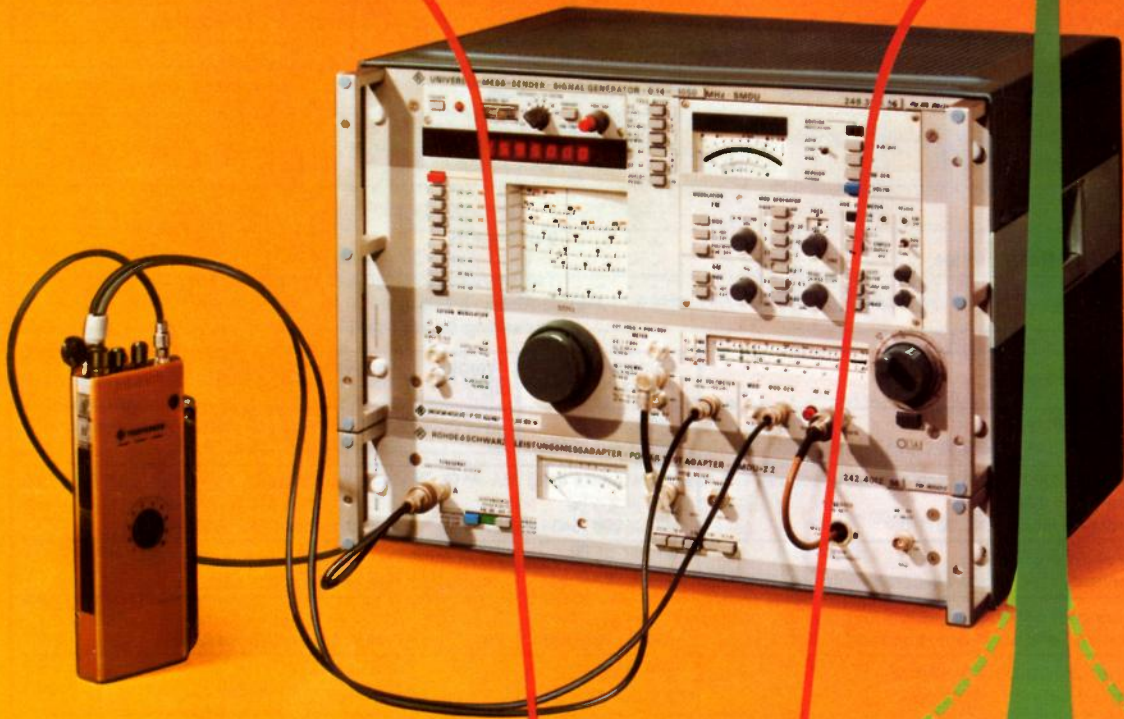

Unsatisfactory
signal generator (< 120 dB/Hz)

INTERFERING
SOURCE

SMDU (140 dB/Hz)

WANTED
SIGNAL



ROHDE & SCHWARZ

Mühdorfstraße 15 Postf. (P.O.B.) 80 1469
Printed in the Fed. Rep. of Germany

D-8000 München 80
Subject to change

Tel. (089) 41 29-1 Int. +49 89 41 29-1 · Telex 5 23 703
Data without tolerances: order of magnitude only
278 (O)