



# SD210 and SD210-2 Spectraterester

## Legacy Manual

COGNITIVE VISION, INC.  
7220 Trade Street, Suite 101  
San Diego, CA 92121-2325 USA

[analyzers@cognitivevision.com](mailto:analyzers@cognitivevision.com)  
[www.cognitivevision.com](http://www.cognitivevision.com)

Tel: 1.858.578.3778 / Fax: 1.858.578.2778  
In USA: 1.800.VIB.TEST (842.8378)

# LEGACY MANUAL POLICY

Cognitive Vision Legacy manuals are those product manuals and documentation that accompanied earlier products and product lines which have since been discontinued (“Legacy Products”). Over the past thirty years, these include products that were sold by Spectral Dynamics, Scientific Atlanta and Smiths Industries.

Cognitive Vision, Inc. provides downloadable copies of these manuals strictly as a courtesy to its customers who continue to use Legacy Products. **IMPORTANT:** Please read the following Disclaimer carefully. Any use of this manual indicates your express agreement with this policy.

If you have any questions regarding this policy, or for additional information regarding the serviceability of any Legacy Product(s), please call our service department.

## DISCLAIMER

IN DOWNLOADING THIS MANUAL, THE USER UNDERSTANDS AND EXPRESSLY AGREES THAT COGNITIVE VISION MAKES NO WARRANTIES WHATSOEVER, EITHER EXPRESS OR IMPLIED, INCLUDING ANY WARRANTY OF MERCHANTABILITY OR FITNESS FOR A PARTICULAR PURPOSE. IN USING THIS MANUAL, THE USER ACKNOWLEDGES THAT ALL PREVIOUS PRODUCT WARRANTIES ISSUED BY SPECTRAL DYNAMICS, SCIENTIFIC ATLANTA AND SMITHS INDUSTRIES FOR LEGACY PRODUCTS HAVE SINCE EXPIRED.

IN PROVIDING THIS MANUAL, COGNITIVE VISION ASSUMES NO LIABILITY OR RESPONSIBILITY WHATSOEVER TO THE USER OF THIS MANUAL, THE USER’S AGENTS AND/OR CUSTOMERS, OR ANY OTHER PARTY, FOR ANY CLAIMED INACCURACY IN THIS MANUAL, OR FOR DAMAGE CAUSED OR ALLEGED TO BE CAUSED DIRECTLY OR INDIRECTLY BY ANY USE OF THIS MANUAL, REGARDLESS OF WHETHER COGNITIVE VISION WAS INFORMED ABOUT THE POSSIBILITY OF SUCH DAMAGES, OR FOR ANY CLAIM MADE AGAINST THE USER’S ORIGINAL PRODUCT WARRANTY.

FURTHER, COGNITIVE VISION SHALL NOT BE RESPONSIBLE FOR ANY INTERRUPTION OF SERVICE, LOSS OF BUSINESS, ANTICIPATORY PROFITS, CONSEQUENTIAL DAMAGES, OR INDIRECT OR SPECIAL DAMAGES ARISING UNDER ANY CIRCUMSTANCES, OR FROM ANY CAUSE OF ACTION WHATSOEVER INCLUDING CONTRACT, WARRANTY, STRICT LIABILITY OR NEGLIGENCE.

NOTWITHSTANDING THE ABOVE, IN NO EVENT SHALL COGNITIVE VISION’S LIABILITY TO THE USER EXCEED AN AMOUNT EQUAL TO THE REPLACEMENT COST OF THIS MANUAL.

COGNITIVE VISION, INC.  
7220 Trade Street, Suite 101  
San Diego, CA 92121-2325 USA

[analyzers@cognitivevision.com](mailto:analyzers@cognitivevision.com)  
[www.cognitivevision.com](http://www.cognitivevision.com)

Telephone: 1.858.578.3778 / Fax: 1.858.578.2778  
IN USA: 1.800.VIB.TEST (842.8378)

SERIAL \_\_\_\_\_

## **USER'S MANUAL**

# **SD210-2 Spectratester**

PROPRIETARY RIGHTS OF SCIENTIFIC-ATLANTA, INC. are involved in the subject matter of this material and all manufacturing, reproduction, use and sales rights pertaining to such subject matter are expressly reserved. It is submitted in confidence for a specified purpose, and the recipient, by accepting this material, agrees that this material will not be used, copied or reproduced in whole or in part, nor its contents revealed in any manner, or to any person, except for the purpose delivered.

## **Scientific-Atlanta**

Spectral Dynamics Division

United States: P.O. Box 23575 • San Diego, CA 92123-0575 • (619) 268-7100 • TWX 910-335-2022

**P/N 22031900  
02-85-03-0000**

## ADDENDUM

### Model SD210-2 Spectrator

The Model SD210-2 is a standard option for the Model SD210 Spectrator. The standard Model SD210 User's Manual and Service Manual, together with this addendum, provides coverage for the Model SD210-2.

#### NOTE

The Service Manual is not provided with the instrument. If required, this manual must be ordered separately.

The "-2" added to the basic model number indicates that the instrument has been provided with a low frequency option Low Pass Filter card, A4A1 (PWA 21066101). The Assembly Drawing (DWG. NO. 21066101) and the Schematic (DWG. NO. 21196400) for this card are included in the Service Manual. The frequency ranges for the low frequency option are 2, 10, 20, 50, 100 and 500 Hz. A butch plate showing the option frequency ranges has been installed on the front panel. The calibration procedures in the Service Manual include calibration procedures for the low frequency option circuit card as well as the standard frequency circuit card.

If both the standard and the low frequency option Low Pass Filter cards have been purchased, conversion from one frequency range to the other is a simple operation. The internal logic actually "recognizes" which Low Pass Filter card is installed and performs the complete conversion. Proceed as follows:

- a. Turn instrument power OFF.
- b. Insert the desired Low Pass Filter card in the A1 slot.
- c. Remove the etched label plate (two screws) for the INPUT FREQ RANGE (Hz) selector. This plate has been etched with the standard frequency ranges on one side and the low frequency ranges on the other side.
- d. Re-install the label plate with the appropriate ranges showing.
- e. Turn instrument power ON.

The instrument is now ready for operation on the selected frequency ranges.

# **USER'S MANUAL**

## **SD210 SPECTRATESTER**

SPECIFICATIONS SUBJECT TO CHANGE WITHOUT NOTICE

PROPRIETARY RIGHTS OF SCIENTIFIC-ATLANTA, INC. are involved in the subject matter of this material and all manufacturing, reproduction, use and sales rights pertaining to such subject matter are expressly reserved. It is submitted in confidence for a specified purpose, and the recipient, by accepting this material, agrees that this material will not be used, copied or reproduced in whole or in part, nor its contents revealed in any manner, or to any person, except for the purpose delivered.

**Scientific-Atlanta**  
Spectral Dynamics Division

United States: P.O. Box 23575 • San Diego, CA 92123-0575 • (619) 268-7100 • TWX 910-335-2022

APRIL 1979

21065100

**MANUAL FORMAT  
USER'S MANUAL**

**SECTION I GENERAL INFORMATION**

**Page**

1.1 Introduction	1-1
1.2 Other Documentation	1-1
1.3 Equipment Description	1-1
1.4 Required Equipment	1-1
1.5 Ancillary Equipment	1-2
1.6 Accessories Furnished	1-2
1.7 Specifications	1-2
1.7.1 Input Signal	1-2
1.7.2 Processing Parameters	1-2
1.7.3 Analysis Characteristics	1-3
1.7.4 Averager Characteristics	1-3
1.7.5 Displays	1-3
1.7.6 External Equipment	1-3
1.7.7 Miscellaneous	1-3
1.8 Replacement Parts	1-4

**SECTION II INSTALLATION**

2.1 Introduction	2-1
2.2 Initial Inspection	2-1
2.2.1 Unpacking	2-1
2.2.2 Equipment Furnished	2-1
2.2.3 Check for Physical Damage	2-1
2.2.4 Reshipment Procedure	2-1
2.2.5 Returned Equipment with Warranty or Damage Claims	2-1
2.3 Safety Precautions	2-1
2.3.1 Explosion Hazard	2-1
2.3.2 Shock Hazard	2-1
2.4 Preparation for Use	2-2
2.4.1 Power Requirements	2-2
2.4.2 Mounting	2-2
2.4.3 Equipment Interconnections	2-2

**SECTION III OPERATION**

3.1 Introduction	3-1
3.2 Front Panel Controls and Indicators	3-1
3.2.1 CRT Group	3-2
3.2.2 ANALYSIS Group	3-2
3.2.3 INPUT Group	3-3
3.2.4 WINDOW Group	3-3
3.2.5 CURSOR Group	3-4
3.3 Rear Panel	3-5
3.3.1 Front Panel Control Group	3-5
3.3.2 Power Group	3-6
3.3.3 Connector Group	3-6
3.4 Initial Power Application	3-7

3.4.1 Preliminary Checks	3-7
3.4.2 Equipment Turn On	3-7
3.4.3 External Equipment Interconnections	3-7
3.5 Initial Setup and Adjustments	3-7
3.5.1 Switch Settings	3-7
3.5.2 Crt Calibration Checks	3-8
3.6 Operational Checkout	3-9
3.6.1 Cursor Control and Display Checks	3-9
3.6.2 Cursor Position and Window Set Checks	3-10
3.6.2.1 Set Window 1 and Test Parameters	3-10
3.6.2.2 Set Windows 2 and 3	3-10
3.6.2.3 Set Windows 4 and 5	3-11
3.6.2.4 Set Windows 6 and 7	3-11
3.6.2.5 Set Windows 8 and 9	3-12
3.6.2.6 Set Window 10	3-12
3.6.2.7 Cursor Position at Overall Signal	3-13
3.6.2.8 Check % Displ Readout and Cursor Second Scale	3-13
3.6.3 Input Level Switch and Alarm Level Checks	3-13
3.6.3.1 Window and Alarm Checks at .2V Level	3-13
3.6.3.2 Window and Alarm Checks at .5V Level	3-14
3.6.3.3 Window and Alarm Checks at 1V Level	3-15
3.6.3.4 Window and Alarm Checks at 2V Level with EXP Average	3-15
3.6.3.5 Window and Alarm Checks at 5V Level	3-16
3.6.3.6 Window and Alarm Checks at 10V Level	3-16
3.6.3.7 Window Bar Display Check	3-16
3.6.3.8 Nonvolatile Memory Check	3-17
3.7 Operation	3-17
3.7.1 Introduction	3-17
3.7.2 Initial Conditions	3-17
3.7.3 Setting Nonvolatile Memory	3-18
3.7.4 Setting WINDOW HEIGHT	3-18
3.7.5 Setting WINDOW WIDTH	3-18
3.7.6 Setting Overlapping Windows	3-19
3.8 Remote Operation	3-19
3.8.1 Output Signals to Remote Station	3-19
3.8.2 Input Control Signals from Remote Station	3-20
3.9 Operator Maintenance	3-21
3.9.1 Introduction	3-21
3.9.2 Cleaning	3-21
3.9.3 Operator Checks	3-22

#### SECTION IV CONCEPT OF OPERATION

4.1 Overview	4-1
4.2 Timing and Input Control Section	4-1
4.3 Processor Memories	4-1
4.4 Central Processing Unit (CPU)	4-1
4.5 Microprogram Control Section	4-1
4.6 Output Control and Display Section	4-3

#### LIST OF ILLUSTRATIONS

Figure	Page
2-1 Interconnect Diagram	2-2
4-1 SD210 Concept of Operation Overview	4-2

## LIST OF TABLES

Table	Page
1-1 Special Replaceable Parts Lists, Printed Circuit Assemblies .....	1-4
1-2 Special Replaceable Parts List, PROMS .....	1-4
1-3 Special Replaceable Parts List, Integrated Circuits .....	1-5
1-4 Special Replaceable Parts List, Controls and Indicators .....	1-5
1-5 Special Replaceable Parts List, Miscellaneous .....	1-6
4-1 Remote Data Input Codes .....	3-21



## SECTION I

### GENERAL INFORMATION

#### 1.1 INTRODUCTION

This manual contains unpacking, initial checkout and operating instructions for the Spectral Dynamics SD210 Spectratester. The manual is divided into four sections, each section covers a specific aspect of the instrument. This section contains a list of other documents available, a brief description of the instrument, ancillary equipment and options, accessories furnished and a replacement parts list.

The manual is written for the operator and contains no maintenance information other than that which can be performed without removing the covers or front panel. It is recommended that each section be read in its entirety before proceeding to the next section.

#### 1.2 OTHER DOCUMENTATION

Spectral Dynamics produces two basic manuals for all equipments: a User's Manual, and a Service Manual. The User Manual is shipped with each instrument; the Service Manual with engineering drawings can be ordered separately.

The Service Manual contains detailed theory of operation, calibration procedures, maintenance information, parts lists, engineering drawings and wire lists. The manual is written for technical personnel with experience in analog and digital circuits. Manual contents will provide the maintenance engineer with information guidelines to repair the instrument. The Service Manual will also provide guidelines, in those cases where the customer may want to modify the instrument for a new application. However, the local Spectral Dynamics' office should be contacted for specific information.

#### 1.3 EQUIPMENT DESCRIPTION

The Model SD210 Spectratester is a stand-alone, hard-wired instrument that combines a 400-line analyzer, ensemble averager, and display oscilloscope (CRT) in a single portable or rack mounted unit. It accepts a single channel analog

signal input and under control of a micro-processor performs a fast fourier transform (FFT) analysis of input signal frequency components up to 10 kHz.

Any rotating device produces noise and vibration frequencies that comprise a unique set of spectral parameters. These parameters can be considered as the "signature" of that particular device and all devices of the same design can be compared to that "signature" for proper operation. The SD210 Spectratester can be preprogrammed with this "signature" (test parameters) to detect dynamic variations between an acceptable (good) device and an unacceptable (bad) one. Signature components of a device under test are directly displayed on the CRT and any portion of the display can be selected and assigned an amplitude limit. An LED readout, in conjunction with a cursor and the CRT display, provides information about the display in a variety of immediately usable forms.

The SD210 can store up to 16 separate sets of these test parameters; each set applying to particular device design. Since the parameters can be stored in a nonvolatile memory (Electrically Alterable Read Only Memory — EAROM), they are retained even if power is turned off or a power failure occurs. A complete set of test parameters consists of a selected spectral range, an input level, type of analysis, number of times to be averaged, and amplitude limits for 10 spectral bands (windows) in the spectral range.

Front panel switches are used to set up these test parameters. Once set up, a key switch on the rear panel is used to lock the test parameters and disable the front panel test parameter switches. In the locked position, the following front panel switches are still active: START TEST, CURSOR CONTROL (except when UNITS switch in MEM Position), CURSOR UNITS, and ALARM RESET.

#### 1.4 REQUIRED EQUIPMENT

An external sensing device is required to produce the input signal to be analyzed. This device may

be any one of several types of dynamic motion or audio measuring devices (transducers). Depending upon the equipment being tested, the input transducer can be either an accelerometer, microphone, velocity pickup or displacement probe.

### 1.5 ANCILLARY EQUIPMENT

Separate connectors are provided on the SD210 rear panel for an external oscilloscope and X-Y Plotter. Internal signals are routed to another rear panel connector to allow remote control of the instrument and provide remote duplication of the front panel alarm indicators.

### 1.6 ACCESSORIES FURNISHED

An accessory kit is furnished with each Model SD210 SpectraTester. The accessory kit is packaged separately and each item in the package should be checked for any damage in shipping. The following items are included in the standard (SD210-1) accessory kit:

Accessory	Part Number
1. User's Manual	21065100
2. Power Cord	10567100
3. BNC Connector	10570700
4. Plug Body	10718100
5. Extender Assembly	10434700
6. Extender Assembly	10432500
7. Bail (not included in - 01)	10470800
8. Cable Assembly	22090-11
9. Amplifier Power Supply	10718000
10. Cable	30150000-15
11. M93 Accelerometer (w/Mtg stud)	3031700

In addition to the above accessory kits for Model SD210-2 instruments (rack or bench mount) include the following:

Accessory	Part Number
1. 2 Brackets, Rack Mounting (3½)	01365300
2. 2 Brackets, Rack Mounting (5¼)	01365400
3. 8 Phillips oval-head screws	—

### 1.7 SPECIFICATIONS

#### 1.7.1 Input Signal

Frequency Range . . . . . 200 Hz to 10 kHz (Standard, others optional)

Frequency Resolution . . . . . ±0.25% of range selected

Sensitivity (for full scale output) . . . . . Seven full scale ranges from 0.100 to 10 Vrms in 1, 2, 5 sequence

Absolute Maximum Input . . . . . 50 Vrms

Dynamic Range . . . . . 0 dB to - 60 dB

Impedance . . . . . 1 Megohm

Coupling . . . . . AC on 200 Hz to 20 kHz ranges, DC on 2 Hz to 50 Hz ranges (optional).

Overload Indication . . . LED display flashes and displays the digit eight in each digit position.

#### 1.7.2 Processing Parameters

Aliasing Filter Passband Ripple . . . . . Less than 0.5 dB p-p

Aliasing Filter Stopband Rejection . . . Greater than 60 dB

Sampling Rate ( $f_s$ ) . . . . . 2.56 times frequency range upper limit.

### 1.7.3 Analysis Characteristics

Resolution.....	400 lines in each frequency range.
Real Time Frequency ..	4 kHz (Nominal)
Frequency Response ..	$\pm 1$ dB over entire frequency range
Dynamic Range.....	Greater than 60 dB. 10 BIT input A/D converter
Average Noise Floor...	Greater than 60 dB below full scale
Amplitude Linearity (linear dynamic range)	
Spectrum .....	$\pm 0.05\%$ of full scale or $\pm 1.0$ dB, whichever is greater
Overall .....	$\pm 1.0\%$ of full scale or $\pm 1.0$ dB, whichever is greater

### 1.7.4 Averager Characteristics

Calculation .....	True power
Number of Averages .	2, 4, 8 or 16 selected by ANALYSIS AVG selector switch

### 1.7.5 Displays

#### 5-Digit LED Display

Hz or kcpm .....	$\pm 0.25\%$ of range selected
% of display .....	0.5
Vrms .....	$\pm 0.01$
dB .....	$\pm 0.1$

#### Internal CRT

#### Continuous Amplitude Viewing

Range .....	0.60 dB
Display Rate .....	50 sweeps/second 25 Spectrum 25 Bars

Display Spectrum ... 400 lines of averaged spectrum information for each analysis range.

Amplitude (Y-axis) ... Linear: 20% of Input level/Division  
LOG: 12 dB/Division

Frequency (X-axis) ... Linear: 80 lines/Division

### 1.7.6 External Equipment

#### Output

Amplitude (Y-axis) ..... Linear: 0 to 5 Vdc (nominal).  
Log: 0 to 5 Vdc (nominal).  
Impedance: 200 ohms.

Frequency (X-axis) ..... Linear: 0 to 5 Vdc (nominal).  
Impedance: 200 ohms.

Pen Lift ..... Ground or open circuit relay contact, 1 A resistive @ 28 Vdc.

#### External CRT (Scope) Outputs

Amplitude (Y-axis) ..... Linear: 0 to 5 Vdc (nominal).  
Log: 0 to 5 (nominal).  
Impedance: 200 ohms.

Frequency (X-axis) ..... Linear: 0 to 5 Vdc (nominal).  
Impedance: 200 ohms.

Retrace Blanking ..... 0 to 5 Vdc positive TTL

Output Overload ..... LED display flashes and displays a digit eight in each digit position.

### 1.7.7 Miscellaneous

#### Intensity Mark (Cursor)

Normal ..... Can be moved left or right at preselected rate or can be stepped to locate on any desired component of real-time, averaged, or window data. A vertical line also appears when the cursor is moved.

Internal Calibration  
Signal ..... Square wave @  $f_s/32$

Calibration Signal (Plotter)

Y-axis ..... Log or Lin: From 0 V  
5 V (adjustable).  
X-axis ..... From 0 V to 5 V (adjust-  
able).  
Remote Outputs ..... Active low; 3.10 V min  
(high), 0.5 V max (low)  
Remote Control  
Inputs ..... Active low; 2.0 min  
(high), 0.8 max (low)  
Remote Data  
Inputs ..... Positive True TTL.

Dimensions	Portable	Rack Mount
Height	19,7 cm (7-3/4")	21,9 cm (8-5/8")
Width	31,8 cm (12-1/2")	42,9 cm (16-7/8")
Depth	58,4 cm (23")	48,6 cm (19-1/8")
Weight (net)	13,6 kg (30 lb)	20,4 kg (45 lb)

Power Requirements... 105-125/210-250 Vac  
(switch selectable), 47-65  
Hz, single phase  
approximately 100 watts.

1.8 REPLACEMENT PARTS

Except for some special SDC specification-controlled parts listed in Tables 1-1 through 1-5, which must be ordered from Spectral Dynamics Corporation, standard electronic parts have been used throughout the instrument. Some miscellaneous standard parts have been included in the tables to aid replacement. Spectral Dynamics Corporation maintains a complete stock of all parts and complete printed circuit assemblies used in this instrument.

When ordering a replacement part or assembly, be sure to include the reference designator, the part number, and a complete description. For printed circuit cards or parts located on printed circuit cards, include the assembly number of the card.

Also include the instrument serial number and the complete model number (including "dash" number).

Table 1-1 Special Replaceable Parts Lists, Printed Circuit Assemblies

Ref. Desig.	Description	Part No.
A1A1	Mother Board Assy.	21064000
A2A1	Control Card Assy.	21053200
A3	CRT Display Assy.	10404201
A3A1	Display Amplifier Assy.	10405400
A4A1	Low Pass Filter Assy.	21066100
A4A2	Analog I/O Assy.	10408900
A4A3	Input Memory/Timing Assy.	21058900
A4A4	Multiplier Assy.	10415800
A4A5	Microprogram Control Assy.	21066400 *
A4A6	Central Processor Assy.	21067300
A4A7	Processor Memory Assy.	21066700
A4A8	Display Control Assy.	21067600
A4A9	Memory Address Assy.	21067000
A10	Extended Interface Assy.	21067900
A4A12	Interface Card Assy.	21054600
PS1	Power Supply Assy.	10413901
PS1A1	Regulator Assy.	10414500
PS1A2	Inverter Assy.	10413200
PS1A3	Power Panel Assy.	10410901
—	Extender Assy.	10432500
—	Extender Assy.	10434700

\*21163900 for SN41 and up.

Table 1-2 Special Replaceable Parts List, PROMS

Ref. Desig.	Description	Part No.
For SN01-40:		
A4A3U12	IC,PROM(INP1)	10438300
A4A3U23	IC,PROM(INP2)	10438400
A4A5U6	IC,PROM(STX1)	21079500
A4A5U7	IC,PROM(STX2)	21079600
A4A5U8	IC,PROM(STX3)	21079700
A4A5U17	IC,PROM(STX4)	21079800
A4A5U18	IC,PROM(STX5)	21079900
A4A5U19	IC,PROM(STX6)	21080000
A4A5U28	IC,PROM(STX7)	21080100
A4A5U29	IC,PROM(STX8)	21080200
A4A5U30	IC,PROM(STX9)	21080300
A4A5U39	IC,PROM(STX10)	21080400
A4A5U40	IC,PROM(STX11)	21080500
A4A5U41	IC,PROM(STX12)	21080600
A4A5U39Δ	IC,PROM(STX13)	21180900

**Table 1-2 Special Replaceable Parts List, PROMS (Continued)**

A4A5U40Δ	IC,PROM(STX14)	21181000	A4A5U12	IC,PROM(STY1)	21166700
A4A5U41Δ	IC,PROM(STX15)	21181100	A4A5U13	IC,PROM(STY2)	21166800
A4A7U38	IC,PROM(LSQ1)	10461600	A4A5U14	IC,PROM(STY3)	21166900
A4A7U40	IC,PROM(LSIN)	10463700	A4A5U22	IC,PROM(STY4)	21167000
A4A7U41	IC,PROM(LCOS)	10463800	A4A5U23	IC,PROM(STY5)	21167100
A4A8U14	IC,PROM(STR2)	21083700	A4A5U24	IC,PROM(STY6)	21167200
A4A8U15	IC,PROM(STR1)	21083800	A4A5U31	IC,PROM(STY7)	21167300
For SN41 and up replace STX1 through STX15 with the following:			A4A5U32	IC,PROM(STY8)	21167400
			A4A5U33	IC,PROM(STY9)	21167500

**Table 1-3 Special Replaceable Parts List, Integrated Circuits**

Ref. Desig.	Description	Part No.
A3A1U1,3	IC, Quad Bilateral Switch, Fairchild Part No. 4066PC.	10615500
A4A1U2,3,8,9,16,17,28	IC, Multiplexer/Demultiplexer, Single 8-Channel with Logic Level Conversion, Fairchild Part No. 4051PC.	10627400
A4A2U5,22	IC, Dual Operational Amplifier, Signetics Part No. N5558V.	10514000
A4A2U6	IC, 12-Bit Successive Approximation Register, AMD Part No. AM2504DC.	10594700
A4A2U11,13	IC, Quad Bilateral Switch, Fairchild Part No. 4066PC.	10615500
A4A2U15	IC, Quad Current Switch, Intersil Part No. ICL8018AC-PD.	10590500
A4A2U23,32	IC, Quad Current Switch, Intersil Part No. ICL8019AC-PD.	10587500
A4A3U7,8,18,19,29,30,40,41,49,50	IC, 1 × 1024 Bit Random Access Memory, Synertek Part No. SYP21LO2A	10587301
A4A4U1,15,29	IC, 2's Complement Multiplier (4 × 2), Fairchild Part No. 93S43DC.	10594801
A4A6U20-26	IC, Central Processing Element, Intel Part No. D3002.	10672500
A4A7U1-22,29-36,59-61	IC, 1 × 1024 Bit Random Access Memory, Synertek Part No. SYP21LO2A.	10587301
A4A7U52,54	IC, 8-Bit Multiplying D to A Converter, Motorola Part No. MC1408L.	10675800
A4A7U62	IC, Dual Operational Amplifier, Motorola Part No. MC1458C.	10514000
A4A10U32,33	IC, Electrically alterable Read only memory, GI Part No. ER3400.	10721400
A4A1041	IC, DC-DC Power Source, 5V, Reliability Inc. Part No. VP15/15	10721500
A4A10U48	IC, Voltage Regulator, 15V, Fairchild Part No. uA7912UC	10626802
PS1A1U1	IC, Precision Voltage Regulator, 2-37V, Fairchild Part No. uA723DC.	10511001
PS1A1U2	IC, Positive Voltage Regulator, 12V, Fairchild Part No. MC7812CP.	10511403
PS1A1U3	IC, Negative Voltage Regulator, Adjustable, 2.2-30V, Fairchild Part No. uA79GC.	10661600
PS1A1U4	IC, Positive Voltage Regulator, Adjustable, 5-30V, Fairchild Part No. uA78GC.	10661601
PS1A2U1	IC, Precision Voltage Regulator, 2-37V, Fairchild Part No. uA723DC.	10511001
PS1A2U3	IC, Buffered Quad 2-input NAND Gate, Fairchild Part No. 4011PC.	10622600
PS1A2U4	IC, Dual Flip-Flop with Set/Reset, Fairchild Part No. 4013PC.	10589000
PS1A2U5	IC, Buffered Quad 2-input NOR Gate, Fairchild Part No. 4011PC.	10606600

**Table 1-4 Special Replaceable Parts List, Controls and Indicators.**

Ref. Desig.	Description	Part No.
A1A2S1	Switch, Key, Arrow-Hart Part No. 1561L.	10705300
A1A2S2,3	Switch, Toggle, Standard Lever, DPDT, C & K Components Part No. 7101Z, (BAR, AVG).	10531716

**Table 1-4 Special Replaceable Parts List, Controls and Indicators. (Continued)**

<b>Ref. Desig.</b>	<b>Description</b>	<b>Part No.</b>
A2A1DS1-11	Indicator, LED, Solid State, Red Flooded, Monsanto Part No. MV5025 (ALARMS, TEST COMPLETE).	10535600
A2A1S16	Switch, Toggle, Flatted Lever, PC Mounted, DPDT, C & K Components Part No. 7215P3C, (CURSOR LEFT/RIGHT).	10531722
A2A1S2,4,6,8,10	Switch, Slide, 6-Position, IEE Shadow Inc. Part No. CL6PVIX6BBMSPC1 (Y-DISPL, OPERATE MODE, AVG, FREQ, CURSOR MODE).	10681701
A2A1S1,3,5,7,9,12	Switch, Slide, 12-Position, IEE Shadow MC Part No. CL12PVIX12BBMSPC1 (LEVEL, NO, WIDTH – MSD + LSD, HEIGHT – MSD – LSD).	10681700
A2A1S11,13,14,15	Switch, Push Button, Momentary, SPDT, C & K Components Part No. 8121C, (PLOT START, TEST START, ALARM RESET, WINDOW SET).	10640509
A2A1U1-5	Display, LED, 7-Segment, Common Cathode, Orange 0.3", Numeric, Monsanto Part No. 3640A (Cursor Readout).	10665901
A3R1	Potentiometer, Panel Mounted, 500k ohms, (INTENSITY)	10319705
A3R2	Potentiometer, Panel Mounted, 2 Megohms, (FOCUS).	10319706
A3R3	Potentiometer, Panel Mounted, 5k ohms, Allen Bradley Part No. WA2G040S502UA, (ILLUM).	10548513
A3A1 (DS1, DS2)	Lamp Assembly, CRT Graticule Illumination.	10404400
A3A1R21,23,26,29	Potentiometer, Trimmer, 10k ohms, Beckman Part No. 89PR10K (X-GAIN), X-OFFSET, Y-GAIN, Y-OFFSET.	10544709
A4A3S1	Switch, Toggle, Right Angle Mounting, SPDT, C & K Components Part No. 7101A (SINE DITHER).	10531800
A1W1S1	Switch/Indicator, Push Button (POWER).	10139203
PS1A2DS1	Surge Voltage Protector, Siemens Part No. B1-A230.	10620300
PS1A2DS2	Lamp, Neon, Wire Terminals, Chicago Miniature Part No. A1A.	10614900
PS1A3S1,2	Switch, Slide, DPDT Locking, Switchcraft Part No. 46256LFR. (115/230).	10528600
PS1A3XF1	Fuseholder, 3AG, Littlefuse Part No. 342004A.	10534500
—	Tube, Cathode Ray, 7 cm Diagonal, Rect., Brimar Part No. D7-201GH.	10668300

**Table 1-5 Special Replaceable Parts List, Miscellaneous**

<b>Ref. Desig.</b>	<b>Description</b>	<b>Part No.</b>
A1A2B1	Fan, 115 Vac, 50/60 Hz, 75 CFM, Rotron Model WR2H1, Part No. 027119	10689900
A4A3Y1	Crystal, 16.384 MHz.	21349806
PS1A1L1	Coil, 50uH, Model 1H-20	10453600
PS1A1T1	Transformer, Power	10376000
PS1A2L1-4	Ferrite Bead, Shielded, Ferroxcube Part No. K500100/3B.	10609600
PS1A2T1	Transformer, Power	10377200
PS1A3L1,2	Coil, Filter Choke, 11mh @ 1 Amp. Dale Part No. C1372.	10668701
—	Twist Coil, 600 ohms, Brimar Part No. TW-28.	10668500
—	Filter, Polarizing, CRT.	10403900
—	Graticule, CRT.	10404100
—	Window, LED Display.	10431600
—	Filter, Foam.	10411100
—	Retainer, Filter.	10411000
—	Grill, Fan.	10411200

## SECTION II

### INSTALLATION

#### 2.1 INTRODUCTION

This section contains instructions for performing an initial inspection of the Model SD210. General safety precautions are included after the initial inspection. Preparation for use and return shipment procedures including procedures for claiming warranty repairs and repacking for shipment are also described in this section.

#### 2.2 Initial Inspection

Although the SD210 is thoroughly inspected mechanically and electrically before packaging for shipment, it must be inspected upon receipt for possible damage in transit.

##### 2.2.1 Unpacking

Use care in removing the instrument from its shipping container to prevent damaging the front panel controls. Save the shipping container and all packing material until the instrument has been inspected and checked for operation.

##### 2.2.2 Equipment Furnished

Check to assure that each item on the packing slip is included with the shipment. Accessory kits may be shipped in separate cartons and each item should be inspected for damage.

##### 2.2.3 Check for Physical Damage

Inspect all panels for dents, signs of chipped paint, or scratches. Check for broken or bent connectors, switches, and broken knobs. Selector switches should be checked to assure that they travel freely over their full range without binding. If there is damage, photos of the damage may be helpful in any subsequent claims.

##### 2.2.4 Reshipment Procedure

If the Model SD210 is to be shipped after receipt, use the original shipping carton and packing material. If original packing material is not

available, materials for reshipment should normally include the following.

- a. A double wall carton with test strength of 350 lb. Carton size should be such that the packing material listed below can be used.
- b. Heavy paper or sheets of cardboard to protect all surfaces.
- c. Nonabrasive material such as polyurethane or cushion paper between projecting parts and wall of carton.
- d. At least 4 inches of shock absorbing material such as extra-firm polyurethane.

#### 2.2.5 Returned Equipment with Warranty or Damage Claims

If the SD210 is found to be damaged in transit or does not operate as specified when received, notify the carrier and the nearest Spectral Dynamics Sales/Service office or Representative immediately. Spectral Dynamics; Sales/Services offices and Representatives are listed at the back of this manual. The local office will arrange for repair or replacement. Be sure to attach a card showing the owner's name, address, telephone number, and a description of the service required.

#### 2.3 SAFETY PRECAUTIONS

##### WARNING

Read the following safety precautions before attempting to operate this instrument.

The Model SD210 SpectraTester presents no hazard to operating personnel if operated in accordance with instructions in this manual.

##### 2.3.1 Explosion Hazard

Do not operate the SD210 SpectraTester in any environment where flammable vapors may exist.

##### 2.3.2 Shock Hazard

When connected to a three-contact power

receptacle, the three-conductor ac power cable supplied with the SD210 grounds the panel and chassis. This grounding protects the operator from possible injury. To preserve this protection when operating from a two-conductor outlet, use a three-conductor two-conductor adapter and connect the adapter wire to ground at the power outlet before connecting the instrument. Covers and safety plates should be removed only by qualified maintenance personnel. Voltages are present inside this instrument whenever the power cord is connected even when the power switch is off.

## 2.4 PREPARATION FOR USE

### 2.4.1 Power Requirements

The SD210 SpectraTester is designed to operate on either 115 Vac or 230 Vac. Therefore, before applying power to the instrument check the following:

- a. Transformer slide switches on the rear panel. *Both* switches must be in the 115 Vac or the 230 Vac position.
- b. Fuse in fuse holder on rear panel is 5A SLO-BLO for either 115 Vac or 230 Vac.

### 2.4.2 Mounting

The SD210 is a portable instrument shipped in a carrying case that can be placed on a work table. With a dash 1 added to the model number the instrument is shipped for installation on a bench or in a 19-inch RETMA rack.

For the Model SD210-1 the carrying case is replaced with side panels and top and bottom slide covers making it suitable for bench mounting.

If rack mounting is required, rack mounting brackets are provided as part of the accessory kit and must be attached before mounting in the rack.

### **CAUTION**

The SD210 must be located where the cooling fan air inlet is not obstructed.

## 2.4.3 Equipment Interconnections

The Model S210 is self-contained requiring only an analog input signal to function. However, external signals are provided at the rear panel plugs for an external X-Y plotter, and X-Y oscilloscope display, and a remote monitor and/or control station. Figure 2-1 shows the interconnections for these equipments. The table below lists the internal signal connections to J9.

### REMOTE STATION LINES

Remote Output		Remote Input	
Signal	Pin Number	Signal	Pin Number
Alarm 1	26	Remote In 2 <sup>0</sup>	13
Alarm 2	1	Remote In 2 <sup>1</sup>	39
Alarm 3	27	Remote In 2 <sup>2</sup>	14
Alarm 4	2	Remote In 2 <sup>3</sup>	40
Alarm 5	28	Remote In 2 <sup>4</sup>	15
Alarm 6	3	Remote In 2 <sup>5</sup>	41
Alarm 7	29	Remote In 2 <sup>6</sup>	16
Alarm 8	4	Remote In 2 <sup>7</sup>	42
Alarm 9	30	Remote CLK	17
Alarm 10	5	Remote Enable	43
Alarm (audio) pulse	36	Remote Start	18
Buffer Test Complete	12	EXT Sampling Frequency	32
Data Not Accepted	38	EXT Sample Select	34
		Remote Reset	37
		Transient Hold	6
		Ground	24,25, 49,50

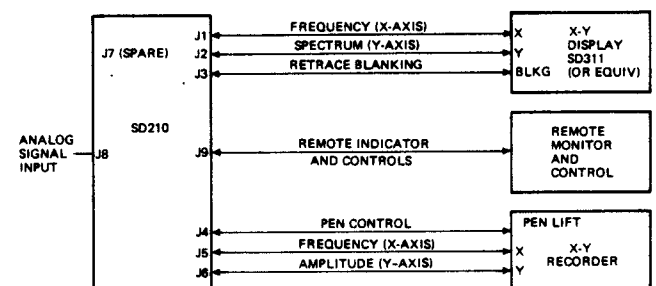

Figure 2-1 Interconnect Diagram



## SECTION III

### OPERATION

#### 3.1 INTRODUCTION

This section provides the operator with a description of all controls and indicators, initial setup and adjustments, operational checkout, and instrument operation including remote operations and operator maintenance. Application information is at the end of the section.

Front panel controls and indicators are divided into five functional groups and a power on-off switch. As illustrated below:

- |                   |                 |
|-------------------|-----------------|
| 1. CRT Group      | 4. Window Group |
| 2. Analysis Group | 5. Power Switch |
| 3. Input Group    | 6. Cursor Group |

#### 3.2 FRONT PANEL CONTROLS AND INDICATORS

To facilitate description, each group is illustrated separately in the following paragraphs.

Front Panel Controls and Indicators

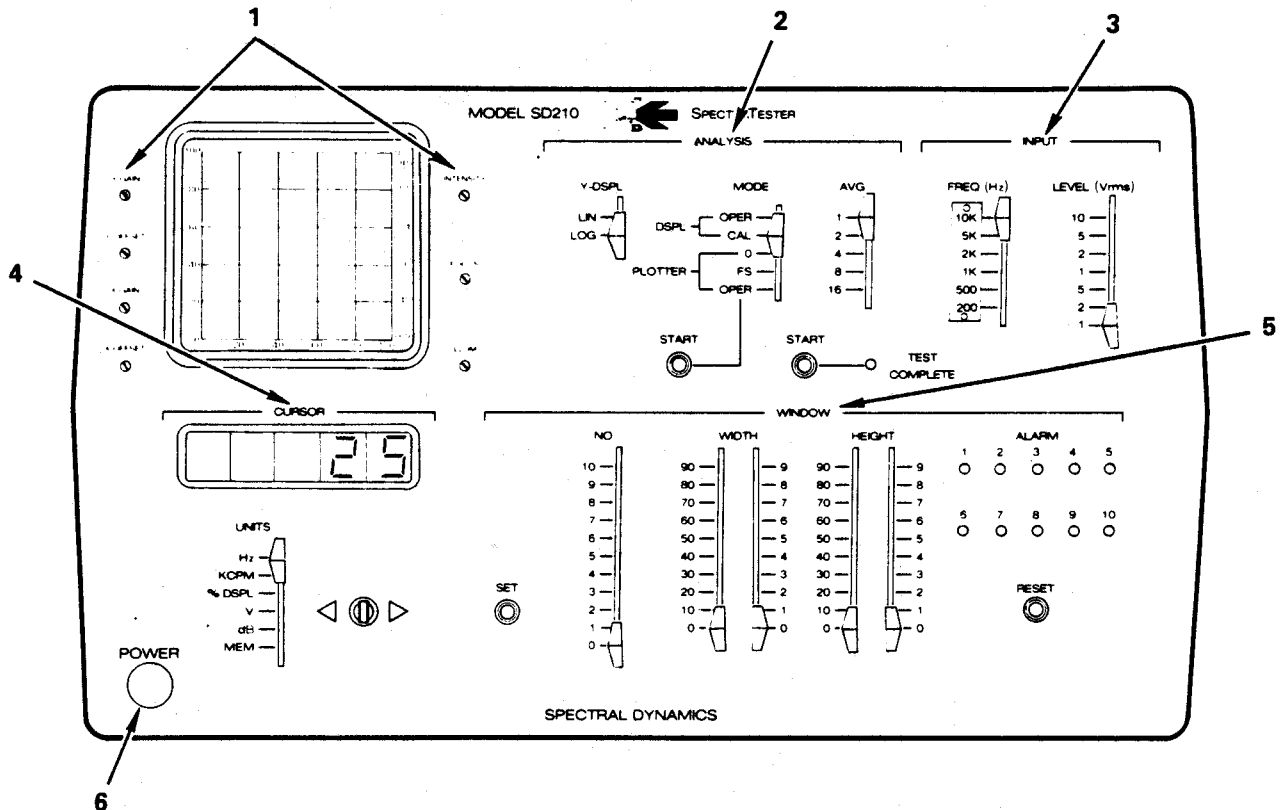

### 3.2.1 CRT Group

Seven screwdriver adjust potentiometers comprise this group. They control the visual pattern displayed on the crt. Once set they should not require further adjustment during a test sequence.

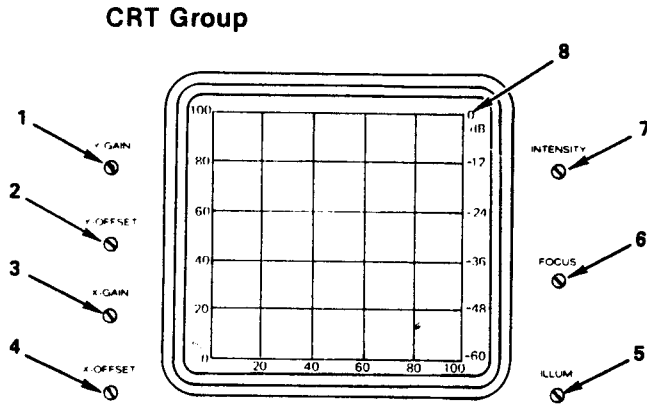

Control or Indicator	Function
1 Y-GAIN	Increases (CW) or decreases (CCW) the gain of the Y-axis amplifier.
2 Y-OFFSET	Moves the crt beam vertically +25% (CW) or -25% (CCW) of full scale.
3 X-GAIN	Increases (CW) or decreases (CCW) the gain of the X-axis amplifier.
4 X-OFFSET	Moves the crt beam horizontally +20% (CW) or -20% of full scale.
5 ILLUM	Brightens (CW) or dims (CCW) the crt graticule lamps.
6 FOCUS	Adjusts the crt beam for sharpest display details.
7 INTENSITY	Brightens (CW) or dims (CCW) the crt beam.
8 GRATICULE	Left-hand scale reads in % of selected input level. Horizontal scale reads in % of selected frequency range. Right-hand scale reads dB function of input levels when LOG Y-DISPL is selected.

### 3.2.2 ANALYSIS GROUP

This group contains three selector switches, two momentary pushbutton switches, and an indicator lamp. Switch settings in this group permit the operator to select a linear or logarithmic vertical display, record the spectrum on an External plotter, and select the number of sequential spectra (an ensemble) that will be averaged while being displayed.

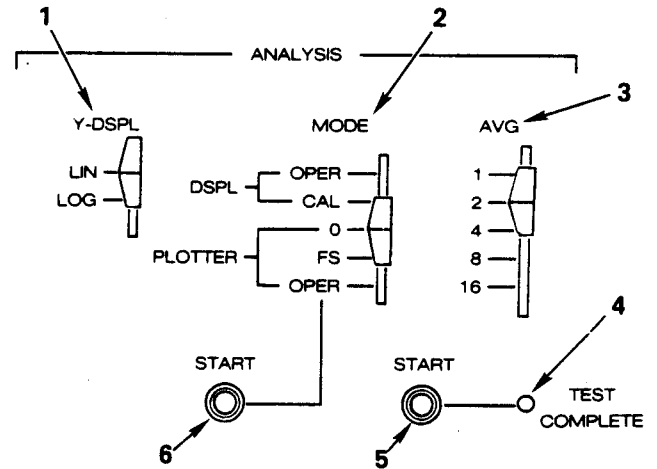

Control or Indicator	Function
1 Y-DISPL	Selects linear or logarithmic vertical crt display; inactive with rear panel key switch locked.
2 MODE	Selects operating or calibrating modes for the crt display or external plotter, inactive with rear panel key switch locked.
3 AVG	Selects the number of spectrum ensembles to be averaged before being displayed. When set to 1, instrument is in Real-Time mode; inactive with rear panel key switch locked.
4 TEST COMPLETE	Lights when number of linear averages is completed. Flashes when exponentially averaging is normalized. For AVG = 1 and rear panel key switch in SET UP, light is off. For AVG = 1 and key switch in LOCK, light flashes.

- 5 (AVG) START Starts spectrum averaging either linearly or exponentially depending upon setting of rear panel EXP/LIN switch.
- 6 (PLOTTER) START Enables output to external plotter with the mode switch in PLOTTER position; plots spectrum display if cursor or spectrum, plots bar display if cursor on bar sweep.

### 3.2.3 INPUT GROUP

The two selector switches in this group allows the operator to set up the internal frequency filters and amplitude attenuators to scale the input signal correctly for analysis and display.

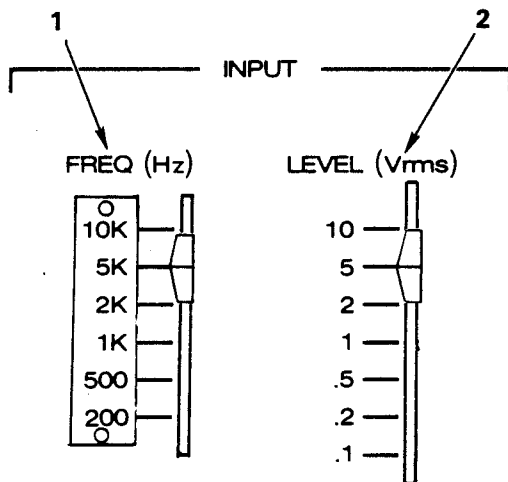

- | Control or Indicator | Function                                                                                                      |
|----------------------|---------------------------------------------------------------------------------------------------------------|
| FREQ (HZ)            | Selects the upper limit frequency of the spectrum to be analyzed; inactive with rear panel key switch locked. |
| LEVEL (Vrms)         | Selects the upper limit rms amplitude of the input signal; inactive with rear panel key switch locked.        |

### 3.2.4 WINDOW GROUP

This group of controls and indicators consists of five slide selector switches, two pushbuttons, and

ten indicator lamps. These controls allow the operator to select up to ten bands (windows) within the displayed spectrum (width) and to automatically test for selected amplitude limits (height) within each band. Indicator lamps corresponding to each test window will light if the spectrum amplitude exceeds the window height.

- | Control or Indicator | Function                                                                                                                                                                                                                                                                                                 |
|----------------------|----------------------------------------------------------------------------------------------------------------------------------------------------------------------------------------------------------------------------------------------------------------------------------------------------------|
| 1 NO                 | Selects the number with which the WIDTH and HEIGHT switch settings are identified; inactive with the rear panel key switch locked.                                                                                                                                                                       |
| 2 WIDTH              | Selects the horizontal limits from cursor position of the test window as a percentage of the selected frequency range; inactive with the rear panel key switch locked.                                                                                                                                   |
| 3 HEIGHT             | Selects the vertical limit of the test window as a percentage of the selected input level; inactive with the rear panel key switch locked.                                                                                                                                                               |
| 4 ALARM              | With rear panel key switch in the locked position, lights when the spectrum height amplitude has been exceeded within the window identified with the corresponding number; with rear panel key switch in SET UP, lights when the corresponding window parameters have been entered (SET switch pressed.) |
| 5 RESET              | Turns off all alarm lights, if key switch is locked.                                                                                                                                                                                                                                                     |
| 6 SET                | Stores the window width and height parameter with the number set on the NO switch; erases all windows when NO O is selected; inactive with the rear panel key switch locked.                                                                                                                             |

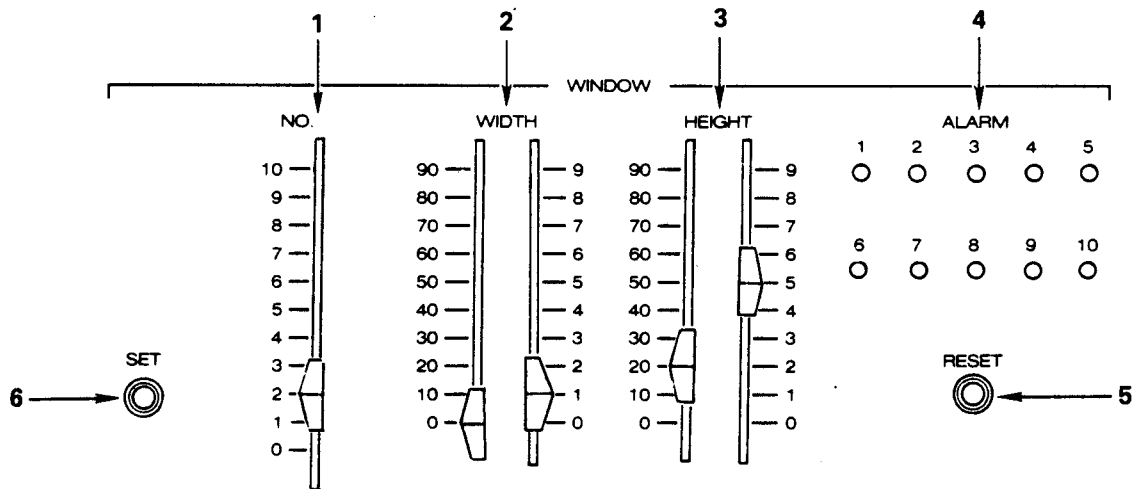

### 3.2.5 CURSOR GROUP

This group consists of a five digit (decimal) readout, a selector switch, and a momentary three-position, spring-return switch. These switches and indicators allow the operator to position the intensified reference dot cursor on the display crt and select specific information about the analyzed spectrum or the bar display at the cursor's location. The POWER switch is below and to the left of the group.

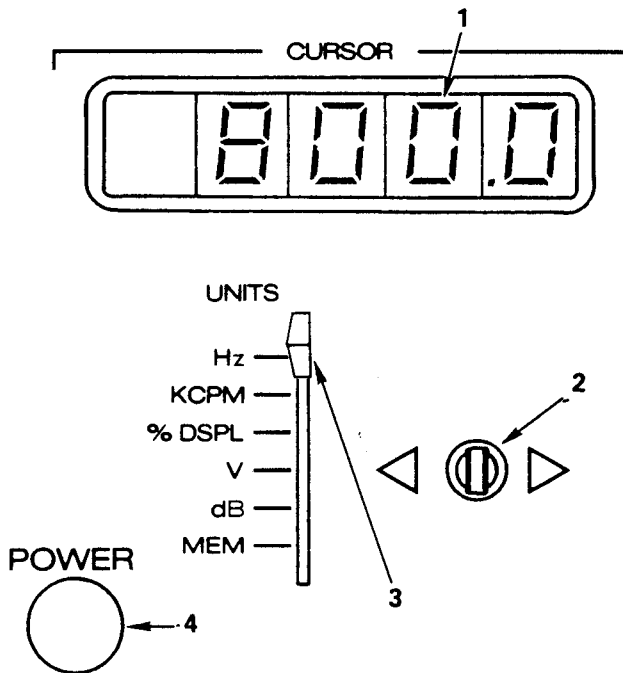

#### Control or Indicator

#### Function

1 CURSOR (Readout)

Indicates the information (at the cursor location) selected on the UNITS switch.

2 CURSOR (CONTROL)

Positions the cursor on the crt display. When the UNIT switch is set to MEM, increments (right) or decrements (left) the nonvolatile memory Reference Address Counter.

3 UNITS

Selects the terms or units of the value appearing in the CURSOR readout. In the MEM position, the readout contains the number of the nonvolatile memory's (EARAM) Reference Address Counter.

3 UNITS

Selects the terms or units of the value appearing in the CURSOR readout. In the MEM position, the readout contains the number of the nonvolatile memory's (EARAM) Reference Address Counter.

4 POWER

When ON, the indicator lights and only the word ON can be seen on the edge of the pushbutton. When OFF, the words "NOT ON" can be seen on the edge of the pushbutton.

### 3.3 REAR PANEL

Mounted on the rear panel are controls for setting input power, front panel operating conditions, and jacks for connecting cables to external equipment.

These rear panel components are divided into three functional groups:

1. Front Panel Control
2. Power
3. Connectors

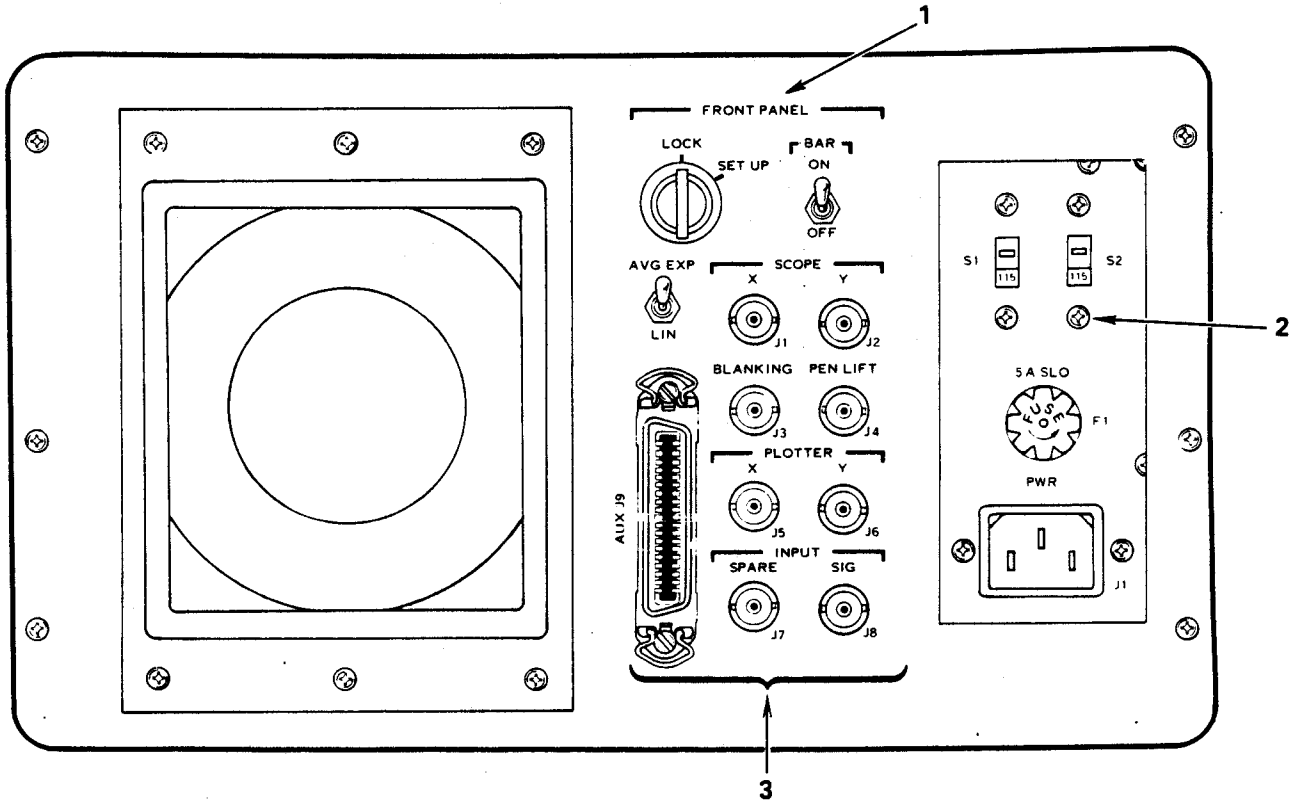

#### 3.3.1 FRONT PANEL CONTROL GROUP

This group of two toggle switches and one key switch sets up operating conditions for the crt display and averaging and controls the use of front panel switches.

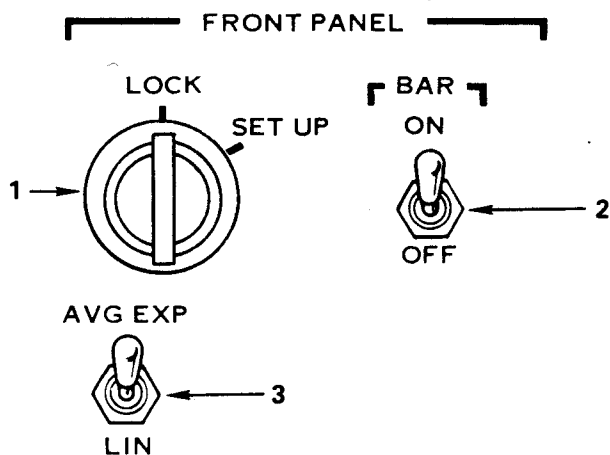

#### Control

1 LOCK

2 BAR

#### Function

When in the SET UP position, this key switch enables all front panel controls. When in the LOCK position, only the CURSOR UNITS, CURSOR CONTROL, PLOTTER START, AVG START, and ALARM RESET switches are active. Key can be removed only when locked.

Controls windows displayed on the crt. When OFF, the windows are not displayed, although the windows are still active in the test circuitry. When ON, the selected windows appear on the crt.

3 AVG EXP/LIN Selects the type of averaging to be performed. When set to LIN, the analysis averages the number of ensembles, displays the results and stops. In EXP, after averaging the first number of ensembles, the analysis continues averaging.

### 3.3.2 POWER GROUP

This group consists of two input ac power slide switches, an ac line fuse, and an ac power jack.

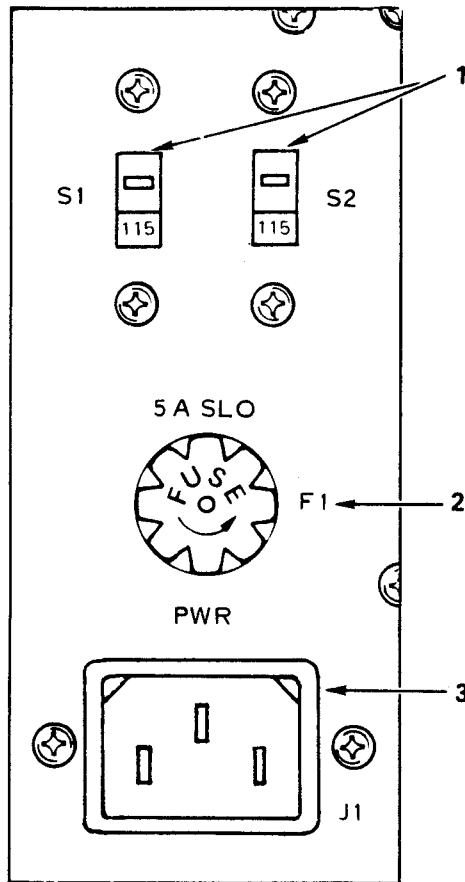

Component	Function
S1, S2	Sets input power for 115 or 230 Vac operation. Both switches <i>must</i> be set to the same position.
F1	Fuse holder with 3AG, 5A, SLO-BLO fuse.

J1 Power jack accepts 3-wire plug and cable for 115 or 230 Vac. Center terminal must be grounded.

### 3.3.3 CONNECTOR GROUP

This group contains 8 BNC jacks and 1 multipin connector.

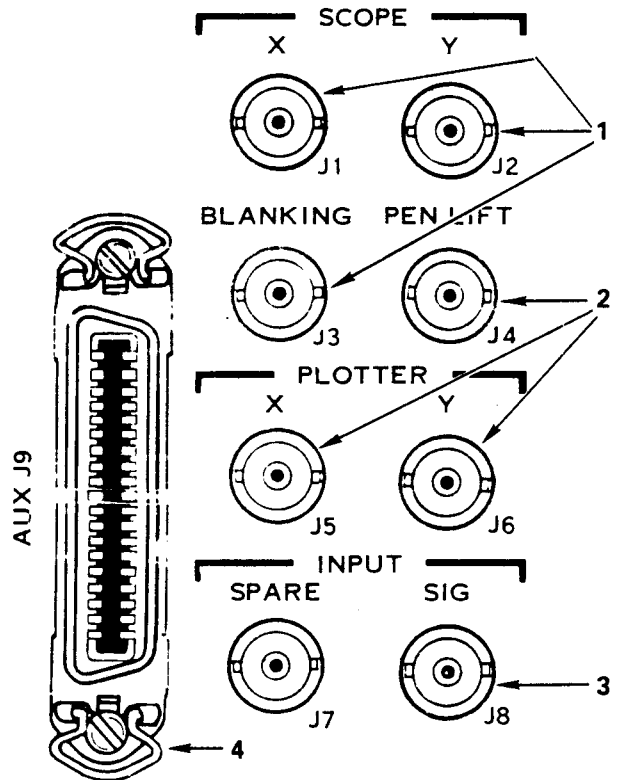

Connector	Function
J1, J2, J3	Provides a means for connecting X, Y, and blanking signal cables to drive an external X-Y display unit to duplicate the SD210 crt display.
J4, J5, J6	Provides a means for connecting X, Y, and Pen control signal cables to drive an external X-Y plotter to produce a permanent record of the SD210 crt display.
J8	Provides a means for connecting the input signal from a transducer device to the SD210.

AUX J9 Provides a means for connecting alarm and certain SD210 status signals to a remote device. Also provides a means for connecting input control signals from a remote station.

### 3.4 INITIAL POWER APPLICATION

#### 3.4.1 Preliminary Checks

The SD210 SpectraTester is designed to operate on either 115 Vac or 230 Vac. Therefore, before applying power to the instrument, check the following:

- Transformer slide switches on the rear panel. *Both* switches must be in the 115 Vac or the 230 Vac position.
- Fuse in fuse holder on rear panel is 5A SLO-BLO for either 115 Vac or 230 Vac.
- Equipment is located so that cooling fan air inlet is not obstructed.

#### 3.4.2 Equipment Turn On

After assuring that the correct voltage is selected and the 5A SLO-BLO fuse is in place, press the POWER pushbutton until the words "NOT ON" can be read on the top edge of the pushbutton. Connect the ac power cord to the ac power source. Depress the POWER pushbutton/indicator. The indicator will light and only the word "ON" will be visible on the pushbutton.

#### 3.4.3 External Equipment Interconnections

The model SD210 is self-contained requiring only an analog input signal. However, external signals are provided at the rear panel plugs for an external X-Y plotter, an X-Y oscilloscope display, and a remote monitor and/or control station. The diagram in paragraph 2.4.3 shows the interconnections for these equipments. If

provided, these connections should be made before continuing.

### 3.5 INITIAL SETUP AND ADJUSTMENTS

The following test conditions check the crt display using the 0 and FS plotter calibration signal and the internal display calibration signal. It is recommended that the operator read this entire subsection (3.5) to become familiar with the intent of the procedures before performing the procedures. If the display is incorrect at any step in the procedure, recheck all previously set switch conditions. If display results are still incorrect, note the discrepancy, the step at which it occurred and continue the checkout. If an external crt display has been connected and power is applied, it will repeat the SD210 display.

#### 3.5.1 Switch Settings

- Turn on equipment power.
- Set rear panel controls as shown.

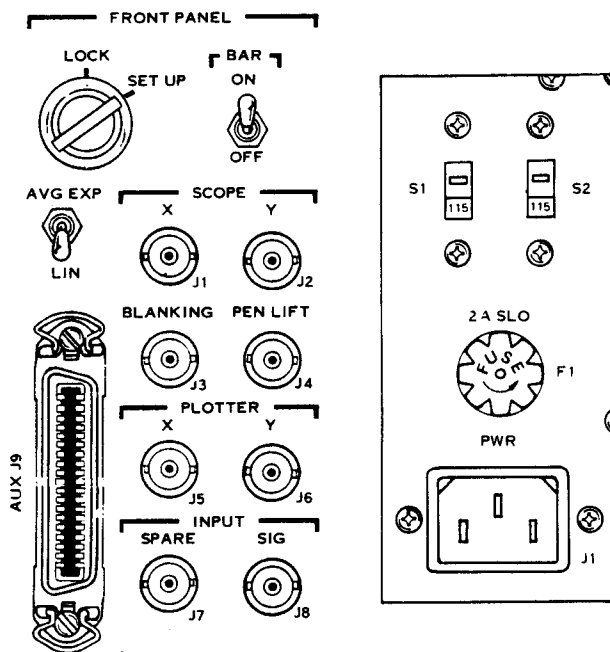

- Set front panel controls as shown.

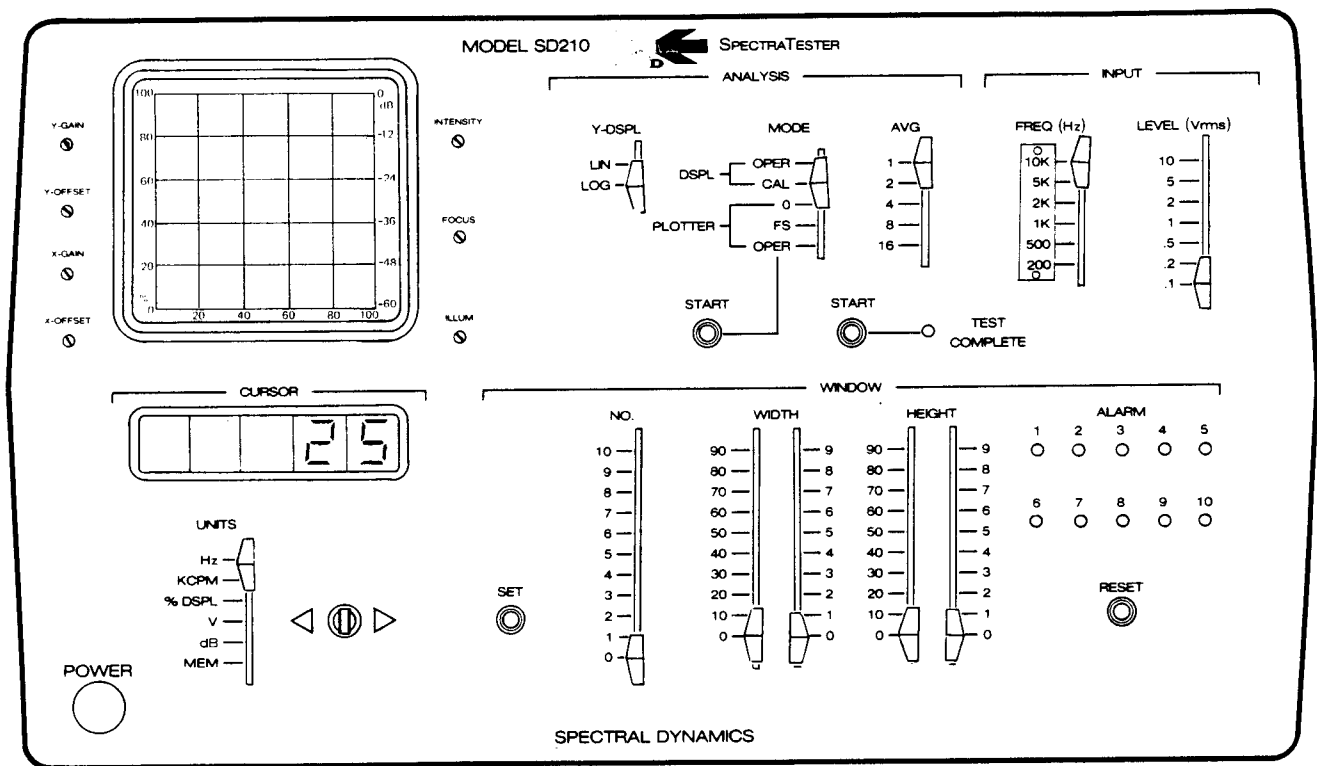

- d. Display will be as shown.
- e. If an external display unit has been connected, the display will be repeated on the external unit.
- b. Set the ANALYSIS MODE selector switch to the PLOTTER O position.
- c. Display will be as shown.

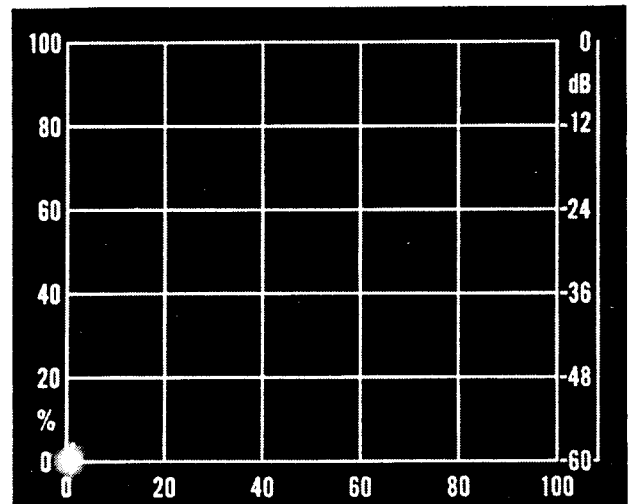
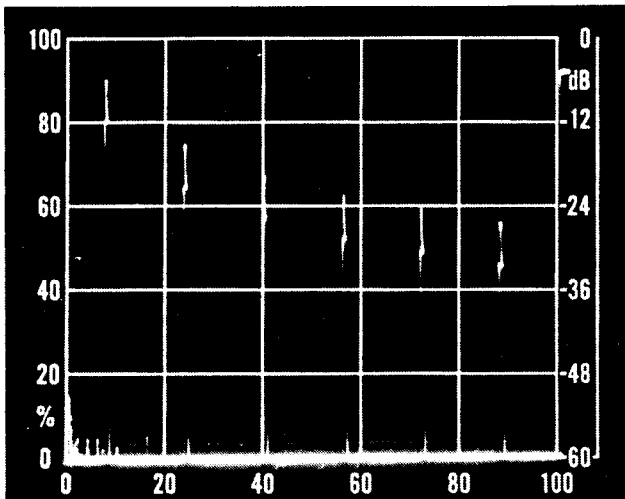

### 3.5.2 Crt Calibration Checks

- a. CRT display will be clear and in focus. If not, set the crt INTENSITY, FOCUS, and ILLUM screwdriver adjustments for the best presentation. If an external crt and or plotter is connected make the equivalent adjustments on the external unit.
- d. Only if required, adjust the X-OFFSET screwdriver adjustment to position the dot at the vertical 0 line.
- e. Only if required, adjust Y-OFFSET screwdriver adjustment to position the dot at horizontal 0 line.



- f. Set the ANALYSIS MODE selector switch to the PLOTTER FS position.
- g. Display will be as shown.

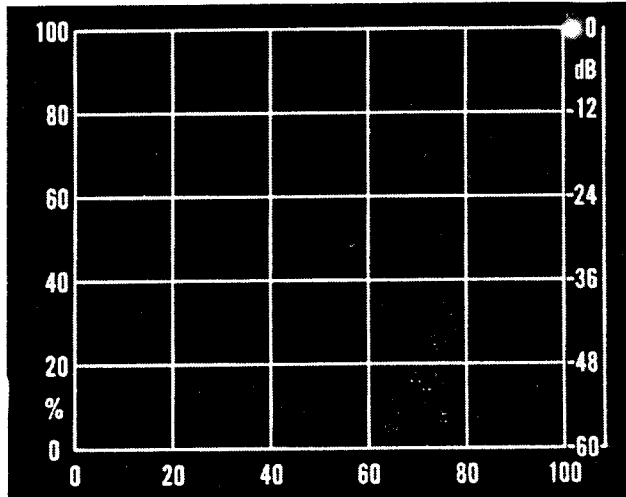

- h. Only if required, adjust the X-GAIN screwdriver adjustment to position the dot at the vertical 100 line.
- i. Only if required, adjust the Y-GAIN screwdriver adjustment to position the dot at the horizontal 100 line.
- j. If adjustments were required for step above repeat steps d through i, as necessary, to eliminate interaction.

### 3.6 OPERATIONAL CHECKOUT

In this section each control and indicator is checked for correct operation and interaction with internal logic circuitry. In performing the checks, the operator will become familiar with each switch function and its overall use in operating the instrument.

#### 3.6.1 Cursor Control and Display Checks

The following test conditions check the cursor control to assure that the cursor intensity dot can be positioned precisely on the crt display and that the correct units are displayed on the cursor readout display.

- a. Set the ANALYSIS MODE selector switch to the DISPL CAL position.
- b. Push the CURSOR control to the right to move intensity dot to the top of the lowest frequency displayed (far left peak).
- c. Cursor readout will be 800.
- d. Set the CURSOR UNITS selector switch to the KCPM position.
- e. Cursor readout will be 48.0.
- f. Set the CURSOR UNITS selector switch to the % DISPL position.
- g. Cursor readout will be 90.
- h. Set the CURSOR UNITS selector switch to the V position.
- i. Cursor readout will be 0.050.
- j. Set the CURSOR UNITS selector switch to the dB position.
- k. Cursor readout will be -06.0.
- l. Set CURSOR UNIT selector switch to MEM position.
- m. CURSOR readout will be 1.
- n. Push CURSOR control switch to the right and release.
- o. CURSOR readout will be 2.
- p. Set UNITS selector switch to the Hz position.

### 3.6.2 Cursor Position and Window Set Checks

The following test conditions check for proper operation of the cursor using the display readout to position the cursor and to set up ten windows and test parameters for storage. If an external crt display is connected, the display conditions indicated will be repeated on the external display.

#### 3.6.2.1 Set Window 1 and Test Parameters

- Push the CURSOR control to the right to move the intensity dot to the top of the first frequency peak.
- Select window switches as shown.

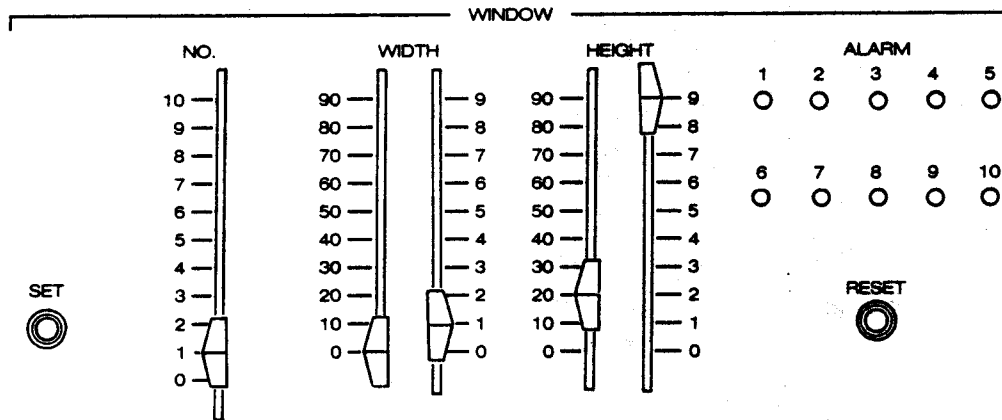

- Press WINDOW SET pushbutton.
- WINDOW ALARM 1 lamp will light.
- With the CURSOR control, move the intensity dot until the cursor readout is at 2400.

- Intensity dot will be on the top of the second frequency peak from the left side of the crt display.

#### 3.6.2.2 Set Windows 2 and 3

Select WINDOW switches as shown.

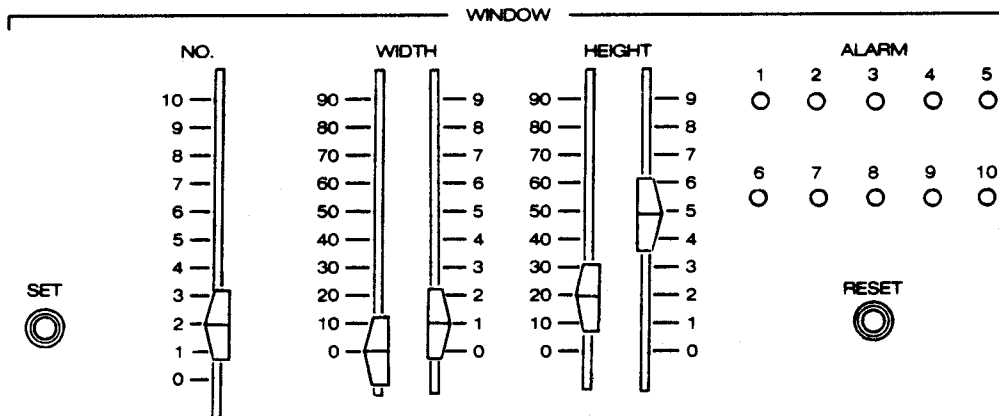

- a. Press WINDOW SET pushbutton.
- b. WINDOW ALARM lamp 2 will light.
- c. Set WINDOW NO. (number) select switch to position 3.
- d. Press WINDOW SET pushbutton.
- e. WINDOW ALARM lamp 3 will light.

- f. With the CURSOR control, move the intensity dot to the right until the cursor readout is at 4000.
- g. Intensity dot will be on top of the third frequency peak from the left side of the crt display.

**3.6.2.3 Set Windows 4 and 5**

Select WINDOW switches as shown.

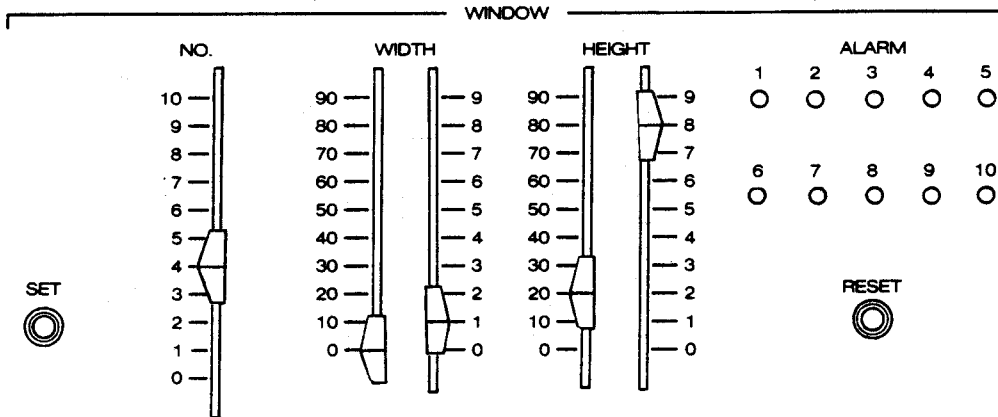

- a. Press WINDOW SET pushbutton.
- b. WINDOW ALARM lamp 4 will light.
- c. Set WINDOW NO. (number) select switch to position 5.
- d. Press WINDOW SET pushbutton.
- e. WINDOW ALARM lamp 5 will light.

- f. With the CURSOR control, move the intensity dot to the right until the cursor readout is at 5600.
- g. Intensity dot will be on top of the fourth frequency peak from the left side of the crt display.

**3.6.2.4 Set Windows 6 and 7**

Select WINDOW switches as shown.

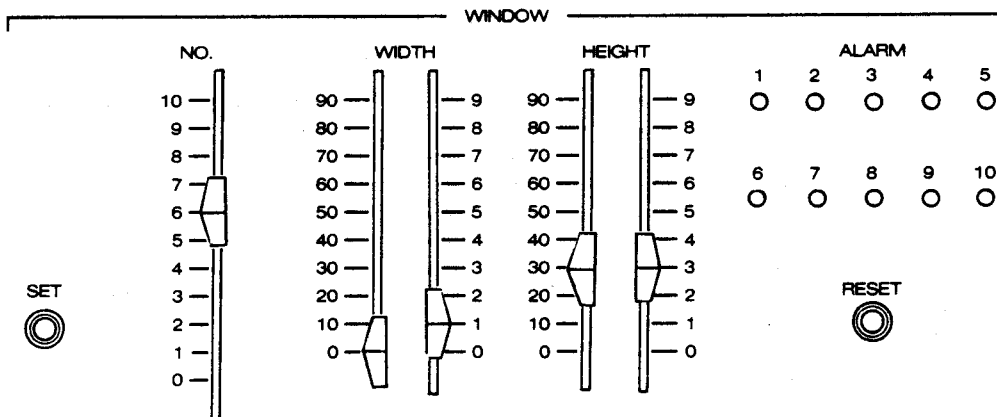

- a. Press WINDOW SET pushbutton.
- b. WINDOW ALARM lamp 6 will light.
- c. Set WINDOW NO. (number) select switch to position 7.
- d. Press WINDOW SET pushbutton.
- e. WINDOW ALARM lamp 7 will light.

- f. With the CURSOR control, move the intensity dot to the right until the cursor readout is at 7200.
- g. Intensity dot will be on top of the fifth frequency peak from the left side of the crt display.

**3.6.2.5 Set Windows 8 and 9**

Select WINDOW switches as shown.

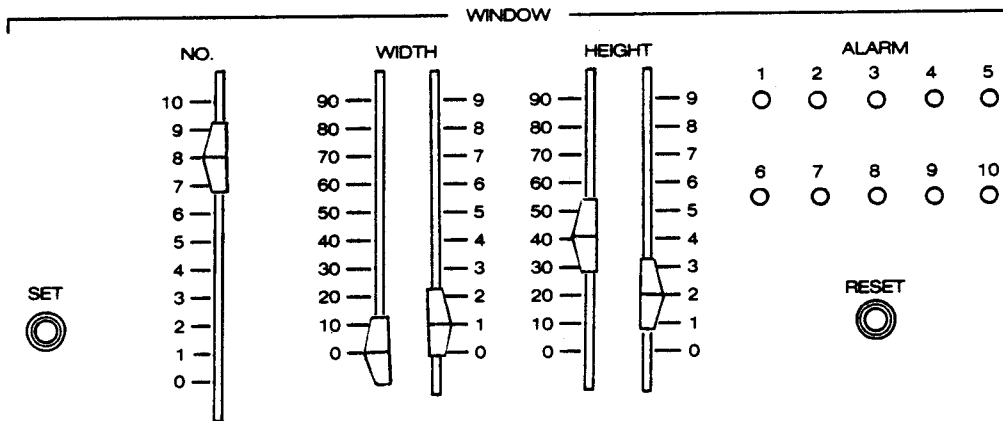

- a. Press WINDOW SET pushbutton.
- b. WINDOW ALARM lamp 8 will light.
- c. Set WINDOW NO. (number) select switch to position 9.
- d. Press WINDOW SET pushbutton.
- e. WINDOW ALARM lamp 9 will light.

- f. With the CURSOR control, move the intensity dot to the right until the cursor readout is at 8800.
- g. Intensity dot will be on top of the sixth frequency peak from the left side of the crt display.

**3.6.2.6 Set Window 10**

Select WINDOW switches as shown.

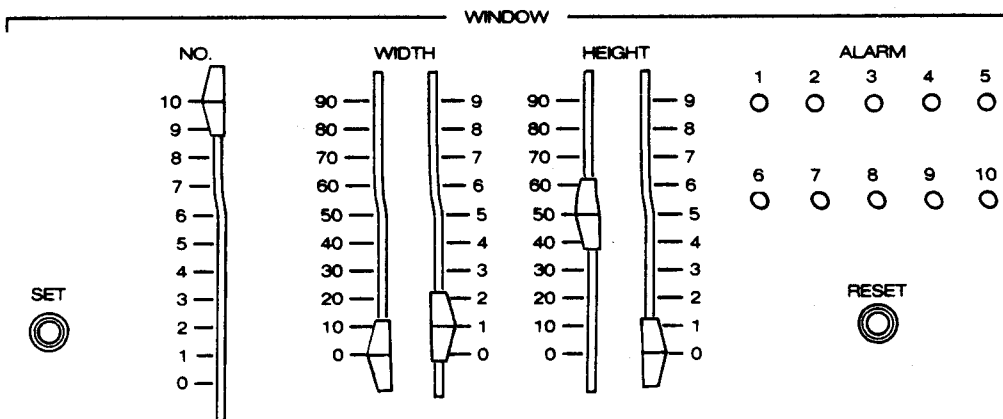

- a. Press WINDOW SET pushbutton.
- b. WINDOW ALARM lamp 10 will light.
- c. On rear panel, set key switch to LOCK position.

### 3.6.2.7 Cursor Position at Overall Signal

The cursor reads frequency and amplitude of the spectrum (first scale) on its first pass across the crt display. When wrapped around to the beginning of the trace, it will read the frequency and amplitude of the windows (second scale). To change the cursor from one scale on the other, the CURSOR control must be held in either direction until it reappears on the other side. The following conditions check cursor operation on the second scale.

- a. With the CURSOR control, move the intensity dot to the right until cursor readout is one step beyond 10000 (i.e. readout is 00).
- b. Intensity dot will be on top of the overall signal, just beyond the crt graticule.
- c. Move intensity dot until it is off scale.
- d. CRT display will be as shown.

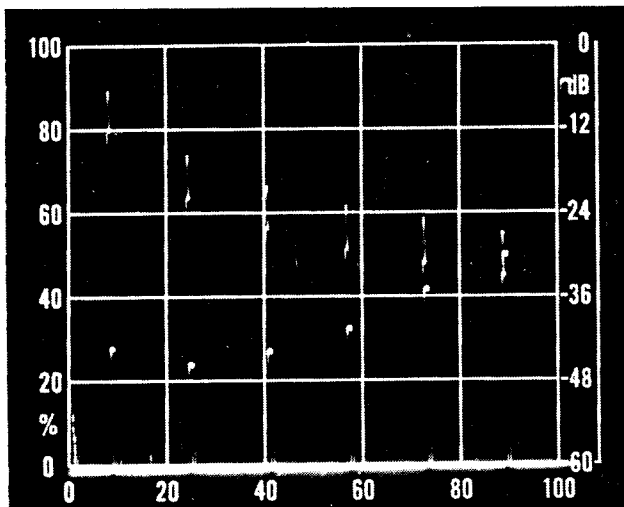

### 3.6.2.8 Check % Displ Readout and Cursor Second Scale

- a. Set all WINDOW select switches (NO. WIDTH, and HEIGHT) to 0 position.

- b. Set CURSOR UNIT selector switch to % DISPL position.
- c. With CURSOR control switch move intensity dot to the right until it reappears on the left side of the crt display.
- d. Continue moving the intensity dot to the top of the first window.
- e. CURSOR readout will be 29.0.
- f. Sequentially move the intensity dot to the top of the 2nd, 3rd, 4th, 5th, and 6th windows.
- g. Cursor readout will be at 25.0, 28.0, 33.0, 42.0, and 50.0, respectively.
- h. Set CURSOR UNITS selector switch to MEM position.
- i. Cursor readout will be 2.
- j. Set CURSOR UNITS selector switch to Hz position.
- k. Position cursor to start of display (cursor readout at 25).

### 3.6.3 Input Level Switch and Alarm Level Checks

The following test conditions check for proper input attenuation levels and window alarm thresholds. As the input level is increased the signal on the crt display will decrease in amplitude but the windows displayed will remain in the same position on the crt display.

#### 3.6.3.1 Window and Alarm Checks at .2V Level

- a. Set ANALYSIS AVG selector switch to position 2.
- b. Set rear panel key switch to SET UP then back to LOCK position.
- c. Press ALARM RESET pushbutton. All ALARM indicators will turn off.
- d. Press AVG START pushbutton.
- e. TEST COMPLETE indicator will turn off then turn on after about 0.5 second.

- f. ALL ALARM indicators will light and audio alarm will sound.
- g. CRT Display will be as shown.

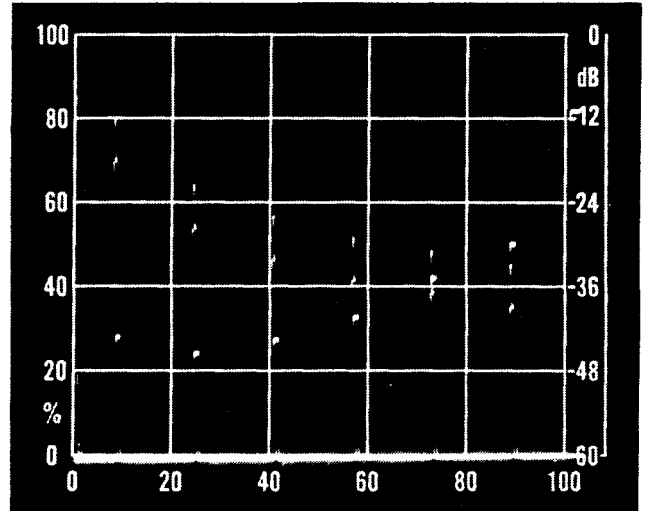
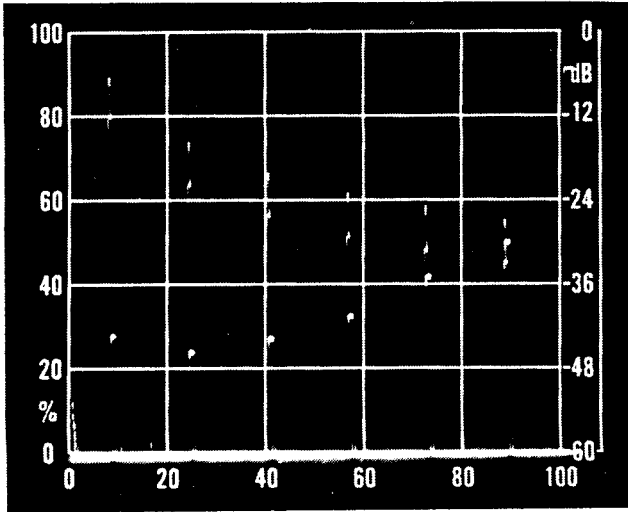

- h. Set input level selector switch to .2 Vrms.
- i. Set ANALYSIS AVG selector switch to position 4.
- j. On rear panel, set key switch to SET UP position then back to LOCK.
- k. Press ALARM RESET pushbutton.
- l. All ALARM lamps will turn off.
- m. Press the AVG START pushbutton.
- n. TEST COMPLETE lamp will turn off then turn on after about 1 second.
- o. ALARM lamps 1 through 9 will light and audio alarm will sound.
- p. CRT Display will be as shown.

### 3.6.3.2 Window and Alarm Checks at .5V Level

- a. Set INPUT LEVEL selector switch to .5 Vrms. ALARM lamps will not change.
- b. Set ANALYSIS AVG selector switch to position 8.
- c. On the rear panel, set key switch to SET UP position then back to LOCK.
- d. Press ALARM RESET pushbutton. All ALARM lamps will turn off.
- e. Press AVG START pushbutton.
- f. TEST COMPLETE lamp will turn off then turn on after about 2 seconds.
- g. ALARM lamps 1 through 7 will light and audio alarm will sound.
- h. CRT Display will be as shown.

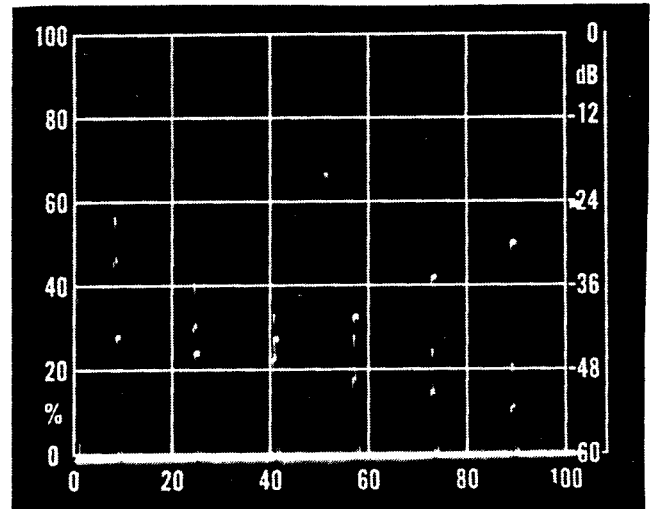
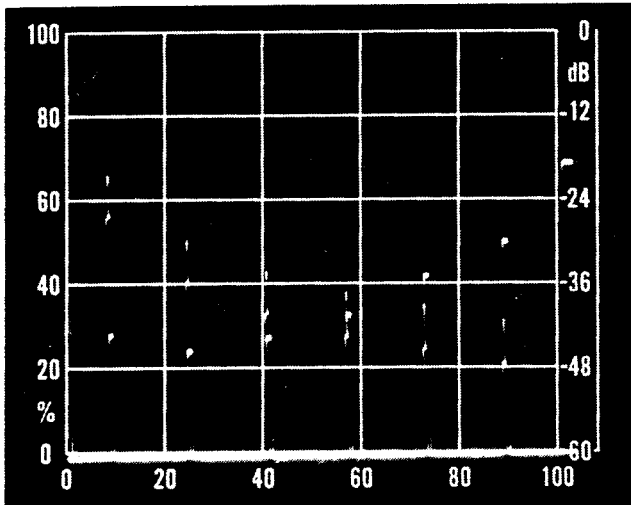

### 3.6.3.3 Window and Alarm Checks at 1V Level

- a. Set INPUT LEVEL selector switch to 1 Vrms position.
- b. ALARM lamps will not change.
- c. Set ANALYSIS AVG selector switch to position 16.
- d. On rear panel, set key switch to SET UP position then back to LOCK.
- e. Press ALARM RESET pushbutton.
- f. ALARM lamps will turn off. Press AVG START pushbutton.
- g. TEST COMPLETE lamp will turn off then turn on after about 4 seconds.
- h. ALARM lamps 1 through 5 will light and audio alarm will sound.
- i. CRT Display will be as shown.

### 3.6.3.4 Window and Alarm Checks at 2V Level with EXP Average

- a. Set INPUT LEVEL selector switch to 2 Vrms position.
- b. ALARM lamps will not change.
- c. Set ANALYSIS AVG selector switch to position 2.
- d. Set rear panel AVG EXP/LIN switch to EXP position.
- e. On the rear panel, set key switch to SET UP position then back to LOCK.
- f. Press ALARM RESET pushbutton.
- g. ALARM lamps will turn off.
- h. Press AVG START pushbutton.
- i. TEST COMPLETE lamp will turn off then turn on flashing after about 0.5 second.

- j. ALARM lamps 1 through 3 will light and audio alarm will sound.
- k. CRT Display will be as shown.

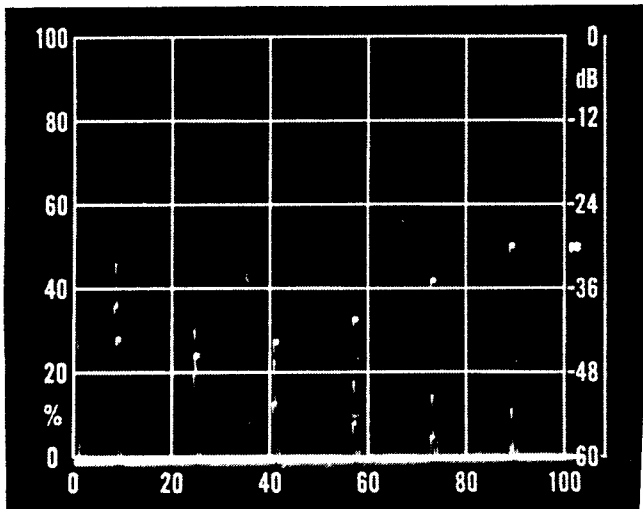

### 3.6.3.5 Window and Alarm Checks at 5V Level

- a. Set INPUT LEVEL selector switch to 5 Vrms position.
- b. ALARM lamps will not change.
- c. On rear panel, set key switch to SET UP position then back to LOCK.
- d. ALARM lamps 2 and 3 will turn off.
- e. CRT Display will be as shown.

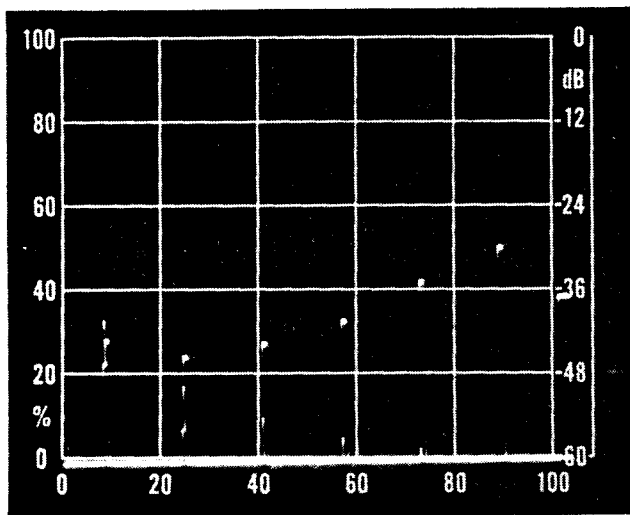

### 3.6.3.6 Window and Alarm Checks at 10V Level

- a. Set INPUT LEVEL selector switch to 10 Vrms position.
- b. ALARM lamps will not change.
- c. On rear panel, set key switch to SET UP position then back to LOCK.
- d. ALARM lamp 1 will turn off.
- e. CRT Display will be as shown.

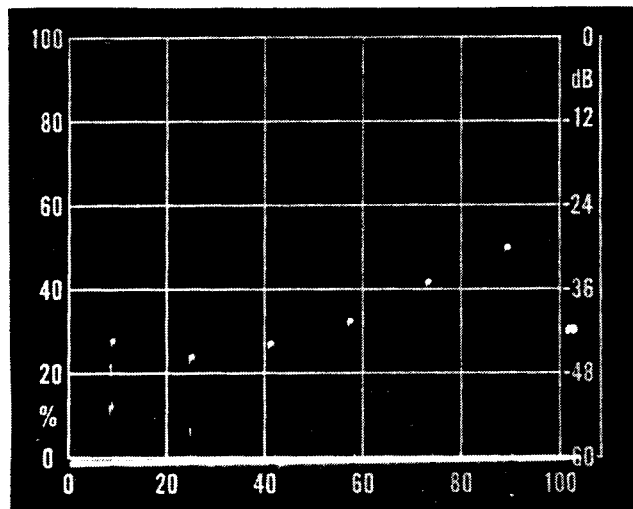

### 3.6.3.7 Window Bar Display Check

- a. Set INPUT LEVEL selector switch to .1 Vrms position.
- b. Set ANALYSIS AVG selector switch to position 2.
- c. On the rear panel, set BAR ON-OFF switch to OFF.
- d. Window bars on crt display will not be displayed.
- e. On the rear panel, set the keyswitch to SET UP then back to LOCK.
- f. Press ALARM RESET pushbutton.
- g. ALARM lamps will turn off.
- h. Press the AVG START pushbutton.
- i. All ALARM lamps will turn on and the audio alarm will sound.



### 3.6.3.8 Nonvolatile Memory Check

All test parameters should be stored in the nonvolatile memory. The test conditions below check for writing into and reading out of the nonvolatile memory.

With the switch conditions as left in paragraph 3.6.3.7 above make the following checks.

- a. On the rear panel, set Bar switch to ON and key switch to SET UP.
- b. Window bars will be displayed on the crt.
- c. Press the ALARM RESET pushbutton.
- d. ALARM lamps will turn off.
- e. Set the UNITS switch to MEM position.
- f. Cursor readout will indicate 02.
- g. Push the CURSOR control to the right and release.
- h. Cursor readout will indicate 03 after approximately 2 seconds.
- i. No windows will be displayed on the crt.
- j. Push the CURSOR control to the left and release.
- k. Windows will reappear on the crt display.
- l. Turn POWER switch on and off.
- m. Cursor readout will indicate 01 and no windows will be displayed on the crt.
- n. With the CURSOR control, increment (to right) cursor readout to 2.
- o. Windows will be displayed on the crt.
- p. On the rear panel, set the key switch to SET UP.
- q. Set all WINDOW switches to 0.
- r. Set UNITS switch to Hz.
- s. Press WINDOW SET pushbutton.
- t. Windows will be erased from the crt display.

## 3.7 OPERATION

### 3.7.1 Introduction

The Model SD210 SpectraTester analyzes a frequency range of the analog input signal and can then be programmed to examine up to ten separate spectral bands for excessive amplitudes. Programming the SD210 consist of assigning a vertical (HEIGHT) and horizontal (WIDTH) limit to form a test window for each selected spectral band.

To provide optimum flexibility, window height and width can be changed in 1% increments. A 1% change in window width is equal to 4 frequency cells. On the Y-DSPL LOG scale, a 1% change is equal to 0.6 dB. On the Y-DSPL LIN scale, a 1% change is equal to 0.01 times the INPUT LEVEL setting.

The paragraphs below present a suggested sequence for setting up the signal analysis and test parameters.

### 3.7.2 Initial Conditions

Before running an operational test, a set of test parameters must be entered into the SD210 memory. A complete set of test parameters includes setting the ANALYSIS and INPUT GROUP switches and all required test windows. When entered into memory, the set of test parameters is identified with the number set into the cursor readout with the UNIT selector switch in the MEM position.

- a. On the rear panel:
  1. Set the key switch to SET UP.
  2. Set the AVG switch to the desired type of averaging (EXP or LIN).
  3. Set the BAR switch to ON.
- b. On the front panel ANALYSIS and INPUT switches.
  1. Set Y-DSPL selector switch to desired type of Y-axis representation.
  2. Set Mode selector switch to OPERATE.
  3. Set AVG selector switch to number of ensembles to be averaged during the test.

4. Set the FREQ (HZ) selector switch to desired frequency range.
5. Set the LEVEL (rms) selector switch to the input signal amplitude.

**NOTE**

DO NOT change the rear panel switches or the ANALYSIS and INPUT switches while setting up test parameter windows.

**3.7.3 Setting Nonvolatile Memory**

On the front panel CURSOR and WINDOW switches:

1. Set CURSOR UNITS selector to HZ.
2. Set all WINDOW SELECTOR switches to 0.
3. Push the WINDOW SET pushbutton.
4. All previous window settings will be deleted.
5. With the CURSOR UNIT selector switch in the MEM position, use the CURSOR CONTROL toggle switch to set the CURSOR readout display to 01.
6. This sets the nonvolatile memory reference address where the test parameters for this operational test will be stored. Once stored, the parameters can be recalled each time the test is to be used.

**3.7.4 Setting WINDOW HEIGHT**

1. Set WINDOW NO selector to 1.
2. Set the CURSOR UNITS selector switch to the % DSPL position.
3. With the CURSOR CONTROL toggle switch, position the cursor to the top of the first frequency peak that will be tested.
4. The CURSOR readout will display the height of the peak.
5. Set the WINDOW HEIGHT selector switches to the value in the CURSOR readout display.

For example:

If the CURSOR readout display is 64, set the left-hand HEIGHT selector switch to 60 and the right-hand switch to 4.

**NOTE**

Although the window bar will move to the selected height, the height information is not entered until the SET pushbutton is pushed.

**3.7.5 Setting WINDOW WIDTH**

1. Using the CURSOR CONTROL toggle, position the cursor to the lower limit of the spectral band to be tested.
2. Set the WINDOW WIDTH selector switches spectral band upper limit.

To determine what the WINDOW WIDTH (WW) settings should be, divide the desired spectral band (SB) by the frequency (FS) that is set on the FREQ (HZ) selector switch; then multiply by 100.

that is:  $WW = \text{Window width.}$

$SB = \text{Spectral band upper limit minus lower limit.}$

$FS = \text{Setting on FREQ (HZ) selector switch.}$

and  $WW = \frac{SB}{FS} \times 100$

For example:

With the FREQ (Hz) switch at 5 kHz (FS = 5000) and CURSOR UNIT switch at Hz to examine the input signal frequencies between 500 Hz and 1300 Hz, (SB = 1300 – 500 = 800) position the cursor until the cursor readout is at 500.

thus,  $SB = 800$

$FS = 5000 \text{ Hz}$

$WW = \frac{800}{5000} \times 100$

$WW = 16$

Therefore the left-hand WINDOW WIDTH selector switch is set to 10 and the right-hand switch is set to 6.

This will generate a window width bar on the crt approximately  $\frac{3}{4}$  of one graticule division.

3. Press the WINDOW SET pushbutton.
4. All switch settings are stored in the Switch Position Code Random Access Memory.
5. Set the WINDOW NO selector switch to the next higher position and continue setting WINDOWS until all windows have been defined (maximum of 10).
6. A complete set of test parameters is now stored in the switch data random access memory and in the nonvolatile memory at the reference address.
7. To set up and store another complete set of test parameters advance the nonvolatile memory reference address counter to the next position and repeat paragraphs 3.7.2, 3.7.3, and 3.7.4.

### 3.7.6 Setting Overlapping Windows

Since any window may be set between any points on the frequency scale, they can be overlapped or stacked at the same location. However, if two windows share the same space, the highest *numbered* window will be displayed on the crt and the portion of lower *numbered* window sharing the same space will not be displayed. All windows (even if overlapped and stacked) will be examined for excessive amplitude and the appropriate alarm will be set if the limits are exceeded.

For example:

In the figure below, window 3 will not be visible in the space shared with window 4. However a signal with an amplitude of arrow C would set both alarm 3 and 4. A signal with an amplitude equal to A would not set either alarm. A signal equal to B or D would set only alarm 4.

## 3.8 REMOTE OPERATION

The following paragraphs describe the output, input, and clock signals for remote operation of the SD210. Refer to the table in paragraph 2.4.3 for signal interconnections on J9AUX.

### OVERLAPPED AND STACKED WINDOWS

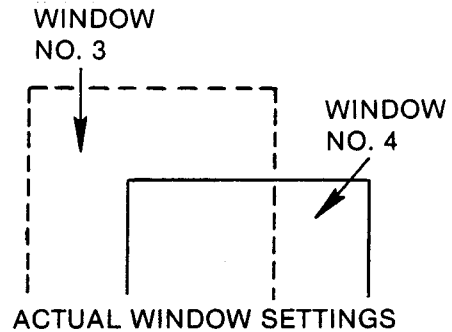

### PORTION OF WINDOW NO. 3 NOT DISPLAYED

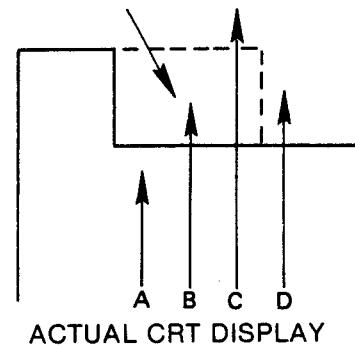

### 3.8.1 Output Signals to Remote Station

The following output signals supply a negative true TTL logic ("0" = 0.6 Vdc max. and "1" = 2.4 Vdc min.) which can be used to drive remote interface circuitry.

#### Remote Alarms (10)

A "1" level is provided when the corresponding ALARM is off. A "1" level indicates to the remote station that the amplitude in that window has been exceeded.

#### Data Not Accepted

A "1" level is provided while remote data is still being processed. This indicates to the remote station that the remote data input lines should not be changed.

#### Buffer Test Complete

A "1" level is provided when in linear averaging the number of ensembles has been processed.

Alternating "0" and "1" levels are provided when in exponential averaging.

### Alarm (audio) Pulse

A "0" level pulse of approximately one second is provided if any alarm is ON.

### 3.8.2 Input Control Signals from Remote Station

The following remote control inputs require negative true TTL-compatible signals (closure to ground). The SD210 provides a pull-up resistor to + 5 Vdc on each input line.

#### Remote Enable

A ground level on this line places the SD210 in the remote mode of operation.

#### Remote Start

A ground level on this line starts the ensemble averaging process.

#### Remote Reset

A ground level on this line will turn off all alarm indicators.

#### Remote Clock

A negative going pulse on this line sets the information on the Remote Data Input lines into a data latch and sets a flip-flop to signal the Microprogram Control that remote data is available.

#### Select External Sample

A ground level on this line will disable the internal sampling frequency and enable the External Sampling Frequency line.

#### External Sampling Frequency

This line permits sampling the input signal at a rate set by an externally selected frequency.

#### Transient Hold

A ground level on this line sets the Memory Hold Flip-Flop and the instrument stops taking samples.

### Remote Data Input

These remote data lines allow the remote station to change test parameters by entering new test parameters (switch settings) into the Switch Code RAM. The SD210 will then analyze the input signal and check for excessive amplitude based on these new test parameters.

The SD210 internal circuitry driven by these lines accepts a positive true TTL logic signal. In the following description the coded inputs are "0" = 0.6 Vdc max. and "1" = 2.4 Vdc min.

The high order 4 lines ( $2^7, 2^6, 2^5, 2^4$ ) represent a specific switch on the SD210 front panel. In Table 1, these switch identifier codes are listed below the switch name.

The low order 4 lines ( $2^3, 2^2, 2^1, 2^0$ ) represent the switch's position for this set of test parameters.

In Table 1, these switch position codes are listed in the first column.

For example:

To set the INPUT FREQ (HZ) switch to the 5 kHz position take the code below the switch name and set line  $2^4, 2^5, 2^6, 2^7$  to ("1" = 2.4 Vdc min):'

$2^7$	$2^6$	$2^5$	$2^4$
0	1	0	1

Now read down the FREQ (HZ) column to 5 K and then across to the code in the first column. Set lines  $2^0, 2^1, 2^2, 2^3$  to:

$2^3$	$2^2$	$2^1$	$2^0$
0	0	0	1

In summary, by using the remote data input lines, each switch position can be redefined for remote operation and thus overriding the positions set up for local operation.

Table 4-1. Remote Data Input Codes

SWITCH ADDR CODE		SWITCH POS CODE											
SWITCH SW. ADDR CODE →	UNITS	PARA NO	AVG	Y-DSPL	MODE	FREQ HZ	LEVEL	WIN NO	WIDTH MSD	WIDTH LSD	HEIGHT MSD	HEIGHT LSD	
POS CODE ↓	0000	0001	0010	0011	0100	0101	0110	1000	1010	1011	1100	1101	
0000	Hz	0	1	LIN	OPER	10K	—	10	90	9	90	9	
0001	KCPM	1	2	LOG	CAL	5K	10	9	80	8	80	8	
0010	%DSPL	2	4		0	2K	5	8	70	7	70	7	
0011	V	3	8		FS	1K	2	7	60	6	60	6	
0100	dB	4	16		OPER	500	1	6	50	5	50	5	
0101	MEM	5				200	.5	5	40	4	40	4	
0110		6					.2	4	30	3	30	3	
0111		7					.1	3	20	2	20	2	
1000		8						2	10	1	10	1	
1001		9						1	0	0	0	0	
1010		10						0					
1011		11						—					
1100		12						—					
1101		13						—					
1110		14						—					
1111		15						SET					

### 3.9 OPERATOR MAINTENANCE

#### 3.9.1 Introduction

Maintenance to be performed by the operator is limited to cleaning, visual inspection, and periodic checks and limited trouble shooting.

#### 3.9.2 Cleaning

Only exterior surfaces should be cleaned by the operator. When the instrument is operating use only a dry cloth or soft brush. If turned off, a cloth dampened with denatured alcohol or a mild solution of soap and water can be used.

#### CAUTION

Many commercial cleaning agents contain compounds that will react with the front panel markings or the crt graticule. Use *only* the recommended cleaning agents.

The following procedure should be performed at least once each month. If the instrument is being used in a dust-filled environment cleaning may be required each day.

#### CAUTION

Do not use any air source to remove dust.

1. Turn the instrument off and disconnect the ac power cord.

2. Using a soft brush remove dust from all selector switch slots, the crt graticule, and the vent fan (rear panel) foam filter.
3. Using a cloth dampened with MS-260 cleaner for plastic, glass and metal (Miller Stephenson Chemical Co., Inc.) wipe the front panel and crt graticule.

### 3.9.3 Operator Checks

The table below lists some possible malfunctions that may be corrected by interpreting the front panel indications and taking the appropriate action.

The Initial Setup and adjustments listed in paragraph 3.5 can be performed to verify that the

instrument is functioning properly. The following procedures can be used to verify specific operations:

Operation	Paragaraph
Cursor Control and Display	3.6.1
Cursor Position and Windows	3.6.2
Input Level Switch and Alarm	3.6.3

If, after performing the above checks, the instrument is still not operating properly notify maintenance personnel.

Malfunction Symptoms	Possible Cause
No Display and Power Push button is in the ON position but not lighted.	<ol style="list-style-type: none"> <li>1. Loose power cord at wall receptacle or at rear of instrument.</li> <li>2. Fuse is blown.</li> <li>3. No power at wall receptacle.</li> </ol>
No Display. Power lamp is ON.	<ol style="list-style-type: none"> <li>1. Crt intensity is too low.</li> <li>2. Input signal not connected or loose; switch to CAL to verify.</li> </ol>
Input Signal but no Windows Displayed.	<ol style="list-style-type: none"> <li>1. Bar switch is in OFF position.</li> <li>2. Window assignments not entered.</li> </ol>
Window Switches analysis, and Input have no effect on Display.	Rear panel key switch is in LOCK position.
Cursor Display reads all 8's.	INPUT LEVEL selector switch is set too low.

## SECTION IV

### CONCEPT OF OPERATION

#### 4.1 OVERVIEW

Figure 4-1 shows the overall concept of operation for the Model SD210. The major functional sections are controlled from the front and rear panel switches or by digital data from a remote station. The analog input signal is conditioned, digitized, and stored by the appropriate timing and control circuitry. The digital data is transferred between functional sections on the common 3000 data bus. This data is processed under Microprogram Control in the correct sequence between memories, and the CPU to perform the Fast Fourier analysis, comparing the results with window limits. Digital-to-analog converters in the control and display section generate analog signals for the crt external oscilloscope and X-Y plotter. Window test results are indicated by turning on a lamp indicating a window limit has been exceeded. The following paragraphs give a functional description of the SD210 based on Figure 4-1.

#### 4.2 TIMING AND INPUT CONTROL SECTION

The timing section generates the frequencies and basic instrument timing clocks for the processor and input data sampling. It establishes these timing signals by dividing the output of a crystal-controlled oscillator into appropriate frequencies. Sampling can also be performed using an external frequency supplied from an optional Remote Station.

The analog input signal is applied to the Input Section where it is conditioned to provide a normalized signal. This normalized signal is digitized and processed for display as the overall signal at the end of the spectrum display.

It is also filtered to limit frequencies higher than the selected input frequency.

After amplification, the filtered signal's amplitude is sampled, converted to digital data, and stored in the input memory. When averaging after a completed number (1024) of samples has been taken

and stored, the timing and control circuitry directs the transfer of the data to the processor memory via the 3000 Data Bus.

#### 4.3 PROCESSOR MEMORIES

These memory units operate under control of the Microprogram Control, CPU, and Timing and Control circuits to store data while being analyzed and processed, provide the CPU with weighting and trigonometric function (Sine, Cosine, Square Root, and Log) tables, and hold the analyzed data for transfer to the Output Display and Control section.

#### 4.4 CENTRAL PROCESSING UNIT (CPU)

As data from the input section is transferred into the processor memory, the CPU applies the appropriate weighting factor. The CPU, under control of the Microprogram Control section, computes the Fast Fourier transform for the transferred block of data and converts it to magnitude for use by the Output Control and Display Section. Real-time data is also averaged by the CPU section and stored in an average memory for the Output Control and Display Section. Data in this memory is retained until a new average operation is stored.

The CPU also compares window settings against the analyzed spectrum and provides the comparison results to the Front Panel Alarm LEDS. Also under Microprogram Control, the CPU computes the required cursor UNITS data and transfers it to the Front Panel Cursor Readout Display.

#### 4.5 MICROPROGRAM CONTROL SECTION

This section provides the sequence of instructions for controlling the 3000 Data Bus and for the processing functions performed by the CPU. It controls programmable read-only memories capable of over 3000 instructions. Internal program sequencing is dependent upon the front and rear panel control settings, remote station status, and operating status of the CPU, Input Section, Processor memories and the Output Control and Display Section.

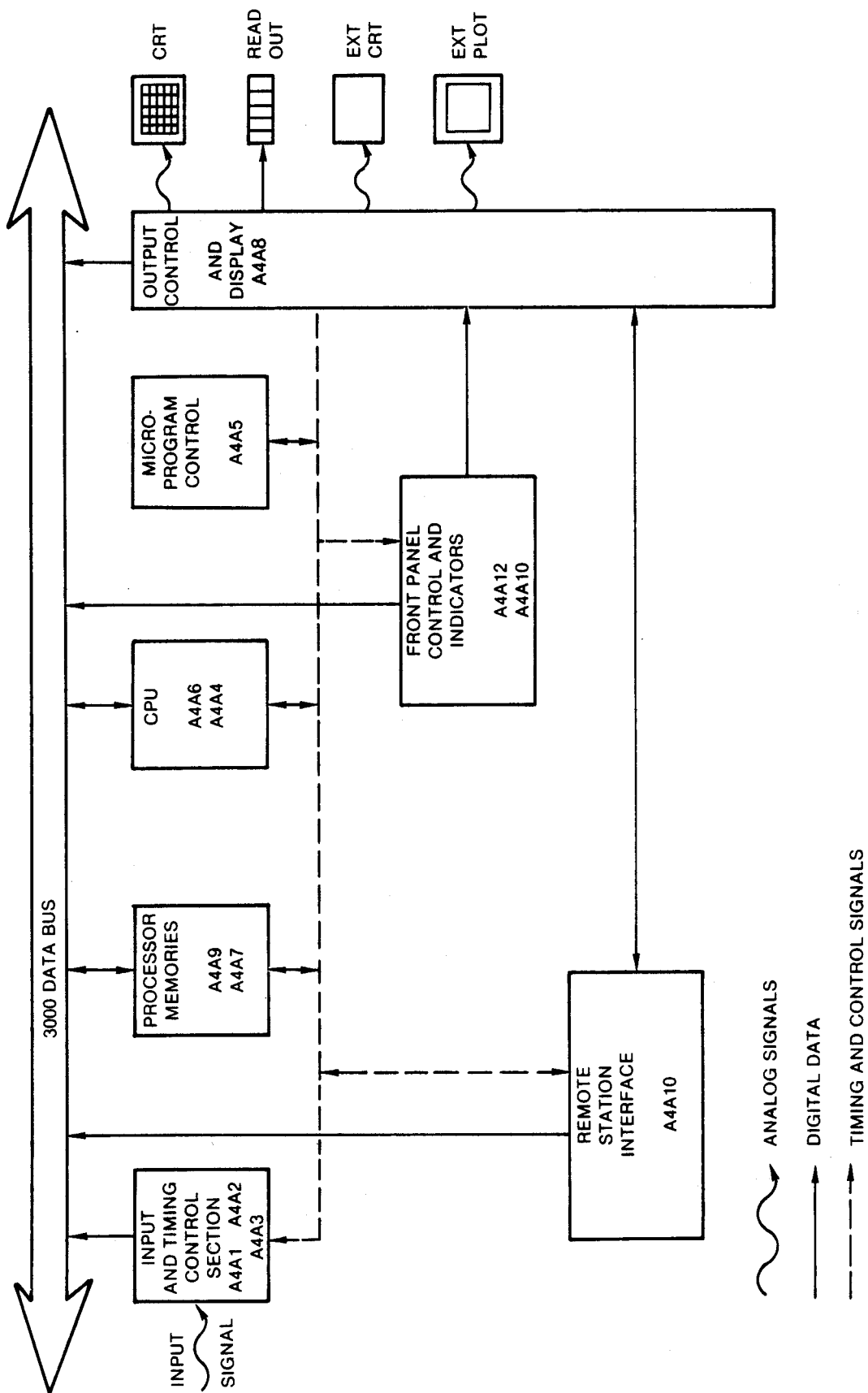

Figure 4-1. SD210 Concept of Operation Overview



#### **4.6 OUTPUT CONTROL AND DISPLAY SECTION**

This section consists of all the required circuitry, including timing and control interfaces, for displaying data on the crt, LED displays, window alarm status, outputs to an external oscilloscope, X-Y plotter and optional remote station indicators. Internal random access memories hold front- and rear-panel status information as well as optional

remote station status. A refresh memory stores the digital data which is converted and rewritten to the crt display to provide a persistent visual presentation. Line cursor and window bar information is also stored for various display outputs. A nonvolatile memory is included in this section. This memory retains the test parameters previously entered even when instrument power is removed.