

# 7151

# COMPUTING MULTIMETER

## OPERATING MANUAL

Issue 3: October 1985

Part No. 71510010



Solartron Instruments, Victoria Road, Farnborough  
Hampshire, England GU14 7PW Telephone: Farnborough (0252) 544433  
Telex: 858245 Solfar G Cables: Solartron Farnborough  
A division of Schlumberger Electronics (UK) Ltd



# Contents

---

<i>Page No.</i>	<i>Para. No.</i>	<i>Title</i>
<b>Chapter 1</b>		
<b>General Information</b>		
1.2	1	Introduction
1.2	2	Safety
1.2	3	Installation
1.4	4	Mains Fuses
1.4	5	Switch ON
1.5	6	Accessories
<b>Chapter 2</b>		
<b>The Front-Panel Controls</b>		
2.2	1	Front/Rear Switching
2.2	2	Measurement Selection
2.3	3	Ranging
2.3	4	Triggering
2.3	5	Measurement Time
2.4	6	Nulling
2.5	7	Other Controls
2.6	8	Display
2.6	8.1	Status Indicators
2.7	8.2	Messages
<b>Chapter 3</b>		
<b>Taking Measurements</b>		
3.2	1	General
3.2	2	Voltage
3.3	3	Current
3.3	4	Resistance
3.3	4.1	2-Terminal
3.4	4.2	4-Terminal
3.5	5	Drift Correction
<b>Chapter 4</b>		
<b>Interference – some causes &amp; cures</b>		
4.2	1	Introduction
4.2	2	Series Mode Interference
4.2	2.1	Series Mode dc
4.3	2.2	Series Mode ac
4.4	3	Common Mode Interference
4.5	4	Remedial Action

<i>Page No.</i>	<i>Para. No.</i>	<i>Title</i>
<b>Chapter 5</b>		<b>Processing Facilities</b>
5.2	1	General
5.2	2	The 2nd Level Keypad
5.3	3	The Menu Hierarchy
5.3	4	Probes
5.4	4.1	High Voltage
5.4	4.2	Current Shunt
5.5	4.3	Temperature
5.5	4.4	Radio Frequency
5.6	5	Programs
5.6	5.1	Program Selection
5.7	5.2	The Compute Control
5.8	5.3	Scale
5.8	5.4	Offset
5.8	5.5	% Deviation
5.9	5.6	Ratio
5.10	5.7	Maxmin
5.11	5.8	Limits
5.12	5.9	Statistics
5.13	5.10	Analog
5.14	5.10.1	Setting-Up
5.15	5.10.2	Oscilloscope
5.16	5.10.3	Chart Recorder
5.16	5.10.4	History File
5.16	5.10.5	Additional Analogue Facilities via Remote Control
5.17	6	Clock
5.18	6.1	Real
5.19	6.2	Elapsed
5.20	6.3	Time of Day
5.20	6.4	Additional Clock Facilities via Remote Control
5.21	7	Power-Fail Recovery
5.21	7.1	Resume
5.21	7.2	Reset
5.22	8	Program Examples

<i>Page No.</i>	<i>Para. No.</i>	<i>Title</i>
<b>Chapter 6</b>		<b>Remote Control</b>
6.2		Command Index
6.3	1	General
6.3	2	Preparation of Instrument for GPIB Use
6.4	3	Implementation of the GPIB Interface
6.4	3.1	Delimiters
6.5	3.2	Buffers
6.5	3.3	Service Request (SRQ)
6.5	3.4	Serial Poll Byte
6.6	3.5	Parallel Poll
6.6	3.6	GPIB Capability Code
6.6	4	Preparation of Instrument for RS232 Use
6.7	5	Implementation of the RS232 Interface
6.7	5.1	Delimiters
6.7	5.2	Buffers
6.8	5.3	Remote/Local Operation
6.8	6	Interface Command Language
6.8	6.1	Command Set (Verbose)
6.24	6.2	Command Set (Shortform)
6.26	7	Default Command Settings
6.26	8	Output Result Rate
6.27	9	Error Reporting
6.28	10	Using 7151 from the GPIB
6.28	10.1	Hewlett Packard HP85
6.29	10.1.1	Example 1
6.30	10.1.2	Example 2
6.32	10.2	Hewlett Packard HP9825
6.32	10.2.1	Example 1
6.33	10.2.2	Example 2
6.34	10.3	Commodore PET 4032 & 8032
6.35	10.3.1	Example 1
6.35	10.3.2	Example 2
<b>Chapter 7</b>		<b>Calibration</b>
7.2	1	General
7.2	2	Entering Calibration Mode
7.3	3	Calibrating a Measurement Range
7.4	4	Restoring the Measurement Functions
7.4	5	Summary
<b>Chapter 8</b>		<b>Rack Mounting the 7151</b>
8.2	1	General
8.3	2	Assembling the Rack
8.4	3	Preparing the Instrument for Rack Mounting
8.5	4	Assembly
<b>Chapter 9</b>		<b>Specification</b>



# Chapter 1

## General Information

---

<i>Page No.</i>	<i>Para. No.</i>	<i>Title</i>
1.2	1	Introduction
1.2	2	Safety
1.2	3	Installation
1.4	4	Mains Fuses
1.4	5	Switch ON
1.5	6	Accessories

## 1 INTRODUCTION

This manual contains operating instructions and other information relevant to the Solartron 7151 Computing Multimeter.

The instrument performs all common measurement functions, and offers: a library of programs; clock controlled measurements; and a programmable power-on status.

The instrument is suitable for general purpose bench work, or for use within a system where 7151 would be operated via one of its remote control interfaces. The interfaces provided are the IEEE 488 (1978) STD system and the RS232C V24 serial system.

## 2 SAFETY

The 7151 multimeter has been designed in accordance with the recommendations of IEC 348. To ensure the user's safety, and the continued safe operation of the instrument, it is advisable to fully observe the procedures and specifications given in this manual.

An Earth wire is provided to ensure the user's safety. Therefore, if an extension mains cable is used, check that the Earth connection is maintained throughout the length of the extension.

When using 7151 on equipment which is capable of delivering high voltages (e.g. inductive circuitry giving high back-emf's, such as the secondary of a large mains transformer), it is most important that 7151's test leads are disconnected from the equipment before switching it off. This ensures that harmful back-emf's do not reach 7151. Care should always be exercised when handling the input leads, especially where high voltages are known to be present, or where high transients could occur.

Whenever it is likely that the safety of the instrument has been impaired – e.g. if it shows visible signs of damage, if it fails to perform correctly, or if the specifications have been exceeded in any way – it should be made inoperative and referred to a suitable repair depot. Any maintenance, adjustment or repair of the multimeter must be carried out only by skilled personnel, and in accordance with the procedures and precautions detailed in the Maintenance Manual (Part No. 71510011).

 Wherever this symbol appears on the front or rear panel it is advisable to consult the appropriate section of this manual for further information.

## 3 INSTALLATION

The 7151 is fitted with a multi-purpose mains input unit which contains the mains fuses, and voltage selector. These items cannot be accessed until the mains connector has been removed. Before applying power to the instrument check that the voltage selector is correctly set, viz the relevant 100V, 120V, 220V or 240V appears in the aperture.

For 220 → 265V mains use the 240V setting  
188 → 230V mains use the 220V setting

110 → 127V mains use the 120V setting  
92 → 115V mains use the 100V setting



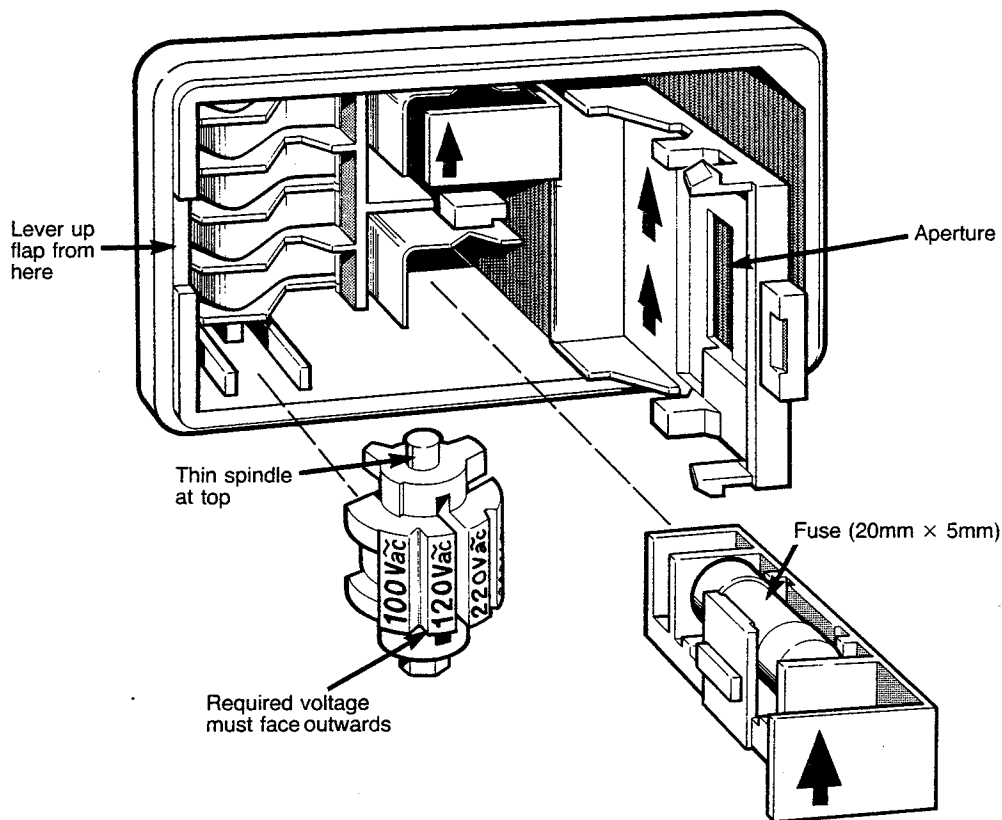

**Fig 1.1** *Mains Input Unit*

To change the selected voltage, gently lever up the hinged flap with a small screwdriver, lift out the voltage selector roller block, and refit it such that the requisite voltage appears in the aperture. Close the flap securely and refit the mains connector.

The instrument is intended for use on nominal 50Hz, 60Hz or 400Hz mains supplies. However, if the frequency deviates from these values, the instrument will still operate correctly, but with reduced interference rejection.

The mains connector supplied with the instrument is usually appropriate to the country of destination but should it require changing, observe the colour convention of the wires:

Connection	Colour
Line	Brown
Neutral	Blue
Earth	Green/Yellow

If rack-mounting 7151, or to obtain the best RFI performance, connect the rear panel earthing terminal to a suitable earthing point (in addition to normal earthing arrangements via the power lead).

## 4 MAINS FUSES

Line and Neutral are both fused in 7151. To access either of these fuses, disconnect the mains lead and gently lever up the flap of the mains input unit (see Fig. 1.1). Inside are two fuseholders marked **[A]**, which pull out. The fuse values are:

for 220V or 240V operation: 100mA slo-blow  
100V or 120V operation: 250mA slo-blow

As replacements, only 20mm × 5mm cartridges can be fitted. If the instrument repeatedly blows its main fuses, and the mains voltage is correctly set, do not insert a larger value of fuse, but have the instrument checked by a suitable authority.

## 5 SWITCH ON

The instrument is switched ON/OFF by the rear panel switch adjacent to the mains input unit. At switch-on, 7151 checks its internal memories, followed by a test of the front panel display. One of two status messages is then displayed which relates to 7151's operating status:

**RESTART:** All multimeter settings, program, probe, and clock information has been initialised following the instrument's last switch-OFF. The instrument will have assumed a particular start-up configuration, the salient points being:

Front panel control  
Voltage dc  
Autorange  
Null OFF  
Nines 5  
Track ON

The complete list of restart parameters is given on page 6.26.

The instrument is ready for use and proceeds with Track ON measurements.

**RESUME:** All multimeter settings, program, probe, and clock information from previous use has been retained. See PWR ON (RESUME) in Chapter 5. If the PWR ON status was last set to RESUME by a remote controller it will be found that the keypad appears to be inoperative. This can be remedied by pressing the **[rtl]** key whereupon full front panel control is offered. If TRACK ON was selected prior to the last mains disconnection the message, **RESUME**, will be displayed for only 0.5s before TRACK ON measurements recommence.

If a user unfamiliar with the operation of 7151 switches it on into a **RESUMEd** status, it will probably be advisable to **RESTART** the instrument before further use.

The sequence which ensures this is:

Key to Press	Displayed Message
	<i>RESUME</i> or measurement result(s)
MENU	<i>PROBES ?</i>
SKIP	<i>PROGS ?</i>
SKIP	<i>CLOCK ?</i>
SKIP	<i>PWR ON?</i>
ENTER	<i>RESUME ?</i>
SKIP	<i>RESTART ?</i>
ENTER	

Switch instrument OFF, then ON again. The displayed message will now read *RESTART*. The instrument is ready for use.

If an internal fault is detected during the start-up sequence a message, *FAIL n*, is displayed. In this unlikely event, the instrument must be repaired before use.

## 6 ACCESSORIES

The 7151 is supplied with the following accessories:

- 1 pair of test leads
- 1 pair of probes
- Auxiliary socket
- Spare fuses



# Chapter 2



## The Front-Panel Controls

---

<i>Page No.</i>	<i>Para. No.</i>	<i>Title</i>
2.2	1	Front/Rear Switching
2.2	2	Measurement Selection
2.3	3	Ranging
2.3	4	Triggering
2.3	5	Measurement Time
2.4	6	Nulling
2.5	7	Other Controls
2.6	8	Display
2.6	8.1	Status Indicator
2.7	8.2	Messages

## 1 FRONT/REAR SWITCHING

Input terminals are provided on the front and rear panels, the use of which depends on whether the instrument is to be rack mounted or freestanding, and on the type of measurement required. Front or rear inputs can be selected by the front panel switch.

INPUT       FRONT    Push button out: front inputs selected  
               REAR     Push button in: rear inputs selected

Selection of front or rear inputs cannot be actioned by remote control. However, a remote controller can interrogate the instrument to determine which set of terminals are in use.

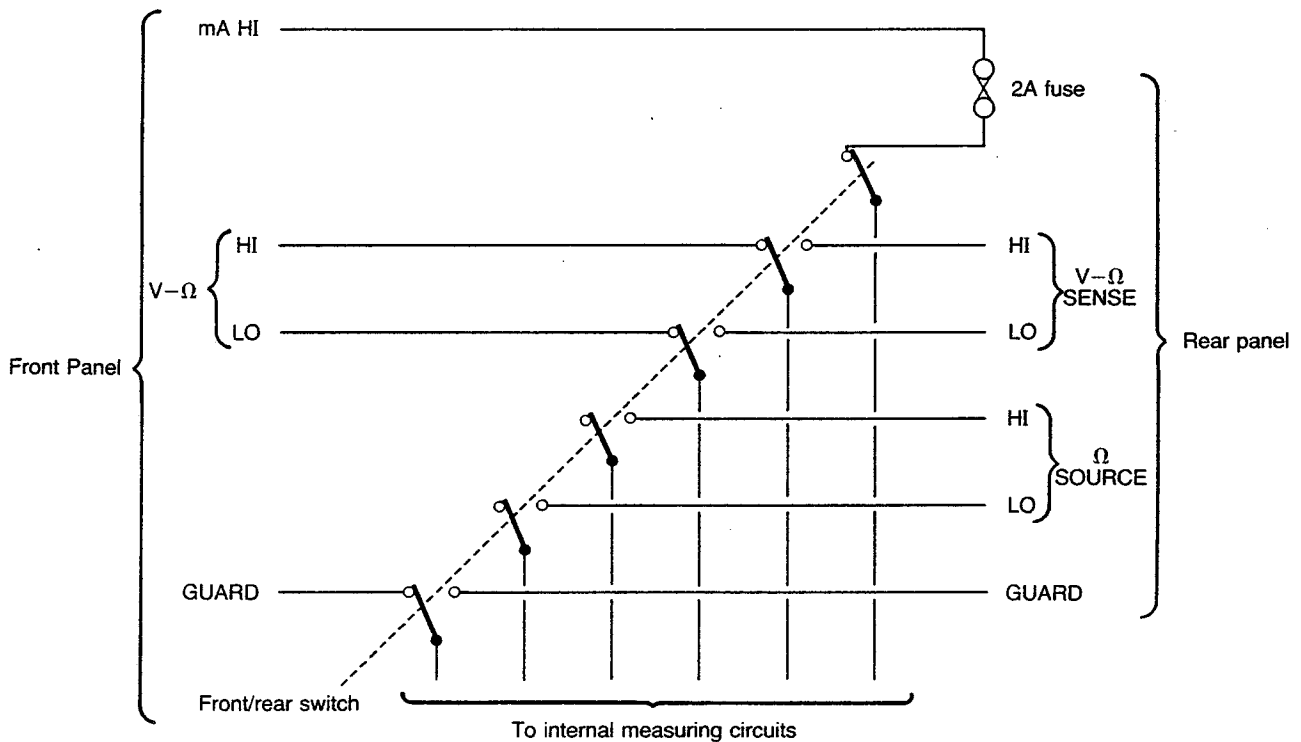
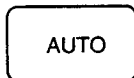

**Fig 2.1** *Switching of Front/Rear Input Terminals*

## 2 MEASUREMENT SELECTION

$V_{\text{---}}$	Voltage, dc 100nV to 1000V in 5 ranges, results in V or mV
$V_{\text{~}}$	Voltage, ac 1 $\mu$ V to 750V in 5 ranges, results in V or mV
$k\Omega$	Resistance 1m $\Omega$ to 20M $\Omega$ in 5 ranges, results in k $\Omega$
$I_{\text{---}}$	Current, dc 1 $\mu$ A to 2A, 1 range, results in mA
$I_{\text{~}}$	Current, ac 10 $\mu$ A to 2A, 1 range, results in mA

### 3 RANGING



Selects autoranging of the chosen measurement function. Upon deselection, the instrument fixes on its present range.



Selects more sensitive measurement range.



Selects less sensitive measurement range.

### 4 TRIGGERING



Selecting TRACK ON causes the instrument to take repetitive measurements. The repetition rate depends upon the selected measurement time, i.e. the smaller the measurement time, the faster the repetition rate.

The display is continuously updated to show the most recent result. With TRACK OFF (deselected), the HOLD indicator is displayed, and the instrument awaits further instructions.



Each press of the SAMPLE key causes the instrument to take a single (one-shot) measurement. The HOLD indicator is extinguished for the duration of each measurement, and the display shows the result of the most recent measurement.

If required, a remote sample switch can be connected to the rear panel Auxiliary socket, pins 6 & 12.

In addition, regular, periodic measurements can be taken by using clock control (see Chapter 5), or alternatively, the instrument can be triggered by a remote controller (see Chapter 6).

### 5 MEASUREMENT TIME

Ordinarily, the measurement time is 400ms. This gives what is referred to as 5×9's result (5 significant figures plus leading digit of 0, 1 or 2). Faster measurements of less resolution, namely of 3×9's and 4×9's can also be taken, but only when the instrument is under remote control. Measurements of greater accuracy can be achieved by using the FILTER or 6×9 control.



Pressing FILTER selects a measurement time of 1.6s and yields a 5×9's result. This provides a high level of immunity against interference, particularly the lower frequency components.

When FILTER is selected the corresponding indicator is visible.

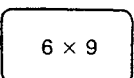

For use with the non-ac ranges only, 6×9's results are created by averaging ten 5×9's (FILTER OFF) measurements. After selection, 7151 takes approximately 8 seconds to produce the first 6×9's result. Either BATCH or WALKING WINDOW 6×9's results may be selected and displayed.

BATCH result – initiated by selecting 6×9 followed by SAMPLE, 7151 takes ten component 5×9's measurements and produces a 6×9's result after approximately 8 seconds. The next batch measurement can then be taken by re-pressing SAMPLE.

WALKING WINDOW result – Initiated by selecting 6×9 followed by TRACK ON, the result is the average of the 10 most recent 5×9's measurements. The first true 6×9's result is produced after approximately 8 seconds, subsequent results every 800ms. Whilst 'building up' ten measurements, the display shows the average value of the 5×9's measurements so far, i.e. average of 1, average of 2 etc. During this period the 6×9's indicator flashes to notify the user that the displayed values are not yet true 6×9's results. Only when the displayed results are true 6×9's does the indicator become steady. The intermediate results are displayed only if none of the programs are Active. Also, there is no output of the intermediate results to the remote control interfaces.

#### Summary of 7151's Measurement Times.

Measurement Time	Category	Notes
6.66ms*	3×9	Fastest time available
40ms*	4×9	Use with 50Hz mains supplies
50ms*	4×9	Use with 60Hz mains supplies
400ms	5×9	Normal use
1.6s FILTER ON	5×9	Use in electrically noisy environments
8.0s (approx.)	6×9	Provides best possible accuracy

\*Remote control only.

## 6 NULLING

This facility permits small dc errors, superimposed on the required input signal to the instrument, to be cancelled out. The causes of these errors might typically be the resistance of the test leads, relays in the measuring path, etc. The errors, which may be cancelled, are:

voltage, dc : at least  $\pm 1\text{mV}$   
 current, dc : at least  $\pm 1\text{mA}$   
 resistance : at least  $\pm 10\Omega$

Briefly, a null (offset) value can be measured for each range of a selected function (non-ac only). These values are then stored in memory along with the null values of any other nulled function. Thereafter, when a measurement is made in a particular function/range, the appropriate null value is recalled from memory, and applied as a correction factor to the measurement result. The dc error at the input is thus cancelled out. Switching off the instrument causes all null values to be destroyed.



Note that the null facility cannot be used on the ac ranges (voltage or current).

NULL

To null the voltage (dc) or resistance ranges: Select the required measurement, V $\overline{=}$  or k $\Omega$ , and fit the test leads to the V- $\Omega$  HI and LO terminals. Short the free ends together. Press NULL to start the process, which automatically nulls each range in turn commencing with the lowest. The display shows *NULL 'n'*, where n=the number of ranges yet to be nulled. Upon completion, the *NULL* indicator is displayed and the instrument returns to the range in use prior to nulling.

To null current, dc, the same procedure is applied, only the input leads must be left open circuit.

On return to a previously nulled function, its null values are recalled. To re-null a particular function, select that function, press NULL to disable all the present null values, and re-press NULL to restart the nulling process.

If an offset exceeds the value which can be nulled, the display shows *HI NULL* and the sequence is halted. The solution is to measure the offset and use this as a correction factor in the *OFFSET* program (see Chapter 5).

## 7 OTHER CONTROLS

rtl

Should the instrument be under remote control, i.e. the *REM* indicator is displayed, pressing  (return to local) returns the instrument to front panel operation. This is provided the GPIB command, Local Lockout (LLO), has not been asserted by a remote controller which prohibits this action (see Chapter 6).

If the GPIB rear panel switch is ON, selecting  when local control is already afforded causes the selected GPIB address to be displayed. Alternatively, *GPIB TO* (Talk Only) or *GPIB LO* (Listen Only) will be displayed. (See Chapter 6).

COMPUTE

The *COMPUTE* control determines whether computed or 'raw' (uncomputed) results are displayed. Computed results can be displayed only if internal programs have already been selected for use.

When computed results are displayed (*COMP* indicator visible), the units of measurement are not. This is because measurements are being manipulated by the programs and the displayed result does not necessarily represent the size of the input.

Further details of the *COMPUTE* control are given in Chapter 5.

MENU

This key gives access to the built-in processing facilities (see Chapter 5) by making the 2nd level of the keyboard operative. The key functions are then identified by the black coloured legends. All DMM operations are halted immediately *MENU* is selected, allowing process options to be examined. To exit the processing mode, re-press *MENU*.

## 8 DISPLAY

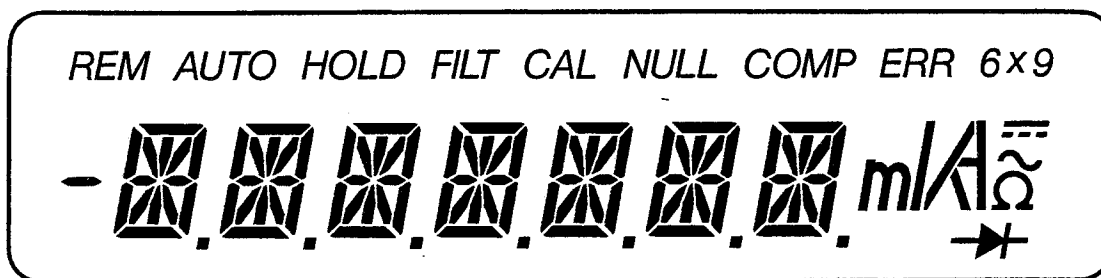

**Fig 2.2** Display during Self-Test

This consists of a 7 digit (leading minus sign) back-lit alpha numeric liquid-crystal display which includes a series of status indicators to show various operating states.

The main part of the display shows the numeric value of a result, its polarity, the units of measurement, messages – for example; indication of an overload, or a user prompt to aid programming of the 7151.

### 8.1 STATUS INDICATORS

Status Indicator	Indicator Flashing	Indicator Steady
REM	—	7151 under remote control
AUTO	—	Autoranging is enabled
HOLD	—	7151 is not measuring
FILT	—	FILT <sub>er</sub> (5×9's) is selected
CAL	Shorting plug inserted in CAL socket	Calibration mode selected
NULL	—	Selected function has been nulled
COMP	—	A computed result is being displayed
ERR	In conjunction with the message, CAL, indicates a calibration fault	—
6×9	10 readings have not yet been averaged	Displayed reading is 6×9's i.e. average of 10 results

## 8.2 MESSAGES

Displayed message	Meaning
Complete display flashing regardless of content	The input signal currently applied is exceeding the full scale value of the selected range. Range up, or disconnect the input.
-OL-	Appears in place of a measurement to indicate that the last measurement exceeded the full scale value at some point during the measurement time. Range up, and repeat the measurement.
----- V==	The function has been changed, but no measurement has yet been taken in the new range. The new units of measurement are displayed.
NULL 'n'	Displayed during a null, where 'n' indicates the number of ranges yet to be nulled.
HI NULL	Null value excessive - the sequence has been halted.
ILLEGAL	Appears when two conflicting modes of operation are selected. For example, attempting to null an ac range.
PROBES ?	Following a press of the MENU key, <i>PROBES</i> (and subsequent facilities) are offered. Press MENU again if these facilities are not required. Measurements can then be resumed.
NO PROG	COMPUTE ON has been selected without any programs being Active.
* TIMER *	Real time clock control has been invoked.
* ARMED *	Elapsed time clock control has been invoked.
GPIB _ _ _	The rtl key has been pressed without 7151 being under remote control.

### Overload Condition

The cause of an overload (-OL-) may not be obvious:

For example, it might be caused by Common or Series mode interference, by excessive transients originating from the equipment under test, or 'pick up' by the test leads.

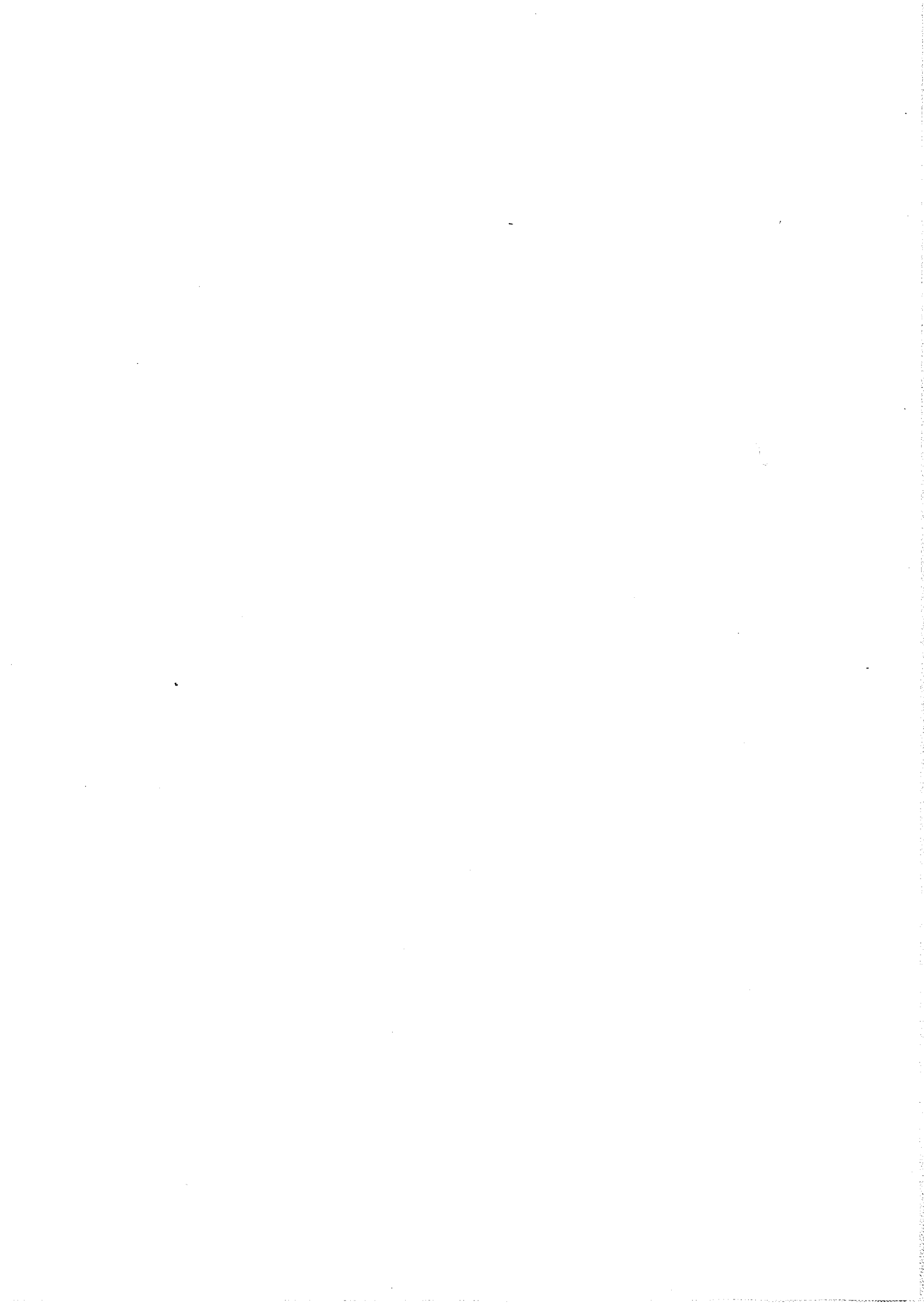

# Chapter 3

## Taking Measurements

---

<i>Page No.</i>	<i>Para. No.</i>	<i>Title</i>
3.2	1	General
3.2	2	Voltage
3.3	3	Current
3.3	4	Resistance
3.3	4.1	2-Terminal
3.4	4.2	4-Terminal
3.5	5	Drift Correction

## 1 GENERAL

For many applications it is sufficient just to connect the unknown quantity (volts, ohms etc.) to 7151 with a pair of test leads connected to the appropriate terminals (V- $\Omega$  HI and LO etc.). Measurements can then be taken.

Very often, however, interference is superimposed on the input signal to the instrument and, if it is large enough, the displayed result may be affected, i.e. unstable, or worse still, steady but incorrect. As it is sometimes difficult to assess whether or not results will be affected by interference, it is advisable to take certain simple precautions that guard against it. Briefly, these are:

- (a) Null the dc ranges prior to their use.
- (b) Connect the Guard terminal to the equipment under test at the source of any suspected Common Mode interference, usually at the point of connection of the LO lead. Although slightly less effective, a compromise is to connect GUARD to LO at the instrument.

For information on the possible causes of interference, see Chapter 4.

It is not normally too important which way round the connecting leads are arranged as the instrument can measure +ve or -ve signals. If -ve, a minus sign will precede the displayed result. If maximum interference rejection is required it is advisable to connect the leads in the conventional manner once the polarity of the measurand is known.

## 2 VOLTAGE (VIA FRONT OR REAR PANEL)

Connect the test leads to the V- $\Omega$  HI and LO terminals and select V $\overline{\text{=}}$  or V $\sim$ . Select AUTO ranging and connect the test leads across the unknown voltage. Connect GUARD as shown. Measurements can be taken by pressing SAMPLE or TRACK.

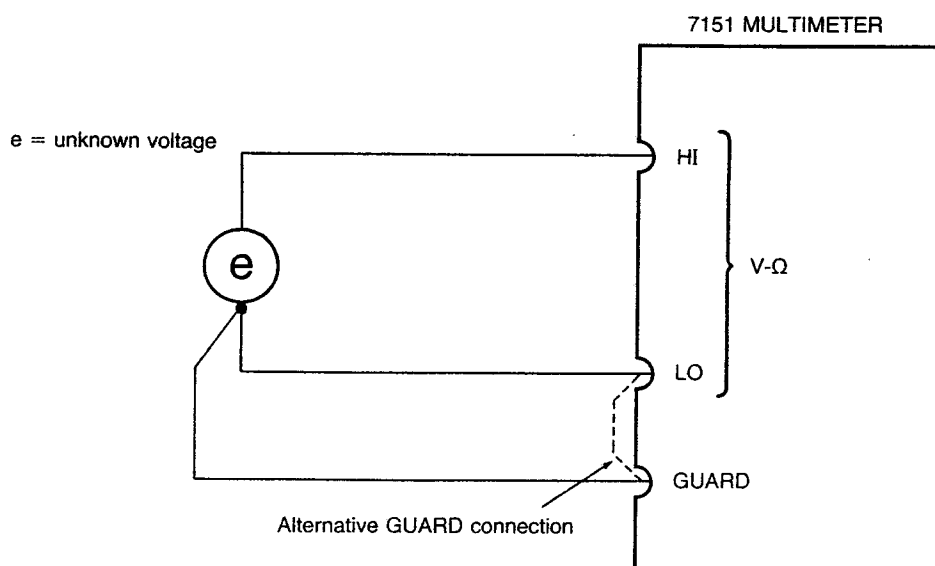
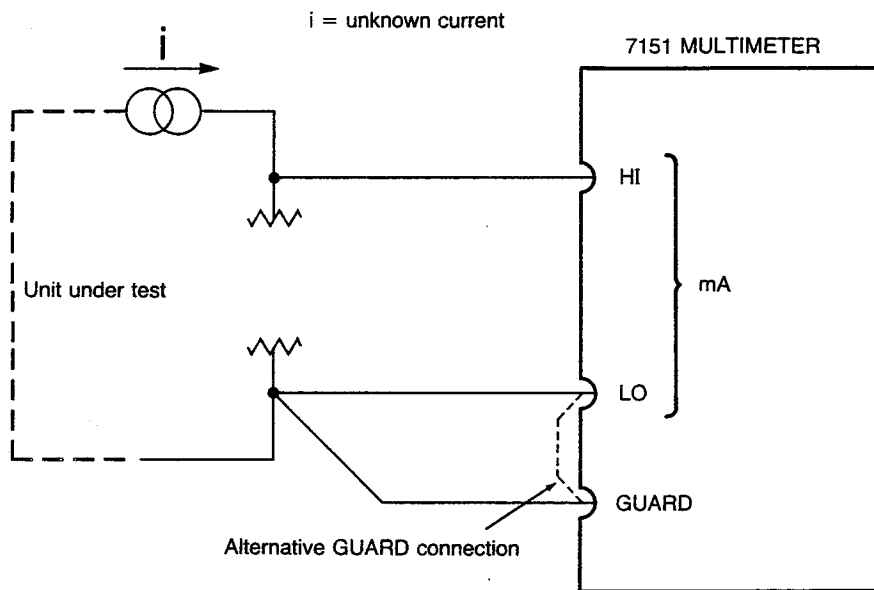

**Fig 3.1** Required connections for voltage measurement

**Note:** Protection against voltages in excess of approx. 1.2kVdc or 1.2kV peak ac is afforded via a spark gap between HI and LO.

### 3 CURRENT (VIA FRONT PANEL ONLY)

Connect the test leads to the mA HI and LO terminals and select  $I_{\text{DC}}$  or  $I_{\text{AC}}$ . Connect the test leads to the unknown current, and the GUARD terminal as shown below. Measurements can be taken by pressing SAMPLE or TRACK.



**Fig 3.2** Required connections for current measurement

**Note:** Protection against currents in excess of 2A is provided by a 2A fast blow fuse mounted on the rear panel.

### 4 RESISTANCE

Resistances can be measured by using the 2-terminal or 4-terminal method. For most applications the 2-terminal method is satisfactory. However, as the value of unknown resistance becomes smaller, the effects of the instrument being remote from the resistance becomes more noticeable. In particular, the connecting leads always have some resistance, typically  $0.25\Omega$ . Therefore the ratio of unwanted resistances to the wanted one may become significant.

In order to ascertain which method should be used, it is sufficient to measure the resistance of the test leads (if not already known), and then calculate their value as a percentage of the resistor under test. If this figure is unacceptable, the 4-terminal method should be used.

A test current for resistance measurement is provided by a constant current generator whose output varies with the selected resistance range;  $100\mu\text{A}$  (for  $2\text{k}\Omega$  &  $20\text{k}\Omega$  range),  $10\mu\text{A}$ ,  $1\mu\text{A}$  and  $100\text{nA}$ .

#### 4.1 2-TERMINAL (VIA FRONT OR REAR PANEL)

Connect the test leads to the V-Ω HI and LO terminals and select kΩ. Short the leads together and perform a null. Select AUTO ranging and connect the test leads across the unknown resistance. Connect GUARD as shown below. Measurements can be taken by pressing SAMPLE or TRACK.

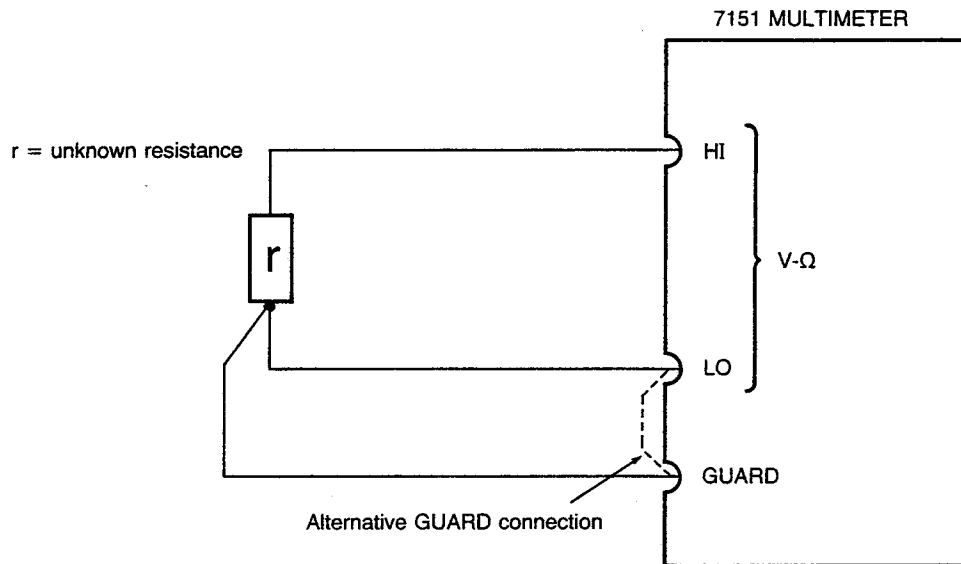

**Fig 3.3** Required connections for 2-terminal resistance measurement

#### 4.2 4-TERMINAL (VIA REAR PANEL ONLY)

Connect the test leads to the rear panel terminals as shown below, select TRACK, short the leads together, and allow readings to settle i.e. allow settling time for thermals. Then, perform a null. Remove the short and connect in the unknown resistance. Take care to connect the V-Ω HI and LO test leads as close as possible to the body of the unknown resistance and allow thermals to settle. Select AUTO ranging; measurements can then be taken by pressing SAMPLE or TRACK.

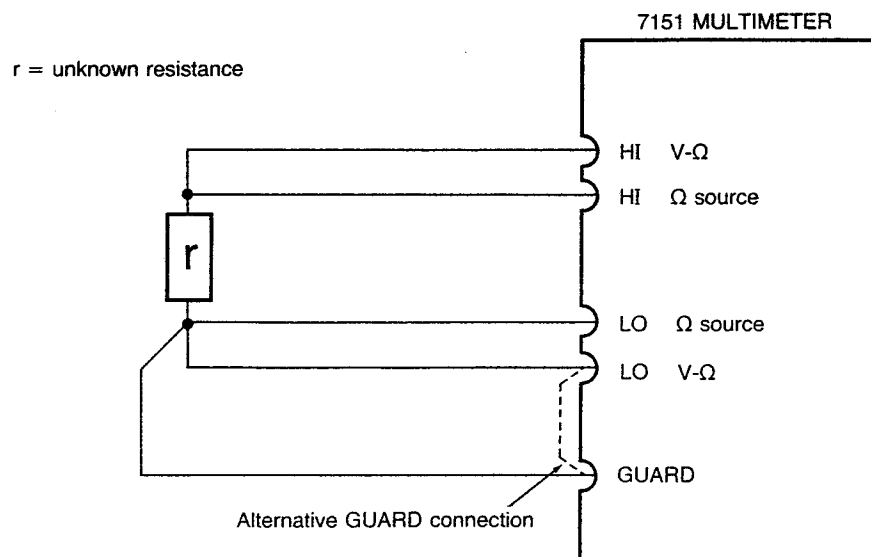

**Fig 3.4** Required connections for 4-terminal resistance measurement



## 5 DRIFT CORRECTION

The instrument automatically compensates for internal drift every 10 secs. Further, a drift correction is performed for every change of measurement function, range, or measurement time. The period over which the drift correction is performed is equal to the selected measurement time.

Under remote control, the user has some choice over when drift corrections are performed. The user may: disable the automatic drift corrections, enable the automatic drift corrections, or cause an additional drift correction to be taken with the next measurement, then reverting back to its previous condition (disabled or enabled). A common usage for disabling the drift corrections is to avoid 'gaps' in TRACKing measurements. For example, when taking measurements with 400ms integration time, the TRACKing speed is normally 2/s. However, after 10s (20 measurements), a drift correction of 400ms is performed, so the 21st and following 19 measurements are delayed by approx. 0.5s. The next 20 measurements would be delayed by a further 0.5s, and so on.

When taking 6×9's measurements, a 400ms drift correction follows each of the component 400ms measurements. Consequently, approx. 8s is taken to produce the 1st 6×9 result.



# Chapter 4

## Interference – some causes & cures

---

<i>Page No.</i>	<i>Para. No.</i>	<i>Title</i>
4.2	1	Introduction
4.2	2	Series Mode Interference
4.2	2.1	Series Mode dc
4.3	2.2	Series Mode ac
4.4	3	Common Mode Interference
4.5	4	Remedial Action

## 1 INTRODUCTION

Consider a DMM measuring a signal applied to its input terminals. The signal presented to the input comprises two components; the required input signal and an unwanted signal (no matter how small). If the unwanted signal is sufficiently large, it invariably causes a change in the DMM reading.

This unwanted signal, or interference, may be ac or dc. Sometimes, the presence of interference is simply indicated by a result that differs from the expected value, or perhaps the last one or two digits are unstable, due to some additional, spurious signal. Very often however, the displayed result gives no indication that the measurement has been affected by interference, and so precautions against it must be taken.

## 2 SERIES MODE INTERFERENCE

The term series mode (or normal mode) arises because the interference is effectively in series with the signal source and voltmeter input. It may arise (a) as part of the source where the signal and interference are inextricably mixed; or (b) as a separately identifiable generator.

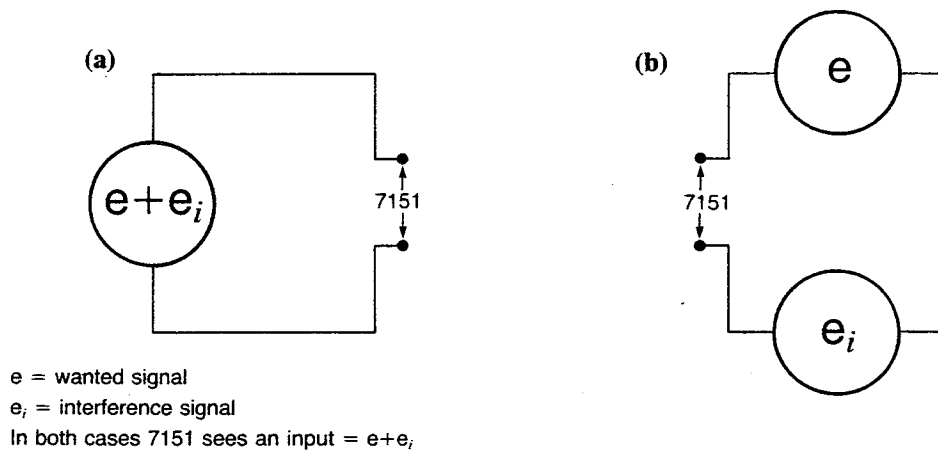

Fig 4.1 Series mode interference

### 2.1 SERIES MODE DC

When the interference is dc there is no way of designing the DMM to ignore it. If the interference is only of the order of microvolts then a zero, or null control may be able to compensate. For example, on Volts, dc, 7151 can null out offsets of at least  $\pm 1\text{mV}$ . If the offset is excessive and cannot be nulled, the user can only take precautions, knowing that the problems may exist. Alternatively, the user could measure the offset, and apply it in the OFFSET program as a correction factor.

If the source of the offset is simply resistance in the test leads then the solution is to make the leads shorter/thicker. Often though, the offset is caused by thermal effects upon connectors, clips, and relays in the measuring path. For example, a simple reed relay with nickel-iron contacts usually has copper connections, i.e. a pair of thermocouples. Any temperature gradient across the relay then results in an emf of approximately  $40 \mu\text{V}/^\circ\text{C}$ .

Other sources of dc interference can result from leakage across nominally good conductors, especially under conditions of high humidity; moisture on exposed terminals may cause galvanic emf's to be generated; screened cables connected to vibrating equipment may generate electrostatic potentials; and so on.

## 2.2 SERIES MODE AC

The most serious form of ac interference is usually derived from the mains supply, i.e. 50Hz, 60Hz, etc.

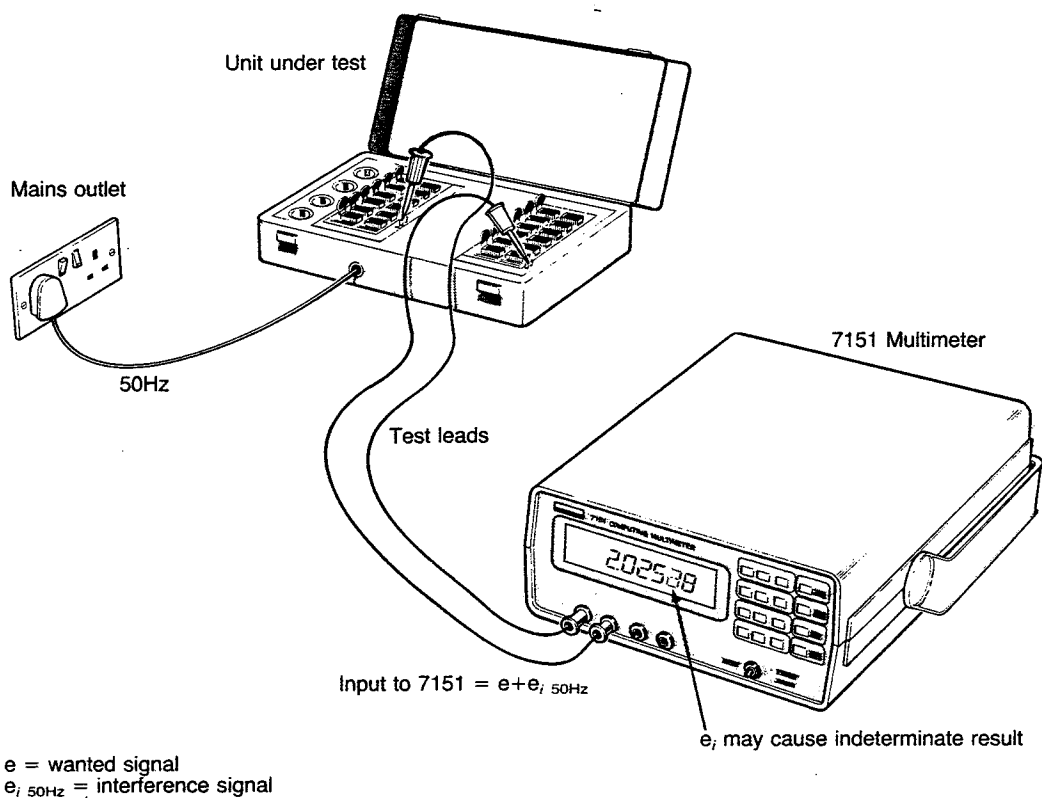

**Fig 4.2** Mains induced interference

This problem can be overcome by designing the DMM so that its measurement times are multiples of the mains frequency period. For example, for 50Hz operation, measurement times of 20ms, 40ms, 60ms ---- etc. would be suitable. Thus the 50Hz induced interference components are averaged out.

However, if the interference is other than mains induced, the most successful way of dealing with it is to use the longest practicable measurement time in order to average out the interference components. When relying on this process however, the DMM's dynamic range becomes important. Consider a DMM with a nominal range of 2.000V having an applied input of 1.700V. A series mode rejection ratio of 40dB (100:1) implies that the DMM can withstand 100mV of ac before 1mV error is displayed. But conversely, it is not true to say that a displayed error of say, 10mV is allowable in addition to the 1.7V input. This is because with a 40dB (100:1) rejection ratio, to display 10mV error implies an error input of 1.0V, in addition to the wanted signal of 1.7V. Consequently, at times the total input to the DMM exceeds the range maximum (2.000V). This problem can easily be avoided by ensuring that plenty of headroom is always given in the selected measurement range, i.e. range up if in doubt.

### 3 COMMON MODE INTERFERENCE

Common mode interference is brought about by a source which is common to both input leads and superimposed as a standing voltage with respect to earth. It is when this common mode voltage is converted to series mode that corruption of a measurement occurs.

If the connecting leads have identical resistances and the currents flowing through them are equal, then there is no potential difference at the DMM input terminals, apart from the input voltage proper, that is. But, in practice, these resistances and currents are unequal (unequal volts drops along the two connecting leads) and the resultant interference becomes series mode again. This can happen particularly if there is some resistance in the LO lead.

To prevent the common mode interference being converted to series mode, the DMM is designed such that its measuring circuitry is 'floating' and enclosed by a protective screen, or GUARD. By connecting the source of common mode voltage to the GUARD, all current produced by this voltage flows into the GUARD instead. Thus the measuring circuitry floats up and down with the interference. The greater the interference, the more effective is the GUARD connection.

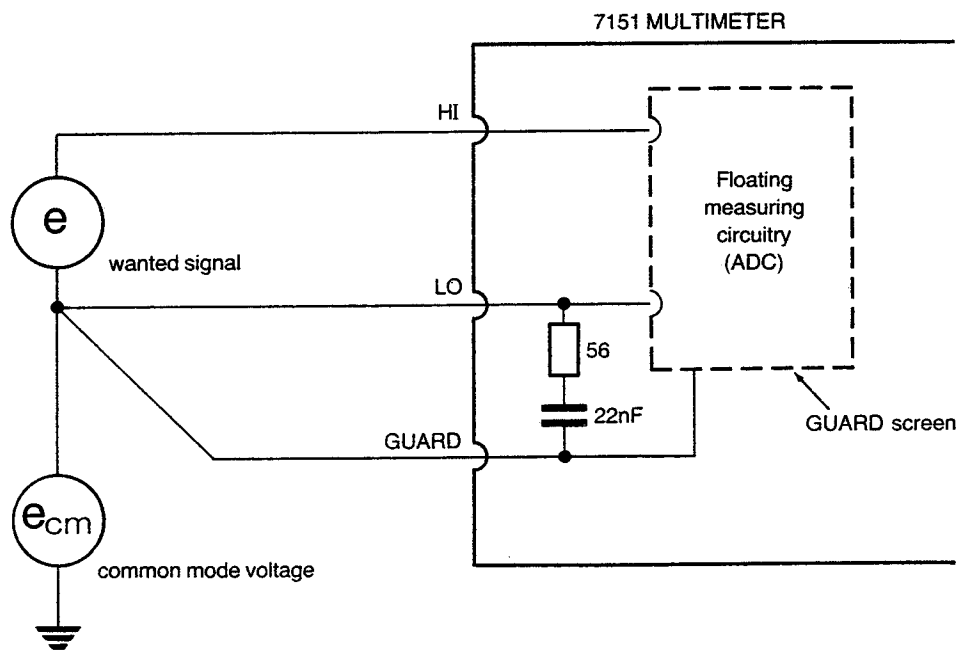

Fig 4.3 7151's Guard arrangement

In 7151 the GUARD is internally ac coupled to the LO terminal by a series RC network. This path provides adequate protection for most ac interference and the GUARD terminal need not necessarily be connected externally. However, it is good policy to always connect the GUARD to a suspected source of common mode interference, usually the point at which the LO lead is connected.

#### 4 REMEDIAL ACTION

Interference can be series or common mode, ac or dc. Here is a summary of the suggested methods for dealing with the interference. In addition, keep the lengths of any connecting leads approximately equal, and to a minimum.

Series mode, dc    Use the null facility to remove small offsets. If the offset is excessive, measure it and use it as a correction factor in the OFFSET program.

Alternatively, attempt to eliminate the offset source from the measuring path.

Series mode, ac    Select a measurement time that is a multiple of the mains period. For example, for 50Hz operation, use 40ms, 400ms etc. For other forms of interference (e.g. noise), use the longest practicable measurement time to average out the effects, 400ms or 1.6s etc. In practice, the higher ohms ranges may be found more susceptible to series mode ac. The real cure here is to use a screened lead where the V- $\Omega$  HI, and  $\Omega$  SOURCE HI & LO leads are screened by an outer braid connected to V- $\Omega$  LO.

Common mode, dc & ac    Connect the GUARD terminal to the source of common mode interference, usually the point to which the LO lead is connected. If possible, use matched connecting leads.





# Chapter 5

## Processing Facilities

---

<i>Page</i>	<i>Para.</i>	<i>Title</i>
5.2	1	General
5.2	2	The 2nd Level Keypad
5.3	3	The Menu Hierarchy
5.3	4	Probes
5.4	4.1	High Voltage
5.4	4.2	Current Shunt
5.5	4.3	Temperature
5.5	4.4	Radio Frequency
5.6	5	Programs
5.6	5.1	Program Selection
5.7	5.2	The Compute Control
5.8	5.3	Scale
5.8	5.4	Offset
5.8	5.5	% Deviation
5.9	5.6	Ratio
5.10	5.7	Maxmin
5.11	5.8	Limits
5.12	5.9	Statistics
5.13	5.10	Analog
5.14	5.10.1	Setting-Up
5.15	5.10.2	Oscilloscope
5.16	5.10.3	Chart Recorder
5.16	5.10.4	History File
5.16	5.10.5	Additional Analogue Facilities via Remote Control
5.17	6	Clock
5.18	6.1	Real
5.19	6.2	Elapsed
5.20	6.3	Time of Day
5.20	6.4	Additional Clock Facilities via Remote Control
5.21	7	Power-Fail Recovery
5.21	7.1	Resume
5.21	7.2	Reset
5.22	8	Program Examples

## 1 GENERAL

Contained within the instrument are: a library of eight programs; a clock which can be run in real or elapsed mode to give time control over measurement; a facility whereby certain accessory probes can be operated easily; the option of next switching-on the instrument into a ready-programmed condition.

All the above can be accessed from the front-panel, or via the remote-control interfaces.

## 2 THE 2ND LEVEL KEYPAD

The various facilities can be accessed and set up by the 2nd level of the keypad, made operative by pressing the MENU key. The key legends coloured black then apply:

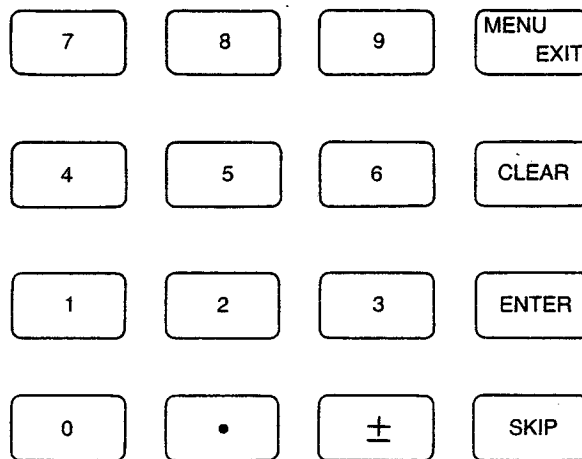
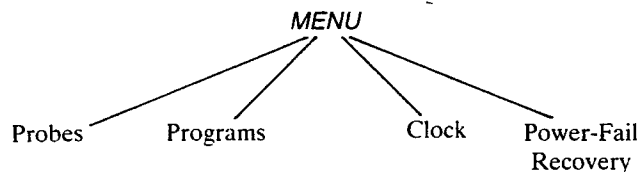

Fig 5.1 The 2nd Level Keypad

- MENU/EXIT** Pressing MENU immediately halts any ongoing measurement activity, and causes the first of the four menu areas to be offered:- *PROBES*.
- To exit from the menu system, for example, after setting up some programs, press MENU (EXIT).
- ENTER** } All facilities offered are controlled by these keys. In general, the  
**SKIP** } instrument displays an option on the screen and the user may respond by:  
(a) pressing ENTER to accept the displayed option.  
(b) pressing SKIP to advance on to the next option. Skipping past the last option in a particular menu area causes the 1st option to be re-offered.
- CLEAR** Should an error be made whilst keying in program constants, or times etc., pressing CLEAR clears the erroneous figures from the display, allowing the correct ones to then be entered.
- Others** The numeric keys are purely for entering probe, program, or clock parameters. The decimal point key has a dual function in that being pressed a second time sets up the exponent. (See Program Example 1)

### 3 THE MENU HIERARCHY

With the initial press of the MENU key, the four menu areas become available.



#### **Probes (PROBES)**

This section provides for simple operation of certain accessory probes. For each probe, function section, range, and any necessary manipulation of results are automatically taken into consideration so that the display always shows an appropriate result.

#### **Programs (PROGS)**

Eight programs are offered providing a wide variety of functions. The programs may be selected singly, or chained together to perform more complex operations in which case they are executed in their order of selection. For each program, the user chooses the appropriate option and then defines any relevant constants.

#### **Clock (CLOCK)**

The clock may be operated in real or elapsed mode to control single sample measurements. In addition, the clock may be used to give the 'time of day' even when clock controlled measurements are not required.

#### **Power-Fail Recovery (PWR ON)**

This allows the user to control the behaviour of the instrument when it is next switched on.

### 4 PROBES (PROBES)

This section of the menu permits use of certain accessory probes, which may be supplied by Solartron, or by the user. Upon selection of *PROBES*, the name of any presently selected probe is displayed. If no probe is selected, the message 'OFF' is displayed. The full choice offered is:

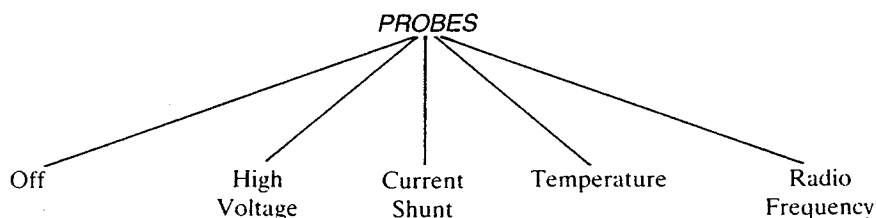

If required, any probe selected may be used in conjunction with the programs and/or clock control.

**4.1 HIGH VOLTAGE (HV)**

Selecting *HV* permits the use of a high voltage probe (division ratio 1000:1) to extend 7151's range of voltage measurement, dc. The probe must be suitable for use with a 10MΩ input impedance instrument.

After selecting *HV*, the probe is connected to the V-Ω HI and LO terminals. Measurements can then be taken by pressing **SAMPLE** or **TRACK**. Results are presented in volts, dc.

Selection Sequence

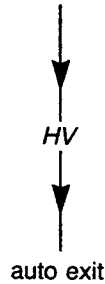

To deselect *HV*, press any function key,  $V=$ ,  $V\sim$  etc., or select *PROBES* followed by *OFF*.

**4.2 CURRENT SHUNT (SHUNT)**

Selecting *SHUNT* permits the use of a current shunt to extend 7151's range of current measurement, ac and dc. The unknown current is read as a voltage developed across the shunt, and the measurements so produced are converted (by 7151) into the appropriate number of milliamps (the displayed units).

After selecting *SHUNT*, the user specifies *I DC* or *I AC*, then enters the resistance of the shunt, *R*, in Ohms. A default value of  $R=0.001$  is built-in which will suit some probes. If this is satisfactory, press **ENTER**, otherwise enter the correct shunt resistance (in Ohms).

The probe is connected across the V-Ω HI and LO terminals, and measurements can then be taken by pressing **SAMPLE** or **TRACK**.

Selection sequence

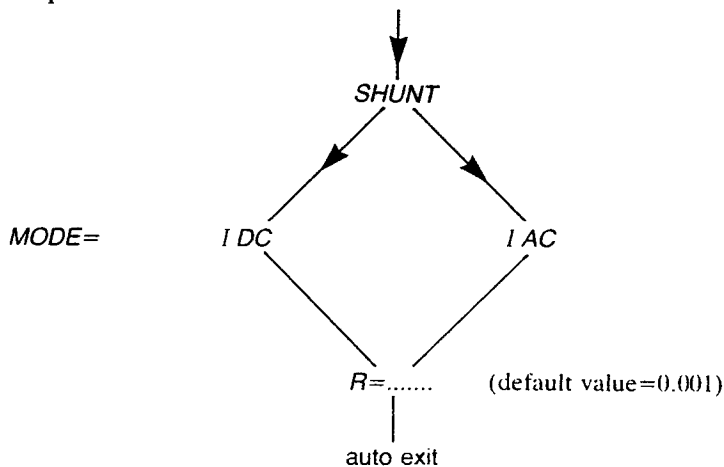

To deselect *SHUNT*, press any function key,  $V=$ ,  $V\sim$  etc., or select *PROBES* followed by *OFF*.

#### 4.3 TEMPERATURE (PRT)

This permits the use of a platinum resistance thermometer (prt). When *PRT* is selected, and a suitable probe fitted, the instrument reads the unknown temperature as a resistance and performs the necessary linearisation (conforming to IEC 751) to present the results in degrees Celsius ( $^{\circ}\text{C}$ ), Fahrenheit ( $^{\circ}\text{F}$ ), or Kelvin (K). The resolution of displayed results is 0.01 degrees.

After selecting *PRT*, and the required display, the user enters the  $R_0$  value of the probe ( $R_0$ =probe resistance at  $0^{\circ}\text{C}$ ), in Ohms. A default value of  $R_0=100.000$  is built-in which is correct for many probes. If this is satisfactory, press ENTER, otherwise enter the correct value of  $R_0$  (in Ohms).

Before taking PRT measurements it is advisable to null the resistance ranges as on page 2.5.

The probe is connected to 7151 by plugging into the rear panel terminals V- $\Omega$  HI and LO, and  $\Omega$  SOURCE HI and LO. Remember to set the FRONT/REAR switch to the REAR position. Before using the prt, read its instructions to ensure that the connections are correct. Measurements can then be taken by pressing SAMPLE or TRACK. No units of measurement are displayed.

Selection Sequence

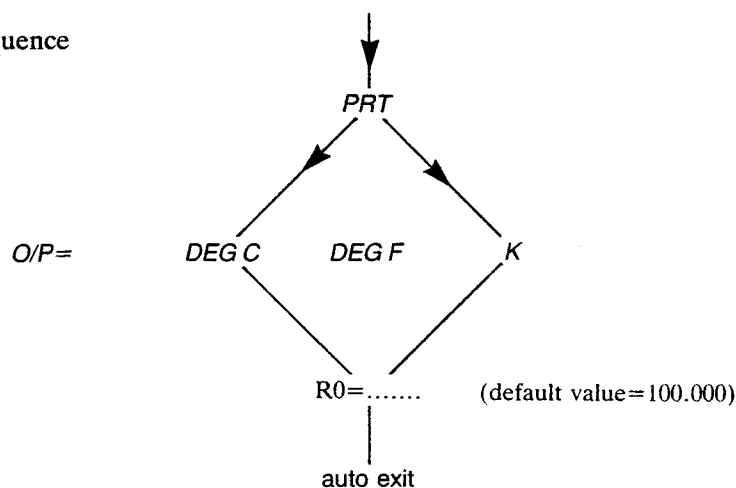

To deselect *PRT*, press any function key,  $V\equiv$ ,  $V\sim$  etc., or select *PROBES* followed by *OFF*.

#### 4.4 RADIO FREQUENCY (RF)

Selecting *RF* permits the use of a peak-sensing, rms-scaled probe, to extend the frequency range over which 7151 can measure voltage, ac.

After selecting *RF*, the probe is connected to the V- $\Omega$  HI and LO terminals. Measurements can then be taken by pressing SAMPLE or TRACK. Results are presented in volts.

Selection Sequence

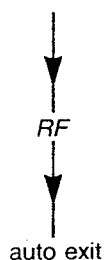

Deselect *RF* by pressing any function key,  $V\equiv$ ,  $V\sim$  etc., or select *PROBES* followed by *OFF*.

## 5 PROGRAMS

Contained within the instrument is a library of eight programs. They are:

Scale	% Deviation	Offset	Ratio
Maxmin	Limits	Statistics	Analog

Each of the eight programs may be considered to be in one of two states:- Active or Idle. Programs selected by the user are held in the Active list whilst unused programs remain in the Idle list. Selecting and setting up a program transfers it from the Idle list to the Active List; cancelling a program has the reverse effect.

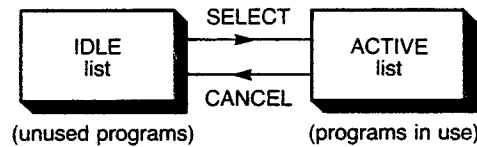

The programs may be used individually, or linked together to perform more complex computations, in which case they are executed in their order of selection. A point to note is that programs can only appear once in any given sequence of programs.

### 5.1 PROGRAM SELECTION

Following the selection of *PROGS*, one of five program actions can be ordered:

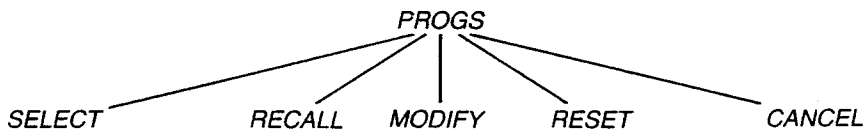

**SELECT** causes programs in the Idle list to be selected. The display prompts the user to set up the options or variables relevant to each program.

**RECALL** allows the contents of an Active program to be examined, usually following a series of measurements. Thus, the chosen options, constants and any results of a particular program can be displayed by repeatedly pressing SKIP.

**MODIFY** permits the options or constants of an Active program to be altered. New parameters are simply keyed in to overwrite the old ones.

**RESET** causes the results of an Active program to be reset, typically prior to commencing a fresh series of measurement using an existing program(s). Programs may be reset individually or collectively.

**CANCEL** causes Active programs to be made inoperative and transferred to the Idle list. User specified constants are not altered by the transfer although results are reset. Programs may be cancelled individually or collectively.

A schematic example of how programs can be selected in any order and transferred to the Active list is shown in Fig. 5.2. Once selected, programs in the Active list can be subjected to the four other actions described above.

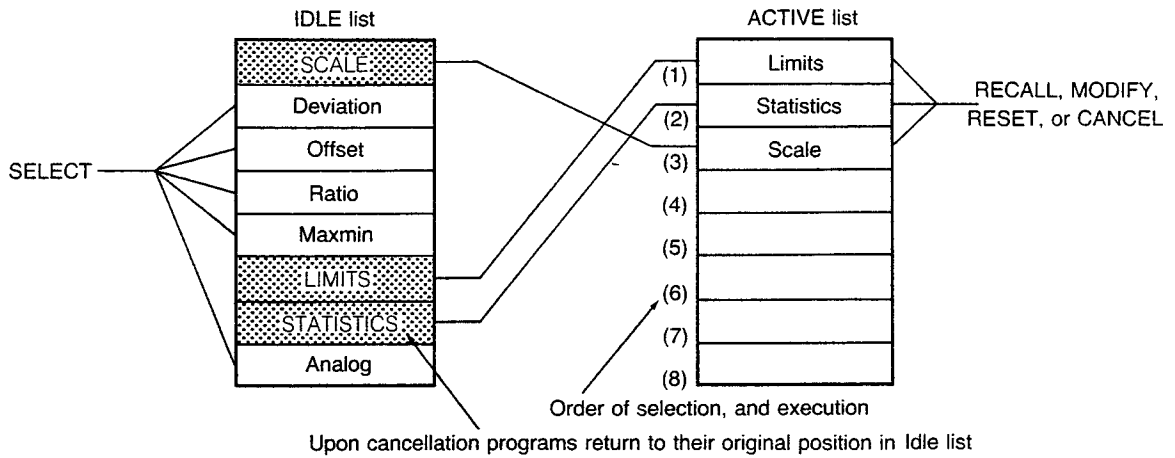

**Fig 5.2 Schematic Program Selection**

Upon cancellation, programs return to their original positions in the Idle list.

**5.2 THE COMPUTE CONTROL**

The COMPUTE key (OFF/ON) determines whether or not measurement results are acted upon by the selected program(s). Selecting a program automatically switches compute on; cancelling all programs switches COMPUTE OFF.

With COMPUTE ON (*COMP* indicator visible) measurement results are fed into the selected programs and processed results are displayed, but with no units of measurement.

With COMPUTE OFF (*COMP* indicator invisible) measurement results completely by-pass the selected programs and are presented on the display as usual.

On reselection of COMPUTE ON, the updating of program results continues.

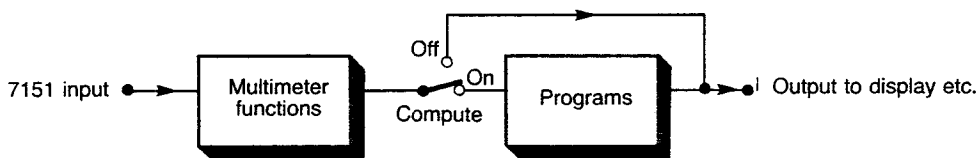

**Fig 5.3 The Compute Control**

### THE PROGRAMS

For each of the Active programs,  $x$ =program input and  $y$ =program output. When more than one program is selected, the output,  $y$ , of one program becomes the input,  $x$ , of the next.

#### 5.3 SCALE (SCALE)

The input to the program is multiplied by a constant,  $M$ .

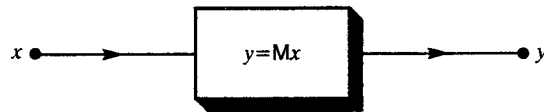

Selection Sequence

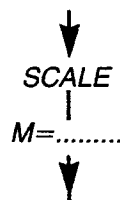

#### 5.4 OFFSET (OFFSET)

This program causes a defined constant,  $C$ , to be added to the input.

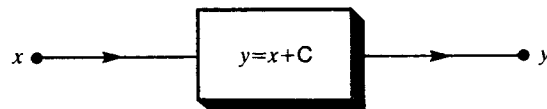

Selection Sequence

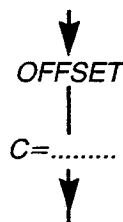

#### 5.5 % DEVIATION (% DEV)

The program evaluates the percentage deviation of an input from a defined nominal, value  $N$ .

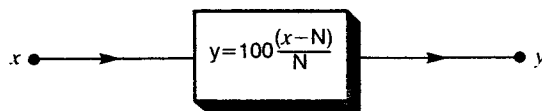

Selection Sequence

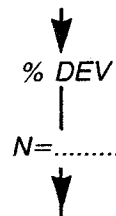



### 5.6 RATIO (RATIO)

One of four computations can be applied to be input:

- (a) The input is divided by a constant, R.
- (b) As (a) but with the result expressed in decibels (dB).
- (c) The input is squared and divided by a constant, R.
- (d) A constant, R, is divided by the input.

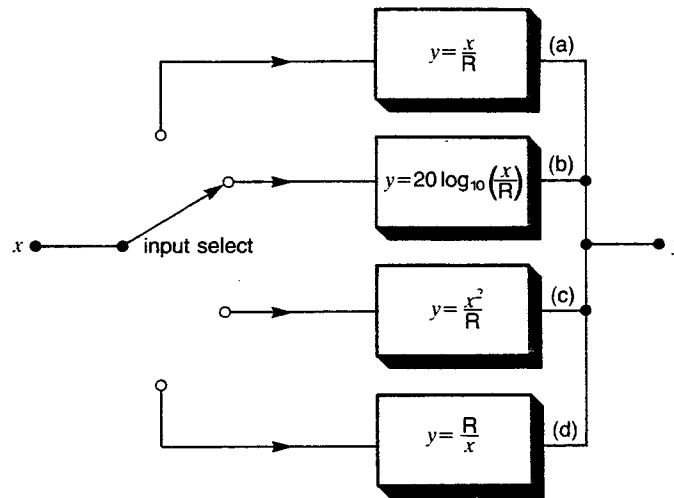

Selection Sequence

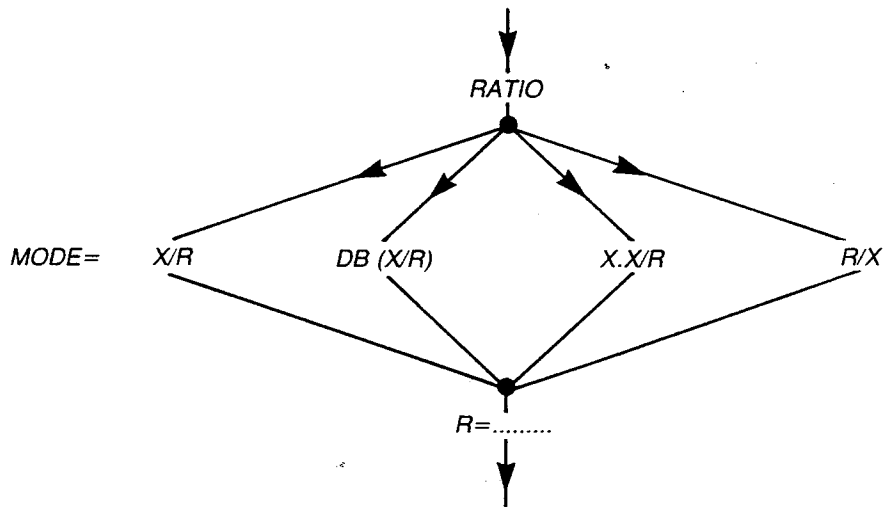

5.7 MAXMIN (MAXMIN)

The program keeps a record of the maximum input (*MAX*), the minimum input (*MIN*), and the peak to peak ( $PP=MAX-MIN$ ) input value. Every input to the program is examined, and *MAX*, *MIN* and *PP* are modified accordingly.

The user may choose the output to be *MAX*, *MIN*, *PP*, or simply the *INPUT*.

All three of the computed values, plus the number of inputs (*N*) fed to the program, are available for *RECALL*.

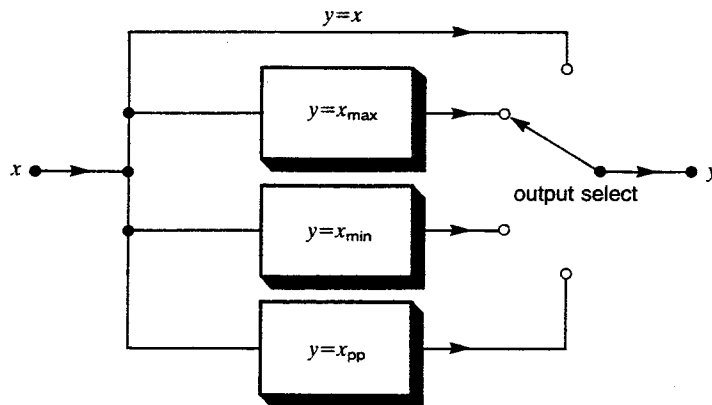

Selection Sequence

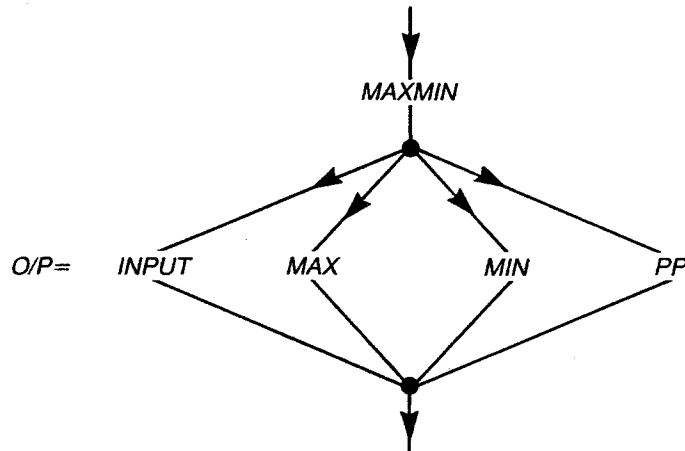

### 5.8 LIMITS (LIMITS)

The program compares each input with two defined constants, H and L. The user can choose from five output options to determine if the input is passed to the output:

- (a) always
- (b) inputs greater than H
- (c) inputs less than L
- (d) inputs equal to or between the limits H and L
- (e) inputs which are outside the limits H and L

Whilst the program is running four quantities are recorded and available for *RECALL*:

- (i) The number of inputs greater than H, (N HI),
- (ii) The total number of inputs less than L, (N LO),
- (iii) The total number of inputs that were equal to or between the two limits, (N GO),
- (iv) The total number of inputs that were outside the limits, (N NOGO),  
i.e. N LO + N HI.

Whenever an input to the program is judged to be NOGO a TTL level signal on the rear panel Auxiliary socket (pin 8) is pulled low. Thus the signal may be used to operate an alarm.

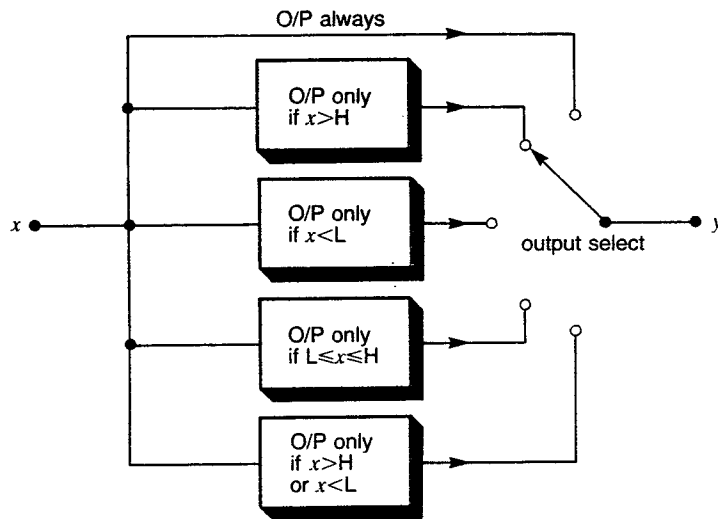

Selection Sequence

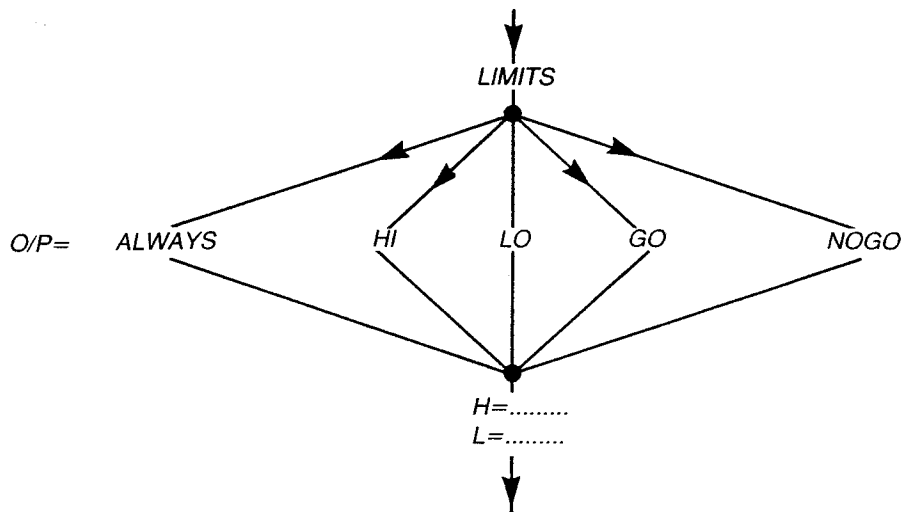

**5.9 STATISTICS (STATS)**

Four statistics of the input are computed. Any one of these computed statistics, or the program input, may be selected as the output. The output options are:

- (a) input
- (b) mean (updated)
- (c) standard deviation (updated)
- (d) variance (updated)
- (e) r.m.s. (updated)

Note that the computed variance and standard deviation are for the sample size, not the population.

Also on *RECALL*, the total number of inputs to the program may be examined.

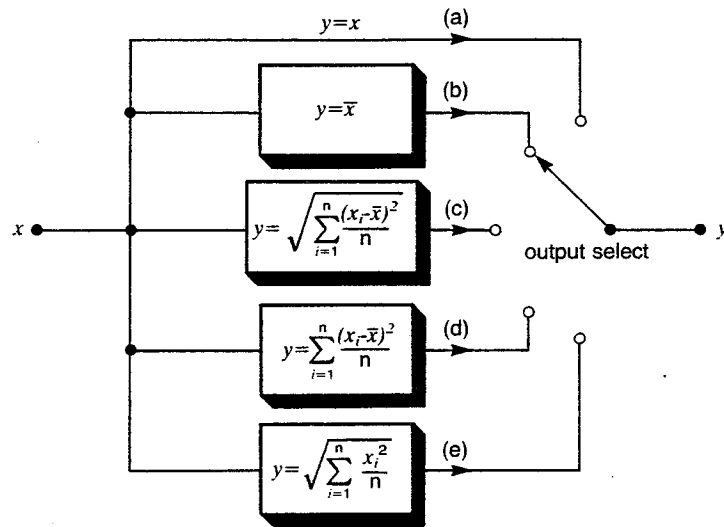

Selection Sequence

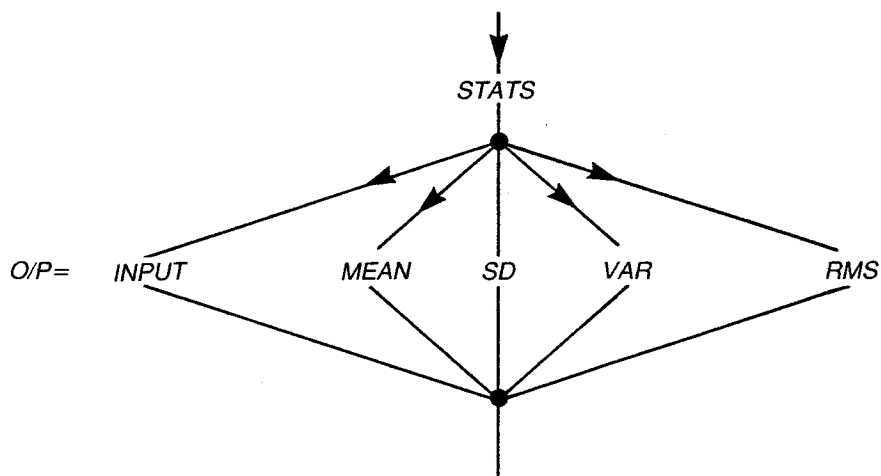

## 5.10 ANALOG (ANALOG), including History File

This program enables its inputs to be converted into analogue signals which can be displayed by an oscilloscope or chart recorder. To this end, a history file is employed, storing the most recent 500 program inputs.

Analog differs from all other programs in that each program input always passes directly to the output (besides being stored in the history file). It can therefore be placed at any point in a program chain without affecting results generated by other programs.

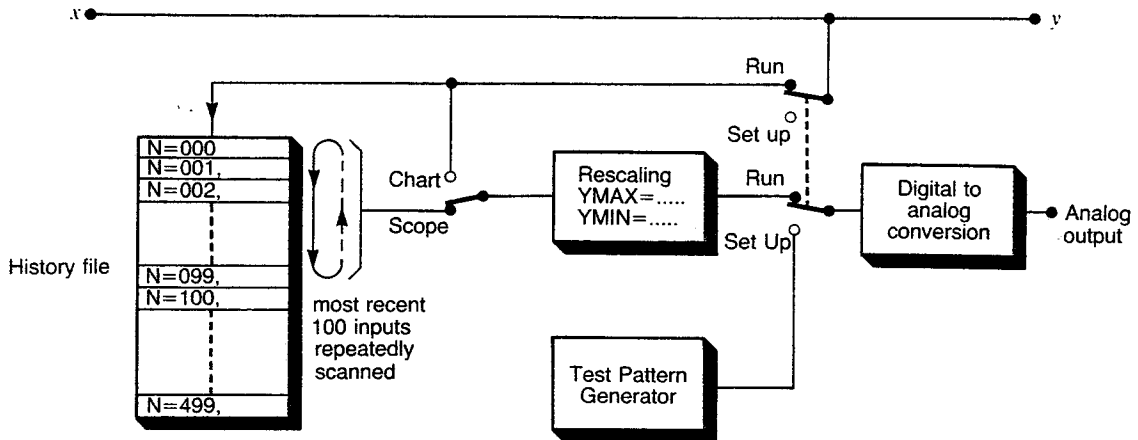

Before being converted to analog signals, the program inputs are rescaled according to two user defined levels,  $Y_{max}$  and  $Y_{min}$ , which are chosen to encompass the expected range of program inputs. Thus the analogue output ( $0 \rightarrow 10V$ ) can be used to represent any window of input values.

When *SCOPE* is selected, the 100 most recent inputs to the history file are repeatedly scanned and output, allowing an oscilloscope to produce a stable display.

When *CHART* is selected, the history file is not scanned; each program input is simply rescaled and output to the chart recorder. Thus each analog output is held constant until the next program input arrives.

### 5.10.1 Setting-Up

The analog output is generated by an 8-bit Digital to Analogue Converter (DAC) which produces an output from 0 to 10V over 256 steps. Of these, 200 represent the input window, defined by  $Y_{max}$  and  $Y_{min}$ ; the other 56 are used to define upper and lower 'dead-bands' to indicate out of range inputs.

If required a repetitive test pattern (see Fig. 5.4), *MODE=SET UP*, can be output to assist in setting up the oscilloscope or chart recorder in readiness for displaying the analog output. No further adjustment of the oscilloscope or chart recorder is required; any change of sensitivity can then be controlled by changing the program's  $Y_{max}$  and  $Y_{min}$  values.

The user then *MODIFYs* the program to *MODE=RUN* and specifies the limits  $Y_{max}$  and  $Y_{min}$  to define the Input Window representation in Fig. 5.4. Inputs to the DAC are then automatically rescaled so that  $Y_{min}$  is represented by an output of 1.1V, and  $Y_{max}$  by 8.9V. If an input to the program exceeds  $Y_{max}$  the output jumps across the 'dead-band' to 10V, giving clear indication of the condition. Similarly, for inputs less than  $Y_{min}$ , output=0V.

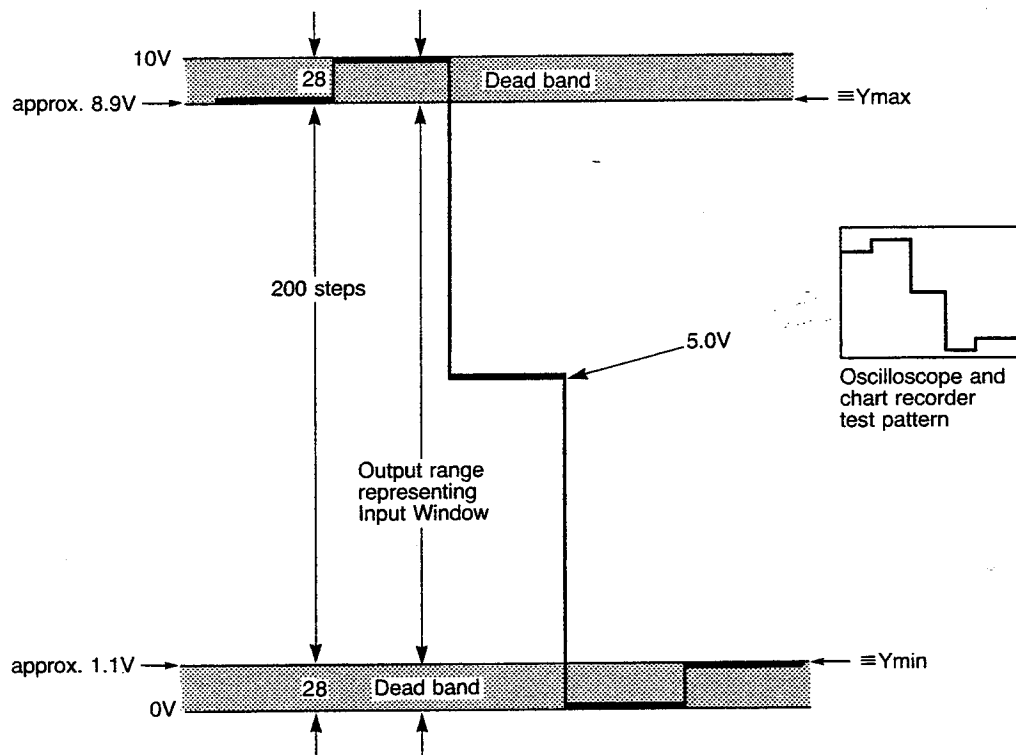

**Fig 5.4** Analog Output Format

### 5.10.2 Oscilloscope (SCOPE)

The analog output is provided on pins 13 (Hi) and 14 (Lo) of the rear panel Auxiliary socket, for connection to an oscilloscope with fixed Y-axis gain (approx. 1V/cm) and offset, and a time-base of approx. 2ms/cm. A TTL level scope trigger signal is provided on pin 9 which goes low for a period of 0.8 $\mu$ s every 30ms.

Before taking measurements, use the set-up pattern to ensure the oscilloscope is correctly adjusted: After selecting *ANALOG*, *O/P=SCOPE*, *MODE=SET UP*, enter the default *YMAX* and *YMIN* values and press *EXIT*. The analog test-pattern is now being output; adjust the oscilloscope so that a display similar to the test pattern in Fig. 5.4 occupies the screen. No further adjustment of the oscilloscope is required.

Reselect *ANALOG* (action:*MODIFY*) and *SCOPE*. Change the mode to *RUN*, and enter the required *YMAX* and *YMIN* values. Press *EXIT* if no other programs are required. Measurements can then be taken by pressing *SAMPLE* or *TRACK*.

Initially, the history file is empty (all locations=zero), and the oscilloscope screen just shows a base line. However, as measurements are taken, the history file fills with results, and the oscilloscope responds accordingly until the 100 most recent results occupy the screen. The most recent result is always to the r.h.s. of the screen.

Should the displayed output be found rather small, or so large that many of the samples are at the 'dead-band' extremes, the program scaling can easily be altered by *MODIFY*ing the *YMAX* and *YMIN* values. Thus the same results as before can be displayed, but with greater, or lesser, resolution.

Note that whilst *MODE=SET UP*, any program inputs do not enter the history file.

### Selection sequence

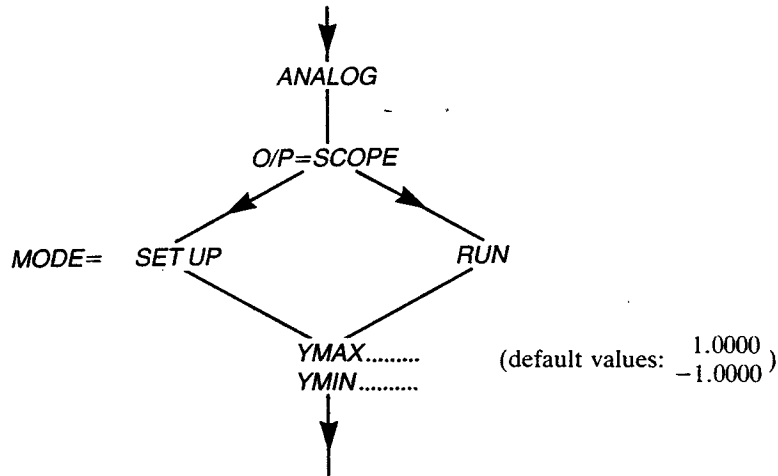

### 5.10.3 Chart Recorder (CHART)

The analog output is provided on pins 13 (Hi) and 14 (Lo) of the rear-panel Auxiliary socket.

Before taking measurements, use the set-up pattern to ensure the chart recorder is correctly adjusted: After selecting *ANALOG*, *O/P=CHART*, *MODE=SET UP*, enter the default *YMAX* and *YMIN* values and press *EXIT*. The analog test pattern is now being output; adjust the chart recorder to obtain the optimum test-pattern trace. No further adjustment of the chart recorder is required.

Reselect *ANALOG* (action:*MODIFY*) and *CHART*. Change the mode to *RUN* and enter the required *YMAX* and *YMIN* values. Press *EXIT*, if no other programs are required. Measurements can then be taken by pressing *SAMPLE* or *TRACK*.

On receipt of an input, the program generates an analogue output which is held constant until the next program input arrives. Thus, the rate of change of the analogue signal varies with the rate at which measurements are made.

Note that whilst *MODE=SET UP*, any program inputs do not enter the history file.

### Selection Sequence

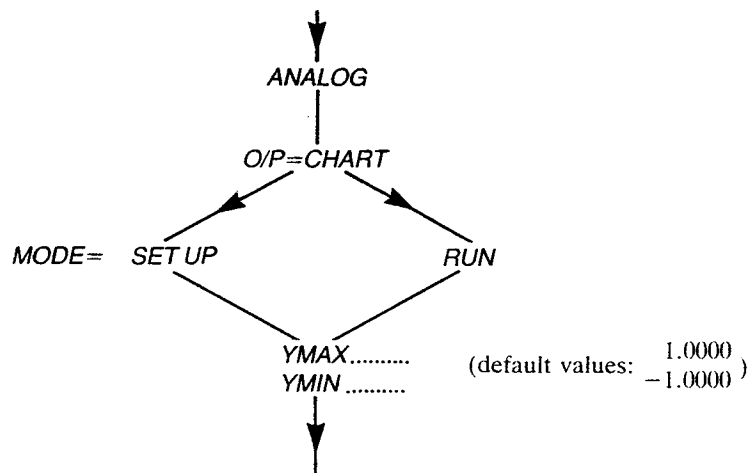

#### 5.10.4 History File (HIST)

Once the Analog program has been selected (*MODE=RUN*), each program input is automatically held in the 500 reading history file.

To use the history file without the Analog output, select *ANALOG, O/P=SCOPE* (or *CHART*), *MODE=RUN*, and whatever values of *YMAX* and *YMIN* happen to be displayed. Press *EXIT* if no other programs are required.

The readings within the history file can be examined only by *RECALLING* the program, and *SKIP*ping past *O/P=SCOPE* (or *CHART*), *MODE=RUN, YMAX* and *YMIN*. Then, a message, *HIST=n*, is displayed where *n*=the number of history file (program) entries. Press *SKIP* to access the file. Then displayed is *n=000,-----*, the value of the most recent entry, stored in location 000. To examine the next most recent entry, *n=001*, press *SKIP*, and so on. To examine a particular location, say location 51, key the number 51, and press *ENTER*. *n=052* etc., can then be displayed by using the *SKIP* key as before.

To exit from the history file, key in an invalid number, i.e. outside the range 0 →499, or press *EXIT*, or *SKIP* past *n=499*.

#### 5.10.5 Additional Analogue Facilities via Remote Control

##### Graphical Output

A remote controller can be used to obtain a plot of the history file contents. The scaling constants, *YMAX* and *YMIN* are again defined to encompass the expected range of inputs. The command *DUMP a TO b GRAPH* is then sent which causes the file contents to be printed. In addition to the numeric result, a row of 40 dots is printed alongside. The dot furthest to the left (right) represents *YMIN* (*YMAX*), i.e. the 40 dots represent the range of *YMIN* →*YMAX*. Superimposed on the row of dots will be a single asterisk, its position relative to *YMIN* and *YMAX* representing the size of the history file result. So, as successive lines are printed, a graph is formed but at 90° to the numeric results. Thus, the graphical output can best be appreciated as a hard copy from a printer or teletype.

For example, "DUMP 25 TO 23 GRAPH" could produce an output such as this:

```
N=025 26.79483 .....*.....
N=024 24.98162 .....*.....
N=023 19.74858 .....*.....
```

If the asterisk is printed to the left of the row of dots, the input was less than *YMIN*; if the asterisk is printed to the right, the input was greater than *YMAX*.

The graph output can also be used on a real-time basis, in much the same way as the chart output works. In order to do this, the *ONCLOCK* command must also be incorporated. See Chapter 6.



## 6 CLOCK (CLOCK)

The clock can be operated in real or elapsed mode with a one-second resolution, providing time control over measurements for periods of up to seven days. If the real or elapsed clock is currently active the only choice offered by the menu is to abort the clock control.

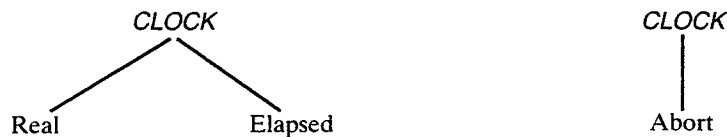

The format of the displayed times is usually hhmmss (hours, minutes, and seconds). However, if the clock is to be specified so that measurements span more than one day, the displayed format would be hhmmssd (hours, minutes, seconds and day).

When using the keypad to enter in the various times, decimal points need not be specified (i.e. between hours and minutes etc.). Any unspecified digits are assumed to be zeroes. For example, to key in the time, 12.00HRS, press the keys 1,2,ENTER.

Once clock control has been invoked, the function, range, measurement time, etc., may still be altered without corrupting the clock. Also, measurements may be made as usual by pressing SAMPLE or TRACK(ON). When doing this however, the user runs the risk of missing some of the time controlled measurement results.

**6.1 REAL (REAL)**

The user defines the *TIME* (of day), *BEGIN*, *PERIOD*, and *END* times (hours, minutes, seconds, and if required, the day). When *TIME=BEGIN*, the first measurement is triggered and the display shows the result. Measurements are triggered every *PERIOD* until *TIME=END*. If *END* coincides with a *PERIOD* the measurement is triggered as usual, and the clock is then halted. The *TIME* (of day) is activated immediately *ENTER* is pressed after keying in the time.

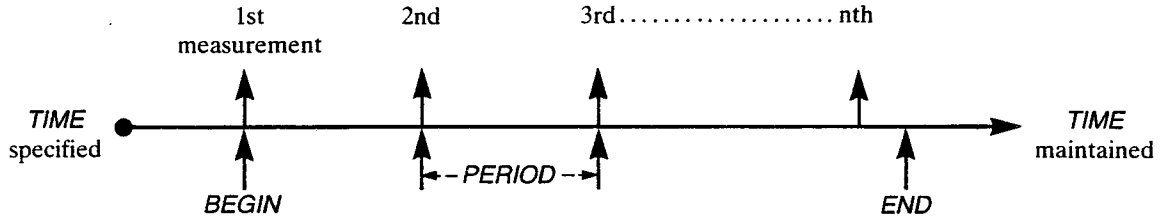

After the clock has been enabled, the message *\*TIMER\** is displayed until the first measurement occurs. If the day has been specified, the day during which the clock is enabled is referred to as *DAY 0*.

After the *END* time has been reached, the real time clock continues to run, keeping note of the time of day.

**Selection Sequence**

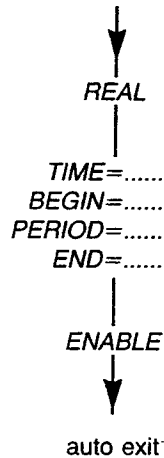

**De-selection** Once invoked, *REAL* clock control can be stopped (aborted) by selecting *CLOCK* followed by *ABORT*. Normal multimeter operations can then be continued.

**Note:** If *PWR ON* has been set to *RESUME* and a mains power interruption occurs during *REAL* clock control, measurements recommence on power resumption with the same *BEGIN*, *PERIOD* and *END* times, only a clock trigger is generated after approx. 5 secs, and every subsequent *PERIOD*, i.e. the effective 'phase' of the *PERIOD* is affected by a mains interruption.

## 6.2 ELAPSED (ELAPSE)

The user defines the *BEGIN*, *PERIOD*, and *END* times (hours, minutes, seconds and, if required, the day). The clock is then enabled which resets the clock and holds it at zero (real time unaffected). The message, *\*ARMED\**, is then displayed.

Thereafter, the next press of the *SAMPLE* key commences the elapsed clock and the display shows, -----, until the first measurement trigger occurs. This takes place after a time delay=*BEGIN* has elapsed. Subsequent measurement triggers occur every *PERIOD*, and finish when the elapsed clock=*END*. If *END* coincides with a *PERIOD* the measurement is triggered as usual, and the clock is then halted.

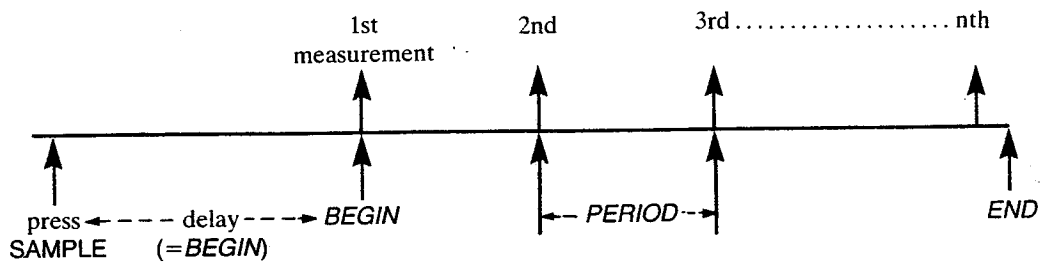

A point to note is that all the above times are elapsed with respect to when the *SAMPLE* key is pressed. If the day has been specified, this delays the time in question, *BEGIN*, *PERIOD*, etc., by multiples of 24HRS. Entering DAY 1 against a time delays that event by 24HRS; DAY 2 48HRS, and so on.

### Selection Sequence

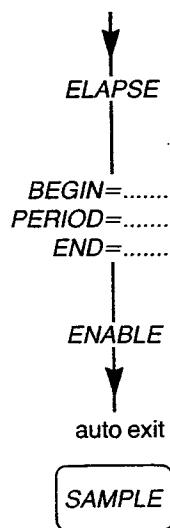

**De-selection** Once invoked, Elapsed clock control can be stopped (aborted) by selecting *CLOCK* followed by *ABORT*. Normal multimeter operations can then be continued.

### 6.3 TIME OF DAY

If the user wishes to set (or alter) the *TIME* of day without taking clock controlled measurements, this can be done by selecting the *REAL* clock, entering *TIME* of day, and pressing **EXIT** to restore the multimeter functions. The clock is activated immediately **ENTER** is pressed after keying in the time. Thereafter, the *TIME* of day may be examined by selecting *REAL* clock.

In the event of the mains supply being disconnected the clock continues to run for at least 12 days, typically 24 days.

### 6.4 ADDITIONAL CLOCK FACILITIES VIA REMOTE CONTROL

#### **Onclock**

By default, after the real or elapsed clock is invoked, single sample measurements ('TRIG' command) are taken at every clock trigger defined by **BEGIN**, **PERIOD**, and **END**. The full default command is:

ONCLOCK TRIG

However, under remote control, the command,

ONCLOCK [command string]

can be issued which causes the entered command string to be executed at every clock trigger, instead of just taking a single sample measurement. This facility is particularly useful when it is necessary to take processed batch measurements where programs need to be automatically reset before the next batch commences.

#### **Date**

A calendar is provided that can present **DAY**, **MONTH**, and **YEAR** information to a remote controller. In the event of the mains power supply being disconnected the calendar continues to be updated for at least 12 days, typically 24 days. Note that the calendar plays no part in real or elapsed clock control.

## 7 POWER-FAIL RECOVERY (*PWR ON*)

This permits 7151 to be next switched-ON into its last used condition. This may be useful if programs or real-time controlled measurements are to be preserved following a mains power failure, or if the user simply does not want to bother re-programming the instrument when next used.

Alternatively, the instrument can be set so that at switch-OFF, all facilities (except real clock and calendar) are reset.

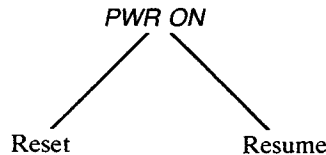

### 7.1 RESUME (*RESUME*)

All multimeter settings, program, probe, and clock information is retained at switch-OFF. These parameters can be retained for at least 12 days (typically 24 days). Items not retained at switch-OFF are: an uncompleted calibration sequence, null values, and elapsed clock control.

Note that when *RESUME* is selected, it is important that the instrument is not switched-OFF whilst a measurement is being made, otherwise all program results will be reset.

After selecting *RESUME*, normal multimeter operations can be continued.

Selection Sequence

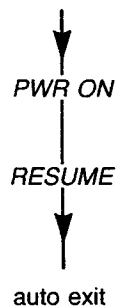

### 7.2 RESET (*RESET*)

All multimeter settings, program, probe, and clock information will be lost, and reset to their default states at switch-OFF (see Chapter 6 for full list of default states). Items that survive the reset are the real clock (time of day) and calendar, which continue to update for at least 12 days (typically 24 days) after switch-OFF.

After selecting *RESET*, normal multimeter operations can be continued.

Selection Sequence

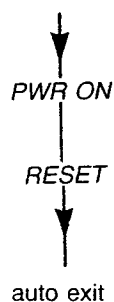

## 8 PROGRAM EXAMPLES

### Example 1

To take a series of measurements and divide each result by a scaling factor, of say,  $4.2 \times 10^{-2}$ .

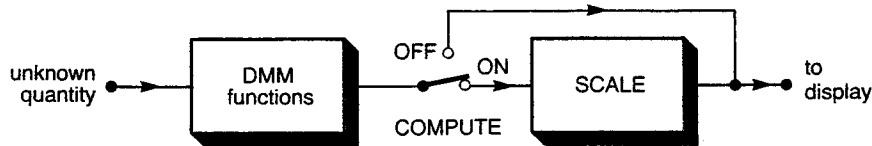

*Required Program Structure*

Access the processing facilities by pressing MENU.

When Offered, ENTER	When Offered, SKIP	Notes
<p><i>PROGS ?</i></p> <p><i>CANCEL ?</i> <i>ALL ?</i></p> <p><i>SELECT ?</i> <i>SCALE ?</i> <i>M=4.2-2</i></p> <p>.....</p> <p><i>SELECT ?</i></p>	<p><i>PROBES ?</i></p> <p><i>SELECT ?</i> <i>RECALL ?</i> <i>MODIFY ?</i> <i>RESET ?</i></p> <p><i>CANCEL ?</i></p>	<p>Before calling up the required programs it is wise to check that none are already Active. SKIP through and <i>CANCEL ALL</i> prior to program selection to make sure. Enter required scaling factor. The 2nd press of the <input type="text" value="."/> key serves to set up the exponent.</p>

No further programs are required so press EXIT to restore the DMM functions. Notice that the *COMP* indicator is now visible. This means that computed results (subjected to the scaling factor) are to be displayed. Select the required function, range, and measurement time. Measurements can now be taken by pressing *SAMPLE* or *TRACK*. If ordinary (uncomputed) measurements need to be displayed, press *COMPUTE* to by-pass the Scale program. The *COMP* indicator will then be invisible. To restore computed results, re-press *COMPUTE*.

**Note:** When computed results are displayed, the *COMP* indicator is visible but the units of measurement are not, i.e. the displayed result does not necessarily directly represent the size of the input signal.

## Example 2

To examine the tolerances of a batch of 'identical' resistors. Say we require to find the Standard Deviation of the batch and the worst case variation of resistor values. Two programs need to be used: MAXMIN and STATS. It is easily arranged that the updated Standard Deviation is displayed for each resistor sampled. Remember that programs are actioned in their order of selection, and the output of the final program is the one displayed.

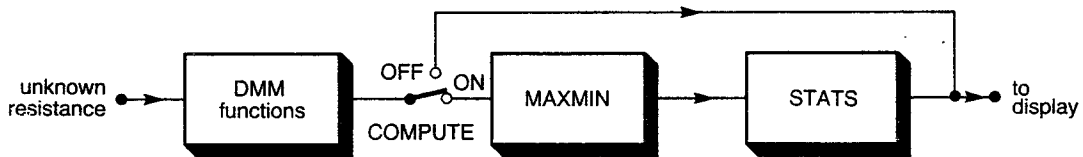

*Required Program Structure*

Access the processing facilities by pressing MENU.

When Offered, ENTER	When Offered, SKIP	Notes
<i>PROGS ? SELECT ?</i>	<i>PROBES ?</i>	Any programs to be engaged ? SKIP through until name of required program is displayed.
<i>MAXMIN ? O/P=INPUT ? SELECT ?</i>	<i>SCALE ? % DEV ? OFFSET ? RATIO ?</i>	
<i>STATS ?</i>	<i>SCALE ? % DEV ? OFFSET ? RATIO LIMITS ?</i>	Any more programs to be engaged? SKIP through until name of required program is displayed.
<i>O/P=SD ?</i>	<i>O/P=INPUT ? O/P=MEAN ?</i>	SKIP through until name of required output option is displayed.
<i>----- SELECT ?</i>		

No further programs are required. Press EXIT to restore the DMM functions.

Notice the *COMP* indicator is now visible. This means that computed results will be displayed (the output of the final program).

Select the appropriate function, range and measurement time. Connect the 1st resistor to the input terminals, and press **SAMPLE**. The display will show the standard deviation of the first resistor (zero). Connect the 2nd resistor, and press **SAMPLE**. The display will show the updated standard deviation of the two resistors, and so on.

When the batch has been sampled, the programs may be RECALLED to examine the undisplayed quantities:

When Offered, ENTER	When Offered, SKIP	Notes
<i>PROGS ?</i>	<i>PROBES ?</i>	
<i>RECALL ?</i>	<i>SELECT ?</i>	
<i>MAXMIN ?</i>	<i>O/P=INPUT?</i>	The selected output option was input.
	<i>N=.....</i>	No. of program inputs was:
	<i>MAX=.....</i>	The max value was:
	<i>MIN=.....</i>	The min value was:
	<i>PP=.....</i>	The peak to peak value was:
<i>RECALL ?</i>		The selected output was standard deviation
<i>STATS ?</i>	<i>O/P=S D</i>	
	<i>N=.....</i>	No. of program inputs was:
	<i>MEAN=.....</i>	The mean value was:
	<i>S D=.....</i>	The standard deviation was:
	<i>VAR=.....</i>	The variance was:
	<i>R M S=.....</i>	The r.m.s. value was:
	.....	
	<i>RECALL ?</i>	

Exit the programs by pressing EXIT. Otherwise, re-use the programs after *RESET*ting them.

If the programs are no longer required, *CANCEL* them, leaving the instrument ready for re-use.

When Offered, ENTER	When Offered, SKIP	Notes
<i>CANCEL ?</i>	<i>MODIFY ?</i>	} SKIP through to find the required action.
<i>ALL ?</i>	<i>RESET ?</i>	
.....		Cancel all programs.
<i>CANCEL ?</i>		

All programs have been cancelled. Restore normal front-panel control by pressing EXIT.



**Example 3**

To periodically measure a quantity and calculate its percentage deviation from a fixed value. An operator is not on hand to record the results so they must be stored in memory, ready for *RECALL*.

Voltage measurements are to be taken for 30 minutes, every 30 seconds, and compared against a reference of 10.45 Vdc. Clock control, and the % DEV and ANALOG (History File) programs need to be called up.

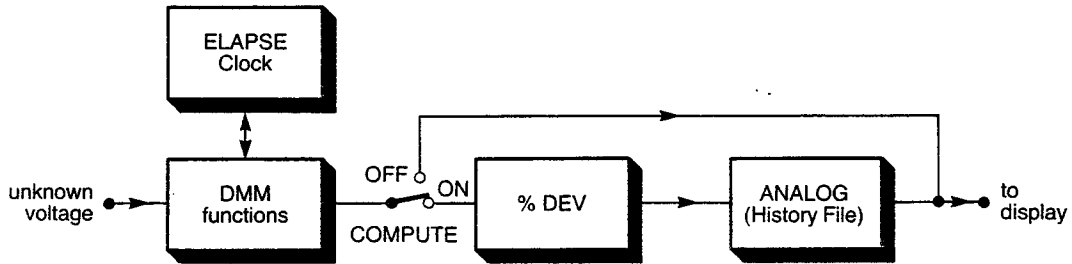

*Required Program Structure*

In an application that involves programs and clock control, it is usually more convenient to set up the programs prior to the clock.

Access the processing facilities by pressing MENU, and check that no programs are already called up. If in doubt, CANCEL ALL as per Example 1 before entering the new programs.

When Offered, ENTER	When Offered, SKIP	Notes
<p><i>PROGS ? SELECT ?</i></p> <p><i>% DEV ? N=10.45 SELECT ?</i></p> <p><i>ANALOG? O/P=SCOPE ? MODE=RUN YMAX=1.0000 YMIN=-1.0000</i></p> <hr style="border-top: 1px dashed black;"/> <p><i>SELECT ?</i></p>	<p><i>PROBES ?</i></p> <p><i>SCALE ?</i></p> <p><i>SCALE ? OFFSET ? RATIO ? MAXMIN ? LIMITS ? STATS ?</i></p>	<p>Any programs to be engaged ?</p> <p>Enter reference figure</p> <p>Skip through until name of required program is displayed.</p> <p>ENTER these parameters to make the program Active. The mode must be set to <i>RUN</i>.</p>



#### Example 4

To periodically measure a slowly varying quantity during certain times of the day. In addition, it is necessary to know how many of the measurements fall outside some specified limits and what the worst case input variation is. The results are to be stored for later display by an oscilloscope.

The mains voltage is to be measured every 5 mins. over the Monday morning 'peak demand' period commencing at 5 a.m. and finishing at 10 a.m. Because of the 'unsocial' hour at which measurements must commence, 7151 is required to be set up on the preceding Friday. We later require to output the results as a waveform on the oscilloscope, specifically examining the voltage variation between 235V and 243V. In addition, we need to know how many of the 61 measurements were between the limits 238V and 241V, and the peak voltage variation.

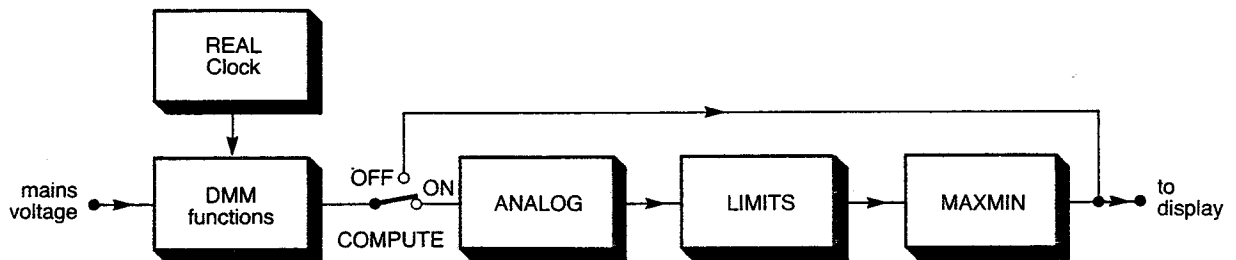

#### Required Program Structure

In this example the Analog program needs to be placed before the Maxmin program since it is to output the peak to peak voltage variation.

Access the processing facilities by pressing MENU, and check that no programs are already called up.

When Offered, ENTER	When Offered, SKIP	Notes
<p><i>PROGS ? SELECT ?</i></p> <p><i>ANALOG ? O/P=SCOPE ? MODE=SET UP YMAX=1.00000 YMIN=-1.00000</i></p> <hr/> <p><i>SELECT ?</i></p>	<p><i>PROBES ?</i></p> <p><i>SCALE ? % DEV ? OFFSET ? RATIO ? MAXMIN ? LIMITS ? STATS ?</i></p>	<p>SKIP through to find the Analog program.</p> <p>The Analog program is only called up at this stage in order to output the test-pattern to the oscilloscope.</p>

EXIT the programming mode. The test pattern is now being output via the Aux. socket (pins 13 & 14). Adjust the oscilloscope to give the optimum display. Sensitivity approx. 1v/cm, time-base approx. 2ms/cm.

Switch off oscilloscope if it is not required for some time. The programs can now be entered as required. Press MENU.

When Offered, ENTER	When Offered, SKIP	Notes
<p>PROGS ?</p> <p>MODIFY ? ANALOG ?</p> <p>O/P=SCOPE</p> <p>MODE=RUN YMAX=243 YMIN=235</p> <p>SELECT ?</p> <p>LIMITS ? O/P=ALWAYS H=241 L=238 ENGAGE ?</p> <p>MAXMIN ?</p> <p>O/P=PP</p> <p>----- SELECT ? -----</p> <p>CLOCK ?</p> <p>REAL ? TIME= 16 32 00 (eg) BEGIN=05 00 00 3 PERIOD=00 05 00 END= 10 00 00 3 ENABLE ?</p>	<p>PROBES ?</p> <p>SELECT ? RECALL ?</p> <p>MODE=SETUP ?</p> <p>MODIFY ? RESET ? CANCEL ?</p> <p>SCALE ?   MAXMIN ?</p> <p>STATS ?       RATIO ?</p> <p>O/P=INPUT ? O/P=MAX ? O/P=MIN ?</p> <p>PROBES ? PROGS ?</p> <p>ELAPSE ?</p>	<p>Modify program and enter required parameters. High limit 241V, Low limit 238V. Units are not entered.</p> <p>SKIP through to find the LIMITS program.</p> <p>ENTER required parameters. High limit 241V, Low limit 238V. Units are not entered.</p> <p>SKIP through to find the MAXMIN program.</p> <p>Press EXIT/MENU twice to access the clock.</p> <p>Measurements begin when TIME=BEGIN i.e. 5 a.m. of the 3rd day (Monday). Day of clock initiation is referred to as Day 0.</p>

**\*TIMER\*** will now be displayed until the first measurement takes place. Thereafter, the display shows the updated maximum voltage variation. To display the waveform of the voltage variation, simply switch on the oscilloscope.

Individual results may be examined by *RECALLing* the History File, if required. This does not prevent the oscilloscope waveform from being re-displayed. Also the *ANALOG YMAX* and *YMIN* values can be *MODIFYed* as necessary to enable a greater/lesser resolution of the voltage variation waveform to be displayed.



# Chapter 6

## Remote Control

---

<i>Page No.</i>	<i>Para. No.</i>	<i>Title</i>
6.2		Command Index
6.3	1	General
6.3	2	Preparation of Instrument for GPIB Use
6.4	3	Implementation of the GPIB Interface
6.4	3.1	Delimiters
6.5	3.2	Buffers
6.5	3.3	Service Request (SRQ)
6.5	3.4	Serial Poll Byte
6.6	3.5	Parallel Poll
6.6	3.6	GPIB Capability Code
6.6	4	Preparation of Instrument for RS232 Use
6.7	5	Implementation of the RS232 Interface
6.7	5.1	Delimiters
6.7	5.2	Buffers
6.8	5.3	Remote/Local Operation
6.8	6	Interface Command Language
6.8	6.1	Command Set (Verbose)
6.24	6.2	Command Set (Shortform)
6.26	7	Default Command Settings
6.26	8	Output Result Rate
6.27	9	Error Reporting
6.28	10	Using 7151 from the GPIB
6.28	10.1	Hewlett Packard HP85
6.29	10.1.1	Example 1
6.30	10.1.2	Example 2
6.32	10.2	Hewlett Packard HP9825
6.32	10.2.1	Example 1
6.33	10.2.2	Example 2
6.34	10.3	Commodore PET 4032 & 8032
6.35	10.3.1	Example 1
6.35	10.3.2	Example 2

## COMMAND INDEX

Page No.	Verbose	Shortform	Description
<b>Measurement</b>			
6.12	DRIFT	Y	Controls the drift correct facility.
6.14	MODE	M	Selects the measurement function.
6.15	NINES	I	Selects the measurement time.
6.15	NULL	Z	For cancelling small dc offsets.
6.17	PROBES	-	Sets up 7151 to use accessory probes.
6.21	RANGE	R	Selects the measurement range.
6.24	TRACK	T	For taking repetitive measurements.
6.24	TRIG	G	For taking single sample measurements.
<b>System</b>			
6.11	DCL	A	Initialises 7151.
6.11	DELIMIT	U	For defining GPIB output delimiters.
6.11	DISPLAY	D	Enables/disables the display.
6.13	LITERALS	N	Enables/disables non-numeric portion of results.
6.14	LOCK	K	Enables/disables rtl key.
6.16	OUTPUT	-	Enables/disables results output.
6.17	POLL	J	Configures parallel poll response.
6.22	RESUME	-	Determines 7151's switch-ON behaviour.
6.22	SERIAL	-	Reconfigures RS232 settings and delimiters.
6.23	SRQ	Q	Determines generation of SRQ.
6.23	STATUS	!	Causes output of present error status.
	-	E	Causes echoback of all present shortform commands.
<b>Calibration</b>			
6.9	CALIBRATE	C	Permits 7151's calibration.
6.13	HI	H	For entering calibration high point.
6.14	LO	L	For entering calibration low point.
6.21	REFRESH	-	Refreshes existing calibration constants.
6.24	WRITE	W	For calculating and storing cal. constants.
<b>Clock Control</b>			
6.9	BEGIN	-	Determines when clock control starts.
6.10	CLOCK	-	Enables/disables clock control.
6.10	DATE	-	For setting the date.
6.13	END	-	Determines when clock control ends.
6.16	ONCLOCK	-	Determines action at each time signal.
6.16	PERIOD	-	Determines interval between time signals.
6.23	TIME	-	For setting real time.
<b>Program</b>			
6.9	CANCEL	-	For deselecting Active programs.
6.10	COMPUTE	-	Enables/disables processing.
6.12	DUMP	-	Causes output of the history file.
6.15	MODIFY	-	For altering settings of an Active program.
6.21	RECALL	-	For examining Active program contents.
6.21	RESET	-	For initialising results of Active programs.
6.22	SELECT	-	Selects an Idle program for use.
<b>Program Names</b>			
6.18	Scale	-	These names are not commands in their own right and must be used in conjunction with one of the five program actions.
6.18	Offset	-	
6.18	% Deviation	-	
6.19	Ratio	-	
6.19	Maxmin	-	
6.19	Limits	-	
6.20	Statistics	-	
6.20	Analog	-	

All shortform commands are given on page no. 6.24.



## 1 GENERAL

This chapter contains information on how to set up 7151 for use via either of its remote control interfaces and gives the salient details of how each interface is implemented.

Full control of 7151's facilities can be achieved via the interfaces. The facilities consist of all those offered at the front-panel, plus some additional ones.

The interfaces permit commands to be sent to the instrument that initiate measurements, process the data, and finally, return the results to the remote controller, or other output device. The interfaces are:

- (a) The IEEE 488(1978)STD parallel transmission system, also known as the General Purpose Interface Bus (GPIB).
- (b) The EIA RS232C V24 serial transmission system.

Since many types of controller are available, rarely with any two employing the same language, it is beyond the scope of this manual to give a large variety of precise program statements that apply to all controllers. However, as an aid to users unfamiliar with the operation of instruments from a remote controller, several example programs have been included, written in the languages of certain popular controllers.

If 7151 is to be connected to other instruments (besides the controller) the GPIB system of interconnection will probably be used. A description of the interaction between a controller and GPIB connected instruments is not attempted in this manual – that is left to the accompanying publication, "Introduction to the GPIB", the reading of which is recommended if a greater understanding of the subject is required.

## 2 PREPARATION OF INSTRUMENT FOR GPIB USE

Address and Talk/Listen selection.

When 7151 is to be used in conjunction with a controller, set the rear panel selector switches as indicated below:

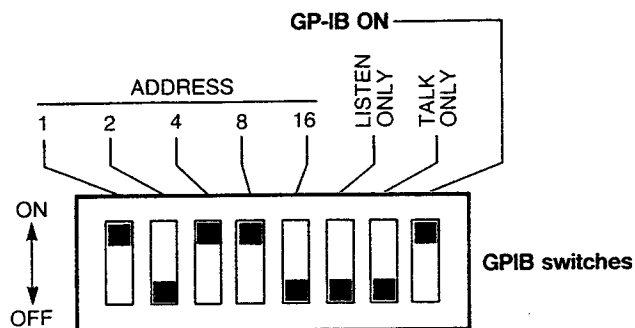

GPIB : ON  
TALK ONLY : OFF  
LISTEN ONLY : OFF

ADDRESS : 1,2,4,8 & 16. – Select as required. For example, to set 7151's address to 21, put switches 16,4 and 1 to the ON position. The permissible address range is normally 0 →30. Remember, each GPIB instrument must process a unique address.

For operation without a controller: e.g. if a printer only is connected to 7151, the TALK ONLY mode should be selected, in addition to GPIB ON.

**Note:** Any alteration to the switch settings is only actioned if the *PWR ON* facility is set to *RESET*, and the instrument switched OFF, and ON again.

Interconnect 7151 and the controller with a standard GPIB cable.

The GPIB socket is situated on the rear panel and is of the Amphenol 24-way variety. For information, the pin-outs of the connector are given below.

Pin	Signal	Pin	Signal
1	DI01	13	DI05
2	DI02	14	DI06
3	DI03	15	DI07
4	DI04	16	DI08
5	EOI	17	REN
6	DAV	18	} Earth returns (OV) of pins 5 → 11
7	NRFD	19	
8	NDAC	20	
9	IFC	21	
10	SRQ	22	
11	ATN	23	
12	Shield (OV)	24	

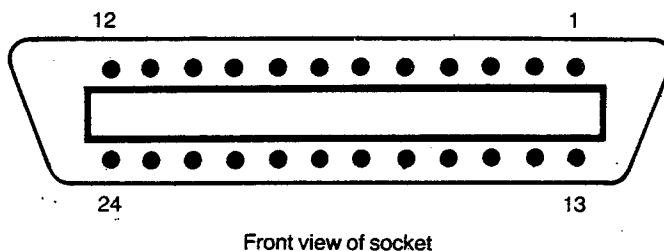

### 3 IMPLEMENTATION OF THE GPIB INTERFACE

#### 3.1 DELIMITERS

**Input** – When a controlling instrument sends a command string to 7151 it signals the end of the string with a special character(s) known as a delimiter(s). This is usually performed automatically by the controller. Command strings must be delimited by either:

- (a) EOI with last string character
- (b) LF following the last string character. CR is ignored.

EOI = End Or Identify  
LF = Line Feed  
CR = Carriage Return

Where it is possible to select the input delimiter, it is advantageous to send EOI together with the last command string character, since this combination economises on input buffer space.

**Output** – When a string of data is output from 7151 to another instrument (controller, printer etc.), it is necessary to terminate the data string with a delimiter. The particular delimiter required is a function of the receiving instrument (controller etc.) and should be specified in its operating manual.

The command, DELIMIT, allows the user to specify a suitable delimiter, of up to six characters in length.

### 3.2 BUFFERS

**Input** – A buffer of 80 bytes (characters) is provided. If a command string of excessive length is sent to 7151, it ordinarily reacts on receipt of the end-of-string delimiter by rejecting the string (and sets the error bit within the status byte). A fresh command string could then be issued.

However, if SRQ on ERROR (or BOTH) has been commanded, a fresh command string cannot be issued until the controller performs a serial poll of 7151.

**Output** – A buffer is provided, whose contents may be read once only (they are erased on output). Overwriting of the output buffer contents occurs when:

- (a) they are the result of a Track (ON) measurement. This permits the instrument's most recent measurement to be read when it is left in Track (ON).
- (b) a new command string is received in the input buffer. Therefore, if the contents of the output buffer are required, ensure that they are read before a new command string is issued.

### 3.3 SERVICE REQUEST (SRQ)

This signal can be generated to indicate a particular operating condition. The particular condition that triggers SRQ can be defined by sending to 7151 the appropriate SRQ command.

The condition could be when an error occurs, when a result is available, or the two combined.

Once SRQ has been generated, it can be released only by performing either a serial poll, or by initialising the instrument with the DCL (Device Clear) command.

### 3.4 SERIAL POLL BYTE

If the controller conducts a Serial Poll, 7151 responds by outputting a Serial Poll status byte onto the data lines. The byte contains information relevant to 7151's welfare and is organised to follows:

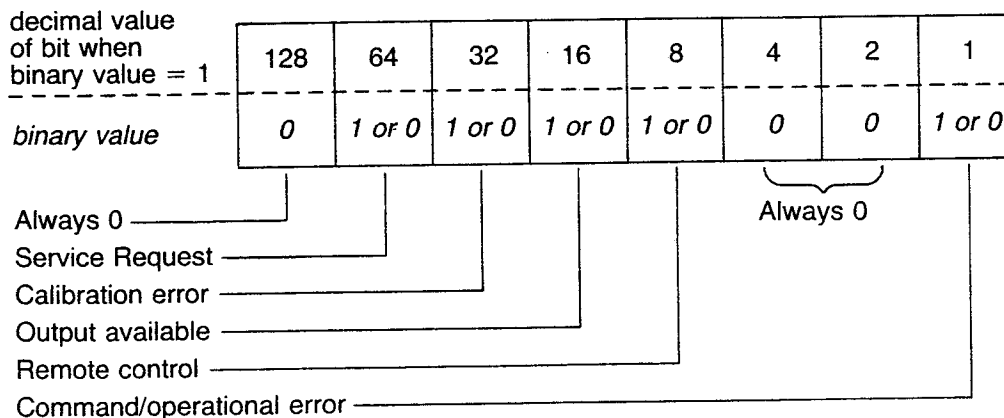

Each of the above conditions is true when the bit in question = 1, and false when the bit in question = 0.

The controller reads the binary status byte (above) and computes its decimal representation from the relevant bit values. From this, it can deduce the status of 7151 by means of a suitable program. For example, if the decimal value of the byte is 80, SRQ was generated because an output was available (i.e.  $16 + 64 = 80$ ).

### 3.5 PARALLEL POLL\*

The instrument can be configured to respond to a parallel poll on any of the data lines DI01→8. It may also be configured not to respond to a parallel poll at all. However, the sense of the response cannot be altered and is fixed at Active Low.

**Note:** The instrument only responds to a parallel poll if 7151 is simultaneously generating SRQ.

\*See GPIB Capability Code, Parallel Poll (below).

### 3.6 GPIB CAPABILITY CODE

The interface obeys the following sub-sets of the IEEE 488 (1978) STD.

SH1 Source handshake  
AH1 Acceptor handshake  
T5 Basic talker, serial poll, talk only selectable, unaddressed if MLA  
L3 Listen only selectable, unaddressed if MTA  
SR1 Service Request  
RL1 Remote/local  
DC1 Device clear  
C0 Not a controller  
DT1 Device trigger, full capability  
E1 Open collector drivers

PP Parallel poll. 7151 has a parallel poll capability, but the manner in which it is configured is not covered by any of the above standard's subsets. Instead, parallel poll configuring is achieved using the 7151 command, 'POLL...'. Re-configuring is simply achieved by the controller sending a further POLL command. This offers an advantage over the conventional PP2 sub-set in which re-configuring would be achieved using switches at the instrument.

## 4 PREPARATION OF INSTRUMENT FOR RS232 USE

The RS232 signals are available from the Auxiliary (15-way Canon D-type) socket on the rear panel. This unconventional socket has been employed intentionally since it also presents certain non-RS232 signals. To present the RS232 signals on a conventional socket a conversion adaptor has to be used. The pin-outs of the Auxiliary socket as viewed from the rear panel is as follows:

Pin	Signal	Pin	Signal
1	+5v	9	Trigger output
2	TxD	10	RxC
3	RxD	11	-12V
4	RTS	12	Remote Sample
5	CTS	13	Analog O/P Hi
6	0V	14	Analog O/P Lo
7	0V	15	DTR
8	Alarm output		

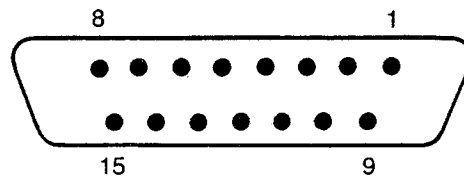

**Note:** Any alteration to the switch settings is only actioned if the *PWR ON* facility is set to *RESET*, and the instrument switched OFF, and ON again.

### Switch Configuration

The rear-panel switch-bank is used to switch on the RS232 interface and to set the baud rate, parity and stop bits. These parameters must be set so that their values match those at the controller. The RS232 switch should be set to ON.

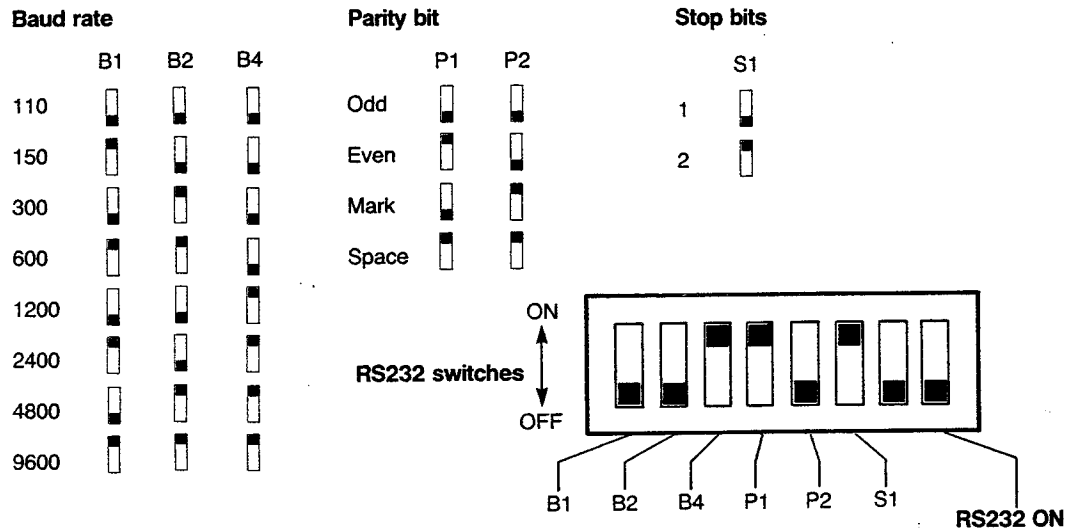

## 5 IMPLEMENTATION OF THE RS232 INTERFACE

### 5.1 DELIMITERS

**Input** – when a terminal sends a command string to 7151, it must signal the end of the string with a special character(s) known as a delimiter(s). 7151 expects the Carriage Return (CR) character to delimit any received command string.

**Output** – By default, 7151's output strings are delimited by the ASCII characters, CR, LF, plus 4 NULLS. The nulls provide a time delay to allow for a printer's carriage to return before starting a new line (this prevents data from being output whilst a printer is unable to reproduce it). However, a delimiter of the user's choice, up to six ASCII characters in length, may be specified where required by issuing the appropriate SERIAL DELIMIT command.

### 5.2 BUFFERS

**Input** – A buffer of 80 bytes (characters) is provided. If a command string of excessive length is sent to 7151, it reacts by outputting an error message on receipt of the 81st character (assuming echoback has not been suppressed). Further characters are accepted as valid.

**Editing** – Various editing facilities are provided, giving some control over the input buffer:

	Control Key	Character Key
Delete last character	RUB-OUT	-
Delete line	CONTROL	X
Re-echo line so far	CONTROL	D
Suppress echoback	CONTROL	N
Restore echoback	CONTROL	O

**Output** – To ensure the legibility of data flows, any ongoing output from the buffer is suspended (between strings) if fresh commands are received by the input buffer. In this case, if an echoback of the new command string is required, it begins only after the interrupted output string has been completely output. Overwriting of the buffer contents occurs when they are the result of a track measurement. This ensures that the most recent result is always ready for output.

### 5.3 REMOTE/LOCAL OPERATION

Sending a command string to 7151 whilst in 'Local' automatically puts it under remote-control.

A 'LOCK' command is provided which can disable the  key and completely inhibit front-panel operation.

## 6 INTERFACE COMMAND LANGUAGE

7151's interface command language is common to both interfaces and consists mainly of English language words (verbose commands).

e.g. MODE VDC  
LITERALS OFF  
RANGE AUTO  
NINES 5

All facilities can be controlled with commands of this type.

In order to maintain compatibility with 7151's predecessor, the 7150, the 7151 can also be commanded using single letter codes (shortform commands).

e.g. M0  
N1  
R0  
I 3

However, only the commands common to both 7151 and 7150 are provided with the shortform capability; the extended facilities of 7151 can be commanded only with verbose commands. Once the user becomes familiar with 7151's commands, or software/buffer space is at a premium, he can combine the verbose and shortform commands as required.

### 6.1 COMMAND SET (VERBOSE)

On the following pages the flow diagrams indicate the necessary syntax for each command structure. The general flow is from left to right (starting with the command word) unless an arrowed line indicates otherwise. Optional items are indicated with by-pass lines.

A brief description of the symbols used in the flow diagrams is given below.

indicates that a SPACE character should be used to separate the adjacent items.

indicates that an EQUALS character should be used to separate the adjacent items.

indicates that a user specified value/text should be entered e.g. program constants.

indicates that one of a set of predefined values/texts should be entered e.g. program options.

indicates the valid end of a command. This may be either (a) a colon ":" if another command follows within the same command string, or (b) the end of string terminator (LF or EOI if using the GPIB, CR if using the RS232).

? Where ? appears in the following diagrams it allows the user to query the status of the particular command. For example, sending MODE ? causes 7151 to return a message such as MODE=VDC (FRONT).

**BEGIN** Selects the start time for the CLOCK control facility.

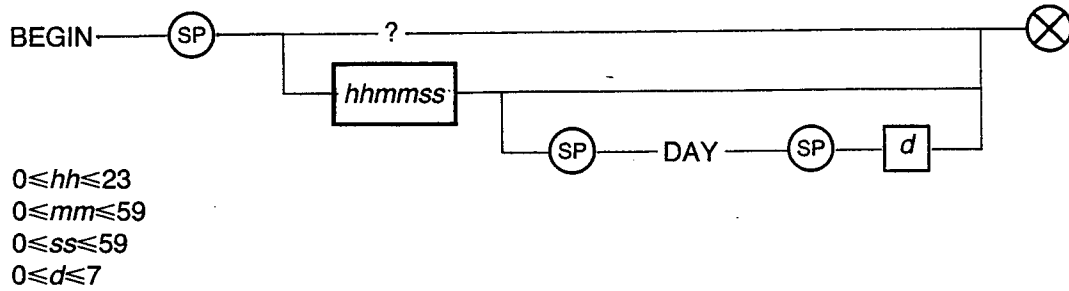

If the clock is to be used in the ELAPSE mode, then BEGIN determines the time delay from the receipt of a trigger to the first time signal. For each DAY specified, 24 hours is added to the time delay.

If the clock is to be used in the REAL mode, then BEGIN determines the actual time at which the first time signal occurs. If the DAY is to be specified, the day during which the clock is invoked is referred to as DAY 0, the following day, DAY 1 and so on.

If the day is not specified then DAY 0 is assumed.

**CALIBRATE** Puts 7151 into the calibration mode.

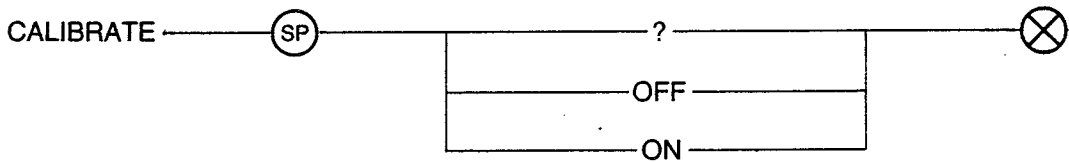

The 'CAL enable' jack socket must be shorted before the CALIBRATE ON command is sent.

Once 7151 is in the calibration mode, the other calibration related commands can be sent.

**CANCEL** Deselects Active programs.

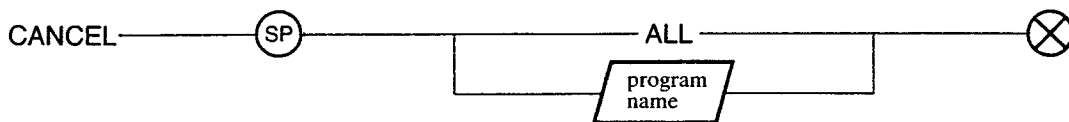

If no programs are left selected after using CANCEL, 7151 automatically reverts to the COMPUTE OFF condition.

Cancelling a program automatically resets its results (if any). User-specified parameters, however, will not be altered.

**CLOCK** Enables/disables the clock control facility.

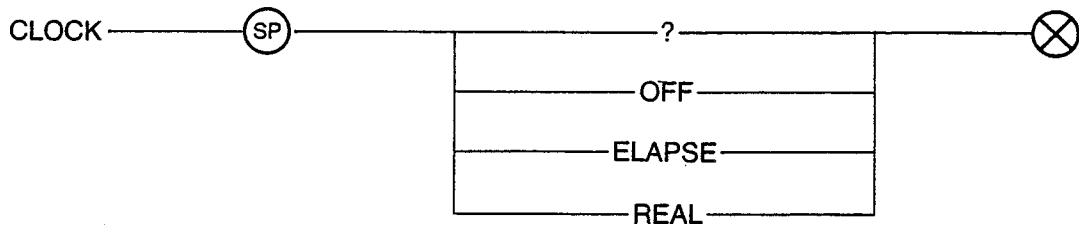

CLOCK OFF disables the clock control facility. It does not affect TIME or DATE.

CLOCK ELAPSE (independent of TIME value) primes the clock control for use in the elapsed mode. The internal elapsed clock is reset and held at zero. Thereafter the next TRIG command starts the elapsed clock.

CLOCK REAL enables the real time clock control. The first time signal is generated when TIME=BEGIN.

**COMPUTE** Permits overall enable/disable of programs.

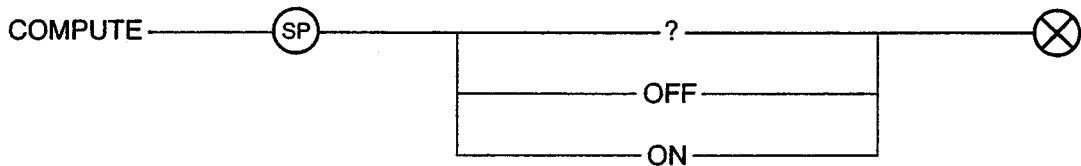

The COMPUTE control determines whether or not measurement results pass into the Active programs.

Attempting to send COMPUTE ON when no programs have been selected results in an error condition.

Measurements taken with COMPUTE OFF do not affect any programs or their results.

**DATE** For setting and examining the date.

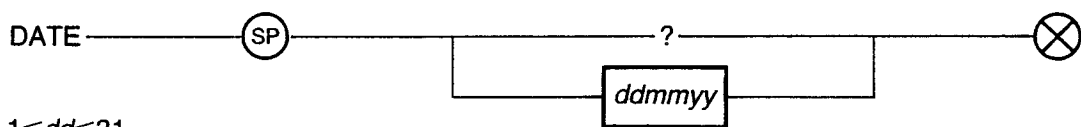

$1 \leq dd \leq 31$   
 $1 \leq mm \leq 12$   
 $0 \leq yy \leq 99$

Up to six digits of date can be specified e.g. DATE 240885.

The DATE increments each time the TIME passes through 000000, and plays no part in REAL or ELAPSE clock control.



**DCL** Initialises the 7151 to the state (Device Clear) given on page 6.26.



All 7151 command settings (except TIME & DATE) revert to a pre-determined condition.

DCL is a duplication of the GPIB interface command "Device Clear", allowing an RS232 controller to perform the same function.

**DELIMIT** For defining the GPIB output delimiters.

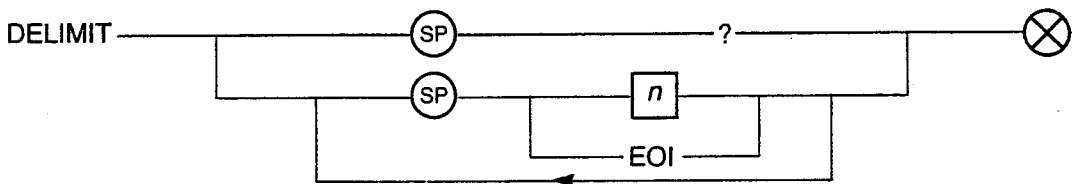

$0 \leq n \leq 127$

**n** is the decimal equivalent of each of the required ASCII characters. EOI can be specified as one of the delimiters. This results in EOI being asserted with the previous character. Up to six delimiting characters may be specified.

For example, "DELIMIT 13 10 EOI" sets the output delimiters as CR, and LF with EOI.

**DISPLAY** Enables/disables 7151's display, or allows user messages to be displayed.

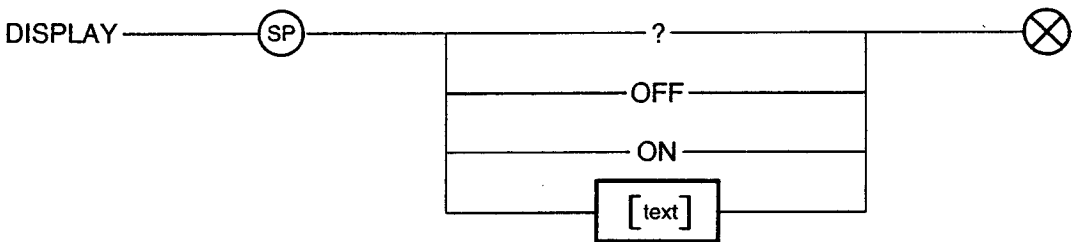

The DISPLAY command determines whether or not results are presented to the display. In addition, the command can be used for displaying a user prompt.

e.g. DISPLAY [TESTING] causes the word "TESTING" to be displayed.

**DRIFT** Controls 7151's timed drift correction facility.

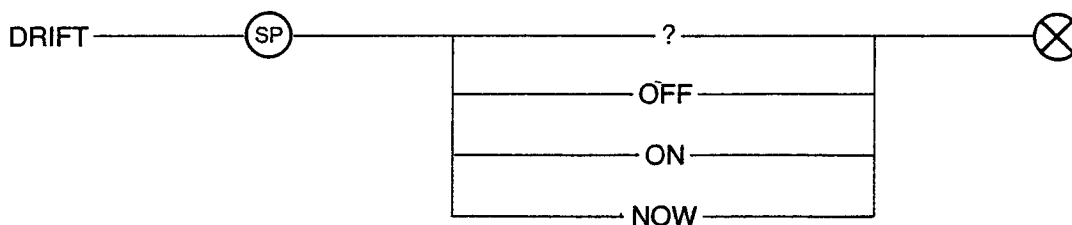

DRIFT ON/OFF enables/disables the 10s timed drift correct.

DRIFT NOW enables a drift correct with the next measurement. The previous status (ON/OFF) is then adopted.

**DUMP** Permits examination of the Analog program's history file.

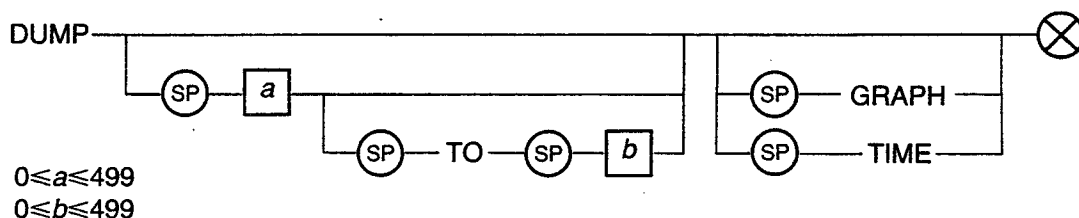

The most recent history file entry is 0; the oldest, 499.

If the command, "DUMP" is sent, the entire history file is output, starting with the most recent entry.

If the command, "DUMP a" is sent, only the entry at location a is output.

If the command, "DUMP a TO b" is sent, all entries from a to b are output, starting with a, and ending with b.

If GRAPH is specified i.e. "DUMP a TO b GRAPH", the entries will be accompanied by a graphical representation of their values, according to the Analog program's YMAX and YMIN. The left hand dot represents YMIN, the right hand dot represents YMAX. The range in between is linear.

For example, "DUMP 25 TO 23 GRAPH" could produce an output such as this:

```
N=025 26.79483 .....*.....
N=024 24.98162 .....*.....
N=023 19.74858 .....*.....
```

If TIME is specified, i.e. "DUMP a TO b TIME", the entries will be accompanied by the time at which each measurement was taken (assuming the measurements were initiated by real or elapsed clock control).

**END** Sets the end time for the clock control facility.

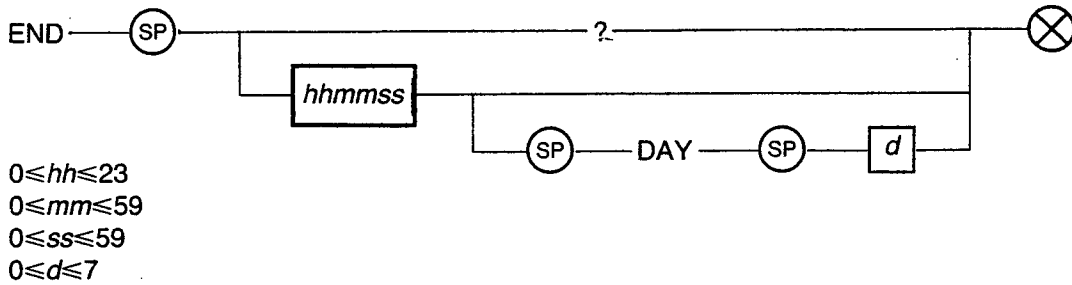

If the clock is to be used in the **ELAPSE** mode, then **END** determines when the time signals cease with respect to the clock's initiating trigger. For each **DAY** specified, 24 hours is added to the time delay.

If the clock is to be used in the **REAL** mode, then **END** determines the actual time at which the clock time signals cease. If the **DAY** is to be specified, the day during which the clock is invoked is referred to as **DAY 0**, the following day **DAY 1** and so on.

If the day is not specified then **DAY 0** is assumed.

**HI** Defines the upper calibration point when calibrating a given range.



**n** must be an integer number no longer than 6 digits. No decimal point is required, regardless of the range being calibrated. See Chapter 7, Calibration, for further details.

**LITERALS** Suppresses the non-numeric portion of a result output string.

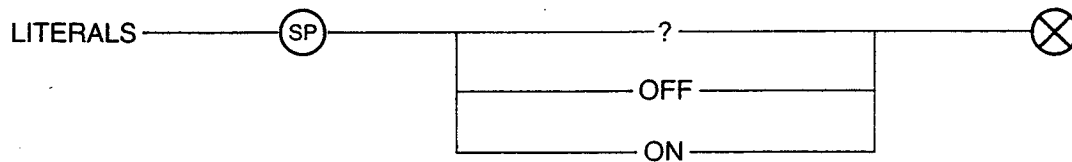

With "LITERALS ON", a typical measurement result output string may be:

"+2.798450 \_ V \_ DC \_ \_ \_ \_ 01.15.00 \_ DAY \_ 5"

With "LITERALS OFF", the same output string would be:

"+2.798450"

**LO** Defines the lower calibration point when calibrating a given range.

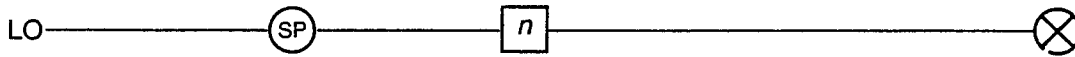

**n** must be an integer number no longer than 6 digits. No decimal point is required, regardless of the range being calibrated. See Chapter 7, Calibration, for further details.

**LOCK** Enables/disables the front-panel **rtl** (return to local) key.

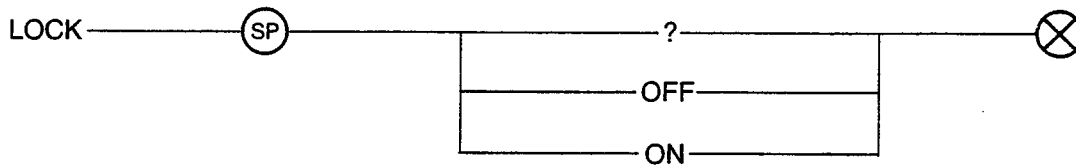

The **LOCK** command provides RS232 controllers (and GPIB controllers which cannot issue the interface command LLO) with the ability to disable the **rtl** key.

With “**LOCK OFF**”, 7151 performs as per the IEEE488 STD and can respond to the GPIB command LLO.

With “**LOCK ON**”, 7151’s **rtl** key is disabled, regardless of whether LLO has been sent.

If an RS232 controller issues “**LOCK OFF**”, 7151 is simultaneously returned to local (front-panel) operation.

**MODE** Selects the required measurement function.

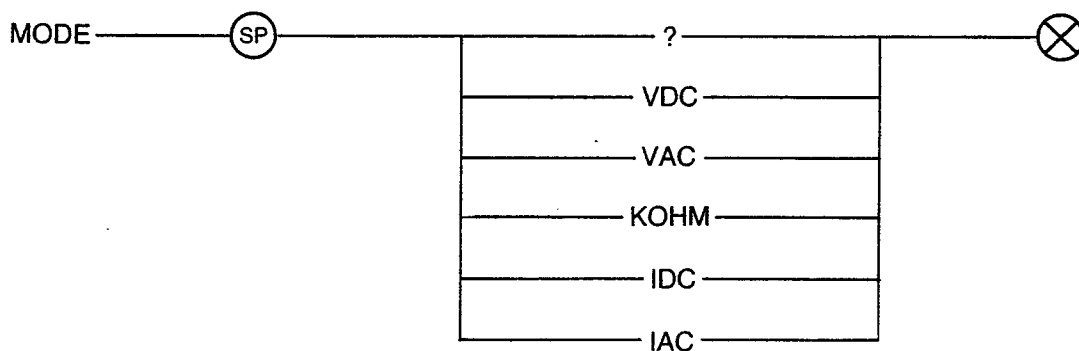

Sending a “**MODE .....**” command automatically switches out any previously selected **PROBE** function.

On recall, (**MODE ?**) the selected measurement function is output. In addition, the output indicates whether front or rear input terminals have been selected.

**MODIFY** For altering the settings of an Active program.

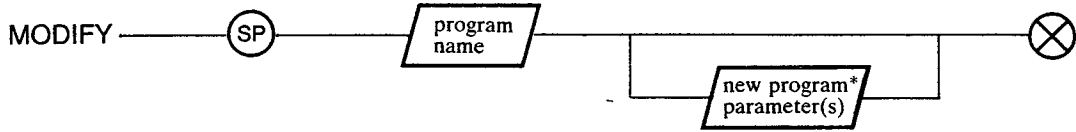

\*refer to the program concerned.

Only the program parameters requiring change need be specified.

**NINES** Controls the instrument's measurement time.

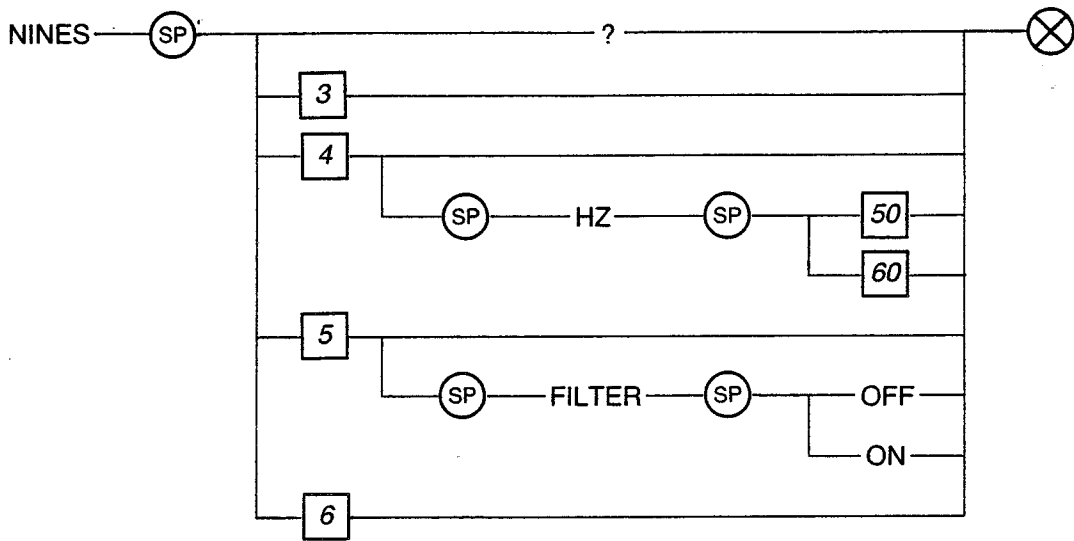

Command	Measurement Time	Notes
NINES 3	6.66ms	Once the line frequency has been specified, 7151 remembers this and gives the correct measurement time when "NINES 4" is next commanded. The default setting of 5×9's is 400ms. Commanding "NINES 5 FILTER ON" changes measurement time to 1.6s. Commanding "NINES 5 FILTER OFF" restores 400ms measurements.
NINES 4 HZ 50	40ms	
NINES 4 HZ 60	50ms	
NINES 5	400ms	
NINES 5 FILTER OFF	400ms	
NINES 5 FILTER ON	1.6s	
NINES 6	8.0s (approx)	

**NULL** Permits small non-ac offsets to be cancelled out.

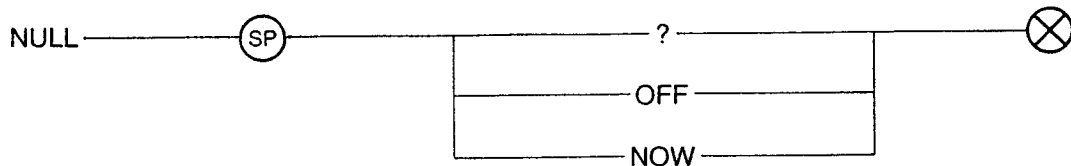

"NULL NOW" causes a null to be performed on the selected function (all ranges).  
 "NULL OFF" destroys the null values for each range of the selected function.  
 "NULL ?" causes either "NULL OFF" or "NULL ON" to be returned to the controller.

**ONCLOCK** Determines the action to be taken at the time signals generated by the clock (REAL or ELAPSE).

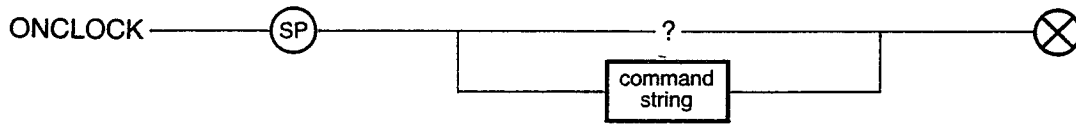

By default the single sample command "TRIG" is generated at every time signal. However, the command can be redefined so that an alternative action is performed at every time signal.

For example, "ONCLOCK RECALL STATS: RESET STATS"

Only an end-of-string (e.g. CR) can delimit this command. Any colons (normal command separators) are considered to be a valid part of the ONCLOCK command string.

**OUTPUT** Enables/disables 7151's output, or allows user messages to be output.

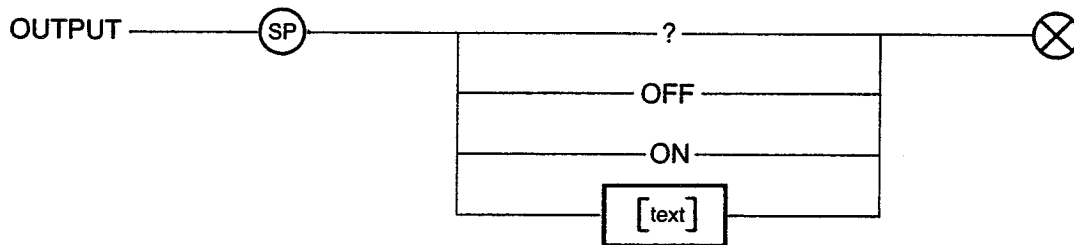

The OUTPUT command determines whether or not 7151's results are presented to the interfaces, but does not prevent 7151 from responding to query (?) commands. In addition, the command can be used for outputting a user message. e.g. "OUTPUT [DONE]" causes the word "DONE" to be output.

**PERIOD** Sets the interval time for the clock control facility.

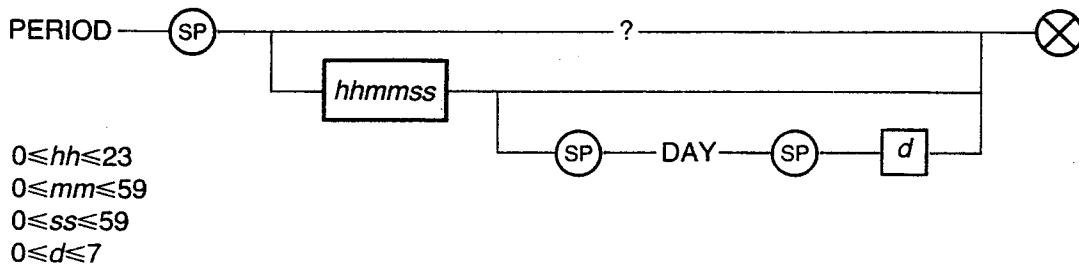

Whether real or elapsed clock control is used, PERIOD determines the time interval between successive clock signals. For each DAY specified, 24 hours is added to the selected PERIOD. If DAY is not specified, DAY 0 is assumed.

For example,  
 "PERIOD 180000 DAY 2" sets up the interval time to be 66 hours.

**POLL** Configures the GPIB parallel poll response

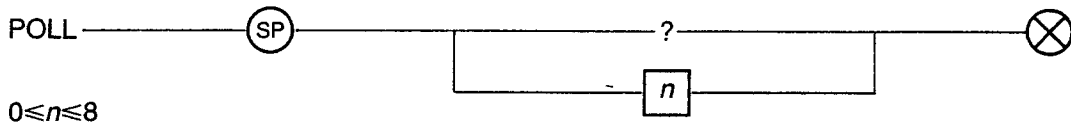

The response of 7151 to the GPIB command “parallel poll enable” is controlled by the “POLL” command rather than the interface command “parallel poll configure”.  
**POLL 0** unconfigures 7151.  
**POLL n** configures 7151 to respond on a particular DIO line.  
 ( $1 \leq n \leq 8$ )

The response to a parallel poll enable only occurs if 7151 is simultaneously generating SRQ.

**PROBES** Permits use of certain accessory probes.

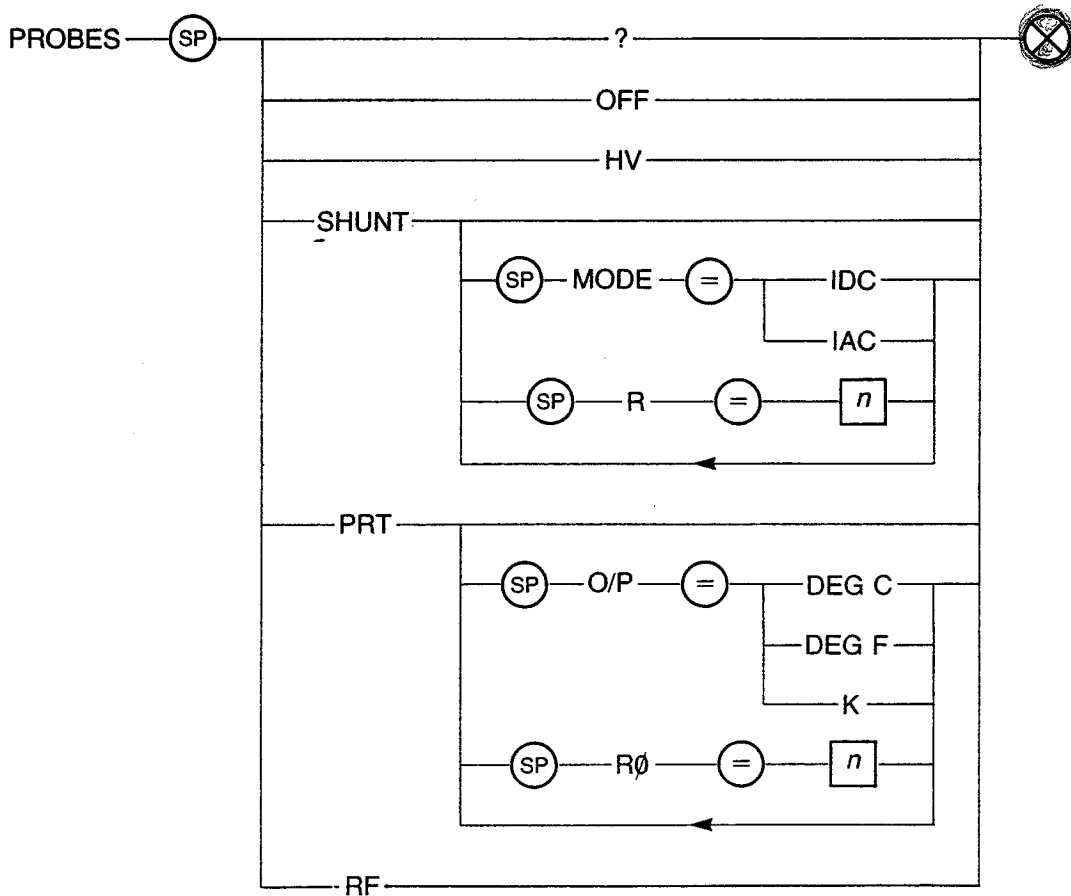

$n$  – resistance of probe (in ohms)

- “PROBE OFF”                      deselects any probe already in use.
- “PROBE HV”                        enables a high voltage probe to be used, and sets 7151 to VDC autorange. All results are multiplied by 1000 to give displayed results in volts.
- “PROBE SHUNT \_ \_ \_ \_”        enables a current shunt to be used, sets 7151 to the appropriate function (IDC or IAC), autorange, and divides all results by the user-specified shunt resistance, R. Displayed results are in milliamps.
- “PROBE PRT\_ \_ \_ \_”            enables a platinum resistance thermometer (prt) probe to be used, sets 7151 to KOHM, autorange, and linearises all measurements to give the required units. The user specifies prt resistance, R0 (resistance at 0°C), and required display: Celsius, Fahrenheit or Kelvin. Displayed results are in degrees.
- “PROBE RF”                        enables any peak sensing rms-scaled probe to be used for extending 7151’s range of measurement, ac, up to radio frequencies (RF). The instrument is set to autorange and results are presented in volts, dc.

The PROBE command automatically reverts to the OFF condition when any new “MODE \_ \_ \_ \_” command is issued.

**Note:** In response to a PROBES ? command, 7151 may generate up to three separate output strings.

**PROGRAMS** These are not commands in their own right and can be used only in conjunction with the program commands; SELECT, RECALL, MODIFY, RESET, or CANCEL.

**SCALE program**

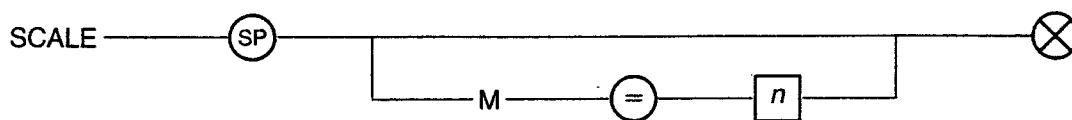

$n$ =value of constant, M

**OFFSET program**

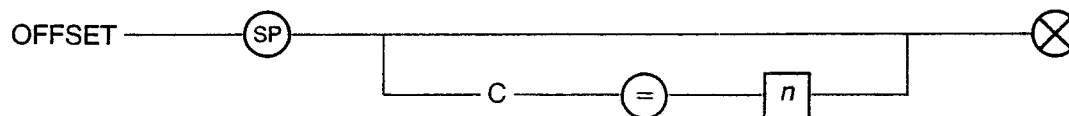

$n$ =value of constant, C

**% DEVIATION program**

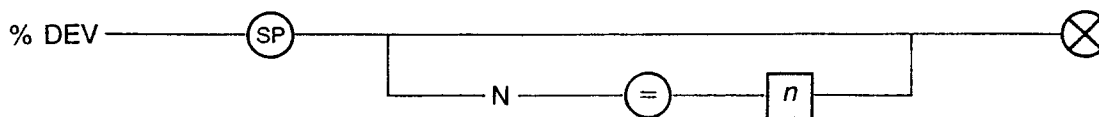

$n$ =value of constant, N



**RATIO program**

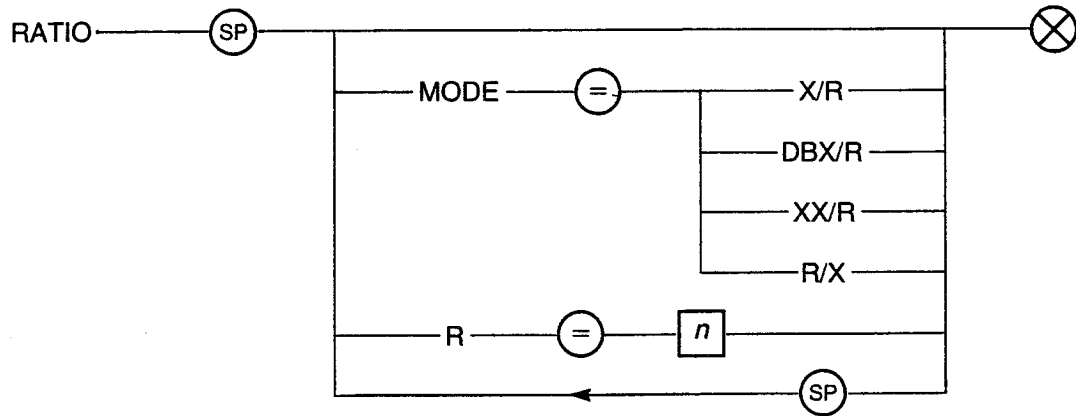

$n$ =value of constant, R

**Note:** In response to a RECALL RATIO command 7151 generates two separate output strings.

**MAXMIN program**

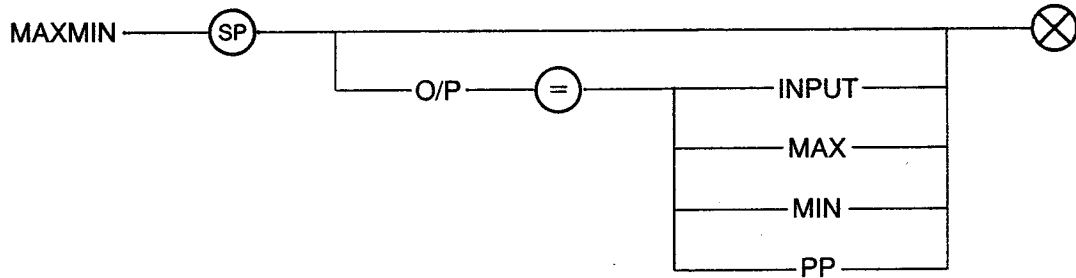

**Note:** In response to a RECALL MAXMIN command, 7151 generates five separate output strings.

**LIMITS program**

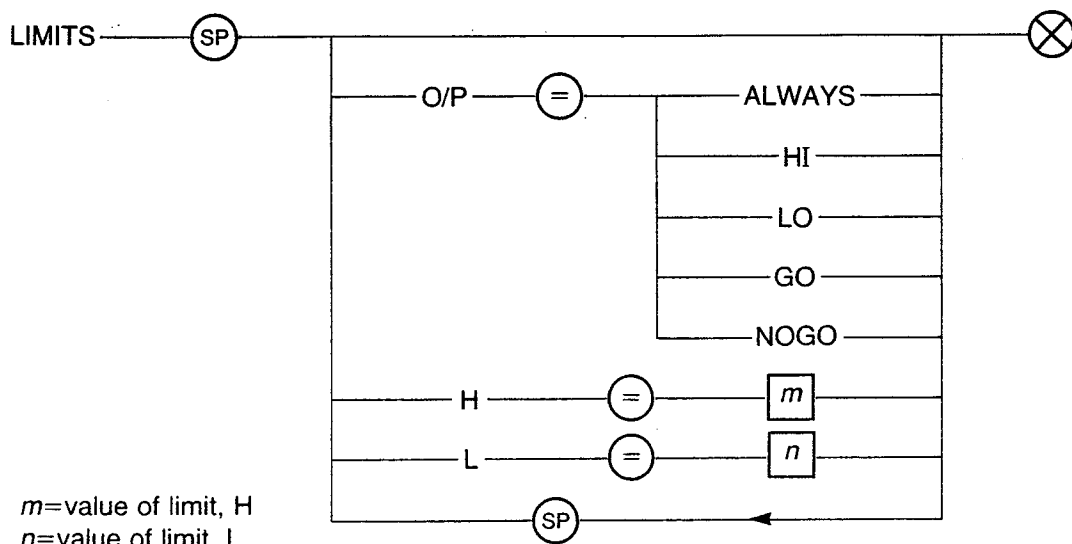

$m$ =value of limit, H  
 $n$ =value of limit, L

**Note:** In response to a RECALL LIMITS command, 7151 generates seven separate output strings.

**STATISTICS program**

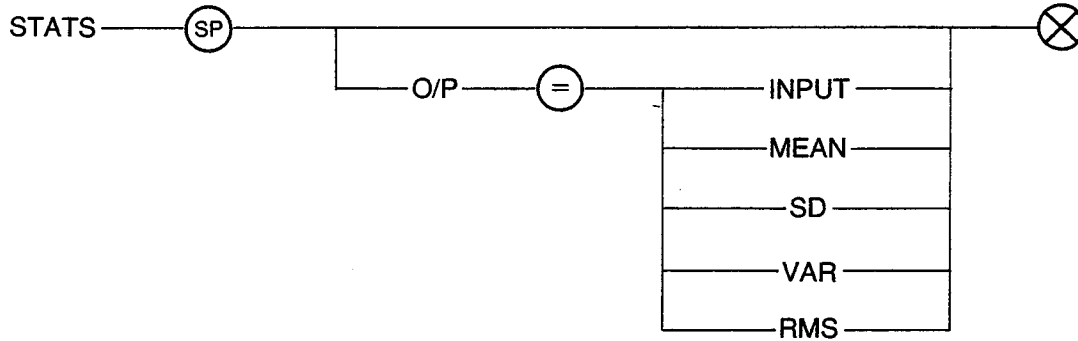

**Note:** In response to a RECALL STATS command, 7151 generates six separate output strings.

**ANALOG program**

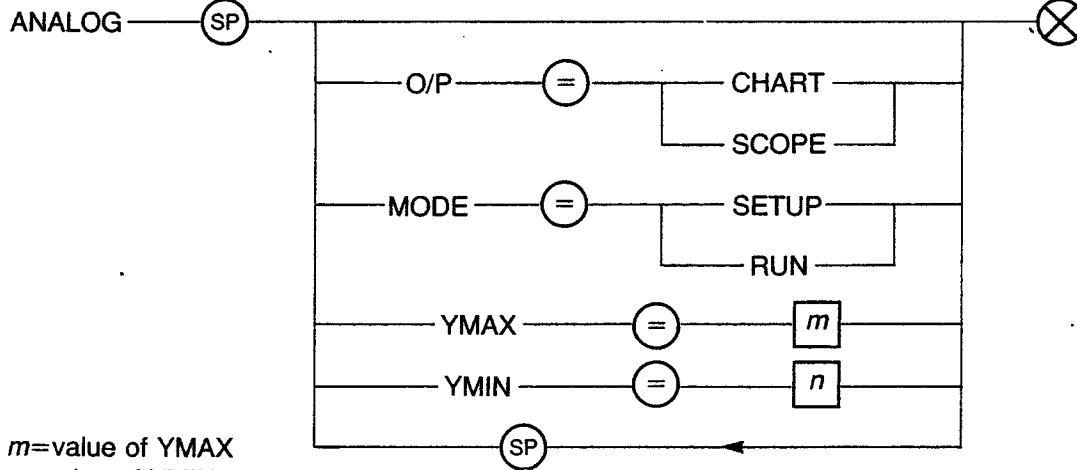

*m*=value of YMAX  
*n*=value of YMIN

**Note:** In response to a RECALL ANALOG command, 7151 generates five separate output strings.

**RANGE** Selects particular measurement range, or autorange.

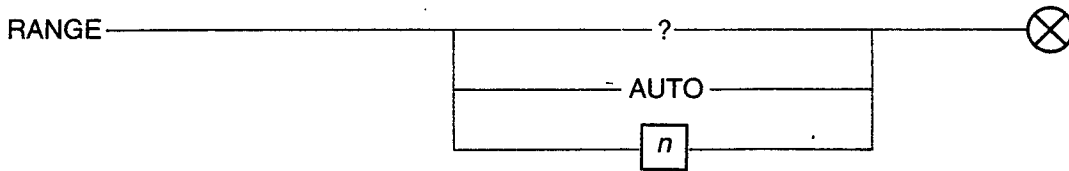

“RANGE AUTO” causes 7151 to change range to suit the applied input signal.

To select a fixed range the value  $n$  is specified where  $n$  is equal to the expected size of the input signal. 7151 responds by fixing to the most appropriate range for that input.

The breakpoints for the fixed ranges are 0.2, 2, 20, 200, 2 000, 20 000.

For example,

“RANGE 18.7” fixes on the range 20

“RANGE 20.05” fixes on the range 200

On recall, “RANGE ?” the response string includes indication of whether fixed, or auto range is selected.

**RECALL** permits examination of the settings and results of Active programs.

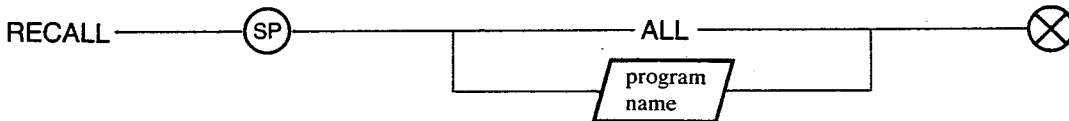

“RECALL ALL” causes 7151 to output the number of Active programs, followed by the names of those programs in their order of selection.

“RECALL program name” causes 7151 to output all settings and results of the specified Active program

**REFRESH** Re-inforces the contents of the calibration memory.



If the instrument is due for re-calibration and the existing state of calibration is satisfactory, sending the REFRESH command re-writes the constants with their existing values. This command can be sent only if “CALIBRATE ON” has already been specified.

**RESET** Resets the results (if any) of an Active program, but not its settings.

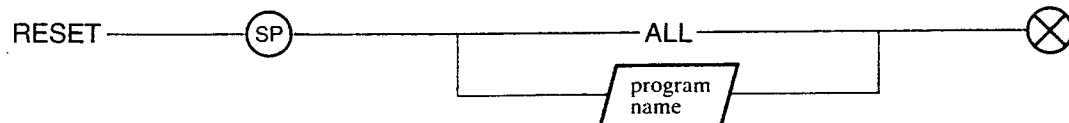

“RESET ALL” causes the results of all Active programs to be reset (to zero).

“RESET .....” causes the results of the specified Active program to be reset.

**RESUME** Determines the behaviour of 7151 at switch-ON.

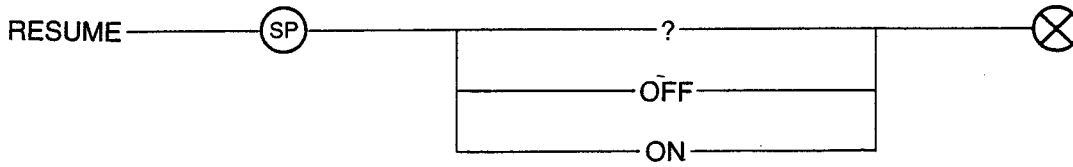

“RESUME OFF” causes 7151 to ‘RESTART’ when it is next switched ON.  
 “RESUME ON” causes 7151 to ‘RESUME’ its settings, clock, probe, and program parameters when it is next switched-ON.

**SELECT** Calls up programs for use.

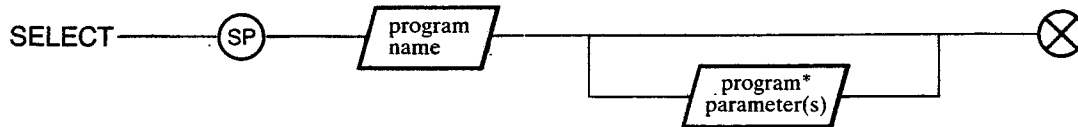

\*refer to the program concerned.

Selecting any program(s) automatically turns ON the COMPUTE control.

**SERIAL** Configures (reconfigures) the RS232 interface.

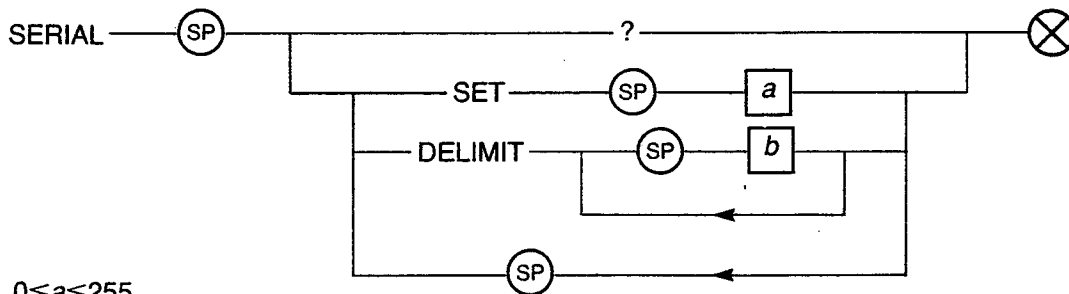

$0 \leq a \leq 255$   
 $0 \leq b \leq 127$

SERIAL command allows the user to specify baud rate, number of stop bits, parity, and output delimiters.

**a** a decimal equivalent of an 8 bit binary number. It determines RS232 ON/OFF parity, stop bits, and baud rate. The decimal equivalent corresponds to the value generated by the rear panel switch settings.

	Parameter	Value	Parameter	Value
Baud Rate	110	0	RS232 ON	128
	150	1	RS232 OFF	0
	300	2	2 Stop Bits	32
	600	3	1 Stop Bit	0
	1200	4	Parity Odd	0
	2400	5	Parity Even	8
	4800	6	Parity Mark	16
	9600	7	Parity Space	24

For example, to set RS232 ON, 1 Stop Bit, Parity Even, Baud Rate = 1200

$$a = 128 + 0 + 8 + 4 = 140$$

**b** a decimal equivalent of each of the required ASCII output delimiter characters. Up to 6 characters may be specified.

For example, the command "SERIAL SET 140 DELIMIT 13 10" switches the RS232 interface ON, 1 Stop Bit, Parity Even, Baud Rate = 1200, and selects CR LF as output delimiters.

**SRQ** Controls generation of the service request (GPIB).

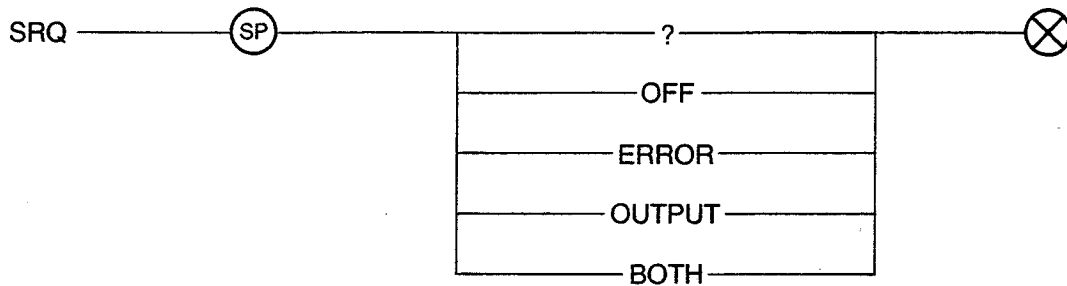

There are two conditions on which 7151 can generate a service request.

- (a) When an error is detected (e.g. bad command etc.)
- (b) When an output string is available.

The user can specify both, either, or none of these conditions to generate SRQ.

**STATUS** Allows the last error (if any) detected by 7151 to be examined.

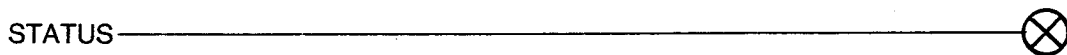

An output string generated in response to this command contains an error number followed by a brief descriptive phrase. The position of the error number in the string is fixed.

Once reported, the error status within 7151 reverts to the no error condition. A typical response to the command might be:

"ERROR 13 PROGRAM NOT SELECTED"

**TIME** For setting and examining the real time clock (i.e. time of day)

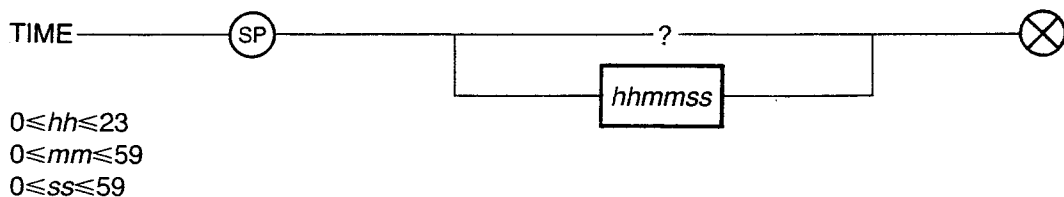

$0 \leq hh \leq 23$   
 $0 \leq mm \leq 59$   
 $0 \leq ss \leq 59$

e.g. "TIME 094500"

Note that the TIME plays no part in ELAPSE clock control. The DATE is incremented whenever TIME passes through 000000.

**TRACK** Enables/disables repetitive measurements.

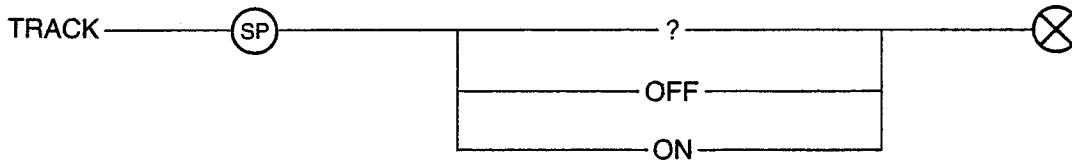

“TRACK ON” causes 7151 to self-trigger and take successive measurements.  
 “TRACK OFF” inhibits this facility.

**TRIG** Triggers one or more single sample measurements.

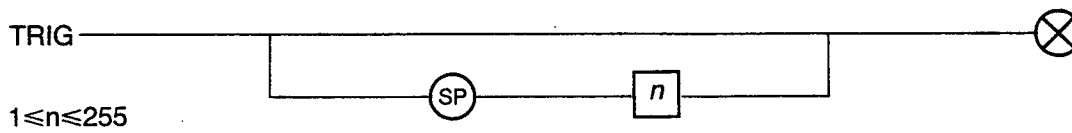

“TRIG” causes a single measurement to be made.  
 “TRIG *n*” causes *n* measurements to be taken.

**WRITE** Causes 7151 to compute and store the values of calibration constants.

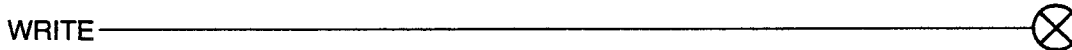

Following the “WRITE” command, if the calibration values are successfully computed and stored, the message, O.K., is displayed by 7151. If unsuccessful, an error message is displayed and returned to the controller.

## 6.2 COMMAND SET (SHORTFORM)

In general, the command syntax is that of a single character command followed by an integer argument (where necessary). Separators are not required between commands; spaces are ignored.

Shortform command	Verbose command	Description
A	DCL	Initialises 7151.
C0 1	CALIBRATE OFF ON	Normal operation. Calibration mode.
D0 1	DISPLAY ON OFF	Display enabled. Display inhibited.
E		Causes 7151 to output the present settings of all shortform commands, in alphabetical order.
G	TRIG	Single sample.
H	HI	Enter calibration high point.
I0 1 2 3 4 5	NINES 3 4 HZ 50 4 HZ 60 5 FILTER OFF 6 5 FILTER ON	6.66 ms measurement time. 40 ms measurement time. 50 ms measurement time. 400 ms measurement time. 8.0 s measurement time (approx). 1.6 s measurement time.

Shortform command	Verbose command	Description
J0 1 2 3 4 5 6 7 8	POLL 0 1 2 3 4 5 6 7 8	No response to parallel poll. Respond on DIO line 1 line 2 line 3 line 4 line 5 line 6 line 7 line 8
K0 1	LOCK OFF ON	rtl key operates as per IEEE 488 STD. rtl key disabled.
L	L0	Enter calibration low point.
M0 1 2 3 4	MODE VDC VAC KOHM IDC IAC	When M? is sent the response does not include an indication of whether front or rear inputs are selected.
N0 1	LITERALS ON OFF	Numeric output with literals. Numeric output only.
Q0 1 2 3	SRQ ERROR BOTH OFF OUTPUT	SRQ on error only. SRQ on error or output. SRQ disabled. SRQ on output only.
R0 1 2 3 4 5 6	RANGE AUTO 0.2 2 20 200 2000 20000	When specifying the argument (range) of R, and that range is not valid for the selected function, 7151 automatically adopts the nearest valid range. For example, if current, dc is selected, sending any argument (0→6) with R causes the one suitable range to be selected. On echoback, the Range setting, R, is followed by two numbers e.g. R13; the first number gives autorange status (0=off, 1=on); the second number gives the present range.
T0 1	TRACK OFF ON	Single sample measurements can be taken. Repetitive measurements are taken.
U0 1 2 3 4 5 6 7 8	DELIMIT 13 10 3 13 10 3 EOI 13 10 EOI 3 EOI 13 10 3 EOI 13 32	Output delimiter CR LF ETX CR LF ETX EOI CR LF EOI ETX EOI CR LF ETX EOI CR SPACE
		When the U? command is sent 7151 responds by returning an argument (0 →9). 0 →8 correspond to the above delimiters; U9 indicates that a delimiter has been selected with the DELIMIT command.
W	WRITE	Writes calibration constants.
Y0 1 2	DRIFT ON NOW OFF	Timed drift corrects enabled. Drift correct with next measurement. Timed drift corrects disabled.
Z0 1	NULL OFF NOW	Disable null. Take a new null.
?	?	When preceded by a command letter, 7151 outputs the present setting of that command.
!	STATUS	Causes present error status to be output.

## 7 DEFAULT COMMAND SETTINGS

Each command always assumes one of its settings by virtue of either the switch ON process, or commands issued by the controller.

**Power-on** If the PWR ON facility has been set to RESUME, it powers up into the same state of command as when it was last used (null values and ELAPSE clock are reset though). If the PWR-ON Facility was left unselected or set to RESET, then at power-up, all the settings will be reset so that the instrument adopts the Device Clear condition where the following commands are assumed:

BEGIN 0.	END 0	PERIOD 000001
CALIBRATE OFF	LITERALS ON	POLL 0
CANCEL ALL	LOCK OFF	PROBES OFF
COMPUTE OFF	MODE VDC	RANGE AUTO
CLOCK OFF	NINES 5 FILTER OFF	RESUME OFF
DELIMIT 13 10	NULL OFF	SRQ ERROR
DISPLAY ON	ONCLOCK TRIG	TRACK ON
DRIFT ON	OUTPUT ON	SERIAL SET a* DELIMIT 13 10 0 0 0 0

\*a depends on the rear-panel switch settings.

Calibration, TIME, and DATE are unaffected by RESET (or Device Clear).

At power-ON, a RESTART (or RESUMED) message is output to the controller which conveys the TIME (of day), DATE, software version, and whether the calibration is GOOD or FAIL.

## 8 OUTPUT RESULT RATE

The result rates listed in the Specification pages are maximum figures and certain procedures have to be observed if these rates are to be matched. This applies particularly when taking 3×9's (25/s) or 4×9's (14/s or 12/s) measurements.

The important points are:

- (a) Disable drift corrects (DRIFT OFF)
- (b) Switch display OFF (DISPLAY OFF)
- (c) Numeric output only (LITERALS OFF)
- (d) Cancel all programs (CANCEL ALL)
- (e) No probes (PROBES OFF)



## 9 ERROR REPORTING

If an input overload is detected by 7151 during a measurement period, the data string contained within the output buffer will contain the ASCII character, !, to indicate the error. Thus, when the string is output to a remote controller, the error indicator accompanies it.

If an operating error has occurred (or is suspected), a controller can send the STATUS command to 7151, causing it to examine the last error (if any) detected. The resulting output string is of the form error 'n' + fault condition, where n = the error message number. Once reported, the error status within 7151 reverts to a no error condition in readiness for any further error. If more than one error occurs only the most recent one is reported.

Regardless of any other operation, error messages are always presented to the interfaces, and to the display of at least one second.

### Error Messages

DISPLAYED ERROR MESSAGE (via interface)		Notes
ERROR 00	OK	
ERROR 01	BAD COMMAND	Check command.
ERROR 02	BAD ARGUMENT	Check syntax
ERROR 03	I/P BUFFER OVERFLOW	Break command string into smaller parts
ERROR 04	HI NULL	Reduce offset value or use it as a correction factor in OFFSET program.
ERROR 05	ILLEGAL MODE FOR NULL	Cannot null ac ranges
ERROR 06	ILLEGAL MODE FOR 6×9s	Cannot use 6×9's on ac ranges
ERROR 08	CAL INHIBITED	Insert CAL shorting plug
ERROR 09	COMMAND ILLEGAL IN CAL	
ERROR 10	CAL OUTSIDE LIMITS	Recalibrate instrument
ERROR 12	INVALID PROGRAM NAME	Check against menu
ERROR 13	PROGRAM NOT SELECTED	Select it, if required
ERROR 14	PROGRAM ALREADY SELECTED	Reselect 'action' e.g. MODIFY or RESET
ERROR 15	INVALID OPTION SELECTED	
ERROR 16	NUMERIC OVERFLOW	Result of a computation outside range EXP ±30 Re-arrange arithmetic
ERROR 17	NO PROGRAMS SELECTED	Cannot have COMPUTE ON with no programs selected.
ERROR 18	CLOCK ALREADY ON	
ERRORS 7 AND 11 are unassigned		

## 10 USING 7151 FROM THE GPIB

The following procedures and programs are given primarily to enable users with only elementary programming knowledge to operate 7151 from a GPIB controller. For each of the following program examples, only the bare essentials have been given, in order to make them easily understood. Much program detail often serves purely to tabulate results or to format them in a particular way; such content can initially be regarded as cosmetic, and is mostly excluded.

Beginning in this way the user can experiment with the programs by inserting his own formatting, or other instructions, tailoring the programs to suit his requirements.

The programs are given initially in the Hewlett-Packard HP85 controller language for which they are fully explained, and modifications suggested. The programs are also listed in the languages of the HP9825, Commodore PET 4032 & 8032 controllers.

### 10.1 HEWLETT-PACKARD HP85

#### **Preliminaries**

Ensure that any necessary modules are fitted to the controller. Set 7151's GPIB address to a number (in the range 0 to 30) currently unused by any other instrument connected to the same GPIB. Address no. 26 is used in the example programs. Set GPIB to ON, TALK & LISTEN to OFF.

Interconnect the instruments with a GPIB connector cable, plugged into the appropriate sockets (24 way connector on 7151 rear panel).

Switch ON the equipment.

Before entering any example programs, erase any existing programs in the HP85 by simultaneously depressing the SHIFT and SCRATCH keys, followed by ENDLINE.

Press the ENDLINE key after entering each program line. Once the program has been fully entered, press RUN to start the program, press RESET to stop the program.

### 10.1.1

#### Example 1

This program causes measurements to be taken by 7151, and the results output via the GPIB to the controller where they are displayed on its screen. 7151 is to be set up as follows, with the commands taken from the Verbose Command set:

	Command
Function Vdc	MODE VDC
Range 20V	RANGE 20
Measurement time 400ms	NINES 5
Track ON	TRACK ON
Results with literals	LITERALS ON

The output delimiter is chosen to match the requirements of the controller. The default setting of 7151, CR LF, suits HP85.

#### Program Listing

```
10 CLEAR 726
20 REMOTE 726
30 DIM A$[100]
40 OUTPUT 726;"MODE VDC"
50 OUTPUT 726;"RANGE 20"
60 OUTPUT 726;"NINES 5"
70 OUTPUT 726;"LITERALS ON"
80 OUTPUT 726;"TRACK ON"
90 ENTER 726; A$
100 DISP A$
110 GOTO 90
120 END
```

Press RUN to start the program.

Press RESET to stop the program.

#### Listing Description

line 10 Clears 7151 to its default state.  
line 20 Sets 7151 into remote control (only the  rtl key operative)  
line 30 Defines the string variable (storage area) called A\$ and its length (100 characters) into which measurement results from 7151 are placed.  
line 40  
| Outputs the required commands to 7151 (MODE VDC etc.).  
line 80  
line 90 Causes a measurement result to be taken from 7151 and placed in the location A\$.  
line 100 Causes the contents of A\$ to be displayed.  
line 110 Sets up a program loop.

#### Useful Modifications

- Any of 7151's programs can be selected by inserting the appropriate command into the listing. For example, to display results subject to a multiplication factor of 6.5, insert this program line between lines 70 & 80: OUTPUT 726;"ENGAGE SCALE M=6.5"  
Renummer the other program lines to suit.
- If a printer is to be connected in via the GPIB, the results from 7151 could easily be directed to it. Say the printer's address is set to 24, and replace the existing line 100 with:  
OUTPUT 724; A\$

### 10.1.2 Example 2

This program causes single shot measurements to be produced when required by pressing one of the special function keys, say K1. To exit from the program, another special function key is pressed, say K2. The measurement results are to be displayed on the screen; 7151 is to be set up as follows:

	<b>Command</b>
Function Vac	MODE VAC
Range 20V	RANGE 20
Measurement time 6.66ms	NINES 3
Track OFF	TRACK OFF
Single sample	TRIG
Results with literals	(Default State)

#### Program Listing

```
10 CLEAR 726
20 REMOTE 726
30 DIM A$(100)
40 OUTPUT 726;"MODE VAC"
50 OUTPUT 726;"RANGE 20"
60 OUTPUT 726;"NINES 3"
70 OUTPUT 726;"TRACK OFF"
80 ON KEY# 1 GOTO 110
90 ON KEY# 2 GOTO 150
100 GOTO 100
110 OUTPUT 726;"TRIG"
120 ENTER 726;A$
130 DISP A$
140 GOTO 80
150 CLEAR
160 DISP "PROGRAM TERMINATED"
170 END
```

Press RUN to start the program.  
Press RESET to stop the program.

#### Listing Description

line 10 Clears 7151 to its default state.  
line 20 Sets 7151 into remote control (only the rtl key operative)  
line 30 Defines the string variable called A\$, and its length.  
line 40  
| Outputs the required commands to 7151 (MODE VAC etc.).  
line 70  
line 80 When K1 is pressed, program execution passes to line 110.  
line 90 When K2 is pressed, program execution passes to line 150.  
line 100 Waits for a key – press.  
line 110 Outputs to 7151 the single sample command, "TRIG".  
line 120 Reads a result from 7151 and stores it in A\$.  
line 130 Displays the contents of A\$.  
line 140 Sets up a program loop ready for the next key – press.  
line 150 Clears the screen.  
line 160 The legend "PROGRAM TERMINATED" is displayed.

### Useful Modifications

Say it is required to take some statistics of the above measurement results. The updated stats. results are to be displayed on request. The means of resetting the stats. is also to be provided, enabling new batches of results to be obtained.

The details to be added to the program are:

- (a) Inclusion of the STATS. program.
- (b) Inclusion of commands to RECALL and RESET the STATS program.
- (c) Definition of two more special function keys, say K3 to recall and display the updated statistics, and K4 to reset the stats. results prior to taking a new batch of measurements.

### Revised listing

```
10 CLEAR 726
20 REMOTE 726
30 DIM A$(100)
40 CLEAR
50 OUTPUT 726;"MODE VAC"
60 OUTPUT 726;"RANGE 20"
70 OUTPUT 726;"NINES 3"
80 OUTPUT 726;"TRACK OFF"
90 OUTPUT 726;"SELECT STATS O/P=INPUT"
100 ON KEY# 1 GOTO 150
110 ON KEY# 2 GOTO 290
120 ON KEY# 3 GOTO 190
130 ON KEY# 4 GOTO 260
140 GOTO 140
150 OUTPUT 726;"TRIG"
160 ENTER 726;A$
170 DISP A$
180 GOTO 140
190 OUTPUT 726;"RECALL STATS"
200 DISP "★ STATS RESULTS SO FAR★"
210 FOR I=1 TO 6
220 ENTER 726;A$
230 DISP A$
240 NEXT I
250 GOTO 140
260 OUTPUT 726;"RESET STATS"
270 DISP "★ STATS RESULTS RESET★"
280 GOTO 140
290 CLEAR
300 DISP "★PROGRAM TERMINATED★"
310 END
```

line 210 When STATS is recalled there are 6 strings of data to be read (O/P = INPUT, N = \_\_\_\_, R.M.S. = \_\_\_\_\_ etc.).

line 240 The statement "FOR I=1 TO 6" causes lines 210 and 220 to be repeated 6 times. 'I' is incremented for each loop, and when 'I=6', program execution continues at line 250.

## 10.2 HEWLETT-PACKARD HP9825

### General

Output Delimiter recognised by HP9825 : CR, LF.

### Preliminaries

Ensure that the GPIB interface 98034A is fitted to one of the rear slots on the HP9825. The interface 'select code', which is switchable by means of the rotary switch on the interface, should be set to 7 (normal factory setting).

Ensure that a 98214A ROM cartridge is fitted to one of the 4 front slots in the HP9825 (up to 4 ROM cartridges can be fitted).

Set 7151 GPIB address to 26, as this is used in the following programs. If required, any other address in the range 0 to 30, with the exception of address 21, can be selected, providing that the appropriate program lines are amended accordingly. Address 21 is factory set for the HP9825.

Connect the lead from GPIB interface to the 7151 GPIB socket.

Switch ON the equipment.

Before entering any programs, erase any existing programs by pressing the ERASE and EXECUTE keys.

Remember to press the STORE key after entering each program line.

### 10.2.1 Example 1 (per HP85 Ex. 1)

#### Program Listing

```
0 dim A$[100]
1 clr 726
2 rem 726
3 wrt 726,"mode vdc"
4 wrt 726,"range 20"
5 wrt 726,"nines 5"
6 wrt 726,"literals on"
7 wrt 726,"track on"
8 red 726, A$
9 dsp A$
10 goto 8
```

Press RUN to start the program.  
Press STOP to stop the program.

### 10.2.2 Example 2 (per HP85 Ex. 2)

Prior to running the program the f0 and f1 (special function keys) must be defined as follows:

f0:★1→A i.e. when 'f0' is pressed (to take a measurement) A becomes equal to 1  
f1:★2→A when 'f1' is pressed (to exit the program) A becomes equal to 2

The procedure for programming the special function keys is as follows:

1. Press FETCH
2. Press f0
3. Enter the definition, i.e. ★1→A (★means Immediate Execute)
4. Press STORE
5. Press FETCH
6. Press f1
7. Enter the definition, i.e. ★2→A
8. Press STORE

#### Program Listing

```
0 dim A$[100]
1 clr 726
2 rem 726
3 wrt 726,"mode vac"
4 wrt 726,"range 20"
5 wrt 726,"nines 5"
6 wrt 726,"track off"
7 "loop":
8 if A=1;0 →A; gto "trigger"
9 if A=2;0 →A; gto "end"
10 gto "loop"
11 "trigger":trg 726
12 red 726, A$
13 dsp A$
14 gto "loop"
15 "end":dsp "program terminated"
16 end
```

Press RUN to start the program.  
Press STOP to stop the program.

### 10.3 COMMODORE PET 4032 & 8032

#### General

**Polling** – The PET 4032 & 8032 do not have the normal polling facility. However, the 7151 command, !, may be used as a substitute. Incorporated into a program, the ! command causes 7151 to output an error message which can then be examined to ascertain if an error has occurred. If an error is indicated, the user may take appropriate action. During a long program, the ! command could be sent periodically to detect any error that may have arisen in the 7151.

**Lockout** – As the PET 4032 & 8032 do not have a 'local lockout' (LLO), or 'Go to Local' (GTL) command, the 7151 command, LOCK, must be used to disable/enable the rtl key on the front panel.

**Output Delimiter** – The output delimiter must be CR.

Other delimiters, such as LF, should not be cleared from the 7151 output buffer after a measurement and would therefore corrupt the subsequent reading.

**Bus Transfers** – In practice, the PET may attempt to read data from the 7151 before a measurement result is ready and thus a zero reading would be produced. To avoid this, the IF statement is included with the bus transfer statement. This will cause the program to keep repeating the INPUT instruction until a reading is available. At this point the status of the PET will change from 1 to 0 and the program will continue. Status=1 means no output is available, Status=0 means an output is available.

**Cursor Control Characters** – These special characters, used within the programs, are echoed on the VDU and printed on the hardcopy listing. For example, the CLR character echoes a heart-shaped symbol in reverse video.

**Addressing** – Only the addresses, 5, 6, 7 and 9 to 30 inclusive, can be used for the 7151 when a PET is used as the controller. The remaining addresses are allocated to the PET as follows:

0 Keyboard	3 VDU
1 Cassette 1	4 IEEE Device 4 (Printer)
2 Cassette 2	8 Disk Drives

#### Preliminaries

Set the 7151 address to 26, as this is the address used in the programs.

Connect the lead from the GPIB port on the 4032/8032 (port nearest the mains switch) to the 7151 GPIB socket.

Switch on the equipment.



### 10.3.1 Example 1 (per HP85 Ex. 1)

#### Program Listing

```
10 OPEN 1,26
20 PRINT #1,"DCL":FOR I=1 TO 2000:NEXT I
30 PRINT #1,"MODE VDC"
40 PRINT #1,"DELIMIT 13"
50 PRINT #1,"RANGE 20"
60 PRINT #1,"NINES 5"
70 PRINT #1,"LITERALS ON"
80 PRINT #1,"TRACK ON"
90 INPUT #1, A$: IF ST<>0 THEN 90
100 PRINT A$
110 GOTO 90
120 END
```

Press RUN to start the program.  
Press STOP to stop the program.

#### Listing Description

line 10 Opens file 1 and assigns it to the instrument at address 26.  
line 20 Clears 7151 and gives a delay (count 2000) before line 30.  
line 30  
|  
| Sets up 7151 with the necessary commands.  
|  
line 80  
line 90 Looks to 7151, takes a result and places it in A\$. If no result is ready, this line is repeated until a result is received.  
line 100 The contents of A\$ are printed.  
line 110 Sets up a program loop.

### 10.3.2 Example 2 (per HP85 Ex. 2)

#### Program Listing

```
10 OPEN 1,26
20 PRINT #1,"DCL"
30 FOR I=1 TO 2000:NEXT I
40 PRINT #1,"MODE VAC"
50 PRINT #1,"RANGE 20"
60 PRINT #1,"NINES 5"
70 PRINT #1,"TRACK OFF"
80 PRINT #1,"DELIMIT 13"
90 GET B$
100 IF B$="A" THEN 130
110 IF B$="B" THEN 180
120 GOTO 90
130 PRINT #1,"TRIG"
140 INPUT #1, A$: IF ST<>0 THEN 140
150 PRINT A$
160 GOTO 90
170 CLOSE 1
180 PRINT "PROGRAM TERMINATED"
190 END
```



# Chapter 7

## Calibration

---

<i>Page No.</i>	<i>Para. No.</i>	<i>Title</i>
7.2	1	General
7.2	2	Entering Calibration Mode
7.3	3	Calibrating a Measurement Range
7.4	4	Restoring the Measurement Functions
7.4	5	Summary

## 1 GENERAL

The user is advised to re-calibrate 7151 annually.

The instrument is re-calibrated by using its internal calibration routine, in conjunction with a remote controller and accurate calibration standards.

If the instrument's existing state of calibration is judged to be satisfactory, the user can simply re-write the existing calibration constants by sending the REFRESH command to 7151 once it is in the calibration mode.

## 2 ENTERING CALIBRATION MODE

Insert a shorted 2.5mm jack plug into the rear panel CAL socket, causing the front panel CAL indicator to repeatedly flash. The short may be within the plug itself, or externally via a switch. The plug must remain fitted throughout the calibration, and can be removed after calibration is complete.

**Note:** Do not switch mains power on or off when the shorting plug is fitted, otherwise the internal calibration constants may be altered.

Using the controller, send the command CALIBRATE ON to 7151, putting it into the calibration mode. The CAL indicator should then be steady. Also displayed is the word, 'CAL'. Once the calibration mode has been selected, the following conditions apply:

- (a) Three commands cannot be used:
- |       |  |
|-------|--|
| TRIG  |  |
| TRACK | 'OFF' status is adopted                              |
| NULL  | 'OFF' status is adopted, all<br>nulls being deleted. |
- (b) Four commands become available:
- |         |   |  |
|---------|---|--|
| HI      | } | described in next section.                 |
| LO      |   |  |
| WRITE   |   |  |
| REFRESH |   | for refreshing existing cal.<br>constants. |

### 3 CALIBRATING A MEASUREMENT RANGE

Using the controller, select the function and range to be calibrated by sending the appropriate MODE and RANGE commands.

7151 must then be supplied with two precisely known reference inputs (non-negative); one at approximately nominal full scale (referred to as the Hi point), and one at approximately zero (referred to as the Lo point). In the case of ac ranges the Lo point should not be less than approximately 5% of nominal full scale rather than zero. This ensures that all inputs are within the optimum part of 7151's linear range.

After a reference input is applied, 7151 must be informed of the precise value of the input. This is achieved by using the HI command for a Hi point, and the LO command for a Lo point. These commands must be accompanied by an integer argument number, of up to six digits in length, which expresses the applied input in terms of a 5×9's count.

An integer value of 200000 corresponds to nominal full scale for any range.

For example, applying 2V on the 2V range, enter 200000  
applying 20V on the 20V range, enter 200000  
applying 5V on the 200V range, enter 005000

Apply the Hi point input to 7151 for the requisite function/range.

For example, 2.00843V on 2Vdc range.

Using the controller, send the HI command to 7151.

For example, HI200843.

7151 responds by displaying 'Hi Pt' for about 1.5 seconds, during which time it measures the applied reference input. When finished, the instrument displays (and outputs) its measured count, e.g. 214576. It is of no consequence if the displayed count differs from the applied input.

Repeat the above procedure for the Lo point. For example, reference = 0V (short circuit), and send the LO command. For example LO0 (leading zeroes need not be specified).

Having specified the Hi point and Lo point (in any order), send the command WRITE to 7151 (no argument required). This causes the calibration constants for the selected range/function to be calculated and stored in memory. If successful, the message 'Good' is displayed. If unsuccessful, an error message will be displayed and output to the controller.

Repeat the above instructions for each function/range to be calibrated.

## 4 RESTORING THE MEASUREMENT FUNCTIONS

Using the controller, send 7151 the command CALIBRATE OFF. The CAL indicator will then flash indicating that the CAL shorting plug is still fitted.

Withdraw the CAL shorting plug. The CAL indicator should then be invisible, the instrument being ready for normal use.

## 5 SUMMARY

- (a) Insert CAL shorting plug (2.5mm) in rear panel socket.
- (b) Select the calibration mode by sending the CALIBRATE ON command.
- (c) Select the requisite function and range to be calibrated and perform the calibration sequence. Repeat for each range/function to be calibrated.
- (d) De-select the calibration mode by sending the CALIBRATE OFF command.
- (e) Remove CAL plug.

Equipment required:

Accurate calibrator (for voltage, resistance, or current) remote controller.

# Chapter 8

## Rack Mounting the 7151

---

<i>Page No.</i>	<i>Para. No.</i>	<i>Title</i>
8.2	1	General
8.3	2	Assembling the Rack
8.4	3	Preparing the Instrument for Rack Mounting
8.5	4	Assembly

## **1 GENERAL**

This requires the rack mounting kit which is available as an accessory (part no. 71501). Each kit allows two 7151's to be mounted side by side in a standard 19" rack (kit height is 2U's high). If one instrument only is to be mounted, the blanking plate can be fitted. The dimensions of the rack are 440(w) × 88.5(h) × 276mm(d). The rack front panel has a width of 482mm, the distance between mounting centres being 462mm.

Before attempting to assemble the kit, refer to the instructions below and the accompanying illustrations.

Each kit contains:

- 4 struts
- 2 side plates
- 2 centre trims
- 2 rack ears
- 8 M4×8mm screws (for fitting the struts and rack ears)
- 4 M3×10mm screws (for fitting the centre trims)
- 4 M4×16mm screws (for fitting the 7151's)
- 1 blanking plate
- 8 captive nuts (four for each 7151)



## 2 ASSEMBLING THE RACK

Fit the two rear struts to the side plates, using the M4×8mm screws. Ensure that the struts are fitted to the 'rear' ends of the side plates, the correct orientation of the side plates being given by the relative position of the holes marked 'A' in Fig. 8.1.

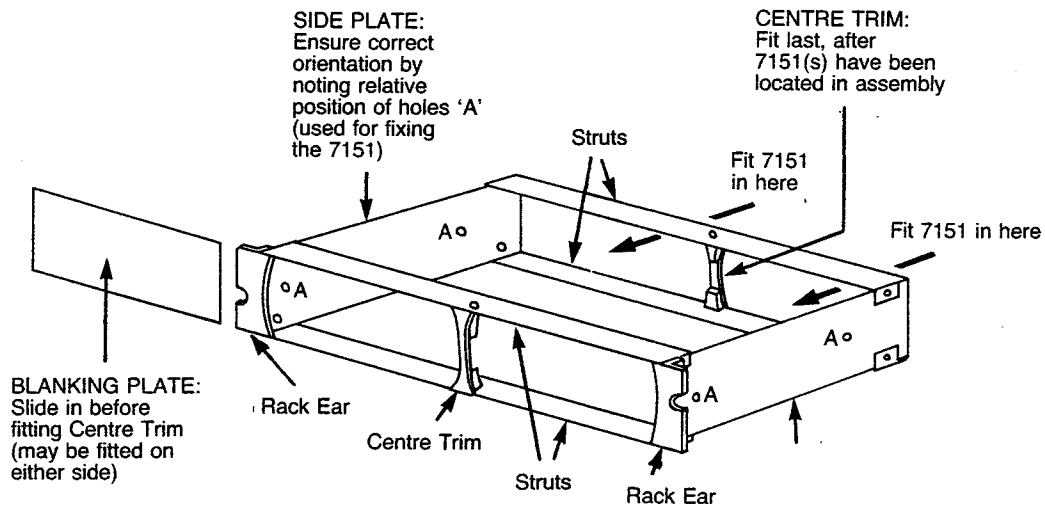

Fig 8.1

Fit the 2 front struts and 2 rack ears to the side plates using the remaining four M4×8mm screws.

If only one 7151 is to be fitted, locate the blanking plate into the appropriate position (left-hand or right-hand side) by sliding the plate into the inner recess in the rack ear. Next, take a centre trim and butt it against the other edge of the blanking plate, and fix the trim to the front struts with the M3×10mm screws. This locks the blanking plate in position.

If two 7151's are to be fitted, omit the blanking plate, but fit the centre trim.

### 3 PREPARING THE INSTRUMENT(S) FOR RACK MOUNTING

With the carrying handle in the position shown in Fig. 8.2, gently pull it away from the case at the pivot points and detach the handle. Note that on later models the handle can be detached only when it is pointing vertically upwards.

Peel off the trim on both sides of the instrument.

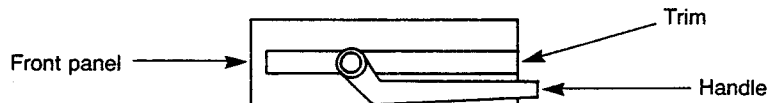

Fig 8.2

Remove the 4 rubber feet from the underside of the instrument, by carefully prising them out with a small screwdriver. See Fig. 8.3.

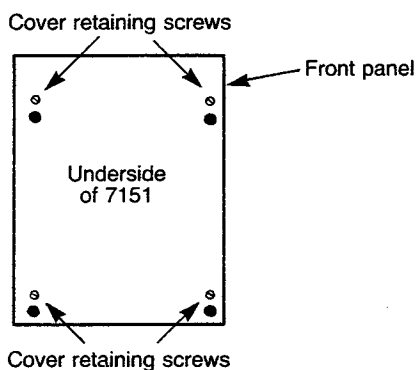

Fig 8.3

Remove the 4 cover retaining screws on the 7151 underside and carefully lift off the top cover.

Fit the 4 captive nuts into the four slots indicated in Fig. 8.4; two in the top cover, and two in the base moulding.

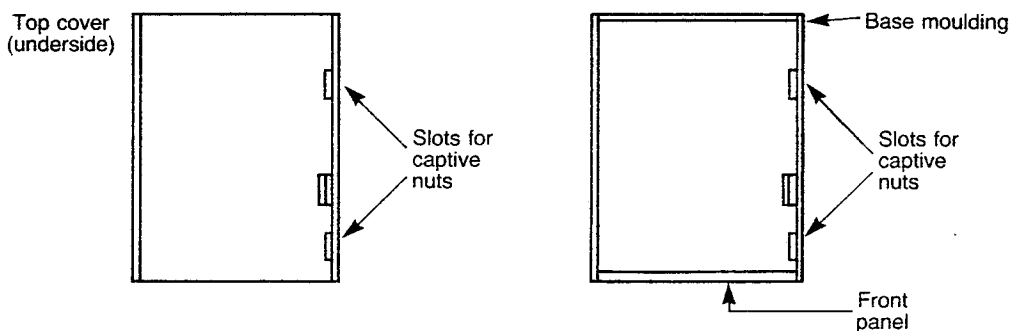

Fig 8.4

Refit the top cover and replace the cover-retaining screws.

## 4 ASSEMBLY

Slide (each) 7151 into the finished assembly from the rear as shown in Fig. 8.1. The front moulding on the 7151 will then butt against the front centre trim and rack ear, such that the instrument protrudes from the front of the assembly by approximately 6mm. Fix (each) 7151 to the adjacent side plate by using two of the M4×16mm screws, passing the screws through the holes in the side plate and into the captive nuts. Use only the screws provided, or ensure that screws do not exceed 16mm in length (longer screws can damage the instrument).

Fit the rear centre trim to the rear struts, securing it with the remaining M3 screws.

Fit the complete assembly into a standard 19" rack, ensuring that adequate ventilation is provided.

Refer to Chapter 1, Section 3 before connecting 7151 to a mains supply.



# Chapter 9

## Specification

---



# Chapter 9 Specification

## ACCURACY

The following apply to the Accuracy sections:  
Limits of Error: expressed as  $\pm$  [% reading + digits]  
apply after 2 hours warm-up  
ac inputs > 1% of range  
dc and resistance with null in use

Calibration Temperature ( $T_c$ ) is the temperature of the calibration environment. Solartron calibration occurs at 20°C and is directly traceable to the National Physical Laboratory. Re-calibration is valid at  $T_c$  from 18°C to 25°C.

Temperature Coefficient need be applied only outside the temperature span quoted with  $T_c$  and is valid from 0 to 40°C.

## VOLTAGE DC

### SCALE LENGTH & SENSITIVITY

Nominal Range	6½ digits		5½ digits	
	Sensitivity	Full Scale	Sensitivity	Full Scale
200mV	100nV	235.0000mV	1µV	235.000mV
2V	1µV	2.350000V	10µV	2.35000V
20V	10µV	23.50000V	100µV	23.5000V
200V	100µV	235.0000V	1mV	235.000V
1000V	1mV	1000.000V	10mV	1000.00V

The full scale will vary with calibration, drift correct and null.

### ACCURACY

Limits of Error, 5½ digit display, filter in. All ranges.

For 24 hrs at $T_c \pm 1^\circ\text{C}$	0.002 + 3
For 1 yr at $T_c \pm 5^\circ\text{C}$	0.008 + 3

### Temperature coefficients

Limits of error:	<0.001%rdg/°C
Zero (Null not in use):	<0.2µV/°C

Range of Null:	>± 1mV
Input current:	<150pA
Input resistance:	10MΩ±1%

### Overload protection

Autorange:	1.2kV peak
Commanded range:	20, 200 or 1000V: 1.2kV peak 200mV or 2V: 750V rms

### BUS CONTROL

Commands select integration time

Scale Length	Integration Time	Tracking Speed*	Additional Error
6½	4s	1/s	2 digits + 1µV
5½ filter in	1.6s	0.6/s	—
5½ filter out	400ms	2/s	2 digits
4½	50ms	12/s	1 digit
4½	40ms	14/s	1 digit
3½	6.67ms	25/s	1 digit

\*7151 is capable of these speeds; the rate of throughput depends on system configuration, particularly software overhead.

## VOLTAGE AC

Measures true rms of ac component

### SCALE LENGTH & SENSITIVITY

5½ digits

Nominal Range	Sensitivity	Full Scale
200mV	1µV	235.000mV
2V	10µV	2.35000V
20V	100µV	23.5000V
200V	1mV	235.000V
1000V	10mV	750.00V

The full scale will vary with calibration and drift correct.

### ACCURACY

5½ digit display, all ranges.

Limits of Error for 24 hours at  $T_c \pm 1^\circ\text{C}$

20Hz to 40Hz	40Hz to 10kHz	10kHz to 30kHz	30kHz to 100kHz
0.25 + 20	0.05 + 20	0.05 + 50	0.4 + 300

Limits of Error for 1 year at  $T_c \pm 5^\circ\text{C}$

Add 0.04% reading to 24 hour figures

Frequency range 10Hz to 20Hz:	add ± 0.65% rdg
100kHz to 300kHz:	<1dB total
300kHz to 500kHz:	<3dB total
Temperature coefficient:	<0.008% rdg/°C

### Non-sinusoidal inputs

Peak input must not exceed 5 × full scale, or 1.2kV peak.

Additional error for 10:1 crest factor: 1%rdg

Input impedance: 1MΩ, 100pF

### Maximum ratings

Autorange:	< 1kHz:	750V rms or 1.2kV peak
	> 1kHz:	200V rms
Command range: 200mV, 2V,	< 1kHz:	500V rms
	> 1kHz:	120V rms
20, 200 or 1000V,	< 30kHz:	750V rms or 1.2kV peak
	> 30kHz:	2 × 10 <sup>7</sup> VHz
		400V

DC content:

### BUS CONTROL

Commands select integration time

Scale Length	Integration Time	Tracking Speed*	Additional Error
5½ filter in	1.6s	0.6/s	—
5½ filter out	400ms	2/s	—
4½	50ms	12/s	1 digit
4½	40ms	14/s	1 digit
3½	6.67ms	25/s	1 digit

## RESISTANCE

### SCALE LENGTH & SENSITIVITY

6½ digits

Nominal Range	Sensitivity	Full Scale	Test Current
2kΩ	1mΩ	2.350000	100μA
20kΩ	10mΩ	23.50000	100μA
200kΩ	100mΩ	235.0000	10μA
2000kΩ	1Ω	2350.000	1μA
20000kΩ	10Ω	23500.00	100nA

The full scale will vary with calibration, drift correct and null.

### ACCURACY

5½ digit display, filter in.

Nominal Range	For 24 hrs at T <sub>e</sub> ± 1°C	For 1 year at T <sub>e</sub> ± 5°C	Temp Coeff ppm/°C
2kΩ	0.002% + 3	0.02% + 3	20
20kΩ	0.002% + 3	0.02% + 3	20
200kΩ	0.003% + 3	0.03% + 3	30
2000kΩ	0.003% + 3	0.03% + 3	30
20000kΩ	0.03% + 20	0.08% + 20	100

Range of Null: > ± 10Ω  
 Overload protection: 240V rms  
 Open circuit voltage: < 7V

### BUS CONTROL

Commands select integration time

Scale Length	Integration Time	Tracking Speed*	Additional Error
6½	4s	1/s	2 digits + 10mΩ
5½ filter in	1.6s	0.6/s	—
5½ filter out	400ms	2/s	2 digits
4½	50ms	12/s	1 digit
4½	40ms	14/s	1 digit
3½	6.67ms	25/s	1 digit

## TEMPERATURE

Intended for use with platinum resistance thermometers to IEC 751. See Accessories, page 15.

Temperature range: -200 to +600°C  
 Resolution: 0.01°C  
 Error in conformance to IEC 751: < 0.1°C  
 Displayed units, selectable: °C, °F or K  
 Resistance at 0°C: selectable

## CURRENT DC

### SCALE LENGTH & SENSITIVITY

Nominal Range	6½ digits		5½ digits	
	Sensitivity	Full Scale	Sensitivity	Full Scale
2000mA	1μA	2350.000	10μA	2350.00

The full scale will vary with calibration, drift correct and null.

### ACCURACY

Limits of Error, 5½ digit display, filter in.

For 24 hours at T <sub>e</sub> ± 1°C:	0.02 + 3
For 1 year at T <sub>e</sub> ± 5°C:	0.04 + 3
Temperature coefficient	< 0.005% rdg/°C
Range of Null:	> ± 1mA
Overload protection:	fused 2A/250V rms
Burden at full scale:	< 0.8V

### BUS CONTROL

Commands select integration time

Scale Length	Integration Time	Tracking Speed*	Additional Error
6½	4s	1/s	2 digits + 10μA
5½ filter in	1.6s	0.6/s	—
5½ filter out	400ms	2/s	2 digits
4½	50ms	12/s	1 digit
4½	40ms	14/s	1 digit
3½	6.67ms	25/s	1 digit

## CURRENT AC

Measures true rms of ac component

### SCALE LENGTH & SENSITIVITY

Nominal Range	Sensitivity	Full Scale
2000mA	10μA	2350.00

The full scale will vary with calibration and drift correct.

### ACCURACY

Limits of Error, 40Hz to 440Hz, 5½ digit display, filter in.

For 24 hours at T <sub>e</sub> ± 1°C:	0.05 + 20
For 1 year at T <sub>e</sub> ± 5°C:	0.2 + 20
Temperature coefficient:	< 0.01%rdg/°C

### Non-sinusoidal inputs

Peak input must not exceed 5 × full scale.  
 Additional error for 10:1 crest factor: 1% rdg

Overload protection: fused 2A/250V rms  
 Burden at full scale: < 0.8V

### BUS CONTROL

Commands select integration time

Scale Length	Integration Time	Tracking Speed*	Additional Error
5½ filter in	1.6s	0.6/s	—
5½ filter out	400ms	2/s	—
4½	50ms	12/s	1 digit
4½	40ms	14/s	1 digit
3½	6.67ms	25/s	1 digit

\*7151 is capable of these speeds; the rate of throughput depends upon system configuration, particularly software overhead.



## INTERFERENCE REJECTION

### Normal Mode, dc measurement

6½, 5½, 4½ digits, 50/60 Hz ± 0.1%:	>60dB
6½ digits, 50/60 Hz ± 10%:	>55dB

### Effective Common Mode with 1kΩ imbalance

DC measurement: rejection of dc:	>140dB
6½, 5½, 4½ digits, 50/60 Hz ± 0.1%:	>120dB
6½ digits, 50/60 Hz ± 10%:	>100dB
AC measurement: 50/60 Hz ± 10%:	> 40dB

Maximum permitted common mode: 500V dc or peak

## INTERFACES

Built in as standard

### IEEE 488 (1978)

Provides full talker/listener facilities and remote control of all 7151 functions.

Subset: SH1, AH1, T5, TE0, L3, LE0, E1, SR1, RL1, DC1, C0, DT1, and parallel poll.

### RS232C

T<sub>x</sub> data, R<sub>x</sub> data, CTS, RTS, DTR.

Speed:	50 to 9600 baud
Parity:	switch selected
Stop bits:	1 or 2

## BATTERY

Charge time (when fully discharged):	20 hrs
Hold-up time:	12 days min. 24 days typ.
Life:	>5 years
Data retention:	RESUME conditions, History File, etc.

## GENERAL

Power supply:	
Voltage (switch selected):	92 to 127V or 188 to 265V
Frequency:	50, 60 or 400Hz
Consumption:	< 25VA
Protection:	
Power supply, fused Line and Neutral:	240V: 100mA slo-blo 120V: 250mA slo-blo fused 2A
Current measurement:	spark gap 1.2kV min
Voltage measurement:	
Environment:	
Temperature, working: RH <30%:	0 to 50°C
RH 90%:	0 to 40°C
Temperature, storage:	-30 to 70°C
Maximum operating humidity:	90%
Otherwise to Def. Std. 66/31 Issue 01 Cat III	
Safety: designed to conform to IEC 348	
Dimensions:	
Height:	88mm (3.46in)
Width (including handle):	228mm (8.98in)
Depth:	278mm (10.94in)
Weight:	3.0kg (6.6lbs)

## ACCESSORIES

### Temperature Probe (71517A)

100Ω platinum resistance sensor to IEC 751 Grade A. Complete with connecting leads for 4-terminal measurement.

Temperature range:	-50 to +250°C
Error:	<0.7°C

### Radio Frequency Probe (70457F)

Peak-sensing, the probe provides dc voltage to the multimeter, which displays the rms value. Complete with fittings and adaptors.

Limits of Error:	1V rms sine wave 100kHz to 500MHz: ±1dB 100kHz to 750MHz: ±3dB 100mV to 40V
Voltage Range:	200V
DC Isolation:	0 to +50°C
Working Temperature:	1m
Lead Length:	

### High Voltage Probe (70457E)

Extends measurement of dc voltage to 40kV. Complete with fittings and adaptors.

Voltage Range:	1kV to 40kV
Division Ratio at 20kV, 23°C:	(1000 : 1) ±0.5%
Limits of Error 1kV to 40kV, 23°C:	±3%
Temperature Coefficient:	<200ppm/°C
Working Temperature:	0 to +50°C
Lead Length:	1.8m

### Current Shunt, 10A (70457X)

Extends the current measuring capacity to 10A. Simple plug-in unit.

Shunt Value:	1mV/A
Accuracy:	±0.9% fs
Range:	1 to 10A
Temperature Coefficient:	±250ppm/°C
Maximum Voltage Burden:	100mV at 10A
Absolute Max. Current:	12A

### NATO Connection Set (71517C)

Two input leads with interchangeable alligator clips, spades, hooks and probes. NATO Stock No. 6625-99-744-2794.

### Rack Mounting Kit (71501)

The 7151 is a ½-rack width unit. Using the 71501 allows two 7151's to be mounted side-by-side in one 19 inch width.

