

**Extended Diagnostics Unit
for
11000-Series Power Supplies
067-1264-00**

WARNING

The following servicing instructions are for use by **Qualified Personnel Only**. To avoid personal injury do not perform any servicing unless you are qualified to do so.

Prior to using the Extended Diagnostics Unit to troubleshoot power supplies in compatible oscilloscope mainframes, **refer to the Operators and Service Safety Information** in the appropriate oscilloscope manuals.

Copyright © 1987 Tektronix, Inc. All rights reserved. Contents of this publication may not be reproduced in any form without the written permission of Tektronix, Inc.

Products of Tektronix, Inc. and its subsidiaries are covered by U.S. and foreign patents and/or pending patents.

TEKTRONIX, TEK, SCOPE-MOBILE, and  are registered trade-marks of Tektronix, Inc. TELEQUIPMENT is a registered trademark of Tektronix U.K. Limited.

Printed in U.S.A. Specification and price change privileges are reserved.

INSTRUMENT SERIAL NUMBERS

Each instrument has a serial number on a panel insert, tag, or stamped on the chassis. The first number or letter designates the country of manufacture. The last five digits of the serial number are assigned sequentially and are unique to each instrument. Those manufactured in the United States have six unique digits. The country of manufacture is identified as follows:

B000000	Tektronix, Inc., Beaverton, Oregon, USA
1000000	Tektronix Guernsey, Ltd., Channel Islands
2000000	Tektronix United Kingdom, Ltd., London
3000000	Sony/Tektronix, Japan
7000000	Tektronix Holland, NV, Heerenveen, The Netherlands

Introduction

The 11000-Series Extended Diagnostics Unit (EDU) is a tool for troubleshooting the power distribution systems of 11000-Series Oscilloscopes without removing the power-supply unit.

To protect the oscilloscopes mainframe, 11000-series power supplies are designed to shut down completely for various reasons such as excessive current demand, voltage faults, or temperature faults. All faults cause the same effect, no output voltages. The Extended Diagnostics Unit connects to the Diagnostic Port (J44) of the Control Rectifier board in the power supply module to indicate the cause of power supply shutdown.

Basic Operation

The EDU is equipped with a FAULT indicator to signal that a power distribution fault has been detected by the power-module in the oscilloscope mainframe. When the FAULT indicator is illuminated, power supply shutdown has occurred or is imminent.

Below the FAULT indicator are 10 indicators for Digital voltage supplies and 10 indicators for Analog voltage supplies which will further indicate the reason for shutdown. Once the EDU indicates that a particular supply distribution system has a fault (e.g., -17 V supply or +5.1 V [B] supply) then the problem can be investigated further by referring to the power supply troubleshooting procedures for the oscilloscope mainframe under test. See the appropriate service manual.

The EDU indicators will illuminate when triggered by faults lasting for 10 μ s or more. The indicators will remain on until the RESET button is engaged or until the power module automatically clears the internal latch and allows the power supply to turn on again. Also, a random indicator display will occur at initial installation of the EDU or at power on of the oscilloscope mainframe. Use the RESET button to clear the indicator display.

Normally when a transient current or voltage fault occurs, the appropriate indicator will light and then extinguish if the fault condition terminates before power-supply shutdown is terminated. If you wish to detect if a supply has been in a transient fault condition, tie pin 14 of the EDU to ground which defeats the automatic clear signal from the power supply module. Then, when a current or voltage fault condition occurs in a particular supply distribution system, the appropriate indicator will turn on and stay on until the RESET button is pressed.

Table 1 provides specific information for each supply distribution system indicated on the EDU display panel.

Troubleshooting procedures

The preceding data provides general information about the features and capabilities of the EDU. For specific installation and power supply troubleshooting information, unique to a particular oscilloscope (e.g., 11401), refer to the power supply diagnostics in the appropriate service manual.

Extended Diagnostics Unit—067-1264-00

TABLE 1
Indicator Identification for Extended Diagnostics Unit

Indicator	Information	Resultant Regulated Power Supply
FAULT Indicator	Indicates oscilloscope power distribution fault (power module shutdown has occurred or is imminent).	
DIGITAL		
+5.1A	The +5.1 V [A] supply ¹ has been current limited.	+5.1 V [A]
+5.1B	The +5.1 V [B] supply ¹ has been current limited.	+5.1 V [B]
+5.1C	The +5.1 V [C] supply ¹ has been current limited.	+5.1 V [C]
+5.1D	The +5.1 V [D] supply ¹ has been current limited.	+5.1 V [D]
+5.1E	The +5.1 V [E] supply ¹ has been current limited.	+5.1 V [E]
+5.1F	The +5.1 V [F] supply ¹ has been current limited.	+5.1 V [F]
OVER VOLT ±5.1	Over-voltage on any positive or negative 5.1 V digital supply ¹ .	Any positive 5.1 V or negative 5.2 V Supply.
-5A	The -5 V [A] supply ¹ has been current limited.	-5.2 V [A]
-5B	The -5 V [B] supply ¹ has been current limited.	-5.2 V [B]
-2	The -2 V supply ¹ has been current limited.	-2 V
ANALOG		
+7A	The +7 V [A] supply ² has been current limited.	+5.0 V [A]
-7A	The -7 V [A] supply ² has been current limited.	-5.0 V [A]
+17	The +17 V supply ² has been current limited.	+15 V
-17	The -17 V supply ² has been current limited.	-15 V
+54	The +54 V supply ² has been current limited.	+50 V
-54	The -54 V supply ² has been current limited.	-50 V
-7B	The -7 V [B] supply ² has been current limited.	-5.0 V
PRIMARY	Signifies excessive line power demand. When lighted alone, it signifies a major fault in the power supply such as a blown fuse, shorted power device, or thermal shutdown (allow 20 minutes cooling for thermal shutdown).	
REG. VOLTAGE	One of the regulated output voltages (± 5.0 A, B; ± 15.0 ; ± 50.0) ² is out of tolerance. Also indicated if the oscilloscope powers up in an erratic manner. (e.g., because of power surges).	
+7B CURRENT	The +7 V [B] supply ² has been current limited.	+5.0 V

¹ Located on the Control Rectifier circuit diagram in the oscilloscope power supply schematics.

² Located on the Regulator circuit diagram in the oscilloscope power supply schematics.

Checkout Procedure

The Checkout Procedure allows the user to quickly check that the Test Fixture is operating correctly with a minimum amount of external test equipment, making it ideal for applications such as new installation or periodic on-site verification.

Test Equipment

Table 2 contains requirements and examples of test equipment required to perform the Checkout Procedure. Procedure steps are based on the test equipment examples given, but other equipment with similar specifications may be substituted. Setup information and related adapters/connectors may need alteration for use with different equipment.

TABLE 2
Test Equipment

Description	Minimum Specification and Purpose	Examples of Applicable Test Equipment
1. Power Supply	5 V to 15 V output, 100 mA. Supplies power to EDU.	1. Tektronix PS 501-1 Power Supply with a TM500-Series Power Module. 2. Tektronix PS 503A Power Supply with a TM500-Series Power Module.
2. Test Leads	Compatible with power supply used. Used to carry power from the power supply to the EDU.	One each red; Tektronix Part No. 012-0266-00. One each black; Tektronix Part No. 012-0266-01. Two each; 013-0107-05 Probe Tips.
3. Circuit Board Square-Pin Connector strip	24 pin male-to-male connector (0.025 in. square-pins on 0.100 in. center spacing). Provides access to signal inputs from 24-pin female connector	Tektronix Part No. 131-3059-00. (break 36-pin connector into groups of 12 pins; two groups of 12 are required)
4. RC Pulser Test Strap	Cable strap and RC network (0.01 μ F capacitor in parallel with a 100 k Ω resistor.)	See Figure 1 for part numbers and assembly instructions.

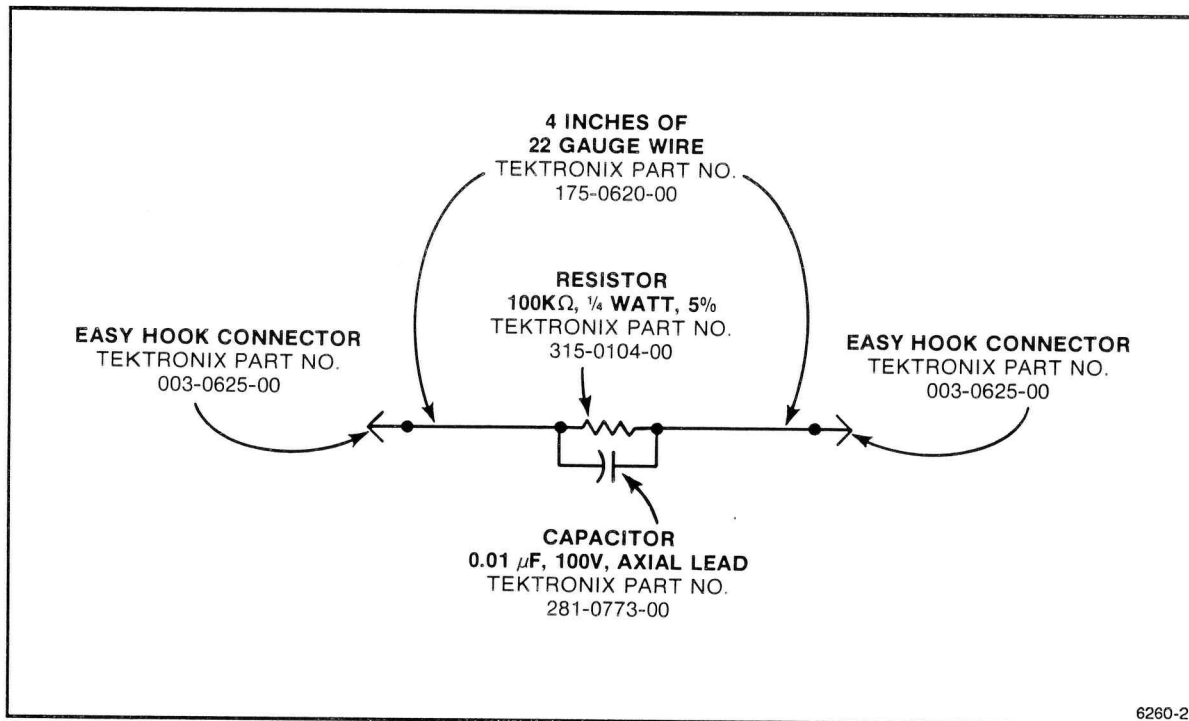

Figure 1. Assembly diagram for RC Pulser Test Strap.

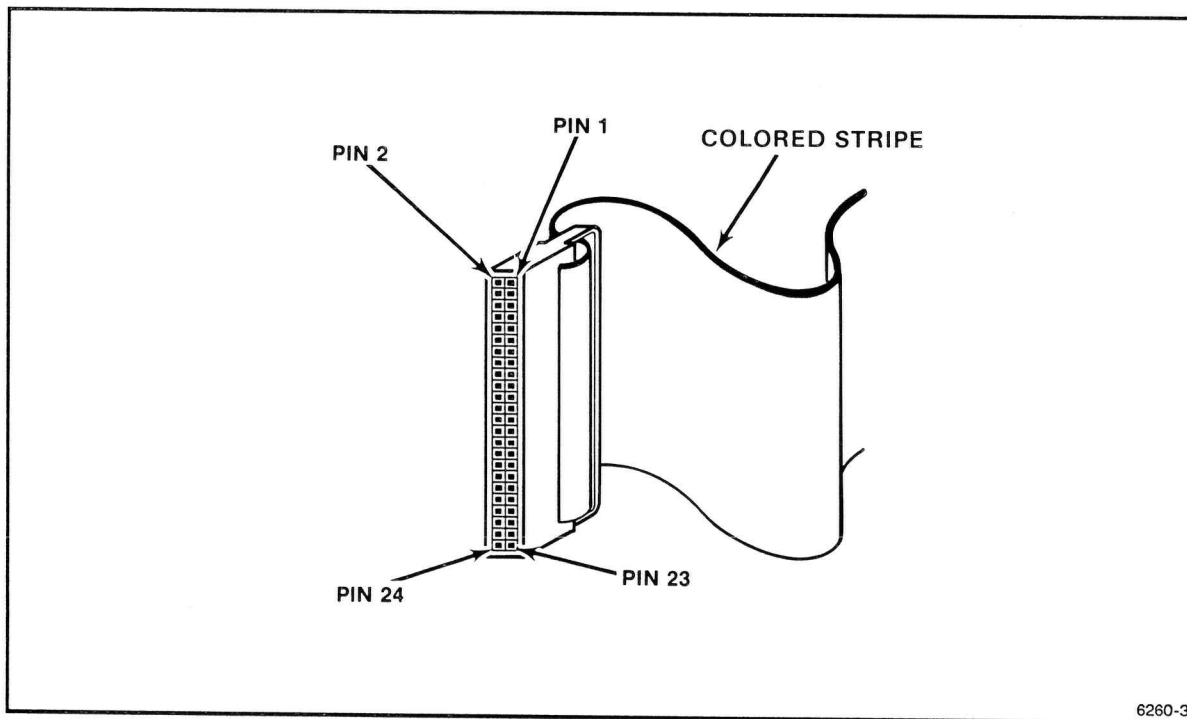
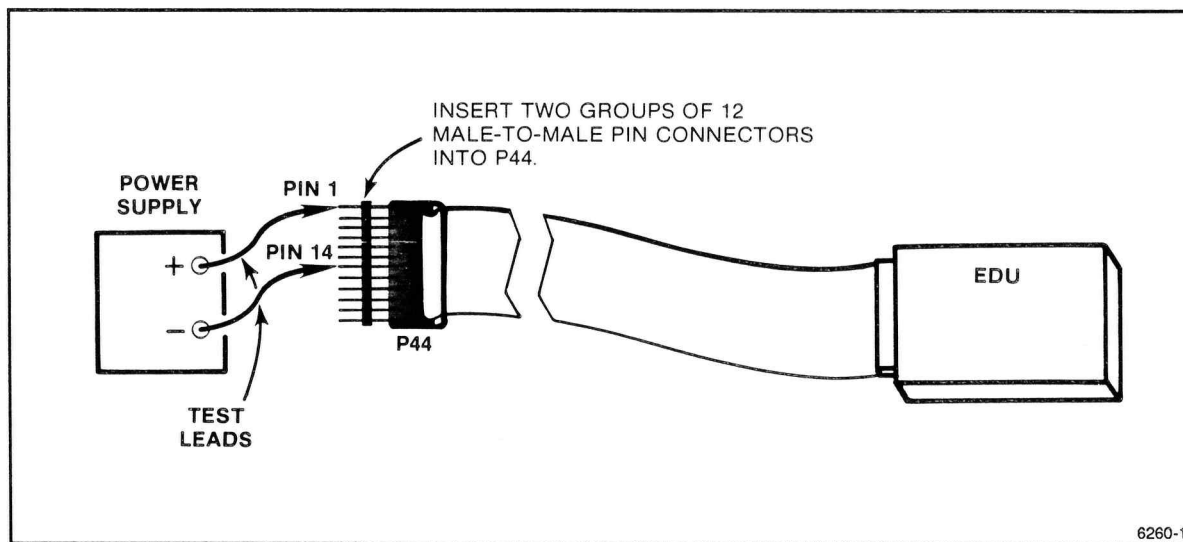

Figure 2. P44 pin identification.

Setup Conditions



Settings

Power Supply.....Power On

- a. Press the EDU RESET button to clear indicator display.
- b. Check—that only the FAULT indicator is on.
- c. Connect the RC pulser test strap from pin 14 to pin 3 of J44 (applies a 100 μ s pulse to the +5.1 V [F] current fault sense input).
- d. Check—that 5.1F indicator is illuminated and remains illuminated until the RESET button is engaged.

Extended Diagnostics Unit—067-1264-00

- e. With one end of the RC pulser test strap connected to J44 pin 14, move the other end to each pin listed below and check that the appropriate indicator is illuminated.

J44 Pin	Fault Indicated
1	(+12 v Control Power)
2	(not connected)
3	+5 1F CURRENT
4	±5.1 OVERVOLT
5	+5.1D CURRENT
6	+5.1E CURRENT
7	+5.1B CURRENT
8	+5.1C CURRENT
9	-5A CURRENT
10	+5.1A CURRNNT
11	-7B CURRENT
12	PRIMARY CURRENT
13	REG. VOLTAGE
14	FAULT (Control Power Ground)
15	-17 CURRENT
16	+17 CURRENT
17	-7A CURRENT
18	+7A CURRENT
19	-54 CURRENT
20	+54 CURRENT
21	-5B CURRENT
22	-2 CURRENT
23	+7B CURRENT
24	(not connected)

- f. Check that all indicators are illuminated.
- g. Press the RESET button and check that all indicators are extinguished and that only the FAULT indicator comes back on.
- h. This completes the checkout of the 067-1264-00 Calibration Fixture. Remove the male-male pin-connectors from P44.

Replaceable Mechanical Parts

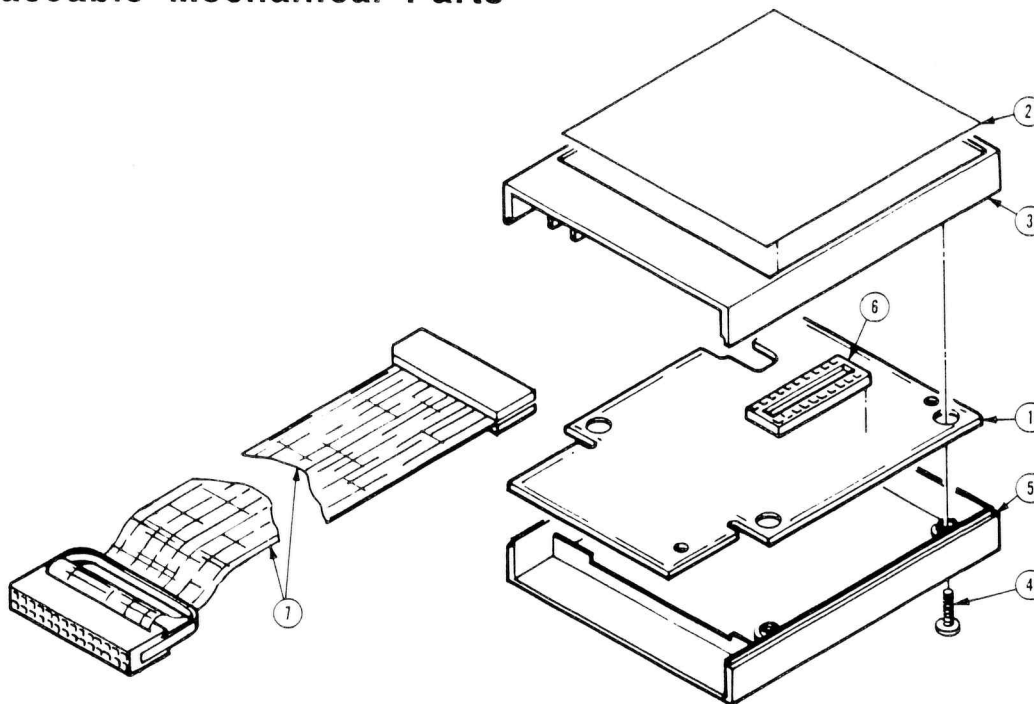

CROSS INDEX - MFR. CODE NUMBER TO MANUFACTURER

Mfr. Code	Manufacturer	Address	City, State, Zip Code
09922	BURNDY CORP	RICHARDS AVE	NORWALK CT 06852
80009	TEKTRONIX INC	4900 S W GRIFFITH DR	BEAVERTON OR 97077
TK1543	CAMCAR/TEXTRON	P O BOX 500 516 18TH AVE	ROCKFORD IL 61101

Fig. & Index No.	Tektronix Part No.	Serial/Assembly No.		Qty	12345 Name & Description	Mfr.	
		Effective	Discont			Code	Mfr. Part No.
1-1	-----			1	CIRCUIT BD ASSY:EXTENDED DIAGNOSTICS (NOT AVAILABLE)		
-2	333-3407-00			1	.PANEL,FRONT:	80009	333-3407-00
-3	200-2503-02			1	.COVER,ROM PACK:TOP,ABS,SMOKE TAN,EXT DIA (ATTACHING PARTS)	80009	200-2503-02
-4	211-0372-00			4	.SCREW,MACHINE:4-40 X 0.312,PNH,STL (END ATTACHING PARTS)	TK1543	880-00020-003
-5	200-2504-03			1	.COVER,ROM PACK:BOTTOM,ABS,SMOKE TAN,EXT DIA	80009	200-2504-03
-6	136-0752-00			2	.SKT,PL-IN ELEK:MICROCIRCUIT,20 DIP	09922	D1LB20P-108
-7	174-0426-00			1	.CA ASSY,SP,ELEC:24,26 AWG,12.0 L,RIBBON	80009	174-0426-00
					STANDARD ACCESSORIES		
	070-6240-00			1	SHEET,TECHNICAL:1100 SERIES,EXTENDER DIAGNOSTICS	80009	070-6240-00

Extended Diagnostics Unit—067-1264-00

Replaceable Electrical Parts

CROSS INDEX - MFR. CODE NUMBER TO MANUFACTURER

Mfr. Code	Manufacturer	Address	City, State, Zip Code
01121	ALLEN-BRADLEY CO	1201 SOUTH 2ND ST	MILWAUKEE WI 53204
03508	GENERAL ELECTRIC CO SEMI-CONDUCTOR PRODUCTS DEPT	W GENESEE ST	AUBURN NY 13021
05397	UNION CARBIDE CORP MATERIALS SYSTEMS DIV	11901 MADISON AVE	CLEVELAND OH 44101
05464	INDUSTRIAL ELECTRONIC ENGINEERS INC	7720 LEMONA AVE	VAN NUYS CA 91405
09353	C AND K COMPONENTS INC	15 RIVERDALE AVE	NEWTON MA 02158
11236	CTS OF BERNE INC	406 PARR ROAD	BERNE IN 46711
50434	HEWLETT-PACKARD CO OPTOELECTRONICS DIV	640 PAGE MILL RD	PALO ALTO CA 94304
57668	ROHM CORP	16931 MILLIKEN AVE	IRVINE CA 92713
80009	TEKTRONIX INC	4900 S W GRIFFITH DR P O BOX 500	BEAVERTON OR 97077

Component No.	Tektronix Part No.	Serial/Assembly No. Effective Dscont	Name & Description	Mfr. Code	Mfr. Part No.
	-----		CIRCUIT BD ASSY:EXTENDED DIAGNOSTICS (NOT AVAILABLE.ORDER 067-1264-00)		
C130	283-0156-00		CAP,FXD,CER DI:0.001 UF,+80-20%,200V	05397	C315C102Z2R5CA
C139	283-0156-00		CAP,FXD,CER DI:0.001 UF,+80-20%,200V	05397	C315C102Z2R5CA
C140	283-0156-00		CAP,FXD,CER DI:0.001 UF,+80-20%,200V	05397	C315C102Z2R5CA
C145	283-0156-00		CAP,FXD,CER DI:0.001 UF,+80-20%,200V	05397	C315C102Z2R5CA
C200	283-0156-00		CAP,FXD,CER DI:0.001 UF,+80-20%,200V	05397	C315C102Z2R5CA
C209	283-0156-00		CAP,FXD,CER DI:0.001 UF,+80-20%,200V	05397	C315C102Z2R5CA
C250	283-0156-00		CAP,FXD,CER DI:0.001 UF,+80-20%,200V	05397	C315C102Z2R5CA
C300	283-0156-00		CAP,FXD,CER DI:0.001 UF,+80-20%,200V	05397	C315C102Z2R5CA
C309	283-0156-00		CAP,FXD,CER DI:0.001 UF,+80-20%,200V	05397	C315C102Z2R5CA
C400	283-0156-00		CAP,FXD,CER DI:0.001 UF,+80-20%,200V	05397	C315C102Z2R5CA
C420	283-0156-00		CAP,FXD,CER DI:0.001 UF,+80-20%,200V	05397	C315C102Z2R5CA
C429	283-0156-00		CAP,FXD,CER DI:0.001 UF,+80-20%,200V	05397	C315C102Z2R5CA
C445	283-0156-00		CAP,FXD,CER DI:0.001 UF,+80-20%,200V	05397	C315C102Z2R5CA
C449	283-0156-00		CAP,FXD,CER DI:0.001 UF,+80-20%,200V	05397	C315C102Z2R5CA
C520	283-0156-00		CAP,FXD,CER DI:0.001 UF,+80-20%,200V	05397	C315C102Z2R5CA
C525	283-0156-00		CAP,FXD,CER DI:0.001 UF,+80-20%,200V	05397	C315C102Z2R5CA
C530	283-0156-00		CAP,FXD,CER DI:0.001 UF,+80-20%,200V	05397	C315C102Z2R5CA
C535	283-0156-00		CAP,FXD,CER DI:0.001 UF,+80-20%,200V	05397	C315C102Z2R5CA
C540	283-0156-00		CAP,FXD,CER DI:0.001 UF,+80-20%,200V	05397	C315C102Z2R5CA
C545	283-0156-00		CAP,FXD,CER DI:0.001 UF,+80-20%,200V	05397	C315C102Z2R5CA
DS330	150-1083-00		LAMP,LED RDOUT:RED,10 ELEM BAR GRAPH	50434	HDSP-4820
DS339	150-1083-00		LAMP,LED RDOUT:RED,10 ELEM BAR GRAPH	50434	HDSP-4820
DS400	150-1077-00		LT EMITTING DIO:RED,650NM,40MA MAX	05464	LL201R
Q130	151-0508-00		TRANSISTOR:WJT,SI,TO-98	03508	X13T520
Q139	151-0508-00		TRANSISTOR:WJT,SI,TO-98	03508	X13T520
Q140	151-0508-00		TRANSISTOR:WJT,SI,TO-98	03508	X13T520
Q145	151-0508-00		TRANSISTOR:WJT,SI,TO-98	03508	X13T520
Q200	151-0508-00		TRANSISTOR:WJT,SI,TO-98	03508	X13T520
Q209	151-0508-00		TRANSISTOR:WJT,SI,TO-98	03508	X13T520
Q250	151-0508-00		TRANSISTOR:WJT,SI,TO-98	03508	X13T520
Q300	151-0508-00		TRANSISTOR:WJT,SI,TO-98	03508	X13T520
Q309	151-0508-00		TRANSISTOR:WJT,SI,TO-98	03508	X13T520
Q400	151-0508-00		TRANSISTOR:WJT,SI,TO-98	03508	X13T520
Q420	151-0508-00		TRANSISTOR:WJT,SI,TO-98	03508	X13T520
Q429	151-0508-00		TRANSISTOR:WJT,SI,TO-98	03508	X13T520
Q445	151-0508-00		TRANSISTOR:WJT,SI,TO-98	03508	X13T520

Replaceable Electrical Parts (cont)

Component No.	Tektronix Part No.	Serial/Assembly No. Effective Dscont	Name & Description	Mfr. Code	Mfr. Part No.
Q449	151-0508-00		TRANSISTOR:WJT,SI,TO-98	03508	X13T520
Q520	151-0508-00		TRANSISTOR:WJT,SI,TO-98	03508	X13T520
Q525	151-0508-00		TRANSISTOR:WJT,SI,TO-98	03508	X13T520
Q530	151-0508-00		TRANSISTOR:WJT,SI,TO-98	03508	X13T520
Q535	151-0508-00		TRANSISTOR:WJT,SI,TO-98	03508	X13T520
Q540	151-0508-00		TRANSISTOR:WJT,SI,TO-98	03508	X13T520
Q545	151-0508-00		TRANSISTOR:WJT,SI,TO-98	03508	X13T520
R130	307-0486-00		RES NTWK,FXD,FI:100 OHM,20%,1.125W	11236	750-101-R100 OHM
R230	315-0152-00		RES,FXD,FILM:1.5K OHM,5%,0.25W	57668	NTR25J-E01K5
R231	315-0152-00		RES,FXD,FILM:1.5K OHM,5%,0.25W	57668	NTR25J-E01K5
R232	315-0152-00		RES,FXD,FILM:1.5K OHM,5%,0.25W	57668	NTR25J-E01K5
R233	315-0152-00		RES,FXD,FILM:1.5K OHM,5%,0.25W	57668	NTR25J-E01K5
R234	315-0152-00		RES,FXD,FILM:1.5K OHM,5%,0.25W	57668	NTR25J-E01K5
R235	315-0152-00		RES,FXD,FILM:1.5K OHM,5%,0.25W	57668	NTR25J-E01K5
R236	315-0152-00		RES,FXD,FILM:1.5K OHM,5%,0.25W	57668	NTR25J-E01K5
R240	315-0152-00		RES,FXD,FILM:1.5K OHM,5%,0.25W	57668	NTR25J-E01K5
R241	315-0152-00		RES,FXD,FILM:1.5K OHM,5%,0.25W	57668	NTR25J-E01K5
R242	315-0152-00		RES,FXD,FILM:1.5K OHM,5%,0.25W	57668	NTR25J-E01K5
R260	307-0707-00		RES NTWK,FXD,FI:4,4.7K OHM,2%,0.2W EA	01121	108B472
R261	307-0707-00		RES NTWK,FXD,FI:4,4.7K OHM,2%,0.2W EA	01121	108B472
R300	307-0486-00		RES NTWK,FXD,FI:100 OHM,20%,1.125W	11236	750-101-R100 OHM
R320	307-0675-00		RES NTWK,FXD,FI:9,1K OHM,2%1.25W	11236	750-101-R1K OHM
R349	307-0675-00		RES NTWK,FXD,FI:9,1K OHM,2%1.25W	11236	750-101-R1K OHM
R350	307-0675-00		RES NTWK,FXD,FI:9,1K OHM,2%1.25W	11236	750-101-R1K OHM
R351	307-0707-00		RES NTWK,FXD,FI:4,4.7K OHM,2%,0.2W EA	01121	108B472
R430	315-0152-00		RES,FXD,FILM:1.5K OHM,5%,0.25W	57668	NTR25J-E01K5
R431	315-0152-00		RES,FXD,FILM:1.5K OHM,5%,0.25W	57668	NTR25J-E01K5
R432	315-0152-00		RES,FXD,FILM:1.5K OHM,5%,0.25W	57668	NTR25J-E01K5
R433	315-0152-00		RES,FXD,FILM:1.5K OHM,5%,0.25W	57668	NTR25J-E01K5
R434	315-0152-00		RES,FXD,FILM:1.5K OHM,5%,0.25W	57668	NTR25J-E01K5
R435	315-0152-00		RES,FXD,FILM:1.5K OHM,5%,0.25W	57668	NTR25J-E01K5
R436	315-0152-00		RES,FXD,FILM:1.5K OHM,5%,0.25W	57668	NTR25J-E01K5
R440	315-0152-00		RES,FXD,FILM:1.5K OHM,5%,0.25W	57668	NTR25J-E01K5
R441	315-0152-00		RES,FXD,FILM:1.5K OHM,5%,0.25W	57668	NTR25J-E01K5
R442	315-0152-00		RES,FXD,FILM:1.5K OHM,5%,0.25W	57668	NTR25J-E01K5
R460	307-0707-00		RES NTWK,FXD,FI:4,4.7K OHM,2%,0.2W EA	01121	108B472
R461	307-0707-00		RES NTWK,FXD,FI:4,4.7K OHM,2%,0.2W EA	01121	108B472
R530	307-0486-00		RES NTWK,FXD,FI:100 OHM,20%,1.125W	11236	750-101-R100 OHM
S230	260-1970-00		SWITCH,PUSH:0.4VA,20V MAXIMUM	09353	8125J81E

Extended Diagnostics Unit—067-1264-00

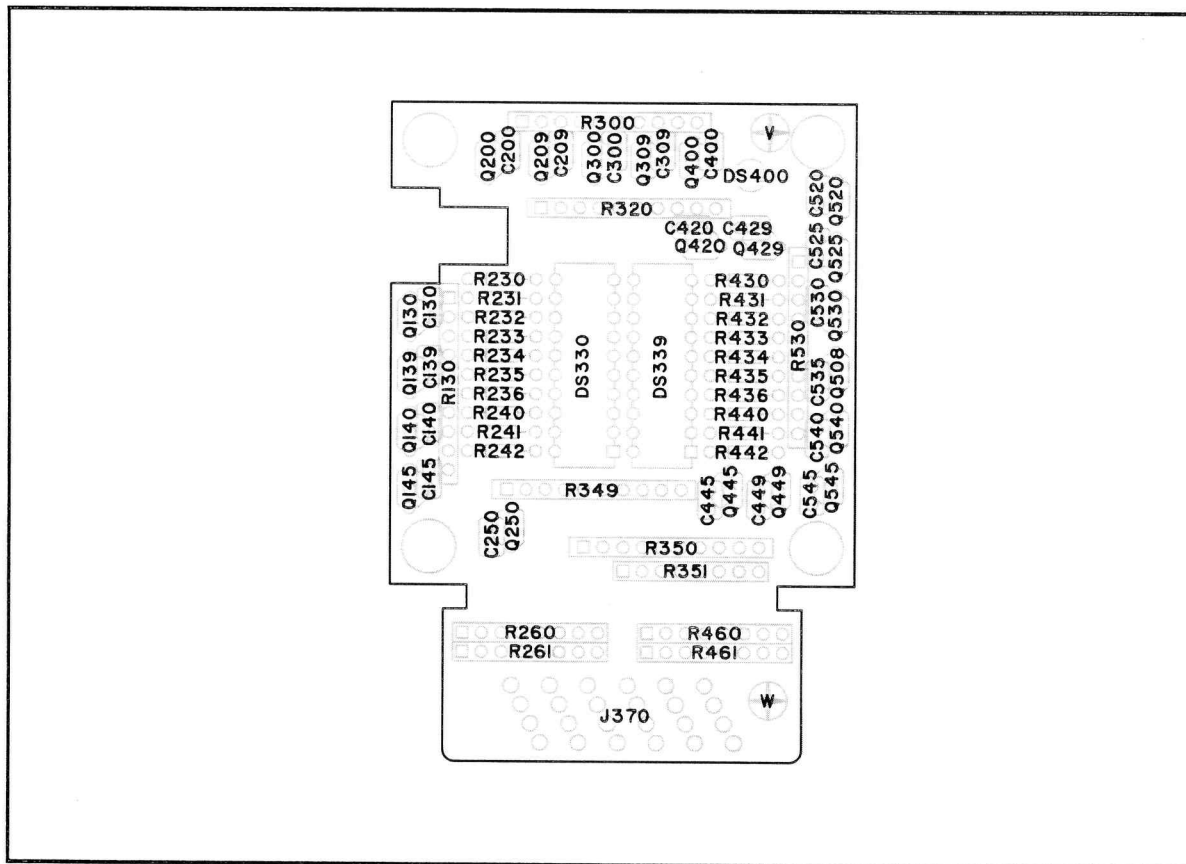
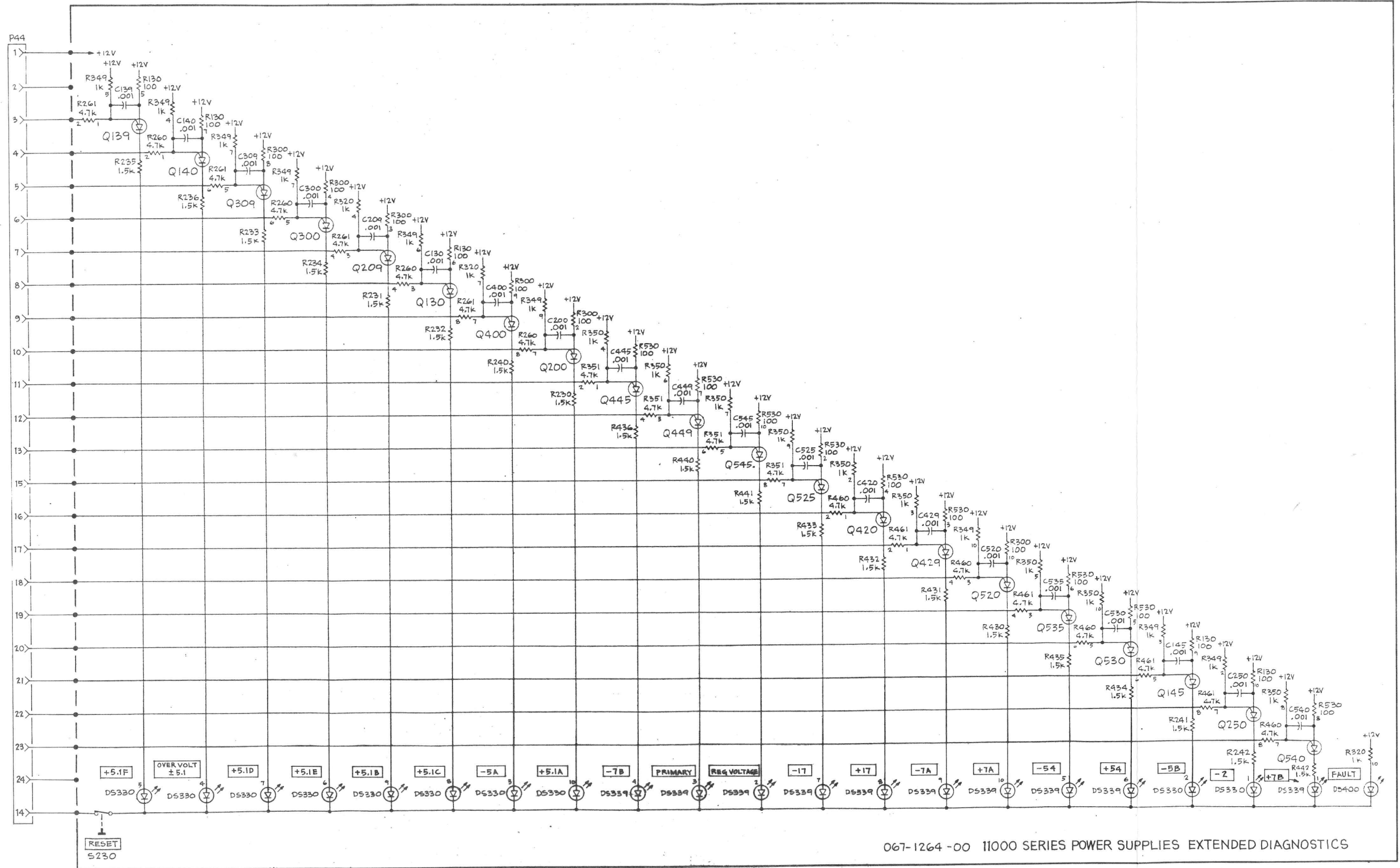

Figure 3. Circuit Board Assembly for 067-1264-00.



067-1264-00 11000 SERIES POWER SUPPLIES EXTENDED DIAGNOSTICS