



Tektronix, Inc.  
P.O. Box 500  
Beaverton, Oregon 97077

070-2038-00

**TEKTRONIX®**

**465**  
**OSCILLOSCOPE AND**  
**DM44**  
**DIGITAL MULTIMETER**  
**OPERATORS**

INSTRUCTION MANUAL

Serial Number \_\_\_\_\_ First Printing JULY 1976

## **WARRANTY**

**All TEKTRONIX instruments are warranted against defective materials and workmanship for one year. Any questions with respect to the warranty should be taken up with your TEKTRONIX Field Engineer or representative.**

**All requests for repairs and replacement parts should be directed to the TEKTRONIX Field Office or representative in your area. This will assure you the fastest possible service. Please include the instrument Type Number or Part Number and Serial Number with all requests for parts or service.**

**Specifications and price change privileges reserved.**

**Copyright © 1976 by Tektronix, Inc., Beaverton, Oregon. Printed in the United States of America. All rights reserved. Contents of this publication may not be reproduced in any form without permission of Tektronix, Inc.**

**U.S.A. and foreign Tektronix products covered by U.S. and foreign patents and/or patents pending.**

**TEKTRONIX is a registered trademark of Tektronix, Inc.**

# TABLE OF CONTENTS

	Page		Page
LIST OF ILLUSTRATIONS	iv	<b>BASIC OSCILLOSCOPE DISPLAYS</b>	<b>16</b>
LIST OF TABLES	v	NORMAL SWEEP DISPLAY	16
<b>BEFORE OPERATING</b>	<b>1</b>	MAGNIFIED SWEEP DISPLAY	17
INTRODUCTION	1	DELAYED SWEEP DISPLAY	17
SAFETY INFORMATION	1	MIXED SWEEP DISPLAY	18
OPERATING VOLTAGE	1	X-Y DISPLAY	18
Line Voltage Selection	2	SINGLE SWEEP DISPLAY	19
Regulating Range Selection	2	<b>DM44 DISPLAYS AND MEASUREMENTS</b>	<b>20</b>
OPTIONS	3	RESISTANCE	20
<b>CONTROLS, CONNECTORS, AND INDICATORS</b>	<b>4</b>	VOLTS	22
VERTICAL	4	TEMPERATURE	24
DISPLAY	7	Accuracy Check	24
DM44	7	TIME AND 1/TIME	27
TRIGGER	8	<b>APPLICATIONS AND MEASUREMENTS</b>	<b>28</b>
HORIZONTAL, CALIBRATOR, AND POWER	12	PRELIMINARY	28
REAR PANEL	14	Signal Ground	28
LEFT SIDE PANEL	14	Input Coupling Capacitor Precharging	28
RIGHT SIDE PANEL	14		

# TABLE OF CONTENTS (cont)

<b>APPLICATIONS AND MEASUREMENTS (cont)</b>	<b>Page</b>	<b>APPLICATIONS AND MEASUREMENTS (cont)</b>	<b>Page</b>
OPERATOR'S ADJUSTMENTS AND CHECKS	29	PHASE DIFFERENCE MEASUREMENTS	42
Trace Rotation	29	HIGH RESOLUTION PHASE DIFFERENCE	
Probe Compensation	29	MEASUREMENTS	43
Vertical Gain Check	30	PULSE JITTER MEASUREMENTS	44
Basic 465 Timing Check	30	DELAYED OR MIXED SWEEP	
DM44 Timing Check	30	MAGNIFICATION	45
External Horizontal Gain Check	31	Magnified Sweep Starts After Delay	45
PEAK-TO-PEAK VOLTAGE		Triggered Delay Sweep Magnification	46
MEASUREMENTS—AC	31		
INSTANTANEOUS VOLTAGE		<b>BASIC 465 DELAYED OR MIXED SWEEP TIME</b>	
MEASUREMENTS—DC	32	<b>MEASUREMENTS</b>	<b>48</b>
ALGEBRAIC ADDITION	34	TIME DIFFERENCE BETWEEN REPETITIVE	
COMMON MODE REJECTION	35	PULSES (BASIC 465)	48
AMPLITUDE COMPARISON		TIME DURATION MEASUREMENTS	
MEASUREMENTS	36	(BASIC 465)	49
TIME-DURATION MEASUREMENTS	37	FREQUENCY MEASUREMENTS (BASIC 465)	50
FREQUENCY MEASUREMENTS	38	TIME DIFFERENCE BETWEEN TWO PULSES	
RISETIME MEASUREMENTS	39	FROM DIFFERENT SOURCES (BASIC 465)	51
TIME DIFFERENCE BETWEEN TWO		RISETIME (BASIC 465)	52
PULSES FROM DIFFERENT SOURCES	40	MIX (BASIC 465)	53
TIME COMPARISON MEASUREMENTS	41		

# TABLE OF CONTENTS (cont)

<b>DM44 DELAYED OR MIXED SWEEP TIME MEASUREMENTS</b>	<b>Page</b> <b>54</b>	<b>OPERATOR'S SPECIFICATIONS (cont)</b>	<b>Page</b>
TIME DIFFERENCE BETWEEN REPETITIVE PULSES (DM44)	56	Z AXIS INPUT	65
TIME DURATION MEASUREMENTS (DM44)	57	OUTPUTS	65
FREQUENCY MEASUREMENTS (DM44)	58	AC POWER SOURCE	65
TIME DIFFERENCE BETWEEN TWO PULSES FROM DIFFERENT SOURCES (DM44)	58	ENVIRONMENTAL	65
RISETIME (DM44)	60	<b>DM44 DIGITAL MULTIMETER</b>	<b>66</b>
MIX (DM44)	61	RESISTANCE	66
<b>OPERATOR'S SPECIFICATIONS</b>	<b>62</b>	TIME	66
465 OSCILLOSCOPE	62	1/TIME	66
VERTICAL	62	TEMPERATURE	66
TRIGGERING	63	DC VOLTAGE	66
DIFFERENTIAL TIME MEASUREMENT (BASIC 465)	63	<b>ACCESSORIES</b>	<b>68</b>
DIFFERENTIAL TIME MEASUREMENT (DM44)	64	STANDARD ACCESSORIES	68
HORIZONTAL	64	OPTIONAL ACCESSORIES	68
X-Y	64	<b>OPTIONS</b>	<b>69</b>
CALIBRATOR	64	OPTION 1	69
		OPTION 4	69
		OPTION 7	69

# LIST OF ILLUSTRATIONS

	Page		Page
Fig. 1. Regulating range selector and line fuse.	3	Fig. 17. Common-mode rejection.	36
Fig. 2. Vertical controls, connectors, and indicators.	4	Fig. 18. Time duration.	38
Fig. 3. Display and DM44 controls, connectors, and indicators.	6	Fig. 19. Risetime.	39
Fig. 4. Trigger controls, connectors, and indicators.	8	Fig. 20. Time difference between two pulses from different sources.	40
Fig. 5. Trigger controls, connectors, and indicators.	10	Fig. 21. Phase difference.	43
Fig. 6. Horizontal, calibrator, and power controls, connectors, and indicators.	15	Fig. 22. High-resolution phase difference.	43
Fig. 7. Rear panel and left side panel controls, connectors, and indicators.	21	Fig. 23. Pulse jitter.	44
Fig. 8. Resistance.	23	Fig. 24. Delayed sweep magnification.	46
Fig. 9. Volts.	25	Fig. 25. Time difference between repetitive pulses.	49
Fig. 10. Temperature.	29	Fig. 26. Time duration.	50
Fig. 11. Probe compensation.	30	Fig. 27. Time difference between two pulses from different sources.	51
Fig. 12. Basic 465 timing check.	31	Fig. 28. Risetime.	53
Fig. 13. DM44 timing check.	32	Fig. 29. Time difference between repetitive pulses.	56
Fig. 14. Peak-to-peak voltage of a waveform.	33	Fig. 30. Time duration and frequency measurements.	57
Fig. 15. Instantaneous voltage measurements.	35	Fig. 31. Time difference between two pulses from different sources.	59
Fig. 16. Algebraic addition.		Fig. 32. Risetime.	60



# LIST OF TABLES

	Page		Page
TABLE 1 Regulating Ranges	2	TABLE 4 Centigrade to Fahrenheit Conversion	26
TABLE 2 Resistance Ranges	20	TABLE 5 DM44 Delayed Sweep Displays	54
TABLE 3 Volts Ranges	22		

# BEFORE OPERATING

## INTRODUCTION

The Tektronix 465 Oscilloscope is a dual-channel portable instrument. The dual-channel dc-to-100 MHz vertical system provides calibrated deflection factors from 5 millivolts to 5 volts/division. The sweep trigger circuits are capable of stable triggering over the full bandwidth capabilities of the vertical deflection system. The horizontal deflection system provides calibrated sweep rates from 0.5 second to 0.05 microsecond/division along with delayed sweep features for accurate relative-time measurements. A X10 magnifier extends the calibrated sweep rate to 5 nanoseconds/division. The instrument operates over a wide variation of line voltages and frequencies. Maximum power consumption is about 100 watts.

The Tektronix DM44 Digital Multimeter measures 0 ohm to 20 megohms, 0 dc volt to 1200 dc volts (+ or -), or (using the temperature probe) -55°C to +150°C. The measurement is displayed on a 3-1/2 digital display while the oscilloscope operates normally.

The digital multimeter and oscilloscope combine to provide a digital readout of the time between any two

points on the oscilloscope display. Both time measurement points are displayed on the crt at the same time. The 1/TIME function can provide direct measurement of frequency.

## SAFETY INFORMATION

The instrument is designed to operate from a single-phase power source with one of the current-carrying conductors (the Neutral Conductor) at ground (earth) potential. Operation from power sources where both current-carrying conductors are live with respect to ground (such as phase-to-phase on a three-wire system) is not recommended, since only the Line Conductor has over-current (fuse) protection within the instrument.

The instrument has a three-wire power cord with a three-terminal polarized plug for connection to the power source and safety-earth. The ground (earth) terminal of the plug is directly connected to the instrument frame. For electric-shock protection, insert this plug only in a mating outlet with a safety-earth contact.



## OPERATING VOLTAGE

**CAUTION**

*This instrument may be damaged if operated with the line voltage selector switch or the regulating range selector set for the wrong applied line voltage or if the wrong line fuse is used.*

### Line Voltage Selection

This instrument operates from either a 115-volt or a 230-volt nominal line voltage source, 48 to 440 hertz. To convert from one nominal line voltage range to the other, move the Line Voltage Selector switch (located on side panel) to indicate the correct nominal voltage. A 115-to-230 volt adapter may be required for the line-cord plug. Be sure to use the correct line fuse for the line voltage selected (see Table 1).

### Regulating Range Selection

The Regulating Range Selector assembly (located on the rear panel) is set for one of the line voltage ranges shown in Table 1. It also contains the line fuse for overload protection.

To change the regulating range:

1. Disconnect the instrument from the power source.
2. Loosen the two captive screws that hold the cover on the selector assembly; then pull to remove the cover.
3. Pull out the range selector switch bar (see Fig. 1). Select a range from Table 1 which is centered about the average line voltage. Slide the bar to the desired position and push it in. Push the cover on and tighten the screws.

**TABLE 1**  
**Regulating Ranges**

Range Selector Switch Position	Regulating Range	
	115-Volts Nominal	230-Volts Nominal
LO (Switch bar in lower holes)	99 to 121 volts	198 to 242 volts
M (Switch bar in middle holes)	104 to 126 volts	207 to 253 volts
HI (Switch bar in upper holes)	108 to 132 volts	216 to 264 volts
Fuse Size	1.5 A 3AG Fast-blow	0.75 A 3AG Fast-blow

# CONTROLS, CONNECTORS AND INDICATORS

## VERTICAL

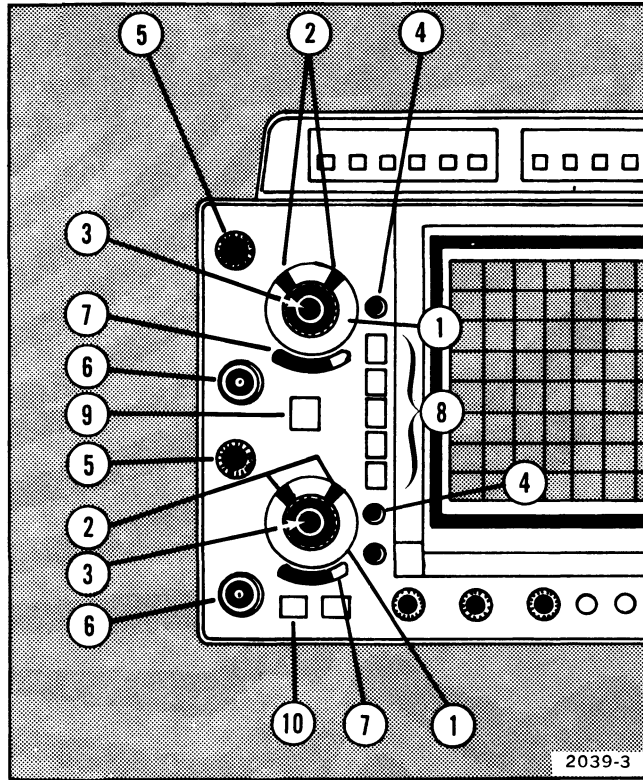

Fig. 2. Vertical controls, connectors, and indicators.

**1. CH 1 and CH 2 VOLTS/DIV**—Selects the vertical deflection factor in a 1-2-5 sequence (VAR control must be in the calibrated detent for the indicated deflection factor).

**2. VOLTS/DIV Readout**—Consists of two small lamps for each channel, located beneath the skirt of each VOLTS/DIV knob. One or the other lamp will light up to indicate the correct deflection factor when a probe with a scale-switching connector is used. A probe without this connector lights the X1 lamp.

**3. VAR**—Provides continuously variable uncalibrated deflection factors between the calibrated settings of the VOLTS/DIV switch, and extends the maximum vertical deflection to at least 12.5 volts per division (5 volt position).

**4. UNCAL Lamp**—Indicates when the VAR VOLTS/DIV control is out of the calibrated detent and the vertical deflection factor is uncalibrated.

**5. POSITION**—Positions the display vertically. In the X-Y mode, the CH 2 POSITION control positions on the Y axis (vertically) and the Horizontal POSITION control positions on the X-axis (horizontally).

**6. CH 1 OR X and CH 2 OR Y**—Input connectors for application of external signals to the inputs of the vertical amplifier. In the X-Y mode of operation, the signal connected to the CH 1 OR X connector provides horizontal deflection and the signal connected to the CH 2 OR Y connector provides vertical deflection.

**7. AC-GND-DC**—Selects the method used to couple a signal to the input of the vertical amplifier. In the AC position, signals are capacitively coupled to the vertical amplifier. The dc component of the input signal is blocked. In the GND position, the input of the vertical amplifier is disconnected from the input connector and grounded to allow the input coupling capacitor to precharge. In the DC position, all components of the input signal are passed to the input amplifier.

**8. VERT MODE**—Selects mode of operation for vertical amplifier system.

CH 1: Channel 1 only is displayed.

**ALT:** Provides dual-trace display of the signals of both channels. Display is switched between channels at the end of each sweep. Useful at sweep rates faster than about 50 microseconds/division.

**ADD:** Signals applied to the CH 1 and CH 2 input connectors are algebraically added, and the algebraic sum is displayed on the crt. The INVERT switch in Channel 2 allows the display to be CH 1 plus CH 2 or CH 1 minus CH 2. Useful for common-mode rejection to remove an undesired signal or for dc offset.

**CHOP:** Provides dual-trace display of the signals of both channels. Display is switched between channels at a repetition rate of approximately 250 kHz. Useful at sweep rates slower than about 50 microseconds/division, or when a dual-trace, single-sweep display is required.

**CH 2:** Channel 2 only is displayed. It must be selected in X-Y operation.

**9. 20 MHz BW/TRIG VIEW**—Dual-purpose switch that limits the bandwidth of the vertical amplifier system to approximately 20 MHz when pulled, or when pressed, causes the signal applied to A Trigger Generator to be displayed on the crt.

**10. INVERT**—Channel 2 display is inverted in the INVERT (button in) position.



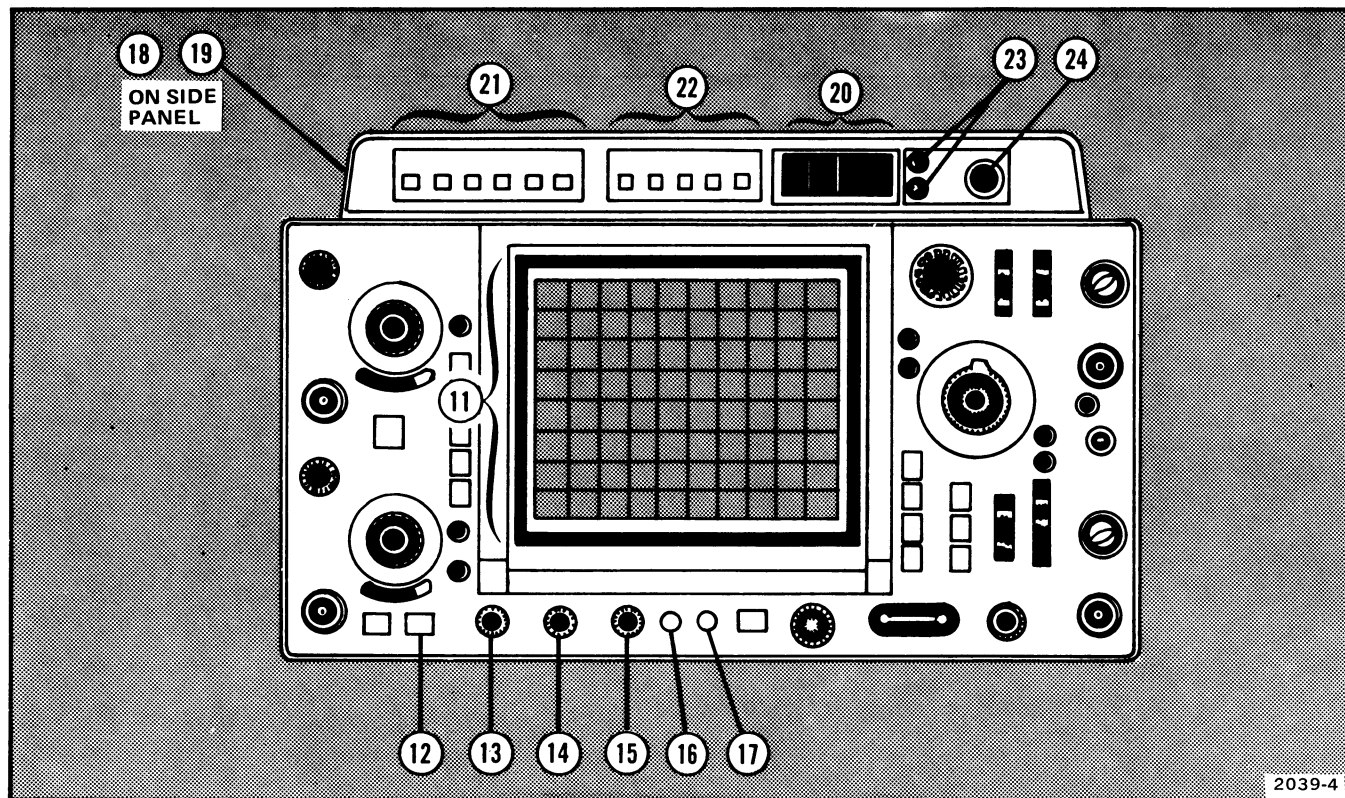

Fig. 3. Display and DM44 controls, connectors, and indicators.



## DISPLAY

**11. Internal Graticule**—Eliminates parallax. Risetime, amplitude and measurement points are indicated at the left-hand graticule edge.

**12. BEAM FINDER**—Compresses the display to within the graticule area independently of display position or applied signals and provides a visible viewing level.

**13. INTENSITY**—Controls brightness of the crt display.

**14. FOCUS**—Adjusts for optimum display definition.

**15. SCALE ILLUM**—Controls graticule illumination.

**16. ASTIG**—Used in conjunction with the FOCUS control to obtain a well-defined display. It does not require readjustment in normal use.

**17. TRACE ROTATION**—Adjusts trace to align with the horizontal graticule lines.

## DM44

**18. Input Connectors**—Two banana jacks provide + (red) and COM (black) inputs for voltage and resistance only.

**19. Probe Connector**—Input connector for the temperature probe.

**20. Readout**—Negative polarity indication is automatic for negative dc voltage and temperature with no polarity indication for positive measurement. A blinking display indicates overrange. The decimal point is positioned by the FUNCTION and RANGE controls for multimeter operation and by the oscilloscope A TIME/DIV switch in the TIME or 1/TIME modes.

**21. RANGE**—Selects from .2 V to 1.2 kV dc in 5 ranges (1200 volts is the maximum safe input in the 1.2 kV dc mode); from 200 ohms to 20 megohms in 6 ranges.

**22. FUNCTION**—Selects VOLTS, OHMS, TEMP (°C), 1/TIME, or TIME functions of the DM44.

**23. Scale Factor Lamps**—Two lamps.

In the TIME function, the Readout and Scale Factor Lamps indicate the time difference between the two intensified zones on the crt display. One lamp or the other will light to indicate ms or  $\mu$ s. No lamp lit indicates seconds.

In the 1/TIME function the Readout and Scale Factor Lamps indicate the number of measured intervals per unit of time. One lamp or the other will light to indicate intervals per ms (1/ms lamp) or intervals per  $\mu$ s (1/ $\mu$ s lamp). No

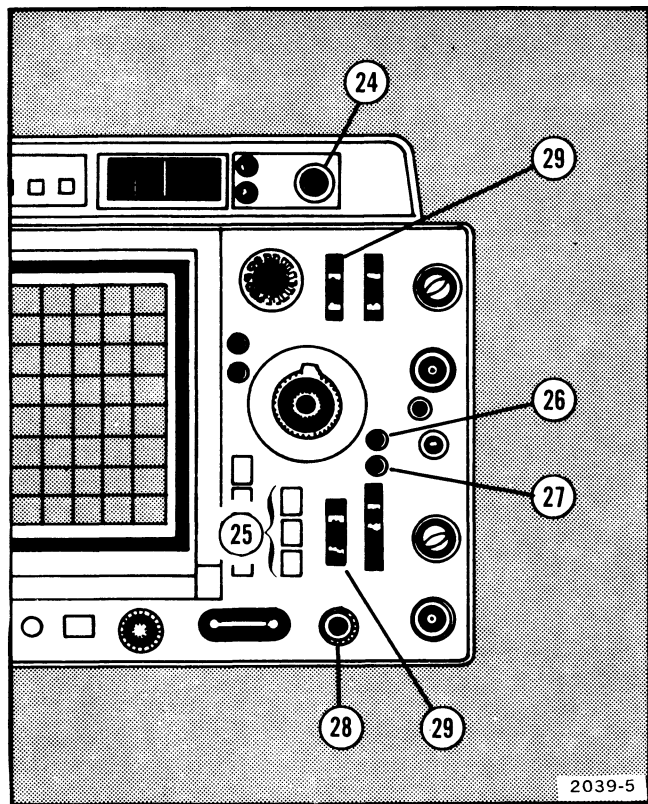

Fig. 4. Trigger controls, connectors, and indicators.

lamp lit indicates intervals per second. If the duration of one event is being measured, the Readout and Scale Factor Lamps indicate frequency. The 1/ms lamp indicates kHz, the 1/ $\mu$ s lamp indicates MHz, and no lamp lit indicates Hz.

**24.  $\Delta$  TIME**—Used in conjunction with the DELAY TIME POSITION control in the TIME and 1/TIME functions. The  $\Delta$  TIME control moves only the time-measurement point. The DELAY TIME POSITION control moves both the reference point and the time-measurement point. With the time-measurement point to the left of the reference point the Readout indicates a negative time difference.

*NOTE*

*You can modify your instrument to make the DELAY TIME POSITION control move only the reference point. The procedure for making this modification is located in the Maintenance section of the DM44 Service manual.*

**TRIGGER**

**25. TRIG MODE**—Determines the mode of trigger operation for A Sweep.

**AUTO:** Sweep is initiated by the applied trigger signal. In the absence of an adequate trigger signal, or if the trigger repetition rate is less than about 20 hertz, the sweep free runs and provides a bright reference trace.

**NORM:** Sweep is initiated by the applied trigger signal. In the absence of an adequate trigger signal, there is no trace. When the trigger rate is too low for AUTO use NORM.

**SINGL SWP:** When this pushbutton is pushed, the A Sweep operates in the single sweep mode. After a single sweep is displayed, further sweeps cannot be presented until the SINGLE SWP button is again pushed. It is useful when the signal to be displayed is not repetitive or varies in amplitude, shape or time causing an unstable conventional display. It can also be used to photograph a nonrepetitive signal.

**26. READY Lamp**—Indicates A Sweep is "armed" and, upon receipt of an adequate trigger signal, will present a single-sweep display.

**27. TRIG Lamp**—Indicates that A Sweep is triggered and will produce a stable display. It is useful for setting up the trigger circuits when a trigger signal is available without a display on the crt (for example, when using external triggers).

**28. A TRIG HOLDOFF**—Provides continuous control of time between sweeps. Allows triggering on aperiodic signals (such as complex digital words). In the fully clockwise position (B ENDS A), A sweep is reset at the end of B sweep to provide the fastest possible sweep repetition

rate for delayed-sweep presentations and low-repetition rate signals. Use the A trigger controls for the best possible display before using the A TRIG HOLDOFF control.

**29. COUPLING**—Determines method used to couple signals to the trigger generator circuit.

**AC:** Signals are capacitively coupled to the input of the trigger generator. Dc is rejected and signals below about 30 Hz are attenuated.

**LF REJ:** Signals are capacitively coupled to the input of the trigger circuit. Dc is rejected and signals below about 50 kHz are attenuated. It is useful for providing a stable display of the high-frequency components of a complex waveform.

**HF REJ:** Signals are capacitively coupled to the input of the trigger circuit. Dc is rejected and signals below about 30 Hz and above about 50 kHz are attenuated. It is useful for providing a stable display of the low-frequency components of a complex waveform.

**DC:** All components of a trigger signal are coupled to the input of the trigger circuit. It is useful for providing a stable display of low-frequency or low-repetition rate signals, except the combination of the ALT (dual trace) mode with the trigger SOURCE switch in NORM.

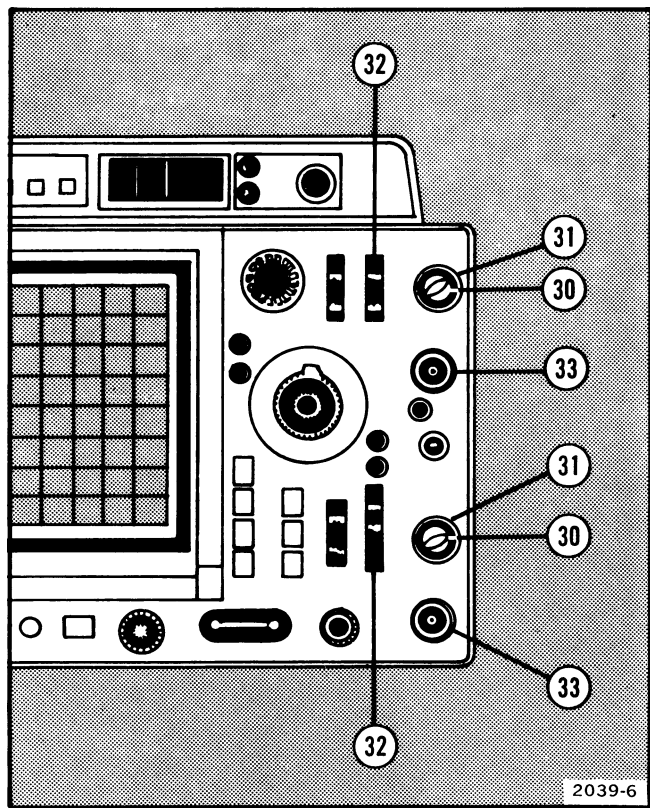

Fig. 5. Trigger controls, connectors, and indicators.

**30. SLOPE**—Selects the slope of the trigger signal that starts the sweep.

+: Sweep can be triggered from the positive-going portion of a trigger signal.

-: Sweep can be triggered from the negative-going portion of a trigger signal.

Correct SLOPE setting is important in obtaining a display when only a portion of a cycle is being displayed.

**31. LEVEL**—Selects the amplitude point on the trigger signal at which the sweep is triggered. It is usually adjusted for the desired display after trigger SOURCE, COUPLING and SLOPE have been selected.

**32. SOURCE**—Determines the source of the trigger signal coupled to the input of the trigger circuit.

**NORM:** Trigger source is displayed signal(s). It does not indicate time relationship between CH 1 and CH 2 signals. However, stable triggering of non-time-related signals usually can be obtained by setting VERT MODE to ALT, SOURCE to NORM and COUPLING to LF REJ. Carefully adjust LEVEL for a stable display.

**CH 1:** A sample of the signal available in Channel 1 is used as a trigger signal. CH 2 signal is unstable if it is not time-related.

**CH 2:** A sample of the signal available in Channel 2 is used as a trigger signal. CH 1 signal is unstable if it is not time-related.

**LINE (A Trigger circuit only):** A sample of the power-line frequency is used as a trigger signal. It is useful when the input signal is time-related (multiple or submultiple) to the line frequency or when it is desirable to provide a stable display of a line-frequency component in a complex waveform.

**EXT:** Signals connected to the External Trigger Input connectors are used for triggering. External signals must be time-related to the displayed signal for a stable display. It is useful when the internal signal is too small or contains undesired signals that could cause unstable triggering. It is useful when operating in CHOP mode.

**EXT ÷ 10 (A Trigger circuit only):** External trigger signal is attenuated by a factor of 10.

**STARTS AFTER DELAY (B Trigger circuit only):** B Sweep runs immediately after the delay time selected by the DELAY-TIME POSITION control. When making differential time measurements you must use this mode to obtain valid measurements. On instruments equipped with a DM44 you must use this mode to obtain valid measurements when using the TIME or 1/TIME functions.

**33. External Trigger Inputs**—Input connectors for external trigger signals.

## HORIZONTAL, CALIBRATOR, AND POWER

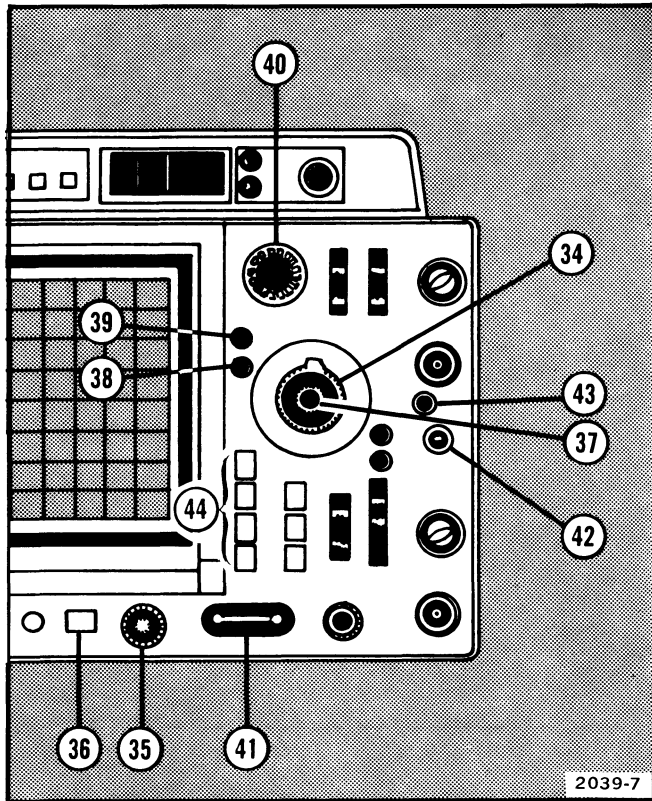

Fig. 6. Horizontal, calibrator, and power controls, connectors, and indicators.

**34a. A AND B TIME/DIV AND DELAY TIME**—A TIME/DIV switch (clear plastic skirt) selects the sweep rate of the A Sweep circuit for A sweep only operation and selects the basic delay time (to be used by the DELAY-TIME POSITION control) for delayed sweep operation. B TIME/DIV switch (pull out and rotate to unlock) selects the sweep rate for the B Sweep circuit for delayed sweep operation only. A VAR control must be in the calibrated detent for calibrated A Sweep rates. When both TIME/DIV switches are fully counterclockwise to the X-Y position, the horizontal (X-axis) display is the CH 1 input.

**34b. DM44 A AND B TIME/DIV AND DELAY TIME**—The controls operate in the same manner as 37a above. The A TIME/DIV switch also controls the TIME lamps and decimal point location when the DM44 is in the TIME or 1/TIME MODE.

**35. FINE/POSITION**—Positions the display horizontally for A sweep and B sweep or on the X-axis (horizontally) in the X-Y mode.

**36. X10 MAG**—Increases displayed sweep rate by a factor of 10. It extends fastest sweep rate to 1 nanosecond/division. The magnified sweep is the center division of the unmagnified display (0.5 division either side of the center graticule line).

**37. VAR**—Provides continuously variable sweep rates between the calibrated settings of the A TIME/DIV switch. It extends the slowest A Sweep rate to at least 1.25 seconds/division. The A Sweep rate is calibrated when the control is set fully clockwise to the calibrated detent. Must be in the detent position to make accurate differential time measurements. On instruments equipped with a DM44 the VAR control must be in the detent position to make accurate measurements in the TIME and 1/TIME functions.

**38. UNCAL Lamp**—Indicates the A Sweep rate is uncalibrated (VAR control out of the calibrated detent).

**39. X10 MAG Lamp**—Indicates that the X10 magnifier is on.

**40a. DELAY TIME POSITION**—Provides variable sweep delay to more than 10 times the delay time indicated by the A TIME/DIV switch.

**40b. DM44 DELAY TIME POSITION**—Operates in the same manner as 41a. Also, when the DM44 is in the TIME or 1/TIME function, this control operates in conjunction with the  $\Delta$  TIME control. The DELAY TIME POSITION control moves both the reference point and the time-measurement point. The  $\Delta$  TIME control moves only the time-measurement point. With the time-measurement point to the left of the reference point the Readout indicates a negative time difference.

#### NOTE

*You can modify your instrument to make the DELAY TIME POSITION control move only the reference point. The procedure for making this modification is located in the Operating Information section of the DM44 Service manual.*

**41. CALIBRATOR**—A combination current loop/square-wave voltage output that permits the operator to compensate voltage probes and check vertical gain, current probes and oscilloscope operation. It is not intended to verify time-base calibration.

**42. POWER**—Turns instrument power on and off.

**43. LOW LINE Lamp**—Indicates that the applied line voltage is below the lower limit of the regulating range selected by the Regulating Range Selector.

**44. HORIZ DISPLAY**—Determines the mode of operation for the horizontal deflection system.

A: Horizontal deflection provided by A Sweep at a sweep rate determined by the setting of the A TIME/DIV switch. B sweep is inoperative.

**MIX:** The first part of the horizontal sweep is displayed at a rate set by the A TIME/DIV switch and the latter part of the sweep at a rate set by the B TIME/DIV switch. Relative amounts of the display allocated to each of the two sweep rates are determined by the setting of the DELAY-TIME POSITION control.

**A INTEN:** The sweep rate is determined by the A TIME/DIV switch. An intensified portion appears on the display during the B Sweep time, which is about 10 times the B TIME/DIV switch setting. This switch position provides a check of the duration and position of the B Sweep (delayed sweep) with respect to the A Sweep (delaying sweep).

**B DLYD:** The sweep rate is determined by the B TIME/DIV switch with the delay time determined by the setting of the DELAY TIME (A TIME/DIV) switch and the DELAY-TIME POSITION control.

## REAR PANEL

**45. A +GATE**—Provides a positive-going rectangular pulse coincident with the A Sweep time, which can be used to trigger the signal source (with TRIG MODE switch set to AUTO).

**46. B +GATE**—Provides a positive-going rectangular pulse coincident with the B Sweep time, which can be used to trigger the signal source after a selected delay time, providing that A Sweep is triggered internally.

**47. CH 1 VERT SIGNAL OUT**—Provides a sample of the signal applied to the CH 1 input connector.

**48. EXT Z-AXIS**—Permits intensity modulation of the crt display. Does not affect display waveshape. Signals with fast rise and fall provide the most abrupt intensity change. Signals must be time-related to the display for a stable display. Useful for adding time markers in uncalibrated modes of operation.

**49. Line Fuse Holder**—Contains the line fuse and the regulating range selector. See Table 1 for change information.

**50. Regulating Range Selector**—Shown in Medium regulating range. See Table 1 for change information.

**51. Line Cord**—Makes the connection between the oscilloscope and the power source. The cord may be conveniently stored by wrapping it around the feet on the rear panel.

**52. MOD SLOTS**—A number in either slot indicates the instrument contains an option or other modifications.

## LEFT SIDE PANEL

Access for externally available adjustments (see Fig. 7).

## RIGHT SIDE PANEL

**LINE VOLTAGE SELECTOR SWITCH** (located on the right side)—Selects either 115 V or 230 V nominal line voltage.



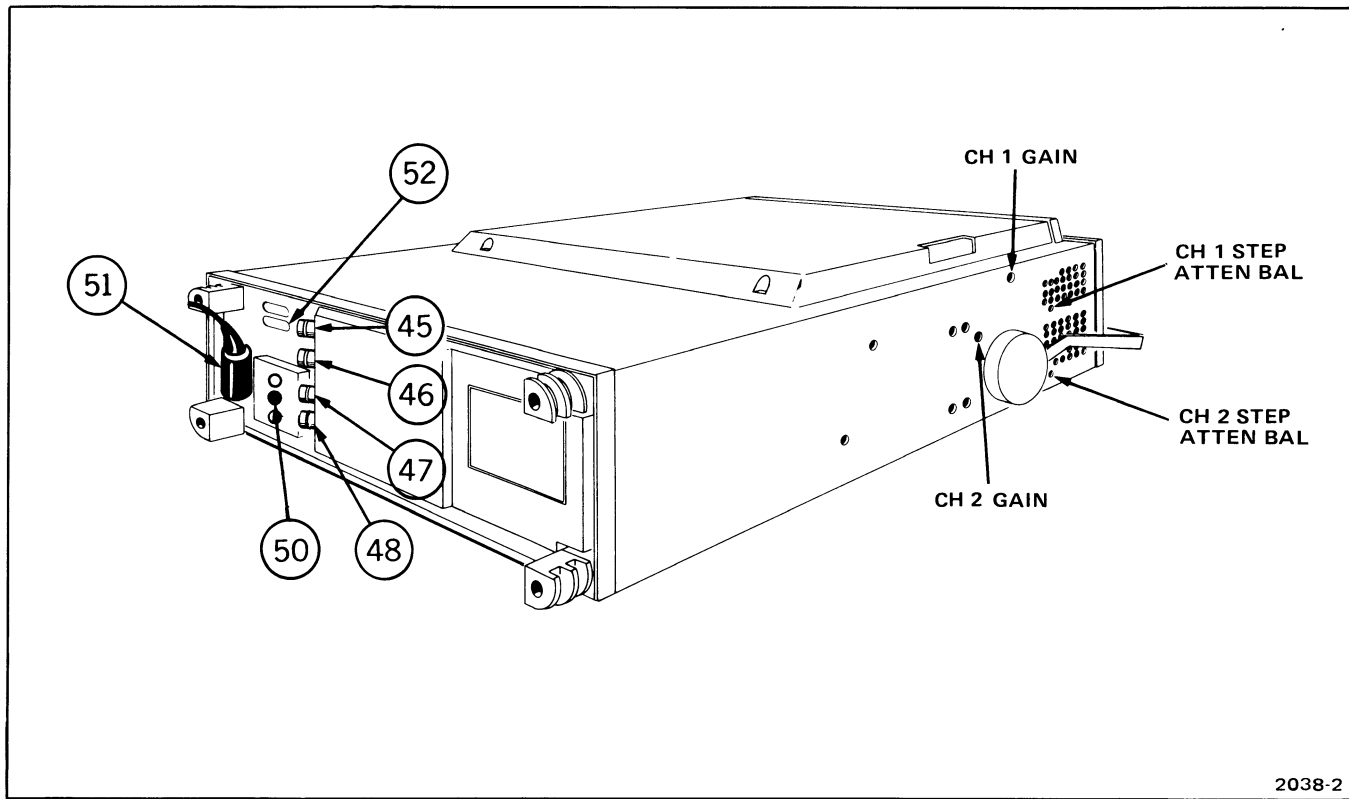

Fig. 7. Rear panel and left side panel controls, connectors, and indicators.

# BASIC OSCILLOSCOPE DISPLAYS

These instructions permit the operator to obtain the most commonly used basic displays.

## NORMAL SWEEP DISPLAY

1. Set the controls as follows:

### Vertical

VERT MODE	CH 1
VOLTS/DIV	Position determined by amplitude of signal to be applied
VOLTS/DIV VAR	Calibrated detent
AC-GND-DC	AC
Vertical POSITION	Midrange
20 MHz BW	Not limited (yellow band not visible)
INVERT	Button out

### Display

INTENSITY	Fully counterclockwise
-----------	------------------------

### Horizontal

TIME/DIV Switches	Locked together at 1 ms
A TIME/DIV VAR	Calibrated detent
HORIZ DISPLAY	A
X10 MAG	Off (button out)
POSITION	Midrange

### Trigger

(Both A and B if applicable)

SLOPE	+
LEVEL	0
SOURCE	NORM
COUPLING	AC
TRIG MODE (A only)	AUTO
A TRIG HOLDOFF	NORM

2. Pull the POWER switch (on). Connect the signal to the CH 1 input connector.

3. Adjust the INTENSITY control for the desired display brightness. If the display is not visible with the INTENSITY control at midrange, press the BEAM FINDER pushbutton and adjust the CH 1 VOLTS/DIV switch to reduce the vertical display size. Center the compressed display with the vertical and horizontal POSITION controls; release the BEAM FINDER pushbutton.

4. Set the CH 1 VOLTS/DIV switch and vertical POSITION control to locate the display within the display area.

5. Adjust the A Trigger LEVEL control for a stable display.

6. Set the A TIME/DIV switch and the horizontal POSITION control to locate the display within the display area. Then adjust the FOCUS control as needed.

## MAGNIFIED SWEEP DISPLAY

1. Obtain a Normal Sweep Display.

2. Adjust the horizontal POSITION control to move the area to be magnified to within the center graticule division (0.5 division on each side of the center vertical graticule line). It may be necessary to change the TIME/DIV switch setting.

3. Push the X10 MAG switch (on) and adjust the horizontal POSITION control for precise positioning of the magnified display. Divide the TIME/DIV setting by 10 to determine the magnified sweep rate.

## DELAYED SWEEP DISPLAY

### NOTE

*Differential time measurements and measurements using the TIME or 1/TIME functions of the DM44 are invalid when the B Trigger SOURCE switch is not set to STARTS AFTER DELAY.*

1. Obtain a Normal Sweep Display.
2. Set the HORIZ DISPLAY switch to A INTEN and the B Trigger SOURCE switch to STARTS AFTER DELAY.
3. Pull out on the B TIME/DIV knob and turn cw until the intensified zone is the desired length. Adjust the INTENSITY control as needed to make the intensified zone distinguishable from the rest of the display. If your instrument is equipped with a DM44, set the FUNCTION switch to a function other than TIME or 1/TIME for a single delayed sweep. Dual delayed displays are discussed in step 6.
4. Adjust the DELAY TIME POSITION control to move the intensified zone to cover the portion of the display to be displayed in delayed form.
5. Set the HORIZ DISPLAY switch to B DLY'D. The intensified zone noted in steps 3 and 4 is now displayed in delayed form. The delayed sweep rate is indicated by the dot on the B TIME/DIV knob.
6. If your instrument is equipped with a DM44, delayed displays of two signals can be obtained at the same time. The DM44 will indicate the time difference between the beginning of the delayed displays. To obtain two delayed displays set the FUNCTION switch to TIME and the VERT

MODE switch to ALT. The DELAY TIME POSITION control positions both delayed displays. The ALT DELAY control positions only the CH 2 delayed display.

7. For a delayed display with less jitter, set the B Trigger SOURCE switch to the same position as the A Trigger SOURCE switch and adjust the B LEVEL control for a stable display.

## MIXED SWEEP DISPLAY

1. Obtain a normal sweep display.
2. Pullout on the B TIME/DIV knob and turn cw to the desired sweep rate. If your instrument is equipped with a DM44 set the FUNCTION switch to a function other than TIME or 1/TIME for a single mixed display. Dual mixed displays are discussed in step 4.
3. Set the HORIZ DISPLAY switch to MIX. The display now contains two sweep rates. The first portion of the display is at the A sweep rate while the latter portion of the display is at the B sweep rate. The start of the B sweep rate portion can be changed by adjusting the DELAY TIME POSITION control.

4. If your instrument is equipped with a DM44, mixed sweep displays of two signals can be obtained at the same time. The DM44 will indicate the time difference between the beginning of the B sweep portions of the two displays. To obtain two mixed sweep displays set the FUNCTION switch to TIME and the VERT MODE switch to ALT. The DELAY TIME POSITION control positions both mixed displays. The  $\Delta$  TIME control positions only the CH 2 mixed display.

## X-Y DISPLAY

1. Preset the instrument controls as given in step 1 of Normal Sweep Display, then turn the instrument power on. Allow several minutes for instrument warm-up.

2. Set the TIME/DIV switches to X-Y and the VERT MODE switch to CH 2. Apply the vertical signal to the CH 2 OR Y input connector and the horizontal signal to the CH 1 OR X input connector.

3. Advance the INTENSITY control until the display is visible. If the display is not visible with the INTENSITY control at midrange, press the BEAM FINDER pushbutton

and adjust the CH 1 and CH 2 VOLTS/DIV switches until the display is reduced in size, both vertically and horizontally. Center the compressed display with the POSITION controls (CH 2 POSITION vertically, Horizontal POSITION horizontally); release the BEAM FINDER pushbutton. Adjust the FOCUS control for a well-defined display.

## SINGLE SWEEP DISPLAY

1. Obtain a Normal Sweep Display. For random signals, set the trigger circuit to trigger on a signal that is approximately the same amplitude and frequency as the random signal.

2. Push the SINGL SWP button on the A TRIG MODE switch. The next trigger pulse starts the sweep and displays a single trace. If no triggers are present, the READY lamp lights, indicating the A Sweep Generator circuit is set and waiting to be triggered.

3. After the sweep is complete, the circuit is "locked out" and the READY lamp is out. Press the SINGL SWP button to prepare the circuit for another single-sweep display.

# DM44 DISPLAYS AND MEASUREMENTS

Except for the TIME and 1/TIME functions, the DM44 is independently usable anytime the oscilloscope is turned on. The TIME and 1/TIME functions are discussed in the Oscilloscope Applications and Measurements section of this manual under Delayed or Mixed Sweep Measurements.

## RESISTANCE

### CAUTION

*The meter may be damaged by attempting to measure voltage if the meter is in the resistance mode of operation (OHMS FUNCTION button pushed in) and the applied voltage is in excess of 120 V rms.*

1. Push in the OHMS FUNCTION button and the 20 M $\Omega$  RANGE button. See Fig. 8.
2. Connect the + and COM leads to the unknown resistance.
3. Reduce the range, using the following table, until a proper readout is obtained.

TABLE 2

Resistance Ranges

RANGE	READOUT	MEASUREMENT
20 M $\Omega$	20.00—02.00	20 M $\Omega$ —2 M $\Omega$
2 M $\Omega$	2.000—0.200	2 M $\Omega$ —200 k $\Omega$
200 k $\Omega$	200.0—20.00	200 k $\Omega$ —20 k $\Omega$
20 k $\Omega$	20.00—02.00	20 k $\Omega$ —2 k $\Omega$
2 k $\Omega$	2.000—0.200	2 k $\Omega$ —200 $\Omega$
200 $\Omega$	200.0—000.0	200 $\Omega$ —0 $\Omega$

A blinking readout on any range, when connected to any unknown resistance, indicates an overrange condition and a need to select a higher range.

A blinking readout, when meter leads are disconnected is normal.

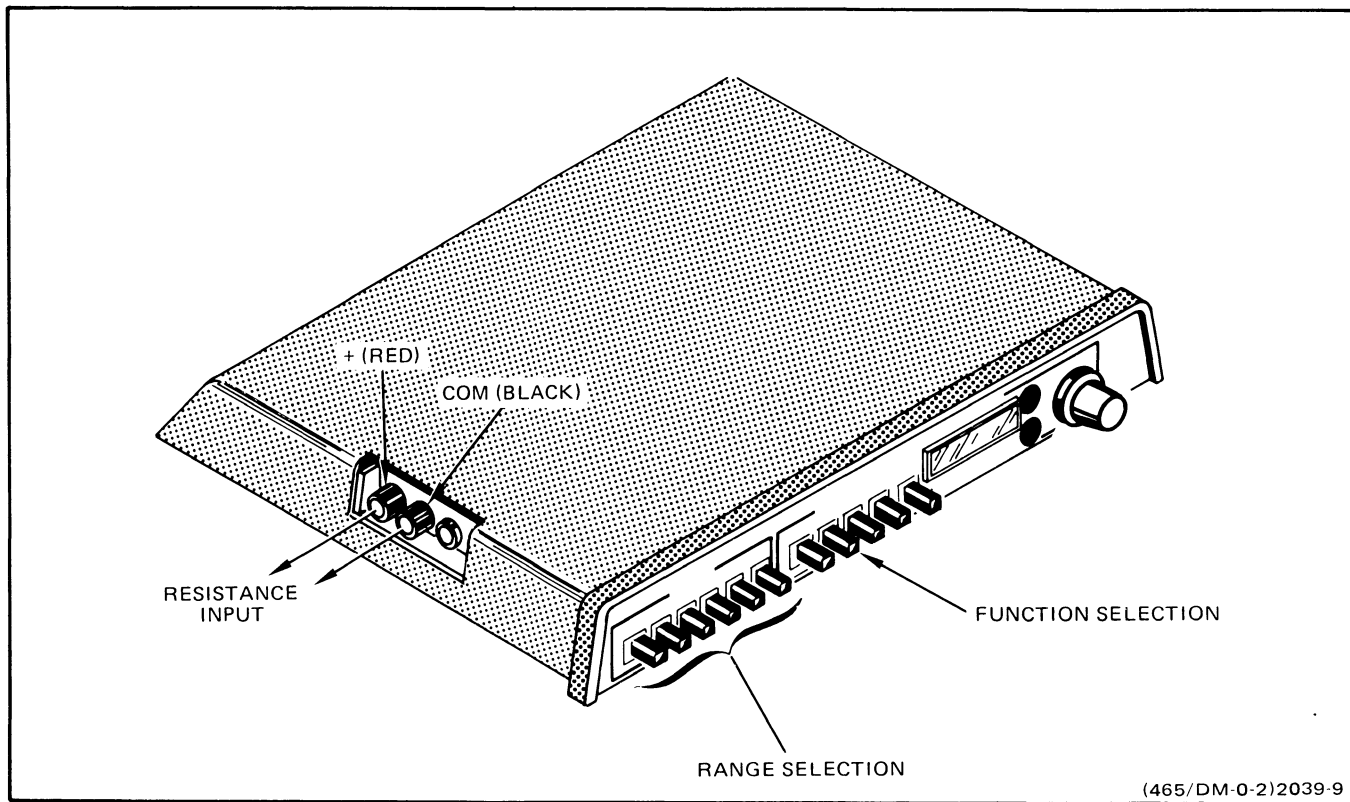

(465/DM-0-2)2039-9

Fig. 8. Resistance.

## VOLTS

### CAUTION

*The maximum safe input voltage is  $\pm 1200$  V (dc + peak ac) between the + and COM inputs or between the + input and chassis.*

*The maximum COM floating voltage is  $\pm 500$  V (dc + peak ac) to chassis.*

*The meter may be damaged by attempting to measure voltage if the meter is in the resistance mode of operation and the applied voltage is in excess of 120 V rms.*

*If the reading exceeds 1200 V or the readout blinks (indicating overrange) disconnect the + lead at once to prevent possible meter damage.*

1. Push in the VOLTS FUNCTION button and the 1.2 kV RANGE button. See Fig. 9.

2. Connect the COMMON lead to the reference point (usually a ground or test point) and the HIGH lead to the unknown voltage to be measured and observe the reading.

3. Reduce the range, using Table 3, until a proper readout is obtained.

### NOTE

*When no voltage is applied in the 20 V to 1.2 kV ranges, the readout is 0000 and individual readout elements may blink. Also, noise picked up by the meter leads may increase the readout in the .2 V and 2 V ranges.*

*A blinking readout on any range indicates an overrange condition and a need to select a higher range.*

**TABLE 3**  
**Volts Ranges**

RANGE	READOUT	MEASUREMENT
1.2 kV	1.200—0.200	1.2 kV—200 V
200 V	200.0—020.0	200 V—20 V
20 V	20.000—02.00	20 V—2 V
2 V	2.000—0.200	2 V—.2 V
200 mV	0.200—0.000	.2 V—0 V



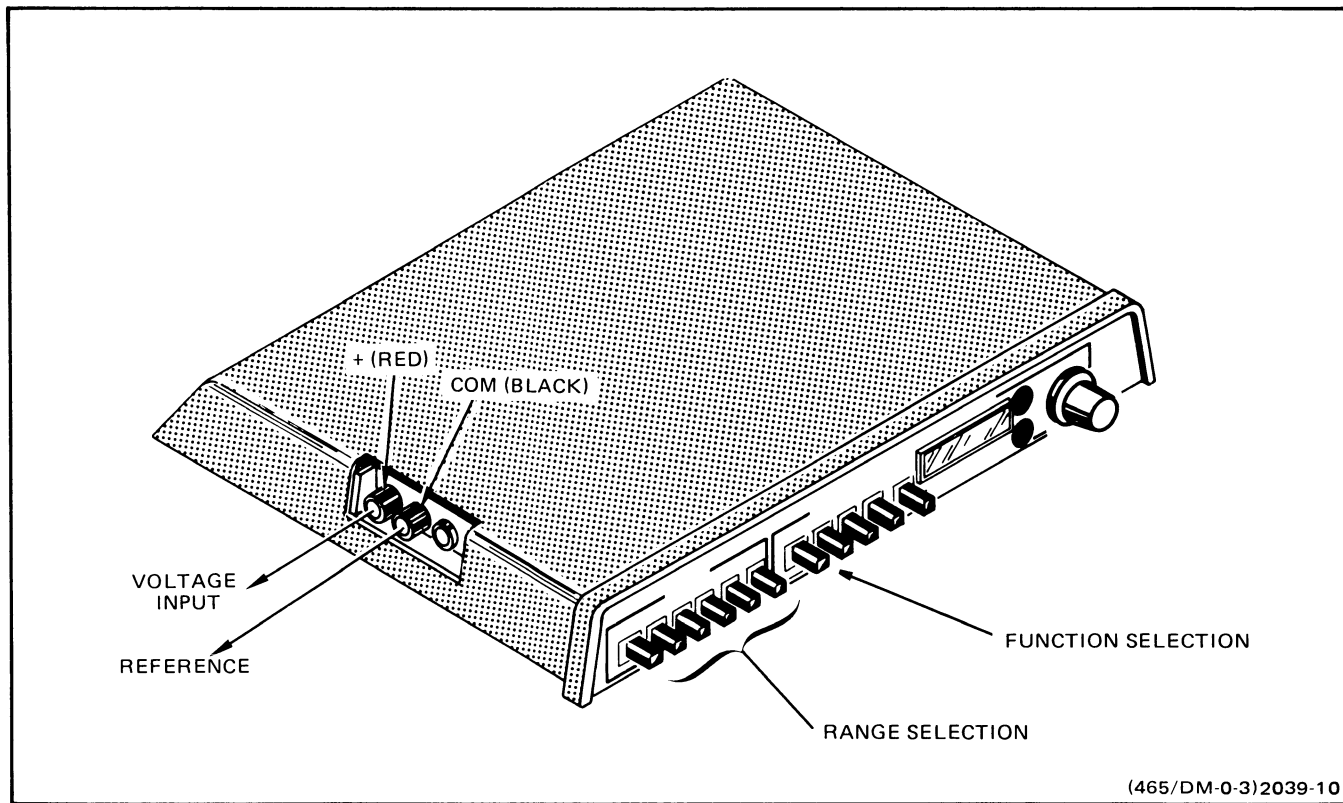

Fig. 9. Volts.

## TEMPERATURE

### CAUTION

*The maximum safe voltage on the measurement surface is  $\pm 400$  V (dc + peak ac) above chassis ground.*

*The sensor tip is fragile and may break if dropped or subjected to excessive stress. Force exerted on the sensor tip should not exceed 20 pounds.*

*If the reading exceeds  $-55^{\circ}\text{C}$  or  $+150^{\circ}\text{C}$ , remove the probe at once to prevent probe damage.*

1. Push in the TEMP ( $^{\circ}\text{C}$ ) FUNCTION button. See Fig. 10.

2. Apply the temperature probe to the device to be measured so the flat surface of the probe tip mates against the device to be measured and observe the reading. See Table 4 to convert the reading from centigrade to fahrenheit.

## NOTE

*Temperature accuracy is affected by several factors such as the angle of contact between the probe and the device to be measured, a thermal gradient, heat removed from the device by the probe, etc.*

*These items and other probe information are in the probe manual, which should be reviewed.*

## Accuracy Check

The DM44 is calibrated to its original probe, giving accurate readings within  $2^{\circ}\text{C}$  for examples that follow. The DM44 should be recalibrated to any replacement probe.

In the following checks, use an accurate thermometer to verify water temperature. Anything in solution affects the melting temperature and the boiling point is affected by changes in altitude and barometric pressure.

### Low Temperature

Allow a container (preferably insulated) of crushed ice to melt until there are only a few pieces of ice remaining.

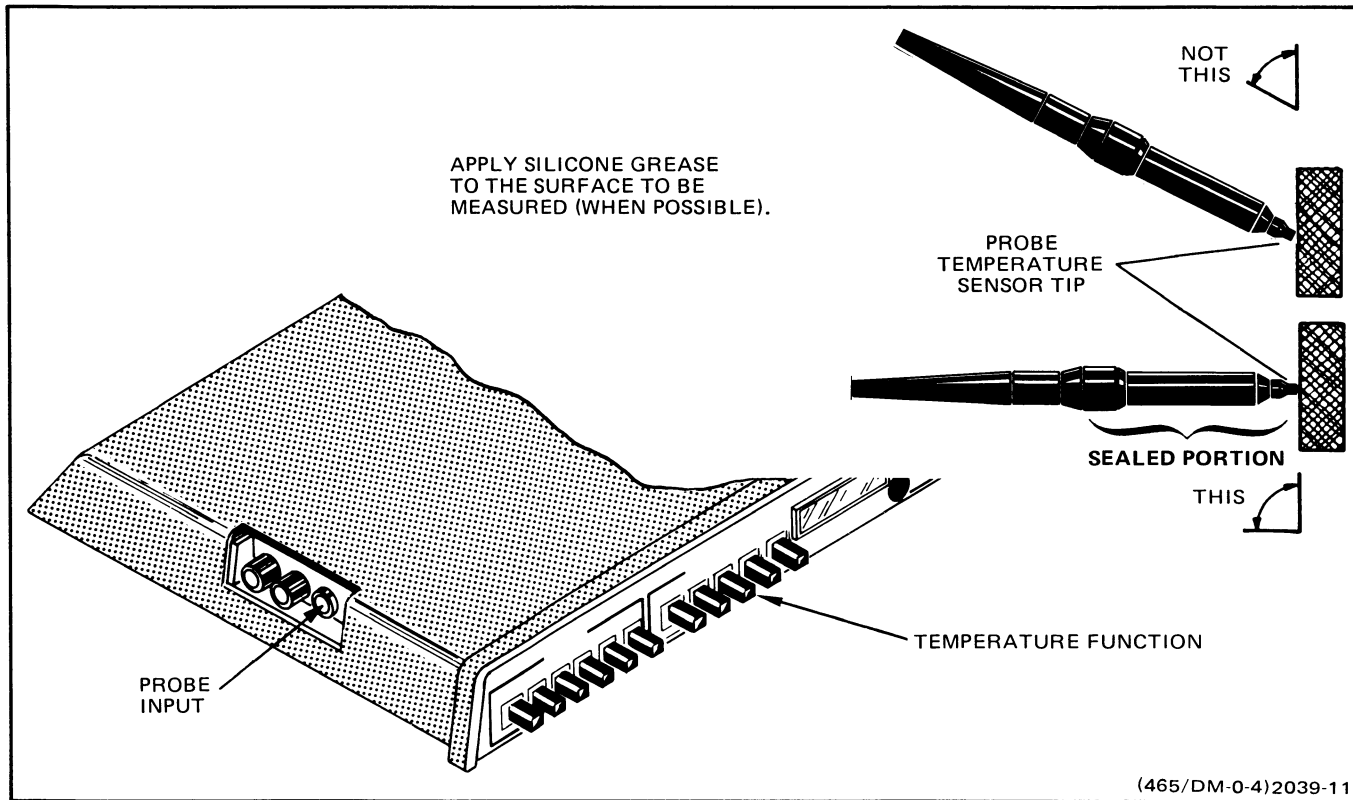
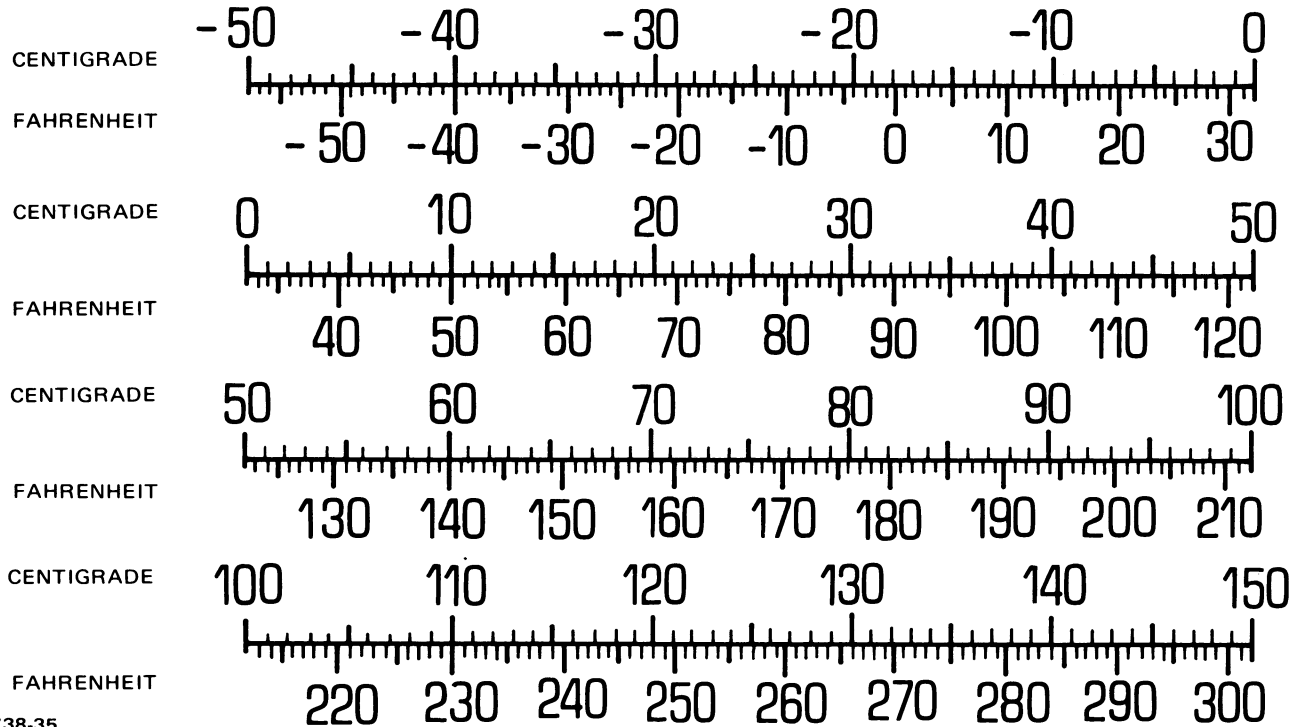

Fig. 10. Temperature.

TABLE 4  
CENTIGRADE TO FAHRENHEIT CONVERSION



1738-35

**CAUTION**

*To prevent possible probe damage, be sure only the sealed portion of the probe is immersed (see Fig. 10).*

Put the probe tip into the water, avoiding the side or bottom of the container. Wait for the readout to stabilize, indicating the probe has reached the water temperature.

The readout should be  $-2^{\circ}\text{C}$  to  $2^{\circ}\text{C}$ . There should be ice remaining after the test to verify that inserting the probe did not raise the water temperature.

### **High Temperature**

Bring water to a slow boil (to prevent splattering). Put the probe tip into the water, avoiding the side or bottom of the container. Wait for the readout to stabilize, indicating the probe has reached the water temperature.

The readout should be between  $98^{\circ}\text{C}$  and  $102^{\circ}\text{C}$  for clean water at sea level.

### **TIME AND 1/TIME**

See DM44 DELAYED OR MIXED SWEEP TIME MEASUREMENTS in this manual.

# APPLICATIONS AND MEASUREMENTS

Refer to Basic Oscilloscope Displays as needed to obtain correct displays.

## PRELIMINARY

### Signal Ground



*Avoid cross-grounding because instrument damage may occur.*

The most reliable measurements are made when the oscilloscope ground is connected to the ground of the unit under test by the ground strap on the signal probe. Also a ground lead can be connected to the ground banana jack on the oscilloscope chassis to establish a common ground with the unit under test.

### Input Coupling Capacitor Precharging

In the GND position, the input signal is connected to ground through a one-megohm resistor to form a precharging network. This network allows the Input Coupling capacitor to charge to the average dc voltage

level of the signal applied to the probe. Thus, any large voltage transients accidentally generated will not be applied to the amplifier input. The precharge network also provides a measure of protection to the external circuitry by reducing the current levels that can be drawn from the external circuitry during capacitor charging.

The following procedure should be used whenever the probe tip is connected to a signal source having a different dc level than that previously applied, especially if the dc level difference is more than 10 times the VOLTS/DIV setting.

1. Before connecting the probe tip to a signal source, set the Input Coupling switch to GND.
2. Touch the probe tip to oscilloscope chassis ground. Wait several seconds for the Input Coupling capacitor to discharge.
3. Connect the probe tip to the signal source.
4. Wait several seconds for the Input Coupling capacitor to charge.

5. Set the Input Coupling Switch to AC. The display will remain on the screen so the ac component of the signal can be measured in the normal manner.

## OPERATOR'S ADJUSTMENT AND CHECKS

To verify measurement accuracy, perform the following checks and adjustments before making a measurement. See the Calibration section of the Service manual for calibration information.

### Trace Rotation Adjustment

Normally not required. Obtain a Normal Sweep Display using only steps 1 through 3. Set the CH 1 input Coupling switch to GND to display a free-running trace with no vertical deflection. Adjust the TRACE ROTATION (screw-driver adjustment located below the crt graticule) to align the trace with the center horizontal graticule line.

### Probe Compensation

Miscompensation is one of the greatest sources of operator error. Most attenuator probes are equipped with adjustments to ensure optimum measurement accuracy. Probe compensation is accomplished as follows:

Obtain a Normal Sweep Display presentation of the calibrator square-wave voltage. Set the appropriate VOLTS/DIV switch to .1 V position and the Input coupling to DC. Check the waveform presentation for overshoot or rolloff, and if necessary, readjust compensation for flat tops on the waveforms. See Fig. 11. Refer to probe manual for method of compensating the probe being used.

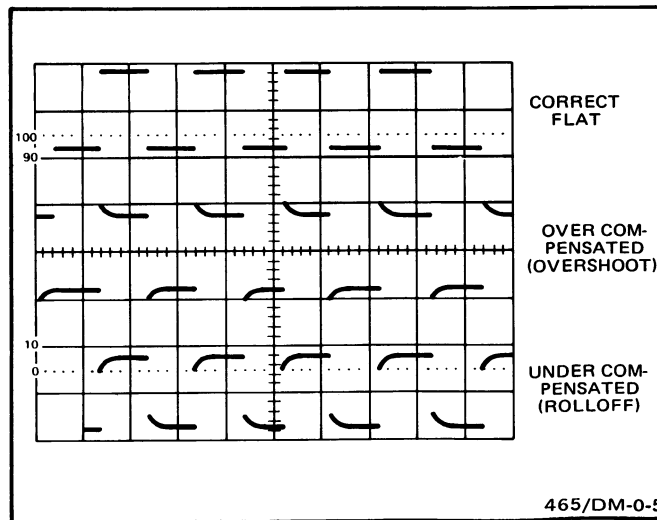

Fig. 11. Probe compensation.

## Vertical Gain Check

Obtain a Normal Sweep Display presentation of the calibrator square-wave voltage. Set the appropriate VOLTS/DIV switch to the 50 mV position and the Input Coupling switch to DC. Make sure the VAR VOLTS/DIV control is in the calibrated detent. Check that the vertical deflection is 5.8 to 6.2 divisions.

## Basic 465 Timing Check (60 Hertz Line Only)

Obtain a Normal Display. Set the A TIME/DIV switch to 5 ms position. Set the A Trigger SOURCE switch to LINE. Push the TRIG VIEW switch and hold it in. This displays a sample of the line voltage. Use the A Trigger LEVEL control to vertically position the top of the display to within the display area. Use the horizontal position control to position the left peak to the left graticule edge (see Fig. 12). Verify the horizontal distance between the first and the fourth peaks is 9.8 to 10.2 divisions. If the fourth peak is not visible, verify the horizontal distance between the first and the third peaks is 6.53 to 6.79 divisions.

## DM44 Timing Check (60 Hertz Line Only)

Perform the Basic 465 Timing Check to verify the accuracy of the horizontal deflection system.

Leave controls set as for the Basic 465 Timing Check except as follows:

B TIME/DIV  
HORIZ DISPLAY  
B SOURCE  
FUNCTION  
 $\Delta$  TIME

5  $\mu$ s  
A INT  
STARTS AFTER DELAY  
TIME  
To move the time-  
measurement point to the  
right of the reference  
point.

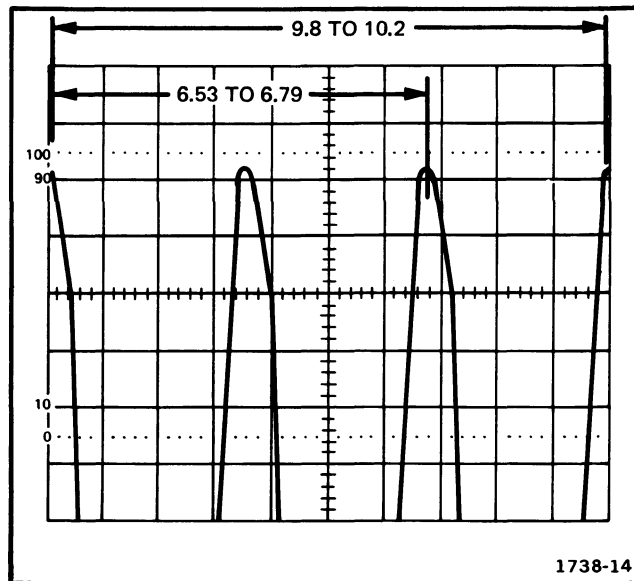

1738-14

Fig. 12. Basic 465 timing check.



Push the TRIG VIEW button and hold it in. Use the DELAY TIME POSITION control to move the reference point to the center horizontal graticule line (see Fig. 13, Point A). Use the ALT DELAY control to move the time-measurement point to the center horizontal graticule line on the next cycle (see Fig. 13, Point B). Verify the readout is 16.49 to 16.84 and the ms lamp is lit.

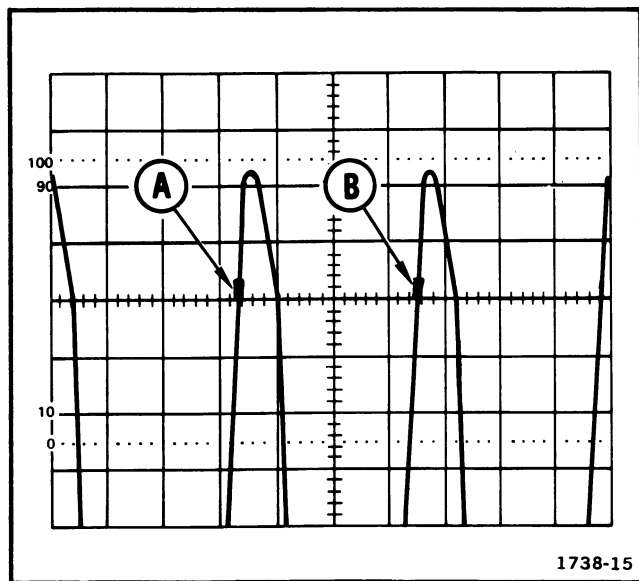

Fig. 13. DM44 timing check.

### External Horizontal Gain Check

(If X-Y operation is to be used.) Use steps 1 through 3 of the Basic Oscilloscope Displays procedure for obtaining a Normal Sweep Display of the calibrator square-wave voltage waveform; then, set the TIME/DIV switch to X-Y. With the calibrator signal connected to the CH 1 OR X input connector and the CH 1 VOLTS/DIV switch set to 50 mV, the crt display should be two dots separated horizontally by 5.75 to 6.25 divisions.

### PEAK-TO-PEAK VOLTAGE MEASUREMENTS—AC

Obtain a Normal Display. Make sure the VAR VOLTS/DIV control is in the calibrated detent. Vertically position the display so the lower portion coincides with a horizontal graticule line (see Fig. 14, Point A). Horizontally position the display so one of the upper peaks coincides with the center vertical graticule line (see Fig. 14, Point B). Measure the vertical deflection from peak-to-peak (Point A to Point B).

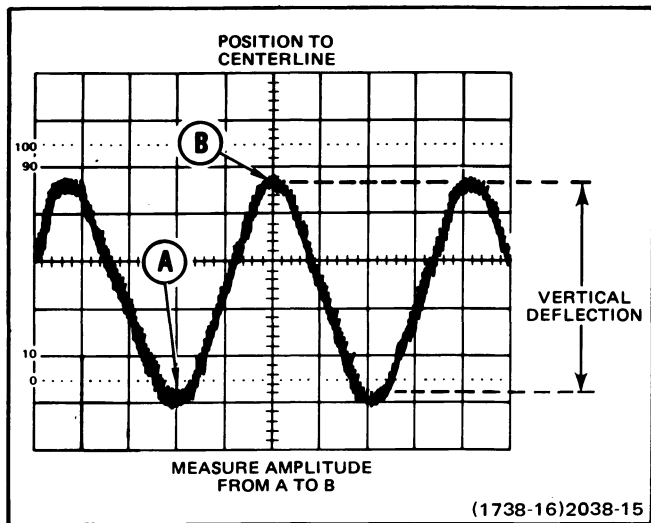

Fig. 14. Peak-to-peak voltage of a waveform.

**NOTE**

*If the amplitude measurement is critical or if the trace is thick as a result of hum and/or noise on the signal, a more accurate measurement can be obtained by measuring from the top of a peak to the top of a valley. This will subtract the trace thickness from the measurement.*

Multiply the vertical deflection just measured by the VOLTS/DIV switch setting. Also include the attenuation factor of the probe if the probe does not have a scale-factor switching connector.

Example: The peak-to-peak vertical deflection measured is 4.6 divisions (see Fig. 14) with a VOLTS/DIV switch setting of .5.

Using the formula:

$$\text{Volts Peak-to-peak} = \text{vertical deflection (divisions)} \times \text{VOLTS/DIV setting}$$

Substituting the given values:

$$\text{Volts Peak-to-Peak} = 4.6 \times 0.5 \text{ V} = 2.3 \text{ volts.}$$

**INSTANTANEOUS VOLTAGE MEASUREMENTS—DC**

Obtain a Normal Display. Make sure the VAR VOLTS/DIV control is in the calibrated detent.

To determine the polarity of the voltage to be measured, set the input coupling switch to GND and vertically position the baseline to the center of the crt. Set the input coupling switch to DC. If the waveform moves to above the center of the crt, the voltage is positive. If the waveform moves to below the center of the crt, the voltage is negative.

Set the input coupling switch to GND and position the baseline to a convenient reference line. For example, if the voltage to be measured is positive, then position the baseline to the bottom graticule line.

Switch the Input Coupling Switch to DC. Measure the divisions of vertical deflection between the reference line and the desired point on the waveform (see Fig. 15). Multiply the vertical deflection by the VOLTS/DIV switch setting. Include the attenuation factor of the probe if the probe does not have a scale-factor switching connector.

**EXAMPLE:** The vertical distance measured is 4.6 divisions (see Fig. 15), the waveform is above the reference line, and the VOLTS/DIV switch is set to 2.

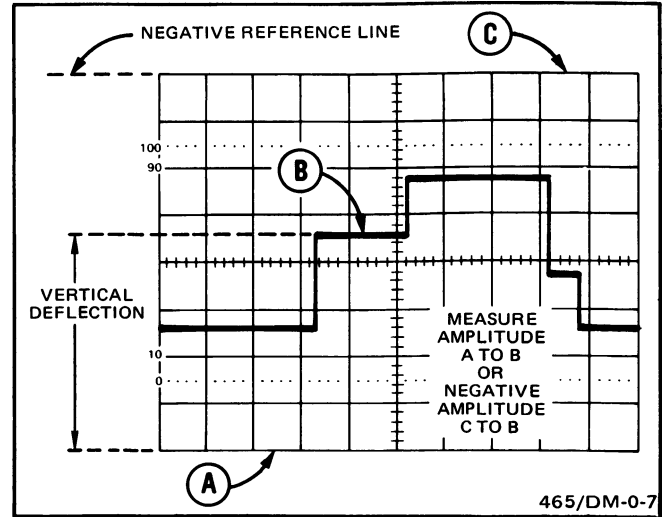

**Fig. 15. Instantaneous voltage measurement.**

Using the formula:

$$\text{Instantaneous Voltage} = \text{vertical distance (divisions)} \times \text{polarity} \times \text{VOLTS/DIV setting}$$

$$\text{Substituting: } = 4.6 \times (+1) \times 2 \text{ V} = 9.2 \text{ volts.}$$

If a negative voltage is to be measured, position the trace to the top graticule line and measure from C to B (see Fig. 15).

The ground reference line can be checked at any time by switching to the GND position.

This method can also be used to measure one voltage with respect to another. Position one of the voltage levels to a convenient reference line. Measure the divisions of vertical deflection between the reference line and the other voltage level. Substitute this value in the formula just given.

## ALGEBRAIC ADDITION

In the ADD position of the VERT MODE switch, the waveform displayed is the algebraic sum of the signals applied to the CH 1 and CH 2 inputs ( $CH\ 1 + CH\ 2$ ). If the CH 2 INVERT switch is pushed, the waveform displayed is the difference of the signals applied to the CH 1 and CH 2 inputs ( $CH\ 1 - CH\ 2$ ). The total deflection factor in the ADD mode is equal to the deflection factor indicated by either VOLTS/DIV switch (when both VOLTS/DIV switches are set to the same position).

The following general precautions should be observed when using the ADD mode.

1. Do not exceed the input voltage rating of the oscilloscope.

2. Do not apply signals that exceed an equivalent of about eight times the VOLTS/DIV switch settings. For example, with a VOLTS/DIV switch setting of 0.5, the voltage applied to that channel should not exceed about four volts. Large voltages may distort the display.

A common use of the ADD mode is to provide a dc offset for a signal riding on a dc level.

**EXAMPLE:** The Channel 1 signal is on a 3 division, positive dc level (using the center line as zero volts). See Fig. 16A. Multiply 3 divisions by the VOLTS/DIV switch setting to determine the dc-level value. Apply a negative dc level (or a positive level using the CH 2 INVERT switch), of the value determined, to Channel 2 input. See Fig. 16B. The ADD mode puts the resultant display within the operating range of the POSITION controls.

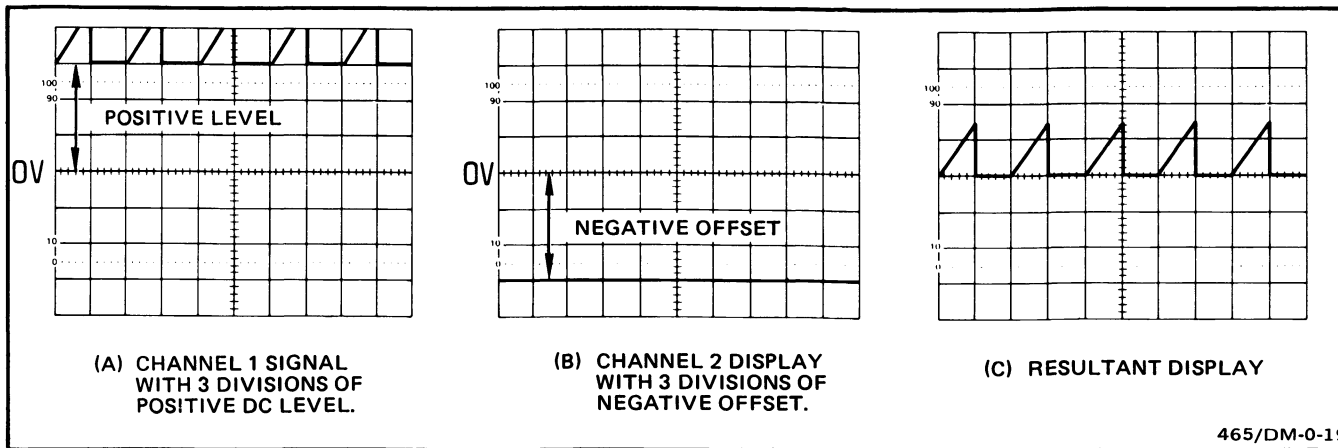

Fig. 16. Algebraic addition.

## COMMON-MODE REJECTION

The ADD mode can be used to display signals that contain undesirable components. These undesirable components can be eliminated through common mode rejection. The precautions given under algebraic addition should be observed.

EXAMPLE: The signal applied to the CH 1 input contains unwanted line frequency components (see Fig. 17A). To remove the undesired components use the following procedure.

1. Connect a line frequency signal to the CH 2 input.
2. Set the VERT MODE switch to ALT and the CH 2 INVERT switch to on (button in). Adjust the CH 2

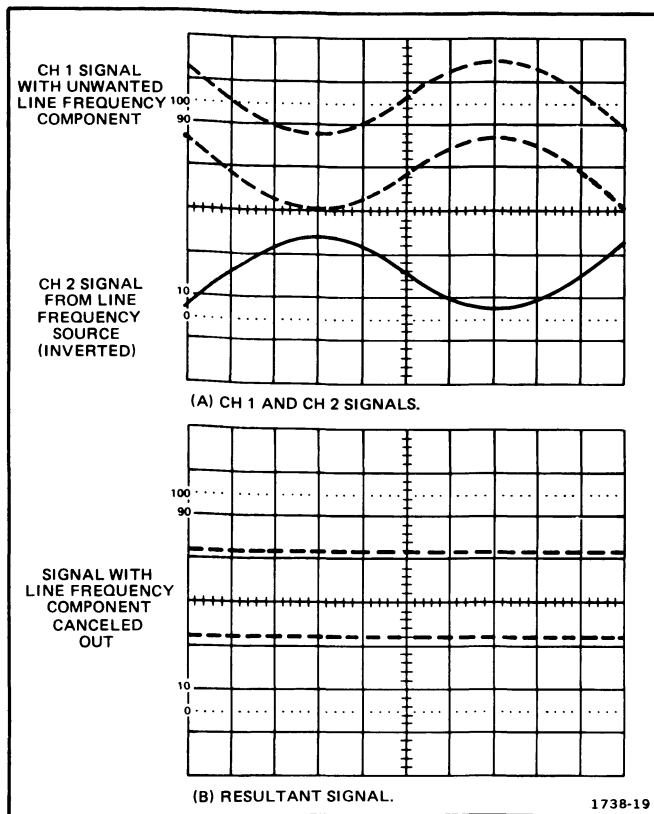

Fig. 17. Common-mode rejection.

VOLTS/DIV and VAR VOLTS/DIV controls so the CH 2 display is about the same amplitude as the undesired portion of the CH 1 display (see Fig. 17A).

3. Set the VERT MODE switch to ADD. Slightly readjust the CH 2 VAR VOLTS/DIV control for maximum cancellation of the undesired signal component (see Fig. 17B).

## AMPLITUDE COMPARISON MEASUREMENTS

If comparisons of an unknown signal with a reference signal are repetitious (e.g., on an assembly line test) it is possible to obtain more accurate easily read measurements if the VAR VOLTS/DIV control is adjusted to set the reference signal to an exact number of divisions. The unknown signal can then be quickly and easily compared with or adjusted to an exact number of divisions.

Other unknown signals may be measured without disturbing the setting of the VAR VOLTS/DIV control by establishing a vertical conversion factor and an arbitrary deflection factor. The amplitude of the reference signal must be known before a vertical conversion factor can be established.

Determine the vertical conversion factor using this formula:

$$\text{Vertical Conversion Factor} = \frac{\text{reference signal amplitude (volt)}}{\text{vertical deflection (divisions)} \times \text{VOLTS/DIV switch setting}}$$

Determine the arbitrary deflection factor using the formula:

$$\text{Arbitrary Deflection Factor} = \frac{\text{Vertical Conversion Factor}}{\text{VOLTS/DIV switch setting}}$$

To measure the amplitude of an unknown signal, set the VOLTS/DIV switch to a setting that provides sufficient vertical deflection to make an accurate measurement. Do not readjust the VAR VOLTS/DIV control. Measure the vertical deflection in divisions and calculate the amplitude of the unknown signal using the following formula:

$$\text{Signal Amplitude} = \text{Arbitrary deflection factor} \times \text{Vertical deflection (divisions)}$$

or

$$\text{Signal Amplitude} = \text{Vertical Conversion Factor} \times \text{VOLTS/DIV switch setting} \times \text{Vertical deflection (divisions)}$$

**EXAMPLE:** The reference signal amplitude measured is 30 volts with a VOLTS/DIV switch setting of 5 and the VAR VOLTS/DIV control adjusted to provide a vertical deflection of 4 divisions.

Substituting these values in the vertical conversion factor formula:

$$\text{Vertical Conversion Factor} = \frac{30}{4 \times 5} = 1.5$$

Then with a VOLTS/DIV switch setting of 1, the peak-to-peak amplitude of an unknown signal, 5 divisions high can be determined by using the signal amplitude formula:

$$\text{Signal Amplitude} = 1 \text{ V} \times 1.5 \times 5 = 7.5 \text{ volts.}$$

## TIME-DURATION MEASUREMENTS

Obtain a Normal Sweep display. Be sure the VAR TIME/DIV control is set to the calibrated detent. Set the TIME/DIV switch for a single event and position the display to place the time measurement points to the center horizontal graticule line (see Fig. 18).

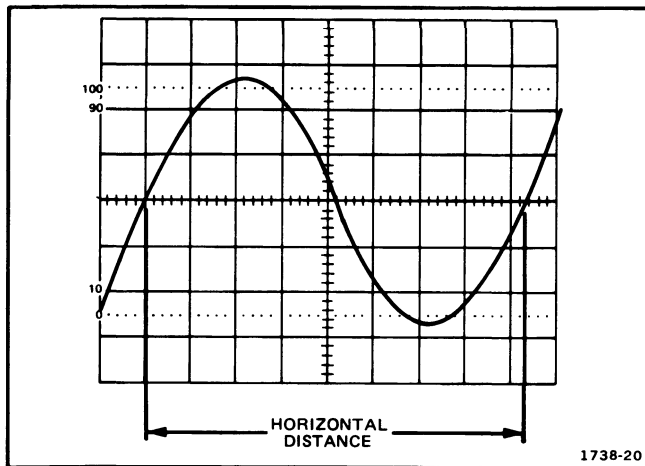

Fig. 18. Time duration.

Measure the horizontal distance between the time measurement points. Multiply the distance measured by the setting of the TIME/DIV switch. If sweep magnification is used, divide this answer by 10.

EXAMPLE: The distance between the time measurement points is 8.3 divisions (see Fig. 18) and the TIME/DIV switch is set to 2 ms with the magnifier off.

Using the formula:

$$\text{Time Duration} = \frac{\text{horizontal distance (divisions)} \times \text{Time/Div setting}}{\text{magnification}}$$

Substitute the given values:

$$\text{Time Duration} = 8.3 \times 2 \text{ ms} = 16.6 \text{ milliseconds}$$

## FREQUENCY MEASUREMENTS

Time Duration measurements can be used to determine the frequency of a recurrent signal as follows:

1. Measure one cycle of the waveform as described in Time-Duration Measurements.
2. Take the reciprocal of the time duration to determine the frequency.

EXAMPLE: The frequency of the signal shown in Fig. 18, which has a time duration of 16.6 milliseconds is:

$$\text{Frequency} = \frac{1}{\text{time duration}} = \frac{1}{16.6 \text{ ms}} = 60 \text{ hertz}$$



## RISETIME MEASUREMENTS

Risetime measurements use the same methods as time-duration measurements, except the measurements are made between the 10% and 90% points of the waveform. Falltime is measured between the 90% and 10% points on the trailing edge of the waveform.

Obtain a Normal Sweep Display. Set A SLOPE to +. Use a sweep speed setting that displays several cycles or events (if possible) and be sure the VAR TIME/DIV control is in the calibrated detent. Set the VOLTS/DIV switch and VAR control (or signal amplitude) for exactly a five-division display. Set vertical positioning so the display bottom touches the 0% graticule line and the display top touches the 100% graticule line.

Set the TIME/DIV switch for a single-event display with the risetime spread horizontally as much as possible. Horizontally position the display so the 10% point on the waveform intersects the second vertical graticule line (see Fig. 19).

Measure the horizontal distance between the 10% and 90% points and multiply the distance measured by the setting of the TIME/DIV switch.

EXAMPLE: The horizontal distance between the 10% and 90% points is 5 divisions (see Fig. 19) and the TIME/DIV switch is set to 1  $\mu$ s.

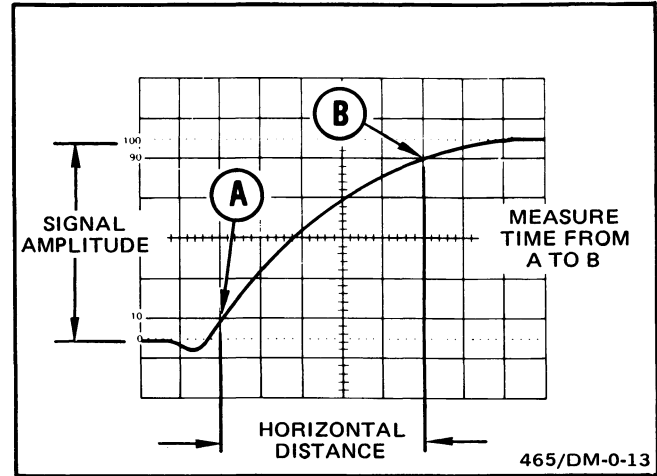

Fig. 19. Risetime.

Using the time duration formula to find risetime:

$$\begin{array}{l} \text{Time} \\ \text{Duration} \\ \text{(risetime)} \end{array} = \begin{array}{l} \text{horizontal} \\ \text{distance} \\ \text{(divisions)} \end{array} \times \begin{array}{l} \text{TIME/DIV} \\ \text{setting} \end{array}$$

Substituting the given values:

$$\text{Risetime} = 5 \times 1 \mu\text{s} = 5 \text{ microseconds.}$$

## TIME-DIFFERENCE BETWEEN TWO PULSES FROM DIFFERENT SOURCES

Obtain a Normal Sweep Display. Make sure the VAR TIME/DIV control is in the calibrated detent. Set the A Trigger SOURCE switch to CH 1. Connect the reference signal to CH 1 and the comparison signal to CH 2. Connect the signals to the input connectors using probes or cables with equal time delay.

Set the VERT MODE switch to either CHOP or ALT. In general, CHOP is more suitable for low-frequency signals and the ALT position is more suitable for high-frequency signals. Center each of the displays vertically (see Fig. 20).

Measure the horizontal difference between the two signals. Multiply the measured difference by the setting of the TIME/DIV switch; if sweep magnification is used, divide this answer by 10.

**EXAMPLE:** The TIME/DIV switch is set to  $50 \mu\text{s}$ , the MAG switch to X10 and the horizontal difference between waveforms is 4.5 divisions (see Fig. 20).

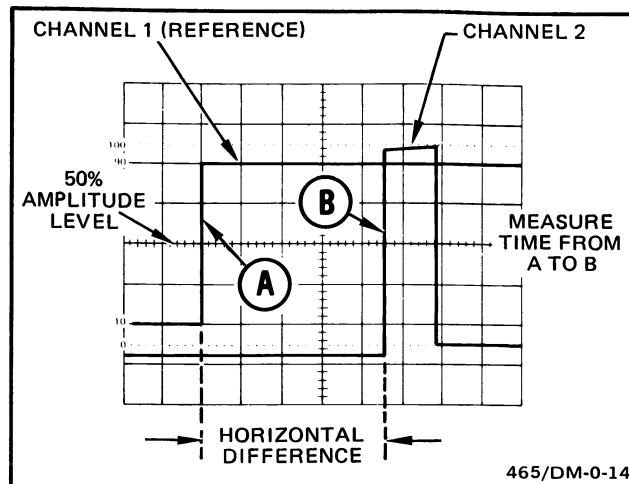

**Fig. 20. Time difference between two pulses from different sources.**

Using the formula:

$$\text{Time Difference} = \frac{\text{Time/Div setting} \times \text{horizontal difference (divisions)}}{\text{magnification}}$$

Substituting the given values:

$$\text{Time Difference} = \frac{60 \mu\text{s} \times 4.5}{10} = 22.5 \text{ microseconds}$$

## TIME COMPARISON MEASUREMENTS

If comparisons of an unknown signal with a reference signal are repetitious (e.g., on assembly line test) it is possible to obtain more accurate, easily read measurements if the VAR TIME/DIV control is adjusted to set the reference signal to an exact number of divisions. The unknown signal can then be quickly and easily compared with, or adjusted to, an exact number of divisions.

Other unknown signals may be measured without disturbing the setting of the VAR TIME/DIV control by establishing a horizontal conversion factor and an arbitrary deflection factor. The time duration of the reference signal must be known before a horizontal conversion factor can be established.

Determine the horizontal conversion factor using the formula:

$$\text{Horizontal Conversion Factor} = \frac{\text{reference signal time duration (seconds)}}{\text{Horizontal deflection (divisions)} \times \text{TIME/DIV switch setting}}$$

Determine the arbitrary deflection factor using this formula:

$$\text{Arbitrary Deflection Factor} = \text{horizontal conversion factor} \times \text{TIME/DIV switch setting}$$

To measure the time duration of an unknown signal, set the TIME/DIV switch to a setting that provides sufficient horizontal deflection to make an accurate measurement. Do not readjust the VAR TIME/DIV control. Measure the horizontal deflection in divisions and calculate the time duration using the formula:

$$\text{Time Duration} = \text{arbitrary deflection factor} \times \text{horizontal deflection (divisions)}$$

or

$$\text{Time Duration} = \text{horizontal conversion factor} \times \text{TIME/DIV switch setting} \times \text{horizontal deflection (divisions)}$$

**EXAMPLE:** The reference signal frequency measured is 455 hertz (time duration: 2.19 milliseconds) with a TIME/DIV switch setting of .2 ms, and the VAR TIME/DIV control adjusted to provide a horizontal deflection of eight

divisions. Substituting these values in the horizontal conversion factor formula:

$$\text{Horizontal Conversion Factor} = \frac{2.19 \text{ ms}}{8 \times 0.2 \text{ ms}} = 1.37$$

Then with a TIME/DIV switch setting of 50  $\mu\text{s}$ , the time duration of an unknown signal that completes one cycle in seven horizontal divisions, can be determined by using the time duration formula:

$$\text{Time Duration} = 1.37 \times 50 \mu\text{s} \times 7 = 480 \mu\text{s}$$

This answer can be converted to frequency by taking the reciprocal of the time duration (see applications on Determining Frequency).

## PHASE DIFFERENCE MEASUREMENTS

Use either the CHOP or ALT mode. Set the A TRIGGER SOURCE switch to CH 1. The reference signal should precede the comparison signal in time. Use coaxial cables or probes that have equal time delay to connect the signals to the input connectors.

If the signals are of opposite polarity, set the INVERT pushbutton to invert the Channel 2 display (signals may be of opposite polarity due to 180° phase difference; if so, take this into account in the final calculation). Set the CH 1 and CH 2 VOLTS/DIV switches and the CH 1 and CH 2 VAR controls so the displays are equal in amplitude.

Set the TIME/DIV switch for about a one-cycle waveform. Position the display and turn the A VAR TIME/DIV control for 1 reference signal cycle in exactly eight divisions (see Fig. 21). Each division of the graticule represents 45° of the cycle (360° ÷ 8 divisions = 45°/division). The sweep rate can be stated in terms of degrees as 45°/division.

Measure the horizontal difference between corresponding points on the waveforms and multiply the distance measured (in divisions) by 45°/division (sweep rate) to obtain the amount of phase difference.

EXAMPLE: The horizontal difference is 0.6 division with a sweep rate of 45°/division as shown in Fig. 21.

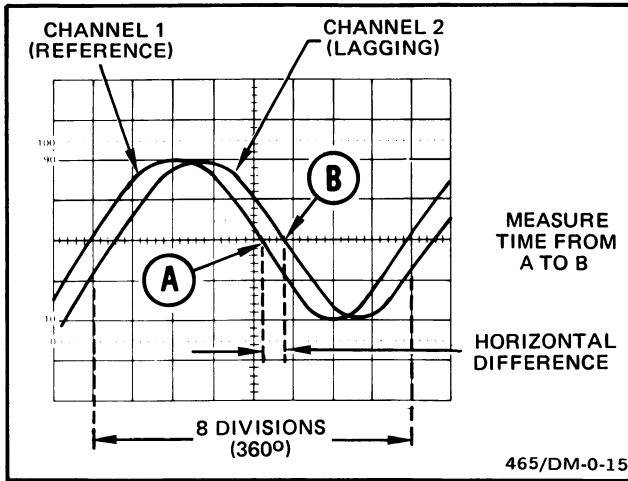

Fig. 21. Phase difference.

Using the formula:

$$\text{Phase Difference} = \frac{\text{horizontal difference}}{\text{divisions}} \times \text{sweep rate (degrees/div)}$$

Substituting the given values:

$$\text{Phase Difference} = 0.6 \times 45^\circ = 27^\circ.$$

## HIGH RESOLUTION PHASE DIFFERENCE MEASUREMENTS

Make more accurate phase measurements by increasing the sweep rate (without changing the A VAR TIME/DIV control) by using the X10 MAG mode. Delayed sweep magnification may also be used (see Fig. 22).

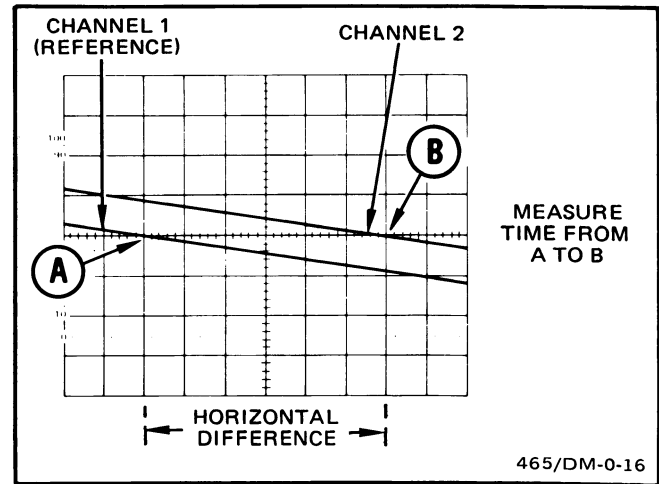

Fig. 22. High-resolution phase difference.

EXAMPLE: If the sweep rate were increased 10 times with the magnifier, the magnified sweep rate would be  $45^\circ \div 10 = 4.5^\circ/\text{division}$ . Fig. 22 shows the same signals as used in Fig. 21 but with the X10 MAG switch set to X10. With a horizontal difference of 6 divisions, the phase difference is:

$$\text{Phase Difference} = \text{horizontal difference (divisions)} \times \text{magnified sweep rate (degrees/div)}$$

Substituting the given values:

$$\text{Phase Difference} = 6 \times 4.5^\circ = 27^\circ.$$

## PULSE JITTER MEASUREMENTS

Be sure the VAR TIME/DIV switch is in the calibrated detent. Set the B TIME/DIV switch to intensify the full rising portion of the pulse. Set the HORIZ DISPLAY switch to B DLY'D.

Pulse jitter is shown by horizontal movement of the pulse and includes the inherent jitter of the Delayed Sweep (see Fig. 23). Multiple the distance by the B TIME/DIV switch setting to obtain pulse jitter time.

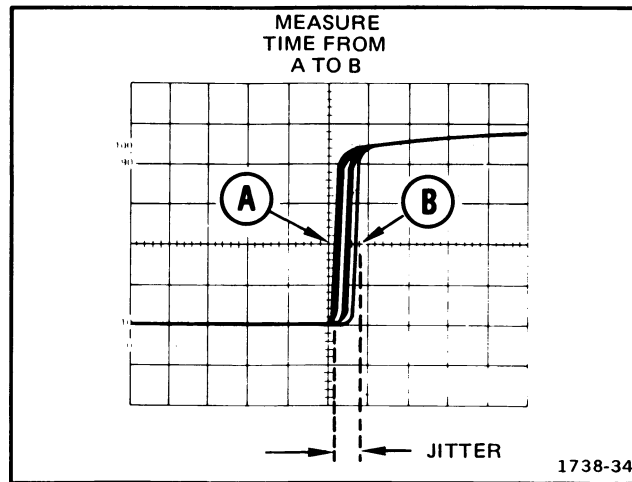

Fig. 23. Pulse jitter.

## DELAYED OR MIXED SWEEP MAGNIFICATION

The delayed sweep features of the 475 can be used to provide higher apparent magnification than is provided by the X10 MAG switch. The sweep rate of the delayed sweep (B sweep) is not actually increased; the apparent magnification is the result of delaying the B sweep an amount of time selected by the A TIME/DIV switch and the DELAY-TIME POSITION control before the display is presented at the sweep rate selected by the B TIME/DIV switch. The following method uses the STARTS AFTER DELAY position of the B Trigger SOURCE switch to allow the delayed portion to be positioned with the DELAY-TIME POSITION control. If there is too much jitter in the delayed display, use the Triggered B Sweep mode of operation.

### Magnified Sweep Starts After Delay

1. Connect the signal to either input connector. Set the VERT MODE switch to display the channel used.
2. Set the VOLTS/DIV switch to produce a display about four divisions in amplitude.
3. Set the A TIME/DIV switch to a sweep rate which displays the complete waveform.

4. Set the HORIZ DISPLAY switch to A INT and the B Trigger SOURCE switch to STARTS AFTER DELAY. Instrument equipped with DM44. Verify that the FUNCTION switch is not set to TIME or 1/TIME.

5. Position the start of the intensified zone with the DELAY-TIME POSITION control to the part of the display to be magnified.

6. Set the B TIME/DIV switch to a setting which intensifies the full portion to be magnified. The start of the intensified zone remains as positioned above (see Fig. 24).

7. Set the HORIZ DISPLAY switch to B DLY'D to magnify the portion of A sweep that is intensified (see Fig. 24).

8. Time measurements can be made from the display in the conventional manner. The sweep rate is determined by the setting of the B TIME/DIV switch.

9. The apparent sweep magnification can be calculated by dividing the A TIME/DIV switch setting by the B TIME/DIV switch setting.

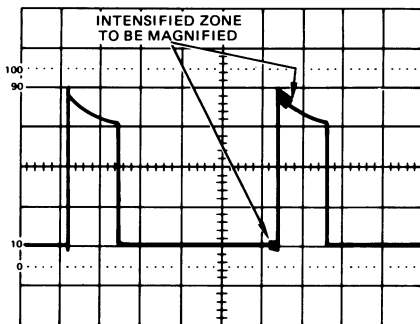

(A) A INTENSIFIED DISPLAY

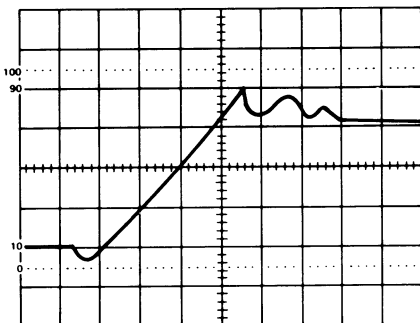

(B) B DELAYED DISPLAY

1738-31

Fig. 24. Delayed sweep magnification.

EXAMPLE: The apparent magnification of a display with an A TIME/DIV switch setting of .1 ms and a B TIME/DIV switch setting of  $1 \mu\text{s}$  is:

$$\text{Apparent Magnification (Delayed Sweep)} = \frac{\text{A TIME/DIV setting}}{\text{B TIME/DIV setting}}$$

Substituting the given values:

$$\text{Apparent Magnification} = \frac{1 \times 10^{-4}}{1 \times 10^{-6}}$$

The apparent magnification is 100 times.

### Triggered Delayed Sweep Magnification

The delayed sweep magnification method just described may produce too much jitter at high apparent magnification ranges. Operating the B Sweep in a triggered mode provides a more stable display since the delayed display is triggered at the same point each time.



1. Set up the display as given in steps 1 through 6 under "Magnified Sweep Starts After Delay."

2. Set the B Trigger SOURCE switch to the same position as the A Trigger SOURCE switch.

3. Adjust the B LEVEL control so the intensified zone on the trace is stable. (If an intensified zone cannot be obtained, see step 4.)

4. Inability to intensify the desired portion indicates that the signal does not meet the triggering requirements.

If the condition cannot be remedied with the B Triggering controls or by increasing the display amplitude (lower VOLTS/DIV setting), trigger B Sweep externally.

5. When the correct portion is intensified, set the HORIZ DISPLAY switch to B DLY'D. Slight readjustment of the B LEVEL control may be necessary for a stable display.

6. Measurements are made and magnification factors are calculated as in the STARTS AFTER DELAY mode previously given.

# BASIC 465 DELAYED OR MIXED SWEEP TIME MEASUREMENTS

The delayed sweep modes can be used to make more accurate time measurements.

## TIME DIFFERENCE BETWEEN REPETITIVE PULSES (BASIC 465)

Obtain a Delayed Sweep Display. For the most accurate measurement, set the B TIME/DIV switch to the fastest sweep speed that gives usable (visible) intensified zones.

With the HORIZ DISPLAY switch set to A INTEN, use the DELAY TIME POSITION dial to move the intensified zone to the first pulse (see Fig. 25A).

Set the HORIZ DISPLAY switch to B DLY'D. Adjust the DELAY TIME POSITION dial to move the pulse (or rising portion) to some vertical reference line (see Fig. 25B). Note the setting of the DELAY TIME POSITION dial. Turn the DELAY TIME POSITION dial clockwise to move the second pulse to the same vertical reference line (if several pulses are displayed, return to A INTEN to locate the correct pulse). Do not change the settings of the horizontal POSITION and FINE controls. Note the setting of the DELAY TIME POSITION dial.

Determine the time difference using the following formula:

$$\text{Time Difference} = \left[ \begin{array}{c} \text{second} \\ \text{dial} \\ \text{setting} \end{array} - \begin{array}{c} \text{first} \\ \text{dial} \\ \text{setting} \end{array} \right] \times \begin{array}{c} \text{delay time} \\ \text{A TIME/DIV} \\ \text{setting} \end{array}$$

EXAMPLE: Assume the first dial setting is 1.31 and the second dial setting is 8.81 with the A TIME/DIV switch set to  $0.2 \mu\text{s}$  (see Fig. 25).

Using the formula:

$$\text{Time Difference} = \left[ \begin{array}{c} \text{second dial} \\ \text{setting} \end{array} - \begin{array}{c} \text{first dial} \\ \text{setting} \end{array} \right] \times \begin{array}{c} \text{delay time} \\ \text{(A TIME/DIV} \\ \text{setting)} \end{array}$$

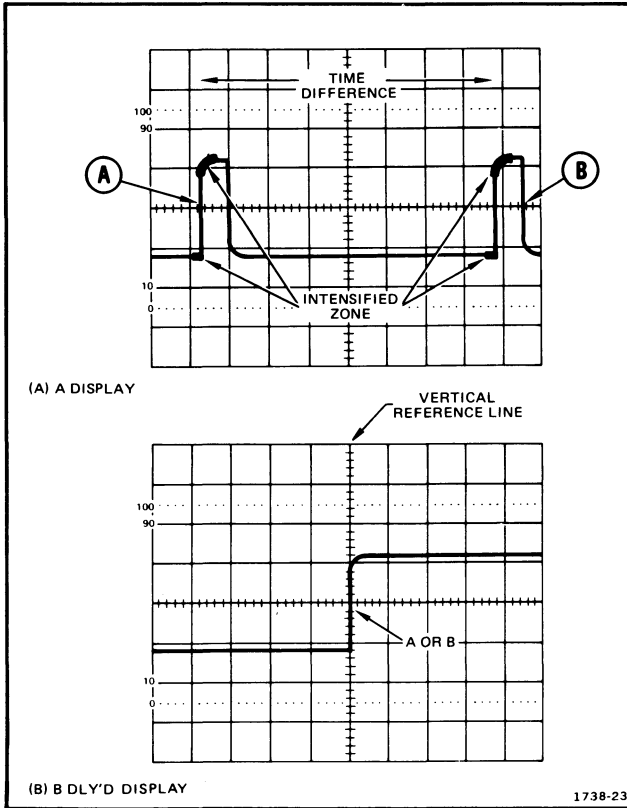

Fig. 25. Time difference between repetitive pulses.

Substituting the given values:

$$\text{Time Difference} = (8.81 - 1.31) \times 0.2 \mu\text{s}.$$

The time difference is 1.5 microseconds.

## TIME DURATION MEASUREMENTS (BASIC 465)

Obtain a Delayed Sweep Display. Set the A TIME/DIV switch to display a single event. Be sure the VAR TIME/DIV control is in the calibrated detent. For the most accurate measurement, set the B TIME/DIV switch to the fastest sweep speed that gives a usable (visible) intensified zone. Vertically position the display to place the time measurement points to the center horizontal graticule line (see Fig. 26).

Use the DELAY TIME POSITION dial to move the start (left-hand edge) of the intensified zone to just touch the intersection of the signal and the center horizontal graticule line (see Fig. 26, Point A). Note the DELAY TIME POSITION dial setting.

Use the DELAY TIME POSITION dial to move the start of the intensified zone to the second time measurement point (see Fig. 26, Point B). Note the DELAY TIME POSITION dial setting.

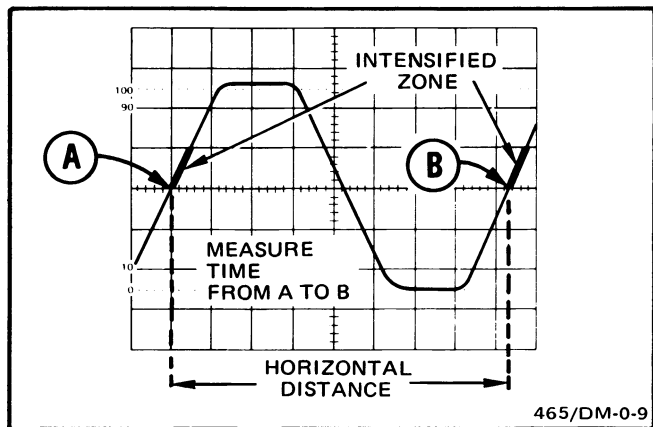

Fig. 26. Time duration.

Substitute the DELAY TIME POSITION dial settings into the time difference formula to obtain the time duration.

EXAMPLE: The A TIME/DIV switch is set to 2 ms and the B TIME/DIV switch is set to .1 ms.

The DELAY TIME POSITION dial setting at Point A (Fig. 26) is 1.20. The DELAY TIME POSITION dial at Point B (Fig. 26) is 9.53. To find the time duration use the formula:

$$\text{Time Difference} = \frac{\text{Time} - \text{Time}}{\text{Duration}} = \left[ \begin{array}{c} \text{second} \\ \text{dial} \\ \text{setting} \end{array} - \begin{array}{c} \text{first} \\ \text{dial} \\ \text{setting} \end{array} \right] \times (\text{A TIME/DIV setting})$$

Substituting the given values:

$$\text{Time Duration} = (9.53 - 1.20) \times 2 \text{ ms} = 16.66 \text{ ms}$$

## FREQUENCY MEASUREMENTS (BASIC 465)

The frequency of a recurrent signal can be calculated by taking the reciprocal of the time duration of one event.

EXAMPLE: The time duration of one event (Point A to Point B, Fig. 26) is 16.66 milliseconds.

Using the formula:

$$\text{Frequency} = \frac{1}{\text{time duration}}$$

Substituting the given values:

$$\text{Frequency} = \frac{1}{16.66 \text{ ms}} = 60 \text{ hertz}$$

## TIME DIFFERENCE BETWEEN TWO PULSES FROM DIFFERENT SOURCES (BASIC 465)

Make sure the VAR TIME/DIV control is in the calibrated detent. Set the A Trigger SOURCE switch to CH 1. Connect the reference signal to CH 1 and the comparison signal to CH 2. Connect the signals to the input connectors using probes or cables with equal time delay.

Set the VERT MODE switch to either CHOP or ALT. In general, CHOP is more suitable for low-frequency signals and the ALT position is more suitable for high-frequency signals. Center each of the displays vertically (see Fig. 27A).

Set the HORIZ DISPLAY switch to A INT and the B Trigger SOURCE to STARTS AFTER DELAY. Set the B TIME/DIV switch 20 times faster than the A TIME/DIV switch (when possible).

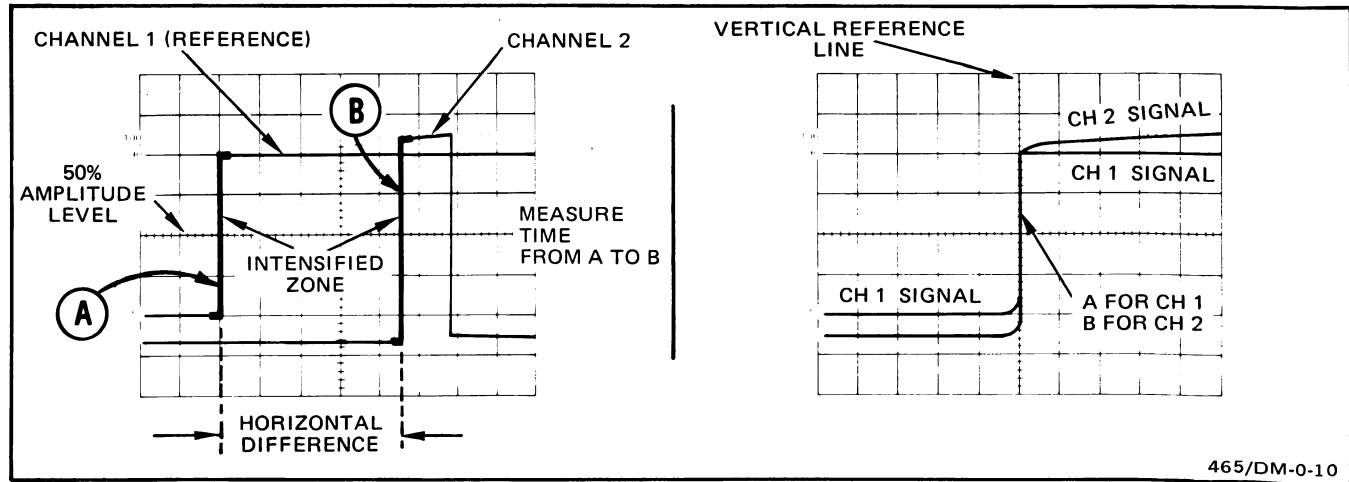

Fig. 27. Time difference between two pulses from different sources.

Use the DELAY TIME POSITION dial to move the intensified zone to the CH 1 pulse. Set the HORIZ DISPLAY switch to B DLY'D. Readjust the DELAY TIME POSITION dial to move the CH 1 pulse or rising portion to some vertical reference line (see Fig. 27B). Note the DELAY TIME POSITION dial setting.

Use the DELAY TIME POSITION dial to move the CH 2 pulse or rising portion to the same reference line. Again note the DELAY TIME POSITION dial setting.

Substitute the DELAY TIME POSITION dial settings in the time difference formula to find the time difference.

EXAMPLE: The A TIME/DIV switch is set to  $50 \mu\text{s}$  and the B TIME/DIV switch is set to  $2 \mu\text{s}$ . Use the DELAY TIME POSITION dial to move the CH 1 pulse to the reference line. The DELAY TIME POSITION dial setting is 2.60.

Use the DELAY TIME POSITION dial to move the CH 2 pulse to the reference line. The DELAY TIME POSITION dial setting is 7.10.

To find the time difference use the formula:

$$\text{Time difference} = \left[ \begin{array}{c} \text{second} \\ \text{dial} \\ \text{setting} \end{array} - \begin{array}{c} \text{first} \\ \text{dial} \\ \text{setting} \end{array} \right] \times \begin{array}{c} \text{delay time} \\ \text{(A TIME/DIV} \\ \text{setting)} \end{array}$$

Substituting the given values:

$$\text{Time Difference} = (7.10 - 2.60) \times 50 \mu\text{s} = 225 \mu\text{s}$$

## RISETIME (BASIC 465)

Risetime measurements use the same methods as time-duration measurements, except the measurements are made between the 10% and 90% points of the waveform. Falltime is measured between the 90% and 10% points on the trailing edge of the waveform.

Use a sweep speed setting that displays several cycles or events (if possible) and be sure the VAR TIME/DIV control is in the calibrated detent. Set the VOLTS/DIV switch and the VAR control (or signal amplitude) for exactly a five-division display. Set vertical positioning so the display bottom touches the 0% graticule line and the display top touches the 100% graticule line (see Fig. 28).

Set the A TIME/DIV switch for a single-event display with the risetime spread horizontally as much as possible. Horizontally position the display so the 10% point of the waveform intersects the second vertical graticule line (see Fig. 28). Set the B TIME/DIV switch to the fastest sweep speed that provides a usable (visible) intensified zone.

Use the DELAY TIME POSITION dial to move the start of the intensified zone (left-hand edge) to just touch the

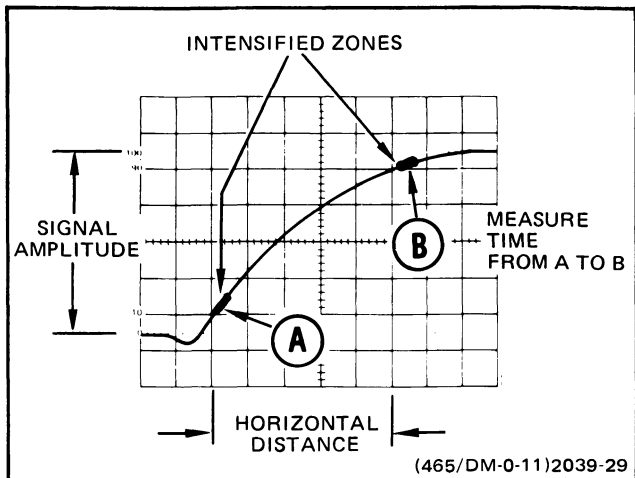

Fig. 28. Risetime.

intersection of the signal and the 10% graticule line (see Fig. 28, Point A). Note the DELAY TIME POSITION dial setting.

Use the DELAY TIME POSITION dial to move the start of the intensified zone to just touch the intersection of the signal and the 90% graticule line (see Fig. 28, Point B). Note the DELAY TIME POSITION dial setting.

Substitute the DELAY TIME POSITION dial settings in the time difference formula to find the risetime.

EXAMPLE: The A TIME/DIV switch is set to  $1 \mu\text{s}$ . The DELAY TIME POSITION dial setting at point A (Fig. 28) is 2.50. The DELAY TIME POSITION dial setting at point B (Fig. 28) is 7.50. To find the risetime use the formula:

$$\text{Time Difference} = \text{Risetime} = \left[ \begin{array}{c} \text{second} \\ \text{dial} \\ \text{setting} \end{array} - \begin{array}{c} \text{first} \\ \text{dial} \\ \text{setting} \end{array} \right] \times \text{delay time} \text{ (A TIME/DIV setting)}$$

Substituting the given values:

$$\text{Risetime} = (7.50 - 2.50) \times 1 \mu\text{s} = 5 \text{ ms.}$$

## MIX (BASIC 465)

For the MIX mode of operation, the same general procedures can be used. With the first part of the display at a sweep rate set by the A TIME/DIV switch and the second part of the display at a sweep rate set by the B TIME/DIV switch, it is not necessary to switch display modes to ensure location of the correct pulse.

However, inaccuracies are introduced into the measurement by the transition from A to B sweeps. The B DLY'D mode is the most accurate and therefore recommended mode of making differential time measurements.

## DM44 DELAYED OR MIXED SWEEP TIME MEASUREMENTS

Most measurements of time, time-duration, frequency, time difference and risetime are more easily performed using the TIME function of the DM44 and the delayed-sweep mode of the oscilloscope. Table 5 lists the DM44 and oscilloscope operating modes and the crt display obtained in these modes.

**TABLE 5**  
**DM44 Delayed Sweep Displays**

DM44 FUNCTION	HORIZ DISPLAY	VERT MODE	DISPLAY OBTAINED
VOLTS OHMS, OR TEMP	A INT <sup>1</sup>	CH 1, CH 2, OR ADD	One intensified zone, DELAY TIME POSITION moves intensified zone.
		ALT or CHOP	Two intensified zones, one on each channel display. Intensified zones are coincident in time. DELAY TIME POSITION moves both intensified zones.
	MIX	CH 1, CH 2, OR ADD	One mixed display. Position of transition point determined by DELAY TIME POSITION.
		ALT OR CHOP	Two mixed displays, one on each channel display. Transition points are coincident in time. Position of transition points determined by DELAY TIME POSITION.

<sup>1</sup>In the B DLY'D mode, the intensified zones (that are displayed in the A INTEN mode) will be displayed at the B sweep rate.



**TABLE 5 (cont)**  
**DM44 Delayed Sweep Displays**

DM44 FUNCTION	HORIZ DISPLAY	VERT MODE	DISPLAY OBTAINED
TIME OR 1/TIME	A INT <sup>2</sup>	CH 1, CH 2 OR ADD	Two intensified zones. DELAY TIME POSITION moves both intensified zones. Δ TIME moves only one intensified zone.
		ALT	Two intensified zones. Reference point appears on CH 1 display. Measurement point appears on CH 2 display. DELAY TIME POSITION moves both intensified zones. Δ TIME moves only the measurement point (on the CH 2 display).
	MIX	CHOP	Two pairs of intensified zones, one pair on each channel display. The pairs are coincident in time with each other. DELAY TIME POSITION moves all four intensified zones. Δ TIME moves two intensified zones.
		CH 1, CH 2, OR ADD	Two mixed displays on the same trace. Not generally used since mixed displays overlap.
		ALT	Two mixed displays, one on each channel display. DELAY TIME POSITION moves transition point of both displays. Δ TIME moves transition point of CH 2 display only.
		CHOP	Four mixed displays, two on each channel display. Not generally used since mixed displays overlap.

<sup>2</sup>Your instrument may be modified to make the DELAY TIME POSITION and Δ TIME controls operate independently. The instructions for making this modification are located in the Maintenance section of the DM44 Service manual.

## TIME DIFFERENCE BETWEEN REPETITIVE PULSES (DM44)

Set the controls as follows:

FUNCTION	TIME
HORIZ DISPLAY	A INTEN
B SOURCE	STARTS AFTER DELAY
A TIME/DIV	To display 2 pulses
B TIME/DIV	3 or 4 positions more
	cw than A TIME/DIV
$\Delta$ TIME	To move the time-
	measurement point to
	the right of the refer-
	ence point
VAR TIME/DIV	Detent position

Position the display approximately as shown in Fig. 29A. Use the DELAY TIME POSITION control to move the reference point to the first pulse. Both intensified zones will move when the DELAY TIME POSITION control is adjusted. Use the  $\Delta$  TIME control to move the time-measurement point to the second pulse.

Set the HORIZ DISPLAY switch to B DLY'D. Slightly readjust the  $\Delta$  TIME control to superimpose the waveforms (see Fig. 29B). The DELAY TIME POSITION control may need to be slightly readjusted to keep the display on screen. The Readout and Scale Factor Lamps now indicate the time difference between the pulses.

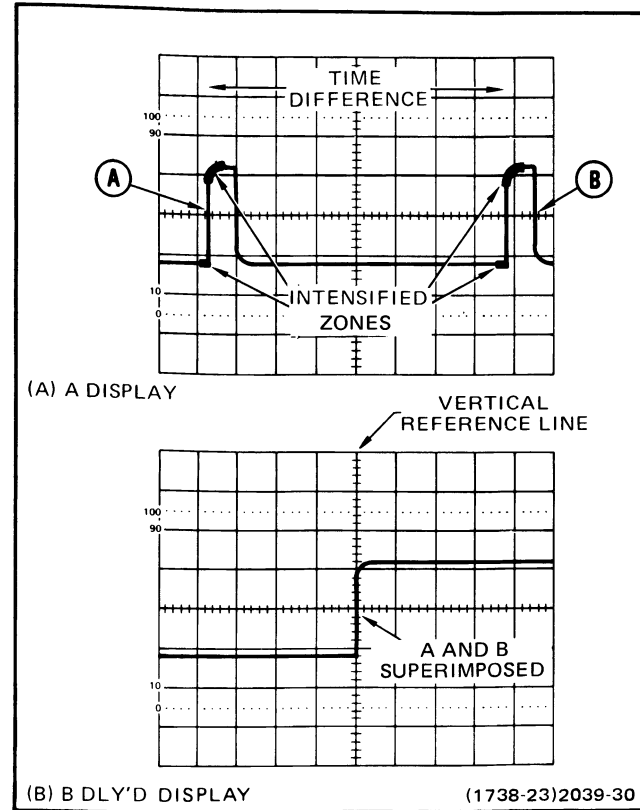

Fig. 29. Time difference between repetitive pulses.

To find the pulse repetition rate, superimpose the waveforms as above and set the FUNCTION switch to 1/TIME. The Readout and Scale Factor Lamps now indicate the repetition rate.

## TIME DURATION MEASUREMENTS (DM44)

Set controls as follows:

FUNCTION	TIME
HORIZ DISPLAY	A INTEN
B SOURCE	STARTS AFTER DELAY
A TIME/DIV	To display a single event.
B TIME/DIV	3 or 4 positions more cw than A TIME/DIV
$\Delta$ TIME	To move the time- measurement point to the right of the refer- ence point.
VAR TIME/DIV	Detent position

Use the DELAY TIME POSITION control to move the reference point to a horizontal graticule line (see Fig. 30A, Point A). Use the  $\Delta$  TIME control to move the time-

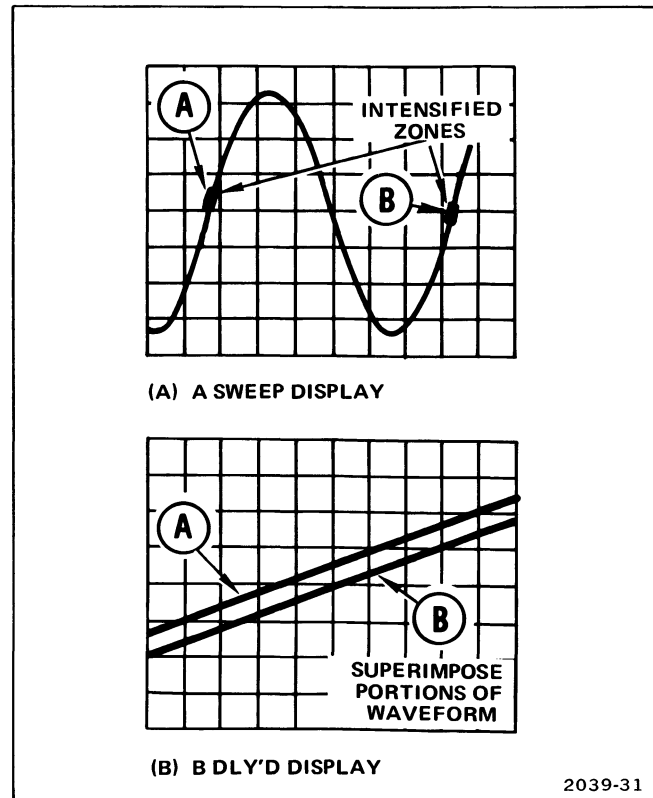

Fig. 30. Time duration and frequency measurements.

measurement point to near the same horizontal graticule line on the next cycle of the waveform (see Fig. 30A, Point B).

Set the HORIZ DISPLAY switch to B DLY'D. Slightly readjust the  $\Delta$  TIME control to superimpose the displayed waveform portions (see Fig. 30B). The DELAY TIME POSITION control may need to be slightly readjusted to keep the display on screen. The Readout and Scale Factor Lamps indicate the time duration.

A blinking display indicates an over-range condition. This occurs on measurements as follows:

A Time/Div Set To Decade Multiples of	Spacing Between Intensified Zones Less Than
1	0.25 DIV
2	0.5 DIV
5	1.0 DIV

## FREQUENCY MEASUREMENTS (DM44)

To measure frequency, use the same procedure as for Time Duration Measurements except set the FUNCTION switch to 1/TIME. With the display superimposed the Readout and Scale Factor Lamps indicate the frequency. The Scale Factor Lamps indicate the scale factor as follows:

1/ms Lamp	1/ $\mu$ s Lamp	Multiplier
OFF	OFF	Hz
ON	OFF	kHz
OFF	ON	MHz

## TIME DIFFERENCE BETWEEN TWO PULSES FROM DIFFERENT SOURCES (DM44)

Set controls as follows:

A SOURCE	CH 1
VERT MODE	ALT
HORIZ DISPLAY	A INT
B SOURCE	STARTS AFTER DELAY
B TIME/DIV	3 or 4 positions more
	cw than A TIME/DIV
VAR TIME/DIV	Detent position

Connect the reference signal to the CH 1 input and the comparison signal to the CH 2 input. Connect the signals to the inputs with cables or probes having equal time delays.

Adjust the DELAY TIME POSITION control to move the reference point to the desired spot on the reference (CH 1) display (see Fig. 31A, Point A). In the ALT vertical mode the reference point appears on the CH 1 display while the time-measurement point appears on the CH 2 display.

Adjust the  $\Delta$  TIME control to move the time-measurement point to the desired spot on the CH 2 display (see Fig. 31A, Point B).

Set the HORIZ DISPLAY switch to B DLY'D. Slightly readjust the DELAY TIME POSITION and  $\Delta$  TIME controls to superimpose the waveforms (see Fig. 31B). The Readout and Scale Factor Lamps indicate the time difference.

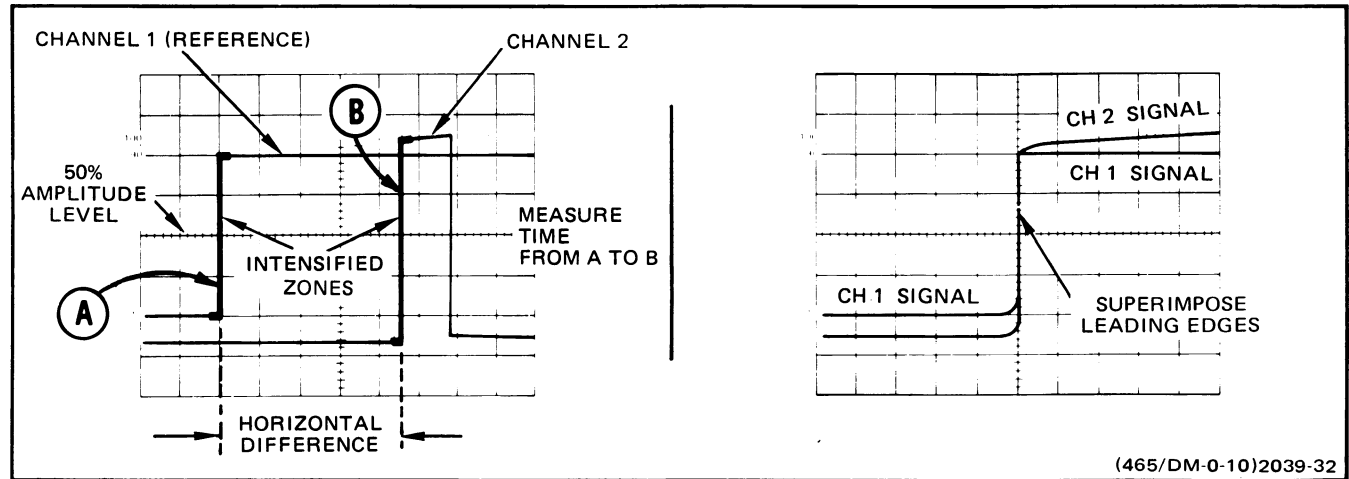

Fig. 31. Time difference between two pulses from different sources.

## RISETIME (DM44)

Set controls as follows:

FUNCTION	TIME
HORIZ DISPLAY	A INTEN
B SOURCE	STARTS AFTER DELAY
B TIME/DIV	3 or 4 positions more cw than A TIME/DIV
$\Delta$ TIME	To move the time- measurement point to the right of the refer- ence point

Set the A TIME/DIV switch to a setting that displays several events. Set the VOLTS/DIV and VAR VOLTS/DIV so the amplitude of the display is exactly 5 divisions. Vertically position the display so the bottom touches the 0% graticule line and the top touches the 100% graticule line.

Adjust the DELAY TIME POSITION control to move the reference point to the 10% graticule line (see Fig. 32 Point A). Adjust the  $\Delta$  TIME control to move the time measurement point to the 90% graticule line (see Fig. 32, Point B). The Readout and Scale Factor Lamps indicate the risetime.

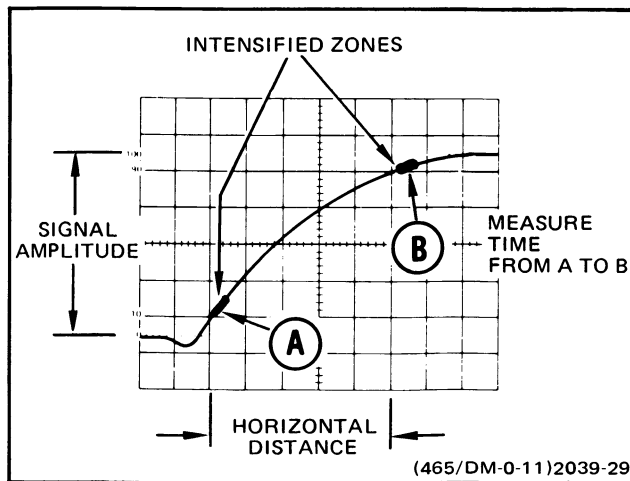

Fig. 32. Risetime.

## MIX (DM44)

For the MIX mode of operation, the same general procedures can be used. With the first part of the display at a sweep rate set by the A TIME/DIV switch, and the second part of the display at a sweep rate set by the B TIME/DIV

switch, it is not necessary to switch display modes to ensure location of the correct pulse.

However, inaccuracies are introduced into the measurement by the transition from A to B sweeps. The B DLY'D mode is the most accurate and therefore the recommended mode of making differential time measurements.

# OPERATOR'S SPECIFICATIONS

Refer to the service manual for complete specifications. Specifications given are for an operating range of 0°C to +40°C unless otherwise stated.

## 465 OSCILLOSCOPE

### VERTICAL

**Deflection Factor Accuracy:** Within 3% in the calibrated position.

**Frequency Response:** Dc to at least 100 MHz for CH 1 and CH 2. Ac-coupled, low-frequency response is 10 Hz or less. Use of a 10X probe extends frequency response to 1 Hz.

**Risetime:** 3.5 nanoseconds or less (calculated from  $0.35 \div$  bandwidth in MHz).

**Maximum Input Voltage:** Dc-coupled 250 V (dc + peak ac) or 500 V p-p ac at 1 kHz or less; ac-coupled, 500 V (dc + peak ac) or 500 V p-p ac 1 kHz or less.

**Positive-Going Step Aberrations:** Less than +3%, -3%, not to exceed 3% peak-to-peak, excluding the ADD mode.

**Common-Mode Rejection Ratio (ADD Mode with CH 2 Inverted):** At least 10:1 at 20 MHz for common mode signals of 6 divisions or less with GAIN adjusted for best CMRR at 50 kHz.

**Input Gate Current:** 0.5 nA or less (0.1 div at 5 mV/DIV), from -15°C to +30°C.

**Channel Isolation:** At least 100:1 at 25 MHz.

**CHOP Mode Repetition Rate:** Approximately 250 kHz.

**Cascaded Operation (CH 1 OUT into CH 2) sensitivity:** Approximately 1 mV/DIV. Bandwidth is dc to at least



50 MHz, with CH 2 OUT connected to CH 1 input. AC-coupled, using a 50  $\Omega$ , 42-inch BNC cable, terminated in 50  $\Omega$  at CH 2 Input.

## TRIGGERING

### Sensitivity

**Ac Coupled Signal:** 0.3 div internal or 50 mV external, from 30 Hz to 25 MHz; increasing to 1.5 div, internal or 150 mV external at 100 MHz.

**LF REJ Coupled Signal:** 0.5 div internal or 100 mV external, from 50 kHz to 25 MHz; increasing to 1.5 div internal or 300 mV external at 100 MHz. Attenuates signals below about 50 kHz.

**HF REJ Coupled Signal:** 0.5 div internal or 50 mV external, from 30 Hz to 50 kHz. Attenuates signals below about 50 Hz and above about 50 kHz.

**DC Coupled Signal:** 0.3 div internal or 50 mV external, from dc to 25 MHz; increasing to 1.5 div internal or 150 mV external at 100 MHz.

**EXT  $\div$  10 Signal:** Amplitude requirements are multiplied by 10.

### External Trigger Input

**Maximum Input Voltage:** 250 V (dc + peak ac) or 250 V p-p ac (1 kHz or less).

### Level Control Range in Ext

At least + and  $-2$  V, 4 V p-p; EXT  $\div$  10 is at least + and  $-20$  V, 40 V p-p.

### Trigger View

**Deflection Factor:** About 50 mV/div in EXT and about 500 mV/div in EXT  $\div$  10.

**Risetime:** 5 ns or less.

**Trigger Centering Point:** Within 1.0 division of screen center.

## DIFFERENTIAL TIME MEASUREMENT (BASIC 465)

**Accuracy for Measurements Greater than One Major Dial Division:** Within  $\pm 1\%$  from  $+15^\circ\text{C}$  to  $+35^\circ\text{C}$ . Within  $\pm 2.5\%$  from  $-15^\circ\text{C}$  to  $+55^\circ\text{C}$ .

**Accuracy for Measurements Less than One Major Dial Division:** Within  $\pm 0.01$  major dial divisions from  $+15^{\circ}\text{C}$  to  $+35^{\circ}\text{C}$ . Within  $\pm 0.03$  major dial divisions from  $-15^{\circ}\text{C}$  to  $+55^{\circ}\text{C}$ .

## DIFFERENTIAL TIME MEASUREMENT (DM44)

Refer to TIME AND 1/TIME under DM44 DIGITAL MULTIMETER.

### HORIZONTAL

**Sweep Rate Accuracy:** Within 2%, unmagnified, and 3% magnified, from  $+20^{\circ}\text{C}$  to  $+30^{\circ}\text{C}$  for A and B Sweeps.

**Mixed Sweep Accuracy:** Within 2% plus the measured A Sweep inaccuracy, when viewing the A portion only. B Sweep portion remains the same as above.

**Trigger Holdoff Variable:** Increases A Sweep holdoff time by at least a factor of 10.

**Delay Time Jitter:** 1 part, or less, in 50,000 (0.002%) of 10 times the A TIME/DIV switch setting.

**Calibrated Delay Time (VAR control to CAL):** Continuous from  $0.2\ \mu\text{s}$  to at least 5 seconds after the start of A (delaying) sweep.

### X-Y

**X-Axis Sensitivity (X10 MAG turned off):** Same as the vertical system.

**X-Axis Bandwidth:** Dc to at least 4 MHz, with a 10 division reference signal.

**Phase Difference Between X- and Y-Axis Amplifiers:** Within  $3^{\circ}$  from dc to 50 kHz.

**Deflection Accuracy:** Within 4%.

## CALIBRATOR

**Output Voltage:** 0.3 V within 1% and within 0.3% from  $+20^{\circ}\text{C}$  to  $+30^{\circ}\text{C}$ .

**Output Current:** 30 mA within 2% from  $+20^{\circ}\text{C}$  to  $+30^{\circ}\text{C}$ .

**Repetition Rate:** About 1 kHz.

## Z AXIS INPUT

**Sensitivity:** Noticeable intensity modulation, at normal intensity settings, by a 5 V p-p signal. A positive-going signal decreases intensity.

**Frequency Range (Usable):** Dc to 50 MHz.

**Maximum Input Voltage:** 100 V (dc plus peak ac) or 100 V p-p ac at 1 kHz or less.

## OUTPUTS

### CH 1 Out

**Output Voltage:** At least 50 mV/div into 1 M $\Omega$ ; to at least 25 mV/div into 50 ohms.

**Bandwidth:** Dc to at least 50 MHz into 50 ohms.

**DC Level:** About 0 volts.

### A+ and B+ Gates

**Output Voltage:** About 5.5 V of positive-going pulse.

**Output Resistance:** About 500 ohms.

## AC POWER SOURCE

### Regulating Ranges:

	115 V	230 V
Low	99 V to 121 V	198 V to 242 V
Medium	104 V to 126 V	207 V to 253 V
High	108 V to 132 V	216 V to 264 V

**Line Frequency:** From 48 Hz to 440 Hz.

**Maximum Power Consumption:** 100 watts at 115 V, 60 Hz, medium range.

## ENVIRONMENTAL

**Operating Temperature:**  $-15^{\circ}\text{C}$  to  $+55^{\circ}\text{C}$ .

**Operating Altitude:** To 15,000 feet. Maximum operating temperature decreases  $1^{\circ}\text{C}/1,000$  feet, above 5,000 feet.

**Humidity (Operating and Storage):** 5 cycles (120 hours) referenced to MIL-E-16400F.

# DM44 DIGITAL MULTIMETER

## RESISTANCE

**Maximum Safe Input Voltage:** 120 V rms between + and COM inputs.

**Resistance Accuracy:** 200  $\Omega$  range—within 0.25%  $\pm 1$  count, plus probe resistance; 2 k $\Omega$ , 20 k $\Omega$ , 200 k $\Omega$ , and 2 M $\Omega$  ranges—within 0.25%  $\pm 1$  count; 20 M $\Omega$  range—within 0.3%  $\pm 1$  count.

**Temperature Dependence:** 20 k $\Omega$ , 200 k $\Omega$  and 2 M $\Omega$  ranges—250 ppm/ $^{\circ}$ C; 200  $\Omega$ , 2 k $\Omega$  and 20 M $\Omega$  ranges—350 ppm/ $^{\circ}$ C.

**Resolution:** 0.1  $\Omega$ .

**Recycle Time:** At least 3 measurements/second.

**Response Time:** All ranges within 1 second except 2 M $\Omega$  and 20 M $\Omega$  (within 5 seconds).

## TIME

**Accuracy:** +15 $^{\circ}$ C to +35 $^{\circ}$ C; within 1% of reading  $\pm 1$  count. -15 $^{\circ}$ C to 55 $^{\circ}$ C; within 2.5% of reading  $\pm 1$  count.

## 1/TIME

**Accuracy:** +15 $^{\circ}$ C to +35 $^{\circ}$ C; within 2% of reading  $\pm 1$  count. -15 $^{\circ}$ C to +55 $^{\circ}$ C; within 3.5% of reading  $\pm 1$  count.

## TEMPERATURE

**Range:** -55 $^{\circ}$ C to +150 $^{\circ}$ C in 1 range.

**Accuracy:** Original Probe—Within 2 $^{\circ}$ C, -55 $^{\circ}$ C to +125 $^{\circ}$ C. Within 3 $^{\circ}$ C, +125 $^{\circ}$ C to +150 $^{\circ}$ C.

**Replacement Probe:** Accuracy will equal original probe accuracy after DM44 is compensated.

**Maximum Safe Voltage on Measurement Surfaces:**  $\pm 100$  V (dc + peak ac) above chassis ground.

**Temperature (Storage and Operating):** Probe Body and Cable, -55 $^{\circ}$ C to +105 $^{\circ}$ C. Probe Sensor Tip, -55 $^{\circ}$ C to +150 $^{\circ}$ C.

## DC VOLTAGE

**Maximum Safe Input Voltage:**  $\pm 1200$  V (dc + peak ac) between + and chassis.

**Common Floating Voltage:**  $\pm 500$  V (dc + peak ac) to chassis.

**DC Voltage Accuracy:** Within 0.1% of reading,  $\pm 1$  count.

**Temperature Dependence:** 44 ppm/ $^{\circ}$ C.

**Resolution:** 100  $\mu$ V.

**Recycle Time:** At least 3 measurements/second.

**Response Time:** Within 0.5 second.

**Normal/Common Mode Rejection Ratio:**

**Normal Mode**—At least 60 dB at 50 Hz and 60 Hz.

**Common Mode**—At least 100 dB at dc; 80 dB at 50 Hz and 60 Hz.

**Input Impedance:** 10 M $\Omega$ .

# ACCESSORIES

## STANDARD ACCESSORIES INCLUDED

2 Probes, 10X, 2M, with accessories	010-6105-03
1 Accessory Pouch, Snap (w/o DM)	016-0535-02
1 Accessory Pouch (DM)	016-0594-00
1 Accessory Pouch, Zipper	016-0537-00
1 Operator's Manual	070-2038-00
1 Service Manual (465)	070-1861-00
2 Fuses, 1.5 A 3AG fast-blow	159-0016-00
2 Fuses, 0.75 A 3AG fast-blow	159-0042-00
1 Filter, Blue Plastic (installed)	337-1674-00
1 CRT Filter, Clear Plastic	337-1674-01
1 Adapter, Ground Wire	134-0016-01
1 Pair, Test Leads (DM)	003-0120-00
1 Service Manual (DM44)	070-2036-00
1 P6430 Temperature Probe (DM44)	010-6430-00

## OPTIONAL ACCESSORIES

C-5A Option 2 low cost fixed focus Camera.—Order C-5A Option 2.

Protective Cover—Waterproof, blue vinyl—Order 016-0554-00.

Folding Polarized Viewing Hood—Order 016-0180-00.

Folding Viewing Hood, light-shielding—Order 016-0592-00.

Folding Viewing Hood, light-occluding—Order 016-0566-00.

Mesh Filter—Improves contrast and EMI filter—Order 378-0726-01.

SCOPE-MOBILE Cart—Occupies less than 18 inches aisle space, has storage area in base—Order 200 C.

Test Lead Set—1 black lead with banana plug and grounding clip, 1 red lead with banana plug and probe. Includes retractable hook tip and IC test probe cover. May be used with other miniature probe tip accessories. Order 012-0427-00.

# OPTIONS

Your instrument may contain the following options:

## OPTION 7

### OPTION 1

Deletes P6430 temperature probe from the DM 44.

At the time of this writing, instruments having the DM44 do not have the Option 7 available.

### OPTION 4

The instrument is modified to meet certain specifications on radiated interference requirements. There is no change in operating instructions.

Option 7 permits operation on 12 or 24 Vdc with no performance deterioration. Circuitry is provided to protect against damage due to connection of 24 V when in the 12 V mode of operation. The 24-volt external input permits use with conventional dc power (marine and aircraft).