

INTRODUCTION

Testing integrated circuit operational amplifiers with a curve tracer is a relatively easy operation, one well suited for short-run incoming inspection or circuit design and characterization. The TEKTRONIX 577-D1 Storage Curve Tracer with its 178 Linear IC Test Fixture provides facilities for most common op amp tests (timing and rate tests, however, do require the use of additional Tektronix test equipment).

In testing op amps, the 178 Linear IC Test Fixture acts as the interface unit, supplying appropriate voltages, currents, and loads as set by the operator. An easy-to-use function switch automatically configures the 178 for each test, a series of controls sets power supply voltages and sweep signal input frequency and amplitude; a multi-position switch allows selection of load and source resistance. The 178 also contains the display vertical sensitivity control.

The 577-D1 Mainframe furnishes the display, display controls, and supporting circuits such as primary power supplies.

Op amps are connected to the 178 using a special slide-in circuit card plus a plug-in socket adapter. The standard circuit card supplied with the 178 sets the system to work with op amps; socket adapters provide the proper mounting configuration. Other circuit cards and adapters are available for various IC types and packages.

In most op amp tests on the curve tracer, the op amp under test is inserted in a feedback loop that derives its control voltage from the differential between op amp output and a zero reference. Typically, the test will measure the additional signal required to counteract some op amp internal characteristic and keep the output at zero.

NOTE: These procedures have been designed to be sufficiently general for testing most individual device types in the op amp family. However, this section provides actual settings, check values, and part numbers necessary for testing a 741-type op amp. This information is given in brackets at appropriate points throughout the section.

This section provides instructions for the specific tests listed below. These are preceded by general set-up instructions.

- 1) Input Offset Voltage
- 2) Input Bias Current
- 3) Input Offset Current
- 4) Common-Mode Rejection Ratio (cmrr)
- 5) Gain
- 6) Output Voltage Swing
- 7) Positive Supply Voltage Rejection Ratio
- 8) Negative Supply Voltage Rejection Ratio
- 9) Dual Power supply Voltage Rejection Ratio

GENERAL SET-UP

EQUIPMENT REQUIRED:

577-178-D1 (storage) Linear IC Curve Tracer, Standard Op Amp Card, 5 to 8 patch cords, op amp to be tested [741-type, in 8-pin package], specifications for that op amp, corresponding socket adapter [14-Lead Dual-In-Line Package, Tektronix part number 136-0443-00; or 16-Lead Dual-In-Line Package, Tektronix part number 136-0442-00], and appropriate nomenclature panel [Tektronix part number 333-1770-00].

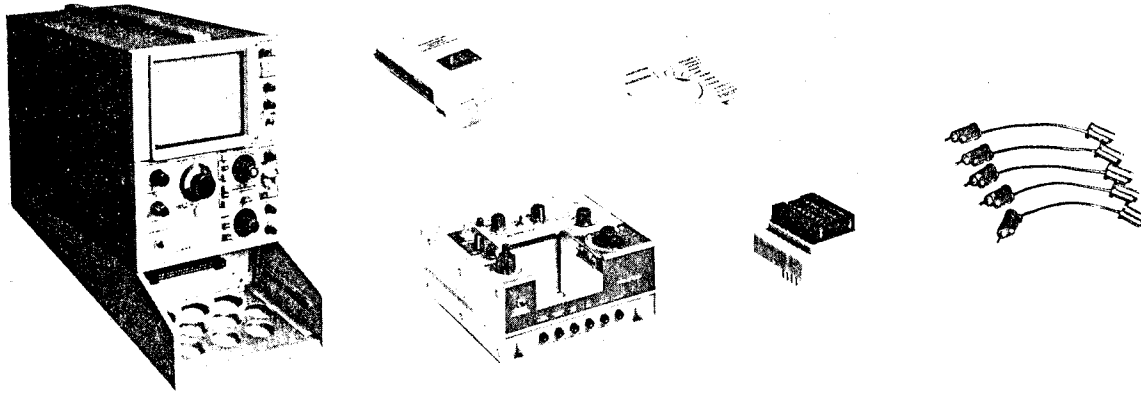

SET-UP:

- 1) Install 178 — If 178 Fixture is not already installed in 577, do so first (with power off). See Figure 0-1.

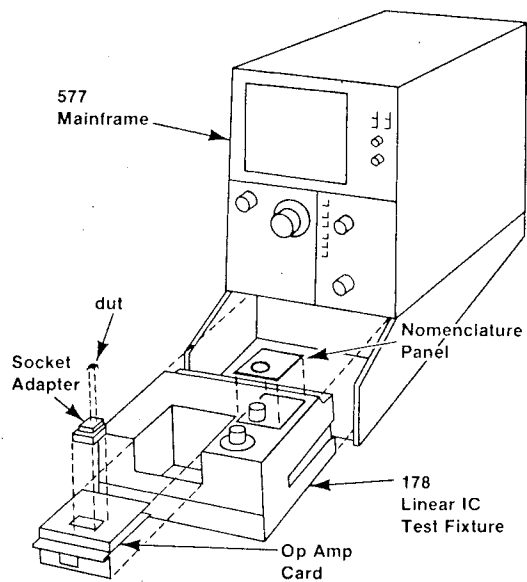
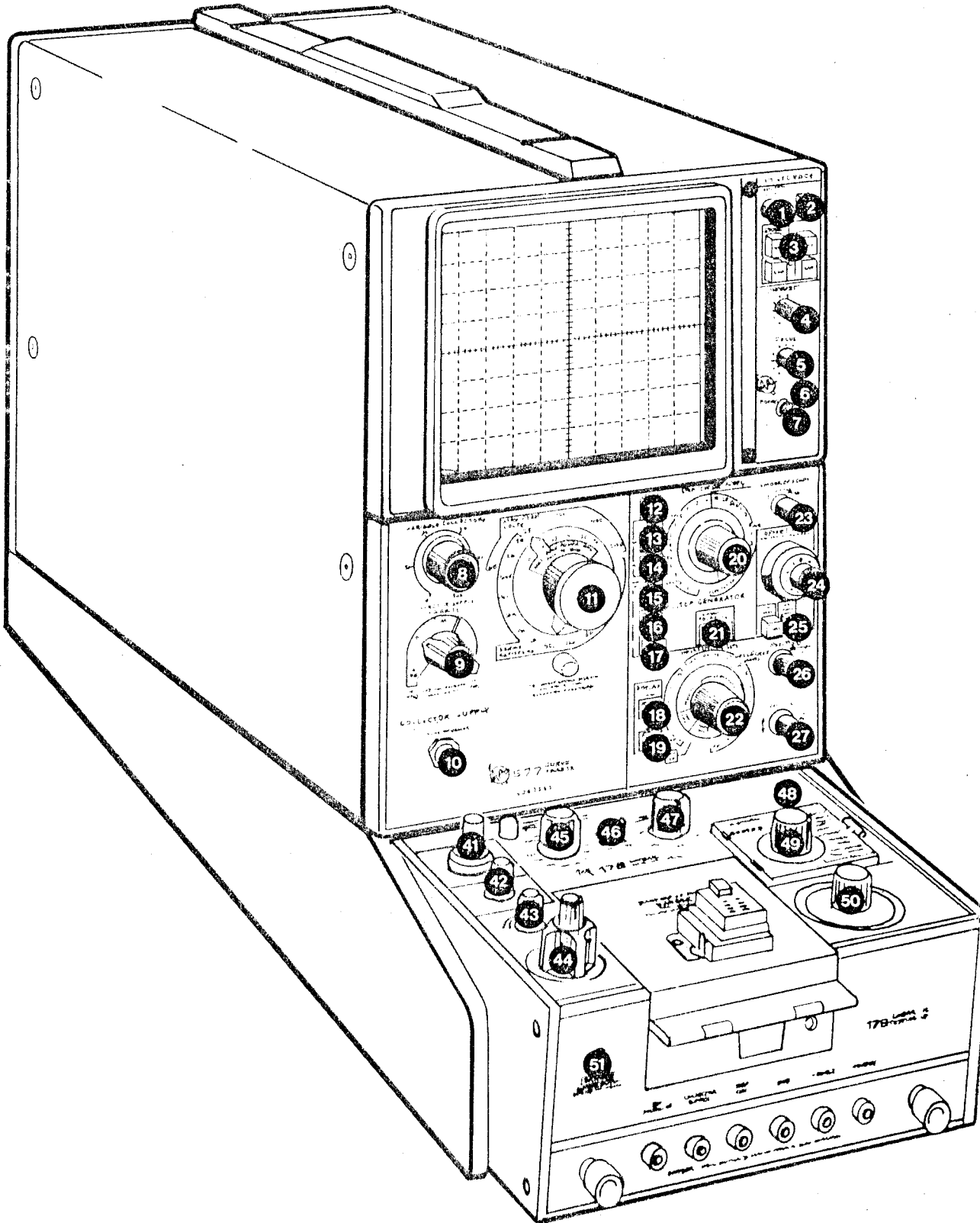

Figure 0-1 Installing linear IC test fixture.

GENERAL SET-UP DIAGRAM



TEKTRONIX
CURVE TRACERS

GENERAL SET-UP continued

- 2) Install AMPLIFIER nomenclature panel on FUNCTION SWITCH. If panel is not in place around FUNCTION switch, install it now. See Figure 0-2. **(B)**
- 3) Prepare device card— Remove device card from 178. See Figure 0-1.

Make following connections as necessary:

- a) Connect jumpers — using Op Amp symbol drawn on card and basing diagram from specifications for device to be tested, connect jumpers between socket pin pc board connectors and corresponding function. At least V+, V-, +IN, -IN, and OUT must be connected. (See Figure 0-3 for connections for 741-type devices.) **(A)**
 NOTE: 8-pin or 14-pin DIP devices may be used with 16-pin DIP adapter, but pin numbers shown on card for second side of device must be mentally replaced with new pin numbers.
- b) Set current limits—there are separate current limit controls for V+ and V- supplies on card. See Figure 0-3. **(B)**
 Adjustment range is approximately 10 mA (ccw) to 150 mA (cw). Set to center. Alternately set to appropriate value for device to be tested. (For procedure for more exact setting, see 577-178D1 Linear IC Curve Tracer manual, p. 2-10.)
- c) Set feedback — Set switch on device card to NORM. See Figure 0-3. **(C)**

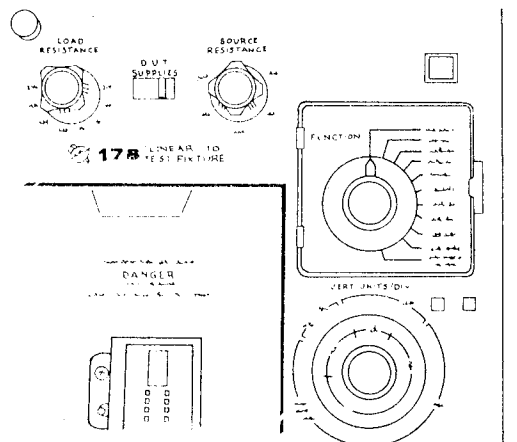

Figure 0-2 Installing nomenclature panel

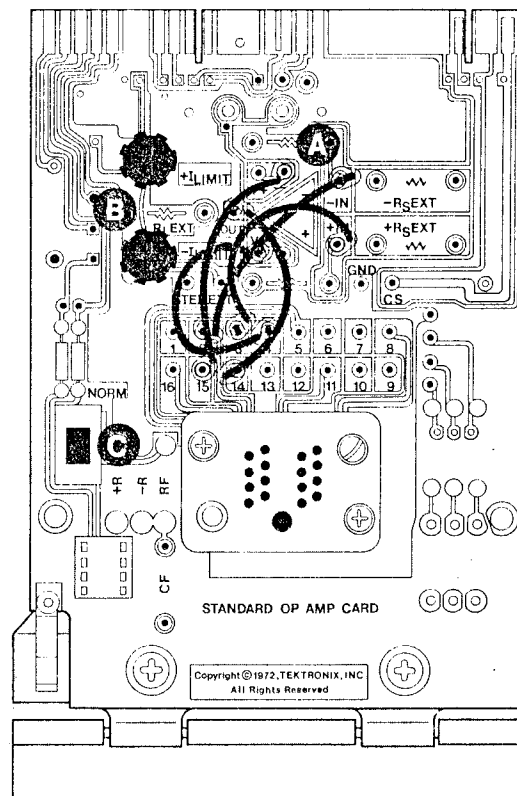
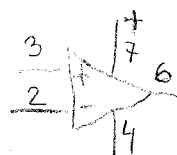

Figure 0-3 Standard op amp card.



GENERAL SET-UP continued

Reinstall device card in 178. See Figure 0-4.

- d) Install adapter — Install device adapter into socket on device card. See Figure 0-5.

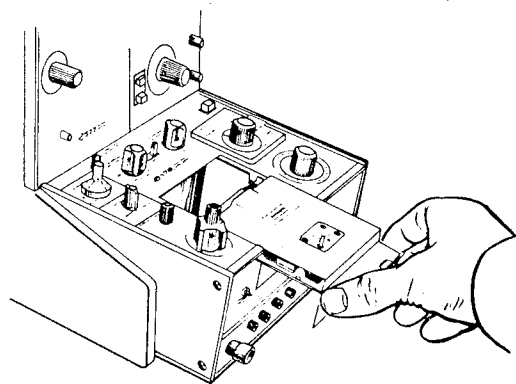

Figure 0-4 Reinstalling device card in 178.

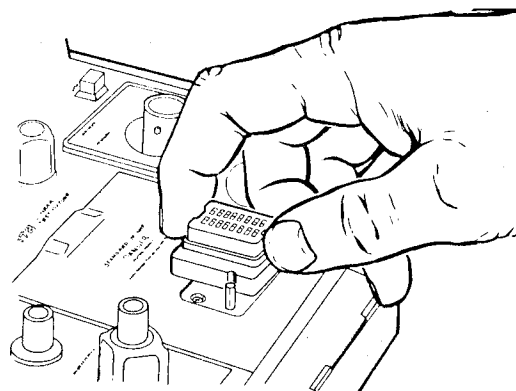

Figure 0-5 Installing device card adapter in socket.

GENERAL SET-UP continued

- 4) Set unused controls off — Referring to op amp set-up diagram (foldout), set:
- COLLECTOR SUPPLY POLARITY to + **9**
 - VARIABLE COLLECTOR % to minimum (ccw) **8**
 - Press STEP FAMILY-SINGLE in and release **14**
 - PULSE 300 μ S out **12**
 - STEP X.1 in **20**

Ignore STEP/OFFSET AMPL OFF-SET AID, NUMBER OF STEPS, OFFSET MULTIPLIER. **20 25 23 24**

- 5) Set initial conditions— referring to Op Amp set-up diagram (foldout), set controls as follows:
- NOTE: This preliminary procedure has been designed to be applicable to all of the following tests. In each case, the detailed test procedure contains minor modifications to the settings of this procedure. Thus, it is possible to perform only one, some, or all of the tests, in any sequence.

On 577:

- MAX PEAK VOLTS to 25 **11**
- MAX PEAK POWER-WATTS to .6 **11**
- DISPLAY FILTER in **19**
- DISPLAY INVERT in (normal) **18**
- STEP RATE NORM in **16**
- HORIZ VOLTS/DIV to 5V **22**
- X10 HORIZ MAG to off **26**
- X10 VERT MAG to off **27**
- BRIGHTNESS control to maximum (cw) **1**
- INTENSITY control to minimum (ccw) **4**
- HORIZ POSITION to center **26**
- VERT POSITION to center **27**

On 178:

- DUT SUPPLIES to OFF **46**
- LOAD RESISTANCE to $2k\Omega$ **45**
- SOURCE RESISTANCE to 50Ω **47**
- + SUPPLY to 15V (or rated voltage for device) **41**
- - SUPPLY to TRACK + SUPPLY **42**
- SWEEP AMPLITUDE to minimum (ccw) **43**
- SWEEP FREQUENCY to .1Hz **44**
- FUNCTION to OFFSET V **49**
- VERT UNITS/DIV to 50 mV **50**

GENERAL SET-UP continued

6) Obtain trace — Using controls on 577:

- a) Pull POWER ON switch. Wait for warm up. **7**
- b) Clear screen — Press the UPPER and LOWER STORE buttons and then UPPER and LOWER ERASE. Release STORE buttons. **3**
- c) Find spot — Press BEAM FINDER button in, and advance INTENSITY control until spot is clearly visible. **6 4**
- d) Center spot — Using VERTICAL and HORIZONTAL POSITION controls, center spot. Use BEAM FINDER to see present direction if spot is off-screen. **27 26 6**

7) Insert device — Insert device to be tested in socket. See Figure 0-6.

Set-up procedure is now complete.

Proceed to selected test.

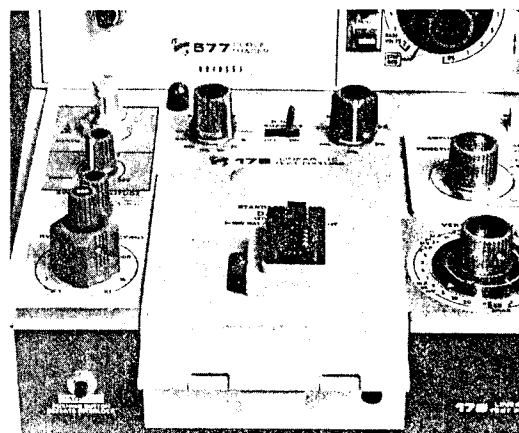
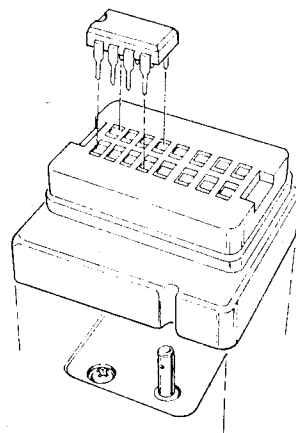

Figure 0-6 Device inserted in socket.

TEST 1: INPUT OFFSET VOLTAGE

Input offset voltage is the amount of dc voltage input needed to keep the op amp output at zero with no applied signal voltage.

In this test, the op amp being tested is made part of a feedback loop together with another amplifier supplied in the curve tracer. The curve trace sweep generator attempts to drive the op amp output over its working range, but the feedback loop supplies a voltage input to the op amp that, when amplified, cancels out this driving voltage.

This input voltage, which keeps the op amp output at zero, is therefore the input offset voltage.

WHAT THE DISPLAY SHOWS

The display shows input offset voltage, measured between the op amp's inverting input and non-inverting input, on the vertical axis, and the voltage applied by the sweep generator to the op amp output on the horizontal axis. Specifications are met when the trace stays within the vertical band specified, over the defined horizontal range.

PROCEDURE:

- 1) Set controls— Beginning with general Op Amp set-up, change controls as follows:

On 577:

- HORIZ VOLTS/DIV to smallest value at least $\frac{1}{4}$ of specified testing domain excursion from zero [+10V range, 5V] **22**

On 178:

- FUNCTION to OFFSET **49**
- SOURCE RESISTANCE to specification value [10 k Ω] **47**
- VERT UNITS/DIV to smallest value at least $\frac{1}{3}$ of specified maximum offset voltage [2 mV] **50**
- DUT SUPPLIES to ON **46**

TEST 1: INPUT OFFSET VOLTAGE continued

- 2) Zero display — Press DISPLAY ZERO and hold in while centering display with VERT and HORIZ POSITION controls of 577. 48 27 26
- 3) Measure trace— Advance SWEEP AMPLITUDE on 178 to obtain full range of specified input offset voltage. Press UPPER and LOWER STORE buttons on 577 to obtain clear, lasting trace. (If necessary, press UPPER and LOWER ERASE first to clear screen.) Check to see that vertical displacement is within specified value [3 divisions, equal to 6 mV] over op amp's specified output range [+10V, 2 divisions each way from center]. See Figure 1-1. 43 3
- 4) Turn off device — Switch DUT SUPPLIES to OFF. 46

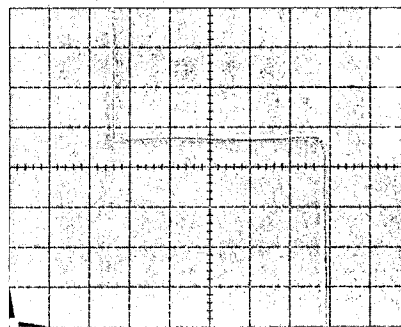

Figure 1-1. Input offset voltage.

TEST 2: INPUT BIAS CURRENT

Input bias current is the amount of dc current flowing into the op amp inputs, tested over the full input voltage range. Alternately, it may be specified only with a zero voltage input.

This test is done twice, once for the inverting and once for the non-inverting input. In each run-through, current into the selected terminal is measured as the sweep generator drives the common mode input voltage over the full input range. A feedback loop keeps the output at zero by supplying the appropriate voltage to the input opposite to the one being tested.

WHAT THE DISPLAY SHOWS

The display shows current into the selected input on the vertical axis graphed against common-mode input voltage on the horizontal. Specifications are met when the trace stays between specified limits on the vertical over the specified horizontal domain.

PROCEDURE:

Following steps are performed twice, once for each of two positions of FUNCTION switch.

- 1) Set controls— Beginning with general Op Amp set-up, change controls as follows:
 - On 577:
 - HORIZ VOLTS/DIV to smallest value at least $\frac{1}{4}$ specified common mode voltage excursion from zero [$\pm 10V$, 5V setting] **22**
 - FUNCTION to + INPUT I (first time) through entire test; then to - INPUT I (second time) through entire test **45**
 - SOURCE RESISTANCE to specification value [50Ω] **47**
 - VERT UNITS/DIV to smallest value at least $\frac{1}{3}$ of specified maximum input bias [$.2\mu A$] **50**
 - DUT SUPPLIES to ON **46**
 - SWEEP AMPLITUDE to maximum (cw) **43**

TEST 2: INPUT BIAS CURRENT continued

- 2) Zero display — Press DISPLAY ZERO and hold in while centering display with VERT and HORIZ POSITION controls of 577. 48 27 26
- 3) Measure Trace — Press UPPER and LOWER STORE buttons on 577 to obtain clear trace. If necessary, press UPPER and LOWER ERASE to clear screen. Check to see that vertical displacement is within specified value [2.5 divs, equal to $.5 \mu\text{A}$] over op amp's specified input common-mode range. Refer to Figures 2-1 and 2-2. 3 2

NOTE: The 577-D1 storage display will not automatically erase the display when the FUNCTION is switched from +INPUT to -INPUT. Do not erase it manually either if you wish to measure input offset current (see test 3). 49

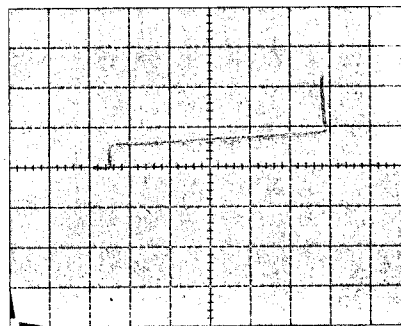

Figure 2-1. + Input bias current.

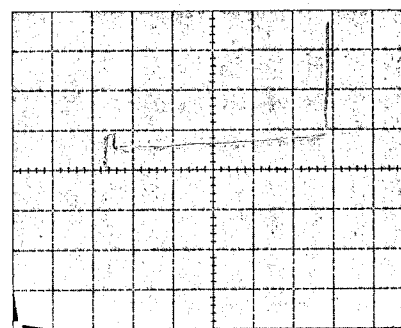

Figure 2-2.—Input bias current. Display was produced by following procedure for +input bias current, however, FUNCTION switch was set to -input bias current.

TEST 3: INPUT OFFSET CURRENT

Input offset current is the amount of differential current flowing into the op amp input required to keep the output at zero with no applied differential voltage.

This specification is checked by examining the results of the positive and negative input bias current tests. The difference between the two values is the input offset current.

WHAT THE DISPLAY SHOWS

This test uses the D1 storage feature to retain the traces of the positive and negative input bias currents on screen. Thus, input bias current is shown on the vertical axis and common-mode input voltage on the horizontal. The difference in displacement between these two curves is the input offset current.

PROCEDURE:

- 1) Perform bias current tests — Perform positive and negative input bias current tests (see test 2 procedures) without erasing display between tests.
- 2) Read display — Check that difference between vertical displacements is within specified limits [2.5 divisions, equal to $0.5 \mu\text{A}$] over full stated horizontal domain [+2 divisions from center] as specified. See Figure 3-1.
- 3) Measure offset current (optional) — To obtain numeric value for offset current, display resolution must be increased.
 - a) Set FUNCTION to + INPUT. Decrease value of VERT UNITS/DIV and then move trace down by turning VERTICAL POSITION control ccw with DISPLAY ZERO held in, until trace starts on bottom graticule line and makes sharp excursion to right crossing center vertical graticule line in top half of screen (see Figure 3-2). If necessary, release X10 VERT MAG to increase display resolution. **49 50 48 27**
 - b) Press UPPER and LOWER STORE to save display. Then switch FUNCTION to -INPUT. Measure vertical separation between traces at intersection with center vertical graticule line. This amount, multiplied by VERT UNITS/DIV, and X10 if used, is zero-point input off-set current. **3 49 27**
- 4) Turn off device — Switch DUT SUPPLIES to OFF. **46**

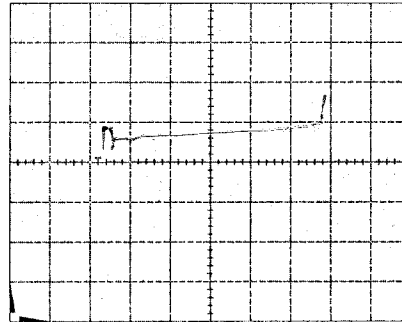

Figure 3-1. + and - input bias current on one display. Typical input offset current is very low and little to no trace separation is noticeable on the display.

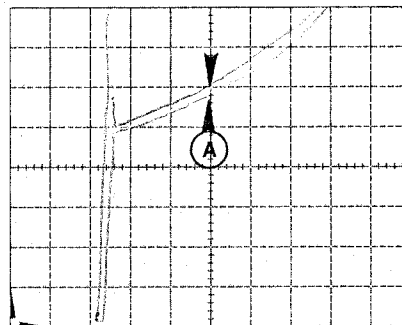

Figure 3-2. + and - input bias current at increased vertical sensitivity can be displayed at the same time. Trace separation at center of display along vertical graticule line is amount of input offset current. Point (A) is the area of measurement.

TEST 4: COMMON-MODE REJECTION RATIO

Common-mode rejection ratio (cmrr) is the ratio of two different modes of signals required to obtain the same output. More specifically, it is the amount of signal applied together to both op amp inputs simultaneously, compared to the size of the signal that produces the same output if applied between the inputs differentially. The signal amplitude is normally measured in volts and fractions, while the ratio is expressed in decibels (dB).

In this test, the sweep generator output is applied to both op amp inputs, driving both in common mode over the set range. At the same time, the feedback loop keeps the op amp output at zero by supplying the required differential input to provide an equal and opposite op amp output as would be produced by the common mode input alone. Thus, at each point, the differential input voltage required to produce a given output is compared to the common mode voltage that produces the equal, but opposite, result.

WHAT THE DISPLAY SHOWS

The vertical axis shows the differential voltage applied to the op amp inputs; the horizontal direction shows the applied common mode voltage. To obtain the cmrr, divide the horizontal deflection, including scale factors, by the vertical deflection, using the common-mode range specified. Specifications are met when this ratio, expressed in dB, falls within the stated value [70dB over -10V to +10V].

PROCEDURE:

- 1) Set controls— Beginning with general Op Amp set-up, change controls as follows:

On 577:

- HORIZ VOLTS/DIV to smallest value at least $\frac{1}{4}$ of specified common mode voltage excursion from zero [5V] **22**

On 178:

- FUNCTION to CMRR **49**
- SOURCE RESISTANCE to $10K\Omega$ **47**
- VERT UNITS/DIV to smallest value at least $\frac{1}{3}$ of input required to produce defined output swing at specified CMRR [.5 mV] **50**
- SWEEP AMPLITUDE to minimum (ccw) **45**

TEST 4: COMMON-MODE REJECTION RATIO cont.

- 2) Zero display — Press DISPLAY ZERO and hold in while centering display with VERT and HORIZ POSITION controls of 577. **48 27 26**
- 3) Turn on device — Switch DUT SUPPLIES to ON. **46**
- 4) Apply input — Advance SWEEP AMPLITUDE to obtain specified common-mode swing on horizontal axis. [2 divs each way from center]. **43**
- 5) Measure trace — Press UPPER and LOWER STORE buttons on 577 to obtain clear, lasting trace. (If necessary, press UPPER and LOWER ERASE first to clear screen). Refer to Figure 4-1. **3 2**
- 6) Calculate cmrr.

$$\text{CMRR} = \frac{\Delta \text{Horiz}}{\Delta \text{Vert}}$$
 In decibels, gain = $20 \log_{10} \frac{\Delta H}{\Delta V}$ dB.
 Compare to specification value.
- 7) Check that horizontal range between sharp knees in curve is at least equal to specified input common mode range.
- 8) Turn off device — Switch DUT SUPPLIES to OFF. **46**

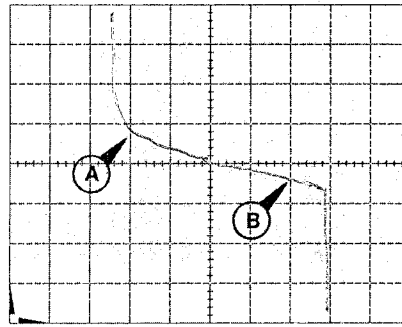

Figure 4-1. Common mode rejection ratio. Total voltage swing between measurement points (A) and (B) is 20 V. Cmrr is calculated by dividing horizontal change by vertical change, then multiplying by $20 \log_{10}$ to convert to dB.

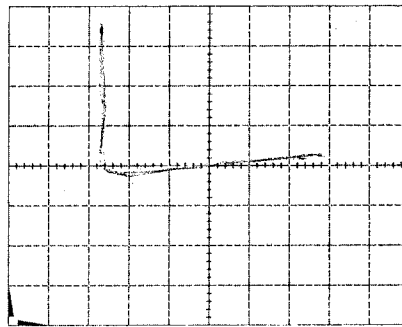

Figure 4-2. CMRR, same measurement with different display.

TEST 5: GAIN

Gain is the ratio of op amp output voltage swing to input voltage change, measured over a specified range. While a curve tracer is particularly useful for verifying that the gain figure measured is applicable over the complete normal operating range of the intended use, gain is normally specified as a measurement based on two points.

In this test, the op amp being tested is made part of a feedback loop together with another amplifier supplied internally in the curve tracer. The sweep generator attempts to drive the op amp output over its working range, but the feedback loop supplies a voltage input to the op amp which, when amplified by the op amp, cancels out this voltage.

The op amp's offset voltage is cancelled out by a sample-hold circuit. The remaining input voltage supplied to the op amp being tested is therefore the amount required to, when amplified, supply a voltage equal to and opposite from that provided by the sweep generator.

WHAT THE DISPLAY SHOWS

The display shows the output voltage on the horizontal, and a voltage equal to the opposite of the op amp input on the vertical. Specifications are met when the change in the vertical displacement is within the limits called for by the gain ratio. This measurement is normally taken between two defined output voltage points [less than 1 mV, or better than 1:200,000 at -10 to +10 V].

PROCEDURE:

- 1) Set controls— Beginning with general Op Amp set-up, change controls as follows:

On 577:

- HORIZ VOLTS/DIV to smallest value at least $\frac{1}{4}$ of specified output voltage excursion from zero [5 V] **22**

On 178:

- FUNCTION to GAIN **49**
- LOAD RESISTANCE to value closest to specified amount [2K Ω] **45**
- VERT UNITS/DIV to smallest value at least $\frac{1}{3}$ of input required to produce defined output swing at specified gain [1 mV] **50**

TEST 5: GAIN continued

- 2) Turn on device — Switch DUT SUPPLIES to ON. **46**
- 3) Zero display — Press ZERO DISPLAY and hold in while centering display with VERT and HORIZ POSITION controls of 577. **48 27 26**
- 4) Apply input — Advance SWEEP AMPLITUDE on 178 to obtain desired output swing on horizontal axis [2 divisions each way from center]. **43**
- 5) Check gain against limits — Press UPPER and LOWER STORE buttons on 577 to obtain a clear, lasting trace. If necessary, press UPPER and LOWER ERASE first to clear screen. Check to see that vertical displacement is within specified value [1 div, or 1mV] at specified points [+ and -2 divs from center], and that gain does not vary excessively over op amp's working output range. Refer to Figure 5-1. **3 2**

Optional Step

- 6) Display actual gain — Switch VERT UNITS/DIV to smaller values until display almost fills screen vertically in region between horizontal points corresponding to specified domain. As necessary, press DISPLAY ZERO to center trace on screen. Press UPPER and LOWER ERASE to clear screen, UPPER and LOWER STORE to save display. Refer to Figure 5-2. **50 48 3 2**
- 7) Calculate gain — Gain is ratio of horizontal displacement, including scale factors. In decibels, it is 20 times log of ratio:

$$\text{Gain} = \frac{\Delta \text{Horiz}}{\Delta \text{Vert}}$$

$$\text{Gain}_{\text{dB}} = 20 \log \frac{\Delta H}{\Delta V} \text{ dB}$$

- 8) Turn off device — Switch DUT SUPPLIES to OFF. **46**

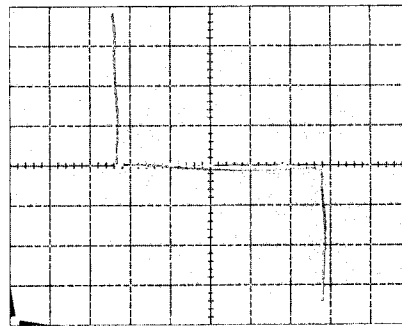

Figure 5-1. Gain curve with a 2-KΩ load, 1mV/div vertical sensitivity.

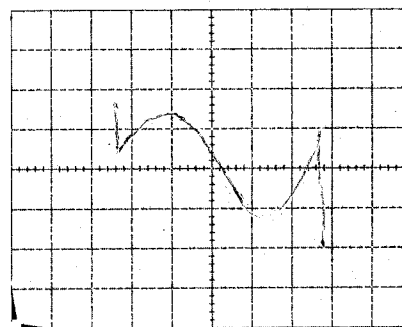

Figure 5-2. Gain curve with a 2-KΩ load, 50 μV/div vertical sensitivity.

TEST 6: OUTPUT VOLTAGE SWING

The output voltage swing test assures that the op amp will produce its rated output voltage when operating into specified loads.

In this test, the op amp being tested is made part of a feedback loop together with another amplifier supplied in the curve tracer. The sweep generator attempts to drive the op amp output over its working range, but the feedback loop supplies a voltage input to the op amp which, when amplified, cancels out this voltage.

The op amp offset voltage is cancelled out by a sample-hold circuit. The output range over which the op amp continues to operate satisfactorily is the output voltage swing.

WHAT THE DISPLAY SHOWS

The display shows the output voltage on the horizontal, and a voltage equal to the opposite of the op amp input on the vertical. Specifications are met when the usable gain slope is close enough to monotonic for the intended use and extends at least to the specified points on the horizontal (see Test 5 for explanation of gain measurements).

PROCEDURE:

It may be necessary to perform this test several times, once for each specified load resistance.

- 1) Set controls— Beginning with general Op Amp set-up, change controls as follows:

On 577:

- HORIZ VOLTS/DIV to smallest value at least $\frac{1}{4}$ of specified domain excursion from zero [5 V] **22**

On 178:

- FUNCTION to GAIN **49**
- SOURCE RESISTANCE to 50 **47**
- VERT UNITS/DIV to smallest value at least $\frac{1}{3}$ of input required to produce defined output swing at specified gain [1 mV] **50**
- LOAD RESISTANCE to specified value [2 K, 10 K] **45**

TEST 6: OUTPUT VOLTAGE SWING continued

- 2) Turn on device — Switch DUT SUPPLIES to ON. **46**
- 3) Zero display — Press ZERO DISPLAY and hold in while centering display with VERT and HORIZ POSITION controls of 577. **48 27 26**
- 4) Apply input — Advance SWEEP AMPLITUDE on 178 to obtain desired output swing on horizontal axis.
- 5) Measure trace — Press UPPER and LOWER STORE buttons on 577 to obtain clear, lasting trace. If necessary, press UPPER and LOWER ERASE first to clear screen. Check to see that middle of the gain curve extends for sufficient horizontal length before making sharp turns to vertical off-screen directions near ends. [2 divs each way from center, equal to $\pm 10\text{V}$ at 2 K, and 2.4 divs, or $\pm 12\text{V}$ at 10 K]. Refer to Figures 6-1 and 6-2. **3 2**

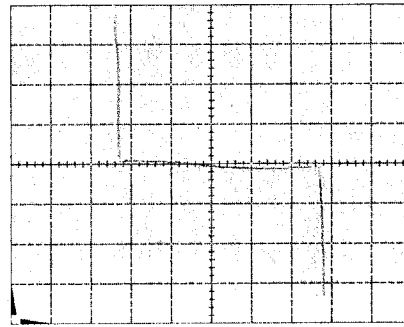

Figure 6-1. Output voltage swing with 2-K Ω load.

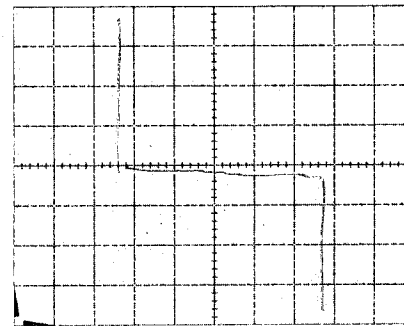

Figure 6-2. Output voltage swing with 10-K Ω load.

TESTS 7, 8 and 9: POWER SUPPLY VOLTAGE REJECTION RATIO

Power supply voltage rejection ratios measure the effect of variations in the power supply voltage compared to the effects of changes in the input signal.

More specifically, rejection ratios are the amount of variation in the power supply voltage measured at the specified terminal divided by the size of the signal that produces the same output if applied between the op amp inputs differentially. The signal amplitude is normally measured in volts and fractions; the ratio is expressed in $\mu\text{V}/\text{V}$ or decibels.

In these tests, the sweep generator is used to vary the voltage on the indicated power supply terminals:

Test 7 – Positive Power Supply Voltage Rejection Ratio (to the positive power input, driving it more positive).

Test 8 – Negative Power Supply Voltage Rejection Ratio (to the negative power input, driving it more negative).

Test 9 – Dual Power Supply Voltage Rejection Ratio (between the positive and negative power supply terminals, driving the voltages farther apart).

At the same time that the voltages on these terminals are being varied, a feedback loop keeps the op amp output at zero by supplying the required differential input to provide an op amp output equal to and opposite from the output that would be produced by the power supply voltage variations, acting alone. This differential input signal is then compared with the corresponding power supply voltage variation applied.

WHAT THE DISPLAY SHOWS

The vertical axis shows the differential voltage applied to the op amp inputs; the horizontal direction shows the variation applied to the power supply voltage under test (positive for Test 7, negative for Test 8, and the positive part for test 9, although both positive and negative actually vary in Test 9). To obtain the appropriate PSRR, divide the horizontal deflection, including scale factors, by the vertical deflection, using the power supply voltage range specified. Specifications are met when this ratio, expressed in $\mu\text{V}/\text{V}$ or dB, falls within the stated value [$150 \mu\text{V}/\text{V}$].

PROCEDURE:

- 1) Set controls— Beginning with general Op Amp set-up, change controls as follows:

On 577:

- HORIZ VOLTS/DIV to smallest value at least $\frac{1}{4}$ of specified supply excursion from its reference [5 V] **22**

On 178:

- FUNCTION to +PSRR for Test 7 **46**
- FUNCTION to -PSRR for Test 8 **49**
- FUNCTION to +PSRR for Test 9 **46**
- SOURCE RESISTANCE to 10K **47**
- VERT UNITS/DIV to smallest value at least $\frac{1}{3}$ of input needed to produce defined output swing at specified PSRR [.5 mV] **50**
- SWEEP AMPLITUDE to minimum (ccw) **43**

TEST 7,8 and 9: POWER SUPPLY REJECTION RATIO continued

- 2) Turn on device – Switch DUT SUPPLIES to ON. **46**
- 3) Zero display – Press ZERO DISPLAY and hold in while centering display with VERT and HORIZ POSITION controls of 577. **48 27 26**
- 4) Apply input – Advance SWEEP AMPLITUDE to obtain specified power supply swing on horizontal axis. **43**
- 5) Measure trace – Press UPPER and LOWER STORE buttons on 577 to obtain clear, lasting trace. (If necessary, press UPPER and LOWER ERASE first to clear screen.) Refer to Figures 7-1, 8-1, and 9-1. **3 2**
- 6) Calculate PSRR –

$$\text{PSRR} = \frac{\Delta \text{ Horiz}}{\Delta \text{ Vert}}$$

$$\text{In dB: PSRR} = 20 \log_{10} \frac{\Delta H}{\Delta V} \text{ dB.}$$
- 7) Compare to specification value.
- 8) Turn off device – Switch DUT SUPPLIES to OFF. **45**

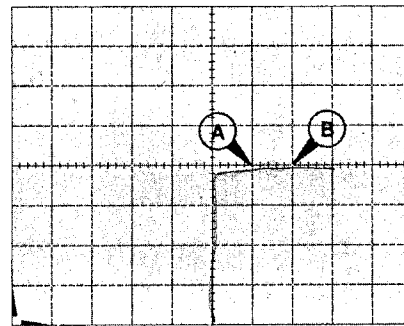

Figure 7-1. + Power supply voltage rejection ratio. Points (A) and (B) are voltage levels, 5 V and 10 V respectively. Change of 5 V in positive supply is comparable to approximately 0.2 mV of signal between its inputs. Ratio of 10 V (± 5 V) to 0.2 mV equals 50,000.

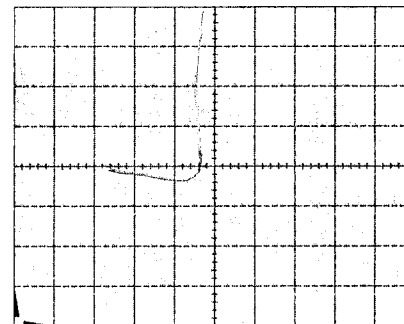

Figure 8-1. - Power supply voltage rejection ratio.

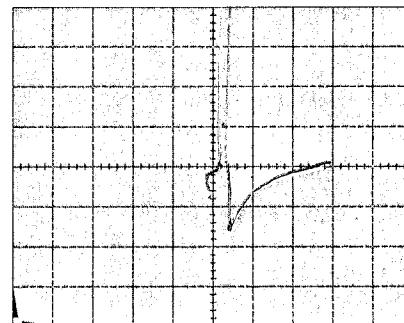

Figure 9-1. Dual power supply voltage rejection ratio.