

2754/2754P

SPECTRUM ANALYZER

VOLUME 1

WARNING

THE FOLLOWING SERVICING INSTRUCTIONS ARE FOR USE BY QUALIFIED PERSONNEL ONLY. TO AVOID PERSONAL INJURY, DO NOT PERFORM ANY SERVICING OTHER THAN THAT CONTAINED IN OPERATING INSTRUCTIONS UNLESS YOU ARE QUALIFIED TO DO SO. REFER TO OPERATORS SAFETY SUMMARY AND SERVICE SAFETY SUMMARY PRIOR TO PERFORMING ANY SERVICE.

Please Check for CHANGE INFORMATION at the Rear of This Manual

First Printing JUL 1986

Tektronix[®]
COMMITTED TO EXCELLENCE

Copyright © 1986 Tektronix, Inc. All rights reserved.
Contents of this publication may not be reproduced in
any form without the written permission of Tektronix, Inc.

Products of Tektronix, Inc. and its subsidiaries are
covered by U.S. and foreign patents and/or pending
patents.

TEKTRONIX, TEK, SCOPE-MOBILE, and  are
registered trademarks of Tektronix, Inc. TELEQUIP-
MENT is a registered trademark of Tektronix U.K.
Limited.

Printed in U.S.A. Specification and price change
privileges are reserved.

Tektronix, Inc.
P.O. Box 500
Beaverton, Oregon 97077

Serial Number

PREFACE

This manual contains service information for the TEKTRONIX 2754/2754P. The information is located in two volumes. Volume 1 contains the text and Volume 2 contains the diagrams and parts lists. The Table of Contents in each volume lists the contents of both volumes.

Manuals that describe other aspects of the product are:

- Operator's Manual
- Operator's Handbook
- Programmer's Manual

Who Should Use This Manual?

This manual is intended for electronic technicians with experience in servicing digital, analog, and rf circuitry. Circuit analysis is mostly functional and should help isolate most malfunctions to a board or block of circuitry. The technician should then be able, with the aid of test equipment, to isolate the malfunction to a specific component or components.

This instrument contains firmware that provides a thorough instrument check during power up and during operation, and if needed, guides the user through an abbreviated front-panel calibration procedure. If calibration cannot be achieved, a diagnostic test detects and isolates most problems to the system, such as 1st LO. The technician can then run troubleshooting diagnostics to further isolate the problem to the board or block of components. Refer to the Maintenance section for diagnostics information.

Documentation Standards

Most terminology and graphics follow ANSI standards. A glossary of terms is provided as an appendix. Refer to the following standards:

- ANSI Y1.1 — Abbreviations
- ANSI Y32.2 — Graphic Symbols
- IEEE 91 — Logic Symbols

Change/History Information

Sometimes instrument changes occur or manual errors are found that make some of the information in the manual inaccurate. When that happens, Manual Change Information notices are inserted at the rear of the manual. This helps ensure that the manual contains the latest and most accurate information available when the product is sold.

History information, with the updated data, is integrated into the text or diagrams. When a text page is updated, the revised pages are identified by a revision date in the lower inside corner of the page. When a diagram is updated, the revision date is placed at the lower center of the diagram. History information is shown with a gray tint. When a component value is changed, the designator on the drawing is boxed with a grey outline. When a circuit is deleted or changed, the original configuration is shown in grey, drawn either at its original location or to the side of the drawing.

If you have a manual other than the one that came with your instrument it may contain revisions that do not apply to your instrument; however all history information that pertains to the earlier instruments is retained. When a major modification has been made to an assembly or circuit board, the data for the replaced assembly will follow the new information and will be identified with appropriate titles or headings such as instrument serial number range or the assembly or board part numbers.

Also, if your instrument has an assembly replaced with a newer version, documentation for the newer assembly may be supplied. Contact any Tektronix Service Center for information.

TABLE OF CONTENTS

The 2754 Service Manual is divided into two volumes.

VOLUME 1

	Page		Page
PREFACE	i	Section 4 PERFORMANCE CHECK	
TABLE OF CONTENTS	ii	Introduction	4-1
LIST OF ILLUSTRATIONS	ix	Incoming Inspection Test	4-1
LIST OF TABLES	xii	Verification of	
SAFETY SUMMARY	xiii	Tolerance Values	4-1
		History Information	4-1
Section 1 GENERAL INFORMATION		Equipment Required	4-1
Product Description	1-1	Firmware Version	4-3
Conformance to		Error Message Readout	4-3
Industry Standards	1-1	Initial Power-Up	4-4
Product Service	1-1	Calibrate Position,	
Instrument Construction	1-2	Center Frequency,	
Installation and		Reference Level,	
Preparation for Use	1-2	and Dynamic Range	4-5
Changing Power Input Range	1-2	PERFORMANCE CHECK	
Replacing Fuses	1-2	PROCEDURE	4-6
Selected Components	1-2	1. Check Center Frequency	
Assembly and		Accuracy	4-6
Circuit Numbering	1-2	2. Check Residual FM	4-8
Power-up Messages	1-3	3. Check Frequency	
Options	1-3	Span/Div Accuracy	4-9
Accessories	1-3	4. Check Sweep Time	
		Accuracy	4-11
Section 2 SPECIFICATION		5. Check Pulse Stretcher	4-12
ELECTRICAL	2-1	6. Check Resolution Bandwidth	
Verification of Tolerance Values	2-1	and Shape Factor	4-12
Frequency Related Characteristics ...	2-1	7. Check Calibrator	
Amplitude Related Characteristics ...	2-7	Output	4-12
Input Signal Characteristics	2-12	8. Check Noise Sidebands	4-13
Output Signal Characteristics	2-15	9. Check Frequency	
Power Requirements	2-16	Response	4-13
General Characteristics	2-17	10. Check Display Dynamic	
		Range and Accuracy	4-17
ENVIRONMENTAL	2-18	11. Check Preselector	
PHYSICAL	2-19	Ultimate Rejection	4-18
		12. Check RF Attenuator Accuracy	
Section 3 INSTALLATION		(0 to 60 dB in 10 dB Steps)	4-18
UNPACKING AND		13. Check IF Gain	
INITIAL INSPECTION	3-1	Accuracy	4-22
CONNECTING POWER	3-2	14. Check Gain Variation Between	
Power Source and		Resolution Bandwidths	4-23
Power Requirements	3-2	15. Check Sensitivity	4-24
STORAGE AND REPACKAGING	3-2	16. Check Residual	
Storage	3-2	Spurious Response	4-25
Repackaging for Shipment	3-3	17. Check Intermodulation	
		Distortion	4-25

TABLE OF CONTENTS (Cont.)

	Page		Page
Section 4 PERFORMANCE CHECK (Cont.)		Section 6 MAINTENANCE	
18. Check Harmonic Distortion	4-26	INTRODUCTION	6-1
19. Check LO Emission	4-27	Removing the Instrument from its Cabinet	6-1
20. Check 1 dB Compression Point	4-29	Static-Sensitive Components	6-1
21. Check Triggering Operation and Sensitivity	4-29	PREVENTIVE MAINTENANCE	6-3
22. Check External Sweep Operation	4-30	Elapsed Time Meter	6-3
23. Check VERT OUTPUT Signal	4-30	Cleaning	6-3
24. Check HORIZ OUTPUT Signal Level	4-31	Lubrication	6-3
GPIB VERIFICATION PROGRAM	4-32	Fixtures and Tools for Maintenance	6-3
		Visual Inspection	6-3
		Transistor and Integrated Circuit Checks	6-3
		Performance Checks and Recalibration	6-4
		Saving Stored Data in Battery-Backup Memory	6-4
Section 5 ADJUSTMENT PROCEDURE		TROUBLESHOOTING	6-4
Introduction	5-1	Troubleshooting Aids	6-4
Equipment Required	5-1	Diagrams	6-4
Preparation	5-2	Circuit Board Illustrations and Component Locator Charts	6-5
1. Adjust Low Voltage Power Supply	5-3	Diagnostics	6-5
2. Adjust Z-Axis and High Voltage Circuits	5-5	General Troubleshooting Techniques	6-5
3. Adjust Deflection Amplifier Gain and Frequency Response	5-6	Semiconductor Checks	6-5
4. Adjust Digital Storage Calibration	5-8	Diode Checks	6-5
5. Adjust Sweep Timing	5-10	Diagnostic Firmware	6-6
6. Adjust Frequency Control System	5-11	Troubleshooting Steps	6-6
7. Adjust Start (0 Hz) Response Amplitude and Mixer Bias	5-12	DIAGNOSTICS	6-6
8. Adjust 1st Converter Bias ^A	5-12	TROUBLESHOOTING USING THE ERROR MESSAGE DISPLAY	6-6
9. Adjust Log Amplifier	5-13	Introduction	6-6
10. Adjust Resolution Bandwidth and Shape Factor	5-16	Combination of Error Messages	6-7
11. Preset the Variable Resolution Gain and Band Leveling	5-18	TRACE MODES	6-15
12. Adjust Calibrator Output Level	5-20	Alternate Frequency Display	6-15
13. Adjust IF Gain	5-21	Auxiliary Synthesizer Control	6-15
14. Adjust B-SAVE A Reference Level	5-22	Correction Disable/Enable	6-15
15. Adjust Preselector Driver (Opt. 01 only)	5-22	CORRECTIVE MAINTENANCE	6-16
16. Adjust Band Leveling for Coaxial Bands (1-5)	5-24	Handling Static Sensitive Components	6-16
17. Phase Lock Calibration	5-26	Obtaining Replacement Parts	6-16
		Parts Repair and Return Program	6-16
		Firmware Version and Error Message Readout	6-16
		Selected Components	6-16
		Replacing EPROM or ROM Devices	6-16
		Surface-Mounted Components	6-17
		Replacing Surface-Mounted Components	6-18

TABLE OF CONTENTS (Cont.)

	Page		Page
Section 6 MAINTENANCE (Cont.)		Power-up Self Test	6-45
Transistor and Integrated		Microcomputer System Test	6-45
Circuit Configurations	6-18	Address Bus Test	6-47
Diode Color Code	6-18	Microcomputer Bus	6-47
Multiple Terminal		Memory Address Decoders	6-48
(Harmonica) Connectors	6-19	Processor Address Decoder	6-49
Resistor Values	6-19	GPIB Board Address Decoders	6-49
Capacitor Marking	6-19	Clocks and Control Lines	6-49
Soldering Techniques	6-19	Instrument Bus Test	6-49
Replacing the Square Pin for		TROUBLESHOOTING ON THE	
the Multi-pin Connectors	6-19	INSTRUMENT BUS	6-50
Servicing the VR Module	6-20	Instrument Bus Data Transfers	6-50
REPLACING ASSEMBLIES		Instrument Bus Registers	6-51
AND SUBASSEMBLIES	6-20	Front-Panel Registers	6-59
Removing and Installing		PROGRAM FOR MOVING STORED	
the GPIB Board	6-20	DATA FROM THE SPECTRUM	
Removing or Replacing		ANALYZER TO TAPE AND	
Semi-rigid Coaxial Cables	6-23	RETURNING IT TO MEMORY	6-60
Replacing the Dual Diode			
Assembly in the 1st Mixer	6-23		
Replacing the Crt	6-23	Section 7 THEORY OF OPERATION	
Repairing the Crt		FUNCTIONAL AND	
Trace Rotation Coil	6-24	GENERAL DESCRIPTION	7-1
Front Panel Assembly Removal ...	6-24	What It Does	7-1
Front-Panel Board Removal	6-24	How It Works	7-1
Replacing Front Panel		First, Second, and	
Pushbutton Switches	6-25	Third Converters	7-1
Main Power Supply		IF Section	7-2
Module Removal	6-25	Display Section	7-2
High Voltage Power Supply	6-25	Frequency Control Section	7-2
Removing and Replacing the		Counter and	
1st LO (YIG Oscillator)	6-25	Phase Lock Section	7-2
Replacing the 1st (YIG) Local		Digital Control Section	7-2
Oscillator Interface Board	6-26	Power Supply Section	7-3
Fan Assembly Removal	6-26	Other Sections	7-3
MAINTENANCE ADJUSTMENTS	6-27	DETAILED DESCRIPTION	7-4
2072 MHz 2nd Converter	6-27	1ST CONVERTER SECTION	7-4
Four Cavity Filter	6-27	RF Interface Circuits	7-4
Mixer	6-27	1st Converter	7-4
110 MHz Three Cavity Filter	6-29	RF Input	7-4
829 MHz Converter Maintenance .	6-30	Preselector Circuits	
Troubleshooting and Calibrating		(Opt. 01 Only)	7-4
the 2182 MHz 2nd LO	6-33	1st Mixer	7-5
Preparing the 2nd L.O.		1st Local Oscillator	7-5
Assembly for Adjustment	6-36	Power Divider	7-5
Reassembling the		Directional Filter	7-5
2nd LO Assembly	6-39	2072 MHz IF Filters	7-5
Troubleshooting and Calibrating		Diplexer and Filter	7-5
the 16-20 MHz Phase Lock Section	6-39	2ND CONVERTER SECTION	7-6
Troubleshooting Aids for the		2072 MHz 2ND CONVERTER	7-7
2182 MHz Phase Locked		Four-Cavity Filter	7-7
2nd LO Assembly	6-43	Mixer Circuit	7-7
MICROCOMPUTER SYSTEM		Precision External Cables	7-8
MAINTENANCE	6-45		
Memory Board Option Switch	6-45		

TABLE OF CONTENTS (Cont.)

	Page		Page
Section 7 THEORY OF OPERATION (Cont.)		Digital Control Circuit	7-31
Filter-to-Mixer		VIDEO PROCESSOR	7-31
RF Input Cable	7-9	Interface with 1405 TV	
2nd LO-to-Mixer		Sideband Adapter	7-31
LO Input Cable	7-9	Video Marker	7-32
2182 MHz PHASE LOCKED		Video Leveling	7-33
2ND LO	7-9	Video Leveler Circuits	7-33
2182 MHz Microstrip		Video Filter Circuits	7-33
Oscillator	7-9	Video Blanking	7-35
2200 MHz Reference		DIGITAL STORAGE	7-35
Board	7-10	Vertical Section	7-36
2200 MHz Reference		Digitizing Circuits	7-39
Mixer	7-10	Address Decoding	7-39
16-20 MHz Phaselock		Interface Logic	7-39
Board	7-10	Maximum Hold	7-39
829 MHz 2ND CONVERTER	7-12	Constant Circuit	7-39
IF Section	7-12	Output Circuits	7-40
829 MHz Diplexer	7-12	Peak/Average Level	
829 MHz Amplifier	7-12	Circuits	7-40
829 MHz 2nd Converter	7-13	Horizontal Section	7-40
110 MHz IF Select	7-14	Marker IC	7-42
LO Section	7-15	Tracking Digital-to-	
Phase Lock Circuit	7-15	Analog Converter	7-42
2nd Local Oscillator		Update Marker Circuits	7-42
Output Circuit	7-17	Fast Retrace Blanking	7-43
719 MHz Output Circuit	7-17	Memories	7-43
3RD CONVERTER SECTION	7-18	DEFLECTION AMPLIFIERS	7-43
110 MHz IF AMPLIFIER	7-18	Horizontal Section	7-43
110 MHz BAND-PASS		Vertical Section	7-44
FILTER	7-19	Z-AXIS AND RF INTERFACE	7-44
3rd CONVERTER	7-19	RF Interface Circuits	7-45
100 MHz Oscillator	7-19	Z-Axis Circuits	7-45
Mixer	7-19	Power-Fail Detector	7-46
Distribution Amplifier	7-19	Power Supply Monitor	7-46
Calibrator	7-20	Timer	7-46
IF SECTION	7-21	HIGH-VOLTAGE SUPPLY	7-46
VARIABLE RESOLUTION	7-21	High-Voltage Oscillator	7-46
VR Input	7-21	Voltage Doubler	7-46
1st Filter Select	7-21	High-Voltage Regulator	7-46
10 dB Gain Steps	7-22	Z-Axis Clipper	7-47
20 dB Gain Steps	7-23	CRT READOUT	7-47
Band Leveling Circuit	7-23	Generating Readout	7-47
Digital Control Circuits	7-24	Readout On/Off Timing	7-47
+5 V Regulator Circuit	7-24	Character Scan	7-47
2nd Filter Select	7-24	Character Generator	
Post VR Amplifier Circuit	7-25	Timing	7-50
LOG AMP and DETECTOR	7-25	Dot Delay	7-50
Log Amplifier Circuits	7-26	Instrument Bus Interface	7-52
Detector Circuit	7-28	Control Port	7-52
DISPLAY SECTION	7-29	Address/Data Port	7-53
FUNCTIONAL DESCRIPTION	7-29	Frequency Dot Marker	7-53
VIDEO AMPLIFIER	7-29	FREQUENCY CONTROL	
Log Mode Circuits	7-29	SECTION	7-56
Linear Mode Circuits	7-30	Sweep	7-56
Pulse Stretch Circuit	7-30	Span Attenuator	7-56

TABLE OF CONTENTS (Cont.)

	Page		Page
Section 7 THEORY OF OPERATION (Cont.)		COUNTER BOARD	7-77
Center Frequency Control	7-56	Address Decoder	7-77
1st LO Driver	7-56	Service Request Circuits	7-77
Preselector Driver		Data Buffers	7-77
(Opt. 01 Only)	7-56	Input Amplifiers and	
SWEEP	7-56	Multiplexer	7-78
Digital Control	7-57	+2 ⁿ Counter	7-78
Sweep Generator	7-58	21-bit Counter	7-78
Trigger Circuits	7-58	PHASE LOCK SYNTHESIZER	7-78
Sweep Holdoff	7-60	Synthesizer	7-78
SPAN ATTENUATOR	7-60	Phase Lock	7-79
Digital Control	7-60	Offset Mixer	7-79
Input Section	7-60	Error Amplifier	7-80
Digital-to-Analog Converter	7-60	Controlled Oscillator	7-81
Decade Attenuator	7-62	Strobe Driver Circuit	7-81
1st LO DRIVER	7-62	DIGITAL CONTROL SECTION	7-83
Digital Control	7-63	Microcomputer	7-83
Input Switching	7-63	Processor	7-83
Oscillator Filter		Microprocessor	7-83
Switch Driver	7-63	Clock	7-87
Summing Amplifier	7-63	Microcomputer Bus	7-87
Oscillator Driver	7-64	Address Decoder	7-87
Reference Supply	7-64	Timer	7-87
Mixer Bias Driver	7-64	PIA and Instrument Bus	7-87
Programmable Bias	7-64	DMA Controller	7-87
PRESELECTOR DRIVER		Interrupt Processing	7-88
(Opt. 01 Only)	7-64	Memory	7-89
Digital Control Circuits	7-65	Address Decoders	7-89
Oscillator Voltage Processor ...	7-65	RAM	7-89
IF Offset	7-66	Options	7-90
Summing Amplifier	7-66	ROM	7-91
Tracking and		ROM Banks and GPIB	7-91
Shaper Circuits	7-66	Address Decoder	7-91
Current Driver	7-67	Bank Selector	7-91
Preselector Switch Driver	7-67	Bank ROMs	7-91
CENTER FREQUENCY		GPIB Switches	7-92
CONTROL	7-67	GPIA	7-92
Operating Modes	7-67	Accessories Interface	7-92
Digital Control	7-69	Front Panel	7-92
Storage Registers	7-70	Potentiometers	7-92
Digital-to-Analog		Output Mode Shift	
Converters	7-70	Registers and LEDs	7-93
Track-and-Hold Amplifier	7-70	Processor	7-93
Write-Back Circuit	7-71	Scanning the Keyboard	7-93
-10 V Reference Buffer	7-71	Scanning the FREQUENCY	
COUNTER and PHASE LOCK		Control Coder	7-94
SECTION	7-72	Outputting the	
FUNCTIONAL DESCRIPTION	7-72	Correct Code	7-94
Phase Lock Assembly	7-72	Software	7-94
Frequency Control	7-73	Main Scan Routine	7-94
Controlling the		Keyboard Check	
Oscillator Frequency	7-73	Subroutine	7-94
Counting the IF	7-73	Frequency Coder	
HARMONIC MIXER	7-73	Subroutine Check	7-95
AUXILIARY SYNTHESIZER	7-74	Output Subroutine	7-95

TABLE OF CONTENTS (Cont.)

	Page		Page
Section 7 THEORY OF OPERATION (Cont.)		Section 8 OPTIONS	
POWER SUPPLY	7-99	Options A1–A5 Power Cord Options	8-1
Line Input Circuits	7-99	Options M1–M5 Extended Service and Warranty Options	8-2
Inverter Circuit	7-99	Option 01 Internal Preselector	8-2
Multivibrator	7-100	Option 07 75Ω Input	8-3
Ramp Generator	7-100	Options 30 and 31	
Primary Regulator	7-100	Rackmount Options	8-5
Inverter Logic	7-100	Installation Requirements	8-5
Inverter Driver	7-101	Option 52 North American 220V	8-5
Output Stage	7-101		
Soft Start and Primary Over-Current Circuits	7-102	Appendix A GLOSSARY	
Rectifier-Filter Circuits (Secondary Section)	7-102	GENERAL TERMS	A-1
+5 V Voltage		FREQUENCY TERMS	A-1
Reference Supply	7-103	AMPLITUDE TERMS	A-2
Regulator Circuits	7-103	DIGITAL STORAGE TERMS	A-3
+5V Over-Voltage			
Protection Circuit	7-103		
Fan Drive Circuit	7-103		

VOLUME 2

Section 9	REPLACEABLE ELECTRICAL PARTS
Section 10	DIAGRAMS
Section 11	REPLACEABLE MECHANICAL PARTS

LIST OF ILLUSTRATIONS

Figure	Page	Figure	Page
	xiv	4-20	Test equipment setup for checking external triggering and horizontal input characteristics. 4-31
2-1	2-19	4-21	Test oscilloscope display of VERT output with a full screen display on the Spectrum Analyzer. 4-32
3-1	3-2		
4-1	4-4	5-1	Low voltage power supply adjustments. 5-4
4-2	4-5	5-2	Crt display adjustment and test point locations. 5-5
4-3	4-7	5-3	Adjustment and test point locations on High Voltage module. 5-6
4-4	4-8	5-4	Test equipment setup for adjusting the Deflection Amplifier. 5-7
4-5	4-9	5-5	Test points on the CRT Readout board. 5-7
4-6	4-10	5-6	Deflection Amplifier test points and adjustments. 5-8
4-7	4-11	5-7	Digital storage adjustment locations. 5-9
4-8	4-12	5-8	Test equipment setup for adjusting sweep timing. 5-9
4-9	4-13	5-9	Sweep board timing adjustment and test point locations. 5-10
4-10	4-14	5-10	Frequency control system test point and adjustment locations. 5-11
4-11	4-16	5-11	1st LO Driver board adjustment and test point locations. 5-12
4-12	4-17	5-12	1st Mixer adjustment location. 5-13
4-13	4-20	5-13	P3035 on the Video Processor board. 5-14
4-14	4-25	5-14	Test equipment setup for adjusting the Log Amplifier. 5-14
4-15	4-26	5-15	Log and Video Amplifier test point and adjustment locations. 5-15
4-16	4-26	5-16	Test equipment setup for adjusting the Variable Resolution module. 5-17
4-17	4-28	5-17	Adjustments on the front of the Variable Resolution module. 5-17
4-18	4-30	5-18	100 kHz filter response over 10 kHz filter response. 5-18
4-19	4-31	5-19	Adjustments on the rear of the Variable Resolution module. 5-19
		5-20	10 kHz, 100 kHz, and 1 MHz filter response. 5-20
		5-21	IF gain test setup, and adjustment and connector locations. 5-21
		5-22	Preselector Driver adjustment setup. 5-23
		5-23	Preselector Driver test point and adjustment locations. 5-24

LIST OF ILLUSTRATIONS (Cont.)

Figure	Page	Figure	Page
5-24	Test equipment setup for band leveling adjustment.	5-25	
5-25	Band leveling adjustment and gain diode locations.	5-25	
5-26	Test equipment setup for adjusting the Phase Lock assembly.	5-27	
5-27	Phase Lock assembly adjustment and test point locations.	5-28	
6-1	Surface-mounted component lead configurations.	6-17	
6-2	Diode polarity markings.	6-18	
6-3	Multipin (harmonica) connectors.	6-19	
6-4	Servicing the VR assembly.	6-20	
6-5	Top deck assemblies.	6-21	
6-6	RF deck assemblies.	6-22	
6-7	Removing the YIG oscillator interface board.	6-26	
6-8	Fan assembly mounting.	6-27	
6-9	110 MHz IF return loss adjustment setup.	6-28	
6-10	110 MHz IF test points and adjustments.	6-29	
6-11	2072 MHz Converter bias adjustments.	6-29	
6-12	829 MHz LO test points and connectors.	6-30	
6-13	829 MHz amplifier test jack and jumper.	6-31	
6-14	829 MHz filter test equipment setup.	6-32	
6-15	829 MHz Converter filter tune tabs.	6-33	
6-16	Correct response for 829 MHz first and second resonators.	6-33	
6-17	Correct response for 829 MHz third and fourth resonators.	6-34	
6-18	2182 MHz 2nd LO frequency accuracy test setup.	6-35	
6-19	2182 MHz Phase Locked 2nd LO adjustment setup.	6-37	
6-20	16—20 MHz Phase Lock circuit test points and component locations.	6-38	
6-21	829 MHz Converter oscillator adjustment and test point locations.	6-38	
6-22	Coaxial test probe construction details.	6-39	
6-23	2182 MHz 2nd MHz Phase Lock adjustment setup.	6-40	
6-24	Tune and Sweep Range adjustments.	6-42	
6-25	3rd Converter test points and adjustments.	6-44	
6-26	Options switch on the Memory board.	6-46	
6-27	A15 through A12 in microcomputer test mode.	6-48	
6-28	Four main block select outputs of address decoder U2045.	6-48	
6-29	RAM select output in relation to 0XXX.	6-48	
6-30	I/O and S1050 select lines in relation to 0XXX.	6-49	
6-31	Chip selects Y0, Y1, Y5, and Y7 in relation to I/O.	6-49	
6-32	Chip selects Y2, Y4, and Y6 in relation to I/O.	6-49	
6-33	Instrument bus check.	6-50	
7-1	Cross section of a four-cavity filter.	7-7	
7-2	Equivalent circuit of the four-cavity filter.	7-8	
7-3	Simplified diplexer diagram.	7-12	
7-4	Equivalent ac circuit of an 829 MHz amplifier.	7-13	
7-5	Equivalent dc circuit of an 829 MHz amplifier.	7-13	
7-6	Block diagram of the phase lock loop in the 829 MHz 2nd Converter.	7-15	
7-7	Bridged "T" attenuator equivalent circuit.	7-18	
7-8	Block diagram of a three stage log amplifier.	7-27	
7-9	Log amplifier gain curve showing break points.	7-27	
7-10	Curve showing end-of-range for a log amplifier.	7-27	
7-11	Simplified detector circuit.	7-28	
7-12	Selection of display position on the log scale.	7-30	
7-13	Functional diagram showing the spectrum analyzer and 1405 TV Sideband Adapter system.	7-32	
7-14	Simplified diagram of video filter.	7-34	
7-15	Vertical control IC block diagram.	7-37	
7-16	Horizontal control IC block diagram.	7-41	
7-17	Block diagram of crt readout.	7-48	
7-18	Character on/off timing.	7-49	
7-19	Character scan.	7-50	

LIST OF ILLUSTRATIONS (Cont.)

Figure	Page	Figure	Page
7-20	Character generator block diagram.	7-30	System memory map.
	7-51	7-31	I/O address space.
7-21	Character timing diagram.	7-32	PIA and Timer address map.
7-22	Frequency dot marker simplified diagram with timing waveforms.	7-33	Options switch bank on the Memory board.
7-23	Simplified digital-to-analog converter.	7-34	Primary regulator input/output waveforms.
7-24	Simplified span decade attenuator.	7-35	Timing waveforms for soft-start circuit.
7-25	DAC variance graph.		
7-26	Simplified tune voltage converter.	8-1	Power cord options.
7-27	Simplified schematic of harmonic mixer.		
7-28	Block diagram of a basic synthesizer.		
7-29	Basic block diagram of a +N synthesizer with a variable modulus prescaler.		
	7-75		

LIST OF TABLES

Table	Page	Table	Page	
2-1	FREQUENCY RELATED CHARACTERISTICS	2-1	6-12	
2-2	AMPLITUDE RELATED CHARACTERISTICS	2-7	7-1	
2-3	INPUT SIGNAL CHARACTERISTICS	2-12	7-2	
2-4	OUTPUT SIGNAL CHARACTERISTICS	2-15	7-3	
2-5	GENERAL CHARACTERISTICS	2-16	7-4	
2-6	POWER REQUIREMENTS	2-17	7-5	
2-7	ENVIRONMENTAL CHARACTERISTICS	2-18	7-6	
2-8	PHYSICAL CHARACTERISTICS	2-19	7-7	
4-1	EQUIPMENT REQUIRED	4-2	7-8	
4-2	CENTER FREQUENCY ACCURACY CHECK POINTS	4-7	7-9	
4-3	SPAN/DIV VERSUS TIME MARKERS FOR SPAN/DIV ACCURACY CHECK	4-10	7-10	
4-4	FREQUENCY RESPONSE CHECK SETTINGS	4-15	7-11	
4-5	FREQUENCY RESPONSE CHECK SETTINGS FOR BANDS 3—5	4-15	7-12	
4-6	0 TO 30 dB RF ATTENUATOR TEST SETTINGS	4-20	7-13	
4-7	30 TO 60 dB RF ATTENUATOR TEST SETTING	4-22	7-14	
4-8	CORRECTION FACTOR TO DETERMINE TRUE SIGNAL LEVEL	4-22	7-15	
4-9	SENSITIVITY	4-24	7-16	
5-1	EQUIPMENT REQUIRED	5-2	7-17	
5-2	POWER SUPPLY TOLERANCES	5-3	7-18	
6-1	RELATIVE SUSCEPTIBILITY TO STATIC DISCHARGE DAMAGE	6-2	7-19	
6-2	SERVICE KITS AND TOOLS	6-4	7-20	
6-3	POWER SUPPLY RANGES	6-9	7-21	
6-4	SELECTED COMPONENTS	6-17	7-22	
6-5	EQUIPMENT REQUIRED FOR RETURN LOSS ADJUSTMENT	6-28	7-23	
6-6	EQUIPMENT REQUIRED FOR 2nd LO CALIBRATION	6-35	7-24	
6-7	EQUIPMENT REQUIRED FOR CALIBRATING THE 16-20 MHz PHASE LOCK CIRCUIT	6-40	8-1	
6-8	RAM TEST	6-46	8-2	
6-9	ROM TEST	6-47	8-3	
6-10	INSTRUMENT BUS REGISTERS	6-53	8-4	
6-11	AUXILIARY SYNTHESIZER VALUES AS A FUNCTION OF N AND A	6-58	8-5	
			8-6	
			FRONT-PANEL REGISTERS	6-60
			2ND CONVERTER IF SELECTION SWITCH AND AMPLIFIER SELECTION	7-6
			BANDWIDTH SELECTION	7-14
			GAIN STEP COMBINATIONS	7-22
			PROGRESSION OF GAIN REDUCTION	7-24
			FILTER COMPONENT COMBINATIONS	7-26
			RF INTERFACE LINES	7-34
			U2039 TRUTH TABLE	7-45
			CONTROL PORT	7-45
			ADDRESS/DATA PORT	7-53
			SWEEP RATE SELECTION CODES	7-53
			TRIGGER SELECTION MODES	7-57
			SWEEP HOLDOFF SELECTION	7-58
			CALIBRATION CONTROL SELECTION CODES	7-58
			ATTENUATION SELECTION CODES	7-62
			U4017 OUTPUT LINES	7-62
			U5031 OUTPUT LINES	7-63
			PRESELECTOR FREQUENCY BANDS	7-65
			ADDRESS 70 FORMATS	7-66
			DAC TUNING CODES	7-70
			U2025 OUTPUT LINES	7-71
			POLL BITS	7-80
			ROM SELECTION DATA	7-88
			FRONT PANEL SWITCH MATRIX CODE/FUNCTION TABLE	7-91
				7-96
			EXTENDED SERVICE AND WARRANTY OPTIONS	8-2
			OPTION 01 ALTERNATE SPECIFICATIONS	8-2
			OPTION 07 ALTERNATE SPECIFICATIONS	8-2
			OPTIONS 21 AND 22 (WAVEGUIDE MIXERS) CHARACTERISTICS	8-4
			OPTION 42 ELECTRICAL CHARACTERISTICS	8-5
				8-6

SAFETY SUMMARY

FOR QUALIFIED SERVICE PERSONNEL ONLY

Do Not Service Alone

Do not perform internal service or adjustment of this product unless another person capable of rendering first aid and resuscitation is present.

Do Not Wear Jewelry

Remove jewelry prior to servicing. Rings, necklaces, and other metallic objects could come into contact with dangerous voltages and currents.

Use Care When Servicing With Power On

Dangerous voltages exist at several points in this product. To avoid personal injury, do not touch exposed connections and components while power is on.

Disconnect power before removing protective panels, soldering, or replacing components.

Power Source

This product is intended to operate from a power source that will not apply more than 250 volts rms between the supply conductor and ground. A protective ground connection by way of the grounding conductor in the power cord is essential for safe operation.

X-Radiation

X-ray emission generated within this instrument has been sufficiently shielded. Do not modify or otherwise alter the high voltage circuitry or the crt enclosure.

TERMS

In This Manual

CAUTION statements identify conditions or practices that could result in damage to the equipment or other property.

WARNING statements identify conditions or practices that could result in personal injury or loss of life.

As Marked on Equipment

CAUTION indicates a personal injury hazard not immediately accessible as one reads the marking, or a hazard to property including the equipment itself.

DANGER indicates a personal injury hazard immediately accessible as one reads the marking.

SYMBOLS

In This Manual



This symbol indicates where applicable cautionary or other information is to be found.

As Marked on Equipment



DANGER — High Voltage.



Protective ground (earth) terminal.



ATTENTION — Refer to manual.



Refer to manual.

Grounding the Product

This product is grounded through the grounding conductor of the power cord. To avoid electrical shock, plug the power cord into a properly wired receptacle before connecting to the product input or output terminals. A protective ground connection by way of the grounding conductor in the power cord is essential for safe operation.

Danger Arising From Loss of Ground

Upon loss of the protective ground connection, all accessible conductive parts (including knobs and controls that may appear to be insulating) can render an electric shock.

Use the Proper Power Cord

Use only the power cord and connector specified for your product.

Use only a power cord that is in good condition.

For detailed information on power cords and connectors see Section 1.

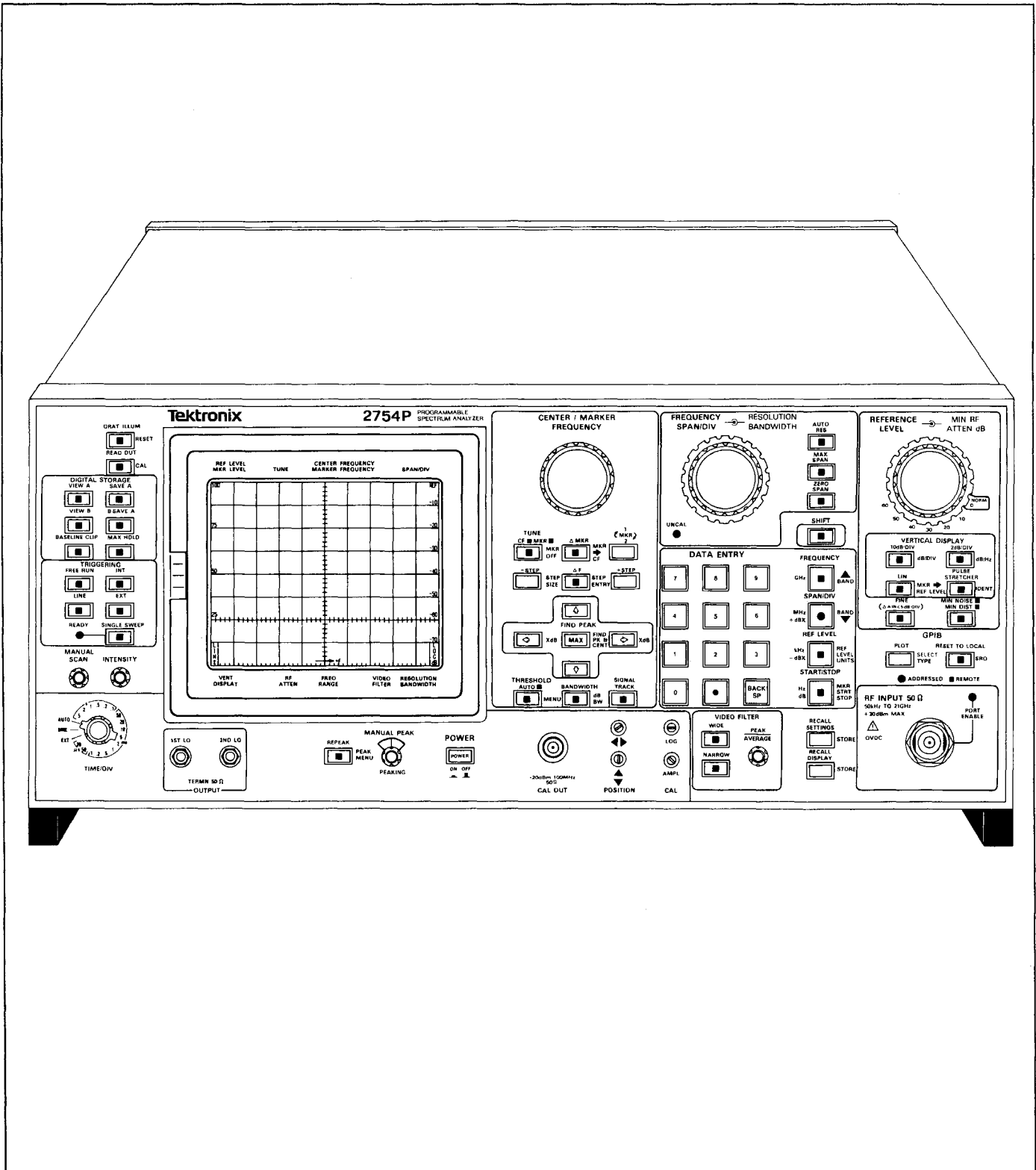

The 2754P Spectrum Analyzer.

GENERAL INFORMATION

Product Description

The 2754 and 2754P (programmable) instruments are high performance, benchtop spectrum analyzers. Microcomputer control of most functions simplifies and enhances operation.

The analyzers feature:

- single and delta marker modes
- synthesizer frequency accuracy
- precise amplitude measurement
- digital storage display
- battery-operated memory for front-panel settings and displays
- diagnostic crt messages
- keypad entry and menu selections

The frequency range is 50 kHz to 21 GHz. Resolution bandwidth is 1 kHz to 1 MHz. Digital storage provides flicker-free displays plus functions to compare and subtract displays, and save maximum values. In addition, up to nine separate displays with their readouts can be stored in battery-powered non-volatile memory, then later recalled for additional analysis and comparison. Up to ten different front-panel control setups can also be stored for future recall.

Select center frequency either by the front-panel tuning knob or by the Data Entry keypad. When using the keypad, it is not necessary to alter the Span/Div setting regardless of the frequency selected. Other parameters, such as vertical display and reference level, are also keypad selectable.

Marker functions provide direct readout of frequency and amplitude at any point along any displayed trace. Relative (delta) frequency and amplitude information between any two points along any displayed trace is also available. The tuning knob moves the markers, and it can also move the display with a stationary frequency marker. It is possible to fix the marker to a position on the display and use the knob to move both the spectrum and the marker at the same time. Refer to Using the Markers Feature in Section 6 of the Operators Manual.

The programmable (P) version of the instrument adds remote control capabilities to the manual instrument features. The front-panel controls (except those intended exclusively for local use, such as INTENSITY)

can be remotely operated through the GPIB port. This allows the spectrum analyzer to be used with a variety of systems and controllers. Refer to the Programmers Manual for additional information.

Conformance to Industry Standards

This spectrum analyzer complies with the following Industry Safety Standards and Regulatory Requirements:

Safety

CSA — Electrical Bulletin

FM — Electrical Utilization Standard Class 3820

ANSI C39.5 — Safety Requirements for Electrical and Electronic Measuring and Controlling Instrumentation.

IEC 348 (2nd edition) — Safety Requirements for Electronic Measuring Apparatus.

Regulatory

VDE 0871 Class B — Regulations for RFI Suppression of High Frequency Apparatus and Installations.

Product Service

To assure adequate product service and maintenance for our instruments, Tektronix has established Field Offices and Service Centers at strategic points throughout the United States and in countries where our products are sold. Several types of maintenance or repair agreements are available.

For example, for a fixed fee, a maintenance agreement program provides maintenance and recalibration on a regular basis. Tektronix will remind you when a product is due for recalibration and perform the service within a specified time.

Tektronix emergency repair service provides immediate service when the instrument is urgently needed.

Contact your local Tektronix Service Center, representative, or sales engineer for details regarding product service.

Instrument Construction

Modular construction provides ready access to the major circuits. Circuit boards containing sensitive circuits are either mounted on metal castings, each of which provides shielding between adjacent modules, or they are mounted within honeycomb-like castings, with feedthrough connectors through the compartment wall. All boards and assemblies plug onto a common interconnect board. Most adjustments and test points are accessible while the instrument is operational and with the modules or assemblies secured in their normal position.

Extenders are available in an optional Service Kit (see Maintenance section under Service Fixtures and Tools for Maintenance). Any module or board can be removed without disturbing the structural or functional integrity of the other modules. The extenders allow most circuit board assemblies to function in an extended position for service or adjustment. The circuit boards mounted on the metal casting can be removed by removing the securing screws. All other circuit boards (which should require minimal service) are accessible by removing a cover plate over the assembly or module.

NOTE

Disassembly of some modules may require special tools and procedures. These procedures are located in the Maintenance section.

Circuits are isolated in shielded compartments to obtain and maintain the frequency stability, sensitivity, and EMI characteristics. While shielding helps ensure spurious-free response, the closeness of the circuits minimizes losses and interactions with other functions. Compartments are enclosed on both sides by metal plates and interconnections between compartments are made by feedthrough terminals rather than cables. If the compartments are opened, be sure that the shields and covers are properly reinstalled before operating.

Installation and Preparation for Use

The Installation section of the manual provides unpacking information and the procedures to prepare the instrument for use. It also includes repackaging information.

Changing Power Input Range

The procedure for changing the input voltage range is described in the Installation section. Details on how to change the line fuse are also given.

The power cord that is supplied with the instrument and the instrument power voltage requirements depend on the available power source (see Specification section). Power cord options are described in the Options section.

Replacing Fuses

Refer to the Installation section for line fuse replacement and the Maintenance section for replacing the power supply fuses.

Selected Components

Some components are selected, matched, or pre-conditioned to meet Tektronix specifications. These components are shown in the parts list and may carry a Tektronix Part Number under the Mfr. Part Number column.

Selected value components are identified on the circuit diagram and in the parts list as a "SEL" value. The component description lists either the nominal value or a range of values. Selection criteria is included in the Maintenance section. Selection procedures are included in the Adjustment Procedure or Maintenance sections of the manual as needed.

Assembly and Circuit Numbering

Each assembly and subassembly are assigned assembly numbers. Generally, each component is assigned a circuit number according to its geographic location within an assembly. The Replaceable Electrical Parts list prefixes these circuit numbers with the corresponding assembly and subassembly numbers.

EXAMPLE: R2080 on assembly A20 becomes A20R2080.

EXAMPLE: U1044 on subassembly A1 of assembly A36 is found in the electrical parts list as A36A1U1044.

Power-up Messages

During the power-up cycle, the firmware version appears on the screen for a short time. Also, when a diagnostic routine fails, a message comes on screen describing the error and what can be done to bypass the problem if it can not be immediately corrected.

Options

The Options section of this manual contains detailed information on all the options currently available for the spectrum analyzer.

Accessories

The Replaceable Mechanical Parts list in the Service Manual, Volume 2, contains the part numbers, descriptions, and ordering information for all standard and optional accessories offered for the spectrum analyzer at this time.

The following list includes all standard accessories currently shipped with each instrument.

- 72 inch, 50 Ω coaxial cable (n to n connector)
- 18 inch, 50 Ω coaxial cable (bnc to bnc connector)
- Adapter (n male to bnc female)
- 4A fast-blow fuse (2 each)¹
- Power cord
- Cord clamp
- Amber crt light filter
- Grey crt light filter
- Crt mesh filter
- Operators Manual
- Service Manual, Volume 1
- Service Manual, Volume 2
- Programmers Manual (2754P Only)

¹If the instrument is wired for 220-240 V operation (Options A1, A2, A3, A4, A5) or if Option 52 is installed (North American configuration for 230 V with standard power cord), 2A slow-blow fuses are used.

SPECIFICATION

This section includes the electrical, physical, and environmental characteristics of this instrument. Any instrument specification changes due to options are listed in the Options section of this manual.

ELECTRICAL CHARACTERISTICS

The following tables of electrical characteristics and features apply to the spectrum analyzer after a 30-minute warm up and after doing the front-panel CAL adjustments, except as noted. The Performance Requirement column defines some characteristics in quantitative terms and in limit form. The Supplemental Information column explains performance requirements or provides performance information. Statements in this column are not considered to be guaranteed performance and are not ordinarily supported by a performance check procedure. Procedures to verify performance requirements are provided in the Performance Check portion of his manual.

The instrument performs an internal calibration check each time power is turned on. This check verifies that the instrument frequency and amplitude performance is as specified. An Instrument Check Out procedure, which does not require external test equipment or technical expertise, is provided in Section 4. This procedure will satisfy most incoming inspections and will help familiarize you with the instrument capabilities.

Verification of Tolerance Values

Perform compliance tests of specified limits, listed in the Performance Requirement column, only after a 30-minute warm-up time (except as noted) and after a doing the front-panel CAL procedure. Use measurement instruments that do not affect the values measured. Measurement tolerance of test equipment should be negligible when compared to the specified tolerance. If the tolerance is not negligible, add the error of the measuring device to the specified tolerance.

Table 2-1
FREQUENCY RELATED CHARACTERISTICS

Characteristic	Performance Requirement	Supplemental Information
Center Frequency Range Internal Mixer		50 kHz–21 GHz Tuned by the CENTER/MARKER FREQUENCY control or the DATA ENTRY pushbuttons
Accuracy (after front-panel CAL has been performed)		Center Frequency Accuracy is specified by two characteristics: <ul style="list-style-type: none"> ● initial accuracy ● center frequency drift during the sweep
Initial (start of sweep) Bands 1 & 5 with SPAN/DIV > 200 kHz, and Bands 2–4 with SPAN/DIV > 100 kHz (1st LO unlocked)	$\pm \{20\%D + (CF \times 10^{-5})\}^a + 15N \text{ kHz}$ Where: D = SPAN/DIV or RESOLUTION BANDWIDTH, whichever is greater CF = Center Frequency N = Harmonic Number	Refer to IF, LO Range, and Harmonic Number specification later in this table for the N value Allow a settling time of one second for each GHz change in CF within a band. In bands 4 & 5, divide the CF change by N.

^aOver the operating temperature range this term is $(CF \times 1.5 \times 10^{-5})$

Table 2-1 (Continued)
 FREQUENCY RELATED CHARACTERISTICS

Characteristic	Performance Requirement	Supplemental Information
Initial Accuracy (Continued) Bands 1 & 5 with SPAN/DIV ≤200 kHz, and Bands 2-4 with SPAN/DIV ≤100 kHz (1st LO locked)	$\pm \{(20\%D) + (CF \times 10^{-5})\}^a$ Hz Where: D = SPAN/DIV or RESOLUTION BANDWIDTH, whichever is greater CF = Center Frequency	
Drift After 30 minute warm up Bands 1 & 5 with SPAN/DIV >200 kHz, and Bands 2-4 with SPAN/DIV >100 kHz (1st LO unlocked)		With constant ambient temperature and fixed center frequency (any error is observed during sweep time) $\leq (25 \text{ kHz})N$ per minute of sweep time
Bands 1 & 5 with SPAN/DIV ≤200 kHz, and Bands 2-4 with SPAN/DIV ≤100 kHz (1st LO locked)		≤ 150 Hz per minute of sweep time
After 1 hour warm up Bands 1 & 5 with SPAN/DIV >200 kHz, and Bands 2-4 with SPAN/DIV >100 kHz (1st LO unlocked)		$\leq (5 \text{ kHz})N$ per minute of sweep time
Bands 1 & 5 with SPAN/DIV ≤200 kHz, and Bands 2-4 with SPAN/DIV ≤100 kHz (1st LO locked)		≤ 50 Hz per minute of sweep time

^aOver the operating temperature range this term is $(CF \times 1.5 \times 10^{-5})$.

Table 2-1 (Continued)
 FREQUENCY RELATED CHARACTERISTICS

Characteristic	Performance Requirement	Supplemental Information
Readout Resolution		≤ 10% of SPAN/DIV to minimum of 1 kHz. 100 Hz in delta mode.
Residual FM		Short term, after 1 hour warm up
Bands 1 & 5 with SPAN/DIV > 200 kHz, and Bands 2-4 with SPAN/DIV > 100 kHz (1st LO unlocked)	≤(7 kHz)N total excursion in 20 ms	
Bands 1 & 5 with SPAN/DIV ≤ 200 kHz, and bands 2-4 with SPAN/DIV ≤ 100 kHz (1st LO locked)	≤(10+2N)Hz total excursion in 20 ms	
Resolution Bandwidth (6 dB down)	Within 20% of selected bandwidth	1 kHz-1 MHz in decade steps
Shape Factor (60 dB/6 dB)	7.5:1 or less	
Noise Sidebands	At least -75 dBc at an offset of 30× resolution bandwidth	
Video Filter Narrow		Reduces video bandwidth to approximately 1/300th of the selected resolution bandwidth.
Wide		Reduces video bandwidth to approximately 1/30th of the selected resolution bandwidth.
Pulse Stretcher Fall Time		30 μs per vertical division (+50%).

Table 2-1 (Continued)
FREQUENCY RELATED CHARACTERISTICS

Characteristic	Performance Requirement	Supplemental Information	
Frequency Span/Div Overall Range			
With SPAN/DIV control		200 Hz–1 GHz (in a 1-2-5 sequence)	
With the DATA ENTRY push-buttons		200 Hz–1.2 GHz (to two significant digits)	
Minimum Span/Div		200 Hz in all bands	
Maximum Span/Div		With SPAN/DIV Control	With DATA ENTRY Pushbuttons
Band 1 (50 kHz–4.2 GHz) ^a		200 MHz	410 MHz ^a
Band 2 (1.7–5.5 GHz)		200 MHz	370 MHz
Band 3 (3–7.1 GHz)		200 MHz	400 MHz
Band 4 (5.4–18 GHz)		1 GHz	1.2 GHz
Band 5 (15–21 GHz)		500 MHz	590 MHz
		In addition, MAX SPAN sweeps across an entire band and ZERO SPAN provides a 0 Hz display.	
Accuracy/Linearity	Within 5% of the selected span/div	Measured over the center 8 divisions	

^aFor Option 01 instruments, band 1 is 50 kHz–1.8 GHz, and the Span/Div range with the SPAN/DIV control is 100 MHz and with the DATA ENTRY pushbuttons is 170 MHz.

Table 2-1 (Continued)
FREQUENCY RELATED CHARACTERISTICS

Characteristic	Performance Requirement		Supplemental Information
Frequency Response			Measured with 10 dB RF attenuation and peaking optimized for each center frequency setting (when applicable) Response is affected by: <ul style="list-style-type: none"> ● input VSWR ● harmonic number (N) ● gain variation ● mixer ● preselector (Opt 01) Digital storage typically increases errors by $\pm 0.5\%$. Display flatness is typically 1 db greater than frequency response.
Coaxial (direct) Input	About the mid-point between two extremes	Referenced to 100 MHz	Refer to the Options section of this manual for variations in this specification.
Band and Freq Range 1 (50 kHz–4.2 GHz) ^a 2 (1.7–5.5 GHz) 3 (3.0–7.1 GHz) 4 (5.4–18.0 GHz) 5 (15.0–21.0 GHz)	± 1.5 dB ± 1.5 dB ± 1.5 dB ± 2.5 dB ± 3.5 dB	± 2.5 dB ± 2.5 dB ± 3.5 dB ± 5.0 dB	

^aFor Option 01 Instruments, band 1 is 50 kHz–1.8 GHz.

Table 2-1 (Continued)
 FREQUENCY RELATED CHARACTERISTICS

Characteristic	Performance Requirement	Supplemental Information		
IF Frequency, LO Range, and Harmonic Number (N) Band and Freq Range 1 (50 kHz–4.2 GHz) ^a 2 (1.7–5.5 GHz) 3 (3.0–7.1 GHz) 4 (5.4–18 GHz) 5 (15–21 GHz)		1st IF (MHz)	(N)	LO Range (MHz)
		2072	1 –	2072–6272
		829	1 –	2529–6329
		829	1 +	2171–6271
		829	3 –	2072–6276
		2072	3 +	4309–6309
Marker(s)		When activated, the marker is a bright dot positioned by the CENTER/MARKER FREQUENCY control or the DATA ENTRY pushbuttons.		
Normal Accuracy	Identical to center frequency accuracy	For the live trace		
Δ MKR Accuracy	1% of total span	For the live trace. ΔMKR activates a second marker at the position of the single marker on the trace. Parenthesis appear on the marker display line indicating that the delta mode is active. The display shows the difference in frequency and amplitude. 1←MKR→2 selects which marker is tuned.		

^aFor Option 01 instruments, band 1 is 50 kHz–1.8 GHz, and the LO Range is 2072–3872.

Table 2-2
AMPLITUDE RELATED CHARACTERISTICS

Characteristic	Performance Requirement	Supplemental Information
Vertical Display Modes		10 dB/Div, 2 dB/Div, and Linear — any integer between 1–15 dB/Div can also be selected with the DATA ENTRY pushbuttons.
Display Dynamic Range		80 dB maximum (Log Mode) 8 divisions (Linear Mode)
Display Dynamic Accuracy 10 dB/div Log Mode	± 1.0 dB/10 dB to a maximum cumulative error of ± 2.0 dB over 80 dB range	
2 dB/div Log Mode	± 0.4 dB/2.0 dB to a maximum cumulative error of ± 1.0 dB over 16 dB range	
Linear Mode	$\pm 5\%$ of full scale	
Reference Level Range Log Mode		Top of the graticule. From -117 dBm to $+40$ dBm; $+40$ dBm includes 10 dB of IF gain reduction ($+30$ dBm is the maximum safe input). Alternate reference levels are: <ul style="list-style-type: none"> ● dBV (-130 dBV to $+27$ dBV) ● dBmV (-70 dBmV to $+87$ dBmV) ● dBμV (-10 dBμV to $+147$ dBμV)
Linear Mode		39.6 nV/Div–2.8 V/Div (1W maximum safe input)
Steps 10 dB/div Log Mode		10 dB for the Coarse Mode 1 dB for the Fine Mode
2 dB/div Log Mode		1 dB for the Coarse Mode 0.25 dB for the Fine Mode
Linear Mode		1-2-5 sequence for Coarse Mode 1 dB equivalent steps for Fine Mode
Set with DATA ENTRY push-buttons		Steps correspond to the display mode in coarse; except, for 2 dB when the steps are 1 dB. In Fine Mode: 1 dB when the mode is 5 dB/div or more 0.25 dB for display modes of 4 dB/div or less (referred to as Delta A Mode)

Table 2-2 (Continued)
AMPLITUDE RELATED CHARACTERISTICS

Characteristic	Performance Requirement	Supplemental Information
Reference Level (Continued) Accuracy		Dependent on the following characteristics: <ul style="list-style-type: none"> ●RF Attenuation Accuracy ●IF Gain Accuracy ●Resolution Bandwidth ●Display Mode ●Calibrator Accuracy ●Frequency Band ●Frequency Response ●<SHIFT> CAL routine reduces error between resolution bandwidths at -20 dBm REF LEVEL. Other reference levels may have larger errors. ●Ambient Temperature Change (±0.15 dB/°C maximum)
RF Attenuator Range		0-60 dB in 10 dB steps
Accuracy Dc-1.8 GHz	Within 0.5 dB/10 dB to a maximum of 1 dB over the 60 dB range	
1.8 GHz-18 GHz	Within 1.5 dB/10 dB to a maximum of 3 dB over the 60 dB range	
18 GHz-21 GHz	Within 3.0 dB/10 dB to a maximum of 6 dB over the 60 dB range	
Marker(s)		When activated, the marker is a bright dot positioned by the CENTER/MARKER FREQUENCY control.
Accuracy (Normal or Delta Mode)		Identical to REF LEVEL accuracy plus cumulative error of display scale (dependent on vertical position) ΔMKR activates a second marker at the position of the single marker on the trace. Parenthesis appear on the marker display line indicating that the delta mode is active. The display shows the difference in frequency and amplitude. 1←MKR→2 selects which marker is tuned.

Table 2-2 (Continued)
AMPLITUDE RELATED CHARACTERISTICS

Characteristic	Performance Requirement	Supplemental Information
Gain Variation Between Resolution Bandwidths		Measurement conditions: <ul style="list-style-type: none"> ●measured at -20 dBm ●Minimum Distortion Mode ●at 25°C ambient temperature ●after front-panel CAL adjustments
With respect to 1 MHz Filter	±0.4 dB	
Between Any Two Filters	0.8 dB	
IF Gain Range		87 dB of gain increase, 10 dB of gain decrease (MIN NOISE activated), in 10 dB and 1 dB steps
Accuracy 1 dB Step	At least 0.2 dB/dB step to 0.5 dB/9 dB steps except at the decade transitions	
Decade Transitions -29 to -30 dBm -39 to -40 dBm -49 to -50 dBm -59 to -60 dBm	0.5 dB or less	Maximum 1 dB cumulative error over 10 dB, measured in MIN NOISE mode.
Maximum Deviation over the 97 dB Range	±2 dB	

Table 2-2 (Continued)
AMPLITUDE RELATED CHARACTERISTICS

Characteristic	Performance Requirement	Supplemental Information		
Differential Amplitude Measurement		Delta A Mode provides differential measurements in 0.25 dB increments. (This is not related to the Delta Marker Mode.)		
Range		0 dB above to 48 dB below the reference level established when the Delta A Mode was activated. DO NOT USE Delta A Mode outside the -117 dBm to +30 dBm reference level range.		
Accuracy		Difference	Steps	Error
		0.25 dB	1	0.15 dB
		2 dB	8	0.4 dB
		10 dB	40	1.0 dB
		48 dB	192	2.0 dB
Spurious Responses Residual	-100 dBm or less	No input signal, referenced to the internal mixer input, and fundamental mixing for Bands 1-3.		
3rd Order Intermodulation Products 50 kHz-21 GHz (Bands 1-5)	-70 dBc or less from any two on-screen signals within any frequency span.	Refer to Option 01 in the Options section for alternate specification. In Minimum Distortion Mode.		
Harmonic Distortion 50 kHz-21 GHz (Bands 1-5)	-60 dBc or less	Measured at -40 dBm input level in Minimum Distortion Mode.		
LO Emission	Less than -10 dBm to 21 GHz	With 0 dB RF Attenuation		

Table 2-2 (Continued)
AMPLITUDE RELATED CHARACTERISTICS

Characteristic	Performance Requirement					Supplemental Information
Sensitivity	Equivalent Input Noise in dBm versus Resolution Bandwidth					Equivalent maximum input noise without internal preselection for each resolution bandwidth for frequency bands 1-5 (50 kHz-21 GHz). The NARROW Video Filter is activated for resolution bandwidths of 1 kHz or less and the WIDE Video Filter for resolution bandwidths above 1 kHz. (See Options 01 and 07 in the Options section for alternate specifications.)
Band and Frequency Range	1 kHz	10 kHz	100 kHz ^a	300 kHz ^a	1 MHz	
1 ^b (50 kHz-4.2 GHz)	-115	-105	-95	-90	-85	
2 & 3 (1.7-7.1 GHz)	-115	-105	-95	-90	-85	
4 (lower part) (5.4-12.0 GHz)	-100	-90	-80	-75	-70	
4 (upper part) (12.0-18.0 GHz)	-95	-85	-75	-70	-65	
5 (15.0-21.0 GHz)	-95	-85	-75	-70	-65	

^a Option 07 replaces the 100 kHz filter with a 300 kHz filter.

^bFor Option 01 instruments, band 1 is 50 kHz-1.8 GHz.

Table 2-3
INPUT SIGNAL CHARACTERISTICS

Characteristic	Performance Requirement	Supplemental Information
RF INPUT		Type N female connector, specified to 21 GHz. (See Option 07 in the Options section for supplemental specifications concerning an additional 75 Ω input.)
Impedance		50 Ω
VSWR with 10 dB or more RF Attenuation 50 kHz–2.5 GHz		1.3:1 (typically 1.2:1)
2.5–6.0 GHz		1.7:1 (typically 1.5:1)
6.0–18 GHz		2.3:1 (typically 1.9:1)
18–21 GHz		3.5:1 (typically 2.7:1)
VSWR with 0 dB RF Attenuation 50 kHz–2.5 GHz		Standard measured within 3 MHz of center of preselector band for Option 01 (does not apply in Band 1). Typically 1.9:1
2.5–6.0 GHz		Typically 1.9:1
6.0–18 GHz		Typically 2.3:1
18–21 GHz		Typically 3.0:1
Maximum Safe Input (With 0 dB RF attenuation)		+13 dBm (Input Mixer Limit) 1 W with 20 dB attenuation
1 dB Compression Point (Minimum) Bands 1–5 (50 kHz–21 GHz)	-20 dBm	With no RF attenuation, in Min Distortion mode.
Optimum RF Input Level for Linear Operation		-30 dBm, referenced to the input mixer This is achieved in Minimum Distortion mode when not exceeding full screen display.

Table 2-3 (Continued)
INPUT SIGNAL CHARACTERISTICS

Characteristic	Performance Requirement	Supplemental Information
HORIZ/TRIG (Rear Panel)		Dc coupled input for external horizontal drive (selected by the EXT position of the front-panel TIME/DIV control) and ac coupled input for external trigger signals (selected at other positions of the TIME/DIV control).
Sweep Input Voltage Range		0 to +10V (dc + peak ac) for full screen deflection
Trigger Input Voltage Range Minimum	At least 1.0V peak from 15 Hz-1 MHz	
Maximum dc + peak ac		50V
ac		$30V_{rms}$ -10 kHz, then derate linearly to $3.5V_{rms}$ at 100 kHz and above.
Pulse Width		0.1 μ s minimum
MARKER/VIDEO (Rear Panel)		External Video input or External Video Marker input, switched by pin 1 of the J104 ACCESSORIES connector.
Marker Input Level		0 to -10V Interfaces with Tektronix 1405 Sideband Adapter.
Video Input Level		0 to +4V for full screen display with pin 1 of the ACCESSORIES connector low.
J104 ACCESSORY (Rear Panel)		25-pin connector (Not RS-232 compatible) Provides bi-directional access to the instrument bus. Also provides external Video select and external preselector drive. Except for the external preselector drive output, all lines are TTL compatible. Maximum voltage on all lines is $\pm 15V$.
Pin 1		External Video Select Low selects External Video Input. High (default) selects Video Marker Input.
Pin 2		External Preselector — Drive signal for an external preselector. Output voltage is proportional to frequency (only Option 01 and in bands 2-5).
Pin 3		External Preselector Return — Ground return for the External Preselector signal.

**Table 2-3 (Continued)
INPUT SIGNAL CHARACTERISTICS**

Characteristic	Performance Requirement	Supplemental Information
J104 ACCESSORY (Continued) Pin 4		Internal Control. High (default) selects internal control. Instrument bus lines are output at the J104 ACCESSORIES connector. Low selects External control. Instrument bus lines at the J104 ACCESSORIES connector accept input from an external controller.
Pin 5		Chassis Ground
Pins 6-13 ^a		Instrument Bus Address lines 7-0 ^a
Pin 14 ^a		Instrument Bus Data Valid signal ^a
Pin 15 ^a		Instrument Bus Service Request signal ^a
Pin 16 ^a		Instrument Bus Poll signal ^a
Pin 17		Data Bus Enable input signal for external controller. High (unasserted) disables external data bus. Low enables external data bus.
Pins 18-25		Instrument Bus Data lines 0-7 Active when external Data Bus Enable (pin 17) is low.

^aOutput when internally controlled (pin 4 high) and input when externally controlled (pin 4 low).

**Table 2-4
OUTPUT SIGNAL CHARACTERISTICS**

Characteristic	Performance Requirement	Supplemental Information
Calibrator (CAL OUT)	-20 dBm \pm 0.3 dB at 100 MHz \pm 10 ppm ^a	100 MHz comb of markers provide amplitude calibration at 100 MHz and markers for frequency and span calibration to 1.0 GHz.
1st LO and 2nd LO OUTPUTs		Provide access to the output of the respective local oscillators. THESE PORTS MUST BE TERMINATED IN 50 Ω AT ALL TIMES.
1st LO OUTPUT Power		+7.5 dBm to +15 dBm
2nd LO OUTPUT Power		-22 dBm to 0 dBm.
VERT (OUTPUT) (Rear Panel)		Provides 0.5V \pm 5% (open circuit) of signal per division of video that is above and below the centerline. Full range -2.0V to +2.0V. Source impedance is approximately 1k Ω .
HORIZ (OUTPUT) (Rear Panel)		Provides 0.5V/Div (open circuit) either side of center. Full range -2.5V to +2.5V. Source impedance is approximately 1k Ω .
PEN LIFT (Rear Panel)		TTL compatible, nominal +5V to lift plotter pen.
10 MHz IF (OUTPUT) (Rear Panel)		Provides access to the 10 MHz IF signal. Output level is approximately -5 dBm for a full screen signal at -30 dBm reference level. Nominal impedance is approximately 50 Ω .

^a Over the operating temperature range this is +15 PPM.

Table 2-4 (Continued)
OUTPUT SIGNAL CHARACTERISTICS

Characteristic	Performance Requirement	Supplemental Information
IEEE STD 488 PORT (P version)		In accordance with IEEE 488-1978 standard and Tektronix Codes and Formats standard (version 81.1). Implemented as SH1, AH1, T5, L3, SR1, RL1, PP1, DC1, DT1, and C0. See Programmers Manual.
(Non P version)		Implemented as SH1, AH0, T3, L0, SR0, RL0, PP0, DC0, DT0 and C0.
PROBE POWER (Rear Panel)		Provides operating voltages for active probes.
Outputs		
Pin 1		+5V at 100 mA maximum
Pin 2		Ground
Pin 3		-15V at 100 mA maximum
Pin 4		+15V at 100 mA maximum
J104 ACCESSORIES (Rear Panel)		All inputs and outputs are listed in Table 2-3 INPUT CHARACTERISTICS.

Table 2-5
POWER REQUIREMENTS

Characteristic	Performance Requirement	Supplemental Information
Line Frequency Range	47-63 Hz	47 Hz to 440 Hz. Operation over 63 Hz exceeds protective grounding conductor leakage current of 3.5 mA. A redundant protective grounding means is essential to protect against electric shock.
Line Voltage Range	90 V _{ac} to 132 V _{ac}	115 V nominal
	180 V _{ac} to 250 V _{ac}	230 V nominal
Line Fuse		
115V Nominal	4A	
230V Nominal	2A Medium-Blow	
Input Power	210 W maximum (3.2A)	At 115V and 60 Hz
Leakage Current		5 mA maximum

**Table 2-6
GENERAL CHARACTERISTICS**

Characteristic	Performance Requirement	Supplemental Information
Sweep		Triggered, auto, manual, and external
Sweep Time	20 μ s/Div–5 s/Div in 1-2-5 sequence (10 s/Div available in AUTO)	
Accuracy	\pm 5% over center 8 divisions	
Triggering		INTERNAL, EXTERNAL, FREE RUN, and SINGLE SWEEP
Internal Trigger Level	2 divisions or more of signal	
External Trigger Input Level	1.0V peak, minimum	EXTERNAL is ac-coupled (15 Hz–1 MHz). Maximum external trigger input is 50V (dc + peak ac).
Crt Readout		Displays all parameters listed on the crt bezel, plus help and operating messages.
Battery-Powered Memory		Instrument settings, displays, calibration offsets, and peaking codes for each band are stored in battery-powered non-volatile RAM.
Battery Life		
At +55°C Ambient Temperature		1–2 years
At +25°C Ambient Temperature		At least 5 years
Temperature Range for Retaining Data Operating		0°C to +50°C
Non-Operating		–30°C to +75°C

**Table 2-7
ENVIRONMENTAL CHARACTERISTICS**

Meets the following MIL T-28800C, type III class 5, style E specifications:		
Characteristic	Description	
Temperature		
Operating	0°C to +50°C	
Non-operating ^a	-40°C to +75°C	
Humidity		
Operating	95% ±5% below +30°C. 75% ±5% above +30°C. 45% ±5% above +40°C.	
Altitude		
Operating	10,000 feet (3050 meters)	
Non-operating	40,000 feet (12000 meters)	
Vibration, Operating (instrument secured to a vibration platform during test)	MIL-Std-810, Method 514 Procedure I (modified). Resonant searches along all three axes at 0.013 inch displacement, for 15 minutes. Dwell for an additional 10 minutes in each axis at the frequency of the major resonance or at 33 Hz if none was found. Resonance is defined as twice the input displacement. Total vibration time is 75 minutes.	
Shock (Operating and Non-operating)	Three 30g, one-half sine, guillotine-type shocks, 11 ms duration in each direction along each major axis; total of 18 shocks.	
Electromagnetic Interference (EMI)	Meets requirements described in MIL-Std-461B Part 4, except as noted.	
Conducted Emissions	Test Method	Remarks
	CE01—60 Hz to 15 kHz	1 kHz to 15 kHz only
	CE03—15 kHz to 50 MHz power leads	15 kHz to 50 kHz, relaxed by 15 dB
Conducted Susceptibility	CS01—30 Hz to 50 kHz power leads	Full limits
	CS02—50 kHz to 400 MHz power leads	Full limits
	CS06—spike power leads	Full limits
Radiated Emissions	Test Method	Remarks
	RE01—30 Hz to 50 kHz magnetic field (measured at 30 cm).	30 — 36 kHz exceptioned.
	RE02—14 kHz to 10 GHz	Full limit
Radiated Susceptibility	RS01—30 Hz to 50 kHz	Full limit
	RS02—Magnetic Induction	To 5 A only, 60 Hz
	RS03—14 kHz to 10 GHz	Up to 1 GHz, 1 V/m

**Table 2-8
PHYSICAL CHARACTERISTICS**

Characteristic	Description
Weight	50 lbs maximum Including standard accessories, except manuals.
Dimensions (See Figure 2-1) Without handles or feet	7 × 17 × 24 inches (17.78 × 43.18 × 60.96 cm)

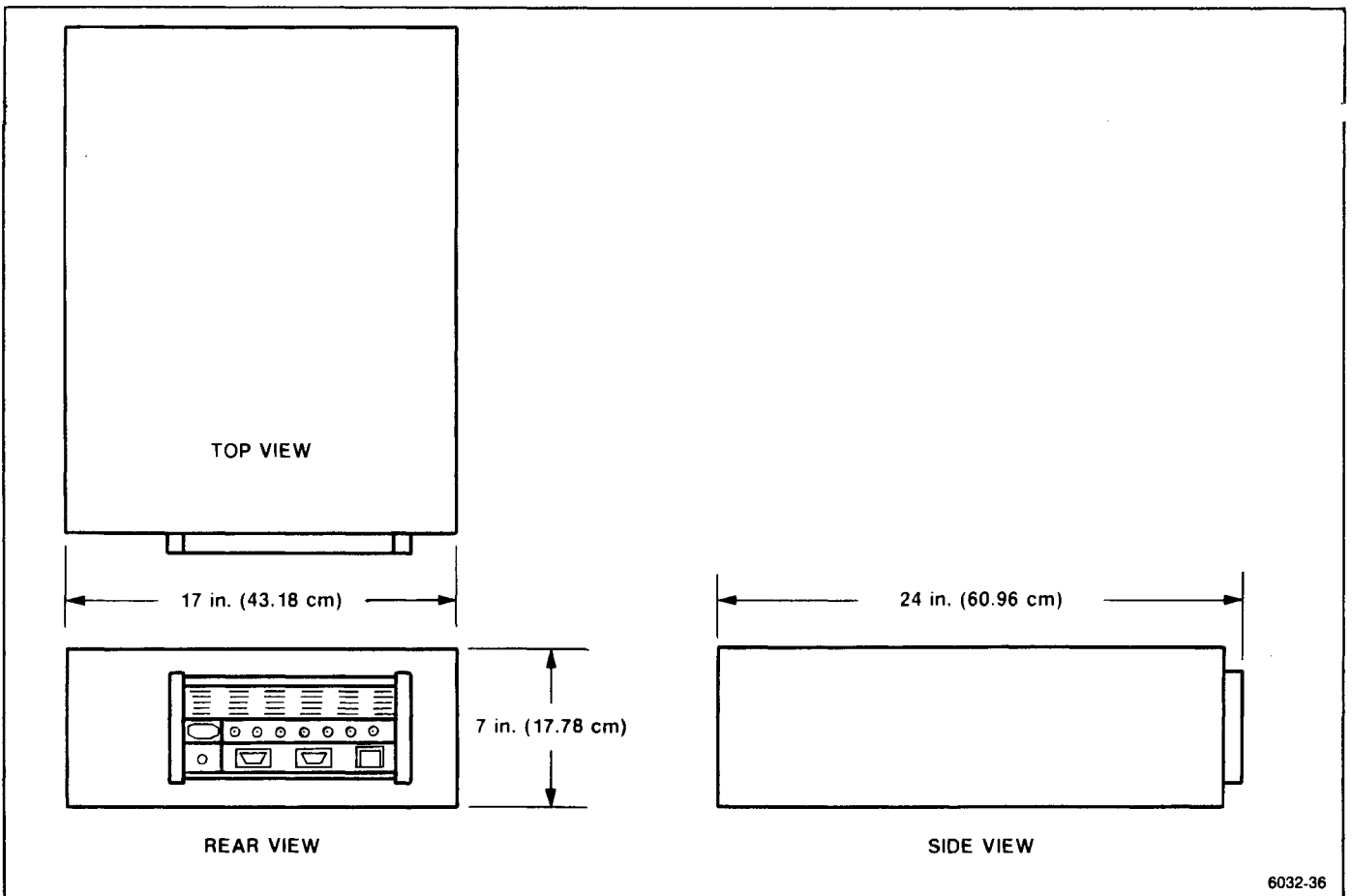

Figure 2-1. Dimensions.

INSTALLATION

This section describes unpacking, installation, power requirements, storage information and repackaging for the 2754/2754P Spectrum Analyzer.

UNPACKING AND INITIAL INSPECTION

Before unpacking the spectrum analyzer, inspect the shipping container for signs of external damage. If the container is damaged, notify the carrier as well as Tektronix, Inc. The shipping container contains the basic instrument and its standard accessories. For a list of the standard accessories, refer to Section 1 of this manual (or, for ordering information, refer to the list following the Replaceable Mechanical Parts list in the Service Manual, Volume 2).

If the contents of the shipping container are incomplete, if there is mechanical damage or defect, or if the instrument does not meet operational check requirements, contact your local Tektronix Field Office or representative.

Keep the shipping container if the instrument is to be stored or shipped to Tektronix for service or repair. Refer to Storage and Repackaging for Shipment later in this section.

The instrument was inspected both mechanically and electrically before shipment, and it should be free of mechanical damage and meet or exceed all electrical specifications. The Operation section of the Operators Manual contains procedures to check functional or operational performance. Perform the functional check procedure to verify that the instrument is operating properly. This check is intended to satisfy the requirements for most receiving or incoming inspections. (A detailed electrical performance verification procedure in the Performance Check section of this manual provides a check of all specified performance requirements, as listed in the Specification section.)

The instrument can be operated in any position that allows air flow in the bottom and out the rear of the instrument. Feet on the four corners allow ample clearance even if the instrument is stacked with other instruments. The air is drawn in by a fan through the bottom and expelled out the back. Avoid locating the instrument where paper, plastic, or any other material might block the air intake.

The spectrum analyzer is equipped with a flipstand to adjust the viewing angle.

WARNING

Removing or replacing the cabinet on the instrument can be hazardous. Only qualified service personnel should attempt to remove the instrument cabinet.

Refer to the Options section of this manual for rack-mount installation instructions.

CAUTION

If the rackmount instrument is extended out of the rack and tipped up to gain access to the bottom or back panels of the cabinet, securely hold the instrument so it cannot fall back into the rack. Use care when doing this to avoid damaging the instrument front panel or equipment that may be mounted above the instrument.

CONNECTING POWER

Power Source and Power Requirements

WARNING

Changing the power input can be dangerous.

- Work safely
- Know the intended power source
- Set the instrument for the power source
- Check the fuse for proper ratings
- Use the power cord and plug intended for the power source

The spectrum analyzer operates from a single-phase power source that has one of its current-carrying conductors (neutral) at ground (earth) potential. Do not operate the spectrum analyzer from power sources where both current-carrying conductors are isolated or above ground potential (such as phase-to-phase on a multi-phase system or across the legs of a 110-220 V single-phase, three-wire system). In this method of operation, only the line conductor has over-current (fuse) protection within the unit. Refer to the Safety Summary at the front of this manual.

The ac power connector is a three-wire, polarized plug with the ground (earth) lead connected directly to the instrument frame to provide electrical shock protection. If the unit is connected to any other power source, connect the unit frame to an earth ground.

Operate the spectrum analyzer from either 115 Vac or 230 Vac nominal line voltage with a range of 90 to 132 or 180 to 250 Vac, at 48 to 440 Hz. Power and voltage requirements are printed on a back-panel plate mounted below the power input jack.

Input power requirements are changed with a switch on the back panel (see Figure 3-1) and by replacing the input line fuse. The instrument uses a 4A fast blow fuse for 115 Vac operation, and a 2A slow blow fuse for 230 Vac operation.

Remove the protective cover and set the line select switch for the appropriate voltage range.

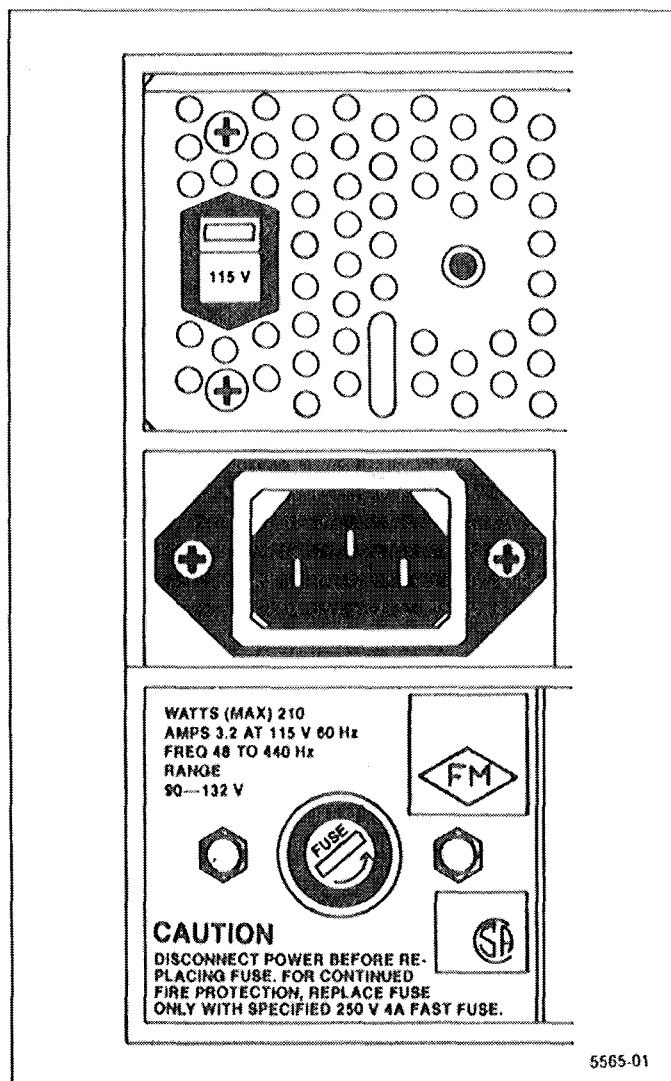

Figure 3-1. Input power selector switch and fuse.

Remove the fuse holder and replace the line fuse with the appropriate fuse for the voltage range selected.

The international power cord and plug configuration is shown in the Options section of this manual.

STORAGE AND REPACKAGING

Storage

Short Term (less than 90 days) — For short term storage, store the instrument in an environment that meets the non-operating environmental specifications in Section 2 of this manual.

Long Term — For instrument storage of more than 90 days, retain the shipping container to repackage the instrument. The battery in the instrument does not require removal. Package the instrument in a vapor barrier bag with a drying agent and store in a location that meets the non-operating environmental specifications in Section 2 of this manual.

If you have any questions, contact your local Tektronix Field Office or representative.

Repackaging for Shipment

When the spectrum analyzer is to be shipped to a Tektronix Service Center for service or repair, attach a tag that shows the owner and address, the name of the individual at your firm that can be contacted, the complete instrument serial number, and a description of the service required. If the original package is unfit for use or not available, use the following repackaging information.

1. Use a corrugated cardboard container with a test strength of 375 pounds (140 kilograms) and inside dimensions that are at least six inches more than the equipment dimensions (refer to the Physical Characteristics in Section 2), to allow for cushioning.
2. Install the instrument front cover, and surround the instrument with plastic sheeting to protect the finish.
3. Cushion the equipment on all sides with packing material or plastic foam.
4. Seal the container with shipping tape or an industrial, heavy-duty stapler.

PERFORMANCE CHECK PROCEDURE

Introduction

The procedures in this section verify that the instrument is performing according to the characteristics that have limits and performance requirements as specified under the Performance Requirement column in Section 2, Specification. Some of the non-specified parameters and instrument functions are also checked. This check verifies that the instrument is calibrated and will perform as described. All tests can be performed without removing the covers of the instrument.

Checks should be performed in sequence because some tests rely on the satisfactory performance of related circuits. Also, the procedures are arranged to minimize test equipment setup. If a performance measurement is marginal or below specification, an adjustment procedure to optimize the circuit performance will be found, under a similar heading, in Section 5, Adjustment Procedure. After adjustment, recheck the performance. We recommend adjusting only those circuits that do not meet performance criteria.

If adjustment fails to return the circuit to specified performance, refer to the Maintenance section for troubleshooting and repair procedures.

Procedures that are unique to instrument options, are described as a sub-part of the step within this section.

Incoming Inspection Test

The Operators manual contains an operational or functional check that checks all functions. This check is recommended for incoming inspections because it requires no external equipment or special expertise and is a reliable indication that the instrument is performing properly.

Verification of Tolerance Values

Compliance tests, of those limits listed in the Performance Requirement column of the instrument specifications, shall be performed after sufficient warm-up time and completion of preliminary preparation steps (such as front-panel adjustments).

Measurement tolerance of test equipment should be negligible in comparison to the specified tolerance; and, when not negligible, the error of the measuring apparatus shall be added to the tolerance specified.

History Information

The instrument and manual are periodically evaluated and updated. If modifications require changes in the procedures, information applicable to earlier instruments will be included within a step or as a sub-part to a step.

Equipment Required

Table 4-1 lists the test equipment and calibration fixtures recommended for the Performance Check. This equipment is also applicable for the adjustment procedures in Section 5, Adjustment Procedure. The characteristics specified are the minimum required for the checks. Substitute equipment must meet or exceed these characteristics. These fixtures are available from Tektronix, Inc., and may be ordered through your local Tektronix Field Office or representative.

Some checks may not be practical because some characteristics may require sophisticated test equipment and/or procedures to accurately measure them. In those cases a compromise may be made in the procedures to facilitate checking the characteristic. When that occurs, a statement or footnote to that fact is added to the step. The more exact method of measuring the characteristic can be supplied by your Tektronix Service Center.

Table 4-1
EQUIPMENT REQUIRED

Equipment or Test Fixture	Characteristics	Recommendation and Use
Test Oscilloscope	Vertical sensitivity, 50 mV/Div to 5 V/Div; Bandwidth, DC to 100 MHz	Any TEKTRONIX 7000-Series oscilloscope with plug-in units for real-time display such as 7A11/7B50A, and P6108 10X Probe
Time Mark Generator	Marker output, 5 s to 20 ns; accuracy 0.001%	TEKTRONIX TG 501 with TM 500-Series Power Module (time/div and span accuracy check)
Frequency Counter	0 to 200 MHz, 1 Hz resolution, 25 mV sensitivity.	TEKTRONIX DC 503A with TM 500-Series Power Module (Calibrator frequency measurement)
Prescaler	Compatible with TEKTRONIX DC 510	TEKTRONIX DP 501 with TM 500-Series Power Module (Center frequency measurement)
Function or Sine-Wave Generator	1 Hz to 1 MHz; 0 to 20 V p-p	TEKTRONIX FG 503 Function Generator (external trigger and horizontal input requirements check)
Signal Generator	10 Hz to 10 MHz, constant output	Hewlett-Packard Model 654A or Model 3336C (used to check attenuator and gain accuracy, and frequency response)
Signal Generator	Two leveled generators, 500 kHz to 2.0 GHz. Output, -100 dBm to +10 dBm; spectral purity 60 dB or more below the fundamental.	TEKTRONIX SG 504, Hewlett-Packard Model 8640A/B and Model 8614A generators (frequency response, IM, and display accuracy checks)
Low Loss (WL Gore) RF Cable	Flat to at least 21 GHz	Tektronix Part No. 006-7609-00 (used to check frequency response)
Crystal Detector	0.01—21 GHz	Hewlett-Packard Model 8473C (used to check frequency response)
Sweep Oscillator	0.01 to 21 GHz; frequency response, ± 1.0 dB, or 2.0 to 21 GHz (with 500 kHz to 2.0 GHz generators)	Hewlett-Packard Model 8350A with Model 83595A Option 002 Plug-in; or, 8620C and 86290B Option 40 Plug-in (frequency response check)
Power Divider	Dc to 22 GHz	Weinschel Model 1579B
Power Meter with Power Sensors	-60 dBm to -20 dBm full scale; 100 kHz to 26 GHz	Hewlett-Packard Model 435A or 436A with 8482A and 8485A Power Sensors
Low-Pass Filter	Must have rolloff of 40 dB or more at 200 MHz	Texscan or Lark
UHF Comb Generator	Provide comb line to 18 MHz; accuracy 0.01%	TEKTRONIX Calibration Fixture 067-0885-00 with TM 500 Power Module (frequency readout accuracy check)
Spectrum Analyzer	Frequency range, 50 kHz to 2.2 GHz	TEKTRONIX 2755, 492A, 494, or 7L14 Option 39 (compression point check)

Table 4-1 (cont)
EQUIPMENT REQUIRED

Equipment or Test Fixture	Characteristics	Recommendation and Use
10 dB/50 Ω Attenuator	dc to 1.8 GHz; ± 1 dB accuracy	Hewlett Packard 33340A Option 10 (RF attenuator accuracy check)
20 dB/50 Ω Attenuator	dc to 1.8 GHz; ± 1 dB accuracy	Hewlett Packard 33340A Option 20 (RF attenuator accuracy check)
2 N Male to APC 3.5 Male Adapters		Maury Model 8023D (RF attenuator accuracy check)
APC 3.5 Male to APC 3.5 Male Adapter		Maury Model 8021B (RF attenuator accuracy check)
APC 3.5 Female to APC 3.5 Female Adapter		Maury Model 8021A (RF attenuator accuracy check)
Interconnect Kit ^a	For Hewlett Packard 8494B and 8496B Step Attenuators	Hewlett Packard 11716A (RF attenuator check)
50 Ω Terminator		Tektronix Part No. 011-0049-01
Step Attenuator	Range, 0 dB – 12 dB, in 1 dB steps; dc – 1 GHz, accuracy ± 0.25 dB to 0.5 GHz	Hewlett Packard 355C (input compression check)
Attenuator (SMA Connectors)	3 dB, 50 Ω ; dc to 20 GHz	Weinschel Model 4M. Tektronix Part No. 015-1053-00
Two Attenuators (bnc connectors)	20 dB, 50 Ω ; dc to 2.0 GHz	Tektronix Part No. 011-0059-02
(50 Ω Coaxial Cable with sma connectors)	5 ns	Tektronix Part No. 015-1006-00
N Male to SMA Male Adapter		Tektronix Part No. 015-0369-00
N Male to BNC Female Adapter		Tektronix Part No. 103-0045-00
BNC T Adapter		Tektronix Part No. 103-0030-00
Two 50 Ω Coaxial Cables		Tektronix Part No. 015-1006-00

Firmware Version

During initial power-up cycle, the instrument type and the front panel processor firmware versions are displayed on the crt for approximately two seconds. The Replacement Parts List in the Service manual, lists the ROMs used for each version. The service manual also lists the firmware operating notes associated with each firmware version.

If the microprocessor cannot set the oscillator frequency, due to a hardware failure, it will continue to try each sweep. The sweep hold off time will increase substantially as it tries. To disable attempted oscillator corrections, press <SHIFT> and then 7. Center frequency accuracy specifications will not be met in this mode. Pressing <SHIFT> 7 again will re-enable oscillator correction routines. Another failure message will appear if the failure has not been corrected.

Error Message Readout

If the microcomputer detects a hardware failure, a failure report will come on screen and remain for about 2 seconds. A status message will then appear and remain for the duration of the failure. Press <SHIFT> . to bring error messages to the screen.

^a The 10 dB step attenuator, 1 dB step attenuator, and interconnect kit must be calibrated together as a single unit, using precision standard attenuators such as Weinschel Model AS-6 attenuator.

Initial Power-Up

a. Connect the spectrum analyzer power cord to an appropriate power source (refer to "Power Source and Power Requirements" in Section 3, Installation) and switch POWER on.

b. When POWER is switched on (power up), the microprocessor runs a memory and I/O test. If no processor system problems are found, the power-up program will complete in approximately 10 seconds, and the instrument will be ready to operate. After the power-up routine, the crt will initialize as shown in Figure 4-1.

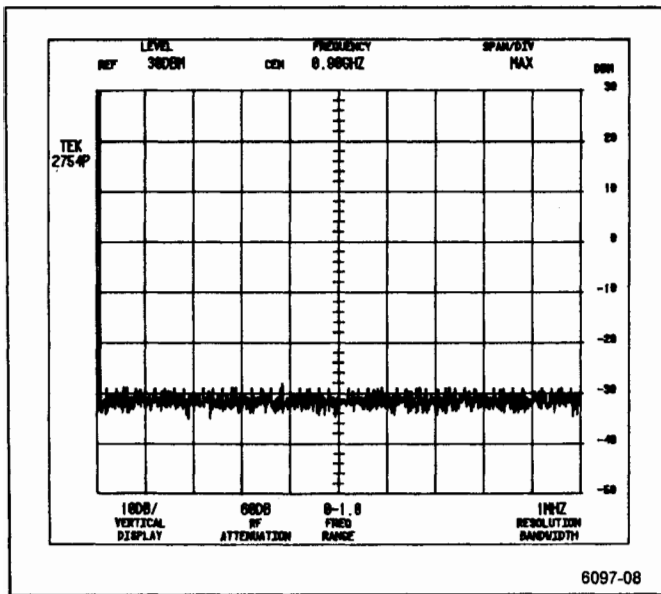

Figure 4-1. Crt display at initial power-up.

NOTE

If a problem exists within the instrument, a failure message will appear on screen. To bypass the failed test and attempt to use the instrument, press the pushbutton as directed in the error message. However, performance may not be as specified.

c. The operating functions and modes should initialize to the following "power-up" state:

REF LEVEL	30DBm
CENTER FREQUENCY	900MHZ
MARKER FREQUENCY	0MHZ
FREQ SPAN/DIV	MAX
VERT DISPLAY	10DB/
RF ATTENUATION	60DB
FREQ RANGE	0—4.2 GHz
	0—1.8 GHz (Option 1)
RESOLUTION BANDWIDTH	1 MHz
READOUT	On
TRIGGERING	FREE RUN
AUTO RES	On
DIGITAL STORAGE	VIEW A/VIEW B on
THRESHOLD	AUTO
All other pushbuttons	Inactive or off

d. Set the MIN RF ATTEN dB control to 0 (NORM) and the PEAK/AVERAGE control fully counterclockwise. Set the TIME/DIV control to AUTO and the REF LEVEL to read -20 DBM, and adjust the INTENSITY control for the desired brightness. Note that the RF ATTENUATION readout is now 10 dB.

e. Connect a 50Ω coaxial cable and a N to bnc adapter between the CAL OUT connector and RF INPUT to apply the CAL OUT signal to the RF INPUT connector.

f. A dot marker will appear in the upper portion of the screen in the MAX SPAN/DIV frequency mode. This marker indicates the location on the display to which the spectrum analyzer frequency is tuned. With a frequency readout of 0.00 GHz, the marker will be in the upper left portion of the screen. Rotate the CENTER/MARKER FREQUENCY control and watch the dot marker move across the display. Notice that the Center FREQUENCY readout (top line) remains at 900 MHz, and that the MARKER FREQUENCY readout (second line) changes according to the position of the marker (dot).

g. Harmonics of the 100 MHz calibrator signal will be displayed as shown in Figure 4-2. To select 100 MHz center frequency, press the pushbutton sequence of FREQUENCY 100 MHz.

h. To change the FREQ SPAN/DIV readout to 100 MHz, press the pushbutton sequence of SPAN/DIV 100 MHz. The dot marker is now horizontally centered, and the 100 MHz calibrator signal is at center screen.

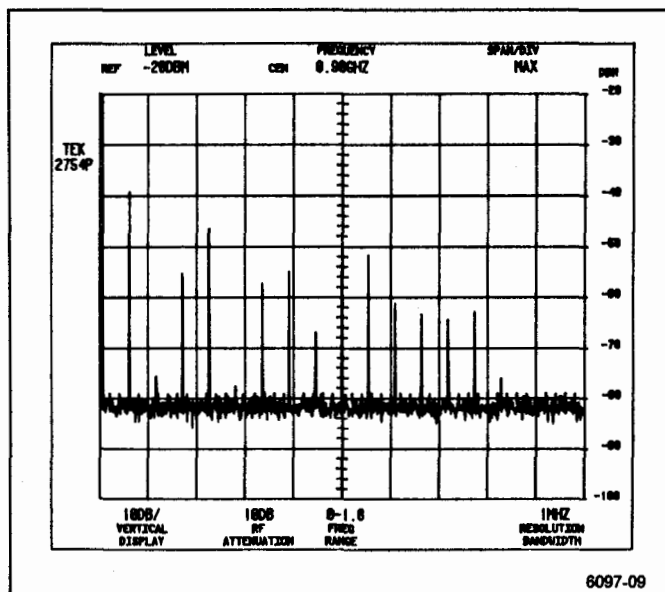

Figure 4-2. Typical display of calibrator signal in Max Span/Div.

Calibrate Position, Center Frequency, Reference Level, and Dynamic Range

NOTE

When the <SHIFT> CAL sequence is pressed, the microcomputer performs a center frequency and reference level calibration. Prompts appear on the screen to guide the user step-by-step through the procedure. This calibration should be done at regular intervals. It must be done before the instrument will meet its center frequency and reference level accuracy performance specifications. It should also be done any time the instrument ambient temperature is substantially different from the last calibration. An explanation of reference level accuracy with respect to ambient temperature is described in the Specification section of the spectrum analyzer Operators Manual.

To observe the results after the microcomputer has completed a calibration routine, press the <SHIFT> 1 sequence. A message will appear on the screen that shows the correction factor used by the microcomputer to center the resolution bandwidth filters to produce a calibrated center frequency. It also shows the correction that was required to bring the amplitude level within 0.4 dB of the 1 MHz filter.

Press the <SHIFT> CAL sequence to start the calibration routine. A prompt message on the screen will guide you through setting the four front-panel adjustments of vertical and horizontal POSITION, and AMPL and LOG CAL. This sets the absolute reference level for the 1 MHz resolution bandwidth filter. An automatic calibration is then done, which measures and corrects for absolute frequency and amplitude (relative to 1 MHz) errors of the filters. This takes approximately 60 seconds. If a message appears on the screen, refer to Error Message Readout earlier in this section. The correction factors are held in memory. Press FINE to continue calibration as instructed or <SHIFT> to exit the routine.

If any amplitude correction factor, at room temperature, for a filter is greater than 1 dB, the filter in the VR assembly should be readjusted. Refer to Section 5, Adjustment Procedure.

PERFORMANCE CHECK PROCEDURE

1. Check Center Frequency Accuracy

This is a two part procedure; Part I checks center frequency accuracy without the 1st LO phase locked, Part II checks accuracy with the 1st LO phase locked. A settling time of 1 s/GHz change in center frequency divided by "N" must be allowed before checking accuracy. A front panel CAL should be done before performing this check.

Center frequency accuracy is a function of how accurate the center frequency is set between sweeps and the amount of frequency drift during the sweep. Frequency drift can be significant during the first 30 minutes after turn-on or when the ambient temperature changes. With a span/div of 200 Hz and 1 kHz resolution bandwidth, the sweep rate is slow enough that frequency drift can be noted if the warmup time is insufficient or the ambient temperature is changing. "N" is the 1st LO harmonic number used for the first conversion (see Table 2-1 for the value of N).

Part I - 1st LO not Phase Locked

Accuracy for Bands 1 and 5 with Span/Div > 200 kHz, and bands 2 through 4 with Span/Div > 100 kHz is $\pm \{(20\% \text{ of the Span/Div or Resolution Bandwidth, whichever is greater}) + (CF \times 10^{-5})\}^a + (N \times 15 \text{ kHz})$.

(1) Use a Frequency Counter and a Prescaler to measure the fundamental output frequency of the Comb Generator (Comb Generator source output excluding the Comb Generator Module).

(2) Make a note of the measured frequency, which is approximately 500 MHz. This is the fundamental frequency referred to in Table 4-2, and will be used to determine each center frequency checked.

(3) Connect the test equipment as shown in Figure 4-3.

(4) Set the Spectrum Analyzer controls as follows, using the Data Entry keypad when appropriate:

REF LEVEL	-10 dB
FREQ SPAN/DIV	210 kHz
RESOLUTION BANDWIDTH	10 kHz
VERTICAL DISPLAY	10 dB/DIV
MIN RF ATTEN	0 dB
PEAK/AVERAGE	Fully Clockwise
TIME/DIV	AUTO

(5) Use the Data Entry keypad to set the FREQUENCY to the fundamental frequency noted in part (2) (rounded off to the nearest kHz).

(6) Check that the displayed signal is within 0.295 divisions (62 kHz) of center screen.

(7) Continue checking frequencies as indicated in Table 4-2 as per the following example:

Check Center Frequency Accuracy at 18.5 GHz

Fundamental indicated by frequency counter = 499.99831 MHz.

Determine Center Frequency to the nearest kHz:

Fundamental $\times 37$ (from Table 4-2)

Use Data Entry keypad to set FREQUENCY to 18.499926 GHz. *18.499937*

Check that the displayed signal is within 1.152 divisions (272 kHz) of center screen.

NOTE

If a particular check should fail, measure the fundamental frequency and recheck.

^a Over the operating temperature range, this term is $\times 1.5 \times 10^{-5}$

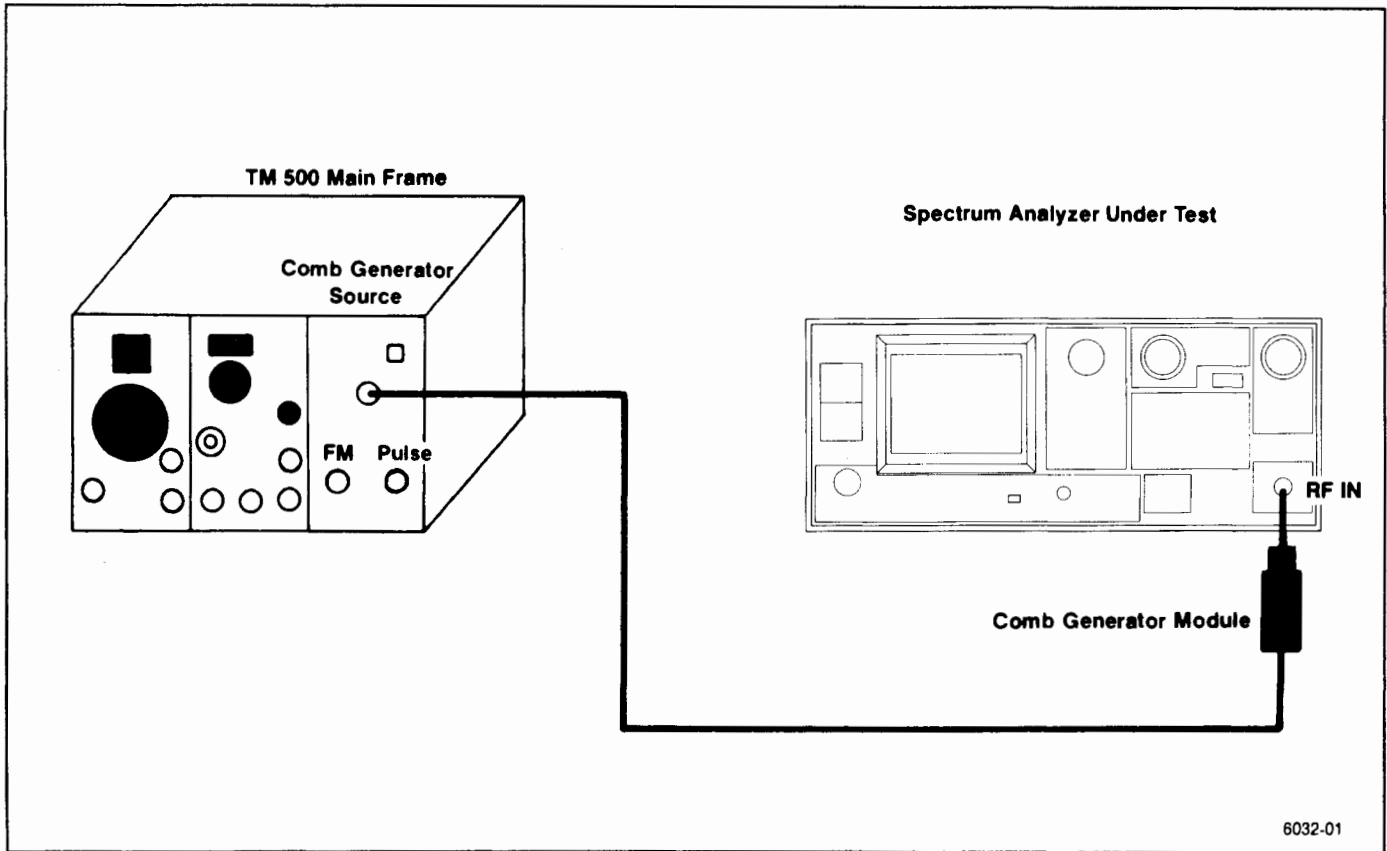

Figure 4-3. Test equipment setup for checking center frequency accuracy.

Table 4-2
CENTER FREQUENCY ACCURACY CHECK POINTS
(1st LO UNLOCKED)

Band	Approximate Frequency	Keypad Entry CENTER FREQUENCY	Frequency Span/Div	Maximum Error
1	0.5 GHz	Fundamental	210 kHz	± 0.295 (± 62 kHz)
	1.0 GHz	Fundamental $\times 2$	210 kHz	± 0.319 (± 67 kHz)
	1.5 GHz	Fundamental $\times 3$	210 kHz	± 0.343 (± 72 kHz)
2	2.0 GHz	Fundamental $\times 4$	110 kHz	± 0.518 (± 57 kHz)
	3.5 GHz	Fundamental $\times 7$	110 kHz	± 0.655 (± 72 kHz)
	5.0 GHz	Fundamental $\times 10$	110 kHz	± 0.791 (± 87 kHz)
3	6.0 GHz	Fundamental $\times 12$	110 kHz	± 0.882 (± 97 kHz)
	6.5 GHz	Fundamental $\times 13$	110 kHz	± 0.927 (± 102 kHz)
	7.0 GHz	Fundamental $\times 14$	110 kHz	± 0.973 (± 107 kHz)
4	7.5 GHz	Fundamental $\times 15$	110 kHz	± 1.291 (± 142 kHz)
	12.5 GHz	Fundamental $\times 25$	110 kHz	± 1.745 (± 192 kHz)
	18.0 GHz	Fundamental $\times 36$	110 kHz	± 2.245 (± 247 kHz)
5	18.5 GHz	Fundamental $\times 37$	210 kHz	± 1.295 (± 272 kHz)
	20.0 GHz	Fundamental $\times 40$	210 kHz	± 1.367 (± 287 kHz)
	21.0 GHz	Fundamental $\times 42$	210 kHz	± 1.414 (± 297 kHz)

Part II - 1st LO Phase Locked

Accuracy for Bands 1 and 5 with Span/Div ≤ 200 kHz and bands 2 through 4 with Span/Div ≤ 100 kHz is \pm {(20% of the Span/Div or Resoln Bandwidth, whichever is greater) + (CF $\times 10^{-5}$) Hz.

- (1) Apply the CAL OUT signal to the RF INPUT.
- (2) Set the Spectrum Analyzer controls as follows:

FREQUENCY	100 MHz
REF LEVEL	-20 dBm
MIN RF ATTEN	0 dB
FREQ SPAN/DIV	200 Hz
TIME/DIV	AUTO
VERTICAL DISPLAY	2 dB/DIV
AUTO RES	On
TRIGGERING	FREE RUN

Reset the REFERENCE LEVEL to bring the top of the signal below the dot marker. Use of the calibrator causes the CF $\times 10^{-5}$ to drop out.

- (3) Check 100 MHz center frequency accuracy by measuring the deviation of the 100 MHz signal from the dot marker. Error must not exceed \pm (20% of the resolution bandwidth) or ± 200 Hz (± 1.0 minor division).

- (4) Repeat this procedure to check the center frequency accuracy to 1.8 GHz in 100 MHz increments. Reset the REF LEVEL as necessary to observe the comb of 100 MHz markers at the upper end of the range.

2. Check Residual FM

Within 7N kHz over 20 ms, with FREQ SPAN/DIV greater than 200 kHz for bands 1 and 5 and greater than 100 kHz for bands 2 through 4.

- a. Apply the Calibrator signal to the RF INPUT.
- b. Set the Spectrum Analyzer controls as follows:

FREQUENCY	100 MHz
FREQ SPAN/DIV	1 MHz
RESOLUTION BANDWIDTH	100 kHz
VERTICAL DISPLAY	2 dB/DIV
MIN RF ATTEN	0 dB
REF LEVEL	-23 dBm
TIME/DIV	AUTO
TRIGGERING	FREE RUN
VIEW A and VIEW B	On

- c. Disable the 1st LO synthesis and phase lock by pressing <SHIFT> 7. A message "FREQUENCY CORRECTIONS DISABLED: PRESS 7" will be displayed on the CRT.

- d. Decrease the SPAN/DIV to 100 kHz while keeping the 100 MHz calibrator signal centered on screen with the CENTER FREQUENCY control.

- e. Set the VERTICAL DISPLAY to LIN. Position the signal so the slope (horizontal versus vertical excursion) of the response can be determined as illustrated in Figure 4-4A. Slope determination may be made easier by switching VIEW B off, and using SINGLE SWEEP and SAVE A to freeze the display at a convenient position on the graticule. The slope should calculate to approximately 8 kHz/division.

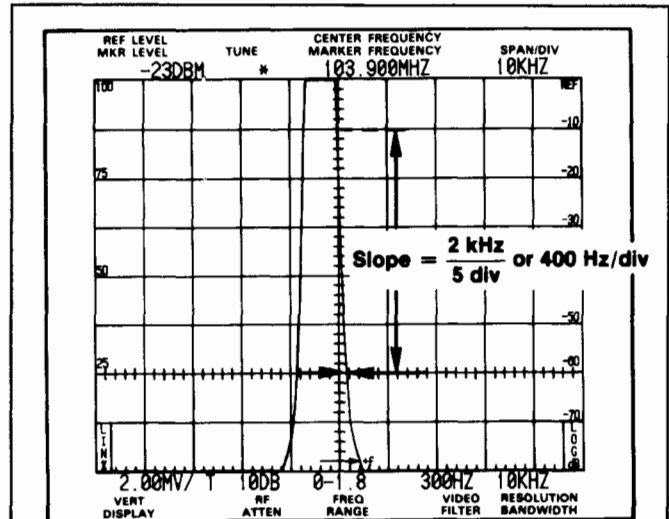

A. Calculating slope of response.

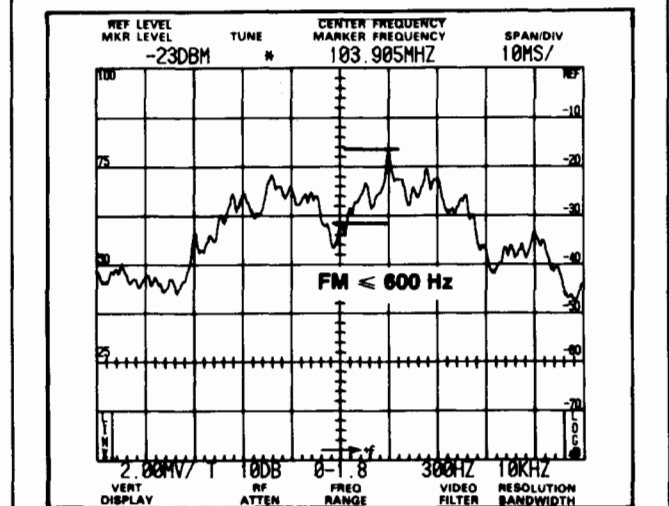

B. Measuring FM as the deviation/division of the response.

5565-65

Figure 4-4. Typical display for measuring residual FM.

f. If SAVE A was used in part d, de-activate SAVE A. Activate ZERO SPAN, set TIME/DIV to 20 ms, and set CENTER FREQUENCY control to position the display near center screen as shown in Figure 4-4B. Use SAVE A to freeze the display for ease in measuring FM. The peak-to-peak amplitude of the display per any horizontal division, scaled to the vertical deflections according to the slope estimated in part d, is the FM. Residual FM must not exceed 7 kHz for 20 ms or 7 kHz/division.

g. Press <SHIFT> 7 to re-enable the phase lock.

3. Check Frequency Span/Div Accuracy

($\pm 5\%$ of the selected span/div over the 8 center divisions of a 10 division display)

Span accuracy is checked by noting the displacement of calibrated markers from their respective graticule lines over the center eight divisions of the screen. The frequency span/div accuracy is checked, for all FREQ SPAN/DIV settings on band 1, at 100 kHz/Div on band 2, (2nd LO check) and at 500 MHz/Div on band 4. The accuracy of the 1 GHz, 2 GHz, 5 GHz, and 10 GHz span/div of the upper bands is directly related to the 100 MHz/Div and 200 MHz/Div spans. Therefore, the 1 GHz/Div, 2 GHz, 5 GHz, and 10 GHz/Div spans are not included in this procedure.

a. Set the Spectrum Analyzer controls as follows:

FREQUENCY	1 GHz
FREQ SPAN/DIV	100 MHz
RESOLUTION BANDWIDTH	AUTO
REF LEVEL	-30 dBm
TIME/DIV	AUTO
VERTICAL DISPLAY	10 dB/DIV

b. Apply the CAL OUT signal to the RF INPUT and set the FREQUENCY to align the 100 MHz markers so the 100 MHz/div accuracy can be measured over the center eight divisions of the display. It may be necessary to change the REF LEVEL to obtain adequate marker amplitude. Maximum deviation (see Figure 4-5) must not exceed 5 MHz.

c. Remove the CAL OUT signal from the RF INPUT and set up the test equipment as shown in Figure 4-6. Set the FREQUENCY to 10 GHz, (band 4, 5.4 to 18 GHz) FREQ SPAN/DIV to 500 MHz, RESOLUTION BANDWIDTH to 100 kHz, and REF LEVEL to -10 dBm. Press <SHIFT> PEAK MENU and select item 3, then set REF LEVEL for the best marker definition. It may also help to reset the CENTER FREQUENCY for better marker definition.

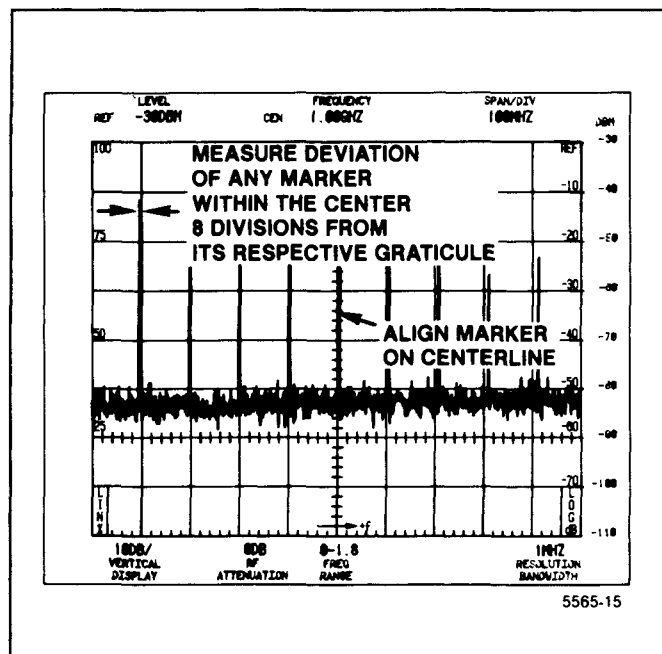

Figure 4-5. Typical marker display for measuring Span/Div accuracy.

d. Tune a marker to center screen then check the accuracy over the center eight divisions of the display. Deviation must not exceed ± 25 MHz/Div.

e. Set the FREQUENCY to 2.0 GHz, FREQ SPAN/DIV to 100 kHz, RESOLUTION BANDWIDTH to 1 kHz, TIME/DIV to 50 ms, and REF LEVEL to -20 dBm.

f. Modulate the Comb Generator signal with 10 μ s markers, from the Time Mark Generator, by applying the Marker Output to the Pulse Input of the Comb Generator as shown in Figure 4-6. Press <SHIFT> PEAK MENU and select item 3.

g. Check FREQ SPAN/DIV accuracy. Error must not exceed ± 5 kHz/Div.

h. Remove the Comb Generator signal from the RF INPUT and connect the Marker Output of the Time Mark Generator to the RF INPUT. Set the FREQUENCY to 100 MHz, FREQ SPAN/DIV to 50 MHz, RESOLUTION BANDWIDTH to 100 kHz, REF LEVEL to 20 dBm, and apply 20 ns time markers from the Time Mark Generator.

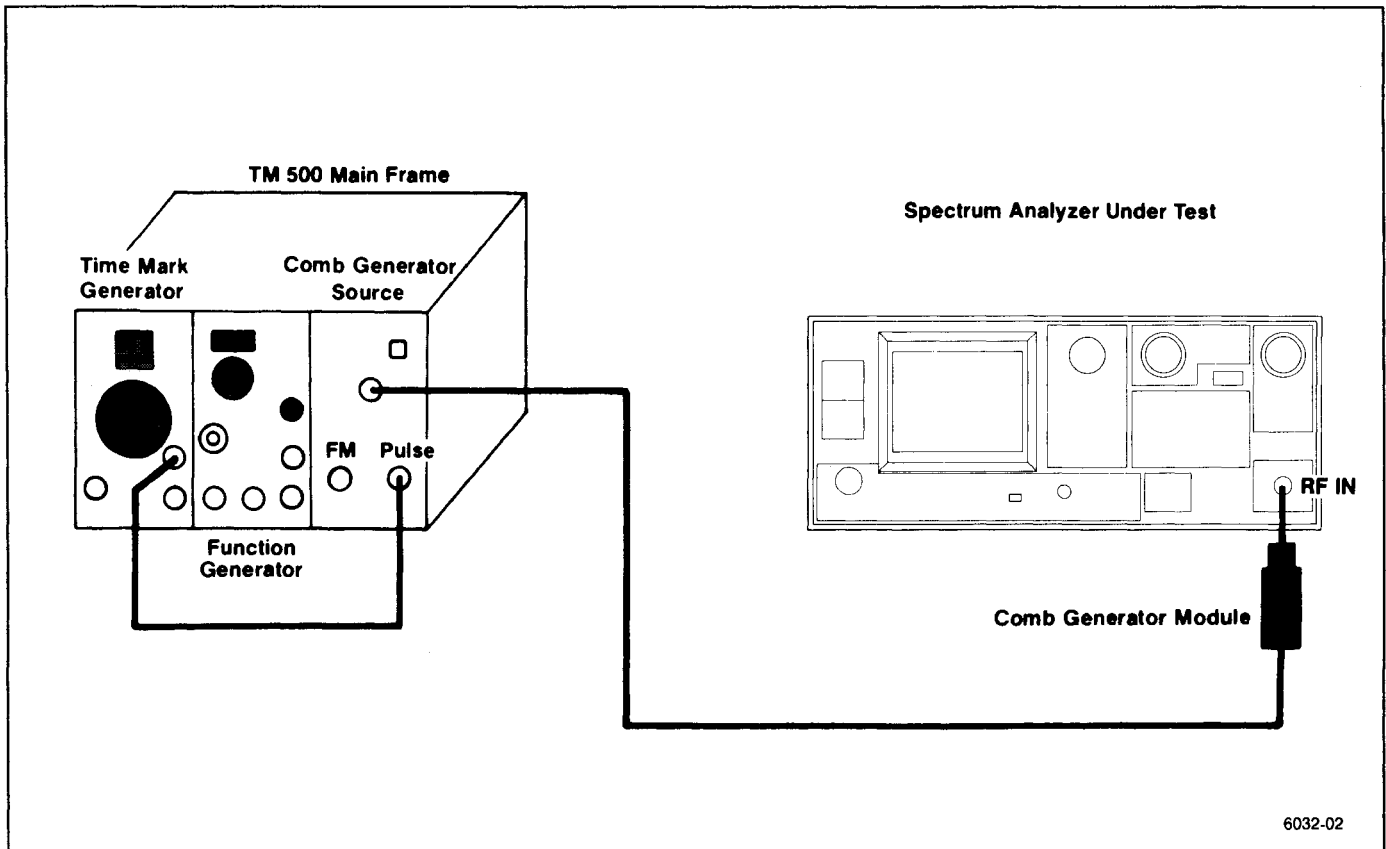

Figure 4-6. Test equipment setup for checking frequency Span/Div and sweep Time/Div accuracy.

i. Reset the REF LEVEL for the best marker definition, and the CENTER FREQUENCY to align the markers so span/div accuracy can be checked for the 50 MHz/div ($\pm 5\%$).

j. Reduce the FREQ SPAN/DIV to 20 MHz, and apply 50 ns (20 MHz) markers.

k. Check the 20 MHz FREQ SPAN/DIV accuracy.

l. Repeat the procedure and check the FREQ SPAN/DIV accuracy from 10 MHz down to 200 kHz. Use Table 4-3 as a guide to relate time markers to FREQ SPAN/DIV settings. Reduce RESOLUTION BANDWIDTH and CENTER FREQUENCY as each setting is checked to maintain marker amplitude and definition.

m. Change the RESOLUTION BANDWIDTH to 1 kHz. Repeat the above procedure to check the 100 kHz to 10 kHz FREQ SPAN/DIV selections.

n. Set the FREQUENCY to 100 kHz, RESOLUTION BANDWIDTH to 1 kHz, and REF LEVEL to 0 dBm. Repeat the above procedure to check the 5 kHz to 200 Hz FREQ SPAN/DIV selections.

Table 4-3
SPAN/DIV VERSUS TIME MARKERS FOR
SPAN/DIV ACCURACY CHECK

FREQUENCY SPAN/DIV	Time Mark Generator Marker Output
20 MHz	50 ns
10 MHz	.1 μ s
5 MHz	.2 μ s
2 MHz	.5 μ s
1 MHz	1 μ s
500 kHz	2 μ s
200 kHz	5 μ s
100 kHz	10 μ s
50 kHz	20 μ s
20 kHz	50 μ s
10 kHz	.1 ms
5 kHz	.2 ms
2 kHz	.5 ms
1 kHz	1 ms

4. Check Sweep Time Accuracy

(Within 5% of the rate selected)

a. Connect the output of a Time Mark Generator set to 10 ms to the rear-panel MARKER/VIDEO input. Connect pin 1 of J104 ACCESSORY connector to ground (connect pin 1 to pin 5).

b. Set the Spectrum Analyzer TIME/DIV to 10 ms, and activate ZERO SPAN and INT TRIGGERING.

c. Use the horizontal POSITION control to align a marker on the 1st graticule line (see Figure 4-7), then check the displacement of markers from their respective positions over the center eight divisions. Individual marker displacement must not exceed 5% or 2 minor divisions.

d. Check the accuracy of the 5 s to 20 μ s TIME/DIV settings by applying appropriate markers for each TIME/DIV setting and noting the displacement as described in part d of this step.

e. Disconnect the test equipment, and the shorting strap from pin 1 of J104 ACCESSORY connector.

NOTE

Disable digital storage for sweep times less than 2 ms.

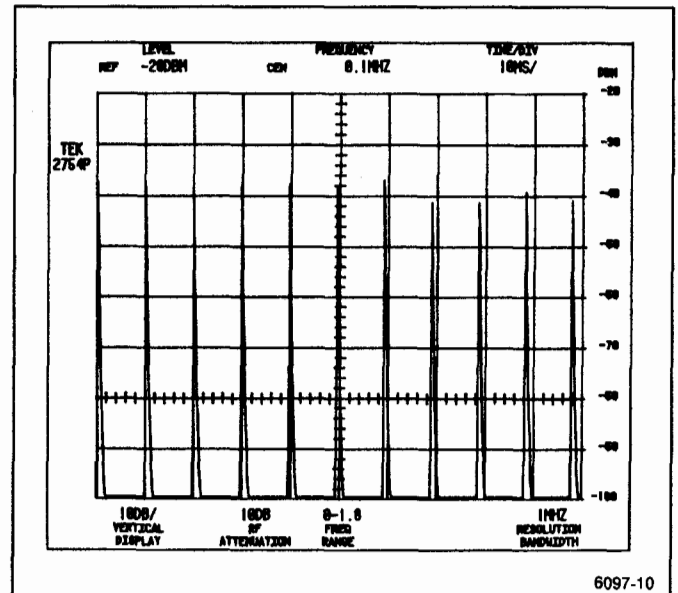

Figure 4-7. Typical display for measuring Time/Div accuracy.

5. Check Pulse Stretcher

This is an operational check only.

a. With the equipment setup the same as step 3, apply .1 ms time marks, from the Time Mark Generator, to the RF INPUT. Set the Spectrum Analyzer controls as follows:

FREQUENCY	2.0 MHz
ZERO SPAN	On
RESOLUTION BANDWIDTH	100 kHz
REF LEVEL	0 dBm
VERTICAL DISPLAY	10 dB/DIV
TIME/DIV	.1 ms
VIEW A and VIEW B	Off
TRIGGERING	INT

b. Activate PULSE STRETCHER and note that this mode extends the fall time of the markers.

c. Remove the test equipment.

6. Check Resolution Bandwidth and Shape Factor

(6 dB bandwidth within 20% of the selected bandwidth; shape factor is 7.5:1 or less)

a. Apply the CAL OUT signal to the RF INPUT. Set the Spectrum Analyzer controls as follows:

FREQUENCY	100 MHz
FREQ SPAN/DIV	500 kHz
RESOLUTION BANDWIDTH	1 MHz
REF LEVEL	-20 dBm
VERTICAL DISPLAY	2 dB/DIV
MIN NOISE	Activated
PEAK/AVERAGE	Fully Clockwise
TIME/DIV	AUTO

b. Measure the 6 dB down bandwidth (see Figure 4-8A). Bandwidth should equal 1 MHz ± 200 kHz.

c. Reset the VERTICAL DISPLAY to 10 dB/DIV and measure the 60 dB down bandwidth (see Figure 4-8B).

d. Check that the shape factor is 7.5:1 or less. The shape factor is the ratio of -60 dB/-6 dB bandwidths (see Figure 4-8).

e. Reset the RESOLUTION BANDWIDTH to 100 kHz, FREQ SPAN/DIV to 100 kHz, and VERTICAL DISPLAY to 2 dB/DIV.

f. Check the resolution bandwidth and shape factor of the 100 kHz filter by repeating parts b through d.

g. Check the resolution bandwidths and shape factors for the 10 kHz, and 1 kHz filters. Shape factor should be 7.5:1 or less.

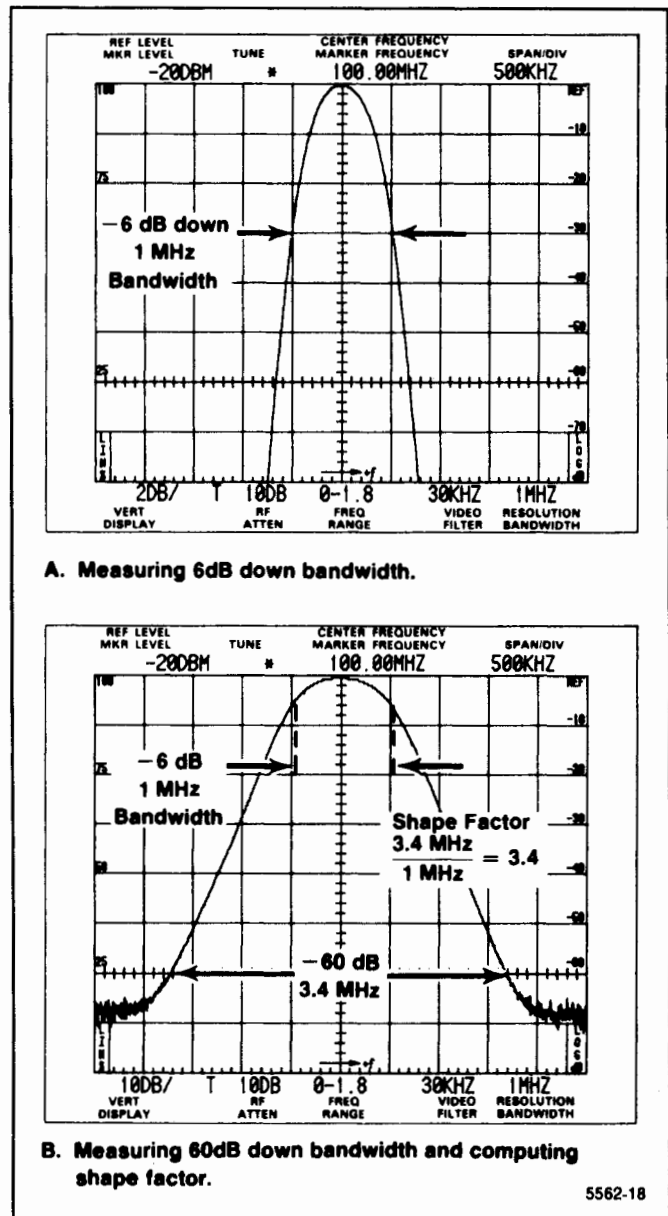

Figure 4-8. Typical display for measuring bandwidth and shape factor.

7. Check Calibrator Output

(-20 dBm ± 0.3 dB at 100 MHz) (100 MHz ± 1 kHz)

NOTE

In this check step, a power meter is used to verify the output level of the reference signal. Harmonics of the signal generator must be greater than 40 dB down from the fundamental.

a. Apply a 100 MHz signal to the power meter through a 3 dB attenuator. Set the generator output level for a reading of -20 dBm on the power meter. This sets up a 100 MHz reference signal.

b. Disconnect the power meter from the signal generator, and connect the reference signal established in part a to the RF INPUT.

c. Set the Spectrum Analyzer controls as follows:

FREQUENCY	100 MHz
FREQ SPAN/DIV	100 kHz
RESOLUTION BANDWIDTH	1 MHz
REF LEVEL	-18 dBm
VERTICAL DISPLAY	2 dB/DIV
TIME/DIV	AUTO
PEAK/AVERAGE	Fully Clockwise

d. Set the spectrum analyzer VERTICAL DISPLAY factor to the ΔA mode by pressing FINE. Set the REF LEVEL such that the top of the signal is on a graticule line near the top of the crt. Reset the REF LEVEL to 0.00 dB by pressing FINE twice. Store the display by activating SAVE A.

e. Remove the reference signal from the RF INPUT and connect the CAL OUT signal in its place using the same cable that was used in part b of this step.

f. Activate VIEW B and VIEW A.

g. Check that the amplitude difference between the VIEW B and SAVE A displays (CAL OUT signal and the reference) does not exceed 0.3 dB.

h. Disconnect the CAL OUT from the RF INPUT, and connect it to a frequency counter.

i. Check that the calibrator frequency is 100 MHz ± 1 kHz.

8. Check Noise Sidebands

(-75 dBc or more at 30 times the resolution bandwidth)

a. Apply the CAL OUT signal to the RF INPUT. Set the Spectrum Analyzer controls as follows:

FREQUENCY	100 MHz
FREQ SPAN/DIV	10 kHz
AUTO RES	On
REF LEVEL	-40 dBm
VERTICAL DISPLAY	10 dB/DIV
TIME/DIV	AUTO
WIDE VIDEO FILTER	On

b. Check that the amplitude of the noise sidebands are 55 dB or more down from the reference level at 30 times the resolution bandwidth (3 divisions away from the center frequency position). See Figure 4-9.

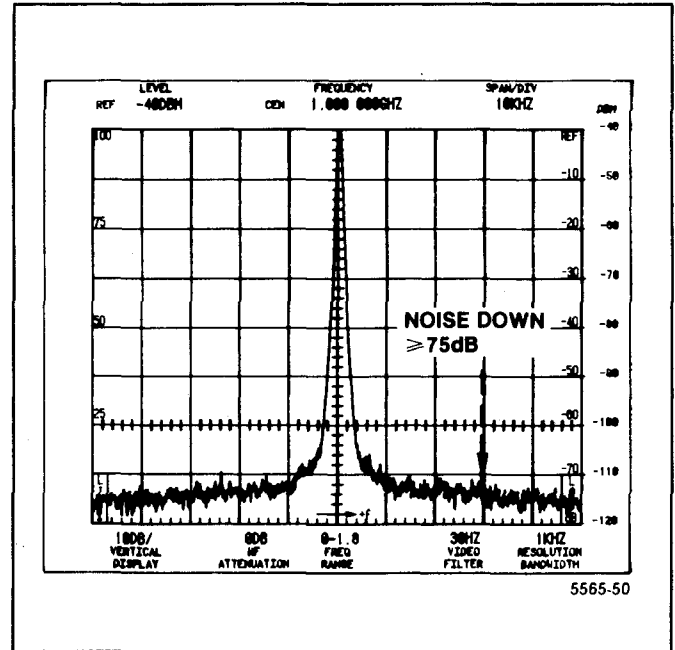

Figure 4-9. Typical display for measuring noise sidebands.

c. Decrease the FREQ SPAN/DIV to 10 kHz and the RESOLUTION BANDWIDTH to 1 kHz.

d. Check that the amplitude of the noise sidebands 30 kHz away from the center frequency position is at least 75 dB below the signal level or 55 dB below the top of the screen.

9. Check Frequency Response

(Response, about the midpoint between two extremes, measured with 10 dB of RF attenuation and peaking optimized in the applicable bands for each center frequency setting, is ± 1.5 dB from 1.7 GHz to 7.1 GHz; ± 2.5 dB from 5.4 to 18 GHz; and ± 3.5 dB from 15 to 21 GHz. Response with respect to 100 MHz is ± 2.5 dB from 50 kHz to 7.1 GHz; ± 3.5 dB from 5.4 to 18 GHz; and ± 5.0 dB from 15.0 to 21 GHz. Response includes the effect of input vswr, mixing mode (N), gain variation, and preselector or mixer. Digital storage typically increases errors by 0.5%.)

The response at each check point, above band 1, should be peaked by pressing <SHIFT> PEAK MENU, and selecting item 3 (REPEAK).

Performance Check Procedure — 2754/2754P Service Vol. 1

If the instrument is a rackmount version, with semi-rigid cables to the rear panel (Option 31), frequency response may degrade at the high end of the frequency range by as much as 2 dB above 3.0 GHz.

a. Check frequency response from 0.01 GHz to 21 GHz (Bands 1 through 5).

(1) Connect the CAL OUT signal to the RF INPUT, and perform the <SHIFT> CAL routine.

(2) Set the Spectrum Analyzer controls as follows:

FREQUENCY	100 MHz
FREQ SPAN/DIV	500 kHz
RESOLUTION	1 MHz
REF LEVEL	-20 dBm
VERTICAL DISPLAY	2 dB/DIV
MIN RF ATTN dB	0
TIME/DIV	AUTO
PEAK/AVERAGE	Fully Counterclockwise

(3) Set the CAL AMPL adjustment for 5 divisions on the Spectrum Analyzer display. This is the 100 MHz reference. Activate SAVE A to save the reference.

(4) Connect the test equipment as shown in Figure 4-10.

(5) Set the sweep oscillator controls for a cw output that matches the SAVE A display (output frequency of 100 MHz and an output amplitude of approximately -20 dBm).

(6) Deactivate SAVE A. Reset the FREQUENCY to 500 MHz, and SPAN/DIV to 100 MHz, and activate MAX HOLD.

(7) Reset the sweep oscillator controls for a sweep output from 0.01 GHz—1 GHz. Enable single sweep on the sweep oscillator.

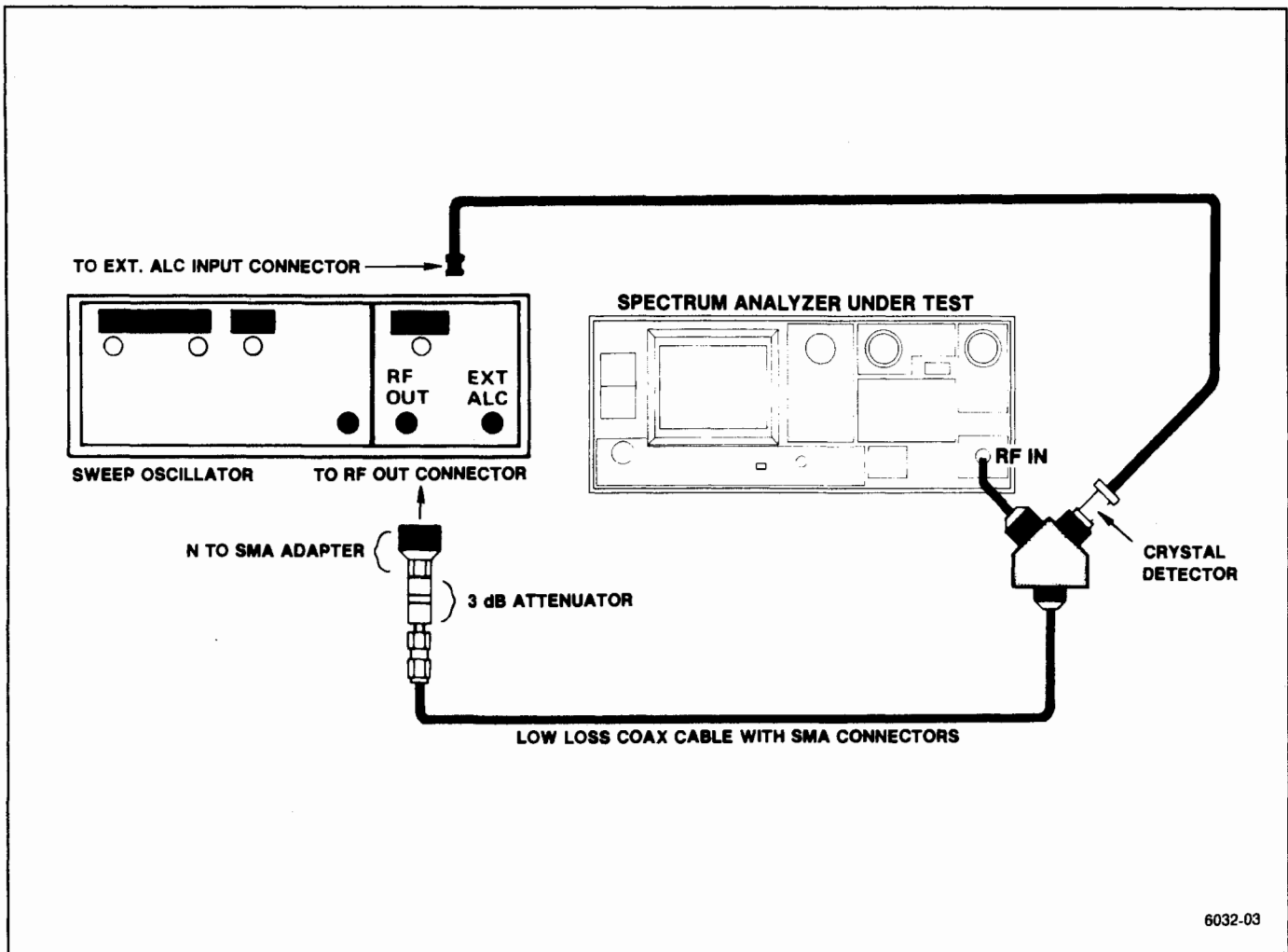

Figure 4-10. Test equipment setup for measuring 0.01 GHz to 21 GHz frequency response.

- (8) Check that amplitude deviation from the 100 MHz reference does not exceed ± 2.5 dB.
- (9) Make a note of the highest and lowest peaks for later comparison.
- (10) Deactivate MAX HOLD, and repeat parts 6 through 10 for frequencies up to 4.2 GHz using the values provided in Table 4-4.
- (11) Calculate the halfway point between the highest and the lowest peak from the peak data noted in parts 9 and 10.
- (12) Check that swept frequency flatness is within ± 1.5 dB in Band 1.

**Table 4-4
FREQUENCY RESPONSE CHECK SETTINGS**

Oscillator Sweep Range	Center Frequency	Span/Div
1—2 GHz	1.5 GHz	100 MHz
2—3 GHz	2.5 GHz	100 MHz
3—4 GHz	3.5 GHz	100 MHz
4—4.2 GHz	4.1 GHz	20 MHz

- (13) Switch the Spectrum Analyzer to Band 2 (<SHIFT> BAND Δ), FREQUENCY to 2.7 GHz, and SPAN/DIV to 200 MHz.
- (14) Reset the sweep oscillator controls for a sweep output from 1.7 GHz—3.7 GHz. Enable single sweep on the sweep oscillator.

NOTE

Before sweeping any range in Bands 2 through 5 in Option 01 Spectrum Analyzers, set the FREQUENCY to the center of the range; apply a cw signal at this center frequency; and peak the response by pushing the <SHIFT> PEAK MENU, and selecting item 3 (REPEAK).

- (15) Check that amplitude deviation from the 100 MHz reference does not exceed ± 2.5 dB.
- (16) Again, make a note of the highest and lowest peaks for later comparison.
- (17) Check frequency response in the range 3.7 GHz—5.5 GHz (FREQUENCY at 4.6 GHz and SPAN/DIV at 200 MHz). Continue making notes of the highest and lowest peaks for comparison later on.
- (18) Check Bands 3 through 5 according to Table 4-5. Be sure to make a note of the highest and lowest peaks after each check.

**Table 4-5
FREQUENCY RESPONSE CHECK SETTINGS FOR BANDS 3—5**

Oscillator Sweep Range	Center Frequency	Span/Div	Band No.
3—5.0 GHz	4.0 GHz	200 MHz	3
5—7.1 GHz	6.05 GHz	210 MHz	3
5.4—7.4 GHz	6.4 GHz	200 MHz	4
7.4—9.4 GHz	8.4 GHz	200 MHz	4
9.4—11.4 GHz	10.4 GHz	200 MHz	4
11.4—13.4 GHz	12.4 GHz	200 MHz	4
13.4—15.4 GHz	14.4 GHz	200 MHz	4
15.4—17.4 GHz	16.4 GHz	200 MHz	4
17.4—18.0 GHz	17.7 GHz	60 MHz	4
15—17.0 GHz	16.0 GHz	200 MHz	5
17—19.0 GHz	18.0 GHz	200 MHz	5
19—21.0 GHz	20.0 GHz	200 MHz	5

(19) Calculate the halfway point between the highest and the lowest peak from the peak data noted in parts 16 and 17.

(20) Check that swept frequency flatness is within ± 1.5 dB in Band 2 and Band 3, within ± 2.5 dB in Band 4, and within ± 3.5 dB in Band 5.

b. Check that the amplitude deviation from the 100 MHz reference does not exceed ± 1.5 dB from 50 kHz to 10 MHz (lower end of Band 1).

(1) Reconnect the test equipment as shown in Figure 4-11. Reset FREQUENCY to 10 MHz.

(2) Set the generator output for -20 dBm at 10 MHz, and set the Spectrum Analyzer controls as follows:

FREQUENCY	10 MHz
FREQ SPAN/DIV	500 kHz
RESOLUTION BANDWIDTH	1 MHz
REF LEVEL	-20 dBm
VERTICAL DISPLAY	2 dB/DIV
MIN RF ATTEN dB	0
TIME/DIV	AUTO
PEAK/AVERAGE	Fully Counterclockwise

(3) Manually tune the Signal Generator towards 50 kHz while simultaneously tuning the CENTER FREQUENCY control to hold the signal at center screen. Note amplitude deviation, and the highest and lowest peaks.

NOTE

As the Signal Generator is tuned towards 50 kHz, the RESOLUTION on the Spectrum Analyzer must be reset to 100 kHz when the generator output frequency reaches 2 MHz. Also, at approximately 200 kHz, the Spectrum Analyzer SPAN/DIV and RESOLUTION must be reset to 50 kHz and 10 kHz respectively to prevent the 0 Hz spur from interfering with the signal.

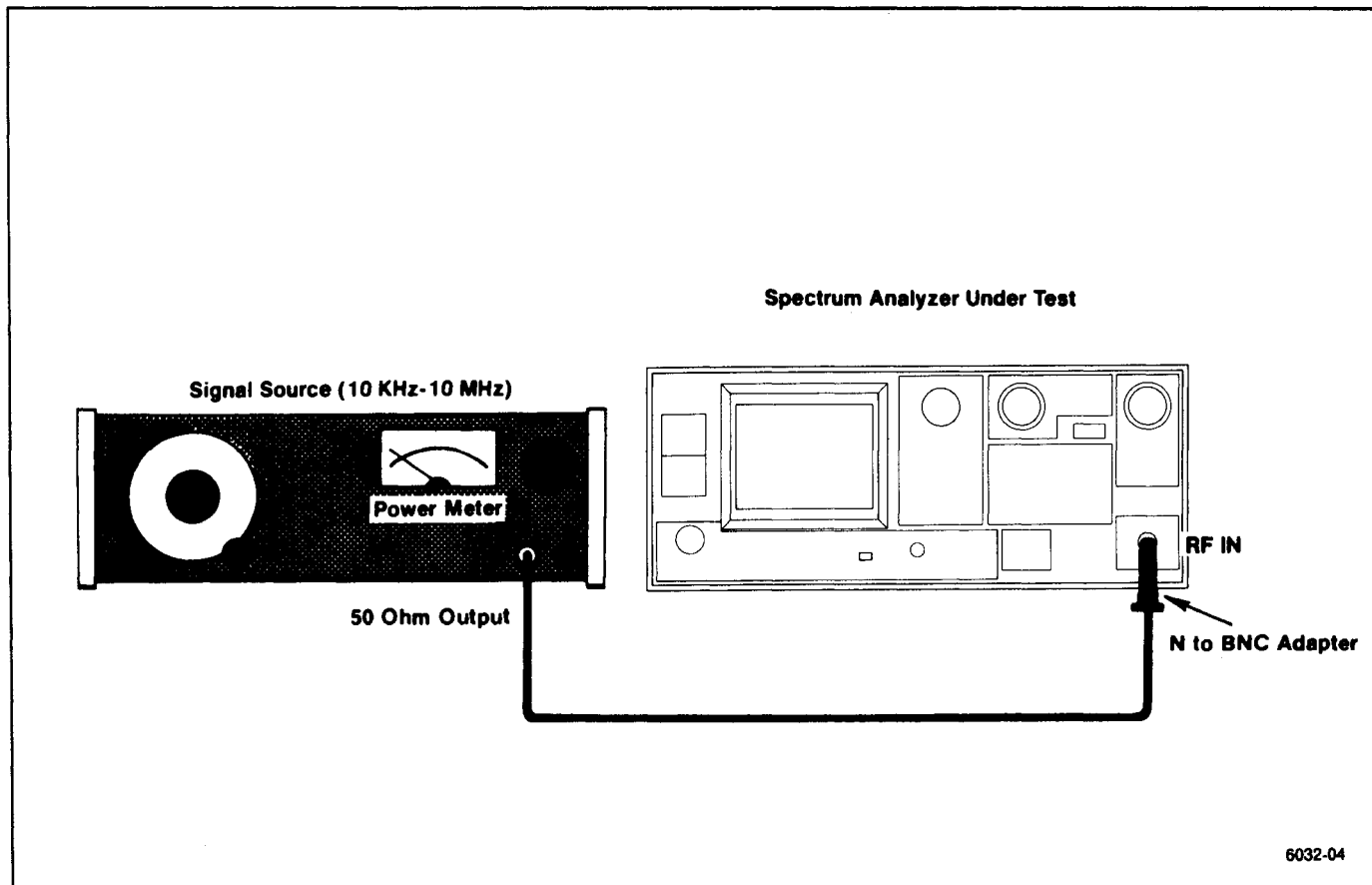

Figure 4-11. Test equipment setup for measuring 10 kHz to 10 MHz frequency response.

(4) Check that amplitude deviation from the 100 MHz reference does not exceed ± 2.5 dB. Also check that flatness is within ± 1.5 dB.

10. Check Display Dynamic Range and Accuracy

(80 dB in 10 dB/DIV mode, with an accuracy of ± 1.0 dB/10 dB to a maximum cumulative error of ± 2.0 dB over the 80 dB window; 16 dB in 2 dB/DIV mode with an accuracy of ± 0.4 dB/2 dB to a maximum cumulative error of ± 1.0 dB over the 16 dB window; Lin mode is $\pm 5\%$ of full scale)

a. Connect the test equipment as shown in Figure 4-12, using the 10 dB and 1 dB step attenuators. Set the Spectrum Analyzer controls as follows:

FREQUENCY	100 MHz
FREQ SPAN/DIV	20 kHz
AUTO RES	On
REF LEVEL	+10 dBm
MIN RF ATTEN	0 dB
VERTICAL DISPLAY	10 dB/DIV
NARROW VIDEO FILTER	On
PEAK/AVERAGE	Fully Clockwise
TIME/DIV	AUTO

b. Set the attenuators for 0 dB attenuation. Set the generator controls for a 100 MHz output frequency, and carefully set the output level such that the signal peak is at the top graticule line.

c. Add 80 dB of external attenuation in 10 dB steps and note that the signal steps down in 10 dB steps.

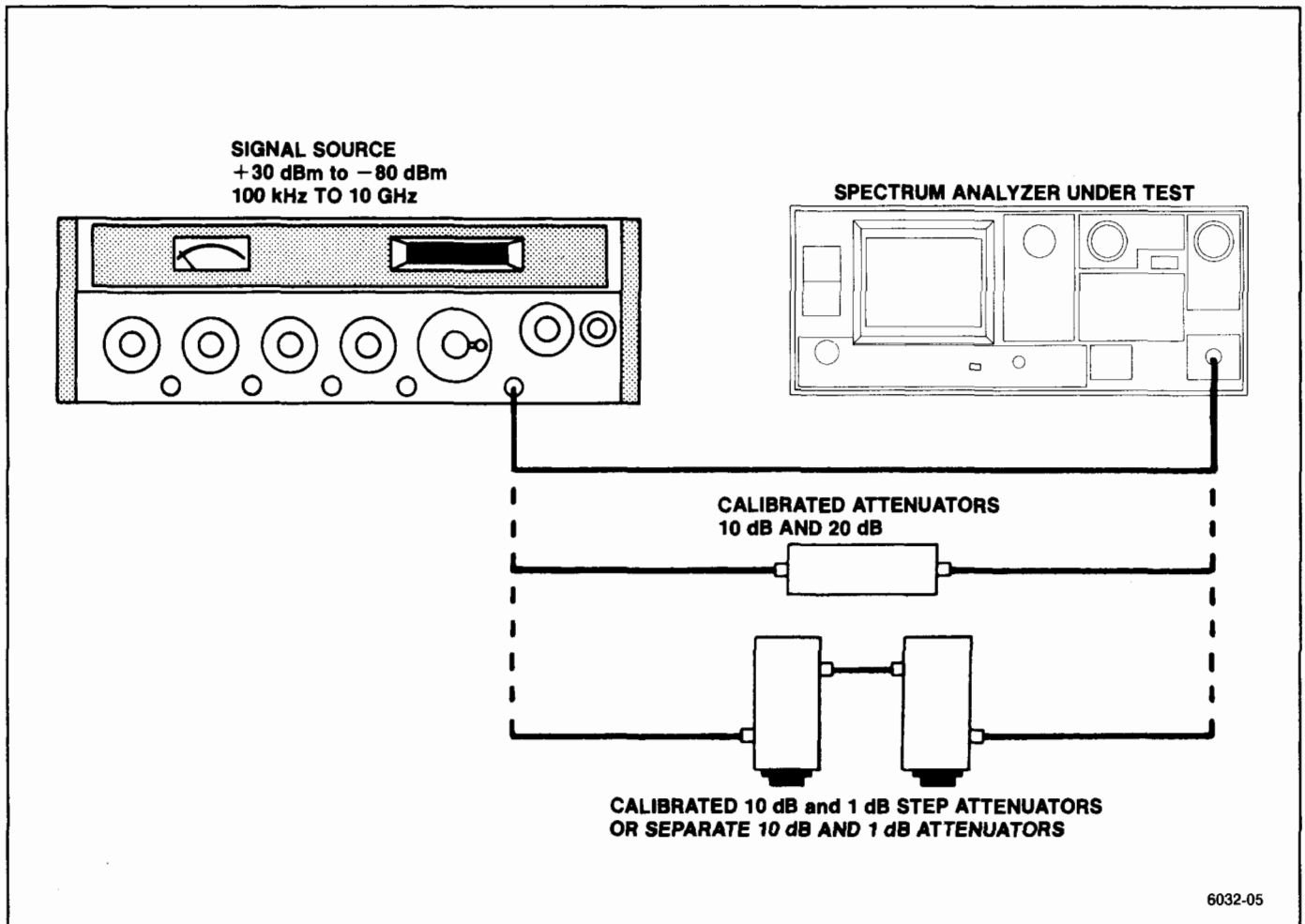

Figure 4-12. Test equipment setup for checking display accuracy.

d. Check that the signal steps down in 10 dB (± 1.0 dB) steps as attenuation is added. Maximum cumulative error should not exceed 2.0 dB over the 80 dB range.

e. Deactivate the NARROW VIDEO FILTER, return the external attenuation to 0 dB, and change the VERTICAL DISPLAY to 2 dB/DIV. Set the signal peak at the reference (top) graticule line, with the generator output control.

f. Add 16 dB of external attenuation in 2 dB steps, and note that the display steps down in 2 dB steps.

g. Check the display accuracy as attenuation is added. Error should not exceed ± 0.4 dB/2 dB step, or exceed a cumulative error of ± 1.0 dB over the 16 dB window.

h. Return the external attenuation to 0 dB. Change the VERTICAL DISPLAY to LIN. Set the signal generator output for a full screen display.

i. Check that the signal amplitude decreases to within ± 0.4 divisions of half screen as 6 dB of external attenuation is added.

j. Check that the signal amplitude decreases to within ± 0.4 divisions of 1/4 screen or half the previous amplitude as an additional 6 dB of attenuation is added.

k. Check that the signal amplitude decreases to within ± 0.4 divisions of 1/8 screen or half the last amplitude as an additional 6 dB of attenuation is added (for a total of 18 dB).

l. Return the VERTICAL DISPLAY to 10 dB/DIV and disconnect the generator from the RF INPUT.

11. Check Preselector Ultimate Rejection

This is a check of preselector operation, not a performance requirement specification. This check applies to the Option 01 instrument only.

a. Connect the test equipment as shown in Figure 4-12, omitting the step attenuators. Set the Spectrum Analyzer controls as follows:

FREQUENCY	3.5 GHz (Band 2)
FREQ SPAN/DIV	10 kHz
AUTO RES	On
REF LEVEL	0 dBm
VERTICAL DISPLAY	10 dB/DIV
MIN RF ATTEN	0 dB
WIDE VIDEO FILTER	On
TIME/DIV	AUTO

b. Set the generator controls for a full screen display output at 3.5 GHz. Peak the response by pushing <SHIFT> PEAK MENU, and selecting item 3 (REPEAK).

c. Change the FREQ RANGE to band 3 (3.0-7.1 GHz).

d. Check that spurious signals are at least 100 dB down from the level established in part b. Spurious signals above 100 dB down from the reference established in part b indicate that the YIG-tuned preselector filter could be defective.

12. Check RF Attenuator Accuracy (0 to 60 dB in 10 dB Steps)

(Within 0.5 dB/10 dB to a maximum of 1 dB over the 60 dB range from dc to 1.8 GHz; within 1.5 dB/10 dB to a maximum of 3 dB over the 60 dB range from 1.8 to 18 GHz; and within 3 dB/10 dB to a maximum of 6 dB over the 60 dB range from 18 to 21 GHz)

NOTE

This is a two part procedure. Part I checks the first 30 dB (0—30 dB) range of the rf attenuator, and Part II checks the remaining 30 dB (30 dB—60 dB) range.

PART I

a. Connect the test equipment as shown in Figure 4-13. Set the Spectrum Analyzer controls as follows:

CENTER FREQUENCY	Test Frequency
SPAN/DIV	200 kHz
RESOLUTION BANDWIDTH	100 kHz
REF LEVEL	-30 dBm
MIN RF ATTEN	0 dB
MIN NOISE	On
VERTICAL DISPLAY	2 dB/DIV
NARROW VIDEO FILTER	On
TIME/DIV	AUTO
PEAK/AVERAGE	Fully Clockwise
VIEW A and VIEW B	On

b. Set the power meter controls as follows:

Mode	Watts
Range Hold	Out
Power Reference	Out

c. Disconnect the power sensor from the power divider, and connect it to the the 1 mW/50 MHz reference output port through an appropriate adapter. Be sure that the 50 MHz reference is turned off.

d. On the power meter, press Sensor Zero and wait for the zero light to turn off. Repeat until a zero is attained.

e. On the power meter, set the 50 MHz reference on and set the Cal Factor switch to the 50 MHz reference. Set the power meter Cal Adj for a 1.000 mW reading.

f. Turn off the 50 MHz reference on the power meter, and reconnect the power sensor to the power divider.

g. Reset the power meter controls as follows:

Cal Factor	Test frequency
Mode	dBm
Range Hold	Out

h. Set the signal generator (HP 8350B/83595A) controls as follows:

Frequency Mode	CW
Frequency	Test Frequency
Output Level	≈-5 dBm

i. Set the generator controls for a -15 dBm power meter reading (approximately -5 dBm generator output level).

j. Tune the CENTER FREQUENCY control to bring the signal to center screen.

k. The Spectrum Analyzer should be displaying a signal of approximately -35 dBm.

l. Use the Spectrum Analyzer's AMPL CAL control to position the signal peak at a convenient graticule line, then activate SAVE A.

m. Establish a reference setting for the first 10 dB increment by pressing dB{Ref} on the power meter.

n. Reset the MIN RF ATTEN dB control to 10 and the REFERENCE LEVEL to -20 dBm. Reset the generator output level for a power meter reading of +10 dB (10 dB increase in output level).

o. Check that the difference between the SAVE A and VIEW B displays is less than 0.5 dB. Make a note of the level difference between the SAVE A and VIEW B displays.

p. To check the next 10 dB step, reset the generator for a 0 dB power meter reading, and replace the 20 dB attenuator with a 10 dB attenuator.

q. Repeat parts m through o, except that the next MIN RF ATTEN dB setting will be 20 and the reference level will be -10 dB (Table 4-6).

r. Repeat the procedure for the third 10 dB step using Table 4-6 as a guide for setup information for the third MIN RF ATTEN dB setting.

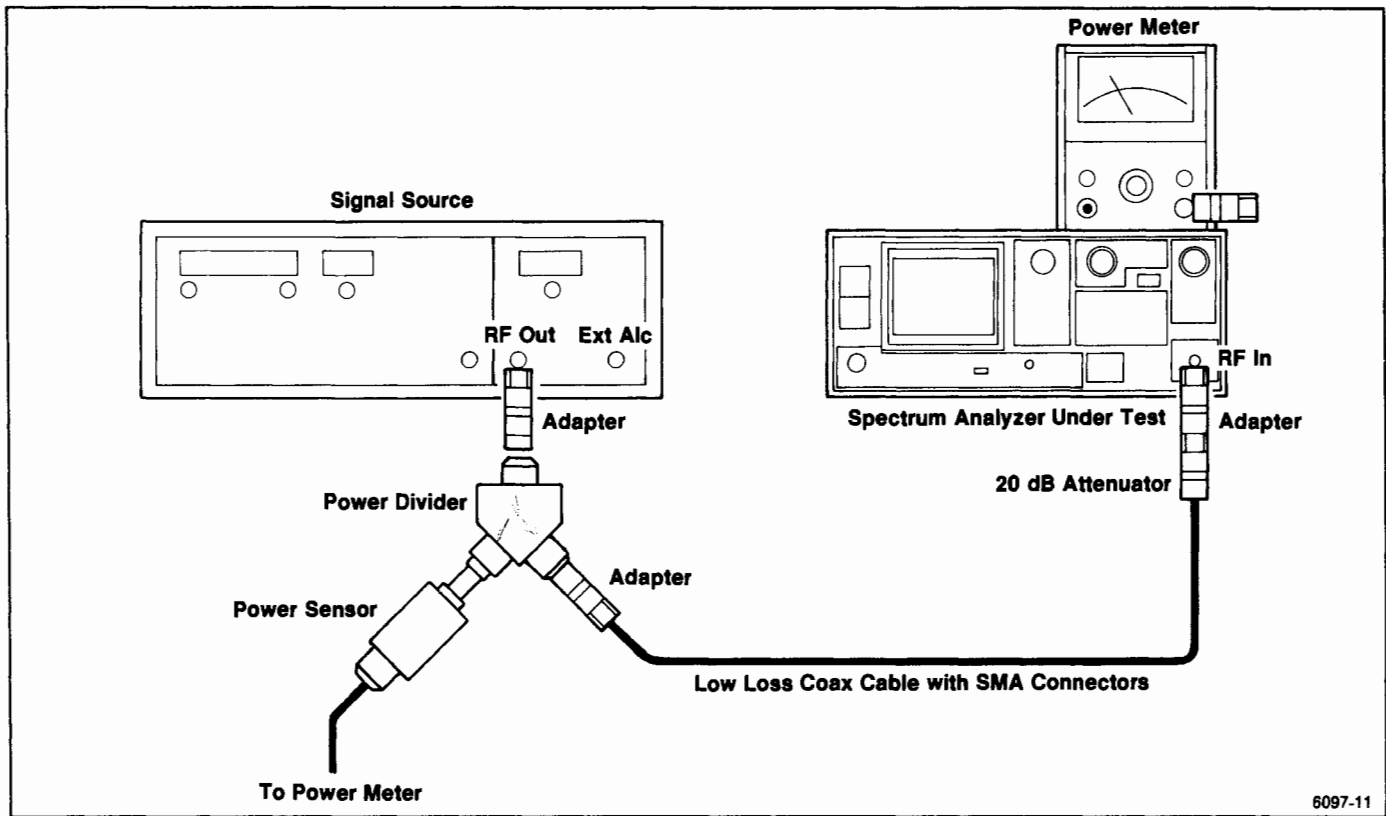

Figure 4-13. RF attenuator test equipment setup.

Table 4-6
0 TO 30 dB RF ATTENUATOR TEST SETTINGS

Spectrum Analyzer Reference Level	MIN RF ATTEN dB Setting	External Attenuator	Power Meter dB(Ref)	Power Meter dBm
-30 dBm	0 dB	20 dB	0 dB=Ref	≈-15 dBm
-20 dBm	10 dB	20 dB	+10 dB	≈-5 dBm
-20 dBm	10 dB	10 dB	0 dB=Ref	≈-15 dBm
-10 dBm	20 dB	10 dB	+10 dB	≈-5 dBm
-10 dBm	20 dB	0 dB	0 dB=Ref	≈-15 dBm
-0 dBm	30 dB	0 dB	+10 dB	≈-5 dBm

PART II

a. The 30—60 dB range is checked in the same fashion as the 0—30 dB range using different power levels because of the output level limitation of the signal generator.

b. Connect the test equipment as shown in Figure 4-13. Set the Spectrum Analyzer controls as follows:

CENTER FREQUENCY	Test Frequency
SPAN/DIV	200 kHz
RESOLUTION BANDWIDTH	100 kHz
REF LEVEL	-25 dBm
MIN RF ATTEN dB	30
MIN NOISE	On
VERTICAL DISPLAY	2 dB/DIV
NARROW VIDEO FILTER	On
TIME/DIV	AUTO
PEAK/AVERAGE	Fully Clockwise
VIEW A and VIEW B	On

c. Set the power meter controls as follows:

Mode	Watts
Range Hold	Out
Power Reference	Out

d. Disconnect the power sensor from the power divider, and connect it to the 1 mW/50 MHz reference output port through an appropriate adapter. Be sure that the 50 MHz reference is turned off.

e. On the power meter, press Sensor Zero and wait for the zero light to turn off. Repeat until a zero is attained.

f. On the power meter, set the 50 MHz reference on and set the Cal Factor switch to the 50 MHz reference. Set the power meter Cal Adj for a 1.000 mW reading.

g. Turn off the 50 MHz reference on the power meter, and reconnect the power sensor to the power divider.

h. Reset the power meter controls as follows:

Cal Factor	Test frequency
Mode	dBm
Range Hold	Out

i. Set the generator controls for a maximum power meter reading, then reduce the generator output level until the meter reads 11 dB less than the maximum.

j. Tune the CENTER FREQUENCY control to bring the signal to center screen. The REF LEVEL may have to be varied slightly to obtain a convenient on-screen display.

k. Use the Spectrum Analyzer's AMPL CAL control to position the signal peak at a convenient graticule line, then activate SAVE A.

l. Establish a reference setting for the first 10 dB increment by pressing dB{Ref} on the power meter.

m. Increase the MIN RF ATTEN dB setting by 10 and reset the REFERENCE LEVEL 10 dB higher than the level set in part j. Reset the generator output level for a power meter reading of +10 dB. Refer to Table 4-7 for setup information at each rf attenuator setting.

n. Check that the difference between the SAVE A and VIEW B displays is less than 0.5 dB. Make a note of the level difference between the SAVE A and VIEW B displays.

o. Continue to check the second and third attenuator steps using Table 4-7 as a guide for setup information. Make a note of the level difference at each step setting between the SAVE A and VIEW B displays.

p. Using the data noted in step o of Part I and steps n and o of Part II, check that deviation over the entire 60 dB range is less than 1 dB.

Table 4-7
30 TO 60 dB RF ATTENUATOR TEST SETTINGS

Spectrum Analyzer Reference Level	MIN RF ATTEN dB Setting	External Attenuator	Power Meter dB(Rel)	Power Meter dBm
-25 dBm	30 dB	20 dB	0 dB-Ref	(Maximum - 11 dBm)
-15 dBm	40 dB	20 dB	+10 dB	(Maximum - 1 dBm)
-15 dBm	40 dB	10 dB	0 dB-Ref	(Maximum - 11 dBm)
-5 dBm	50 dB	10 dB	+10 dB	(Maximum - 1 dBm)
-5 dBm	50 dB	0 dB	0 dB-Ref	(Maximum - 11 dBm)
+5 dBm	60 dB	0 dB	+10 dB	(Maximum - 1 dBm)

Table 4-8
CORRECTION FACTOR TO DETERMINE TRUE SIGNAL LEVEL

dB Ratio of Signal Plus Noise	3.0	4.0	5.0	6.0	7.0	8.0	9.0	10.0	12.0	14.0
Deduct Correction Factor	3.0	2.20	1.65	1.26	0.97	0.75	0.58	0.46	0.28	0.18

13. Check IF Gain Accuracy

(±0.2 dB/dB to a maximum of ±0.5 dB/9 dB except at the decade transitions of -29 dBm to -30dBm, -39 dBm to -40 dBm, -49 dBm to -50 dBm, and -59 dBm to -60 dBm where an additional 0.5 dB can occur for a total of 1 dB/decade. Maximum deviation over the full 97 dB range is within ±2 dB, measured in Min Noise mode)

NOTE

This check requires calibrated attenuators as the standard to check the 10 dB and 1 dB steps. When making signal measurements within 10 dB of the noise floor, a correction factor should be used to correct for the logarithmic addition of noise in the system and analyzer, as shown in Table 4-8.

a. Connect the test equipment as shown in Figure 4-12, using the calibrated 10 dB and 1 dB attenuators (or connect the output of the generator directly to the RF INPUT if individual fixed attenuators are to be used as the standard). Set the Spectrum Analyzer controls as follows, using the Data Entry keypad when necessary:

FREQUENCY	100 MHz
FREQ SPAN/DIV	10 kHz
RESOLUTION BANDWIDTH	10 kHz
REF LEVEL	-10 dBm
MIN RF ATTEN	0 dB
VERTICAL DISPLAY	1 dB/DIV
WIDE VIDEO FILTER	On
TIME/DIV	AUTO
SAVE A	Off

b. Set the generator controls for a 100 MHz output frequency, and a signal amplitude of six divisions.

c. Activate MIN NOISE and note signal level shift. Level shift must not exceed ±0.8 dB, or 4 minor divisions (attenuator plus gain accuracies).

d. Set the output of the signal generator to reposition the signal level at the 6th graticule line.

e. Switch the REF LEVEL from -10 dBm to -20 dBm in 1 dB steps, adding 1 dB of external attenuation at each step. Note incremental accuracy and the 10 dB gain accuracy. Incremental accuracy must be within 0.2 dB/dB. Maximum cumulative error must not exceed 0.5 dB except when stepping from the 9 dB to 10 dB increment, where the error could be an additional 0.5 dB.

f. Deactivate MIN NOISE. Return the 1 dB step attenuator to 0 dB, decrease the output of the signal generator by 10 dB or add 10 dB of external attenuation. Reset the generator output so the signal level is again at the 6th graticule line.

g. Change the REF LEVEL from -20 dBm to -30 dBm, in 1 dB increments, with the 1 dB step attenuator, and note incremental and 10 dB step accuracies.

h. Return the 1 dB step attenuator to 0 dB. Decrease the signal level by 10 dB with external attenuation, or with the signal generator output level control, then re-establish the signal reference amplitude.

i. Check the -30 dBm to -40 dBm gain accuracies as in part e.

j. Repeat the procedure checking gain accuracies to -60 dBm.

k. Establish a signal reference amplitude of -60 dBm, activate NARROW VIDEO FILTER, then check gain accuracy to -70 dBm.

l. Decrease the RESOLUTION BANDWIDTH and FREQ SPAN/DIV to 1 kHz. Re-establish a signal reference level of -70 dBm as described previously.

m. Check the -70 dBm to -80 dBm gain accuracies by repeating the process previously described.

n. Decrease the RESOLUTION BANDWIDTH to 1 kHz and FREQ SPAN/DIV to 200 Hz. Reestablish the signal reference level and check the -80 dBm to -90 dBm and -90 dBm to -100 dBm gain accuracies. These ranges are directly related to the -60 dBm to -70 dBm check (part d-m).

14. Check Gain Variation Between Resolution Bandwidths

(Less than ± 0.4 dB with respect to the 1 MHz filter and $\leq \pm 0.8$ dB between any two filters)

Before performing this check, do a front panel CAL procedure by pressing <SHIFT> CAL and performing the steps prompted by the spectrum analyzer.

a. Apply the CAL OUT signal to the RF INPUT, and set the Spectrum Analyzer controls as follows:

FREQUENCY	100 MHz	
FREQ SPAN/DIV	100 kHz	
RESOLUTION BANDWIDTH	1 MHz	
REF LEVEL	-18 dBm	
MIN RF ATTEN	0 dB	
VERTICAL DISPLAY	1 dB/DIV	(Use Data Entry Keypad)
MIN NOISE	On	
TIME/DIV	AUTO	

b. Activate the ΔA mode by pressing FINE.

c. Reset the REFERENCE LEVEL control to position the calibrator signal at the 7th graticule line (1 major division from the top), then activate SAVE A to store the 1 MHz amplitude.

d. Change the RESOLUTION BANDWIDTH to 100 kHz and FREQ SPAN/DIV to 10 kHz.

e. Check that amplitude deviation from the 1 MHz reference is no more than ± 0.4 dB.

f. Change the RESOLUTION BANDWIDTH to 1 kHz and the FREQ SPAN/DIV to 1 kHz.

g. Check that amplitude deviation from the 1 MHz reference level is no more than ± 0.4 dB.

h. Change the RESOLUTION BANDWIDTH to 1 kHz and the FREQ SPAN/DIV to 200 Hz.

i. Check that the amplitude deviation from 1 MHz is no more than ± 0.4 dB.

j. Check variation between any two filters (0.8 dB) by finding the filter that has the lowest amplitude, saving it on the "A" trace, and comparing the other filters to the saved trace.

**Table 4-9
SENSITIVITY
EQUIVALENT INPUT NOISE (dBm) VERSUS RESOLUTION BANDWIDTH^a**

Band/Frequency	1 MHz	300 kHz ^b	100 kHz	10 kHz	1 kHz
Band 1-3 50 kHz - 7.1 GHz	-85	-90	-95	-105	-115
Band 4 5.4 - 12.0 GHz	-70	-75	-80	-90	-100
Band 4-5 12.0-21.0 GHz	-65	-70	-75	-85	-95

15. Check Sensitivity

(Refer to Table 4-9)

NOTE

Sensitivity is specified according to the input mixer average noise level. The Calibrator signal is the reference used to calibrate the display.

a. Remove the CAL OUT signal from the RF INPUT, and terminate the RF INPUT with its characteristic impedance. Set the Spectrum Analyzer controls as follows:

- | | |
|----------------------|-----------------|
| FREQ RANGE | 0—4.2 GHz |
| FREQ SPAN/DIV | MAX |
| RESOLUTION BANDWIDTH | 1 MHz |
| REF LEVEL | -50 dBm |
| MIN RF ATTEN | 0 dB |
| VERTICAL DISPLAY | 10 dB/DIV |
| WIDE VIDEO FILTER | On |
| PEAK/AVERAGE | Fully Clockwise |
| TIME/DIV | 1 s |

b. Check that the noise floor (level) is down 85 dB or more as per Table 4-9 (35 dB down or more from the -50 dBm REF LEVEL).

c. Reset the RESOLUTION BANDWIDTH to 100 kHz.

d. Check that the noise floor (level) is down 95 dB or more as per Table 4-9 (45 dB down or more from the -50 dBm REF LEVEL).

e. Reset the RESOLUTION BANDWIDTH to 10 kHz, and activate the NARROW VIDEO FILTER.

f. Check that the noise floor (level) is down 105 dB or more as per Table 4-9 (55 dB down or more from the -50 dBm REF LEVEL).

g. Reset the RESOLUTION BANDWIDTH to 1 kHz.

h. Check that the noise floor (level) is down 115 dBm or more as per Table 4-9 (65 dB down or more from the -50 dBm REF LEVEL).

i. Repeat this procedure for the remaining coaxial input frequency range (0 to 21 GHz)

^a Equivalent maximum input noise (average noise for each resolution bandwidth with internal mixer).

^b Option 07 replaces the 100 kHz filter with a 300 kHz filter.

16. Check Residual Spurious Response

(With no input signal, -100 dBm or less, with reference to the mixer input and fundamental mixing for Bands 1-3)

a. Remove any signal connected to the RF INPUT, and terminate the RF INPUT in 50 ohms. Set the Spectrum Analyzer controls as follows:

FREQUENCY	50 MHz
FREQ SPAN/DIV	10 MHz
RESOLUTION BANDWIDTH	10 kHz
REF LEVEL	-50 dBm
MIN RF ATTEN	0 dB
VERTICAL DISPLAY	10 dB/DIV
TIME/DIV	AUTO
PEAK/AVERAGE	ccw

b. Scan the frequency range of bands 1, 2, or 3 in 100 MHz increments. Note the amplitude of any spurious response. Spurious amplitude must not exceed -100 dBm. (Push <SHIFT> STEP SIZE. This allows changing center frequency in 50 MHz increments by use of the + STEP function.)

17. Check Intermodulation Distortion

(Third order products at least 70 dB down from any two on-screen signals, within any frequency span in Band 1)

a. Connect the test equipment as shown in Figure 4-14, and set the Spectrum Analyzer controls as follows:

FREQ RANGE	0-4.2 (Band 1)
FREQ SPAN/DIV	5 MHz
RESOLUTION BANDWIDTH	100 kHz
REF LEVEL	-30 dBm
MIN RF ATTEN	0 dB
VERTICAL DISPLAY	10 dB/DIV
TIME/DIV	AUTO

b. Set the generator outputs approximately 2 MHz apart within the frequency range of band 1, and set the output levels for full screen signals.

c. Decrease the separation of the generator frequencies to 1 MHz. Reset the FREQ SPAN/DIV to 500 kHz and RESOLUTION BANDWIDTH to 10 kHz.

d. Check that the third order IM products are at least 70 dB down from the input signal level. See Figure 4-15.

NOTE

Use the Video Filter and very slow sweep rates to help resolve these sidebands.

e. Decrease the signal separation and FREQ SPAN/DIV settings and re-check for sidebands. Check for IM products at other spans of the frequency range. IM products should be -70 dBc or more.

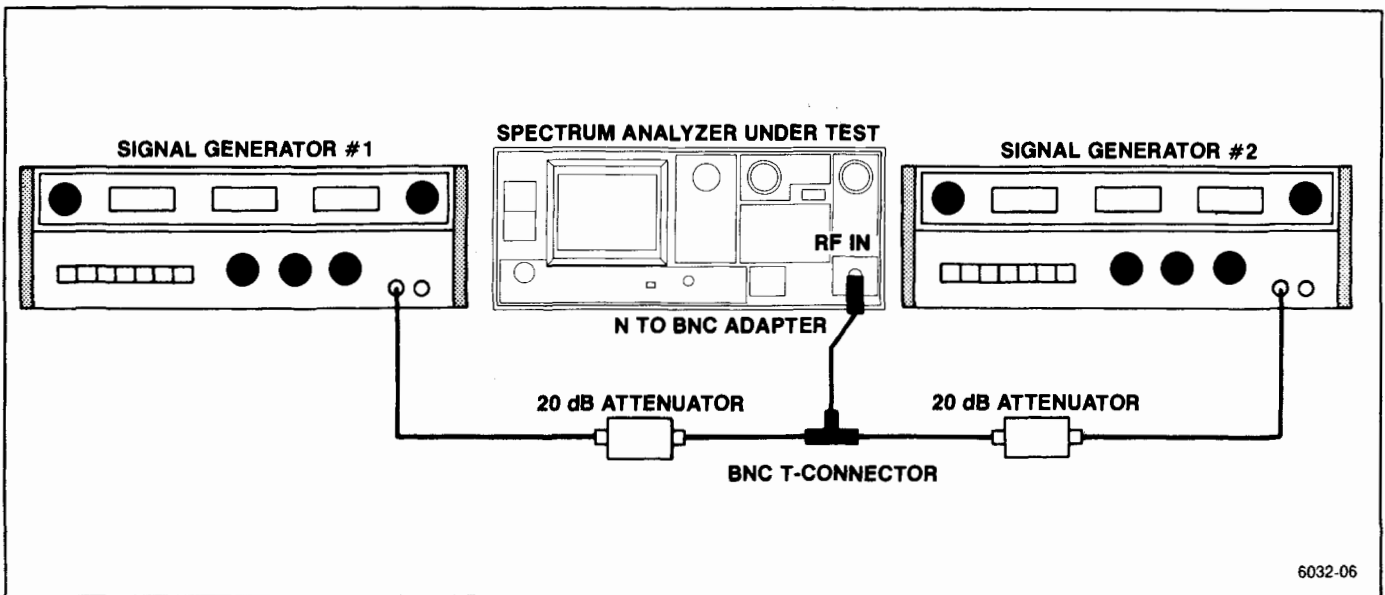

Figure 4-14. Test equipment setup for checking Intermodulation distortion.

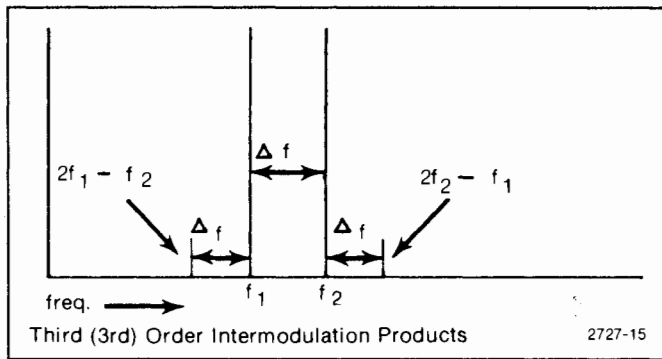

Figure 4-15. Intermodulation products.

f. Change the FREQUENCY RANGE to Band 2 (1.7 - 5.5 GHz), FREQ SPAN/DIV to 50 MHz, and RESOLUTION BANDWIDTH to 100 kHz.

g. Reset the generator outputs approximately 2 MHz apart within the frequency range of band 2, and set the output levels for full screen signals. Reduce the FREQ SPAN/DIV and RESOLUTION BANDWIDTH so the noise floor is at least 70 dB down from the reference level.

h. Check that IM products are at least 70 dB down from the input signal level or top of the screen.

18. Check Harmonic Distortion

(-60 dBc or less from 50 kHz to 21 GHz, tested at -40 dBm in MIN DISTORTION mode)

a. Connect the test equipment as shown in Figure 4-16, and set the Spectrum Analyzer controls as follows:

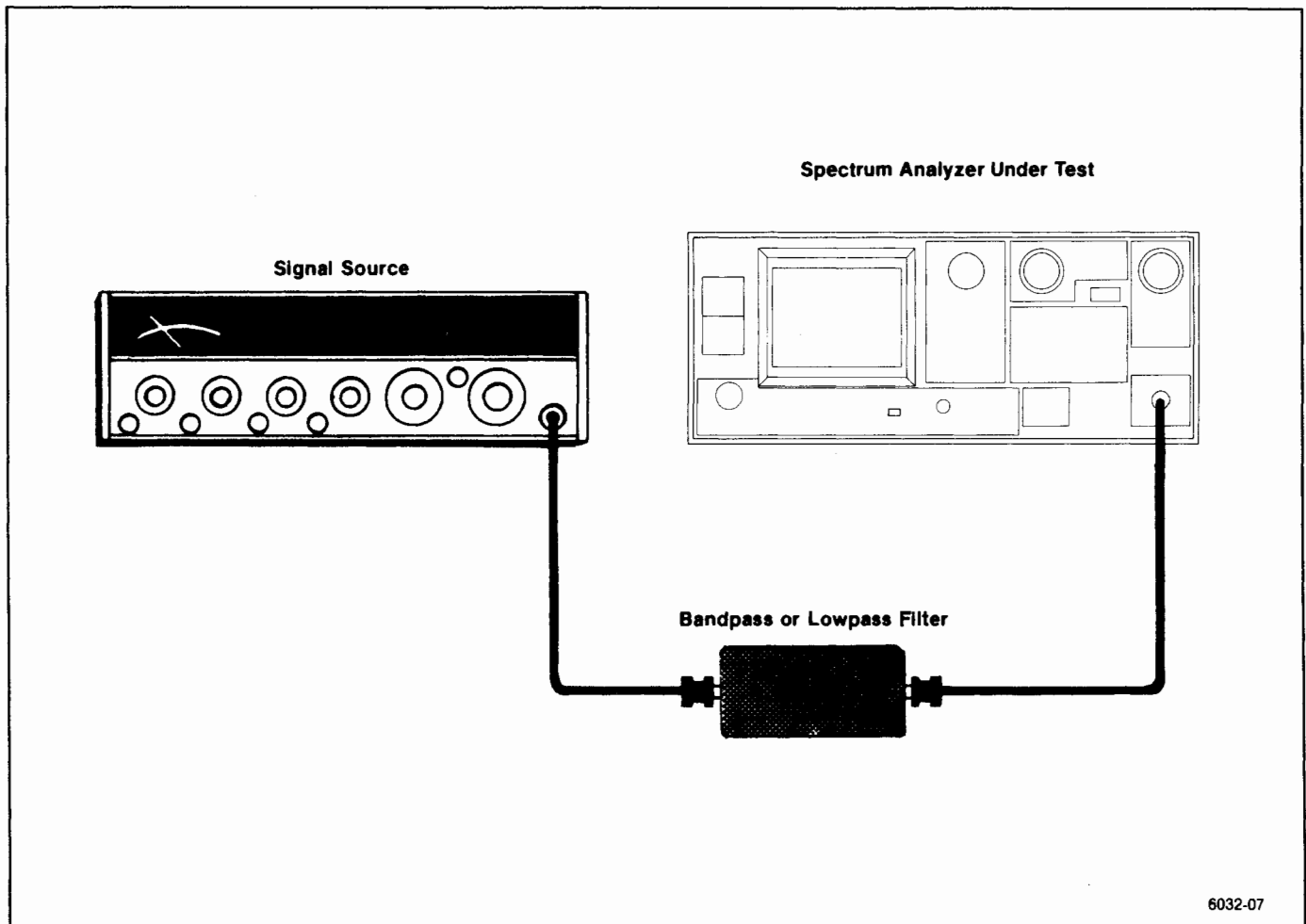

Figure 4-16. Test equipment setup for checking harmonic distortion.

FREQUENCY	same as the signal generator
FREQ SPAN/DIV	5 MHz
AUTO RES	On
REF LEVEL	-40 dBm
MIN RF ATTEN	0 dB
VERTICAL DISPLAY	10 dB/DIV
WIDE VIDEO FILTER	On
MIN DISTORTION	On
VIEW A and VIEW B	On
TIME/DIV	AUTO

b. Adjust the generator frequency for maximum amplitude and set the generator output level for a full screen (-40 dBm) signal.

NOTE

In Figure 4-16, the filter shown must have a minimum of 40 dB rolloff to attenuate multiples of the generator frequency, and the frequency of the signal generator depends on the frequency characteristics of the filter.

c. Set the CENTER FREQUENCY to (2 X Input Frequency), FREQ SPAN/DIV to 500 kHz, and the RESOLUTION BANDWIDTH to 10 kHz.

d. Check that the second harmonic of the input signal is at least 60 dB below the -40 dBm carrier.

e. Set the CENTER FREQUENCY to the 3rd harmonic.

f. Check that the third harmonic of the input signal is at least 60 dB down from the -40 dBm carrier.

19. Check LO Emission

(-10 dBm or less to 21 GHz) (-70 dBm or less for Option 01)

a. Monitor the RF INPUT with a high frequency spectrum analyzer such as a 492A or 2755. Set the test spectrum analyzer controls as follows.

Center Frequency	2072 MHz
Span/Div	2 MHz
Min RF Atten dB	0
Vertical Display	10 dB/DIV
Time/Div	Auto
Triggering	Free Run
Baseline Clip	Off
Reference Level	-70 dBm
Auto Resolution	On
View A and View B	On
Video Filter	Wide
Peak/Average	Fully Clockwise

b. Set the Spectrum Analyzer under test as follows.

CENTER FREQUENCY	0 Hz
REF LEVEL	-30 dBm
SPAN/DIV	100 kHz
MIN RF ATTEN dB	0
PEAK/AVERAGE	Fully Clockwise

c. Check for any indication of LO emission. LO emission must be less than -10 dBm (-70 dBm for Option 01).

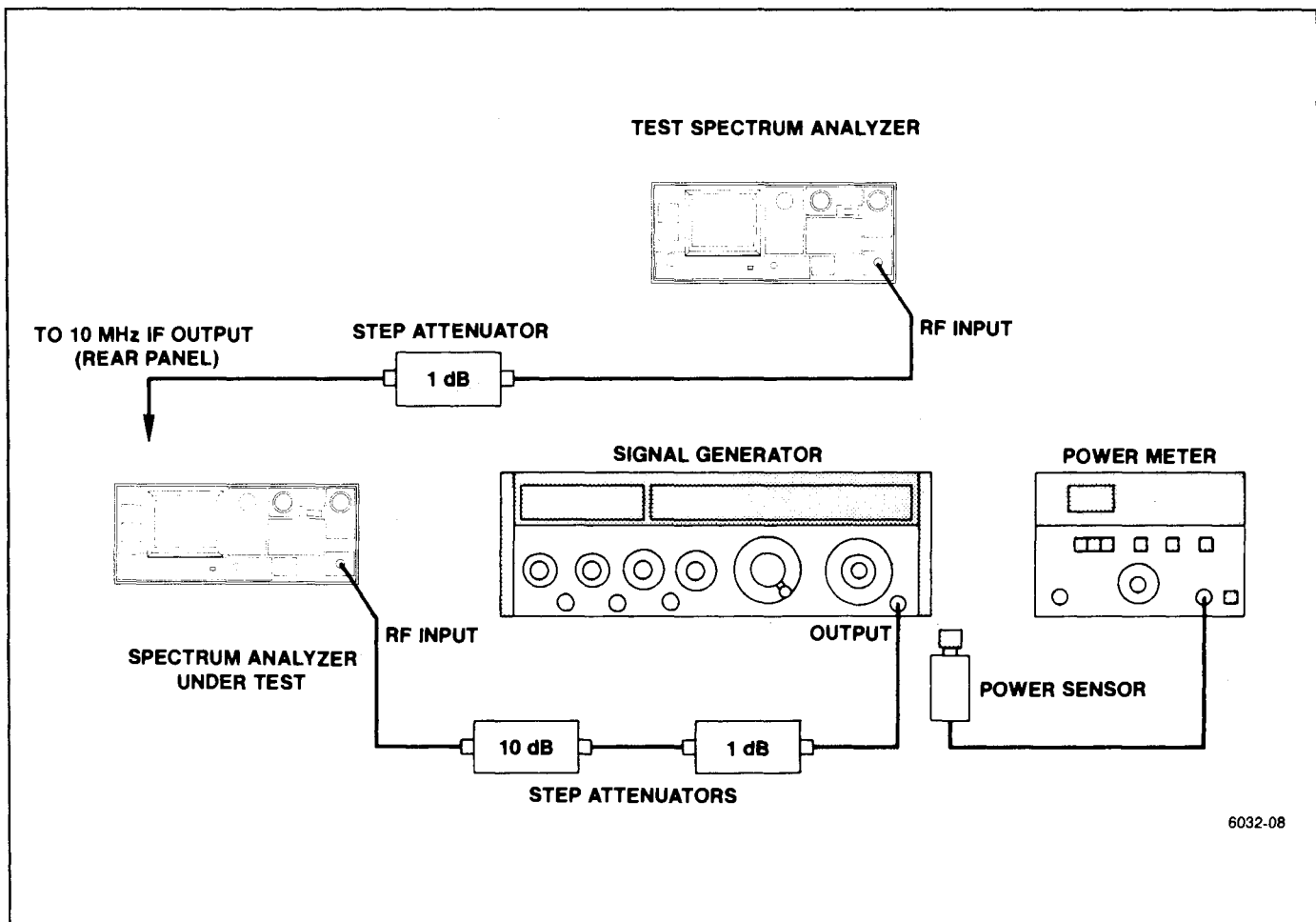

Figure 4-17. Test equipment setup for checking 1 dB input compression point.

20. Check 1 dB Compression Point

(-20 dBm Bands 1 through 5)

NOTE

Calibrate the power meter before making this measurement.

a. Use the power meter to set the output level of a signal generator to 0 dBm at 1.7 GHz. Be sure not to disturb the output level setting of the generator.

b. Connect the test equipment as shown in Figure 4-17, using the generator with the calibrated output level. Set the Spectrum Analyzer controls as follows:

FREQUENCY	1.7 GHz
FREQ SPAN/DIV	100 kHz
AUTO RES	On
REF LEVEL	-30 dBm
MIN RF ATTEN	0 dB
VERTICAL DISPLAY	10 dB/DIV
VIEW A and VIEW B	On
TIME/DIV	AUTO

c. Set the attenuators for 25 dB of attenuation.

d. Monitor the 10 MHz IF output on the rear panel with a test spectrum analyzer through a 1 dB step attenuator. Set this step attenuator for 0 dB of attenuation.

e. Set the test spectrum analyzer controls as follows:

Center Frequency	10 MHz
Frequency Span/Div	1 MHz
Resolution	Auto
Ref Level	-20 dBm
Vertical Display	2 dB/Div
Time/Div	Auto

Adjust the generator frequency to center the signal displayed by the spectrum analyzer.

f. Activate ZERO ^{BUT} SPAN and set the CENTER FREQUENCY control to maximize the 10 MHz signal on the test spectrum analyzer display.

g. Reset the test spectrum analyzer reference level for a four division excursion of the signal.

h. Increase the input signal level to the Spectrum Analyzer by switching out 1 dB of attenuation between the signal generator and the RF INPUT. Add 1 dB of attenuation between the 10 MHz IF output and the test spectrum analyzer.

i. Check that the 10 MHz IF output level on the test spectrum analyzer display remains constant as 1 dB of attenuation is removed from the generator output path and inserted in the 10 MHz IF output path.

j. Continue to increase the input signal level to the RF INPUT by 1 dB increments while increasing the attenuation between the 10 MHz IF output and the test spectrum analyzer until the signal amplitude decreases

1 dB (0.5 division). This is the 1 dB compression point.

k. Check that the 1 dB compression point occurs at -20 dBm or less (20 dB or less attenuation between the generator and the RF INPUT).

21. Check Triggering Operation and Sensitivity

{(2.0 divisions or more for internal trigger, and 1.0 V peak for external trigger (15 Hz to 1 MHz))}

a. Connect the test equipment as shown in Figure 4-18.

b. Set the Spectrum Analyzer controls as follows:

FREQUENCY	100 MHz
FREQ SPAN/DIV	10 kHz
RESOLUTION BANDWIDTH	1 MHz
REF LEVEL	-30 dBm
VERTICAL DISPLAY	LIN
TRIGGERING	INT
TIME/DIV	5 ms
VIEW A and VIEW B	Off

c. Set the signal source output amplitude for -30 dBm, and an output frequency of 100 MHz. Note that the signal source will be modulated by the function generator.

d. Decrease the output of the signal source so the display is half screen, then modulate the signal source with a 1 kHz sine wave.

e. Activate ZERO SPAN and, if necessary, reset the CENTER FREQUENCY control for maximum response.

f. Set the function generator output for a modulation amplitude of two divisions.

g. Check the internal trigger operation in the 15 Hz through 1 MHz frequency range.

NOTE

Because of deflection amplifier response, the display amplitude will decrease at the high frequency end. The triggering signal can also be applied to the MARKER/VIDEO connector on the rear panel if a jumper is connected between pins 1 and 5 (Video Select) of the rear-panel ACCESSORIES connector (Figure 4-19).

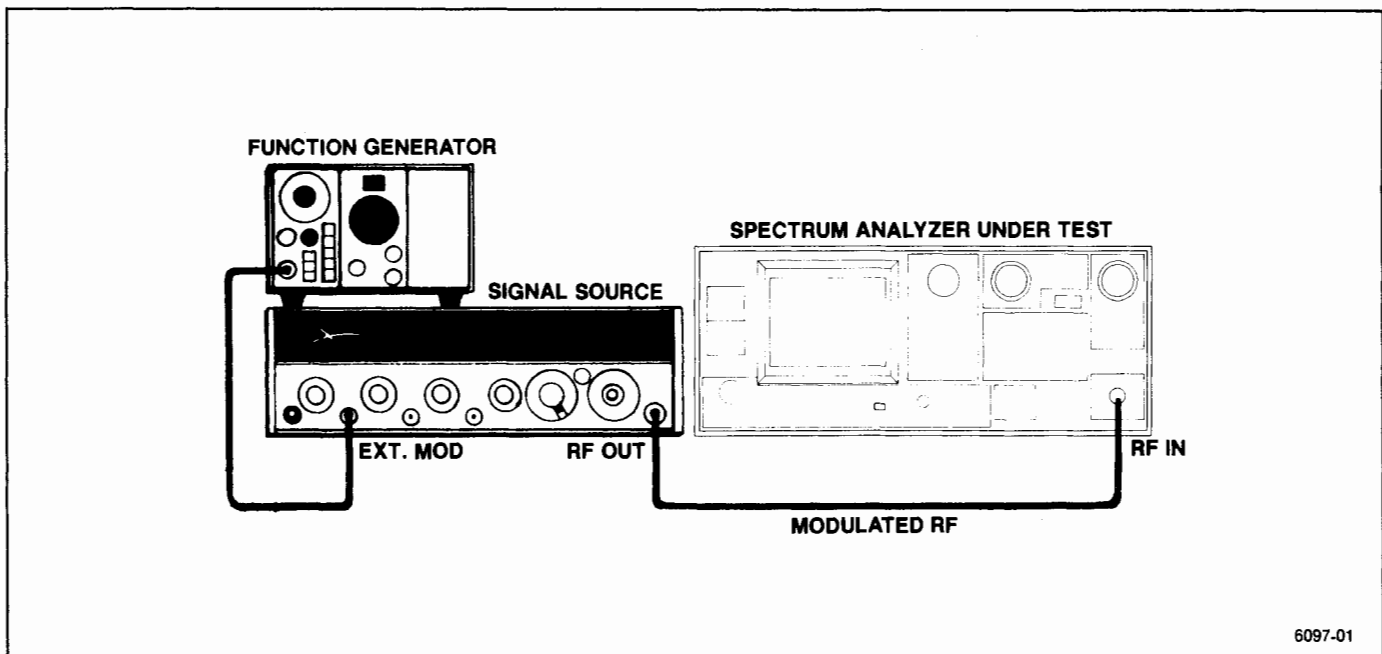

Figure 4-18. Test equipment setup for checking internal trigger characteristics.

h. Reconnect the test equipment as shown in Figure 4-20.

i. Set the function generator output frequency at 1 kHz, and output level at 2 V peak-to-peak, as indicated on the test oscilloscope.

j. Activate EXT TRIGGERING.

k. Check that the sweep is triggered over the frequency range of 15 Hz to 1 MHz.

l. Return the TRIGGERING to FREE RUN and the input signal level to 0 V.

22. Check External Sweep Operation

{0 to 10 V (dc + peak ac) ± 1 V for a full screen deflection}

This is an operational check, not a performance requirement.

a. Connect the test equipment as shown in Figure 4-20. Set the Spectrum Analyzer controls as follows:

VERTICAL DISPLAY	2 dB/DIV
TIME/DIV	EXT
VIEW A and VIEW B	Off

b. Set the function generator controls for no output (0 V).

c. Use the POSITION control to position the crt beam on the left graticule edge. This establishes the 0 V reference.

d. Reset the function generator output frequency to 1 kHz, and increase its output level for a full 10-division sweep on the Spectrum Analyzer.

e. Check that the function generator output level is 20 V peak-to-peak ± 2 V.

NOTE

A variable voltage source can be used in place of the function generator to check external sweep operation. If used, the range would be 0V to +10 V.

f. Disconnect and remove the test equipment. Return TIME/DIV to AUTO.

23. Check VERT OUTPUT Signal

(0.5 V $\pm 5\%$ per division of display from the center-line)

This is an operational check, not a performance requirement.

a. Monitor the VERT OUTPUT with a dc-coupled test oscilloscope.

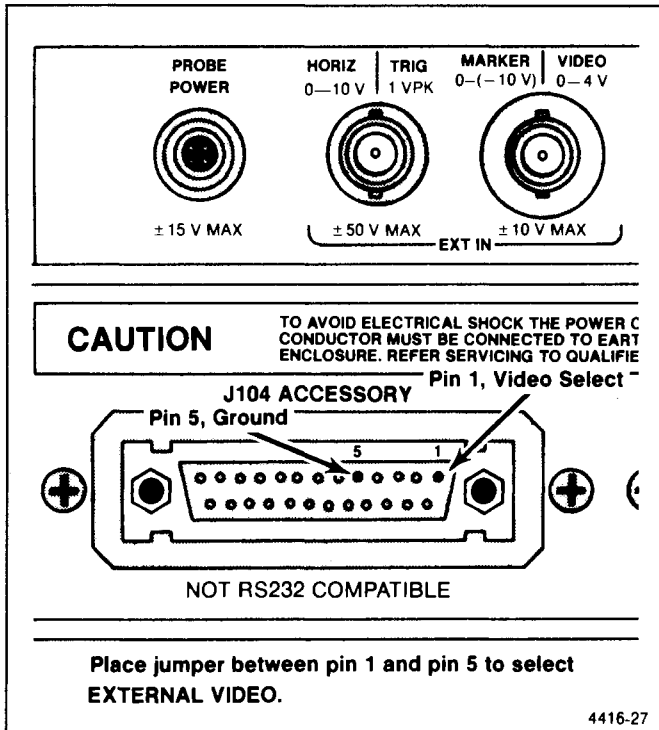

Figure 4-19. External video select pins on ACCESSORIES connector and input to the MARKER | VIDEO for signal to check internal triggering.

b. Set the test oscilloscope controls for a sensitivity of 1 V/div and a sweep rate of 10 ms.

c. Set the Spectrum Analyzer controls as follows:

FREQUENCY	100 MHz
FREQ SPAN/DIV	100 kHz
RESOLUTION BANDWIDTH	100 kHz
REF LEVEL	-20 dBm
VERTICAL DISPLAY	2 dB/DIV
VIEW A and VIEW B	Off
TRIGGERING	FREE RUN
TIME/DIV	AUTO

d. Apply the CAL OUT signal to the RF INPUT and verify that the signal amplitude is full screen.

e. Check that the amplitude of the VERT OUTPUT signal is 4 V peak-to-peak ± 0.2 V centered around 0 Vdc as displayed on the test oscilloscope. See Figure 4-21.

24. Check HORIZ OUTPUT Signal Level

(0.5 V/division $\pm 5\%$ either side of center)

This is an operational check, not a performance requirement.

a. Monitor the HORIZ OUTPUT with a dc-coupled test oscilloscope.

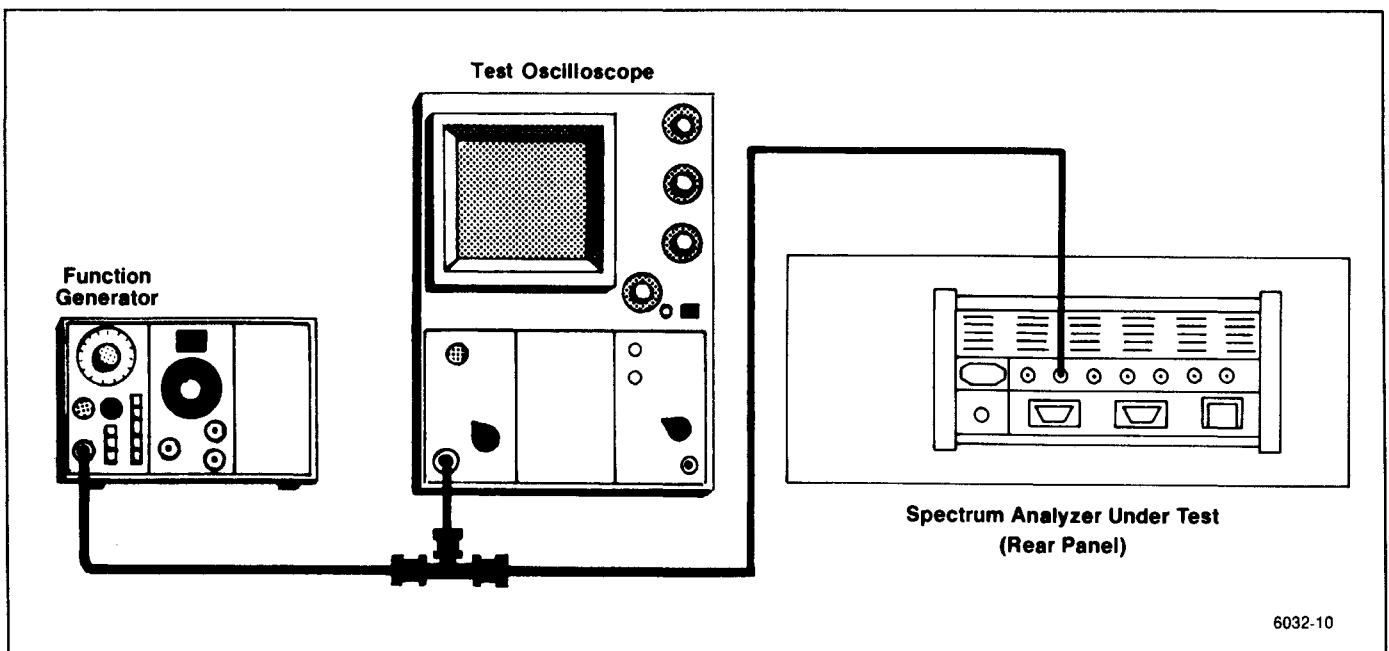

Figure 4-20. Test equipment setup for checking external triggering and horizontal input characteristics.

b. Set TIME/DIV to MNL, and vary the MANUAL SCAN control for a five division beam deflection left and right of center screen. Note the voltage sweep on the test Oscilloscope as the MANUAL SCAN control is varied.

c. Check that the output voltage varies $5\text{ V} \pm 10\%$ peak-to-peak, centered around 0 Vdc .

d. Reset the TIME/DIV to AUTO. Disconnect and remove the test equipment.

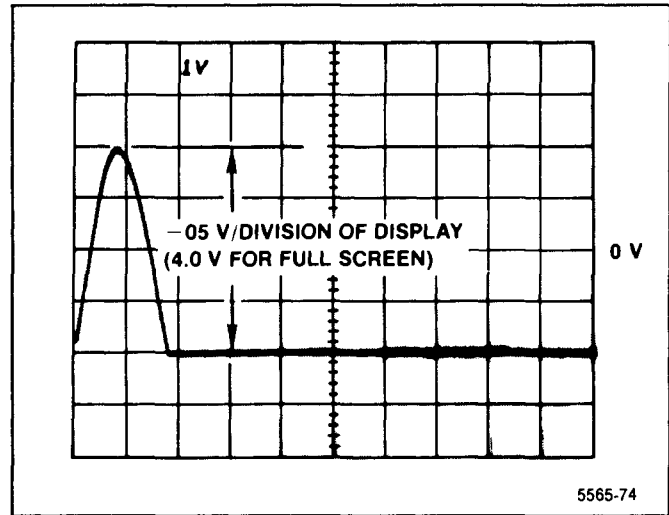

Figure 4-21. Test oscilloscope display of VERT output with a full screen display on the Spectrum Analyzer.

GPIB VERIFICATION PROGRAM

This verification program can be used with a TEKTRONIX 4050-Series Computer Terminal to check the functional operation of the GPIB interface in the Spectrum Analyzer. All interface lines are verified as well as all interface messages, except those for parallel poll. In addition, the instrument interface is checked for operation on other primary addresses, as well as the talk-only and listen-only modes.

The program is written in TEKTRONIX 4050 BASIC, and is divided into individual tests, each for a specific interface line, message, or function. The tests start on even 1000 line numbers to allow easy modification of the program.

The following describes the function of each test in the program.

Lines 1-5000: Interfaces to user definable keys for recovery from a failed test.

Lines 5000-6000: Inputs the primary address of the Spectrum Analyzer under test (1 should be used).

Lines 6000-7000: ID query response test. The instrument must be able to talk and listen, to send out its ID? response and manipulate all eight of the DIO lines for the test to be successful.

Lines 7000-8000: Local lock-out test. Tests correct operation of the interface message that should disable all programmable front-panel controls.

Lines 8000-9000: Go to LOCAL test. Tests correct operation of the interface message that should enable all front-panel controls.

Lines 9000-10000: Group Execute Trigger test. Checks that a GET message does cause the Spectrum Analyzer to abort the present sweep and re-arm the trigger, causing a sweep to start and end, sending out an End-of-Sweep SRQ. Thus, the SRQ line and GET message are verified.

Lines 10000-11000: Selected Device Clear Test. This test verifies that an SDC message resets the Spectrum Analyzer's GPIB output buffer clearing out it's ID? response.

Lines 11000-12000: Device clear test. This test is identical to the selected device clear test, except the universal command DCL is used instead.

Lines 12000-13000: Addressed as listener, talker test. This test checks that the microprocessor correctly recognizes that the GPIA chip has been addressed to listen or talk, and sends the appropriate character to the crt readout (L or T).

Lines 13000-14000: Serial Poll test. This checks correct operation of the serial poll enable (SPE) and serial poll disable (SPD) interface messages. The

status byte is read, and if anything other than ordinary operation is indicated, the instrument fails the test.

Lines 14000-15000: GPIB rear panel switch test. All five primary address switches are checked for correct operation. Three subroutines are called in the process of testing one address switch. The first two send a formatted message to the 4050 display, and the third performs the address switch test.

Lines 15000-16000: Line feed or EOI switch test. Checks for correct selection of line feed as a termination when selected by this switch by sending an ID? terminated only by a line feed.

Lines 16000-17000: Talk-only mode test. When selected, this mode should cause the instrument to send a SET? response and (optionally) a CURVE? response whenever the RESET-TO-LOCAL button is pressed. The string received from the instrument is thus examined for existence of a portion of the correct SET? response after the RESET-TO-LOCAL button is pressed.

Lines 17000-18000: Listen-only mode test. When selected, this mode will cause the instrument to respond to any message on the bus, since it is always addressed to listen. The command REF 0 is sent to the bus without addressing the instrument, then the listen-only mode is deselected and the instrument interrogated to see if it did respond to the REF command while in the listen-only mode.

Lines 18000-19000: Interface clean (and Remote Enable) test. This IFC line on the GPIB will unaddress the instrument's interface. This is verified by noting that the L is not present in the crt readout, indicating that the IFC line worked; also the REN line will be unasserted when the end statement is executed (except for some early 4052 and 4054's). Thus, a front panel in the local mode indicates that the REN line was successfully unasserted. (Evidence it was asserted is that the instrument was able to execute commands sent to it by previous tests.)

Lines 19000-end: Utility routines. Rear panel interface switch test text routine puts headers on the interface switch test display. The rear panel test text routine tells the operator what to do after changing the address switches. Test address switch acquires an ID? response from the instrument on its new address during the address switch test. The SRQ handler will handle SRQ's that occur, although none would be expected, except the power-up SRQ. (The end of sweep SRQ during the GET test is handled by another SRQ handler.) Delay Generator generates delays for other tests. The Failure Decision Handler allows the program to be restarted with the user-definable keys if any test fails.

Performance Check Procedure — 2754/2754P Service Vol. 1

```
1 GO TO 5000
4 B2=1
5 RETURN
20 B2=5
21 RETURN
5000 REM *** 275XP GPIB VERIFICATION PROGRAM ***
5030 INIT
5040 ON SRQ THEN 19280
5050 DIM V$(400),W$(400)
5060 I7=0
5070 PAGE
5080 PRINT "JJ JENTER 275XP'S PRIMARY ADDRESS (DEFAULT = 1) ";
5090 INPUT T$
5100 IF T$<>" " THEN 5130
5110 A1=1
5120 GO TO 5180
5130 A1=VAL(T$)
5140 IF A1>0 AND A1<31 THEN 5180
5150 PRINT "JJ JGERROR!! ";A1;" IS NOT A VALID ADDRESS";
5160 PRINT " ONLY 0 THRU 30 ARE VALID ADDRESSESKK"
5170 GO TO 5080
5180 PAGE
5190 REM
5200 REM
5210 REM
5220 REM
5230 REM
6000 REM ***"ID" QUERY RESPONSE ***
6010 PRINT """" "ID"" QUERY RESPONSE """"
6020 PRINT @A1:"INIT;ID?;SIG"
6030 INPUT @A1:T$
6040 V$=SEG(T$,1,9)
6050 IF V$="ID TEK/27" THEN 6080
6060 PRINT "JJ J*** "ID"" QUERY RESPONSE *** FAIL ***G"
6070 GO TO 19530
6080 WBYTE @32+A1:64,128,-127
6090 PRINT @A1:"WFM ENC:BIN;CUR?"
6100 PRINT @37,0:37,255,255
6110 INPUT %A1:T$
6120 WBYTE @64+A1:
6130 RBYTE R,R,R,T6
6140 WBYTE @95:
6150 IF R=>128 AND T6<128 THEN 7000
6160 PRINT "JJ J*** DIO8 TEST *** FAIL ***G"
6170 GO TO 19530
6180 REM
6190 REM
6200 REM
6210 REM
6220 REM
7000 REM *** LOCAL LOCK-OUT.....LLO ***
7010 PRINT """" LOCAL LOCK-OUT.....LLO """"
7020 WBYTE @32+A1,17:
7030 PRINT @A1:"SET?"
7040 INPUT @A1:V$
7050 PRINT "I I 275XP IN LOCAL LOCK-OUT MODE (LLO)"
7060 PRINT "I I ATTEMPT TO USE 275XP CONTROLS"
7070 PRINT "I I PRESS RETURN <CR> WHEN DONE ";
7080 INPUT T$
7090 PRINT @A1:"SET?"
```

```
7100 INPUT @A1:W$
7110 IF W$ <> V$ THEN 7130
7120 GO TO 8000
7130 PRINT "J*** LOCAL LOCK-OUT.....LLO *** FAIL ***G"
7140 GO TO 19530
7150 REM
7160 REM
7170 REM
7180 REM
7190 REM
8000 REM *** GO TO LOCAL.....GTL ***
8010 PRINT @A1:"INIT;TIM?"
8020 INPUT @A1:R
8030 PRINT @A1:"TIM INC"
8040 PRINT **** GO TO LOCAL.....GTL ****
8050 WBYTE @32+A1,1:
8060 PRINT @A1:"TIM?"
8070 INPUT @A1:T6
8080 IF R <> T6 THEN 8100
8090 GO TO 9000
8100 PRINT "J**** GO TO LOCAL.....GTL *** FAIL ***G"
8110 GO TO 19530
8120 REM
8130 REM
8140 REM
8150 REM
8160 REM
9000 REM *** GROUP EXECUTE TRIGGER.....GET ***
9010 PRINT **** GROUP EXECUTE TRIGGER...GET ****
9020 ON SRQ THEN 9120
9030 I7=0
9040 PRINT @A1:"INIT;TIM 100M;SIG;EOS ON"
9050 WBYTE @32+A1,8:
9060 T6=3
9070 GOSUB 19390
9080 PRINT @A1:"EOS OFF"
9090 IF I7 <> 1 THEN 9150
9100 ON SRQ THEN 19280
9110 GO TO 10000
9120 WBYTE @20:
9130 I7=1
9140 RETURN
9150 PRINT "GROUP EXECUTE TRIGGER...GET *** FAIL ***G"
9160 GO TO 19530
9170 REM
9180 REM
9190 REM
9200 REM
9210 REM
10000 REM *** SELECTED DEVICE CLEAR...SDC ***
10010 PRINT **** SELECTED DEVICE CLEAR...SDC ****
10020 PRINT @A1:"ID?"
10030 WBYTE @32+A1,4:
10040 WBYTE @64+A1:
10050 RBYTE R
10060 IF ABS (R) <> 255 THEN 10080
10070 GO TO 11000
10080 PRINT **** SELECTED DEVICE CLEAR.....SDC *** FAIL ***G"
10090 GO TO 19530
10100 REM
```

Performance Check Procedure — 2754/2754P Service Vol. 1

```
10110 REM
10120 REM
10130 REM
10140 REM
11000 REM *** DEVICE CLEAR.....DCL ***
11010 PRINT "**** DEVICE CLEAR.....DCL ****"
11020 PRINT @A1:"ID?"
11030 WBYTE @20:
11040 WBYTE @64+A1:
11050 RBYTE R
11060 IF ABS (R)<> 255 THEN 11080
11070 GO TO 12000
11080 PRINT "**** DEVICE CLEAR.....DCL *** FAIL ***G"
11090 GO TO 19530
11100 REM
11110 REM
11120 REM
11130 REM
11140 REM
12000 REM ** ADDRESSED AS LISTENER, TALKER ***
12010 PRINT "**** 275XP ADDRESSED AS LISTENER..****"
12020 WBYTE @32+A1:76,79,82,68,79,-63
12030 T6=1
12040 GOSUB 19390
12050 INPUT @A1:V$
12060 T$=SEG (V$,16,1)
12070 IF T$="L" THEN 12100
12080 PRINT "J*** 275XP ADDRESSED AS LISTENER *** FAIL ***G"
12090 GO TO 19530
12100 PRINT "**** 275XP ADDRESSED AS TALKER....****"
12110 PRINT @A1:"INIT;TIM 50M;SIG;SIG;WAI;LORDO?"
12120 INPUT @A1:V$
12130 T$=SEG (V$,16,1)
12140 IF T$="T" THEN 13000
12150 PRINT "**** 275XP ADDRESSED AS TALKER *** FAIL ****"
12160 GO TO 19530
12170 REM
12180 REM
12190 REM
12200 REM
12210 REM
13000 REM *** SERIAL POLL ***
13010 PRINT "**** SERIAL POLL.....SPD/SPE ****"
13020 WBYTE @95,63,24,64+A1:
13030 RBYTE R
13040 WBYTE @95,25:
13050 IF R=0 OR R=16 THEN 13080
13060 PRINT "J*** SERIAL POLL *** FAIL ***G"
13070 GO TO 19530
13080 T6=3
13090 GOSUB 19390
13100 REM
13110 REM
13120 REM
13130 REM
13140 REM
14000 REM *** GPIB INTERFACE REAR PANEL SWITCH TEST ***
14010 PAGE
14011 WBYTE @32+A1, 20, 63:
14020 A1=2
```

```

14030 GOSUB 19000
14040 PRINT " 0 | 0 | 0 | 0 0 0 1 0"
14050 GOSUB 19070
14060 GOSUB 19190
14070 PAGE
14080 A1=4
14090 GOSUB 19000
14100 PRINT " 0 | 0 | 0 | 0 0 1 0 0"
14110 GOSUB 19070
14120 GOSUB 19190
14130 PAGE
14140 A1=8
14150 GOSUB 19000
14160 PRINT " 0 | 0 | 0 | 0 1 0 0 0"
14170 GOSUB 19070
14180 GOSUB 19190
14190 PAGE
14200 A1=16
14210 GOSUB 19000
14220 PRINT " 0 | 0 | 0 | 1 0 0 0 0"
14230 GOSUB 19070
14240 GOSUB 19190
14250 REM
14260 REM
14270 REM
14280 REM
14290 REM
15000 REM *** "LF" OR "EOI" SWITCH ***
15010 PAGE
15020 A1=1
15030 GOSUB 19000
15040 PRINT " 0 | 0 | 1 | 0 0 0 0 1"
15050 GOSUB 19070
15060 PRINT "JJTESTING" "LF" "OR" "EOI" "SWITCH"
15070 GOSUB 19190
15080 WBYTE @32+A1:73,68,63,10
15090 INPUT @A1:T$
15100 T$=SEG (T$,1,9)
15110 IF T$="ID TEK/27" THEN 15140
15120 PRINT "JJ" "LF" "OR" "EOI" "SWITCH *** FAIL ***G"
15130 GO TO 19530
15140 T6=2
15150 GOSUB 19390
15160 REM
15170 REM
15180 REM
15190 REM
15200 REM
16000 REM *** TALK ONLY MODE ***
16010 PAGE
16020 GOSUB 19000
16030 PRINT " 0 | 1 | 0 | 0 0 0 0 1"
16040 GOSUB 19070
16050 PRINT "JJJTESTING TALK ONLY"
16060 INPUT @A1:V$
16070 I7=POS (V$,"FINE OFF",1)
16080 IF I7<>0 THEN 17000
16090 PRINT "JJJTALK ONLY MODE *** FAIL ***G"
16100 GO TO 19530
16110 REM

```

Performance Check Procedure — 2754/2754P Service Vol. 1

```
16120 REM
16130 REM
16140 REM
16150 REM
17000 REM *** LISTEN ONLY MODE ***
17010 PAGE
17020 GOSUB 19000
17030 PRINT " 1 _ 0 _ 0 _ 0 0 0 0 1"
17040 GOSUB 19070
17050 PRINT "J J TESTING LISTEN ONLY"
17060 PRINT @A1:"INI"
17070 T6=-0.5
17080 GOSUB 19390
17090 WBYTE 82,69,70,32,-48
17100 PAGE
17110 GOSUB 19000
17120 PRINT " 0 _ 0 _ 0 _ 0 0 0 0 1"
17130 GOSUB 19070
17140 PRINT @A1:"REF?"
17150 INPUT @A1:V$
17160 IF V$<>"REFLVL +0.0" THEN 17180
17170 GO TO 18000
17180 PRINT "J J LISTEN ONLY MODE *** FAIL ***G"
17190 GO TO 19530
17200 REM
17210 REM
17220 REM
17230 REM
17240 REM
18000 REM *** INTERFACE CLEAR AND REMOTE ENABLE TEST.....IFC & REN ***
18010 PAGE
18020 PRINT "J J TESTING IFC (INTERFACE CLEAR), AND REN (REMOTE ENABLE)"
18030 WBYTE @32+A1:
18040 T6=3
18050 GOSUB 19390
18060 PRINT "J J CHECK THE 275XP CRT, FOR AN ""L"" BETWEEN THE VERTICAL"
18070 PRINT "DISPLAY AND THE MIN RF ATTEN READOUTS."
18080 PRINT "J PRESS RETURN TO CONTINUE.";
18090 INPUT P$
18100 INIT
18110 PRINT "J IF AN "L" IS STILL PRESENT, THE IFC LINE IS FAULTY,"
18120 PRINT "IF THE "L" VANISHED, IFC TESTED OK."
18130 PRINT "J J CHECK ALSO THE 275XP FRONT PANEL FOR PROPER LOCAL CONTROL"
18140 PRI "IF THE FRONT PANEL IS LOCKED OUT, THE REN LINE IS FAULTY, IF"
18150 PRINT "NOT, REN TESTED OK"
18160 PRINT "J J GPIB VERIFICATION COMPLETEG"
18170 END
18180 REM
18190 REM
18200 REM
19000 REM *** REAR PANEL INTERFACE SWITCH TEST TEXT ROUTINE ***
19010 PRINT "SET GPIB ADDRESS SWITCHES TO:"
19020 PRINT "J J LISTEN|TALK|L F ORI ADDRESS"
19030 PRINT " ONLY|ONLY|EOI|16 8 4 2 1"
19040 PRINT "-----|----|-----|-----"
19050 RETURN
19060 REM
19070 REM *** REAR PANEL TEST TEXT ROUTINE ***
19080 PRINT "J J AFTER CHANGING THE SWITCHES, ";
19090 PRINT "PRESS THE REMOTE/LOCAL BUTTON ONCE J J"
```

```

19100 PRINT "I(NOTE: IF YOU GET A GPIB INTERFACE ERROR MESSAGE,"
19110 PRINT "I IT MEANS THAT THE SWITCH(ES) WERE'NT "
19120 PRINT "I READ CORRECTLY. TO RE-TEST, TYPE"
19130 PRINT "I ""RUN"" FOLLOWED BY THE LINE NUMBER IN THE"
19140 PRINT "I ERROR MESSAGE) "
19150 PRINT "JJIPRESS RETURN <CR> WHEN DONE ";
19160 INPUT T$
19170 RETURN
19180 REM
19190 REM *** TEST ADDRESS SWITCH ***
19200 PRINT @A1:"ID?"
19210 INPUT @A1:T$
19220 T$=SEG (T$,1,9)
19230 IF T$="ID TEK/27" THEN 19260
19240 PRINT "ADDRESS SWITCH TEST FAIL"
19250 GO TO 19530
19260 RETURN
19270 REM
19280 REM *** SRQ HANDLER ***
19290 T6=3
19300 GOSUB 19390
19310 POLL Z1,Z1;A1
19320 PRINT @A1:"ERR?"
19330 INPUT @A1:S$
19340 PRINT "GGAN INTERRUPT OCCURRED ON THE BUS, THE 275XP RETURNS ";S$
19350 PRINT "JPRESS RETURN <CR> TO CONTINUE ";
19360 INPUT T$
19370 RETURN
19380 REM
19390 REM *** DELAY GENERATOR ***
19410 REM *** T6 GIVEN IN SEC (GLOBAL) *** I9 SCRATCH ***
19420 IF T6<0 THEN 19510
19430 IF RND (0)>0.5 THEN 19490
19440 REM *** 4051 ***
19450 T6=T6*220
19460 FOR I9=1 TO T6
19470 NEXT I9
19480 GO TO 19510
19490 REM *** 4052
19500 CALL "WAIT",T6
19510 T6=0
19520 RETURN
19530 REM **** FAILURE DECISION HANDLER ****
19540 PRINT "JJISELECT A UDK:"
19550 PRINT "I (1) RE-START"
19560 PRINT "I (5) END"
19570 SET KEY
19580 B2=0
19590 IF B2<>1 AND B2<>5 THEN 19590
19600 IF B2=5 THEN 19630
19610 PAGE
19620 GO TO 6000
19630 END

```

ADJUSTMENT PROCEDURE

Introduction

If the instrument performance is not within specified requirements for a particular characteristic, determine the cause, repair if necessary, then use the appropriate adjustment procedure to return the instrument operation to performance specification. After any adjustment, verify performance by repeating that part of the Performance Check.

Allow the instrument to warm up for at least one hour, in an ambient temperature of +20° C to +30° C before making any adjustments. Waveform illustrations in the adjustment procedure may be idealized and should not be construed as being representative of specification tolerances.

CAUTION

STATIC DISCHARGE CAN DAMAGE MANY SEMICONDUCTOR COMPONENTS USED IN THIS INSTRUMENT.

Many semiconductor components, especially MOS types, can be damaged by static discharge. Damage may not be catastrophic and, therefore, not immediately apparent. It usually appears as a degradation of the semiconductor characteristics. Devices that are particularly susceptible are: MOS, CMOS, JFETs, and high impedance operational amplifiers (FET input stages.) The damaged parts may operate within accepted limits over a short period, but their reliability will have been severely impaired. Damage can be significantly reduced by observing the following precautions.

1. Handle static-sensitive components or circuit assemblies at or on a static-free surface. Work station areas should contain a static-free bench cover or work plane such as conductive polyethylene sheeting and a grounding wrist strap. The work plane should be connected to earth ground.

2. All test equipment, accessories, and soldering tools should be connected to earth ground.

3. Minimize handling by keeping the components in their original containers until ready for use. Minimize the removal and installation of semiconductors from their circuit boards.

4. Hold the IC devices by their body rather than the terminals.

5. Use containers made of conductive material or filled with conductive material for storage and transportation. Avoid using ordinary plastic containers. Any static sensitive part or assembly (circuit board) that is to be returned to Tektronix, Inc., should be packaged in its original container or one with anti-static packaging material.

Equipment Required

Table 5-1 lists test equipment and test fixtures recommended for the adjustment procedure. Test equipment listed in Table 5-1 together with those listed in Table 4-1 in Section 4, Performance Check are required for the adjustment procedure. The characteristics specified are the minimum required for the checks. Substitute equipment must meet or exceed these characteristics.

Table 5-1
EQUIPMENT REQUIRED

Equipment or Test Fixture	Characteristics	Recommendation and Use
Return Loss Bridge	10 MHz to 1 GHz, 50 Ω	Wiltron VSWR Bridge Model 62N50
Attenuator (3 dB miniature)	Frequency, to 5 GHz; connectors 5 mm	Weinchel Model 4M, Tektronix Part No. 015-1053-00
Autotransformer	Capable of varying line voltage from 90 Vac to 130 Vac	General Radio Variac Type W10MT3
Digital Multimeter	10 μ V to 350 Vdc	TEKTRONIX DM 501A or DM 502A
Dc Block		Tektronix Part No. 015-0221-00
Adapter (Seaelectro male to male)		Tektronix Part 103-0098-00
Adapter (bnc female to Seaelectro male)		Tektronix Part No. 103-0180-00
Three Extension Cables (Seaelectro female to Seaelectro male)		Tektronix Part No. 175-2902-00
Adapter (bnc to Seaelectro)		Tektronix Part No. 175-2412-00
Adapter (bnc female to sma male)		Tektronix Part No. 015-1018-00
Cable (20"), Tip Plugs to bnc		Tektronix Part No. 175-1178-00
Coaxial Cable (8")		Tektronix Part No. 012-0208-00
50 Ω Terminator		Tektronix Part No. 011-0049-01
Screwdriver, Tuning		Tektronix Part No. 003-0675-00
Alignment Tool		Tektronix Part No. 003-0968-00
Screwdriver, Flat, 6" with 1/8" Tip		
Screwdriver, Phillips No. 1		
Allen Wrenches (3), 3/32", 5/64", 7/64"		
Service Kit (Extender Boards) ^a		Tektronix Part No. 672-0865-01

Preparation

To prepare the rackmount model for adjustment, refer to the Rackmount part of the Options section of this manual (Section 8).

CAUTION

Do not place the instrument on its front panel as this may cause damage to the front-panel knobs.

Remove the cabinet as follows:

1. Remove the twelve torque screws holding the rear-panel casting, and pull the casting from the instrument.

2. Remove the eight screws holding on the feet, and the eight screws holding on the handle.

3. Pull the cabinet from the rear of the instrument.

4. Place the instrument on the bench and reconnect the power cord.

Some circuit boards and assemblies must be placed on extenders to access test points or adjustments. Before removing these boards and assemblies, the air baffle attached to the left siderail must also be removed.

Turn the power off before removing an assembly.

^a This kit is part of the Service Kit 006-3286-01, listed in the Maintenance Section.

1. Adjust Low Voltage Power Supply

(R6028 and R6061 on the Power Supply board)

This high-efficiency power supply uses an internal oscillator with a frequency of 66 kHz. The frequency adjustment is normally required only after replacing oscillator components; therefore, Part I is the normal adjustment and check procedure, Part II of this step should only be required after repair of the assembly.

WARNING

Since the Spectrum Analyzer uses a high efficiency power supply, with the primary ground potential different from chassis or earth ground, an isolation transformer, with a turns ratio of 1:1 and a 500 VA minimum rating, should be used between the power source and the Spectrum Analyzer power input receptacle.

The transformer must have a three-wire input and output connector with ground through the input and output. Stancor GIS21000 is an example of a suitable transformer. A jumper should also be connected between the primary ground side to chassis ground (emitter of Q2061 and the ground terminal of the input filter FL301.)

If the power supply is separated from the instrument and operated on the bench, hazardous potentials exist within the supply for several seconds after power is disconnected. This is due to the slow discharge of capacitors C6101 and C6111. A relaxation oscillator lights DS5112 (next to C6111) when the potential exceeds 80 V.

Part I

Check and Adjust Low Voltages

- a. Connect a voltage-variable transformer in line with the Spectrum Analyzer power input and set the transformer for 117 Vac. Remove the cover over the Z-Axis and Sweep boards.
- b. Monitor the +15 V test point on the Z-Axis board (Figure 5-1b) with a voltmeter (DVM).
- c. Remove the Power Supply cover screw located below the 10 MHz IF OUTPUT jack on the rear panel (see Figure 5-1a). This will provide access to the +5 V reference supply adjustment R6028.
- d. Adjust R6028 for +15 V on the voltmeter. R6028 is accessed by inserting a narrow-bit screwdriver through the screw hole that was removed in part c of this step.

e. Vary the input voltage from 90 Vac to 132 Vac. Check that the +15 V supply remains regulated, and input power does not exceed 210 W.

f. Check the other supply voltages at the test points indicated in Figure 5-1b, against tolerances listed in Table 5-2.

Table 5-2
POWER SUPPLY TOLERANCES

Supply	Tolerance
+9 V	+8.92 V to +10.1 V
-5 V	-4.96 V to -5.05 V
-7 V	-7 V to -8.5 V
-15 V	-14.84 V to -15.16 V
+5 V	+4.73 V to +5.23 V
+17 V	+16.81 V to +18.6 V
+100 V	+95 V to +105 V
+300 V	+280 V to +310 V

g. Remove the voltage-variable transformer and reconnect the Spectrum Analyzer directly to the power source.

Part II

Adjusting Power Supply Oscillator Frequency

- a. Remove the Power Supply module, as described in the Maintenance section, then remove the Power Supply module cover and disconnect P3045.
- b. Plug the power cord into the power input receptacle and connect it to a suitable power source (115 Vac or 230 Vac, depending on the position of the LINE SELECTOR SWITCH).
- c. Use a plastic or insulated tuning tool or equivalent, to insert between the two on/off power switches (S300) to close these switches (Figure 5-1a).
- d. Connect a test oscilloscope probe, with a deflection sensitivity of 5 V/div and sweep rate of 10 us/div to TP6053 (Figure 5-1a). Note the amplitude of the output waveform, of the oscillator U6059, is approximately 10 V.
- e. Adjust R6061 (Oscillator Freq Adj) for a waveform period of 15 μ s (66 kHz).
- f. Reconnect P3045, replace the Power Supply module cover, and re-install the module on the Spectrum Analyzer.

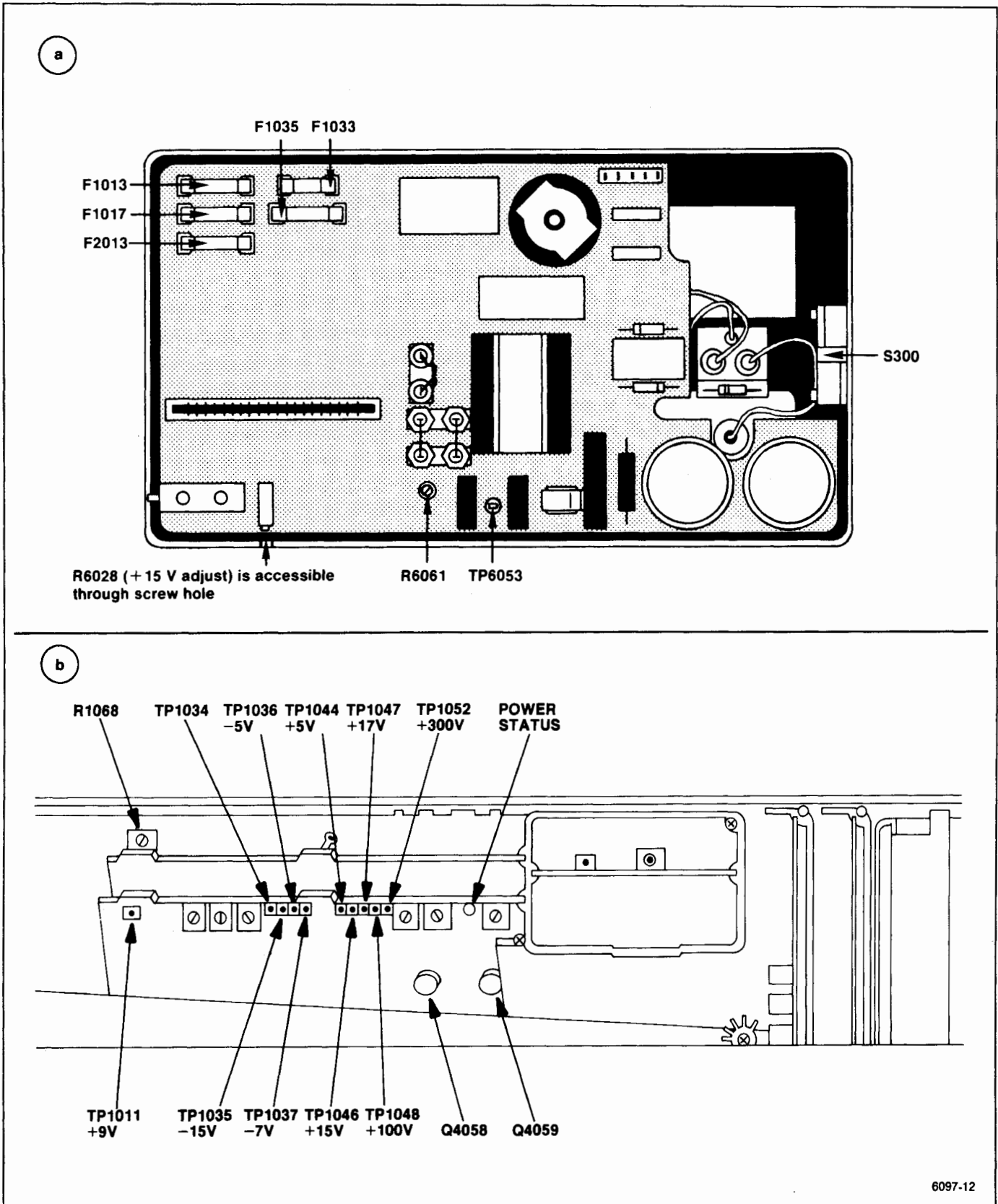

Figure 5-1. Low voltage power supply adjustments.

2. Adjust Z-Axis and High Voltage Circuits

(R1021, R1027, R1030, R1051, and R1058 on the Z-Axis board; R2040 and R3033 on the High Voltage board)

a. Switch POWER off and preset the following Spectrum Analyzer controls:

INTENSITY	Fully Counterclockwise
TIME/DIV	MNL
MANUAL SCAN	Midrange

b. Remove the cover over the Z-Axis and Sweep boards. Set the Intensity Limit R1027, on the Z-Axis board (Figure 5-2) fully counterclockwise and Crt Bias R2040, on the High Voltage board (Figure 5-3) fully clockwise.

c. Switch POWER on and, after the power-up state has stabilized, change the Vertical Display mode to 2 dB/DIV. Deactivate READOUT, VIEW A, and VIEW B.

d. Adjust Crt Bias as follows:

(1) Using a voltmeter in the 20 V range, measure and record the collector voltage of Q4058 or Q4059 on the Z-Axis board (See Figure 5-1b.)

(2) Turn the INTENSITY clockwise until a crt beam dot appears on screen.

(3) Focus the dot by adjusting R3033 on the High Voltage board (Figure 5-3) for the smallest round dot.

(4) Set the INTENSITY for a collector voltage 5.5 V higher than the voltage noted in part d, subpart 1.

(5) Use the non-metallic screwdriver to adjust Crt Bias, R2040, counterclockwise until the crt beam is visible, then clockwise until the beam dot just extinguishes, with the screen shaded. (If no dot appears, with the adjustment fully counterclockwise, this will be the bias setting.)

(6) Turn the INTENSITY clockwise until a dot is visible then defocus the dot with the Focus adjustment, R3033. Adjust Astigmatism R1058 (Figure 5-2) for a round dot then refocus with R3033 for the smallest and sharpest dot.

(7) Turn the INTENSITY counterclockwise until the dot just disappears, and again measure the collector voltage at Q4058 or Q4059. Voltage should equal or exceed the voltage set in part d, subpart 4. If the voltage is less, repeat the procedure for setting Crt bias.

e. Adjust the Crt cathode current as follows:

(1) Switch POWER off, then remove P4036 (Figure 5-3) on the High Voltage board. Turn INTENSITY fully clockwise, MANUAL SCAN fully counterclockwise, and ensure that the TIME/DIV is in the MNL position. Set the Intensity Limit R1027, on the Z-Axis board, (Figure 5-2) fully clockwise.

(2) Connect the voltmeter between TP4028 (Figure 5-3) and the ground lug on the crt shield. Switch POWER back on. After the instrument initializes, activate 2 dB/DIV and switch Digital Storage off.

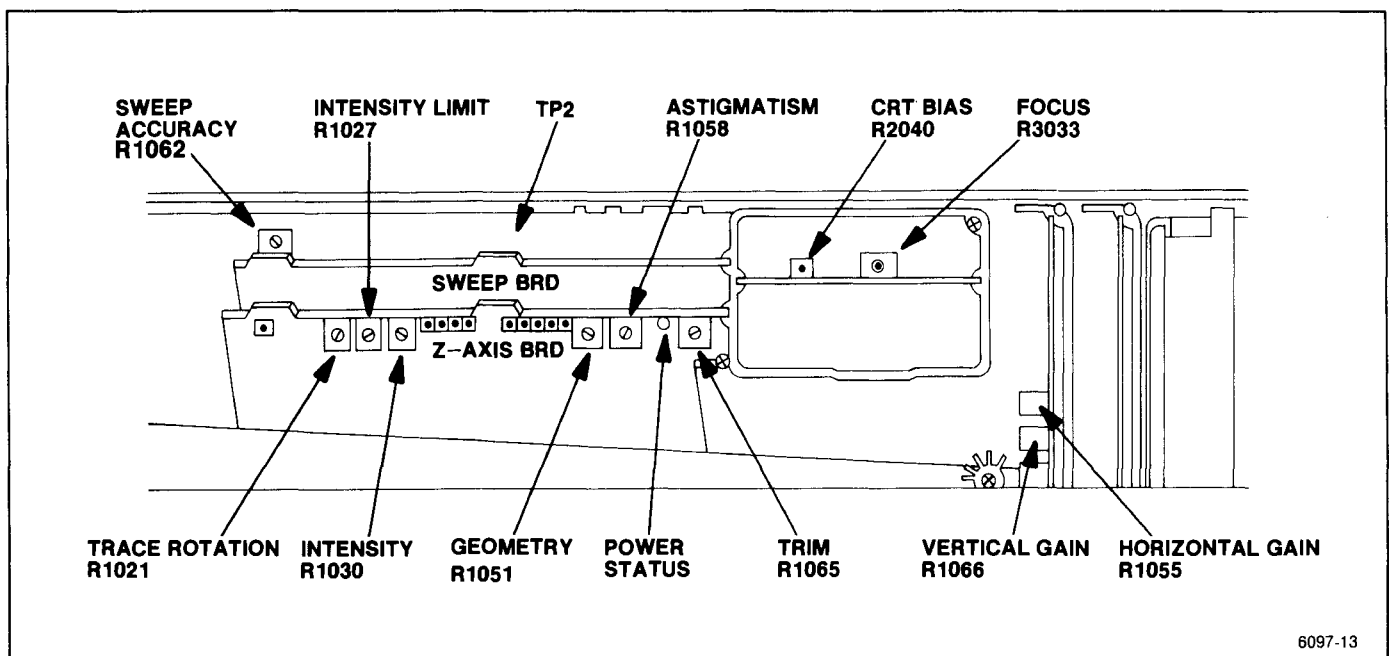

Figure 5-2. Crt display adjustment and test point locations.

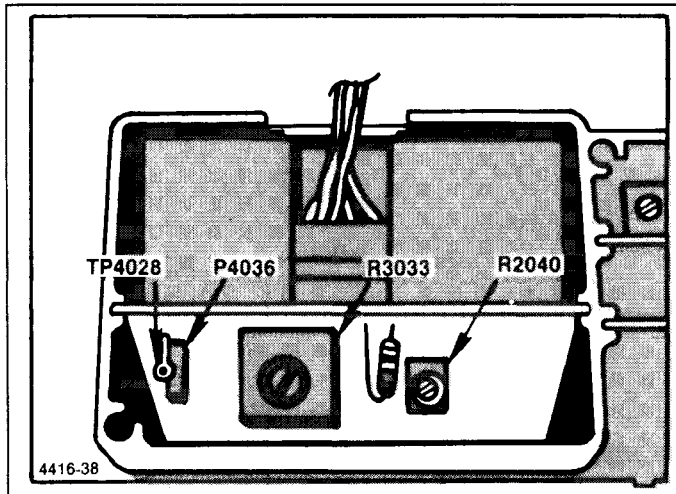

Figure 5-3. Adjustment and test point locations on High Voltage module.

(3) Adjust Intensity Limit R1027 (Figure 5-2) for a voltage reading of 0.9 V at TP4028.

(4) Switch POWER off and re-install the jumper P4036 on the High Voltage board. Turn POWER on and adjust the INTENSITY for normal viewing.

f. Apply the CAL OUT signal to the RF INPUT and set the Spectrum Analyzer controls as follows:

FREQUENCY	100 MHz
FREQ SPAN/DIV	10 MHz
AUTO RES	On
REF LEVEL	-20 dBm
MIN RF ATTEN	0 dB
VERTICAL DISPLAY	2 dB/DIV
NARROW VIDEO FILTER	On
VIEW A and VIEW B	Off
TIME/DIV	AUTO
TRIGGERING	FREE RUN

g. Activate ZERO SPAN and adjust REFERENCE LEVEL until the trace is approximately mid-screen; then adjust the Trace Rotation R1021 (Figure 5-2) so the trace is aligned with the graticule lines.

h. Activate VIEW A and VIEW B then use the PEAK/AVERAGE cursor, positioned at the top then bottom of the screen, as a reference line to adjust Geometry R1051 (Figure 5-2) for the straightest trace at top and bottom of the screen.

i. Change the REF LEVEL to position the trace within the graticule area with the Vertical Display mode of 2 dB/DIV. Adjust INTENSITY so the trace is just visible.

j. Adjust Intensity R1030 (Figure 5-2) so the brightness of the readout characters is slightly higher than the trace. Readout characters should be just visible after the trace has disappeared. This ratio provides the

best setting for photograph purposes. Disconnect CAL OUT signal from the RF INPUT.

3. Adjust Deflection Amplifier Gain and Frequency Response

(C4057, C4061, C5021, C5104, R1055, and R1066 on the Deflection Amplifiers board)

a. Connect the test equipment as shown in Figure 5-4. Set the TIME/DIV to 1 ms. Position the trace on the bottom graticule line.

b. Set the Function generator controls for a 500 Hz sinewave signal, with an amplitude of 0 to +4 V. Connect a jumper between pins 1 and 5 (Ext Video Select and Ground respectively) on the ACCESSORIES connector. Deactivate VIEW A and VIEW B, and set TRIGGERING to INT.

c. Adjust Vert Gain, R1066 (Figure 5-2) for a full screen display.

d. Disconnect the 500 Hz signal from the MARKER/VIDEO input. Remove the jumper between pins 1 and 5 of the ACCESSORIES connector. Reset Triggering to FREE RUN.

e. Set TIME/DIV to MNL. Monitor TP2 on the Sweep board (Figure 5-2) with a voltmeter (Digital Multimeter). Set the MANUAL SCAN control for 0.0 V reading on the voltmeter (TP2). Set the horizontal POSITION control to center the CRT beam (dot).

f. Reset the MANUAL SCAN control for a reading of +5 V at TP2.

g. Adjust Horiz Gain, R1055 (Figure 5-2) to position the crt beam to the right graticule edge (10th graticule line).

h. Reset the MANUAL SCAN control such that crt beam (dot) moves to the left edge of the graticule and check that the voltage at TP2 is now $-5.0 \text{ V} \pm 0.2 \text{ V}$.

i. Disconnect the voltmeter, set TIME/DIV to AUTO, change the test oscilloscope to Ext Trigger, and apply the signal at TP1038 on the Crt Readout board (Figure 5-5) to the test oscilloscope Ext Trigger input. Set the test oscilloscope Time/Div to 2μ .

j. Set the Spectrum Analyzer controls for a triggered sweep, then switch the sweep off by activating SINGLE SWEEP, and ensure READ OUT is on.

k. Monitor the collectors of Q1031 and Q1024, on the Deflection Amplifier board, with test oscilloscope. See Figure 5-6 for the locations of Q1031 and Q1024.

l. Adjust C5021 for the best frequency response (no overshoot or rolloff) as viewed on the test oscilloscope.

m. Monitor the collectors of Q1043 and Q1049, on the Deflection Amplifier board, with test oscilloscope.

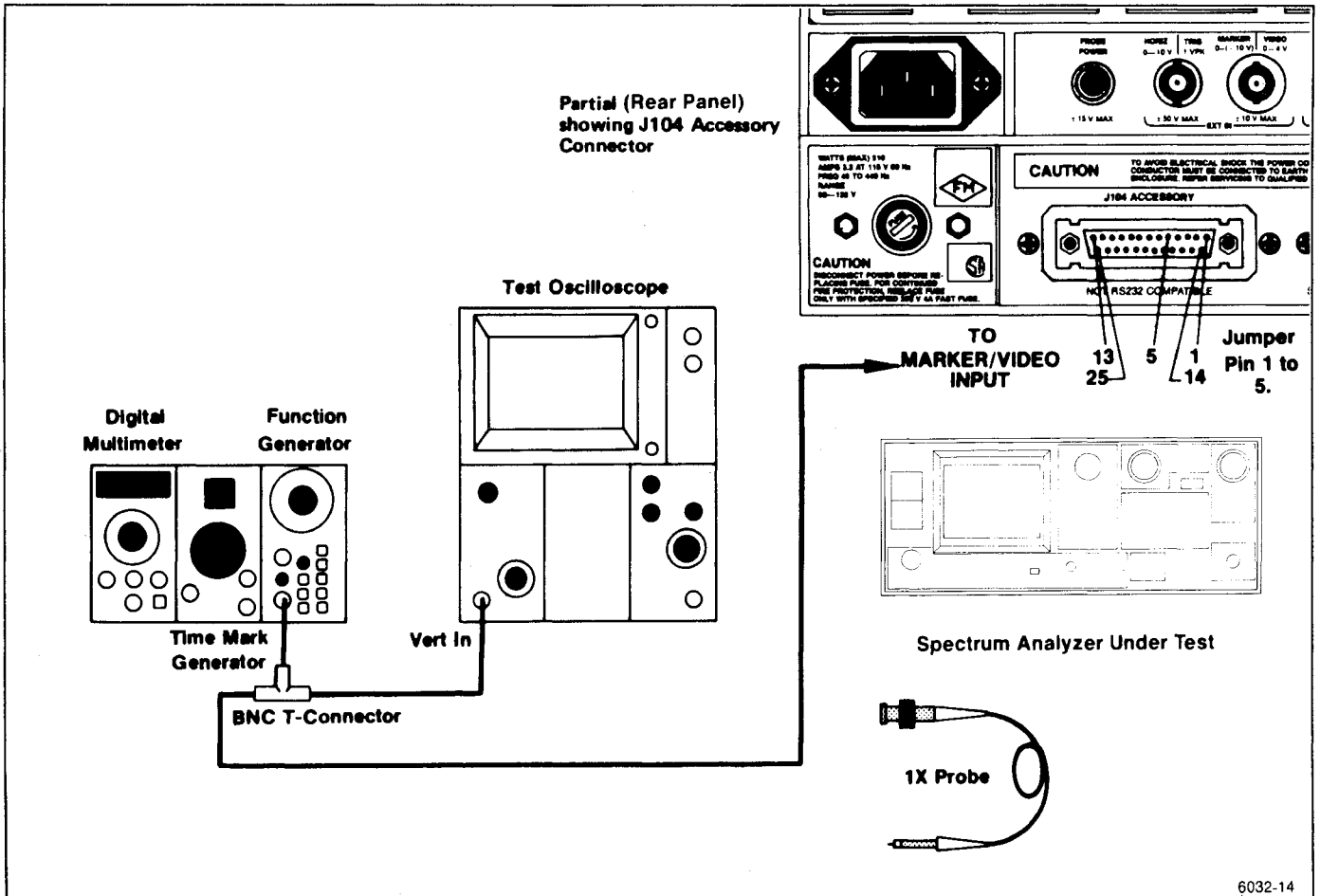

Figure 5-4. Test equipment setup for adjusting the Deflection Amplifier.

- n. Adjust C4057 (Figure 5-6) for the best response.
- o. Monitor the collectors of Q1072 and Q2078, on the Deflection Amplifier board, with test oscilloscope.
- p. Adjust C4061 for the best response.
- q. Monitor the collectors of Q1095 and Q2096, on the Deflection Amplifier board, with test oscilloscope.
- r. Adjust C5104 for best response.
- s. Disconnect the test oscilloscope. Check the appearance of the letter "Z" in GHz of the frequency readout, and if necessary, readjust C5104 and C4061 (vertical output) for the straightest top on the letter "Z".
- t. Set the VERTICAL DISPLAY to LIN, TIME/DIV to MNL, the REF LEVEL for $100\ \mu\text{V}$, and the MANUAL SCAN control fully clockwise.
- u. Adjust C5021 and C4057 for best REF LEVEL readout (straightest letters and numerals).

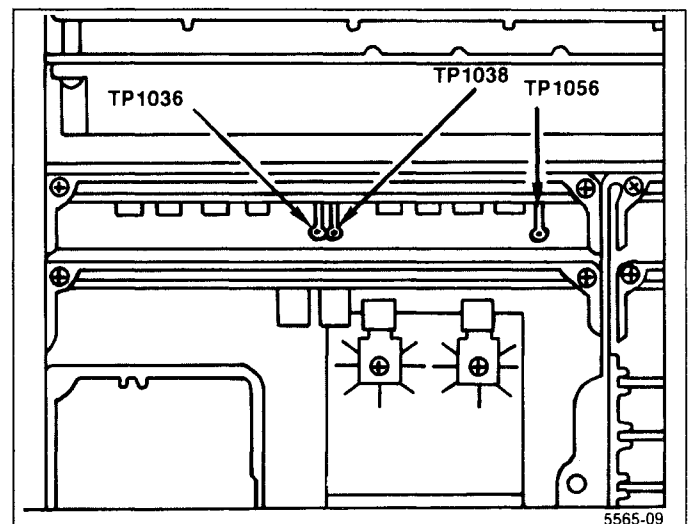

Figure 5-5. Test points on the CRT Readout board.

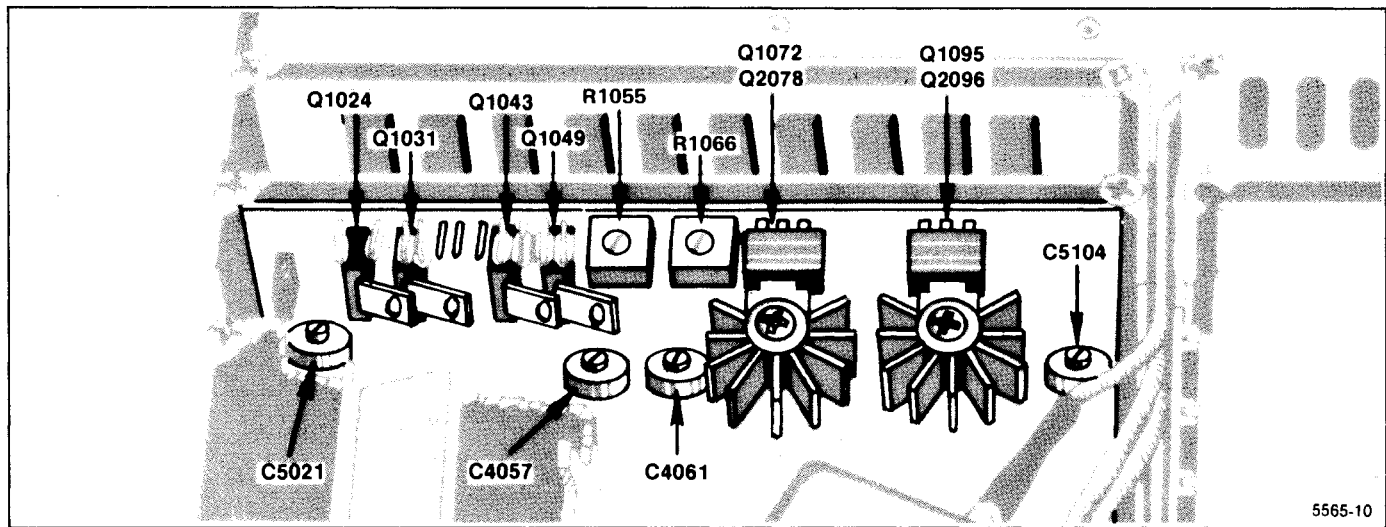

Figure 5-6. Deflection Amplifier test points and adjustments.

4. Adjust Digital Storage Calibration

(R1040, R1050, R1055, and R1060 on the Horizontal Digital Storage board; and R1033, R1034, R1045 and R1046 on the Vertical Storage board)

a. Start the Digital Storage Calibration routine by pressing <SHIFT> 0, and select item 2 (DIGITAL STORAGE CAL). Follow the instructions that are displayed on the crt, referring to Fig. 5-7.

b. Connect CAL OUT signal to the RF INPUT, and set the Spectrum Analyzer controls as follows:

FREQUENCY	100 MHz
FREQ SPAN/DIV	200 kHz
RESOLUTION BANDWIDTH	1 MHz
MIN RF ATTEN	0 dB
VERTICAL DISPLAY	2 dB/DIV
VIEW A and VIEW B	Off
PEAK/AVERAGE	Fully Counterclockwise

c. Set REF LEVEL so the signal peak is about one division above the bottom of the graticule.

d. Adjust Input Offset R1046 (Figure 5-7), on the Vertical Digital Storage board, to match the stored display to the non-stored display while repeatedly switching VIEW B on and off.

e. Reset the REF LEVEL to bring the signal peak close to the top of the graticule.

f. Adjust Input Gain R1034 (Figure 5-7), on the Vertical Digital Storage board, to match the stored display to the non-stored display.

g. Because the offset and gain adjustments interact, repeat parts c through f as necessary.

h. Increase FREQ SPAN/DIV to 10 MHz, and tune the signal to within one division of the right edge of the graticule.

i. Adjust Input Gain R1060, on the Horizontal Digital Storage board (Figure 5-7) to match the horizontal position of the stored signal to that of the non-stored signal.

j. Tune the signal to within 1 division of the left edge of the graticule.

k. Adjust Input Offset R1055 on the Horizontal Digital Storage board to match the horizontal position of the stored signal to that of the non-stored signal.

l. Because of interaction, repeat parts i through k as necessary.

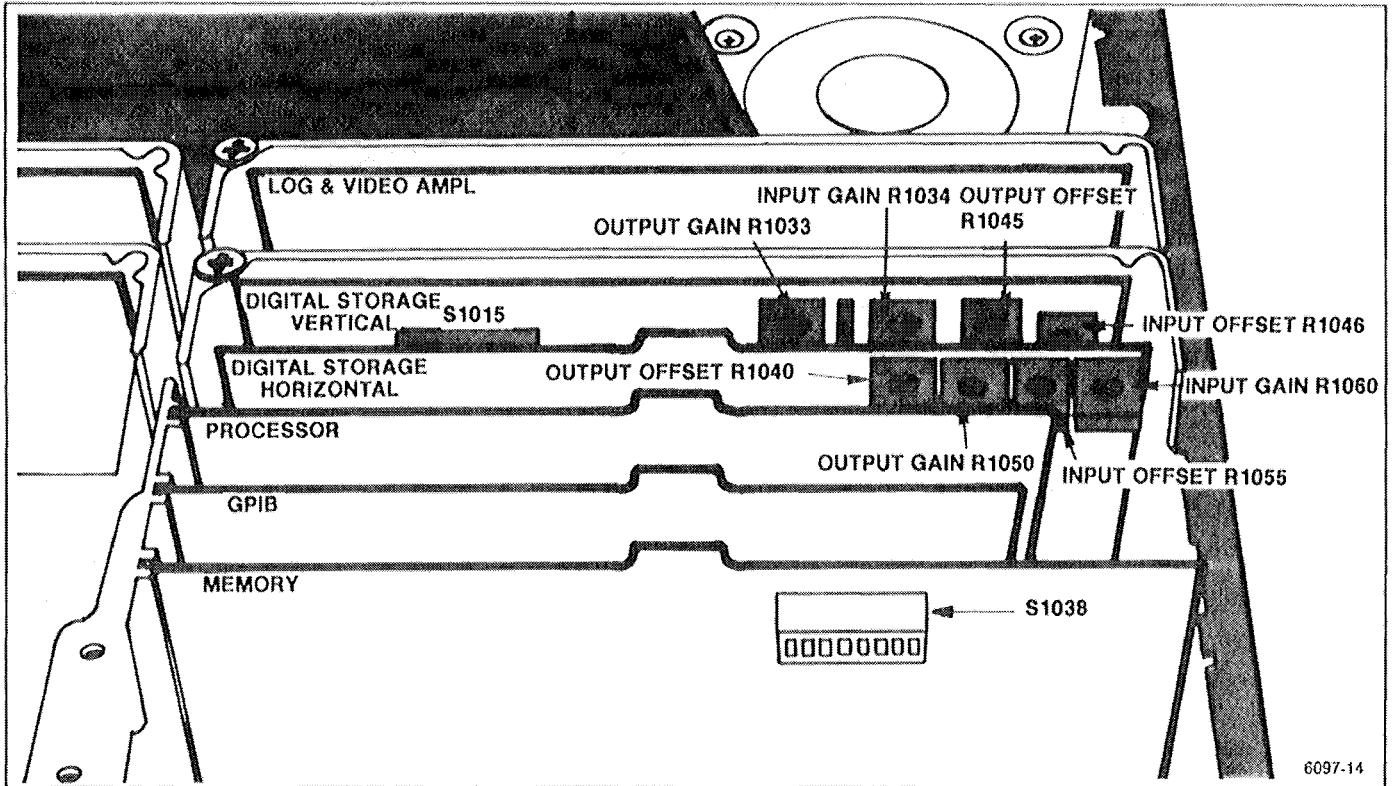

Figure 5-7. Digital storage adjustment locations.

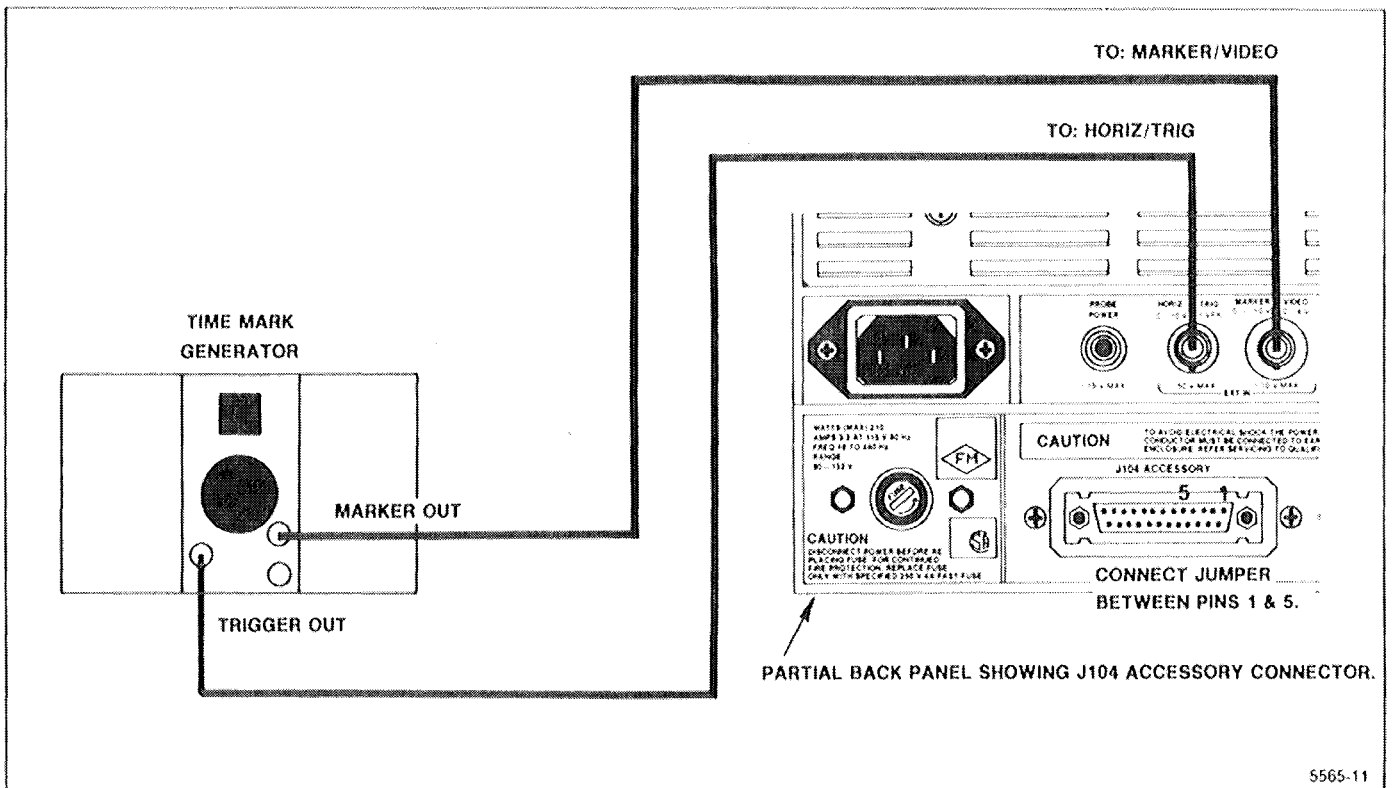

Figure 5-8. Test equipment setup for adjusting sweep timing.

5. Adjust Sweep Timing

(R1062 on the Sweep board)

a. Connect the test equipment as shown in Figure 5-8. Set the following Spectrum Analyzer controls:

FREQ SPAN/DIV	10 MHz or less
TIME/DIV	10 ms
TRIGGERING	EXT

b. Connect a jumper between pins 1 and 5 (Ext Video Select and Ground respectively) on the ACCESSORIES connector.

c. Set the Time Mark Generator controls for 10 ms time marks.

d. Adjust Sweep Timing, R1062 (see Figure 5-9) for 1 marker per division. (Use Horizontal Position adjustment to align markers with graticule lines.)

e. Check the accuracy of the remaining TIME/DIV selections. Error over the center eight divisions must not exceed $\pm 5\%$.

f. Reset the TIME/DIV to AUTO and FREQ SPAN/DIV to MAX, activate AUTO RES, and set TRIGGERING to FREE RUN.

g. Remove the test equipment and the jumper between pins 1 and 5 of the ACCESSORIES connector. Reposition the trace if moved in part d.

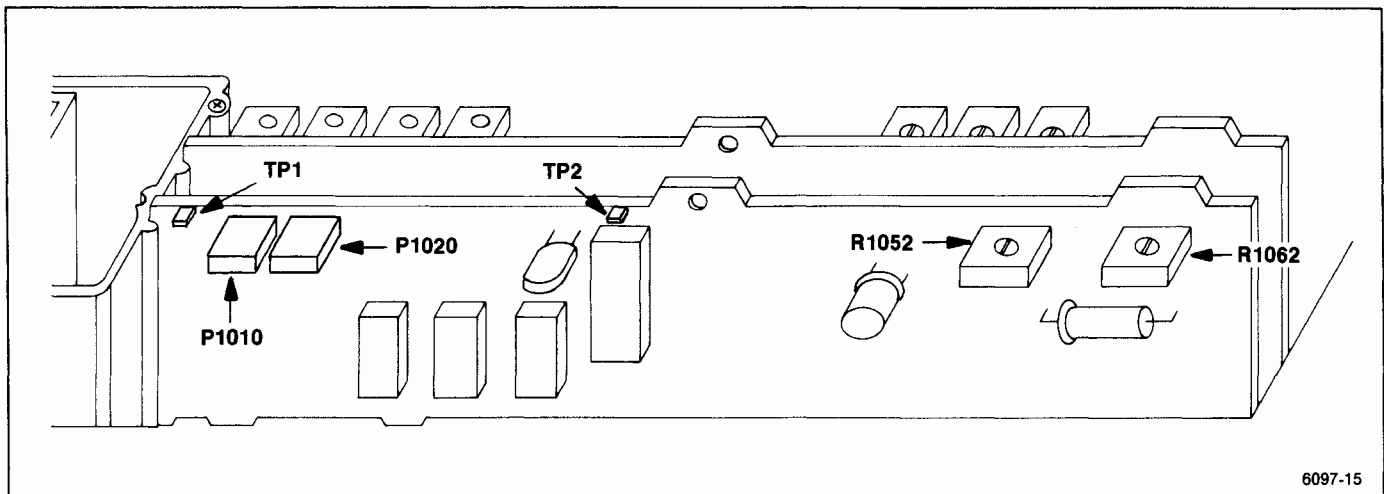

6097-15

Figure 5-9. Sweep board timing adjustment and test point locations.

6. Adjust Frequency Control System

(R1063, R1065, R1067, and R1071 on the Span Attenuator board; and R1028 on the 1st LO Driver board)

The Spectrum Analyzer has a procedure in firmware for calibrating the frequency control system. However, it is possible that some adjustments may be misadjusted enough to cause the microcomputer to display an error message. If this occurs, bypass the step then return to the calibration routine.

a. Test equipment required for this step are a Voltmeter, Time Mark Generator, and Frequency Counter. Set the following Spectrum Analyzer controls:

FREQUENCY	0.0 MHz
FREQ SPAN/DIV	5 MHz
TRIGGERING	FREE RUN

b. Connect a shorting strap from TP1035, on the Span Attenuator board, to chassis ground (Figure 5-10). Monitor TP1073 with the Digital Voltmeter.

c. Adjust Sweep Offset R1063 (Figure 5-10) for 0.00 V.

d. Remove the shorting strap from TP1035. Press <SHIFT> 0 select item 1 (FREQUENCY LOOPS CAL), then item 0 (OVERALL SYSTEM) from the menus. Perform the calibration steps in the directory up to "CONNECT A DVM TO PIN B ON THE CONTROLLED OSCILLATOR BOARD AND GROUND ", then press <SHIFT> to abort.

(1) If a "CALIBRATION STEP CANNOT BE COMPLETED" message is displayed, bypass the step, perform the other adjustments then return to the adjustment and try to bring the adjustment in range. If the problem persists, refer to Troubleshooting the Frequency Control System, in the Maintenance section.

e. Adjust 1st LO Sweep as follows:

(1) Apply the CAL OUT signal to the RF INPUT, set the FREQUENCY to 600 MHz, FREQ SPAN/DIV to 100 MHz, and set the REF LEVEL to display the markers.

(2) Adjust Tune Coil Swp R1065, on the Span Attenuator board (Figure 5-10) for one marker per division over the center eight divisions of the graticule. Reset the CENTER FREQUENCY as necessary to align the markers.

(3) Remove the Calibrator signal and apply 0.2 μ s time marks from the Time Mark Generator to the RF INPUT.

(4) Set the FREQ SPAN/DIV to 5 MHz, REF LEVEL to +10 dBm, and FREQUENCY to about 10 MHz.

(5) Adjust the 1st LO FM Coil Swp R1071 (Figure 5-10) for 1 marker/division over the center eight divisions of the display.

(6) Set the FREQ SPAN/DIV to 20 KHz and apply 50 μ s markers from the Time Mark Generator.

(7) Adjust the 2nd LO Sweep, R1067, for one marker/division over the center eight divisions.

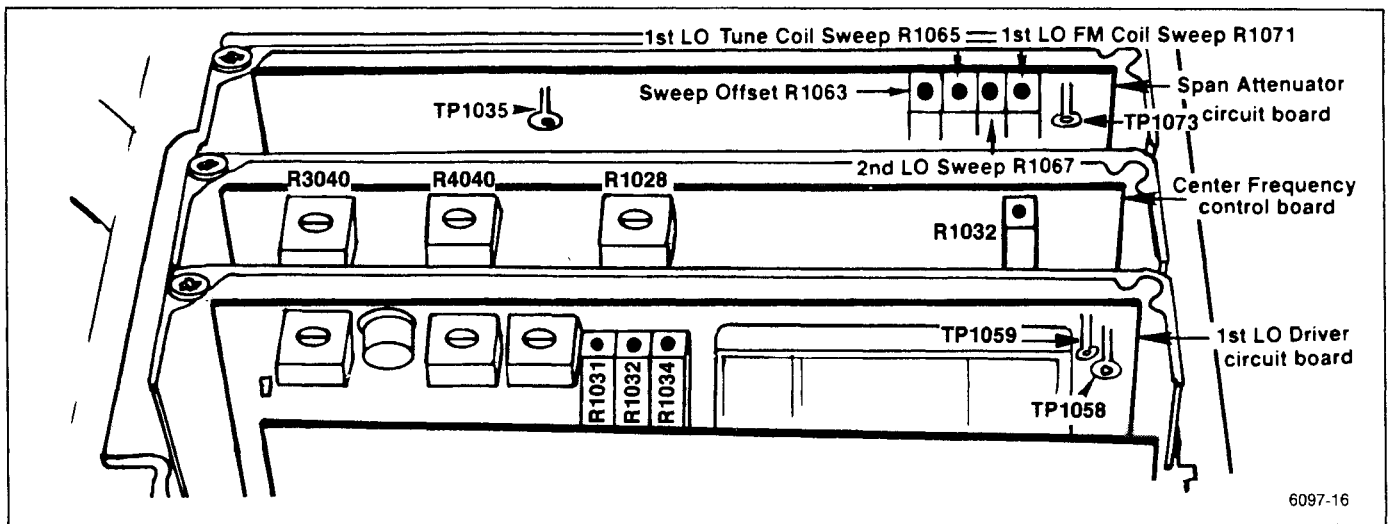

Figure 5-10. Frequency control system test point and adjustment locations.

- f. Adjust Dot Marker position as follows:
 - (1) Disconnect the signal from the RF INPUT.
 - (2) Press <SHIFT> RESET.
 - (3) Adjust Dot Position R1052 on the Sweep board to position the dot marker over the start spur. See Figure 5-9.

7. Adjust Start (0 Hz) Response Amplitude and Mixer Bias

(R1013 on the 1st LO Driver board)

This adjustment should only be done if frequency response problems are encountered.

- a. Set the Spectrum Analyzer controls as follows:

FREQUENCY	2 MHz
FREQ SPAN/DIV	200 kHz
RESOLUTION BANDWIDTH	100 kHz
REF LEVEL	-30 dBm
WIDE VIDEO FILTER	On

b. Monitor TP1011 on the 1st LO Driver board (Figure 5-11) with a voltmeter (voltmeter between TP1011 and crt shield).

c. Adjust R1013 (Figure 5-11) for a reading of -1.0 V.

d. Apply a calibrated -13 dBm, 2 MHz signal to the RF INPUT (input to 1st mixer is now -13 dBm).

e. Activate SAVE A to save the 2 MHz, -13 dBm signal as a reference.

f. Change the FREQUENCY to 0.0 MHz to bring the start (0 Hz) response to center screen.

- g. Adjust R1013 for a null in the amplitude of the 0 Hz response. (Be sure that the dc level at TP1011 DOES NOT exceed +0.1 V as R1013 is adjusted), because this will degrade flatness.) Use a thin screw driver to adjust the tuning screw on the 1st Mixer Diode assembly A12A1. (The tuning screw is towards the rear of the instrument, see Figure 5-12.) Alternately adjust R1013 and the tuning screw for minimum amplitude.

CAUTION

Avoid forcing the tuning screw past the point where it bottoms out. The null should occur about a full turn from the bottom.

- h. The start (0 Hz) response should now be narrower than the 2 MHz reference signal. Turn the diode mixer tuning screw counterclockwise until the start spur response width equals the 2 MHz, -13 dBm reference. The amplitude level is now -13 dBm. This will provide the best overall flatness. Remove the 2 MHz signal from the RF INPUT and deactivate SAVE A and WIDE VIDEO FILTER.

8. Adjust 1st Converter Bias

(R1022 and R1026 on the 1st LO Driver board)

NOTE

These adjustments should only be necessary if frequency response or flatness problems on Bands 4 and 5 are encountered. Bias 1 for the fundamental bands is adjusted in the previous step.

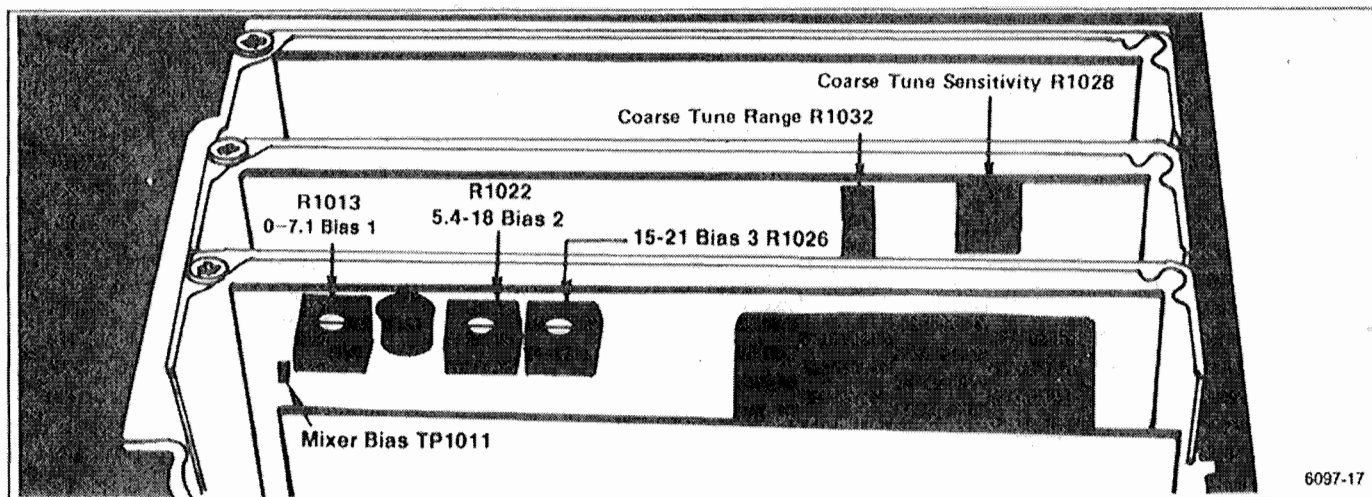

Figure 5-11. 1st LO Driver board adjustment and test point locations.

- a. Push <SHIFT> ΔBand to Band 4 (5.4–18 GHz)
- b. Monitor TP1011 on the 1st LO Driver board (Figure 5-11) with a voltmeter (meter ground at crt shield). Adjust Bias 2 R1022 for a meter reading of -0.25 V.
- c. Push <SHIFT> ΔBAND to Band 5 (15–21 GHz). Adjust Bias 3 R1026 for a meter reading of -0.25 V.
- d. Perform the frequency response check in the Performance Check section. If the instrument fails to meet specifications, adjust the respective bias slightly from these initial settings and recheck frequency response.

9. Adjust Log Amplifier

(R4020, R4052, R4071, R4081, and R1085 on the Log Amplifier board)

CAUTION

Use only an insulated screwdriver or tuning tool, such as Tektronix Part No. 003-0675-00, to make these adjustments.

- a. Set the Log Amplifier correction factors to zero by pressing <SHIFT> 0 (DIAGNOSTIC FUNCTIONS) and selecting item 5 (DISABLE/ENABLE USE OF CAL FACTORS), then item 2 (SET RESULTS TO "UNCALED"). Remove Leveler Disable plug P3035 on the Video Processor board (Figure 5-13).

- b. Switch POWER off. Remove the Log Amplifier and Detector board assembly from the instrument then remove the shield so adjustments are accessible. Replace the assembly in the instrument and switch POWER back on.

- c. Connect the test equipment as shown in Figure 5-14. (P621 must be removed in order to access J621 on the Log Amplifier board. See Figure 5-15.) Set the Spectrum Analyzer controls as follows:

FREQUENCY	2 MHz
FREQ SPAN/DIV	2 MHz
REF LEVEL	-60 dBm
MIN RF ATTEN	0dB
VERTICAL DISPLAY	10 dB/DIV
TIME/DIV	10 ms

- d. Center the two front panel LOG and AMPL CAL adjustments. Set the signal generator controls for a 10 MHz/ $+6$ dBm output. Set the step attenuators for 50 dB of attenuation.

- e. Position the display at a graticule reference line with the vertical POSITION control, then switch the REF LEVEL from -60 dBm to -110 dBm in decade steps.

- f. Adjust the front panel LOG CAL so each 10 dB step equals one division.

- g. Reset the REF LEVEL to -20 dBm and the step attenuators for 0 dB attenuation. Reset vertical position to a graticule line if necessary.

- h. Increase the attenuation through the step attenuators in 10 dB increments to 50 dB.

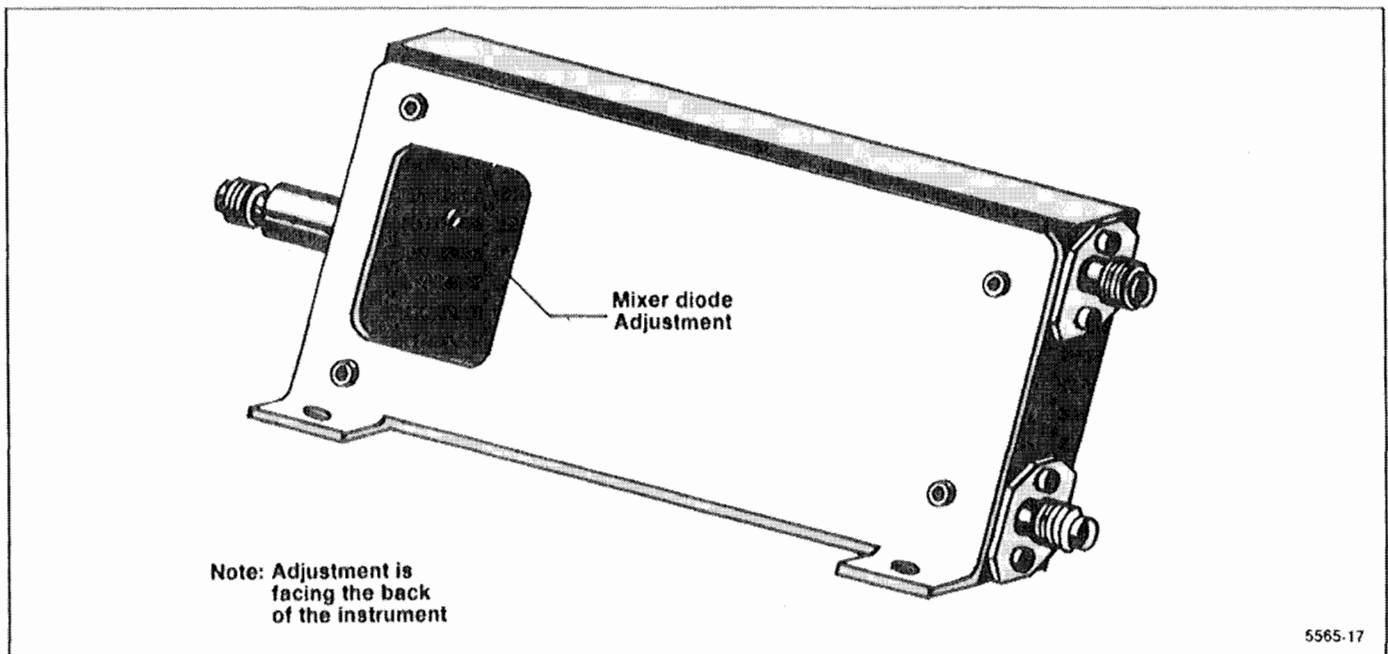

Figure 5-12. 1st Mixer adjustment location.

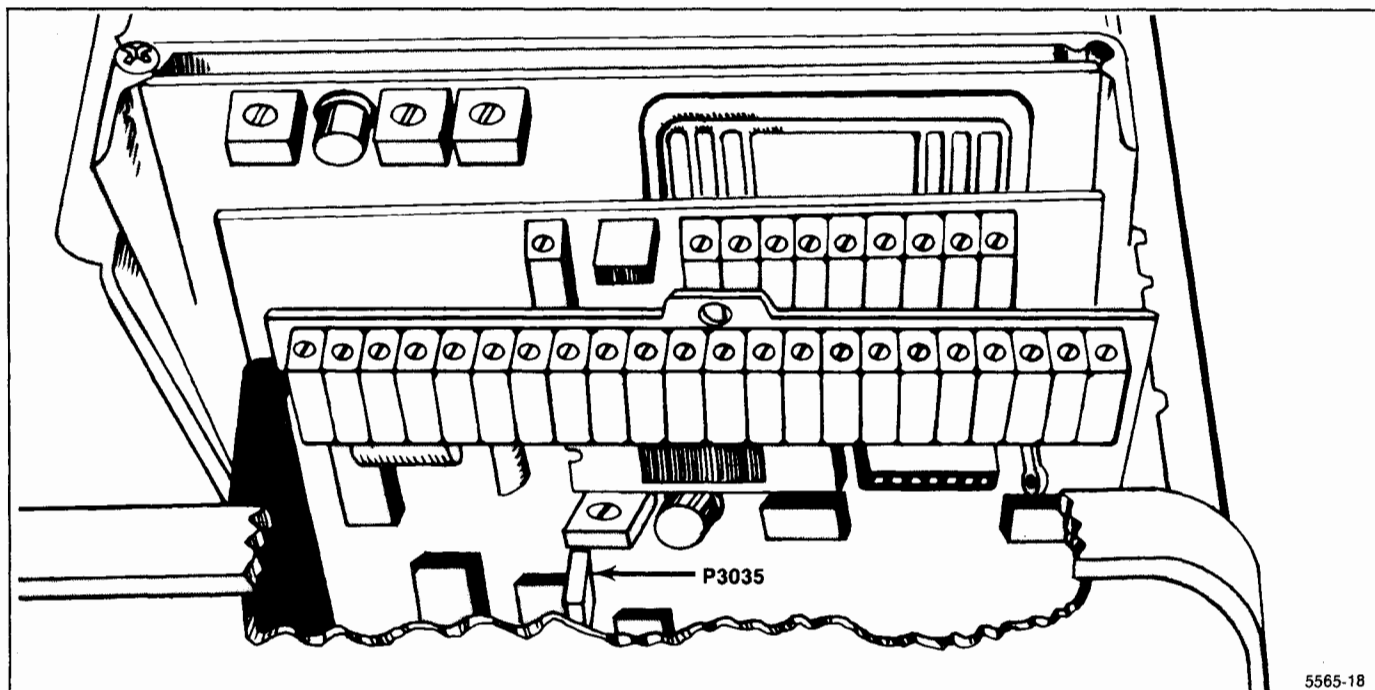

Figure 5-13. P3035 on the Video Processor board.

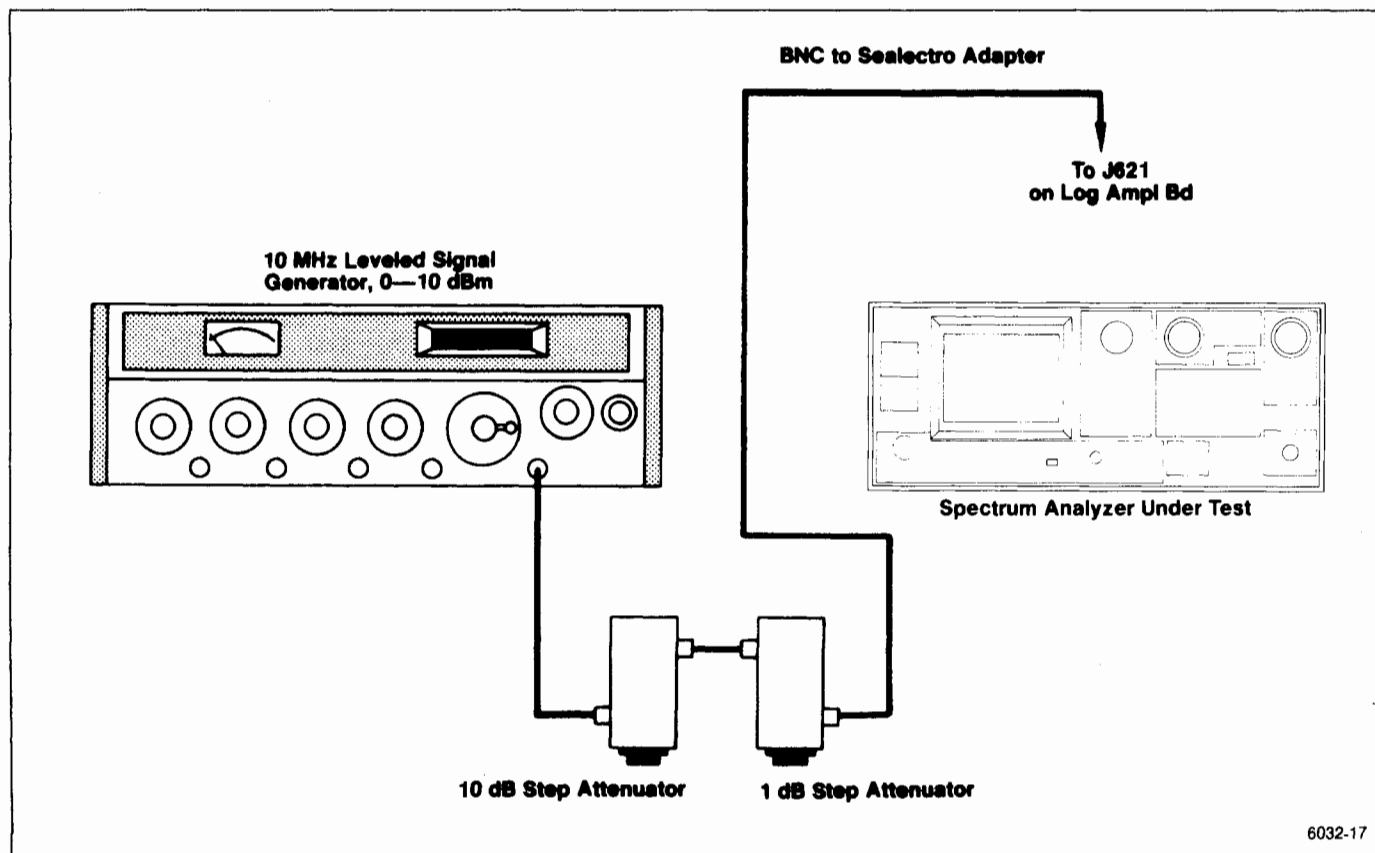

Figure 5-14. Test equipment setup for adjusting the Log Amplifier.

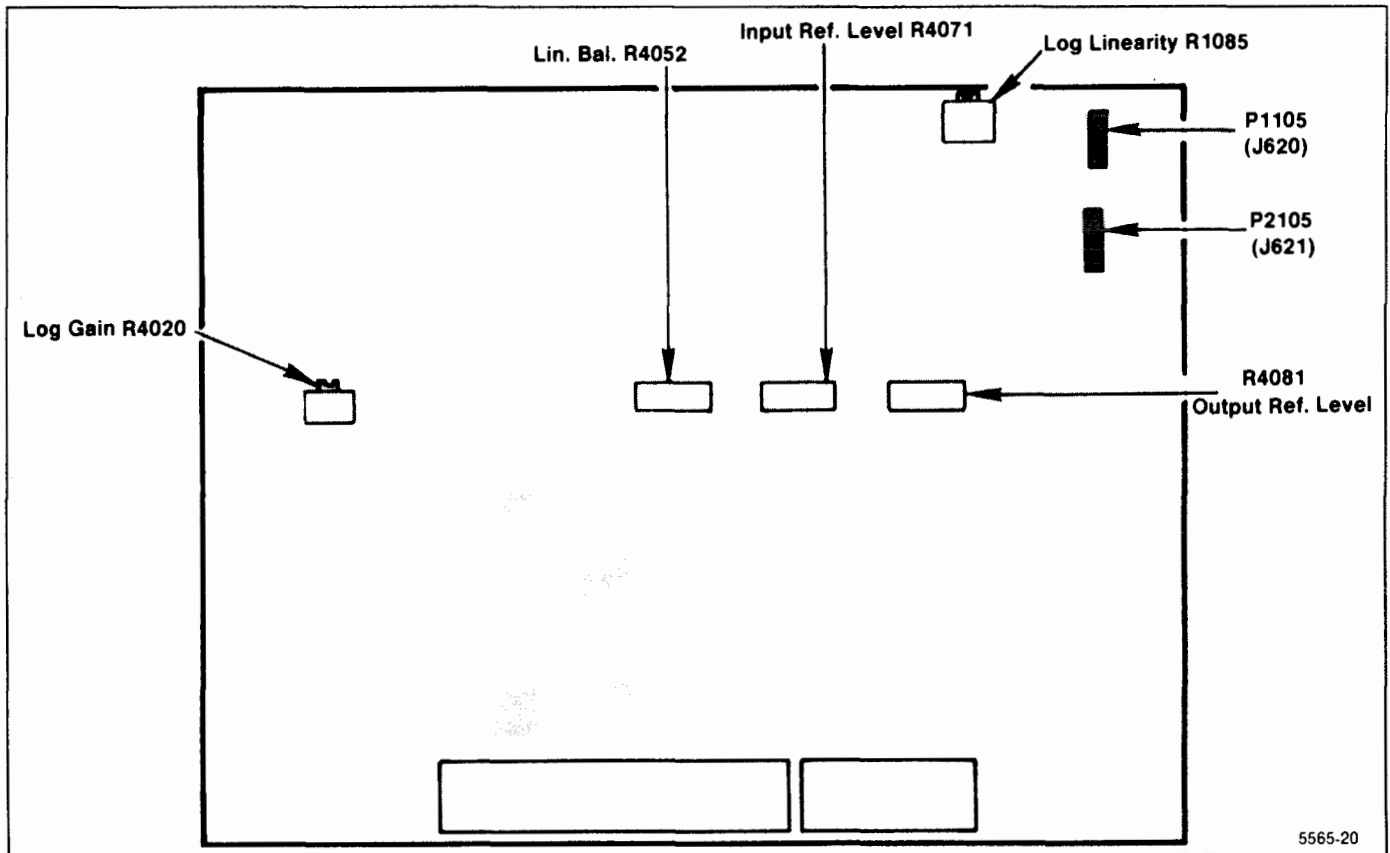

Figure 5-15. Log and Video Amplifier test point and adjustment locations.

i. Adjust the Log Gain, R4020 (Figure 5-15) so each 10 dB increment of attenuation results in one major division of change on the display.

j. Reset vertical position by temporarily removing the signal and setting the vertical POSITION control to position the baseline at the bottom graticule line. Return the step attenuator to 0 dB. Display should be full screen (+6 dBm); if not, readjust the signal generator output for +6 dBm.

k. Adjust Input Ref Level, R4071 (Figure 5-15) for minimum amplitude change between the 10 dB/DIV and 2 dB/DIV displays while alternately switching the VERTICAL DISPLAY between 10 dB/DIV and 2 dB/DIV.

l. Activate 2 dB/DIV and add 10 dB of attenuation. If the 10 dB step (5 division) is short, adjust the gain slightly with R4020 in the same direction; then remove the 10 dB of external attenuation and adjust R4071 for a full screen display. Repeat this check until the 10 dB step is within 0.2 dB of 10 dB. Activate 10 dB/DIV and recheck 10 dB logging.

m. Activate 2 dB/DIV and momentarily remove the input signal to the Log Amplifier. Position the baseline on the bottom graticule line then return the signal to the Log Amplifier.

n. Adjust Output Ref Level, R4081 (Figure 5-15) for a full screen (eight divisions) display.

o. Switch to the 10 dB/DIV mode and set the step attenuators for 40 dB of attenuation. Adjust Log Linearity, R1085 (Figure 5-15) so the display is mid-screen.

p. If a large change in the setting of R1085 was required in part l, repeat the adjustments of R4071 and R4081 because of interaction.

q. Check the accuracy of 10 dB/DIV and 2 dB/DIV display modes by adding attenuation in 10 dB steps for 10 dB/DIV mode and 1 dB steps for the 2 dB/DIV mode and observing that the display steps 1 major division, ± 0.25 minor division, for each 10 dB step, and 0.5 division, ± 0.5 minor division, for the 2 dB mode. (Readjust the signal generator output to establish a new reference level after each step.) After the accuracy of the individual steps has been verified, reset the signal level for full screen. Now add appropriate step attenuation to step the display down screen and measure the worst case error over the dynamic range. Error must not exceed ± 1.5 dB over the first 80 dB of range, or ± 1.0 dB over the 16 dB range.

r. If the 10 dB log step in the 2 dB/DIV mode is long, adjust gain with R4020 for less gain and rebalance R4071.

s. Set the step attenuators to 10 dB and activate 2 dB/DIV.

t. Set the Ref Level to -15 dBm and adjust the signal generator output for a full screen display in the 2 dB/DIV mode.

u. Press LIN and adjust Lin Mode Balance, R4052 (Figure 5-15) for a full screen display. Amplitude of LIN, 2 dB/DIV, and 10 dB/DIV display should now be the same.

v. Check LIN display linearity by adding 6 dB, 12 dB, and 18 dB of attenuation and note the display step down from full screen to, 4 ± 0.4 , 6 ± 0.4 , and 7 ± 0.4 divisions.

w. Remove the signal generator signal connection to the Log Amplifier input jack and replace P621. Switch POWER off, remove Log Amplifier board and replace the shield. Replace P3035 on the Video Processor board. Re-install the assembly and switch POWER on.

10. Adjust Resolution Bandwidth and Shape Factor

(C1022, C2026, C5055, C5048, R1065, R3029, R3033, and R4025 on the VR 2nd Filter Select board) (C1026, C1033, C2037, C3023, C3035, C3050, R2025, and R3035 on the VR 1st Filter Select)

NOTE

The filters in each section are aligned separately, then a signal is applied through both the first and second sections. The final adjustments trim filter shape and bandwidth. Because of interaction, it is easy to offset one filter to compensate for another misadjusted filter; therefore, only adjust each filter in small increments.

The 3 dB down bandwidth of each filter section should be as wide or slightly wider than the 6 dB down point of the combined two filter sections.

Before calibrating the Variable Resolution Bandwidth and Gain, set the correction factors to zero by pressing <SHIFT> 0 and selecting item 5, then item 2.

a. Equipment setup is shown in Figure 5-16.

(1) Remove and install the Variable Resolution module on an extender.

(2) Use a Seaelectro male-to-male adapter and coaxial cable to connect the 10 MHz IF output signal, from the 3rd Converter, to the input of the second section (make connection from plug removed from J693 to J683).

(3) Connect the Variable Resolution output to the input of the Log Amplifier assembly by connecting a cable from J682 on the Variable Resolution Module to J621 on the Log & Video Amplifier assembly (see Figures 5-17 and 5-16).

(4) Apply the CAL OUT signal to the RF INPUT, and set the Spectrum Analyzer controls as follows:

FREQUENCY	100 MHz
FREQ SPAN/DIV	50 kHz
RESOLUTION BANDWIDTH	10 kHz
REF LEVEL	-20 dBm
MIN RF ATTEN	0 dB
VERTICAL DISPLAY	2 dB/DIV

b. Reset the REF LEVEL for a seven division excursion. Tune the display to center screen and activate SAVE A.

c. Change the RESOLUTION BANDWIDTH to 100 kHz and reset REF LEVEL to bring the signal amplitude to about the same level as the 10 kHz response.

d. Adjust C5055, C5048, and C3041 on the VR 2nd Filter Select board (Figure 5-17) for the best 100 kHz filter response (100 kHz bandwidth, 3 dB down, that is centered about the 10 kHz reference). Refer to Figure 5-18.

e. Reset the RESOLUTION BANDWIDTH to 10 kHz, deactivate and reactivate SAVE A to re-establish the 10 kHz reference.

f. Set the FREQ SPAN/DIV to 500 kHz and the RESOLUTION BANDWIDTH to 1 MHz. Reset the REF LEVEL to set the 1 MHz response amplitude to that of the 10 kHz reference.

g. Adjust C2026 and C1022 (Figure 5-17) for the best 1 MHz response centered about the 10 kHz filter response.

h. Disconnect the 10 MHz third converter IF signal from J683 and reconnect it to J693 (see Figure 5-19). Reconnect P683 to J683 (Figures 5-16 and 5-17).

i. Set the FREQ SPAN/DIV to 1 kHz, RESOLUTION BANDWIDTH to 1 kHz and reset the REF LEVEL for a 7 division display. Activate SAVE A.

j. Set the FREQ SPAN/DIV to 10 kHz, RESOLUTION BANDWIDTH to 10 kHz and adjust REF LEVEL for a 7 division display.

k. Adjust C2037 (Figure 5-19) for the best 10 kHz response centered about the 1 kHz reference.

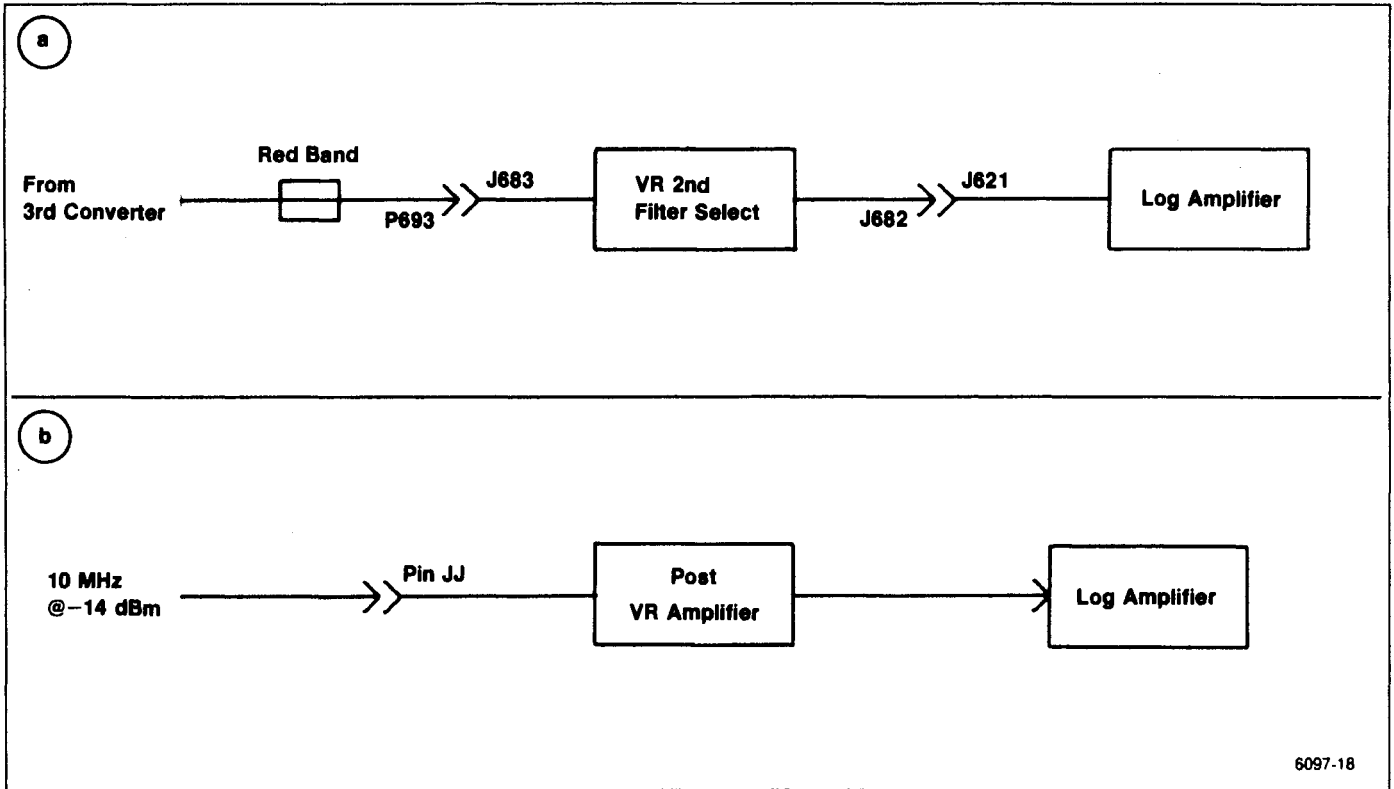

Figure 5-16. Test equipment setup for adjusting the Variable Resolution module.

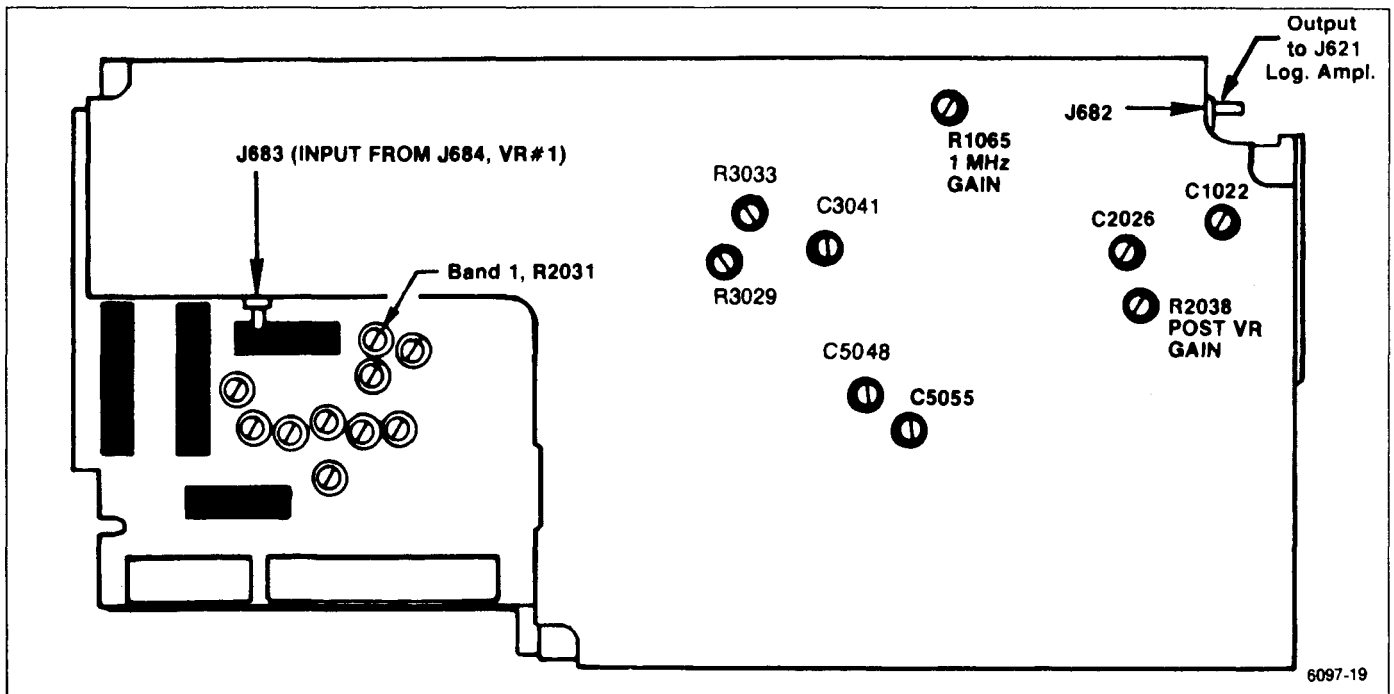

Figure 5-17. Adjustments on the front of the Variable Resolution module.

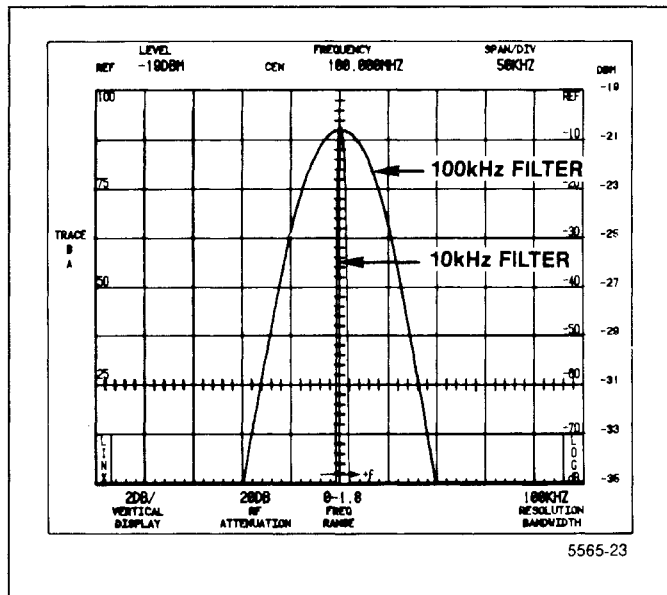

Figure 5-18. 100 kHz filter response over 10 kHz filter response.

- l. Deactivate SAVE A and then reactivate to save the 10 kHz display.
- m. Now, set the FREQ SPAN/DIV to 50 kHz, RESOLUTION BANDWIDTH to 100 kHz.
- n. Adjust C3050, C3035, and C3023 (Figure 5-19) for the best 100 kHz response centered about the 10 kHz filter reference.
- o. Set the RESOLUTION BANDWIDTH to 1 MHz, FREQ SPAN/DIV to 500 kHz.
- p. Adjust the 1 MHz filter response and centering with C1033 and C1026 in the VR Input board (Figure 5-19). Deactivate SAVE A.
- q. Check the waveshape, bandwidth, and centering of all filters. If necessary, make only fine or minor adjustments. Figure 5-20 shows typical response shapes.
- r. Level the gain of the filters as follows:
 - (1) Set the FREQ SPAN/DIV to 500 kHz, RESOLUTION BANDWIDTH to 100 kHz, and REF LEVEL to -20 dBm.
 - (2) Adjust all filters to the 100 kHz level as per the following table. Change FREQ SPAN/DIV as necessary to maintain a suitable display.

Filter	Adjust
1 MHz	R1065
10 kHz	R3033
1 kHz	R3029

Locations of the adjustments are shown in Figure 5-17.

11. Preset the Variable Resolution Gain and Band Leveling

(R2031, R2038, and R3035 on the VR 2nd Filter Select board; R2023 and R2060 on the VR 1st Filter Select board)

NOTE

The Log Amplifier must be calibrated before adjusting any Variable Resolution gain settings. Log Amplifier calibration can be verified by applying a +6 dBm, 10 MHz signal to the input (J621), of the Log Amplifier, and checking for full screen display with the REF LEVEL at -20 dBm.

- a. Before adjusting the Variable Resolution gain and band leveling, set the correction factors to zero by pressing <SHIFT> 0 and selecting menu item 5, then item 2.
- b. Test equipment setup is shown in Figure 5-16B. Set the Spectrum Analyzer controls as follows:

FREQ SPAN/DIV	1 MHz
RESOLUTION BANDWIDTH	100 kHz
REF LEVEL	-20 dBm
MIN RF ATTEN	0 dB
VERTICAL DISPLAY	2 dB/DIV

- c. The gain of the Post VR Amplifier should be 20 dB for best signal-to-noise ratio through the Variable Resolution stages. If any maintenance has been performed on this stage, perform the following steps.

- (1) Remove the cover for the VR 2nd Filter Select board. Disconnect the jumper connector to the input of the Post VR Amplifier (pin JJ).
- (2) Apply a 10 MHz, -14 dBm signal, from a 50 ohm signal source, to pin JJ of the amplifier.
- (3) Adjust Gain R2038 for a full screen display.
- (4) Remove the signal from the input to the Post VR Amplifier and replace the jumper connector to pins JJ at the input to the Post VR Amplifier. Replace the cover for the VR 2nd Filter Select board.

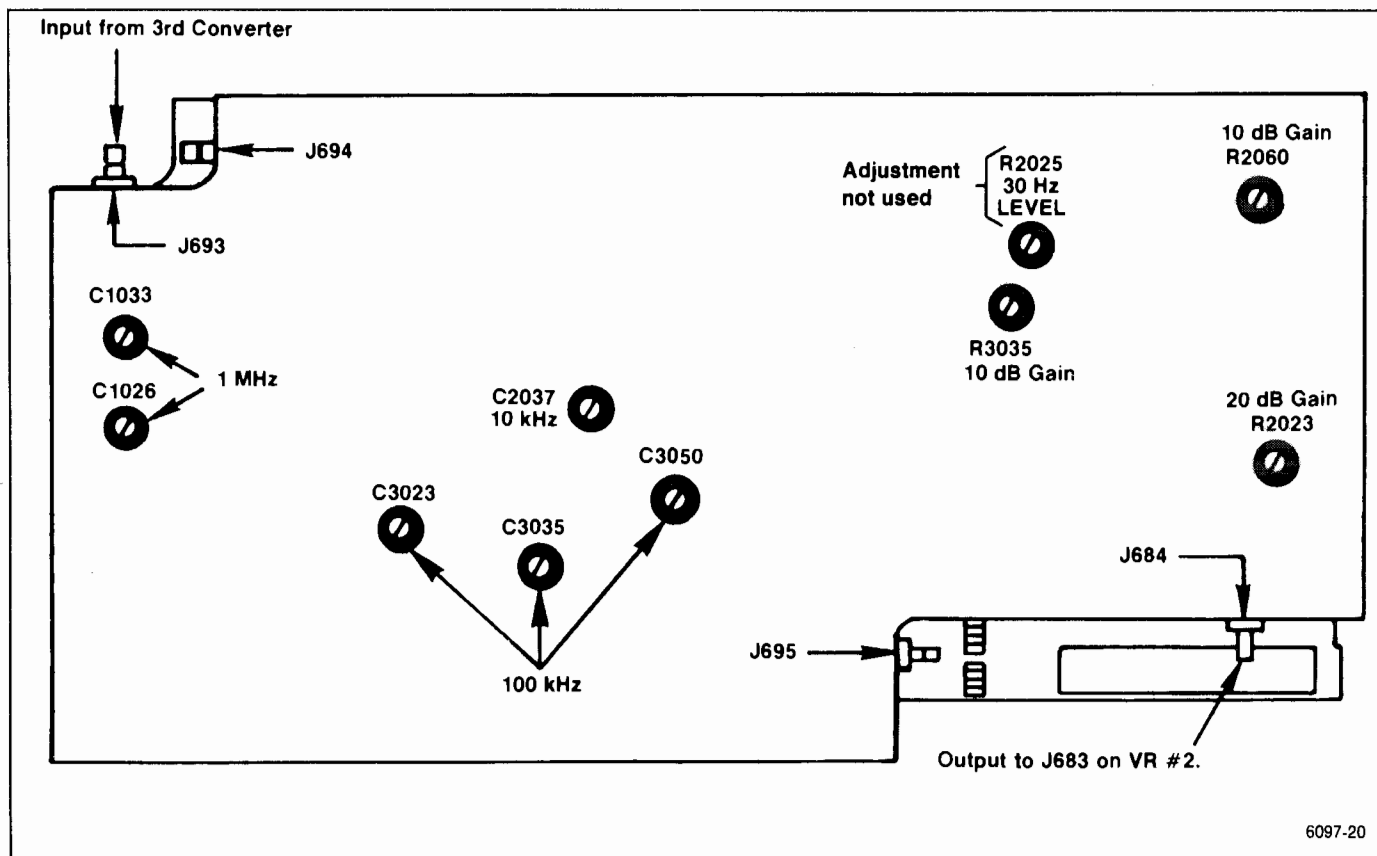

Figure 5-19. Adjustments on the rear of the Variable Resolution module.

d. Set the front panel AMPL CAL fully ccw and set the Band 1 Gain R2031 on VR Mother board #2 (Figure 5-17) fully ccw.

e. Disconnect P693 (Figure 5-19) and activate MIN NOISE. Apply a 10 MHz, -25 dBm signal, from the signal generator, through a bnc-to-Seaelectro adapter to J693. Set the generator frequency to peak the signal amplitude. (Signal amplitude should be between 3.5 and 6.5 divisions. If signal amplitude is not within these limits it indicates a gain problem in the Variable Resolution module.)

f. If the signal amplitude is over 5 divisions, adjust the Post VR Gain R2038 (Figure 5-17) for a 5 division signal amplitude.

g. Reset the front panel AMPL CAL for a 7 division signal.

h. Switch MIN NOISE off, decrease the generator output to -35 dBm, leave the REF LEVEL at -20 dBm, and adjust the 10 dB Gain R3035, on the 10 dB Gain board (Figure 5-19) so the signal amplitude is 7 divisions.

i. Change the generator output to -45 dBm, the REF LEVEL to -40 dBm, and adjust the 20 dB Gain R2023 on the 20 dB Gain Step board (Figure 5-19) for a

7 division signal amplitude.

j. Change the generator output to -65 dBm, the REF LEVEL to -60 dBm, and adjust the 10 dB Gain R2060 on the 20 dB Gain Step board (Figure 5-19) for a 7 division signal amplitude.

k. Set the REF LEVEL to -30 dBm and the generator output to -35 dBm. Check for a 7 division signal amplitude. Repeat this check for -45 , -55 , and -65 dBm input levels. Note that each maintains the 7 division signal to verify that the gain of the Variable Resolution gain stages are correct. Readjust gain if necessary.

l. Remove the 10 MHz signal to J680 and reconnect P680. The final band level adjustments are described after calibrating the Preselector Tracking and checking flatness. The mean level for each band is set to the level of Band 1. Press <SHIFT> CAL to rerun a calibration routine and re-establish processor correction factors.

m. Remove the extender boards and reinstall the Variable Resolution module.

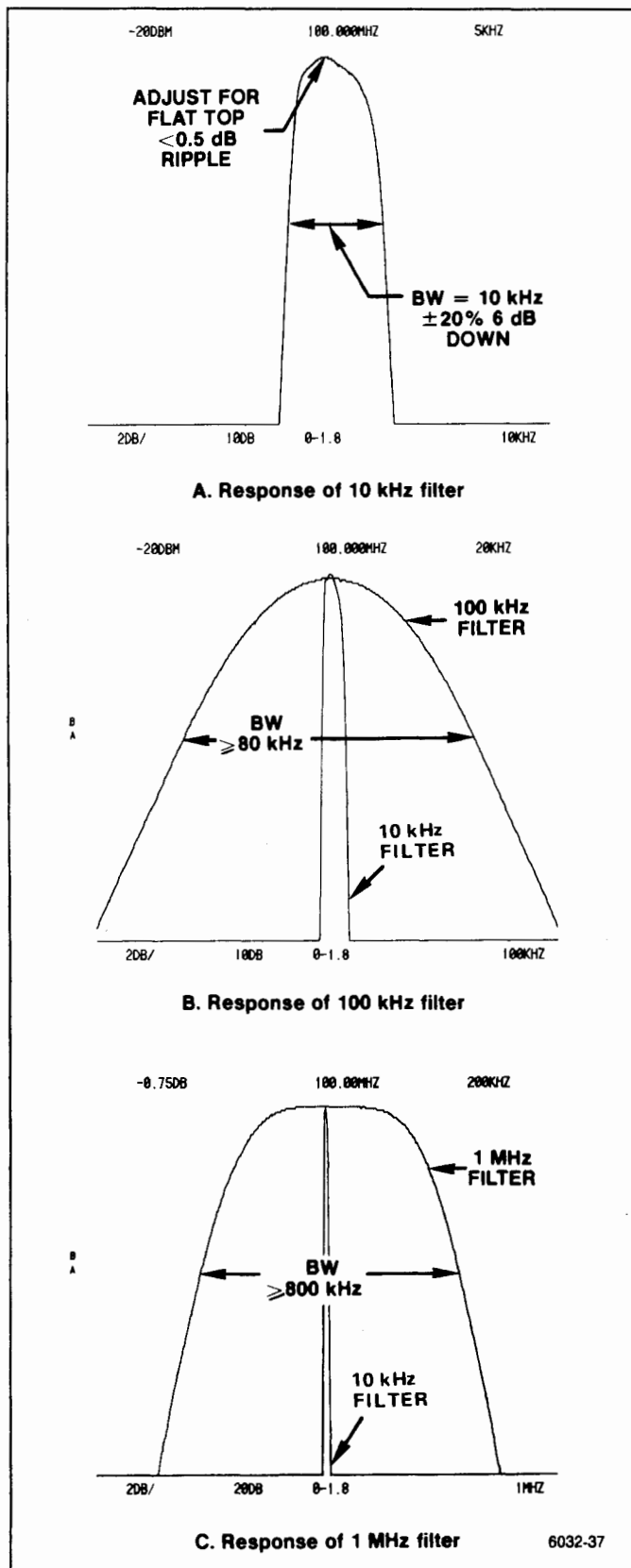

Figure 5-20. 10 kHz, 100 kHz, and 1 MHz filter response.

12. Adjust Calibrator Output Level

(R1041 on the 100 MHz Osc and 3rd Converter board)

NOTE

The calibrator output level is matched to a known reference. A power meter is used to verify the output level of the reference signal generator. Harmonics of the signal generator must be greater than 40 dB down from the fundamental.

a. Apply a 100 MHz signal from the signal generator to the power meter through a 3 dB attenuator. Set the generator output level for a reading of -20 dBm on the power meter. This sets up a reference signal for adjusting the calibrator output level.

b. Disconnect the power meter from the signal generator, and connect the reference signal (from the generator) to the test spectrum analyzer RF INPUT using the same cable that was used to set the reference signal.

c. Set the test spectrum analyzer controls as follows:

FREQUENCY	100 MHz
FREQ SPAN/DIV	100 kHz
RESOLUTION BANDWIDTH	1 MHz
REF LEVEL	-18 dBm
MIN RF ATTEN	0 dB
VIEW A and VIEW B	On
PEAK/AVERAGE	Fully Counterclockwise
TIME/DIV	AUTO
TRIGGERING	AUTO

d. Set the test spectrum analyzer Vertical Display factor to the Δ A mode by pressing FINE. Set the REF LEVEL such that the top of the signal is on a graticule line near the top of the crt. Reset the REF LEVEL to 0.00 dB by pressing FINE twice. Store the display by activating SAVE A.

e. Remove the reference signal from the RF INPUT and connect the CAL OUT signal in its place. Tune the CENTER FREQUENCY control to align the CAL OUT signal with the SAVE A display.

f. Adjust Cal Level R1041, in the 3rd converter (#2 in Figure 5-21) for no displacement between the CAL OUT signal and the reference (VIEW B and SAVE A displays).

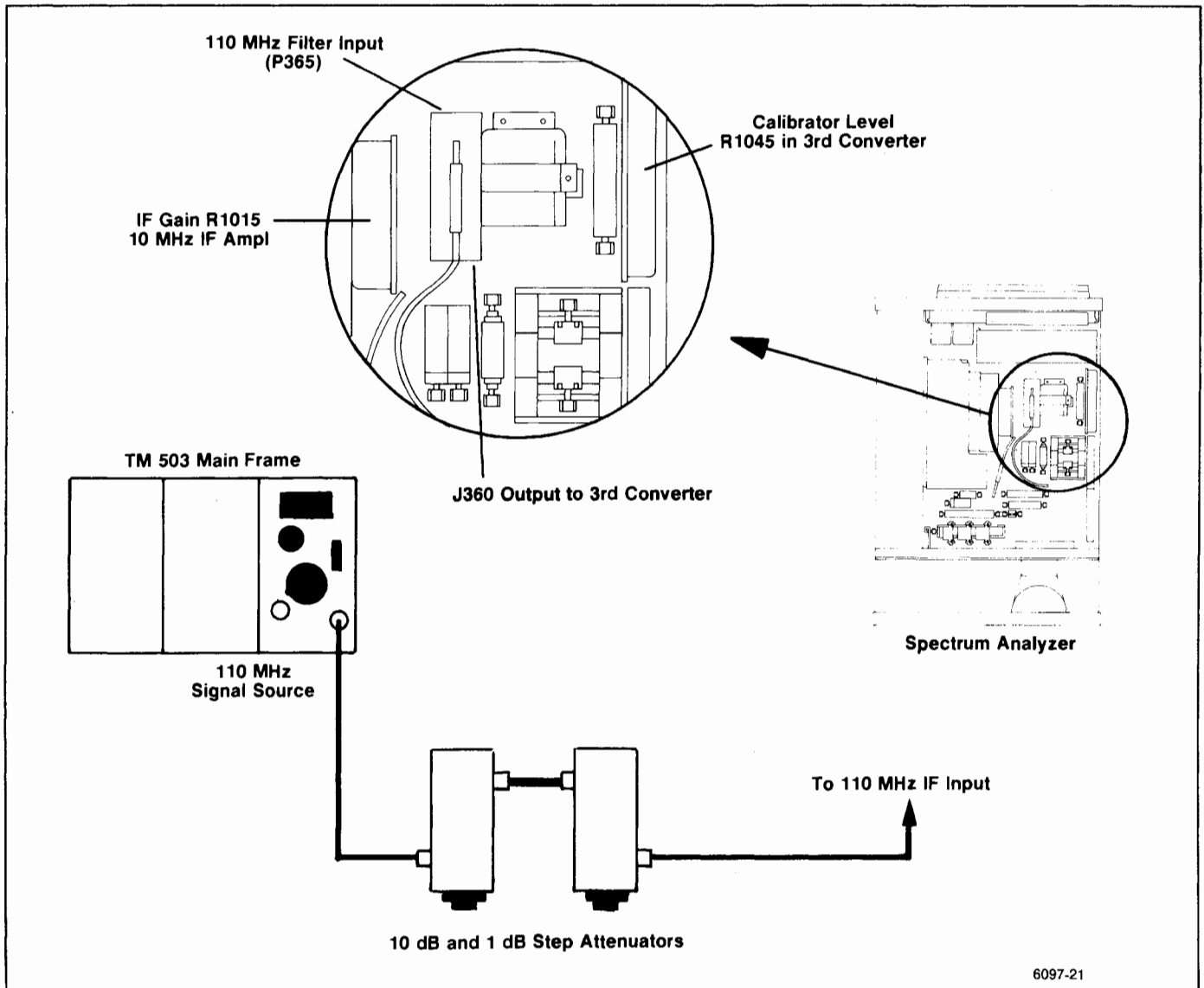

Figure 5-21. IF gain test setup, and adjustment and connector locations.

13. Adjust IF Gain

(R1015 on the 110 MHz Amplifier board)

a. Test equipment setup is shown in Figure 5-21. Set the **RESOLUTION BANDWIDTH** to 1 MHz, **VERTICAL DISPLAY** to 2 dB/DIV, **REF LEVEL** to -20 dBm, and apply a -25 dBm, 110 MHz signal, through step attenuators, to the input (J365) of the 110 MHz filter.

b. Set the step attenuators for 0 dB. Adjust the signal generator frequency for maximum amplitude display. (With -21.5 dBm input the signal level should be 7 divisions or more.) Set the generator output for a 7 division signal reference level.

c. Remove the 110 MHz signal from the 110 MHz filter and reconnect P365.

d. Set the step attenuators for 21 dB attenuation and apply the 110 MHz signal to the input (J321) of the 110 MHz IF amplifier (Figure 5-21).

e. Adjust R1015, 110 MHz IF Gain, for a display amplitude that equals the seven division reference set in part b.

f. Remove the 110 MHz signal and reconnect P321. Apply the **CAL OUT** signal to the **RF INPUT**. Set the Spectrum Analyzer controls as follows:

FREQUENCY	100 MHz
FREQ SPAN/DIV	100 kHz
RESOLUTION BANDWIDTH	100 kHz
REF LEVEL	-20 dBm
VERTICAL DISPLAY	2 dB/DIV

g. Set the front panel AMPL CAL fully ccw and readjust R1015 (110 MHz IF Gain) for 5 divisions of signal. (If this cannot be achieved, it indicates excessive loss through the front end.)

h. Adjust the AMPL CAL for a full screen signal. AMPL CAL adjustment should now have 6 dB down range and 6 dB or more up range.

NOTE

Two variable capacitors, C1054 and C2047 on the 110 MHz IF board, do not require adjustment during calibration. These adjustments require return loss measurements which are maintenance and repair functions.

14. Adjust B-SAVE A Reference Level

(S1015 on the Vertical Digital Storage board)

When B-SAVE A is selected, the expression implemented is (B-SAVE A) +k, where k is a constant set by the input data for an 8-to-4 line encoder, U1015. Each bit will move the reference level about 0.2 minor division. Normally, the reference level is set at the center graticule line; however, it can be set anywhere within the graticule area by the setting of an 8-bit binary switch, S1015 (Figure 5-7). The MSB (switch #8) shifts the display about five divisions, switch #7 half this amount, etc. The following procedure sets the reference level.

Estimate the amount and direction the reference level is to be shifted, then close or open the switches on S1015 to obtain the desired B-SAVE A reference level.

15. Adjust Preselector Driver

(R1031, R1045, R1049, R1052, R1054, R1056, R1061, R1063, R1064, and R1065 on the Preselector driver board)

a. Connect the test equipment as shown in Figure 5-22.

b. Set the time mark generator to 10 nS, and the Comb Generator to On.

c. Connect DVM between the center tap of the MANUAL PEAK potentiometer and ground. Adjust the control for 0 V indication. If index on the knob is not aligned with the mark on the front panel, loosen knob and position the mark so it is aligned.

d. Set the Spectrum Analyzer controls as follows:

FREQUENCY RANGE	1.7—5.5 GHz
FREQ SPAN/DIV	20 MHz
AUTO RES	On
REF LEVEL	-30 dBm

e. Set the CF/MARKER FREQUENCY to center the 2.1 GHz marker. Center the Input Offset adjustment R1031 (Figure 5-23), then center the 2.1 GHz marker with the CF/MARKER FREQUENCY control. Ground TP1069 with a jumper strap.

f. Adjust the Preselector Offset R1064 for maximum response of the 2.1 GHz signal. Remove the grounding strap.

g. Peak the 2.1 GHz signal with the -829 MHz IF Offset R1049 (Figure 5-23).

h. Remove the Time Mark Generator signal to the Comb Generator. Change the REF LEVEL to 0 dBm, set FREQUENCY to 5.5 GHz, and center the 5.5 GHz comb marker on screen.

i. Peak the 5.5 GHz signal with the Preselector Sense, R1065 adjustment.

j. Because of interaction repeat parts g through i.

k. Push <SHIFT> ΔBAND to 5.4—18.0 GHz (Band 4). Set REF LEVEL and RESOLUTION BANDWIDTH to observe the 6 GHz marker. Set the MANUAL PEAK control to peak the 6 GHz signal.

l. Set FREQUENCY to 9 GHz and observe the 9 GHz marker on screen. Peak this response with the X3 Gain R1052 adjustment.

m. Repeat parts k and l to eliminate interaction.

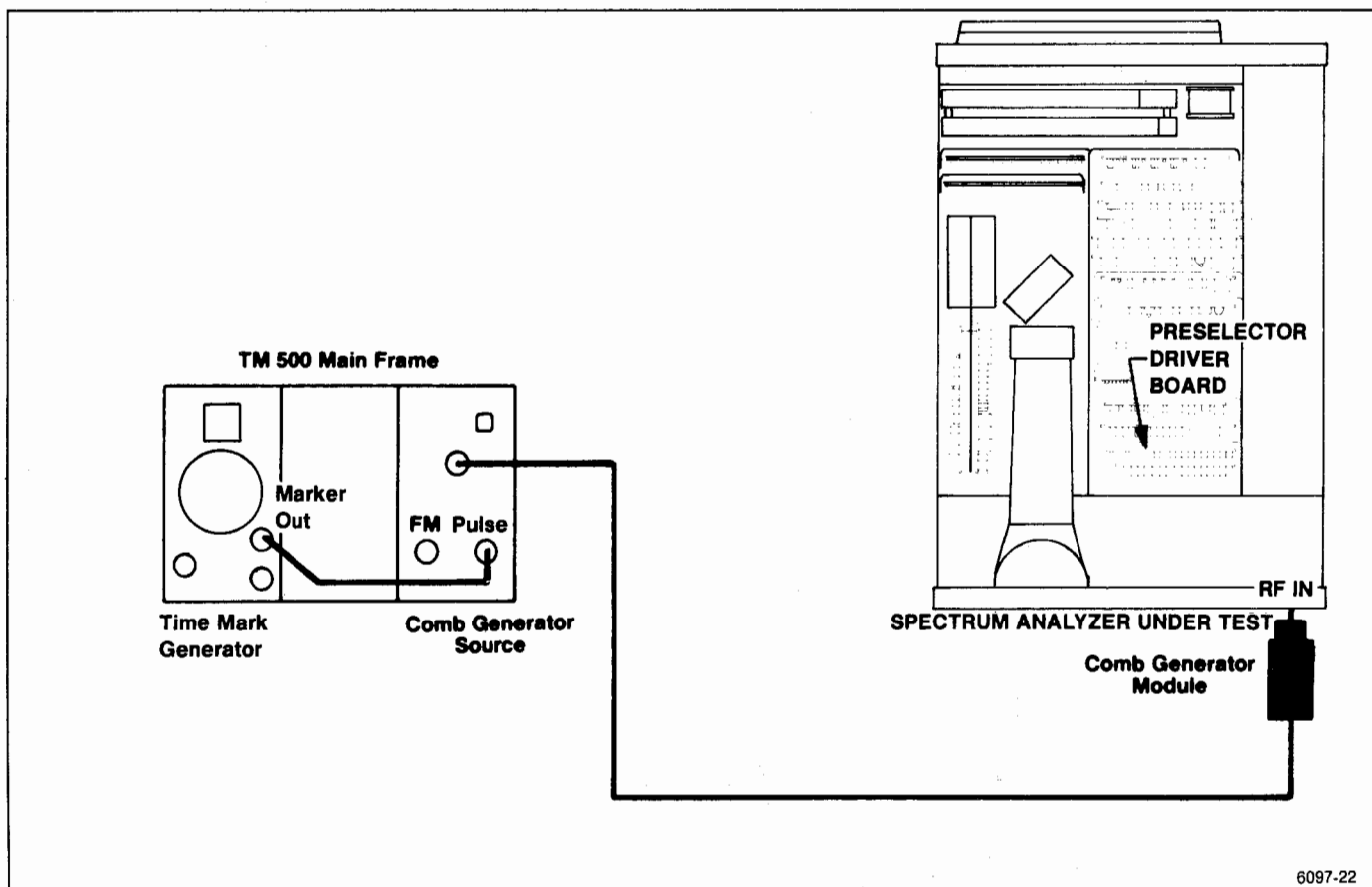

Figure 5-22. Preselector Driver adjustment setup.

n. Increase FREQUENCY to the 12 GHz marker, then peak the 12 GHz point with Shaper #1 R1054 adjustment (Figure 5-23).

o. Set FREQUENCY to center the 17 GHz marker, then peak the signal with Shaper #2, R1056 adjustment.

p. Recheck the 6, 9, 12, and 17 GHz points to verify that they all peak at the same position of the front-panel MANUAL PEAKING control. If they do not, repeat parts g through o.

q. Push <SHIFT> BAND ∇ to 1.7—5.5 GHz (Band 2). Center the 5.5 GHz marker, then peak the signal with the front-panel MANUAL PEAK control.

r. Push <SHIFT> Δ BAND to 5.4—18.0 GHz (Band 4). Center the 5.5 GHz signal with the CF/MARKER FREQUENCY control. Adjust Input Offset R1031, to peak the signal.

s. Repeat parts q and r until the signal amplitude peaks, on both bands, occur at the same position of the MANUAL PEAK control.

t. Set MANUAL PEAK control so the index mark aligns with the front panel mark. Push <SHIFT> BAND ∇ to 1.7—5.5 GHz, and set the CF/MARKER FREQUENCY to center the 3.5 GHz comb marker.

u. Adjust -829 MHz IF Offset R1049 (Figure 5-23) to peak the 3.5 GHz response.

v. Push <SHIFT> Δ BAND to 3.0—7.1 GHz, set the FREQUENCY to 5.0 GHz to observe the marker, then peak the 5.0 GHz signal with the +829 MHz IF Offset R1045 adjustment.

w. Push <SHIFT> Δ BAND to 15—21 GHz. Set the FREQUENCY to 15 GHz, then peak the 15 GHz signal with R1064.

x. Tune the 19 GHz marker to center screen then peak the 19 GHz signal with Shaper #3 R1061 adjustment (Figure 5-23).

y. Tune to the 21 GHz marker then peak the signal with Shaper #4 R1063 adjustment.

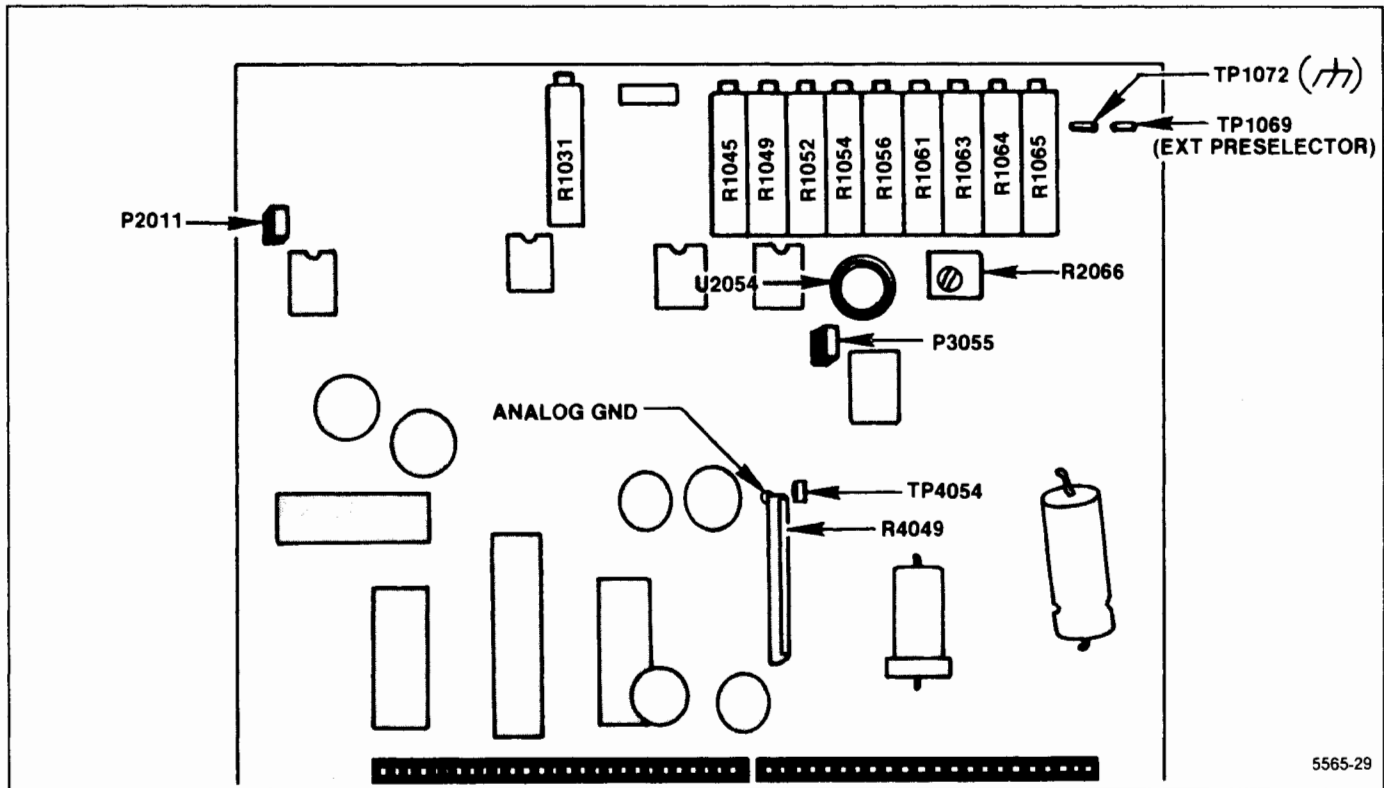

Figure 5-23. Preselector Driver test point and adjustment locations.

z. Recheck the 15, 19, and 21 GHz points to verify that they all peak at the same position of the MANUAL PEAK control.

aa. Push <SHIFT> BAND ∇ to 3.0—7.1 GHz, center a 5.0 GHz signal on screen, then peak the signal with the +829 MHz IF, R1045 adjustment.

ab. Change to the 1.7—5.5 GHz band, center a 3.5 GHz marker on screen, then peak the 3.5 GHz signal with the -829 MHz IF, R1049 adjustment.

ac. The signal peak for all bands should occur with the MANUAL PEAK knob index marker near the front-panel mark.

16. Adjust Band Leveling for Coaxial Bands (Bands 1—5)

(R2031, R3034, R3030, R3019 and R3022 on the VR #2 Mother board)

NOTE

The mean value of the frequency response for each band is set to a -20 dBm reference at 100 MHz.

a. Perform Frequency Response Check of bands 1 through 5 as described in the Performance Check section and note the frequency at the mean level (average level between two extremes) for each band.

b. Perform adjustment step 10 (Presetting the Variable Resolution Gain and Baseline Leveling) prior to proceeding with this step.

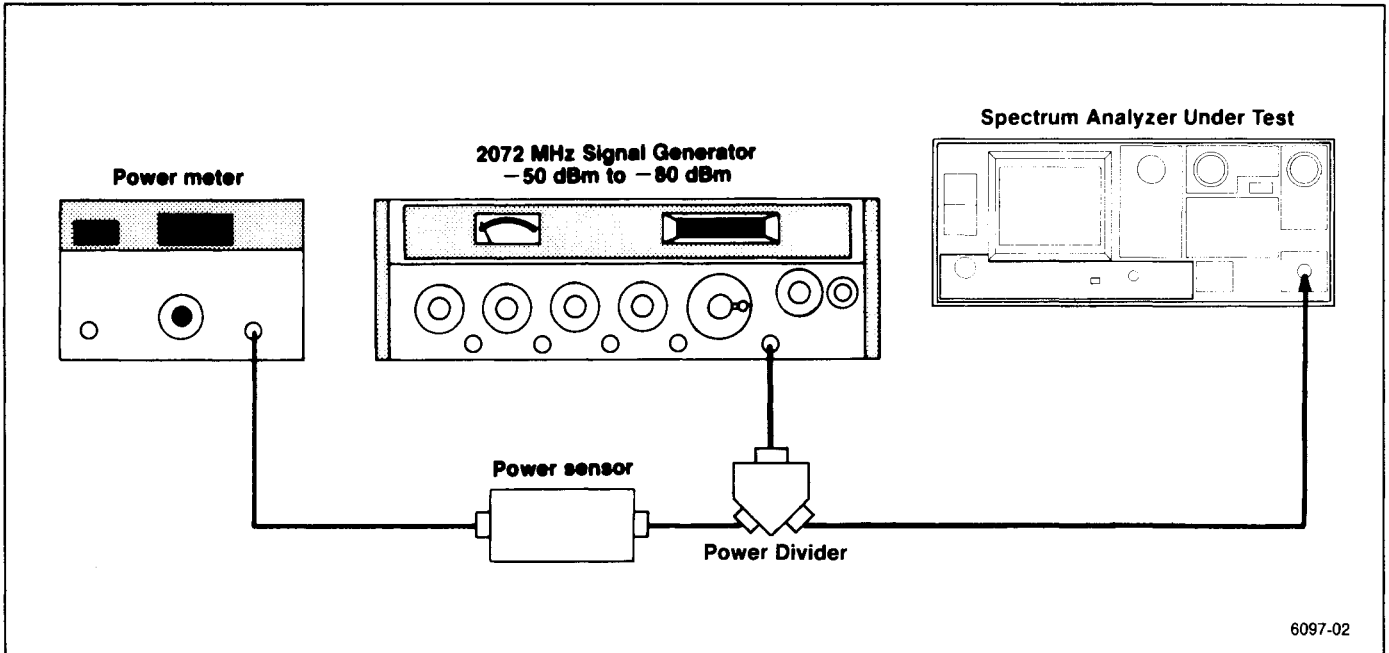

Figure 5-24. Test equipment setup for band leveling adjustment.

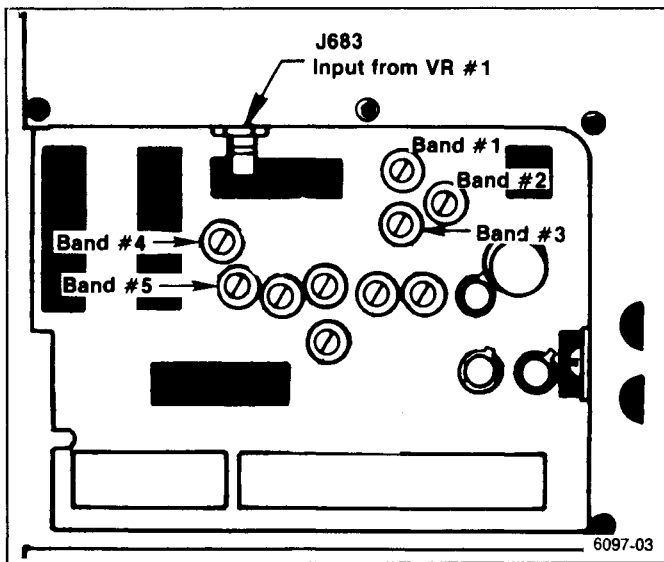

Figure 5-25. Band leveling adjustment and gain diode locations.

c. Put the VR Module on an extender and connect test equipment as shown in Figure 5-24. Set the Spectrum Analyzer controls as follows:

FREQUENCY RANGE	1.7—5.5 GHz
FREQ SPAN/DIV	10 MHz
AUTO RES	On
REF LEVEL	-20 dBm
MIN RF ATTEN	0 dB
VERTICAL DISPLAY	2 dB/DIV
VIEW A and VIEW B	On

d. Apply a calibrated -20 dBm signal, whose frequency is the same as that noted for the mean level in part "a", to the RF INPUT. Set the FREQUENCY to the input signal and reduce the FREQ SPAN/DIV to 500 kHz.

e. Adjust Band 2 Gain R3034 on the VR Mother board #2 (Figure 5-25) for a full screen (-20 dBm) display.

f. Push ΔBAND to 3.0—7.1 GHz (Band 3) and apply a calibrated -20 dBm signal with the same frequency as noted for the mean level in Band 3 for part a of this step.

g. Set the FREQUENCY to the incoming signal and FREQ SPAN/DIV to 500 kHz/Div.

h. Adjust Band 3 Gain R3030 (Figure 5-25) for a full screen display.

i. Repeat the above procedure for each coaxial band (1—5) and set the gain of each with the appropriate adjustment. If the range of any adjustment is insufficient, add or remove a diode between pin DD and the appropriate adjustment potentiometer on the VR Mother board #2, to obtain the required range. Refer to the schematic diagram and component locator for Variable Resolution Mother Boards, in Volume 2. Adding the diode increases gain.

17. Phase Lock Calibration

(C1013 and C2011 on the Controlled Oscillator board; C1032 and C2105 on the Strobe Driver board; R3082 on the Error Amplifier board)

The Phase Lock assembly normally requires calibration only after some part of the assembly has been repaired or replaced. Phase noise, produced by the phase lock loop, is specified for -75 dBc or better, 3 kHz out from the response. This should be checked before calibrating the assembly.

a. Test equipment setup is shown in Figure 5-26. Remove the Phase Lock module and the two cover plates so all circuit test points and adjustments are accessible. Plug the assembly on extender boards and into the instrument. Use extender cables and adapters to reconnect signal cables to their respective connector (cable with yellow band to J501, and the cable with black band to J502).

If desired, the direct reading counter can be connected to the Vertical Output of the test oscilloscope. This will enable the user to observe the display of a test point and get a count, if appropriate, throughout this procedure. The ground side of the test oscilloscope probe will serve as the common ground return for both instruments.

b. Press <SHIFT> CAL and do the directed calibration routine through adjusting the LOG CAL. Press <SHIFT> to return the instrument to normal operation and set REF LEVEL to -30 dBm. Check that the AUTO RES is active (button lit).

c. Check Offset Mixer — This part of the procedure is only required after repair or replacement of the Mixer board.

(1) Connect the Direct Input of the frequency counter to pin N (Figure 5-27) and set the counter controls for a count. Note the frequency.

(2) Connect the counter to pin K and note the frequency.

(3) Connect the counter to the collector of Q1040 and note the frequency. Frequency should equal the difference between pins N and K (e.g., $25.080 - 25.000 = 80$ kHz). Disconnect the counter probe from the collector of Q1040. (4) Connect a test oscilloscope probe to the collector of Q1040 and check for a signal with a frequency between 30 MHz and 94 MHz, 50% duty cycle, and an amplitude of approximately 5 V peak-to-peak.

d. Check Synthesizer

(1) Set the FREQ SPAN/DIV to 200 kHz. Phase lock should occur.

(2) Change FREQ SPAN/DIV to 500 kHz and connect the counter to J500 on the Synthesizer board. Check for a reading of 50.00 MHz.

(3) Connect the counter to TP2040 (Figure 5-27a) and check for a reading that is near 25.0 MHz.

(4) Connect the test oscilloscope to TP1040 (Figure 5-27a) and check for positive pulses with an amplitude of approximately 4 V peak-to-peak.

(5) Change the FREQ SPAN/DIV to 200 kHz and observe that the signal on TP1040, in part 4) is still there.

e. Controlled Oscillator — This part of the check is only required after repair or replacement of the Controlled Oscillator board.

(1) Press <SHIFT> 0 and select item 1 (FREQUENCY LOOPS CAL), then item 5 (PHASELOCK SYNTHESIZER) from the displayed menu.

(2) Follow the instructions until the message, "VERIFY LAST STEP". Due to the interaction of C1013 and C2011 adjustments, the two steps will have to be repeated until the voltages are correct. Alternately press GHz and MHz on the Data Entry keypad, and adjust until the two voltage readings are correct.

(3) Connect the counter to TP 2011 on the Controlled Oscillator board (Figure 5-27a) and alternately press MHz and GHz on the Data Entry keypad, and check for a count reading of either 25.0943 MHz or 25.0328 MHz.

f. Check Operation of Strobe Driver

The "Phase Lock Synthesizer" test is still used for this test. If aborted, press <SHIFT> 0 to return to the Synthesizer routine. Any step in the routine will work.

(1) Connect the test oscilloscope to TP1012 on the Strobe Driver board (Figure 5-27b) and check for a square wave response with a Time/Div setting of 50 ns. Amplitude should be approximately 5 V peak-to-peak.

(2) Connect the test oscilloscope to TP1032 and check for a sinusoidal waveform of approximately 5 V p-p.

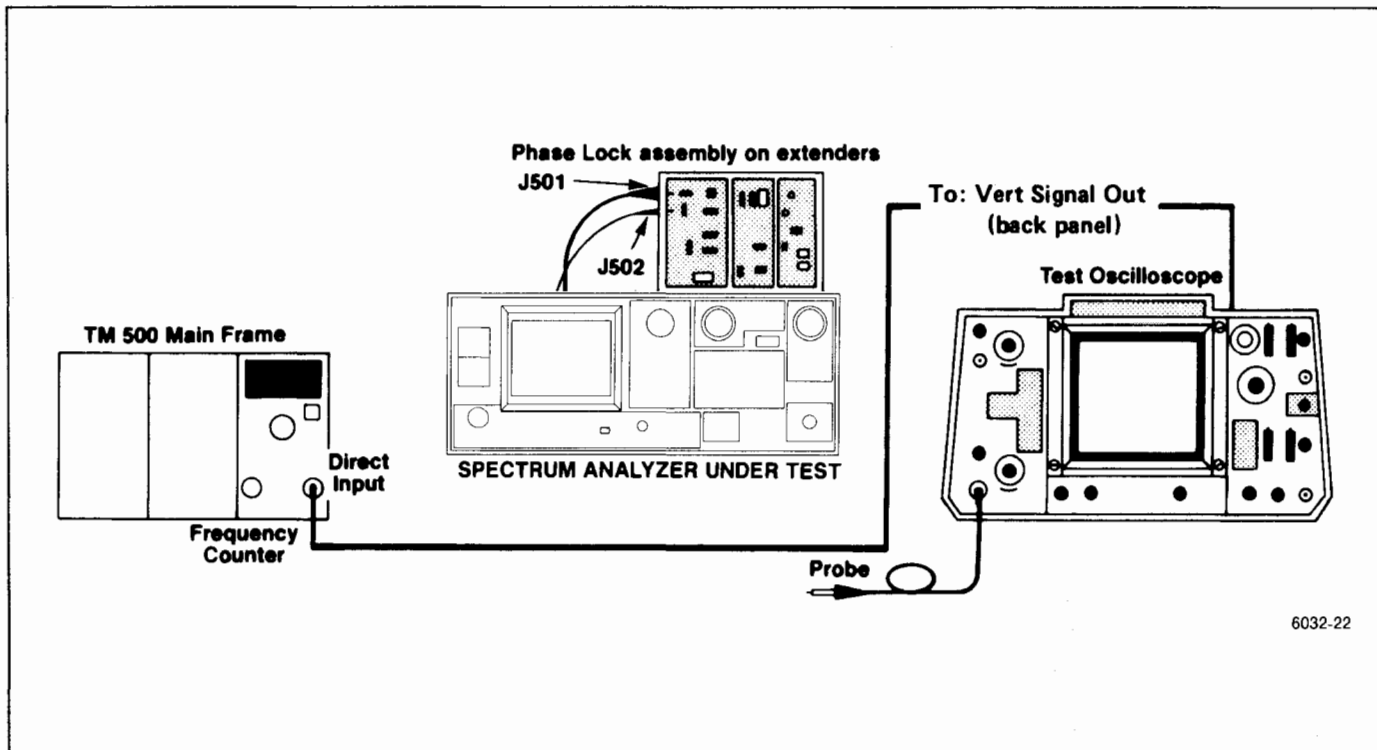

Figure 5-26. Test equipment setup for adjusting the Phase Lock assembly.

(3) Connect the counter to TP1032 and check for a count of either 5.018868 or 5.006477 MHz.

(4) Connect the test oscilloscope to J504 and check for 5 V logic levels.

(5) Press <SHIFT> to abort the test.

g. Error Amplifier — This procedure sets loop gain which is required when either the Phase Lock assembly, 1st LO, Phase Detector, or Error Amplifier is replaced.

(1) Set FREQ SPAN/DIV to 200 kHz then press <SHIFT> 0. The "Diagnostic Functions" menu will now be displayed. Select "Diagnostic Aids" (3), then "1st LO Phase Lock" (0). Phase lock should be disabled.

(2) Connect the test oscilloscope to TP2038 (Figure 5-27b) and set test oscilloscope Time/Div to 20 ms. Check for waveform pulses with an amplitude that is approximately 6 V peak-to-peak.

(3) Press 10 dB/DIV to enable phase lock and note that the message indicates "LOCK ENABLED". Connect the test oscilloscope to TP 3081 (Figure 5-27b) and vary R3082 from stop to stop and note that the beat note signal varies in amplitude. Press <SHIFT> to exit the routine.

(4) Set the TIME/DIV to AUTO, FREQUENCY RANGE to band 2 (1.7—5.5 GHz). Activate MAX SPAN, and turn Digital Storage off.

(5) Remove P3057 (Figure 5-27b), this turns on the strobe to the Phase Gate. Set Loop Gain R3082 fully counterclockwise.

(6) Monitor TP3081 with the test oscilloscope to. Sweep the test oscilloscope externally with the signal at TP2038 (U2048-6) shown Figure 5-27b. Set the test oscilloscope Time/Div to X-Y and horizontal Volts/Div to 0.5 V. Note the beat notes. Beat notes are produced by the difference between strobos from the phase lock (one every 5 MHz) and the particular frequency the 1st LO is tuned to.

(7) Tune the CENTER/MARKER FREQUENCY until the intensified marker on the oscilloscope is at the beatnote minimum.

(8) Reduce the FREQ SPAN/DIV to 20 MHz, and activate VIEW A.

(9) Check that the beat note is >0.5 V peak-to-peak. If the beat note does not meet this requirement, the Phase Gate is may be defective. Adjust R3082 for a minimum but no less than 0.5 V signal.

(10) Replace P3057, disconnect the test oscilloscope trigger and probe connections. Ensure that P3057 is installed correctly; its absence will produce spurious responses on the display.

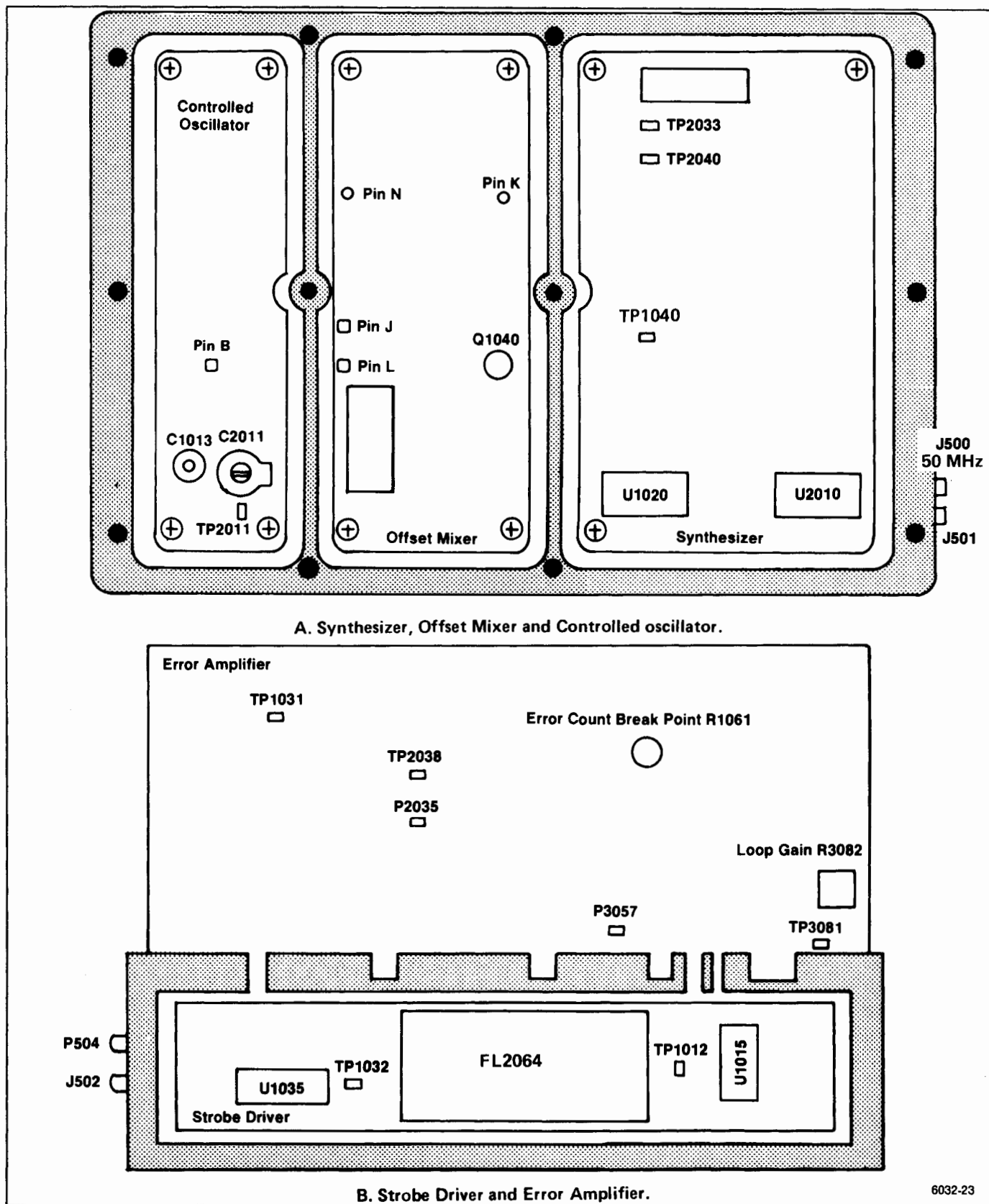

Figure 5-27. Phase Lock assembly adjustment and test point locations.

(11) Reduce FREQ SPAN/DIV to 200 kHz and ensure that phase lock occurs, by the absence of error message and a sweep. Replace the covers on the assembly and reinstall the module in the instrument. Perform the phase lock noise check as described in the Performance Check section.

h. Check Strobe Driver — Excessive noise on the display and intermittent lock are indications that the strobe pulse from the Strobe Driver is noisy or low in amplitude. This can be caused by a mismatch in input or output impedance to the band-pass filter FL2064. The following procedure is required if the filter or any component that affects the input or output impedance match is replaced.

(1) With the instrument in phase lock mode (FREQ SPAN/DIV 200 kHz or less), monitor TP1032 with a test oscilloscope. Note the amplitude of the 5 MHz strobe signal. Amplitude of the sinusoidal strobe signal is normally 5 V to 6 V peak-to-peak.

(2) If the strobe signal amplitude is low and noisy, change the value of select capacitors C1032, C1034, C1016, and C1018 to obtain the maximum strobe pulse amplitude at TP1032. These capacitors range from 3.3 pF to 27 pF.

(3) If the signal amplitude is still low, check the frequency at TP1012 with a frequency counter. Frequency must lie between 5.0067 MHz and 5.0188 MHz. The frequency is a function of the Controlled Oscillator assembly and counter U1022.

(4) Set R1061 to midrange.

MAINTENANCE

INTRODUCTION

This section describes procedures for reducing and preventing instrument malfunction, troubleshooting methods, corrective maintenance, and procedures for recalibrating those assemblies that normally do not require routine calibration.

Removing the Instrument from its Cabinet

To prepare the rackmount model for adjustment, refer to the Rackmount part of the Options section of this manual (Section 8).

Remove the cabinet as follows:

CAUTION

Do not place the instrument on its front panel as this may cause damage to the front-panel knobs.

1. Remove the twelve torque screws holding the rear-panel casting, and pull the casting from the instrument.
2. Remove the eight screws holding on the feet, and the eight screws holding on the handles.
3. Pull the cabinet from the rear of the instrument.
4. Place the instrument on the bench and reconnect the power cord.

Some circuit boards and assemblies must be placed on extenders to access test points or adjustments. Before removing these boards and assemblies, the air baffle attached to the left siderail must also be removed.

Turn the power off before removing an assembly.

Static-Sensitive Components

This instrument contains electrical components that can be damaged by static discharge. See Table 6-1 for the relative susceptibility of various classes of semiconductors. Static voltages of 1 kV to 30 kV can occur in unprotected environments.

CAUTION

Static discharge can damage any semiconductor component in this instrument.

Observe the following precautions to avoid damage:

1. Minimize handling of static-sensitive components.
2. Transport and store static-sensitive components or assemblies in their original containers, on metallized or conductive foam. Label packages that contains static-sensitive assemblies or components.
3. Discharge body static voltage by wearing a grounded wrist strap while handling these components. Static-sensitive assemblies or components should be handled and serviced only at static free work stations by qualified service personnel.
4. Nothing capable of generating or holding a static charge should be allowed on the work station surface.
5. Keep the component leads shorted together whenever possible.
6. Pick up components by the body, never by the leads.
7. Do not slide the components over any surface.
8. Avoid handling components in areas that have a floor or work-surface covering capable of generating a static charge.
9. Use a soldering iron that is connected to earth ground.
- 10) Use only special anti-static suction type or wick type desoldering tools.

**Table 6-1
RELATIVE SUSCEPTIBILITY TO
STATIC DISCHARGE DAMAGE**

Semiconductor Classes	Relative Susceptibility Levels ^a
MOS or CMOS microcircuits or discretes, or linear microcircuits with MOS inputs. (Most Sensitive)	1
ECL	2
Schottky signal diodes	3
Schottky TTL	4
High-frequency bipolar transistors	5
JFET devices	6
Linear microcircuits	7
Low-power Schottky TTL	8
TTL (Least Sensitive)	9

Voltage Equivalent for Levels:

1 — 100 to 500 V	4 — 500 V	7 — 400 to 1000 V (est)
2 — 200 to 500 V	5 — 400 to 600 V	8 — 900 V
3 — 250 V	6 — 600 to 800 V	9 — 1200 V

^a Voltage discharged from a 100 pF capacitor through a resistance of 100Ω.

PREVENTIVE MAINTENANCE

Preventive maintenance consists of cleaning, visual inspection, performance check, and if needed a recalibration. The preventive maintenance schedule that is established for the instrument should be based on the environment in which the instrument is operated and the amount of use. Under average conditions (laboratory situation) a preventive maintenance check should be performed every 1000 hours of instrument operation.

Elapsed Time Meter

A 5000 hour elapsed time indicator, graduated in 500 hour increments, is installed on the Z-Axis/RF Interface circuit board. This provides a convenient way to check operating time. The meter on new instruments may indicate from 200 to 300 hours elapsed time because most instruments go through a factory burn-in time to improve reliability. This is similar to using aged components to improve reliability and operating stability.

Cleaning

Clean the instrument often enough to prevent dust or dirt from accumulating in or on it. Accumulation of dirt and grease acts as a thermal insulating blanket and prevents efficient heat dissipation. It also provides high resistance electrical leakage paths between conductors or components in a humid environment.

Exterior. Clean the dust from the outside of the instrument by wiping or brushing the surface with a soft cloth or small brush. The brush will remove dust from around the front-panel selector buttons. Hardened dirt may be removed with a cloth dampened in water that contains a mild detergent. Abrasive cleaners should not be used.

Interior: Clean the interior by loosening accumulated dust with a dry soft brush, then remove the loosened dirt with low pressure air to blow the dust clear. (High velocity air can damage some components.) Hardened dirt or grease may be removed with a cotton tipped applicator dampened with a solution of mild detergent in water. Do not leave detergent on critical memory components. Abrasive cleaners should not be used. If the circuit board assemblies need cleaning, remove the circuit board by referring to the instructions under Corrective Maintenance in this section.

After cleaning, allow the interior to thoroughly dry before applying power to the instrument.

CAUTION

Do not allow water to get inside any enclosed assembly or components such as the hybrid assemblies, RF Attenuator assembly, potentiometers, etc. Instructions for removing these assemblies are provided in the Corrective Maintenance part of this section. Do not clean any plastic materials with organic cleaning solvents such as benzene, toluene, xylene, acetone or similar compounds because they may damage the plastic.

Lubrication

Components in this instrument do not require lubrication.

Fixtures and Tools for Maintenance

Table 6-2 lists kits and fixtures that are available to aid in servicing the spectrum analyzer.

Visual Inspection

After cleaning, carefully check the instrument for such defects as defective connections and damaged parts. The remedy for most visible defects is obvious. If heat-damaged parts are discovered, try to determine the cause of overheating before the damaged part is replaced; otherwise, the damage may be repeated.

Transistor and Integrated Circuit Checks

All transistors and integrated circuits are soldered on the boards to prevent pin contact problems. Periodic checks of the transistors and integrated circuits is not recommended. The best measure of performance is the actual operation of the component in the circuit. In most cases any degradation in performance will be detected by the microcomputer when it runs its power up routine. Performance of these components is also checked during the performance check or recalibration; any sub-standard transistors or integrated circuits will usually be detected at that time.

When handling a static sensitive devices observe necessary handling procedures to prevent damage.

Table 6-2
SERVICE KITS AND TOOLS

Nomenclature	Tektronix Part No.
Service Kit consisting of:	006-3286-01
1 Front panel extender	067-0973-00
1 Power module extender	067-0971-00
1 Accessories Interface extender	067-0972-00
1 Ribbon cable	175-2901-00
3 Coaxial cables, Seaelectro male-to-Seaelectro female	175-2902-00
1 VR module handle	367-0285-00
1 Circuit board extender assembly kit consisting of:	672-0865-01
1 Left extender board	670-5562-01
1 GPIB extender board	670-8493-00
2 Right extender boards	670-5563-00
1 Frame extrusion for circuit board extender	426-1527-00
6 Screws, panhead with flat and lockwashers	211-0116-00
Screwdriver, flat, with 1/4 to 3/8-inch bit	
Screwdriver, Posidrive® 440-2	
Wrench, 5/16-inch open-end	
Hex drive wrenches, 3/32, 5/64, 7/64-inch	
Service kit consisting of a torque wrench calibrated for 8 lbs	003-1324-00

Performance Checks and Recalibration

The instrument performance should be checked after each 1000 hours of operation or every twelve months if the instrument is used intermittently to ensure maximum performance and assist in locating defects that may not be apparent during regular operation. Instructions for conducting a performance check are provided by the Performance Check section of the service instructions.

Saving Stored Data in Battery-Backup Memory

If either the Memory or GPIB board are removed from the instrument, data stored in battery-backed up non-volatile memory will be lost because the back-up battery on the GPIB board is disconnected. A program for storing data on tape is provided at the end of this section.

TROUBLESHOOTING

The spectrum analyzer contains firmware that will troubleshoot the frequency control system and the power supply. Troubleshooting procedure for this system and the power supply is provided in the Diagnostics part of this section. Also included with this part is a description of the trace modes and their actions. After the defective assembly or component has been located, refer to the Replacing Assemblies and/or Sub-assemblies part of this section for removal and replacement instructions.

The following aids and techniques may help locate a problem or trouble in the instrument.

Troubleshooting Aids

Diagrams — Functional block and circuit diagrams, on foldout pages in the Diagrams section, contain significant waveforms, voltages, and logic data information. Any necessary information as to how the data was acquired, such as operational state of the instrument, is provided on the diagram or adjacent to it. Refer to the Replaceable Electrical Parts list section for a description of all assemblies and components. Diagrams are arranged in signal flow sequence and by sections, such as RF section, IF section, frequency control section, etc., with an accompanying functional block diagram.

Schematic diagrams list the Tektronix Part No. (670-xxxx-) for the assembly or board along with the assembly number (e.g. A50) and name. The last two digits or suffix of the part number are not indicated on the diagram, however, they are listed in the Electrical Parts section. These two digits reflect changes or modifications to the assembly or board. When a change is made to the assembly the suffix rolls one digit. The diagram indicates these changes with a grey tint drawing of the original circuit or if a component changes value the symbol is enclosed with a grey tint box. When a major modification is made to an assembly or board and it is no longer compatible with earlier instruments a new part number is assigned and a separate schematic with associated illustrations are added, all diagrams indicate the new part number and the instrument serial number break. If the assembly is compatible with earlier instruments and the change is significant enough to require a separate schematic, this will also be identified.

NOTE

Corrections to the manual and instrument modifications, if significant, are documented by adding inserts, bound into the rear of the manual, until the information is added to the manual text. Check this "Change Information" section for these changes to the manual or the instrument.

Circuit Board Illustrations and Component Locator Charts — Electrical components, connectors, and test points are identified on circuit board illustrations that are located on the inside fold of the corresponding circuit diagram or the back of the preceding diagram. A grid on the circuit board illustration and the circuit schematic, plus a look-up table, provide the means to quickly locate components on either the diagram or the circuit board.

In most cases, circuit numbers are assigned according to the physical location of the component on the board or assembly. The first digit designates the row of a grid, the second the column, with the last two reserved as an expander. Three digit numbers designate chassis mounted components.

Diagnostics — The spectrum analyzer contains firmware that will assist in locating trouble in the frequency control system and the power supply. This diagnostic information is part of this section.

General Troubleshooting Techniques

Before using test equipment, to measure across static-sensitive components or assemblies, be certain that voltages or current supplied by the test equipment does not exceed the limits of the components to be tested.

Try to isolate the problem to a component through signal analysis. Determine that circuit voltages will not damage the replacement.

Semiconductor Checks — Semiconductor failures account for the majority of electronic equipment failures. All semiconductors are soldered to the boards to reduce pin contact problems. The following guidelines should be observed if you substitute any of these components.

1. Turn the power off before removing an assembly or board.
2. Use a de-soldering tool and 25 W or less soldering iron to remove the components.
3. Use only good components for substitution. Be sure the new component is inserted into the board properly before soldering. Refer to the manufacturer's data sheet for integrated circuit and transistor lead configuration.

NOTE

If a substitute is not available, check the transistor or MOS FET with a dynamic tester such as the TEKTRONIX Type 576 Curve Tracer. Static type testers, such as an ohmmeter, can be used to check the resistance ratio across some semiconductor junctions if no other method is available, however, **DO NOT MEASURE RESISTANCE ACROSS A MOS FET** to avoid damage from static charges. Use the high resistance ranges (R X 1k or higher) so the external test current is limited to less than 6 mA. If uncertain, measure the external test current with an ammeter. Resistance ratios across base-to-emitter or base-to-collector junctions usually run 100:1 or higher. The ratio is measured by connecting the meter leads across the terminals, note the reading, then reverse the leads and note the second reading.

Diode Checks — Most diodes can be checked in the circuit by taking measurements across the diode and comparing these with voltages listed on the diagram. Forward-to-back resistance ratios can usually be taken by referring to the schematic and pulling appropriate transistors and pin connectors to remove low resistance loops around the diode.

CAUTION

Do not use an ohmmeter scale with a high external current to check diode junctions. Do not check the forward-to-back resistance ratios of mixer diodes. See Replacing the Dual Diode Assembly under Removing and Replacing Assemblies.

Diagnostic Firmware

The spectrum analyzer has firmware that contains diagnostic routines that can be used with the Diagnostic part of this section to troubleshoot the Frequency Control system and diagnose Power Supply problems. This part follows General Troubleshooting information. Refer to this part to help isolate problems within this loop. The following are also some general suggestions that may help isolate a problem when troubleshooting.

Troubleshooting Steps

1. Ensure that the problem exists in the spectrum analyzer by checking the operation of associated test equipment.
2. Try to isolate the problem to a circuit or at least board level by evaluating operational symptoms; for example, absence of the frequency dot could be caused by a malfunction in the video summing stage, the marker generator, or switching circuits.
3. Three levels of block diagrams are provided to aid in understanding the theory of operation. The most detailed level is adjacent to the schematic and usually provides signal and voltage levels at critical points within the circuits. Signal levels are usually the levels required to produce full screen deflection.
4. Instructions on how to remove or replace those assemblies which are not obvious, are provided in this section. Refer to this part before removing any assembly for testing or repairing.

5. Visually inspect the area or assembly for such defects as broken or loose connections, improperly connected components, overheated or burned components, chafed insulation, etc. Repair or replace all obvious defects. In the case of overheated components, try to determine the cause of the overheated condition and correct before applying power.

6. Use successive electrical checks to try to locate the problem. An oscilloscope or signature analyzer is a valuable test item for evaluating circuit performance. If applicable, check the calibration adjustments; however, before changing an adjustment note its position so it can be returned to its original setting. This will facilitate recalibration after the trouble has been located and repaired.

7. Determine the extent of the repair needed; if complex, we recommend contacting your local Tektronix Field Office or representative. If minor, such as a component replacement, see the Replaceable Parts list for replacement information. Removal and replacement procedure of the assemblies and sub-assemblies are described under Corrective Maintenance.

CAUTION

When measuring voltages and waveforms, use extreme care when placing meter leads or probes. Some circuit boards have a high component density, access to points within circuits is limited. An inadvertent move of test leads or probe can short a circuit and generate transient voltages that can destroy many static sensitive components.

DIAGNOSTICS

This part consists of explanations and procedures for troubleshooting the frequency control system and the power supply using diagnostic firmware in the spectrum analyzer.

TROUBLESHOOTING USING THE ERROR MESSAGE DISPLAY

Introduction

This part contains procedures for troubleshooting the frequency control system and the power supply. When the microprocessor detects a failure or error in the Frequency Control loops or a failure in the Power Supply voltages it will cause the spectrum analyzer to display an error message near center screen for a few

seconds; this is followed by an error status message near the top of the screen which remains as long as the error or problem exists.

These error messages pertain to problems that exist under current instrument operational modes or front panel settings; for example, an error that pertains to the hardware in the phase lock loop will exist only when the instrument is in the phase lock mode (narrower span/div settings).

The following troubleshooting procedures are keyed to the brief error messages. Some problems may produce more than one error message in which case the spectrum analyzer will display only the predominant error. A listing of all error messages will be displayed if you press <SHIFT> 10dB/DIV. Combinations of error messages may help determine and expedite the process of finding the problem.

Combination of Error Messages

The following is a list of error message combinations and suggestions as to their cause. If the problem is not resolved with the following suggestions, or if the combination of error messages displayed is not covered, proceed to the listing of each error message and how to troubleshoot the problem.

POWER SUPPLY OUT OF REGULATION
(in combination with any other message/s)

A missing or inaccurate supply voltage is probably causing the other errors. Proceed to the POWER SUPPLY OUT OF REGULATION procedure.

TUNING FAILURE — 1ST LO
and
TUNING FAILURE — 2ND LO

The CF Control board is probably the cause, particularly if signals do not tune or do not tune smoothly. The problem is probably the voltage reference or in the digital control section.

Procedure Format

The format for these procedures is such that the problem is diagnosed in a descending order. The aim, to isolate a problem down to one part of the system, usually an assembly (such as a module or board) or a functional section of the assembly. After the problem has been isolated to the assembly or circuit level, refer to the diagrams and circuit description, as suggested under General Troubleshooting Techniques, for further isolation.

The procedures are structured as follows:

Error Message

Troubleshooting Procedure

- 1. _____
- a. _____
- b. _____
- (1) _____
- (2) _____
- 2. _____

Steps at the same level are either sequential or alternative steps, based on measurement or observation. Proceed to the lower-level steps only if the conditions of the higher-level steps are met. If the conditions are not met, proceed to the next step at the same level. An "(E)" at the end of a step, signifies this is as far as this procedure can take you to locate the problem.

Several of the troubleshooting procedures require that frequencies be counted and compared to either an expected value, or the number counted by the spectrum analyzer's internal counter. The frequencies can differ by up to $\{1 \times 10^5 + \text{counter accuracy}\}$.

These procedures, unless specified, assume the frequency range is either band 1 (0 - 1.8 GHz) or band 2 (1.7 - 5.5 GHz).

Some failures, in the frequency control system, may appear only at specific oscillator frequencies. If this occurs, in a higher frequency range, the fundamental frequency of the appropriate oscillator should be determined so it can be set to the same frequency in the lower bands. This can be done by:

(1) Press <SHIFT> 0 and "0", then select either the 1st LO readout (menu item 1) or the 2nd LO readout (menu item 2). The LO frequency will be displayed on the crt CENTER FREQUENCY readout.

(2) After noting the frequency of the oscillator, press <SHIFT> 0 and "0", and select center frequency readout to return to the normal center frequency readout mode.

Since the instrument's power is usually switched on and off during troubleshooting, the power-down settings, that are automatically stored in register 0 of non-volatile memory, should be recalled so the instrument settings and operating mode duplicate those that existed when the error message was generated.

The following, describes each error message and the procedures recommended to locate the problem.

POWER SUPPLY OUT OF REGULATION

Any out-of-tolerance voltage will cause this error message to be displayed. A power supply status circuit within the power supply will change the status LED on the Z-Axis board to red when any supply except -17 V changes by more than 25%. An error message will be also be displayed. An apparent power supply failure can be produced when either the supply fails or a circuit demands excessive current and blows a protective fuse or produces a current limit condition. The following procedure should determine those voltages that are out of range and whether the failure is in the supply or in a circuit outside the supply.

Troubleshooting procedure

WARNING

The spectrum analyzer uses a high efficiency power supply, with the primary ground potential different from chassis or earth ground. An isolation transformer, with a turns ratio of 1:1 And a 500 VA minimum rating, should be used between the power source and the spectrum analyzer power input receptacle. The transformer must have three-wire input and output connectors with a through ground between input and output. Stancor GIS1000 is an example of a suitable transformer. A jumper should also be connected between the primary ground side to chassis ground (emitter of Q2061 and the ground terminal of the input filter FL301).

If the power supply is separated from the instrument and operated on the bench, hazardous potentials exist within the supply for several seconds after power is discon-

nected. This is due to the slow discharge of capacitors C6101 and C6111. DS5112 (next to C6111) lights when the potential exceeds 80 V.

1. Verify that the power supply status LED, on the Z-Axis board, is red. If the LED is green, there is probably a failure in the microprocessor interface. (E)

2. Measure the power supply voltages at the test points on the Z-Axis board. To access the test points, remove the hold down cover over the Sweep and Z-Axis boards.

WARNING

300 V and 100 V are present on the Z-axis board.

The ranges for each supply are listed in Table 6-3. These are tolerance limits which are much tighter than the limits used by the power supply sensing circuit. A supply that exceeds these limits may not trigger the error message or cause the instrument to malfunction. The $+15$ V supply is adjustable and affects the other supplies. Refer to the Adjustment Procedure section of the manual for adjustment information if a supply is just out of tolerance.

a. If all supplies are within limits and the power supply status LED is red, the problem is probably in the power supply status circuit on the Z-Axis board. R1065 may be misadjusted; adjust R1065 to see if the LED changes to green. If it changes, set R1065 at the center of the "green" range. (E)

b. If the $+17$ V or -17 V supply and any other supply or supplies are inaccurate, or, if both the $+9$ V and $+5$ V supplies are inaccurate, the trouble is likely in the Power Supply. (E)

c. If the voltage is high (in absolute value), the trouble is probably in the Power Supply. (E)

d. If the voltage from a fused supply is inaccurate, the trouble is probably in the Power Supply. (E)

e. If the voltage from a fused supply is absent, it indicates the fuse could be blown. To access the fuses, remove the cover at the top left hand corner of the Power Supply module (as viewed from the front of the instrument). A blown fuse generally indicates that one of the circuits that this supply furnishes is defective; however, a fuse may open without an overcurrent condition. Replace the fuse and try again. If the fuse blows, the trouble is definitely in one of the circuits the supply furnishes.

If the fuse is not blown and the voltage is still absent, it indicates the trouble is the Power Supply. (E)

Table 6-3
POWER SUPPLY RANGES

Supply	Range	Test Point	Circuit Protection
+300 V	280 V to 310 V	TP1052	Fuse (F1033)
+100 V	95 V to 105 V	TP1048	Fuse (F1035)
+17 V	16.8 V to 18.6 V	TP1047	Fuse (F2013)
15 V	14.85 V to 15.15 V	TP1046	Current limit
+9 V	8.5 V to 10.5 V	TP1011	Fuse (F1017)
+5 V	4.8 V to 5.2 V	TP1044	Current limit
-5 V	-4.8 V to -.2 V	TP1036	Current limit
-7 V	-7 V to -8.5 V	TP1037	Fuse (F1013)
-15 V	-14.85 V to -15.15 V	TP1035	Current limit
-17 V ^a			Fuse (F3038)
Gnd		TP1034	Ground Reference

f. If the voltage from a current limited supply is absent or low, the problem could be the supply, or circuits the supply furnishes may be drawing excessive current. Turn the POWER off, then disconnect the suspect assemblies or modules from the supply and re-measure the voltage; or, remove the Power Supply from the instrument and measure the unloaded voltages on the Power Supply connector.

(1) If the supply voltage is correct with assembly or module removed, or when the voltage with the power supply removed is normal, the circuits this supply furnishes are causing the problem. (E)

(2) If the voltage for the unloaded supply voltage is still inaccurate, the power supply is defective. (E)

TUNING FAILURE — 1ST LO

The 1st LO is set by a combination hardware/software loop. There are two distinct hardware blocks to the loop: the block that measures the oscillator frequency and the block that sets the oscillator to frequency. The microprocessor system "closes the loop" by determining how far the oscillator must be moved to bring it to the desired frequency. Setting is an iterative process wherein the microprocessor indirectly counts the 1st LO, moves it as needed, and counts again. The 1st LO Tuning Failure error message is displayed when the 1st LO has not been set correctly after a number of iterations which varies with instrument settings.

The 1st LO Control Diagnostic Aid displays data on the crt screen which can be used to determine which part of the loop has failed. A typical display follows. To display this data press <SHIFT> 0, then select 3 DIAGNOSTICS AIDS.

The first two lines list the voltage to be expected at the output of the 1st LO section of the Center Frequency Control and the voltage across the sense resistor of the 1st LO Driver. The nominal values are based on the Desired 1st LO Freq and the nominal tuning sensitivity of the oscillator.

^a The -17 V supply is not monitored by the power supply status circuit nor does it have a test point on the Z-axis board. If this supply fails, the cooling fan will not run. The fan will also not run if the ambient temperature is low. The -17 V supply will probably affect other supplies as well.

1ST LO CONTROL DIAGNOSTIC AID		
	NOMINAL	DAC SET
TUNE VOLTS	-6.79 V	-6.80 V
SENSE VOLTS	3.43 V	3.43 V
	DESIRED	COUNTED
1ST LO FREQ	2.720 504 GHZ	2.719 735 GHZ
MIXER FREQ	45.896 MHZ	46.665 MHZ
1ST LO SETTING ACCURACY		4.981 MHZ
AUXILIARY SYNTHESIZER		212.800 MHZ
PRESS "SHIFT" TO EXIT		

The DAC Set values are based on the setting of the 1st LO tuning DACs. The DAC Set values can differ from the Nominal values because the system cannot be exactly calibrated, the tuning sensitivity of the oscillator is possibly not its nominal value, and the DACs will be moved in an attempt to set the oscillator.

The Desired 1st LO Freq is the frequency to which the processor is trying to move the oscillator. The Counted 1st LO Freq is the frequency the microcomputer has calculated from, the internally counted harmonic mixer output frequency, the Auxiliary Synthesizer frequency, and the assumed harmonic number of the Auxiliary Synthesizer. Because of this last assumption, if the 1st LO is not near the Desired Frequency, the Counted Frequency will not be the actual oscillator frequency, even though the counter is functioning.

The Desired Mixer Freq is the difference between the the Desired 1st LO Freq and the nearest harmonic of the Auxiliary Synthesizer. (The Auxiliary Synthesizer harmonic will always be higher in frequency than the desired 1st LO frequency.)

The 1st LO Setting Accuracy is the maximum permitted difference between the actual and desired LO frequencies. The setting process will end when the difference becomes less than, or equal to, this value. The tolerance depends on frequency span and band.

The Auxiliary Synthesizer Freq is the frequency that is programmed into the +N synthesizer.

This troubleshooting procedure should localize a problem to the oscillator, the oscillator setting block, or the oscillator counting block. If the failure is not in the oscillator, it is further localized within one of the hardware blocks.

Troubleshooting Procedure

1. Press <SHIFT> 0, then 3 to display the Diagnostic Aids menu. Select 1 to display the 1st LO Control Diagnostic Aid information.

2. If the Counted 1st LO Freq is within the 1st LO Setting Accuracy of the Desired Freq readout, press <SHIFT> to return to normal operation. Now determine if the error occurs, for the same center frequency, at frequency spans/division above 5 MHz only, or at spans less than 5 MHz/div. (Frequency range must be 0 — 1.8 GHz or 1.7 — 5.5 GHz.)

a. If the frequency control error occurs only at frequency spans of 5 MHz/div or more, the capacitor switching relay, on the 1st LO assembly, is probably shorted. (E)

b. If the error occurs with a frequency span/div of 5 MHz or less, the 1st LO is probably defective. (E)

3. Measure the voltage across the sense resistor (R1040) on the 1st LO Driver board. If this voltage is within 50 mV of the DAC Set value, measure the frequency on the 1ST LO Output connector. This measured frequency should be within 50 MHz of the frequency calculated by multiplying 800 MHz/V by the voltage that was measured across the sense resistor R1040.

a. If the calculated and measured frequencies are within 50 MHz of each other and the measured frequency agrees with the internally counted 1st LO Freq readout or differs from it by a multiple of the Auxiliary Synthesizer Freq, return to normal operation (by pressing <SHIFT>). Now attempt to calibrate the CF Control board and the 1st LO Driver board by pressing <SHIFT> 0 and select 1, for the CF Control board, or 2, for the 1st LO Driver board, from the menu. Exit from the CF Control board calibration routine by pressing <SHIFT> when the step for R4040 is displayed. If you are able to complete the calibration routine, check to see if the error message is still present. If it is, or if the calibration routines cannot be completed, continue troubleshooting with step 4. (E)

b. If the calculated and measured frequencies are within 50 MHz, but do not meet the above condition in step 3a, measure the Auxiliary Synthesizer output frequency at P1060 on the Auxiliary Synthesizer board.

(1) If the Auxiliary Synthesizer output frequency is correct, measure the input frequency from the Harmonic Mixer with a spectrum analyzer, at the cable connection to P261 on the Auxiliary Synthesizer board. (A counter would probably give an erroneous reading because of the harmonic mixing process). The frequency measured with the spectrum analyzer should equal the sum of the Desired Mixer Freq and the measured 1st LO frequency, less the Desired 1st LO Freq, if the calculated frequency is between 10 MHz and 90 MHz. If the calculated frequency is outside the 10 MHz to 90 MHz range, the 1st LO frequency is far from the desired value. Repeat the previous steps in this procedure.

(a) If the Harmonic Mixer output frequency is correct, measure the frequency at edge connector 15, on the Auxiliary Synthesizer board, with a counter. This should be 1/100th of the Harmonic Mixer output frequency.

(b) A correct frequency measurement indicates the Counter board is defective. (E)

(c) An incorrect frequency measurement indicates the Auxiliary Synthesizer is defective. (E)

(d) The Harmonic Mixer is probably defective if no signal is present at the output or the signal frequency is incorrect. (E)

(2) If the output frequency, at P1060 is incorrect, measure the tune voltage for the 200 - 220 MHz VCO, between TP1066 and TP1074 on the Auxiliary Synthesizer board. The range of the tuning voltage is normally +5 V to +12 V.

(a) If the tune voltage is within the center of its normal range and the output frequency at P1060 is stable (varies no more than 1-2 Hz), the programmable divider in the phase-locked loop is probably defective. (E)

(b) If the tune voltage is in the center portion of its normal range and the output frequency at P1061 is unstable, the loop amplifier is probably defective. (E)

(c) If the tune voltage and oscillator frequency are at the end or outside their range, in the same direction (high or low), C1070 in the VCO may be misadjusted. If adjustment of the capacitor does not correct the problem it is not in the VCO but somewhere else in the loop. (E)

(d) If the tuning voltage and the Auxiliary Synthesizer frequency are in opposite directions from the center of their respective ranges (8.5V and 210 MHz), the VCO is probably defective. (E)

(e) If the calculated and measured frequencies differ by more than 50 MHz, remove the jumper plug P3043 on the 1st LO Driver board and measure the oscillator current.

CAUTION

The oscillator coil has significant inductance. Interrupting the oscillator current will generate high voltage. Remove/replace P3043 or connect/disconnect a current meter after the power is off. (Typical voltages at P3043 can range as high as 35 V.)

The coil current should be: 40 mA/V, where the voltage is the sense-resistor voltage as previously measured across R1040. The measured current should be within 1% of this value.

(3) If the measured and calculated currents are within 1%, return to normal operation (by pressing <SHIFT>) and determine if the frequency control error occurs with frequency span/div of 5 MHz or less, or above 5 MHz/div, with the same center frequency. (The frequency range should be in either band 1 (0-1.8 GHz) or band 2 (1.7-5.5 GHz).

(a) If the frequency control error occurs only with frequency spans of 5 MHz/div or less, one of the noise filter capacitors on the 1st LO Assembly is probably defective. (E)

(b) If the error occurs with frequency spans greater than 5 MHz/div, the 1st LO is probably defective. (E)

(4) If the measured and calculated currents are not equal, the problem is likely in the final stage of the LO Driver. (E)

4. Measure the 1st LO tuning voltage at edge connector 47, of the Center Frequency Control board. This voltage should be within 200 mV of the listed DAC Set value.

a. If the voltage is within this limit, failure of the 1st LO Driver board is indicated. (E)

b. If the voltage is not within the limit, failure of the Center Frequency Control board is indicated. (E)

TUNING FAILURE — 2ND LO

The 2nd LO is set by a combination hardware/software loop. There are two distinct hardware blocks in the loop; the block which measures the oscillator frequency and the block which sets the oscillator to frequency. The microprocessor "closes the loop" by determining how far the oscillator must be moved to bring it to the desired frequency. Setting is an iterative process wherein the microprocessor counts the oscillator frequency, moves it as needed, and counts again. The error message is displayed if the 2nd LO is not set to the desired frequency after a number of iterations, depending on instrument settings.

The 2nd LO Control Diagnostic Aid displays data which can be used to determine which part of the loop has failed. A typical display is shown below. (Ensure that the #3 switch of the Options switch, on the Memory board, is in the open position.) Press <SHIFT> 0, then 3, and select 2nd LO Control (#2) from the menu.

2ND LO CONTROL DIAGNOSTIC AID		
	NOMINAL	DAC SET
TUNE VOLTS	0.01 V	0.19 V
	DESIRED	COUNTED
2ND LO FREQ	2.182 000 GHZ	2.182 140 GHZ
OFFSET FREQ	18.000 000 MHZ	17.860 MHZ
OFFSET SETTING ACCURACY		540.672 KHZ
PRESS "SHIFT" TO EXIT		

The Tune Volts is the voltage that would be expected at the output of the 2nd LO section of the Center Frequency Control. The Nominal voltage is the value needed for the Desired frequency of the oscillator in a perfectly calibrated system. The DAC Set voltage should be produced by the present setting of the 2nd LO tuning DACs. The DAC Set voltage may differ from the Nominal value because the system may not fully calibrated and the DACs will be moved to try to set the oscillator.

The Desired 2nd LO Freq is the frequency to which the microcomputer is trying to move the oscillator. The Counted 2nd LO Freq is that frequency the microcomputer has calculated from the Counted Offset Freq.

The Offset Freq is the frequency of the low-frequency offset VCO in the 2nd LO Assembly. In the 2182 MHz LO, this frequency is the difference between 2200 MHz and the LO frequency. (The 719 MHz LO is derived from the 2182 MHz LO, and the frequency relationships are more complex.) Again, the Desired Freq is the frequency the microcomputer is trying to set the offset, and the Counted Freq is the value read by the internal counter.

The Offset Setting Accuracy is the maximum permitted difference between the actual and desired offset frequencies. The setting process ends when the difference becomes less than or equal to this value. The tolerance depends on frequency span and band.

The following procedure should localize the failure to the 2nd LO assembly, the hardware setting block, or the hardware counting block.

Troubleshooting Procedure

1. Display the diagnostic information for the 2nd LO control loop as outlined above.

2. If the Counted Offset Freq and the Desired Offset Freq are within the Offset Setting Accuracy, the 2nd LO probably has failed.

3. If the Counted Offset Freq is within 100 kHz of the Desired Offset Freq, make sure that P1048 is properly seated on J1048. If the fine tune ground lead is not making good contact, the tuning voltage can shift sufficiently to cause setting failures. (E)

4. If the Counted Offset Freq readout is within 100 kHz of the Desired Offset Freq, the oscillator may be out of calibration. Return to normal operation by pressing <SHIFT>. Try to calibrate the 2nd LO by pressing <SHIFT> 0 and select "4" (2nd LO) from the menu. Now, follow the instructions of the displayed messages. If you are able to complete the calibration routine, check to see if the error condition still exists. If the error is still there or you were unable to complete the calibration routine, proceed to the next step. (E)

5. Measure the 2nd LO Tune Volts at TP1044 on the Center Frequency Control board.

a. If the 2nd LO tuning voltage is within 200 mV of the DAC Set value, measure the 2nd LO frequency at the front-panel 2ND LO Output connector.

(1) If the measured frequency does not agree with the internally Counted readout, the Counter board is probably at fault. (E)

(2) If the frequency agrees with the Counted value, measure the mixed down frequency at the cable going to P513 on the Counter board. This frequency should equal the sum of the Desired Offset Freq and the Desired 2nd LO Freq, less the measured 2nd LO frequency.

(a) If this frequency is present, measure the 2182 MHz oscillator tuning voltage on the feedthrough capacitor C2203 between the 16-20 MHz Phase Lock circuit and the 2182 MHz Microstrip Oscillator in the 2182 MHz Phase Locked 2nd LO Assembly. The normal range of this voltage is 0 V to -12.5 V. With the phase locked loop unlocked, this voltage will probably be slightly outside one end of the range.

(i) If the absolute value (magnitude) of the tuning voltage and the oscillator frequency are off in the same direction from the centers of their respective ranges [6 (-6) V and 2182 MHz], the Microstrip Oscillator has probably failed. (E)

(ii) If the absolute value (magnitude) of the tuning voltage and the oscillator frequency are off in the opposite direction from the center of their respective ranges [6 (-6) V and 2182 MHz], some other part of the lock loop, besides the Microstrip Oscillator, has probably failed. (E)

(b) If the mixed-down frequency is absent, either the 2200 MHz Reference, the 2182 MHz Microstrip Oscillator or the 2200 MHz Reference Mixer probably has failed. (E)

b. If the tuning voltage is not within 200 mV of the DAC Set value, the Center Frequency Control board probably has failed. (E)

PHASE LOCK FAILURE — 1ST LO

The following procedure assumes that the oscillator is at the correct frequency, so the problem must be in the phase lock system.

The following crt display of the 1st LO Phase lock Diagnostic Aid displays data for troubleshooting the 1st LO phase lock loop.

```

1ST LO PHASE LOCK DIAGNOSTIC AID
1st LO FREQ          2.072 000 000 GHZ
STROBE FREQ         5.016 949 MHZ
LOCK DISABLED      PRESS
                   <10dB/DIV>
                   TO
                   ENABLE

PRESS *SHIFT* TO EXIT
    
```

While the troubleshooting information is displayed, the 1st LO is repetitively being stepped ±750 KHz. If LOCK DISABLED is displayed, the lock loop is open between the output of the phase gate and the input to the FM coil. If lock is enabled, the loop is closed, and the fourth line of the display changes to LOCK ENABLED PRESS "10dB/DIV" TO DISABLE.

The 1st LO Freq readout is the frequency the oscillator should be at when locked. The frequency that is measured at the front-panel 1ST LO Out connector will not check exactly with this value because the oscillator is unlocked and stepping in frequency.

The Strobe Freq is the frequency at P502 and P504 of the Phase Lock module.

This procedure should help localize the failure to the Phase Gate or to a section of the phase lock circuitry.

Troubleshooting procedure

Before troubleshooting data on the phase lock loop is displayed, the Freq Span/Div must be in those spans that enable the phase lock mode (200 kHz or less for band 1).

1. Press <SHIFT> 0 then select "0", from the diagnostic aids menu, to display the "1st LO Phase Lock Diagnostic Aid" information. (If an error message UNDEFINED FUNCTION appears after the 1st step, it indicates switch #3 of S1038 (Options) on the Memory board is not in its "open" position.)

2. With an oscilloscope, examine the signal at P242 on the Phase Gate. Beat notes (bursts of signal at up to 500 kHz) at a 10 Hz rate should be present as the oscillator is stepped. Beat note amplitude should be about 6 V peak-peak. The amplitude of the positive and negative peaks should not differ by more than 20%.

a. If beat notes are present, press 10dB/DIV to enable the lock. Check the Error Amplifier output at TP2037, on the Error Amplifier board in the Phase Lock module. Output signal amplitude should be approximately 6 V peak-peak and its frequency should be 10 Hz. The up and down out-of-range signals, on edge connectors 8 and 10 of the Error Amplifier board, should be toggling between 0 V and +5 V.

(1) If there is a signal at TP2037 but one or both of the out-of-range lines is not toggling, the out-of-range comparator on the Error Amplifier board, or the sensing circuit on the Phase Lock Control board, has probably failed. This could cause problems in maintaining lock but not in acquiring lock. If the instrument does not acquire lock, note the out-of-range problem and continue troubleshooting with step 3).

(2) If there is no signal at TP2037, the Error Amplifier has probably failed. (E)

(3) If there is a signal at TP2037, the switching circuit that connects the output of the Error Amplifier to the FM coil of the 1st LO has probably failed. (E)

b. If beat notes are present, but their amplitude is less than 3.8 V (peak-peak), or the amplitude difference of the positive and negative excursions is more than 20%, the Phase Gate is probably defective. (E)

c. If there are no beat notes, measure the strobe frequency, at P504 on the Phase Lock module.

(1) If the strobe frequency is the same as the readout on the diagnostic aid display, it is possible, but not probable, that the 1st LO system is miscalibrated and that the 1st LO is near the wrong harmonic of the Auxiliary Synthesizer. Press <SHIFT> to return to normal operation and look at the calibrator line that is closest in frequency to the frequency (in Band 1) at which the error occurs. If the frequency indicated for the calibrator line is correct (a multiple of 100 MHz), the Phase Gate has probably failed.

If the frequency indicated is incorrect, attempt to calibrate the 1st LO system by pressing <SHIFT> 0 and select 0 (Overall System Cal) from the menu. Exit from the calibration routine when the display for R4040, on the CF Control board appears by pressing <SHIFT>. If the calibration can not be completed, or it does not result in the correct frequency indication for the calibrator line, troubleshoot the 1st LO system using the procedure under TUNING FAILURE —1st LO error message step 3b. (E)

(2) If there is no strobe signal, check for a signal on feedthrough "M", on the Strobe Driver board in the Phase Lock module.

(a) If there is a signal, the Strobe Driver has probably failed. (E)

(b) If there is no signal, the Controlled Oscillator has probably failed. (E)

(3) If the frequency of the strobe signal is erroneous, but is stable (within 1-2 Hz), in the normal strobe range of 5.006477 MHz to 5.018868 MHz, the programmable divider in the Synthesizer has probably failed. (E)

(4) If the listed Strobe Freq is below 5.007, 100 MHz and the actual strobe frequency is slightly above the desired frequency; or above 5.018, 240 MHz and the actual strobe frequency is slightly below the desired frequency, attempt to calibrate the Phase Lock Synthesizer. Press <SHIFT>, to return to normal operation, then press <SHIFT> 0 and select "5" from the menu. If you are able to complete the calibration, check to see if the error message is still present. If it is still displayed, or the calibration routine could not be completed, proceed to the next step as if the strobe frequency was not within the above range. (E)

(5) If the listed Strobe Freq is outside the range in the preceding step, measure the tune voltage for the VCO, at feedthrough "H" on the Controlled Oscillator board in the Phase Lock module. The normal range is from 5.9 V to 11.3 V. With the loop unlocked, the voltage will probably be near or beyond one end of the range.

(a) If the voltage is around the center of the range, the loop filter and amplifier, on the Error Amplifier board, are probably at fault. (E)

(b) If the tuning voltage and the strobe frequency are displaced from the center of their range (8.6 V and 5.013 MHz) in the same direction, the VCO is good and something else within the loop has failed. (E)

(c) If the tuning voltage and the strobe frequency are displaced in opposite directions from the center of their range, the VCO has probably failed. (E)

TRACE MODES

Trace Mode provides information on how the frequency control system is working. It is accessed by pressing <SHIFT> 0, menu item 7, then selecting 1st LO (menu item 1), 2nd LO (menu item 2), MARKER (menu item 3), or DISPLAY RESULTS (menu item 4).

Trace Mode "1", starts tracing the 1st LO control actions. Trace Mode "2", starts tracing the 2nd LO control actions. Trace Mode "3", starts tracing marker correction cycles.

Information from these four trace modes is stored in RAM and can be displayed by selecting DISPLAY RESULTS (menu item 4) from the TRACE MODE menu. This mode displays up to 16 lines of data gathered by the trace modes.

NOTE

Information used is only obtained when the internal frequency correction occurs. This correction is related to the drift rate of the spectrum analyzer and the time between corrections can be as long as 30 seconds. To assure information is available, change the **FREQ SPAN/DIV** one position, then return to the original setting. This forces the correction cycle to occur.

For modes 1 and 2, the first field of the display indicates which mode was active at the time the information was gathered. The second field of the display indicates which attempt at tuning or correcting the oscillator the data is for. The next field contains the tuning DAC settings before a tune or correction took place. The first three digits are the upper DAC settings, the next three digits the lower DAC settings. The next field contains the DAC settings after the tuning or correction was attempted. Again, the first three digits are the upper DAC, and the next three digits the lower DAC settings. The next field indicates the time delay between setting the DACs to the new values and reading the resulting frequency, in units of millisecond. The final field contains the frequency of the oscillator in question, after the tune or correction attempt. Actually, the displayed frequency is the beat note frequency from the auxiliary mixer for the 1st LO (in KHz), and the 16-20 MHz oscillator frequency for the 2nd LO.

For mode 3, the resulting trace display consists of seven columns. The first column is always "4", indicating that the marker is being traced. The second column gives the iteration number of the correction cycle which the displayed line describes. The third column consists of two letters and a number. The first letter is "P" if the data applies to the primary marker and "S" if the data applies to the secondary marker. The second letter is "C" if the oscillators are being counted at the marker position to determine the marker frequency, or "S" if the

marker position is being synthesized to maintain a constant marker frequency. The number in this column is "1" if the 1st LO is being counted at the marker and "2" if the second LO is being counted. The fourth column is the hexadecimal setting of the marker DAC. The fifth column is the decimal digital storage location of the marker. The sixth column is the oscillator settling time in ms before the count. The last column is the harmonic mixer output frequency in KHz for a 1st LO count, or the 16-20 MHz VCO frequency for a 2nd LO count at the marker position.

The sequence <SHIFT> 0, "7", "0", terminates trace actions and erases the RAM of all data.

Alternate Frequency Display

The Alternate Frequency Display mode selects an alternate frequency display instead of the normal Center Frequency display. These alternate frequencies are selected by pressing <SHIFT> 0, selecting menu item 0, and selecting "0", "1", or "2" as indicated by the menu.

The normal Center Frequency is displayed when "0" is selected.

The frequency of the 1st LO is displayed when "1" is selected. This display is updated each time the 1st LO frequency is counted.

The frequency of the 2nd LO is displayed when "2" is selected. This display is updated each time the frequency of the 2nd LO is counted.

Auxiliary Synthesizer Control

The Auxiliary Synthesizer Control can be turned on continuously, or turned on only during correction for the 1st LO tunes. This mode is toggled (turned on continuously or during 1st LO corrections) by pressing <SHIFT> 0, and selecting menu item 4. A message will come on screen indicating which mode the Auxiliary Synthesizer is in.

Correction Disable/Enable

Correction of the 1st and 2nd LO frequencies can be disabled or enabled by pressing <SHIFT> 7 or <SHIFT> 0, and selecting menu item 6. When corrections are disabled, the oscillator frequencies are counted but no further action is taken. This mode can be used to monitor the drift of the oscillators by activating the respective trace mode. When corrections are disabled, the 1st LO cannot be phase locked!

CORRECTIVE MAINTENANCE

Corrective maintenance consists of component replacement and instrument repair. Special techniques and procedures that may be required to remove and replace assemblies and/or components in this instrument are described here.

Handling Static Sensitive Components

Most semiconductor types, both separately and in assemblies, are susceptible to damage to static charge, see Table 6-1 for voltage levels. We recommend static sensitive procedures be implemented for all operations involving semiconductor handling.

Obtaining Replacement Parts

All electrical and mechanical parts are available through your local Tektronix Field Office or representative. The Replaceable Parts list section contains information on how to order these replacement parts.

NOTE

Some components that are heat sunk to the circuit board extrusion or module wall, are soldered to the board after the board is mounted in place. This is necessary to avoid cracking the case when the mounting screw is tightened. These components are identified by a note on the schematic drawing. Their part number appears with chassis mounted components in the Replaceable Electrical Parts list.

Parts orientation and lead dress should be duplicated because some components are oriented to reduce interaction between circuits or control circuit characteristics.

Where applicable, an improved part will be substituted when a replacement is ordered. If the change is complex, your local Field Office or representative will contact you concerning the change. After repair, the circuits may need recalibration.

Parts Repair and Return Program

Assemblies containing hybrid circuits or substrates in a semi-sealed module, and complex assemblies such as the YIG oscillator can be returned to Tektronix for repair under the repair and return program.

Tektronix repair centers provide replacement or repair service on major assemblies as well as the unit. Return the instrument or assembly to your local Field

Office for this service, or contact your local Field Office for repair and exchange rates.

Firmware Version and Error Message Readout

This feature provides readout of the firmware version when the power on/off is cycled. During the initial power-up cycle, the instrument firmware and front panel firmware versions are displayed on the crt for approximately two seconds. The Replaceable Electrical Parts list section, under Memory board (A54) and GPIB board (A56), lists the ROM devices and their Tektronix part numbers for each firmware version.

Whenever an error occurs in an operational routine, an error message on screen describes the nature of the error. Status messages or prompts (see Diagnostics part of this section), are also displayed when running a diagnostic test or calibration procedure.

Selected Components

A few components that are selected to meet certain parameters such as temperature compensation, or to center the range of some adjustable component. The selected components are identified as selectable on the circuit diagram and in the Replaceable Electrical Parts list. The Replaceable Parts list description for the component gives a nominal value. The procedure for selection is explained in the adjustment part of recalibration procedure. Table 6-4 lists these components, their nominal values, and the criteria for selection.

Replacing EPROM or ROM Devices

Firmware for the microcomputer is contained in ROM packs on the Memory and GPIB boards. Refer to the Replaceable Electrical Parts list (Vol. 2) under these assemblies (A54 Memory and A56 GPIB) for the versions and integrated circuit part numbers. All integrated circuits are soldered into sockets on the board to reduce problems that occur due to poor contact because of corrosion or loose pins. Refer to replacing Transistor and Integrated Circuit for procedure.

Table 6-4
SELECTED COMPONENTS

Component Number	Nominal Value	Selection Criteria
A50A5C1038	47 pF	Enhance the adjustment frequency range of C1041
A50A5C1048	47 pF	Enhance the adjustment frequency range of C1042
A46A1R1011 A46A1R1012	10K Ω (Fixed)	Matched for temperature coefficient to 5PPM/ $^{\circ}$ C
A46A1R1013 A46A1R1014	10K Ω (Fixed)	Matched for temperature coefficient to 5PPM/ $^{\circ}$ C
A22A1R1070	6.04k Ω	Sets the Reference Mixer output frequency at 18 MHz \pm 50 kHz
A22A1R2049	6.04k Ω	Adjusts linearity of the 2nd LO sweep
A22A1R2070	6.04k Ω	Adjusts 2nd LO tune range
A22A1R2072	3.83k Ω	Sets 2nd LO sweep
A46A1R1015 A46A1R1016 A46A1R1020	10.5k Ω , 5k Ω , and 10k Ω respectively; (Fixed)	Matched for temperature coefficient to 5PPM/ $^{\circ}$ C
A46A1R1048 A46A1R1049	10K Ω (Fixed)	Matched for temperature coefficient to 5PPM/ $^{\circ}$ C
A46A1R1050 A46A1R1051	10K Ω (Fixed)	Matched for temperature coefficient to 5PPM/ $^{\circ}$ C
A46A1R1052 A46A1R1053 A46A1R1055	5k Ω , 10.5k Ω , and 10k Ω respectively; (Fixed)	Matched for temperature coefficient to 5PPM/ $^{\circ}$ C

Surface-Mounted Components

Surface-mounted parts have been used in this instrument. These parts are mounted on pads on the circuit board, rather than through holes in the board. Lead configuration of these parts is shown in Figure 6-1.

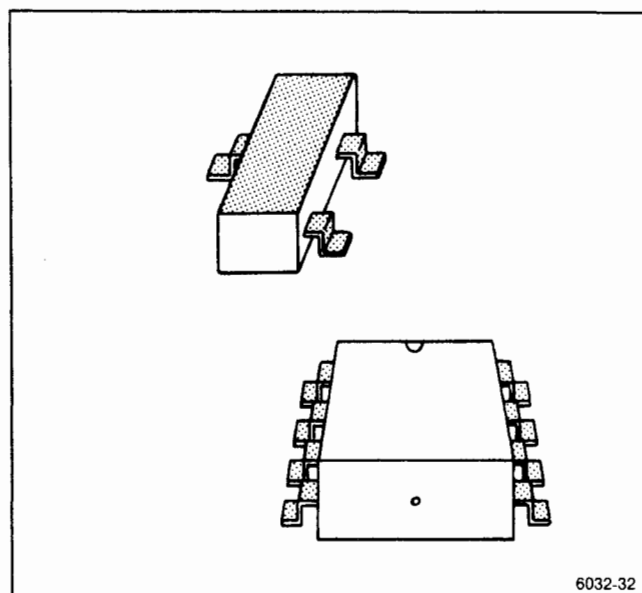

Figure 6-1. Surface-mounted components lead configuration.

The positive end of electrolytic capacitors is identified with a band. Other capacitors and resistors have no visible identification. However, like their axial-leaded counterparts, their values can be measured with a meter.

Surface-mounted semiconductor devices are sensitive to static electricity discharges, and should be treated as outlined in the beginning of this section.

Replacing Surface-Mounted Components

A Hot Air Machine, such as Hart Model 200A manufactured by Nu-Concept Computer Systems Incorporated of Colmar, Pennsylvania, is recommended for unsoldering and soldering surface-mounted components.

Another method to remove and solder surface-mounted components is by using a hot air gun and a pair of tweezers.

Do not apply too much heat, as the pad/s on which the device is soldered may be lifted from the circuit board.

1. Unsolder the component.
2. Clean the board with isopropyl alcohol.
3. Solder in the replacement. Surface-mounted components are pretinned, and should be soldered onto the board with solderpaste rather than solder.

CAUTION

If you use a soldering iron, use one with a small tip. After applying the solderpaste, touch the corner of the pad with the iron to fasten the component. Avoid touching the component with the hot soldering iron. Thermal shock causes hairline cracks that are not visible to the eye.

Transistor and Integrated Circuit Configurations

Lead identification for transistors and integrated circuits, is readily available from manufacture's data books. Integrated circuit pin-outs for Vcc and ground are shown with a box on the schematic diagram. Refer to Soldering Technique in Corrective Maintenance part for unsoldering and soldering instructions.

Diode Color Code

The cathode of each glass encased diode is indicated by a stripe, a series of stripes, or a dot. Some diodes have a diode symbol printed on one side. Figure 6-2 illustrates diode types and polarity markings that are used in this instrument.

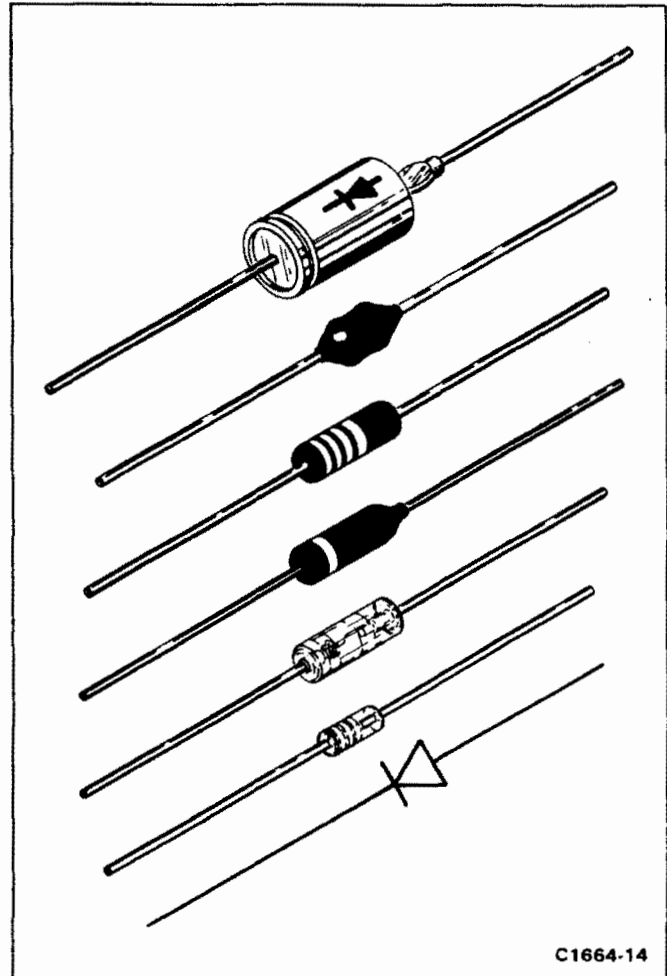

C1664-14

Figure 6-2. Diode polarity markings.

Multiple Terminal (Harmonica) Connectors

Some intercircuit connections are made through pin connectors that are mounted in a harmonica type holder. The terminals in the holder, are identified by numbers that appear on the holder and the circuit diagrams. Connectors are identified on the schematic and board with either the prefix letter "P" or "J" followed by a circuit number. Connector orientation to the circuit board is keyed by a triangle on the holder and the circuit board (see Figure 6-3). In some cases, the triangle or arrow is screened on the chassis adjacent to the connector. Some connectors contain more than one section.

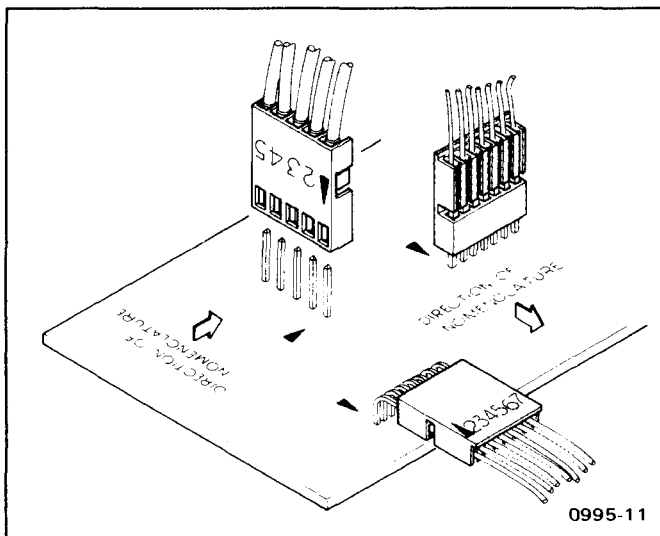

Figure 6-3. Multipin (harmonica) connectors.

Resistor Values

Many types of resistors (such as composition, metal film, tapped, thick film resistor network package, plate, etc.) are used. The value is either color coded in accordance with the EIA color code, or printed on the body of the component.

Capacitor Marking

The capacitance value of ceramic disc, plate, and slug, or small electrolytic capacitors, is marked in microfarads on the side of the component body. The ceramic tubular capacitors and feed-through capacitors are color coded in picofarads.

Soldering Techniques

CAUTION

Disconnect the instrument from its power source before replacing or soldering components.

Some of the circuit boards in this instrument are multilayer; therefore, extreme caution must be used when a soldered component is removed or replaced. Excess heat from the soldering iron and bent component leads may pull the plating out of the hole. We suggest clipping the old component free. Leave enough lead length so the new component leads can be soldered in place. If you desire to remove the component leads, use a 15 W or less pencil type iron. Straighten the leads on the back side of the board; then when the solder melts, gently pull the soldered lead through the hole. A desoldering tool should be used to remove the old solder. Use a desoldering tool that has a low build-up of static charge, such as Silverstat Soldapullit desoldering tool, when unsoldering integrated circuits or transistors.

Replacing the Square Pin for the Multi-pin Connectors

It is important not to damage or disturb the ferrule when removing the old stub of a broken pin. The ferrule is pressed into the circuit board and provides a base for soldering the pin connector.

If the broken stub is long enough, grasp it with a pair of needle nose pliers, apply heat, with a small soldering iron, to the pin base of the ferrule and pull the old pin out. (The pin is pressed into the ferrule so a firm pull is required to pull it out.)

If the broken stub is too short to grasp with pliers, use a small dowel (0.028 inch in diameter) clamped in a vise to push the pin out of the ferrule after the solder has melted.

The old ferrule can be cleaned by reheating socket and placing a sharp object such as a toothpick or small dowel into the hole. A 0.031 inch drill mounted in a pin vise may also be used to ream the solder out of the old ferrule.

Use a pair of diagonal cutters to remove the ferrule from the new pin; then insert the pin into the old ferrule and solder the pin to both sides of the ferrule.

If it is necessary to bend the new pin, grasp the base of the pin with needle-nose pliers and bend against the pressure of the pliers to avoid breaking the board around the ferrule.

Servicing the VR Module

The VR module requires mechanical support when it is installed on board extenders. Mechanical support is provided by moving the mounting plate at the upper side of the module (Figure 6-4A) to the bottom side. This allows installation of a mounting screw through a support bracket into the mounting plate screw hole as shown in Figure 6-4B. For better support, we recommend using a second bracket on the other end. Remove the bracket, turn it over and install it so the threaded studs are below the module.

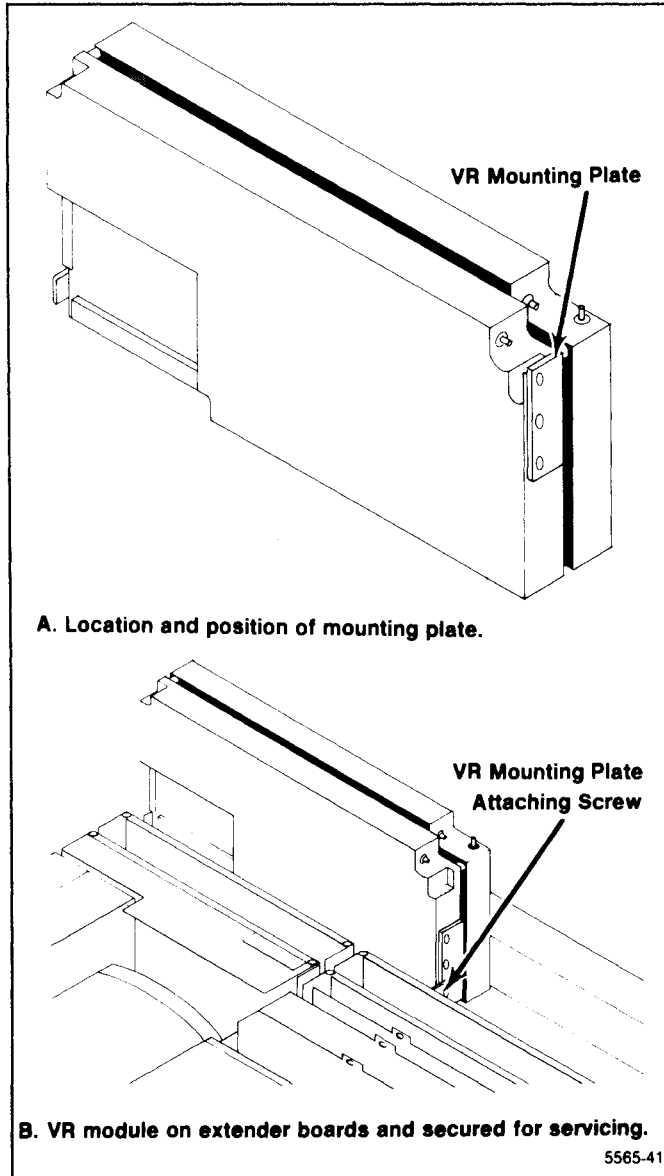

Figure 6-4. Servicing the VR assembly.

REPLACING ASSEMBLIES AND SUBASSEMBLIES

Most assemblies or subassemblies in this instrument are easily removed and replaced. The following describes procedures for replacing those assemblies that require special attention. Top and bottom views are shown in Figures 6-5 and 6-6, respectively. These illustrations show the location and identify most assemblies by their name and assembly number.

NOTE

Remove the airbaffle along the left siderail before removing the adjacent assemblies.

Removing and Installing the GPIB Board

The GPIB board connects to the GPIB port on the back panel, through a GPIB Extender board (A56A1), a ribbon cable (W560), and a GPIB Interface board (A30A57) in the Power Supply module. The GPIB Extender board edge connector is clamped to the connector on the GPIB board by means of a locking key that extends through the connector. When the key is turned, so it faces inward, the connector is clamped. To release the connector, so the GPIB board can be removed, proceed as follows:

1. Unscrew the mounting screws that hold the metal shield over the GPIB, Processor, and Digital Storage boards and remove the shield.
2. Lift the key to the GPIB Extender board connector up so it just clears the board and turn it 90 degrees, so it faces the rear of the instrument. This will spread the connector so the GPIB board can now be pulled from the connector on the Mother board.
3. Use a board puller to pull the GPIB board free from the Mother board.

Install the board as follows:

1. With the key for the GPIB Extender board connector turned so the connector is spread (top of the key facing to the rear of the instrument), slide the GPIB board through the guides and onto the Mother board connector. Ensure that the board is well seated.
2. Turn the key 90 degrees to lock the connectors of the GPIB Extender board and the GPIB board together. Push the key down to its rest position.
3. Re-install the shield over the GPIB, Processor, and Digital Storage boards.

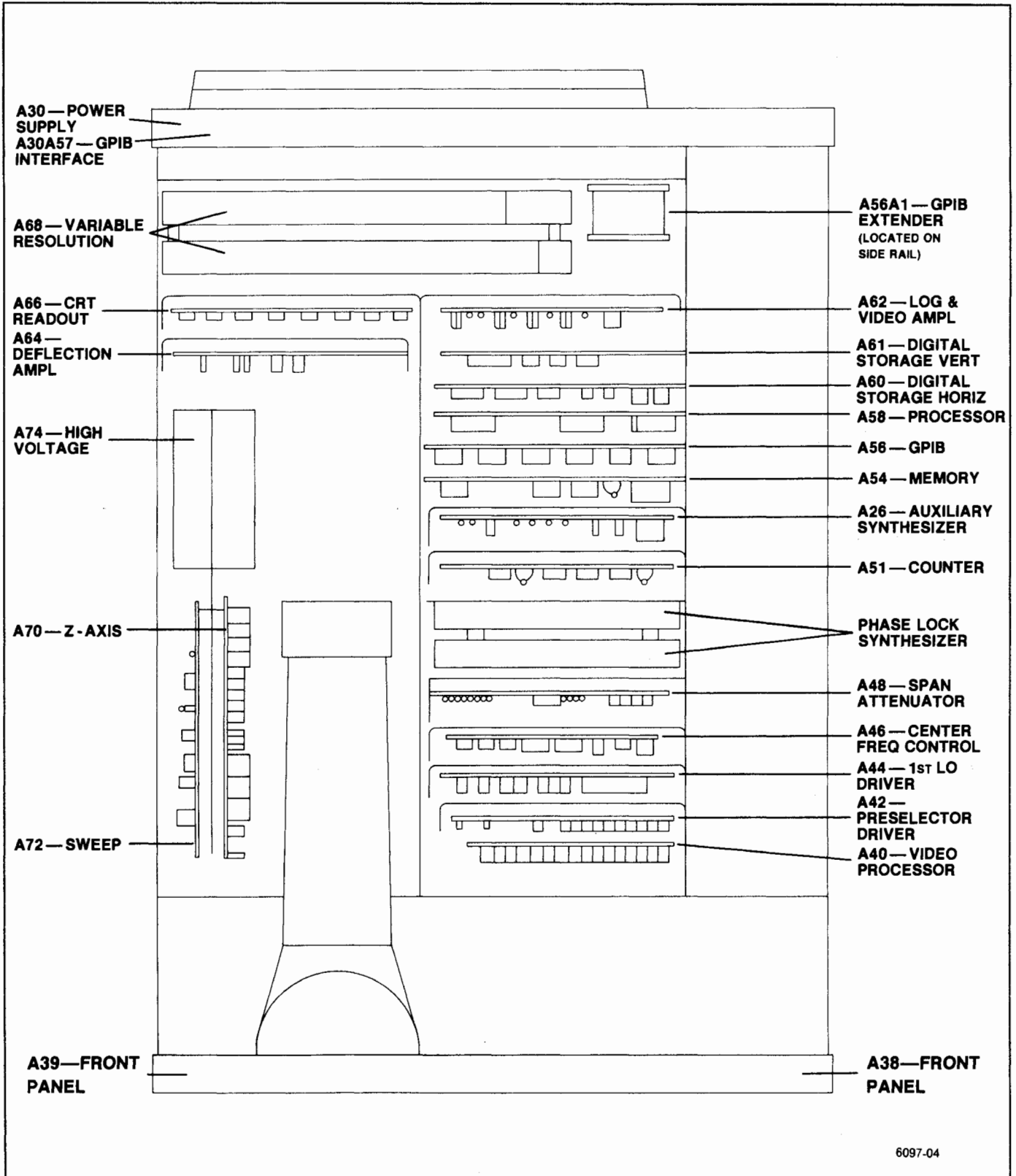

Figure 6-5. Top deck assemblies.

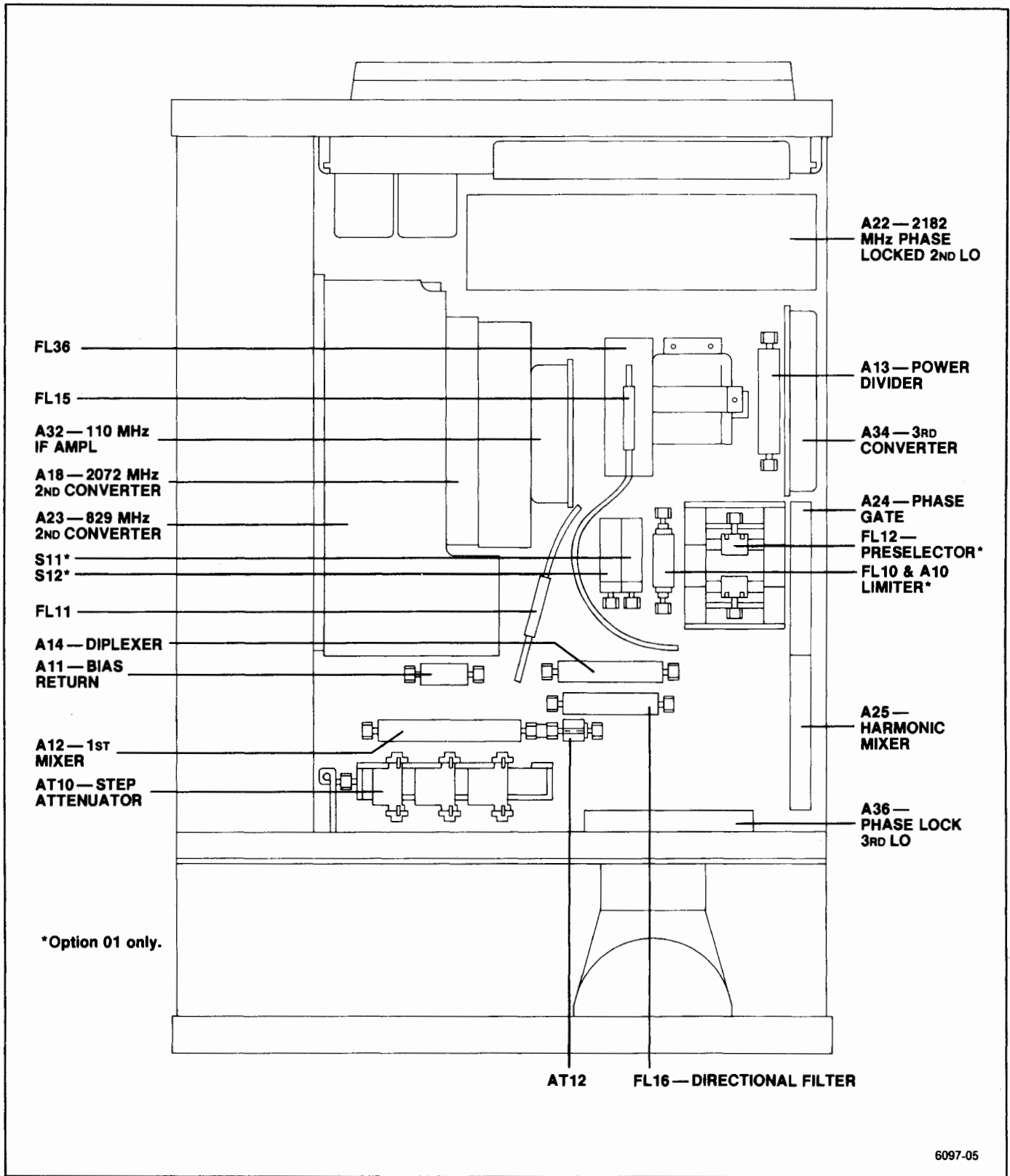

Figure 6-6. RF deck assemblies.

Removing or Replacing Semi-rigid Coaxial Cables

Performance of the instrument is easily degraded if these connectors are loose, dirty, or damaged. The following procedure will help ensure that the connection is good enough to maintain proper performance.

1. Use a 5/16 inch open-end wrench to loosen or tighten the connectors. It is good practice to use a second wrench to hold the rigid (receptacle) portion of the connector to prevent bending or twisting the cable.

2. Ensure that the plug and receptacle are clean and free of any foreign matter.

3. Insert the plug connector fully into the receptacle before screwing the nut on. Tighten the connection to 8 inch pounds to ensure that the connection is tight. Do not overtighten (15 to 20 inch pounds) because this can damage the connector.

Replacing the Dual Diode Assembly in the 1st Mixer

The diode subassembly that houses the Schottky mixer diodes permits easy field replacement of the diodes. The subassembly is secured in place with four 0-80 screws. An 8-32 threaded hole is provided to facilitate insertion and removal of the subassembly. There are three contact points located on the substrate side of the subassembly. Use care to ensure proper fit when mounting and orienting these contacts in the mixer assembly. Insertion and removal of the subassembly more than twice is not recommended due to the gold-ribbon attaching technique used in fabrication.

A tuning screw is adjusted to null a start spur on Band 1. This tuning screw is mounted through the top of the diode assembly, adjacent to the 8-32 hole. If adjustment of this screw is warranted, care should be taken to not force the tuning screw after it bottoms out on the surface of the quartz-suspended substrate.

The diode assembly is packaged in a static-free package. Keep the diode subassembly in this package until ready to install. The following should be used when replacing this assembly.

CAUTION

The diodes are beam-lead devices, mounted on a quartz-suspended substrate. These diodes are extremely sensitive to static electricity discharge. Refer to the caution note on static discharge at the beginning of this section. Do not expose the diode assembly to RF fields.

1. Loosen and disconnect the three coaxial cable connections at the 1st Converter assembly.

2. Remove the two mounting screws, and remove the assembly from the instrument.

3. Remove the four 0-80 screws that hold the diode subassembly in the 1st Converter, and insert a 8-32 screws into the threaded hole provided in the center of the diode assembly.

4. Lift the diode assembly out of the mixer assembly by means of the 8-32 screw, then remove the screw.

5. Open the diode package. Use a pair of tweezers to grasp the diode assembly by its side, and place it on a static-free surface. Grasp the side of the assembly with the fingers. Avoid contact with the diodes. Insert the 8-32 screw.

6. Orient the diode assembly so the three contact tips are aligned with their respective contacts in the mixer; then, using the index fingers of both hands so equal pressure is applied, press the subassembly into place.

7. Insert the four mounting screws, then replace and tighten the three coaxial connectors to 8 in-lbs. Remount the 1st Converter assembly by installing the two mounting screws that hold the assembly to the RF deck.

Replacing the Crt

1. Remove the snap-in printed bezel and crt light filter.

2. Use an 8/64 inch Allen wrench to remove the four bezel screws, unplug and remove the inner bezel.

3. Unsolder the ground wire from the front panel casting and unplug the crt cables at their respective board connections (High Voltage module, Deflection Amplifier board, and Z-Axis board).

4. Slide the crt, with its shield, out through the front panel.

5. Remove the crt shield as follows:

- a. Remove the tube base cap and unplug the socket.

- b. Remove the two side screws that hold the upper shield in place, then remove the shield.

- c. Loosen the screws that clamp the plastic bracket around the crt, then remove the bracket.

6. Install the plastic bracket so the back on the clamp is 5.07 inches from the back of the crt socket guide.

7. Replace the crt shield plus the socket and base shield by reversing the removal procedure. The finished crt assembly length, with cap installed, must equal 11.05 inches. If it is longer, the assembly may short circuit the Deflection Amplifier circuit board when it is installed.

8. Place the spectrum analyzer on its rear panel then loosen the four crt blue plastic mounting blocks on the front casting so they can be readily positioned when the crt is installed.

9. Install the crt with shield assembly through the front panel; seat the wedges on the side of the crt, into the blue plastic mounting blocks.

10. Position the cast bezel and implosion shield in place to ensure that there is clearance between the crt face and the bezel. (The bezel must bottom on the front casting.)

CAUTION

It is very important that the four mounting blocks are loose enough so the bezel retaining screws can be tightened without the bezel touching the crt face. If not the crt or the bezel may crack when the screws are tightened.

11. Remove the bezel and tighten the mounting block screws evenly in a cross pattern to approximately 8 inch pounds. Make sure the crt stays centered in the blue plastic mounting blocks as the screws are tightened.

12. Replace the bezel and implosion shield, reconnect cables to their respective board connectors, and resolder the ground lead to its terminal.

13. Replace crt light filter and snap-in printed bezel.

Repairing the Crt Trace Rotation Coil

The trace rotation coil is part of the crt assembly. If the coil is damaged beyond repair, the crt with the coil must be replaced.

If the "finish" (red) lead is broken, remove the tape and unwind one or two turns so it can be respliced and soldered to the lead wire. Rewind and retape.

If the "start" (black) lead is broken and the lead is too short to re-splice, attempt to fish out the broken end so one or two turns can be unwound, re-splice and solder to the lead; then rewind and retape.

Front Panel Assembly Removal

It is not necessary to remove the front panel assembly to replace any of the push buttons. (Refer to Replacing Front Panel Pushbuttons, that follows this procedure.) The crt is removed with the front-panel assembly.

1. Place the front of the instrument just of the edge of a table, then unscrew and remove the mounting nuts and washers from the RF INPUT, and the two 1st and 2nd LO OUTPUT connectors. Remove the knobs.

2. Unplug the CAL OUT coaxial cable from the 3rd Converter, and unplug the crt from the Z-Axis/RF Interface, High Voltage module, and the Deflection Amplifier.

3. Unplug the front-panel board from the Mother board, and remove the cables connecting the two front-panel boards.

4. Pull off the snap-in crt bezel, and loosen the allen screws holding the crt. Remove the front-panel overlay. Remove the eight screws holding the front-panel assembly to the frame.

Replace the front-panel assembly by reversing the removal procedure.

Front-Panel Board Removal

NOTE

A replacement Front Panel board comes with switches and controls for programable different versions of the spectrum analyzer. Before replacing an existing board, remove the switches and controls on the new board that are not used on the particular version of the instrument.

It is not necessary to remove the front-panel assembly to remove the front-panel board.

1. Remove the front-panel knobs. Remove the cables connecting the two front-panel boards, and the cable connecting the front panel to the Mother board.

2. To remove front panel #1, remove the 8 screws holding it to the subpanel. To prevent losing the grounding rings or bushings between the front-panel controls, gently pull the board from the subpanel.

3. To remove front-panel #2, remove 3 screws holding it to the subpanel.

Replacing Front Panel Pushbutton Switches

1. Remove the front panel board, using the previous procedure.
2. Pull off the switch keycap, and push the switch through the board from the back.
3. When installing a new switch, support the led from the back when appropriate.

Main Power Supply Module Removal

CAUTION

To avoid damage to the Mother board connector J5041 and Interface connector J1034, during removal or installation of the Power Supply module, use the following procedure.

1. Disconnect the power cord and remove the instrument cover. 2. On the circuit board side of the instrument, unplug the coaxial cable connector P620 from the Log and Video Amplifier assembly. On the RF deck side disconnect the plug for the cable to the Reference Lock assembly, at the lower right corner of the Power Supply module.
3. For programmable instruments, remove the cable clamp for the GPIB interconnect cable and unplug P560 to the GPIB Extender board.
4. Remove the three screws that hold the power module to the RF deck flange (bottom right side), then remove the four screws that hold the power supply module to the side rails.
5. With the instrument RF deck on the near side, pull the left side of the power module from its side-rail (no more than 1.5 inch). Now grasp both sides of the module and lift to separate the module from the Mother board.

WARNING

Because C6111 and C6101 discharge very slowly, hazardous potentials exist within the power supply for several minutes after the power switch is turned off. A relaxation oscillator, formed by C5113, R5111, and DS5112, indicate the presence of voltages in the circuit until the potential across the filter capacitors is below 80 V.

6. Loosen and remove the two screws that hold the mounting bracket for P361. Lift the cover off the module and unplug P3045 to the Fan Drive board. The power supply should now be accessible.

7. Reinstall P361 mounting bracket then plug P3045 onto the power supply board and replace the cover.

8. Set the instrument with the RF deck on the near side then hold the power supply module at the rear of the instrument so the right side is touching the side-rail and the left side is about 1.5 inch above its side-rail.

9. Align connectors P5041 and P1034 with their respective Mother board and Interface board connectors, then press the module into place between the side rails.

10. Replace the four module holding screws and the three flange screws.

11. Reconnect the coaxial cables and GPIB cable, if appropriate, then install the cable clamp.

12. Replace the instrument cover.

High Voltage Power Supply

A screw must be removed before the High Voltage Power Supply circuit board can be unplugged and removed. The screw goes through the side-rail into a nylon standoff bushing at the bottom corner of the board.

Removing and Replacing the 1st LO (YIG Oscillator)

1. Unplug and remove the multipin connectors to the assembly. Cut the tie-down that holds the black encased RF coil to the semi-rigid cable.
2. Using a 5/16 inch open-end wrench, loosen and disconnect the semi-rigid coaxial cable.
3. Loosen and remove the four mounting screws that hold the assembly to the RF deck. Remove the 1st LO assembly.
4. To replace the assembly, reverse the removal procedure. Use a tie-down to re-tie the RF coil to the semi-rigid cable to prevent vibration from breaking the coil leads.

Replacing the 1st (YIG) Local Oscillator Interface Board

The YIG oscillator assembly includes an interface circuit board that can be replaced. To replace the board refer to Figure 6-7 and the following procedure. Use a desoldering tool to remove the solder as the leads are unsoldered.

1. Unsolder and lift one end of C1014 (820 uF capacitor) at the top of the board.
2. Unsolder and lift one end of VR1010.
3. Unsolder and lift the + lead of C1016 from the YIG terminal.
4. Unsolder the eight leads to the YIG and lift the board off the assembly.

Fan Assembly Removal

1. Remove power supply as described in this section.
2. Remove six screws that hold the power supply cover in place. Take the coaxial cable out of the plastic retainer clip and lift the power supply cover with fan up, so harmonica connector P3045 can be disconnected and the cover removed.
3. Remove the nuts and lockwashers that hold the fan brackets from the back side of the power supply housing. The fan will fall free from the brackets.
4. The resilient mounts at the corners of the fan frame should be replaced if a new fan is to be installed or fan vibration is generating spurs on the display.
5. Insert four resilient mounts into the corners of the fan, flush with the fan frame.
6. Install one of the fan brackets to the power supply housing by attaching its lock washers and nuts to the back of the housing.

NOTE

Fan brackets should be installed as in Figure 6-8.

7. Insert the posts of the brackets into the holes provided in the resilient mount and install the remaining bracket, with lockwashers and nuts, to the back side of the power supply housing.

8. Reconnect the fan to the Fan Drive board then replace the cover, with the fan, onto the power supply module.

9. After installing the six screws that hold the cover in place, ensure that the fan assembly moves freely. Replace the coaxial cable in the plastic retaining clip.

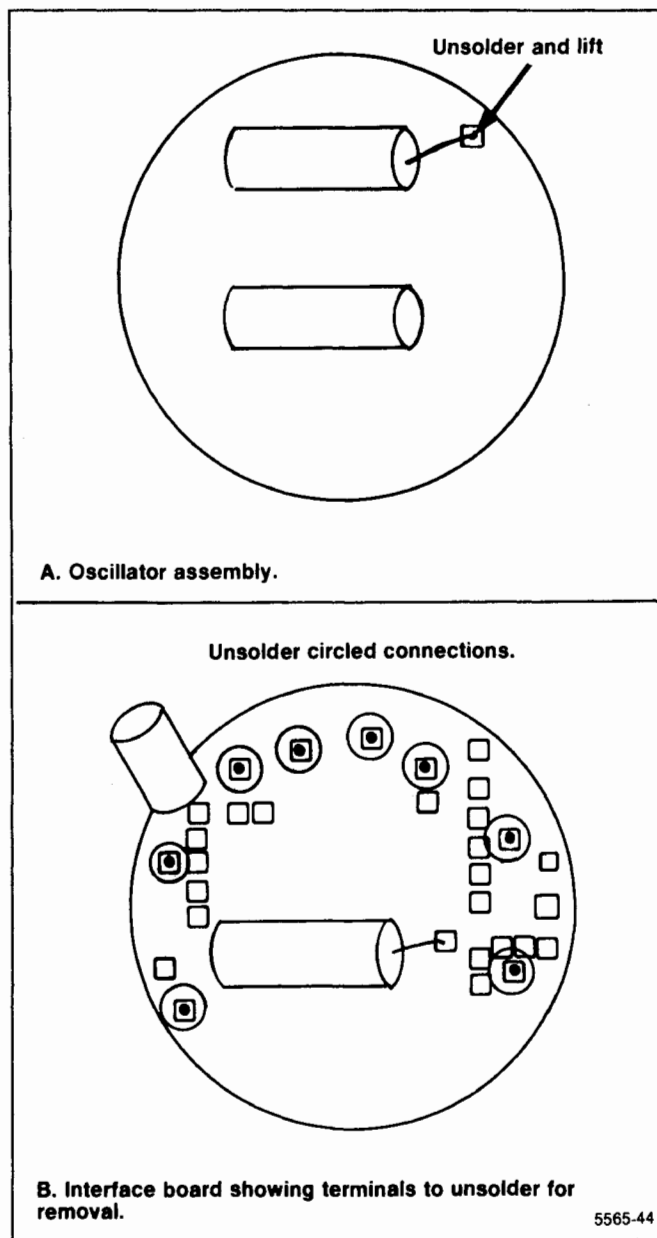

Figure 6-7. Removing the YIG oscillator interface board.

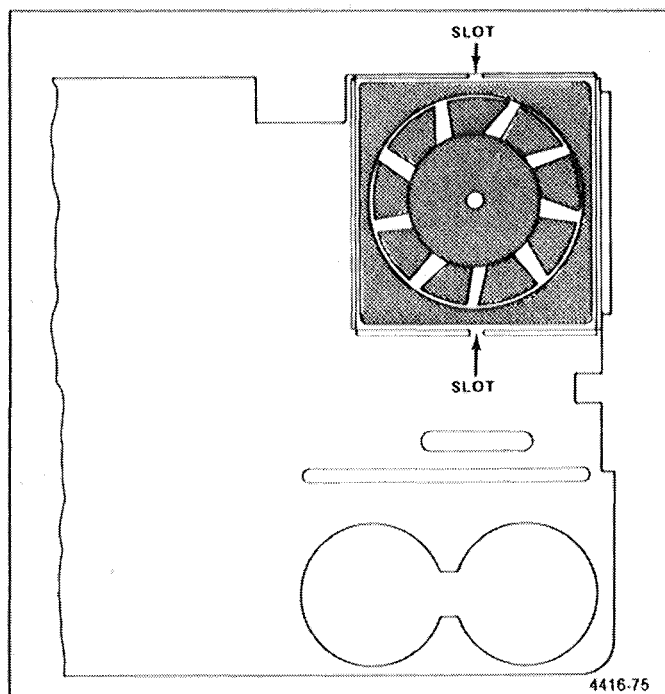

Figure 6-8. Fan assembly mounting.

10. Reinstall the Power Supply assembly as directed under Power Supply Replacement. Apply power and check for normal fan operation.

MAINTENANCE ADJUSTMENTS

The following procedures are not part of the regular calibration. They are only applicable when these assemblies are replaced or after major repair.

110 MHz IF Assembly Return Loss Calibration — (Table 6-5 lists test equipment required to adjust this assembly.)

1. Test equipment setup is shown in Figure 6-9. The IF assembly must be removed to gain access to the adjustments.

2. Apply 110 MHz at 2 V peak-to-peak (+10 dBm) through 35 dB attenuation to the RF Input of the VSWR bridge. Connect the RF Out of the VSWR bridge to the RF Input of the spectrum analyzer. (Do not connect the 110 MHz IF to the VSWR bridge.)

3. Set the test spectrum analyzer Center Frequency to 110 MHz, Frequency Span/Div to 5 MHz, Resolution Bandwidth to 3 MHz, Vertical Display to 10 dB/Div, and Ref Level to -20 dBm.

4. Set the step attenuator for a full screen (-20 dBm) display.

5. Connect the 110 MHz IF input to the VSWR bridge and connect a 50Ω termination to the output of the IF amplifier. Now plug the power cable P3045 into the + and -15 V source and ground the case of the assembly.

6. Adjust C2047 and C1054 (Figure 6-10) simultaneously for minimum signal amplitude on the spectrum analyzer display. Minimum amplitude must be at least 35 dB down from the full screen reference of -20 dBm.

7. Disconnect test equipment setup and replace the 110 MHz IF assembly.

2072 MHz 2nd Converter

The 2nd Converter assembly consists of a four cavity 2072 MHz band-pass filter, mixer, and a 110 MHz low-pass filter. The assembly is precalibrated prior to installation, and requires no calibration after it is installed. We recommend replacing the assembly if it should malfunction. The following procedures describe adjustments that can be made if the biasing should malfunction or the seal on any of the filter tuning slugs is broken. The mixer diodes are not to be replaced in the field. Return the assembly to Tektronix, Inc., for repair.

CAUTION

Do not open the assembly. Adjust the tuning slug only after checking the filter characteristics.

Four Cavity Filter—The characteristics of the filter are checked with a network analyzer. Frequency of the filter is 2072 MHz, bandpass, 15 MHz down, is 1 dB, return loss is 20 dB or greater, and insertion loss is 1 dB. If the seal is broken on any tuning slug, adjust for maximum return loss.

Mixer—To gain access to the Bias adjustments, remove the assembly from its mounting; then remove the mounting plate on the bottom of the assembly. Reconnect the Mixer to the input/output lines, using the same cables (cable length of semi rigid cables is critical). Apply the CAL OUT signal to the RF INPUT and tune a marker to center screen. Simultaneously adjust both bias potentiometers, R1021 and R1022, (see Figure 6-11) for maximum signal amplitude.

Table 6-5
EQUIPMENT REQUIRED FOR RETURN LOSS ADJUSTMENT

Test Equipment	Characteristics	Recommended Type
Spectrum Analyzer	Frequency range ≥ 110 MHz	TEKTRONIX 49X-Series or 7L14 Spectrum Analyzer
Signal Generator	Frequency 110 MHz at +10 dBm	TEKTRONIX SG 503 for the TM 500-Series
VSWR Bridge		Wiltron VSWR Bridge, 62BF50
10 dB and 1 dB Step Attenuators	50 Ω , 0 dB to 40 dB	Hewlett Packard 355C & 355D Step Atten.
Termination	50 Ω	Tektronix Part No. 011-0049-01
Adapter	Bnc-to-Seaelectro	Tektronix Part No. 175-0419-00

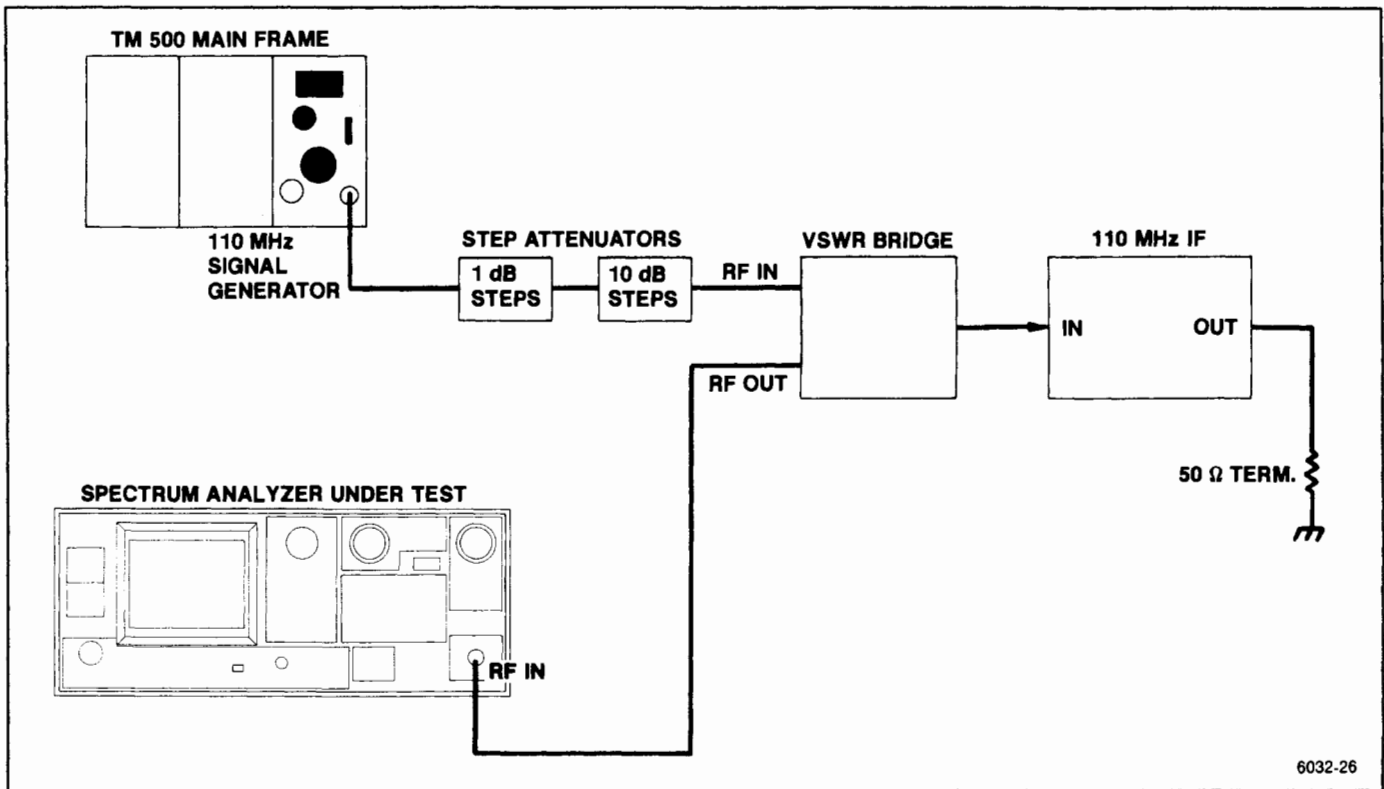

Figure 6-9. 110 MHz IF return loss adjustment setup.

110 MHz Three Cavity Filter

Alignment of this filter is not required unless the spectrum analyzer fails to meet bandwidth specifications. The filters are adjusted for center frequency and response shape so the resolution bandwidth is within specifications. The adjustment procedure is as follows:

1. With the CAL OUT signal applied to the RF INPUT, tune the signal to center screen and reduce the RESOLUTION BANDWIDTH to 1 kHz.

2. Tune the signal to center screen to establish center frequency reference; then increase the RESOLUTION BANDWIDTH to 1 MHz.

3. Adjust the tuning slugs for best response shape, centered around the reference. Ensure bandwidth (6 dB down) is 1 MHz.

4. Check resolution bandwidth accuracy over the range of the RESOLUTION BANDWIDTH selector as per instructions in the Performance Check section to ensure that bandwidth is within specification.

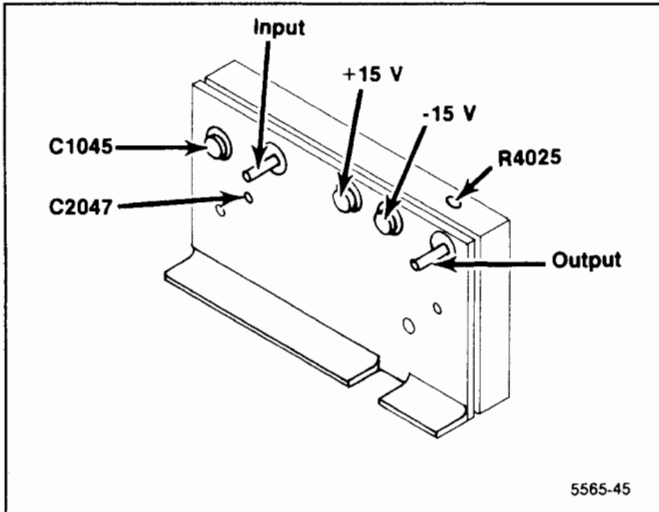

Figure 6-10. 110 MHz IF test points and adjustments.

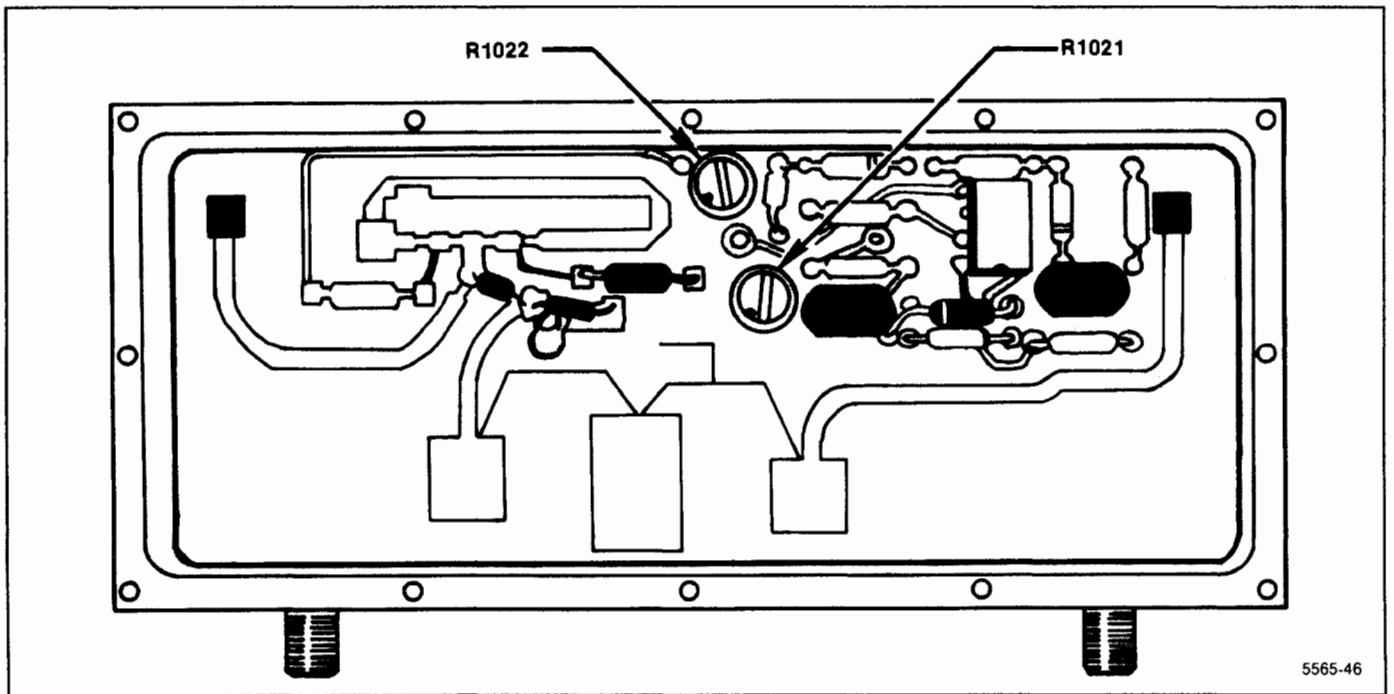

Figure 6-11. 2072 MHz Converter bias adjustments.

829 MHz Converter Maintenance

Some circuit boards in this assembly contain critical-length printed elements. When damaged, these elements are usually not repairable; therefore, the circuit board must be replaced. Even though replacement boards are precalibrated and repair can be accomplished by replacing the board, we recommend sending the instrument or assembly to your Tektronix Service Center for repair and calibration.

The 829 MHz band-pass filter in the IF section, and the 719 MHz LO in the LO section, require adjustment only if the board has been damaged or active components (transistor or varactor) have been replaced. The following describes preparation for service and replacement procedures. The first two steps describe how to gain access to either the LO or the IF section; the remaining steps describe adjustment procedure for each section.

1. To gain access to the LO section:

- a. Switch POWER off; use a 5/64 Allen wrench to loosen and remove the cover screws.
- b. Remove the cover.
- c. Refer to step 3 (within this procedure) for adjustment procedure.

2. To gain access to the IF section

- a. Switch POWER off; use a 5/16 inch wrench to disconnect and remove all coaxial connectors to the 829 MHz converter.
- b. Remove the six mounting screws, unplug the input power connector P4050, then remove the 829 MHz converter assembly.
- c. Turn the assembly over and remove the cover for the IF section.
- d. To troubleshoot or calibrate the circuits, set the assembly at a location so the input power plug P4050 can be reconnected to the Mother board. Be sure to observe plug orientation (pin 1 to pin 1).
- e. Refer to step 4 (within this procedure) for adjustment procedure.

3. 719 MHz Oscillator Range Adjustment

- a. Adjustment requires the following test equipment:
 - A frequency counter with a frequency range to 1 GHz (nine digit readout), sensitivity of 20 mV rms for prescaled input or 15 mVrms for a direct input (such as TEKTRONIX DC 510 counter with a DP 501 prescaler); a digital voltmeter with a 3.5 digit readout (such as TEKTRONIX DM 502A); test leads

for the DVM, a 50Ω coaxial cable with bnc connectors (Tektronix part number 012-0482-00) and a sma male-to-bnc female adapter (Tektronix part number 015-1018-00).

- b. The 2nd LO range is 714.5 MHz to 723.5 MHz (with the cover off). 719 MHz is the optimum center frequency. Frequency of the oscillator is controlled by the Tune Volts from the 25 MHz Phase Lock circuit (located at TP1011) which varies from +5 V (low end) to +11.9 V (high end) with +6.75 V to +7.5 V as the limits for operation at 719 MHz. Set the digital voltmeter to measure 12 V then connect it between TP1011 (Figure 6-12) and ground.

- c. Disconnect the 100 MHz reference from the 3rd Converter by unplugging P235 (Figure 6-12). The oscillator should go to its upper limit and the voltmeter indicate about 11.9 V.

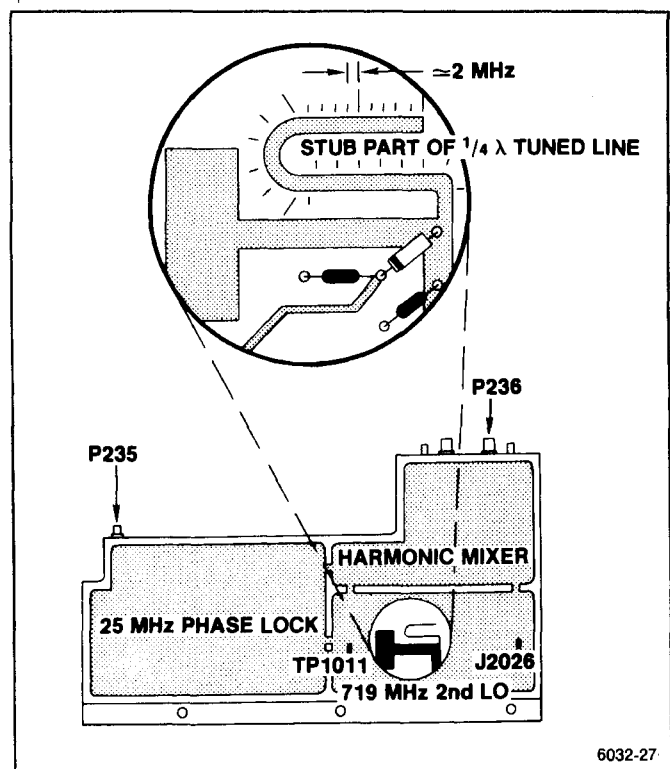

Figure 6-12. 829 MHz LO test points and connectors.

- d. Connect the 75 MHz—1000 MHz input of the frequency counter through a 50Ω coaxial cable to the front panel 2nd LO OUTPUT connector.

- e. Minor adjustments to the oscillator frequency are made by shortening the U-shaped transmission line stub, off the main line. Graduation marks (see Figure 6-12) along the side of the stub provide a guide to calculate frequency correction. Each minor mark from the end or cut across the stub, represents an approximate change of 2 MHz.

Check the frequency by noting the reading on the frequency counter. If above 723.900 MHz, the stub must be lengthened. Solder a bridge across the cut and recheck frequency. Nominal frequency for an uncut stub is 710 MHz.

f. Shorten the line so the frequency is near 723.500 MHz. For example: The frequency difference between the desired and the actual divided by 2 MHz, equals the number of minor divisions from the line end for the new cut. Make a cut across the line and check that the new frequency is between 723.100 MHz and 723.900 MHz. Repeat as necessary.

g. Cover the 719 MHz oscillator cavity with the 829 MHz Converter cover, press down to ensure good shielding, and note the frequency readout of the counter. Frequency should fall within 723.600 MHz and 724.400 MHz.

h. Reconnect P234 (100 MHz) and P237 (2182 MHz) and confirm that phase lock is operating by noting that the voltage on TP1011 is between 6.75 V and 7.5 V. This completes the adjustment of the 719 MHz LO. Replace the cover and reinstall the 829 MHz converter assembly.

4. 829 MHz Coaxial Band-Pass Filter Adjustment

NOTE

This procedure is necessary if the position of one of the variable capacitor loops (tabs) has been altered, changing the bandpass characteristics of the filter.

a. Test equipment required:

Spectrum analyzer with tracking generator (such as a TEKTRONIX 49X-Series Spectrum Analyzer with TR 503 Tracking Generator, or 7L14 with a TR 502 Tracking Generator); Frequency Counter (such as a TEKTRONIX DC 510 Counter with a DP 501 Prescaler); and a Return Loss (such as a Wiltron Model 62BF50 Bridge.)

b. Unsolder and reconnect the jumper, on the 829 MHz Amplifier board, to the test Peltola jack J1029 (see Figure 6-13).

c. Connect the spectrum analyzer, tracking generator, and frequency counter together as a system, with the frequency counter connected to the Auxiliary RF Output of the tracking generator (see Figure 6-14).

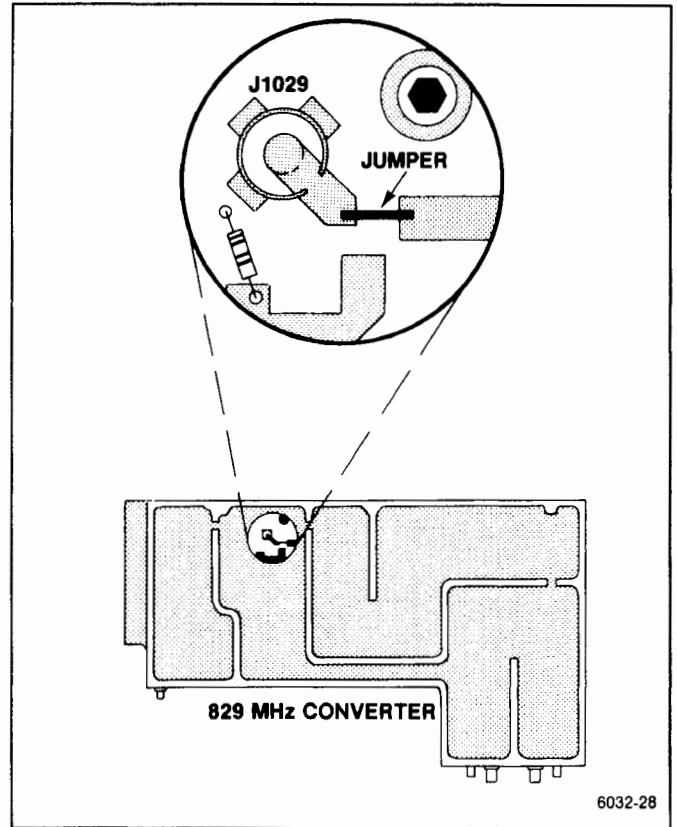

Figure 6-13. 829 MHz amplifier test jack and jumper.

d. Connect the spectrum analyzer/tracking generator system through the return loss bridge to the Peltola jack (J1029) on the 829 MHz amplifier board (see Figure 6-14). Reconnect P235 (100 MHz reference signal) and P237 (2182 MHz input) to the LO section of the converter.

Terminate the 110 MHz Output (J232) connector with 50Ω , using a bnc-to Sealelectro adapter and 20 dB bnc attenuator. Pull the IF SELECT line high by switching to band 2 (1.7-5.5 GHz).

e. Set the test spectrum analyzer Reference Level to -20 dBm, Vertical Display mode to 2 dB/div, Resolution Bandwidth to 300 kHz, and Freq Span/Div to 20 MHz. Tune the Center Frequency for a readout of 829.00 MHz on the frequency counter.

f. Adjust the $1/4$ wavelength lines in the filter in sequence, starting with the resonator at the 829 1 MHz input (see Figure 6-15). Adjustment is made by shorting the adjacent resonator to ground with a low inductance conductor, such as a broad blade screwdriver, then bend the loop or tab of the respective stub with a non-metallic tuning tool to change the series capacitance of the resonator.

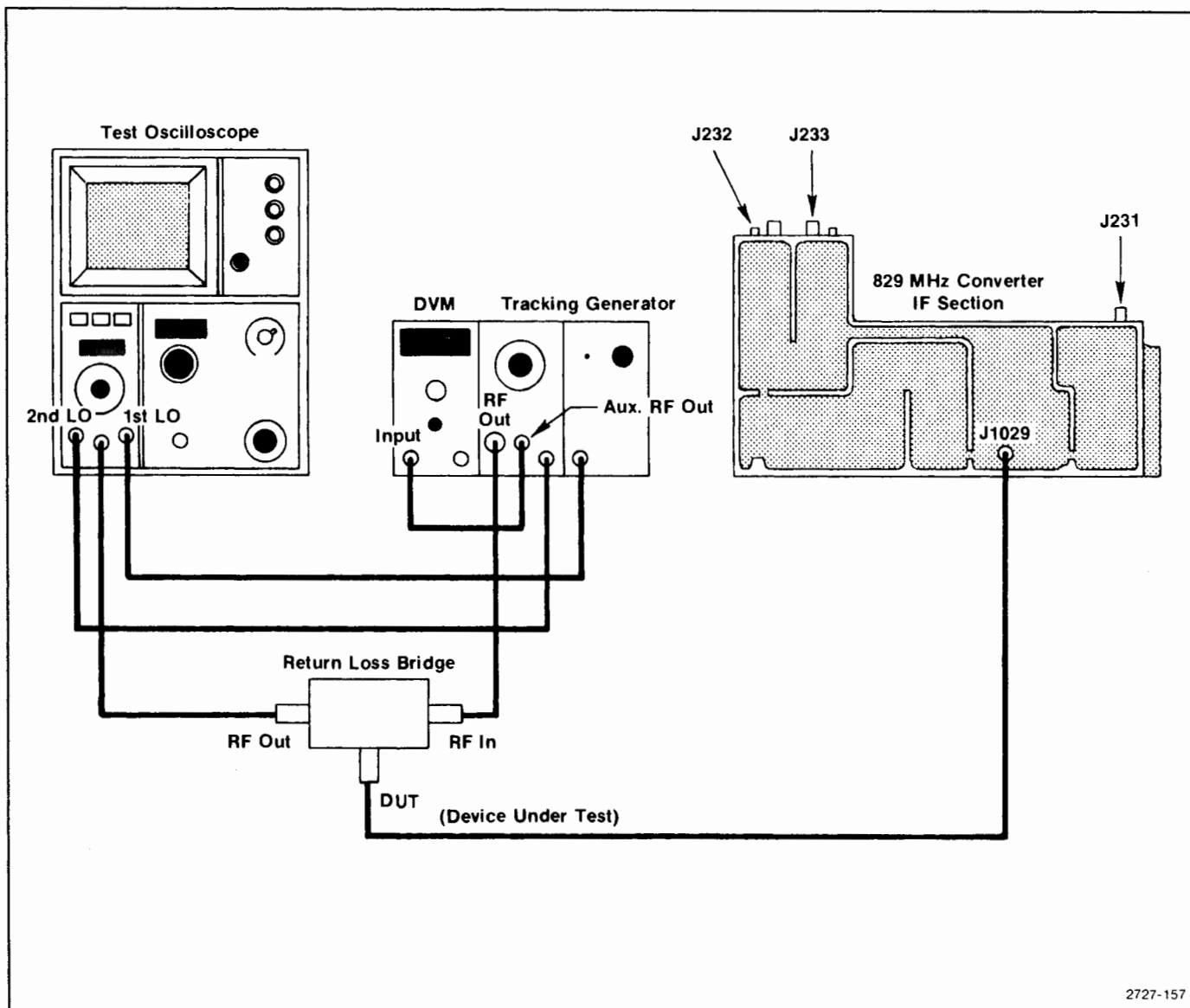

Figure 6-14. 829 MHz filter test equipment setup.

g. With the adjacent resonator (second) shorted to ground, adjust the series capacitance by bending the tab so the response on the spectrum analyzer display is centered at 829 MHz (see Figure 6-16A).

h. Now move the shorting strap (screwdriver) to the next resonator and adjust the tab of the second resonator for a response as indicated in Figure 6-16B.

i. Remove the short from the third resonator and short the fourth resonator. Adjust the third resonator for a response similar to that shown in Figure 6-17A.

j. Repeat the procedure for the final (fourth) resonator for a response similar to that shown in Figure 6-17B.

k. Check that the return loss is equal to or greater than 12 dB.

l. Disconnect the return loss Device Under Test lead to the Peltola jack J1029 on the 829 MHz Amplifier board, then unsolder and reconnect the jumper to the amplifier output.

m. Replace the 829 MHz Converter cover and reinstall the assembly in the Spectrum Analyzer.

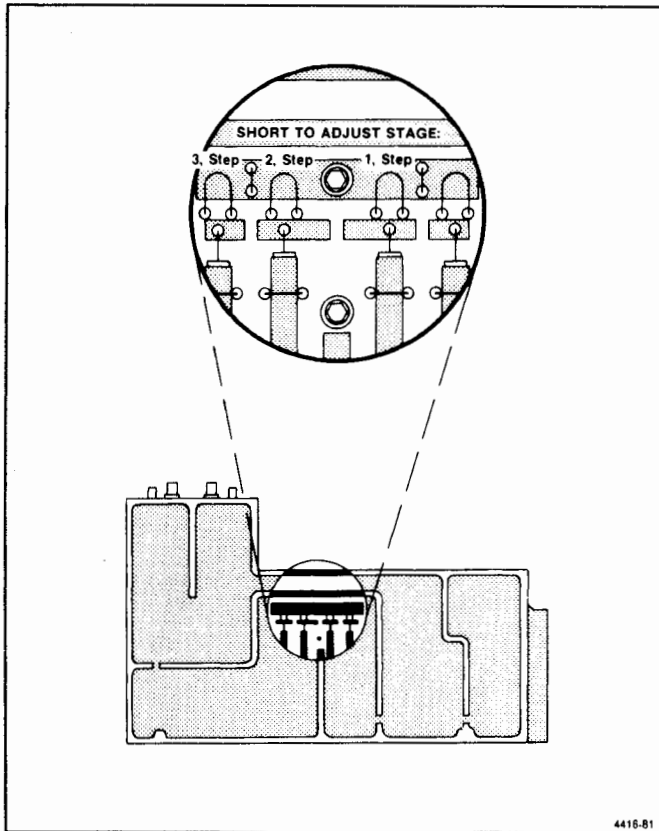

Figure 6-15. 829 MHz Converter filter tune tabs.

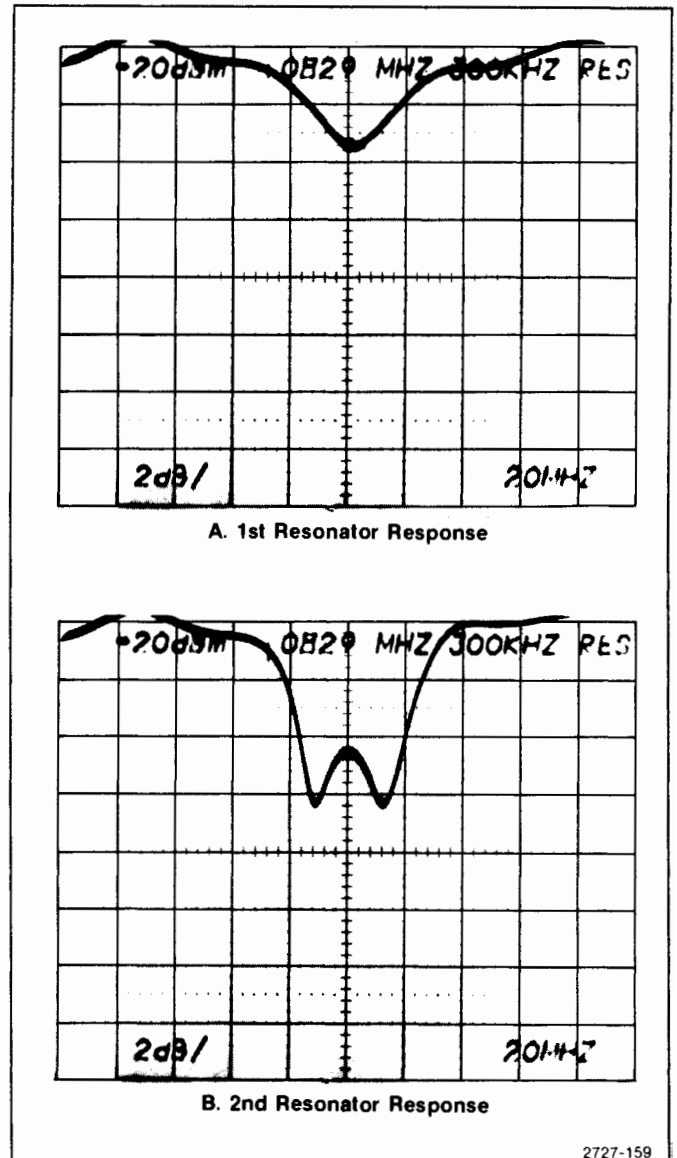

Figure 6-16. Correct response for 829 MHz first and second resonators.

Troubleshooting and Calibrating the 2182 MHz 2nd LO

The 2nd LO assembly contains a phase-locked oscillator (2182 MHz) and its phase-locking circuits. The 14-22 MHz Phase Lock board is contained in a mu-metal housing. The 2182 MHz Oscillator, 2200 MHz Reference, and 2200 MHz Reference Mixer are contained in a machined aluminum housing.

The 2182 MHz Microstrip Oscillator and 2200 MHz Reference Mixer contain critical printed elements. These elements are difficult to repair, therefore the board should be replaced if damaged. If either the varactor diode or the oscillator transistor for the 2182 MHz Oscillator is replaced and the oscillator fre-

quency is beyond adjustment with the frequency adjust tab, described in this procedure, the circuit board must be replaced.

Even though repair can be accomplished by replacing the board, we recommend sending the instrument or assembly to your Tektronix Service Center for repair to insure best performance.

The 2182 MHz Phase Locked 2nd LO requires calibration only when a component within the assembly has been replaced.

Table 6-6 lists test equipment required to calibrate the L.O. section, and Table 6-7 lists equipment for the Phase Lock section.

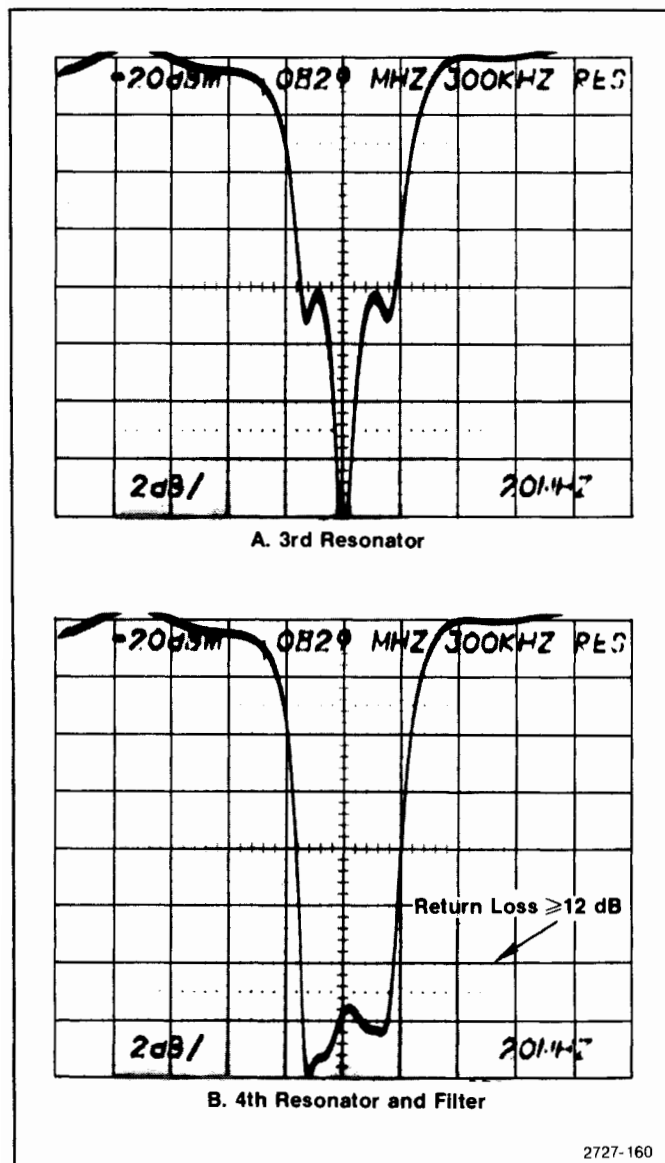

Figure 6-17. Correct response for 829 MHz third and fourth resonators.

1. Check 2nd L.O. Frequency (2182 MHz \pm 1 MHz)

The reference frequency position set up in this step will also be used in the adjustment procedure.

- a. Connect the test equipment as shown in Figure 6-18.
- b. Set the 2754/2754P Spectrum Analyzer to Band 1 and Max Span.
- c. Set the test spectrum analyzer front-panel as follows:

Frequency	2 GHz
Frequency Span/Div	10 MHz
Reference Level	+20 dBm
Auto Resolution	On
Vertical Display	10 dB/Div
Digital Storage	View A & View B
Time/Div	Auto
Triggering	Free Run

d. Set the Time Mark generator for 0.1 μ s markers. Markers should appear on the test spectrum analyzer display, approximately one marker/division.

e. Peak the 2.0 GHz signal for maximum amplitude with the peaking control, if available.

f. Using the 2 GHz signal as a starting point, begin counting markers until the 18th marker is located. The 2 GHz signal should be greater in amplitude than the time markers. The frequency must be tuned towards 2.18 GHz to locate the 18th marker. Increase the reference level as necessary to view the markers.

g. Center the 18th marker on the test spectrum analyzer (center frequency should be approximately 2.18 GHz).

h. Reset the test spectrum analyzer frequency span/division to 1 MHz.

i. Position the 18th marker 2 major divisions to the left of the center graticule line on the test spectrum analyzer (center frequency should be approximately 2.182 GHz), then activate SAVE A.

j. Disconnect the output of the comb generator from the rf input of the test spectrum analyzer.

k. Reset the Reference Level of the test spectrum analyzer to +10 dBm. Connect the 2ND LO output from the 2754 to the rf input of the test spectrum analyzer.

l. Check that the 2nd L.O. output signal is within one major division of the center graticule line (2.181 GHz to 2.183 GHz).

m. If the frequency of the 2nd L.O. is greater than 2.183 MHz or less than 2.181 MHz, adjustment is required. The SAVE A display reference used in part l will be used in the adjustment procedure.

Table 6-6
EQUIPMENT REQUIRED FOR 2nd LO CALIBRATION

Test Equipment	Characteristics	Recommended Type
Spectrum Analyzer	Frequency range to 2.2 GHz	TEKTRONIX 49X-Series or 7L14 Option 39
UHF Comb Generator	500 MHz Pulse Input	Tektronix 067-0885-00 Calibration Fixture with TM 500 Series Power Module
Time Mark Generator	0.1 μ s markers; accuracy 0.001%	TEKTRONIX TG 501 with TM 500 Series Power Module
Signal Generator	Calibrated 100 MHz, with \pm 20 kHz accuracy	Hewlett-Packard Model 8640 A/B
Voltmeter	Measures to within 0.01 V, impedance \geq 1 M Ω	TEKTRONIX DM 502A with TM 500 Series Power Module
Variable Power Supply	0 to 12.5 V, accurate to 0.1 V	TEKTRONIX PS 501 with TM 500 Series Power Module
Terminations (2)	50 Ω , 3 mm connectors	Tektronix Part No. 011-0049-01

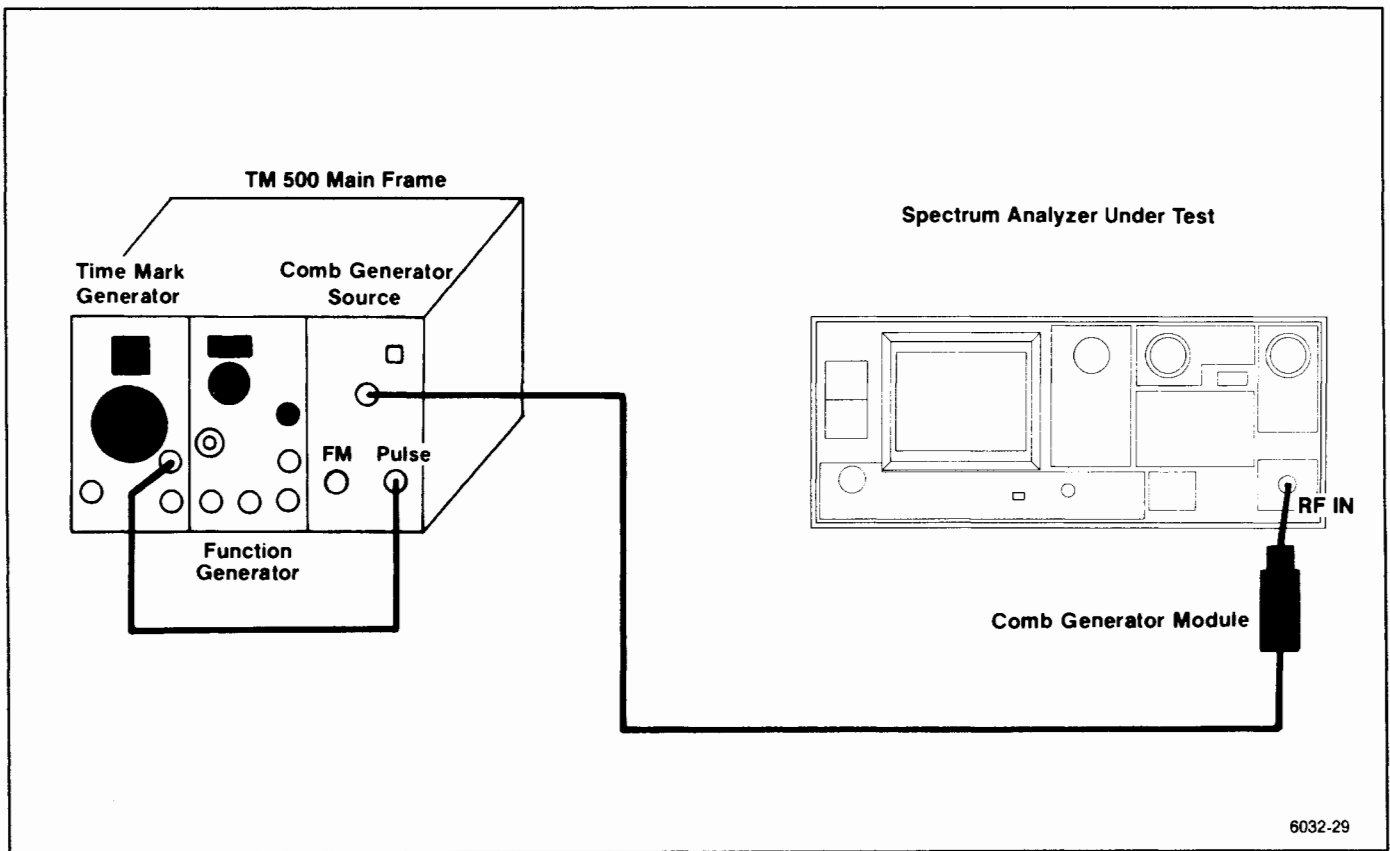

Figure 6-18. 2182 MHz 2nd LO frequency accuracy test setup.

Preparing the 2nd L.O. Assembly for Adjustment

Test equipment setup is shown in Figure 6-19. Turn the POWER off. Remove the cabinet and place the Spectrum Analyzer upside down so the RF deck is exposed. Use a 5/16 inch wrench to loosen and remove the two semi-rigid cable connections to the assembly. Remove the flexible coaxial cable connection to the 100 MHz input.

Remove the 14 screws that hold the cover on the mu-metal section and remove the cover. Unsolder the leads to feedthrough capacitors C2203 and C2204. (These are the center two feedthrough terminals that feed through the circuit board, as shown in Figure 6-20.)

Replace the cover using two or three screws to hold the cover in place.

Remove the mounting screws for the 2nd L.O. assembly. Carefully lift the 2nd L.O. assembly from the chassis and turn it over so the machined aluminum housing is up. Be sure that the power input connections remain intact. Place the assembly on a flat surface. Use a 5/64 Allen wrench to remove the screws holding the lid on the machined aluminum housing, and remove the lid, exposing the three RF circuit boards within the oscillator section.

Install a 50 Ω terminator on the 2182 MHz buffered output port, P222, (see Figure 6-21).

2. Adjust 2nd L.O. Frequency (2182 MHz \pm 1 MHz)

a. Connect the test equipment as shown in Figure 6-19.

b. Set the variable power supply to 0 V. Connect the plus positive (+) terminal to the 2nd LO housing and the negative (-) terminal to the exposed end of C2203 and L2031, through a 1 k Ω resistor.

c. Apply a 100 MHz, 0 dBm signal from the signal generator to the 100 MHz Reference input port, P221. (Frequency must be within 20 kHz of 100 MHz.)

d. Connect the test spectrum analyzer to the 2182 MHz unbuffered output port, P220. This is the test spectrum analyzer with the reference frequency position already set up in step 1. **DO NOT POSITION ANY OF THE CABLES OVER THE 2ND LO ASSEMBLY OSCILLATOR SECTION BECAUSE THEY CAN AFFECT THE FREQUENCY OF THE OSCILLATOR.**

e. Bend the feedback and frequency adjusting tabs, C1021 and C1022 (see Figure 6-21) so they are approximately 30 degrees above the board surface.

f. Apply power to both the Spectrum Analyzer and the variable power supply. Set the voltage output from the variable power supply to 5.0 V. Voltage on C2203 should now equal, -5 V and a signal should appear on the test spectrum analyzer.

g. Check for a voltage of +10.0, \pm 0.7 V across C2023.

h. Check Vbe at TP1015 (B in Figure 6-21). If Vbe is greater than +0.5 V, push the feedback adjustment tab down slightly and if less than -0.3 V, lift the tab. If Vbe is greater than +0.8 V, replace the microstrip oscillator board. If Vbe is more negative than -1 V, check the bias circuitry. Adjust the tab so Vbe is +0.15 V, \pm 0.05 V at TP1015. Do not touch the feedback tab while measuring voltages.

i. Check that the 2nd L.O. signal (frequency) is within one major division of the center graticule line (2.181 GHz to 2.183 GHz). Bend the frequency adjustment tab C1022 (D in Figure 6-21) to bring the oscillator within tolerance. (Bend the tab up to increase frequency and down to lower frequency.) If unable to bring the oscillator frequency within range, replace the 2182 MHz Oscillator board.

j. Check 2182 MHz output power.

NOTE

Before making power measurements, ensure that the unused port is terminated into 50 Ω . Unterminated ports will degrade both frequency and power measurements.

(1) Check for 0 dBm \pm 3 dB output power at the unbuffered port, P220.

(2) Connect the test spectrum analyzer to P222, terminate P220 in 50 Ω , then check for an output level of +10 dBm \pm 3 dB from the buffered port.

3. Check the 2200 MHz Reference Mixer

a. Use a probe, consisting of a short length of semi-rigid coaxial cable with a dc block (see Figure 6-22), to connect the output of the reference mixer at C2204 to the input of the test spectrum analyzer. Ground the outer shield of the coaxial cable against the 2nd LO housing.

b. Confirm that the output signal frequency is 18 MHz \pm 1 MHz. Adjust the tab C1022 (Figure 6-21) for the 2182 MHz Microstrip Oscillator, to bring the 18 MHz within the 1 MHz tolerance.

c. Confirm that the output level of the 18 MHz signal is approximately -36 dBm. If the level is below -46 dBm, check the signal levels from the 2200 MHz Reference Mixer and the 2182 MHz Microstrip Oscillator (-28 dBm, \pm 8 dB from the 2200 MHz Reference Mixer and +8 dBm, \pm 3 dB from the oscillator).

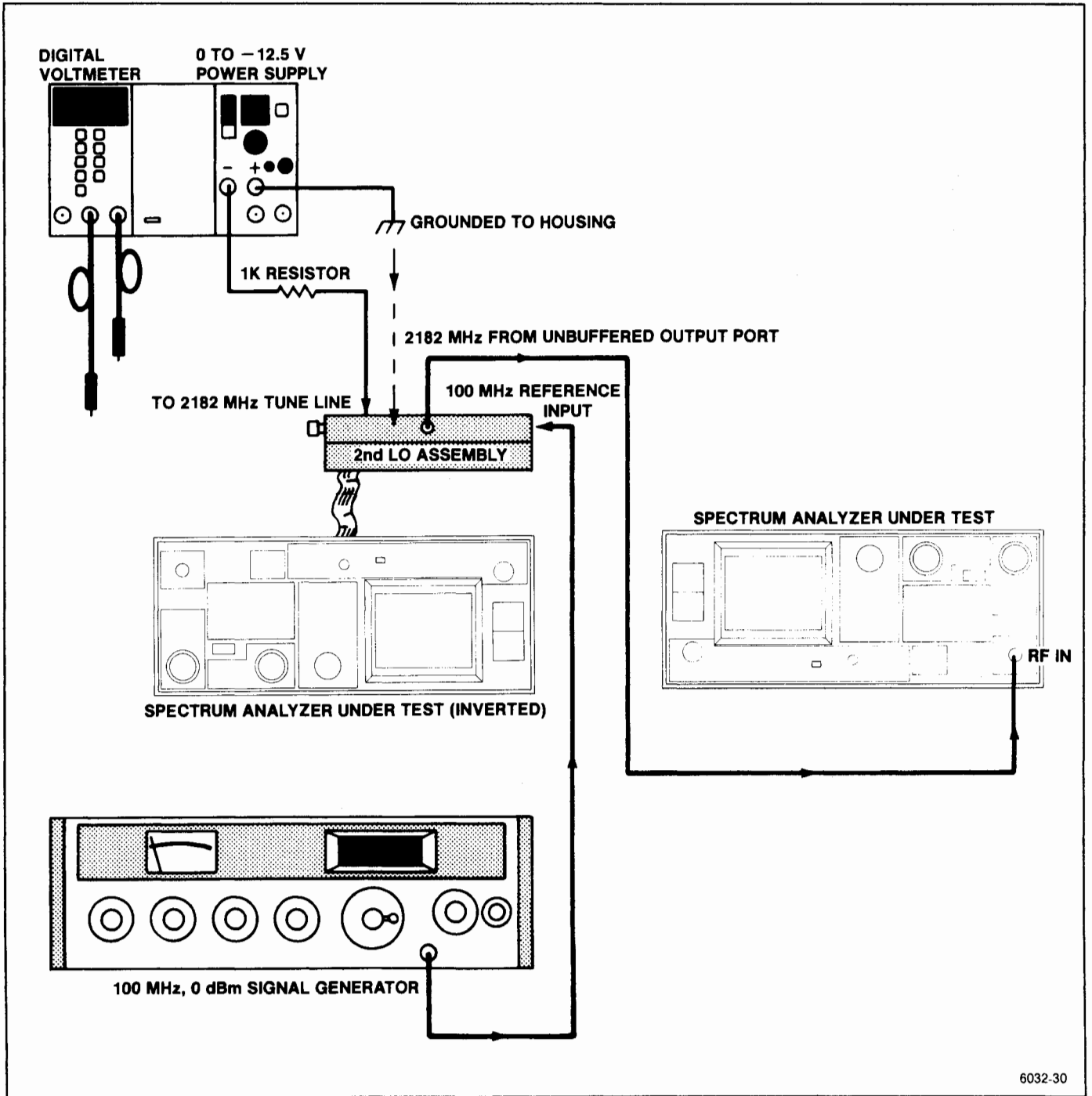
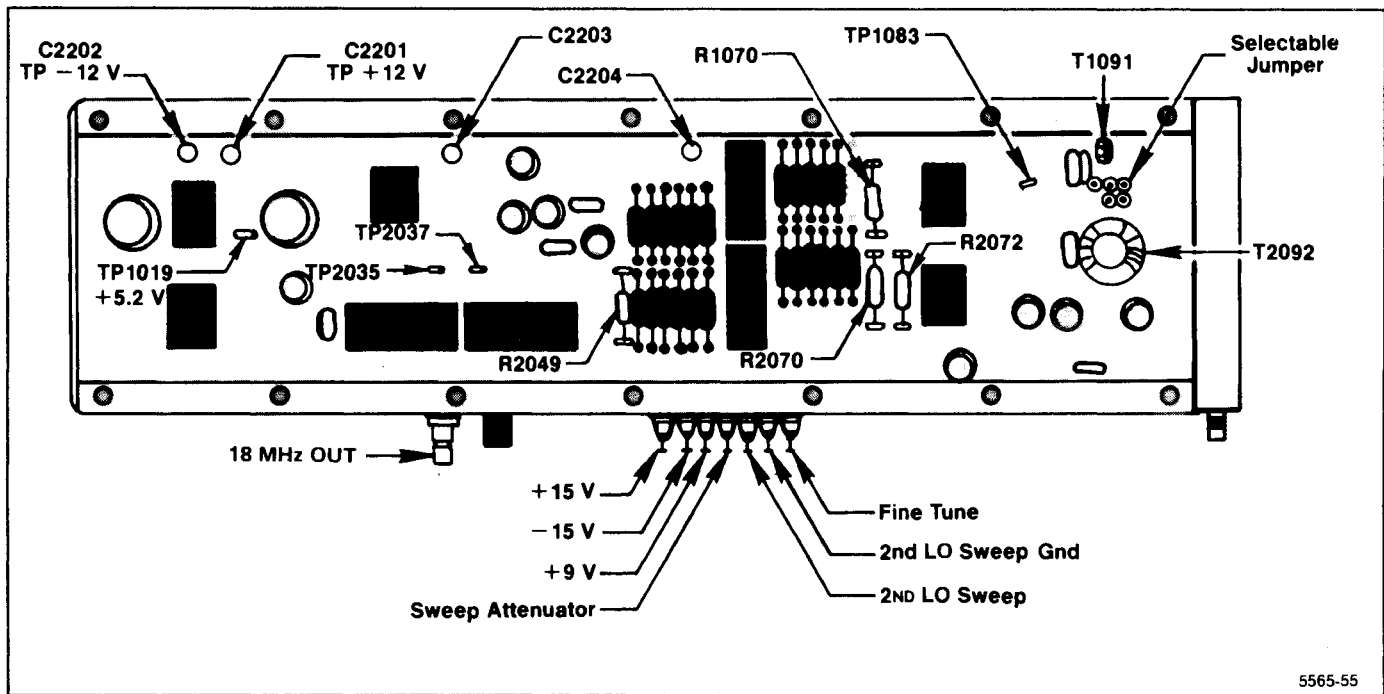
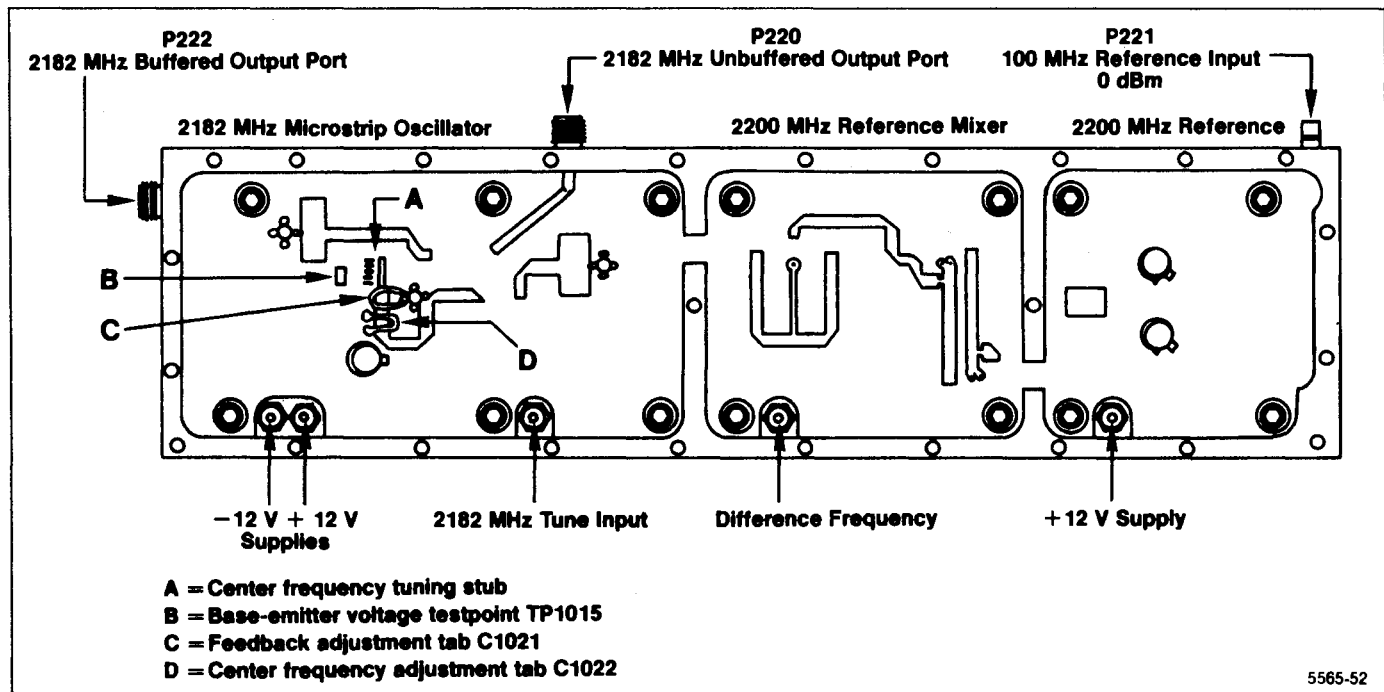

Figure 6-19. 2182 MHz Phase Locked 2nd LO adjustment setup.



5565-55

Figure 6-20. 16—20 MHz Phase Lock circuit test point and component locations.



5565-52

Figure 6-21. 829 MHz Converter oscillator adjustment and test point locations.

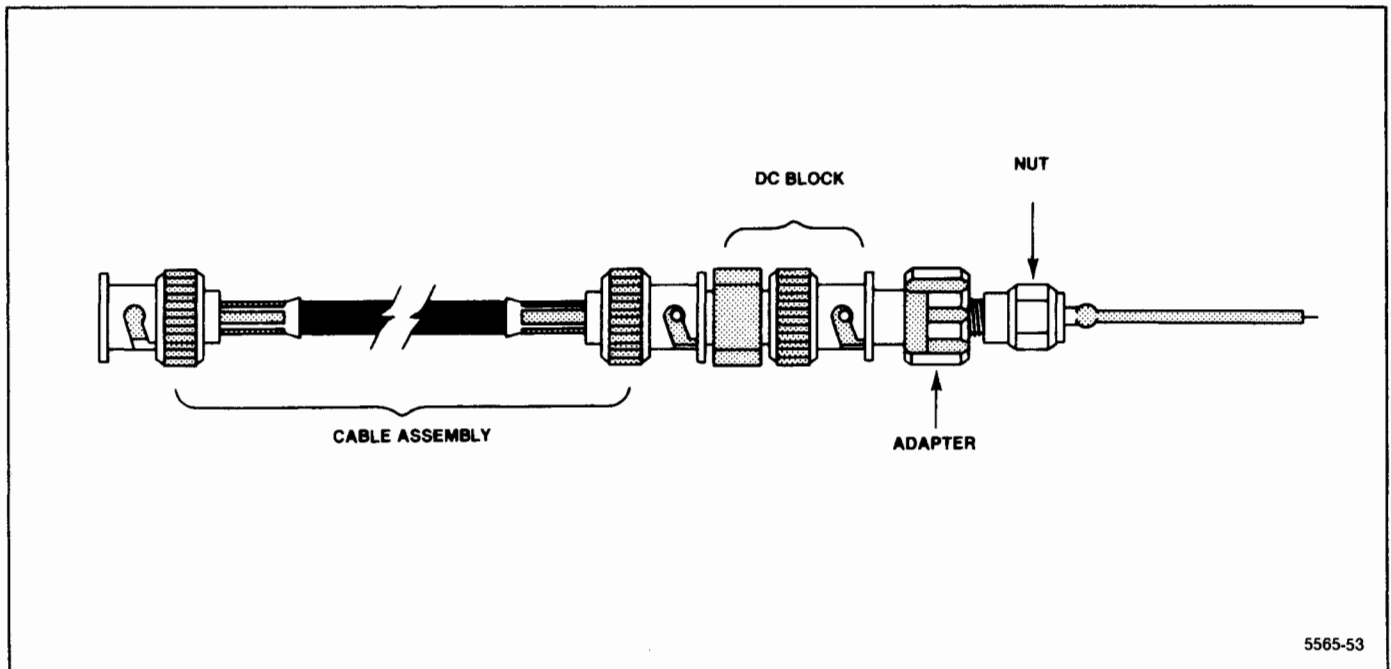

Figure 6-22. Coaxial test probe construction details.

d. Check the 2182 MHz tune range

(1) Vary the voltage to the 2182 MHz tune line between 0 V and -12.5 V and note the frequency change at C2204 (the output of the 2200 MHz Reference Mixer).

(2) The frequency should vary between 20 MHz and 35 MHz as the tune line voltage is varied between 0 V and -12.5 V.

Reassembling the 2nd LO Assembly

1. Disconnect and remove the connections from the variable power supply and the test spectrum analyzer.

2. Replace the lid for the oscillator housing and install the 26 screws. Install the screws loosely, then tighten them starting from the center of the lid and progress along the edges toward the corners to insure that no gaps exist between the lid and the housing. Any gaps will allow RF leakage that can produce spurious responses.

3. Reinstall the assembly on the RF deck. Remove the 50Ω terminations and reconnect the cables. Use a $5/16$ inch open-end wrench to tighten the semi-rigid coaxial connectors to 8 to 10 inch-pounds.

4. Remove the mu-metal lid and reconnect the leads to feedthrough capacitors C2203 and C2204, on the Phase Lock board (Figure 6-20). Replace the lid and install the 14 screws. Tighten the screws from the

center toward the corners of the lid to prevent gaps between the lid and the housing. Do not overtighten because the screws are easily stripped.

Troubleshooting and Calibrating the 16-20 MHz Phase Lock Section

This side of the assembly contains the 16-20 MHz Phase Lock circuit board (see Figure 6-20). Replacing oscillator components in this section may alter sweep linearity and frequency of the 16-20 MHz oscillator. The following checks and calibration should aid in repairing and returning the assembly to satisfactory operation.

1. Preliminary

a. Test equipment setup is shown in Figure 6-23. Remove and install the Center Frequency Control board on an extender board.

b. Switch POWER on and set the FREQ SPAN/DIV to 1 MHz.

Table 6-7
EQUIPMENT REQUIRED FOR CALIBRATING THE
16-20 MHz PHASE LOCK CIRCUIT

Test Equipment	Characteristics	Recommended Type
Digital Voltmeter	Measures to within 0.01 V, impedance $\geq 1M\Omega$	TEKTRONIX TM 500-Series DM 501A, DM 502A, or DM 5010
Frequency Counter	Frequency to 80 MHz	TEKTRONIX TM 500-Series DC 503A, DC 508A, DC 509
Time-Mark Generator	Marker output, 1 s to 1 μ s; accuracy 0.001%	TEKTRONIX TG 501
Service Kit Extender Board		Tektronix Part No. 672-0865-01

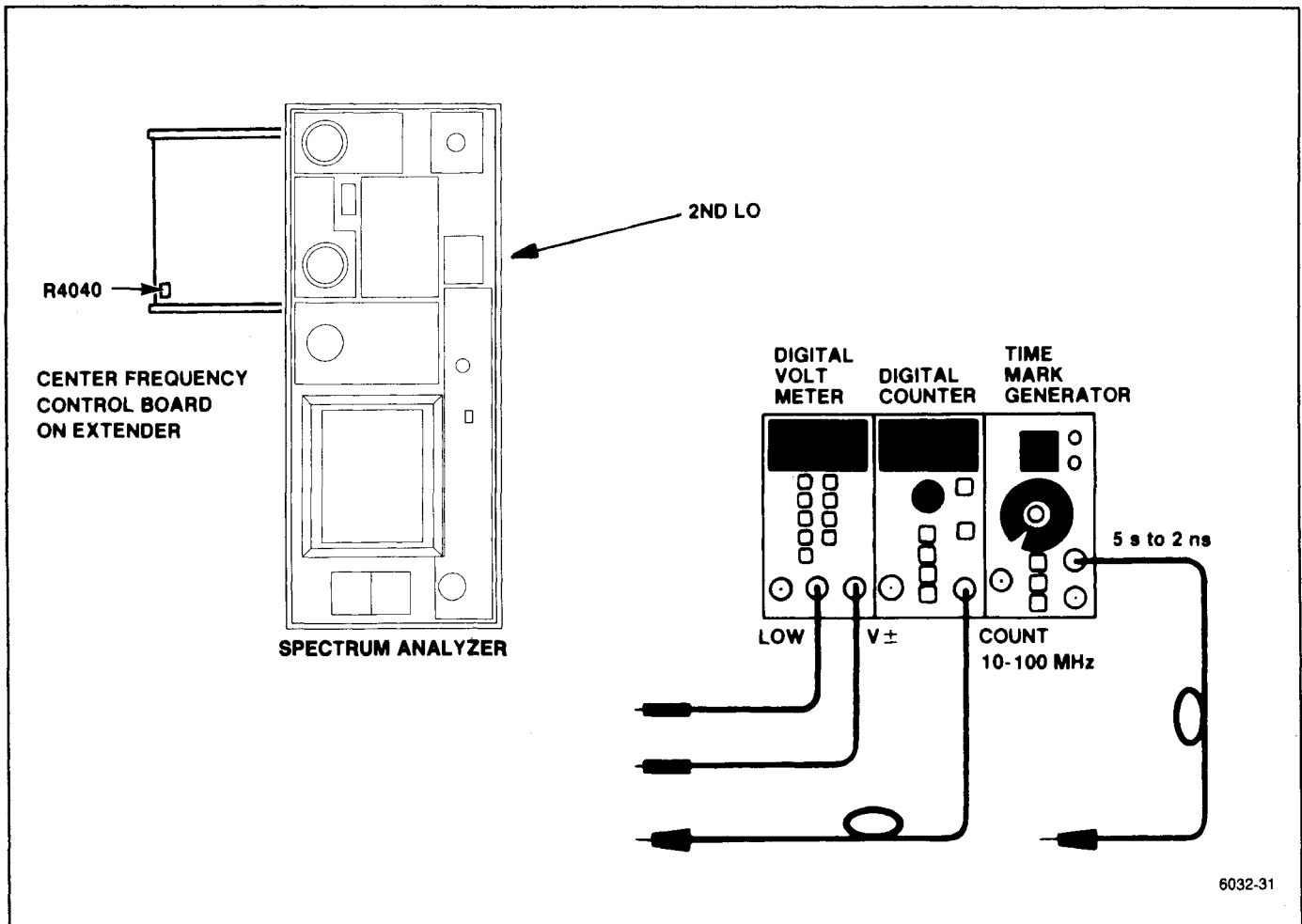

Figure 6-23. 2182 MHz 2nd LO Phase Lock adjustment setup.

2. Check Voltages

a. Check all input voltages at the feedthrough capacitors in the housing wall. Refer to Figure 6-20 or the data printed on the lid. The voltage LEVEL at the sweep and tune input lines should be $0\text{ V} \pm 0.05\text{ V}$ with the FREQ SPAN/DIV $\geq 500\text{ kHz}$.

b. Switch the POWER off. Remove the lid from the mu-metal housing assembly to gain access to internal circuitry.

c. Switch POWER on, then check the internal regulated voltages; $+12\text{ V} \pm 0.4\text{ V}$ at C2201, $-12\text{ V} \pm 0.4\text{ V}$ at C2202, and $+5.2\text{ V} \pm 0.25\text{ V}$ at TP10109 (see Figure 6-20). Check the output of the shaper at TP1083 for a level between $+0.3\text{ V}$ and -0.3 V ($0\text{ V} \pm 0.3\text{ V}$).

3. Setting Center Frequency

a. Connect a frequency counter to TP2035 and note the frequency. If the frequency is $18\text{ MHz} \pm 50\text{ kHz}$ no correction is necessary; proceed to part 4 (Setting Tune Sensitivity and Range). If outside the range proceed as follows:

(1) Turn POWER off. Unsolder and remove one end of Shaper Offset resistor R1070. Unsolder the wire strap between T2092 and T1091, at the T1091 end, and lift it free.

(2) Solder a flexible wire jumper to the T2092 end; then, by means of a plastic tuning tool, attach the free end to one of the three pads for T1091 and note the frequency readout of the counter.

CAUTION

If this flexible wire touches ground while the circuit is operating, the supply regulators can be damaged. The regulators are not protected against a short circuit.

(3) If one of the pads provides a frequency that is within the range of $17.5\text{ MHz} \pm 0.25\text{ MHz}$, solder the wire strap to this pad. If the frequency is still outside the range, move the jumper to the other pad for T2092 and repeat the procedure. Frequency must equal $17.5\text{ MHz} \pm 0.25\text{ MHz}$.

b. Turn POWER OFF. Replace R1070 with a 10 turn $25\text{ k}\Omega$ potentiometer in series with a $5\text{ k}\Omega$ resistor.

c. Turn POWER on and with the counter connected to TP2035, adjust the potentiometer for a frequency readout of $18\text{ MHz} \pm 50\text{ kHz}$.

d. Turn POWER off, measure the total resistance value and replace R1070 with a 1% resistor of this measured value. Switch POWER on and recheck the

frequency to ensure that it is $18\text{ MHz} \pm 50\text{ kHz}$. Disconnect the counter from TP2035.

4. Setting Tune Sensitivity and Range

a. Center the Fine Tune adjustment R4040, on the Center Frequency Control board and the 2nd LO Sweep adjustment R1067, on the Span Attenuator board (Figure 6-24).

b. Decrease the FREQ SPAN/DIV from above 200 kHz to 200 kHz or less. The 2nd LO is now in the center of its tune range.

c. Press <SHIFT> 7 to disable frequency correction; then press <SHIFT> 0, and select item 0 from the menu. Now select frequency display of 2nd LO (2). Readout will now indicate the 2nd LO frequency.

d. Tune the 2nd LO to one end of its range where the frequency readout no longer changes. Note the frequency and measure the voltage on the Tune Line at the input feed-through capacitor (Figure 6-20).

e. Tune the 2nd LO to the other end of its range and again note the frequency and the new voltage reading.

f. Calculate the frequency change per volt (frequency range versus voltage range). Frequency change per volt should equal $128.0\text{ kHz} \pm 10\%$ or range between 140.8 kHz and 115.2 kHz .

g. If the frequency/volt change is low, decrease the value of R2072.

h. Press <SHIFT> 0 and select 2nd LO for calibration. Perform the procedure that is called out to adjust the Fine Tune Range R4040 and Fine Tune Sensitivity R3040 to calibrate the 2nd LO tuning range.

5. Setting Sweep Range

a. Apply $5\text{ }\mu$ time markers from the Time Mark Generator to the RF INPUT. Set the FREQ SPAN/DIV to 500 kHz then back to 200 kHz to center the 2nd LO frequency.

b. Adjust the REF LEVEL to display the 200 kHz markers then center one of the markers with the CENTER FREQUENCY control.

c. Adjust the 2nd LO Sweep R1067, on the Span Attenuator board (Figure 6-24), so the comb lines on opposite sides of the screen, are exactly 8 major divisions apart.

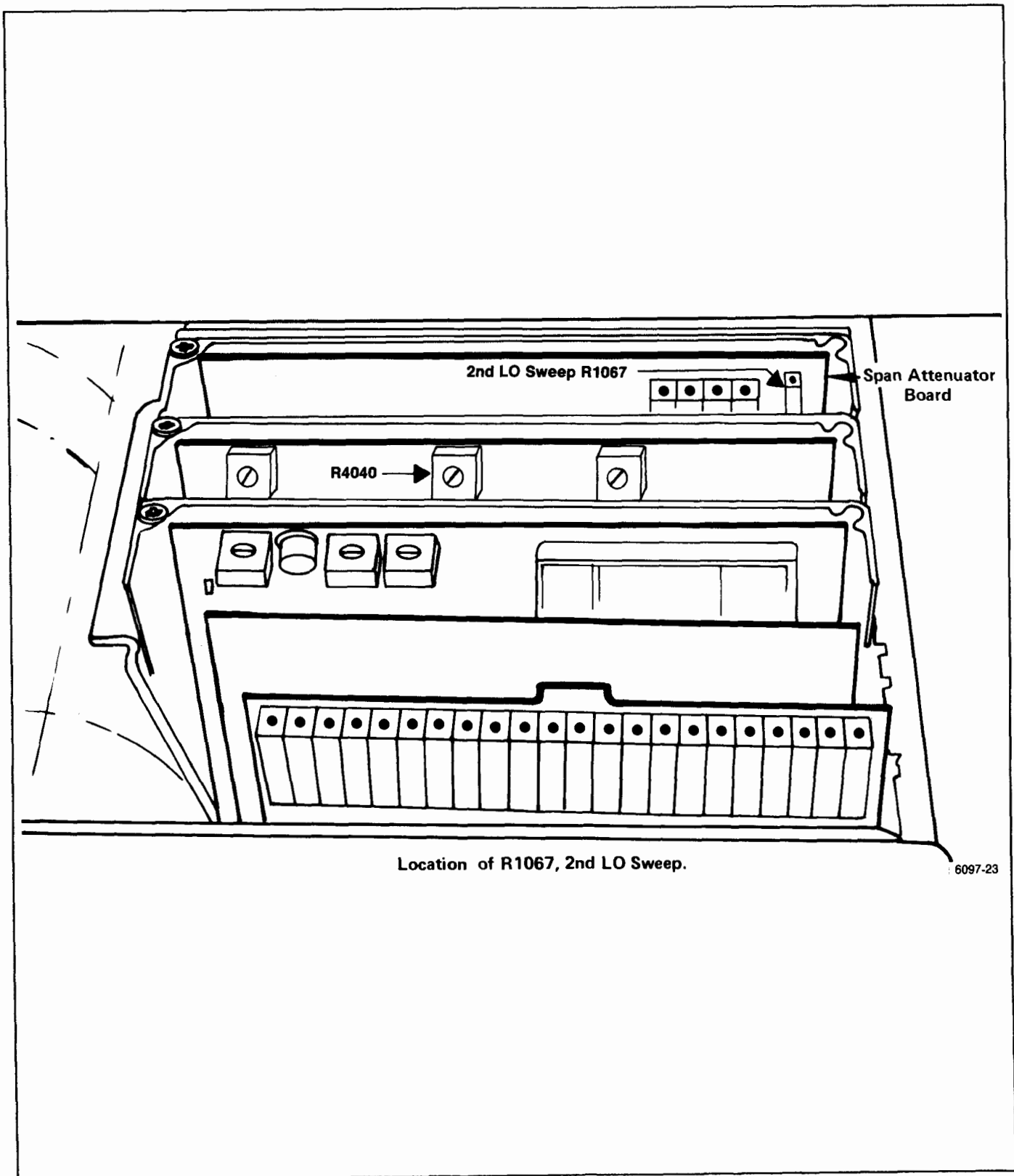

Figure 6-24. Tune and Sweep Range adjustments.

6. Check and Adjust Tune Linearity

a. With Frequency Corrections disabled (see part 2), apply 5 μ s markers from a Time Mark Generator to the RF INPUT. Set the FREQUENCY to 20 MHz, FREQ SPAN/DIV to 200 kHz and activate AUTO RES. Adjust the REF LEVEL so a comb of 200 kHz markers is displayed.

b. Turn the CENTER FREQUENCY control counter-clockwise until the center frequency stops tuning, decrease FREQ SPAN/DIV to 50 kHz then tune the CENTER FREQUENCY up until a marker signal is one major division from the left edge of the graticule. A comb line (or marker signal) should appear on or near the first major division in from the right side of the screen.

c. If the right marker is not exactly 8 divisions from the left marker, note the error to the nearest 0.5 minor division.

d. Turn the CENTER FREQUENCY control clockwise, to increase center frequency, until the next marker signal is one division in from the left edge and again note the spacing between this marker and the marker near the right edge.

e. Continue this process of tuning up in frequency until the center frequency stops tuning, noting the signal spacing at each check point.

f. If the peak-to-peak error is 2.5 minor divisions (25 kHz) or less, the linearity over the center 2 MHz of sweep is satisfactory; if more, the shaper needs adjustment or repair.

g. Switch the FREQ SPAN/DIV to 200 kHz, tune to the low end of the sweep range and note the linearity over the center eight divisions of span, then tune to the high end of the 2nd LO range and again note the linearity. Peak-to-peak deviation should not exceed 0.5 minor division.

h. If the shaper needs adjustment or repair proceed as follows:

(1) A shaper diode or resistor may be defective if the comb line spacing is consistent for part of the tuning range and 30 kHz or more off for the other parts of the sweep. To test the diodes for forward conduction, tune to the low end of the range and short R2049 (Figure 6-20). The output of U1073A (pin 1) should equal about +3 V. U1059 diodes B through G and U2059 diodes A through F should all have a 0.48 V forward drop. Use a floating or digital voltmeter to check the drop.

(2) Turn POWER off then temporarily replace Shaper resistor R2049 with a 20 k Ω potentiometer. Switch POWER on, and adjust the potentiometer to obtain the best overall linearity; decreasing resistance will decrease the spacing between comb lines in the upper portion of the tune range and spread the spacing for the lower portion. Increasing the resistance of R2049 will reverse the effect. When

the correct setting is found, turn POWER off, measure the resistance, and replace with a fixed resistor of the same or near the same value.

It may be necessary to recheck the tune sensitivity and sweep range of the 2nd LO. Repeat steps 4, 5, and 6 if needed.

7. Conclusion

a. Replace the housing lid with its 14 screws.

b. Tighten the screws sequentially, starting from the center of the lid and progressing toward the corners to prevent gaps between the lid and the housing. Use care to not strip the screws as you tighten them.

c. This completes the 2182 MHz Phase Locked 2nd LO calibration. Refer to "Frequency Control System Calibration" in the Adjustment section for recalibrating the system.

Troubleshooting Aids for the 2182 MHz Phase Locked 2nd LO Assembly

NOTE

If the Phase Locked assembly is in the instrument, set the FREQ SPAN/DIV to 500 kHz or more so the 2nd LO is not swept.

The difference frequency from the 2200 MHz Reference Mixer is amplified and fed to output port P224. Nominally the signal at the 18 MHz port is 18 MHz with an output level of approximately -5 dBm into 50 Ω . This port is convenient for monitoring the operation of the 16 MHz to 20 MHz voltage controlled oscillator. When phase lock is operating, the difference frequency exactly equals the frequency of the VCO. If loop lock is not functioning properly, the difference frequency signal will either disappear completely or tune to its range limit of approximately 6 MHz or 30 MHz. Note that when the loop is unlocked, RF leakage from the 16-20 MHz oscillator buffer can be seen at P224 with a level of approximately -35 dBm. The amplified difference frequency can be monitored at TP2035.

Another check of phase lock operation can be done by measuring the dc voltage on the 2182 MHz Tune Line at feedthrough capacitor C2203. Nominally this voltage is approximately -5 V when phase locked. Use a FREQ SPAN/DIV of 500 kHz or greater before measuring. If there is no difference frequency, the voltage will be about 0 V. A voltage of -13 V may indicate loss of signal from the VCO.

Narrow-band noise on the 2nd LO signal may be due to noise modulation of the 16-20 MHz VCO. Monitor the signal at the 18 MHz port to see if the oscillator signal is noisy. Noise on this line is often caused by noise on the ± 12 V lines. Use a differential oscilloscope with 1 Hz to 300 Hz bandwidth limits to check supply noise. Measure the ac differential between the supply and the 2nd LO housing. Less than $5 \mu\text{V}$ peak-to-peak of noise will cause noticeable performance degradation. Output noise from the shaper is typically less than $5 \mu\text{V}$ peak-to-peak.

When making power measurements of microwave circuitry, at circuit board interfaces, use a coaxial probe with very little stray inductance (see Figure 6-22). Ground the outer conductor of the probe to the circuit housing as close as possible to the measurement port. Disconnect other loads from the measurement point.

110 MHz Oscillator in the 3rd Converter

A variable capacitor, C1038, inside the cover (Figure 6-25), should only need adjusting after replacing a component or components in the 100 MHz oscillator circuit.

1. With the cover removed, connect a DVM between TP3042 and TP1011 (ground) and adjust C1038, with a non-metallic tuning tool, for a reading of +5 V.

2. The Cal Amplitude adjustment, R1041, is described in the Adjustment procedure section.

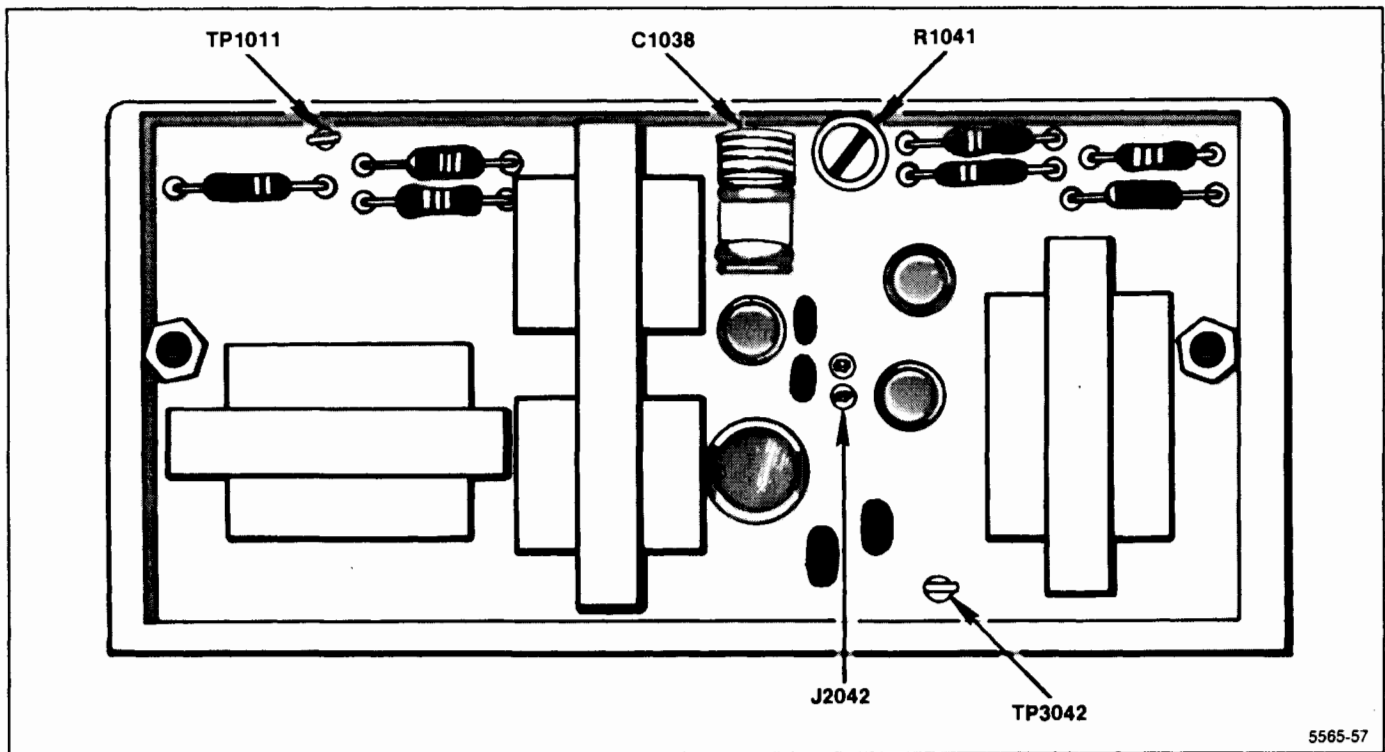

Figure 6-25. 3rd Converter test points and adjustments.