

Service Manual



370B **Programmable Curve Tracer** **070-A842-50**

Revision A

Warning

The servicing instructions are for use by qualified personnel only. To avoid personal injury, do not perform any servicing unless you are qualified to do so. Refer to all safety summaries prior to performing service.

www.tektronix.com

Copyright © Tektronix. All rights reserved. Licensed software products are owned by Tektronix or its suppliers and are protected by United States copyright laws and international treaty provisions.

Tektronix products are covered by U.S. and foreign patents, issued and pending. Information in this publication supercedes that in all previously published material. Specifications and price change privileges reserved.

TEKTRONIX and TEK are registered trademarks of Tektronix, Inc.

Contacting Tektronix

Tektronix, Inc.
14200 SW Karl Braun Drive
P.O. Box 500
Beaverton, OR 97077
USA

For product information, sales, service, and technical support:

- In North America, call 1-800-833-9200.
- Worldwide, visit www.tektronix.com to find contacts in your area.

Warranty 2

Tektronix warrants that this product will be free from defects in materials and workmanship for a period of one (1) year from the date of shipment. If any such product proves defective during this warranty period, Tektronix, at its option, either will repair the defective product without charge for parts and labor, or will provide a replacement in exchange for the defective product. Parts, modules and replacement products used by Tektronix for warranty work may be new or reconditioned to like new performance. All replaced parts, modules and products become the property of Tektronix.

In order to obtain service under this warranty, Customer must notify Tektronix of the defect before the expiration of the warranty period and make suitable arrangements for the performance of service. Customer shall be responsible for packaging and shipping the defective product to the service center designated by Tektronix, with shipping charges prepaid. Tektronix shall pay for the return of the product to Customer if the shipment is to a location within the country in which the Tektronix service center is located. Customer shall be responsible for paying all shipping charges, duties, taxes, and any other charges for products returned to any other locations.

This warranty shall not apply to any defect, failure or damage caused by improper use or improper or inadequate maintenance and care. Tektronix shall not be obligated to furnish service under this warranty a) to repair damage resulting from attempts by personnel other than Tektronix representatives to install, repair or service the product; b) to repair damage resulting from improper use or connection to incompatible equipment; c) to repair any damage or malfunction caused by the use of non-Tektronix supplies; or d) to service a product that has been modified or integrated with other products when the effect of such modification or integration increases the time or difficulty of servicing the product.

THIS WARRANTY IS GIVEN BY TEKTRONIX IN LIEU OF ANY OTHER WARRANTIES, EXPRESS OR IMPLIED. TEKTRONIX AND ITS VENDORS DISCLAIM ANY IMPLIED WARRANTIES OF MERCHANTABILITY OR FITNESS FOR A PARTICULAR PURPOSE. TEKTRONIX' RESPONSIBILITY TO REPAIR OR REPLACE DEFECTIVE PRODUCTS IS THE SOLE AND EXCLUSIVE REMEDY PROVIDED TO THE CUSTOMER FOR BREACH OF THIS WARRANTY. TEKTRONIX AND ITS VENDORS WILL NOT BE LIABLE FOR ANY INDIRECT, SPECIAL, INCIDENTAL, OR CONSEQUENTIAL DAMAGES IRRESPECTIVE OF WHETHER TEKTRONIX OR THE VENDOR HAS ADVANCE NOTICE OF THE POSSIBILITY OF SUCH DAMAGES.

Table of Contents

General Safety Summary	vii
Service Safety Summary	ix
Preface	xi
Introduction	xv
 Specifications	
Product Overview	1-1
Specifications	1-3
Performance Conditions	1-3
Electrical Specifications	1-4
Mechanical Specifications	1-17
Functional Specifications	1-18
Environmental Specifications	1-19
GPIB Interface	1-22
 Operating Information	
Operating Information	2-1
Installation	2-1
Kelvin Sense	2-5
Rackmounting Information	2-7
Repacking for shipment	2-13
 Theory of Operation	
Theory of Operation	3-1
Block Diagram Description	3-1
Circuit Operation	3-6
 Maintenance	
Maintenance	4-1
Preventive Maintenance	4-1
Corrective Maintenance	4-4
 Performance Verification	
Performance Verification	5-1
Using Procedure	5-3
Power Supply	5-12
CRT	5-17
Display	5-26
Horizontal	5-44
Vertical	5-54
Step Generator	5-71
Collector Supply	5-104
AUX Supply	5-119

	Configuration	5-122
	Key Operation and Floppy Disk Drive	5-129
Instrument Options		
	Options	6-1
	Accessories	6-2
Electrical Parts List		
	Replaceable Electrical Parts	7-1
	Parts Ordering Information	7-1
	Using the Replaceable Electrical Parts List	7-2
Diagrams		
	Diagrams	8-1
Mechanical Parts List		
	Mechanical Parts List	9-1
	Parts Ordering Information	9-1
	Using the Replaceable Parts List	9-2

List of Figures

Figure 2-1: Example of Kelvin sense connection	2-6
Figure 2-2: Location of the Rackmount Latch Release	2-7
Figure 2-3: Rackmount hole spacing	2-8
Figure 2-4: Rackmounting Length and Clearance	2-8
Figure 2-5: Rackmounting Hardware	2-9
Figure 2-6: Mounting Stationary Rackmount Sections	2-10
Figure 2-7: Cabinet-to-Rackmount Conversion	2-12
Figure 3-1: 370B Block Diagram	3-3
Figure 5-1: Diagnostic test pattern display	5-32
Figure 5-2: Looping compensation display	5-40
Figure 5-3: Checking Collector high current range	5-67
Figure 5-4: Examining and Adjusting for Step Generator Offset ..	5-73
Figure 5-5: Adjusting for Current Amplifier Bias	5-75
Figure 5-6: Checking for Maximum OFFSET of 200 mA Range ..	5-83
Figure 5-7: Checking for Maximum Current Output of 100 mA and 200 mA range	5-96
Figure 5-8: Adjusting for Collector Supply Amplifier Offset	5-105
Figure 5-9: Examining for DC and LEAKAGE operation	5-113
Figure 8-1: 370B circuit board locator	8-1
Figure 9-1: Cabinet, Rear	9-9
Figure 9-2: Display, Front	9-10
Figure 9-3: Chassis Circuit Boards	9-17
Figure 9-4: Power Supply	9-18
Figure 9-5: Front Panel: L-O-R	9-27
Figure 9-6: LV, L-O-R, Looping Circuit Boards	9-28
Figure 9-7: FDD, Config. Relay, Sense Circuit Boards	9-35
Figure 9-8: Accessories	9-36

List of Tables

Table 1-1: Collector Supply	1-4
Table 1-2: Step Generator	1-7
Table 1-3: AUX Supply	1-10
Table 1-4: Non-store Vertical Deflection System	1-10
Table 1-5: Digital Storage Vertical Acquisition	1-12
Table 1-6: Non-store Horizontal Deflection System	1-13
Table 1-7: Digital Storage Horizontal Acquisition	1-14
Table 1-8: CRT and Readout	1-15
Table 1-9: Adapter Connectors	1-16
Table 1-10: Power Supply	1-17
Table 1-11: Surge Current	1-17
Table 1-12: Mechanical Specification	1-17
Table 1-13: Digital Storage Acquisition Mode	1-18
Table 1-14: Text Display	1-18
Table 1-15: Environmental Specification	1-19
Table 1-16: Certifications and Compliances	1-20
Table 1-17: Installation category and Pollution degree Descriptions	1-21
Table 1-18: GPIB Interface	1-22
Table 2-1: Line voltage ranges	2-1
Table 2-2: Power Cord Color Conductor Identification	2-2
Table 2-3: Power cord identification	2-3
Table 4-1: Power-on System Error Messages	4-24
Table 4-2: Front Panel Control Identification	4-25
Table 5-1: Performance Check and Adjustment Procedure Options	5-2
Table 5-2: Performance Check Summary	5-4
Table 5-3: Test Equipment	5-10
Table 5-4: Voltage Regulation and Ripple	5-13
Table 5-5: Base/Emitter Voltage Accuracy	5-48
Table 5-6: Collector Voltage Accuracy	5-50
Table 5-7: Displayed Horizontal Noise	5-53
Table 5-8: Emitter Current Accuracy	5-61
Table 5-9: Collector Current Accuracy	5-63
Table 5-10: Collector High Current Accuracy	5-67

Table 5-11: Displayed Vertical Collector Noise in CONFIGURATION BASE to COLLECTOR SUPPLY mode	5-70
Table 5-12: OFFSET Voltage	5-79
Table 5-13: OFFSET Voltage	5-80
Table 5-14: OFFSET Current	5-82
Table 5-15: Max Peak Volts	5-108
Table 5-16: Max Peak Volts	5-109
Table 5-17: Maximum Peak Currents	5-111
Table 5-18: Auxiliary Supply Accuracy	5-120
Table 6-1: Standard accessories	6-2
Table 6-2: Optional accessories	6-2
Table 6-3: Recommended accessories	6-3

General Safety Summary

Review the following safety precautions to avoid injury and prevent damage to this product or any products connected to it. To avoid potential hazards, use this product only as specified.

Only qualified personnel should perform service procedures.

To Avoid Fire or Personal Injury

Use Proper Power Cord. Use only the power cord specified for this product and certified for the country of use.

Use Proper Voltage Setting. Before applying power, ensure that the line selector is in the proper position for the power source being used.

Connect and Disconnect Properly. Do not connect or disconnect probes or test leads while they are connected to a voltage source.

Ground the Product. This product is grounded through the grounding conductor of the power cord. To avoid electric shock, the grounding conductor must be connected to earth ground. Before making connections to the input or output terminals of the product, ensure that the product is properly grounded.

Observe All Terminal Ratings. To avoid fire or shock hazard, observe all ratings and markings on the product. Consult the product manual for further ratings information before making connections to the product.

The common terminal is at ground potential. Do not connect the common terminal to elevated voltages.

Do not apply a potential to any terminal, including the common terminal, that exceeds the maximum rating of that terminal.

Do Not Operate Without Covers. Do not operate this product with covers or panels removed.

Use Proper Fuse. Use only the fuse type and rating specified for this product.

Avoid Exposed Circuitry. Do not touch exposed connections and components when power is present.

Do Not Operate With Suspected Failures. If you suspect there is damage to this product, have it inspected by qualified service personnel.

Do Not Operate in Wet/Damp Conditions.

Do Not Operate in an Explosive Atmosphere.

Keep Product Surfaces Clean and Dry.

Provide Proper Ventilation. Refer to the manual's installation instructions for details on installing the product so it has proper ventilation.

Symbols and Terms

Terms in this Manual. These terms may appear in this manual:



WARNING. *Warning statements identify conditions or practices that could result in injury or loss of life.*



CAUTION. *Caution statements identify conditions or practices that could result in damage to this product or other property.*

Terms on the Product. These terms may appear on the product:

DANGER indicates an injury hazard immediately accessible as you read the marking.

WARNING indicates an injury hazard not immediately accessible as you read the marking.

CAUTION indicates a hazard to property including the product.

Symbols on the Product. The following symbols may appear on the product:



WARNING
High Voltage



Protective Ground
(Earth) Terminal



CAUTION
Refer to Manual



Double
Insulated

Service Safety Summary

Only qualified personnel should perform service procedures. Read this *Service Safety Summary* and the *General Safety Summary* before performing any service procedures.

Do Not Service Alone. Do not perform internal service or adjustments of this product unless another person capable of rendering first aid and resuscitation is present.

Disconnect Power. To avoid electric shock, disconnect the mains power by means of the power cord or, if provided, the power switch.

Use Care When Servicing With Power On. Dangerous voltages or currents may exist in this product. Disconnect power, remove battery (if applicable), and disconnect test leads before removing protective panels, soldering, or replacing components.

To avoid electric shock, do not touch exposed connections.

Preface

This is the service manual for the 370B Programmable Curve Tracer. The manual contains information needed to service the 370B to the module level.

Manual Structure

This manual is divided into sections, such as *Specifications* and *Theory of Operation*. Further, some sections are divided into subsections, such as *Product Description* and *Removal and Installation Procedures*.

Sections containing procedures also contain introductions to those procedures. Be sure to read these introductions because they provide information needed to do the service correctly and efficiently. The following contains a brief description of each manual section.

- *Specifications* contains a description of the 370B Programmable Curve Tracer and the characteristics that apply to it.
- *Operating Information* includes general information and operating instructions.
- *Theory of Operation* contains circuit descriptions that support service to the module level.
- *Performance Verification* contains procedures for confirming that the 370B Programmable Curve Tracer functions properly and meets warranted limits.
- *Adjustment Procedures* contains a collection of procedures for adjusting the 370B Programmable Curve Tracer to meet warranted limits.
- *Maintenance* contains information and procedures for performing preventive and corrective maintenance of the 370B Programmable Curve Tracer. These instructions include cleaning, module removal and installation, and fault isolation to the module.
- *Options* contains information on servicing factory-installed options.
- *Electrical Parts List* contains a statement referring you to *Mechanical Parts List*, where both electrical and mechanical modules are listed.
- *Diagrams* contains an block diagram and an interconnection diagram.
- *Mechanical Parts List* includes a table of all replaceable modules, their descriptions, and their Tektronix part numbers.

Manual Conventions

This manual uses certain conventions that you should become familiar with.

Some sections of the manual contain procedures for you to perform. To keep those instructions clear and consistent, this manual uses the following conventions:

- Names of front panel controls appear in the same case (initial capitals, all uppercase, etc.) in the manual as is used on the 370B Programmable Curve Tracer front panel. Front panel names are all upper-case letters; for example, REF, SAVE, VIEW etc.
- Instruction steps are numbered unless there is only one step.

Modules Throughout this manual, any replaceable component, assembly, or part of the 370B Programmable Curve Tracer is referred to generically as a module. In general, a module is an assembly (like a circuit board), rather than a component (like a resistor or an integrated circuit). Sometimes a single component is a module; for example, the chassis of the 370B Programmable Curve Tracer is a module.

Safety Symbols and terms related to safety appear in the *Safety Summary* near the beginning of this manual.

Finding Other Information

Other documentation for the 370B includes:

- The 370B Programmable Curve Tracer *User Manual* contains a tutorial to quickly describe how to operate the 370B Programmable Curve Tracer. It also includes an in-depth discussion on how to more completely use the 370B Programmable Curve Tracer features.

Introduction

This manual contains information needed to properly service the 370B Programmable Curve Tracer as well as general information critical to safe and effective servicing.

To prevent personal injury or damage to the analyzer, consider the following before attempting service:

- The procedures in this manual should be performed only by a qualified service person
- Read the *General Safety Summary* and the *Service Safety Summary*, beginning on page vii
- Read *Preparation for Use* in section 2, *Operating Information*

When using this manual for servicing, be sure to follow all warnings, cautions, and notes.

Performance Check Interval

Generally, the performance check described in section 4, *Performance Verification*, should be done every 12 months. In addition, performance check is recommended after module replacement.

If the analyzer does not meet performance criteria, repair is necessary.

Strategy for Servicing

Throughout this manual, the term, module, refers to any field-replaceable component, assembly, or part of the analyzer.

This manual contains all the information needed for periodic maintenance of the 370B Programmable Curve Tracer (Examples of such information are procedures for checking performance.)

Further, it contains all information for corrective maintenance down to the module level. To isolate a failure to a module, use the fault isolation procedures found in *Troubleshooting*, part of section 6, *Maintenance*. To remove and replace any failed module, follow the instructions in *Removal and Installation Procedures*, also part of section 6. After isolating a faulty module, replace it with a fully-tested module obtained from the factory. Section 9, *Mechanical Parts List*, contains part number and ordering information for all replaceable modules.

Tektronix Service Offerings

Tektronix provides service to cover repair under warranty as well as other services that may provide a cost-effective answer to your service needs.

Whether providing warranty repair service or any of the other services listed below, Tektronix service technicians are well trained to service the waveform generator. They have access to the latest information on improvements to the 370B as well as new options.

Warranty Repair Service

Tektronix warrants this product for one year from date of purchase. The warranty appears on the back of the title page in this manual. Tektronix technicians provide warranty service at most Tektronix service locations. The Tektronix product catalog lists all worldwide service locations or you can visit our Web site for service information: www.tektronix.com.

Self Service

Tektronix supports repair to the module level by providing Module Exchange.

Module Exchange. This service reduces down-time for repair by allowing you to exchange most modules for re-manufactured ones. Each module comes with a 90-day service warranty.

For More Information. Contact your local Tektronix service center or sales engineer for more information on any of the repair or adjustment services just described.

Specifications

Product Overview

The 370B Programmable Curve Tracer is a high-performance, GPIB-programmable digital storage curve tracer that provides static and dynamic semiconductor device testing. This versatile instrument stimulates, measures, and displays the semiconductor characteristics of a variety of two-, three-, and four-terminal devices; including bipolar transistors, field effect transistors, silicon-controlled rectifiers, diodes, thyristors, opto-isolators, wafers, integrated circuits, etc. A variety of measurements can be performed using either grounded-emitter or grounded-base configurations.

The side, top, and bottom cabinet panels provide protection to personnel from operating potentials present within the instrument. In addition, they reduce radiation of electromagnetic interference from the instrument. The cabinet panels are held in place by screws and four plastic panel retainers. To remove the panels, remove the four plastic retainers and three additional securing screws at the rear of the instrument. Pull each panel back to release the front edge. then lift the panels away from the instrument. Operate the instrument with the panels in place to protect the interior from dust, and to maintain cooling airflow.

The collector supply produces AC, rectified AC, or DC voltages ranging from 0 to ± 2000 volts. This high voltage, combined with a current sensitivity of 100 pA/div, permits extended breakdown measurements of a device under test. A step generator produces voltage or current steps of either polarity for application to the base or emitter terminal. The step generator may also be operated in a pulsed mode to control the power dissipated by the DUT.

In addition to conventional curve tracer performance, the 370B Programmable Curve Tracer includes the following features:

- Digital storage capability that allows bright and stable display and useful cursor measurements. The 370B has a mass storage system consists of non-volatile IC memory and 3.5-inch floppy disk drive. Up to 64 families of characteristic curves and front-panel setups can be stored in a floppy disk. Up to 16 families of characteristic curves and front-panel setups can also be stored in non-volatile IC memory. The stored characteristic curves can be recalled for additional analysis and comparison.
- Two extended acquisition modes, called Averaging and Envelope. Averaging reduces display noise in high sensitivity ranges. Envelope mode displays only the maximum and minimum vertical or horizontal excursion of each curve, which is useful for detecting long-term variations such as thermal drift.

- Almost all of the 370B front-panel settings can be controlled by GPIB commands. (Exceptions are those controls intended only for manual operation, such as INTENSITY, FOCUS, GRAT ILLUM, etc.) Also, curve data can be sent to or received from an external controller through the GPIB.
- The printer interface permits sending displayed curve data and digital on-screen readouts to a printer without an external controller.
- Other features include an auxiliary voltage supply, cursor measurement readout, and diagnostic routines.

Specifications

This section contains the 370B Programmable Curve Tracer specifications. All specifications are guaranteed unless labeled “typical”. Typical specifications are provided for your convenience but are not guaranteed.

Performance Conditions

The performance limits in this specification are valid with these conditions:

- The 370B Programmable Curve Tracer must have been calibrated/adjusted at an ambient temperature between +20 °C and +30 °C.
- The 370B Programmable Curve Tracer must be in an environment with temperature, altitude, humidity, and vibration within the operating limits described in these specifications.
- The 370B Programmable Curve Tracer must have had a warm-up period of at least 20 minutes.
- The 370B Programmable Curve Tracer must be operating at an ambient temperature between +10 °C and +40 °C.

Warranted characteristics are described in terms of quantifiable performance limits which are warranted.

Electrical Specifications

Table 1- 1: Collector Supply



Characteristic	Performance Requirement	Operating Information
Polarity		
+ LEAKAGE		Applies positive DC voltage to the collector or base terminal. Measures emitter current. Sensitivity is increased 1000 times.
+ DC		Applies positive DC voltage to the collector or base terminal. Measures collector or base current.
+ 		Applies positive swept voltage to the collector or base terminal. Measures collector or base current.
AC		Applies line-frequency sine wave to the collector or base terminal. Measures collector or base current.
- 		Applies negative swept voltage to the collector or base terminal. Measures collector or base current.
- DC		Applies negative DC voltage to the collector or base terminal. Measures collector or base current.
- LEAKAGE		Applies negative DC voltage to the collector or base terminal. Measures emitter current. Sensitivity is increased 1000 times.
DC mode ripple (no load)	Less than 2% of output voltage	VARIABLE COLLECTOR SUPPLY at 30% or higher
	Less than 0.5% of output voltage	VARIABLE COLLECTOR SUPPLY at 30% or less

Table 1 - 1: Collector Supply (Cont.)

Characteristic	Performance Requirement				Operating Information
Max peak volts					
Max Peak Voltage	16 V, 80 V, 400 V, 2000 V				Selected by the MAX PEAK VOLTS buttons.
Voltage accuracy	Peak open circuit voltage on all ranges within +15%, -0%				At MAX PEAK POWER of 50 W.
Current Available					In PULSE mode of STEP GENERATOR, available current is two times of DC mode.
Peak Volts	16 V	80 V	400 V	2000 V	In PULSE mode of STEP GENERATOR, available current is two times of DC mode.
Range	10 A	2 A	0.4 A	0.05 A	
Max Peak Current	20 A	4 A	0.8 A	0.1 A	
Series Resistance Available					Selection of 0.26 Ω , 1.3 Ω , 6.4 Ω , 32 Ω , 160 Ω , 800 Ω , 4 k Ω , 20 k Ω , 100 k Ω , 500 k Ω , 2.5 M Ω , 12.5 M Ω
Min/Max Resistance Peak Volts Range	16 V	80 V	400 V	2000 V	
Minimum series resistance (Ω)	0.26	6.4	160	20 k	
Maximum series resistance (Ω)	800	20 k	500 k	12.5 M,	
Resistance Accuracy	Within 5% or 0.2 Ω				
Peak power watts Available					Derived from nominal peak open-circuit collector voltage and nominal series resistance values. $P = V * V/(4R)$ for < 220 W $P = (V-I*R)*I$ for 220 W
16, 80 and 400 V range	220 W, 50 W, 10 W, 2 W, 0.4 W, 0.08 W				
2000 V range	50 W, 10 W, 2 W, 0.4 W, 0.08 W				
Variable collector supply					
0 - 100.0%					% of maximum peak voltage value is displayed in the CRT readout area. Provides uncalibrated variable collector supply amplitude control from 0 to 100% in 0.1% increments.
Safety interlocks					The protective cover must be in place over test terminals and lid shut before voltage can be applied to the terminals. When protective cover is open, collector supply is not operated.
Warning Indicator					Red light indicates dangerous voltage is applied to collector or base terminal.
Limiting indicator					Indicates that internal sensing circuit automatic protection is operating.
Looping compensation					
Range	At least 100 pF				Cancels stray capacitance between DUT terminal and ground.

Table 1- 1: Collector Supply (Cont.)

Characteristic	Performance Requirement	Operating Information
Sweep start Voltage Accuracy		Applicable to \pm FULL WAVE mode. Due to stray capacitance between collector and ground terminals, zero-volt-error may occur because of charged offset voltage.
16, 80, 400 V range	\pm 2% of MAX Peak Voltage	
2000 V Range	\pm 15% of MAX Peak Voltage	
Thermal cutoff (typical)		
Operating Temperature	70 °C \pm 2.8 °C	For Collector Supply Amplifier and Series Resistors.
Current limit		
Operating Point	At least 2.0 A, 1.2 A and 0.2 A of primary current of collector transformer.	Depends on Vertical and Max Peak Volts settings.
Voltage limit		
Operating Point	50%, 25%, 5% of Max Peak Volts	Depends on Horizontal and Max Peak Volts settings.
Arc Killer		Collector supply is disabled at least one cycle while the relays or switches are operated.
Output Control		Circuit Breaker mounted on the front panel enables and disables Collector supply, Step Generator and AUX source. No trip for 1.5 A of Collector Transformer primary current. (100% rating of circuit breaker) Trip occurs between 3 second and 80 second for 2.025 A of Collector Transformer primary current. (135% rating of circuit breaker)

NOTE: The collector supply is limited to a maximum continuous peak current operating time under the following duty cycle and ambient temperature conditions:

50 W. Maximum continuous operating time at rated current (100% duty cycle) into a short circuit is 20 minutes at 25 °C ambient, or 10 minutes at 40 °C ambient.

220W. Maximum continuous operating time at rated current(, 100% duty cycle) into a short circuit is 3 minutes at 25 °C ambient, or 90 seconds at 40 °C ambient.

Alternatively, the duty cycle may be limited to 50% at 25 °C ambient or 25% at 40 °C ambient. (A normal family of transistor curves will produce a duty cycle effect to 50% or less, even if operated continuously.)

Collector Supply over-dissipation temporarily shuts off the power, and prints a message on the screen. Collector Supply over-current trips the OUTPUTS breaker, prints a message on the screen, and reset the Collector Supply output to 0%. No damage results when over-dissipation occurs.

Table 1-2: Step Generator

Characteristic	Performance Requirement	Operating Information
Accuracy		Current or Voltage Steps including Offset.
Incremental	1.5%	
Absolute	Less than 1.5% of total output + 3% x STEP AMPLITUDE setting + 1 mV or 1 nA.	
	Less than 1.5% of total output + 10% x STEP AMPLITUDE setting + 1 mV or 1 nA.	With .1X STEP MULTI pressed.
Offset control range	Variable from -10 to + 10 times STEP AMPLITUDE.	
Resolution	STEP AMPLITUDE setting x 1%	
Step transition timing (typical)	Within 3% of collector peak volts including jitter.	Polarity is in AC mode.
Current mode		
Amplitude range	50 nA to 200 mA in a 1 -2-5 sequence of 21 steps.	
Maximum current	20 x STEP AMPLITUDE setting, except 10 x STEP AMPLITUDE when control is set to 200 mA.	Steps and aiding offset
Maximum voltage	At least 10 V	Steps and aiding offset. ¹
Maximum opposing offset current	10 x STEP AMPLITUDE	
Maximum opposing volts	Less than 15 V.	When the voltage limiter is working in opposing current setting condition, the step generator output current value is not guaranteed.
Ripple plus noise	Less than 0.5% x STEP AMPLITUDE + 10 nA.	BW = 20 MHz, with open circuit.
Maximum inductive load (typical)	1 μ H	
Output impedance (typical)	More than 1/(0.3% of STEP AMPLITUDE current setting per volt) Ω	
Fall and rise time (typical)	Within 25 μ s for 1 step or 100 μ s for 10 steps.	1 k Ω load, 100 μ A/step
Overshoot and undershoot (typical)	Within 10% of transition amplitude.	1 k Ω load, 100 μ A/step

Table 1-2: Step Generator (Cont.)

Characteristic	Performance Requirement	Operating Information
Voltage Mode		
Amplitude switch range	50 mV to 2 V, in a 1-2-5 sequence of 6 steps	
Maximum voltage	20 x STEP AMPLITUDE	
Maximum current	At least 500mA at 10V or less, at least 200mA at 15 V, at least 10 mA at 40 V. ²	
Short circuit current limiting	500 mA, +50%, -20%	
Maximum opposing offset volts	10 x STEP AMPLITUDE	
Maximum opposing current	Less than 20 mA	
Ripple plus noise	Less than 0.5% x STEP AMPLITUDE + 10 mV	BW = 20 MHz, with open circuit.
Maximum capacitive load (typical)	0.01 μ F	
Output Impedance (typical)	200 m Ω or less	
Fall and rise time (typical)	Within 50 μ s for 1 step or 100 μ s for 10 steps. 1 k Ω load, 2 V/step.	1 k Ω load at 2 V/step
Overshoot (typical)	Within 10% of transition amplitude. 1 k Ω load, 2 V/step.	1 k Ω load at 2 V/step
Step rates	2 x line frequency (1 x line frequency in AC collector supply mode). Steps occur at 0 collector voltage.	
Pulsed steps	80 μ s or 300 μ s wide, \pm 10%	At mesial line, with 1 k Ω load, 1 mA /STEP
Steps and offset polarity	Corresponds to Collector Supply Polarity when STEP GENERATOR POLARITY INVERT is disabled. Opposite to Collector Supply Polarity when STEP GENERATOR POLARITY INVERT is selected or CONFIGURATION switch is set to BASE COMMON. BASE COMMON configuration disables STEP GENERATOR POLARITY INVERT.	
Number of steps	Ranges from 0 to 10.	

1 Available max current of Step Generator in 100 mA and 200 mA/step.

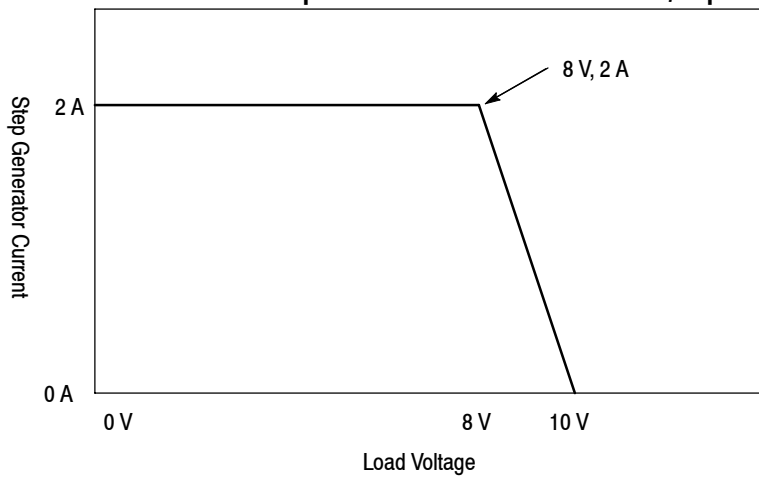

2 Step Generator max voltage output, in 2 V/step.

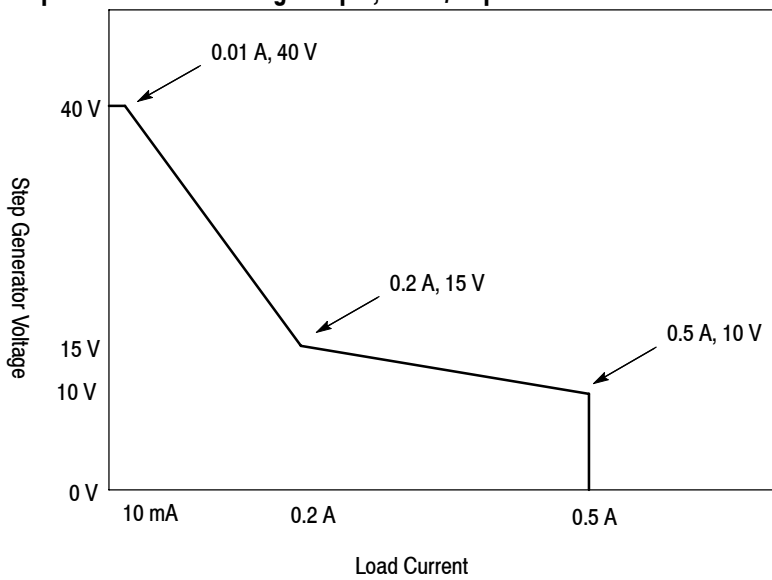

Table 1-3: AUX Supply

Characteristic	Performance Requirement	Operating Information
Range	From -40 to +40 volts, with 20 mV step resolution.	
Accuracy	Within 50 mV + 1.5% of total output	
Output current	At least 100 mA at ± 20 V. At least 10 mA at ± 40 V. ³	
Ripple pulse noise	Less than 50 mV _{p-p}	

³ Max voltage output and current of AUX SUPPLY.

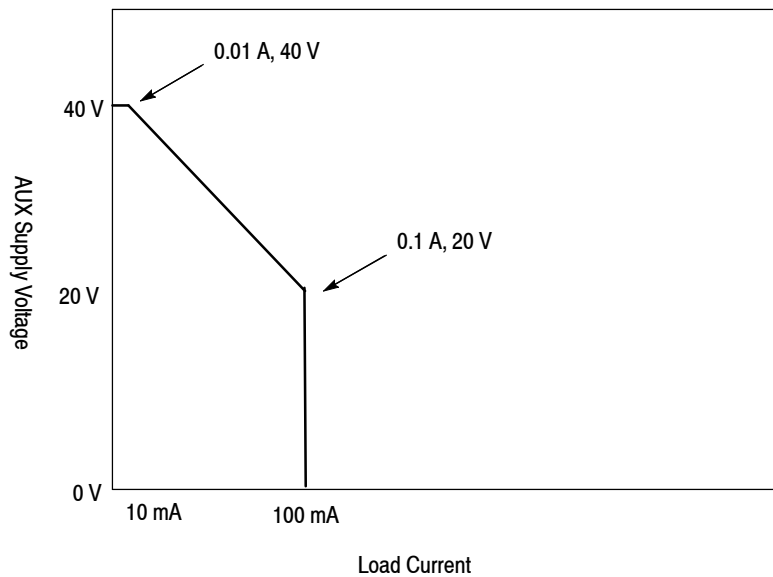

Table 1-4: Non-store Vertical Deflection System

Characteristic	Performance Requirement	Operating Information
Cursor		WINDOW
Accuracy (typical)	Within 0.06 division	
Collector/Base Current		
Range	1 μ A/div to 2 A/div in a 1-2-5 sequence. x10 MAG extends maximum sensitivity to 100 nA/div (1 nA resolution).	
Accuracy (typical)	Within 2% of WINDOW cursor readout + 0.1 x VERT/DIV setting.	

Table 1-4: Non-store Vertical Deflection System (Cont.)



Characteristic	Performance Requirement				Operating Information	
Maximum displayed noise or ripple					Except for switching noise at +  and -  mode	
Max Volts Range	16 V	80 V	400 V	2000 V		
Noise or Ripple	1 $\mu\text{A}_{\text{p-p}}$	1 $\mu\text{A}_{\text{p-p}}$	2 $\mu\text{A}_{\text{p-p}}$	5 $\mu\text{A}_{\text{p-p}}$		
Emitter current						
Range	1 nA/div to 2 mA/div in a 1-2-5 sequence. x10 MAG extends maximum sensitivity to 100 pA/div.				Collector Supply Polarity is either +LEAKAGE or -LEAKAGE mode.	
Accuracy	Within 2% of WINDOW cursor readout +0.1 x VERT/DIV settings + 1 nA					
Maximum displayed noise or ripple	Depending on setting of MAX PEAK VOLTS					
Max Volts Range	16 V	80 V	400 V	2000 V		
Noise or Ripple	1 nA _{p-p}	1 nA _{p-p}	2 nA _{p-p}	5 nA _{p-p}		
Step generator display						
Range (typical)	1 step/division					
	1 step/10 divisions					With x10 MAG
	10 steps/division					With STEP MULTI .1 x
Accuracy	Within 0.3 division					
Display offset (typical)						
Range	± 10 divisions with 0.1 div resolution.					
Accuracy	Within 1.5% of offset + 0.1 x VERT/DIV setting					
Display x10 MAG (typical)						
Accuracy	Within 1.5% of window cursor readout + 0.3 x VERT/DIV setting.					
Display Invert (typical)						
Accuracy	Within 0.1 x VERT/DIV setting					

Table 1-5: Digital Storage Vertical Acquisition

Characteristic	Performance Requirement	Operating Information
A/D Converter		
Resolution	10 bits for 10.24 divisions, 100 counts per division	
Max data points	1024	
Max sampling rate	Line frequency x 1024	
Min sampling rate	Line frequency x 2	
Collector/Base Current		
Range	1 μ A/div to 2 A/div in a 1 -2-5 sequence. x10 MAG extends maximum sensitivity to 100 nA/div (1 nA resolution).	
Accuracy	Within 1.5% of DOT cursor readout + 0.05 x VERT/DIV setting.	
Emitter Current		
Range	1 nA/div to 2 mA/div in a 1-2-5 sequence. x10 MAG extends max sensitivity to 100 pA/div (1 pA resolution).	Collector supply polarity is either +LEAKAGE or - LEAKAGE
Accuracy	Within 1.5% of DOT cursor readout + 0.05 x VERT/DIV setting + 1 nA.	
Step Generator display		
Range	1 step/division 1 step/10 divisions 10 steps/division	With x10 MAG With STEP MULTI .1 x
Accuracy	Within 0.3 division	
Display offset		
Range	\pm 10 divisions in 0.1 division resolution	
Accuracy	Within 1.5% of offset +0.06 x VERT/DIV setting	
Display x10 MAG		
Accuracy	Within 1.5% of DOT cursor readout +0.3 x VERT/DIV setting	
Display Invert		
Accuracy	Within 0.04 x VERT/DIV setting	

Table 1-6: Non-store Horizontal Deflection System

Characteristic	Performance Requirement	Operating Information
Cursor		
Accuracy (typical)	within 0.06 division	WINDOW Cursor
Collector Volts		
Range	50 mV/div to 500 V/div in a 1 -2-5 sequence. x10 MAG extends maximum sensitivity to 5 mV/div (50 μ V resolution).	
Accuracy (typical)	Within 2% of WINDOW cursor readout + 0.1 x HORIZ/DIV setting.	
Maximum displayed noise	Less than 0.02% of MAX PEAK VOLTS setting.	
Base/Emitter Volts		
Range	50 mV/div to 5 V/div in a 1-2-5 sequence. x 10 MAG extends maximum sensitivity to 5 mV/div (50 μ V resolution).	
Accuracy (typical)	Within 2% of WINDOR cursor readout + 0.1 x HORIZ/DIV setting.	
Input impedance	At least 100 M Ω	
Maximum displayed noise	Less than 10 mV _{p-p}	With 1 M Ω resistor connected between Base and Emitter terminals, BASE OPEN configuration, and 0 Number of Steps.
Step Generator Display		
Range	1 step/division	
	1 step/10 division	With x10 MAG
	10 steps/division	With STEP MULTI .1 x
Accuracy	Within 0.3 division	
Display Offset		
Range	± 10 divisions in 0.1 division steps.	
Accuracy	Within 1.5% of offset + 0.1 x HORIZ/DIV setting.	
Display x10 MAG		
Accuracy	Within 1.5% of window cursor readout + 0.3 x HORIZ/DIV setting.	
Display Invert		
Accuracy	Within 0.1 x HORIZ/DIV setting.	

Table 1-7: Digital Storage Horizontal Acquisition

Characteristic	Performance Requirement	Operating Information
A/D Converter		
Resolution	10 bits for 10.24 divisions. 100 counts per division.	
Max data points	1024	
Max sampling rate	Line frequency x 1024	
Min sampling rate	Line frequency x 2	
Collector Volts		
Range	50 mV/div to 500 V/div in a 1-2-5 sequence. X10 MAG extends maximum sensitivity to 5 mV/div (50 μ V resolution).	
Accuracy	Within 1.5% of dot cursor readout + 0.05 x HORIZ/DIV setting.	
Base/Emitter Volts		
Range	50 mV/div to 5 V/div in a 1-2-5 sequences. x 10 MAG extends maximum sensitivity to 5 mV/div (50 μ V resolution)	
Accuracy	Within 1.5% of dot cursor readout + 0.05 x HORIZ/DIV setting.	
Step Generator display		
Range	1 step/division 1 step/10 divisions 10 steps/division	With X10 MAG With STEP MULTI .1 x
Accuracy (typical)	Within 0.3 division	
Display offset		
Range	\pm 10 divisions in 0.1 division resolution.	
Accuracy	Within 1.5% of DOT cursor readout + 0.01 x HORIZ/DIV setting.	
Display x10 MAG		
Accuracy	Within 1.5% of DOT cursor readout + 0.3 x HORIZ/DIV setting.	
Display Invert		
Accuracy	Within 0.04% x HORIZ/DIV setting.	

Table 1-8: CRT and Readout

Characteristic	Performance Requirement	Operating Information
CRT		
Type		Electrostatic deflection
Phosphor		P31
Acceleration potential		12 kV typical
Screen size		178mm(7 in) diagonal internal graticule and on-screen scale factor readout.
Total addressable points (graticule area)		1000 x 1000
Geometry	0.5 minor division or less of tilt or bowing; 0.75 minor division or less of keystone.	
Resolution		At least 10 lines/div
Spot size		Within 0.95 mm at screen center; elsewhere on screen: within twice center value.
Orthogonality	90°, within 0.3°	
Trace rotation range (typical)	At least ± 3°	
READOUT		
		Automatic on-screen display. Over range shown by a flashing display.
VERT/DIV	100 pA to 2 A	
HORIZ/DIV	5 mV to 500 V.	
PER STEP	5 nA to 200 mA, and 5 mV to 2 V.	
OFFSET		4-digit value.
β or gm/DIV	500 x 10 ⁻⁹ to 400 x 10 ⁶ for β and 50 x 10 ⁻⁹ S to 400 S for gm	
CURSOR		4-digit Horizontal and Vertical values without x 10 MAG, 5-digit with MAG.
% of COLLECTOR PEAK VOLTS		0.0% to 100.0% in 0.1% step.
Aux Supply	- 40.00 V to + 40.00 V	

Table 1-9: Adapter Connectors







Characteristic	Performance Requirement	Operating Information
Collector Collector Sense 		
Maximum output voltage		± 2000 V
Maximum output current		± 20 A
Base Base Sense 		
Maximum output voltage		± 400 V
Maximum output current		± 20 A
Emitter Emitter Sense 		
Maximum output voltage		± 40 V
Maximum output current		± 20 A
Step Gen Out connector 		
Maximum output voltage		± 40 V
Maximum output current		± 2 A
Aux Supply Connector 		
Maximum output voltage and current		± 40 V @ ± 10 mA, or ± 20 V @ ± 100 mA.
Ext Base or Emitter Connector 		
Maximum input voltage		± 40 V
Maximum input current		± 2 A

Table 1-10: Power Supply

Characteristic	Performance Requirement	Operating Information
Rating Voltage	115 VAC / 230 VAC	
Line voltage range		
115 VAC	High 107 VAC to 132 VAC Low 90 VAC to 110 VAC	
230 VAC	High 214 VAC to 250 VAC Low 180 VAC to 220 VAC	
Frequency Range	48.0 to 63.0 Hz	
Power Consumption	Max. 400 W, 3.5 A Typical 120 W, 1.3 A at 115 V, 50 Hz	
Fuse		
115 VAC	125 V, 4 A, Slow-Blow	
230 VAC	250 V, 2 A, Slow-Blow	

Table 1-11: Surge Current

Characteristic	Description
Surge Current	80 A peak (25°C) for ≤ 5 line cycles, after product has been turned off for at least 30 s.

Mechanical Specifications

Table 1-12: Mechanical Specification

Characteristic	Performance Requirement	Operating Information
Net Weight		
Standard instrument	Approx. 37 kg (82 lb)	
Option 1R	Approx. 38 kg (84 lb)	
Dimensions		
Height	326 mm (12.8 in) with feet 310 mm (12.2 in) without feet	
Width	429 mm (16.9 in)	
Depth	635 mm (25.0 in)	

Functional Specifications

Table 1- 13: Digital Storage Acquisition Mode

Characteristic	Performance Requirement	Operating Information
Normal	Acquires and displayed each curve.	
Envelope		
Vertical Envelope	Acquires and displays the maximum and minimum vertical excursion of each curve.	
Horizontal Envelope	Acquires and displays the maximum and minimum horizontal excursion of each curve.	
Averaging	Acquires and displays the average of last 16 acquisitions.	

Table 1- 14: Text Display

Characteristic	Performance Requirement	Operating Information
Alphanumeric character Set (1)	ASCII character set except double quote ("), u is recognized as μ) GPIB-accessible with the TEXT command.	
Alphanumeric character Set (2)	A,B,....,Y,Z,(Space),m, u, n,o,,,0,.....,9,-,*,(,), Accessible with the Position Control buttons.	
Maximum text string length	24 characters	
Character size	Approximately 3 mm height, 2 mm width.	

Environmental Specifications

Table 1-15: Environmental Specification

Characteristic	Performance Requirement
Temperature	
Operating	+10 °C to +40 °C
Nom-Operating	-20 °C to +60 °C
Transportation	-40 °C to +65 °C
Temperature gradient	
Operating	≤ 15 °C per hour (no condensation)
Non-operating	≤ 30 °C per hour (no condensation)
Humidity	
Operating and Non-operating	Five cycles (120 hours) with equipment tested at 80% relative humidity. Tested on-operating at 60 °C and operating to meet MIL-STD-810C method 507.1 procedure IV, modified as specified in MIL-T-28800B paragraph 4.5.1.1.2.
Relative Humidity	
Operating	20% to 80% (no condensation) Maximum wet bulb temperature shall be 29 °C.
Storage	10% to 90% (no condensation) Maximum wet bulb temperature shall be 40.0 °C.
Transportation	5% to 95% (no condensation) Maximum wet bulb temperature shall be 45.0 °C.
Altitude	
Operating	Up to 3.0 km (10000 feet). Maximum operating temperature decreases 1 °C each 1,000 feet above 1.5 km (5,000 feet).
Non-Operating	Up to 15 km (50000 feet).
Vibration	
Operating	2.352 m/s ² (0.24 G _{rms}), 5 Hz to 500 Hz
Shock (non-operating)	196 m/s ² (20 G), half-sine, 11 ms duration. Three shocks per axis in each direction (18 shocks total)
Bench handling	
Operating	Drop from 10 cm (4 in) tilt, or 45 ° which ever less (Tilt not to balance to point.)
Packaged transportation drop	Meets the limits of the National Safe Transit Association test procedure 1A-B-2; 10 drops of 61 cm (24 in).
Packaged transportation vibration	Meets the limits of the National Safe Transit Association test procedure 1A-B-1 ;excursion of 2.5 cm (1 in) p-p at 4.63 Hz 10.8ms/s ² (1 .1 G) for 60 minutes.

Table 1- 16: Certifications and Compliances

Category	Standards or description
EC Declaration of Conformity - EMC	Meets intent of Directive 89/336/EEC, amended by 93/68/EEC; EN 61326-1: 1997 Product Family Standard for Electrical Equipment for Measurement, Control, and Laboratory Use-EMC Requirement.
Emissions	EN 55011 Class A Radiated and Conducted Emissions EN 61000-3-2 Power Line Harmonic EN 61000-3-3 Line Voltage Alteration and Flicker
Immunity	EN 61000-4-2 Electrostatic Discharge Immunity EN 61000-4-3 Radiated RF Electromagnetic Field Immunity Note: The output level of Step Generator may vary in this test. EN 61000-4-4 Electrical Fast Transient/Burst Immunity EN 61000-4-5 Surge Immunity Note: The output level of collector supply may decrease in this test. EN 61000-4-6 Conducted Disturbance induced by RF Field Immunity EN 61000-4-8 Power Frequency Electromagnetic Field Immunity EN 61000-4-11 Voltage Drop, Short Interruptions and Voltage Variations Immunity Note: The output of Collector Supply is disabled after this test.
Australia/New Zealand Declaration of Conformity - EMC	Complies with EMC provision of Radio Communications Act per the following standard: Industrial, Scientific, and Medical Equipment: 1992
Safety	UL3111-1 CAN/CSA C22.2 NO. 1010.1
Self-Declaration	EN 61010-1 with second amendment
Installation Category	Power input - Installation Category II (as defined in IEC 61010-1, Annex J)
Pollution Degree	Pollution degree 2 (as defined in IEC 61010-1)

Table 1-17: Installation category and Pollution degree Descriptions

Characteristics	Description	
Installation category	Terminals on this product may have different installation category designations. The installation categories are:	
	<i>Category</i>	<i>Descriptions</i>
	CAT III	Distribution-level mains (usually permanently connected). Equipment at this level is typically in a fixed industrial location
	CAT II	Local-level mains (wall sockets). Equipment at this level includes appliances, portable tools, and similar products. Equipment is usually cord-connected
CAT I	Secondary (signal level) or battery operated circuits of electronic equipment	
Pollution degree	A measure of the contaminates that could occur in the environment around and within a product. Typically the internal environment inside a product is considered to be the same as the external. Products should be used only in the environment for which they are rated.	
	<i>Category</i>	<i>Descriptions</i>
	Pollution Degree 1	No pollution or only dry, nonconductive pollution occurs. Products in this category are generally encapsulated, hermetically sealed, or located in clean rooms.
	Pollution Degree 2	Normally only dry, nonconductive pollution occurs. Occasionally a temporary conductivity that is caused by condensation must be expected. This location is a typical office/home environment. Temporary condensation occurs only when the product is out of service.
	Pollution Degree 3	Conductive pollution, or dry, nonconductive pollution that becomes conductive due to condensation. These are sheltered locations where neither temperature nor humidity is controlled. The area is protected from direct sunshine, rain, or direct wind.
Pollution Degree 4	Pollution that generates persistent conductivity through conductive dust, rain, or snow. Typical outdoor locations.	

GPIB Interface

The IEEE-488-1978 (GPIB) standard defines the GPIB interface functions and the allowed subsets of those functions.

Table 1- 18: GPIB Interface

Function	Implemented As
Source handshake	SH1
Acceptor Handshake	AH1
Talker	T6
Listener	L4
Service request	SR1
Remote Local	RL2
Parallel poll	PP0
Device Clear	DC1
Device trigger	DT0
Controller	C0

Operating Information

Operating Information

This section provides the following information:

- Initial inspection procedure
- Installation procedures
- Kelvin Sense
- Rackmounting Information
- Repackaging procedure for shipment

Installation

Initial Inspection

This instrument was thoroughly inspected for mechanical and electrical defects before shipment. It should be free of marks or scratches and meet or exceed all electrical specifications. To confirm this, inspect the instrument for physical damage incurred in transit and test the electrical performance by following the *First Time Operation* in the 370B Programmable Curve Tracer User Manual.

Power Source Information

This instrument operates from a power source having a neutral or near ground (earth) potential. It is not intended for operation from two phases of a multi-phase system, nor across legs of a single phase, three wire system. This instrument can be operated from either a 115 volt or 230 volt nominal supply source, 48 to 63 Hz. Table 2-1 is a listing of the line voltage ranges, line frequency range, and power consumption.

Table 2-1: Line voltage ranges

RANGE switch	NORMAL switch	
	115 VAC	230 VAC
HIGH	107 VAC to 132 VAC	214 VAC to 250 VAC
LOW	90 VAC to 110 VAC	180 VAC to 220 VAC
Power consumption		
Max.	400 W, 3.5 A at 132 V, 60 Hz	
Typical	120 W, 1.3 A at 115 V, 50 Hz	

Operating Voltage Selection and Line Fuse Verification

The LINE VOLTAGE SELECTOR switches (NOMINAL and RANGE, located on the rear panel) allow selection of the operating line voltage. To select the correct operating line voltage:

1. Disconnect the 370B from the AC power source before changing the operating voltage.
2. Select the nominal AC power source voltage with the NOMINAL switch, and
3. Select the operating line voltage with the RANGE switch.



CAUTION. To prevent damage to the instrument, always check the settings of the LINE VOLTAGE SELECTOR switches located on the rear panel of the 370B before connecting the instrument to the line voltage source.

To verify that the power input fuse is for the nominal AC source voltage selected, perform the following:

1. Use the small straight slot screwdriver to pry the cap (with the attached fuse inside) out of the fuse holder.
2. Verify proper fuse value:

Nominal voltage 230 V	2 A medium blow
Nominal voltage 115 V	4 A medium blow
3. Install the proper fuse and reinstall the fuse holder cap.

Power Cord Information

A power cord with the appropriate plug configuration is supplied with each instrument. The color coding of the power cord conductors appears in Table 2-2. Also, should you require a power cord plug other than that supplied, refer to Table 2-3, Power Cord Identification.

Table 2-2: Power Cord Color Conductor Identification

Conductor	Color	Alternate
Ungrounded (Line)	Brown	Black
Grounded (Neutral)	Light Blue	White
Grounded (Protective Ground)	Green / Yellow	Green / Yellow

Table 2-3: Power cord identification

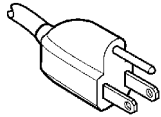
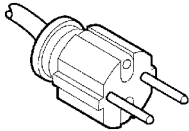
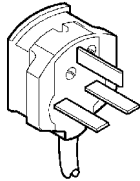
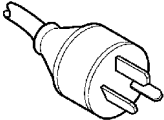
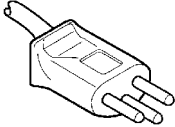
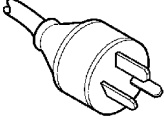
Plug configuration	Normal usage	Option number
	North America 125 V	Standard
	Europe 220 V	A1
	United Kingdom 240 V	A2
	Australia 240 V	A3
	Switzerland 220 V	A5
	China 240 V	AC
	No power cord supplied.	A9



WARNING. *This instrument operates from a single phase power source, and has a detachable three-wire power cord with a two-pole, three-terminal grounding type plug. The voltage to ground (earth) from either pole of the power source must not exceed the maximum rated operating voltage (250 volts rms).*

Before making connection to the power source, make sure that the instrument is set for the power source voltage, and is equipped with a suitable plug (two-pole, three-terminal, grounding type).

This instrument is safety class 1 equipment (IEC designation). All accessible conductive parts are directly connected through the grounding conductor of the power cord to the grounding contact of the power plug. Therefore, the power plug must only be inserted in a mating receptacle with a grounding contact. Do not defeat the grounding connection. Any interruption of the grounding connection can create an electric shock hazard.*

For electric shock protection, connect the instrument to ground before connecting to the instrument input or output terminals.

** International Electrotechnical Commission.*

Operating Temperature

The 370B can be operated where the ambient air temperature is between +10 °C and +40 °C. After storage at temperatures outside the operating limits, allow the chassis temperature to reach the safe operating limits before applying power. The 370B is cooled by air drawn in through the air filter on the rear panel and blown out through holes in the side panels. For proper instrument cooling, provide adequate clearance on the rear and sides of the instrument to ensure free air flow and dissipation of heat away from the instrument.



WARNING. *Following use of the 370B at high power settings, the device, fixture, or protective cover may be hot enough to cause injury. Avoid touching any of these items until cooled.*

Test adapter and Protective cover

To use the 370B to display and measure the characteristic curves of most devices, a test adapter and the protective cover must be installed. Four test adapters are provided as standard accessories. Six other test adapters are available as optional accessories. The test adapter is inserted into the adapter connectors provided on the front panel. These connectors allow two devices to be set up at a time.



WARNING. *Dangerous voltage may appear at the front panel collector and base terminals. To avoid injury or equipment damage, do not remove the protective cover.*



CAUTION. *Double-wide test adapters are designed to fit in the left set of adapter connectors. If you try to forcibly install a double-wide test adapter in the right side, you might damage the connector. The connectors are identified by the following numbers:*

A1006

A1007

A1009

A1010

Kelvin Sense

The 370B provides the adaptor connector equipped with Kelvin sense terminals. The Kelvin sense is the way to measure voltage with two independent terminals connecting to each of DUT leads; the Force terminal that supplies power and the Sense terminal senses the voltage. By using the Kelvin sense mechanism, you can make a high precision measurement because that the effect of conductance from the contact between the cables and DUT leads is suppressed to a minimum. The Sense terminals in the 370B adaptor connector and the A1001 through A1005 test adapters are for Kelvin sensing. The measurement can be performed without Sense terminals, however, if you need high precision measurement, use the those terminals.

Connections for Kelvin Sensing

When a DUT does not fit in any of the test adaptors and you prepare a specific test adaptor, for example, use cables to connect terminals and DUT leads as shown in Figure 2-1 for Kelvin sensing.



CAUTION. Confirm that the the DUT leads and the force terminals: C, B and E are firmly connected. Making improper connections may cause the DUT to be broken. Before a measurement, also verify that the cables are not down and the contact between the terminals and cables are made properly. To avoid electric shock and damage to the instrument, perform measurement only within the protective cover Do not disable the interlock mechanism and/or do not take the cables out of the protective cover to perform measurement without or outside the cover.

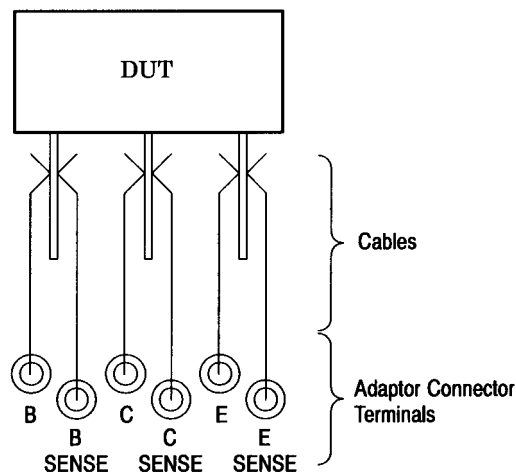

Figure 2- 1: Example of Kelvin sense connection

Rackmounting Information

Latching The 370B incorporates a spring-latch design built into the rackmounting ear. To release, pull the rackmount latch release (see Figure 2-2). To relatch, push the rackmount latch release until the spring latches engage.

For those applications that require additional rackmounting security, the rackmounting ears of the 370B are drilled for screw fasteners (see Figure 2-2).

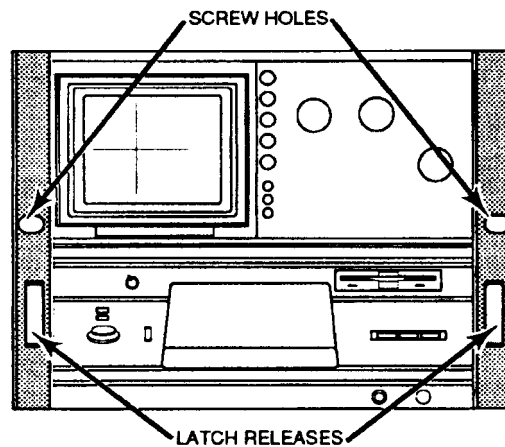

Figure 2-2: Location of the Rackmount Latch Release

Rackmounting The 370B fits most commercial consoles and 19-inch racks with rail holes that conform to universal spacing. See Figure 2-3 for hole spacing details.



WARNING. *The 370B weighs more than 36Kg(80 lb). To avoid personal injury, use care when lifting the instrument, and where required, seek help in lifting and positioning the 370B into the rack. Once the 370B is installed in a rack, use care that when extended, the 370B does not tip the rack forward, causing personal injury or instrument damage.*

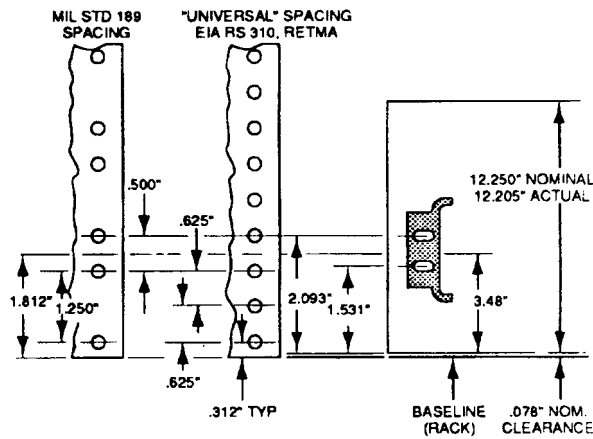

Figure 2-3: Rackmount hole spacing

When rackmounting the 370B, take note of the following: Allow one inch clearance above and below, and on the left and right sides of the 370B for air circulation. Allow at least three inches of clearance between the 370B rear panel and the rack enclosure for adequate cooling air and to provide cable clearance. The depth of the 370B from behind the rack ears to the rear panel is 480mm (18.9 in). The rack depth must be at least 559 mm (22 in) (see Figure 2-4) to meet the rear clearance requirement.

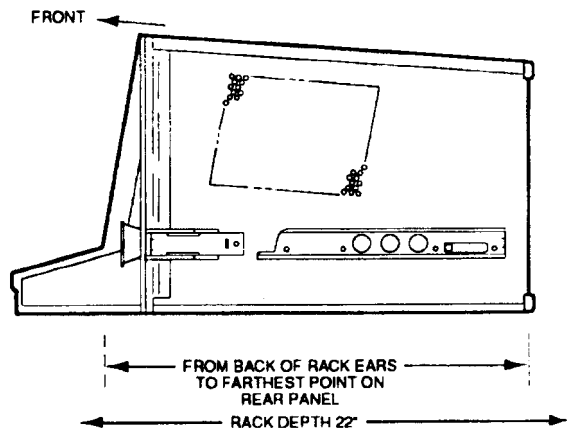

Figure 2-4: Rackmounting Length and Clearance

The 370B is 312 mm (12.25 in) high, a multiple of 45 mm (1.75 in) (the standard rack spacing). If the 370B is installed in a rack with standard hole spacing, and positioned some multiple of 45 mm (1.75 in) from the bottom or top, all holes should line up and no drilling should be required.

The slide-out tracks mount easily to the rack front and rear vertical mounting rails if the inside distance between the rails is within 503 mm (19.8 in) to 674 mm (26.5 in). If the tracks are to be installed in a rack having other dimensions, provide extra support (for example, extensions to the rear mounting brackets) for the rear ends of the slide-out tracks.

The front rack rails must be at least 17 inches apart. The front lip of the stationary-track section mounts in front of the rail. (Use bar nuts behind untapped front rails.) The front lip of the stationary track section must mount in front of the front rail to allow the 370B spring latch to function properly.

The slide-out tracks consist of two assemblies, one for each side of the instrument. Each assembly consists of three sections (see Figure 2-5). The stationary section of each track attaches to rack rails as shown in Figure 2-6. The chassis section mounts on the instrument and is installed at the factory. The intermediate section fits between the other two sections, allowing the instrument to be fully extended out of the rack.

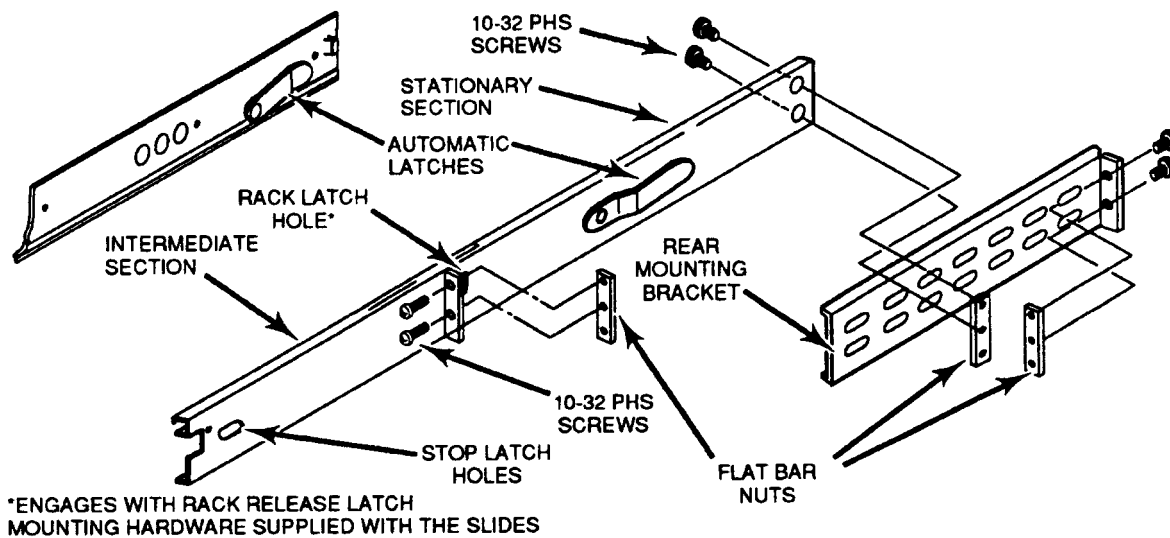

Figure 2-5: Rackmounting Hardware

The stationary and intermediate sections for both sides are shipped as a matched set and should not be separated. The package includes matched sets for both sides and mounting hardware. To identify the assemblies, note that the automatic latch and intermediate section latch stop holes are located near the top when the matched sets are properly mated to the chassis sections.

To mount the instrument in a rack, perform the following:

1. Select the appropriate holes in the rack rail, using Figure 2-3 as a guide.
2. Mount the stationary-track sections to the front rack rails with truss head screws (and bar nuts, if necessary).
3. Mount the stationary-track sections to the rear rails, using one of the methods depicted in Figure 2-6. Note that the rear mounting bracket can be installed to fit either deep or shallow cabinet racks.
4. After mounting the instrument in the slide-out tracks, adjust for proper width by loosening the front and rear screws and allowing the slides to seek the proper width. Center the instrument, then tighten the screws.

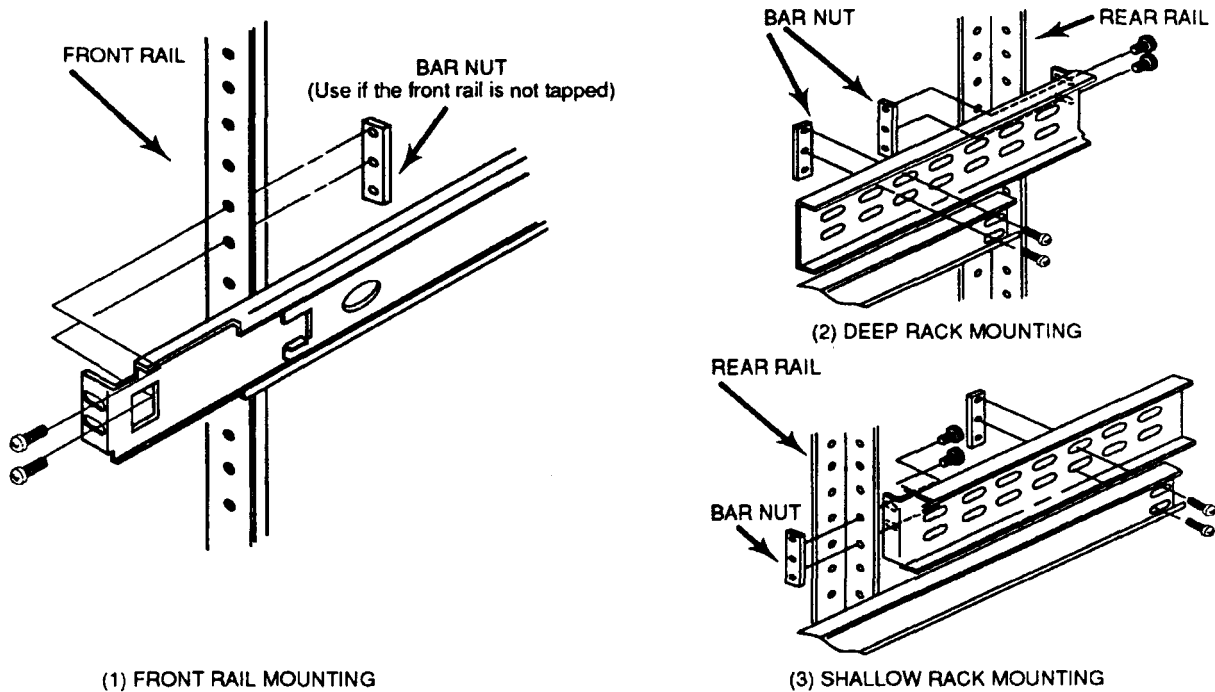

Figure 2-6: Mounting Stationary Rackmount Sections

5. Push the instrument into the rack, and check that the automatic spring latch engages the spring latch catch to hold the instrument in place.
6. Extend the instrument out of the rack by pulling the rackmount latch releases on the front panel (see Figure 2-2) out to disengage the spring latches. Then, pull the instrument out.
7. Once the instrument is out of the rack, press the latch release and push the instrument back into the rack.

**Rackmount to Cabinet
Conversion**

To convert the 370B rackmount version to a cabinet model, use the following procedure (see Figure 2-7):

1. Remove the bracket from each corner of the instrument rear panel.
2. Replace the left and right side panels with cabinet model side panels.
3. Mount a carrying handle assembly on the left and right sides of the top.
4. Fasten a foot at each corner on the bottom of the instrument.

Cabinet to Rackmount Conversion

To convert the 370B cabinet model to a rackmount version, use the following procedure (see Figure 2-7):

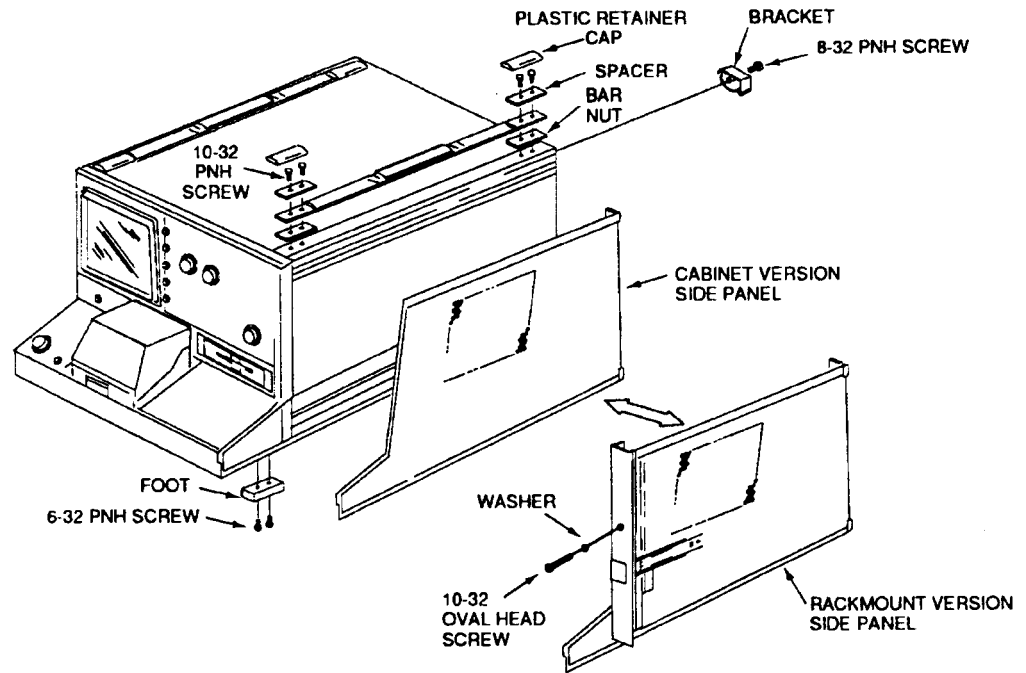

Figure 2-7: Cabinet-to-Rackmount Conversion

1. Remove the bracket from each corner on the rear panel.
2. Replace the side panels with rackmount version side panels.
3. Attach brackets at each corner on the rear panel.
4. Remove both carrying handle assemblies:
 - a. Remove the plastic retainer caps that conceal the screws located at each end of the handle.
 - b. Remove the screw, spacer and bar nut, then lift off the carrying handle assembly.

Repacking for shipment

If this instrument is to be shipped long distances, we recommend that the instrument be repackaged the same as when it arrived. The cartons and packaging material in which your instrument was shipped should be saved and used for this purpose.

If your instrument is to be shipped to a Tektronix Service Center for service or repair, attach a tag to the instrument showing the following:

- Owner of the instrument (with address)
- Name of a person at your firm to contact
- Instrument type
- Instrument serial number
- Description of the service required

If the original packaging is unfit for use or not available, package the instrument as follows:

1. Obtain a corrugated cardboard shipping carton with a 170kg(375lb) test strength that has inside dimensions at least six inches greater than the instrument dimensions.
2. Surround the instrument with polyethylene sheeting to protect the finish.
3. Cushion the instrument on all sides by tightly packing dunnage or urethane foam between the carton and the instrument, allowing three inches on all sides.
4. Seal the carton with shipping tape or with an industrial stapler.
5. Write the address of the Tektronix Service Center and your return address on the carton in one or more prominent locations.

Theory of Operation

Theory of Operation

This section describes the operation of the 370B Programmable Curve Tracer circuits. The section is divided into two parts: Block Diagram Description and Detailed Circuit Operation.

Block Diagram Description

The following description is an overview of the 370B operation. Figure 3-1 is an overall block diagram of the 370B. The numbers enclosed in diamonds within each block in Figure 3-1 indicate the schematic diagrams associated with the block.

The 370B is a static and dynamic semiconductor tester that displays and allows measurement of static and dynamic semiconductor characteristics obtained under simulated operating conditions.

The 370B consists of five major functional sections:

- Collector Supply
- Data Acquisition and Display
- Control and Processing
- Interface
- Power Supply

Stimulus Generators

The Stimulus Generators simulate operating conditions for the DUT by producing voltages and currents that are applied to the DUT. They include the Collector Supply, the Step Generator, the Aux Supply, and the PLL and Clock Circuits.

The Collector Supply produces sine-wave ac, full-wave rectified sine waves (positive and negative), and positive and negative DC voltages. The amplitude of the output can be varied from 0 to 2000 volts. The Collector Supply output is applied to either the collector or the base (or equivalent) terminal of the device under test.

The Step Generator Circuit produces ascending or descending steps of current or voltage at a normal rate of one step for each half-sine wave of the Collector Supply. The amount of current or voltage per step, total number of steps and offset voltage and current can be controlled. This Step Generator output may be applied to either the base or the emitter (or equivalent) terminals of the device under test.

The Auxiliary Supply produces auxiliary power for the DUT. The output voltage range is ± 0 to 40 volts. This output can be applied to any terminal of the DUT.

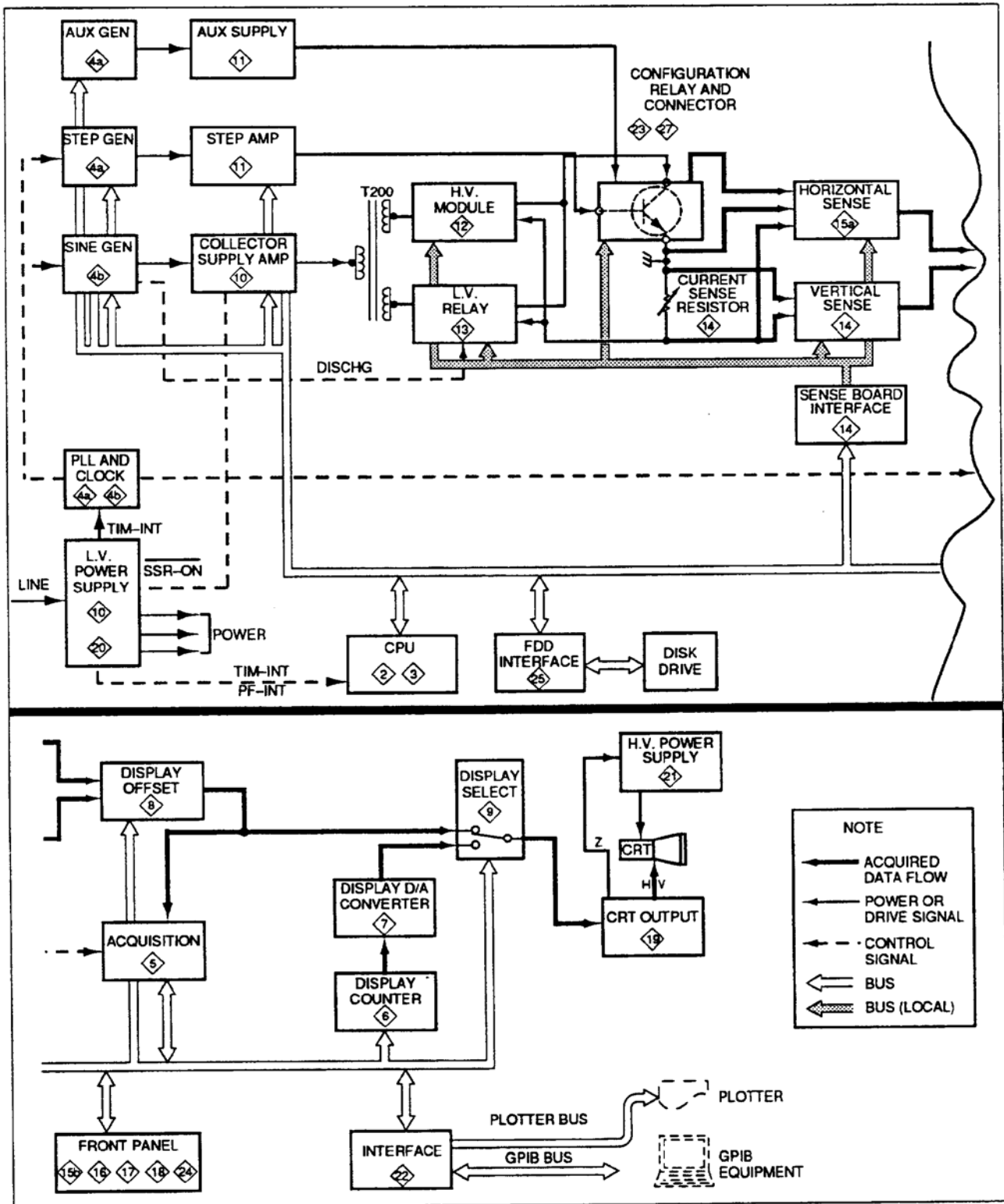

Figure 3-1: 370B Block Diagram

The PLL and Clock Circuit generates a synchronous signal for the Step Generator and the Sine Wave generator. This Circuit also generates synchronous signals for the Acquisition Circuits.

This block consists of the following circuits.

- AUX GEN Circuit
- STEP GEN Circuit
- SIN GEN Circuit
- PLL and CLOCK Circuit
- AUX SUPPLY Circuit
- Collector Supply Amp Circuit
- Step Amp Circuit
- H.V. Module Circuit
- L.V. Relay Circuit
- Collector Terminal Circuit

Data Acquisition and Display

These circuits sense, acquire, and display the effect of the Collector Supply and Step Generator on the DUT. The block consists mainly of the Sense Circuit, the Acquisition Circuit, the Digital Display Circuit, and the Display Circuit.

The Sense Circuit senses and amplifies voltages and currents of each terminal of the DUT. This circuit also compensates for errors produced by IR drops between the DUT terminals and the supply. The amplifier sensitivity is controllable.

The Acquisition Circuit converts sensed analog data into digital data, that is, the fetch and A/D convert functions. This acquired data is sent to the CPU Circuit.

The Digital Display Circuit converts digital data into analog display signals. This digital data includes stored curve and operating information.

The Display circuit selects store or non-store data and displays curves and 370B operating information.

The Data Acquisition and Display Circuits consist of the following:

- Acquisition Circuit
- Display Counter Circuit
- Display D/A Converter Circuit
- Display Offset Circuit
- Display Select Circuit
- Vertical Sense Circuit
- Sense Board Interface Circuit
- Horizontal Sense Circuit
- CRT Output Circuit
- H.V. Power Supply Circuit

Control and Processing

These circuits control the 370B and process acquired data. They include the CPU Circuit, the Front Panel Circuit, and Floppy Disk Circuit.

The CPU Circuit controls an operations of the 370B, including Collector Supply and Step Generator Control, Sense Circuit Control, CRT Display Control, Front Panel Control, Floppy Disk Control, etc. The circuit also processes the acquired data from the device under test. These operations are controlled by the microprocessor and its operating programs through the Address, Data, and Control Bus lines.

The Front Panel Circuit interfaces the operator to the 370B. This circuit reads keys, switches and rotary encoder information to set the 370B to the desired measurement condition. This also displays these settings to the operator by LED and numerical displays.

The Floppy Disk Circuit memorizes acquired data from the device under test and the 370B setting information. The data and information are stored in the 3.5-inch floppy disk.

The Control and Processing Circuits consist of the following:

- CPU Circuit
- Front Panel Circuit
- Floppy Disk Circuit

Interface

These circuits interface the microprocessor data with the printer and the peripheral equipment. The circuit consists of the GPIB (General Purpose Interface Bus) interface Circuit and the Printer Control Circuit.

Power Supply

These circuits supply low-voltage operating power to the 370B. These voltages in turn are used to generate the high voltages, such as that used on the CRT. There are two major circuits, the Power Supply and the Interrupt Signal Generator.

The Power Supply converts the AC line voltages into DC voltages that supply power for 370B operation.

The Interrupt Signal Generator generates timer interrupt and power fail interrupt signals. These signals synchronize the 370B circuits, and provide a harmless shutdown when power fails.

Circuit Operation

This part of the Theory of Operation provides a description of the electrical operation of the 370B. The number enclosed in a diamond preceding a portion of text denotes the schematic diagram under discussion.

Interconnection

This circuit is located on the A1 Mother Board. The circuit connects inter-board signals of the 370B. These signals include control signals, drive signals, data signals, reference signals, sense signals, ground lines, and power supply lines.

MPU

The MPU circuitry is located on the A2 CPU board. It consists of a 68000 Microprocessor, Power-Up Reset Circuit Clock Generator, Buffers, Wait Timing Generator, and Interrupt Control Logic Circuit.

Memory

The Memory circuit consists of the ROM, RAM, Battery Backup, address selector, and buffers.

Generator <4a> The Generator Circuit is located on the A3 A/D Board.

NOTE. The 370B has two step generator output modes, *PULSED OFFSE MODE* and *DC OFFSET MODE*. The Pulse Offset is the default mode. It can be changed to *DC OFFSET MODE* with the jumper J310 on the A3 A/D Board.



CAUTION. When the device under test (DUT) is Normally-On type transistor, Pulsed Offset will cause additional heat-up for the DUT. For the Normally-On type transistor, DC Offset mode should be used.



CAUTION. When the device under test (DUT) is Normally-Off type transistor, DC Offset will cause additional heat-up for the DUT. For the Normally-Off type transistor, Pulsed Offset mode should be used.

Pulsed Offset. When the measurement mode is set to Single or Sweep, and the Step Generator Voltage is set, the base line offset is applied only in the internal measurement operation interval. Pulsed Offset functions only when Step Generator is PULSE MODE, (short pulse or long).

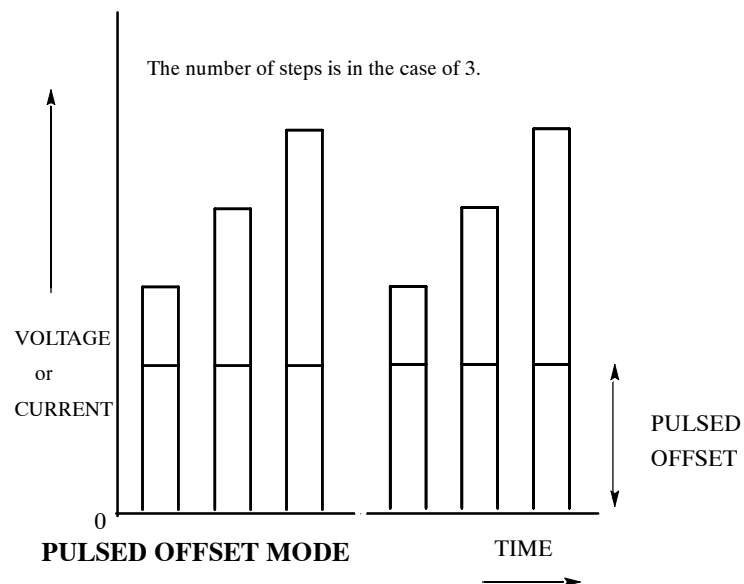

DC Offset. Base line offset voltage is always applied to the DUT in spite of Step Generator mode and the Measurement Mode setting.

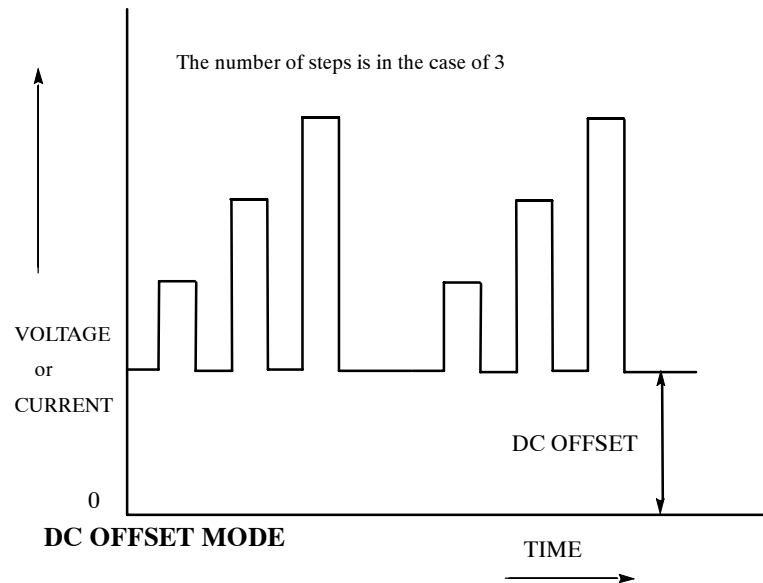

**Collector Supply
Generator <4b>**

The Collector Supply Generator Circuit, located on the A3 A/D board, consists of a Sine Wave Timing Generator, Sine Wave Generator, Collector Level Control Circuit and High Voltage Sine Wave Attenuator Circuit. These circuits generate a sine wave synchronized to the line frequency, which is the source of the Collector signal.

Acquisition <5>

The Acquisition Circuit, located on the A3 A/D Board, consists of an S/H (Sample and Hold) and Select Circuit, A/D Circuit, A/D Timing Circuit, Acquisition Memory Control Circuit, Acquisition Memory Circuit and Bus Interface Circuit.

These circuits perform A/D conversion of the HD and VD signals from the A5 Display Control Board, write them into Acquisition memory, and transfer data to the CPU.

**Display Counter Circuit
<6>**

The Display Counter Circuit is located on the A4 Digital Display Board. The Display Counter Circuit consists of the Bus Buffer, the 4.5 MHz Oscillator, Display Counter, Address Switch & CPU Control, Display RAM, Bus Transceiver, Dot Cursor Generator, Character & Latch Controller. These circuits determine whether the CPU accesses the Display RAM, or whether the Display Counter reads out the Display RAM contents to control signals for the digital display.

Display D/A Converter Circuit <7>

The Display D/A Converter Circuit is located on A4 Digital Display Board. The Display D/A Converter Circuit consists of:

- X data & Attribute Prefetch Latch
- X-Y Data & Attribute Load Latch
- X 10-bit DAC & Y 10-bit DAC
- X & Y Low-pass Filter
- Font Latch
- Character ROM & Shift Register
- X & Y Readout Position Latch
- Readout Attribute Latch
- 8-bit Adder
- X Readout Step Generator
- X Readout DAC and Y Readout DAC

These circuits convert the digitized waveform data, readout data and cursor data from the Display RAM into an analog signal and generate the z-axis signal.

Display Offset Circuit <8>

The Display Offset Circuit is located on the A5 Display Control Board. The Display Offset Circuit consists of the Control Logic Circuit, Offset D/A Converter, Polarity Select Circuit, Source Select Circuit Zero & Invert Select Circuit and Gain Select Circuit. These circuits select the horizontal and vertical source inputs for the CRT display and provide them with calibrated offset voltages to execute display functions such as DISPLAY OFFSET, MAG, CRT CAL, DISPLAY INVERT and COLLECTOR SUPPLY POLARITY.

Display Select <9>

The Display Select circuit is located on the A5 Display Control board. The circuit consists of the Signal Select Logic Circuit, Unblank & Z Select Circuit, and the Horizontal & Vertical Preamp. This circuit block selects and amplifies the source inputs that are displayed on the CRT. Selection of the source inputs are performed by the Signal Select Logic Circuit. The Z signal for the source inputs is controlled by the Un-blank & Z Select Circuit.

Collector Supply Amplifier <10>

This circuit is located on the A6 Collector Supply board and the A19 L.V. Supply board. The circuit consists of the Collector Supply Amplifier Circuit, the Voltage Limiter Circuit, the Current Limiter Circuit, the Limit Detector Circuit, the Power Supply and Control Circuit and the Control Signal Decoder Circuit. These circuits amplify signals from the Sine Wave Generator (located on the A3 A/D board) and provide driving voltage for collector supply transformer.

Step Amplifier <11>

The Step Amplifier circuits are located on the A7 Step Generator board. This circuit transforms the output of the Step Generator on the A/D Board into current or voltage steps of various amplitudes to be applied to the device under test. The STEP AMPLITUDE switch determines the amplitude of the steps. The circuit

consists of the Control Signal Latches, Relay Drivers, 0.5-1-2 Ranging Circuit, and Step Amplifier. This circuit also includes the Auxiliary Supply Circuit.

H.V. Module <12>

This circuit consists of Transformer, H.V. Module, Relay Control Signal Decoder Circuit and LOR Relay Circuit and is active when the MAX PEAK VOLTS is set to 2000. These circuits provide the sine-wave ac, the full-wave rectified sine wave and the DC voltage that range from 0 volts to 2000 volts peak. These voltages are applied to the collector of the device under test via the A34 LOR Relay board.

Collector Supply Low Voltage <13>

This circuit is located on the A9 L.V. Relay board and the A35 Looping board. The circuit consists of Transformer, Full-wave Rectifier Circuit, Smoothing Circuit, Output Power Limiter Circuit, Looping Compensator Circuit, Relay Control Signal Decoder Circuit, Relay Circuit and Discharging Circuit. These circuits provide the sine-wave ac, the full-wave rectified sine wave and the DC voltages. These voltages are supplied in three ranges, from 0 volts to 16 volts, from 0 volts to 80 volts and from 0 volts to 400 volts. These voltages are applied to the collector or base of the device under test via the A34 LOR Relay board, the A10 Sense board and the A33 Configuration Relay Board.

Vertical Sense <14>

This circuit is located on the A10 Sense board, and consists of the Sense Board Interlock Circuit, the Interface Circuit, and the Vertical Sense Circuit. The interlock Circuit protects this board from generating arcs, overheating, and operation when the cover is open. The Sense Board Interface Circuit interfaces this board with the A2 CPU board. The Vertical Sense Circuit compensates for looping, senses and amplifies collector, emitter and base current.

Horizontal Sense <15a>

This circuit consists of the Collector Voltage Sense Circuit, the Base Voltage Sense Circuit, Overrun Detector Circuit, the Horizontal Amplifier circuit and the Timer Circuit. It measures either collector or base voltage of the device under test and eliminates transient voltage on the Collector or Base Terminal.

Low Key Interface <15b>

This circuit is located on the A13 Key Interface board, and consists of the Bus Buffer Circuit, the Address Decoder Circuit, the Rotary Encoder Circuit, the Status Port Circuit and Lower Panel Key and Display Circuit. These circuits interface signals with the A2 CPU board, set up VARIABLE COLLECTOR SUPPLY settings, transfer the status data to the A2 CPU board, control the lower panel LED displays, and transfer the key input data from the lower panel keys.

Front Panel Key Interface <16>

This circuit is located on the A11 Main Key board, and consists of the Bus Buffer Circuit, the Address Decoder Circuit, the Variable Control Circuit, and the Switch Matrix Circuit. These circuits interface signals between the A2 CPU

board and the A12 Sub Key board, set up VERTICAL, HORIZONTAL and STEP AMPLITUDE settings, and control focus and intensity, etc.

**Front Panel LED & Key
<17>**

This circuit is located on the A12 Sub Key board, and consists of the Front Panel Display Circuit and the Front Panel Key Matrix Circuit. The circuit is controlled by the A11 Main Key board, displays the Main Key setting information, and transfers key input data from the key matrix.

Configuration LED <18>

This circuit is located on the A15 Configuration LED board, and consists of LEDs and associated components. LEDs display the CONFIGURATION setting information. When the microprocessor reads address A8030(HEX), the CONFIGURATION key status is read into the microprocessor.

**CRT Output Amplifier
<19>**

This circuit is located on the A18 CRT Output board, and consists of the Horizontal Output Amplifier, the Vertical Output Amplifier, and the Z-axis Amplifier. The Horizontal and Vertical Output Amplifiers convert current signals from the preamplifier of the A5 Display Control board into deflection plate driving voltages for the CRT. The Z-axis Amplifier converts the current signal from the unblanking logic of the A5 Display Control board into the driving voltage for the Grid Bias and DC Restorer Circuit of the A20 H.V. REC board. The Horizontal and Vertical Output Amplifiers are similar, so only the Horizontal Output Amplifier is discussed here.

Power Supply <20>

This circuit is located on the A19 L.V. Supply board and the A27 Primary board. This board consists of the Primary Circuit, the Low-voltage Power Supply Circuit and the Interrupt Generator Circuit. This circuit supplies low voltage power for the 370B and generates the interrupt signals.

H.V. Power Supply <21>

The H.V. Power Supply is located on the A20 H.V. REG board. This circuit consists of the High-voltage Generator Circuit, the High-voltage Regulator Circuit, the Grid Bias and DC Restorer Circuit, the Focus Amplifier and DC Restorer Circuit, the Anode Multiplier Circuit, the Rectifier Filter Circuit and the CRT Circuit. This circuit provides the various high voltage operating potentials required by the CRT, and displays the 370B data.

**GPIB & Printer Interface
<22>**

This circuit is located on the A22 GPIB Interface board. The circuit consists of the Bus Buffer Circuit, the Address Decoder Circuit, the GPIB Address Switch, the GPIB Controller Circuit, the GPIB Bus Driver Circuit, the Printer Controller Circuit and the Printer Bus Driver Circuit. The function of this circuit is to transfer the microprocessor data to the printer and to communicate with other instruments via the bidirectional general purpose interface bus (GPIB). These functions are under control of the microprocessor and the communication handling software, which are located on the A2 CPU board.

- Configuration Relay <23>** The Configuration Circuit is located on the A23 Configuration Relayboard. This circuit consists of two relays. These relays are driven by the CONFIGURATION control.
- LOR Key <24>** This circuit is located on the A14 LOR Key board, and consists of LEDs and associated components. LEDs display the LEFT-RIGHT-STANDBY switch setting information. When the microprocessor reads address A8030(HEX), the LEFT-RIGHT-STANDBY key status is read into the microprocessor. The Warning LED indicates that dangerous voltage may be applied to the collector or base terminals. The Limiter LED indicates that the automatic protection is operating.
- FDD Interface <25>** This circuit is located on the A23 FDD Interface board. The circuit consists of the Bus Buffer Circuit, the Address Decoder Circuit, the FDD Controller Circuit and the FDD Bus Driver Circuit. The function of this circuit is to communicate with the FDD unit.

Maintenance

Maintenance

This section of the manual contains information for performing preventive maintenance, troubleshooting, and corrective maintenance for the 370B Programmable Curve Tracer.

Preventive Maintenance

Preventive maintenance, when performed on a regular basis, can prevent instrument breakdown and may improve the reliability of the instrument. The severity of the environment to which the instrument is subjected will determine the frequency of maintenance. A convenient time to perform preventive maintenance is preceding electrical adjustment of the instrument.

Cabinet Removal



WARNING. *Dangerous potentials exist at several points throughout this instrument. When the instrument is operated with the covers removed, do not touch exposed connections or components. Some transistors have voltages present on the case. Disconnect power before cleaning the instrument or replacing parts.*

The side, top, and bottom cabinet panels provide protection to personnel from operating potentials present within the instrument. In addition, they reduce radiation of electromagnetic interference from the instrument. The cabinet panels are held in place by slotted fasteners. To remove the panels, turn each fastener counterclockwise a quarter turn with a large screwdriver. Lift the panels away from the instrument. Operate the instrument with the panels in place to protect the interior from dust.

Cleaning

The 370B should be cleaned as often as operating conditions require. Accumulation of dirt in the instrument can cause overheating and component breakdown. Dirt on components acts as an insulating blanket and prevents efficient heat dissipation. It also provides an electrical conduction path that may result in instrument failure.



CAUTION. *Avoid the use of chemical cleaning agents that might damage the plastics used in this instrument. Use a non-residue type of cleaner, preferably Isopropyl alcohol or totally denatured ethyl alcohol. Before using any other type of cleaner, consult your Tektronix Service Center or representative.*

Exterior. Loose dust accumulated on the outside of the instrument can be removed with a soft cloth or small brush. The brush is particularly useful for dislodging dirt on and around the front-panel controls. Dirt that remains can be removed with a soft cloth dampened in a mild detergent and water solution. Abrasive cleaners should not be used.

CRT. Clean the plastic light filter, implosion shield, and the CRT face plate with a soft, lint-free cloth dampened with denatured alcohol.

Interior. Cleaning the interior of the instrument should only be occasionally necessary. The best way to clean the interior is to blow off the accumulated dust with dry, low-velocity air (approximately 5 lbs/sq in). Remove any dirt that remains with a soft brush or a cloth dampened with a mild detergent and water solution. A cotton swab is useful for cleaning in narrow spaces, or for cleaning more delicate circuit components.



CAUTION. *Circuit boards and components must be dry before applying power to prevent damage from electrical arcing.*

The high-voltage circuits should receive special attention. Excessive dirt in this area may cause high-voltage arcing and result in improper instrument operation.

Visual Inspection

The 370B should be inspected occasionally for such defects as broken connections, improperly seated semiconductors, damaged or improperly installed circuit boards, and heat-damaged parts. The corrective procedure for most visible defects is obvious; however, particular care must be taken if heat-damaged parts are found. Overheating usually indicates other trouble in the instrument; therefore, correcting the cause of overheating is important to prevent recurrence of the damage.

Semiconductor Checks

Periodic checks of the semiconductors are not recommended. The best check of semiconductor performance is actual operation in the instrument. More details on semiconductors are given under Troubleshooting later in this section.

Periodic Electrical Adjustment

To ensure accurate measurements, check the electrical adjustment of this instrument after each 2000 hours of operation, or annually if used infrequently. In addition, replacement of components may necessitate adjustment of the affected circuits. Complete adjustment instructions are given in Section XXFour, Performance Check and Adjustment. This procedure can be helpful in localizing certain troubles in the instrument, and in some cases, may correct them.

Corrective Maintenance

Corrective maintenance consists of instrument repair. Special techniques required to replace boards in the 370B Programmable Curve Tracer are given here.

Component Removal and Replacement



WARNING. *To avoid electric-shock hazard, always disconnect the instrument from the power source before removing or replacing components or sub-assemblies.*

The exploded-view drawings associated with the Replaceable Mechanical Parts list (located at the rear of this manual) may be helpful in the removal or disassembly of individual components or sub-assemblies.

Preparations for Component Removal and Replacement. Before removing or replacing a component, it may be necessary to open or remove panels, keyboards, etc. The following is the procedure for these preparations.

Cabinet Panel Removal.

1. The 370B has three cabinet panels, top, right, and left.
2. Remove the four cabinet panel retainers from each corner of the 370B rear panel.
3. Remove the top cabinet panel by first removing its securing screw at the rear. Slide the panel back to remove it.
4. Remove the right and left cabinet panels by first removing each securing screw at the rear. Pull each panel back slightly to release it from the front casting. Then, move the top of the panel outward. Remove each panel by either sliding it to the rear or by lifting it from the bottom groove in the main body.
5. Replace cabinet panels in the reverse order of removal.

Rear Panel Removal.

1. Remove the four cabinet panel retainers from each corner of the rear panel.
2. Remove the top, left, and right cabinet panels from the main body of the 370B. (See the Cabinet Panel Removal instructions.)
3. Remove any connector(s) attached to the outside of the rear panel at the IEEE STD 488 PORT, the PRINTER INTERFACE PORT, or the AC INPUT.
4. Remove the six screws securing the rear panel
5. Pull the rear panel out and carefully lower it away from the main body. Do not stretch any connector wires inside the panel.

NOTE. *When removing connectors from a board, tag each one to prevent misconnection while reassembling.*

6. Remove the following connectors from inside the rear panel:

J270 and J274 from the A27 Primary circuit board P16 and P18 from the FL100 Filter.

NOTE. *Remove the A2 CPU and the A3 A/D circuit boards before the next step. (See the Plug-in Boards removal instructions.)*

J220 from the A1 Mother circuit board Both ground wires from the main body chassis.

7. Remove the rear panel.

NOTE. *Removal of the A22 Interface circuit board, the A27 Primary circuit board, or the B100 Cooling Fan is described later in this section. To remove one of these circuit boards or the fan from the rear panel, see the removal instructions for that component.*

8. Replace the rear panel in the reverse order of removal.

Connector Replacement.

1. The 370B uses many types of connectors; some of them are very similar in appearance. Tag each connector before removing to avoid confusing one connector with another.
2. Some connectors have latches to prevent erroneous removal during operation. Release these latches when disconnecting them.
3. Be sure to properly orient each connector when reconnecting it.



CAUTION. *Some connectors are symmetrical. These are indexed by a mark that denotes pin 1.*

Drawer Unit Removal.

1. Remove the right and left cabinet panels from the main body.
2. Remove the eight screws (four flat-head and four round-head) from each of the mounting brackets that secure the drawer unit to the main body. Remove both the right and left mounting brackets.
3. Pull the drawer unit forward away from the 370B.
4. Replace the drawer unit in the reverse order of removal.

NOTE. *Before replacing the left or right mounting bracket, make certain that the label on one access hole is properly aligned with the internal potentiometers. (The brackets are interchangeable and could be installed on the wrong side.)*

Cathode-Ray Tube Removal.

NOTE. Before removing the CRT, be certain that removal is necessary by checking associated circuits.

Remove the Cathode-Ray Tube (CRT) as follows:



WARNING. The CRT may retain a dangerous electrical charge. Before removing the CRT, the anode must be fully discharged by shorting the CRT anode to the chassis. Wait approximately ten minutes and again firmly short the anode to the chassis, then remove the CRT.

Use extreme care when handling a CRT. Breakage of the CRT causes a high-velocity scattering of glass fragments (implosion). Wear protective clothing and safety glasses. Avoid striking the CRT on any object that might cause it to crack or implode. When storing a CRT, place it in a protective carton or face down in a protected location on a smooth surface with a soft mat under the face plate.

1. Remove the rear panel and the top cabinet panel.
2. Loosen the two screws located on both sides of the CRT base-pin until the tension of the springs on these screws is released.
3. Remove the CRT base-pin socket from the rear of the CRT.
4. Disconnect the CRT anode cap from the jack located on the left side of the CRT. Ground the CRT anode to the chassis to dissipate any stored charge remaining in the CRT.
5. Remove the CRT bezel cover from the lower side of the CRT bezel by pulling it off with your finger-nail. Remove the CRT bezel from the front panel by removing the two screws located on the lower side of the bezel.
6. Remove the CRT filter, CRT spacer, and CRT implosion shield from the CRT frame.
7. Remove the four screws located on the inner sides of the frame.
8. Remove the CRT frame by removing the four remaining screws located on the outer sides of the CRT frame. Remove the cushion from the CRT face plate.
9. Remove the graticule illumination lamp assembly from both sides of the CRT.
10. Hold one hand on the CRT face plate and gently pull out the CRT while pushing on the CRT base pins.

Cathode-Ray Tube Replacement.

Replace the Cathode Ray Tube (CRT) as follows:

1. Place four CRT retainers into each guide line located at each corner of the front panel CRT opening.
2. Insert the CRT into the front panel opening and set it firmly against the CRT clamp ring located at the rear of the CRT shield.
3. Clean the CRT face plate and place the A28 and A29 lamp boards on the right and left sides of the CRT, respectively.
4. Replace the CRT cushion. Fasten the CRT frame by fixing four screws located on the outer sides of the CRT frame.
5. Tighten the four screws located on the inner sides of the CRT frame by applying 5 kg/cm (4.3 inch-lb) of torque.
6. Tighten the two screws beside the CRT base until the springs on the screws are fully compressed.
7. Replace the CRT base-pin socket on the CRT base pins.
8. Replace the CRT implosion shield, CRT spacer, and CRT filter.
9. Replace the CRT bezel and bezel cover.
10. Reconnect the CRT anode cap.
11. Replace the rear panel and the top cabinet panel.

NOTE. *Replacing the CRT requires re-adjustment of the 370B.*

Boards To determine the location of a circuit board, see Figure 8-1 (page 8-1) in Section of diagrams.

Chassis-Mounted Boards.

Remove and replace all chassis-mounted circuit boards as follows:

1. Disconnect all pin connectors attached to the board, or that connect the board to other parts of the instrument.
2. Remove the securing screws.
3. Remove the chassis-mounted board.
4. Replace chassis-mounted boards in the reverse order of removal. Be sure to match the index arrow or index mark on the multi-pin connector to the corresponding arrow on the board.

NOTE. *To remove a specific circuit board, other circuit boards, chassis parts, or panels may require removal. If such is the case, refer to the removal instructions for that assembly as required.*

A1 Mother Circuit Board. Remove and replace the A1 Mother circuit board as follows:

1. Remove the top, left, and right cabinet panels from the main body.
2. Remove A2, A3, A4, and A5 circuit boards from the main body. (See the Plug-In Boards removal instructions.)
3. Remove the connectors for J10, J12, J110, J180, J190, J220, J400, J410, and J412 from the board.
4. Remove the connector for J60 from the A6 Collector Supply Output circuit board. Remove the connector for J70 from the A7 Step Generator circuit board. Remove the connector for J192 from the A19 L.V. Supply circuit board.
5. Remove the A1 Mother circuit board by removing the eight screws from the board.
6. Replace the A1 Mother circuit board in the reverse order of removal.

A2, A3, A4, A5 Plug-in Boards. Remove and replace the plug-in boards as follows:

1. Remove the top cabinet panel from the main body.
2. Remove the two circuit board retainers.
3. Remove the plug-in board by pulling up on the ejector tab at each end of the board.
4. Replace the plug-in board by aligning the board with the guide slots (components on the side away from the CRT) and inserting it, holding the tabs parallel to the top of the board.
5. Slide the board down through the slots until the edge connectors rest on the bus slot connectors on the A1 Mother board.
6. Push the module down into the bus slot connectors of the A1 Mother board. Press firmly on the board, but do not press on components.
7. Replace the two circuit board retainers.

A method to change from PULSED OFFSET MODE to DC OFFSET MODE.

NOTE. The 370B has two step generator output modes, *PULSED OFFSET MODE* and *DC OFFSET MODE*. The Pulse Offset is the default mode.

It can be changed to DC OFFSET MODE with the jumper J310 on the A3 A/D Board.



CAUTION. *When the device under test (DUT) is Normally-On type transistor, Pulsed Offset will cause additional heat-up for the DUT. For the Normally-On type transistor, DC Offset mode should be used.*



CAUTION. *When the device under test (DUT) is Normally-Off type transistor, DC Offset will cause additional heat-up for the DUT. For the Normally-Off type transistor, Pulsed Offset mode should be used.*

Pulsed Offset. When the measurement mode is set to Single or Sweep, and the Step Generator Voltage is set, the base line offset is applied only in the internal measurement operation interval.

DC Offset. Base line offset voltage is always applied to the DUT in spite of Step Generator mode and the Measurement Mode setting.

1. The A3 A/D BoardA3 is pulled out.
2. Change J310 on the A3 A/D Board Pin 2-3 from Pin 1-2.
(A ▽ mark is attached to pin 1 of J310. Refer to section of diagram (page 8-5)).

A6 Collector Supply Output Circuit Board. Remove and replace the A6 Collector Supply Output circuit board as follows:

1. Remove the top and left cabinet panels from the main body.
2. Remove the electrical shield of the A6 Collector Supply Output circuit board from the main body by removing the four securing screws.
3. Remove the connectors for J60 and J62 from the board and remove the connector for J64 from the A19 L.V. Supply circuit board.
4. Remove the four screws that secure the heat sink of the board to the chassis.
5. Remove the A6 Collector Supply Output circuit board by removing the two screws from the board.
6. Replace the A6 Collector Supply Output circuit board in the reverse order of removal.



CAUTION. *If the transistors with heat sink (Q438, Q440, Q538, Q540) are replaced, make sure that all four insulation washers on the transistors are placed in position. Without these insulators, destructive electric short circuits will occur.*

NOTE. *At the time of replacement, no silicone grease application is required because of the high heat conductivity of the insulation washer.*

A7 Step Generator Circuit Board. Remove and replace the A7 Step Generator circuit board as follows:

1. Remove the right cabinet panel from the main body.
2. Remove the connectors for J70, J72, and J74 from the board.
3. Remove the three screws located on the lower side of the board.
4. Remove the three screws fastening the heat sink of the board to the main body. Support the board as these screws are removed so it does not fall and become damaged.
5. Remove the A7 Step Generator circuit board.
6. Replace the A7 Step Generator circuit board in the reverse order of removal.

A9 L.V. Relay Circuit Board and A35 Looping Circuit Board. The A35 Looping circuit board is located on the A9 L.V. Relay circuit board. Remove and replace the A9 L.V. Relay circuit board and the A35 Looping circuit board as follows:

1. Pull out the drawer unit from the main body of the 370B.
2. Remove the guard box assembly cover from the drawer unit by removing the four screws.

NOTE. *When removing connectors from a board, tag each one to prevent misconnection while reassembling.*

3. Remove the connectors for J80, J82, J89, J90, J91, J92A, J92B, J93, J94, J95, J97, J98, J99, J150, P160, J400, and J410 from the A9 L.V. Relay circuit board. Remove the connector for J90 from the A10 Sense circuit board, which is located to the right of the A9 L.V. Relay circuit board.
4. Remove the six screws from the board, and remove the two screws that secure the heat sink (and board) to the guard box.
5. Remove the A9 L.V. Relay circuit board by grasping the heat sink and lifting the board.
6. Remove the A35 Looping circuit board from the A9 L.V. Relay circuit board by removing solder for J84 and J85 connectors of the A35 Looping circuit board.

NOTE. *The heat sink of the A9 L.V. Relay circuit board is also used as the current return of the floating ground. Therefore secure firmly the two screws securing the heat sink to the guard box when replacing the A9 L.V. Relay circuit board.*

7. Replace the A9 L.V. Relay circuit board and A35 Looping circuit board in the reverse order of removal.

A10 Sense Circuit Board and A13 Key Interface Circuit Board. The A13 Key Interface circuit board is located on the A10 Sense circuit board. Remove and replace the A10 Sense circuit board and A13 Key Interface circuit board as follows:

1. Pull out the drawer unit from the main body of the 370B.
2. Remove the connector for J100 from the A13 Key Interface circuit board.
3. Remove the six screws securing the support bracket for the A24 FDD assembly and the A23 FDD Interface circuit board to the chassis.
4. Remove the bracket with the A24 FDD assembly and A23 FDD Interface circuit board attached.
5. Remove the connector for J142 from the A13 Key Interface circuit board.

NOTE. *Steps 6 and 7 are instructions for removal of the A13 Key Interface board. Proceed to step 8, if you don't need to remove this board.*

6. Remove the two screws from the A13 Key Interface circuit board.

NOTE. *The A10 Sense circuit board and A13 Key Interface circuit board are connected to one another by circuit board mounted connectors J130 and P130. Be careful not to damage the connector when removing and replacing the board.*

7. Pull up the A13 Key Interface circuit board to disconnect the interface connection between the A10 Sense circuit board and A13 Key Interface circuit board, releasing the two board retaining latches with a pair of pliers.
8. Remove the connectors for J414, J415, J416, J417, and J418 from the A10 Sense circuit board.
9. Remove the P411 connector with cable assembly by removing the two screws securing the P411 connector to the drawer unit.

NOTE. *When removing connectors from a board, tag each one to prevent misconnection while reassembling.*

10. Remove the connectors for J90, J104, J140, J301 , J302, J330, and J419 from the A10 Sense circuit board, and remove the connector for P160 from the A9 L.V. Relay circuit board.
11. Remove the screw holding the guard box wire lug (which is located to the front in the guard box) to the guard box chassis.
12. Remove the two flat-head screws securing the heat sink of the A10 Sense circuit board to the right side of the drawer unit.
13. Remove the six screws from the A10 Sense circuit board.
14. Remove the A10 Sense circuit board.
15. Replace the A10 Sense circuit board and the A13 Key Interface circuit board in the reverse order of removal.

NOTE. *When troubleshooting the A10 Sense circuit board below the A13 Key Interface, A13 Key Interface circuit board can be used to stand by connecting P131 on the A13 Key Interface circuit board with J131 on the A10 Sense circuit board.*

A11 Main Key Circuit Board. Remove and replace the A11I Main Key circuit board as follows:

1. Remove the CRT bezel from the front panel, (See step 5 of the Cathode-Ray Tube Removal instructions.)
2. Remove the right cabinet panel from the main body.
3. Remove the two securing screws from the right side of the front panel, and pull out the front panel.
4. Remove the connector for J110 from the A1 Mother circuit board and remove the screw holding the ground wire lug. Then remove the front panel.
5. Pull out the eight knobs (three large and five small) from the front panel.
6. Remove the A11 Main Key circuit board by removing the six screws securing the board.

NOTE. A11 Main Key circuit board and A12 Sub Key circuit board are connected to one another by circuit board mounted connectors J100, J120, P100 and P120. Be careful not to damage the connectors when removing and replacing the board.

7. Replace the A11 Main Key circuit board in the reverse order of removal.

A12 Sub Key Circuit Board. Remove and replace the A12 Sub Key circuit board as follows:

1. Remove the A11 Main Key circuit board. (See the NOTE in the last part of the A11 Main Key Circuit Board removal instructions.)
2. Remove the A12 Sub Key circuit board by removing the six spacer posts from the board.
3. Replace the A12 Sub Key circuit board in the reverse order of removal.

A14 LOR Key Circuit Board. Remove and replace the A14 LOR Key circuit board as follows:

1. Pull out the drawer unit from the main body of the 370B.
2. Remove the protective box from the Test Adapters.
3. Remove the four flat-head screws securing the Test Adapter Mounting Plate assembly to the center front of the drawer unit.
4. Remove the two flat-head screws securing the right front panel assembly to the right front side of the drawer unit.
5. Remove the right front panel assembly by lifting it out.
6. Remove the connector J140 from the A10 Sense circuit board.
7. Remove the A14 LOR Key circuit board by removing the three nuts securing the board.
8. Replace the A14 LOR Key circuit board in the reverse order of removal.

A15 Configuration LED Circuit Board.



CAUTION. When replacing or removing the rotary encoder S200, tighten the mounting nuts to a torque of 8 kg/cm when remounting the encoder. Excessive tightening torque can cause failures.

Remove and replace the A15 Configuration LED circuit board as follows:

1. Pull out the drawer unit from the main body of the 370B.
2. Remove the protective box from the Test Adapters.
3. Remove the four flat-head screws securing the Test Adapter Mounting Plate assembly to the center front of the drawer unit.
4. Remove the two flat-head screws securing the left front panel assembly to the left front side of the drawer unit.
5. Remove the left front panel assembly by lifting it out.
6. Remove the connectors for J200 and J210 from the board. Remove the connector for J150 from the A9 L.V. Relay circuit board.
7. Remove the A15 Configuration LED circuit board by removing the two nuts securing the board.
8. Replace the A15 Configuration LED circuit board in the reverse order of removal.

A18 CRT Output Circuit Board. Remove and replace the A18 CRT Output circuit board as follows:

1. Remove the top cabinet panel from the main body of the 370B.
2. Remove the (plastic) insulator by removing its four securing screws from the A18 CRT Output circuit board.
3. Remove the connectors for J180, J182, J184, and J186 from the board.
4. Remove the A18 CRT Output circuit board by removing the four spacer posts from the board.
5. Replace the A18 CRT Output circuit board in the reverse order of removal.

A19 L.V. Supply Circuit Board. Remove and replace the A19 L.V. Supply Circuit board as follows:

1. Remove the top, left, and right cabinet panels from the main body.
2. Remove the rear panel. (See the Rear Panel Removal instructions.)

NOTE. When removing connectors from a board, tag each one to prevent misconnection while reassembling.

3. Remove the connectors for J64, J72, J190, J192, J194, J196, J198, J280, and J290 from the board.
4. Remove the three screws that secure the heat sink of the A19 L.V. Supply circuit board to the chassis.
5. Remove the A19 L.V. Supply circuit board by removing its three securing screws from the rear edge of the board.
6. Replace the A19 L.V. Supply circuit board in the reverse order of removal.

A20 H.V. Regulator Circuit Board. Remove and replace the A20 H.V. Regulator circuit board as follows:

1. Remove the left cabinet panel from the main body.
2. Remove the shield covering the A20 H.V. Regulator circuit board from the main body by removing the four securing screws.
3. Remove the retainer, that holds the transistor on the board to the chassis, by removing its screw.



WARNING. *The CRT anode circuit retains up to 2400 Volt of charge. Be sure the anode cap is completely grounded to the chassis before handling the circuit board.*

4. Remove the CRT anode cap from the jack on the left side of the CRT.
Ground the CRT anode cap to the chassis to dispel any stored charge.
5. Remove the connectors for J182, J194, and J200 from the board.
6. Remove the A20 H.V. Regulator circuit board by removing the four screws from the corners of the board.
7. Replace the A20 H.V. Regulator circuit board in the reverse order of removal.

A22 Interface Circuit Board. Remove and replace the A22 Interface circuit board as follows:

1. Remove the A2 CPU and the A3 A/D circuit boards. (See the A2, A3, A4, and A5 Plug-in Circuit Board removal instructions.)
2. Remove the connector for J220 from the A1 Mother circuit board.
3. Remove the four screws that secure the IEEE STD 488 PORT connector and the PRINTER INTERFACE PORT connector to the rear panel.

4. Remove the rear panel. (See the Rear Panel Removal instructions.)
5. Remove the A22 Interface circuit board and its (plastic) insulation cover by removing the four securing screws from the board.
6. Replace the A22 Interface circuit board in the reverse order of removal.

A23 FDD Interface Circuit Board. Remove and replace the A23 FDD Interface circuit board as follows:

1. Pull out the drawer unit from the main body of the 370B.
2. Remove the connector for J100 from the A13 Key Interface circuit board.
3. Remove the connector (through the W200 on the A23 FDD Interface circuit board) from the FDD assembly.
4. Remove the A23 FDD Interface circuit board by removing the four securing screws from the board.
5. Replace the A23 FDD Interface circuit board in the reverse order of removal.

A27 Primary Circuit Board. Remove and replace the A27 Primary circuit board as follows:

1. Remove the rear panel. (See the Rear Panel Removal instructions.)
2. Remove the connectors for J270, J272, and J274 from the board.

NOTE. Removal of connector J272 may be difficult with the (plastic) insulation cover installed over the board. The upper corner of the cover may keep one of the connector's latches from releasing. Remove the cover first if this problem occurs.

3. Remove the (plastic) insulation cover and the A27 Primary circuit board by removing the four securing screws from the board.
4. Replace the A27 Primary circuit board in the reverse order of removal.

A28, A29 Graticule Illumination Lamp Circuit Board. Remove and replace A28 and A29 Graticule Illumination Lamp circuit boards as follows:

1. Remove the CRT bezel cover from the lower side of the CRT bezel by pulling it off with your fingernail. Remove the CRT bezel from the front panel by removing the two screws located on the lower side of the bezel.
2. Remove the (blue) CRT filter, the CRT spacer, and the CRT implosion shield from the CRT frame.

3. Remove the CRT frame by first removing the four round head screws from the inner sides of the frame. Then remove the four flat-head screws from the outer sides of the CRT frame.
4. Remove the top cabinet panel.
5. Remove connector(s) J280 and/or J290 from the A19 L.V. Supply circuit board.
6. Remove the (internal scale illumination) light reflector, the light reflector retainer, and the retainer spring by pulling them out from alongside the CRT face plate.
7. Remove the A28 or A29 Graticule Illumination Lamp circuit board by removing the two screws that secure the board in place.
8. Replace the A28 or A29 Graticule Illumination Lamp circuit board in the reverse order of removal.

A33 Configuration Relay Circuit Board. Remove and replace the A33 Configuration Relay circuit board as follows:

1. Remove the right front panel assembly. (See step 1 through 5 of the A14 LOR Key circuit board removal instructions.)

NOTE. *When removing connectors from a board, tag each one to prevent misconnection while reassembling.*

2. Remove the connectors for J102, J103, and J104 from the board.
3. Remove the connectors for J302, J330, and J419 from the A10 Sense circuit board.
4. Remove the A33 Configuration Relay circuit board by removing the four screws from the board.
5. Replace the A33 Configuration Relay circuit board in the reverse order of removal.

A34 LOR Relay Circuit Board. Remove and replace the A34 LOR Relay circuit board as follows:

1. Remove the A9 L.V. Relay circuit board. (See the A9 L.V. Relay Circuit Board removal instructions.)
2. Remove the two screws securing the wires to J91 and J95. Remove the connector for J301 from the A10 Sense circuit board.

3. Remove the A31 Relay circuit board by removing the six screws securing the relays on the board to the guard box chassis.
4. Replace the A34 LOR Relay circuit board in the reverse order of removal.

A24 Floppy Disk Drive Assembly. Remove and replace the A24 FDD assembly as follows:

1. Pull out the drawer unit from the main body of the 370B.
2. Remove the connector (through the W200 on the A23 FDD Interface circuit board) from the A24 FDD assembly.
3. Remove the A24 FDD assembly by removing the four securing screws from the FDD assembly.
4. Replace the A24 FDD assembly in the reverse order of removal.

H.V. Relay Module. Remove and replace the H.V. Relay module as follows:

1. Remove the A9 L.V. Relay circuit board. (See the A9 L.V. Relay Circuit Board removal instructions.)
2. Remove the four screws securing the wires to J8, J11, J12, and J13 on the Series Resistor module.
3. Remove the H.V. Relay module by removing the four screws securing the H.V. Relay module to the guard box chassis.
4. Replace the H.V. Relay module in the reverse order of removal.

NOTE. See the label on the Series Resistor module showing the destination of each wire and connector.

Series Resistor Module. Remove and replace the Series Resistor module as follows:

1. Remove the A9 L.V. Relay circuit board. (See the A9 L.V. Relay Circuit Board removal instructions.)

NOTE. When removing connectors from a board, tag each one to prevent misconnection while reassembling.

2. Remove the six screws securing the wires to J1, J2, J8, J 11, J12, and J13 on the Series Resistor module. Remove the two screws securing the wires to J91

and J95 on the A34 LOR Relay circuit board. Remove the screw securing the wire to J1 on the Input Relay module.

3. Remove the nut holding the guard box wire lug.
4. Remove the Series Resistor module by removing the four screws securing the module to the guard box chassis.
5. Replace the Series Resistor module in the reverse order of removal.

NOTE. See the label on the Series Resistor module showing the destination of each wire and connector.

Input Relay Module. Remove and replace the Input Relay module as follows:

1. Perform parts 1 through 4 of the removal instructions for the A10 Sense circuit board.
2. Remove the three screws securing the wires to J1, J3, and J4 on the Input Relay module.
3. Remove the Input Relay module and the shield by removing the four screws.
4. Replace the Input Relay module in the reverse order of removal.

NOTE. See the label on the Input Relay module showing the destination of each wire and connector.

Cooling Fan. Remove and replace the Cooling Fan (B100) as follows:

1. Remove the rear panel. (See the Rear Panel Removal instructions.)
2. Remove the protective cover and remove the connector for J272 from the A27 Primary Circuit board.
3. Remove the Cooling Fan together with the fan cover, filter, and fan guard by removing four screws and nuts.

NOTE. Before reinstalling the cooling fan, be certain that the J272 wires are at the bottom left corner (as facing the rear). Also check that the air flow arrow marked on the fan housing is pointing toward the inside of the 370B.

4. Replace the Cooling Fan in the reverse order of removal.

Line Fuse. The line fuse used in the 370B is located within the filter unit on the rear panel. Replace the line fuse only with one of proper type and rating.

Remove and replace the line fuse as follows:

1. Remove the AC power cable connector from the line filter housing in the rear panel.
2. Remove the fuse cover by pulling it out from the line filter. Insert some flat-edged tool (such as a straight-slot, screw-driver blade tip) into the small groove in the outer left side of the housing. Use the tool to pull, or pry, the fuse cover loose.
3. Remove the line fuse from its fuse cover.
4. Replace the line fuse in the reverse order of removal.

Semiconductors. Do not replace semiconductors unless actually defective. If removed from their sockets during routine maintenance, return them to their original sockets. Unnecessary replacement of semiconductors may affect the adjustment of the instrument. When semiconductors are replaced, check the operation of circuits that may be affected.



WARNING. *To avoid electric shock hazard, always disconnect the 370B from the power source before removing or replacing components.*

Replacement semiconductors should be of the original type or a direct replacement. When removing soldered-on transistors, use a solder-removing wick to remove the solder from the circuit board pads.

An extracting tool should be used to remove the in-line integrated circuits to prevent damaging the pins. This tool is available from Tektronix, Inc.; order Tektronix part 003-0619-00.

If an extracting tool is not available, use care to avoid damaging the pins. Pull slowly and evenly on both ends of the integrated circuit. Try to avoid disengaging one end from the socket before the other.

Adjustment After Repair

After any electrical component has been replaced, the adjustment of that particular circuit should be checked, as well as the adjustment of any closely related circuits.

Diagnostic Routines

The 370B has four diagnostic routines: Two Power-on Diagnostic routines, a User Initiated Diagnostic routine, and GPIB diagnostic routine.

Power On Diagnostic Routines. At power on, the 370B runs the Power On Diagnostic routine to execute the following tests:

- Boot ROM check
- System RAM check
- Display RAM check
- Acquisition RAM check
- Push button test

After completion of Power on Diagnostic routines, the 370B displays a “SELFTTEST PASS” message at the error message area of the CRT and sets the initial settings.

If the 370B is turned on with the FAST/SHIFT key pressed, a more detailed Power On Diagnostic routine is made, in the following order:

- Boot ROM check
- System RAM check
- Display RAM check
- Acquisition RAM check
- LED check
- Display quality check
- Push button test

To exit this diagnostic routine, press the **FAST/SHIFT** button.

■ System ROM Check

After confirming that the boot ROMs are in the correct sockets, the 370B diagnoses the boot ROMs by checksum.

If a boot ROM fatal error is found, (such as misinsertion) the memory index display blinks with 0 and 1.

When checksum error is found, the error message is displayed on the error message area of the CRT. The format of this messages is as follows: ROM 000X

When X is the hexadecimal number whose bit 1 through bit 4 respectively indicates the error status of boot ROMs.

■ **System RAM Check**

The 370B checks the system RAM by read/write operation. If a system RAM fatal error is found (such as bus shorted), the memory index display blinks with 0 and 2.

When read/write errors are found, the error message is displayed on the error message area of the CRT. The format of this message is as follows:

RAM XXXXX YYYY

Where XXXXX is a hexadecimal representation of the address of the RAM in error, and YYYY is a hexadecimal representation of error bits in that address (for example, error message “RAM 00000 0018” indicates that a read/write error is detected in bit 4 and bit 5 of the system RAM at address 00000).

In the above cases, the 370B does not advance the diagnostics routine.

■ **Display RAM Check**

The 370B checks the Display RAM by read/write operation.

If a read/write error is found (such as bus shorted), the memory index display blinks with 0 and 3, and the 370A does not advance the diagnostics routine.

■ **Acquisition RAM Check**

The 370B checks the Acquisition RAM by a read/write operation.

If a read/write error is found (such as bus shorted), the memory index display blinks with 0 and 4, and the 370B does not advance the diagnostics routine.

Table 4-1 shows the Power-on System Error Messages displayed on the memory index display.

■ **Acquisition ROM Check**

The 370B checks the Flash ROM by checksum.

When a Flash ROM fatal error is founded(such as bus shorted), the memory index display alternately blinks 0 and 5, and the 370B does not advance to the next routine.

Table 4- 1: Power-on System Error Messages

Display	Description
0/1 (blink)	System ROM error (e.g., misinsertion)
0/2 (blink)	System RAM error (e.g., bus shorted)
0/3 (blink)	Display RAM Read/Write error (e.g., bus shorted)

Table 4-1: Power-on System Error Messages (Cont.)

Display	Description
0/4 (blink)	Acquisition RAM Read/Write error (e.g., bus shorted)
0/5 (blink)	Flash ROM error (e.g., bus shorted)

- **LED Check**

The 370B turns on all front-panel LEDs sequentially for visual check.

- **Display Quality Check**

The 370B displays the Logo mark , and a CRT adjustment pattern on the CRT for CRT control adjustment. For the implementation of this adjustment pattern, refer to Section of Performance Verification.

Pressing the **FAST/SHIFT** button exits this routine.

- **Push Button Test**

The 370B executes push button test (FAST/SHIFT button is not tested in this case). If an error is found, the error message is displayed at the bottom of the CRT. The Error Message is indicated by the following format:

<STRING> KEY ERROR

<STRING> identifies the front panel control as listed in Table 4-2.

The following message appears on the text area of the CRT simultaneously with the above error message:

PRESS FAST KEY TO GO ON

You can ignore the displayed error and push the FAST/SHIFT button to carry out the measurement, but the displayed key function will not necessarily occur correctly.

Table 4-2: Front Panel Control Identification

Control	Message
Display NON STORE	NON STORE
Display STORE	STORE
Display REF	REF
Display VIEW	VIEW
Display ENTER	ENTER
Display INVERT	INVERT

Table 4-2: Front Panel Control Identification (Cont.)

Control	Message
MEMORY up	MEMORY up
MEMORY down	MEMORY down
Setup SAVE	SAVE
Setup RECALL	RECALL
MAX PEAK VOLTS up	PEAK VOLTS up
MAX PEAK VOLTS down	PEAK VOLTS down
MAX PEAK POWER WATTS up	PEAK WATTS up
MAX PEAK POWER WATTS down	PEAK WATTS down
Collector Supply POLARITY up	POLARITY up
Collector Supply POLARITY down	POLARITY down
HARDCOPY	HARDCOPY
GPIB PLOT	PLOT
ACQ MODE (STORE MODE) up	ACQ MODE up
ACQ MODE (STORE MODE) down	ACQ MODE down
Measurement REPEAT	REPEAT
Measurement SINGLE	SINGLE
Measurement SWEEP	SWEEP
MAG	MAG
FAST/SHIFT	FAST/SHIFT
NUMBER OF STEPS up	# OF STEPS up
NUMBER OF STEPS down	# OF STEPS down
Step Generator VOLTAGE	VOLTAGE
Step Generator CURRENT	CURRENT
Step Generator OFFSET OPPOSE	OPPOSE
Step Generator OFFSET AID	AID
Step Generator POLARITY	STEP POLARITY
Step Generator MULTI	STEP MULTI
Step Generator PULSE	PULSE up
AUX up	AUX up
AUX down	AUX down
CURSOR Mode up	CURSOR up
CURSOR Mode down	CURSOR down
Position CURSOR	CURSOR

Table 4-2: Front Panel Control Identification (Cont.)

Control	Message
Position DISPLAY	DISPLAY
Position Control up	POSITION up
Position Control left	POSITION left
Position Control down	POSITION down
Position Control right	POSITION right
CONFIGURATION up	CONFIGURATION up
CONFIGURATION down	CONFIGURATION down
LEFT	LEFT
STANDBY	STANDBY
RIGHT	RIGHT
INTERLOCK	COVER ON COVER OFF
VERTICAL CURRENT/DIV	VERTICAL XX (0 - 16)
HORIZONTAL VOLTS/DIV	HORIZONTAL XX (0 - 16)
STEP AMPLITUDE	STEP AMP XX (0 - 16)
VARIABLE COLLECTOR SUPPLY	VARIABLE XX (0 - 25)
OUTPUTS	OUTPUT ENABLE OUTPUT DISABLE
PROTECTIVE COVER	COVER ON COVER OFF

■ User Initiated Diagnostic Routine

Pressing both the FAST/SHIFT button and Position DISPLAY button enters the Users Initiated Diagnostic routine. This routine displays a number or message that corresponds to the front panel push button or rotary switch pressed or rotated. Thus, you can diagnose whether the front panel controls are operating normally. Table 4-2 lists the buttons, switches and associated messages. To exit this routine, press both the FAST/SHIFT button and the Position DISPLAY button again.

■ GPIB Diagnostic Routine

The GPIB TEST? command initiates the 370B boot ROM and RAM diagnostic routines. The 370B responds to this command by returning boot ROM and RAM information to the controller in the following format:

```
TEST ROM:000X (ROM error code)
RAM:YYYY (RAM error code)
```

The TEST query response consists of two hexadecimal numbers that indicate if a ROM or RAM IC was found to be defective. These numbers must be translated to the binary equivalent to determine the ROM and RAM locations. (If an ROMs and RAMs are good, the TEST query response is ROM:0000, RAM:0000.)

Performance Verification

Performance Verification

The Performance Check and Adjustment Procedure:

- Checks key electrical specifications
- Provides instructions for determining whether adjustment is necessary
- Provides instructions for making all internal adjustments
- Provides optional functional check instructions

Adjustment Interval. To maintain instrument accuracy, check performance every 2000 hours of operation or annually if used infrequently.

NOTE. *The Performance Check and Adjustment Procedure is a multipurpose procedure. Time can be saved by performing only those steps necessary for your application. Carefully read Table 5-1 to select the appropriate procedure option for the task to be performed.*

Table 5- 1: Performance Check and Adjustment Procedure Options

Task	Procedure Options
Performance Check (Checking key electrical specifications)	<p>Perform the Power-Up Sequence at the beginning of the Performance Check and Adjustment Procedure.</p> <p>Perform those steps with titles beginning with “Checking” and identified with a ✓ in the bar above the heading (see the Procedure Index at the beginning of the procedure).</p> <p>NOTE: If a “Checking” step also contains the word “Adjusting” in the title and a † in the bar above the title, ignore those parts of the step with adjustment instructions.</p>
Adjustment	<p>Perform the Power-Up Sequence at the beginning of the Performance Check and Adjustment Procedure.</p> <p>Perform only those steps with “Adjusting” in the title and a † in the bar above the title (see the Procedure Index at the beginning of the procedure).</p> <p>NOTE: Perform all parts of these adjustment steps; most adjustments are preceded by instructions for determining whether adjustment is necessary and followed by instructions for verifying that the adjustment was correctly performed.</p>
Performance Check and Adjustment	<p>Perform the Power-Up Sequence at the beginning of the Performance Check and Adjustment Procedure.</p> <p>Perform all steps in the procedure with a † or a ✓ (or both) in the bar above the step title (see the Procedure Index at the beginning of the procedure).</p> <p>NOTE: Steps for “Examining” characteristics only (i.e., those with no “Checking” or “Adjusting” instructions included) are not necessary for checking specifications or making adjustments.</p>
Partial Performance Check or Adjustment	<p>Perform the Power-Up Sequence at the beginning of the Performance Check and Adjustment Procedure.</p> <p>Perform the desired steps (e.g., A1, B3, etc.) using the SETUP CONDITIONS at the beginning of each step.</p>
Functional Check of Front Panel Controls and Connectors	Perform the First Time Operation procedure in the 370B User Manual.
Complete Functional Check	<p>Perform the Power-Up Sequence at the beginning of the Performance Check and Adjustment Procedure.</p> <p>Perform only those steps with titles beginning with “Checking” or “Examining”.</p> <p>NOTE: If a “Checking or an Examining step also contains the word “Adjusting” in the title and a † in the bar above the title, ignore those parts of the step with adjustment instructions.</p>

Before making adjustments, thoroughly clean and inspect the 370B instrument as instructed in the Maintenance section of this manual.

Using Procedure

The following aids are used in this procedure:

Performance Check Summary. The Performance Check Summary lists key characteristics checked in the procedure and the procedure steps in which they are checked. It also indicates which steps contain adjustments which may affect the specified performance of characteristics.

Power-Up Sequence. The Power-Up Sequence ensures that operating conditions are stable and repeatable, and must be performed before any complete or partial procedure is performed.

Initializing the 370B. The 370B is initialized at the beginning of most the 370B procedure steps to prevent the carry-over of inappropriate setup conditions from previous steps. Initialization also allows each step to be performed independently if only portions of the procedure are performed.

Subsection Headings. The procedure is divided into subsections by major circuit function. For example: A. Power Supply, B. CRT, etc. Each subsection contains steps to check or adjust characteristics of that major circuit.

Step Titles and Title Bars. The title of each step begins with “checking adjusting” or “examining”, or a combination of these words.

- Checking indicates that an electrical specification is checked.
- Adjusting indicates that instructions are given to make one or more internal adjustments.
- Examining indicates that a functional check of the circuit is performed and that no electrical specifications are checked.

Each step with instructions for checking and/or adjusting instrument characteristics has a title bar positioned over the step title. The title bar contains a ✓ and/or a † to quickly identify the purpose of the step.

Specifications. All steps that check specifications list those specifications immediately after the step title.

Setup Conditions. Each step has setup conditions enclosed in a box, which include all equipment, connections, and control settings necessary to begin the step.

Parts of Steps. Each step is composed of sequential parts with alphabetic indexing. The parts are arranged into functional groups so that, for instance, if a performance check is being performed, adjustment instructions may be skipped.

Performance Check Summary

Table 5-2 lists key characteristics checked in this procedure and the steps in which they are checked. Also listed are steps containing adjustment instructions which may affect a characteristic's specified performance. The specifications for characteristics listed in Table 5-2 are given at the beginning of the procedure step in which they are checked.

Table 5-2: Performance Check Summary



Characteristic	Checked	Adjusted
Collector Supply		
POLARITY	Not Specified; examined in G5	
+ LEAKAGE	Not Specified; examined in G5	
+ DC	Not Specified; examined in G5	
+ 	Not Specified; examined in G5	
AC	Not Specified; examined in G5	
- 	Not Specified; examined in G5	
- DC	Not Specified; examined in G5	
- LEAKAGE	Not Specified; examined in G5	
DC Mode Ripple	G3	
Max Peak Volts	G2	G2
Voltage Accuracy	G2	
Range	G2	
Max Peak Current	G4	
Peak Power Watts	G2, G4	G2
Variable Collector 0 to 100.0 % Supply	Not Specified; examined in G5	
Safety Interlocks	Not Specified; examined in G5	
Warning Indicator	Not Specified; examined in G5	
Limiter Indicator	Not Specified; examined in G6, G7	
Looping Compensation	Not Specified; examined in C7	C7
Voltage Limiter	G6	
Current Limiter	G7	

Table 5-2: Performance Check Summary (Cont.)

Characteristic	Checked	Adjusted
STEP GENERATOR		
Accuracy (Current or voltage steps including offset)		
Incremental	F6, F7, F8,	F1, F2
Absolute	F4, F5, F9, F10	F1, F2
Offset Control Range	F4, F5	
Resolution	F4	
Current Mode		
Amplitude Range	F5	
Max Current	F10	
Max Opposing Volts	F13	
Output Impedance	F3	
Voltage Mode		
Amplitude switch range	F4	
Max voltage	F9	
Max opposing	F11	
Pulsed Steps	F13	
Steps and Offset Polarity	F14	
Number Of Steps	F6, F8	
AUX SUPPLY		
Range (and resolution)	H1	
Accuracy	H1	
Ripple Plus Noise	H2	

Table 5-2: Performance Check Summary (Cont.)

Characteristic	Checked	Adjusted
NON STORAGE VERTICAL DEFLECTION SYSTEM		
Maximum Displayed Noise or Ripple	E7	C7
Calibrator Voltage	Not Specified; examined in C1	
DIGITAL STORAGE VERTICAL ACQUISITION		
Collector Current		
Range	E6a, E6b	
Accuracy	E6a, E6b	E1, E2
Emitter Current		
Range	E5	
Accuracy	E5	E1, E3
Display Offset		
Accuracy	C6	C2, C3, C4
Display MAG X10 Accuracy	E5	
Display Invert Accuracy	C5	
NON STORAGE HORIZONTAL DEFLECTION SYSTEM		
Collector Volts		
Displayed Noise	D6	
Base/Emitter Volts		
Input Impedance	D5	
Displayed Noise	D6	
Calibrator Voltage	Not Specified; examined in C1	
DIGITAL STORAGE HORIZONTAL ACQUISITION		
Collector Volts		
Range	D4	
Accuracy	D4	D1
Base/Emitter Volts		
Range	D3	
Accuracy	D3	D1
Display Offset		
Range	C6	
Accuracy	C6	C2, C3, C4
Display MAG X10 Accuracy	D2	
Display Invert Accuracy	C5	

Table 5-2: Performance Check Summary (Cont.)

Characteristic	Checked	Adjusted
CRT		
Cathode Voltage	Not Specified; examined in B1	
Intensity	Not Specified; examined in B2	B2
Astigmatism and Focus	Not Specified; examined in B3	B3
Intensity Controls	Not Specified; examined in B4, B5, B6	
Geometry	C4	C4
Orthogonality	C4	C4
POWER SUPPLY		
Deviation	Not Specified; examined in A1	
Ripple	Not Specified; examined in A1	
PLL	A2	
Reference Voltage	A3	A3

Power-Up Sequence

The performance of this instrument can be checked at any ambient temperature from +10 °C to +40 °C unless otherwise stated. Adjustment must be made at an ambient temperature from +20 °C to +30 °C for the specified tolerances to apply.



WARNING. Adjustment of the 370B should only be performed by a qualified service technician.

1. Check that the 370B has been set for the proper power source, and that a suitable power cord has been attached.
2. Remove the 370B cabinet panels to gain access to internal adjustment and test points.

For instructions on cabinet panel removal, refer to the description under the heading COMPONENT REMOVAL AND REPLACEMENT in Section 4 of this manual.



WARNING. Use extreme care when operating the 370B with the covers removed, due to the line voltage, high voltage, and high current levels present.

3. Connect the 370B to a suitable power source.

4. Press the **POWER** button and allow at least 20 minutes warmup before proceeding.

Initializing the 370B

The following procedure saves the power-up default 370B settings for use when the procedure calls for you to “Initialize the 370B”.

1. Press the **SETUP SAVE** button to store the default settings in memory location 1.

These default settings plus the manual initialization settings are used as starting settings throughout this procedure, except as noted otherwise.

2. Now, to Initialize the 370B:
 - a. Press the **SETUP RECALL** button (with the MEMORY index set to location 1).
 - b. Make the additional manual settings:

OUTPUTS	ENABLED
Protective Cover	Closed

The power-up default settings are as follows:

DISPLAY	
Mode	STORE
VERTICAL	2 A COLLECTOR
HORIZONTAL	2 V COLLECTOR
INVERT	Off
COLLECTOR SUPPLY	
MAX PEAK VOLTS	16
MAX PEAK POWER WATTS	0.08
POLARITY	+ 
STEP GENERATOR	
Mode	CURRENT
STEP AMPLITUDE	50 nA
NUMBER OF STEPS	5
OFFSET	0.0 nA
POLARITY	+
INVERT	Off
STEP MULTI .1X	Off

PULSE	Off
ACQ MODE	NORM
MEASUREMENT	REPEAT
MAG X10	Off
POSITION	CURSOR
CURSOR	OFF
AUX SUPPLY	0.00 V
CONFIGURATION	BASE STEP GEN
VARIABLE COLLECTOR SUPPLY	0 %
RIGHT-LEFT-STANDBY	STANDBY

Test Equipment The test equipment listed in Table 5-3 is required for a complete Performance Check and Adjustment of the instrument. However, complete checking or adjusting may not always be necessary or desirable. You may be satisfied with checking only selected characteristics, thereby reducing the amount of test equipment actually required.

The specifications for test equipment listed in Table 5-3 are the minimum required to check performance requirements of the 370B. Detailed operating instructions for test equipment are not given in these procedures; refer to the test equipment instruction manual if more information is needed.

Special Futures Special fixtures are used where they facilitate instrument adjustment. These fixtures are available from Tektronix, Inc. Order by part number from Tektronix Field Offices or representatives.

Test Equipment Alternatives The checks and adjustment procedures are based on the first item of equipment given as an example. When other equipment is substituted, control settings or setups may have to be altered. If the exact item of equipment given as an example in Table 5-3 is not available, first check the Minimum Specifications column carefully to see if any other equipment might suffice. Then check the Purpose column to see where this item is used. If used for a performance check or adjustment that is of little or no importance for your measurement requirements, the item and corresponding step(s) can be deleted.

Table 5-3: Test Equipment

Item	Minimum Specification	Purpose	Example of Applicable Test Equipment
1. Test Oscilloscope	Bandwidth, DC to 150 MHz; deflection factor, 2 mV to 5 V/div (with 10X, 10 M Ω probe)	Used to check ripple.	a. Tektronix 2445B 150 MHz Oscilloscope with P6137 Probe. b. Refer to Tektronix Products catalog for compatible equipment.
2. Calibrator	Voltage range: 500.0 mV to 1000 V; Accuracy: 0.1 mV; Resolution: 0.1 mV, Current range: 10.00 μ A to 1.999 A; Accuracy: 0.1%	Supplies a reference voltage to the 370B.	Fluke 5101B
3. Digital Multimeter	4.5 digit DCV: 1000 V, Accuracy: 0.05%; Resolution: 0.1 mV; Input imp: 10,000 M Ω (100 mV, 1 V, 10 V range): DCA: 1.28 A; Accuracy: 0.1 nA; Ω : 25 M Ω ; Accuracy: 0.05%; Resolution; 0.01 Ω	Used throughout the checks and adjustments to measure voltage, current and resistance.	a. Fluke 8505A Option 02A, 03 b. Keithley 195A W/OP 1950
	4.5 digit DCV: 1000 V, Accuracy: 0.05%; Resolution: 0.1 mV; Input Imp: 10 M Ω (20 V range)	Used to examine -2400 V	Tektronix DM501A
4. Tool, Alignment	Combination hex wrench and screwdriver tips for electronics use.	Used to perform internal adjustments.	Tektronix part number 003-0489-00
5. Banana Plugs	Banana plug with cap	Used to hold resistors and probe hooks.	Tektronix part number 134-0016-01 and 134-0198-00
6. Screw Driver	POZIDRIV; length: 8 1/2 inch Point size #1, #2	Used to remove panels and High Voltage shield cover.	Tektronix part number 003-0293-00
7. Patch Cord	Banana Plug-Jack to Banana Plug-Jack	Used throughout the procedure	Tektronix part number 198-5621-00 and 198-5625-00
8. High Voltage Probe	Voltage range: 0 - 3 kV (DC, AC); Accuracy: \pm 1%	Used to examine -2400 V	Fluke 80K-6
9. Test Lead		Used throughout the procedure	Fluke Y8131
10. Resistors	25 M Ω , 0.1%, 1/2 W 2.5 M Ω , 0.1%, 1/2 W 250 k Ω , 0.1%, 1/2 W 1 M Ω , 5%, 1/4 W 10 M Ω , 5%, 1/4 W 100 Ω , 5%, 1/4 W 0.025 Ω , 0.1%, 4 W	To check: • emitter accuracy • collector accuracy in 500 mA, 1 A, 2 A range • horizontal display noise • base input impedance • step generator accuracy in 100 mA and 200 mA range • step generator ripple To adjust: • step generator	Tektronix part number 067-1337-00

Table 5-3: Test Equipment (Cont.)

Item	Minimum Specification	Purpose	Example of Applicable Test Equipment
11. Transistor	2N3904	Used as DUT for acquisition of curve data.	Tektronix part number 151-0190-00
12. Printer		Used to check the printer interface	CBM, model iDP3240
13. Controller	GPIB Support	Used to check the GPIB	a. IBM PC with Tektronix GURU card running BASICA. b. IBM PC with National Instruments PC2 or PC2A card running BASICA. c. Hewlett-Packard 200 or 300 Series Scientific Computer running 200 or 300 BASIC.
14. Floppy Disk	3.5 inch, 2HD	Used to store displayed curve data and instrument settings.	
15. Test Adapter		Used to hold the DUT.	Tektronix A1007
16. Extended Cable		Operate instrument with drawer unit detached.	Tektronix part number 067-0187-00

Power Supply

Equipment Required (see Table 5-3):

- Digital Multimeter
- Test Oscilloscope

A1. Examining Voltage Deviation and Ripple

NOTE. The characteristics examined in this step are examples of typical instrument operation; they are not specifications.

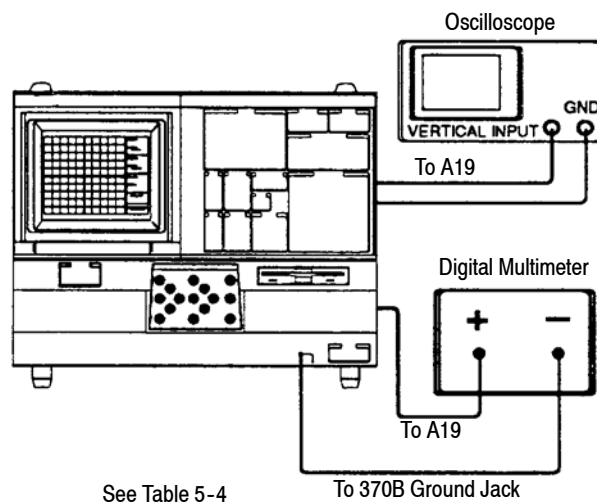

370B settings:

Initialize 370B

Test Equipment Settings:

Digital Multimeter Mode DC Voltage

Test Oscilloscope

Vertical Sensitivity 20 mV/div

Time 5 ms/div

Trigger Auto

Examining Voltage Deviation.

1. Connect the digital multimeter to the +5 test point on the A19 LV Supply board.
2. EXAMINE the digital multimeter reading at the +5 test point and each of the other power supply test points listed in Table 5-4 for voltage levels within the given deviation.

Examining Ripple.

3. Disconnect the digital multimeter and connect the test oscilloscope to the +5 test point.
4. EXAMINE the test oscilloscope display at each of the test points listed in Table 5-4: for ripple displays within the given deviation.

Removing Setup.

5. Disconnect the test oscilloscope.

Table 5-4: Voltage Regulation and Ripple

Voltage	Test Point	Deviation Limits (V)	Ripple (mV)
+5.2 V	+5	+4.99 to +5.41	\leq 200
-12 V	-12	-11.4 to -12.6	\leq 100
+12 V	+12	+11.4 to +12.6	\leq 100
-6.5 V	-6.5	-6.35 to -6.65	\leq 50
+6.5 V	+6.5	+6.35 to +6.65	\leq 50

A2. Adjusting PLL

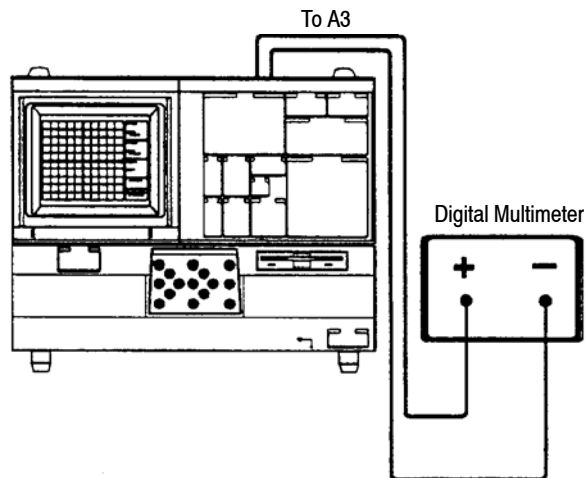

370B settings:

Initialize 370B

Test Equipment Settings:

Digital Multimeter Mode DC Voltage

1. Connect the Digital Multimeter test leads to A-GND test point and 9 pin of U100.
2. In case that the frequency of line power supply is 50 Hz, adjust R473 PLL FREQ-1 adjustment on the A3 A/D board for a digital multimeter readout of 2.2 ± 0.1 V.
3. In case that the frequency of line power supply is 60 Hz, adjust R104 PLL FREQ-1 adjustment on the A3 A/D board for a digital multimeter readout of 3.1 ± 0.1 V.
4. Connect the Digital Multimeter test leads to A-GND test point and 9 pin of U470.
5. In case that the frequency of line power supply is 50 Hz, adjust R473 PLL FREQ-2 adjustment on the A3 A/D board for a digital multimeter readout of 2.2 ± 0.1 V.
6. In case that the frequency of line power supply is 60 Hz, adjust R104 PLL FREQ-2 adjustment on the A3 A/D board for a digital multimeter readout of 3.1 ± 0.1 V.

**A3. Checking the +2 V and
-2 V Reference
Adjusting the +2 V and
-2 V Reference (A19 R500
and R516)**



- The +2 V and -2 V Reference is accurate to within 0.001 V.

NOTE. *The characteristics examined in this step are examples of typical instrument operation; they are not specifications.*

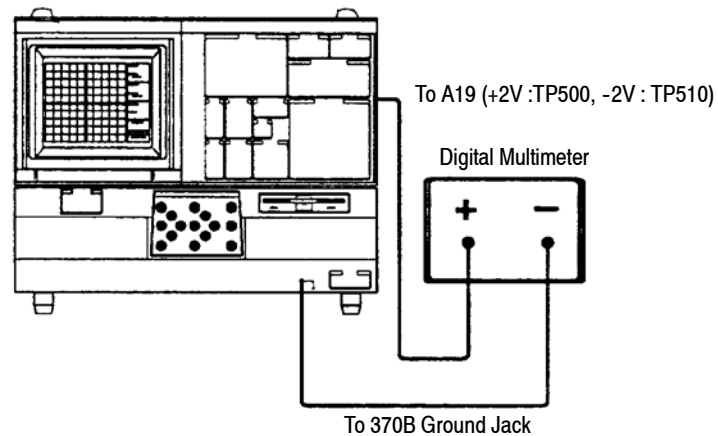

370B settings:

Initialize 370B

Test Equipment Settings:

Digital Multimeter Mode DC Voltage

Checking the +2 V Reference.

1. Connect DMM with TP500 on the A19 LV Supply Board.
2. CHECK for a digital multimeter reading of +1.999 V to +2.001 V.

If not within these limits, the following adjustment is necessary.

Adjusting the +2 V Reference.

3. ADJUST +2 V ADJ on the A19 LV Supply Board, for a digital multimeter reading of +2.000 V.

Checking the -2 V Reference.

4. Connect DMM with TP510 on the A19 LV Supply Board.
5. CHECK for a digital multimeter reading of -1.999 V to -2.001 V.
If not within these limits, perform part d. Adjusting the -2 V Reference
6. ADJUST -2 V ADJ on the A19 LV Supply Board, for a digital multimeter reading of -2.000 V.

Removing the Setup.

7. Disconnect the positive lead of the digital multimeter from the test point.

CRT

Equipment Required (see Table 5-3):

- Digital Multimeter
- High Voltage Probe for Digital Multimeter
- Pozidrive Screwdriver with #1 Point

B1.Examining the -2400 V Cathode Supply

NOTE. The characteristics examined in this procedure are provided as examples of typical instrument operation; they are not specifications.

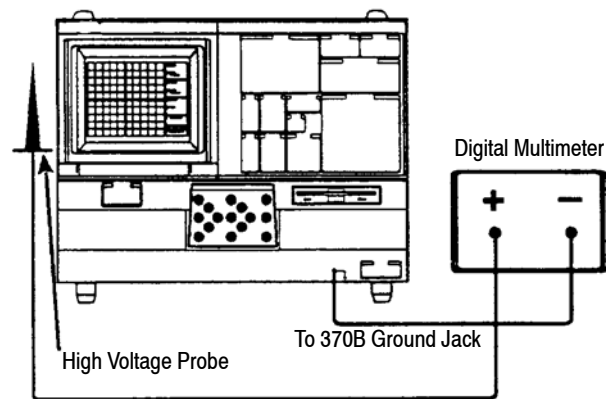

370B settings:

Initialize 370B; then set the following controls as indicated.

INTENSITY

NON STORE

STORE/VIEW Full counterclockwise

Test Equipment settings:

Digital Multimeter with High Voltage Probe

Mode DC Voltage

Removing the High Voltage Shield.



WARNING. To avoid electric shock hazard, be certain the 370B POWER switch is set to OFF before removing or replacing the high voltage shield and connecting the Digital Multimeter to the 370B. Be certain that the Digital Multimeter ground lead is connected to the 370B ground terminal.

1. Change the following 370B setting:

POWER OFF

2. Use a #1 Pozidrive screwdriver to remove the high voltage shield from the left side of the 370B. (There are three shields on the left side; remove the center shield.)

Measuring the Cathode Voltage.

3. Connect the ground lead of High Voltage Probe to chassis ground, and the High Voltage Probe to TP400 on the A20 HV Regulator Board.

4. Change the following 370B setting:

POWER ON

5. EXAMINE the Digital Multimeter for a reading of -2304 V to -2496 V.

Disconnecting the Meter.



WARNING. To avoid electric shock hazard, be certain the 370B POWER switch is set to OFF before disconnecting the Digital Multimeter lead and the high voltage shield.

6. Change the following 370B setting:

POWER OFF

7. Disconnect the High Voltage Probe and Digital Multimeter from the 370B.

Replacing the High Voltage Shield.

8. Replace the high voltage shield.

9. Change the following 370B setting:

POWER ON

B2. Examining CRT Bias Adjusting CRT Bias (A20 R210)

†

NOTE. The characteristics examined in this step are provided as examples of typical instrument operation to aid in the adjustment of R210; they are not specifications.

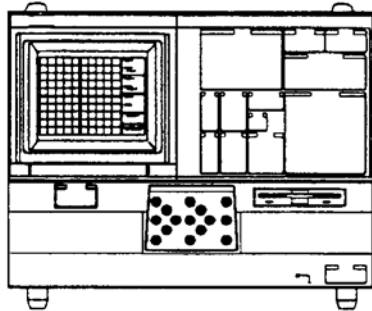

370B settings:

Initialize 370B; then set the following controls as indicated.

DISPLAY

Mode NON STORE

COLLECTOR SUPPLY

POLARITY AC

Examining CRT Bias.

1. Change the following 370B settings:

INTENSITY

NON STORE

STORE/VIEW Fully counterclockwise

READOUT

Cursor Fully counterclockwise

GRAT ILLUM

Fully counterclockwise

2. EXAMINE the CRT for the displayed spot to be barely visible.

If the spot is bright or not visible at all, the following adjustment may be necessary.

Adjusting CRT Bias.

NOTE. R210 can be adjusted through the access hole in the high voltage shield.

3. ADJUST Grid Bias adjustment R210 on the A20 HV Regulator Board until the CRT spot is barely visible.

B3. Examining Astigmatism Adjusting Astig (A18 R420)

†

NOTE. The characteristics examined in this step are provided as examples of typical instrument operation to aid in the adjustment of R420; they are not specifications.

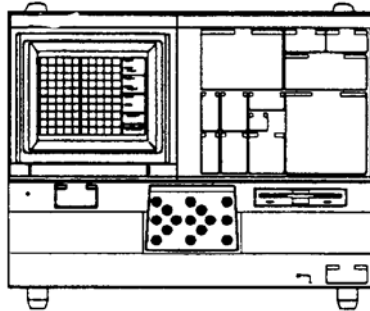

370B settings:

POWER	OFF
FOCUS	Fully counterclockwise

1. While pressing the **FAST/SHIFT** button, set the 370B **POWER** switch to ON. This displays the Frame Test Pattern on the CRT.

Examining Astigmatism.

2. Change the following 370B settings:

INTENSITY

NON STORE

STORE/VIEW

Largest possible displayed
center spot

READOUT

Cursor

Fully counterclockwise

3. EXAMINE the center spot for a circular shape. If the center spot is not circular, the following adjustment may be necessary.

Adjusting Astigmatism.

4. ADJUST ASTIG adjustment R420 on the A18 CRT Output Board for a circular spot shape.

5. Change the following 370B settings:

FOCUS

Clockwise for smallest
possible spot

INTENSITY

NON STORE

STORE/VIEW

Normal Viewing

READOUT

Cursor

Normal Viewing

6. EXAMINE the CRT for the Frame Test Pattern to be similarly in focused.
If the Frame Test Pattern is not similarly focusing, the following adjustment may be necessary.
7. READJUST ASTIG adjustment R420 on the A18 CRT Output Board for slightly compromise between the center dot and the outer frame.

Removing the Setup.

8. Press the **FAST/SHIFT** key to exit the Frame Test Pattern.

B4. Examining NON STORE/STORE/VIEW INTENSITY Operation

NOTE. *The characteristics examined in this step are examples of typical instrument operation; they are not specifications.*

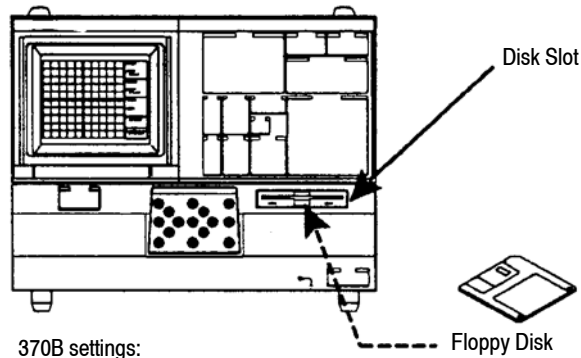

370B settings:
Initialize the 370B; then set the following controls as indicated.

DISPLAY

VERTICAL	STEP GEN
OUTPUTS	ENABLED
VARIABLE COLLECTOR SUPPLY	100 %
Protective Cover	Closed
INTENSITY	
NON STORE	
STORE/VIEW	Normal Viewing

NOTE. *Be sure to use a formatted floppy disk to perform this procedure.*

Entering waveform data

Entering waveform data.

1. Set the MEMORY number to **2**, using the up **MEMORY** button.
2. Press **ENTER**. Examine the display for the “ENTER COMPLETE” message.

Examining NON STORE Intensity.

3. Change the following 370B setting:

DISPLAY	
Mode	NON STORE
VARIABLE COLLECTOR	about 50 %
SUPPLY	

4. EXAMINE the CRT for a continuous increase in NON STORE waveform brightness as the NON STORE/STORE/VIEW INTENSITY control is turned from fully counterclockwise to fully clockwise.

Examining STORE Intensity.

5. Change the following 370B setting:

DISPLAY	
Mode	STORE

6. EXAMINE the CRT for a continuous increase in STORE waveform brightness when the NON STORE/STORE/VIEW INTENSITY control is turned from fully counterclockwise to fully clockwise.

Examining VIEW Intensity.

7. Change the following 370B setting:

DISPLAY	
Mode	VIEW

8. EXAMINE the CRT for a continuous increase in VIEW waveform brightness when the NON STORE/STORE/VIEW INTENSITY control is turned from fully counterclockwise to fully clockwise.

B5. Examining REF INTENSITY Operation

NOTE. The characteristics examined in this step are examples of typical instrument operation; they are not specifications.

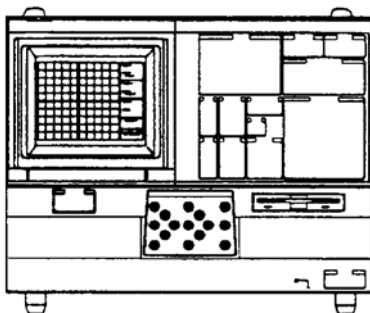

370B settings:

Initialize 370B

1. Press the **REF** button.
2. Change the following 370B setting:

DISPLAY INVERT ON

3. EXAMINE the CRT for a continuous increase in brightness of the viewed trace as the REF INTENSITY control is turned from full counterclockwise to fully clockwise.

B6. Examining READOUT/CURSOR INTENSITY Operation

NOTE. *The characteristics examined in this step are examples of typical instrument operation; they are not specifications.*

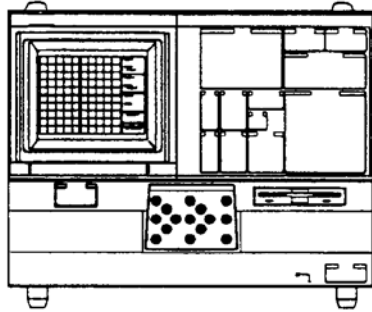

370B settings:

Initialize the 370B; then set the following control as indicated.

CURSOR

Mode	WINDOW
------	--------

1. EXAMINE the display for a continuous increase in readout and cursor brightness as the READOUT/CURSOR INTENSITY control is turned from fully counterclockwise to fully clockwise.
2. Change the following 370B setting:

INTENSITY

READOUT

CURSOR	Normal viewing level
--------	----------------------

Display

Equipment Required (see Table 5-3)

- Digital Multimeter

C1. Examining Calibrator Voltage

NOTE. The characteristics examined in this step are examples of typical instrument operation; they are not specifications.

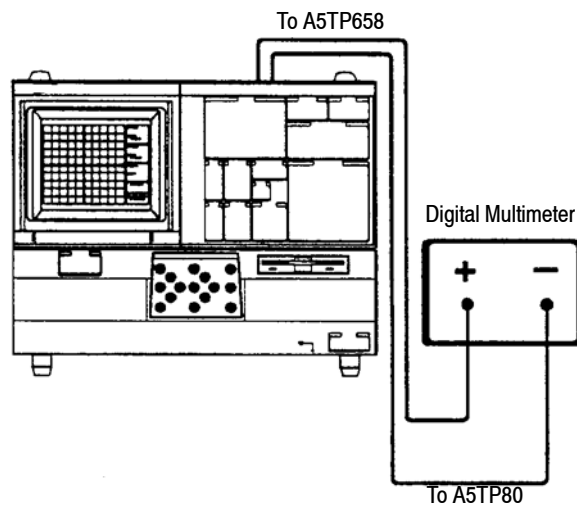

370B settings:

Initialize the 370B

Test Equipment settings:

Digital Multimeter Mode DC Voltage

Examining Horizontal CAL ZERO.

1. Change the following 370B setting:

DISPLAY

Mode

CAL ZERO

CAL ZERO is initiated by pressing the **NON STORE** button while holding down the **FAST/ SHIFT** button.

2. EXAMINE the digital multimeter for a reading between -0.995 V and -1.005 V

Examining Horizontal CAL FULL.

3. Change the following 370B setting:

DISPLAY

Mode CAL FULL

CAL FULL is initiated by pressing the **REF** button while holding down the **FAST/SHIFT** button.

4. EXAMINE the digital multimeter for a reading between $+0.995\text{ V}$ and $+1.005\text{ V}$.
5. Disconnect the digital multimeter positive lead from TP658.

Examining Vertical CAL FULL.

6. Connect the digital multimeter positive lead to TP648 on the A5 Display Control Board.
7. EXAMINE the digital multimeter for a reading between $+0.995\text{ V}$ and $+1.005\text{ V}$.

Examining Vertical CAL ZERO.

8. Change the following 370B setting:

DISPLAY

Mode CAL ZERO

9. EXAMINE the digital multimeter for a reading between -0.995 V and -1.005 V .

Removing the Setup.

10. Change the following 370B setting:

DISPLAY	
Mode	CAL OFF

CAL OFF is initiated by pressing the **STORE** button while holding down the **FAST/SHIFT** button.

11. Disconnect the digital multimeter from TP648 and TP80.

C2. Adjusting V Zero and H Zero (A3R600 and A3R590)

†

NOTE. The characteristics examined in this step are provided as examples of typical instrument operation to aid in the adjustment of R600 and R590; they are not specifications.

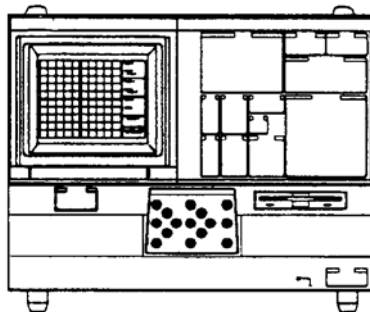

370B settings:

Initialize the 370B; then set the following controls as indicated.

COLLECTOR SUPPLY	AC
POLARITY	
CURSOR	
Mode	DOT
DISPLAY	
Mode	CAL ZERO

CAL ZERO is initiated by pressing the **NON STORE** button while holding down the **FAST/SHIFT** button.

Determining if Adjustment is Necessary.

1. Examine the vertical CURSOR readout for a reading that does not exceed ± 0.06 A and the horizontal CURSOR readout for a reading that does not exceed 0.06 V.

If the CURSOR readouts are not within these limits, the following adjustment is necessary.

Adjust H Zero and V Zero.

2. Press INVERT button in DISPLAY MENU.
3. Adjust R590 so that the horizontal CURSOR readout for a reading may not change.
Adjust R600 so that the vertical CURSOR readout for a reading may not change.

C3. Adjusting Storage Gain (A3R610)

†

NOTE. The characteristics examined in this step are provided as examples of typical instrument operation to aid in the adjustment of R610; they are not specifications.

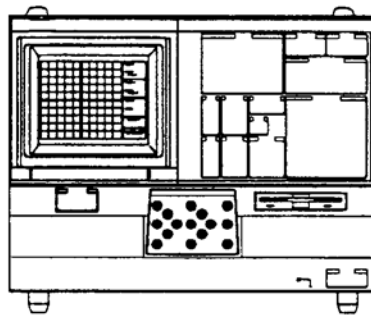
**370B settings:**

Initialize the 370B; then set the following controls as indicated.

DISPLAY

Mode CAL ZERO

CURSOR

Mode DOT

CAL ZERO is initiated by pressing the **NON STORE** button while holding down the **FAST/SHIFT** button.

Determining Adjustment is Necessary.

1. EXAMINE the vertical and horizontal CURSOR readouts for readings of 0.00 ± 0.06 .

If the CURSOR readouts are not within these limits, the following adjustment is necessary.

Adjusting Storage Gain.

2. ADJUST Storage Gain adjustment R610 on the A3 A/D Board for Vertical and Horizontal CURSOR readouts of 0.00.

Examining Storage Gain for CAL FULL.

3. Change the following 370B setting:

DISPLAY	
Mode	CAL FULL

CAL FULL is initiated by pressing the **REF** button while holding down the **FAST/SHIFT** button.

4. EXAMINE the vertical and horizontal CURSOR readout for a reading of 20.00 ± 0.36 .

Removing the Setup.

5. Change the following 370B setting:

DISPLAY	
Mode	CAL OFF

CAL OFF is initiated by pressing the **STORE** button while holding down the **FAST/SHIFT** button.

C4. Checking Orthogonality and Geometry

✓ †

Specifications:

Examining Store Position, Non Store Gain, and D/A Gain

- Orthogonality is 90° within 0.3°.
- Geometry includes two categories: (1) Tilt or bowing is no more than 0.5 minor division. (2) Keystone effect is no more than 0.75 minor division.

Adjusting SX Position (A5 R508), SY Position (A5 R528), D/A Gain (A4 R842), X Gain (A5 R554), Y Gain (A5 R574), Orthogonality (A5 R80), Geom (A18 R410)

NOTE. Characteristics in EXAMINE steps are provided as examples of typical instrument operation to aid in adjustment; they are not specifications.

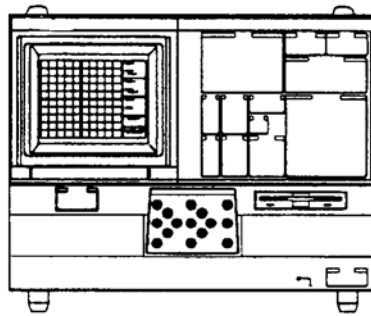

370B settings: NON

Initiating the Test Pattern.

1. Change the following 370B setting:

POWER OFF

2. Hold the **FAST/SHIFT** button depressed and set the 370B POWER to ON.

This initiates the diagnostic routine. The corporate logo first appears, followed by the display test pattern shown in Figure 5-1.

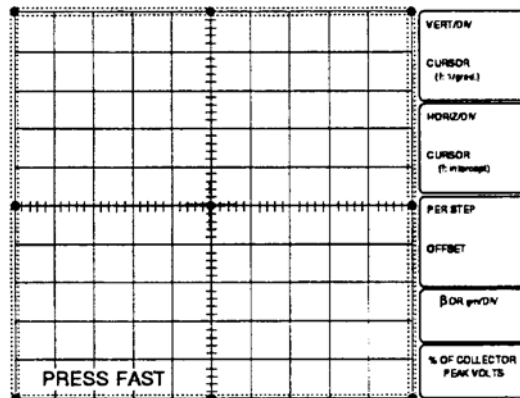

Figure 5- 1: Diagnostic test pattern display

The test pattern consists of the Frame Test Pattern overlaid over the Dot Test Pattern.

3. Turn the **GRAT ILLUM** control fully clockwise for maximum brightness.
4. Set the Frame Test Pattern to the same intensity as the graticule using the Intensity **READOUT/CURSOR** control and set the Dot Test Pattern slightly brighter using the intensity **NON STORE/STORE/VIEW INTENSITY** control.

Examining Store Position.

5. **EXAMINE** the display to determine whether the center cross mark of the Frame Test Pattern aligns with the center dot of the Dot Pattern.

If the pattern centers do not align, the following adjustments are necessary.

Adjusting SY Position and SX Position.

The SX and SY Position controls change the Frame Test Pattern position without affecting the Dot Test Pattern position.

6. **ADJUST** SY Position adjustment R528 and SX Position adjustment R508 on the A5 Display Control Board so that the center cross mark of the Frame Test Pattern conforms to the center dot of the Dot Pattern (not the center of the graticule).

Examining and Adjusting D/A Gain.

7. EXAMINE the display to determine whether the outer eight dots of the Dot Pattern are located between the inner frame and outer frame of the Frame Test Pattern.

If the location is not correct, the following adjustment is necessary.

8. ADJUST D/A Gain adjustment R842 on the A4 Digital Display Board to position the outer eight dots between the inner frame and outer frame of the Frame Test Pattern.

D/A Gain adjusts the size of the Frame Test Pattern without changing the Dot Test Pattern size.

Checking and Adjusting the Display. The Dot and Frame Test Pattern are visual aids for display alignment. Positioning, straightening and sizing of the display involves several adjustments. Three of these adjustment, GEOMETRY, TRACE ROTATION, and ORTHOGONALITY are interactive.

- GEOMETRY adjusts the curvature of the sides, top and bottom of the test pattern:
- TRACE ROTATION tilts the test pattern about a pivot point approximately 2 1/2 divisions from the right side of the graticule on the horizontal center line.
- ORTHOGONALITY changes the test pattern shape from rhombic to rectangular.
- X-GAIN and Y-GAIN change the test pattern from rectangular to square.
- Front-panel POSITION controls change the position of the whole display.

Checking Orthogonality.

9. Change the following 370B settings:

POSITION controls

Vertical and Horizontal	Position the center dot to graticule center.
TRACE ROTATION	Position the three intermediate horizontal dots on the center horizontal graticule line.

10. CHECK that the three intermediate vertical dots conform to the center vertical graticule line within 0.5 minor division.

If the dots do not conform, the following adjustment is necessary.

Adjusting Orthogonality.

11. ADJUST Orthogonality adjustment R80 on the A5 Display Control Board so that the three intermediate vertical dots conform to the center vertical graticule line.

Examining Non-Store Gain.

12. EXAMINE the display to determine if the Dot Pattern's outer eight dots are positioned within the inner and outer frame patterns.

If the positioning is not correct, the following adjustment is necessary.

Adjusting X-Gain and Y-Gain.

13. ADJUST X-Gain adjustment R554 and Y-Gain adjustment R574 on the A5 Display Control Board to position the Dot Pattern's outer eight dots within the inner and outer Frame Patterns.

Checking and Adjusting Geometry.

14. Change the following 370B settings:

POSITION controls

Vertical and Horizontal	Position the center dot of the Dot Pattern at graticule center.
-------------------------	---

15. CHECK the Frame Pattern for ≤ 0.5 minor division of bowing and ≤ 0.75 minor division of keystone effect. If the bowing and keystone effect are not within these limits, the following adjustment may be necessary.
16. ADJUST Geometry adjustment R410 on the A18 CRT Output Board (if necessary) for minimum display bowing.

Examining the Display for Adjustment Interaction.

17. EXAMINE the display for all dots to be between the outer frame and inner frame of the Frame Test Pattern, within 0.5 minor division.

If not, repeat parts 10 through 14.

18. EXAMINE the display for the graticule periphery to be between the outer frame and inner frame of the frame test pattern, within 0.5 minor division.

If not, repeat parts 10 through 14.

19. EXAMINE the display for the center dot to be at graticule center, within 0.5 minor division.

Removing the Test Pattern.

20. Press the **FAST/SHIFT** button to exit the diagnostic routine.

C5. Checking DISPLAY INVERT Accuracy



Specification:

- DISPLAY INVERT for Digital Storage Vertical and Horizontal acquisition is accurate to within 0.04 of VERT/DIV or HORIZ/DIV setting.

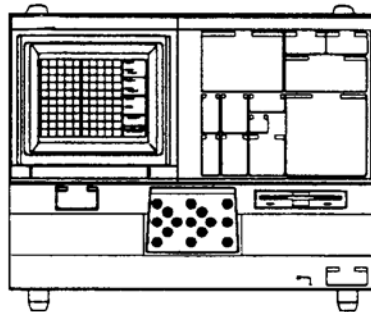

370B settings:

Initialize the 370B; then set the following controls as indicated.

DISPLAY

Mode CAL ZERO

CURSOR

Mode DOT

CAL ZERO is initiated by pressing the **NON STORE** button while holding down the **FAST/SHIFT** button.

1. Change the following 370B setting:

DISPLAY

INVERT ON

2. The indicator above the INVERT button will light.

3. Check that the spot moves from lower left corner to the upper right corner of the graticule and the vertical CURSOR readout and horizontal CURSOR readout are 0.00 ± 0.08 .

C6. Checking Display Offset Accuracy ✓

Specifications:

- For Digital Storage Vertical and Horizontal Acquisition, the center-line display can be vertically and horizontally offset up to ten divisions in 0.1 division steps.
- Display Offset is accurate to within {1.5 % of the offset (in divisions) +0.01 division of the setting}.

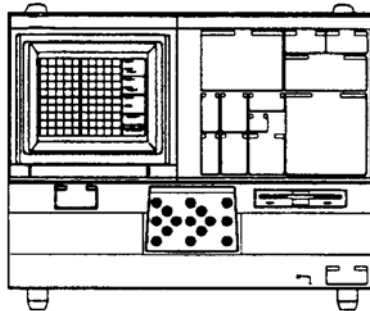

370B settings:

Initialize the 370B; then set the following controls as indicated.

DISPLAY

Mode CAL ZERO

CURSOR

Mode DOT

POSITION

Mode DISPLAY

Hold down the **FAST/SHIFT** button and press the **NON STORE** button to enter the CAL ZERO mode.

Checking Positive Offset.

1. EXAMINE the display, as the right Position Control button is pressed, for the spot to move continuously from lower left corner to lower right corner.
2. EXAMINE the display, as the up Position Control button is pressed, for the spot to move continuously from lower right corner to upper right corner.
3. CHECK the vertical and horizontal CURSOR readout within ± 0.32 V.

Checking Negative Offset.

4. Change the following 370B setting:

COLLECTOR SUPPLY

POLARITY

- 

POSITION

Simultaneously press the up and down Position Control buttons, then simultaneously press the left and right Position Control buttons.

5. EXAMINE the display, as the left Position Control button is pressed, for the spot to move continuously from upper right corner to upper left corner.
6. EXAMINE the display, as the down Position Control button is pressed, for the spot to move continuously from upper left corner to lower left corner.
7. CHECK the vertical and horizontal CURSOR readouts within ± 0.32 V.

C7. Adjusting Looping Compensation (A10R139, A10R224, A35R500, A35R501, A35R502, A35R503, A35R504)

†

NOTE. The characteristics examined in this step are provided as examples of typical instrument operation to aid in the adjustment of R139, R224, R500, R501, R502, R503, R504; they are not specifications.

The accuracy of the vertical displayed noise may be affected by these adjustments. See E7.

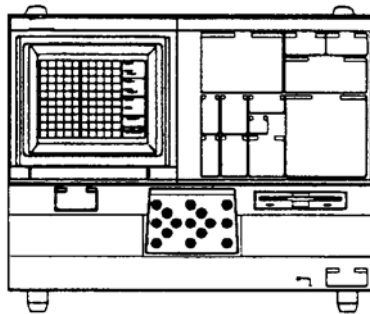

370B settings:

Initialize the 370B; then set the following controls as indicated.

DISPLAY

Mode	NON STORE
VERTICAL CURRENT/DIV	1 μ A COLLECTOR
HORIZONTAL VOLTS/DIV	200 V COLLECTOR
COLLECTOR SUPPLY	2000 V
MAX PEAK VOLTS	
POSITION	DISPLAY
OUTPUTS	ENABLED
VARIABLE COLLECTOR SUPPLY	100 %
MAX PEAK POWER WATTS	50 W
Protective Cover	Closed

1. Press the “up” Position Control button to move the trace to graticule center.

NOTE. Following adjustments from 2 to f are preliminary adjustment.

Preliminary Adjustment.

2. Preset the following 370B adjustments:

A10R139 (TAN-DELTA)	center
A10R224 (LOOP GAIN)	center

A cutout in the right siderail provides adjustment access.

A cutout in the right side of the guard box provides adjustment access.

3. ADJUST R503 2000 V LOOPING adjustment on the A35 Looping board for overlapping of the loop using LOOPING COMPENSATION control.
4. ADJUST R500 LOOPING BALANCE adjustment on the A35 Looping board to minimize the vertical projection of the left portion of the loop using the LOOPING COMPENSATION control.
5. ADJUST R139 TAN-DELTA on the A10 Sense board to align the display with the horizontal graticule line using the LOOPING COMPENSATION control.
6. Change the Max Peak Power Watts from 50 W to 0.08 W.
7. ADJUST R224 LOOPING GAIN adjustment on the A10 Sense board to minimize the vertical projection of the left portion of the loop using the LOOPING COMPENSATION control.
8. Change the Max Peak Power Watts from 0.08 W to 50 W.
9. Repeat steps 3 through 7.

Examining 2000 V LOOPING.

10. Change the following 370B settings:

DISPLAY	
HORIZONTAL VOLTS/DIV	200 V COLLECTOR
COLLECTOR SUPPLY	2000 V
MAX PEAK VOLTS	
VARIABLE COLLECTOR SUPPLY	100 %
LOOPING COMPENSATION	Minimum trace width

11. EXAMINE the left end of the displayed trace for optimum overlay of the loop, and the right side to run parallel with the horizontal graticule lines.

If the overlay is not optimum, and the trace does not parallel the horizontal graticule lines, the following adjustment is necessary.

Adjusting 2000 V LOOPING.

12. ADJUST R503 2000 V LOOPING adjustment on the A35 Looping board for optimum overlay of the left portion of the loop. See Figure 5-2.

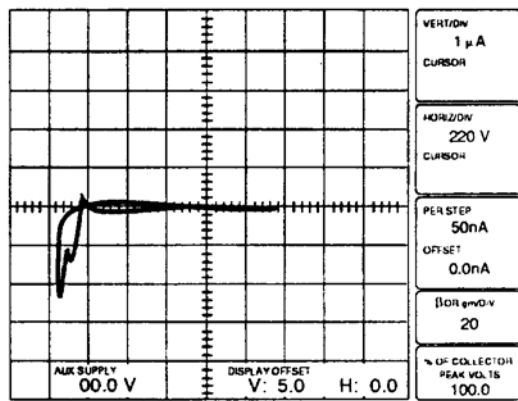

Correct

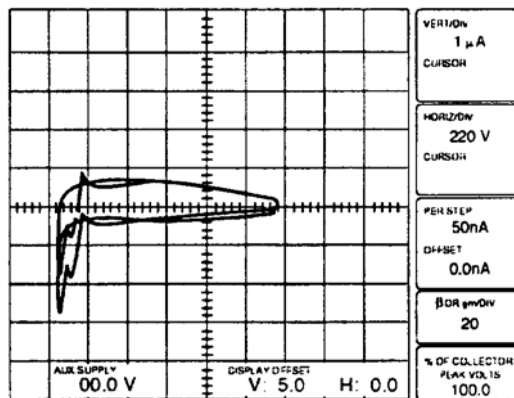

Incorrect

Figure 5-2: Looping compensation display

A cutout in the left side of the guard box provides adjustment access.

Adjusting LOOP BALANCE.

13. ADJUST R500 LOOP BALANCE on the A35 Looping board to align the display with the horizontal graticule line, using the LOOPING COMPENSATION control.

If necessary, repeat steps 12 and 13.

Adjusting TAN-DELTA.

14. Change the following 370B setting:

COLLECTOR SUPPLY
MAX PEAK POWER 50 W
WATTS

15. ADJUST TAN-DELTA R139 on the A10 Sense board to align the display with the horizontal graticule line, using the LOOPING COMPENSATION control.

Readjusting LOOP BALANCE.

16. Change the following 370B settings:

COLLECTOR SUPPLY
MAX PEAK POWER 0.08 W
WATTS

17. READJUST R500 LOOP BALANCE on the A35 Looping Board to align the display with the horizontal graticule line, using the LOOPING COMPENSATION control.

If necessary, repeat steps 14 through 17.

Examining 400 V LOOPING.

18. Change the following 370B settings:

DISPLAY

HORIZONTAL VOLTS/DIV 50 V COLLECTOR

COLLECTOR SUPPLY 400 V

MAX PEAK VOLTS

VARIABLE COLLECTOR SUPPLY 100 %

LOOPING COMPENSATION Minimum trace width

19. EXAMINE the left end of the displayed trace for optimum overlay of the trace.

If the left end of the trace doesn't overlay correctly, the following adjustment is necessary.

Adjusting 400 V LOOPING.

20. ADJUST R501 400 V LOOPING adjustment on the A35 Looping board for optimum overlay of the left end of the trace.

Examining 80 V LOOPING.

21. Change the following 370B settings:

DISPLAY

HORIZONTAL VOLTS/DIV 10 V COLLECTOR

COLLECTOR SUPPLY 80 V

MAX PEAK VOLTS

VARIABLE COLLECTOR SUPPLY 100 %

LOOPING COMPENSATION Minimum trace width

22. EXAMINE the left portion of the displayed trace for optimum overlay (see Figure 5-2). If the overlay is not optimum, the following adjustment is necessary.

Adjusting 80 V LOOPING.

23. ADJUST R502 80 V LOOPING adjustment on the A35 Looping board for optimum overlay of the left portion of the trace.

Examining 16 V LOOPING.

24. Change the following 370B settings:

DISPLAY	
HORIZONTAL VOLTS/DIV	2 V COLLECTOR
COLLECTOR SUPPLY	16 V
MAX PEAK VOLTS	
VARIABLE COLLECTOR	100 %
SUPPLY	
LOOPING COMPENSATION	Minimum trace width

25. EXAMINE the left portion of the displayed trace for optimum overlay of the trace (see Figure 5-2).

If the overlay is not optimum, the following adjustment is necessary.

Adjusting 16 V LOOPING.

26. ADJUST R504 16 V LOOPING adjustment on the A35 Looping board for optimum overlay of the left portion of the trace.

Horizontal

Equipment Required (see Table 5-3):

- Calibrator (DC Voltage Source)
- 1 M Ω , 5 %, 0.25 W Resistor
- 10 M Ω , 5 %, 0.25 W Resistor

D1. Adjusting H Balance (A10R460)

NOTE. *The characteristics examined in this step are provided as examples of typical instrument operation to aid in the adjustment of R460; they are not specifications.*

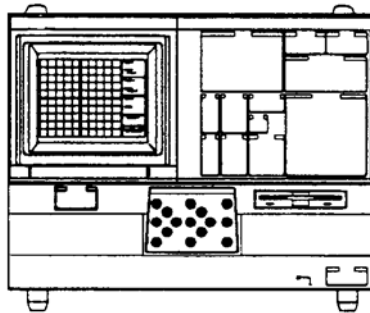

370B settings:

Initialize the 370B; then set the following controls as indicated.

COLLECTOR SUPPLY	AC
POLARITY	
MAG X10	On
CURSOR	
Mode	DOT
OUTPUTS	ENABLED
LEFT-RIGHT-STANDBY	LEFT or RIGHT
Protective Cover	Closed

Determining if Adjustment Is Necessary.

1. EXAMINE the horizontal CURSOR readout for a reading of 0, ± 60 mV.

If the reading is not within these limits, the following adjustment is necessary.

Adjusting H Balance.

2. ADJUST H Balance adjustment R460 on the A10 Sense Board for a horizontal CURSOR readout of 0 mV.

A cutout in the right side rail provides adjustment access.

**D2. Checking horizontal
MAG X10 Accuracy**

Specification:

- OFFSET with MAG set to X10 is accurate to within (1.5 % of the readout +0.3 division of the setting).

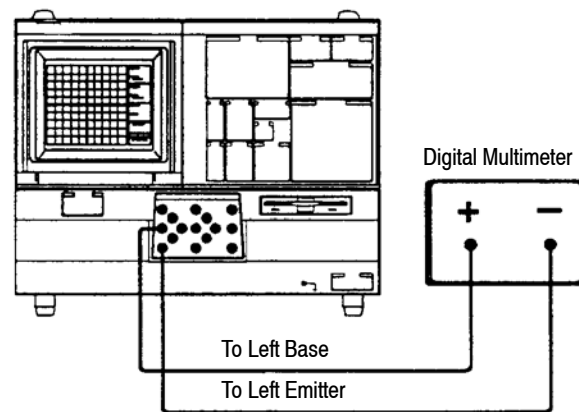

370B settings:

Initialize the 370B; then set the following controls as indicated.

MAG	X10
COLLECTOR SUPPLY	AC
POLARITY	
DISPLAY	
HORIZONTAL	200 mV BASE/EMITTER
Horizontal Position	- 20

STEP GENERATOR

Mode	VOLTAGE
STEP AMPLITUDE	1 V
OFFSET	4 V
NUMBER OF STEPS	0
CURSOR POSITION	DOT
Mode	DISPLAY
OUTPUTS	ENABLED
LEFT-RIGHT-STANDBY	LEFT
Protective Cover	Closed
Test Equipment setting	
Digital Multimeter	
Mode	DC Voltage

Checking horizontal MAG X10 Accuracy.

1. CHECK that the difference between horizontal CURSOR readout and Digital Multimeter reading is within ± 120 mV.

Removing the Setup.

2. Change the following 370B setting:

LEFT-RIGHT-STANDBY STANDBY

3. Remove the digital multimeter leads from the 370B.

D3. Checking HORIZONTAL BASE/EMITTER Accuracy and Range in STORE Mode



Specifications:

- The BASE/EMITTER settings are accurate to within 1.5 % of the readout +0.05 division of the setting.

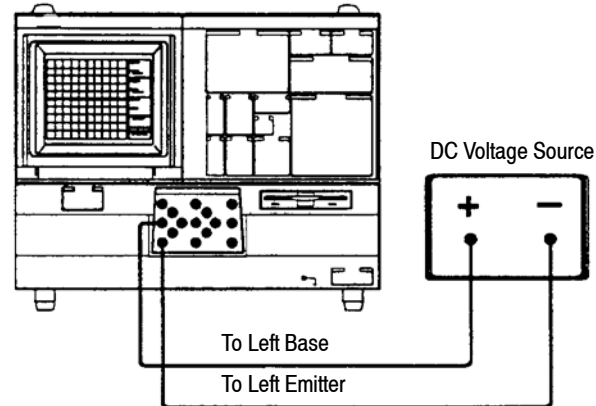

370B settings:

Initialize the 370B; then set the following controls as indicated.

DISPLAY	
HORIZONTAL	50 mV BASE/EMITTER
CURSOR	
Mode	DOT
CONFIGURATION	BASE OPEN (EXT)
OUTPUTS	ENABLED
Protective Cover	Closed
Test Equipment setting	
Calibrator	
Output	0.00 V

NOTE. Disregard the flashing cursor on the 370B display.

Checking Base/Emitter Accuracy.

1. Change the following 370B setting:

LEFTLEFT-RIGHT-STANDBY LEFT

2. CHECK that the horizontal CURSOR readout is within the CURSOR Readout limits for each HORIZONTAL (BASE/EMITTER) VOLTS/DIV and DC Voltage setting listed in Table 5-5.

There are two DC Voltage values given for each HORIZONTAL VOLTS/DIV setting in Table 5-5; check for both.

To check the 2 V and 5 V Horizontal Volts/Div settings, push the Operate button on the Voltage Source.

Table 5-5: Base/Emitter Voltage Accuracy

HORIZONTAL VOLTS/DIV Setting	Calibrator DC Voltage	Horizontal CURSOR Readout
50 mV	0.000 mV	± 2.5 mV
	450.0 mV	440.8 mV to 459.2 mV
200 mV	0.000 mV	± 10 mV
	1800 mV	1763 mV to 1837 mV
2 V	0.00 V	± 0.10 V
	18.00 V	17.63 V to 18.37 V

Removing the Setup.

3. Change the following Test Equipment setting:

Calibrator
Output Standby

4. Disconnect the Calibrator leads from the 370B.

D4. Checking HORIZONTAL COLLECTOR Voltage Accuracy and Range in STORE Mode



Specifications:

- The HORIZONTAL COLLECTOR settings are accurate to within 1.5 % of the readout +0.05 division of the setting.

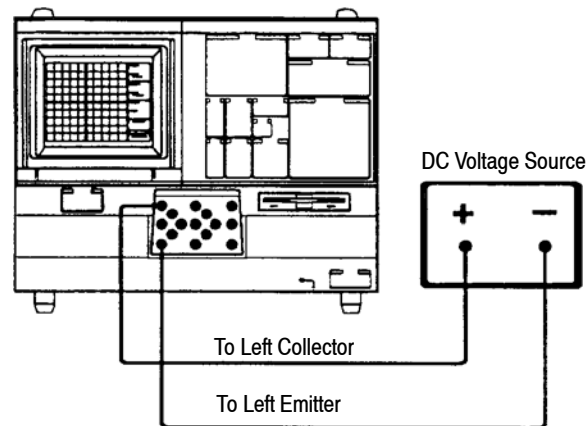

370B settings:

Initialize the 370B; then set the following controls as indicated.

DISPLAY

HORIZONTAL 50 mV COLLECTOR

COLLECTOR SUPPLY MAX 400 VOLT/DIV
PEAK VOLTS

CURSOR

Mode DOT

Protective Cover Closed

LEFT-RIGHT-STANDBY LEFT

Test Equipment setting

Calibrator

Output 0.00 V DC



WARNING. Extreme caution must be used when performing the following step due to the dangerous potentials present at the input of the 370B.

The protective cover should be installed.

Checking Collector Voltage Accuracy.

1. CHECK that the horizontal CURSOR readout is within the CURSOR Readout limits for each HORIZONTAL CURRENT VOLTS/DIV and DC Voltage setting listed in Table 5-6.

There are two DC Voltage values given for each HORIZONTAL VOLTS/DIV setting in Table 5-6: Check for both.

Removing the Setup.

2. Change the following 370B setting:

LEFT-RIGHT-STANDBY SATNDBY

3. Change the following test equipment setting:

Calibrator
Output 0.00 V



WARNING. Be certain that the output of the Calibrator is set to zero or Standby before connecting or disconnecting the test leads.

4. Disconnect the Calibrator leads from the 370B.

Table 5- 6: Collector Voltage Accuracy

HORIZONTAL VOLTS/DIV Setting	Calibrator DC Voltage	Horizontal CURSOR Readout
50 mV	0.000 mV	± 2.5 mV
	450.0 mV	440.8 mV to 459.2 mV
1 V	0.00 mV	± 50 mV
	9 V	8.82 V to 9.18 V
20 V	0.00 mV	± 1.0 V
	180 V	176.3 V to 183.7 V
100 V	0.00 mV	± 5 V
	900.00 V	881.5 V to 918.5 V
500 V	0.00 mV	± 25 V
	1000 V	960 V to 1040 V

D5. Checking Base Input Impedance



Specifications:

- Input impedance is at least 100 M Ω .

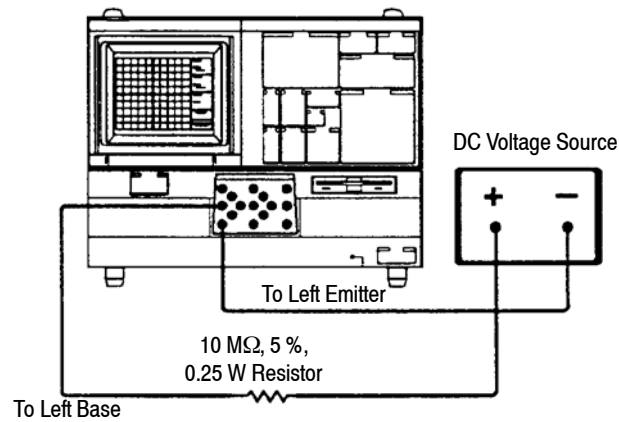

370B settings:

Initialize the 370B; then set the following controls as indicated.

CONFIGURATION	BASE OPEN (EXT)
DISPLAY	
HORIZONTAL	2 V BASE/EMITTER
CURSOR	
Mode	DOT
OUTPUTS	ENABLED
LEFT-RIGHT-STANDBY	LEFT
Protective Cover	Closed
Test Equipment setting	
Calibrator	
Output	20 V DC

Checking Input Impedance.

- CHECK that the horizontal CURSOR reading is more than 18.3 V.

Removing the Setup.

2. Set the Calibrator output to 0 V.
3. Remove the resistor and Calibrator.

D6. Checking Horizontal Displayed Noise



Specifications:

- Displayed noise (peak-peak) in COLLECTOR VOLTS is <math><0.02\%</math> of MAX PEAK VOLTS setting.

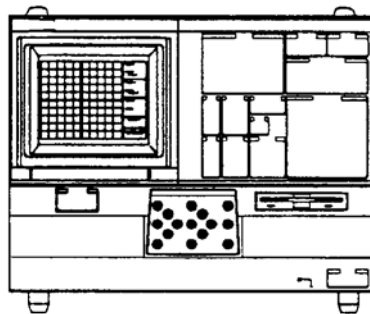

370B settings:

Initialize the 370B; then set the following controls as indicated.

COLLECTOR SUPPLY POLARITY	AC
MAX PEAK POWER WATTS	220
VARIABLE COLLECTOR SUPPLY	0 %
MAG X10	On
DISPLAY	
Mode	NON STORE
HORIZONTAL VOLT/DIV	5 mV COLLECTOR
OUTPUTS	ENABLED
Protective Cover	Closed

Checking Noise at COLLECTOR VOLTS.

1. CHECK that the spot width is no more than 3.2 mV (3.2 minor divisions) peak-peak (see Table 5-7).

Table 5-7: Displayed Horizontal Noise

COLLECTOR SUPPLY MAX PEAK VOLTS	Horizontal Spot Width (Noise)
	Collector Volts
16	3.2 mV (3.2 min. div)
80	16 mV (3.2 div)
400	80 mV (16 div) (1.6 div ; 50 mV / DIV)
2000	400 mV (8div ; 50mV/DIV)

2. Change the following 370B setting:

MAX PEAK VOLTS 80

3. CHECK that the spot width is no more than 16 mV (3.2 divisions) peak-peak (see Table 5-7).

4. Change the following 370B setting:

MAG X10 Off

MAX PEAK VOLTS 400

5. CHECK that the spot width is no more than 80 mV (1.6 divisions) peak-peak (see Table 5-7).

Vertical

Equipment Required (see Table 5-3):

- Calibrator (Precision Voltage and Current Source)
- Resistor: 2.5 M Ω , 0.1 %, 0.5 W
- Resistor: 250 k Ω , 0.1 %, 0.5 W
- Resistor: 25 M Ω , 0.1 %, 0.5 W
- Resistor: 0.025 Ω , 0.1 %, 4 W

E1. Adjusting V Balance (A10R250)

†

NOTE. The characteristics examined in this step are provided as examples of typical instrument operation to aid in the adjustment of R250; they are not specifications.

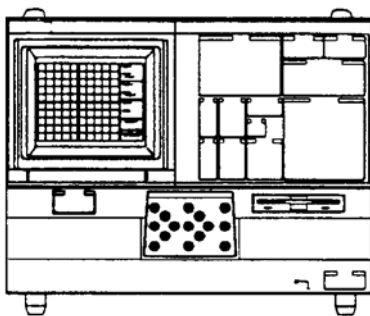

370B settings:

Initialize the 370B; then set the following controls as indicated.

COLLECTOR SUPPLY	AC
POLARITY	
MAG X10	On
CURSOR	
Mode	DOT
LEFT-RIGHT-STANDBY	LEFT or RIGHT
Protective Cover	Closed
OUTPUTS	ENABLED

Determining if Adjustment is Necessary.

6. Rotate the **LOOPING COMPENSATION** control fully clockwise, then counterclockwise.
7. **EXAMINE** the vertical **CURSOR** readout for a reading less than 60 mA.

If the readout is not within these limits, the following adjustment is necessary.

Adjusting V Balance.

8. **ADJUST V Balance** adjustment R250 on the A10 Sense Board; for a vertical **CURSOR** readout to 0 mA.

The adjustment is accessible through the right lower rail cutout.

E2. Adjusting Looping Balance (A10R238)

†

NOTE. *The characteristics examined in this step are provided as examples of typical instrument operation to aid in the adjustment of R238; they are not specifications.*

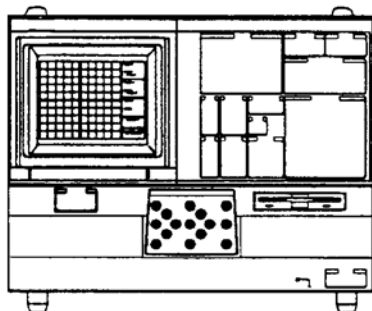
**370B settings:**

Initialize the 370B; then set the following controls as indicated.

COLLECTOR SUPPLY	AC
POLARITY	
MAG X10	On
CURSOR	
Mode	DOT

LEFT-RIGHT-STANDBY	LEFT or RIGHT
Protective Cover	Closed
OUTPUTS	ENABLED

Determining if Adjustment is Necessary.

1. Set the **LOOPING COMPENSATION** control fully clockwise, then counterclockwise.
2. Note the vertical CURSOR readout.
3. Set the **LOOPING COMPENSATION** control fully clockwise.
4. Note the vertical CURSOR readout.
5. EXAMINE the difference of the vertical CURSOR readout between noted part 2 and 4.

If the difference of readout is not within 20 mA, the following adjustment may be necessary.

It is not specification.

Adjusting Looping Compensation.

6. ADJUST Looping Balance adjustment R238 on the A10 Sense Board for a vertical CURSOR readout as noted in part 2. Return the **LOOPING COMPENSATION** control to fully counterclockwise.

E3. Adjusting Leakage Compensation (A10R270)

†

NOTE. The characteristics examined in this step are provided as examples of typical instrument operation to aid in the adjustment of R270; they are not specifications.

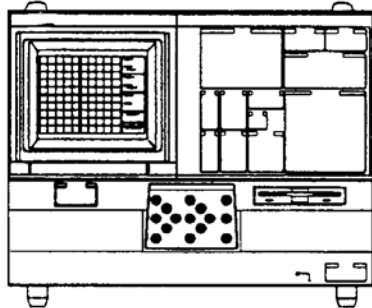

370B settings:

Initialize the 370B; then set the following controls as indicated.

COLLECTOR SUPPLY POLARITY	+ LEAKAGE
DISPLAY VERTICAL CURRENT/DIV	1 nA EMITTER
CURSOR Mode	DOT
POSITION Mode	DISPLAY
OUTPUTS	ENABLED
Protective Cover	Closed

Determining if Adjustment is Necessary.

1. Press the up Position Control button to position the dot center horizontal graticule line.
2. EXAMINE the vertical CURSOR readout for a reading within 1.03 nA. If the readout is not within these limits, the following adjustment may be necessary. Otherwise, proceed to the next step.

Adjusting Leakage Compensation.

3. ADJUST Leakage Compensation adjustment R270 on the A10 Sense Board; for a Vertical CURSOR readout of 0.00 nA.

E4. Checking vertical MAG X10 Accuracy



Specification:

- OFFSET with MAG set to X10 is accurate to within (1.5 % of the readout +0.3 division of the setting).

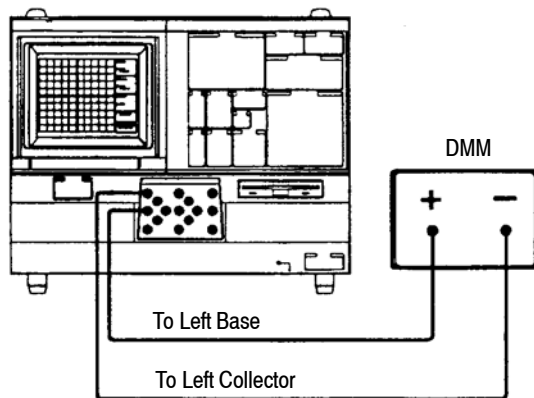

370B settings:

Initialize the 370B; then set the following controls as indicated.

COLLECTOR SUPPLY

POLARITY	AC
MAX PEAK POWER WATTS	220

MAX X10 On

DISPLAY

HORIZONTAL	50V COLLECTOR
VERTICAL	1mA COLLECTOR

STEP GENERATOR

Mode	CURRENT
STEP AMPLITUDE	10mA
OFFSET	- 100mA
NUMBER OF STEPS	0

CURSOR DOT

POSITION	
Mode	DISPLAY
LEFT-RIGHT-STANDBY	LEFT
OUTPUTS	ENABLED
Protective Cover	Closed
Test Equipment setting	
Digital Multimeter	
Mode DC	Current

Checking vertical MAG X10 Accuracy.

1. Set the the following 370B setting:

POSITION	Use the “down” Position control button to set the spot near the vertical center.
----------	--

2. CHECK that the difference between the vertical CURSOR readout and the Digital Multimeter reading is within ± 1.8 mA.

Removing the Setup.

3. Change the following 370B setting:

LEFT-RIGHT-STANDBY	STANDBY
--------------------	---------

4. Remove the digital multimeter leads from the 370B.

E5. Checking EMITTER CURRENT Accuracy and Range in STORE Mode



Specifications:

- STORE mode EMITTER CURRENT/DIV settings are accurate to within 1.5% of the readout +0.05 division of the setting +1 nA.

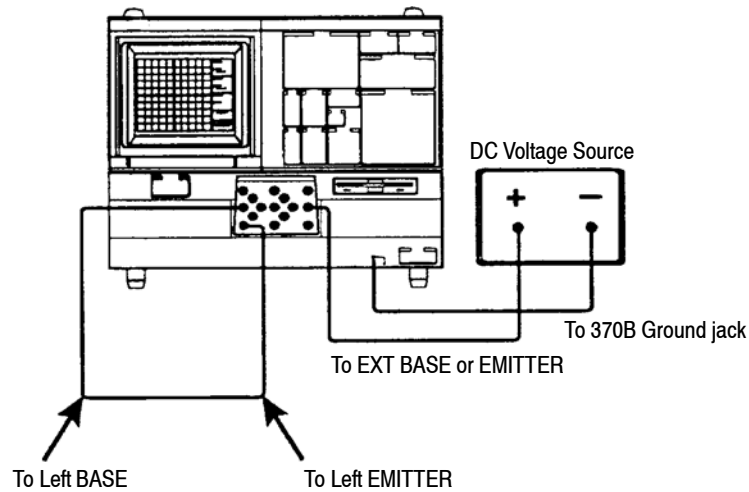

370B settings:

Initialize the 370B; then set the following controls as indicated.

COLLECTOR SUPPLY

POLARITY + LEAKAGE

DISPLAY

HORIZONTAL 500 V COLLECTOR

VERTICAL 1 nA EMITTER

CURSOR

DOT

POSITION

MODE DISPLAY

OFFSET HORIZONTAL 1.0 DIV

CONFIGURATION

BASE OPEN (EXT)

OUTPUTS

ENABLED

LEFT-RIGHT-STANDBY

LEFT

Protective Cover

Closed

Test Equipment setting

Calibrator

Output 0.000 V

Checking 1 nA

1. CHECK that the vertical CURSOR readout is within the limits listed in Table 5-8 for each combination of VERTICAL CURRENT/DIV and Calibrator settings.

Checking 20 nA

2. CHECK that the vertical CURSOR readout is within the limits listed in Table 5-8 for each combination of VERTICAL CURRENT/DIV and Calibrator settings.

Checking 500 nA

3. CHECK that the vertical CURSOR readout is within the limits listed in Table 5-8 for each combination of VERTICAL CURRENT/DIV and Calibrator settings.

Removing the Setup.

4. Change the following 370B setting:

LEFT-RIGHT-STANDBY STANDBY

5. Disconnect the voltage source from the 370B.

Table 5-8: Emitter Current Accuracy

VERTICAL CURRENT/DIV Setting	Calibrator DC Voltage	Theoretical Current Value	Vertical CURSOR Readout
1 nA (shunt resistor 25M Ω)	0.000 V	0A	0.00 \pm 1.05 nA
	225 mV	9nA	7.82nA to 10.18 nA
20 nA(shunt resistor 2.5M Ω)	0.000 V	0A	0.00 \pm 2.0 nA
	450 mV	180nA	175.3 nA to 184.7 nA
500 nA(shunt resistor 250k Ω)	0.000 V	0A	0.00 \pm 26 nA
	1125 mV	4500nA	4407 nA to 4593 nA

**E6.a. Checking
COLLECTOR CURRENT
Accuracy and Range in
STORE Mode**



Specifications:

- STORE mode COLLECTOR CURRENT/DIV settings are accurate to within 1.5 % of the readout +0.05 division of the setting.

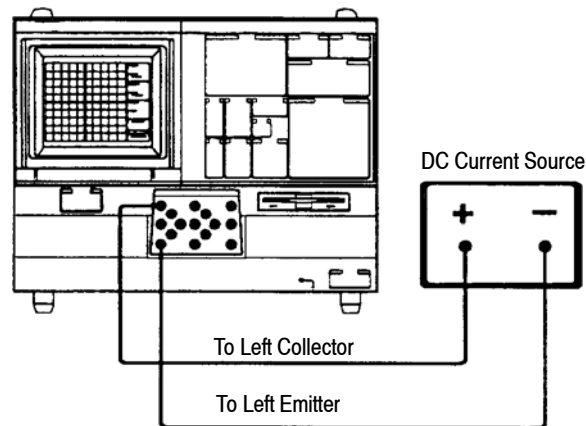

370B settings:

Initialize the 370B; then set the following controls as indicated.

DISPLAY

VERTICAL 1 μ A CURRENT/DIV
HORIZONTAL 500 V VOLT/DIV

COLLECTOR SUPPLY

POLARITY -

MAX PEAK POWER WATTS 220

CURSOR

Mode DOT

LEFT-RIGHT-STANDBY LEFT

Protective Cover Open

Test Equipment setting

Calibrator

Output 0.00 A

1. CHECK that each setting of the VERTICAL CURRENT/DIV control listed in Table 5-9 produces a vertical CURSOR readout within the limits given for a Calibrator setting of 0.00 μ A (open circuit).

- Change the following test equipment setting:

Calibrator

Output 9.00 μA

- CHECK that each combination of VERTICAL CURRENT/DIV and Calibrator settings listed in Table 5-9 produces a vertical CURSOR readout within the given limits.

Removing the Setup.

- Change the following Test Equipment setting:

Calibrator

Output 0.00 μA

- Disconnect the DC current source from the 370B.
- Close the Protective Cover.

Table 5-9: Collector Current Accuracy

VERTICAL CURRENT/DIV Setting	Calibrator DC Current	Vertical CURSOR Readout
1 μA	0.00 μA	$\pm 0.05 \mu\text{A}$
	-9.00 μA	-8.82 μA to -9.18 μA
20 μA	0.00 μA	$\pm 1.0 \mu\text{A}$
	-180.00 μA	-176.3 μA to -183.7 μA
500 μA	0.00 μA	$\pm 25 \mu\text{A}$
	-4500 μA	-4408 μA to -4592 μA
1 mA	0.00 μA	$\pm 0.05 \text{ mA}$
	-9.00 mA	-8.82 mA to -9.18 mA
20 mA	0.00 μA	$\pm 1.0 \text{ mA}$
	-180.0 mA	-176.3 mA to -183.7 mA

**E6b. Checking
COLLECTOR CURRENT
Accuracy for 500 mA/DIV
through 2 A/DIV (Alternate
Method)**



Specification:

- STORE mode COLLECTOR CURRENT/DIV, MAG mode X10 settings are accurate to within 1.5 % of readout +0.3 division of setting.

NOTE. This step is recommended for full scale measurement of CURRENT/DIV settings greater than 500 mA/DIV.

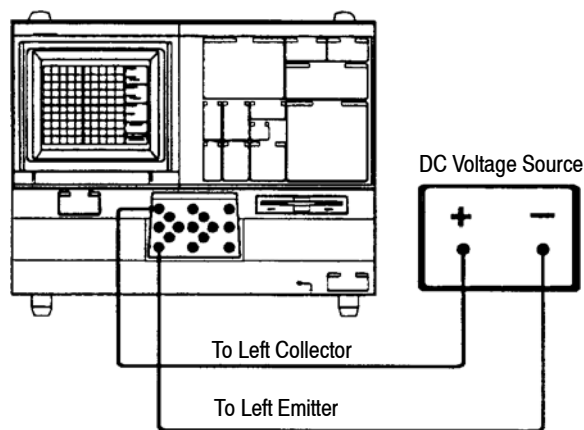

370B settings:

Initialize the 370B; then set the following controls as indicated.

DISPLAY

VERTICAL 500 mA COLLECTOR
HORIZONTAL 50 mV COLLECTOR

COLLECTOR SUPPLY

POLARITY + DC
COLLECTOR SUPPLY MAX 400
PEAK VOLTS

CURSOR

Mode DOT

POSITION

Mode DISPLAY
LEFT-RIGHT-STANDBY LEFT

OUTPUT ENABLED

Protective Cover Open

Test Equipment setting

Calibrator

Output	112.5 mV
--------	----------

Checking Accuracy.

1. Move the spot to the graticule center with the **Position Control** buttons.
2. Change the following 370B setting:

MAG X10	On
---------	----

3. Note the Horizontal CURSOR readout.
4. Change the following Test equipment and 370B settings:

Calibrator

Output	225 mV
--------	--------

370B

MAG X10	Off
---------	-----

POSITION	Move the spot to the graticule center with the Position Control buttons.
----------	--

5. Change the following 370B setting:

MAG X10	On
---------	----

6. Note the Horizontal CURSOR readout.
7. Change the following Test equipment and 370B settings:

Calibrator

Output	250 mV
--------	--------

370B

MAG X10	Off
---------	-----

POSITION	Move the spot to the graticule center with the Position Control buttons.
----------	--

8. Change the following 370B setting:

MAG X10	On
---------	----

9. Note the Horizontal CURSOR readout.

10. Change the following Test Equipment and 370B settings:

Calibrator	
Output	Standby
370B	
MAG X10	Off
COLLECTOR SUPPLY MAX PEAK VOLTS	16
MAX PEAK POWER WATTS	220
POSITION	Simultaneously press the up and down Position Control buttons, then simultaneously press the left and right Position Control buttons.

11. Disconnect the Calibrator.

12. Connect the 0.025 Ω resistor as shown in Figure 5-3, then close the Protective Cover.

13. Change the following 370B setting:

VARIABLE COLLECTOR SUPPLY	Clockwise until the Horizontal CURSOR readout to about 112.5 mV.
------------------------------	--

14. Move the spot to the graticule center with the Position Control buttons.

15. Change the following 370B setting:

MAG X10	On
VARIABLE COLLECTOR SUPPLY	Set so the Horizontal CURSOR readout is nearest that noted in part 3.

Difference value should be within 0.5 mV.

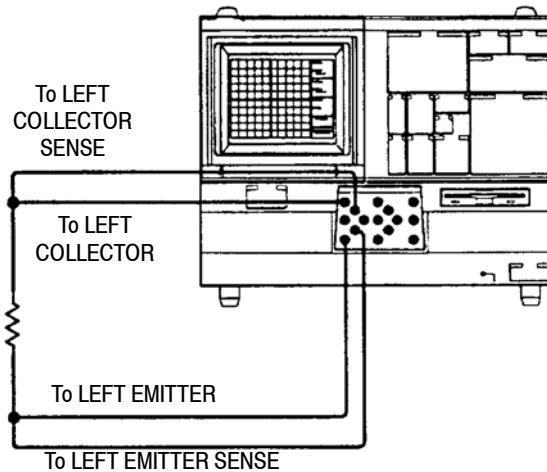

Figure 5-3: Checking Collector high current range

16. CHECK that the Vertical CURSOR readout is within the limits given in Table 5-10 for 50 mA/DIV.

Table 5-10: Collector High Current Accuracy

VERTICAL CURRENT/DIV Setting	VARIABLE COLLECTOR SUPPLY	Vertical CURSOR Readout
50 mA	112.5 mV (4.5A)	4500 ± 82.5 mA
100 mA	225 mV (9A)	9000 ± 165 mA
200 mA	250 mV (10A)	10000 ± 210 mA

Checking 1 A/DIV Accuracy.

17. Change the following 370B settings:

MAG X10	Off
POSITION	Simultaneously press the up and down Position Control buttons, then simultaneously press the left and right Position Control buttons.

DISPLAY

VERTICAL

1A COLLECTOR

VARIABLE COLLECTOR
SUPPLY

Clockwise until the Horizontal
CURSOR readout to about 250 mV.

18. Move the spot to the graticule center with the **Position Control buttons**.

19. Change the following 370B settings:

MAG X10

On

VARIABLE COLLECTOR
SUPPLY

Set so the Horizontal CURSOR
readout is nearest that noted in part 6.

Difference value should be within 0.5 mV.

20. CHECK that the Vertical CURSOR readout is within the limits given in Table 5-10 for 100 mA/DIV when the Horizontal CURSOR readout is the same as that in part 6.

Checking 2 A/DIV Accuracy.

21. Change the following 370B settings:

MAG X10

Off

DISPLAY

VERTICAL

2A COLLECTOR

VARIABLE COLLECTOR
SUPPLY

Move the spot to the graticule center
with the Position Control buttons.

22. Change the following 370B settings:

MAG X10

On

VARIABLE COLLECTOR
SUPPLY

Set so the Horizontal CURSOR
readout is nearest that noted in part 9.

Difference value should be within 0.5 mV.

23. CHECK that the Vertical CURSOR readout is within the limits given in Table 5-10 for 200 mA/DIV when the Horizontal CURSOR readout is the same as that in part 6.

Removing the Setup.

24. Change the following 370B setting:



LEFT-RIGHT-STANDBY STANDBY

25. Open the Protective Cover.

26. Remove the resistor.

E7. Checking Vertical Displayed Noise

Specifications:

- Collector and Base Current Mode Vertical Displayed noise are accurate to within 1 μA at 16 V and 80 V, 2 μA at 400 V, 5 μA at 2000 V MAX PEAK VOLTS setting, except for switching noise at +  and -  mode.

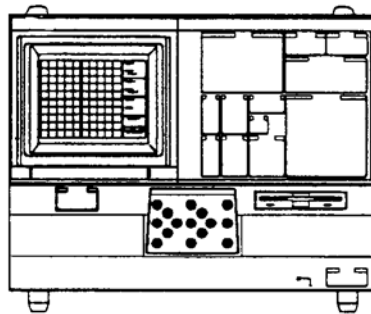

370B settings:

Initialize the 370B; then set the following controls as indicated.

DISPLAY

Mode	NON STORE
VERTICAL CURRENT/DIV	1 μA COLLECTOR
HORIZONTAL VOLTS/DIV	500V COLLECTOR
COLLECTOR SUPPLY MAX PEAK VOLTS	2000V
POSITION	
Mode	DISPLAY
OUTPUTS	ENABLED
VARIABLE COLLECTOR SUPPLY	100 %
Protective Cover	Closed

Checking Collector Vertical Displayed Noise In CONFIGURATION COLLECTOR to COLLECTOR SUPPLY mode.

1. Press the up Position Control button to move the displayed waveform to center graticule.
2. Set the front-panel **LOOPING COMPENSATION** to minimum looping.
3. CHECK that vertical width of the displayed waveform is within the limits 5 mA (5 div) at the 100 % of VARIABLE COLLECTOR SUPPLY setting.

Checking Collector Vertical Displayed Noise in CONFIGURATION BASE to COLLECTOR SUPPLY mode.

4. Change the following 370B setting:

CONFIGURATION	BASE COLLECTOR SUPPLY
---------------	--------------------------

5. Set the front-panel **LOOPING COMPENSATION** to minimum looping.
6. CHECK that vertical width of the displayed waveform is within the limits given in Table 5-11 for each combination of settings for the MAX PEAK VOLTS and the HORIZONTAL VOLTS/DIV controls with the 100 % of VARIABLE COLLECTOR SUPPLY setting.

Table 5- 11: Displayed Vertical Collector Noise in CONFIGURATION BASE to COLLECTOR SUPPLY mode

COLLECTOR SUPPLY MAX PEAK VOLTS	HORIZONTAL COLLECTOR VOLTS/DIV Setting	Vertical width of the waveform
16	2 V/DIV	1 μ A (1 div)
80	10 V/DIV	1 μ A (1 div)
400	50 V/DIV	2 μ A (2 div)

Step Generator

Equipment Required (see Table 5-3):

- Digital Multimeter
- Resistor, 1 M Ω , 5 %, 0.5 W
- Resistor, 100 Ω , 5 %, 0.5 W
- Resistor, 0.025 Ω , 0.1 %, 4 W

F1. Adjusting .1X Balance (A3R332) and Step Generator Offset (A3R360)

NOTE. The characteristic examined in this step is provided as an example of typical instrument operation to aid in the adjustment of R332, R360; it is not a specification.

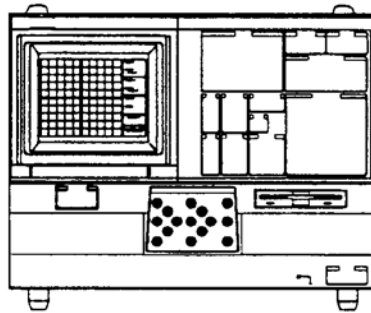

370B settings:

Initialize the 370B; then set the following controls as indicated.

COLLECTOR SUPPLY POLARITY	AC
STEP GENERATOR	
Mode	VOLTAGE
STEP MULTI .1X	On
STEP AMPLITUDE	200 mV
NUMBER OF STEPS	0
MAX X10	On
DISPLAY	
HORIZONTAL	5 mV BASE/EMITTER

OUTPUTS	ENABLED
Protective Cover	Closed

Examining and Adjusting for Zero Output Volts.

1. Note the horizontal spot position.
2. Change the following 370B setting:

STEP GENERATOR	
STEP MULTI .1X	Off

3. EXAMINE that the spot moves within ± 1 divisions from the noted position of step 1.

If the spot is not within this limit, the following adjustment is necessary.

4. ADJUST .1X Balance adjustment R332 on the A3 A/D board for minimum horizontal display shift, when STEP MULTI .1X is set between On and Off.

Examining and Adjusting for Step Generator Offset.

5. Set the following Test Equipment setting:

Digital Multimeter Mode	DC Volts
-------------------------	----------

6. Connect the Digital Multimeter between the TP310 (SG) and the TP 500 (A GND) on the A3 A/D board as shown in Figure 5-4.

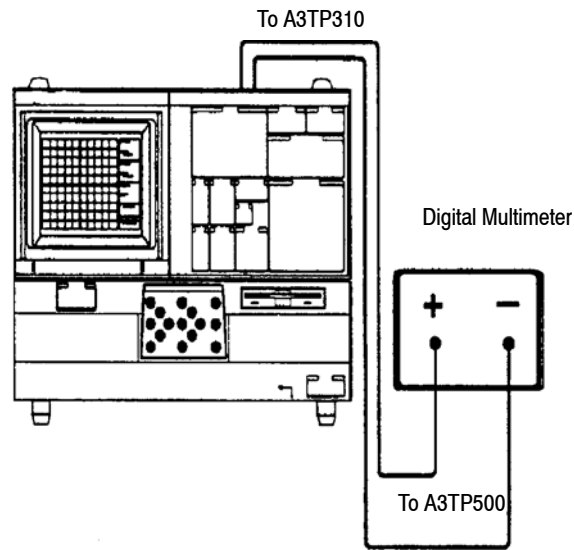

Figure 5-4: Examining and Adjusting for Step Generator Offset

7. EXAMINE the Digital Multimeter for reading of 0 mV, ± 1 mV.

If the Digital Multimeter reading is not within this limit, the following adjustment is necessary.

8. ADJUST the Step Generator Offset adjustment R360 on the A3 A/D board for 0 mV of Digital Multimeter reading.

Removing the Setup.

9. Disconnect the Digital Multimeter from 370B.

**F2. Adjusting Step
Generator Zero (A7R310)
Current Amplifier Bias
(A7R467) Current Zero
(A7R603)**

†

NOTE. The characteristic examined in this step is provided as an example of typical instrument operation to aid in the adjustment of R310, R467, R603; it is not a specification.

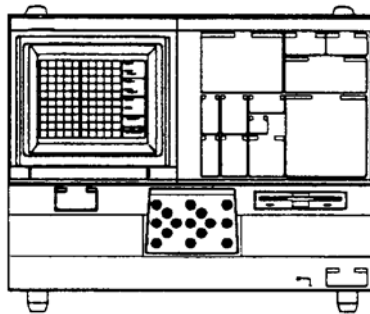

370B settings:

Initialize the 370B; then set the following controls as indicated.

COLLECTOR SUPPLY	AC
POLARITY	
STEP GENERATOR	
VOLTAGE	On
STEP AMPLITUDE	500 mV
NUMBER OF STEPS	0
MAX X10	On
DISPLAY	
Mode	NON STORE
HORIZONTAL	5 mV BASE/EMITTER
OUTPUTS	ENABLED
Protective Cover	Closed

Examining and Adjusting for Zero Output Volts.

1. EXAMINE that the spot moves within ± 0.5 divisions, between the 500 mV and 200 mV of STEP AMPLITUDE setting.

If the spot is not within this limit, the following adjustment is necessary.

2. Set the STEP AMPLITUDE to 200 mV, then note the spot position.
3. Set the STEP AMPLITUDE to 500 mV.
4. ADJUST SG ZERO adjustment R310 on the A7 Step Generator Board to the noted position of part 2.

Adjusting for Current Amplifier Bias.

5. Set the following 370B and Test Equipment settings:

STEP GENERATOR

Mode	CURRENT
Digital Multimeter Mode	DC Volts

6. Connect the Digital Multimeter across R491 on the A7 Step Generator Board as shown in Figure 5-5.

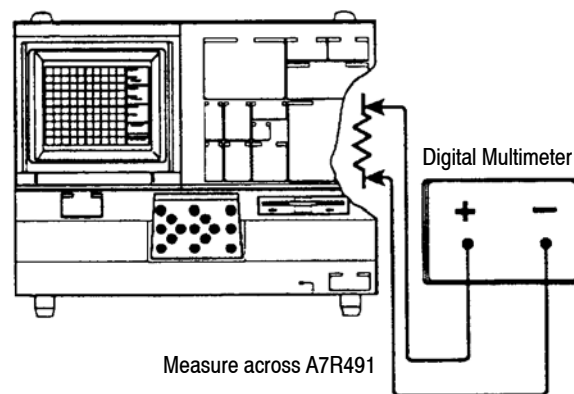

Figure 5-5: Adjusting for Current Amplifier Bias

7. ADJUST BIAS adjustment R467 on the A7 Step Generator Board for a Digital Multimeter reading of 6 mV.

This adjustment sets bias current to the optimum level for long term reliability.

Removing the Setup.

8. Disconnect the Digital Multimeter from R491.

Checking and Adjusting for Zero Output Current.

9. Connect the 100 Ω resistor to the Left Base and Left Emitter jacks, then close the protective cover.

10. Change the following 370B settings:

DISPLAY

HORIZONTAL 100 mV BASE/EMITTER

STEP GENERATOR

STEP AMPLITUDE 100 mA

LEFT-RIGHT-STANDBY LEFT

11. Note the horizontal position of the spot.

12. Change the following 370B settings:

DISPLAY

HORIZONTAL 50 mV BASE/EMITTER

STEP GENERATOR

STEP AMPLITUDE 50 mA

13. EXAMINE that the spot moves within ± 0.5 divisions, between the setting of part 10 and 12.

If the spot is not within this limit, the following adjustment is necessary.

14. ADJUST Current Zero adjustment R603 on the A7 Step Generator Board to move the spot one-half over the noted position of part 11.

15. If necessary, repeat steps 10 through 14.

Removing the Setup.

16. Remove the 100 Ω resistor.

F3. Adjusting Current Balance (A7R325)

†

NOTE. The characteristics examined in this step is provided as an example of typical instrument operation to aid in the adjustment of R325; it is not a specification.

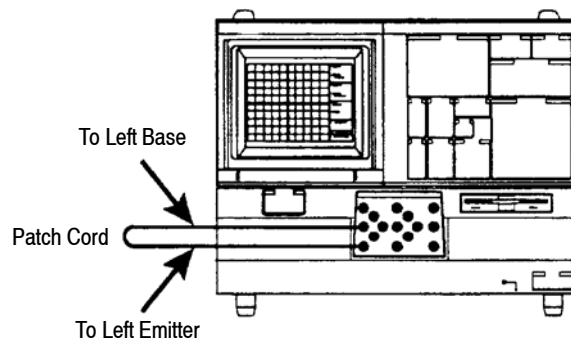

370B settings:

Initialize the 370B; then set the following controls as indicated.

COLLECTOR SUPPLY	220
MAX PEAL POWER WATTS	
STEP GENERATOR	
STEP AMPLITUDE	10 mV
NUMBER OF STEPS	0
PULSE	LONG
DISPLAY	
VERTICAL CURRENT	1 mA COLLECTOR
CURSOR	DOT
POSITION	DISPLAY
OUTPUTS	ENABLED
LEFT-RIGHT-STANDBY	LEFT
Protective Cover	Closed

Examining for Current Balance.

1. Move the spot to vertical graticule center while pressing the “up” Position Control button.
2. Note the vertical CURSOR readout.
3. Turn the **VARIABLE COLLECTOR SUPPLY** for a horizontal cursor readout of 10.00 V.
4. EXAMINE the vertical CURSOR readout for the difference in value from part 3 is between 0.00 and 0.30 mA.

If it is not within this limit, the following adjustment is necessary.

Adjusting for Current Balance.

5. Adjust R325 on A7 Step Generator board to the value noted in part 3.

Removing the Setup.

6. Remove the patch cord.

F4. Checking OFFSET Accuracy in VOLTAGE Mode



Specification:

- Absolute accuracy is less than (1.5 % of the total output + 3 % of the STEP AMPLITUDE setting + 1 mV).

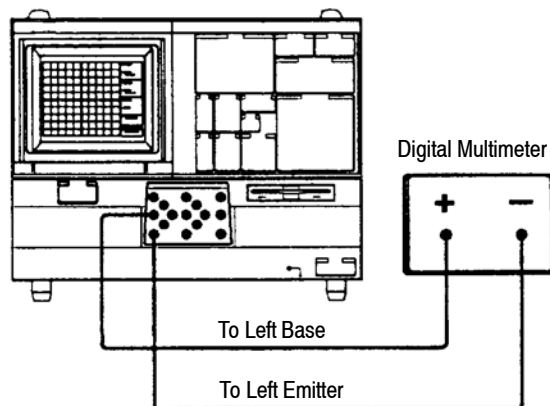

370B settings:

Initialize the 370B; then set the following controls as indicated.

DISPLAY	
HORIZONTAL	5 V BASE/EMITTER
STEP GENERATOR	
Mode	Voltage
STEP AMPLITUDE	2 V
OFFSET	0.0 mV
NUMBER OF STEPS	0
COLLECTOR SUPPLY	AC
POLARITY	
LEFT-RIGHT-STANDBY	LEFT
OUTPUTS	ENABLED
Protective Cover	Closed
Test Equipment Settings:	
Digital Multimeter Mode	DC Voltage

Checking Zero OFFSET without INVERT.

- CHECK that it is within the range of $0.0 \pm 61\text{mV}$ that digital multimeter measurement is limit value.

Checking Maximum OFFSET without INVERT.

- Change the following 370B setting:

STEP GENERATOR	
STEP AMPLITUDE	200 mV
OFFSET AID	+ 2 V

- CHECK that the digital multimeter measurement is within the limits shown in Table 5-12 under Maximum OFFSET for each setting of the STEP AMPLITUDE control.

Table 5- 12: OFFSET Voltage

STEP AMPLITUDE	Digital Multimeter Reading (Max OFFSET)
200 mV	+ 1963 mV to + 2037 mV
2 V	+ 19.64 V to + 20.36 V

Checking Maximum OFFSET with INVERT.

4. Change the following 370B settings:

STEP GENERATOR

POLARITY INVERT ON (*)

(*) The indicator above the INVERT button will light up.

5. CHECK that the Digital Multimeter measurement is within the limits shown in Table 5-13 under Maximum OFFSET for each setting of the STEP AMPLITUDE control.

Table 5- 13: OFFSET Voltage

STEP AMPLITUDE	Digital Multimeter Reading (Max OFFSET)
100 mV	- 1019 mV to - 981 mV
1 V	- 10.18 V to - 9.82 V

Removing the Setup.

6. Change the following 370B setting:

LEFT-RIGHT-STANDBY STANDBY

7. Remove the digital multimeter leads from the 370B.

F5. Checking OFFSET Accuracy in CURRENT Mode



Specifications:

- Absolute Accuracy is less than (1.5 % of the total output + 3 % of the STEP AMPLITUDE setting + 1 nA).

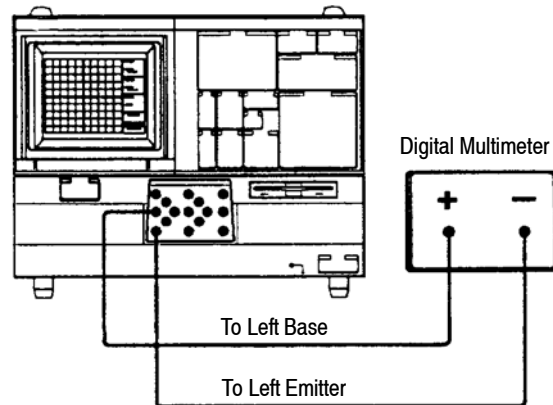

370B settings:

Initialize the 370B; then set the following controls as indicated.

DISPLAY

VERTICAL CURRENT STEP GEN

STEP GENERATOR

Mode CURRENT

STEP AMPLITUDE 200 nA

OFFSET AID + 2000 nA

NUMBER OF STEPS 0

POLARITY INVERT ON

OUTPUTS ENABLED

LEFT-RIGHT-STANDBY LEFT

Protective Cover Closed

Test Equipment Settings: - 2

Digital Multimeter Mode DC Current

NOTE. Before checking these parameters, note the count error of the Digital Multimeter and subtract it from the reading obtained in the procedure.

Use a TEKTRONIX DM501A for measuring the 200 mA range.

Checking Maximum OFFSET with INVERT.

1. CHECK that the Digital Multimeter measurement is within the limits shown in Table 5-14 under Maximum OFFSET for each setting of the STEP AMPLITUDE control.

Table 5- 14: OFFSET Current

STEP AMPLITUDE Setting (\pm)	Digital Multimeter Reading Limits with max OFFSET (\pm)
200nA	\pm 1963 nA to \pm 2037 nA
2 μ A	\pm 19.64 μ A to \pm 20.36 μ A
20 μ A	\pm 196.4 μ A to \pm 203.6 μ A
200 μ A	\pm 1964 μ A to \pm 2036 μ A
2 mA	\pm 19.64 mA to \pm 20.36 mA
20 mA	\pm 196.4 mA to \pm 203.6 mA
200 mA	\pm 1964 mA to \pm 2037 mA

Checking Maximum OFFSET without INVERT.

2. Change the following 370B setting:

STEP GENERATOR
 POLARITY INVERT Off

The INVERT indicator will go out.

3. CHECK that the digital multimeter measurement is within the limits shown in Table 5-14 under Maximum OFFSET for each setting of the STEP AMPLITUDE control.

Removing the Setup.

4. Change the following 370B setting:

LEFT-RIGHT-STANDBY STANDBY

5. Remove the Digital Multimeter.

Alternate Method.

6. Change the following Test Equipment setting:

Digital Multimeter Mode	Volts
-------------------------	-------

7. Connect a $0.025\ \Omega$ Resistor to the Left Base jack (B) to the Left Emitter jack (E) and connect the Digital Multimeter to the leads of the Resistor as shown in Figure 5-6.

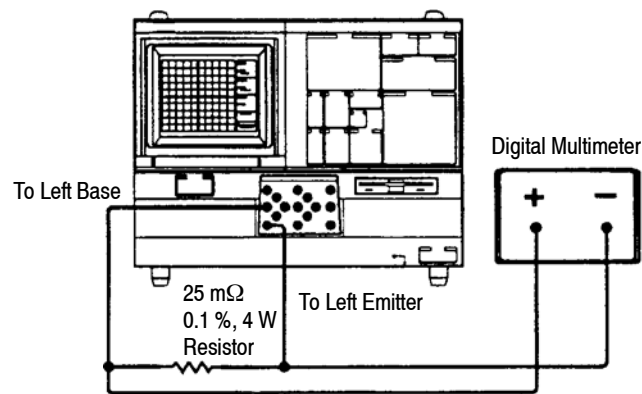

Figure 5-6: Checking for Maximum OFFSET of 200 mA Range

Checking Maximum OFFSET of 200 mA Range.

8. Change the following 370B settings:

STEP GENERATOR

POLARITY INVERT	Off
STEP AMPLITUDE	200 mA
OFFSET	2000 mA

9. CHECK that the Digital Multimeter readout is 49.1 mV to 50.9 mV.

10. Change the following 370B settings:

STEP GENERATOR

POLARITY INVERT	ON
-----------------	----

11. CHECK that the Digital Multimeter readout is -49.1 mV to -50.9 mV.

12. Removing the Setup.

13. Change the following 370B setting:

LEFT-RIGHT-STANDBY STANDBY

14. Remove the Digital Multimeter.

**F6. Checking Step
Incremental Accuracy in
VOLTAGE Mode**



Specifications :

- Incremental accuracy is 1.5 %.

Moving the Store/Non-Store Jumper.

1. Change the following 370B setting:

POWER OFF

2. Remove the A3 A/D Board from the card cage located on the right side of the 370B.

NOTE. See test Point and Adjustment Locations 1 for the location of A3 and jumper J34. For details on removing and replacing Plug-in Boards, see the instructions under “Component Removal and Replacement” in section 3, maintenance.

3. Change the position of Jumper J34 from pins 1 - 2 to pins 2 - 4 (CAL position).

When the jumper is moved from pins 1 - 2 to pins 2 - 4, STORE Mode is disabled.

4. Replace the A3 A/D Board in the 370B card cage. Do not re-install the circuit board retainers.

5. Change the following 370B setting:

POWER ON

6. Press the up and right Position Control buttons to moved the displayed spot to the graticule center (V:5.0 H:5.0).

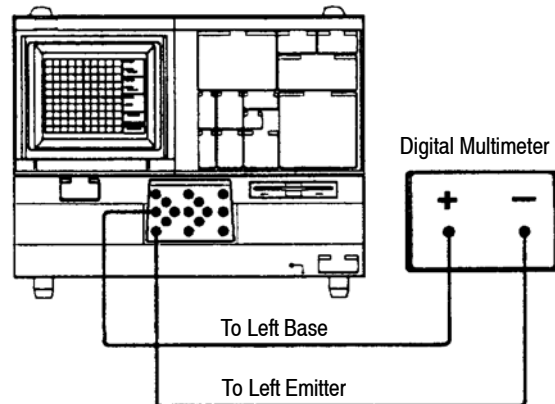

370B settings:

Initialize the 370B; then set the following controls as indicated.

DISPLAY

Mode	NON STORE
HORIZONTAL VOLTS	2 V BASE/EMITTER
COLLECTOR SUPPLY POLARITY	+DC

STEP GENERATOR

Mode	VOLTAGE
STEP AMPLITUDE	2 V
NUMBER OF STEPS	10
POSITION	DISPLAY
LEFT-RIGHT-STANDBY	LEFT
OUTPUTS	ENABLED
Protective Cover	Closed

Test Equipment Settings:

Digital Multimeter Mode	DC Voltage
-------------------------	------------

NOTE. See Test point and Adjustment Location 1 for the location of the circuit board and jumper associated with this step

Checking Step 0 and 1.

- Record the value of the digital multimeter reading.
- Change the following 370B setting:

MEASUREMENT

Press the MEASUREMENT REPEAT button to move the displayed spot 1 division to the right.

9. Record the value of the digital multimeter reading.
10. CHECK the reading value for Step 1 differs from the reading value for Step 0 within $2.000\text{V} \pm 30\text{ mV}$.

Checking Steps 2 through 10.

11. CHECK that for each time the spot is advanced 1 division with the MEASUREMENT REPEAT button.
12. Record the value of the digital multimeter reading.
13. CHECK the voltage difference from the previous value are within $2.000\text{ V} \pm 30\text{ mV}$.

Checking INVERT.

14. Change the following 370B setting:

STEP GENERATOR
POLARITY INVERT On

Step Generator output should be automatically return to Step 0.

15. Record the value of the digital multimeter reading and CHECK the voltage difference for INVERT by repeating parts 7 through 13 (For INVERT, the spot will move in the opposite direction).

NOTE. *If steps F7., F8., F9. and F10. will not be performed, complete the instructions given under Replacing the Store/Non-Store Jumper, at the end of Step F13, before proceeding to another step or ending the procedure.*

F7. Checking Step Multi .1X Accuracy in VOLTAGE Mode



Specification:

- Incremental accuracy is 1.5 %.

NOTE. If the previous step was not performed, complete the instructions given under Moving the Store/Non-Store Jumper, at the beginning of Step F8, before proceeding with this step.

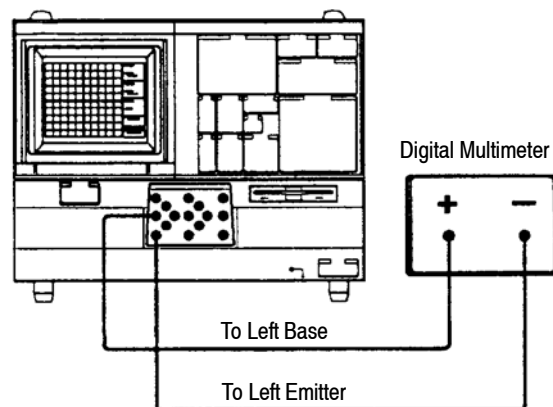

370B settings:

Initialize the 370B; then set the following controls as indicated.

DISPLAY

Mode	NON STORE
HORIZONTAL VOLTS	2 V BASE/EMITTER

COLLECTOR SUPPLY POLARITY	+DC
---------------------------	-----

STEP GENERATOR

Mode	VOLTAGE
STEP AMPLITUDE	2 V
NUMBER OF STEPS	10

POSITION	DISPLAY
----------	---------

LEFT-RIGHT-STANDBY	LEFT
--------------------	------

OUTPUTS	ENABLED
---------	---------

Protective Cover	Closed
------------------	--------

Test Equipment Settings:

Digital Multimeter Mode DC Voltage

press the up and right Position Control buttons to move the displayed spot to the graticule center (V:5.0 H:5.0).

Checking Step 0 and 1.

1. Change the following 370B settings:

STEP GENERATOR

STEP MULTI .1X On

MAG X10 On

2. Record the value of the digital multimeter reading.
3. Change the following 370B setting:

MEASUREMENT

Press the REPEAT button to move the spot 1 division to the right.

4. Record the value of the digital multimeter reading.
5. CHECK the reading value for Step 1 differs from the reading value for Step 0 within $200 \text{ mV} \pm 3 \text{ mV}$.

Checking Steps 2 through 10.

6. CHECK that for each time the spot is advanced 1 division with the MEASUREMENT REPEAT button.
7. Record the value of the digital multimeter reading.
8. CHECK the voltage difference from the previous reading are within $200 \text{ mV} \pm 3 \text{ mV}$.

NOTE. *If steps F8, F9, and F10. will not be performed, complete the instructions given under Replacing the Store/Non-Store Jumper, at the end of Step F10, before proceeding to another step or ending the procedure.*

F8. Checking Step Incremental Accuracy in CURRENT Mode



Specifications:

- Incremental Accuracy is 1.5 %.

NOTE. If previous step was not performed, complete the instruction given under Moving the Store/Non-Store Jumper, at the beginning of Step F6, before proceeding with this step.

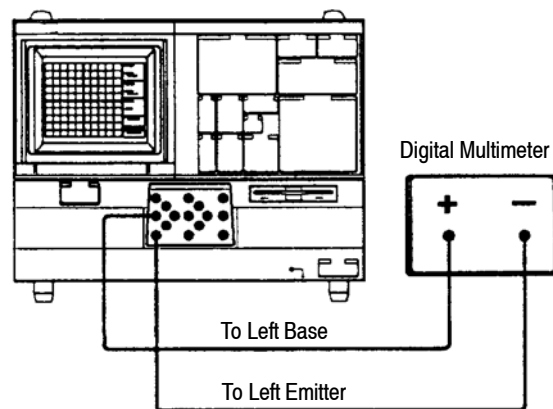

370B settings:

Initialize the 370B; then set the following controls as indicated.

DISPLAY	
Mode	NON STORE
VERTICAL CURRENT	STEP GEN
COLLECTOR SUPPLY POLARITY	+DC
STEP GENERATOR	
Mode	CURRENT
STEP AMPLITUDE	200 mA
NUMBER OF STEPS	10
LEFT-RIGHT-STANDBY	LEFT
OUTPUTS	ENABLED
Protective Cover	Closed
Test Equipment Settings:	
Digital Multimeter Mode	DC Current

Checking Accuracy of Steps 0 and 1.

1. Record the value of digital multimeter reading.
2. press **MEASUREMENT REPEAT** once.
Note that the displayed spot moves 1 division higher.
3. CHECK the reading value for Step 1 differs from the reading value for Step 0 within $200 \text{ mA} \pm 3 \text{ mA}$.

Checking Accuracy of Steps 2 through 10.

4. CHECK that for each time the spot is advanced 1 division with the MEASUREMENT REPEAT button.
5. Record the value of the digital multimeter reading.
6. CHECK the current difference from the previous reading are within $200 \text{ mA} \pm 3 \text{ mA}$.

NOTE. *If step, F9. and F10. will not be performed, complete the instructions given under Replacing the Store/ Non-Store Jumper, at the end of Step F10 before proceeding to another step or ending the procedure.*

Removing the Setup.

7. Change the following 370B setting:

LEFT-RIGHT-STANDBY STANDBY

8. Remove the Digital Multimeter.

F9. Checking Maximum Voltage Output in VOLTAGE Mode



Specifications :

- Absolute accuracy of the Step Generator is less than 1.5 % of the output voltage +3 % of the STEP AMPLITUDE setting + 1 mV.
- Maximum voltage output is 20 times the STEP AMPLITUDE setting.

NOTE. If previous step was not performed, complete the instructions given under Moving the Store/Non-Store Jumper, at the beginning of Step F8, before proceeding with this step.

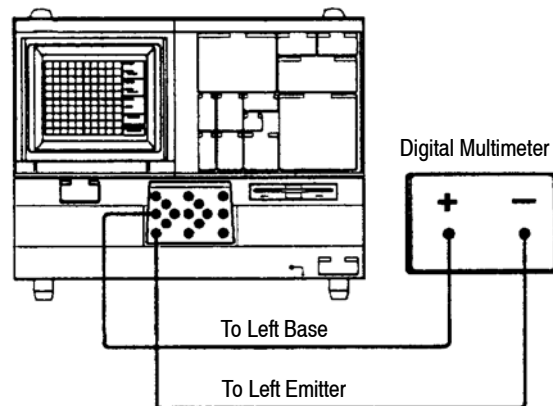

370B settings:

Initialize the 370B; then set the following controls as indicated.

DISPLAY

Mode	NON STORE
HORIZONTAL VOLTS/DIV	STEP GEN
COLLECTOR SUPPLY POLARITY	+DC

STEP GENERATOR

Mode	VOLTAGE
STEP AMPLITUDE	2 V
NUMBER OF STEPS	10
OFFSET	20 V
POSITION	DISPLAY
LEFT-RIGHT-STANDBY	LEFT

OUTPUTS	ENABLED
Protective Cover	Closed
Test Equipment Settings:	
Digital Multimeter Mode	DC Voltage

Checking Maximum Voltage.

1. Simultaneously press the **FAST/SHIFT** and left Position Control buttons to move the displayed spot to the left-most graticule line.
2. Change the following 370B setting:

MEASUREMENT	Press the REPEAT button several times to move the displayed spot to the right-most graticule line.
-------------	--

The Digital Multimeter reading should be approximately 40 V.

3. Check that the digital multimeter reading is between 39.34 and 40.66 V

Checking INVERT.

4. Press the **STEP GENERATOR INVERT** button to **On**.
Step Generator output should be automatically return to Step 0.
5. Simultaneously press the **FAST/SHIFT** and right Position Control buttons to move the displayed spot to the right-most graticule line.
6. Change the following 370B settings:

MEASUREMENT	Press the REPEAT button several times to move the displayed spot to the left-most graticule line.
-------------	---

The Digital Multimeter reading should be approximately -40 V.

7. Check that the digital multimeter reading is between -40.66 V and -39.34 V

Removing the Setup.

8. Change the following 370B setting:

LEFT-RIGHT-STANDBY	STANDBY
--------------------	---------

9. Remove the Digital Multimeter.

NOTE. If step F10 will not be performed, complete the instructions given under Replacing the Store/Non-Store Jumper, at the end of Step F10, before proceeding to another step or ending the procedure.

F10. Checking Maximum Current Output in CURRENT Mode



Specification:

- Absolute Accuracy is less than (1.5 % of the total output + 3 % of the STEP AMPLITUDE setting + 1 nA).
- Maximum current output is 20 times the STEP AMPLITUDE setting, except at 200 mA, where it is 10 times the setting.

NOTE. If the previous step was not performed, complete the instructions given under Moving the Store/Non-Store Jumper, at the beginning of Step F8, before proceeding with this step.

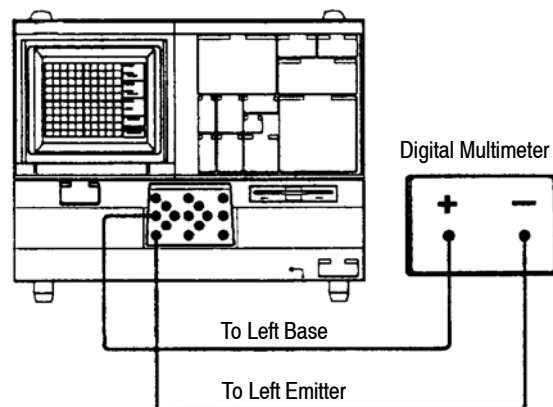

370B settings:

Initialize the 370B; then set the following controls as indicated.

DISPLAY

Mode	NON STORE
VERTICAL CURRENT	STEP GEN

COLLECTOR SUPPLY POLARITY	+DC
STEP GENERATOR	
Mode	CURRENT
STEP AMPLITUDE	100 mA
NUMBER OF STEPS	10
OFFSET	+1000 mA
POSITION	DISPLAY
LEFT-RIGHT-STANDBY	LEFT
OUTPUTS	ENABLED
Protective Cover	Closed
Test Equipment Settings:	
Digital Multimeter Mode	DC Current

NOTE. Before checking these parameters, note the count error of the Digital Multimeter and subtract it from the reading obtained in the procedure.

Checking about 100 mA.

1. Simultaneously press the **FAST/SHIFT** and down Position Control buttons to move the displayed spot to the bottom-left graticule line.
2. Change the following 370B setting:

MEASUREMENT	Press the REPEAT button several times to move the displayed spot to the top-left graticule line.
-------------	--

The Digital Multimeter reading should be approximately 2000 mA.

3. Check that the digital multimeter reading is between 1967 mA and 2033 mA

NOTE. Use a *TEKTRONIX DM501A* to check.

Checking INVERT.

4. Press the **STEP GENERATOR INVERT** button to **On**.

Step Generator output should be automatically return to Step 0.

5. Simultaneously press the **FAST/SHIFT** and up Position Control buttons to move the displayed spot to the top-left graticule line.
6. Change the following 370B settings:

MEASUREMENT	Press the REPEAT button several times to move the displayed spot to the bottom-left graticule line.
-------------	---

The Digital Multimeter reading should be approximately -2000 mA.

7. Check that the digital multimeter reading is between -1967 and -2033 mA

Removing the Setup.

8. Change the following 370B setting:

LEFT-RIGHT-STANDBY	STANDBY
--------------------	---------

9. Disconnect the digital multimeter leads from the 370B.

Alternate Method.

10. Change the following 370B and Test Equipment settings:

STEP GENERATOR	Off
POLARITY INVERT	
STEP AMPLITUDE	100 mA
Digital Multimeter Mode	Volts

11. Connect a 0.025 Ω Resistor between the Left Base jack (B) and the Left Emitter jack (E) and connect the Digital Multimeter to the leads of the Resistor as shown in Figure 5-7.

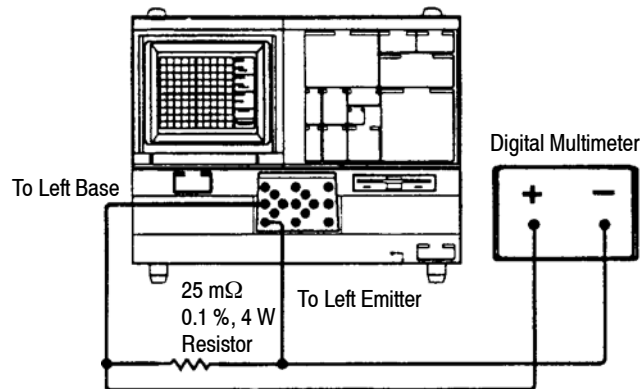

Figure 5-7: Checking for Maximum Current Output of 100 mA and 200 mA range

Checking 100 mA.

12. Simultaneously press the **FAST/SHIFT** and left Position Control buttons to move the displayed spot to the left-most graticule line. Change the following 370B settings:

LEFT-RIGHT-STANDBY	LEFT
Protective Cover	Closed
MEASUREMENT	Press the REPEAT button several times to move the displayed spot to the right-most graticule line.

13. CHECK that the Digital Multimeter readout is 49.175 mV to 50.825 mV.

Checking -100 mA.

14. Change the following 370B settings:

STEP GENERATOR	On
POLARITY INVERT	
STEP AMPLITUDE	100 mA

15. Simultaneously press the **FAST/SHIFT** and right Position Control buttons to move the displayed spot to the right-most graticule line.

16. CHECK that the Digital Multimeter readout is -50.825 mV to -49.175 mV.

Removing the Setup.

17. Change the following 370B setting:

LEFT-RIGHT-STANDBY STANDBY

18. Remove the resistor and the Digital Multimeter.

NOTE. *Maximum 370B Step Generator current is 2 A; therefore, the 100 mA STEP GENERATOR STEP AMPLITUDE setting have the same performance requirement.*

Replacing the Store/Non-Store Jumper.

19. Change the following 370B setting:

POWER OFF

20. Remove the A3 A/D Board.

21. Move jumper J34 from pins 2 - 4 to pins 1 - 2 (ZERO position).

22. Replace the A3 A/D Board and the circuit board retainers across the top of the card cage.

23. Change the following 370B setting:

POWER ON

F11. Checking Maximum Opposing Offset Current in VOLTAGE Mode



Specification:

- Maximum opposing offset current is less than 20 mA.

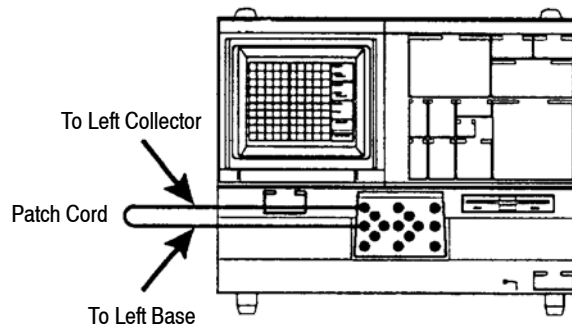

370B settings:

Initialize the 370B; then set the following controls as indicated.

DISPLAY

VERTICAL CURRENT/DIV 5 mA COLLECTOR

COLLECTOR SUPPLY AC
POLARITY

MAX PEAK POWER WATTS 220

STEP GENERATOR

Mode VOLTAGE

STEP AMPLITUDE 2 V

NUMBER OF STEPS 0

OFFSET -20 V

CURSOR DOT

Checking without INVERT.

1. Set the **LEFT-RIGHT-STANDBY** switch to **LEFT**.
2. CHECK for vertical CURSOR reading of less than 20 mA.

Removing the Setup.

3. Change the following 370B setting:

LEFT-RIGHT-STANDBY STANDBY

4. Disconnect the Patch Cord from the 370B.

F12. Checking Maximum Opposing Offset Volts in CURRENT Mode



Specification:

- Maximum Opposing Volts in Current Mode is less than 15 volts.

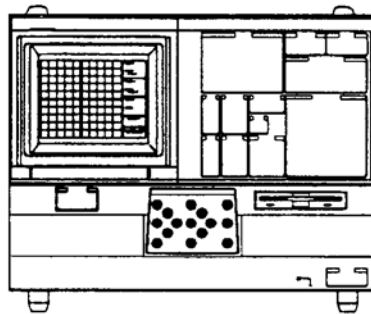

370B settings:

Initialize the 370B; then set the following controls as indicated.

DISPLAY

HORIZONTAL VOLTS/DIV 2 V BASE/EMITTER

COLLECTOR SUPPLY AC
POLARITY

STEP GENERATOR

Mode CURRENT

STEP AMPLITUDE 200 mA

NUMBER OF STEPS 0

OFFSET -2000 mA

CURSOR DOT

OUTPUTS ENABLED

Protective Cover Closed

Checking Maximum Opposing Volts without INVERT.

1. Set the **LEFT-RIGHT-STANDBY** switch to **LEFT**.
2. CHECK that the horizontal CURSOR readout is no more than -15 V.

Checking Maximum Opposing Volts with INVERT.

3. Change the following 370B setting:

STEP GENERATOR On
 POLARITY INVERT

The indicator beside the INVERT button will light.

4. CHECK that the horizontal CURSOR readout is no more than +15 V

F13. Checking PULSE Width



Specification

- Pulse Width is $80 \mu\text{s} \pm 10 \%$ for the SHORT setting of the PULSE selector and $300 \mu\text{s} \pm 10 \%$ for the LONG setting at half amplitude.

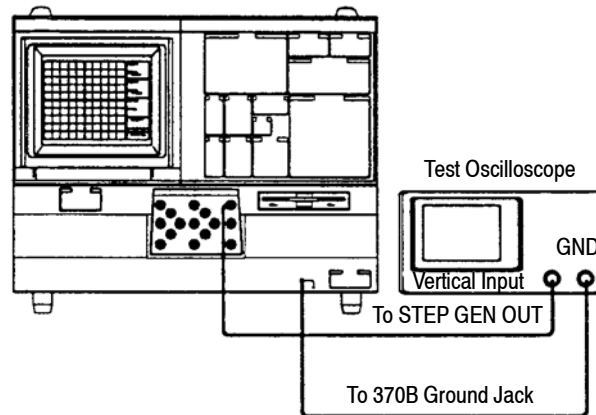

370B settings:

Initialize the 370B; then set the following control as indicated.

STEP GENERATOR

Mode	VOLTAGE
STEP AMPLITUDE	2 V
NUMBER OF STEPS	1
PULSE	LONG
OUTPUTS	ENABLED
Protective Cover	Closed

Test Equipment settings:

Test Oscilloscope	
Vertical Sensitivity	500 mV/div DC
Horizontal	50 μ s/div
Trigger Mode	Auto
Trigger Slope	+

Checking LONG PULSE Width.

1. CHECK that the pulse width is $300 \mu\text{s} \pm 10 \%$ (as measured by the test oscilloscope).

Checking SHORT PULSE Width.

2. Change the following 370B and Test Equipment settings:

370B:

STEP GENERATOR PULSE	SHORT
-------------------------	-------

Test Equipment settings:

Test Oscilloscope	
Horizontal	10 μ s/div

3. CHECK that the pulse width is $80 \mu\text{s} \pm 10 \%$.

F14. Examining Step Generator Polarity Operation

NOTE. The characteristics examined in this step are examples of typical instrument operation; they are not specifications.

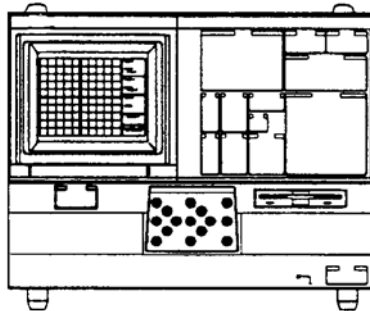

370B settings:

Initialize the 370B; then set the following controls as indicated.

DISPLAY

HORIZONTAL VOLTS/DIV 500 mV BASE/EMITTER

COLLECTOR SUPPLY AC
POLARITY

STEP GENERATOR

Mode VOLTAGE

STEP AMPLITUDE 100 mV

OFFSET 1000 mV

CURSOR DOT

OUTPUTS ENABLED

Protective Cover Closed

Examining POLARITY INVERT Operation.

1. Press the **POLARITY INVERT** button.
2. EXAMINE that the red INVERT LED for lights and the green LED in the STEP GENERATOR POLARITY window changes from + to -, and the CRT to see that the displayed waveform changes from right to left from graticule center.
3. Press the **POLARITY INVERT** button to **OFF**.

Examining the CONFIGURATION BASE COMMON Operation.

4. Change the following 370B setting:

CONFIGURATION	EMITTER STEP GEN
---------------	------------------

5. EXAMINE the green LED in the STEP GENERATOR POLARITY window changes from + to -, and the CRT to see that the displayed waveform changes from right to left from graticule center.

The red INVERT LED will not light.

6. Change the following 370B setting:

CONFIGURATION	BASE STEP GEN
---------------	---------------

Examining the COLLECTOR SUPPLY POLARITY Operation.

7. Change the following 370B setting:

COLLECTOR SUPPLY POLARITY	- 
------------------------------	---

8. EXAMINE the green LED in the STEP GENERATOR POLARITY window changes from + to -, and the CRT to see that the displayed waveform is above the horizontal center graticule line.

The red INVERT LED will not light.

Adjusting Collector Supply Offset.

3. Change the following Test Equipment setting:

Digital Multimeter Mode DC Voltage

4. Connect the Digital Multimeter test leads to pin 1 and pin 3 of P62 as shown in Figure 5-8. (These are the COLLECT-OUT and ground pins.)

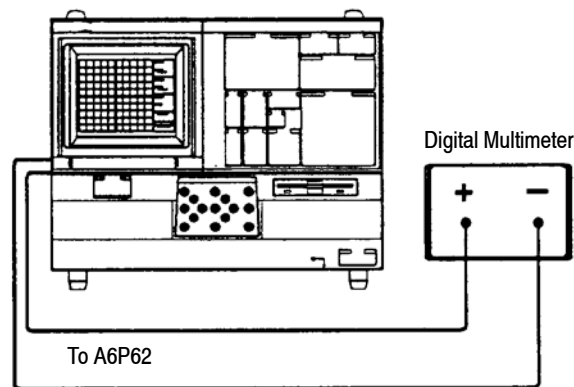

Figure 5-8: Adjusting for Collector Supply Amplifier Offset

5. Change the following 370B setting:

POWER ON

6. ADJUST CS OFFSET adjustment R412 on the A6 Collector Supply Board for a digital multimeter readout of $0.0 \text{ mV} \pm 0.1 \text{ mV}$.

Removing the Setup.

7. Change the following 370B setting:

POWER OFF

8. Remove the digital multimeter test leads from the 370B.
9. Replace the electrical shield.
10. Change the following 370B setting:

POWER ON

**G2. Checking MAX PEAK VOLTS Accuracy
Adjusting Collector Supply Gain (A6R401)**

† ✓

Specification:

- MAX PEAK VOLTS selection include 16, 80, 400, and 2000.
- MAX PEAK VOLTS accuracy for the COLLECTOR SUPPLY is +15 % and -0 % for 16, 80, 400, and 2000 V settings.

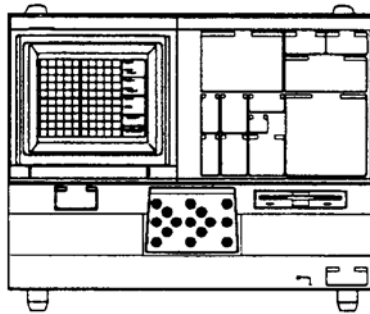

370B settings:

Initialize the 370B; then set the following control as indicated.

COLLECTOR SUPPLY

MAX PEAK POWER WATTS	220
POLARITY	+ DC
CURSOR Mode	DOT
OUTPUTS	ENABLED
VARIABLE COLLECTOR SUPPLY	100 %
Protective Cover	Closed

Checking 16 Max Peak Volts.

1. CHECK the horizontal CURSOR readout for a reading within the limits given in Table 5-15 for 16 MAX PEAK VOLTS.

Checking 80, 400, 2000 MAX PEAK VOLTS.

2. Change the following 370B settings:

DISPLAY
 HORIZONTAL VOLTS/DIV 10 V COLLECTOR
 COLLECTOR SUPPLY
 MAX PEAK POWER 80
 WATTS
 VARIABLE COLLECTOR 100 %
 SUPPLY

3. CHECK the horizontal CURSOR readout for a reading within the limits given in Table 5-15 for 80 MAX PEAK VOLTS.
4. CHECK that the horizontal CURSOR readout is accurate within the limits given in Table 5-15 by repeating steps 2 and 3 for each HORIZONTAL VOLTS/DIV and MAX PEAK VOLTS setting in Table 5-15.

MAX PEAK POWER WATTS should automatically change to 50 when the MAX PEAK VOLTS setting is changed from 400 to 2000.

If not within these limits, the following adjustment is necessary.

Adjusting Collector Supply Gain.

5. Change the following 370B settings:

370B settings:
 DISPLAY
 HORIZONTAL VOLTS/DIV 2 V COLLECTOR
 COLLECTOR SUPPLY
 MAX PEAK POWER 16
 VOLTS
 MAX PEAK POWER 220 WATTS
 WATTS
 CURSOR Mode DOT
 VARIABLE COLLECTOR 100 %
 SUPPLY

6. ADJUST CS Gain adjustment R401 on the A6 Collector Supply Board for a horizontal CURSOR readout of 17.2 V.

R401 can be adjusted through the access hole in the protective shield.

7. Recheck from 1 to 4.

Table 5- 15: Max Peak Volts

MAX PEAK VOLTS	HORIZONTAL VOLTS/DIV setting	MAX PEAK POWER WATTS setting	Horizontal CURSOR Readout Limits setting
16	2 V	220	16.0 V to 18.4 V
80	10 V	220	80.0 V to 92.0 V
400	50 V	220	400 V to 460 V
2000	500 V	50	2000 V to 2300 V

G3. Checking DC Mode Ripple



- DC Mode Ripple tor 2 % of the full range voltage.

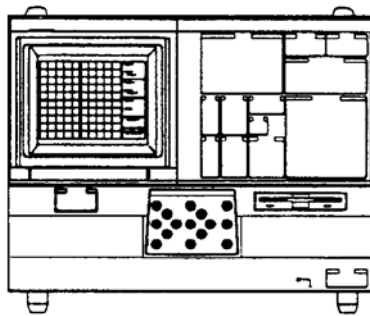

370B settings:

Initialize the 370B; then set the following control as indicated.

DISPLAY Mode	NON STORE
COLLECTOR SUPPLY	
MAX PEAK POWER WATTS	220
POLARITY	+ DC
POSITION	DISPLAY
OUTPUTS	ENABLED
VARIABLE COLLECTOR SUPPLY	100 %
Protective Cover	Closed

Checking 16 MAX PEAK VOLTS DC Mode Ripple.

1. Move the spot to graticule center with the Position Control buttons.
2. Change the following 370B setting:

MAG X10 On

3. CHECK the display spot for its width to be within the limit given in Table 5-16 for 16 MAX PEAK VOLTS.

Checking 2000 MAX PEAK VOLTS DC Mode Ripple.

4. Change the following 370B settings:

DISPLAY
 HORIZONTAL VOLTS / DIV 50 V COLLECTOR
 COLLECTOR SUPPLY
 MAX PEAK VOLTS 2000
 VARIABLE 100 %
 COLLECTORSUPPLY

5. Move the spot to graticule center with the right Position Control button.
6. CHECK the display spot for its width to be with the limit given in Table 5-16 for 2000 MAX PEAK VOLTS.

MAX PEAK POWER WATTS should be automatically change to 50 when the MAX PEAK VOLTS setting is changed from 16 to 2000.

Table 5-16: Max Peak Volts

MAX PEAK VOLTS setting	HORIZONTAL VOLTS/DIV setting	MAX PEAK POWER WATTS	Maximum Spot Width (Ripple)
16	200 mV	220	320 mV (1.6 div)
2000	50 V	50	40 V (0.8 div)

G4. Checking Maximum Peak Currents



Specification:

- Minimum Current Available Current is ≥ 10 A for the 16 V COLLECTOR SUPPLY, ≥ 2 A for 80 V, 400 mA for 400 V, and 50 mA for 2000 V.

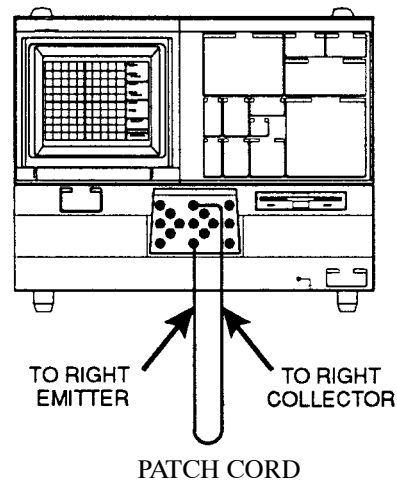

370B settings:

Initialize the 370B; then set the following control as indicated.

DISPLAY

HORIZONTAL VOLT/DIV 500

COLLECTOR SUPPLY

MAX PEAK POWER 220
WATTS

POLARITY + DC

CURSOR Mode DOT

POSITION DISPLAY

OUTPUTS ENABLED

LEFT-RIGHT-STANDBY RIGHT

Protective Cover Closed

Checking 16 V Maximum Current.

1. CHECK that the trace can reach the value specified in Table 5-17 when VARIABLE COLLECTOR SUPPLY control is turned clockwise.

Checking 80, 400, 2000 V Maximum Current.

2. Change the following 370B settings:

DISPLAY
 VERTICAL CURRENT/DIV 500 mA
 COLLECTOR SUPPLY
 MAX PEAK VOLTS 80

3. CHECK that the trace can reach the value specified in Table 5-17 when VARIABLE COLLECTOR SUPPLY control is turned clockwise.
4. CHECK that the trace can reach the value specified in Table 5-17 by repeating steps 2 and 3 for each VERTICAL CURRENT/DIV and MAX PEAK VOLTS setting in Table 5-17.

MAX PEAK POWER WATTS should be automatically change to 50 when the MAX PEAK VOLTS setting is changed from 400 to 2000.

Removing the Setup.

5. Change the following 370B settings:

COLLECTOR SUPPLY
 MAX PEAK VOLTS 16 V
 LEFT-RIGHT-STANDBY STANDBY

6. Remove the patch cord from the 370B.

Table 5-17: Maximum Peak Currents

MAX PEAK VOLTS settings	MAX PEAK POWER WATTS	VERTICAL CURRENT/DIV setting	VERTICAL CURSOR Readout
16 V	220 W	2 A	\cong 10 A (5 div)
80 V	220 W	500 mA	\cong 2 A (4 div)
400 V	220 W	100 mA	\cong 400 mA (4 div)
2000 V	50 W	10 mA	\cong 50 mA (5 div)

6. EXAMINE the displayed spot extends toward 100 % as the VARIABLE COLLECTOR SUPPLY control is rotated clockwise.
7. Set the **OUTPUTS** to **DISABLED**.
8. EXAMINE that the displayed trace goes back to lower left corner and that the OUTPUT DISABLED message appears for a few seconds in the lower left corner of the display.
9. Set the **OUTPUTS** to **ENABLED**.
10. EXAMINE that the OUTPUT ENABLED message appears in the the lower left corner of the display for a few seconds.

Examining +DC POLARITY.

11. Change the following 370B and Test Equipment settings:

370B:

COLLECTOR SUPPLY + DC
POLARITY

VARIABLE COLLECTOR 100 %
SUPPLY

Test Oscilloscope:

Vertical 5 V/div DC

Trigger Mode auto

12. Connect the Test Oscilloscope as shown in Figure 5-9 and close the Protective Cover.

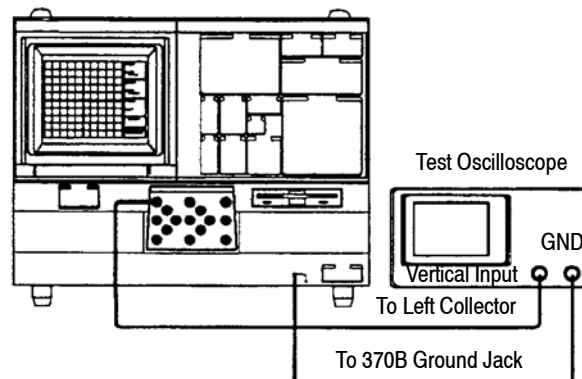

Figure 5-9: Examining for DC and LEAKAGE operation

13. EXAMINE the display for the spot to move from the lower left corner along the bottom horizontal graticule line as the VARIABLE COLLECTOR SUPPLY control is rotated clockwise to 100 %.

14. EXAMINE the Test Oscilloscope display for DC.

Examining +LEAKAGE POLARITY.

15. Change the following 370B setting:

COLLECTOR SUPPLY	+ LEAKAGE
POLARITY	

16. EXAMINE the display for the spot to position the same as in part 13.

17. EXAMINE the Test Oscilloscope display for DC.

Examining AC POLARITY.

18. Change the following 370B settings:

COLLECTOR SUPPLY	AC
POLARITY	
VARIABLE COLLECTOR	100 %
SUPPLY	

19. EXAMINE the display for a horizontal trace starting from graticule center and extending out of the display area.

Examining -  POLARITY.

20. Change the following 370B settings:

COLLECTOR SUPPLY	- 
POLARITY	
VARIABLE COLLECTOR	100 %
SUPPLY	

21. EXAMINE the display for a horizontal trace extending along the top horizontal graticule line from the upper right corner.

Examining - DC POLARITY.

22. Change the following 370B setting:

COLLECTOR SUPPLY - DC
POLARITY

23. EXAMINE the display for the spot to position the peak of part 21.

24. EXAMINE the Test Oscilloscope display for DC.

Examining - LEAKAGE POLARITY.

25. Change the following 370B setting:

COLLECTOR SUPPLY - LEAKAGE
POLARITY

26. EXAMINE the display for the spot to position the same as part 23.

27. EXAMINE the Test Oscilloscope display for DC.

Removing the Setup.

28. Change the following 370B setting:

LEFT-RIGHT-STANDBY STANDBY

29. Disconnect the Test Oscilloscope.

**G6. Examining the
LIMITER Indicator in
Voltage Mode**

NOTE. *The characteristics examined in this step are examples of typical instrument operation; they are not specifications.*

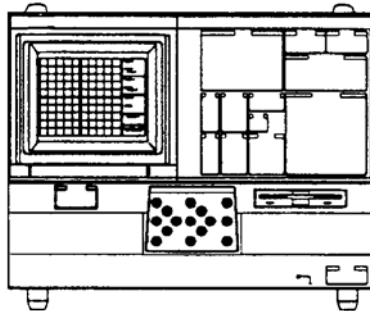

370B settings:

Initialize the 370B; then set the following controls as indicated.

COLLECTOR SUPPLY

MAX PEAK VOLTS 400

OUTPUTS ENABLED

Protective Cover Closed

Examining the Limiter Indicator for 400 MAX PEAK VOLTS Range.

1. EXAMINE the LIMITER indicator besides the LEFT-RIGHT-STANDBY for turn on when the VARIABLE COLLECTOR SUPPLY control is rotated clockwise.

Examining the Limiter Indicator for 2000 MAX PEAK VOLTS Range.

2. Change the following 370B settings:

COLLECTOR SUPPLY

MAX PEAK VOLTS 2000

MAX PEAK POWER 2
WATTS

3. EXAMINE the LIMITER indicator for turn on when the VARIABLE COLLECTOR SUPPLY control is rotated clockwise.

4. Change the following 370B setting:

HORIZONTAL VOLTS/DIV 5 V COLLECTOR

5. EXAMINE the LIMITER indicator for turn on when the VARIABLE COLLECTOR SUPPLY control is rotated clockwise.

G7. Examining the LIMITER Indicator in Current Mode

NOTE. The characteristics examined in this step are examples of typical instrument operation; they are not specifications.

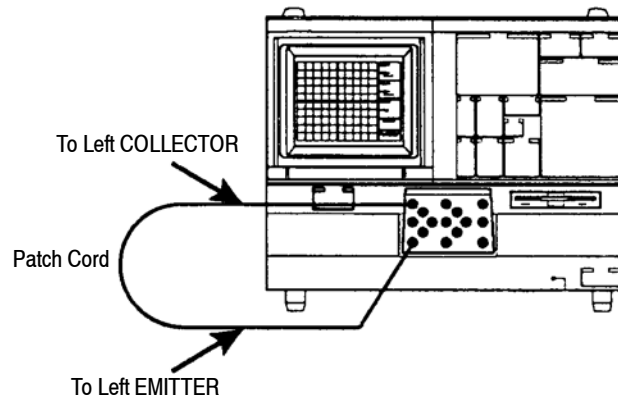

370B settings:

Initialize the 370B; then set the following controls as indicated.

DISPLAY

VERTICAL CURRENT/DIV 100 μ A COLLECTOR

COLLECTOR SUPPLY

MAX PEAK VOLTS 400

OUTPUTS ENABLED

LEFT-RIGHT-STANDBY LEFT

Protective Cover Closed

Examining the Limiter for 0.08 MAX PEAK POWER WATTS Range.

1. EXAMINE that the LIMITER indicator next to the LEFT-RIGHT-STANDBY lights when the VARIABLE COLLECTOR SUPPLY control is rotated clockwise and watch for the peak of the trace to be brightening.

Examining the Limiter for 0.4 MAX PEAK POWER WATTS Range.

2. Change the following 370B settings:

DISPLAY

VERTICAL CURRENT/DIV 500 μ A COLLECTOR

COLLECTOR SUPPLY

MAX PEAK POWER 0.4
WATTS

3. EXAMINE that the LIMITER indicator lights when the VARIABLE COLLECTOR SUPPLY control is rotated clockwise and that the peak of the trace brightens.

Examining the Limiter for 10 MAX PEAK POWER WATTS Range.

4. Change the following 370B settings:

DISPLAY

VERTICAL CURRENT/DIV 5 mA COLLECTOR

COLLECTOR SUPPLY

MAX PEAK POWER 10
WATTS

5. EXAMINE that the LIMITER indicator lights when the VARIABLE COLLECTOR SUPPLY control is rotated clockwise and that the peak of the trace brightens.

Removing the Setup.

6. Change the following 370B setting:

LEFT-RIGHT-STANDBY STANDBY

7. Remove the Patch Cord from the 370B.

AUX Supply

Equipment Required (see Table 5-3):

- Test Oscilloscope
- Digital Multimeter

H1. Checking AUX SUPPLY Accuracy, Resolution, and Range



Specifications:

- The Aux Supply is accurate to less than $(50 \text{ mV} + 1.5 \% \text{ of the total output})$.
- Resolution is 20 mV.
- Range is from - 40 V to + 40 V.

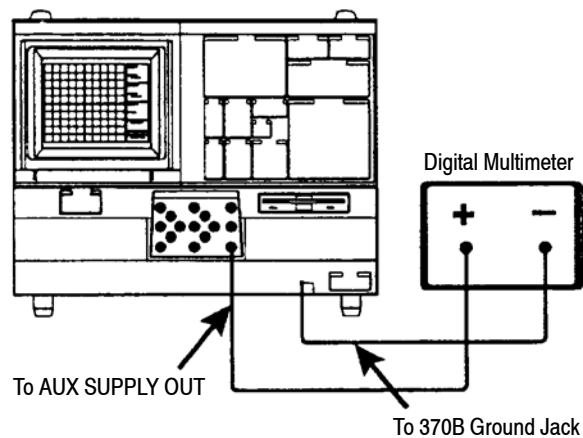

370B settings:

Initialize the 370B; then set the following control as indicated.

OUTPUTS	ENABLED
Protective Cover	Closed

Test Equipment Settings:

Digital Multimeter Mode	DC Voltage
-------------------------	------------

Checking Accuracy.

1. CHECK that the AUX SUPPLY readout on the 370B display is 0.00 V. (AUX SUPPLY will not show on screen for 0.00 V.)
2. CHECK that the digital multimeter reading is within the limits given in Table 5-18 for 0.00 V.

Table 5-18: Auxiliary Supply Accuracy

AUX readout	Digital Multimeter Reading
0.00 V (no display)	± 0.05 V
+40.00 V	+39.35 V to +40.65 V
-40.00 V	-40.65 V to -39.35 V

Checking Resolution.

3. CHECK that each time one of the AUX SUPPLY arrow buttons (up or down) is pressed, the AUX SUPPLY readout and digital multimeter reading change by 20 mV.

Checking Range.

4. Change the following 370B setting:

AUX SUPPLY -40.00 V (as indicated in
the AUX SUPPLY readout)

5. CHECK that the digital multimeter measurement is within the limits given in Table 5-18 for -40.00 V.

6. Change the following 370B setting:

AUX SUPPLY +40.00 V (as indicated in
the AUX SUPPLY readout)

7. CHECK that the digital multimeter measurement is within the limits given in Table 5-18 for +40.00 V.

Removing the Setup.

8. Disconnect the digital multimeter leads from the 370B.

H2. Checking AUX SUPPLY Ripple and Noise



Specification:

- Displayed Ripple and Noise is less than 50 mV peak to peak.

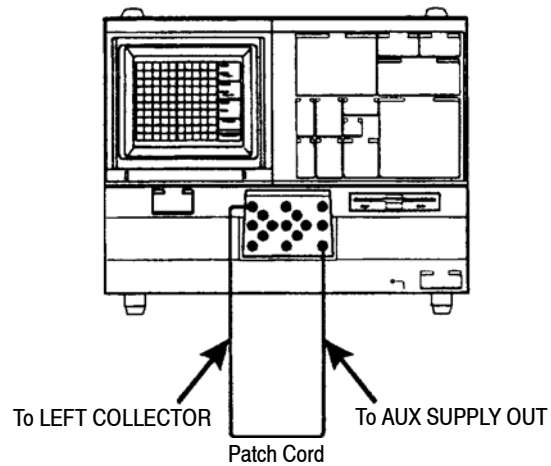

370B settings:

Initialize the 370B; then set the following controls as indicated.

DISPLAY

Mode NON STORE

HORIZONTAL VOLTS/DIV 50 mV COLLECTOR

COLLECTOR SUPPLY

POLARITY AC

LEFT-RIGHT-STANDBY LEFT

Checking Ripple and Noise.

1. CHECK that the spot width is within 1 horizontal division.

Removing the Setup.

2. Disconnect the patch cord from the 370B.

Configuration

Equipment Required (see Table 5-3):

- Test Oscilloscope
- Digital Multimeter

I1. Examining Collector Configuration

NOTE. The characteristics examined in this step are examples of typical instrument operation; they are not specifications.

The following procedure checks operation of the relays that carry the Collector Supply to the Test Fixture Adapter Jacks.

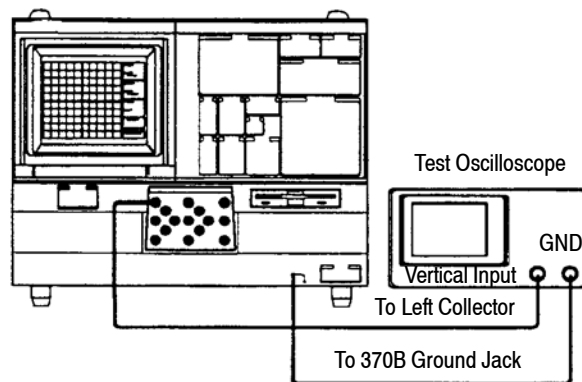

370B settings:

Initialize the 370B; then set the following controls as indicated.

LEFT-RIGHT-STANDBY	LEFT
OUTPUTS	ENABLED

Test Equipment Settings:

Test Oscilloscope:

Vertical Sensitivity	5 V/div DC
Horizontal Scale	2ms/div
Trigger Mode	Auto
Trigger Source	Line

Examining Internal Operation for LEFT.

1. Connect a test lead with a banana plug to the LEFT C(Collector) jack. Connect a Probe hook from the Test Oscilloscope to the test leads clip, and ground lead to the Ground plug.
2. Close the Protective Cover and turn the VARIABLE COLLECTOR SUPPLY control.
3. EXAMINE the test oscilloscope for rectified waveform to be displayed.
4. Change the following 370B setting:

LEFT-RIGHT-STANDBY	STANDBY
--------------------	---------

5. EXAMINE the test oscilloscope for no waveform to be displayed.
A small waveform may be displayed by stray capacitance.

Examining Internal Operation for RIGHT.

6. Move the test lead with banana plug to the RIGHT C(Collector) and close the Protective Cover.
7. EXAMINE the test oscilloscope for no waveform to be displayed.
A small waveform may be displayed by stray capacitance.
8. Change the following 370B setting:

LEFT-RIGHT-STANDBY	RIGHT
--------------------	-------

9. EXAMINE the test oscilloscope for rectified waveform to be displayed.

Examining the Collector for OPEN.

10. Change the following 370B setting:

CONFIGURATION	COLLECTOR OPEN
VARIABLE COLLECTOR SUPPLY	100 %

11. EXAMINE the test oscilloscope for no waveform display.
A small waveform may be displayed by stray capacitance.

Removing the Setup.

12. Change the following 370B setting:

LEFT-RIGHT-STANDBY STANDBY

13. Disconnect the test lead and probe from the 370B.

12. Examining Base Configuration

NOTE. *The characteristics examined in this step are examples of typical instrument operation; they are not specifications.*

The following procedure checks operation of the relays that carry the Step Generator signal and Collector Supply to the Test Fixture Adapter Jacks.

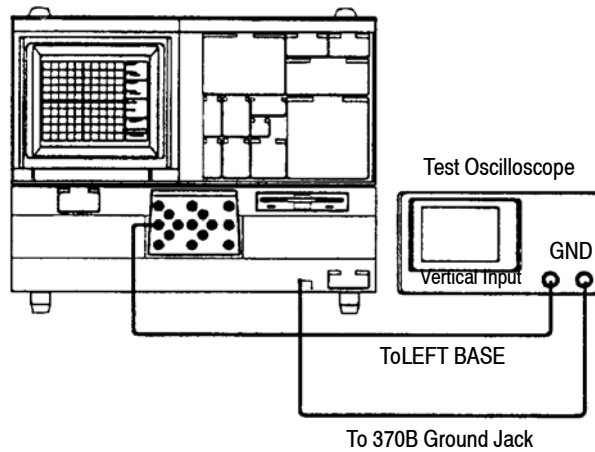

370B settings:

Initialize the 370B; then set the following controls as indicated.

STEP GENERATOR

Mode	VOLTAGE
STEP AMPLITUDE	2 V
LEFT-RIGHT-STANDBY	LEFT
OUTPUTS	ENABLED
Protective Cover	Closed

Test Equipment Settings:**Test Oscilloscope:**

Vertical Sensitivity	5 V/div DC
Horizontal	10 ms/div
Trigger Mode	Auto
Trigger Slope	-

Examining Internal Operation for LEFT.

1. EXAMINE the test oscilloscope display for a step waveform.
2. Change the following 370B setting:

LEFT-RIGHT-STANDBY STANDBY

3. EXAMINE the test oscilloscope for no step waveform display.

A small waveform may be displayed by stray capacitance.

Examining Internal Operation for RIGHT.

4. Connect the test oscilloscope between the RIGHT B(BASE) and ground jacks, and close the protective cover
 5. EXAMINE the test oscilloscope for no step waveform display.
- A small waveform may be displayed by stray capacitance.
6. Change the following 370B setting:

LEFT-RIGHT-STANDBY RIGHT

7. EXAMINE the test oscilloscope for a step waveform to be displayed.

Examining External Base Input.

8. Change the following 370B setting:

CONFIGURATION BASE OPEN (EXT)

9. EXAMINE the test oscilloscope for no step waveform display.
10. Use a patch cord to connect the STEP GEN OUT and EXT BASE or EMITTER IN jacks, and close the protective cover.

11. EXAMINE the test oscilloscope for a step waveform to be displayed.

Checking Base SHORT (EMITTER) Configuration.

12. Disconnect the patch cord and connect the test oscilloscope between the STEP GEN OUT and ground jacks.

13. Change the following 370B and Test Equipment settings:

370B:

CONFIGURATION	BASE SHORT (EMITTER)
---------------	----------------------

Protective Cover	Closed
------------------	--------

Test Equipment Settings:

Mode	Ω
------	----------

14. EXAMINE the test oscilloscope does not display a step waveform.

15. Disconnect the Test Oscilloscope and connect the Digital Multimeter to the RIGHT B(BASE) and E(EMITTER) jacks.

16. EXAMINE that the RIGHT B and E are shorted.

Resistance is approximately 1 Ω or less.

17. Change the following 370B setting:

LEFT-RIGHT-STANDBY	LEFT
--------------------	------

18. Connect the Digital Multimeter to the LEFT B(BASE) and E(EMITTER) jacks.

19. EXAMINE that the LEFT B and E are shorted.

Resistance is approximately 1 Ω or less.

Checking Base COLLECTOR SUPPLY CONFIGURATION.

20. Disconnect the Digital Multimeter.

21. Change the following 370B and Test Equipment settings:

370B:

CONFIGURATION	BASE COLLECTOR SUPPLY
---------------	-----------------------

OUTPUT	ENABLED
--------	---------

Test Oscilloscope:

Vertical Sensitivity	5 V/div DC
Horizontal	2 ms/div
Trigger Mode	Line

22. Connect a test leads with banana plug to the LEFT B jack. Connect a probe hook from the Test Oscilloscope to the test lead clip, and the ground lead to to the Ground jack.
23. Close the Protective Cover and turn the VARIABLE COLLECTOR SUPPLY control.
24. EXAMINE the test Oscilloscope for rectified waveform to be displayed.

Removing the Setup.

25. Change the following 370B setting:

LEFT-RIGHT-STANDBY STANDBY

26. Disconnect the Test Lead and Probe from the 370B.

I3. Examining Emitter Configuration

NOTE. The characteristics examined in this step are examples of typical instrument operation; they are not specifications.

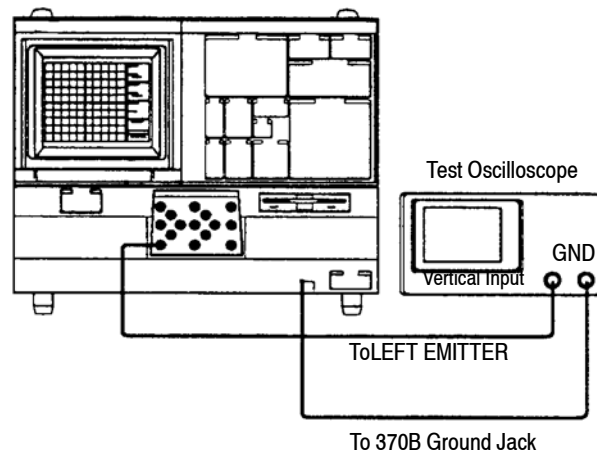

370B settings:

Initialize the 370B; then set the following controls as indicated.

STEP GENERATOR

Mode	VOLTAGE
STEP AMPLITUDE	1 V
CONFIGURATION	EMITTER STEP GEN
OUTPUTS	ENABLED
Protective Cover	Closed

Test Equipment Settings:

Test Oscilloscope:

Vertical Sensitivity	2 V/div DC
Horizontal	10 ms/div
Trigger Mode	Auto
Trigger Slope	+

Examining Internal Operation for LEFT.

1. EXAMINE the test oscilloscope display for a step waveform.

Examining Internal Operation for RIGHT.

2. Connect the test oscilloscope between the RIGHT E (Emitter) and ground jacks and close the protective cover.
3. EXAMINE the test oscilloscope display for a step waveform.

Examining External Operation.

4. Change the following 370B setting:

CONFIGURATION	EMITTER OPEN (EXT)
---------------	--------------------

5. EXAMINE the test oscilloscope for no step waveform display.
6. Use a patch cord to connect the STEP GEN OUT and EXT BASE or EMITTER IN jacks, and close the protective cover.
7. EXAMINE the test oscilloscope display for a step waveform.

Removing the Setup.

8. Disconnect the test oscilloscope and remove the patch cord from the 370B.

Key Operation and Floppy Disk Drive

Equipment Required (see Table 5-3):

- 2HD Floppy Disk

J1. Examining Key Operation

NOTE. *The characteristics examined in this step are examples of typical instrument operation; they are not specifications.*

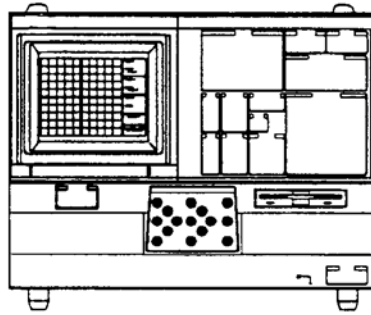

370B settings:
Initial setting

Examining Key Operation.

1. Simultaneously press the **FAST/SHIFT** and the **POSITION DISPLAY** buttons to enter “KEY CHECK MODE”.
2. EXAMINE all buttons and knobs while pressing or turning them to change the display.

Except the INTENSITY, FOCUS, GRAT ILLUM, POSITION, and TRACE ROTATION controls.

3. Simultaneously press the **FAST/SHIFT** and the **POSITION DISPLAY** buttons to exit “KEY CHECK MODE”.

J2. Examining Floppy Disk Drive Operation

NOTE. *The characteristics examined in this step are examples of typical instrument operation; they are not specifications.*

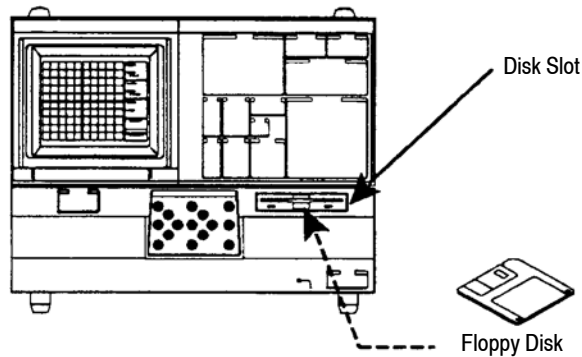

370B settings:

Initial setting

Installing the Floppy Disk.

1. Set the write-protect tab of the floppy disk to write-enable position.
2. Install the floppy disk in the floppy disk slot of the 370B.



CAUTION. *The following step for data formatting will erase all data on the floppy disk.*

Formatting the Floppy Disk.

3. Press the **SAVE/FORMAT** button while holding down the **FAST/SHIFT** button, then press the **SAVE/FORMAT** button.
4. EXAMINE the "FORMAT END" message is displayed after formatting.

Examining Read Write Operation.

5. Press the **RECALL/DIRECTORY** button while holding down the **FAST/SHIFT** button.
6. Press the up **MEMORY** button to set the **DIRECTORY PAGE** to 7.

7. EXAMINE the <READ ERROR> message is not displayed at any of the memory locations.
8. EXAMINE the <READ ERROR> message is not displayed at any of the memory locations when repeating steps 6 and 7 from DIRECTORY PAGE 8 to 28.
9. Press the **STORE** button to exit from the directory display mode.

Instrument Options

Options and Accessories

Options

This subsection describes the following options available with the 370B Programmable Curve Tracer.

- Option 1R (Rack mounting)
- Option D1 (Test result report)
- Option A9 (No power cord supplied)

Option 1R 370B Programmable Curve Tracer comes configured for installation in a 19-inch wide instrument rack.

Option D1 A calibration data test result report will be provided with the 370B Programmable Curve Tracer when this option is specified.

Option A9 370B Programmable Curve Tracer comes without the power cord.

Accessories

Standard Accessories

The 370B Programmable Curve Tracer includes the standard accessories listed in Table 6-1:

Table 6-1: Standard accessories

Accessory	Part number
User Manual (English)	070-A838-XX
Fuse	
250 V, 2 A, Medium-blow	159-0260-00
125 V, 4 A, Medium-blow	159-0259-00
Protective Cover	337-3344-02
Utility Software (FDD)	063-3341-XX
Power Cord	161-0066-00
Test Adapters	
Blank Adapter	A1001
In-line Adapter	A1002
Axial Lead Adapter	A1005

Optional Accessories

The following optional accessories, listed in Table 6-2, are recommended for use with the instrument:

Table 6-2: Optional accessories

Accessory	Part number
Service Manual	070-A842-XX
Test Adapter	
TO-3/TO-66 Adapter	A1003
4 and 6 Lead Transistor Adapter	A1007
4 and 6 Lead FET Adapter	A1009
IC Adapter	A1010
SOT23, SMD Adapter	A1023
GPIB Cable, 2m	012-0991-00
Rack Mount Kit	016-0930-00
Cart	K475

This appendix describes the various options as well as the standard and optional accessories that are available for the 370B Programmable Curve Tracer.

**Recommended
Accessories**

The following optional accessories, listed in Table 6-3, are recommended for use with the instrument:

Table 6-3: Recommended accessories

Accessory	Model number
Thermal Printer CBM, Thermal Printer (http://www.jcbm.co.jp)	iDP3240

Electrical Parts List

Replaceable Electrical Parts

The modules that make up this instrument are often a combination of mechanical and electrical subparts. Therefore, all replaceable modules are listed in section, *Mechanical Parts List*. Refer to that section for part numbers when using this manual.

The repair of the 370B Programmable Curve Tracer is the exchange of the board fundamentally.

This section contains a list of the electrical components for the 370B Programmable Curve Tracer. Use this list to identify and order replacement parts.

Parts Ordering Information

Replacement parts are available through your local Tektronix field office or representative.

Changes to Tektronix products are sometimes made to accommodate improved components as they become available and to give you the benefit of the latest improvements. Therefore, when ordering parts, it is important to include the following information in your order.

- Part number (see Part Number Revision Level below)
- Instrument type or model number
- Instrument serial number
- Instrument modification number, if applicable

If you order a part that has been replaced with a different or improved part, your local Tektronix field office or representative will contact you concerning any change in part number.

Change information, if any, is located at the rear of this manual.

Part Number Revision Level

Tektronix part numbers contain two digits that show the revision level of the part. For most parts in this manual, you will find the letters XX in place of the revision level number.



When you order parts, Tektronix will provide you with the most current part for your product type, serial number, and modification (if applicable). At the time of your order, Tektronix will determine the part number revision level needed for your product, based on the information you provide.

Using the Replaceable Electrical Parts List

The tabular information in the Replaceable Electrical Parts List is arranged for quick retrieval. Understanding the structure and features of the list will help you find all of the information you need for ordering replacement parts. The following table describes each column of the electrical parts list.

Parts List Column Descriptions

Column	Column Name	Description
1	Component Number	The component number appears on diagrams and circuit board illustrations, located in the diagrams section. Assembly numbers are clearly marked on each diagram and circuit board illustration in the <i>Diagrams</i> section, and on the mechanical exploded views in the <i>Replaceable Mechanical Parts</i> list section. The component number is obtained by adding the assembly number prefix to the circuit number (see Component Number illustration following this table). The electrical parts list is arranged by assemblies in numerical sequence (A1, with its subassemblies and parts, precedes A2, with its subassemblies and parts). Chassis-mounted parts have no assembly number prefix, and they are located at the end of the electrical parts list.
2	Tektronix Part Number	Use this part number when ordering replacement parts from Tektronix.
3 and 4	Serial Number	Column three indicates the serial number at which the part was first effective. Column four indicates the serial number at which the part was discontinued. No entry indicates the part is good for all serial numbers.
5	Name & Description	An item name is separated from the description by a colon (:). Because of space limitations, an item name may sometimes appear as incomplete. Use the U.S. Federal Catalog handbook H6-1 for further item name identification.
6	Mfr. Code	This indicates the code number of the actual manufacturer of the part.
7	Mfr. Part Number	This indicates the actual manufacturer's or vendor's part number.

Replaceable electrical parts list

Component number	Tektronix part number	Serial no. effective	Serial no. discontin'd	Name & description	Mfr. code	Mfr. part number
A1	671-0236-02			CIRCUIT BD ASSY:MOTHER	80009	671023602
A2	671-B126-01			CIRCUIT BD ASSY:CPU	80009	671B12601
A3	671-B213-00			CKT BD ASSY:A/D	80009	671B21300
A4	670-9306-04			CIRCUIT BD ASSY:DIGITAL DISPLAY	80009	670930604
A5	670-9307-05			CIRCUIT BD ASSY:DISPLAY CONTROL	80009	670930705
A6	670-9308-06			CIRCUIT BD ASSY:COLLECTOR SUPPLY	80009	670930806
A7	670-9309-09			CIRCUIT BD ASSY:STEP GENERATOR	80009	670930909
A9	671-1183-04			CIRCUIT BD ASSY:LV RELAY	80009	671118304
A10	671-B212-00			CIRCUIT BD ASSY:SENSE BOARD	80009	671B21200
A11	671-B235-00			CIRCUIT BD ASSY:MAIN KEY	80009	671B23500
A12	671-1149-02			CIRCUIT BD ASSY:SUB KEY	80009	671114902
A13	671-1238-02			CIRCUIT BD ASSY:KEY INTERFACE	80009	671123802
A14	671-B244-00			CIRCUIT BD ASSY:LOR KEY	80009	671B24400
A15	671-B245-00			CIRCUIT BD ASSY:CONFIGURATION LED	80009	671B24500
A18	670-9319-02			CIRCUIT BD ASSY:CRT OUTPUT	80009	670931902
A19	670-9320-01			CIRCUIT BD ASSY:LV SUPPLY	80009	670932001
A20	670-B211-00			CIRCUIT BD ASSY:H.V. REGULATOR	TK0191	670B21100
A22	671-B127-01			CIRCUIT BD ASSY:INTERFACE	80009	671B12701
A23	671-B128-01			CIRCUIT BD ASSY:FDD INTERFACE	80009	671B12801
A24	119-B105-00			FLOPPY DISK UNI:3.5 INCH W/INTERFACE (STANDARD ACCESSORY)	80009	119B10500
A27	670-9323-00			CIRCUIT BD ASSY:PRIMARY	80009	670932300
A28	670-9324-02			CIRCUIT BD ASSY:LAMP	80009	670932401
A29	670-9324-02			CIRCUIT BD ASSY:LAMP	80009	670932402
A33	671-1096-03			CIRCUIT BD ASSY:CONFIGURATION RELAY	80009	671109603
A34	671-1140-01			CIRCUIT BD ASSY:LOR RELAY	80009	671114001
A35	671-1147-03			CIRCUIT BD ASSY:LOOPING	80009	671114703

Replaceable electrical parts list (Cont.)

Component number	Tektronix part number	Serial no. effective	Serial no. discontinued	Name & description	Mfr. code	Mfr. part number
A1W60	174-0291-00			CA ASSY,SP,ELEC:16,28 AWG,18.5 L,RIBBON	80009	174029100
A1W70	174-0292-00			CA ASSY,SP,ELEC:16,28 AWG,4.3 L,RIBBON	80009	174029200
A1W192	174-0294-00			CA ASSY,SP,ELEC:16,28 AWG,12.6 L,RIBBON	80009	174029400
A6W64	174-0301-00			CA ASSY,SP,ELEC:4,22 AWG,16.0 L	80009	174030100
A6W66	174-0304-00			CA ASSY,SP,ELEC:2,26 AWG,6.0 L,RIBBON	80009	174030400
A9W90	174-1774-00			CA ASSY,SP,ELEC:40,26 AWG,8.0 L,RIBBON	80009	174177400
A11W110	174-0293-00			CA ASSY,SP,ELEC:40,28 AWG,4.3 L,RIBBON	80009	174029300
A14W140	174-1832-00			CA ASSY,SP,ELEC:14,28 AWG,23.0 L,RIBBON	80009	174183200
A15W150	174-1775-00	.301393	.301497	CA ASSY,SP,ELEC:16,26 AWG,18.0 L,RIBBON	80009	174177500
A15W150	174-1775-01	.301498		CA ASSY,SP,ELEC:16,28 AWG,250MM L,RIBBON	80009	174177501
A22W220	174-0295-00			CA ASSY,SP,ELEC:26,28 AWG,11.0 L,RIBBON	80009	174029500
A23W100	174-1692-00			CA ASSY,SP,ELEC:24,28 AWG,12.0 L,RIBBON	80009	174169200
A23W200	174-1611-00			CA ASSY,SP,ELEC:34,28 AWG,9.0 L,RIBBON	80009	174161100
A33W330	174-1951-00			CA ASSY,SP,ELEC:14,28 AWG,11.0 L,RIBBON	80009	174195100

Replaceable electrical parts list (Cont.)

Component number	Tektronix part number	Serial no. effective	Serial no. discont'd	Name & description	Mfr. code	Mfr. part number
B100	119-3674-00	.301393	.32156	FAN,TUBEAXIAL:115 VAC,240MA,19W,2650 RPM	80009	119367400
B100	119-2310-01	.302157		FAN,TUBEXIAL:115VAC,230MA,16W,2650RPM	80009	119231001
F100	159-0259-00			FUSE , CARTRIDGE :4A, 125V, MEDIUM (115V ONLY)	80009	159025900
F100	159-0260-00			FUSE , CARTRIDGE :2A, 250V, MEDIUM (230V ONLY)	80009	159026000
W3	198-5683-00			WIRE SET, ELEC:	80009	198568300
W4	198-5700-00			WIRE SET, ELEC:	80009	198570000
W14	196-3099-00			LEAD, ELECTRICAL:24 AWG, 10.0 L	80009	196309900
W16	196-3110-00			LEAD,ELECTRICAL: 18 AWG,7.0 L,8-9	80009	196311000
W17	196-3112-01			LEAD,ELECTRICAL: 18 AWG,6.0 L,5-4	80009	196311201
W18	196-3111-00			LEAD,ELECTRICAL: 18 AWG,7.0 L,8-9	80009	196311100
W19	196-3098-01			LEAD, ELECTRICAL: 18 AWG , 7.0 L,5-4	80009	196309801
W66	174-0304-00			CA ASSY,SP, ELEC :2,26 AWG,6.0 L, RIBBON	80009	174030400
W72	174-0310-00			CA ASSY,SP, ELEC :10,22 AWG, 1 8.0 L, RIBBON	80009	174031000
W91	198-5680-01			WIRE SET, ELEC:	80009	198568001
W93	198-5696-00			WIRE SET, ELEC:	80009	198569600
W95	198-5680-00			WIRE SET, ELEC:	80009	198568000
W102	198-5679-00			WIRE SET, ELEC:	80009	198567900
W103	198-5682-00			WIRE SET, ELEC:	80009	198568200
W104	198-5681-00	.301393	.301977	WIRE SET, ELEC:	80009	198568100
W104	198-5681-01	.301978		WIRE SET, ELEC:	80009	198568101
W111	196-3096-00			LEAD, ELECTRICAL: 18 AWG,3.5 L,5-4	80009	196309600
W142	174-1693-00			CA ASSY,SP,ELEC:34,28 AWG,1 30.0 L,RIBBON	80009	174169300
W180	174-0314-00			CA ASSY,SP,ELEC:9,26 AWG,7.5 L,RIBBON	80009	174031400
W182	174-0309-00			CA ASSY,SP, ELEC : 1 0,22 AWG,5.0 L,RIBBON	80009	174030900
W190	174-0328-00			CA ASSY,SP,ELEC:4,18 AWG,15.5 L	80009	174032800
W194	174-0308-00			CA ASSY,SP,ELEC:6,22 AWG,20.0 L,RIBBON	80009	174030800
W210	198-5686-00			WIRE SET, ELEC :	80009	198568600
W270	174-0327-00			CA ASSY,SP,ELEC:2,18 AWG,7.0 L	80009	174032700
W272	161-0255-01	.301393	.301412	CABLE ASSY,PWR,;2,0.75MM SQ,250V,3A	80009	161025501
W272	198-5733-00	.301413	.301577	WIRE SET,ELEC:	80009	198573300
W272	161-0257-01	.301578	.302156	CABLE ASSY,PWR,;125V,1A.200MML	80009	161025701
W280	174-0313-00			CA ASSY,SP,ELEC:2,26 AWG,30.0 L,RIBBON	80009	174031300
W290	174-0312-00			CA ASSY,SP,ELEC:2,26 AWG,22.0 L,RIBBON	80009	174031200
W400	174-0296-00			CA ASSY,SP, ELEC :34,28 AWG,5.5 L, RIBBON	80009	174029600
W401	198-5685-00			WI RE SET, ELEC :	80009	198568500
W402	196-3270-00			LEAD, ELECTRICAL:26 AWG,28.0 L, N-0	80009	196327000
W410	198-5468-00			WIRE SET,ELEC :	80009	198546800
W490	198-5714-00			WIRE SET, ELEC :W/D - SUB CONN	80009	198571400
W491	198-5713-00			WIRE SET, ELEC :W/D - SUB CONN	80009	198571300

Diagrams

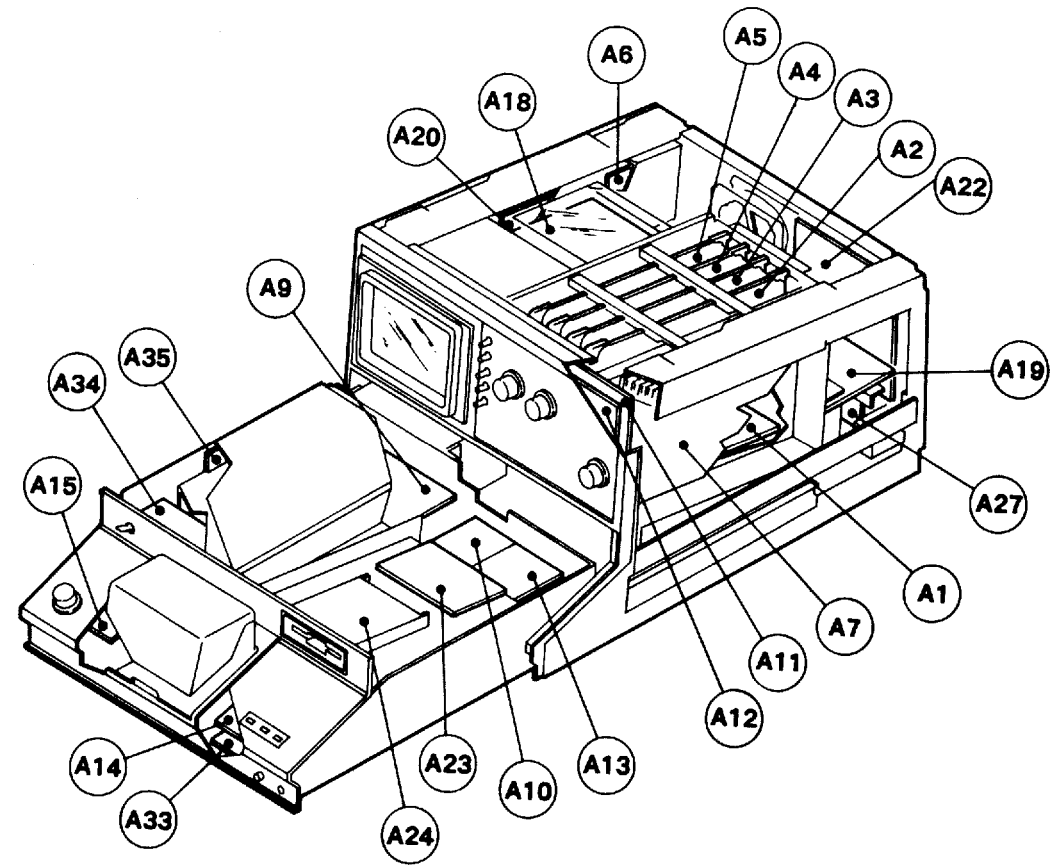
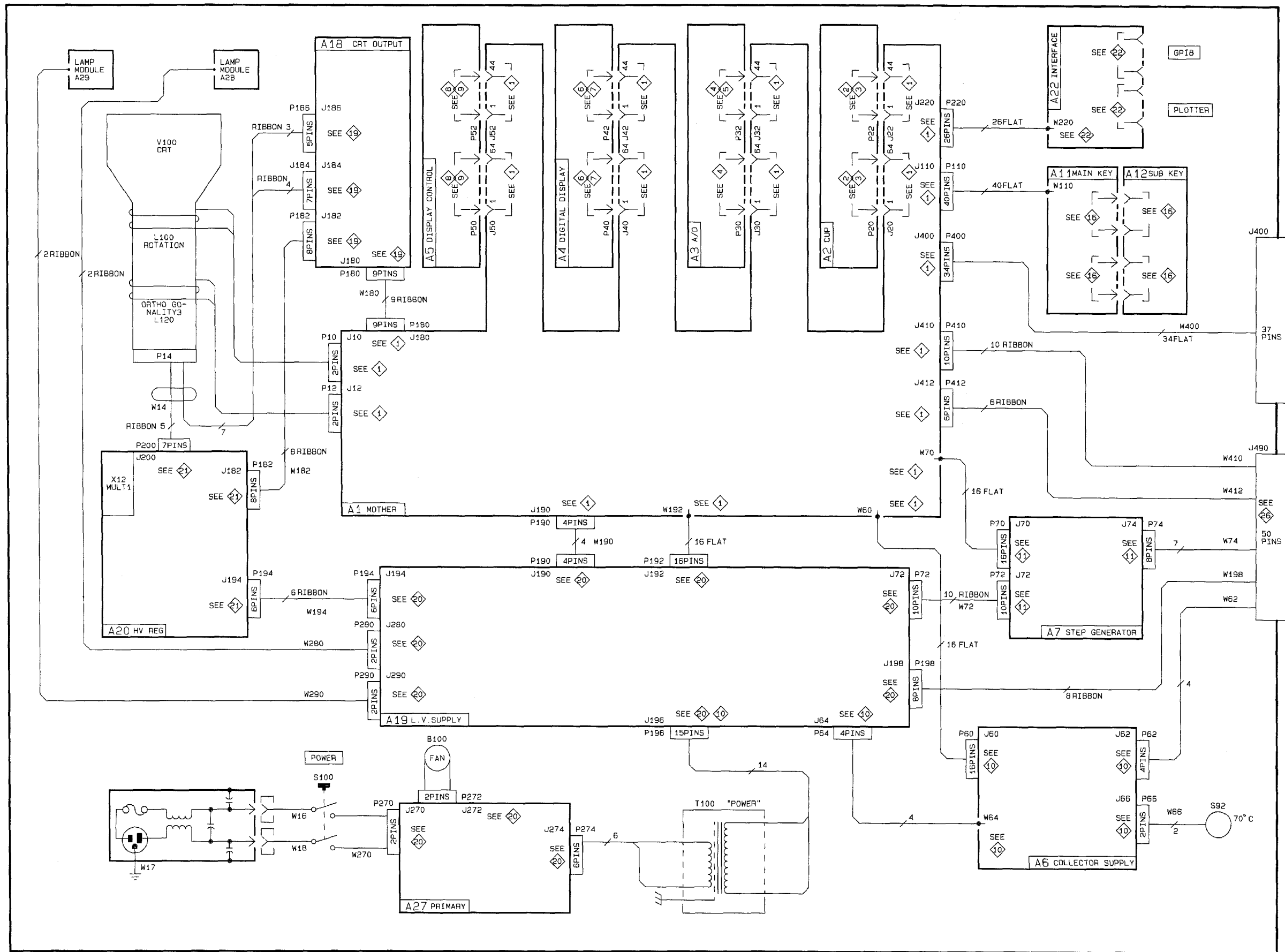
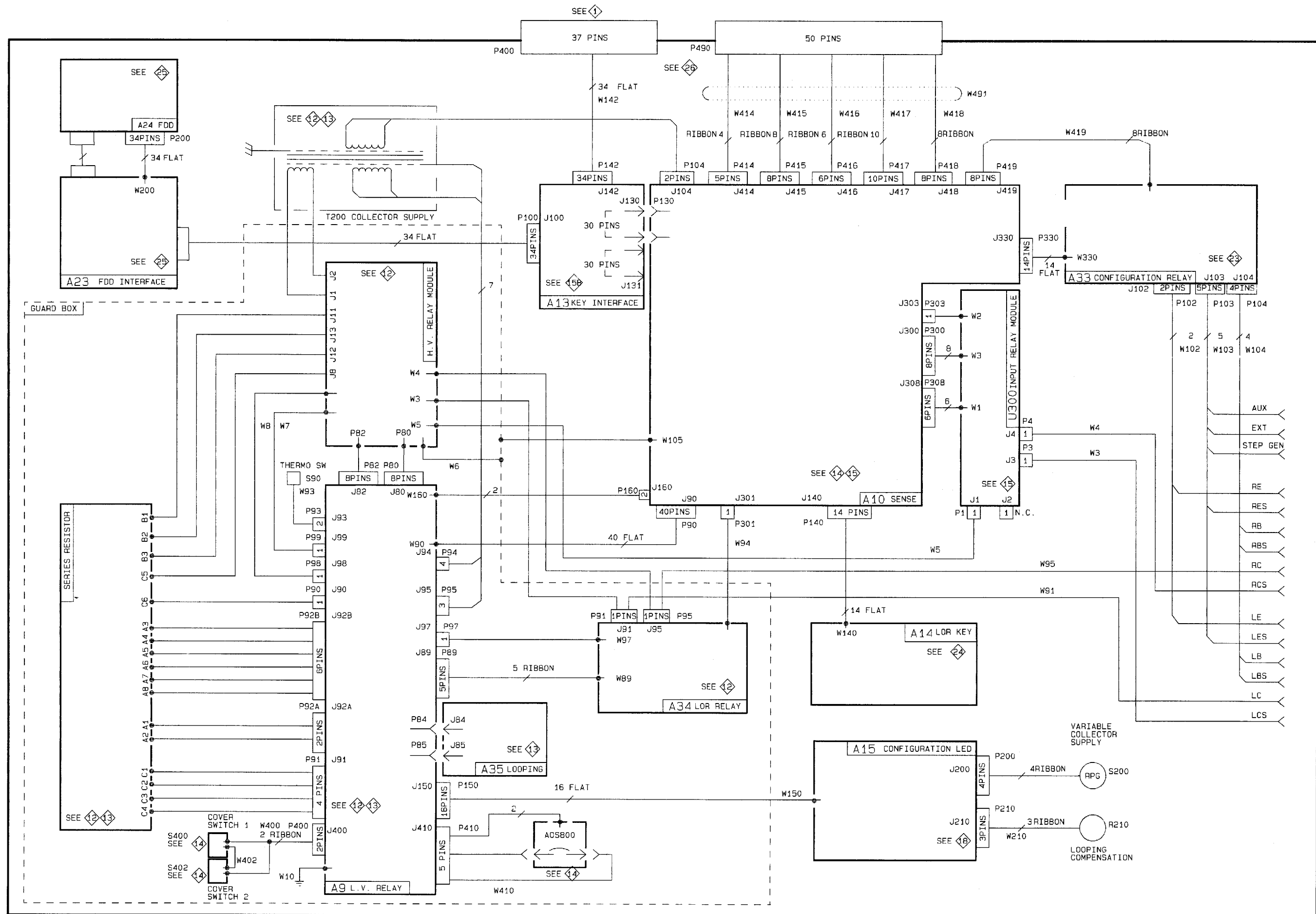

Figure 8-1: 370B circuit board locator



CIRCUIT BOARD INTERCONNECTIONS 1



CIRCUIT BOARD INTERCONNECTIONS 2

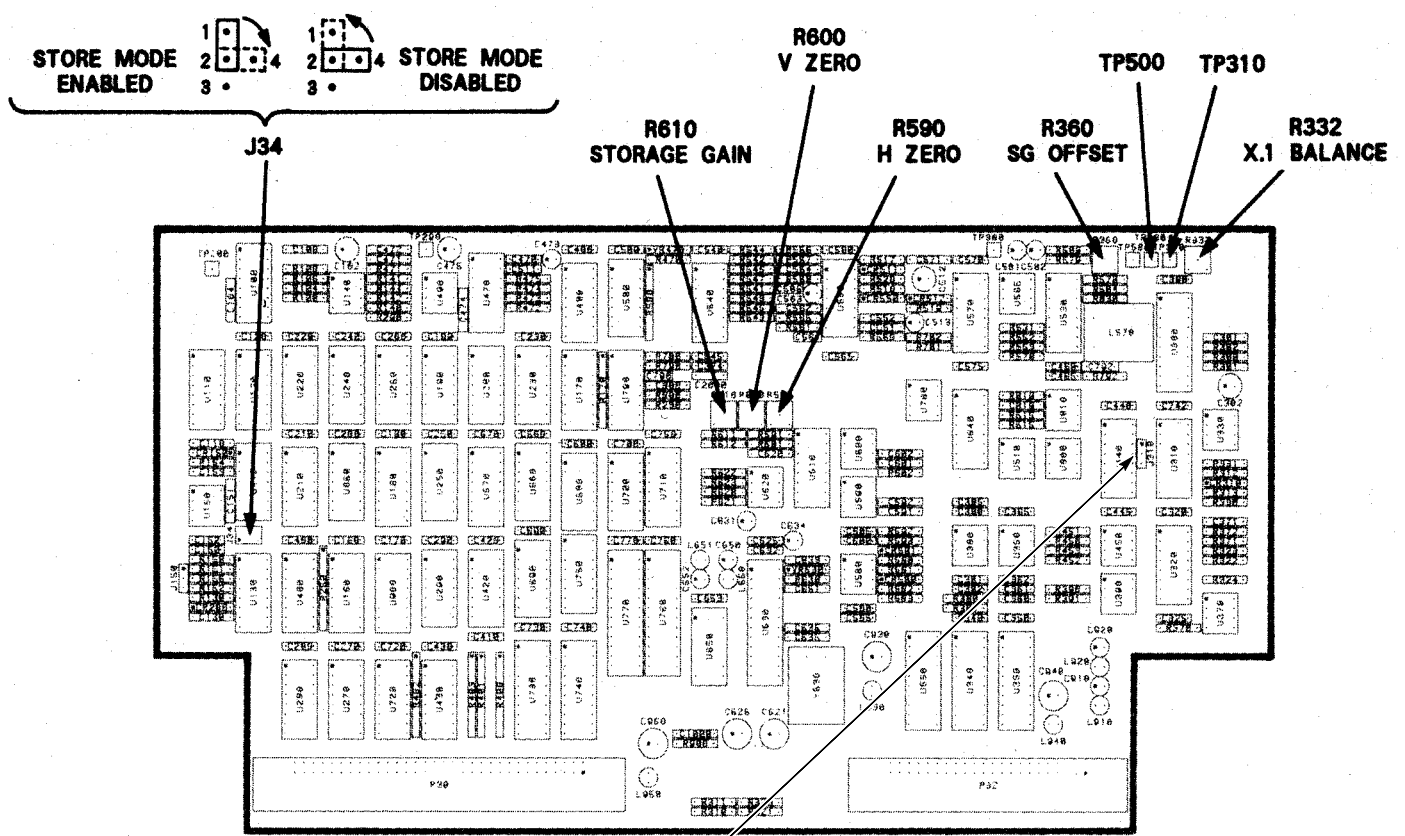

A3 A/D

J310

Establishment in shipping is pin 1 and 2 are connected .
 (PULSED OFFSET MODE)

J310 is changed to make DC OFFSET MODE.
 (pin 2 and 3 are connected .)

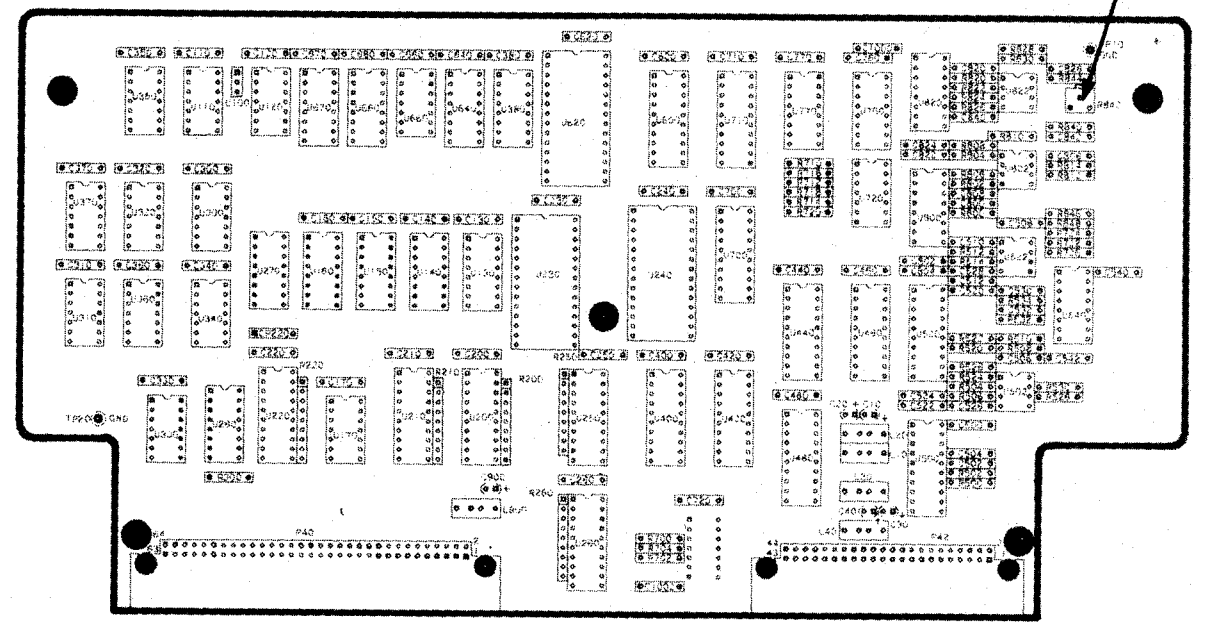

A4 DIGITAL DISPLAY

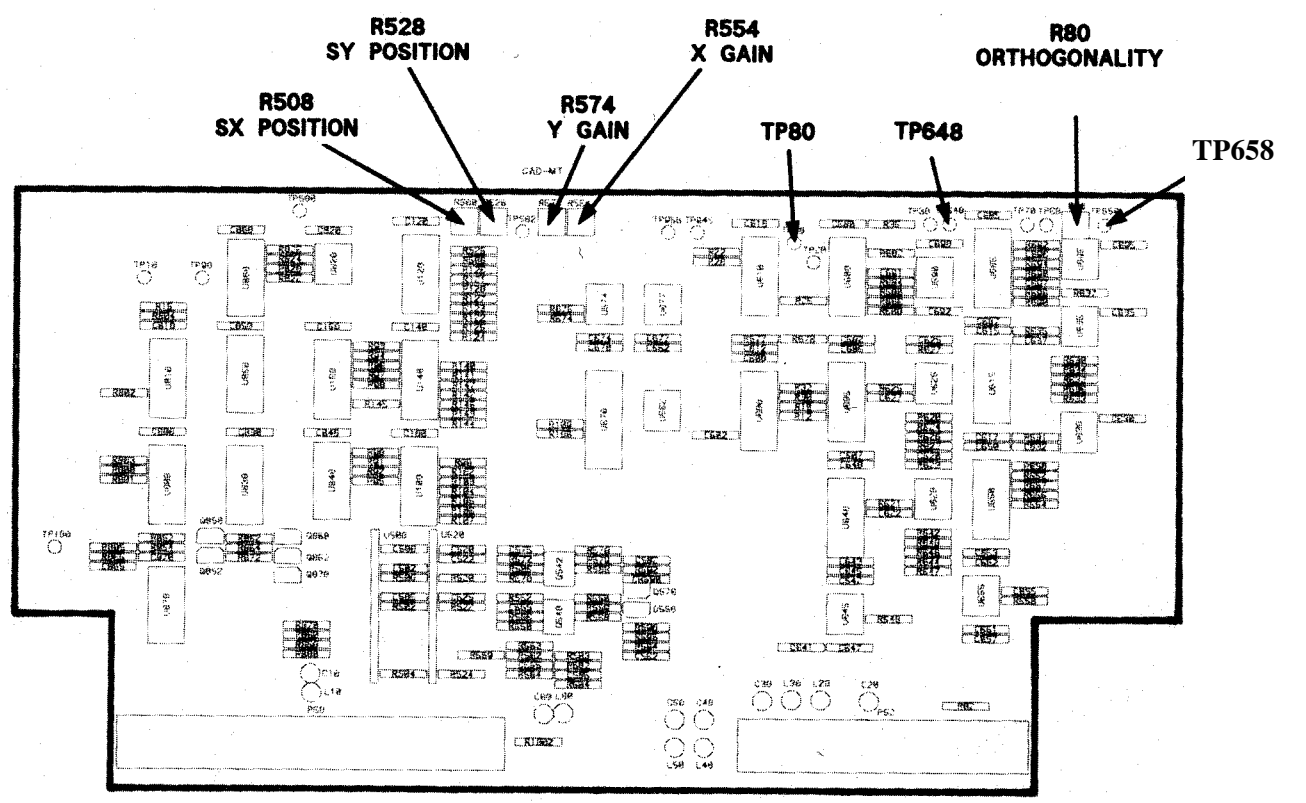

A5 DISPLAY CONTROL

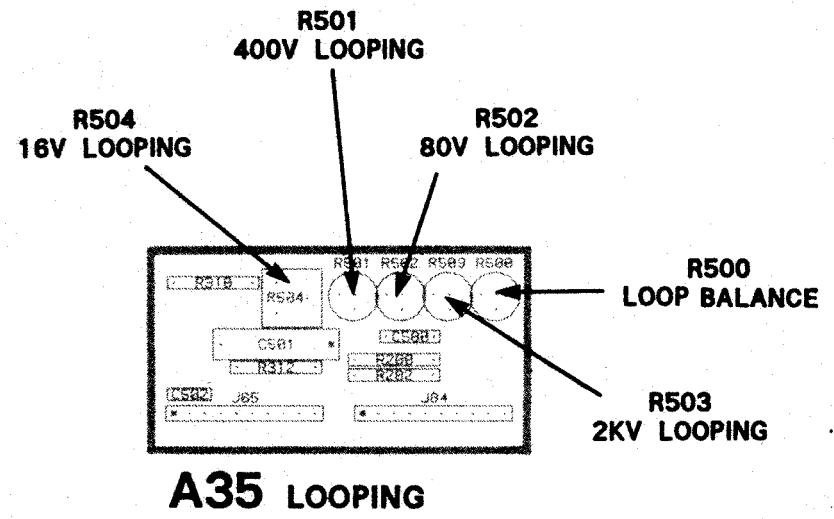
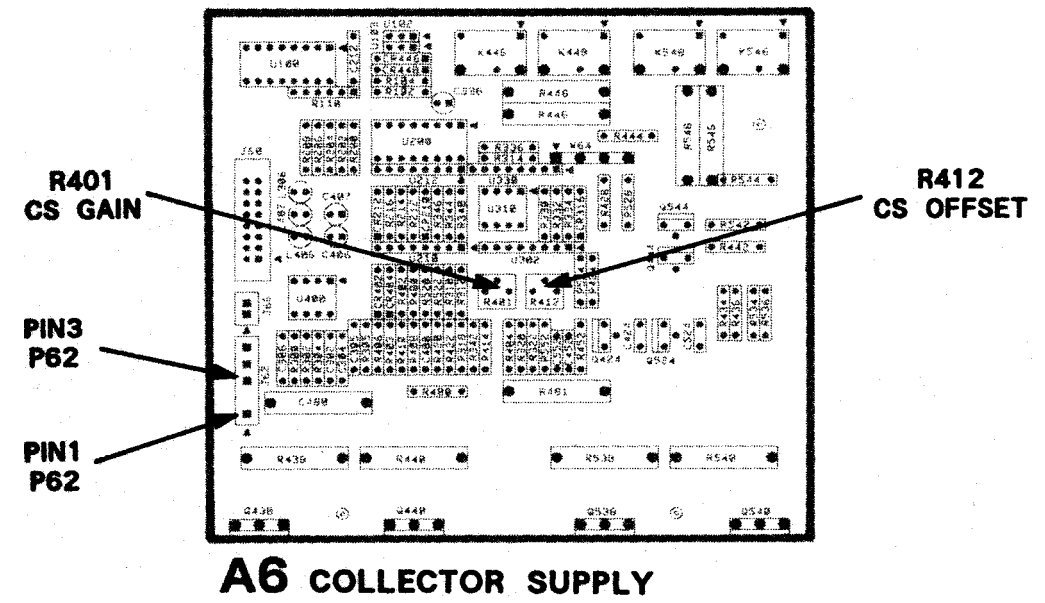
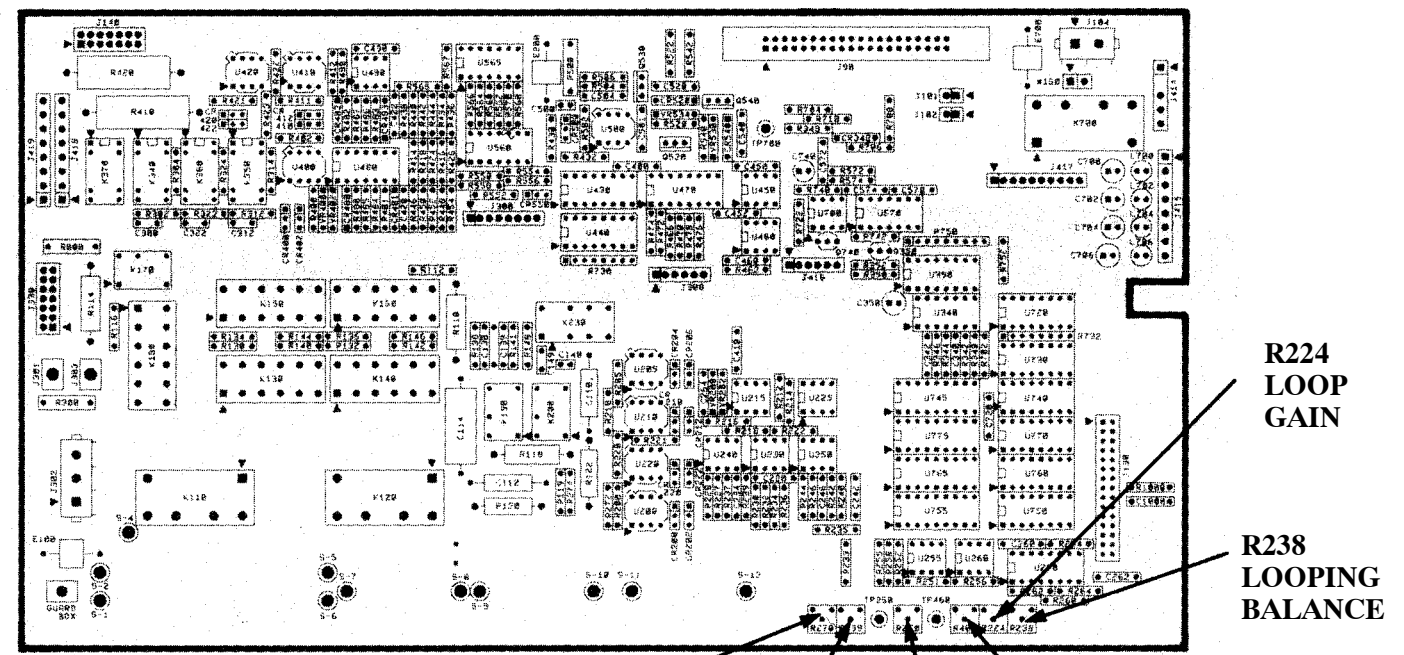
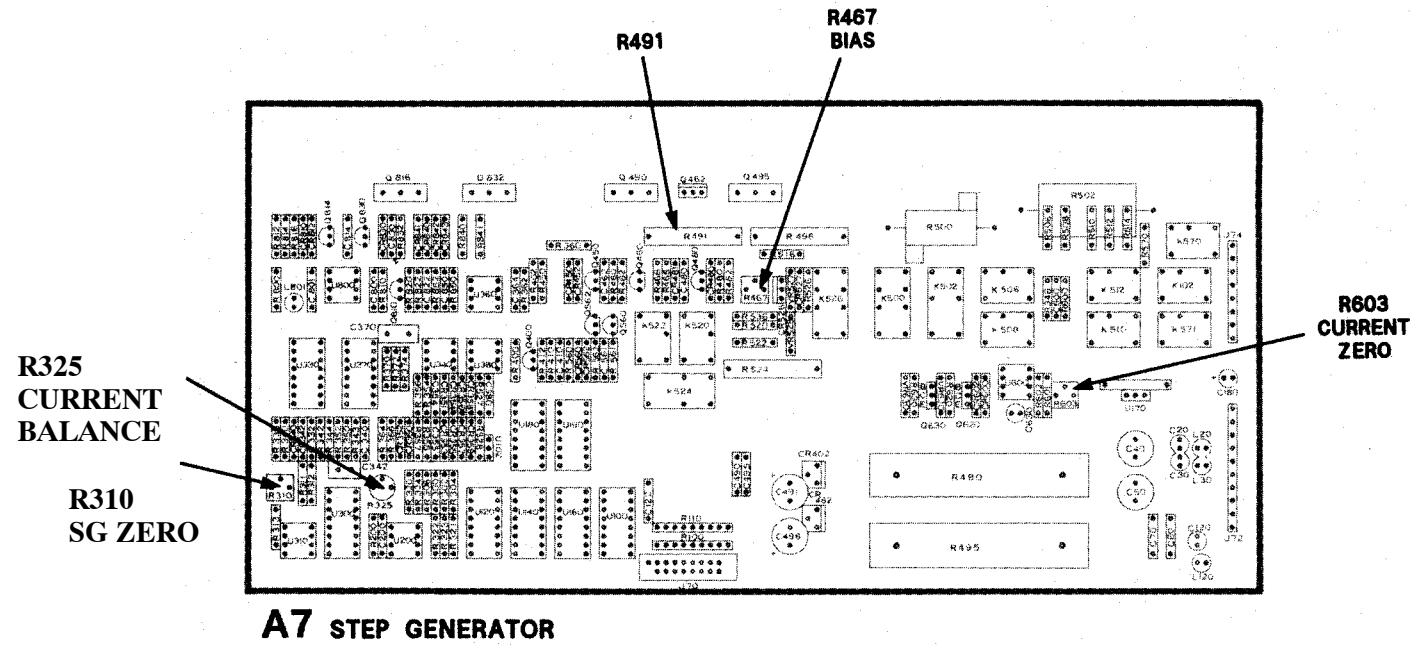

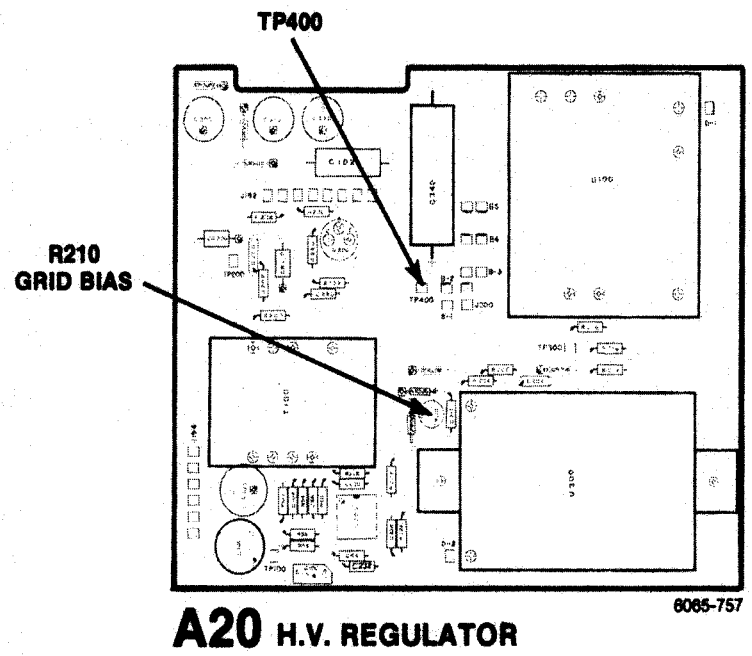
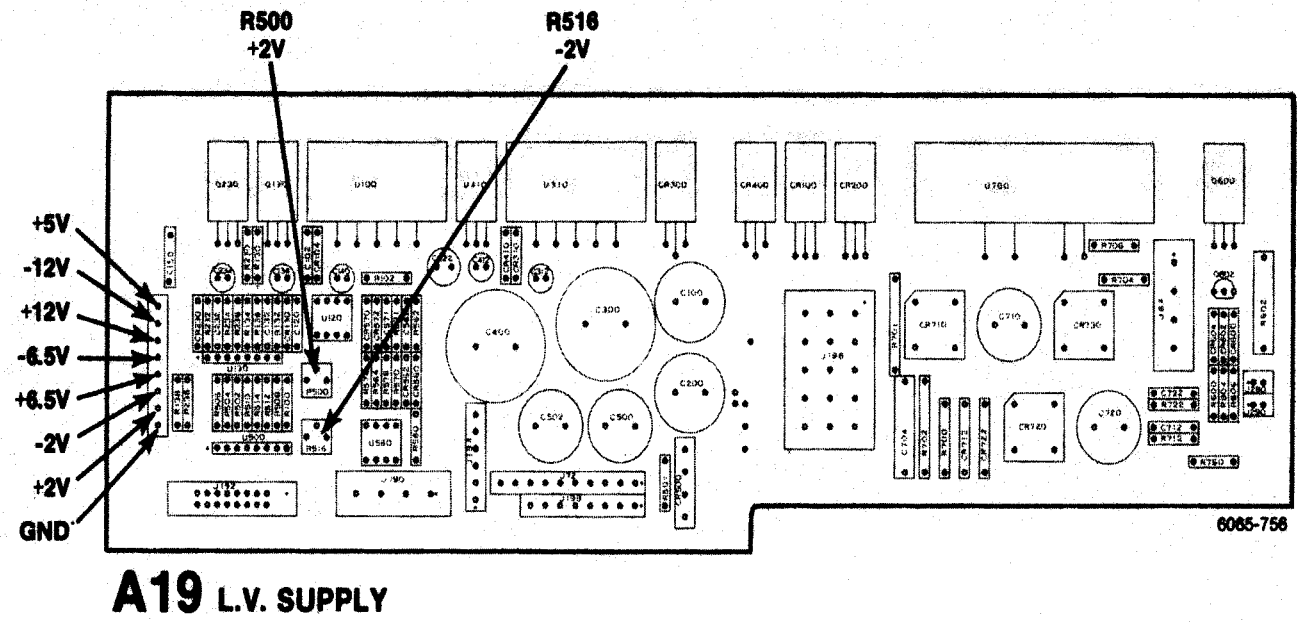
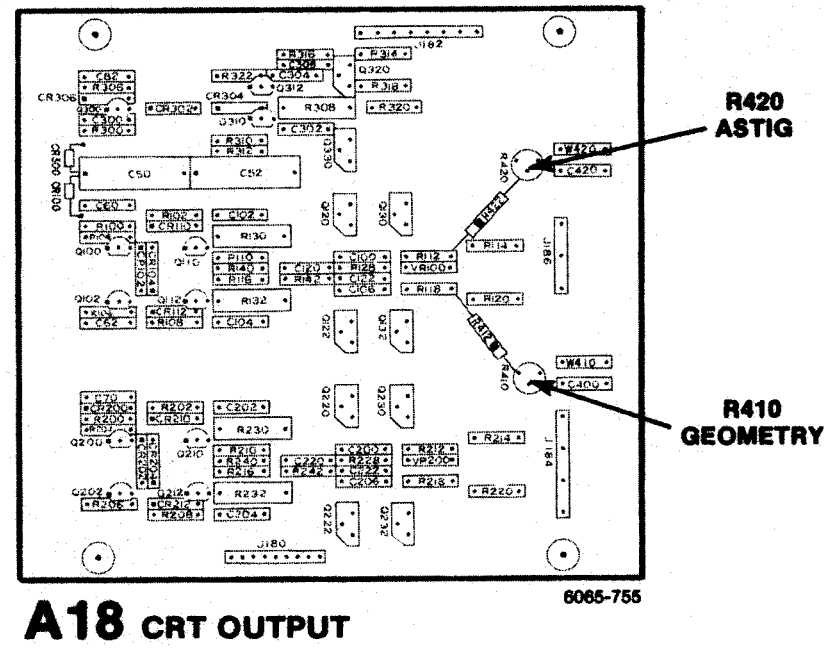

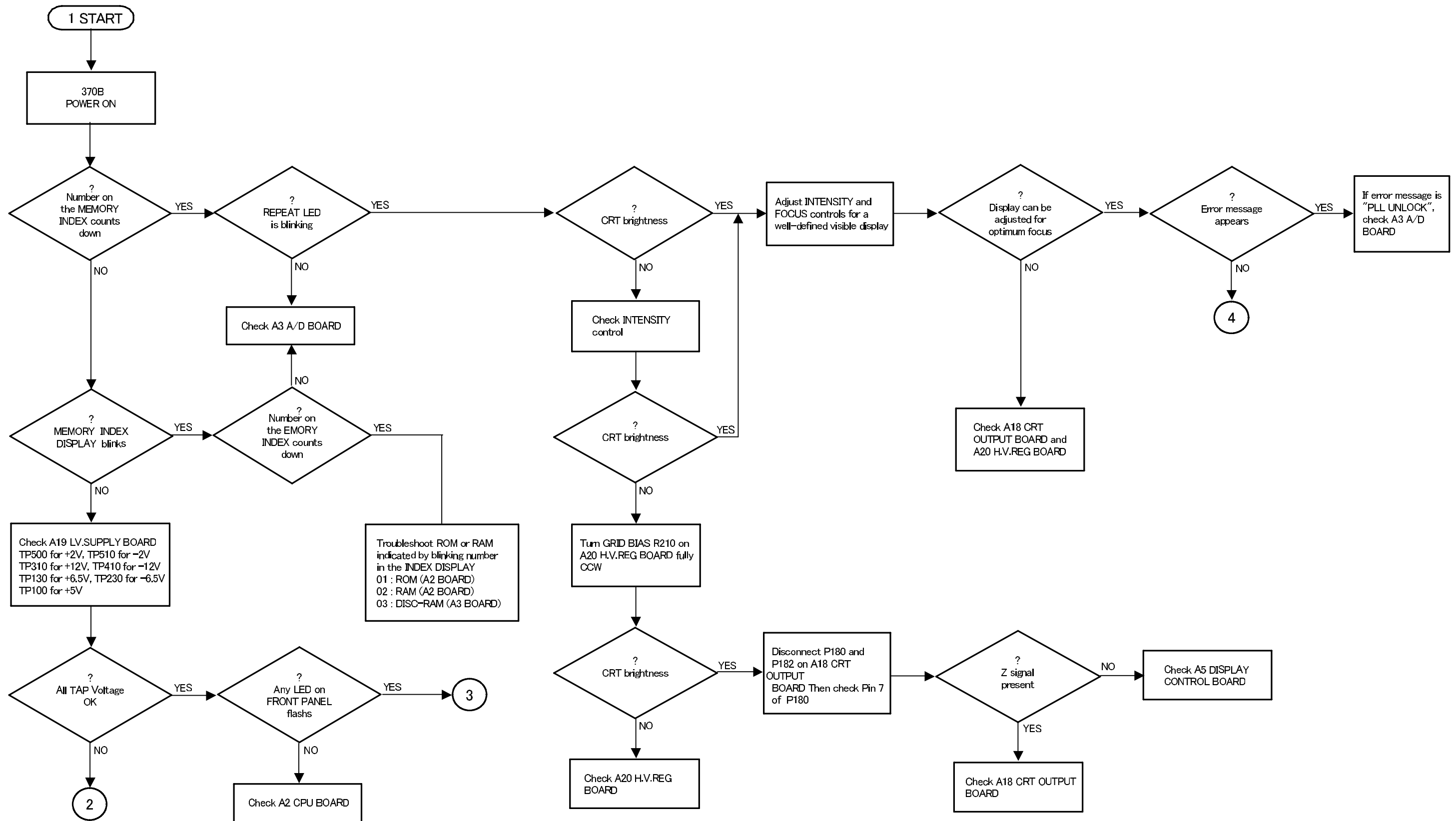

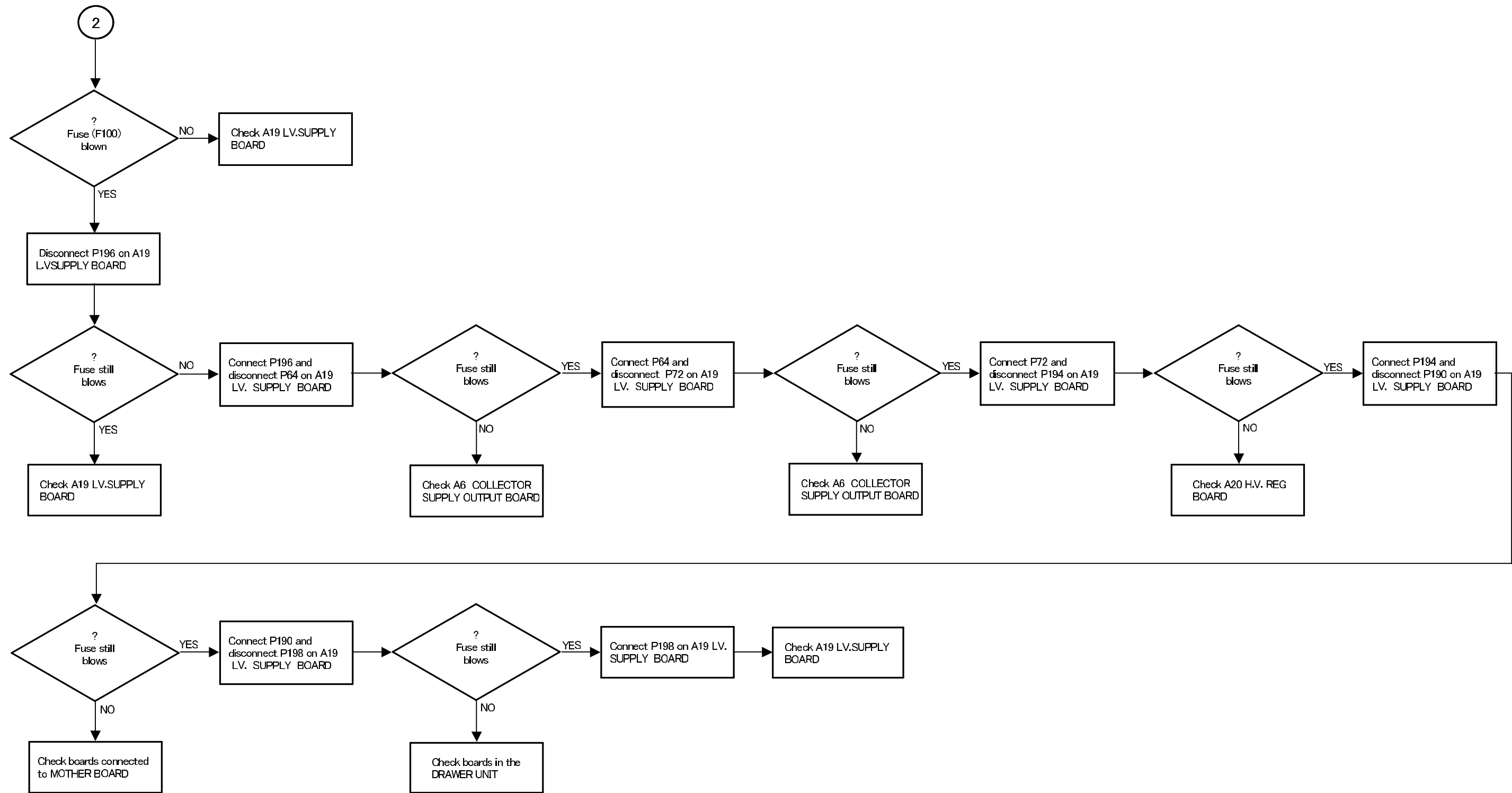

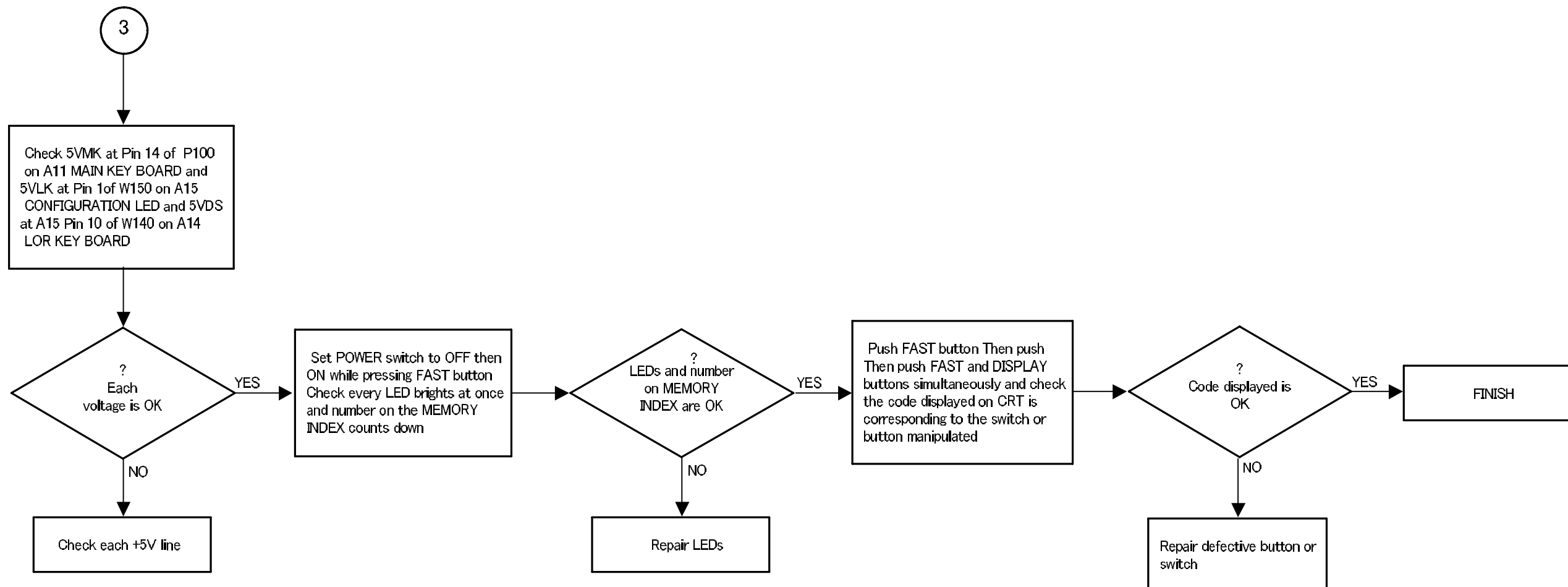

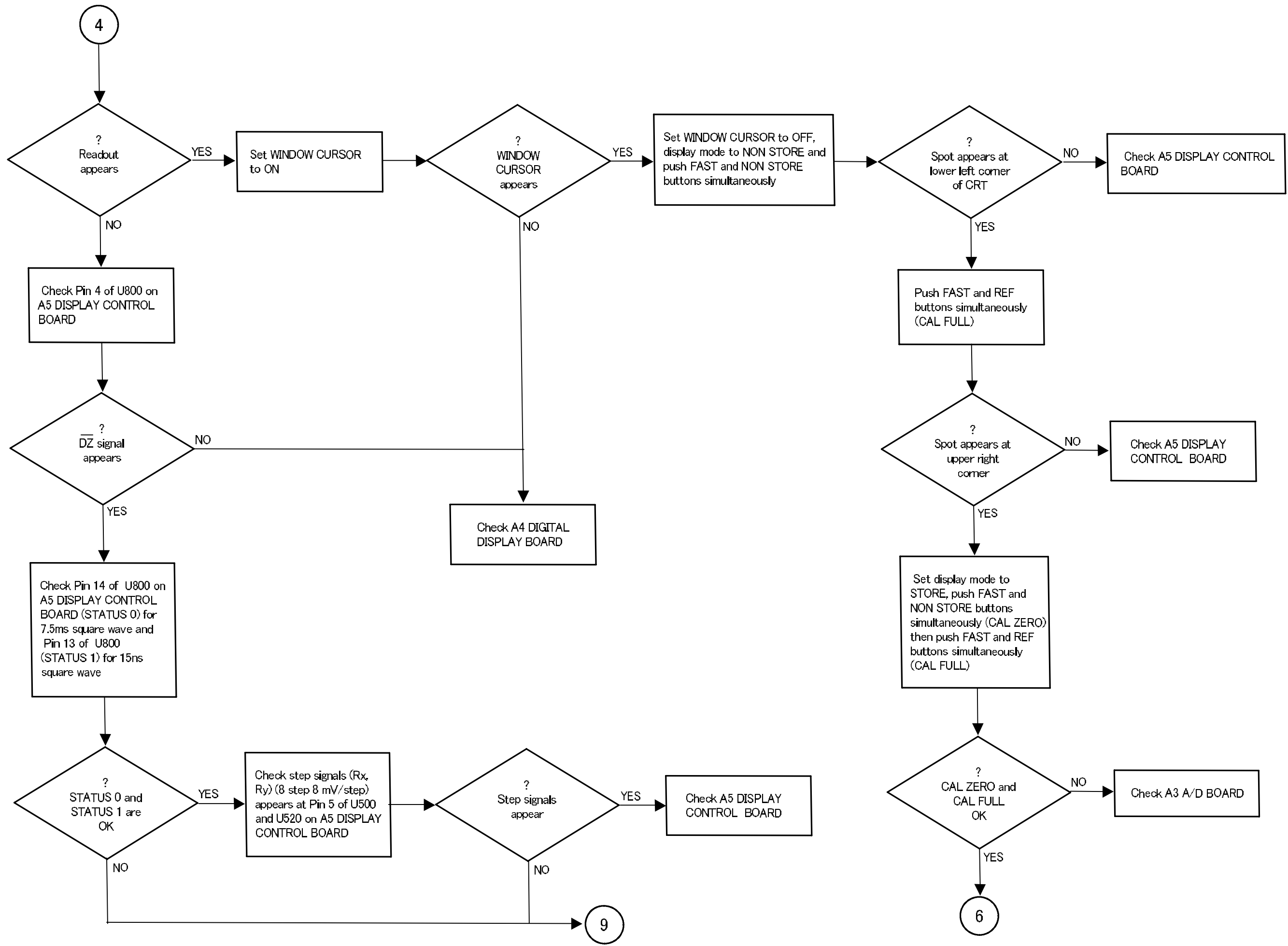

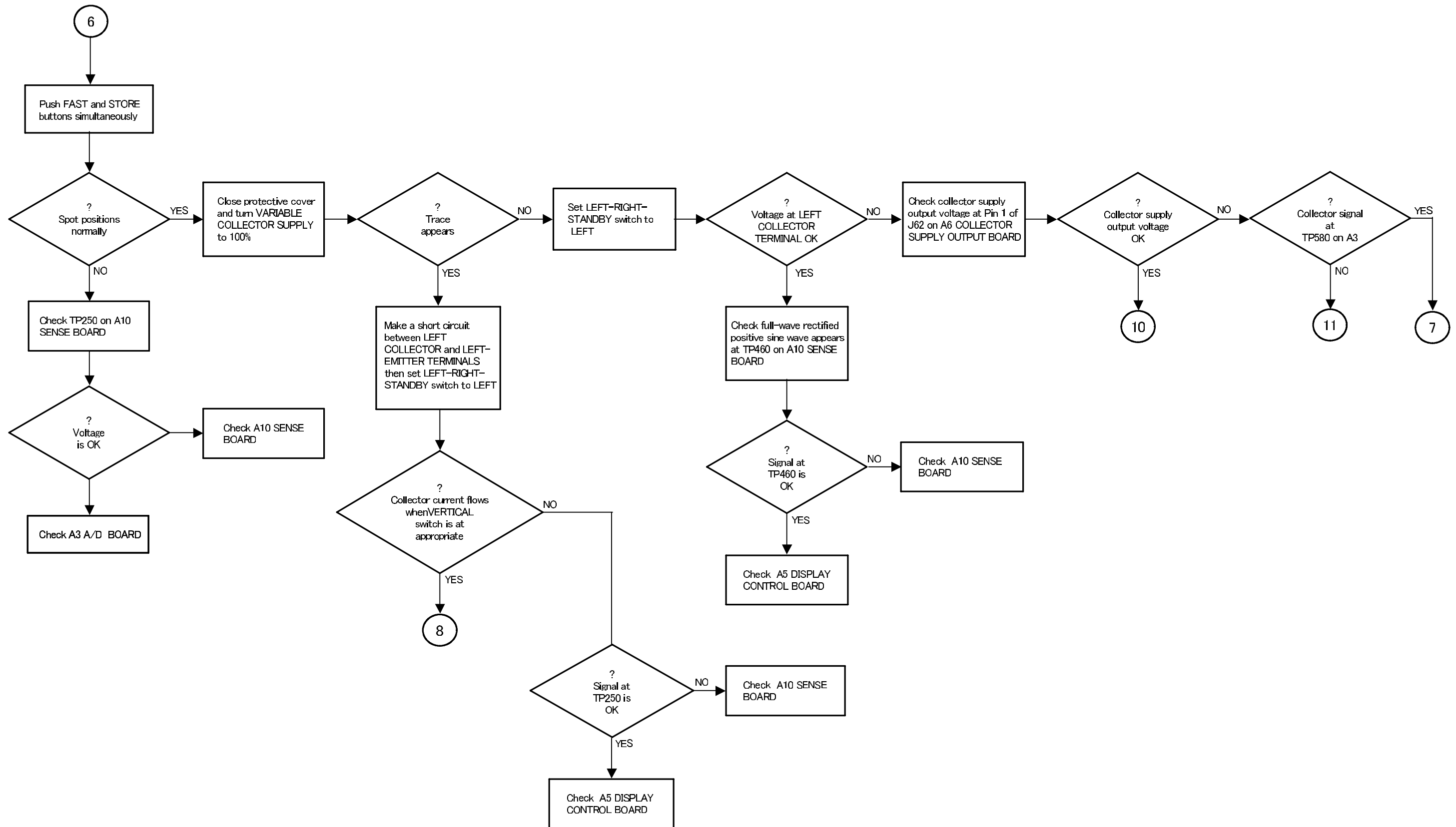

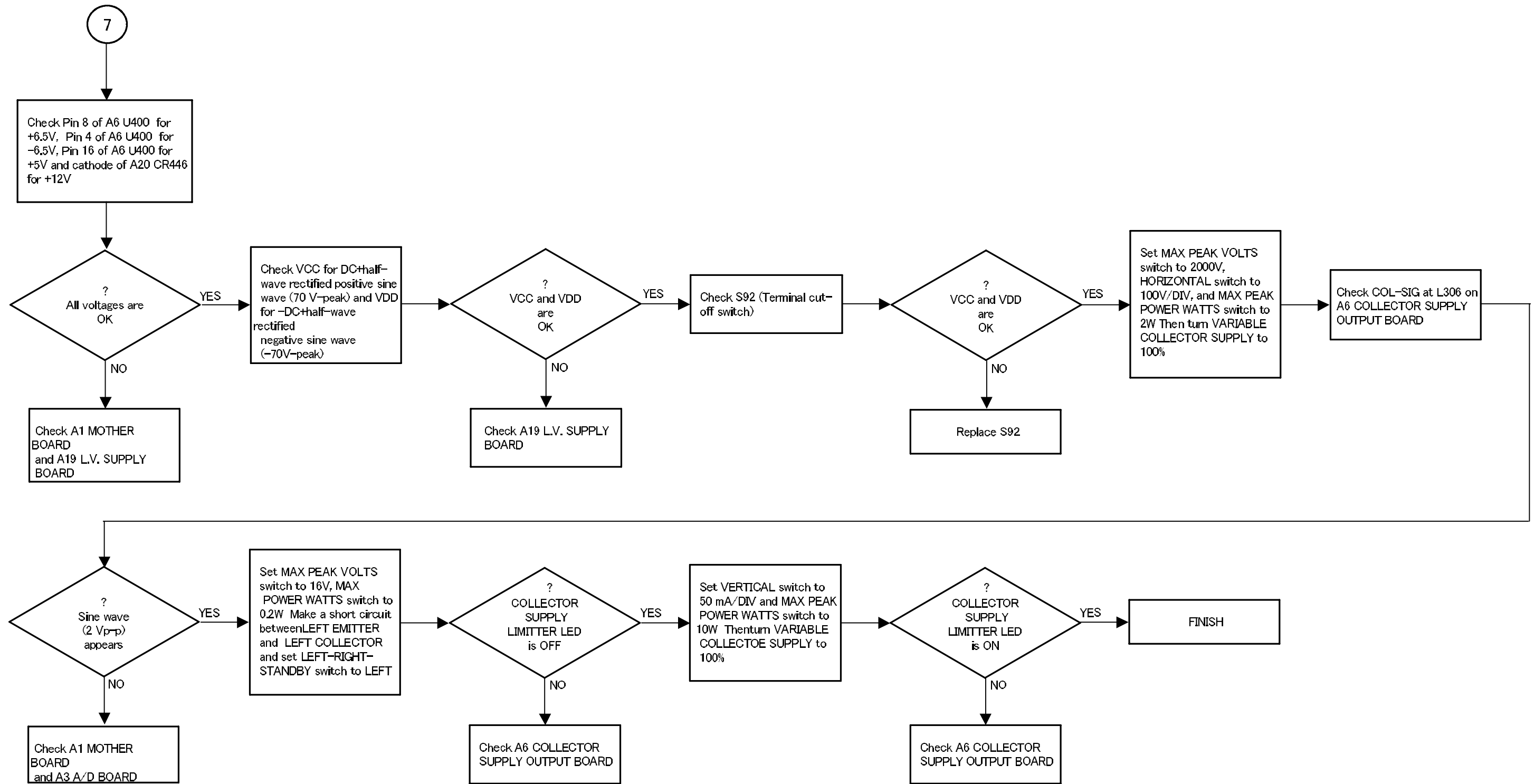

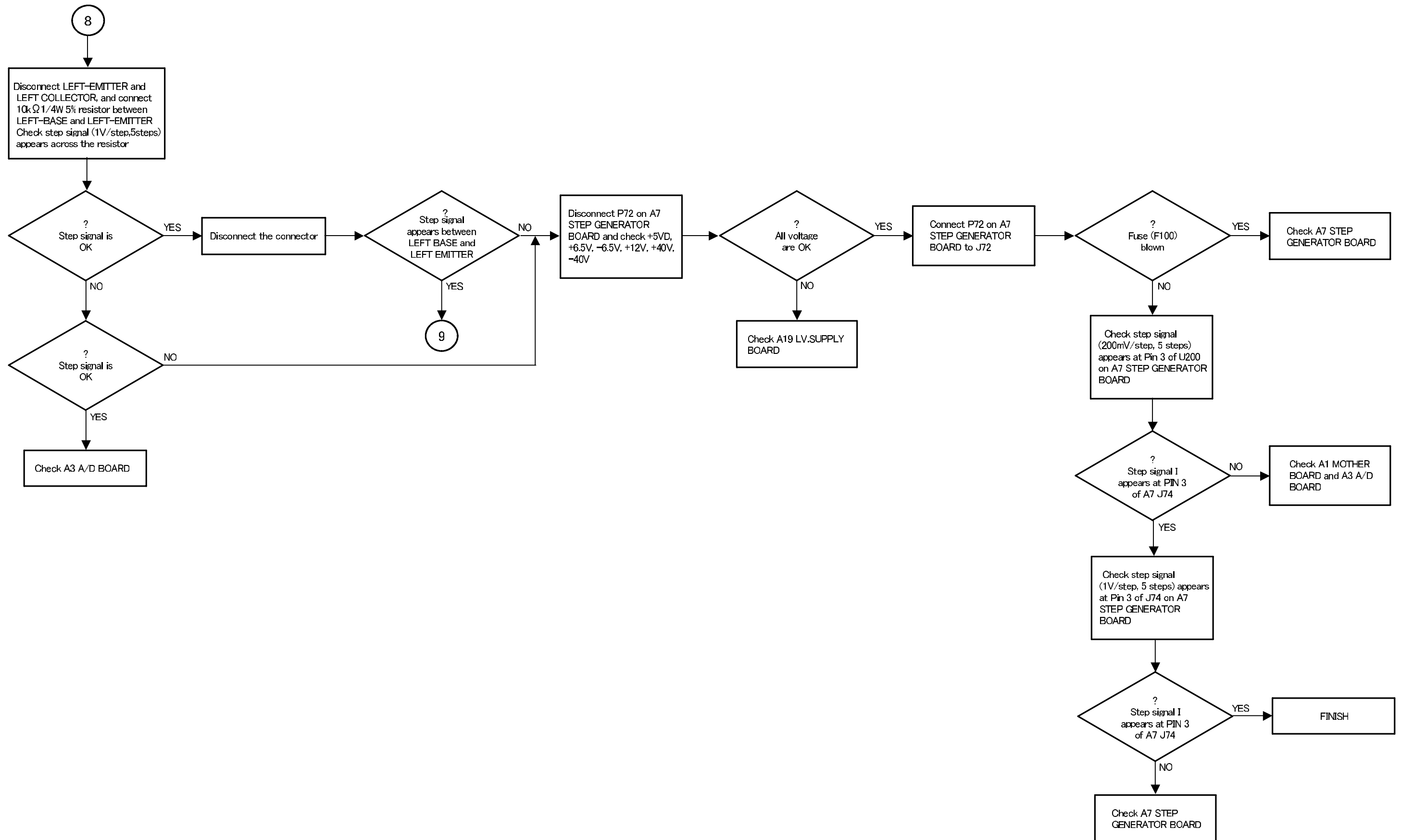

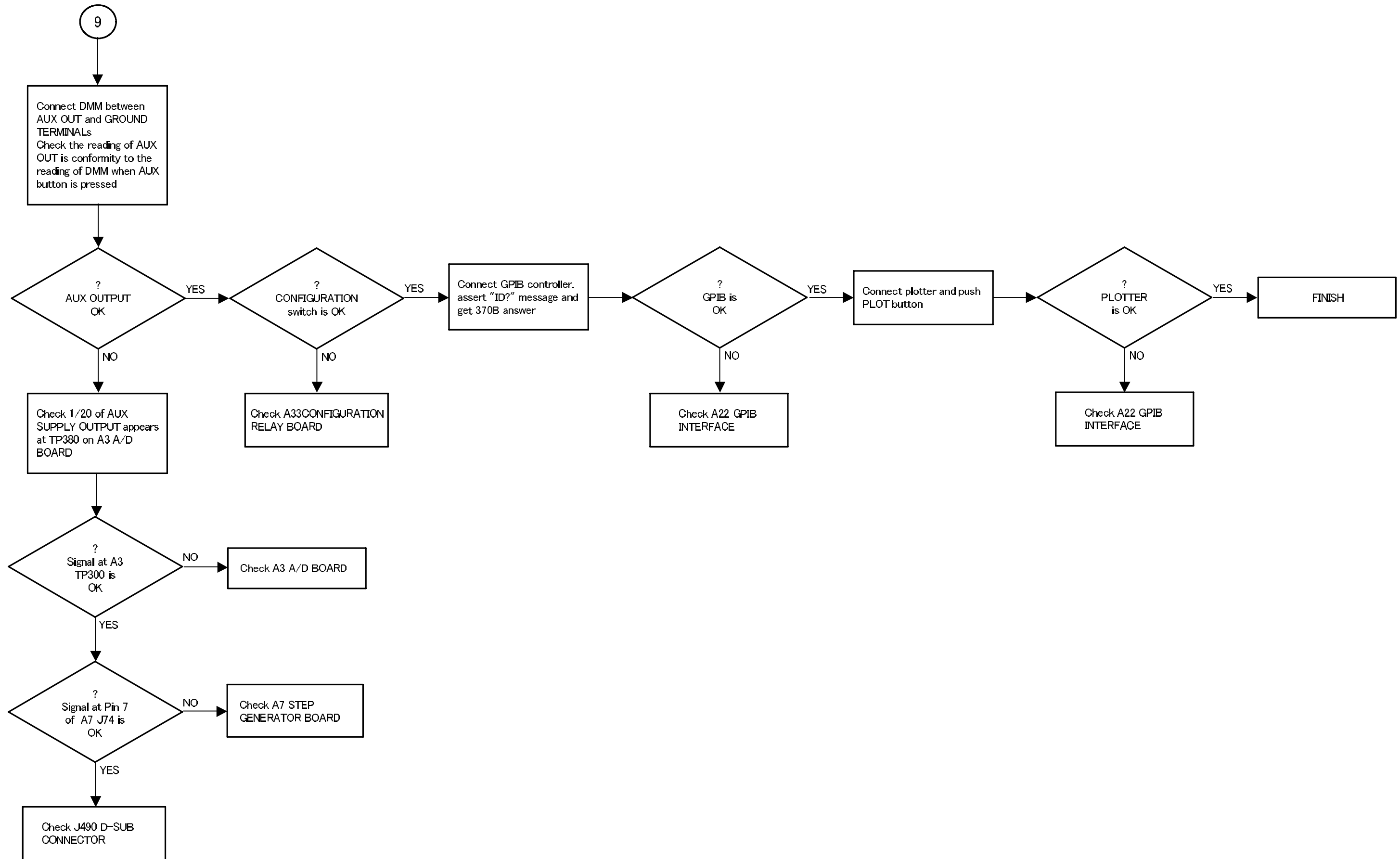

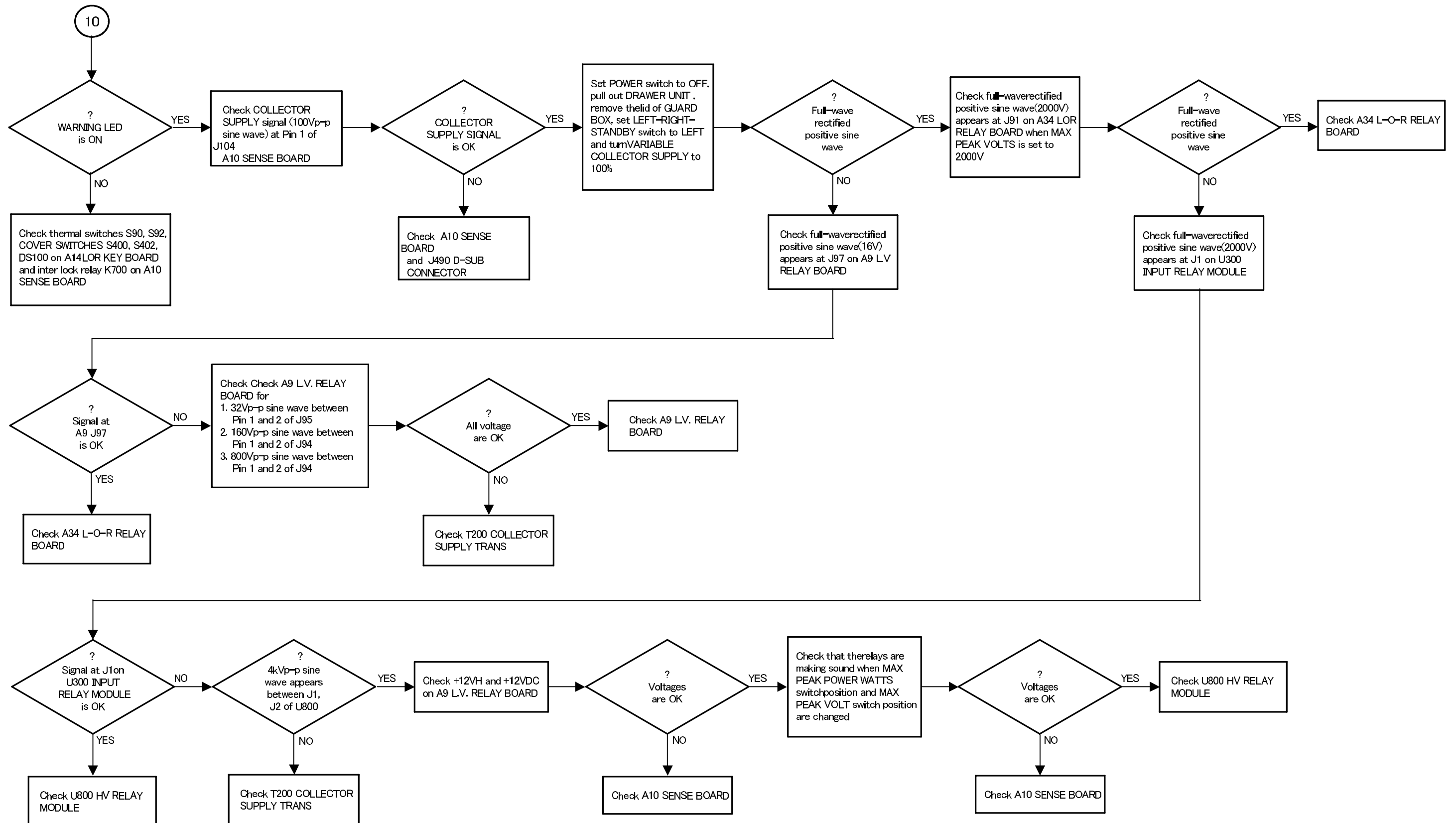

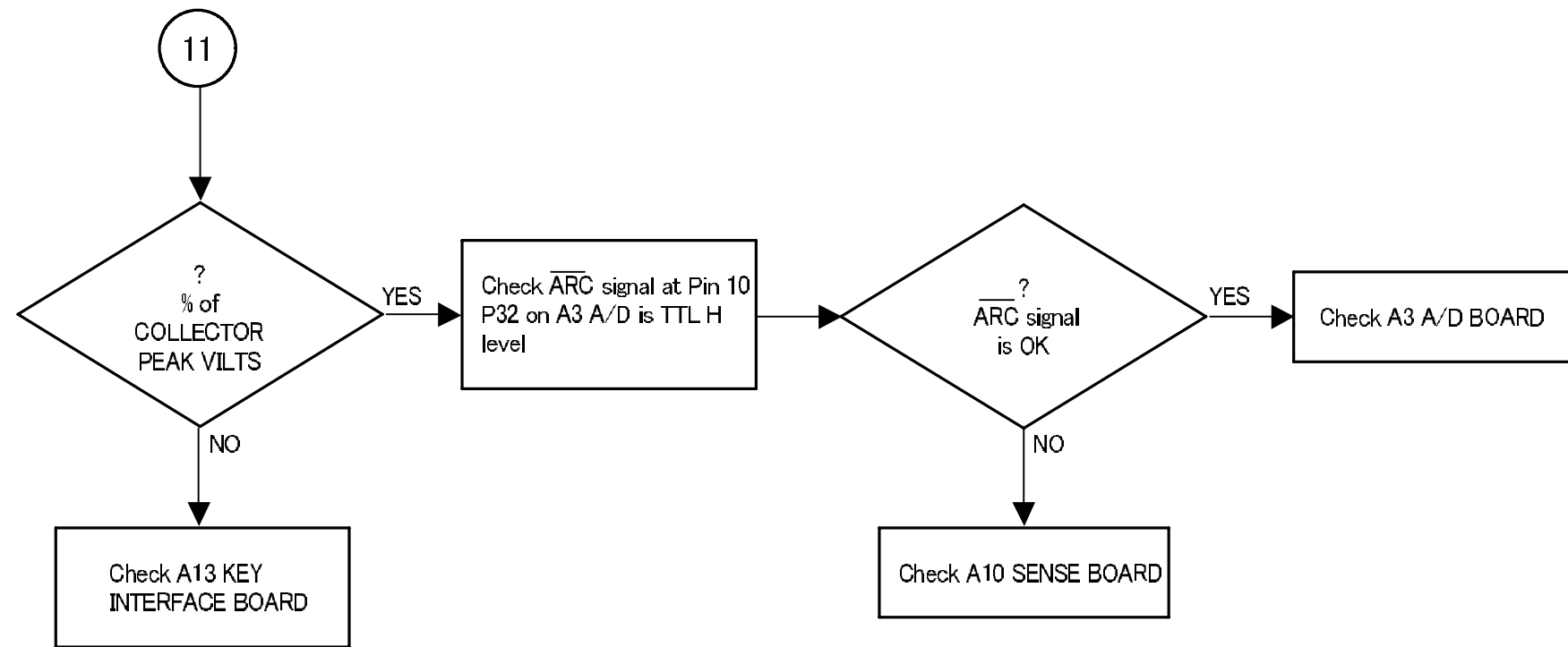

Mechanical Parts List

Mechanical Parts List

This section contains a list of the replaceable modules for the 370B. Use this list to identify and order replacement parts.

Parts Ordering Information

Replacement parts are available through your local Tektronix field office or representative.

Changes to Tektronix instruments are sometimes made to accommodate improved components as they become available and to give you the benefit of the latest circuit improvements. Therefore, when ordering parts, it is important to include the following information in your order.

- Part number (see Part number Revision Level below)
- Instrument type or model number
- Instrument serial number
- Instrument modification number, if applicable

If you order a part that has been replaced with a different or improved part, your local Tektronix field office or representative will contact you concerning any change in part number.

Change information, if any, is located at the rear of this manual.

Part Number Revision Level

Tektronix part numbers contain two digits that show the revision level of the part. For most parts in this manual, you will find the letters XX in place of the revision level number.

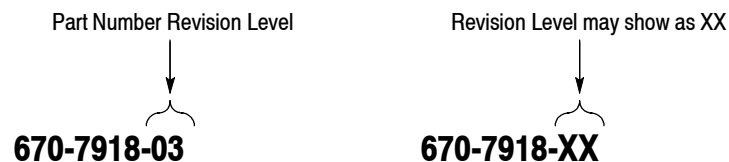

When you order parts, Tektronix will provide you with the most current part for your product type, serial number, and modification (if applicable). At the time of your order, Tektronix will determine the part number revision level needed for your product, based on the information you provide.

Module Servicing Modules can be serviced by selecting one of the following three options. Contact your local Tektronix service center or representative for repair assistance.

Module Exchange. In some cases you may exchange your module for a remanufactured module. These modules cost significantly less than new modules and meet the same factory specifications. For more information about the module exchange program, call 1-800-TEK-WIDE, extension 6630.

Module Repair and Return. You may ship your module to us for repair, after which we will return it to you.

New Modules. You may purchase replacement modules in the same way as other replacement parts.

Using the Replaceable Parts List

This section contains a list of the mechanical and/or electrical components that are replaceable for the analyzer. Use this list to identify and order replacement parts. The following table describes each column in the parts list.

Parts List Column Descriptions

Column	Column Name	Description
1	Figure & Index Number	Items in this section are referenced by component number.
2	Tektronix Part Number	Use this part number when ordering replacement parts from Tektronix.
3 and 4	Serial Number	Column three indicates the serial number at which the part was first effective. Column four indicates the serial number at which the part was discontinued. No entries indicates the part is good for all serial numbers.
5	Qty	This indicates the quantity of parts used.
6	Name & Description	An item name is separated from the description by a colon (:). Because of space limitations, an item name may sometimes appear as incomplete. Use the U.S. Federal Catalog handbook H6-1 for further item name identification.
7	Mfr. Code	This indicates the code of the actual manufacturer of the part. (Code to name and address cross reference is located after this page.)
8	Mfr. Part Number	This indicates the actual manufacturer's or vendor's part number.

Abbreviations Abbreviations conform to American National Standard ANSI Y1.1-1972.

Mfr. Code to Manufacturer Cross Index The following table cross indexes codes, names, and addresses of manufacturers or vendors of components listed in the parts list.

Manufacturers cross index

Mfr. code	Manufacturer	Address	City, state, zip code
S3109	FELLER	72 VERONICA AVE UNIT 4	SUMMERSET NJ 08873
TK0AR	KITAGAWA IND CO LTD	2-4-26 MUROMACHI NIHONBASHI CHUO-KU	TOKYO JAPAN
TK0AU	CHIYODA DENSHI CO LTD	2-5-12 MITA MEGURO-KU	TOKYO JAPAN
TK0BI	ACOUS IND CO LTD	2-6 TA-CO KANDA CHIYODA-KU	TOKYO JAPAN
TK0BK	SHOWA KOSAN CO LTD	2-947 IKEBUKURO TOSHIMA-KU	TOKYO JAPAN
TK0BV	KYODO LIGHT METAL CO LTD	2-5-3 NIHONBASHI CHUO-KU	TOKYO JAPAN
TK0CB	T K Y MFG CO LTD	2-18-8 MASUGATA TAMA-KU KAWASAKI-CITY	KANAGAWA JAPAN
TK0CF	YASUDA MFG CO LTD	81-1 OKESHITA NISHIMAKADO NUMAZU-CITY	SHIZUOKA JAPAN
TK0FB	NIHON BURNDY	3-26-33 TAKANASA MINATO-KU	TOKYO JAPAN
TK00Z	H Y ASSOCIATES CO LTD	1-2-2 MOMOI SIGINAMI-KU	TOKYO JAPAN
TK0191	TEKTRONIX JAPAN, Ltd	5-9-31 KITASHINAGAWA, SHINAGAWA-KU, TOKYO	TOKYO JAPAN 141-0001
TK0413	ADAMS SUPPLY COMPANY	1850 W 205TH ST P O BOX 2938	TORRANCE CA 90509
TK0435	LEWIS SCREW CO	4300 S RACINE AVE	CHICAGO IL 60609-3320
TK0588	UNIVERSAL PRECISION PRODUCTS	1775 NW 216TH	HILLSBORO OR 97123
TK1181	SEA-TAC INDUSTRIES INC	1217 FOURTH AVE N	KENT WA 98031
TK1267	BALCK ELECTRIC CORP	P O BOX 50934	PALO ALTO CA 94303
TK1499	AMLAN INC	97 THORNWOOD RD	STAMFORD CT 06903-2617
TK1665	PORTLAND DIE AND STAMPING INC	4805 SE 26TH	PORTLAND OR 97202
TK1741	COLMAN FASTENERS CO LTD	HATTONS ROAD OFF WESTINGHOUSE RD TRAFFORD PARK	MANCHESTER M17 1DF ENGLAND
TK1943	NEILSEN MANUFACTURING INC	3501 PORTLAND ROAD NE	SALEM OR 97303
TK2541	AMERICOR ELECTRONICS LTD	2682 W COYLE AVENUE	ELK GROVE VILLAGE IL 60007
TK2548	XEROX BUSINESS SERVICES DIV OF XEROX CORPORATION	14181 SW MILLIKAN WAY	BEAVERTON OR 97077
0JR05	TRIQUEST CORP	3000 LEWIS AND CLARK HWY	VANCOUVER WA 98661-2999
0KB01	STAUFFER SUPPLY	810 SE SHERMAN	PORTLAND OR 97214
07416	NELSON NAME PLATE CO	3191 CASITAS	LOS ANGELES CA 90039-2410
11897	PLASTIGLIDE MFG CORP	2701 W EL SEGUNDO BLVD	HAWTHORNE CA 90250-3318
12327	FREEWAY CORP	9301 ALLEN DR	CLEVELAND OH 44125-4632
12697	CLAROSTAT MFG CO INC	12055 ROJAS DRIVE SUITE K	EL PASO, TX 79936

Manufacturers cross index (Cont.)

Mfr. code	Manufacturer	Address	City, state, zip code
13103	THERMALLOY CO INC	2021 W VALLEY VIEW LN PO BOX 810839	DALLAS TX 75381
73743	FISCHER SPECIAL MFG CO	111 INDUSTRIAL RD	COLD SPRING KY 41076-9749
78189	ILLINOIS TOOL WORKS INC SHAKEPROOF DIV	ST CHARLES ROAD	ELGIN IL 60120
8X345	NORTHWEST SPRING & MFG CO	5858 SW WILLOW LANE	LAKE OSWEGO OR 97035
80009	TEKTRONIX INC	14150 SW KARL BRAUN DR PO BOX 500	BEAVERTON OR 97077-0001
83486	ELCO INDUSTRIES INC	1101 SAMUELSON RD	ROCKFORD IL 61101
86928	SEASTROM MFG CO INC	701 SONORA AVE	GLENDALE CA 91201-2431
93907	TEXTRON INC CAMCAR DIV	600 18TH AVE	ROCKFORD IL 61108-5181
99742	PERMACEL TAPE DIV AN AVERY CO	U S HIGHWAY 1 P O BOX 671	NEW BRUNSWICK NJ 08903

Replaceable mechanical parts list

Fig. & index number	Tektronix part number	Serial no. effective	Serial no. discontin'd	Qty	Name & description	Mfr. code	Mfr. part number
1-1	390-0984-XX			1	CABINET SIDE:LEFT (ATTACHING PARTS)	80009	3900984XX
-2	211-0504-XX			1	SCREW,MACHINE:6-32 X 0.250,PNH,STL (END ATTACHING PARTS)	TK0435	ORDER BY DESC
-3	367-0535-XX			2	HANDLE,CARRYING:16.54 L,BLUE VINYL (ATTACHING PARTS)	TK0191	3670535XX
-4	212-0628-XX			8	SCREW,SHOULDER:10-32 X 0.4 L,RDH,STL (END ATTACHING PARTS)	93907	ORDER BY DESC
-5	386-1624-XX			4	PLATE,HDL RTNG:STAINLESS STEEL	TK1943	ORDER BY DESC
-6	386-1283-XX			4	PLATE,HDL MTG:FRONT	0JR05	ORDER BY DESC
-7	200-0728-XX			4	COVER,HDL END:1.91 X 0.91 X 0.36 BLUEACETAL	0JR05	200-0728-XX
-8	426-2371-XX			1	FRAME,SECTION:TOP LEFT,TEK TAN,AL (ATTACHING PARTS)	80009	4262371XX
-9	211-0507-XX			1	SCREW,MACHINE:6-32 X 0.312,PNH,STL	TK0435	ORDER BY DESC
-10	211-0510-XX			2	SCREW,MACHINE:6-32 X 0.375,PNH,STL	TK0435	ORDER BY DESC
-11	211-0538-XX			5	SCREW,MACHINE:6-32 X 0.312,FLH,STL (END ATTACHING PARTS)	TK0435	ORDER BY DESC
-12	124-0446-XX			1	STRIP,TRIM:TOP RIGHT	80009	1240446XX
-13	426-2372-XX			1	FRAME,SECTION:TOP RIGHT,TEK TAN,AL (ATTACHING PARTS)	80009	4262372XX
-14	211-0507-XX			1	SCREW,MACHINE:6-32 X 0.312,PNH,STL	TK0435	ORDER BY DESC
-15	211-0538-XX			1	SCREW,MACHINE:6-32 X 0.312,FLH,STL	TK0435	ORDER BY DESC
-16	211-0510-XX			2	SCREW,MACHINE:6-32 X 0.375,PNH,STL	TK0435	ORDER BY DESC
-17	211-0504-XX			5	SCREW,MACHINE:6-32 X 0.250,PNH,STL (END ATTACHING PARTS)	TK0435	ORDER BY DESC
-18	124-0447-XX			1	STRIP,TRIM:TOP RIGHT	80009	1240447XX
-19	426-2141-XX			1	FRAME SECT,CAB.:LEFT (ATTACHING PARTS)	80009	4262141XX
-20	211-0559-XX			1	SCREW,MACHINE:6-32 X 0.375,FLH,STL	TK0435	1593-300
-21	211-0504-XX			4	SCREW,MACHINE:6-32 X 0.250,PNH,STL (END ATTACHING PARTS)	TK0435	ORDER BY DESC
-22	426-2142-XX			1	FRAME SECT,CAB.:RIGHT (ATTACHING PARTS)	80009	4262142XX
-23	211-0559-XX			1	SCREW,MACHINE:6-32 X 0.375,FLH,STL	TK0435	1593-300
-24	211-0504-XX			3	SCREW,MACHINE:6-32 X 0.250,PNH,STL (END ATTACHING PARTS)	TK0435	ORDER BY DESC
-25	407-3890-XX			1	BRACKET,SUPPORT:ALUMINUM (ATTACHING PARTS)	80009	4073890XX
-26	212-0002-XX			4	SCREW,MACHINE:8-32 X 0.25,FLH,100 DEG,STL	0KB01	ORDER BY DESC
-27	212-0004-XX			4	SCREW,MACHINE:8-32 X 0.312,PNH,STL (END ATTACHING PARTS)	TK0435	ORDER BY DESC
-28	407-3890-XX			1	BRACKET,SUPPORT:ALUMINUM (ATTACHING PARTS)	80009	4073890XX

Replaceable mechanical parts list (Cont.)

Fig. & index number	Tektronix part number	Serial no. effective	Serial no. discont'd	Qty	Name & description	Mfr. code	Mfr. part number
-29	212-0002-XX			4	SCREW,MACHINE:8-32 X 0.25,FLH,100 DEG,STL	OKB01	ORDER BY DESC
-30	212-0004-XX			4	SCREW,MACHINE:8-32 X 0.312,PNH,STL (END ATTACHING PARTS)	TK0435	ORDER BY DESC
-31	334-7747-XX			1	MARKER,IDENT:	80009	3347747XX
-32	426-2211-XX			1	FRAME SECTION:BOTTOM,LEFT (ATTACHING PARTS)	TK0191	ORDER BY DESC
-33	211-0559-XX			2	SCREW,MACHINE:6-32 X 0.375,FLH,STL (END ATTACHING PARTS)	TK0435	1593-300
-34	124-0448-XX			2	STRIP,TRIM:BOTTOM	80009	1240448XX
-35	348-0128-XX			4	FOOT,CABINET:BLACK POLYURETHANE (ATTACHING PARTS)	80009	3480128XX
-36	211-0513-XX			8	SCREW,MACHINE:6-32 X 0.625,PNH,STL (END ATTACHING PARTS)	TK0435	ORDER BY DESC
-37	426-2134-XX			1	FRAME SECTION:FRONT,LEFT (ATTACHING PARTS)	TK0191	4262134XX
-38	211-0538-XX			2	SCREW,MACHINE:6-32 X 0.312,FLH,STL (END ATTACHING PARTS)	TK0435	ORDER BY DESC
-39	426-2138-XX			1	FRAME SECTION:BOTTOM,RIGHT (ATTACHING PARTS)	TK0191	4262138XX
-40	211-0559-XX			2	SCREW,MACHINE:6-32 X 0.375,FLH,STL (END ATTACHING PARTS)	TK0435	1593-300
-41	334-3379-XX			1	MARKER,IDENT:MARKED GROUND SYMBOL	07416	ORDER BY DESC
-42	426-2135-XX			1	FRAME SECTION:FRONT,RIGHT (ATTACHING PARTS)	TK0191	4262135XX
-43	211-0538-XX			2	SCREW,MACHINE:6-32 X 0.312,FLH,STL (END ATTACHING PARTS)	TK0435	ORDER BY DESC
-44	351-0770-XX			2	GUIDE,TEST FXTR:BOTTOM (ATTACHING PARTS)	80009	3510770XX
-45	211-0038-XX			6	SCREW,MACHINE:4-40 X 0.312,FLH,STL (END ATTACHING PARTS)	TK0435	ORDER BY DESC
-46	441-1739-XX			1	CHAS,CRV TRACER:BOTTOM (ATTACHING PARTS)	80009	4411739XX
-47	211-0541-XX			2	SCREW,MACHINE:6-32 X 0.25,FLH,STL (END ATTACHING PARTS)	TK0435	ORDER BY DESC
-48	390-0987-XX			1	CABINET BOTTOM: (ATTACHING PARTS)	80009	3900987XX
-49	211-0007-XX			6	SCREW,MACHINE:4-40 X 0.188,PNH,STL (END ATTACHING PARTS)	TK0435	ORDER BY DESC
-50	390-1088-XX			1	CABINET,TOP:ALUMINUM (ATTACHING PARTS)	80009	3901088XX
-51	211-0504-XX			1	SCREW,MACHINE:6-32 X 0.250,PNH,STL (END ATTACHING PARTS)	TK0435	ORDER BY DESC
-52	426-2136-XX			1	FRAME SECT,CAB.:REAR,AL	80009	4262136XX

Replaceable mechanical parts list (Cont.)

Fig. & index number	Tektronix part number	Serial no. effective	Serial no. discontinued	Qty	Name & description	Mfr. code	Mfr. part number
-53	390-0985-XX			1	CABINET SIDE:RIGHT (ATTACHING PARTS)	80009	3900985XX
-54	211-0504-XX			1	SCREW,MACHINE:6-32 X 0.250,PNH,STL (END ATTACHING PARTS)	TK0435	ORDER BY DESC
-55	333-A428-00			1	PANEL,REAR:370B,ALUMINUM (ATTACHING PARTS)	80009	3333717XX
-56	211-0507-XX			6	SCREW,MACHINE:6-32 X 0.312,PNH,STL (END ATTACHING PARTS)	TK0435	ORDER BY DESC
-57	343-1272-XX			2	RTNR,CAB.COVER:BLUE,PLASTIC (ATTACHING PARTS)	80009	3431272XX
-58	213-0782-XX			2	SCREW,TPG,TF:8-32 X 0.625,FILH,STL (END ATTACHING PARTS)	83486	ORDER BY DESC
-59	-----			1	MARKER,IDENT:MKD SERIAL NO		
-60	200-3300-XX			1	GUARD,FAN: (ATTACHING PARTS)	80009	2003300XX
-61	129-1126-XX			4	SPACER,POST:21.5MM L,4-40,6-32 THD,BRS (END ATTACHING PARTS)	80009	129112600
-62	378-0278-XX			1	FILTER,AIR:125MM X 5MM THK	TK0191	3780278XX
-63	200-3277-XX			1	COVER,FAN:ALUMINUM (ATTACHING PARTS)	80009	2003277XX
-64	211-0008-XX			4	SCREW,MACHINE:4-40 X 0.25,PNH,STL (END ATTACHING PARTS)	TK0435	ORDER BY DESC
-65	343-1271-XX			2	RTNR,CAB.COVER:BLUE,PLASTIC (ATTACHING PARTS)	80009	3431271XX
-66	213-0782-XX			2	SCREW,TPG,TF:8-32 X 0.625,FILH,STL (END ATTACHING PARTS)	83486	ORDER BY DESC
-67	119-2310-01			1	FAN,TUBEAXIAL:(B100) (ATTACHING PARTS)	80009	119231001
-68	210-0457-XX			4	NUT,PL,ASSEM WA:6-32 X 0.312,STL (END ATTACHING PARTS)	TK0435	ORDER BY DESC
-69	161-0257-01			1	CABLE ASSY,PWR:(W272)	80009	161025701
-70	129-A590-00			2	SPACER,POST:	80009	129A59000
-71	361-0704-XX			4	SPACER,CKT BD:0.504 L X 0.188 HEX,BRS	80009	3610704XX
-72	342-A149-00			1	INSULATOR,PLATE:CIRCUIT BOARD,PC	80009	3420894XX
-73	671-B127-01			1	CKT BOARD ASSY:INTERFACE(A22) (ATTACHING PARTS)	80009	671B12700
-74	211-0871-00			4	SCR,ASSEM M3 X 6,PNH,STL (END ATTACHING PARTS) CKT BOARD ASSY INCLUDES:	TK0191	211087100
-75	671-B127-01			2	CONN,RCPT,ELEC:(A22,J350&J450) (ATTACHING PARTS of A22)	80009	671B12701
-76	174-0295-00			1	CA ASSY,SP,ELEC:(A22W220)	80009	174029500
-77	342-0782-XX			1	INSULATOR,FILM:PRIMARY BOARD	80009	3420782XX

Replaceable mechanical parts list (Cont.)

Fig. & index number	Tektronix part number	Serial no. effective	Serial no. discont'd	Qty	Name & description	Mfr. code	Mfr. part number
-78	670-9323-00			1	CKT BOARD ASSY:PRIMARY(A27) (ATTACHING PARTS)	80009	670932300
-79	211-0661-XX			4	SCR,ASSEM WSHR:4- 40 X 0.25,PNH,STL (END ATTACHING PARTS) CKT BOARD ASSY INCLUDES:	TK0435	ORDER BY DESC
-80	131-3666-00			1	CONN,RCPT,ELEC:CKT BD,2 PIN:(A27J272)	80009	131366600
-81	131-3669-00			1	CONN,RCPT,ELEC:CKT BD,6 PIN:(A27J274)	80009	131366900
-82	131-3667-00			1	CONN,RCPT,ELEC:CKT BD,3 PIN:(A27J270)	80009	131366700
-83	119-3603-00			1	FILTER,RFI:115/230V,4A:(FL100) (ATTACHING PARTS)	80009	119360300
-84	211-0537-XX			2	SCREW,MACHINE:6-32 X 0.375,TRH,STL	TK0435	ORDER BY DESC
-85	210-0407-XX			2	NUT,PLAIN,HEX:6- 32 X 0.25,BRS	73743	3038-402
-86	210-0006-XX			2	WASHER,LOCK:#6 INTL,0.018 THK,STL (END ATTACHING PARTS)	78189	1206-00-00-0541
-87	196-3112-01			1	LEAD,ELECTRICAL:18 AWG,6.0 L,5-4:(W17)	80009	196311201
-88	210-0202-XX			1	TERMINAL,LUG:0.146 ID,LOCKING,BRZ (ATTACHING PARTS)	TK1181	ORDER BY DESC
-89	211-0565-XX			1	SCREW,MACHINE:6-32 X 0.250,TRH,STL (END ATTACHING PARTS)	TK0435	ORDER BY DESC
-90	196-3098-01			1	LEAD,ELECTRICAL:18 AWG,7.0 L,5-4:(W19)	80009	196390800
-91	210-0202-XX			1	TERMINAL,LUG:0.146 ID,LOCKING,BRZ (ATTACHING PARTS)	TK1181	ORDER BY DESC
-92	211-0565-XX			1	SCREW,MACHINE:6-32 X 0.250,TRH,STL (END ATTACHING PARTS)	TK0435	ORDER BY DESC
-93	210-0202-XX			1	TERMINAL,LUG:0.146 ID,LOCKING,BRZ (ATTACHING PARTS)	TK1181	ORDER BY DESC
-94	210-0407-XX			1	NUT,PLAIN,HEX:6-32 X 0.25,BRS (END ATTACHING PARTS)	73743	3038-402
-95	220-A178-00			1	NUT,PLATE,	80009	220A17800

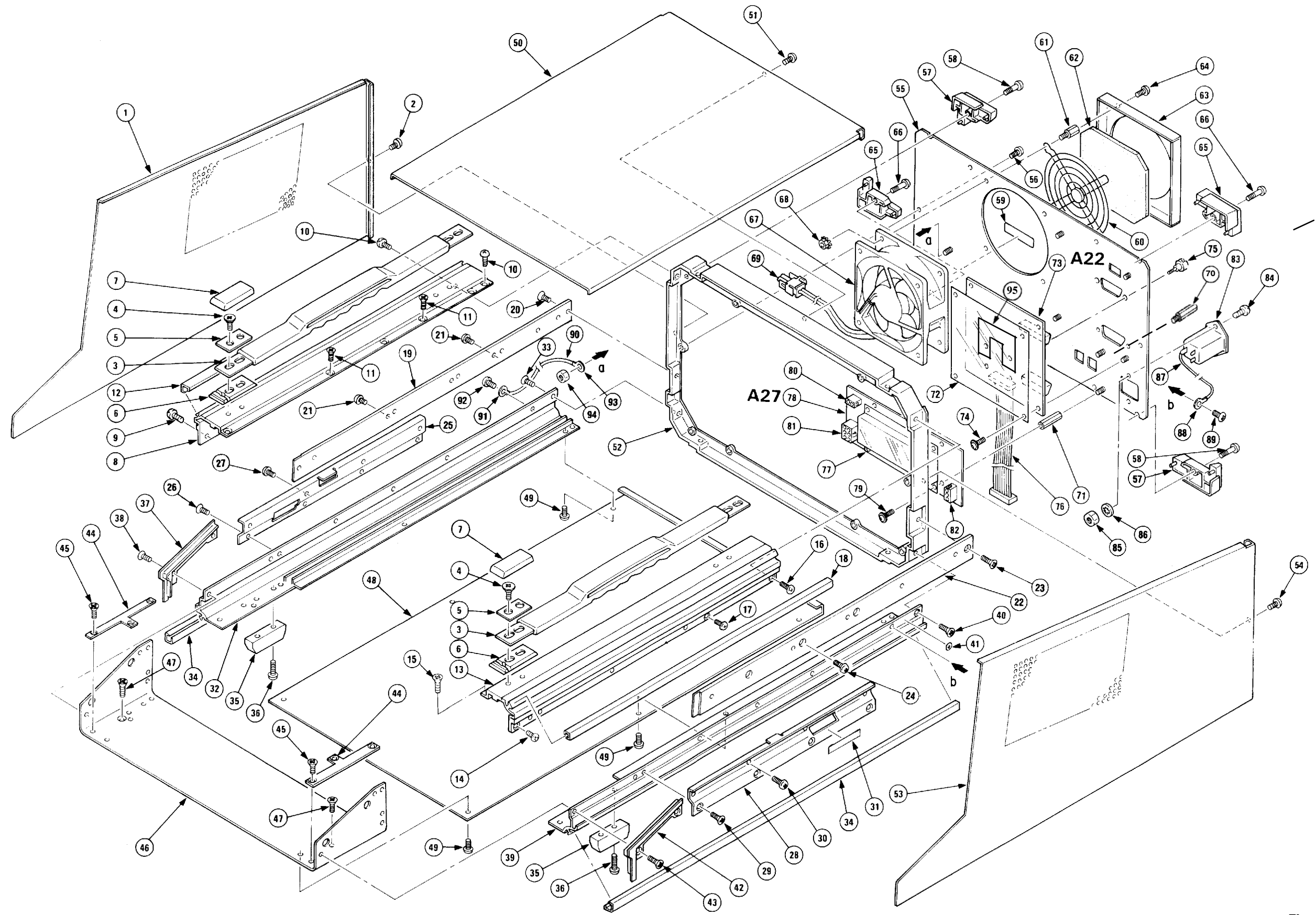

Figure 9-1: Cabinet, Rear

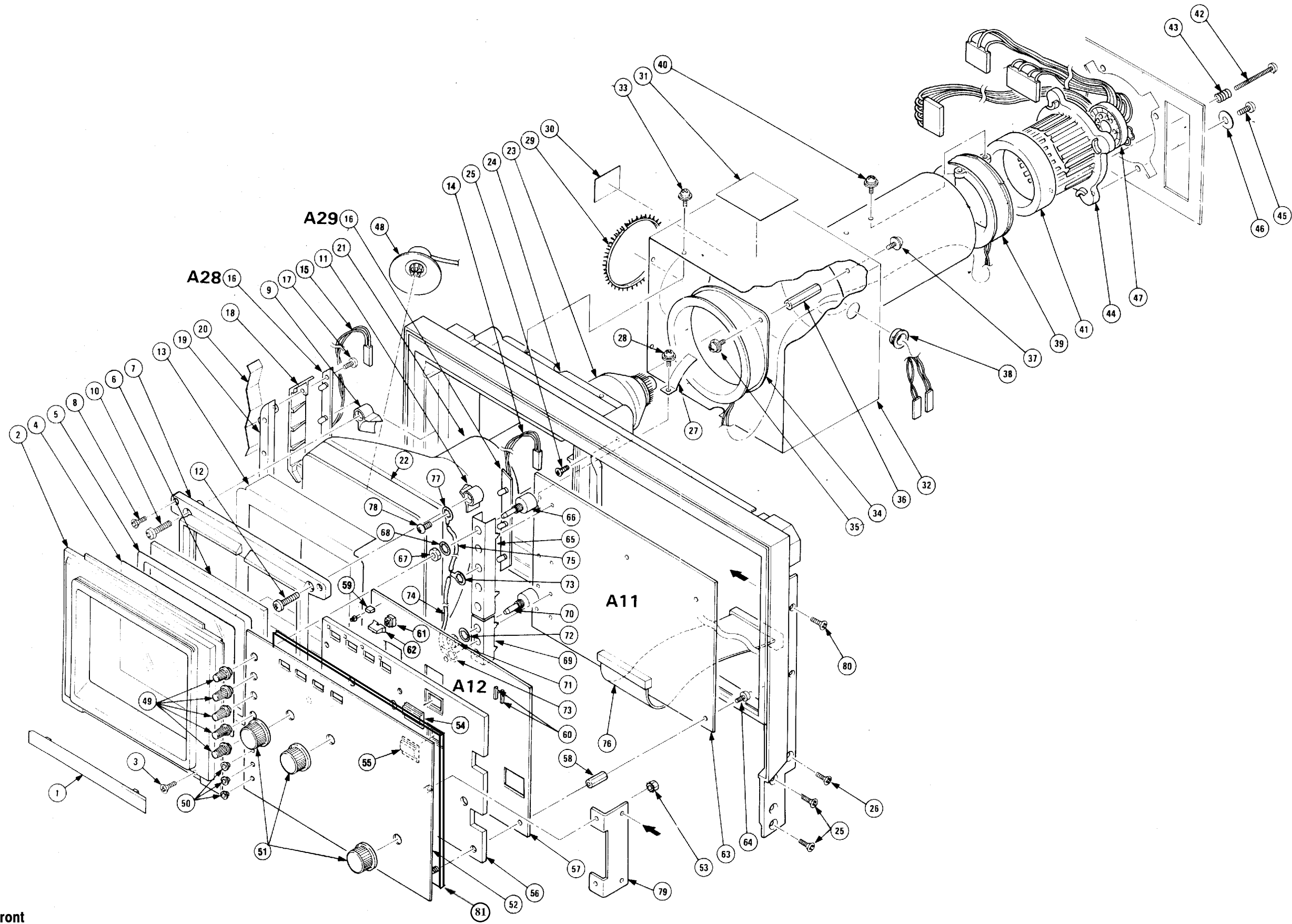

Figure 9-2: Display, Front

Replaceable mechanical parts list

Fig. & index number	Tektronix part number	Serial no. effective	Serial no. discontinued	Qty	Name & description	Mfr. code	Mfr. part number
2-1	200-3281-XX			1	COVER,BEZEL:POLYCARBONATE,TEK TAN	80009	2003281XX
-2	200-3276-XX			1	BEZEL,CRT:PC,TEK TAN (ATTACHING PARTS)	80009	2003276XX
-3	211-0538-XX			2	SCREW,MACHINE:6-32 X 0.312,FLH,STL (END ATTACHING PARTS)	TK0435	ORDER BY DESC
-4	378-0276-XX			1	FILTER,LT,CRT:BLUE,108.4MM X 134.4MM X 1MM	80009	3780276XX
-5	361-1381-XX			1	SPACER,RING:CRT,0.4MM	80009	3611381XX
-6	337-3328-XX			1	SHIELD,CRT:CLEAR	80009	3373328XX
-7	426-2133-XX			1	FRAME,CRT: (ATTACHING PARTS)	80009	4262133XX
-8	211-0512-XX			4	SCREW,MACHINE:6-32 X 0.5,FLH,STL (END ATTACHING PARTS)	TK0435	ORDER BY DESC
-9	343-1269-XX			2	RETAINER,CRT:FRONT,(A) (ATTACHING PARTS)	80009	3431269XX
-10	212-0022-XX			2	SCREW,MACHINE:8-32 X 1.5,PNH,STL (END ATTACHING PARTS)	TK0435	2011-300
-11	343-1270-XX			2	RETAINER,CRT:FRONT,(B) (ATTACHING PARTS)	80009	3431270XX
-12	212-0022-XX			2	SCREW,MACHINE:8-32 X 1.5,PNH,STL (END ATTACHING PARTS)	TK0435	2011-300
-13	331-0491-XX			1	MASK,CRT:	80009	3310491XX
-14	174-0313-00			1	CA ASSY,SP,ELEC:2,26AWG,30.0 L,RIBBON:(W280)	80009	174031300
-15	174-0312-00			1	CA ASSY,SP,ELEC:2,26AWG,22.0 L,RIBBON:(W290)	80009	174031200
-16	670-9324-XX			2	CKT BOARD ASSY:LAMP(A28 & A29) (ATTACHING PARTS)		
-17	211-0062-XX			4	SCREW,MACHINE:2-56 X 0.312,PNH,STL (END ATTACHING PARTS)	TK0435	ORDER BY DESC
-18	343-1268-XX			2	RETAINER,LIGHT:REFLECTOR	80009	3431268XX
-19	378-0614-XX			2	REFLECTOR,LIGHT:INT SCALE ILLUMINATION	OJR05	ORDER BY DESC
-20	214-3886-XX			2	SPRING,RTNR:SCALE LAMP	80009	2143886XX
-21				1	ELECTRON TUBE:(V100)		
-22	253-0267-XX			1	TAPE,PRESS SENS:0.08 X 20 X 20000MM,AL FOIL	80009	2530267XX
-23	253-0137-XX			1	TAPE,SILICONE:RED RBR,1.25 X 0.02	99742	2650
-24	426-A191-00			1	FRAME,FRONT: (ATTACHING PARTS)	80009	4262333XX
-25	211-0538-XX			8	SCREW,MACHINE:6-32 X 0.312,FLH,STL	TK0435	ORDER BY DESC
-26	211-0541-XX			2	SCREW,MACHINE:6-32 X 0.25,FLH,STL (END ATTACHING PARTS)	TK0435	ORDER BY DESC
-27	214-3880-XX			1	CONTACT,SPRING:GROUNDING CRT (ATTACHING PARTS)	80009	2143880XX
-28	211-0661-XX			1	SCR,ASSEM WSHR:4-40 X 0.25,PNH,STL (END ATTACHING PARTS)	TK0435	ORDER BY DESC

Replaceable mechanical parts list (Cont.)

Fig. & index number	Tektronix part number	Serial no. effective	Serial no. discont'd	Qty	Name & description	Mfr. code	Mfr. part number
-29	255-1106-XX			1	PLASTIC CHANNEL:250 X 3.3 X 4.0MM,NYLON	80009	2551106XX
-30	334-6691-XX			1	MARKER,IDENT:MKD DANGER	80009	3346691XX
-31	334-6805-XX			1	MARKER,IDENT:MKD WARNING	80009	3346805XX
-32	337-3325-XX			1	SHIELD,CRT: (ATTACHING PARTS)	80009	3373325XX
-33	211-0661-XX			4	SCR,ASSEM WSHR:4-40 X 0.25,PNH,STL (END ATTACHING PARTS)	TK0435	ORDER BY DESC
-34	108-1345-02			1	COIL,TUBE DEFL:TRACE ROTATOR:(L100) (ATTACHING PARTS)	80009	108134502
-35	211-0661-XX			2	SCR,ASSEM WSHR:4-40 X 0.25,PNH,STL (END ATTACHING PARTS)	TK0435	ORDER BY DESC
-36	129-1123-XX			2	SPACER,POST:33MM L,4-40 THD,BRASS (ATTACHING PARTS)	80009	1291123XX
-37	211-0661-XX			2	SCR,ASSEM WSHR:4-40 X 0.25,PNH,STL (END ATTACHING PARTS)	TK0435	ORDER BY DESC
-38	348-0948-XX			1	GROMMET,PLASTIC:BLACK,RING,9.5MM ID	80009	3480948XX
-39	108-1347-01			1	COIL,TUBE DEFL:Y-AXIS ALIGNMENT:(L120) (ATTACHING PARTS)	80009	108134701
-40	211-0661-XX			2	SCR,ASSEM WSHR:4-40 X 0.25,PNH,STL (END ATTACHING PARTS)	TK0435	ORDER BY DESC
-41	354-0347-XX			1	RING,CRT CLAMP:2.127 ID X 2.595 OD X 0.563 (ATTACHING PARTS)	0JR05	ORDER BY DESC
-42	211-0170-XX			2	SCREW,MACHINE:4-40 X 2.25,PNH,SST	TK0435	ORDER BY DESC
-43	214-1333-XX			2	SPRING,HLCPS:0.213 OD X 0.375,CLE,CU-BE (END ATTACHING PARTS)	8X345	ORDER BY DESC
-44	343-0205-XX			1	RTNR,ELCTRN TU:3.0 DIA X 1.5 L,DELTRIN (ATTACHING PARTS)	80009	3430205XX
-45	211-0578-XX			4	SCREW,MACHINE:6-32 X 0.438,PNH,STL	TK0435	ORDER BY DESC
-46	210-0949-XX			4	WASHER,FLAT:0.141 ID X 0.5 OD X 0.062,BRS (END ATTACHING PARTS)	12327	ORDER BY DESC
-47	196-3099-00			1	LEAD,ELECTRICAL:24 AWG,10.0 L:(W14)	80009	196309900
-48	119-2162-01			1	HV MODULER: 2kV INPUT,12kV OUTPUT	80009	119216201
-49	366-0625-XX			5	KNOB:SILVER GRAY,9.5MM OD	80009	3660625XX
-50	358-0378-XX			3	BUSHING,SLEEVE:0.131 ID X 0.18 OD X 0.125L	80009	3580378XX
-51	366-0620-XX			3	KNOB:SILVER GRAY,25MM OD	80009	3660620XX
-52	333-A429-00			1	PANEL,FRONT:370B	80009	3333715XX
-53	210-0586-XX			2	NUT,PL,ASSEM WA:4-40 X 0.25,STL (END ATTACHING PARTS)	TK0435	ORDER BY DESC
-54	378-0349-XX			1	FILTER,LED DSPL:GRAY,10.8 & 18.3M,PC	80009	3780349XX
-55	378-0277-XX			1	FILTER,LT,CRT:SMOKE GRAY	80009	3780277XX
-56	351-0853-XX			1	GUIDE,PB:370B MAIN KEY BD,PC	80009	3510853XX

Replaceable mechanical parts list (Cont.)

Fig. & index number	Tektronix part number	Serial no. effective	Serial no. discontinued	Qty	Name & description	Mfr. code	Mfr. part number
-57	671-1149-02			1	CIRCUIT BD ASSY:SUB KEY(A12) (ATTACHING PARTS)		
-58	129-1131-XX			6	SPACER,POST:12.7MM L,4-40 THD,BRASS (END ATTACHING PARTS) CKT BOARD ASSY INCLUDES:	80009	1291131XX
-59	129-1128-XX			54	.SPACER,POST:5.1MM,L,POLYCARBONATE	80009	1291128XX
-60	131-3677-XX			8	.CONN,RCPT,ELEC:1 X 5 FEMALE	80009	1313677XX
-61	260-2156-00			38	SWITCH,KEY:(A12S300,S301,S302,S303,S304,S305, S310,S311,S312,S313,S314,S315,S320,S321,S322,S323, S324,S325,S330,S331,S332,S333,S335,S350,S351,S353, S354,S355,S360,S361,S362,S363,S364,S365,S370,S371, S372,S373)	80009	260215600
-62	366-0617-XX			44	PUSH BUTTON:SILVER GRAY,9.6 X 4.2 X 8.5MM	80009	3660617XX
-63	671-B235-00			1	CKT BOARD ASSY:MAIN KEY(A11) (ATTACHING PARTS)	80009	671B23500
-64	211-0661-XX			6	SCR,ASSEM WSHR:4-40 X 0.25,PNH,STL (END ATTACHING PARTS) CKT BOARD ASSY INCLUDES:	TK0435	ORDER BY DESC
-65	407-3474-XX			1	.BRACKET,ANGLE:VAR RES MTG	80009	4073474XX
-66	311-2457-00			5	RES,VAR,NONWW:P/NL,10K OHM,1/2W,20%:(A11R302,R312,R322,R330,R340) (ATTACHING PARTS)	80009	311245700
-67	210-0583-XX			5	.NUT,PLAIN,HEX:0.25-32 X 0.312,BRS	73743	2X-20319-402
-68	210-0046-XX			4	.WASHER,LOCK:0.261 ID,INTL,0.018 THK,STL (END ATTACHING PARTS)	78189	1214-05-00-0541
-69	407-3475-XX			1	.BRACKET,ANGLE:VAR RES MTG,W/CUT LEAD	80009	4073475XX
-70	311-2456-00			3	RES,VAR,NONWW:P/NL,10K OHM,1/2W,20%: (A11R350,R360,R370) (ATTACHING PARTS)	80009	311245600
-71	210-0583-XX			3	.NUT,PLAIN,HEX:0.25-32 X 0.312,BRS	73743	2X-20319-402
-72	210-0046-XX			2	.WASHER,LOCK:0.261 ID,INTL,0.018 THK,STL (END ATTACHING PARTS)	78189	1214-05-00-0541
-73	210-0223-XX			2	.TERMINAL,LUG:0.26 ID,LOCKING,BRZ	0KB01	210-0223-XX
-74	196-3096-00			1	LEAD,ELECTRICAL:18 AWG,3.5 L,5-4:(A11W111)	80009	196309600
-75	196-3096-00			1	LEAD,ELECTRICAL:18 AWG,3.5 L,5-4:(A11W112)	80009	196309600
-76	174-0293-00			1	CA ASSY,SP,ELEC:40,28 AWG,4.3L,RIBBON:(A11W110)	80009	174029300
-77	210-0201-XX			1	.TERMINAL,LUG:0.12 ID,LOCKING,BRZ	TK1741	2004-4 PHOSPHOR
-78	211-0008-XX			1	SCREW,MACHINE:4-40 X 0.25,PNH,STL	TK0435	ORDER BY DESC
-79	407-3851-XX			1	BRACKET,ANGLE:FRONT PANEL MTG,AL (ATTACHING PARTS)	80009	4073851XX
-80	211-0106-XX			2	SCREW,MACHINE:4-40 X 0.625,FLH,STL (END ATTACHING PARTS)	TK0435	ORDER BY DESC
-81	386-A842-00			1	SUB PANEL	80009	386A84200

Replaceable mechanical parts list (Cont.)

Fig. & index number	Tektronix part number	Serial no. effective	Serial no. discont'd	Qty	Name & description	Mfr. code	Mfr. part number
3-1	441-1740-XX			1	CHASSIS,CKT BD:370B,ALUMINUM	TK0191	4411740XX
-2	255-0334-XX			1	PLASTIC CHANNEL:12.75 X 0.175 X 0.155,NYLON	11897	122-NN-2500-060
-3	343-0778-XX			2	CLAMP,CABLE:5MM ID,NYLON	80009	3430778XX
-4	348-0948-XX			1	GROMMET,PLASTIC:BLACK,RING,9.5MM ID	80009	3480948XX
-5	351-0769-XX			2	GUIDE,CKT BD:	80009	3510769XX
-6	343-1289-XX			1	CLAMP,CABLE:STEEL	80009	3431289XX
-7	343-1084-XX			3	CLAMP,CABLE:NYLON	80009	3431084XX
-8	255-1107-XX			1	PLASTIC CHANNEL:500 X 3.7 X 4.0MM,NYLON	80009	2551107XX
-9	255-0334-XX			1	PLASTIC CHANNEL:12.75 X 0.175 X 0.155,NYLON	11897	122-NN-2500-060
-10	255-0334-XX			1	PLASTIC CHANNEL:12.75 X 0.175 X 0.155,NYLON	11897	122-NN-2500-060
-11	670-9309-09			1	CKT BOARD ASSY:STEP GEN(A7) (ATTACHING PARTS)	80009	670930909
-12	211-0661-XX			3	SCR,ASSEM WSHR:4-40 X 0.25,PNH,STL (END ATTACHING PARTS) CKT BOARD ASSY INCLUDES:	TK0435	ORDER BY DESC
-17	211-0315-XX			1	.SCR,ASSEM WSHR:4-40 X 0.437,PHN,STL (END ATTACHING PARTS)	TK0435	ORDER BY DESC
-21	156-0446-00			1	MICROCKT,DGTL:3-TERM POSI VOL REG +12V:(A7U170)	80009	156044600
-22	214-4003-XX			1	.HEAT SINK,XSTR:TO-220,AL (ATTACHING PARTS)	80009	2144003XX
-23	211-0661-XX			1	.SCR,ASSEM WSHR:4-40 X 0.25,PNH,STL	TK0435	ORDER BY DESC
-24	210-0586-XX			1	.NUT,PL,ASSEM WA:4-40 X 0.25,STL (END ATTACHING PARTS)	TK0435	ORDER BY DESC
-26	174-0310-00			1	CA ASSY,SP,ELEC,10,22 AWG18.0 RIBBON:(W72)	80009	174031000
-27	671-0236-02			1	CIRCUIT BD ASSY:MOTHER,(A1) (ATTACHING PARTS)	80009	671023602
-28	211-0661-XX			8	SCR,ASSEM WSHR:4-40 X 0.25,PNH,STL (END ATTACHING PARTS) CKT BOARD ASSY INCLUDES:	TK0435	ORDER BY DESC
-39	407-3479-XX			1	BRACKET,CKT BD:ALUMINUM (ATTACHING PARTS)	80009	4073479XX
-40	211-0507-XX			2	SCREW,MACHINE:6-32 X 0.312,PNH,STL (END ATTACHING PARTS)	TK0435	ORDER BY DESC
-41	670-9320-01			1	CKT BOARD ASSY:LV SUPPLY,(A19) (ATTACHING PARTS)	80009	670932001
-42	211-0661-XX			3	SCR,ASSEM WSHR:4-40 X 0.25,PNH,STL	TK0435	ORDER BY DESC
-43	211-0507-XX			3	SCREW,MACHINE:6-32 X 0.312,PNH,STL (END ATTACHING PARTS) CKT BOARD ASSY INCLUDES:	TK0435	ORDER BY DESC
-44	214-3874-XX			1	.HT SK,PWR SPLY:LV,AL (ATTACHING PARTS)	80009	2143874XX
-45	211-0661-XX			3	.SCR,ASSEM WSHR:4-40 X 0.25,PNH,STL (END ATTACHING PARTS)	TK0435	ORDER BY DESC

Replaceable mechanical parts list (Cont.)

Fig. & index number	Tektronix part number	Serial no. effective	Serial no. discont'd	Qty	Name & description	Mfr. code	Mfr. part number
-46	151-0561-00			2	TRANSISTOR:PNP,SI,PWR:(Q230,Q600) (ATTACHING PARTS)	80009	151056200
	151-0562-00			1	TRANSISTOR:PNP,SI,PWR:(A19Q130) (ATTACHING PARTS)	80009	151056200
-47	211-0244-XX			3	.SCR,ASSEM WSHR:4-40 X 0.312,PNH,STL (END ATTACHING PARTS)	TK0435	7772-312
-48	156-2830-00			1	MICROCKT,LINEAR:VOLTAGE REG,+12V:(A19U310) (ATTACHING PARTS)	80009	156283000
	156-2831-00			1	MICROCKT,LINEAR:VOLTAGE REG,+5V,STR:(A19U100), (ATTACHING PARTS)	80009	156283100
-49	211-0315-XX			4	.SCR,ASSEM WSHR:4-40 X 0.437,PHN,STL	TK0435	ORDER BY DESC
-50	342-0790-XX			2	.INSULATOR,FILM:MICA,0.07MA (END ATTACHING PARTS)	80009	3420790XX
-51	152-1119-00			2	SEMICON DVC,DI:RECT,SI,100V,10A:(A19CR100,CR300) (ATTACHING PARTS)	80009	152111900
	152-1120-00			2	SEMICON DVC,DI:RECT,SI,100V,10A:(A19CR200,CR400, U410) (ATTACHING PARTS)	80009	152112000
-52	211-0244-XX			5	.SCR,ASSEM WSHR:4-40 X 0.312,PNH,STL (END ATTACHING PARTS)	TK0435	7772-312
-53	148-1010-00			1	RELAY,SOL STATE:5A,250VAC:(A19U700) (ATTACHING PARTS)	80009	148101000
-54	211-0244-XX			2	.SCR,ASSEM WSHR:4-40 X 0.312,PNH,STL (END ATTACHING PARTS)	TK0435	7772-312
-55	131-3668-00			2	CONN,RCPT,ELEC:CKT BD,4 PIN:(A19J64,J190)	80009	131366800
-56	131-3671-00			1	CONN,RCPT,ELEC:CKT BD,15 PIN:(A19J196)	80009	131367100
-57	131-0589-00			3	TERMINAL,PIN:PRESSFIT/PCB,;MALE,STR:(A19J72,J194, J198)	22526	48283-087
-58	131-0608-00			2	CONN,TERMINAL:PRESSFIT/PCB,;MALE,STR:(A19J280,J290)	22526	48283-018
-59	174-0328-00			1	CA ASSY,SP,ELEC:4,18 AWG,15.5 L:(W190)	80009	174032800
-60	174-0308-00			1	CA ASSY,SP,ELEC:(W194)	80009	174030800
-61	348-1048-XX			2	PAD,CUSHIONING:150MM X 12MM X 13MM	TK0191	3481048XX
-62	343-1273-XX			2	RETAINER,CKT BD:BRASS (ATTACHING PARTS)	80009	3431273XX
-63	211-0504-XX			2	SCREW,MACHINE:6-32 X 0.250,PNH,STL (END ATTACHING PARTS)	TK0435	ORDER BY DESC
-64	671-B126-01			1	CKT BOARD ASSY:CPU(A2)	80009	671B12601
-69	105-0899-XX	.301393	.301782	2	.EJECTOR,CKT BD:NYLON	80009	1050899XX
	105-0978-XX	.301783		2	.EJECTOR,CKT BD:NYLON	TK00Z	21-0608
-70	337-3326-XX	.301393	.302428	1	.SHIELD,ELEC:CPU BD (ATTACHING PARTS)	80009	3373326XX
-71	211-0661-XX	.301393	.302428	5	.SCR,ASSEM WSHR:4-40 X 0.25,PNH,STL (END ATTACHING PARTS)	TK0435	ORDER BY DESC
-72	671-B213-00			1	CKT BOARD ASSY:A/D(A3)	80009	671B21300

Replaceable mechanical parts list (Cont.)

Fig. & index number	Tektronix part number	Serial no. effective	Serial no. discont'd	Qty	Name & description	Mfr. code	Mfr. part number
-73	131-3650-00			1	CONN,PLUG,ELEC:CKT BD,RTANG,2 X 32,0.1 SP:(A3P30)	80009	131365000
-79	337-3326-XX			1	.SHIELD,ELEC:CPU BD (ATTACHING PARTS)	80009	3373326XX
-80	211-0661-XX	.301393	.302428	5	.SCR,ASSEM WSHR:4-40 X 0.25,PNH,STL (END ATTACHING PARTS)	TK0435	ORDER BY DESC
-81	670-9306-04			1	CKT BOARD ASSY:DGTL DISPLAY(A4)	80009	670930604
-85	105-0899-XX	.301393	.301782	2	.EJECTOR,CKT BD:NYLON	80009	1050899XX
	105-0978-XX	.301783		2	.EJECTOR,CKT BD:NYLON	TK00Z	21-0608
-86	337-3326-XX			1	.SHIELD,ELEC:CPU BD (ATTACHING PARTS)	80009	3373326XX
-87	211-0661-XX			5	.SCR,ASSEM WSHR:4-40 X 0.25,PNH,STL (END ATTACHING PARTS)	TK0435	ORDER BY DESC
-88	670-9307-05			1	CKT BOARD ASSY:DISPLAY CONT(A5)	80009	670930705
-93	337-3326-XX	.301393	.302428	1	.SHIELD,ELEC:CPU BD (ATTACHING PARTS)	80009	3373326XX
-94	211-0661-XX	.301393	.302428	5	.SCR,ASSEM WSHR:4-40 X 0.25,PNH,STL (END ATTACHING PARTS)	TK0435	ORDER BY DESC

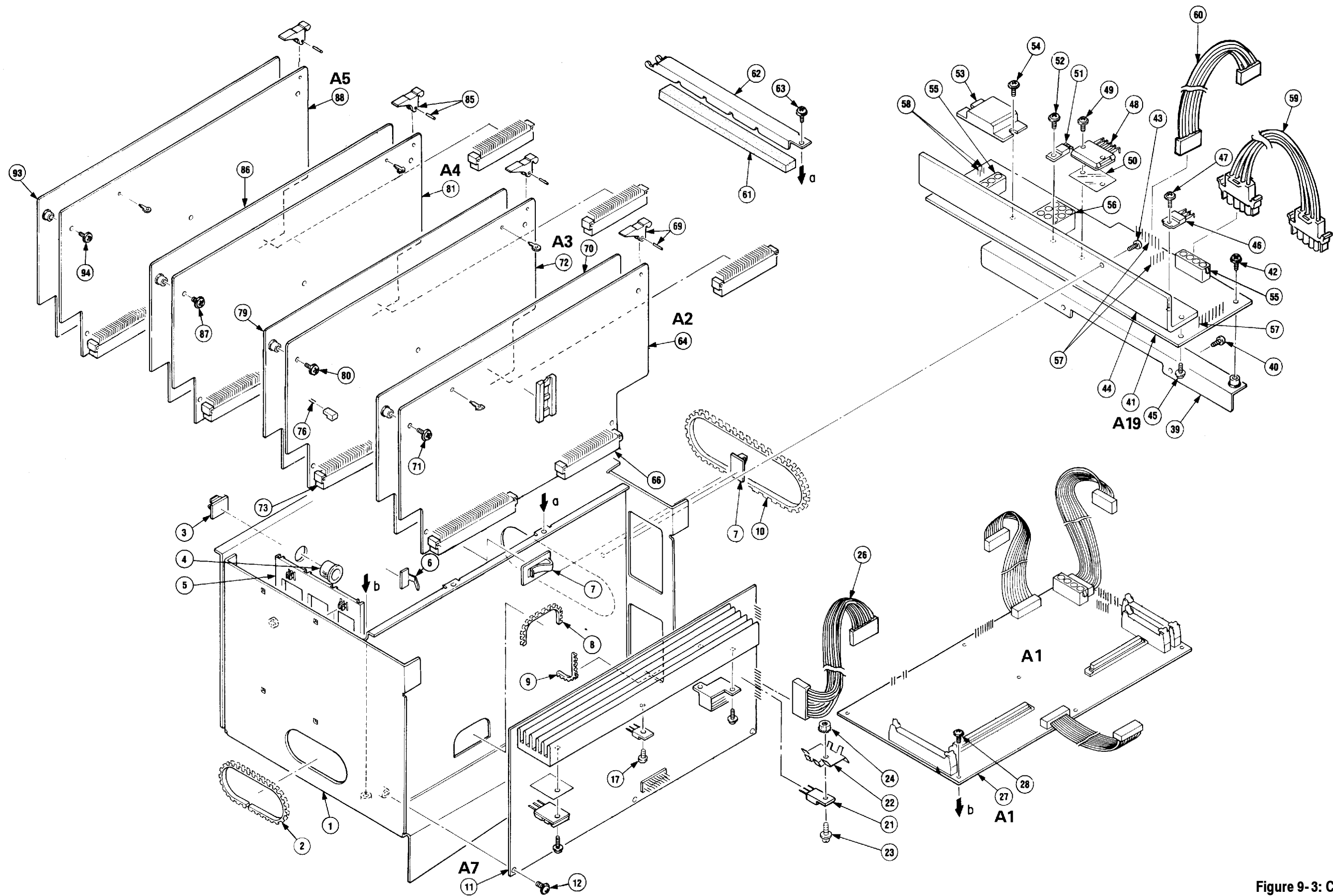

Figure 9-3: Chassis Circuit Boards

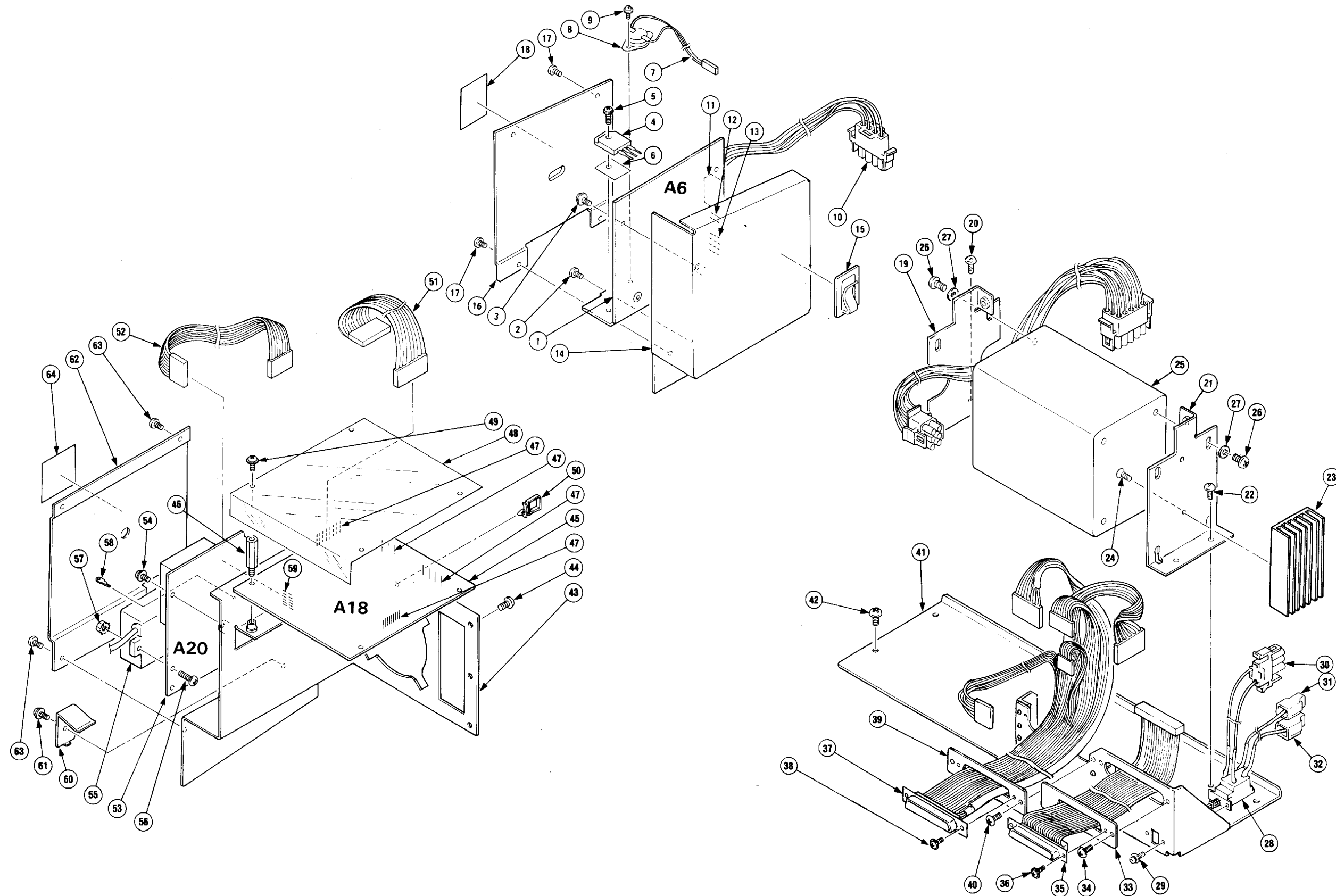

Figure 9-4: Power Supply

Replaceable mechanical parts list

Fig. & index number	Tektronix part number	Serial no. effective	Serial no. discontinued	Qty	Name & description	Mfr. code	Mfr. part number
4-1	670-9308-06			1	CKT BOARD ASSY:COLL SPLY OUT(A6) (ATTACHING PARTS)	80009	670930806
-2	211-0507-XX			2	SCREW,MACHINE:6-32 X 0.312,PNH,STL	TK0435	ORDER BY DESC
-3	211-0661-XX			2	SCR,ASSEM WSHR:4-40 X 0.25,PNH,STL (END ATTACHING PARTS) CKT BOARD ASSY INCLUDES:	TK0435	ORDER BY DESC
-4	151-1201-00			2	TRANSISTOR:PMOS,FET,PWR,200V:(A6Q438,Q440)	80009	151120100
	151-1202-00			2	(A6Q538,Q540) (ATTACHING PARTS)	80009	151120200
-5	211-0315-XX			4	.SCR,ASSEM WSHR:4-40 X 0.437,PHN,STL	TK0435	ORDER BY DESC
-6	342-0787-XX			4	.INSULATOR,PLATE:XSTR,TO-3P,SI RUBBER (END ATTACHING PARTS)	80009	3420787XX
-7	174-0304-00			1	CA ASSY,SP,ELEC:2,26 AWG,6.0 L,RIBBON: (A6W66)	80009	174030400
-8	260-2332-01			1	SWITCH,THERMOSTATIC:NC,OPEN 70 DEG C,3A,250V: (A6S92) (ATTACHING PARTS)	TK0191	260233201
-9	211-0661-XX			2	.SCR,ASSEM WSHR:4-40 X 0.25,PNH,STL (END ATTACHING PARTS)	TK0435	ORDER BY DESC
-10	174-0301-00			1	CA ASSY,SP,ELEC:4,22 AWG,16.0 L:(A6W64)	80009	174030100
-11	131-3672-00			1	CONN,RCPT,ELEC:HEADER,16 PIN:(A6J60)	80009	131367200
-12	131-0608-00			1	CONN,TERMINAL:PRESSFIT/PCB,;MALE,STR: (A6J66)	22526	48283-018
-13	131-0589-00			1	TERMINAL,PIN:PRESSFIT/PCB,;MALE,STR:(A6J62)	22526	48283-087
-14	407-3470-XX			1	BRACKET,CKT BD:COLLECTOR SUPPLY OUTPUT	80009	4073470XX
-15	343-1084-XX			2	CLAMP,CABLE:NYLON	80009	3431084XX
-16	337-3330-XX	.301393	.302394	1	SHIELD,ELEC:COLLECTOR SUPPLY (ATTACHING PARTS)	80009	3373330XX
-17	211-0008-XX	.301393	.302394	4	SCREW,MACHINE:4-40 X 0.25,PNH,STL (END ATTACHING PARTS)	TK0435	ORDER BY DESC
-18	334-6695-XX	301393	.302394	1	MARKER,IDENT:MKD DANGER & POT	80009	3346695XX
-19	407-3478-XX			1	BRACKET,XFMR:LEFT,ALUMINUM (ATTACHING PARTS)	80009	4073478XX
-20	212-0507-XX			2	SCREW,MACHINE:10-32 X 0.375,PNH,STL (END ATTACHING PARTS)	TK0435	MACHINE SCREW
-21	407-3907-XX			1	BRACKET,XFMR:RIGHT,ALUMINUM (ATTACHING PARTS)	80009	4073907XX
-22	212-0507-XX			2	SCREW,MACHINE:10-32 X 0.375,PNH,STL (END ATTACHING PARTS)	TK0435	MACHINE SCREW
-23	214-3974-XX			1	HEAT SINK,ELEC:TRANSFORMER,ALUMINUM (ATTACHING PARTS)	80009	2143974XX
-24	211-0538-XX			2	SCREW,MACHINE:6-32 X 0.312,FLH,STL (END ATTACHING PARTS)	TK0435	ORDER BY DESC
-25	120-1678-01			1	XFMR,PWR,STU:100-120VAC IN,48-66HZ:(T100) (ATTACHING PARTS)	80009	120167801

Replaceable mechanical parts list (Cont.)

Fig. & index number	Tektronix part number	Serial no. effective	Serial no. discount'd	Qty	Name & description	Mfr. code	Mfr. part number
-26	212-0507-XX			8	SCREW,MACHINE:10-32 X 0.375,PNH,STL	TK0435	MACHINE SCREW
-27	210-1003-XX			8	WASHER,FLAT:0.2 ID X 0.438 OD X 0.036 BRS (END ATTACHING PARTS)	12327	ORDER BY DESC
-28	260-2323-00			1	SWITCH,PUSH:DPST,15A,250V,ON/OFF:(S100) (ATTACHING PARTS)	80009	260232300
-29	211-0751-XX			2	SCR,ASSEM WSHR:M3 X 8 (END ATTACHING PARTS)	80009	2110751XX
-30	174-0327-00			1	CA ASSY,SP,ELEC:2,18 AWG,7.0 L:(W270)	80009	174032700
-31	196-3110-00			1	LEAD,ELECTRICAL:18 AWG,7.0 L,8-0:(W16)	80009	196311000
-32	196-3111-00			1	LEAD,ELECTRICAL:18 AWG,7.0 L,8-9:(W18)	80009	196311100
-33	386-5485-XX			1	PLATE,CONN MTG:FEMALE,STEEL (ATTACHING PARTS)	80009	3865485XX
-34	211-0507-XX			2	SCREW,MACHINE:6-32 X 0.312,PNH,STL (END ATTACHING PARTS)	TK0435	ORDER BY DESC
-35	174-0296-00			1	CA ASSY,SP,ELEC:34,28 AWG,5.5 L,RIBBON:(W400) (ATTACHING PARTS)	80009	174029600
-36	211-0661-XX			2	SCR,ASSEM WSHR:4-40 X 0.25,PNH,STL (END ATTACHING PARTS)	TK0435	ORDER BY DESC
-37	198-5714-00			1	WIRE SET,ELEC:370B,W/D-SUB CONN:(W490) (ATTACHING PARTS)	80009	198571400
-38	211-0661-XX			2	SCR,ASSEM WSHR:4-40 X 0.25,PNH,STL (END ATTACHING PARTS)	TK0435	ORDER BY DESC
-39	386-5909-XX			1	PLATE,CONN MTG:FEMALE,STEEL (ATTACHING PARTS)	80009	3865909XX
-40	211-0507-XX			2	SCREW,MACHINE:6-32 X 0.312,PNH,STL (END ATTACHING PARTS)	TK0435	ORDER BY DESC
-41	441-1948-XX			1	CHAS ASSY,CURV:TRCR,REAR,AL (ATTACHING PARTS)	80009	4411948XX
-42	211-0507-XX			4	SCREW,MACHINE:6-32 X 0.312,PNH,STL (END ATTACHING PARTS)	TK0435	ORDER BY DESC
-43	441-1743-XX			1	CHASSIS,CRT:LEFT (ATTACHING PARTS)	80009	4411743XX
-44	211-0504-XX			3	SCREW,MACHINE:6-32 X 0.250,PNH,STL (END ATTACHING PARTS)	TK0435	ORDER BY DESC
-45	670-9319-02			1	CKT BOARD ASSY:CRT OUTPUT(A18) (ATTACHING PARTS)	80009	670931902
-46	129-1139-XX			4	SPACER,POST:25MM L,W4-40 THD,BRASS (END ATTACHING PARTS) CKT BOARD ASSY INCLUDES:	80009	1291139XX
-47	131-0608-00			1	CONN,TERMINAL:PRESSFIT/PCB,;MALE,STR:(A18J180)	22526	48283-018
	131-0589-00			3	TERMINAL,PIN:PRESSFIT/PCB,;MALE,STR (A18J182,J184,J186)	22526	48283-087
-48	342-0785-XX			1	INSULATOR,PLATE:CRT OUTPUT (ATTACHING PARTS)	80009	3420785XX

Replaceable mechanical parts list (Cont.)

Fig. & index number	Tektronix part number	Serial no. effective	Serial no. discontinued	Qty	Name & description	Mfr. code	Mfr. part number
-49	211-0661-XX			4	SCR,ASSEM WSHR:4-40 X 0.25,PNH,STL (END ATTACHING PARTS)	TK0435	ORDER BY DESC
-50	343-1288-XX			1	CLAMP,CABLE:PLASTIC	80009	3431288XX
-51	174-0309-00			1	CA ASSY,SP,ELEC:10,22 AWG,5.0 L,RIBBON:(W182)	80009	174030900
-52	174-0314-00			1	CA ASSY,SP,ELEC:9,26 AWG,7.5 L,RIBBON:(W180)	80009	174031400
-53	670-B211-00			1	CKT BOARD ASSY:HV REG(A20) (ATTACHING PARTS)	80009	670B21100
-54	211-0661-XX			4	SCR,ASSEM WSHR:4-40 X 0.25,PNH,STL (END ATTACHING PARTS) CKT BOARD ASSY INCLUDES:	TK0435	ORDER BY DESC
-55	119-2162-01			1	HV MODULE:(A20U300) (ATTACHING PARTS)	80009	119216201
-56	211-0012-XX			2	.SCREW,MACHINE:4-40 X 0.375,PNH,STL	TK0435	ORDER BY DESC
-57	210-0586-XX			2	.NUT,PL,ASSEM WA:4-40 X 0.25,STL (END ATTACHING PARTS)	TK0435	ORDER BY DESC
-58	214-0579-00			3	TERM,TEST POINT:PCB,TEST POINT;EYELET: (A20TP200,TP300,TP400)	0J260	ORDER BY DESC
-59	131-0589-00			3	TERMINAL,PIN:PRESSFIT/PCB,;MALE,STR: (A20J182,J194,J200)	22526	48283-087
-60	343-1275-XX			1	RETAINER,XSTR:HV,SST (ATTACHING PARTS)	80009	3431275XX
-61	211-0661-XX			1	SCR,ASSEM WSHR:4-40 X 0.25,PNH,STL (END ATTACHING PARTS)	TK0435	ORDER BY DESC
-62	337-3329-XX			1	SHIELD,ELEC:HV REG (ATTACHING PARTS)	80009	3373329XX
-63	211-0008-XX			4	SCREW,MACHINE:4-40 X 0.25,PNH,STL (END ATTACHING PARTS)	TK0435	ORDER BY DESC
-64	334-6694-XX			1	MARKER,IDENT:MKD DANGER & POT	80009	3346694XX

Replaceable mechanical parts list (Cont.)

Fig. & index number	Tektronix part number	Serial no. effective	Serial no. discount'd	Qty	Name & description	Mfr. code	Mfr. part number
5-1	333-3514-XX			1	PANEL,FRONT:371,PWR SW (ATTACHING PARTS)	80009	3333514XX
-2	200-0103-XX			1	NUT,PLAIN,KNURL:0.25-28 X 0.375 INCH OD,BRS	TK0588	ORDER BY DESC
-3	355-0507-XX			1	STUD,SHOULDERED:BINDING POST,BRS	TK0588	ORDER BY DESC
-4	210-0455-XX			1	NUT,PLAIN,HEX:0.25-28 X 0.375,BRS	73743	3089-402
-5	210-0046-XX			1	WASHER,LOCK:0.261 ID,INTL,0.018 THK,STL (END ATTACHING PARTS)	78189	1214-05-00-0541
-6	344-0396-XX			1	CLIP,CABLE:PVC	80009	3440396XX
-7	426-2334-XX			1	SUBPANEL,TEST F:	80009	4262334XX
-8	333-3718-XX			1	PANEL,FRONT	80009	3333718XX
-9	407-3472-XX			1	BRACKET,ANGLE:LOWER,PANEL (ATTACHING PARTS)	80009	4073472XX
-10	210-0586-XX			2	NUT,PL,ASSEM WA:4-40 X 0.25,STL	TK0435	ORDER BY DESC
-11	211-0038-XX			2	SCREW,MACHINE:4-40 X 0.312,FLH,STL (END ATTACHING PARTS)	TK0435	ORDER BY DESC
-12	122-0183-XX			1	ANGLE,RAIL:SUBPANEL MTG,LEFT (ATTACHING PARTS)	80009	1220183XX
-13	210-0586-XX			1	NUT,PL,ASSEM WA:4-40 X 0.25,STL	TK0435	ORDER BY DESC
-14	211-0038-XX			5	SCREW,MACHINE:4-40 X 0.312,FLH,STL (END ATTACHING PARTS)	TK0435	ORDER BY DESC
-15	351-0854-XX			1	GUIDE,PB:370B VAR COIL SUPPLY BD,PC (ATTACHING PARTS)	80009	3510854XX
-16	210-0586-XX			2	NUT,PL,ASSEM WA:4-40 X 0.25,STL (END ATTACHING PARTS)	TK0435	ORDER BY DESC
-17	311-2457-00			1	RES,VAR,NONWW:P/NL,10K OHM,1/2W,20%:(R210) (ATTACHING PARTS)	80009	311245700
-18	210-0583-XX			1	NUT,PLAIN,HEX:0.25-32 X 0.312,BRS	73743	2X-20319-402
-19	210-0046-XX			1	WASHER,LOCK:0.261 ID,INTL,0.018 THK,STL (END ATTACHING PARTS)	78189	1214-05-00-0541
-20	366-0626-XX			1	KNOB:SILVER GRAY,12MM OD	80009	3660626XX
-21	198-5686-00			1	WIRE SET,ELEC:(W210)	80009	198568600
-22	260-2497-03			1	SWITCH,ROTARY:ENCODER:(S200) (ATTACHING PARTS)	80009	260249703
-23	210-0207-XX			1	TERMINAL,LUG:0.385 OD,PLAIN,BRS (END ATTACHING PARTS)	12697	01136902
-24	366-0621-XX			1	SHELL,KNOB:TEKTAN,30MM OD X 15MM H,ABS	80009	3660621XX
-25	377-0609-XX			1	INSERT,KNOB:8.6MM ID X 16MM OD X 8MM H,AL (ATTACHING PARTS)	80009	3770609XX
-26	213-0022-XX			1	SETSCREW:4-40 X 0.188,STL (END ATTACHING PARTS)	0KB01	ORDER BY DESC
-27	671-B245-00			1	CKT BOARD ASSY:CONFIG.LED(A15) (ATTACHING PARTS)	80009	671B24500

Replaceable mechanical parts list (Cont.)

Fig. & index number	Tektronix part number	Serial no. effective	Serial no. discontinued	Qty	Name & description	Mfr. code	Mfr. part number
-28	210-0586-XX			2	NUT,PL,ASSEM WA:4-40 X 0.25,STL (END ATTACHING PARTS) CKT BOARD ASSY INCLUDES:	TK0435	ORDER BY DESC
-29	129-1128-XX			6	.SPACER,POST:5.1MM,L,POLYCARBONATE	80009	1291128XX
-30	131-0589-00			2	TTERMINAL,PIN:PRESSFIT/PCB,;MALE,STR: (A15J200,J210)	22526	48283-087
-31	174-1775-01			1	CA ASSY,SP,ELEC:16,28 AWG,250MM L,RIBBON: (A15W150)	80009	174177501
-32	366-0617-XX			2	PUSH BUTTON:SILVER GRAY,9.6 X 4.2 X 8.5MM	80009	3660617XX
-33	386-5395-XX			1	PLATE,MTG ASSY:TEST ADAPTER (ATTACHING PARTS)	80009	3865395XX
-34	211-0025-XX			4	SCREW,MACHINE:4-40 X 0.375,FLH,STL (END ATTACHING PARTS)	TK0435	ORDER BY DESC
-35	386-5919-XX			1	PLATE,ELEC:GND,ALUMINUM	80009	3865919XX
-36	348-0970-XX			2	SHLD GSKT,ELEK:FINGER TYPE,0.75 L	80009	3480970XX
-37	210-0269-XX			1	TERMINAL,LUG:0.257 ID,PLAIN,BRS TINNED	0KB01	905-020
-38	343-1367-XX			3	CLAMP,LOOP:3.3MM ID,NYLON (ATTACHING PARTS)	TK0AR	30-0608
-39	210-0407-XX			3	NUT,PLAIN,HEX:6-32 X 0.25,BRS (END ATTACHING PARTS)	73743	3038-402
-40	343-1286-XX			1	CLAMP,CABLE:6.8 ID,NYLON (ATTACHING PARTS)	80009	3431286XX
-41	210-0407-XX			1	NUT,PLAIN,HEX:6-32 X 0.25,BRS (END ATTACHING PARTS)	73743	3038-402
-42	136-0887-XX			4	SOCKET,PIN TERM:0.16 DIA,RED	80009	1360887XX
-43	136-0888-XX			11	SOCKET,PIN TERM:0.16 DIA,GRAY	80009	1360888XX
-44	210-0241-XX			2	TERMINAL,LUG:0.515 ID,PLAIN,STL	TK1665	ORDER BY DESC
-45	198-5680-01			1	WIRE SET,ELEC:(W91)	80009	198569600
-46	198-5680-00			1	WIRE SET,ELEC:(W95)	80009	198568000
-47	198-5683-00			1	WIRE SET,ELEC::(W3)	80009	198568300
-48	198-5700-00			1	WIRE SET,ELEC:(W4)	80009	198570000
-49	198-5681-01			1	WIRE SET,ELEC:(W104)	80009	198568101
-50	198-5682-00			1	WIRE SET,ELEC:(W103)	80009	198568200
-51	198-5679-00			1	WIRE SET,ELEC:(W102)	80009	198567900
-52	343-0549-XX			4	STRAP,TIEDOWN,E:0.098 W X 4.0 L,ZYTEL	TK1499	HW-047
-53	407-3889-XX			1	BRACKET,MTG:ADAPTER PL W/PRESSNUT,AL (ATTACHING PARTS)	80009	4073889XX
-54	211-0038-XX			4	SCREW,MACHINE:4-40 X 0.312,FLH,STL (END ATTACHING PARTS)	TK0435	ORDER BY DESC
-55	407-3484-XX			2	BRACKET,SW MTG:ALUMINUM (ATTACHING PARTS)	80009	4073484XX

Replaceable mechanical parts list (Cont.)

Fig. & index number	Tektronix part number	Serial no. effective	Serial no. discount'd	Qty	Name & description	Mfr. code	Mfr. part number
-56	211-0038-XX			4	SCREW,MACHINE:4-40 X 0.312,FLH,STL (END ATTACHING PARTS)	TK0435	ORDER BY DESC
-57	260-2324-00			2	SWITCH,SENS:(S400,S402) (ATTACHING PARTS)	80009	260232400
-58	213-0986-XX			4	SCREW,MACHINE:2-26 X 12MM,HEX,BRS	80009	2130986XX
-59	210-0938-XX			4	WASHER,FLAT:0.109 ID X 0.25 OD X 0.032,STL	TK0413	ORDER BY DESC
-60	210-0054-XX			4	WASHER,LOCK:#4 SPLIT,0.025 THK STL (END ATTACHING PARTS)	86928	ORDER BY DESC
-61	198-5685-00			1	WIRE SET,ELEC:(W401)	80009	198568500
-62	196-3270-00			1	LEAD,ELECTRICAL:26 AWG,28.0 L,N-0(W402)	80009	196327000
-63	343-0549-XX			3	STRAP,TIEDOWN,E:0.098 W X 4.0 L,ZYTEL	TK1499	HW-047
-64	344-0395-XX			1	CLIP,CABLE:NYLON	80009	3440395XX
-65	344-0396-XX			2	CLIP,CABLE:PVC	80009	3440396XX
-66	333-A440-00			1	PANEL,FRONT: (The panel which a character isn't being printed on.)	80009	333A44000
-67	407-3472-XX			1	BRACKET,ANGLE:LOWER,PANEL (ATTACHING PARTS)	80009	4073472XX
-68	210-0586-XX			2	NUT,PL,ASSEM WA:4-40 X 0.25,STL	TK0435	ORDER BY DESC
-69	211-0038-XX			2	SCREW,MACHINE:4-40 X 0.312,FLH,STL (END ATTACHING PARTS)	TK0435	ORDER BY DESC
-70	122-0184-XX			1	ANGLE,RAIL:SUBPANEL MTG,RIGHT (ATTACHING PARTS)	80009	1220184XX
-71	210-0586-XX			1	NUT,PL,ASSEM WA:4-40 X 0.25,STL	TK0435	ORDER BY DESC
-72	211-0038-XX			5	SCREW,MACHINE:4-40 X 0.312,FLH,STL (END ATTACHING PARTS)	TK0435	ORDER BY DESC
-73	351-0855-XX			1	GUIDE,PB:370B LEFT-STANDBY-RIGHT SWBD	80009	3510855XX
-74	671-B244-00			1	CKT BOARD ASSY:LOR KEY(A14) (ATTACHING PARTS)	80009	671B24400
-75	210-0586-XX			3	NUT,PL,ASSEM WA:4-40 X 0.25,STL (END ATTACHING PARTS) CKT BOARD ASSY INCLUDES:	TK0435	ORDER BY DESC
-76	129-1128-XX			3	.SPACER,POST:5.1MM,L,POLYCARBONATE	80009	1291128XX
-77	150-1176-00			2	LT EMITTING DIO:RED(A14DS100,DS400)	80009	150117600
-78	174-1832-00			1	CA ASSY,SP,ELEC:14,28 AWG,23.0 L,RIBBON(A14W140)	80009	174183200
-79	366-0617-XX			3	PUSH BUTTON:SILVER GRAY,9.6 X 4.2 X 8.5MM	80009	3660617XX
-80	426-2336-XX			1	SUBPANEL,TEST F:ALUMINUM	80009	4262336XX
-81	333-3716-XX			1	PANEL,FRONT:	80009	3333716XX
-82	426-2331-XX			1	FRAME:POLYCARBONATE	80009	4262331XX
-83	343-1084-XX			2	CLAMP,CABLE:NYLON	80009	3431084XX
-84	407-3857-XX			1	BRACKET,CMPNT:CKT BREAKER,ALUMINUM (ATTACHING PARTS)	80009	4073857XX

Replaceable mechanical parts list (Cont.)

Fig. & index number	Tektronix part number	Serial no. effective	Serial no. discontinued	Qty	Name & description	Mfr. code	Mfr. part number
-85	210-0586-XX			2	NUT,PL,ASSEM WA:4-40 X 0.25,STL (END ATTACHING PARTS)	TK0435	ORDER BY DESC
-86	260-2499-00			1	CIRCUIT BREAKER:SPST,1.5A,250 VAC(S800)	80009	260249900
-87	198-5468-00			1	WIRE SET,ELEC:(W410)	80009	198546800
-88	337-3344-XX			1	SHIELD,ELEC:PROTECTIVE BOX,PC	80009	3373344XX
-89	337-A851-00			1	SUB PANEL(Printed matter)	80009	337A85100
	650-4574-00			1	TEST ADAPTER ASSY W/CABLE	80009	650457400
	(The parts numberd 33 to 65 (except for 54) are assembled into this kit.)						

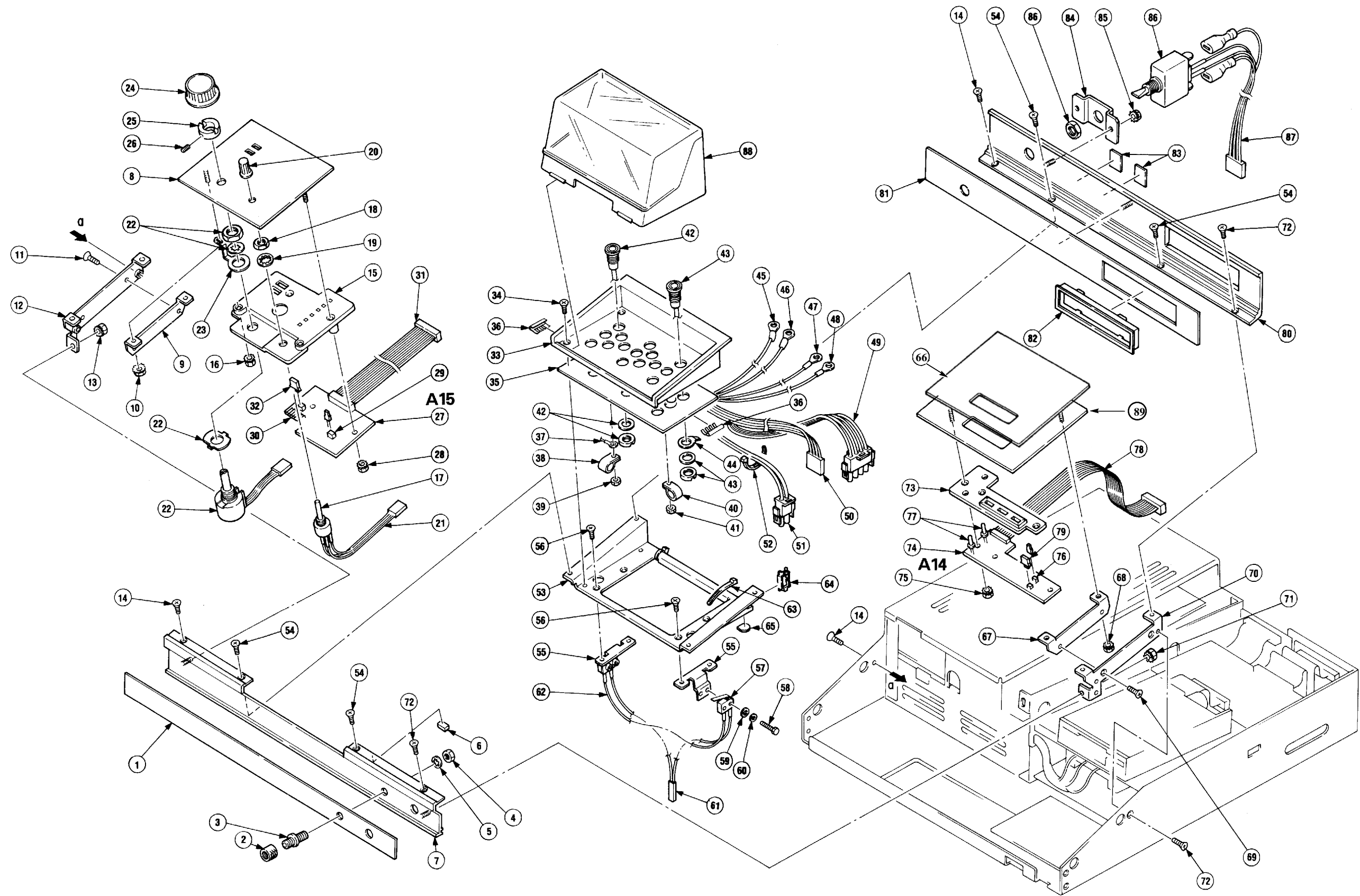

Figure 9-5: Front Panel: L-O-R

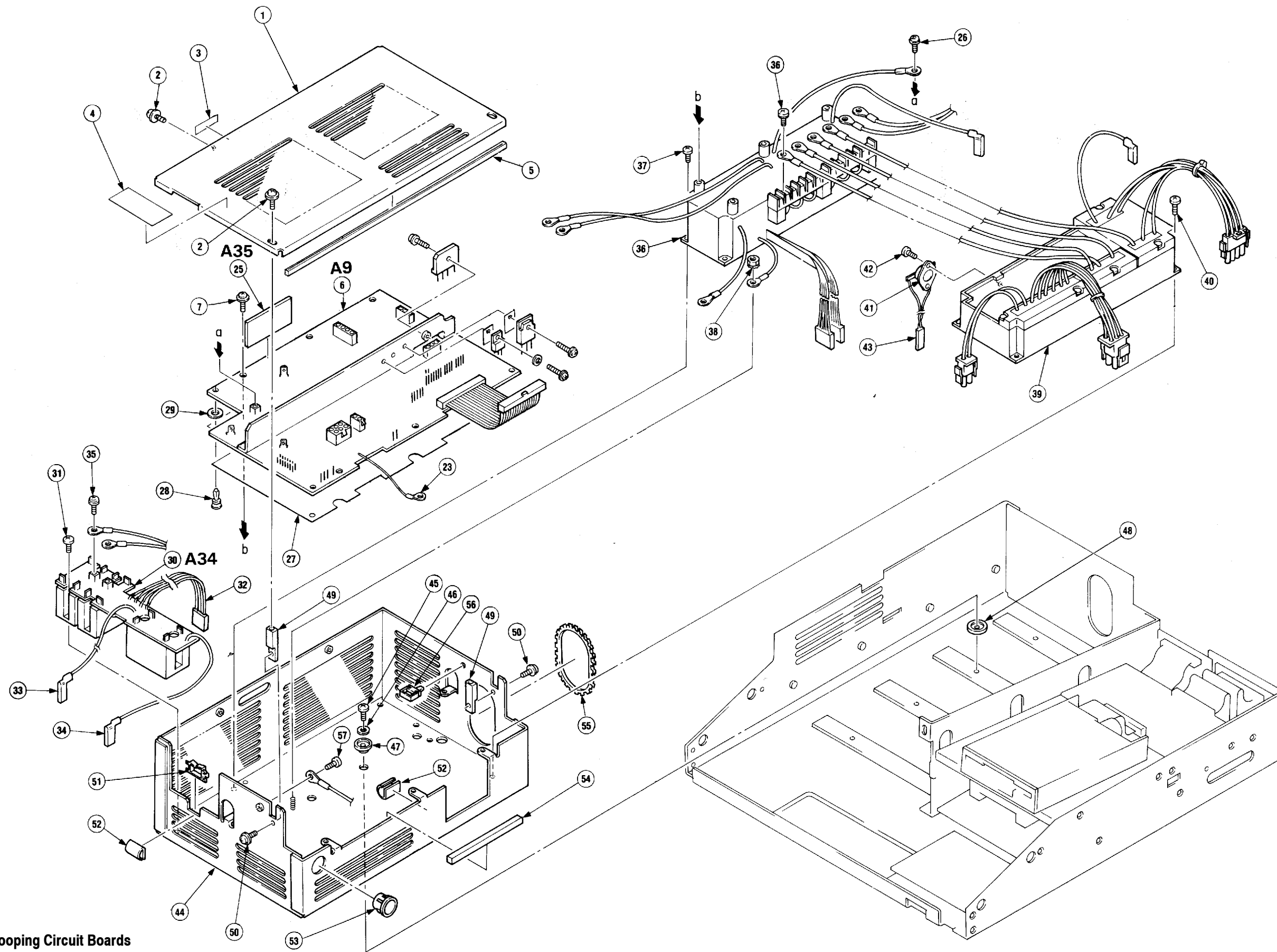

Figure 9-6: LV, L-O-R, Looping Circuit Boards

Replaceable mechanical parts list

Fig. & index number	Tektronix part number	Serial no. effective	Serial no. discontin'd	Qty	Name & description	Mfr. code	Mfr. part number
6-1	441-1923-XX			1	CHAS,TEST FXTR:GUARD BOX COVER,AL (ATTACHING PARTS)	80009	4411923XX
-2	211-0661-XX			4	SCR,ASSEM WSHR:4-40 X 0.25,PNH,STL (END ATTACHING PARTS)	TK0435	ORDER BY DESC
-3	334-7730-XX			1	MARKER,IDENT:MKD LOOPING INFO	80009	3347730XX
-4	334-6690-XX			1	MARKER,IDENT:MKD CAUTION & DANGER	80009	3346690XX
-5	252-0719-XX			1	PLASTIC SH,CHAN:0.047 X 0.063 THK,39.37 L	80009	2520719XX
-6	671-1183-04			1	CKT BOARD ASSY:LV RELAY(A9) (ATTACHING PARTS)	80009	671118304
-7	211-0729-XX			8	SCR,ASSEM WSHR:6-32 X 0.437,PH,STL (END ATTACHING PARTS) CKT BOARD ASSY INCLUDES:	TK0435	ORDER BY DESC
-23	196-3301-00			1	LEAD,ELECTRICAL:18 AWG,6.0 L,W/LUG:(A9W10)	80009	196330100
-25	671-1147-03			1	CKT BOARD ASSY:LOOPING(A35)	80009	671114703
-26	211-0751-XX			1	.SCR,ASSEM WSHR:M3 X 8	80009	2110751XX
-27	342-0895-XX			1	INSULATOR:POLYCARBONATE,LV CKT BD (ATTACHING PARTS)	80009	3420895XX
-28	210-3110-XX			4	RIVET,SOLID:5.5MM L X 3.4MM OD,TRUSS,NYLON	TK0BK	27-0601
-29	210-1475-XX	.301393	.301917	4	WASHER,PLAIN:3.56 ID X 7.94 OD X 0.8 THK (END ATTACHING PARTS)	80009	2101475XX
-30	671-1140-01			1	CKT BOARD ASSY:LOR RELAY(A34) (ATTACHING PARTS)	80009	671114001
-31	211-0504-XX			6	SCREW,MACHINE:6-32 X 0.250,PNH,STL (END ATTACHING PARTS) CKT BOARD ASSY INCLUDES:	TK0435	ORDER BY DESC
-32	198-5688-00			1	WIRE SET,ELEC:(A34W89)	80009	198568800
-33	196-3276-00			1	LEAD,ELECTRICAL:18 AWG,37.0 L,9-N(A34W94)	80009	196327600
-34	198-5687-00			1	LEAD,ELECTRICAL:(A34W97)	80009	198568700
-35	211-0751-XX			2	.SCR,ASSEM WSHR:M3 X 8	80009	2110751XX
-36	119-3414-02			1	HIGH V MODULE:W/18 RELAYS:(U800) (ATTACHING PARTS)	80009	119341402
-37	211-0504-XX			4	SCREW,MACHINE:6-32 X 0.250,PNH,STL (END ATTACHING PARTS)	TK0435	ORDER BY DESC
-38	210-0457-XX			1	NUT,PL,ASSEM WA:6-32 X 0.312,STL	TK0435	ORDER BY DESC
-39	307-1541-01			1	RES,FXD,FILM:1.1 OHM TO 25K OHM,2%,W/CONN:(R400) (ATTACHING PARTS)	80009	307154101
-40	211-0504-XX			4	SCREW,MACHINE:6-32 X 0.250,PNH,STL (END ATTACHING PARTS)	TK0435	ORDER BY DESC
-41	260-2328-01			1	SWITCH,THRMSTC:NC,OPEN,70.0,3.0 A,250V:(S90) (ATTACHING PARTS)	S3385	5003F70B1-GUL
-42	211-0008-XX			2	SCREW,MACHINE:4-40 X 0.25,PNH,STL (END ATTACHING PARTS)	TK0435	ORDER BY DESC
-43	198-5696-00			1	WIRE SET,ELEC:(W93)	80009	198569600
-44	441-1922-XX			1	CHAS,TEST FXTR:GUARD BOX,ALUMINUM (ATTACHING PARTS)	80009	4411922XX

Replaceable mechanical parts list (Cont.)

Fig. & index number	Tektronix part number	Serial no. effective	Serial no. discont'd	Qty	Name & description	Mfr. code	Mfr. part number
-45	211-0511-XX			8	SCREW,MACHINE:6-32 X 0.5,PNH,STL	TK0435	ORDER BY DESC
-46	210-0803-XX			8	WASHER,FLAT:0.15 ID X 0.375 OD X 0.032,STL (END ATTACHING PARTS)	12327	ORDER BY DESC
-47	342-0774-XX			8	INSULATOR,BSHG:4MM ID X 6MM THK,16MM OD	80009	3420774XX
-48	361-1380-XX			8	SPACER,RING:3MM L X 8.1MM ID	80009	3611380XX
-49	220-0105-XX			2	NUT BLOCK:4-40 X 5.5MM,BRS (ATTACHING PARTS)	TK019 1	2200105XX
-50	211-0661-XX			2	SCR,ASSEM WSHR:4-40 X 0.25,PNH,STL (END ATTACHING PARTS)	TK0435	ORDER BY DESC
-51	344-0395-XX			1	CLIP,CABLE:NYLON	80009	3440395XX
-52	344-0396-XX			2	CLIP,CABLE:PVC	80009	3440396XX
-53	348-0949-XX			1	GROMMET,PLASTIC:BLACK,RING,15MM ID	80009	3480949XX
-54	255-1108-XX			1	PLASTIC CHANNEL:1000 X 4.4 X 5.0MM,NYLON	80009	2551108XX
-55	255-0334-XX			1	PLASTIC CHANNEL:12.75 X 0.175 X 0.155,NYLON	11897	122-NN-2500-060
-56	343-1288-XX			1	CLAMP,CABLE:PLASTIC	80009	3431288XX
-57	211-0504-XX			1	SCREW,MACHINE:6-32 X 0.250,PNH,STL	TK0435	ORDER BY DESC

Replaceable mechanical parts list (Cont.)

Fig. & index number	Tektronix part number	Serial no. effective	Serial no. discontin'd	Qty	Name & description	Mfr. code	Mfr. part number
7-1	441-1919-XX			1	CHAS,TEST FXTR:MAIN,AL	80009	4411919XX
-2	342-0776-XX			1	INSULATOR,FILM:370B	80009	3420776XX
-3	344-0396-XX			1	CLIP,CABLE:PVC	80009	3440396XX
-4	343-0549-XX			1	STRAP,TIEDOWN,E:0.098 W X 4.0 L,ZYTEL	TK1499	HW-047
-5	351-0774-XX			3	GUIDE,SLIDE:PWR SW,POLYCARBONATE (ATTACHING PARTS)	80009	3510774XX
-6	211-0038-XX			3	SCREW,MACHINE:4-40 X 0.312,FLH,STL (END ATTACHING PARTS)	TK0435	ORDER BY DESC
-7	384-1703-XX			1	EXTENSION SHAFT:PWR SW	80009	3841703XX
-8	214-3420-XX			1	SPRING,HLCPS:10.0MM OD X 9.5MM L,CLE,SST	80009	2143420XX
-9	366-1767-XX			1	PUSH BUTTON:BLACK,GREEN INDICATOR	80009	3661767XX
-10	122-0181-XX			1	ANGLE,RAIL:LEFT (ATTACHING PARTS)	80009	1220181XX
-11	211-0502-XX			4	SCREW,MACHINE:6-32 X 0.188,FLH,STL (END ATTACHING PARTS)	TK0435	ORDER BY DESC
-12	122-0182-XX			1	ANGLE,RAIL:RIGHT (ATTACHING PARTS)	80009	1220182XX
-13	211-0502-XX			4	SCREW,MACHINE:6-32 X 0.188,FLH,STL (END ATTACHING PARTS)	TK0435	ORDER BY DESC
-14	441-1920-XX			1	CHAS,TEST FXTR:ALUMINUM,MID (ATTACHING PARTS)	80009	4411920XX
-15	211-0538-XX			7	SCREW,MACHINE:6-32 X 0.312,FLH,STL	TK0435	ORDER BY DESC
-16	210-0457-XX			1	NUT,PL,ASSEM WA:6-32 X 0.312,STL (END ATTACHING PARTS)	TK0435	ORDER BY DESC
-17	344-0395-XX			1	CLIP,CABLE:NYLON	80009	3440395XX
-18	348-0949-XX			1	GROMMET,PLASTIC:BLACK,RING,15MM ID	80009	3480949XX
-19	255-0334-XX			1	PLASTIC CHANNEL:12.75 X 0.175 X 0.155,NYLON	11897	122-NN-2500-060
-20	407-3486-XX			2	BRACKET,XFMR:ALUMINUM (ATTACHING PARTS)	80009	4073486XX
-21	220-0410-XX			6	NUT,PL,ASSEM WA:10-32 X 0.375 HEX,STL (END ATTACHING PARTS)	0KB01	511-101200-50-0
-22	120-1677-01			1	XFMR,PWR,STU:CLCT SUPPLY,70V IN,40-66HZ(T200) (ATTACHING PARTS)	80009	120167701
-23	212-0507-XX			4	SCREW,MACHINE:10-32 X 0.375,PNH,STL (END ATTACHING PARTS)	TK0435	ORDER BY DESC
-24	407-3854-XX			1	BRACKET,ANGLE:ALUMINUM,SUPPORT (ATTACHING PARTS)	80009	4073854XX
-25	211-0538-XX			4	SCREW,MACHINE:6-32 X 0.312,FLH,100 DEG,STL (END ATTACHING PARTS)	TK0435	ORDER BY DESC
-26	198-5713-00			1	WIRE SET,ELEC:370B,W/D-SUB CONN(W491) (ATTACHING PARTS)	80009	198571300
-27	211-0661-XX			2	SCR,ASSEM WSHR:4-40 X 0.25,PNH,STL (END ATTACHING PARTS)	TK0435	ORDER BY DESC
-28	386-5917-XX			1	PLATE,CONN MTG:STEEL (ATTACHING PARTS)	80009	3865917XX

Replaceable mechanical parts list (Cont.)

Fig. & index number	Tektronix part number	Serial no. effective	Serial no. discont'd	Qty	Name & description	Mfr. code	Mfr. part number
-29	211-0510-XX			2	SCREW,MACHINE:6-32 X 0.375,PNH,STL (END ATTACHING PARTS)	TK0435	ORDER BY DESC
-30	174-1693-00			1	CA ASSY,SP,ELEC:34,28 AWG,130.0 L,RIBBON(W142) (ATTACHING PARTS)	80009	174169300
-31	211-0661-XX			2	SCR,ASSEM WSHR:4-40 X 0.25,PNH,STL (END ATTACHING PARTS)	TK0435	ORDER BY DESC
-32	386-5484-XX			1	PLATE,CONN MTG:MALE,STEEL (ATTACHING PARTS)	80009	3865484XX
-33	211-0510-XX			2	SCREW,MACHINE:6-32 X 0.375,PNH,STL (END ATTACHING PARTS)	TK0435	ORDER BY DESC
-34	119-B105-00			1	FLOPPY DISK DRIVE:(A24)STAND.ACC (ATTACHING PARTS)	80009	119B10500
-35	211-0751-XX			4	SCR,ASSEM WSHR:M3 X 8 (END ATTACHING PARTS)	80009	2110751XX
-36	337-3588-XX			1	SHIELD,ELEC:ALUMINUM (ATTACHING PARTS)	80009	3373588XX
-37	211-0658-XX			4	SCR,ASSEM WSHR:6-32 X 0.312,PNH,STL,POZ (END ATTACHING PARTS)	TK0435	17691-300
-38	407-3855-XX			1	BRKT,TEST FXTR:ALUMINUM,FDD MTG (ATTACHING PARTS)	80009	4073855XX
-39	211-0538-XX			3	SCREW,MACHINE:6-32 X 0.312,FLH,STL	TK0435	ORDER BY DESC
-40	211-0507-XX			3	SCREW,MACHINE:6-32 X 0.312,PNH,STL (END ATTACHING PARTS)	TK0435	ORDER BY DESC
-41	334-6696-XX			1	MARKER,IDENT:MKD DANGER	80009	3346696XX
-42	671-B128-01			1	CKT BOARD ASSY:FDD INTERFACE (A23) (ATTACHING PARTS)	80009	671B12801
-43	211-0661-XX			4	SCR,ASSEM WSHR:4-40 X 0.25,PNH,STL (END ATTACHING PARTS) CKT BOARD ASSY INCLUDES:	TK0435	ORDER BY DESC
-45	174-1611-00			1	CA ASSY,SP,ELEC:34,28 AWG,9.0 L,RIBBON(A23W200)	80009	174161100
-46	174-B903-00			1	CA ASSY,SP,ELEC:(A23W100)		
-47	119-3477-02			1	RELAY MODULE:W/8 RELAYS (U300 SHOULD BE CHANGED WITH A10C322 20 PF.)(U300) (ATTACHING PARTS)	80009	119347702
-48	211-0244-XX			4	SCR,ASSEM WSHR:4-40 X 0.312,PNH,STL (END ATTACHING PARTS)	TK0435	7772-312
-49	337-3629-XX			1	SHIELD,ELEC:INPUT RELAY MODULE,AL	80009	3373629XX
-50	671-1238-02			1	CKT BD ASSY:KEY INTERFACE(A13) (ATTACHING PARTS)	80009	671123802
-51	211-0661-XX				SCR,ASSEM WSHR:4-40 X 0.25,PNH,STL (END ATTACHING PARTS) CKT BOARD ASSY INCLUDES:	TK0435	ORDER BY DESC
-54	671-B212-00			1	CKT BOARD ASSY:SENSE(A10) (ATTACHING PARTS)	80009	671B21200
-55	211-0661-XX			6	SCR,ASSEM WSHR:4-40 X 0.25,PNH,STL	TK0435	ORDER BY DESC
-56	129-0713-XX			6	SPACER,POST:19.05MM L,W/4-40 THD EA END	80009	1290713XX

Replaceable mechanical parts list (Cont.)

Fig. & index number	Tektronix part number	Serial no. effective	Serial no. discontinued	Qty	Name & description	Mfr. code	Mfr. part number
-57	211-0538-XX			2	SCREW,MACHINE:6-32 X 0.312,FLH,STL	TK0435	ORDER BY DESC
-58	129-1328-XX			4	SPACER,POST:15MM L,4-40 THD,BRASS	80009	1291328XX
-59	343-1446-XX			2	RETAINER,CKT BD:12.7MM L,NYLON	80009	3431446XX
-60	213-0146-XX			2	SCREW,TPG,TF:6-20 X 0.312,TYPE B,PNH,STL	TK0435	ORDER BY DESC
-61	129-1131-XX			2	SPACER,POST:12.7MM L,4-40 THD,BRASS (END ATTACHING PARTS) CKT BOARD ASSY INCLUDES:	80009	1291131XX
-62	214-3877-XX			1	.HT SK,CKT BD:AL (ATTACHING PARTS)	80009	2143877XX
-63	211-0661-XX			3	.SCR,ASSEM WSHR:4-40 X 0.25,PNH,STL (END ATTACHING PARTS)	TK0435	ORDER BY DESC
-77	671-1096-03			1	CKT BD ASSY:CONFIG.RELAY(A33) (ATTACHING PARTS)	80009	671109603
-78	211-0661-XX			4	SCR,ASSEM WSHR:4-40 X 0.25,PNH,STL	TK0435	ORDER BY DESC
-79	129-1328-XX			4	SPACER,POST:15MM L,4-40 THD,BRASS (END ATTACHING PARTS) CKT BOARD ASSY INCLUDES:	80009	1291328XX
-86	174-B904-00			1	CA ASSY,SP,ELEC:	80009	174B90400

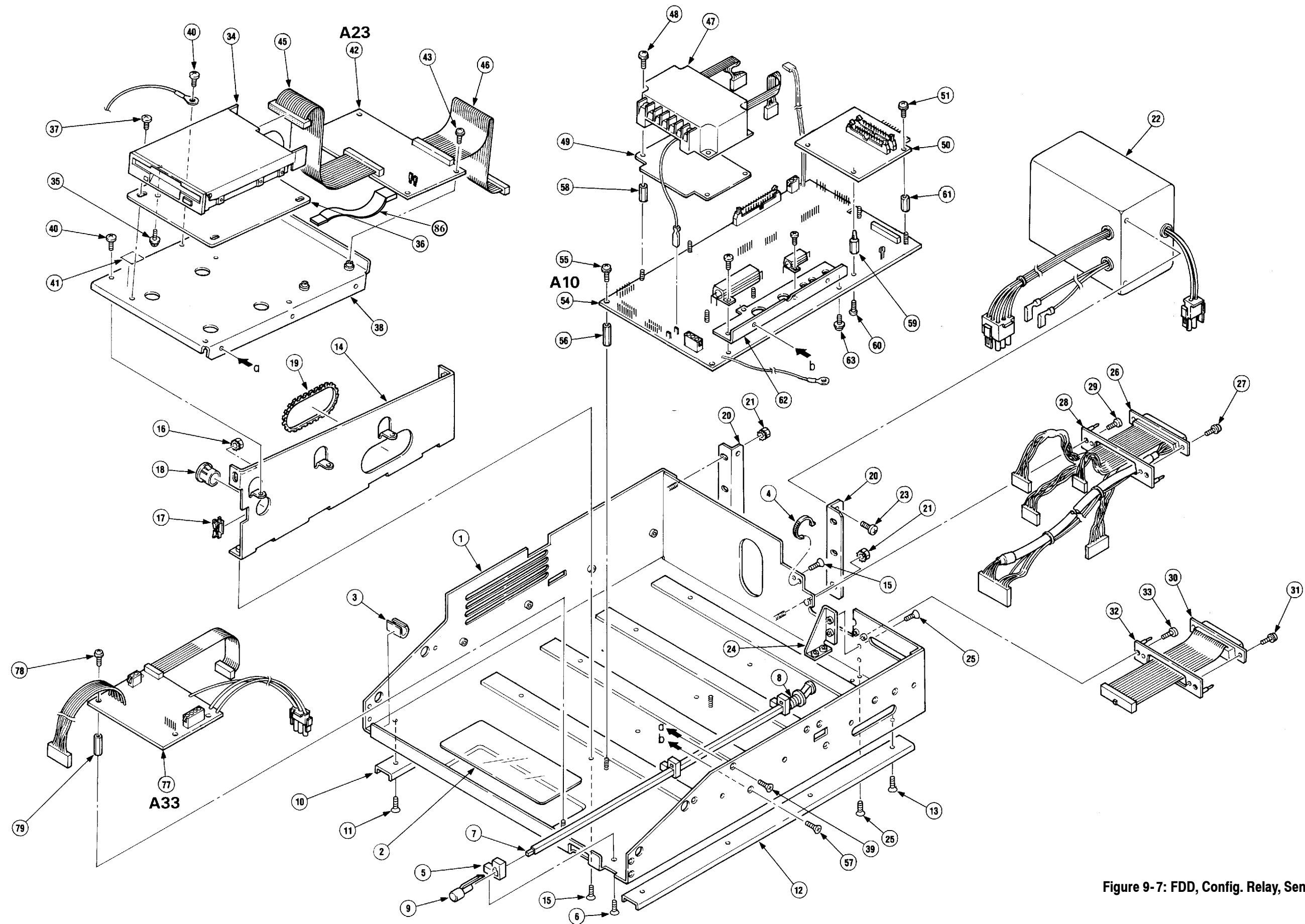

Figure 9-7: FDD, Config, Relay, Sense Circuit Boards

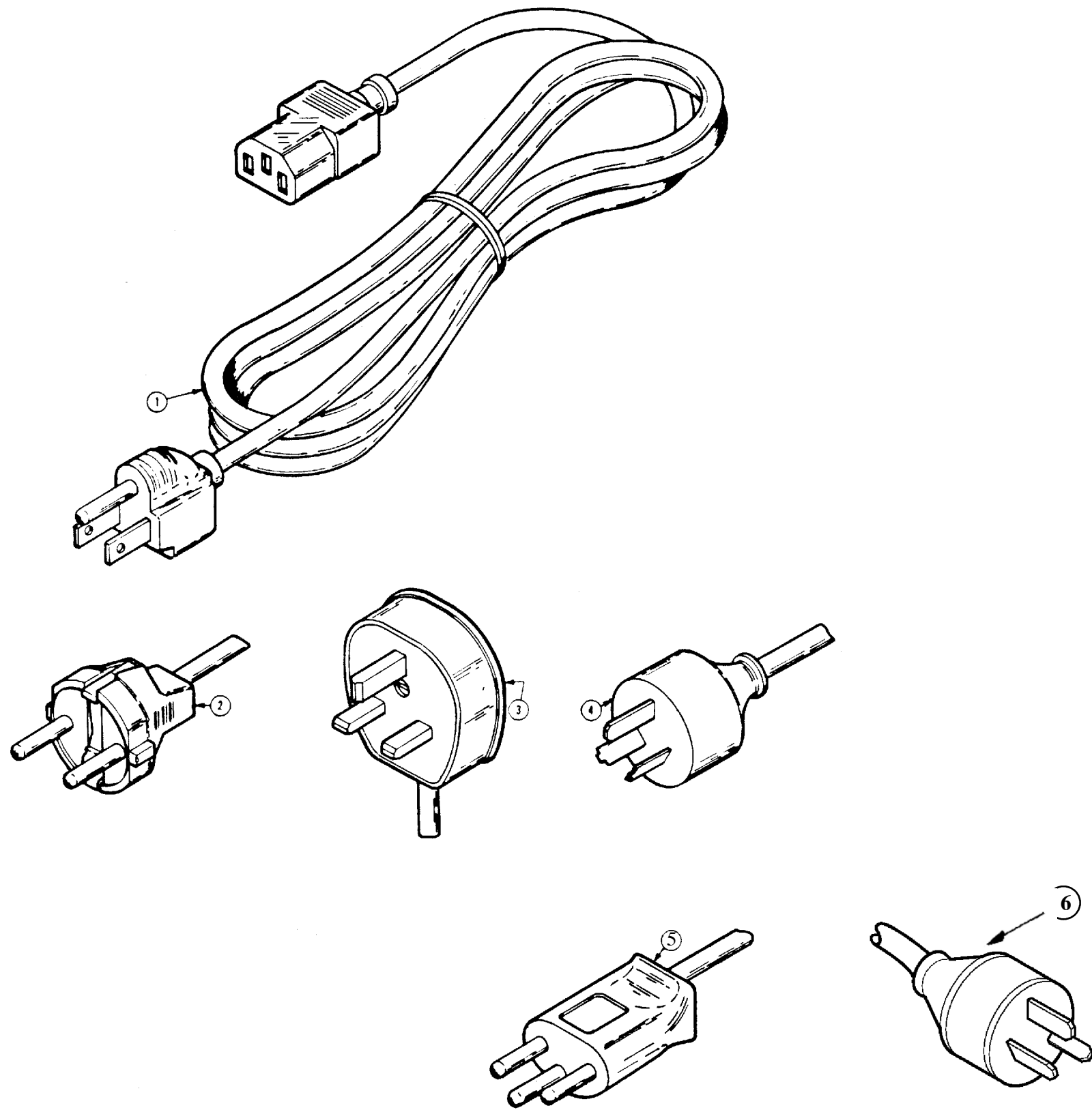

Figure 9-8: Accessories

Replaceable mechanical parts list

Fig. & index number	Tektronix part number	Serial no. effective	Serial no. discont'd	Qty	Name & description	Mfr. code	Mfr. part number
STANDARD ACCESSORIES							
	070-A838-50			1	USER MANUAL,370B	TK2548	PER TEK P/N
	159-0260-XX			1	FUSE,CARTRIDGE:2A,250V,MEDIUM-BLOW	80009	1590260XX
	159-0259-XX			1	FUSE,CARTRIDGE:4A,125V,MEDIUM-BLOW	80009	1590259XX
	337-3344-02			1	SHIELD,ELEC:PROTECTIVE COVER	80009	3373344XX
	063-3341-XX			1	UTILITY SOFTWARE(FD)	80009	0633341XX
	-----			1	A1001,TEST ADAPTER:BLANK ADAPTER		
	-----			1	A1002,ADAPTER,TEST:IN-LINE ADAPTER		
	-----			1	A1005,ADAPTER,TEST:AXIAL LEAD ADAPTER		
8-1	161-0066-00			1	CA ASSY,PWR:3,18 AWG,250V/10A,98 INCH,STR (STANDARD ONLY)	S3109	161006600
-2	161-0066-09			1	CA ASSY,PWR:3,0.75MM SQ,250V/10A,99 INCH (OPTION A1 ONLY)	S3109	86511000
-3	161-0066-10			1	CA ASSY,PWR:3,0.1MM SQ,250V/10A,2.5 METER (OPTION A2 ONLY)	S3109	BS/13-H05VVF3G0
-4	161-0066-11			1	CA ASSY,PWR:3,1.0MM SQ,250V/10A,2.5 METER (OPTION A3 ONLY)	S3109	198-000
-5	161-0157-00				CABLE ASSY,PWR,:3 X 0.75MM SQ,250V,7.0 L (OPTION A5 ONLY)	TK1267	ORDER BY DESC
-6	161-0304-00			1	CABLE ASSY,PWR,:3 X 1.0MM SQ,250V/10A, 2.5 METER (OPTION AC ONLY)		
OPTIONAL ACCESSORIES							
	070-A838-XX				SERVICE MANUAL,370B		
	-----				A1003,TEST ADAPTER:TO-3/TO-66	80009	070A83800
	-----				A1007,TEST ADAPTER:4 & 6 LEAD TRANSISTOR	80009	0707780XX
	-----			1	A1009,TEST ADAPTER:4 & 6 LEAD FET		
	-----			1	A1010,TEST ADAPTER:IC		
	-----			1	A1023,TEST ADAPTER:SOT23,SMD ADAPTER		
	012-0991-00			1	GPIB CABLE :2m		
	016-0930-00			1	RACK MOUNT KIT		
	K475			1	CART		
				1			
				1			
				1			

