TECHNICAL MANUAL

**OPERATOR'S, ORGANIZATIONAL, DIRECT SUPPORT
AND GENERAL SUPPORT MAINTENANCE MANUAL
INCLUDING REPAIR PARTS AND SPECIAL TOOLS LISTS
FOR
VERTICAL AMPLIFIER AM-6787(P)/U
(TEKTRONIX MODEL 7SII SAMPLING UNIT)
(NSN 6625-00-489-6449)**

HEADQUARTERS, DEPARTMENT OF THE ARMY

30 JULY 1980

**5****SAFETY STEPS TO FOLLOW IF SOMEONE
IS THE VICTIM OF ELECTRICAL SHOCK****1****DO NOT TRY TO PULL OR GRAB THE INDIVIDUAL****2****IF POSSIBLE , TURN OFF THE ELECTRICAL POWER****3****IF YOU CANNOT TURN OFF THE ELECTRICAL
POWER, PULL, PUSH, OR LIFT THE PERSON TO
SAFETY USING A WOODEN POLE OR A ROPE OR
SOME OTHER INSULATING MATERIAL****4****SEND FOR HELP AS SOON AS POSSIBLE****5****AFTER THE INJURED PERSON IS FREE OF
CONTACT WITH THE SOURCE OF ELECTRICAL
SHOCK, MOVE THE PERSON A SHORT DISTANCE
AWAY AND IMMEDIATELY START ARTIFICIAL
RESUSCITATION**

This manual contains copyright material reproduced by permission the Tektronix Company. All rights are reserved.

TECHNICAL MANUAL }
No. 11-6625-2750-14&P }

HEADQUARTERS
DEPARTMENT OF THE ARMY
WASHINGTON, DC, July 30, 1980

OPERATOR'S, ORGANIZATIONAL, DIRECT SUPPORT
AND GENERAL SUPPORT MAINTENANCE MANUAL
INCLUDING REPAIR PARTS AND SPECIAL TOOLS LISTS
FOR
VERTICAL AMPLIFIER AM-6787(P)/U
(TEKTRONIX MODEL 7S11 SAMPLING UNIT)
(NSN 6625-00-489-6449)

REPORTING ERRORS AND RECOMMENDING IMPROVEMENTS

You can help improve this manual. If you find any mistakes or if you know of a way to improve the procedures, please let us know. Mail your letter or DA Form 2028 (Recommended Changes to Publications and Blank Forms), direct to: Commander, US Army Communications and Electronics Materiel Readiness Command ATTN: DRSEL-ME-MQ, Fort Monmouth, New Jersey 07703. In either case, a reply will be furnished direct to you.

TABLE OF CONTENTS

SECTION	0	INTRODUCTION	Page
		Scope.....	0-1
		Indexes of Publications.....	0-1
		Maintenance Forms, Records, and Reports.....	0-1
		Reporting Equipment Improvement Recommendations (EIR)	0-1
		Administrative Storage.....	0-1
		Destruction Army Electronics Materiel.....	0-1

TABLE OF CONTENTS

SECTION 1	SPECIFICATION	Page
	General Information	1-1
	Electrical	1-1
	Environmental Characteristics	1-2
	Physical Characteristics	1-2
SECTION 2	OPERATING INSTRUCTIONS	
	General Information	2-1
	Installation	2-1
	Mating	2-1
	First-Time Operation	2-2
	Equivalent-Time Sampling Operation	2-2
	Controls and Connectors	2-2
	Basic Operating Information	2-2
	Basic Applications	2-9
SECTION 3	BASIC SAMPLING PRINCIPLES	
	Introduction	3-1
	Basic Sampling Techniques	3-1
	Effective Sampling Time	3-4
	Traveling Wave Sampling Gate	3-5
	Dot Response (Loop Gain)	3-5
	Smoothing	3-5
	Smoothing of Random Noise	3-6
	Tangential Noise	3-7
	Display Sensitivity-Deflection Factor	3-7
	DC Offset	3-7
	Real-Time Sampling	3-8
	Sweep Rates	3-8
SECTION 4	CIRCUIT DESCRIPTION	
	Introduction	4-1
	Block Diagram	4-1
	Feedback Loop and Pulse Amplifier Chain	4-1
	Vertical Output Amplifier	4-1

TABLE OF CONTENTS (cont)

	Sweep Unit Drive	4-1
	Readout Logic	4-3
	Circuit Description	4-3
	Trigger Logic	4-3
	Post Amplifier and Attenuators	4-3
	Memory	4-5
	Output Amplifier	4-8
	Real Time Oscillator	4-8
	Gate Generator	4-9
	Readout Logic	4-11
	Power Distribution and Decoupling	4-11
SECTION 5	MAINTENANCE	
	Introduction	5-1
	Preventive Maintenance	5-1
	General	5-1
	Cleaning	5-1
	Lubrication	5-1
	Visual Inspection	5-1
	Calibration	5-1
	Parts Identification	5-1
	Parts Replacement	5-2
	Troubleshooting	5-4
	Introduction	5-4
	Troubleshooting Aids	5-4
	Troubleshooting Techniques	5-5
	Transistor Checks	5-5
	Diode Checks	5-5
	Field Effect Transistors (FET)	5-6
SECTION 6	PERFORMANCE CHECK/CALIBRATION	
	Introduction	6-1
	Test Equipment Required	6-1
	Short Form Procedure-	6-2
	Preliminary Procedure	6-3
	Check -12.2-Volt Power Supply	6-5
	Check Interdot Blanking	6-6
	Check Dot Response and Smoothing	6-7
	Adjust Memory Gate Width (R460) and Memory Gain (C275) With Normalizer Head	6-7

TABLE OF CONTENTS (cont)

Adjust Memory Gate Width (R460) and Memory Gain (C275) With Sampling Head	6-8
Adjust Variable Balance (R305) and Smoothing Balance (R245)	6-9
Check Deflection Factor Accuracies, Variable Control Range and Adjust GAIN	6-10
Check Memory Overdrive Recovery	6-11
Check Vertical Signal Out	6-11
Check Vertical Gain Change in SMOOTH	6-11
Check Memory Slash	6-11
Check Delay	6-12
Check/Adjust Real Time Sampling (R415)	6-12
Check DC Offset and Adjust Position (R325)	6-12
Check Real-Time Trigger Amplifier Output	6-14

SECTION 7

ELECTRICAL PARTS LIST

Abbreviations and Symbols
Parts Ordering Information
Index of Electrical Parts List
Electrical Parts List
Parts List Abbreviations

SECTION 8

DIAGRAMS AND MECHANICAL PARTS ILLUSTRATIONS

Diagrams
Mechanical Parts Illustrations
Repackaging Instructions

SECTION 9

MECHANICAL PARTS LIST

Mechanical Parts List Information
Index of Mechanical Parts Illustrations
Mechanical Parts List
Accessories

CHANGE INFORMATION

Abbreviations and symbols used in this manual are based on or taken directly from IEEE Standard 260 "Standard Symbols for Units", MIL-STD-12B and other standards of the electronics industry. Change information, if any, is located at the rear of this manual.

APPENDIX	A.	REFERENCES.....	A-1
APPENDIX	B.	COMPONENTS OF END ITEM LIST (Not Applicable)	
APPENDIX	C.	ADDITIONAL AUTHORIZATION LIST (Not Applicable)	
APPENDIX	D.	MAINTENANCE ALLOCATON	
Section	I.	Introduction	D-1
	II.	Maintenance Allocation Chart for Vertical Amplifier AM-6787(P)/U.....	D-3
	III.	Tools and Test Equipment Requirements for Amplifier AM-6787P)/U	D-4
	IV.	Remarks (Not Applicable)	
APPENDIX	E.	EXPENDABLE SUPPLIES AND MATERIALS (Not Applicable)	

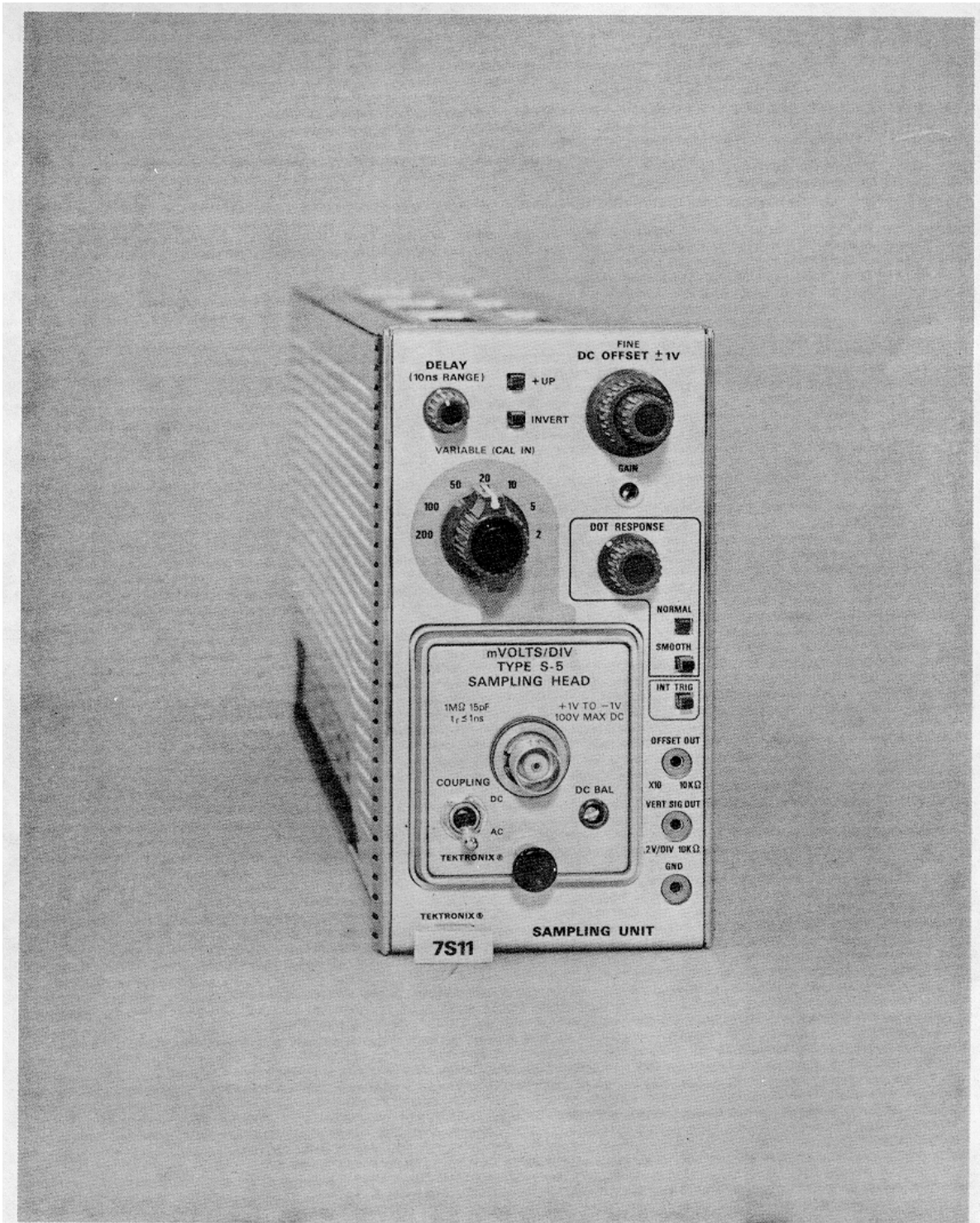

Fig. 1-1. 7S11 Sampling Unit.

SECTION 0 INTRODUCTION

0-1. Scope

This manual describes Vertical Amplifier AM-6787(P)/U, which is identified throughout this manual as Tektronix Model 7S11 Sampling Unit. The manual includes technical data, installation, operation and maintenance instructions. Section 7 includes a Cross-Reference Index between the Tektronix part numbers and the equivalent NATO/National Stock Number (NSN). Appendix A contains a list technical manuals and other publications that pertain to the AM-6787P/U and to equipments that support it. Appendix D contains the Maintenance Allocation Chart (MAC) which defines the levels and scope of maintenance functions for the equipment the Army system.

0-2. Indexes of Publications

- a. DA Pam 310-4. Refer to the test issue of DA Pam 310-4 to determine if there are any new editions, changes, or additional publications pertaining to the equipment.
- b. DA Pam 310-7. Refer to DA Pam 310-7 to determine if there are any modification work orders (MWO's) pertaining to the equipment.

0-3. Maintenance Forms, Records, and Reports

a. *Reports of Maintenance and Unsatisfactory Equipment.* Department of the Army forms and procedures used for equipment maintenance will be those prescribed by TM 38-750, The Army Maintenance Management System.

b. *Report of item and Packaging Discrepancies.* Fill out and forward SF 364 (Report of Discrepancy (ROD)) as prescribed in AR 735-11-2/DLAR 4140.55/-NAVSUPINST 4440.127E/AFR 400.54MCO 4430.E.

c. *Discrepancy Shipment Report (DISREP) (SF36D1).* Fill out and forward Discrepancy in Shipment Report (DISREP) (SF 361) as prescribed in AR 55-38/-NAVSUPINST 4440.127E/AFR 400.54MCO 4430.E.

and DLAR 4500.15.

0-4. Reporting Equipment Improvement Recommendations (EIR)

If your AM-6787 (P)/U needs improvement, let us know. Send us an EIR. You, the user, are the only one who can tell us what you don't like about your equipment. Let us know why you don't like the design. Tell us why a procedure is hard to perform. Put on an SF 368 (Quality Deficiency Report). Mail it to Commander, US Army Communications and Electronics Materiel Readiness Command, ATTN: DRSEL-ME-MQ, Fort Monmouth, New Jersey 07703. We'll send you a reply.

0-5. Administrative Storage

The AM-6787(P)/U can be stored in stockrooms, warehouses, or other protected facilities. The equipment should be protected from excessive humidity, sand, dust and chemical contaminants. Before putting the AM-6787P/U into administrative storage, make the following preparations:

- a. Perform the preventive maintenance inspections prescribed in Section 5 of this manual.

- b. Refer to Section 8 of the manual for repackaging instructions. If the required materials are available, repackage as indicated in Section 8. If complete repackaging materials are not available, at least protect the unit with protective plastic or paper wrapping. Store the equipment in a cardboard or wooden carton with protective packing material around it.

- c. Store the equipment indoor, protected from the elements. Maintain the equipment at moderate temperature and humidity.

0-6. Destruction of Army Electronics Materiel

Destruction of Army electronics materiel to prevent enemy use shall be in accordance with TM 750-244-2

SECTION 1 7S11 SPECIFICATION

Change information, if any, affecting this section will be found at the rear of the manual.

General Information

The 7S11 Sampling Unit is a single channel vertical amplifier plug-in unit designed for operation in Tektronix 7000-Series Oscilloscopes. The 7S11 accepts the S-Series Sampling Heads. The Sampling Head determines the input characteristics and the availability of a trigger pickoff.

The S-Series Sampling Head used can be plugged into the 7S11 or used remotely on an optional extender cable unit. The 7S11 provides the power for the sampling head. Interconnections to the sampling head circuits are provided by the connector in the sampling head compartment of the 7S11.

The 7S11 and a 7T11 Sampling Sweep Unit operated in the center plug-in compartments of a 7000-Series oscilloscope provide a single channel sampling system. Two 7S11's and one 7T11 provide dual-trace sampling, using the electronic switching in the oscilloscope vertical amplifier. X-Y operation is provided by two 7S11 's operated in the center plug-in compartments of the oscilloscope.

If a trigger pickoff is provided in the sampling head interconnections between two 7S11's and the 7T11 through the fixed and movable shoes provide a trigger selection circuit to trigger the 7T11. An internally reconstructed signal is provided to trigger a real-time time-base such as the 7B50

Sampled signals are presented to both the oscilloscope vertical amplifier and to the front panel connectors for external use with auxiliary equipment such as pen recorders

**Table 1-1.
ELECTRICAL**

TABLE 1-1 (cont)

Characteristic	Performance
Gain Accuracy (Ratio to add to accuracies of source, oscilloscope, attenuators, etc.)	Within 3% when NORMAL/SMOOTH function is NORMAL, with GAIN adjusted at any Units/Division switch setting Within 6% when NORMAL/SMOOTH function is SMOOTH
Units/Division Variable Range	Extends deflection factor from 1 unit/division or less to at least 400 unit/division
GAIN Range	Permits adjustment of deflection factor at any Units/Division switch setting for all 7000-series oscilloscopes.
DELAY Range	At least 10 ns.
Memory Slash	0.1 division or less at 20 Hz for ambient temperature of 0°C to less than 30°C.
DC OFFSET Range	+1 volt to -1 volt or more. ¹
OFFSET OUT Range	+10 volts to -10 volts or more.
Relation to actual Offset	Actual Offset = (0.1) (Offset Out) within 2%.
Source resistance (related to actual Offset)	10 kΩ within 1%.
VERTICAL SIGNAL OUT Amplitude in volts (Referenced to input)	(Signal input in volts) (200 units/Div within 2%. 2.4 volts peak-to-peak maximum.
Deflection factor (Referenced to CRT)	200 mV/ displayed division within 3% in + UP or INVERT.
Source resistance	10 kΩ within 0.5%

Characteristic	Performance
Deflection Factor Units/Division Range	2 to 200 in seven steps in 1, 2, 5 sequence. The Units/Division are those labeled on the sampling head.

¹ Unless otherwise stated on sampling head front-panel.

ENVIRONMENTAL CHARACTERISTICS

Storage-altitude up to 50,000 feet or 15,000 meters and -55°C. Operating characteristics are the same as those listed in the 7000-series oscilloscope manual.

PHYSICAL CHARACTERISTICS

Dimensions	
Height	5 inches (12.7 centimeters)
Width	3 inches (7.6 centimeters)
Length	14 1/2 inches (37 centimeters)

Approximate dimensions including knobs and connectors.

Finish	Front panel is anodized aluminum.
Weight	
Net	About 2 pounds (0.9 kilogram).
Shipping	About 3 1/4 pounds (1.46 kilograms).

STANDARD ACCESSORIES

Standard accessories supplied with the 7S11 are listed on the last page of the Mechanical Parts List section. For optional accessories available for use with this instrument, see the Tektronix, Inc. catalog.

SECTION 2 OPERATING INSTRUCTIONS

Change information, if any, affecting this section will be found at the rear of the manual.

General Information

This section discusses installation, first time operation, function of front panel controls and connectors, basic operation and applications of the 7S11. If you are unfamiliar with sampling, it may be helpful to read Section 3, Basic Tektronix Sampling Principles, before proceeding with this section.

The 7S11 is a single-channel sampling unit for use in a sampling system consisting of a Tektronix 7704 or 7504 Oscilloscope mainframe, a sampling sweep unit (7T11) or real-time time-base and a 7S11 -sampling head combination. The 7S11 accepts an S-series sampling head which determines the input characteristics of the sampling system and (except for the Type S-3 Sampling Head) provides a trigger pickoff.

The 7S11 can be use for real time operation with real-time time-base units such as the 7B71 or 7B70 with the 7704 Oscilloscope, or the 7B51 or 7B50 with the 7504 Oscilloscope. An internal trigger source from the display signal is provided for real time operation. Nevertheless, the maximum useable sweep rate is about .1 ms/div (with a 1 kHz signal), since at higher frequencies the horizontal dot size increases and the number of dots per division becomes less than three.

The vertical deflection factors of 2 to 200 are calibrated to the units labeled on the sampling head. Three-foot and six-foot sampling head extender cables are available to operate the S-series sampling heads remotely. Order the three-foot sampling head extender cable by Tektronix Part No. 012-0124-00. Order the six-foot sampling head extender cable by Tektronix Part No. 012-0125-00. Contact your local Tektronix Field Engineer or Representative for price and availability of these optional accessories.

Installing the 7S11 in the Oscilloscope

Insert the 7S11 into the Right Vertical opening of the oscilloscope and slide the 7S11 completely into the compartment. The 7S11 will lock into place with the spring loaded latch knob.

Insert the sampling head into the 7S11 with the latch knob free to move until completely in the 7S11, then push the latch to lock the head in place. To remove, pull the latch knob away from the panel, then pull the unit from the 7S11.

The 7T11 Sampling Sweep Unit, normally used with the 7S11, must be installed in the A Horizontal opening next to the 7S11 to make connections between the two units through side connectors (the movable and fixed shoes).

Mating

The 7S11 Vertical Output Amplifier gain must be matched to the oscilloscope CRT deflection factor for accurate gain measurements. The GAIN control, a screwdriver adjustment on the front panel, adjusts the Vertical Output Amplifier gain of the 7S11. Adjustment of this GAIN control using the Type 284 Pulse Generator as a signal source is shown under Equivalent Time Sampling Operation which follows. For further Gain information, refer to the Gain Adjustment instructions later in this section.

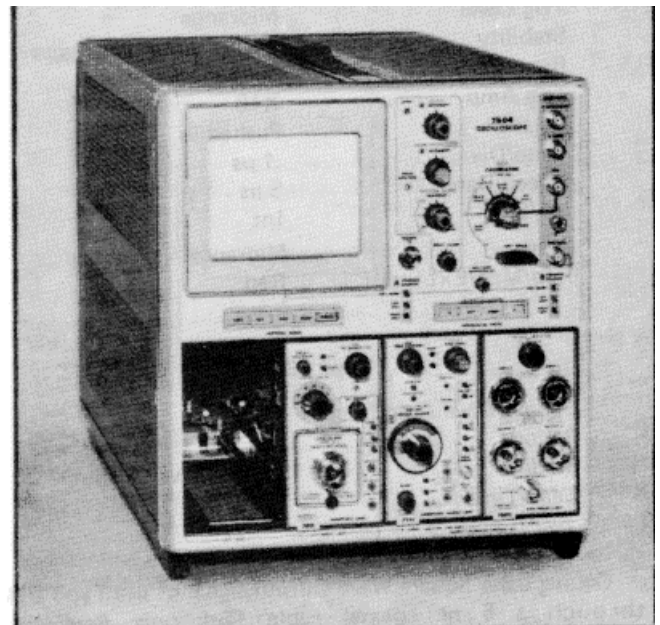

Fig. 2-1. Equivalent time sampling system.

Equivalent-Time Sampling Operation

Equivalent time sampling operation as described here is provided by a system consisting of the 7504 Oscilloscope, the 7S11 Sampling Unit, the Type 2-1 Sampling Head, and the 7T11 Sampling Sweep Unit. The system is shown in Fig. 2-1. Operation of the oscilloscope, sampling head, and the sampling sweep unit is covered more fully in each instrument's manual. In this description, a Type 284 Pulse Generator is used as a signal source.

Set the Oscilloscope Vertical Mode switch to Right, the A Trigger Source switch at Right Vert, and the Horizontal Mode switch to A.. Other oscilloscope controls may be in any desired position.

Set the 7S11 controls as follows:

DELAY	Midrange
+UPIINVERT	+UP
DC OFFSET and FINE	Midrange
VARIABLE	Pushed in
Units/Div	200
DOT RESPONSE	Midrange
NORMAL/MOOTH	NORMAL

Set the 7T11 controls as follows:

Time Position and Fine Slope	Fully clockwise +
Trig Level	Midrange
Stability	Fully counterclockwise
Random/Sequential	Sequential
Trig Amp	X10
Variable	Pushed in
Time/Div	.1 μ s
Sweep Range	5 μ s
Int/Ext	Int
Scan	Midrange
Rep/Man/Ext Input	Rep

Type 284

Square Wave Amplitude	1.0 V
Period	1 Js
Mode	Square Wave Output
Lead Time	75 ns

Connect the Squaw Wave Output signal of the Type 284 through a 5 ns coaxial cable (Tektronix Part No. 017-0512-00) to the input connector of the Sampling Head installed in the 7S11.

Center the trace on the graticule with the DC OFFSET control and adjust the Trig Level and Stability controls on the 7T11 clockwise for a stable display. The GAIN adjustment is properly set if the amplitude is 5 vertical divisions. If the amplitude is not correct, adjust the GAIN control with a small screwdriver for 5 divisions of vertical deflection.

NOTE

Operating the sampling head without the input connector terminated by a 50 Ω resistor or coaxial cable will cause a few millivolts vertical shift to the zero signal baseline. This occurs because the strobe kickout signal is reflected from the open input connector. The kickout signal arrives back at the sampling bridge during sampling time, while the bridge is still conducting. To avoid this baseline shift, connect the input circuitry, then set the display zero reference point. Use at least 20 cm of airline between the Type S-1 input and a fast generator (such a tunnel diode pulse generator) or circuit that is sensitive to the fast Strobe kickout signal.

CONTROLS AND CONNECTORS

A brief description of the function and operation of the controls and connectors of the 7S11 follows. The control setup chart, Fig. 2-2, shows the front panel with an S-series sampling head installed. This figure may be reproduced and used as a test setup record for special applications or procedures, or it may be used as a training aid for familiarization with this instrument.

DELAY (10 ns RANGE)	Varies the time position of the applied signal in relation to displayed signals from other vertical instruments operating in the same main frame.
+UPANVERT	In the + UP button setting, a positive input signal deflects the CRT beam upward. In the INVERT push button setting, the displayed signal is inverted, a negative signal deflects the CRT beam upward.
DC OFFSET \pm 1 V	Applies internal signal offset voltage of +1 to -1 volt to the sampling head. The input signal zero reference (related to the CRT) is the DC Offset voltage instead of ground. Permits all portions of a +1-volt input signal to be positioned through the CRT graticule area vertically even at a deflection factor of 2 units per division. Verti-

TYPE 7S11 SAMPLING UNIT SETUP CHART

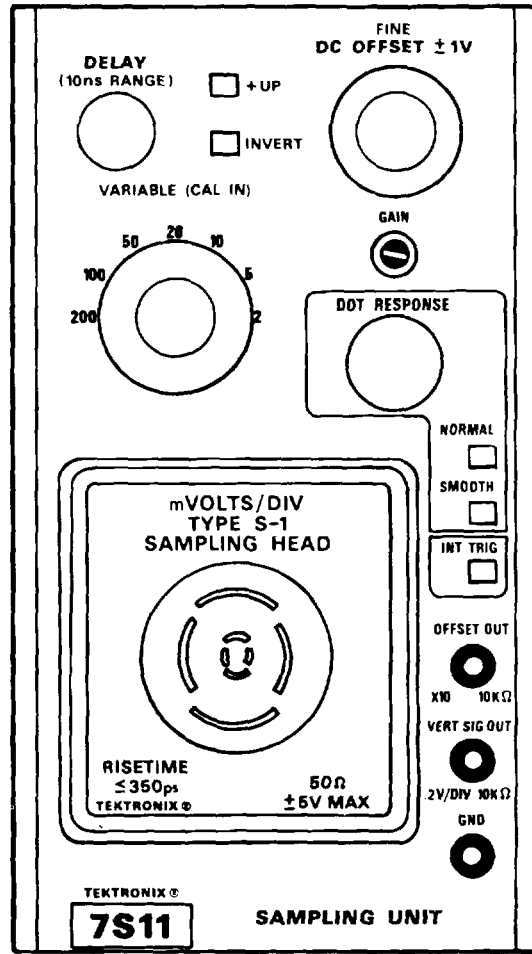

DATA:

Fig. 2-2. Control Setup Chart.

cal deflection total is 16 mV with a deflection factor of 2 mV/Div, and 1.6 V when the deflection factor is 200 mV/Div. The front panel OFFSET jack allows accurate slide-back voltage measurements to be made of part or all of a signal at 10X the actual offset voltage applied to the head.

FINE Provides vernier control of the DC Offset function. Concentric with the DC OFFSET ± 1 V control.

Units/Div Selects calibrated deflection factor from 200 units/div to 2 units/div in a 1-2-5 sequence. The units are selected and named on the adjacent S-series sampling head. For example, with a Type S-1 Sampling Head, the Units/Div switch set at 100, each major division of deflection corresponds to 100 millivolts of applied signal at the S-1 input connector when the VARIABLE control is at the (CAL IN) position.

VARIABLE (CAL IN) Provides uncalibrated, variable vertical deflection factor between labeled values of the Units/Div switch. When the VARIABLE control is rotated from the counter-clockwise position, displayed amplitude varies from less than 0.5 to more than 2.5 times the calibrated displayed amplitude.

DOT RESPONSE Permits adjustment of loop gain for optimum dot transient response when the NORMAL/SMOOTH switch is in the NORMAL position.

GAIN Screwdriver adjustment permits calibration of the vertical output amplifier gain to match the oscilloscope CRT deflection factor.

NORMAL/SMOOTH Selects unity loop gain at the NORMAL push button setting. Reduces the loop gain to 0.3 or less at SMOOTH push button setting. NORMAL provides the correct loop gain required when measuring risetime. SMOOTH reduces the effect of random noise on the display while requiring high sampling dot density for the correct displayed risetime.

INT TRIG Push button selects internal trigger operation between two 7S11's. Internal triggering is canceled when associated time base in the same 7000-series mainframe is switched to external triggering. Lights up when internal triggering is restored.

OFFSET OUT X10 10 k Ω Unless otherwise specified on the sampling head front-panel, the open circuit voltage at this miniature connector is ten times the internal DC Offset voltage as set by the DC OFFSET control. The output resistance is 10 k Ω

VERT SIG .2V/DIV 10 k Ω A facsimile signal (the same Mem-OUT ory output signal that drives the Vertical Amplifier) is available at this miniature connector. The .2 V/DIV label applies only when the VARIABLE control is at its CAL IN position and is limited to about 2.5 V maximum. (The VARIABLE control alters the CRT deflection factor but does not change the signal amplitude fed to the VERT SIG OUT miniature connector.) Output voltage swing is not limited to the magnitude displayed on the CRT. Permits a non-sampling type oscilloscope to monitor the facsimile signal. Output resistance is 10 k Ω .

GND Miniature connector provides a convenient front-panel ground point.

BASIC OPERATING INFORMATION

Dual Trace

The dual-trace features of the 7504 Oscilloscope Vertical Mode permits observation of two 7S11 displays simultaneously. This is useful for comparing amplitude, risetime, waveshape, and time relationship of two signs. The sweep can use either 7S11 as the internal trigger source. Be sure to trigger from the 7S11 with the earliest signal event. Use input signal cables with equal delays to preserve the time relationship of the two signals.

The DELAY control adds a variable to the time coincidence of the two signals to accommodate small time difference in cables or sampling heads, so that both signals can be displayed in the correct time relationship.



Fig. 2-3. Dual trace operation.

Dual-trace sampling operation requires two 7S11 Sampling Units, a 7T11 Sampling Sweep Unit, and two S-series sampling heads installed in the 7504 Oscilloscope. As with single-trace operation, the 7T11 must be installed in the A Horiz opening adjacent to the 7S11 for internal triggering connections. The second 7S11 is installed in the Left Vert opening. See Fig. 2-3. Set the controls as follows:

7S11 Sampling Units

DELAY	Midrange
+UP/INVERT	+UP
DC OFFSET and FINE VARIABLE	Midrange Pushed in
Units/Div	50
DOT RESPONSE	Unity loop gain (Fig. 2-5)
NORMAL/SMOOTH	NORMAL

7T11 Sampling Sweep Unit

Time Position and Fine Slope	Fully clockwise +
Trig Level and Stability	For triggered display
Random/Sequential	Random
Trig Amp	X1
Variable	Pushed in
Time/Div	5 μ s
Sweep Range	50 μ s
Int/Ext	Ext 50 Ω 2 V MAX
Scan	9 o'clock setting
Rep/Man/Ext Input	Rep

Type 284 Pulse Generator

Mode	Pulse Output
Lead Time	75 ns

Set the 7504 Oscilloscope Vertical Mode switch to Chop. Connect the Type 284 Pulse Output signal to the sampling head input connectors through a power divider and two 5 ns coaxial cables. Connect the Type 284 Trigger Output signal to the 7T11 Trig Input connector through a 50 E coaxial cable and 3 mm to BNC adapter, supplied with the 7T11.

Adjust the 7T11 Trig Level control for a stable display. Center both traces on the graticule vertically with the DC OFFSET controls. This properly triggered dual-trace display will be similar to Fig. 2-4A.

Time Position. To show DELAY control operation, change the 7T11 Sweep Range switch to 5 #s and the Time/Div switch 2 ns. Turn the Time Position control counterclockwise to place the rising portion of the pulses on the graticule. Time difference between the two displays should be eliminated by adjusting one or both DELAY controls.

Add

The algebraic addition of two signals can be obtained with the Oscilloscope Vertical Mode switch set in the Add position. The DELAY control can be used to compensate for small time differences between displays before making accurate algebraic addition of the two signals. For accurate algebraic addition, both sampling heads should be same type. Use the same display as described under dual-trace time positioning.

The two signals can be superimposed using the DC OFFSET and DELAY controls for most accurate time coincidence setting. Set the Oscilloscope Vertical Mode switch to Add. The superimposed signals at dual-trace will be similar to the display of Fig. 2-4B.

Push the INVERT switch on one 7S11. The display shown in Fig. 2-4C is nearly a straight line indicating equal and opposite signal amplitude. Rotate the DELAY control of either 7S11 and notice that any time difference between the two displays will appear as a pulse, either positive or negative depending on the time position relative to the time coincidence.

Dot Response. The loop gain of the sampling unit is changed with adjustment of the DOT RESPONSE control. Random process sampling (available with the 7T11) or

multiple triggering (with a real-time time base) are convenient ways to adjust the DOT RESPONSE control to a setting of unity loop gain (each sample responding to the full

signal amplitude). 100 millivolts with the Type 284 Pulse Output signal applied to two inputs through the power divider (keeping the same signal connections as above) would use the Random mode of the 7T11.

Push the +UP switch and the Oscilloscope Vertical Mode switch Left or Right button. Observe the display as the DOT RESPONSE control is rotated clockwise and counter-clockwise. A setting of unity loop gain occurs when the random dots do not overshoot or undershoot the display the Fig. 2-5.

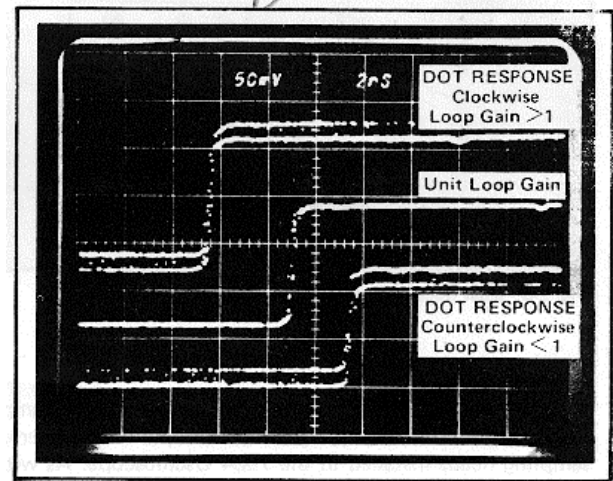
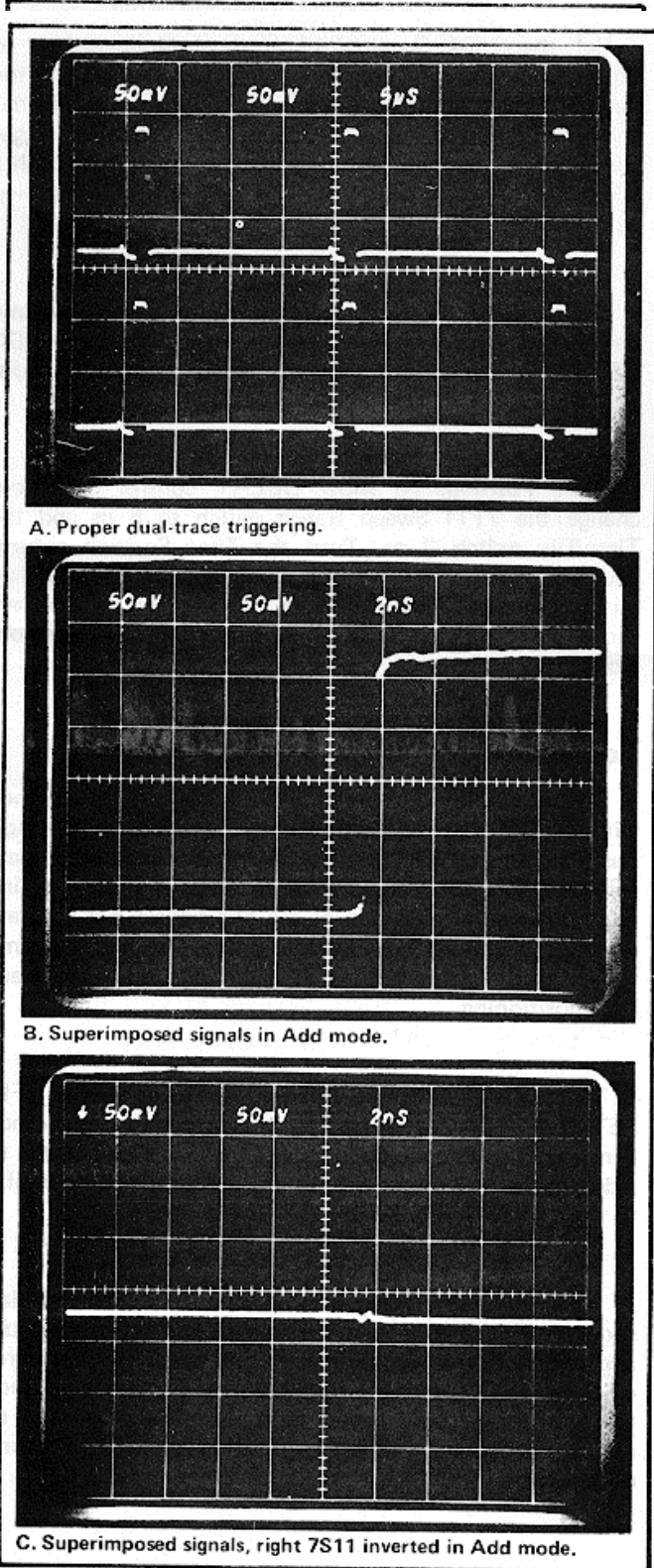

Fig. 2-5. Loop gain adjustment, triple exposure

Vertical-Horizontal (X-Y)

Two 7S11 Sampling Units operated in the center compartments (Right Vert and A Horiz) of the 7504 Oscilloscope will produce the X-Y display for phase difference calculation See Fig. 2-6A. Any time-related signals which do not exceed sampling head input specifications may be used at the input connectors

The 7S11 in the Right Vert compartment controls the vertical deflection and the 7S11 in the A Horiz compartment controls horizontal deflection. Set the Oscilloscope Vertical Mode switch at Right and the Horizontal Mode to A Horiz. To produce a Lissajous figure, apply a sine wave to both input connectors through the power divider and 5 ns coaxial cables. The Type 284 1 ns Sine Wave Output can be used. Set the Units/Div switches at 10 and VARIABLE controls for a 6 division display both vertically and horizontally; the DELAY control of either 7S11 can be used to give a circle display (90° out of phase) or a diagonal straight line (90 or 180° out of phase) for setting the 6 divisions. Set the DELAY control for the diagonal straight line to eliminate phase difference at the 5 ns coaxial cable inputs.

After these adjustments, the system is ready to show accurate phase difference displays over a wide range of frequencies. Connect the signals to the 5 ns coaxial cable

inputs. Fig. 2-6C shows a method for calculating the phase difference between the two signals.

Real Time Sampling

Caution

Never operate the real-time time-base without the side covers in place because of possible damage to the movable shoe contacts or to parts in the time-base unit

Real Time Sampling operation uses the three slowest ranges of the 7T11 Sweep Range switch or a real-time time-base unit such as the 7B50, 7B51, 7B70 or 7B71. The 7S11 provides oscillator controlled Strobe Drive pulses to the sampling head, independent of the real-time time-base unit. The repetitive Strobe Drive pulses are turned on when the 7T11 Sweep Range switch is at the 50, 5, and .5 ms ranges or when the time-base unit is a real-time time-base unit. Real time internal triggering is available even when the sampling head does not contain a trigger pickoff circuit. Install the 7S11 and real-time time-base units in the center compartments (or the Left Vert and B Horiz) of the oscilloscope.

The 7504 Oscilloscope Calibrator Output of 1 kHz, Amplitude switch at 0.4 V into 50 Ω may be used as the signal source. Connect the Calibrator Output to the sampling head input connector through a 50 Ω coaxial cable and BNC to GR adapter. Set the Units/Div switch to 100 and the time-base unit Time/Div switch to .5 ms. Obtain a stable display with the Level/Slope control or the Trig Level and Stability controls.

Real time sampling offers DC offset capabilities matched with good overload recovery. Random noise in the display can be reduced through smoothing with the DOT RESPONSE control and SMOOTH operation.

NOTE

Type S-5 Sampling Head vertical noise may be reduced for real time sampling by lowering the oscillator frequency by adjusting Rep Rate control (R415). This also will lower the dot density.

Gain Adjustment

The GAIN control (a front-panel screwdriver adjustment) matches the gain of the 7S11 vertical output amplifier to the Oscilloscope CRT deflection factor. The gain should be checked and adjusted each time the 7S11 is used with a different oscilloscope. A 1% difference is possible between channels.

An accurate voltage source should be used into the input connector of the sampling head. The signal source impedance must be considered when it drives the input of a 50 Ω sampling head.

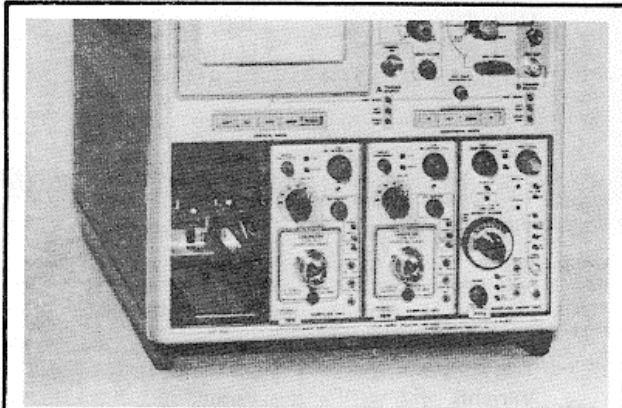

A. Installed Sampling Units.

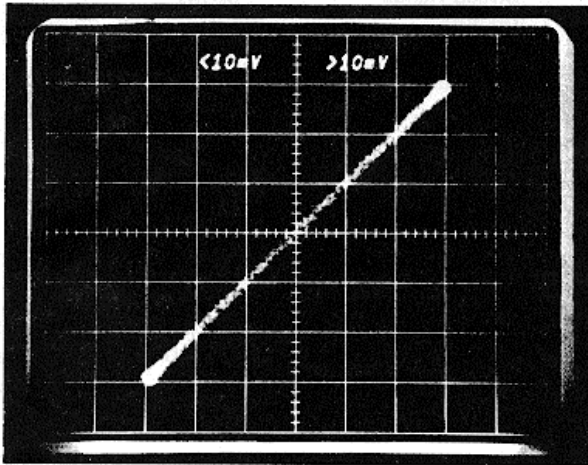

B. In phase display.

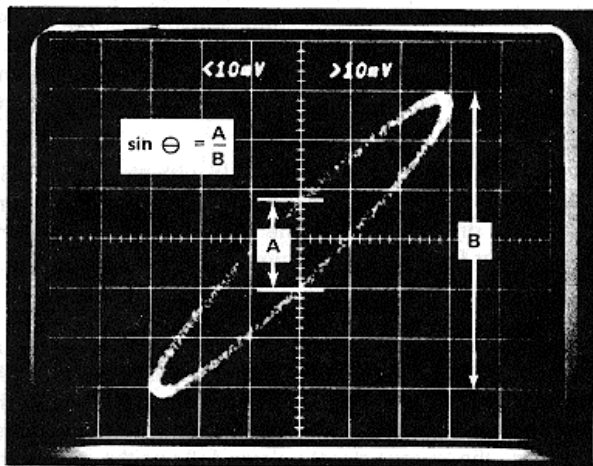

C. Calculation of Θ method.

Fig. 2-6. X-Y operation.

7S 11	
DELAY	Midrange
+UP/INVERT	+UP
DC OFFSET and FINE	Midrange
VARIABLE	Pushed in
Units/Div	200
DOT RESPONSE	Midrange
NORMAL/SMOOTH	NORMAL

7S11	
DELAY	Midrange
+UP/INVERT	+UP
DC OFFSET and FINE	Midrange
VARIABLE	Pushed in
Units/Div	100
DOT RESPONSE	Unity loop gain
NORMAL/SMOOTH	NORMAL

7T11	
Time Position and Fine	Fully clockwise
Slope	+
Trig Level	Triggered display
Stability	Triggered display
Random/Sequential	Sequential
Trg Amp	X1
Variable	Pushed in
Time/Div	.2 μ s
Sweep Range	50 μ s
Int/Ext	Ext
Scan	9 o'clock position
Rep/Man/Ext Input	Rep

7T11	
Time Position and Fine	Fully clockwise
Slope	+
Trig Level	Triggered display
Stability	Triggered display
Random/Sequential	Sequential
Trig Amp	X1
Variable	Pushed in
Time/Div	.5 ms
Sweep Range	50 ms
Int/Ext	Int
Scan	Optional
Rep/Man/Ext Input	Rep

Type 284	
Square Wave Amplitude	1.0 V
Period	1 μ s
Mode	Square Wave Output
Lead Time	Optional

7504	
Calibrator Volts	4 V (0.4 V into 50 Ω)
Rate	1 kHz

used. The Oscilloscope Calibrator output, with an accuracy within 1%, can be used also.

Using the Type 284. Set the controls as follows using the Type 284, accuracy withing 0.5% producing 7S11 deflection factor better than 3.5%, as the signal source to check or adjust the GAIN control of the 7S11 and 50 Ω sampling head:

Connect the Square Wave Output signal from the Type 284 to the sampling head input connector through a coaxial cable. Connect the Trigger Output signal from the Type 284 to the 7T11 Trig Input connector through a coaxial cable and BNC to 3 mm adapter.

Adjust the 7T11 Trig Level control for a stable display. Center the trace on the graticule with the DC OFFSET controls and observe the square wave amplitude. If the amplitude is not 5 vertical divisions, adjust the GAIN control with a small screwdriver for 5 vertical divisions.

Using Oscilloscope Calibrator. Set the controls as follows using the Oscilloscope Calibrator as the signal

source to check or adjust the GAIN control of the 7S11 and 50 Ω sampling head. The 1 kHz, 0.4 V output has an accuracy of $\pm 1\%$, producing a 7S11 deflection factor accuracy better than 4%.

Apply the signal from the Oscilloscope Calibrator Volts output connector to the sampling head input connector through a BNC coaxial cable and BNC to GR adapter. Adjust the Trig Level control for a stable display of the square wave. Set the DOT RESPONSE control to unity loop gain (no overshoot or undershoot at the leading front corner).

Center the trace on the graticule with the DC OFFSET controls and observe the amplitude. If the amplitude is not 4 vertical divisions, adjust the GAIN control with a small screwdriver for 4 vertical divisions.

Vertical Signal Output

A composite signal is available at the Vertical Signal Out-put jack (VERT SIG OUT). This signal is taken after the sampling process and is a proportional representation of the display signal rather than the input signal itself. In real time sampling, the output signal voltage follows the rate of the internal real time oscillator. The open circuit voltage at the jack is 200 millivolts per division of display when the VARIABLE control is pushed in. The output resistance is

10 k Ω , The signal is not affected by the Oscilloscope Vertical Mode switch. The signal is changed by the Units/Div switch, the DC OFFSET controls, and the NORMAL/ SMOOTH switches. The INVERT switch does not invert the signal. Output voltage swing is limited to 2.5 volts peak or about 6 divisions above and below the graticule center depending on the actual position. The Units/Div switch is active but the output voltage is always proportional to the CRT display (0.2 V/Div) up to 12 divisions maximum peak to peak. Since the signal at the Vertical Output jack is an equivalent time signal, it is useful for pen recorder applications when the sampling sweep unit external input is driven by the recorder.

The OFFSET OUT monitor jack permits accurate measurement of the DC voltage set by the DC OFFSET controls. The output voltage has a range of +10 to -10 volts. Unless otherwise specified on the sampling head front panel, the monitor jack output voltage is ten times the internal DC offset voltage. The output resistance is 10 k Ω

BASIC APPLICATIONS

Vertical Deflection Measurements

Vertical displacement of the trace on the CRT is directly proportional to the signal at the sampling head input connector installed in the 7S11. The amount of displacement for a given signal can be selected with the Units/Div switch. To provide sufficient deflection for best resolution, set the Units/Div switch so the display spans a large portion of the graticule. Also, when measuring between points on the display, be sure to measure consistently from either the bottom, middle, or top of the trace. This prevents the width of the trace from affecting the measurements.

To make a vertical deflection difference measurement between two points on the display, proceed as follows:

1. Note the vertical deflection, in graticule divisions, between the two points on the display. Make sure the VARIABLE control is in the CAL position.

NOTE

The vertical deflection factor is determined by the Units/Div switch and the value of the units of measure as stated on the sampling head front panel. The ratio of the input signal to the resultant deflection is called the deflection factor. For example, with the sampling head unit values stated as m V/Div, and the Units/Div switch set to 20, the vertical deflection factor will be 20 m V/division

2. Multiply the divisions of vertical deflection by the deflection factor, and the external attenuator or probe

attenuation factor (if any). The product is the voltage difference between the two points measured.

For example, suppose you measure 4.4 divisions of deflection between two points on the display and the Units/Div switch is set for 20 mV/Div. Multiply 20 millivolts/division by 4.4 divisions, the product is 88 millivolts. This is the voltage difference at the input connector between the two points on the display. Now assume there is a 10X external attenuator (probe) between the input connector and the signal source. To determine the actual signal voltage at the source, multiply 10 (the attenuation factor of the probe) by 88 millivolts; this product (880 millivolts or 0.88 volts) is the actual voltage at the signal source.

It is also possible to measure an instantaneous (or DC) voltage to ground from the display. This measurement is accomplished in the same manner, except that with no signal applied, you must first establish a ground-reference point on the CRT.

NOTE

To establish the ground reference point be sure the input connectors either terminated by a 50 Ω resistor or coaxial cable connected to the input.

To do this, trigger the sampling sweep unit with the signal source and display a trace. Then, position the trace so it is exactly aligned with one of the graticule lines. The actual graticule line you select will be largely determined by the polarity and amplitude of the applied signal. After establishing the ground reference, make no further adjustments with the DC OFFSET control.

Apply the signal and measure the voltage in the manner previously described. Make all measurements from the established ground reference point. Accuracy of this measurement is within $\pm 3\%$.

If the applied signal has a relatively high DC level, the ground-reference point and the actual signal may be so far apart that neither will appear on the CRT. In this case, refer to the following discussion on "Voltage Measurements Using the DC Offset Control."

Voltage Measurements Using the DC OFFSET Control. Unless otherwise stated on the sampling head front panel, the DC offset voltage cancels the effect of an applied DC voltage of up to ± 1 volt at the sampling head input. Also, accurate slideback amplitude measurements of the applied signal can be obtained by positioning the display at various points and measuring the amount of voltage change at the OFFSET OUT monitor jack.

Source resistance for the voltage at the OFFSET OUT monitor jack is 10 k Ω ; therefore, meter loading may be a factor if other than an infinite-impedance meter is used. The accuracy of the DC offset voltage measurement depends on the accuracy and the loading effect of the measuring device. The following measuring devices are recommended, in order of preference, for monitoring voltage at the OFFSET jacks.

- (1) Differential, non-loading DC voltmeter accurate within 0.2% or better. This type of device provides absolute offset voltage measurements accurate within 2%. Measurements of small changes in offset voltage can be made more accurately than 2%.
- (2) Vacuum-tube voltmeter with an input impedance of at least 10 megohms Accuracy of the VTVM should be as high as practical.
- (3) Zero-center ± 1 mA milliammeter with as high an accuracy as practical. The milliammeter should be connected directly between the OFF-SET OUT monitor jack and ground. When using a milliammeter, 1 milliamperes is equivalent to 1 volt of the actual offset voltage. The loading effect is within 2% + the error percentage determined by: $100 (R_{\text{meter}}/10000)$.

Slideback Measurement Procedure. To measure the voltage difference between two points on a waveform (such as peak or peak-to-peak volts), proceed as follows:

1. Set the DC OFFSET control to about midrange.
2. Apply the signal to be measured to the sampling head input. Adjust for a stable display with about 7 divisions of vertical deflection between the two points of the signal to be measured.
3. With the DC OFFSET controls move one of the points to be measured to the center line of the graticule and measure the voltage at the OFFSET OUT monitor jack. Use one of the measuring devices mentioned previously.
4. With the DC OFFSET control, move the display so the other point to be measured is aligned with the centerline of the graticule and again measure the voltage at the OFFSET OUT monitor jack.
5. Find the difference between the voltage measured in step 3 and the voltage measured in step 4, and divide by 10.

The result is the voltage difference, in volts, between the two points on the waveform. This voltage tolerance is $\pm 2\%$ of the input signal plus the tolerance and loading effect of the measuring device.

Use of Smoothing

Random process sampling does not generally permit the use of smoothing. This process requires unity loop gain to construct a coherent display from the samples taken at random. When using random process sampling, operate the 7S11 with the NORMAL switch pushed in, and adjust the DOT RESPONSE control to unity loop gain.

Normal process sampling does permit the use of smoothing. Time and amplitude noise may sometimes be objectionable when operating at minimum deflection factors or maximum sweep rates. For Smoothing operate the 7S11 with the SMOOTH switch pushed in.

This will reduce the random noise by about one half by decreasing the gain of the sampling feedback loop. Fig. 2-7 shows the advantage of using smoothing when observing a low-amplitude signal.

Dot Density. Normally the risetime of the display will not be significantly affected in smoothed operation if the dot density is sufficient. If, however, the display waveform shape is affected when the SMOOTH switch is pushed in, a compromise must be made between smoothing and dot density. Fig. 2-7C illustrates the effect produced when the dot density is low with smoothed operation. This effect can be compared to the high dot density of the same input signal as shown in Fig. 2-7B.

"False" Displays

Because sampling displays only a fraction of any one cycle of a repetitive signal, it is sometimes possible to obtain a false equivalent-time display of the signal. The incorrect equivalent-time display occurs when the sampling rate is an exact multiple of the signal rate. Each sample vertical position represents the correct signal amplitude, but an incorrect number of samples is taken, causing the false equivalent-time display.

False equivalent-time displays can be detected by changing the sampling sweep unit Scan control; i.e., changing the dot density. Occasionally such a false equivalent-time display occurs when the sampling sweep unit triggering circuit is adjusted to free run, and at the same time the triggering signal amplitude synchronizes it falsely. Any time the display equivalent time changes when changing the dot density, alter the Time/Div switch to obtain a display with an

equivalent time that does not change with dot density change. Usually the sweep rate should be increased (turn the Time/Div control clockwise), but some false displays can be obtained when the signal repetition rate is slower than can be shown by equivalent-time normal process sampling.

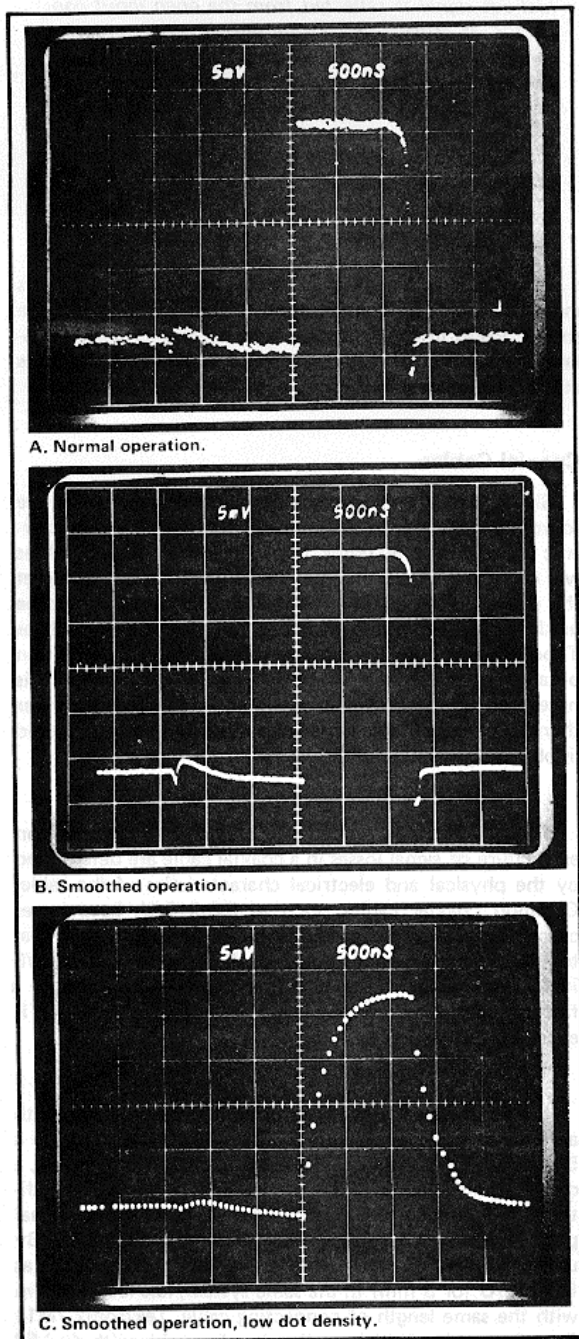

Fig. 2-7. Use of NORMAL/SMOOTH switch in sequential process sampling for decreasing display noise when viewing a low amplitude

Operating instructions-7S11

When that occurs, the display can usually be corrected by changing to real-time sampling. Fig. 2-8 gives an example of a false and a correct display for two sweep rates when the signal is a 500 MHz sine wave.

Time Domain Reflectometry (TDR)

The 7S11 with the Type S-1 Sampling Head can be used for Time Domain Reflectometry displays. TDR using the Type 284 Pulse Generator is described in the Type 284 Instruction Manual. Very fast displays, and special TDR analysis of small reactances is possible with the Type S-4 and the Type S-50. See the Type 1S2 Instruction Manual for information about such fast displays.

Pen Recorder Operation

The signal available at the Vert Sig Out jack provides a convenient source for driving the Y axis of a pen recorder. It is common practice to manually scan the CRT (with the

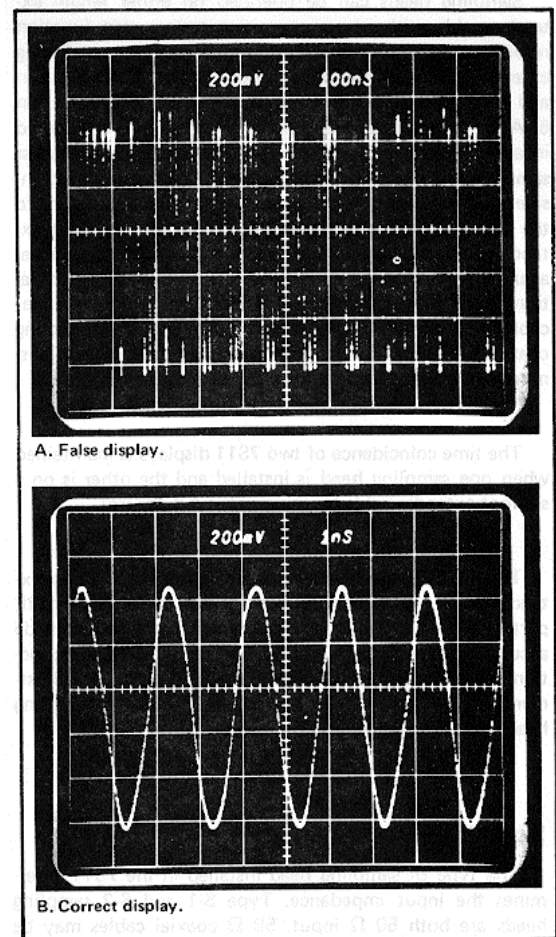

Fig. 2-8. Typical false and correct displays using a 500 MHz signal input

NOTE

Operating the sampling head without the input connector terminated by the 50 Ω resistor or coaxial cable will cause a vertical shift of the zero signal baseline by a few millivolts. This is because the strobe kickout signal is reflected from the open input connector. It arrives back at the sampling bridge during sampling time, while the bridge is still conducting. Set the display zero reference point with the input circuit connected, not before connecting it. Also use at least a 20 cm airline between the sampling head input and a fast generator or circuit that is sensitive to the fast strobe kickout signal.

When connecting a signal to the input, many factors must be taken into consideration, including loading of the source, losses in coaxial cables, time delay, AC or DC coupling, attenuation of large signals and matching impedances at high frequencies

sampling sweep plug-in controls) while driving the time axis of the recorder with the sweep output voltage. Another method for pen recording is to couple the scanning voltage of the recorder to the external sweep input connector of the sweep unit. Be sure the sweep voltage from the recorder agrees with the limits of the input to the sampling sweep plug-in. The source resistance of the output jack is 10 k Ω . This impedance must be considered in the calibration of some types of pen recorder amplifiers.

Use of a Sampling Head Extender Cable

Two different sampling head extender cables are available for operating one or both sampling heads outside the 7S11. One is three feet long (Tektronix Part No.012-0124-00), and the other six feet long (Tektronix Part No. 012-0125-00). Contact your Tektronix Field Engineer or Representative for price and availability information.

Sampling heads can be operated on either length extender cable without compromising system step function response. Loop gain adjustment range may be lost with long extender cables so special calibration of the 7S11 loop gain and memory gate width controls is necessary. See Section 6. Also, the extender cable signal delay must be considered in allowing proper pretrigger leadtime for normal process sampling. As compared to operating the sampling head in-side the 7S11 use of a three foot cable adds about 5 ns to the required pretrigger leadtime; use of the six foot extender cable adds about 10 ns. To illustrate the above, assume the following conditions: 7T11 Sequential operation; Type S-1 or S-2 Sampling Head on 3-foot extender cable from the 7S11; and external trigger 50 Ω coupling coaxial cable with 5 ns signal delay. With these conditions, minimum trigger leadtime for a fast step display is 73 ns.

The time coincidence of two 7S11 displays is maintained when one sampling head is installed and the other is on a six foot extender cable by using a DELAY control.

The first time a sampling head is operated on an extender cable, its Bridge Bal control may need adjustment, particularly if DC Offset measurements are to be made accurately referenced to ground. The sampling head instruction manual describes Bridge Bal adjustments. Readjustment of the control may be required when the sampling head is again installed directly into the 7S 11.

Input Connectors

The type of sampling head installed in the 7S11 determines the input impedance. Type S-1 and S-2 sampling heads are both 50 Ω input. 50 fl coaxial cables may be used for applying input signals with minimum signal low or distortion.

Coaxial Cables

Signal cables that connect the vertical signal from the source to a 50 Ω input connector should have a characteristic impedance of 50 ohms. Impedance ohms Impedance 50 ohms will cause reflections that may make it difficult to interpret the display. High-quality low-loss coaxial cables should be used, especially with high speed sampling heads such as Type 5-2 and Type S-4, to ensure that all the information obtained at the source will be delivered to the input. If it is necessary to use cables with characteristic impedance other than 50 ohms, suitable impedance-matching devices will aid in obtaining meaningful displays.

The characteristic impedance, velocity of propagation and nature of signal losses in a coaxial cable are determined by the physical and electrical characteristics of the cable. Common coaxial cables, such as RG-213/U, have losses caused by energy dissipation in the dielectric proportional to the signal frequency. Some small diameter cables (1/8 inch) lose much of the high-frequency information of a fast-rise pulse in a very few feet of cable, while the 3 mm is excellent for low losses.

Losses of high frequency information can be shown with a fast rise pulse generator and sampling system. Using a 5-ns-delay RG-58A/U coaxial cable as a connecting cable, a display similar to Fig. 2-9A can be shown. Adding an additional 10 ns-delay RG-58A/U coaxial cable in the signal path results in a display similar to that of Fig. 2-9B. By using larger diameter, higher quality cable such as RG-213/U (or 3 mm) in the same system, less loss is shown with the same length of connecting cable. Tektronix 7M 11 Dual Delay-Line is high quality, low loss cable with dual 50 Ω , 75 ns delay lines.

Attenuating the Input Signal

The maximum signal amplitude that should be applied to the input connector of the sampling head will depend upon the sampling head installed in the 7S11. To attenuate the signals to 50 Ω input sampling heads, use an attenuator probe and/or external coaxial attenuators. The attenuators must have good frequency response beyond the frequency response of the sampling head to avoid reducing system performance. High quality coaxial attenuators are available through your Tektronix Field Office or Representative with attenuation factors such as 10X, 5X and 2X. When the attenuators are stacked, their attenuation factors multiply; i.e., two 10X attenuators produce 100X attenuation. The 50 Ω attenuators must be matched to 50 Ω input and output impedances to provide their stated attenuation factor.

To divide a signal into two equal parts, and maintain a good 50 Ω impedance match, use a power divider such as GR 874 TPD Tektronix Part No. 017-0082-00. The loss between any two of the power divider connectors is 6 dB (half voltage) when each connector has a 50 Ω circuit connected.

Passive Probes. The Tektronix P6034 10X Probe and the P6035 100X Probe are moderate-resistance passive probes designed for use with 50-ohm systems. They are small in size permitting measurements to be made in miniaturized circuitry. Power rating is 0.5 watt up to a frequency of 500 MHz. Momentary voltage peaks up to 500 volts can be permitted at low frequencies, but voltage derating is required at higher frequencies. Characteristic data is given in the probe instruction manuals.

The P6034 10X Probe places 500 ohms resistance and less than 0.8 pF capacitance in parallel with the signal source at low frequencies. The probe bandwidth is DC to approximately 3.5 GHz, and risetime is 100 picoseconds or less (10% or 90%). At 1 GHz the input resistance is about 300 ohms and the capacitive reactance is about 400 ohms.

The P6035 100X Probe places 5 Ω resistance and less than 0.7 pF capacitance in parallel with the signal source at low frequencies. Bandwidth of the probe is DC to approximately 1.5 GHz, and risetime is 200 picoseconds or less (10% to 90%). At 1 GHz the input resistance is about 2 kΩ and the capacitive reactance is about 450 ohms.

Built-in Probes. Another satisfactory method of coupling fractional nanosecond signals from within a circuit is to design the circuit with a built-in 50-ohm output terminal. With this built-in probe, the circuit can be monitored without being disturbed. When the circuit is not being tested, a 50-ohm terminating resistor can be substituted for the test cable. If it is not convenient to build in a permanent 50-ohm test point, an external coupling circuit, which may be considered a probe, can be attached to the circuit.

Several factors must be considered when constructing such a built-in signal probe. A probe designed to transfer energy from a source to a load, with controlled fidelity and attenuation. Both internal and external characteristics affect its operation. It must be able to carry a given energy level, be mechanically adaptable to the measured circuit, and be equally responsive to all frequencies within the limits of the system. The probe must not load the circuit significantly or the display may not present a true representation of the circuit operation. Loading may even disrupt the operation of the circuit. When it is necessary to AC-couple the probe, the capacitor should be placed between the series attenuator resistance and the 50-ohm probe cable to minimize differences between the input

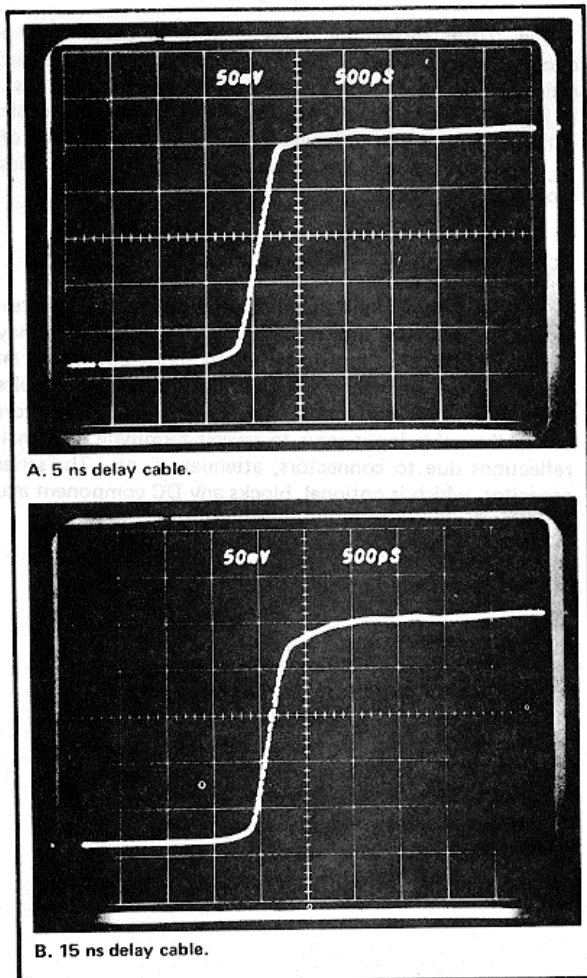

Fig. 2-9. Coaxial cables in a fast-rise system.

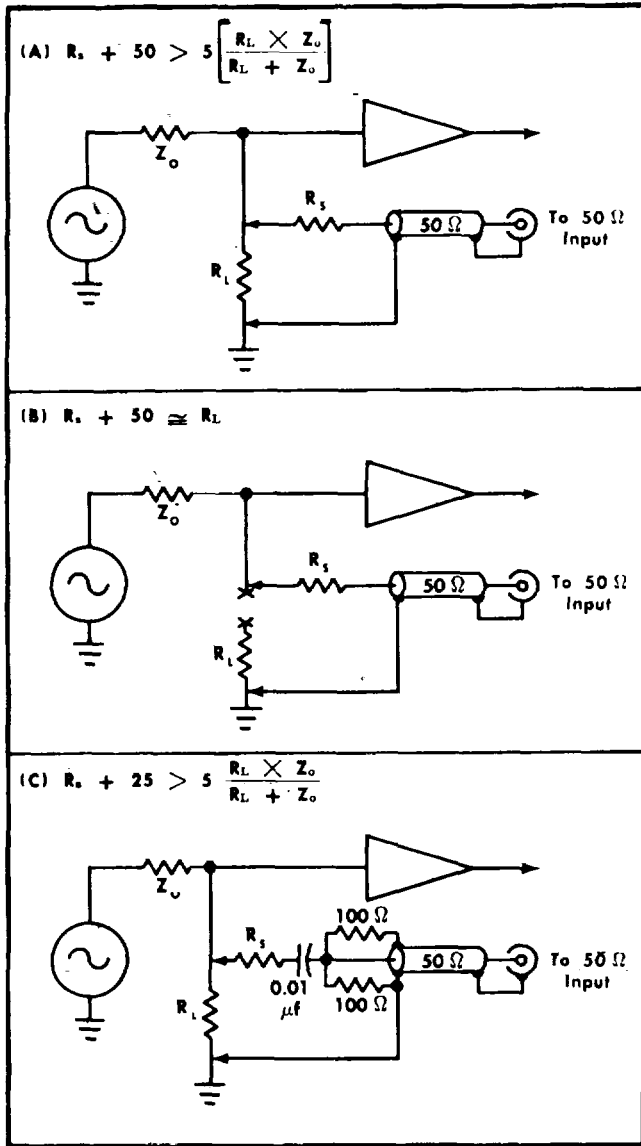

Fig. 2-10. Built-in probes for coupling to a test circuit. (A) Parallel method; (B) series method; (C) reverse-terminated parallel method.

characteristics with and without the capacitor. In a 50-ohm environment, stray capacitance to ground has a shorter and more uniform time constant than if the capacitor were placed at the signal source where the impedance is usually higher and sometimes of unknown value.

Fig. 2-10A shows the parallel method of coupling to a circuit under test. Resistor R_s is connected in series with the 50-ohm input cable to the sampling unit, placing $R_s + 50$ ohms across the impedance in the circuit. This method usually requires the use of an amplitude correction factor. In order to avoid overloading the circuit, the total resistance of $R_s + 50$ ohms should not be less than 5 times the impedance of the device (R_L in parallel with Z_0) requiring a 20% correction. The physical position of R_s will affect the fidelity of the coupling.

Fig. 2-10B shows the series method of coupling to a circuit. Resistor R_s plus the 50 ohm Sampling Head input resistance replaces the impedance of the circuit under test. If R_L is 50 ohms simply substitute the 50-ohm test cable without R_s . It is best to locate R_s in the original position of R_L and to ground the coaxial cable where R_L was grounded.

A variation of the parallel method is the reverse-terminated network shown in Fig. 2-10C. This system may be used across any impedance up to about 200 ohms. At higher source impedances, circuit loading would require more than 20% correction. The two 100-ohm resistors across the cable input serve to reverse-terminate any small reflections due to connectors, attenuators, etc. The series capacitor, which optional, blocks any DC component and protects the resistors.

SECTION 3 BASIC SAMPLING PRINCIPLES

Change information, if any, affecting this section will be found at the rear of the manual

Introduction

This section provides a basic functional description of the vertical channels of sampling oscilloscopes. A discussion of equivalent-time sampling process is included. Operating instructions, including first time operation, are given in Section 2

BASIC SAMPLING TECHNIQUES

The current state of the electronic art does not permit direct cathode-ray tube display of fractional-nanosecond risetime low-level signals. Risetimes in the order of 0.35 ns can be displayed on a CRT if the signal is at least several volts in amplitude.

An inherent limitation in linear amplifiers is the compromise necessary between bandpass and gain. A high gain amplifier is a low bandpass amplifier; and conversely, wide-band amplifiers are necessarily low gain amplifiers. For any particular configuration, gain times bandpass is nearly a constant, so anything done to increase the gain will proportionately reduce the bandpass and vice versa. The gain-bandpass product limitation of linear amplifiers restricts the display of millivolt signals on a CRT to the 50 to 200 MHz region.

The sampling technique permits the quantitative display (on a CRT) of a facsimile of fractional-nanosecond rise-time low-level signals. In sampling, many cycles of an input signal are translated into one cycle of low-frequency information. The change takes place at the input of the sampling bridge or traveling wave sampling gate. Since only the sampling bridge is subjected to the input signal high frequencies, and all the amplification takes place at relatively low frequencies, the performance of a sampling system is not dependent on the gain-bandpass limitations of conventional amplifiers.

However, the sampling technique introduces some limitations of its own. The sampling process being described is restricted to repetitive signals of low amplitude (typically 1 or 2 volts peak to peak), from low impedance sources. Fortunately, most fractional-nanosecond risetime signals exist in low impedance environments and are generally low amplitude. Piping the signal from the circuit under test to

the input of the sampling oscilloscope vertical channel requires a more sophisticated technique than lower bandpass systems. In spite of its limitations, sampling can measure fast signals that otherwise defy observation.

A sampling system looks at the instantaneous amplitude of a signal during a specific small time period, remembers the amplitude, and displays a single dot on the CRT corresponding to the amplitude. After a dot is displayed for a fixed amount of time, the system again looks at the instantaneous amplitude of a different cycle of the input signal. Each successive look, or sample, is at a slightly later time in relation to a fixed point of each signal cycle. Each sample is displayed as a spot on the CRT. Generally, the vertical position of the dot represents the equivalent time when the sample was taken. After many cycles of the input signal, the sampling system has reconstructed and displayed a single facsimile made up of many samples, each sample taken from a different cycle of the input signal.

Fig. 3-1 illustrates the equivalent time reconstruction of a repetitive square wave. The CRT display is a series of dots rather than the conventional oscilloscope continuous presentation. In the illustration, a series of samples is taken of the input signal. After each sample, when memory has been established and stabilized, the CRT is unblanked and a dot appears. A large number of such dots form the display.

The number of dots per horizontal unit of display is called dot density. The dot density of a display is controlled by the operator to provide the best compromise between resolution and repetition rate of the display. Since only one sample is taken from any particular input cycle, the time required to reconstruct a display is a function of the dot density selected and the repetition rate of the signal. The higher the dot density selected (for higher resolution), the longer the time required to construct the equivalent time display. The higher the repetition rate of the signal, the less time required to reconstruct the waveform (limited by a maximum repetition rate of the system)

Sampling requires repetitive input signals, though not necessarily signals with constant repetition rate. The equivalent time between dots is determined by the time delay between the fixed point on the signal at which triggering occurs, and the point at which the sample is taken. Since

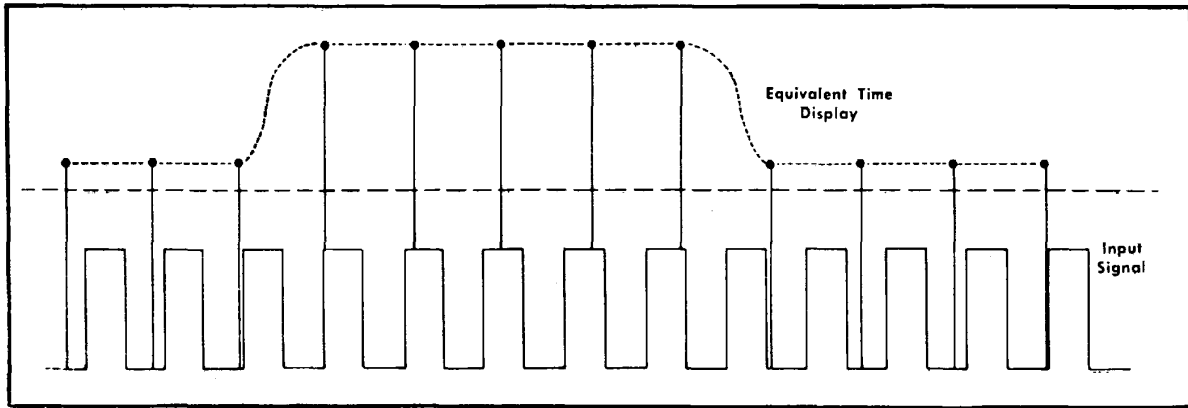

Fig. 3-1. Equivalent time display of repetitive real time signal by means of the sampling techniques.

both time reference (triggering-time and sample-time) are taken from the same cycle of the signal, the signal repetitions do not have to be identical in amplitude, time duration, and shape. Any differences in the individual cycles show as noise or jitter in the reconstructed display.

Sampling systems have maximum signal repetition rates at which samples can be taken and accurately displayed. The primary limit is the time required for the preamp and the AC amplifier to stabilize after a sample has been taken.

Signals below 100 kHz may have considerable repetition rate jitter and still the sampling oscilloscope will present a sample of each cycle, without display jitter. For signals with a repetition rate higher than 100 kHz, the timing unit

holds off retriggering for a maximum of about 10 ps. This means that a sample will not be taken from every cycle of a high repetition rate signal. Only those cycles are sampled which occur after the end of the holdoff. If the signal is truly repetitive and each cycle is identical, these "missed" cycles are of little significance.

The circuits in the vertical channel of a Tektronix sampling oscilloscope comprise an error-sampled feedback system with ratchet memory. The memory output is not reset to zero after displaying a dot. The memory output remains at the displayed amplitude of each dot in succession until it is corrected by the next sample. The amplitude difference between the two samples is then the error between the memory output and the new sampled amplitude.

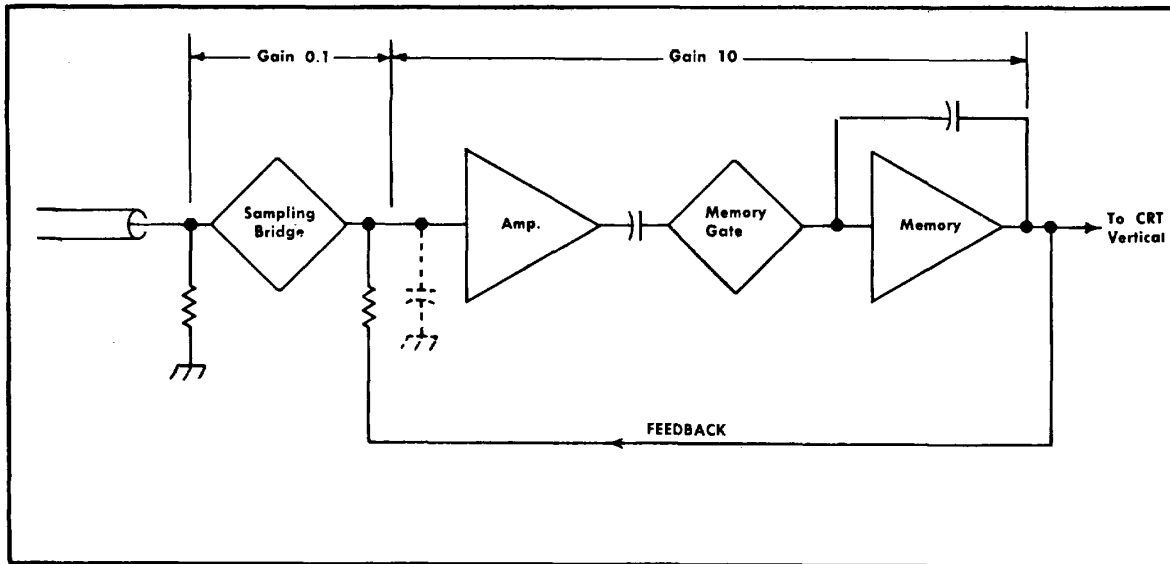

Fig. 3-2. Simplified block diagram of an error-sampled feedback system with a ratchet memory.

Fig. 3-2 shows a simplified block diagram of an error-sampled feedback system with ratchet memory. The output signal from the sampling bridge is the difference, or error, between the instantaneous amplitude of the signal at sample time and the previously memorized amplitude. A change is made to the memory output only when the instantaneous amplitude of the signal at sample time is different from the memory output. The memory output "ratchets" up or down at sample time as a result of the error signal sampled. The transition of memory from one output voltage to another occurs between displayed dots, and is therefore not seen on the CRT.

The error-sampled ratchet-memory technique has the advantage of allowing displayed noise to be "smoothed". Smoothing is discussed later in this section. The error-sampled approach also minimizes signal kickout into the input cable by the sampling bridge interrogate pulse (hereafter called "strobe" pulse). Since the sample is always the difference between the signal and the memory output, the

error-signal and kickout are much smaller in amplitude than they would be if the memory output reverted to zero and the entire signal was sampled after each dot.

The output from the sampling bridge at sampling time is about 2% of the difference between the signal voltage and the memory output. The 2% signal is the input to the first amplifier. The output of the amplifier is AC-coupled to a memory gate. The memory gate couples the signal to the memory amplifier during the time it is gated on. The memory amplifier changes the memory feedback voltage to equal the signal voltage at the instant of sampling. These changes in memory output occur while the CRT is blanked, and do not show up in the display. The memory output does not revert to zero, but remains at a fixed voltage until corrected by the next error signal. (The signal to the amplifier of a typical sampling system is only about 2% of the error signal sampled by the bridge. The percentage of response, or attenuation through the sampling bridge, is the sampling efficiency)

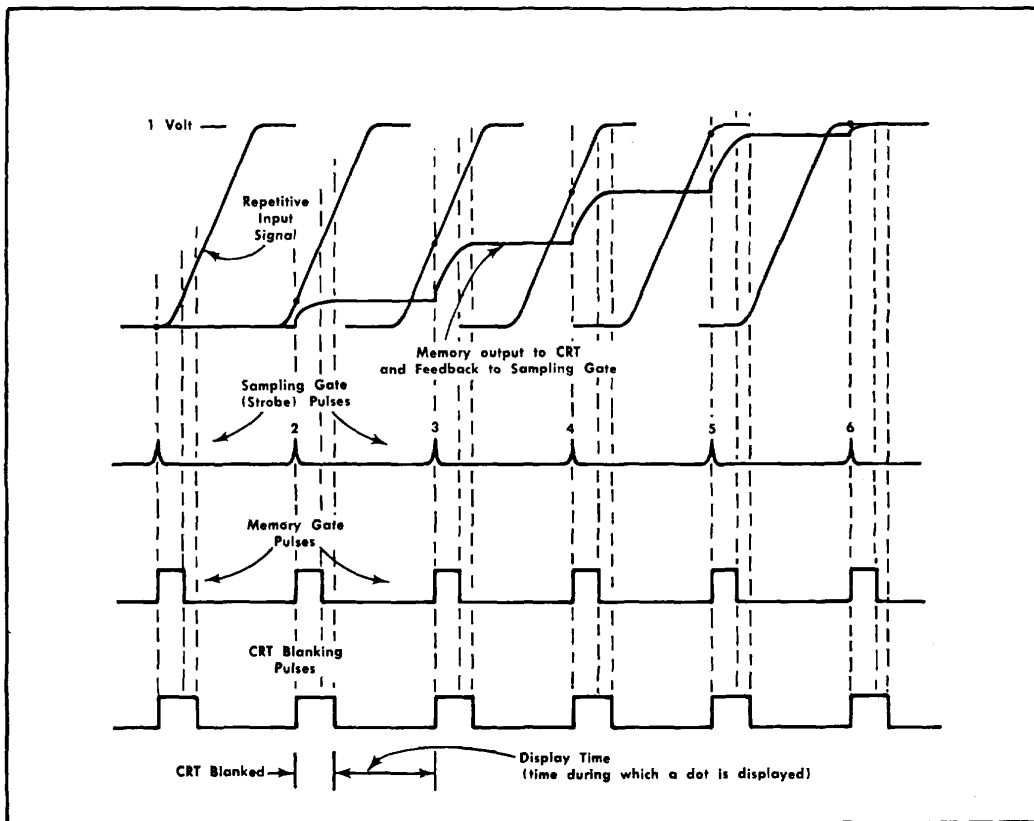

Fig. 3-3. Simplified representation of an error-sampled ratchet-memory waveform.

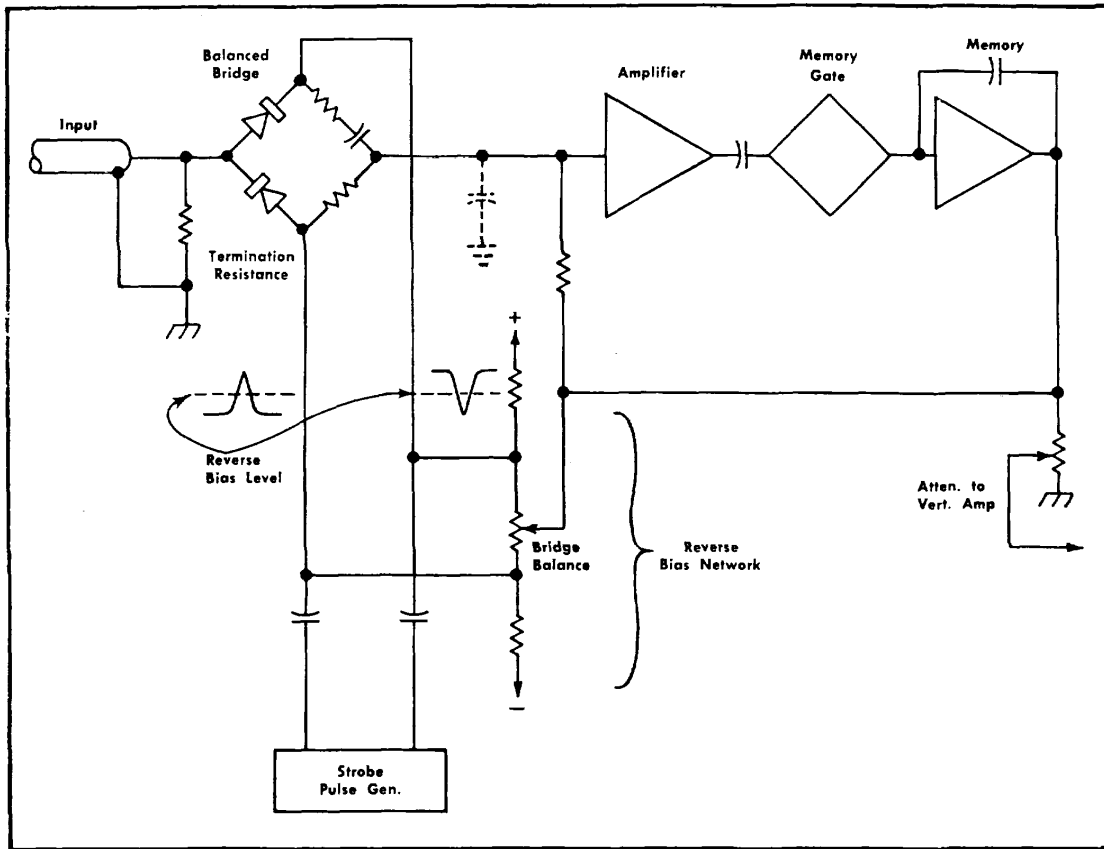

Fig. 3-4. Simplified diagram, showing how the strobe pulse cause the sampling bridge to conduct,

At each sample time, the difference between the memory feedback and the 2% signal value is amplified and applied to the memory circuit via the memory gate, to cause the memory output to follow a rising signal in a series of steps as shown in Fig. 3-3. This figure shows the input signal and memory feedback voltages for six samples along the rise of a step waveform.

At the time of sample 1, the input signal and the feedback voltage are equal. There is no error voltage, so the memory output is not changed. The CRT is blanked until the circuit stabilizes after the memory gate pulse ends.

At the time of sample 2, the input signal is (for example) 0.1 volt. The memory output is 0. Assuming a sampling efficiency of 10%, the input of the amplifier receives 10% of the error signal, or 0.01 volt. The 0.01 volt, times the gain of the amplifier (X10), corrects the memory output and feedback to equal the 0.1 volt signal at sample time. Again, the CRT is blanked during this change until the circuit is stabilized.

At the time of sample 3, the difference between the input signal and the feedback is 0.35 volt. The amplifier input responds to 10% of 0.035 volt. The gain of the amplifier and memory changes the feedback 0.35 volt to the new value of 0.45 volt (equal to the signal at number three sampling time). The CRT is again blanked during this change until the circuit is stabilized.

Effective Sampling Time

The minimum risetime a sampling system can display is controlled by the time interval during which the strobe pulse applies forward bias to the sampling bridge diodes. The duration of the bridge forward bias is controlled by the time the strobe pulse exceeds a fixed reverse bias. Special circuitry is used to make the strobe duration as short as possible consistent with noise and diode recovery time. The strobe pulse is generated by a snap-off diode and a short section of shorted transmission line called a clipping line. The effective bridge conduction time is adjusted primarily by controlling the amplitude and duration of the strobe pulse, thus controlling the time during which the strobe

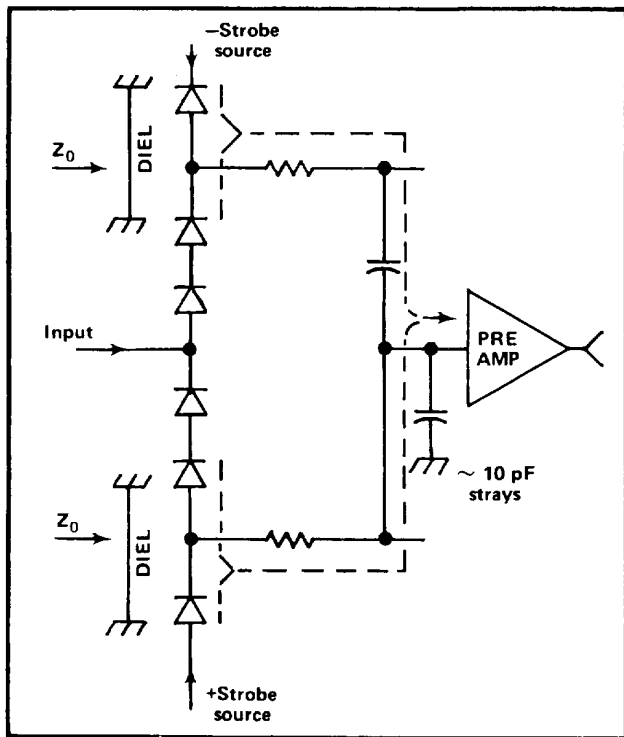

Fig. 3-5. error-signal source and path to Preamp shown by dottedlines. DIEL denotes dielectric other than air

Pulse exceeds the reverse bias. Adjusting the reverse bias is a secondary means of controlling the sampling bridge conducting time. Fig. 3-4 shows how the strobe pulse breaks through the reverse as on the sampling bridge. The reverse bias is shown by dashed lines through the strobe pulses.

Traveling Wave Sampling Gate

The sampling system may use a traveling wave gate instead of the sampling bridge as the input stage. Fig 3-5 shows a simplified schematic of the wave sampling gate. The input signal is connected to the Preamplifier only during the time a sample is taken. The six diodes form the traveling wave gate.

Step response is determined by the travel time of the strobe drive pulse end through part of the sampling gate. In a sampling bridge, the step response is determined by the strobe pulse width.

Part of the input signal is stored temporarily between sampling gate diodes at the strobe pulse end; then it is fed to the Preamplifier at a slower rate than the step response traveling wave sampling gate to minimize reflections of fast pulse signals. The environment of following circuitry passes only moderate rate-of-rise signals.

Dot Response (Loop Gain)

dot response is the ability of the system to reduce the error voltage to zero after each sample. When the gain of the memory feedback loop is equal to (and compensates for) the attenuation across the sampling bridge, the loop gain is unity or 1. In this case, the memory feedback voltage equals the value of sampling time signal voltage.

If a the loop gain is less than unity, the memory output signal and feedback to the first amplifier is less than necessary to reduce the error voltage to zero. The memory out put and the feedback will then approach the signal asymptotically after several samples have been taken. The error voltage thus approaches zero (for a steady state signal) after several samples, a being reduced by the same factor after each SAMPLE. In the case of a loop gain of less than unity, the feedback voltage is effectively a moving average of several preceding samples.

If the loop gain is greater than unity, the feedback voltage will be greater than the error signal after each sample. The displayed dot sequence of a step signal will then alternately overshoot and undershoot for a few samples.

For least displayed waveform distortion, the loop gain must be unity, allowing the system to track the input signal as closely as possible.

Smoothing

A loop gain of less than unity can be useful, if the resulting compromise is understood and the system is operated properly. random noise in the display is reduced when loop gain is less than unity, since several consecutive samples are averaged. The averaging may also slow down the fastest display risetime capability, depending upon the number of dots contained in the step transition and or the loop gain. By increasing the number of dots in a step transition, the display will follow the actual step transition more closely.

Fig. 3-6 shows the usual effects on a step display when smoothing is used for two different sampling densities (sampling density or dot density is the number of samples or dots per horizontal division). In the 7S11 the operational choice of loop gain is either 1.0 (NORMAL) OR 0.3 (SMOOTH) AND THE UNITY LOOP GAIN (NORMALDISPLAYS).

In Fig 3-6B the sampling density is increased, showing a difference of one sample in the SMOOTH and NORMAL positions between the 10% and 90% points of the step transition.

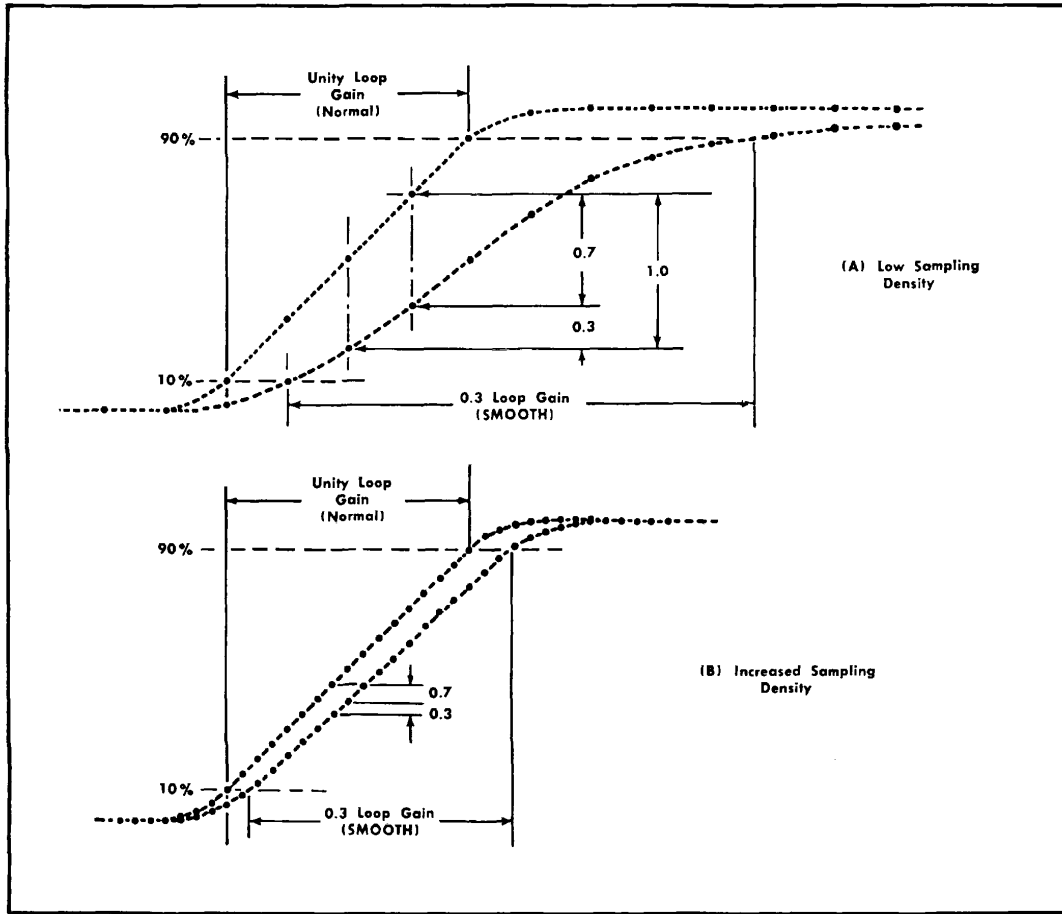

Fig. 3-6. Equivalent-time display with and without smoothing for two different sampling densities

When the smoothed mode has a loop gain of 0.3, as in the 7S11, 15 or more samples between the 10% and 90% points of a risetime will result in the smoothed and unsmoothed displays having essentially the same risetime. When the smoothed display contains 12 samples between the 10% and 90% point, the smoothed risetime will be about 6% longer than for the unsmoothed display. As the number of samples contained in the risetime is reduced below 12, the difference between smoothed and unsmoothed display increase rapidly.

Smoothing of Random Noise

When the loop gain is reduced to 0.3, the displayed dots represent the average of several consecutive samples. Noise of a random nature will be materially reduced in the display at the possible expense of introducing an error in the displayed risetime.

Therefore, if random noise is apparent, reducing the loop gain may improve the display. Note that this is only true for random noise. Systematic noise (noise with its repetition rate harmonically related to the signal) is treated as part of the signal.

The 7S11 has a loop gain control labeled NORMAL-SMOOTH. In the SMOOTH mode loop gain is reduced to 0.3 Always check that there is sufficient sampling density to warrant smoothing. This can be done by changing the dots/division. (or samples/division) control on the timing unit, and observing the effect of sampling density on the displayed risetime.

Smoothing cannot be applied where the full amplitude of each sample is required. When using the random sampling sweep unit like the 7T11, each sample requires unity

loop gain. The display dots are not presented in time sequence, and therefore cannot be averaged.

Tangential Noise

Traditionally the amplitude of random noise in an amplifier is qualified by stating the equivalent RMS value of the noise referred to the input of the amplifier. In the case of a CRT sampling display, qualifying the noise amplitude by stating its RMS value is somewhat unsatisfactory. The visible effect of the random noise is more nearly 3 times the RMS value of the noise. Peak-to-peak limits of truly random noise would have to be stated as - infinity to + infinity. Obviously these broad limits would reveal nothing about the amount of significant noise to expect in a display. It has been determined empirically that 90% of the dispersion caused by random noise closely approximates the visible widening of the trace. The noise can be described as existing between two horizontal tangents representing the significant upper and lower limits of the trace width. Hence, the term TANGENTIAL NOISE. Tangential noise is defined as an equivalent peak-to-peak voltage at the input of a sampling system that will cause the same trace widening as 90% of the random noise. 5% of the dots can be expected to fall above the trace width and 5% below it. This method of stating the noise figure of a sampling system is considered to be more meaningful than the RMS value, in that it more closely approximates the actual observed trace widening. Measurement of tangential noise is described in the Sampling Head instruction manual.

Display Sensitivity-Deflection Factor

The two terms "display sensitivity" and "deflection factor" are often mistakenly interchanged. Deflection factor is defined as the ratio of the input signal amplitude to the resultant displacement of the indicating spot. When the oscilloscope vertical gain control is calibrated in volts per division, it is indicating deflection factor. Deflection sensitivity is the reciprocal of deflection factor. Sensitivity is indicated by a vertical gain control calibrated in divisions per volt.

There is ways some point within the oscilloscope vertical amplifier after which the signal remains at a fixed deflection factor. The signal out of the vertical memory amplifier of a sampling oscilloscope is usually the first point at which the standard vertical deflection signal exists. Thus, the memory and feedback voltages previously mentioned always deflect the CRT spot vertically with a fixed deflection factor.

Fig. 3-7A shows a simplified block diagram of a sampling bridge and amplifier combination where the gain of the amplifier just compensates for the attenuation of the sampling bridge. In Fig. 3-7B the amplifier has twice as much gain as is necessary to compensate for the low sampling efficiency. By introducing a 2:1 attenuator in the feedback

path between the memory output and the bridge output, the dot response is still maintained at unity. Now, only half as much input signal produces the same memory output as in Fig. 3-7A.

Fig. 3-7 shows two fixed attenuators in each example. The usual method of changing amplifier and memory gain in a sampling unit is to attenuate the signal through (or to) it. The attenuator in series with the amplifier and memory is called the forward attenuator, in contrast to the feedback attenuator.

The attenuators in Fig. 3-7 and Fig. 3-8 show that both the "forward gain" and the "feedback attenuator" are related when changing a sampling system vertical deflection factor.

The system deflection factor can be altered two ways: (1) by changing both the forward and the feedback attenuation and thereby maintaining the same loop gain, and (2) by changing only the feedback attenuation, at the expense of varying the loop gain. If loop gain is not greater than unity, and many samples are included in a signal transition, the memory feedback to the sampling bridge always approaches the signal amplitude regardless of the forward attenuator attenuation ratio.

Since loop gain is determined by the combined forward and feedback attenuation ratios, the dot response can be altered without altering the deflection factor by changing the forward attenuation only. Increasing the forward attenuation ratio (decreasing the amplifier and memory gain) "smooths" the display by making the loop gain less than unity.

DC Offset

Since the sampling bridge can be operated over a range of +2 to -2 volts of input signal, and the system has resolution capability of 2 mV/div, it is advantageous to be able to display a small vertical "window" of the input signal. Fig. 3-8 shows the method of adding a DC offset voltage to the memory feedback. The error signal produced at sampling time is no longer referenced to ground. Instead, it is referenced to the DC offset voltage.

A DC Offset voltage is recognized as a signal by the sampling bridge, which adds it algebraically to the error signal. Therefore, the memory feedback signal in a system with DC Offset includes a DC value to cancel the DC Offset voltage at the output side of the sampling bridge. The deflection factor of a system with DC Offset is center ground the DC Offset voltage instead of ground. This permits portions of the signal (other than ground) to be positioned to the CRT center, without altering the deflection factor.

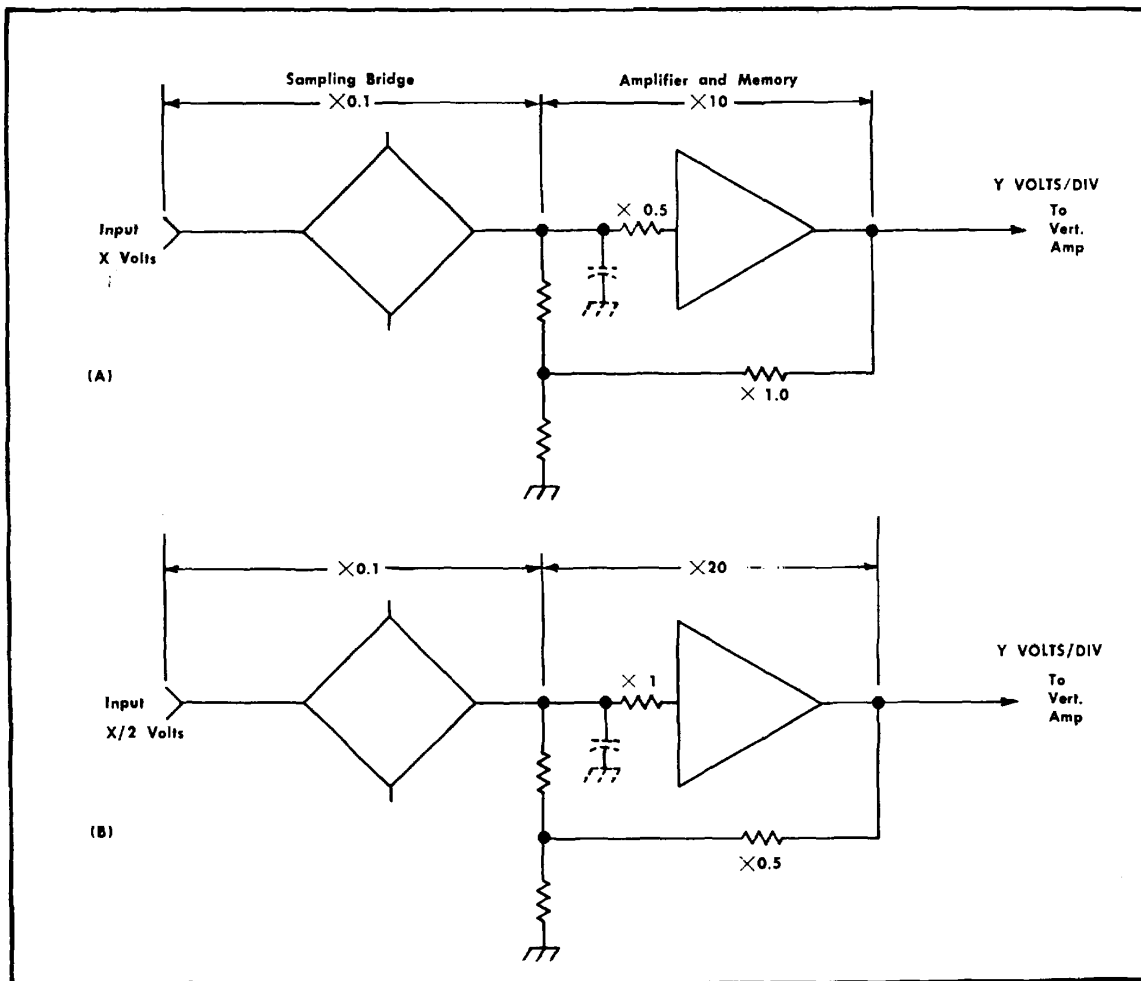

Fig. 3-7. Method of decreasing the vertical deflection factor while maintaining unity loop gain..

Real-Time Sampling

Real-time sampling is a method of operation in which the samples are taken at a constant rate from relatively low frequency signals (DC to 20 kHz approximately) and displayed at a sweep rate determined by the Time/Div switch on the time-base unit. Thus, the samples are taken continuously along the input signal rather than taking one sample from each cycle of the signal. The displayed series of dot follows the actual shape of the input signal waveform.

In real-time sampling operation, the vertical signal provides the trigger to start the sweep. The display, however, is composed of samples at a fixed repetition rate, not necessarily related to the input frequency.

Sweep Rates

this range of sweep rates available for use real time sampling is from the slowest rate provided by the real time sweep unit to about 0.1 ms/div. At this sweep rate, the usual 50 kHz sampling rate provides about 100 samples/sweep. At faster sweep rates above 0.1 ms/div, the display dots begin to have significant horizontal dimension due to their duration in real time, and interpretation of the display becomes difficult.

The characteristics of real-time sampling, in addition to slow sweeps at full bandwidth, are reduction of random noise in the display through smoothing, and DC offset capability matched with good overload recovery.

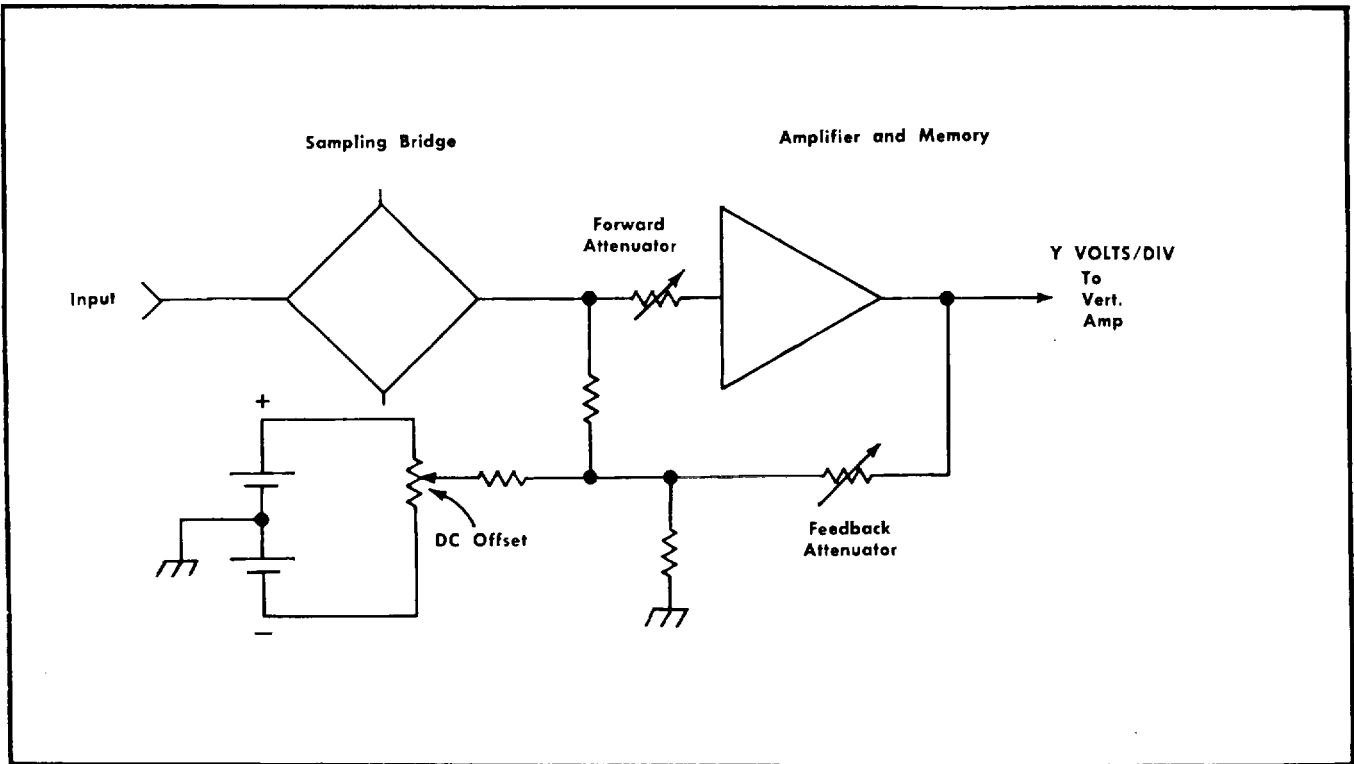

Fig. 3-8. Method of adding a DC Offset voltage to the memory feedback.

3-9/3-10

SECTION 4 CIRCUIT DESCRIPTION

Change information, if any, affecting this section will be found at the rear of the manual

Introduction

This section of the manual contains a block diagram description and a circuit description of the 7S11 Sampling Unit. The block diagram description is an expansion of Section 3, Basic Sampling Principles. The circuit description follows the sequence of diagrams at the back of this manual.

BLOCK DIAGRAM

Ref to Fig 4-1 and the complete block diagram at the back of the manual during the following description. Both fig 4-1 and the complete block diagram include a simplified block of a typical sampling head. The 7S11 Sampling Unit functions as part of a sampling system only when a sampling head is installed, so a sampling system only when a sampling head is installed, so a sampling head block is included.

Feedback Loop and Pulse amplifier Chain

Fig 4-1 relates to fig. 3-4 and Fig 3-8 The reconstructed signal out of the Memory block (Fig 4-1) is the first point in the 7S11 at which the amplitude is always a standard value of 0.5 volt per CRT vertical division. There is no signal between the sampling head output and the Memory input when the sampling head input signal just after each sample is taken. Signals through the amplifier chain are greatest in amplitude when the sampled signal is at its full amplitude difference from the last sample. This is called the error signal.

To complete the association Fig 4-1 with Section 3, the following describes the operating cycle:

- a. The sampling head bridge applies an error signal to the head preamp whenever there is a voltage difference at the bridge input and output terminals at sampling time. The error-signal voltage amplitude is just a few per cent of the difference (sampling efficiency), and the pulse duration out of the bridge is equal to the bridge conduction time. A small storage capacitance at the head Preamp input time-stretches the pulse so the pulse chain can amplify the error signal pulses at moderate rates of rise.
- b. The time stretched pulse is amplified by the 7S11 Post Amplifier and sent forward into the attenuating network made up the NORMAN/SMOOTH switch,

the DOT RESPONSE Control and the forward Attenuator portion of the Units/Div switch.

- c. The AC Amplifier again amplifies the pulse and applies it to the Memory circuit during conduction time of the Memory Gate. In effect the error signal charge applied to the head Preamp is then transferred to the feedback capacitor of the Memory circuit.

- d. The Memory circuit applies its error signal corrected output voltage to both the vertical amplifier and the feedback attenuator and sampling head bridge output terminal. Control of the input deflection factor by the forward and feedback Attenuators is describe near the end of Section 3. The DOT RESPONSE control is also described in Section 3.

Vertical Output Amplifier

The INVERT/+UP switch and the Vertical Output Amplifier drive the oscilloscope vertical amplifier stage

Sweep Unit Drive

Drive from the timing unit is applied to the sampling head avalanche and snap-off and the Memory gate Driver. The timing unit controls the free running oscillator used in the 7S11

Sampling Operation. The 7S11 is a single-channel sampling unit when used with a 7T11 or other sampling sweep unit in a 7000-series oscilloscope.

For dual-channel operation, another 7S11 must be installed in the adjacent vertical compartment of the oscilloscope. Interconnection between the two 7S11's and the sampling sweep unit are made by connecting-shoes on the plug-ins. These interconnections combine the Trigger Logic circuits of the two 7s11's into a bistable multivibrator, and complete the other connections necessary to provide amplification of internally-generated triggers. For external trigger operation, the sampling sweep Internal

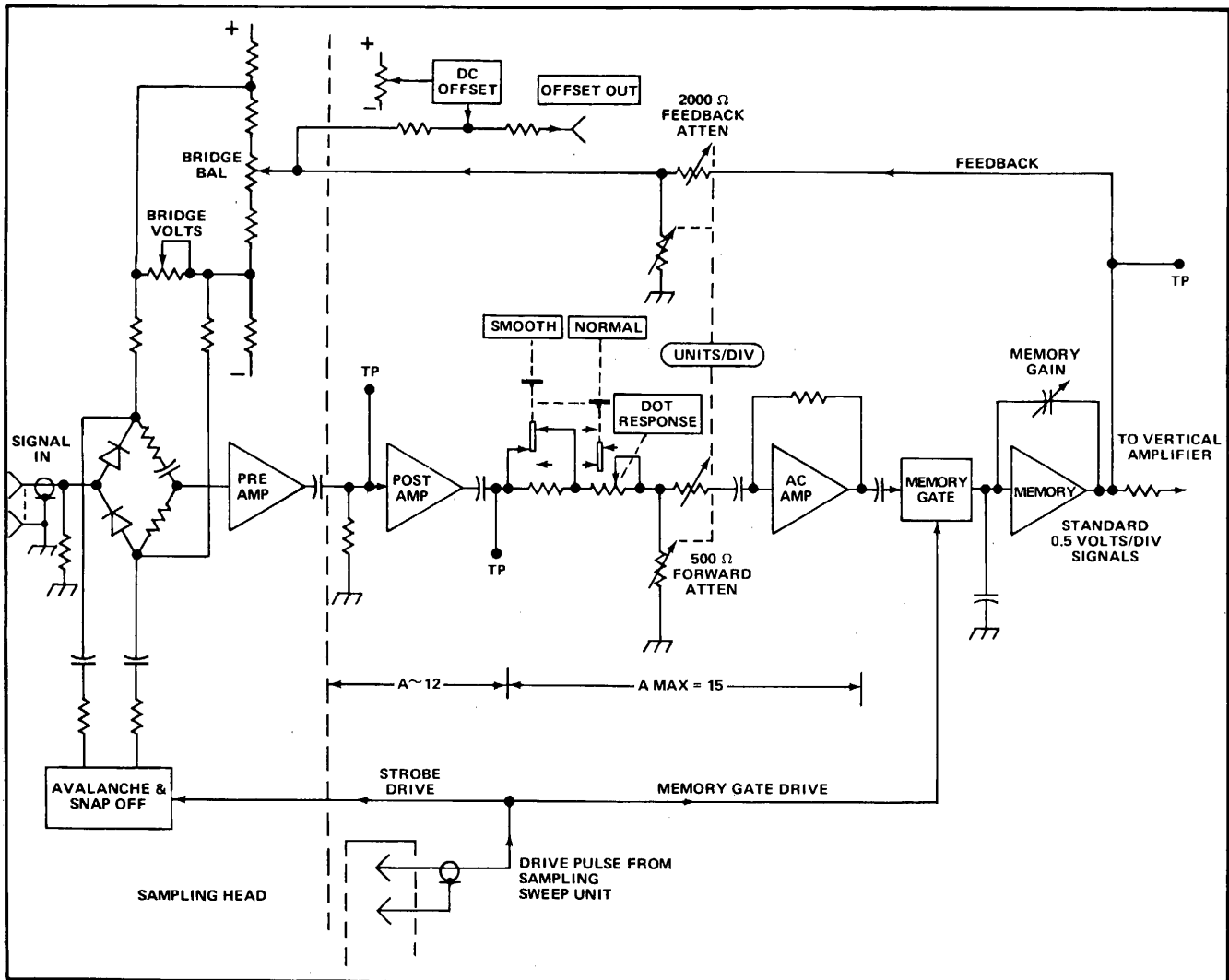

Fig. 4-1. The 7S11 and sampling head feedback loop block diagram

Mode trigger amplifiers and the bitable multivibrator are disabled.

Non-Sampling Operation. When the 7S11 is used for dual-channel real time operation in company with a non sampling time base unit, no sampling drive pulse is available, nor is a ground provided for the Real Time Oscillator and Trigger Logic multivibrator. The Real Time Oscillator will oscillate at the specified frequency and drive the Memory Gate Driver and the CRT blanking circuit. Internal trigger is obtained from the Real Time Trigger block. The operational differences between the two types of time bases are explained in the Operating Instructions, Section

Readout Logic

The Readout logic in the 7S11 provides the necessary time-slot current to operate the Scale Factor readout on the indicator oscilloscope. Currents supplied from the 7S11 control the display of decimal magnitude, Normal/Invert, Normal/Uncal, 1-2-5 Scaling and the symbols m, A, V and 1. The indicator oscilloscope manual includes the details of Scale Factor Readout operation.

CIRCUIT DESCRIPTION

The following circuit description follows the sequence of the diagrams in Section 9.

Trigger Logic

The Trigger Logic circuit (see Post Amplifier and Attenuators circuit diagram) consists of Q108, Q113, Q116 and associated components. The circuit sets the level for forward bias of the timing unit trigger amplifier so that the trigger is passed from the sampling head to the timing unit (see Fig. 4-2A). The Internal setting of the timing unit trigger switch grounds the base of Q113 through R109, and the collector of Q108 through R108-R109. Q108 is reverse biased by current through R102 and CR108 to clamp the base at +15.6 volts. CR113 is off and Q113 is forward biased by the current through R111 and R109. Conduction causes Q113 collector to be more positive than the cathode of CR116 so that both CR116 and CR115 are off. CR116 supplies current to the lamp, DS116, indicating that this 7S11 is supplying the internal trigger to the timing unit. R115 sets the base current for Q116.

Setting the trigger switch in the timing unit to EXT removes the ground from R109, which turns on CR113 and clamps Q113 base at 5.6 volts, a reverse bias. Q108 remains at reverse bias as with Internal trigger operation. CR115 clamps Q116 base at -0.6 volt so Q116 is off and the INT TRIG lamp is off. CR116 is on reverse biasing the timing unit transistor, so no trigger signal from the sampling head can trigger the timing unit. Two 7S11 units operated together will complete the bi-stable multivibrator shown in Fig. 4-2B. Selection of the desired 7S11 as the Internal trigger source is done through the turning off of Q108 in that unit.

The Internal setting of the trigger switch in the timing unit provides ground to both halves of the bistable multivibrator. Pushing the INT TRIG switch momentarily places a positive trigger on Q108 (in the desired 7S11), puts reverse bias between base and emitter, and turns on CR108, which clamps Q108 base at +15.6 volts. The positive trigger is applied to Q108 collector in the second 7S11, which turns that Q108 on, adding current through R109 to the current through R111 and R109 to clamp Q113 base at +5.6 volts through CR113. Operation of the Off 7511 is the same as discussed for External trigger operation with a single 7S11. The On 7S11 operates similar to a single 7S11 in Internal trigger operation.

Switching the timing unit trigger switch to one of the EXT positions removes the ground from the R109 common point. The R109 common point rises to +5.6 volts, the clamped voltage at the bases of the Q113's, so the multivibrator remains in the state in which it was set. The multivibrator remains in the state in which it was set when the timing unit trigger mode is again placed at Internal unless the other 7S11 INT TRIG button is pushed. Post Amplifier and Attenuators

Post Amplifier and Attenuators

The Post Amplifier and Attenuators diagram includes the Post Amplifier, Forward and Feedback attenuators, DC Offset, and the Trigger Logic.

The Post Amplifier is a two-stage non-inverting operational amplifier with AC coupled complementary emitter followers between the second stage and the output. The input impedance is 90.9 A, which properly terminates the coaxial cable feed from the sampling head. Output impedance is very low to provide signal current to the 500 Ohm Forward Attenuator. Total AC gain is approximately 12, producing a 2.4 volt output signal for a 0.2 volt input signal. DC gain is essentially unity and feedback keeps the amplifier within its proper dynamic range.

Q123 and Q128 are the amplifier transistors, and Q133 and Q136 are the output emitter followers. Q133 ensures low output impedance for positive output signals, and Q136 ensures low output impedance for negative output signals. Each emitter follower has a resistor in the collector for parasitic oscillation suppression. C134 permits the output emitters to be at different DC voltages and ensures that the emitter of the non-driving transistor follows the output voltage.

Output of the Post Amplifier is AC coupled to the NORMAL/SMOOTH switch, DOT RESPONSE control and the Forward Attenuator (part of the Units/Div switch).

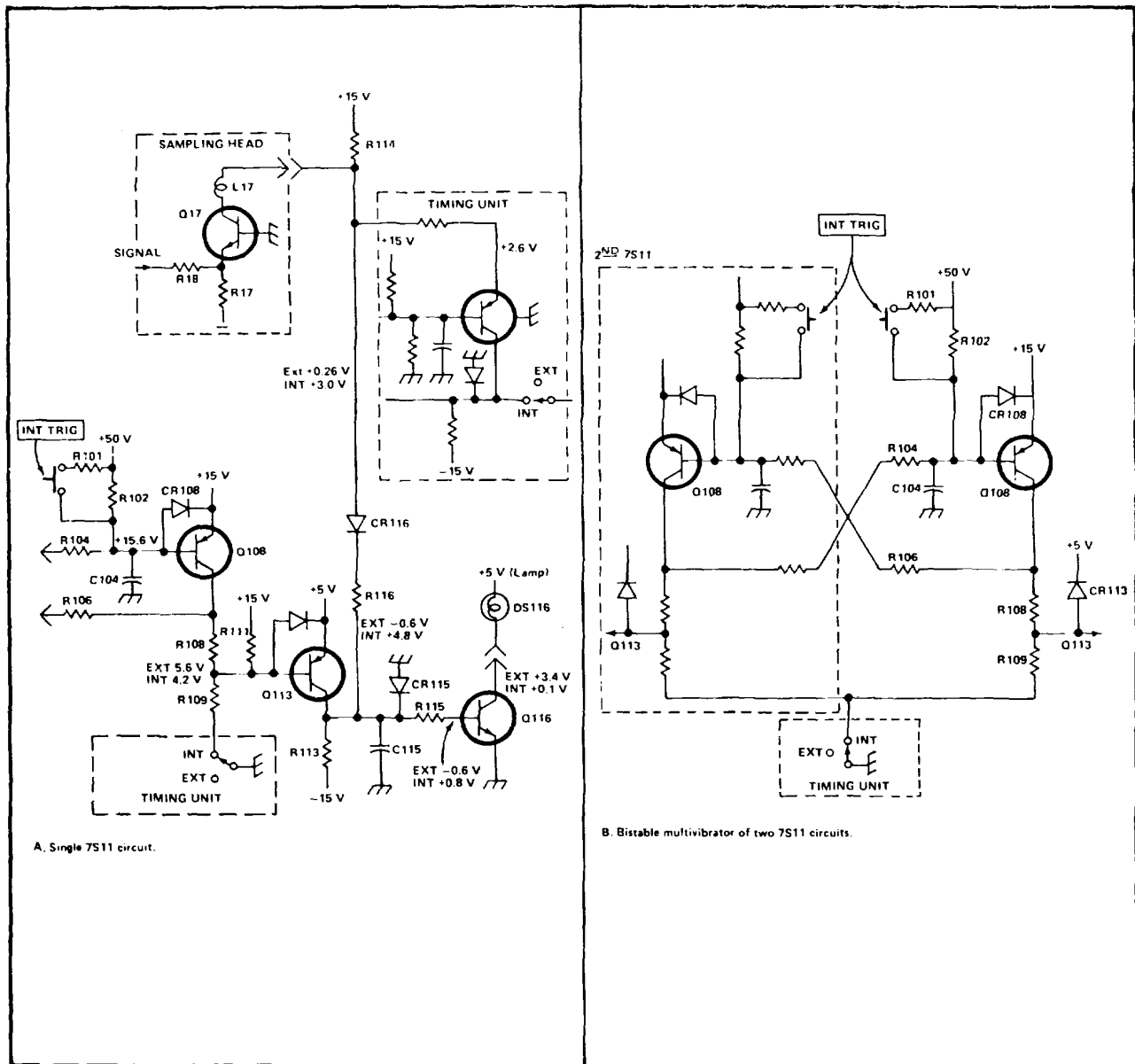

Fig. 4-2. Trigger Logic circuit

the Forward Attenuation Network consists of the NORMAL/SMOOTH switch, the DOT RESPONSE control, and the Forward Attenuator portion of the Units/Div switch

Pushing the SMOOTH switch introduces R141 in series with the Post Amplifier output signal. reducing the loop gain to 0.3 or less compared to loop gain in the NORMAL setting. R142 maintains a constant 500 0 load on the output stage for time constant and amplitude considerations.

The Forward Attenuator, made up of resistors R145A through R145G, presents a constant 500 Ω load to the driving side. The input resistance to the AC Amplifier is changed by the forward attenuator from 1 kΩ to 100 kΩ in seven steps. Six of the seven resistors are always in parallel connection to ground, with the seventh in series with the signal to the AC Amplifier input. Signal pulse amplitude across the forward attenuator input resistance (500Ω to ground) does not change when the Units/Div switch position is changed. Attenuation occurs because of a changing current drive into the low impedance of the operational AC

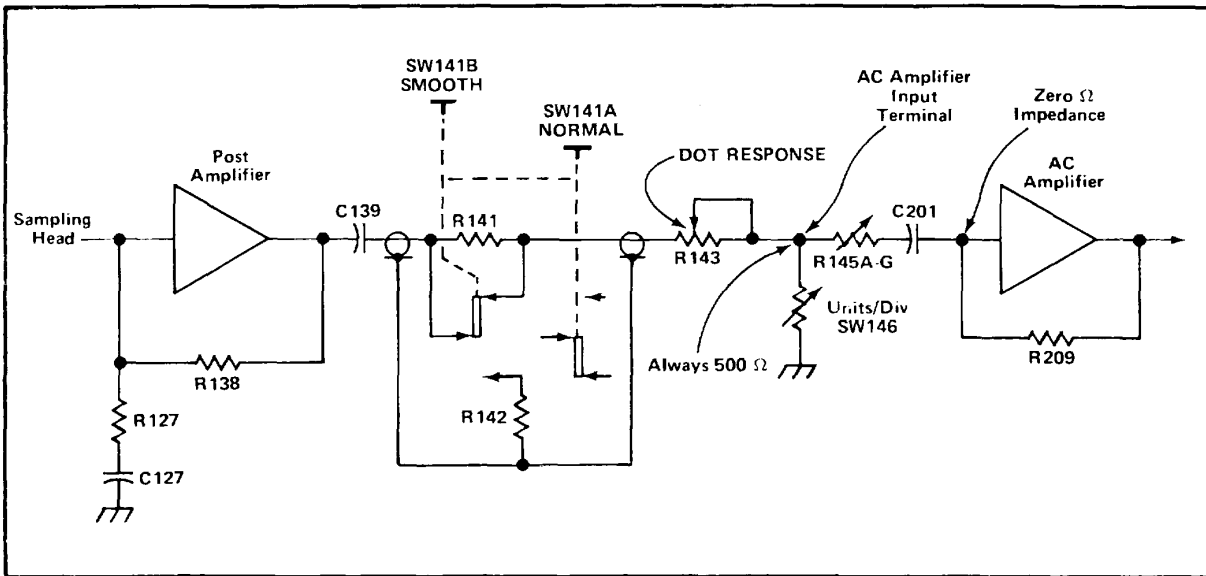

Fig. 4-3. Forward attenuation network, showing that the output resistor of the Units./Div forward Attenuator is actually the Amplifier input resistor.

Amplifier, Fig 4-3 shows the full forward attenuator network and identifies the AC Amplifier input terminal

The AC Amplifier gain is controlled by the ratio of feedback resistor R209 to the value of the series element of R145. The gain changes from 15 at 2 units/div to 0.15 at 200 units/div.

The Forward Attenuator portion of the Units/Div switch is ganged with the Feedback Attenuator portion. The result is that changing the Units/Div switch does not change the dot response (or loop gain). Changing either the NORMAL/SMOOTH SWICH OR the DOT RESPONSE control changes the forward signal, and thus changes the loop gain.

The Feedback Attenuator and the DC Offset are connected together within the sampling head where they are combined and applied to the Sampling Bridge output terminals output terminals. The Feedback Attenuator receives the Memory circuit output signal from a very low impedance. The attenuator places one of seven resistors in series with the Memory output signal, and the other six resistors are paralleled to ground as slightly more than 2000Ω. Maximum attenuation (at 2 Units/Div) allows 0.42% of the Memory signal to pass to the Sampling Bridge circuit. Minimum attenuation (at 200 Units/Div) allows 0.42% of the Memory signal to pass to the Sampling Bridge circuit. Minimum attenuation (at 200 Units/Div) allows 42% is corrected to exactly 0.40% and 40% by the parallel value of r147, R149 and the 53 kΩ to ground inside the sampling head. (The forward Attenuator ratio or AC Amplifier gain ratio of 100:1, and the feedback attenuator ratio of 1:100 ensure that the

loop gain is not altered throughout the Units. Div switch range).

The DC Offset Circuit is a single transistor emitter follower that converts the fairly high resistance of the Dc OFFSER control to a fairly low resistance at the emitter. Q163 emitter voltage follows the voltage of the arm of the DC OFFSET control, offset by -0.6 volt. Q163 output resistance, R165(19.1kΩ) and 2000 Ω of the Feedback Attenuator. Thus the DC OFFSET voltage at Q163 emitter develops a fixed voltage across the Feedback Attenuator 2000 Ω regardless of the Units/Div switch setting

Memory

The memory diagram includes the AC Amplifier, the Memory Gate, and the Memory Amplifier.

The AC Amplifier (whose gain is described above with the Forward Attenuation Network) is an inverting operational amplifier with AC coupled complementary emitter followers at the output. Q204 is the voltage amplifier, Q208 emitter follower adds current gain to Q204 collector signal, and q212-Q214 provide the very low output resistance.

The amplifier input is AC coupled by C201 to permit the amplifier DC operating voltages to be independent of the change made in input resistance by the base voltage, the collector voltage changes

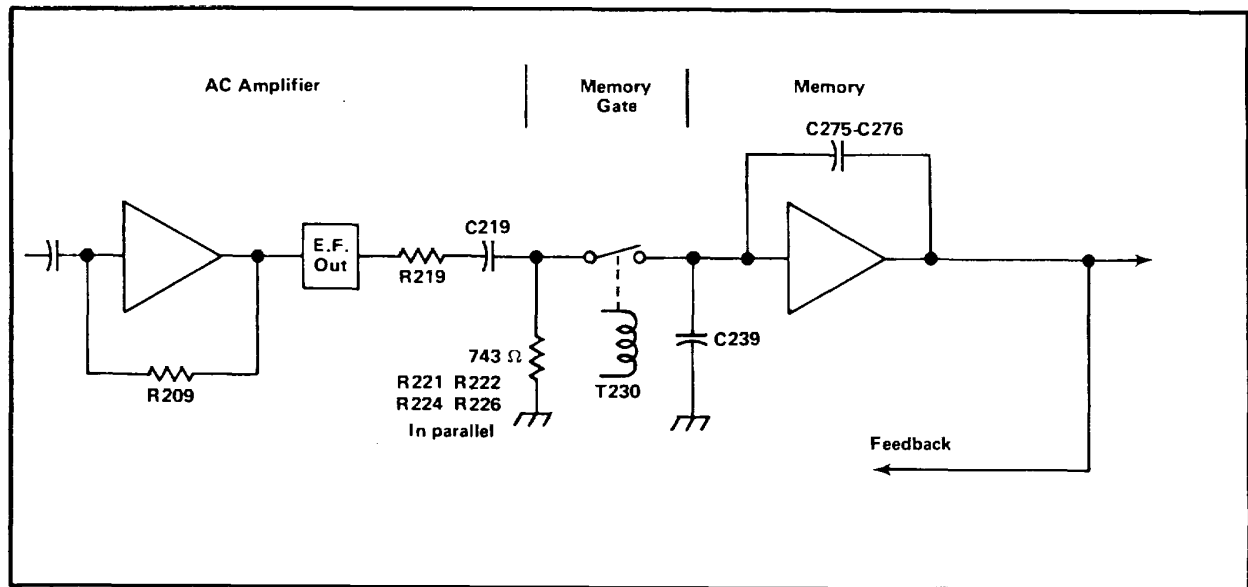

Fig. 4-4. Basic Memory Gate circuit between AC Amplifier and Memory Amplifier.
(Detailed block of Memory diagram.)

in the opposite direction and Q208 emitter drives current of the opposite polarity through R209 back to the 0204 base. The input and feedback signal currents are nearly equal, keeping the base voltage almost constant. The output signal is coupled to the Memory gate by Q212, Q214, and R219 C219. R219 limits the signal output current, ensuring that C219 does not receive a significant charge for output signals of high pulse amplitude.

CR201 and CR206 provide protection when transistors are removed from their sockets. CR201 conducts if Q208 is removed, and CR206 conducts if Q204 is removed. Parasitic suppressing resistors include R206, R207, R211, R213 and R214

The Memory Gate is a special pulse-driven diode gate that ensures a very high input resistance to the Memory except for about 0.15 to 0.20 us at the time of each sample. During the conduction time, the Memory Gate is a low impedance that allows the AC amplifier to introduce a charge into the Memory.

. **Fig. 4-4** is a detailed block diagram of the circuits on the Memory diagram. The Memory Gate is represented by a resistor, a coil and a relay switch. The resistor is the parallel value of the four biasing resistors which ensure that the four gating diodes are normally not conducting. This equivalent circuit shows that the Memory input is zero volts when there is no error signal at sample time.

Looking from the Memory Gate output toward its input, the four gating diodes are normally reverse biased by the

voltage of Zener diode VR221. (Two of the four diodes provide very high reverse biased leakage resistance, although they don't turn off very fast. The other two turn off fast at the end of the gating pulse, although they don't provide both sides of the memory gate diodes.

The gate diodes are forward biased into conduction by T230 at the time of each sample due to the drive pulse from the Memory Gate Driver. T230 is a toroidal transformer specially wound to balance capacitive and inductive coupling to the two secondary windings. The winding with only one end connected provides the capacitive balance. The magnetic toroid core provides the inductive balance. Thus, the drive pulse is converted to identical drive signal to ensure that the output junction of the four diodes accurately divides the 5 volts of VR221-C221. This places the junction of CR237-CR239 at ground when no error signal is applied from the AC Amplifier. The functions of the two limiting diodes CR224-CR226 and the Memory Gate are discussed in the Memory description next. R229, R231 and CR232 are shunt, damping loads to T230 which minimize self-inductance ringing when the memory gate drive pulse ends.

The Memory amplifier is an integrating operational amplifier with special low leakage (high DC resistance) in-pu-t circuit. The input and feedback components are capacitors, making the AC input impedance very low. The internal high gain ensures a very low output resistance; so that as

long as there is no change at the input, the output DC voltage remains stable. The input low leakage circuit has no DC connection to ground except during the time the Memory Gate conducts.

The Memory amplifier is specially decoupled from the power supplies because the output stage (0262 and 0266) can require a current pulse as great as 30 mA for a 20 volt output change at sample time. The decoupling networks are R261-C261 and R267-C267. L268 in the VERT SIG OUT and feedback lead presents a high impedance to the Memory output for high frequency (fast change) signals. The inductor ensures that the output amplifier does not have to provide high current to the output load. L268 slows the output signal response, but at a time when the CRT is blanked.

A dual junction FET (0242) is the input stage. It is biased for essentially no leakage at the input gate, and the stage has high voltage gain at the in-phase output drain lead. Any voltage change at the left Q242 gate lead is amplified and applied to the inverting amplifier Q256. Q256 collector circuit applies proper bias to both bases of the output complementary emitter follower pair, 0262-0266 and re-stores the DC level negatively so a zero input signal (at the left side of 0242) is also a zero output signal. 0256 collector and 0262-0266 output lead operate linearly through the range of +10 to -10 volts.

Because of the high open-loop gain, the Memory Amplifier does not have the fast risetime that the prior amplifier have. The AC Amplifier output pulse duration is shorter than the Memory Amplifier risetime. C239 at 0242 input gate lead accepts some of the charge from the AC Amplifier, stores it until the Memory amplifier can respond, and then loses the charge again due to feedback current.

A cycle of operation at sample time takes the following sequence:

a. The Memory Gate drive pulse arrives at essentially the same time the Sampling Bridge is strobed into conduction. The CRT is blanked during this same time. Propagation delay through the three AC coupled amplifiers is quite short. (The fact that the Memory amplifier input is always at zero volts, and the Memory Gate is balanced around zero volts, prevents any false changes in C275-C276 charge. Therefore, there is no change in the Memory amplifier output voltage during the time the Memory Gate conducts ahead of the arrival of the AC Amplifier output signal).

b. The AC Amplifier applies a pulse signal through R219-C219 and the Memory Gate to the Memory amplifier put. C239 accepts some of the charge until the amplifier begins to respond, driving an equal and opposite current back to the input through the feedback capacitors.

c. Since the AC Amplifier output signal is applied to the Memory Amplifier "virtual signal ground" input, C219 receives about 10% of the total error signal charge before the Memory Gate stops conducting. Thus, as the AC Amplifier output returns to its quiescent voltage, the output side of C219 overshoots. The 743 0 of the Memory Gate discharges C219 well in advance of the next error signal.

If the 7S11 is displaying a single transition step over the full graticule with the display starting at the lower left and ending at the upper right, the error signal is very large during retrace. Such large error signals (even during random process sampling) apply a significant charge to C219. In this case, the overshoot at the end of the error signal pulse is large enough to cause one side of the Memory Gate to conduct and remove some of the intended charge in the feedback capacitors. Two normally non-conducting clamp diodes prevent such undesired removal of memory charge. CR224 and CR226 help to discharge C219 if it receives too great a charge during the Memory Gate conduction time, thus preventing false amplitude displays. These two diodes do not conduct at any other time.

d. As the Memory Gate drive pulse ends, C239 charge is removed by the Memory amplifier feedback. This causes the Memory output voltage to continue changing toward proper amplitude for a short period of time after the Memory Gate stops conducting. As soon as C239 is returned to normal, the output voltage remains fixed until the next sample.

The actual resting voltage at the left Q242 gate may not be precisely zero, but it is within a few millivolts of zero. Any deviation from zero can be due to several things: slight differences in conduction of the Memory Gating diodes; slight differences in resistance of the four Memory Gate biasing resistors; some small error signal being generated at each sample time even when the sampling head input signal is zero. 0242 right gate voltage is adjusted over a small range to allow the above-normal variations. Adjustment of the right Q242 gate voltage is called the Smoothing Balance adjustment, because it is set so there is no change in Memory amplifier output when the forward attenuation is changed. The forward attenuation is changed by pushing either the NORMAL or SMOOTH switch. Whatever small zero-input error signal may exist in the system, it always has an average value that will not alter the memory stored charge. Changing the forward attenuation changes the peak amplitude of the residual error signal, but not its average voltage zero value. Therefore, 0242 gate voltage is adjusted to equal the average voltage zero value of the residual error signal, and the trace does not move when the NORMAL or SMOOTH switch is pushed.

Memory output voltage limits of about +10 and -10 are

The diodes, CR272 and CR274, are reverse biased by 9volts each. If the output tries to go more positive than about +10 volts, CR274 conducts ($9 + 0.6 = 9.6$ volts)reducing the amplifier gain to much less than 1. If the output tries to go more negative than about -10 volts,CR272 conducts, reducing the amplifier gain to much less than 1. The clamping diodes prevent the amplifier transistors from saturating at the time of an overdrive signal, and thus ensure fast transition away from the clamped voltage at the next sample.

CR242 conducts only when Q242 is removed from socket while the power is on, thus keeping -50 volts off the source leads when Q242 is plugged in. Temperature compensation of the amplifier is accomplished effectively by the source-coupled FET input amplifier and CR257 and CR259. Q252 is an active load for Q242. This active load causes the signal current to the base of Q256 to be about twice the signal current out of the drain of Q242. Q52 also serves to speed up the circuit response time. The two identical halves of Q242 compensate each other so their total current does not change with temperature change. CR257 and CR259 have junction-drop temperature coefficients similar to Q262 and Q266 base-emitter junctions, and thus stabilize the output circuit

The Memory amplifier drives the front panel vertical output jack through a resistive attenuator that delivers 40%of the memory signal through 10 k Ω . The jack is labeled VERT SIG OUT, 0.2 V/DIV, 10 k Ω . The memory output signal is the standard deflection signal mentioned in Section3, and is 0.5 volt/CRT division. The Memory drives the Vertical Output through the Invert switch.

NOTE

The Memory output limits of ± 10 volts at 0.5 V/div equal 40 CRT divisions of display area, required when operating at high sensitivity and many div is ins of DC OFFSET. The whole pulse amplifier chain is designed for full response and fast recovery so that on-screen displays have accurate deflection factors and DC offset reference. Such operation provides accurate signals at the front panel Vert Output jack, even though much of the signal is not displayed on the CRT

Output Amplifier

The Output Amplifier diagram includes the Vertical Output and the Real Time Trigger.

The Vertical Output amplifier follows the Invert switch, INVERT/+UP which sets the signal path from the Memory circuit. The Vertical Output amplifier consists of a two- stage push-pull balanced circuit. The first stage includes the VARIABLE gain control and the Position adjustment in the

common emitter circuit of Q314 and Q334. The Position adjustment changes the current through each side of push-pull circuit for a center-screen output voltage. Gain of mum gain occurs with minimum resistance between the two emitters. The Variable balance adjustment sets the level on the base of Q334 so that no current flows between emitters under no-signal conditions. This ensures that there is no ground reference shift of the trace when the VARIABLE control is turned.

The second stage of the Vertical Output amplifier includes the GAIN adjustment, which varies the emitter generation of Q344 and Q354. The push-pull outputs are applied to the oscilloscope vertical amplifier as a current source.

The Real time Trigger amplifier (Q362 and Q366 is a balanced circuit with push-pull input from the first stage of the Vertical Output amplifier. Positive and negative trigger signals are applied to the timing unit through the oscilloscope interface.

Gate Generator

The Gate Generator diagram includes the Real Time Oscillator and Memory gate Driver. The sampling drive pulse from the sampling sweep trigger event and further delayed in the Delay circuit. The Memory Gate Driver circuit provides the proper time-positioning of the Memory Gate pulse so that the error signals are gated at the correct time. The Real time Oscillator oscillates at about 47.5 kHz to start the sampling process when driven by a non-sampling sweep unit.

The Memory Gate Driver is preceded by a blocking oscillator (Q430 and associated components) which standardizes sampling sweep. Until the positive sampling drive pulse occurs. Q430 is cut off and its collector is at +15 volts. The arriving pulse causes the transistor to start conduction as a normal amplifier, but the regenerative feedback from T430 via CR430 quickly drives Q430 into saturation. As the current through T430 reaches a steady value, the counter-EMF generated in the secondary of T430 is stopped by the reverse-biasing of CR430. Q430 remains in saturation until cut off when the sampling drive pulse ends.

The Memory Gate Driver circuit consists of a low current amplifier (Q452) and a monostable multivibrator (Q456-Q464). At quiescence, the base voltage of Q452 (determined by the DELAYCONTROL SETTING) IS BETWEEN +11 AND +15 VOLTS. The current through Q452 is about 1 mA, which is insufficient to forward-bias Q456. Diode CR455 holds the base of Q456 at -15.6 volts to ensure that the

Memory Gate Driver output does not change as the DELAY control is changed. Q464 is reverse-biased by the current through R461, R460 (Memory Gate Width adjustment), CR462 and R462, and its base voltage is clamped at +0.6volts by CR464. The collector voltage of Q464 rests at -14.5 volts

When the blocking oscillator fires, the negative-going transition at Q430 collector is integrated into a fast negative going ramp by R434 and C434. The ramp voltage drops to a level (determined by the DELAY control setting) sufficient to forward-bias CR434 and shortly thereafter, Q452 is driven to conduct harder. The additional current required by the emitter of Q452 is furnished by C451, and the collector of Q452 rises far enough to forward-bias Q456. When Q456 conducts its collector voltage drops, the negative change is coupled by C460 to reverse-bias CR462, which turns on Q464. R464 applies a steady 50 mA current to the Memory Gate transformer primary (T230) for about 180 nanoseconds. The positive-going change at the collector of Q464 is coupled back to the base of Q456 as positive feedback, holding Q456 in conduction.

The negative-going transition at the collector of Q456 is also coupled via C457 and C447 to the base of Q452, holding that transistor in hard conduction. The Strobe for the sampling head is taken from the junction of C457 and C447.

The regeneration from C447 to Q452 does not last as long as that holding Q456 in conduction, but since the base voltage of Q456 cannot go more positive than about -14.4volts, Q452's collector voltage does not change. The position of the Memory Gate Width control adjusts the charge rate of C460 and therefore the conduction time of Q464. The conduction time and gate duration vary directly with the resistance of R460.

As C460 charges toward +15 volts, CR462 again conduct turns Q464 off, ending the Memory Gate pulse and the drive to the base of Q456. However, Q456 was in saturation, so it does not stop conducting immediately. The collector voltage of Q456 rises positive about 350 ns after the transistor was turned on. This RC rise is slow and does not couple much energy through either C457 or C460.

Real Time Oscillator

The Real Time Oscillator consists of two blocking oscillator circuits. One, a low frequency blocking oscillator, is composed of transistor Q404 and associated circuitry. The second, a high frequency blocking oscillator, is composed of transistors Q408, Q410 and associated circuitry. The Real Time Oscillator circuit is controlled by the oscillator control line from the sampling sweep unit. When the

latter control line is at the high state, neither of the two oscillators can operate since their source of current is shunted by diodes CR413 and CR414 (see Gate Generator diagram 4). When the oscillator control line is at the low state, both diodes are back biased and the oscillators can operate.

The low frequency blocking oscillator uses transformer coupling from emitter to base to perform the oscillator action. During equivalent time sampling operation, the anode of CR413 is held at about +.6 volt. Most of the current from R404 travels through CR413, and Q404 remains reverse biased. When the sampling sweep unit TIME/DIV switch is rotated to a real time position, the oscillator control line drops to a point slightly below ground potential and the cathode of CR413 drops to about -.6 volt. As the cathode of CR413 drops below ground potential, Q404 begins to conduct. Current through T430 couples positive feedback via CR401 to the base of Q404, driving it further into conduction. The current for the rapid saturation of Q404 is furnished first by C406; then as the emitter of Q404 rises positive, CR402 begins to conduct and clamps the emitter of Q404 at about +.6 volt. The field around T400 begins to collapse, rapidly driving Q404 into cutoff. The result at the base of Q408 is a single positive pulse used to drive the high frequency blocking oscillator.

When the oscillator control line is at the high state, the anode of CR414 is at approximately ground potential, which is sufficient for the diode to conduct. Since there is no difference in potential from the cathode of CR413 to the cathode of CR414, both Q408 and Q410 are reverse biased when the oscillator control line is at the high state. When the sampling sweep unit is switched to a real time TIME/DIV setting, the oscillator control line drops to approximately -0.6 volt. The cathode potential of CR414 drops to approximately -1.2 volts at which point Q410, CR411 and Q408 begin conduction (the base of Q408 is pulled positive by the conduction of Q404). The change in the collector of Q410 through the primary of T410 starts positive feedback to the base of Q410. Q410 is driven rapidly into saturation. When Q410 saturates, the collapsing field across T410 then drives Q410 into cutoff. The result is a sharp negative pulse, which is coupled across C418 to the base of Q422. Although the repetition rate of the high frequency oscillator depends primarily on the output rate of the low frequency oscillator, the high frequency oscillator output frequency can be varied by the repetition rate adjustment, R415.

Transistor Q422 inverts the negative pulse from the high frequency oscillator and drives the base of Q430 when the sampling sweep unit is in real time operation.

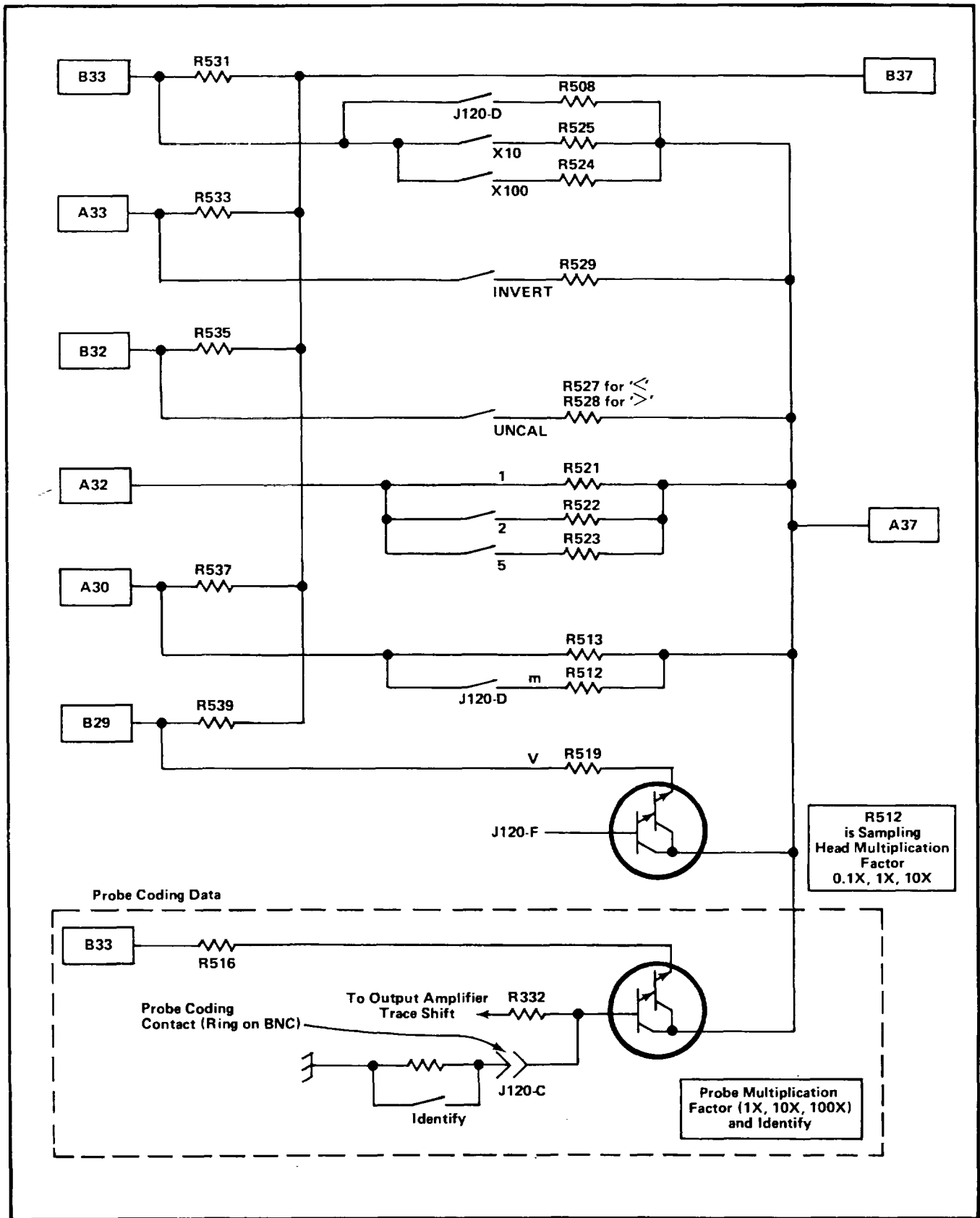

Fig. 4-5. Simplified Readout Logic Coding.

Readout Logic

The Readout Logic diagram shows the circuitry used to generate different current levels for analog coding. The transistors and diode are used to simplify the switching. Fig. 4-5 shows a simplified diagram of the switches and resistance's used for encoding. In some sampling heads there is no probe coding. Probe coding is performed via a ring around the BNC connector and 0506 and 0516 which convert the resistance value in the probe into analog current pulses during time slot 1, B33. Trace identification is implemented by grounding the probe coding ring around the BNC connector.

Power Distribution and Decoupling

The Power Distribution & Decoupling diagram contains the power supply decoupling networks and internal power supply for the S-series sampling head. Power from the indicator oscilloscope enters through the center circuit board at the rear.

The -12.2 Volt Supply consists of the comparator Q624 and the series regulator 0626. The output voltage is compared with the reference divider voltage of R621-R622.

The voltage reference divider, R621 and R622, applies approximately -12.2 volts to the base input of 0624. This reference is coupled to the emitter-base junction of the output side of 0624 through common emitter resistor R624.

A positive-going change in voltage decreases the current through the output collector of 0624 which places a more negative voltage on the base of 0626. As the current through 0626 increases, the output voltage decreases to its proper value.

0624 is protected from reverse bias by diodes CR624 and CR625.

SECTION 5 MAINTENANCE

Change information, if any affecting this section will be found at the rear of the manual.

Introduction

This section of the manual contains maintenance information for use in preventive maintenance, corrective maintenance or troubleshooting of the 7S11.

PREVENTIVE MAINTENANCE

General

Preventive maintenance consists of cleaning, visual inspection, lubrication, etc. Preventive maintenance performed on a regular basis will help prevent instrument failure. The severity of the environment to which the 7S11 is subjected will determine the frequency of maintenance.

Cleaning

The 7S11 should be cleaned as often as operating conditions require. Accumulation of dirt in the instrument can cause overheating and component breakdown. Dirt on components acts as an insulating blanket and prevents efficient heat dissipation. It also provides an electrical conduction path.

The top and bottom covers of the instruments in which the 7S11 operates provide protection against dust in the interior of the instrument. Operating without the covers in place will require more frequent cleaning.

CAUTION

Avoid the use of chemical cleaning agent which might damage the plastic used in this instrument. Some chemicals to avoid are benzene, toluene, xylene, acetone or similar solvents.

External. Loose dust accumulated on the outside of the 7S11 can be removed with a soft cloth or small paint brush. The paint brush is particularly useful for dislodging dirt on and around the front-panel controls. Dirt which remains can be removed with a soft cloth dampened in a mild solution of water and detergent. Abrasive cleaners should not be used.

Interior. Dust in the interior of the instrument should be removed occasionally due to its electrical conductivity under high-humidity conditions. The best way to clean the interior is to blow off the accumulated dust with dry, low-velocity air. Remove any dirt which remains with a soft paint brush or a cloth dampened with a mild detergent 3rd water solution.

Lubrication

The reliability of potentiometers, rotary switches and other moving parts can be increased if they are kept properly lubricated. Use a cleaning-type lubricant (such as Tektronix Part No. 006-0218-00) on switch contacts. Lubricate switch detents with a heavier grease (such as Tektronix Part No. 006-0219-00). Potentiometers should be lubricated with a lubricant which will not affect electrical characteristics (such as Tektronix Part No. 006-0220-00). Do not over-lubricate. A lubrication kit containing the necessary lubricants and instructions is available from Tektronix. Order Tektronix Part No. 003-034200). The VARIABLE on/off slide switch uses Beacon #325 grease, Tektronix Part No. 006-0147-00.

Visual Inspection

The 7S11 should be inspected occasionally for such defects as broken connections, improperly seated transistors, damaged circuit boards and heat-damaged parts.

The remedy for most visible defects is obvious; however, care must be taken if heat-damaged parts are located. Overheating is usually only a symptom of trouble. For this reason, it is essential to determine the actual cause of overheating before the heat-damaged parts are replaced; otherwise, the damage may be repeated.

Calibration

To ensure accurate measurements, check the calibration of this instrument after each 500 hours of operation or once every six months.

Parts Identification

Identification of Switch Wafers. Wafers of switches shown on the circuit diagram are numbered from the first

wafer located behind the detent section of the switch to the last wafer. The letters F and R indicate whether the front or the rear of the wafer is used to perform the particular switching function. For example, the designation 2R printed by a switch section on a schematic identifies the switch section as being on the rear side of the second wafer when counting back from the front panel.

Wiring Color Code. The wiring in the 7S11 is color coded to facilitate circuit tracing

Resistor Coding. The 7S11 uses a number of very stable metal film resistors identified by their gray background color and color coding.

If the resistor has three significant figures with a multiplier, the resistor will be EIA color coded. If it has four significant figures with a multiplier, the value will be printed on the resistor. For example, a 333 kΩ resistor will be color coded, but a 333.5 kΩ resistor will have its value printed on the resistor body.

The color-coding sequence is shown in Fig. 5-1.

Capacitor Marking. The capacitance values of common disc capacitors and small electrolytic are marked in micro-farads on the side of the component body. The white ceramic capacitors used in the 7S11 are color coded in picofarads using a modified EIA code (Fig. 5-1).

Diode Color Code. The cathode end of each glass encased diode is indicated by a stripe, a series of stripes or a dot. For most silicon or germanium diodes with a series of stripes, the color-code also indicates the type of diode or identifies the Tektronix Part Number using the resistor color-code system (e.g., a diode color-coded blue or pink-brown-gray-green indicates Tektronix Part Number 152-0185-00). The cathode and anode end of metal-encased diodes can be identified by the diode symbol marked on the body.

Parts Replacement

All parts used in the 7S11 can be purchased directly through your Tektronix Field Office or Representative.

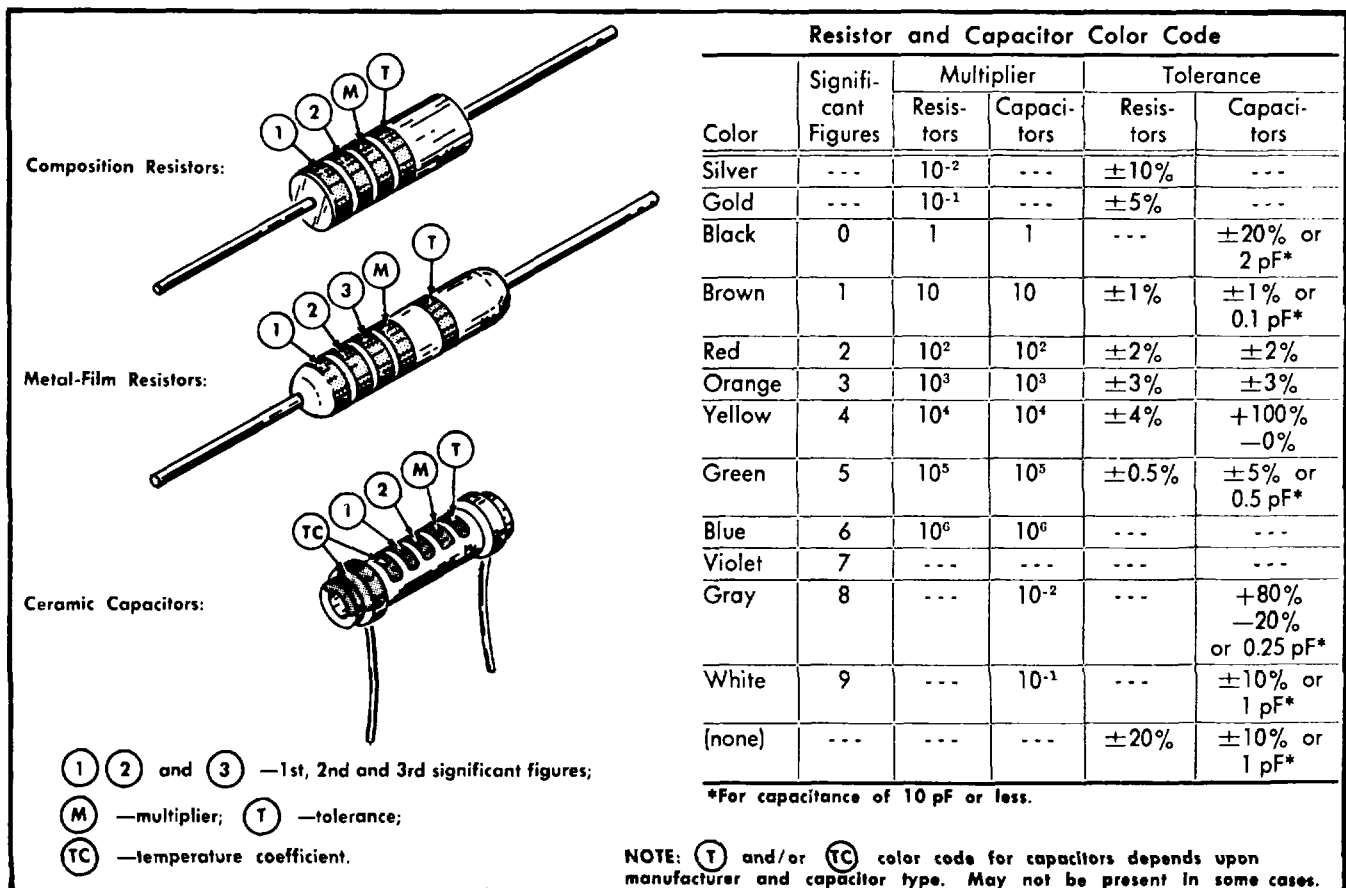

Fig. 5-1. resistor and ceramic capacitor color-code.

However, replacements for standard electronic items can generally be obtained locally in less time than is required to obtain them from Tektronix. Replacements for the special parts used in the assembly of the 7S11 should be ordered from Tektronix since these parts are either manufactured or selected by Tektronix to satisfy a particular requirement. Before purchasing or ordering, consult the Electrical Parts List to determine the value, tolerance and rating required.

NOTE

When selecting the replacement parts, it is important to remember that the physical size and shape of a component may affect its performance at high frequencies. Parts orientation and lead dress should duplicate those of the original part since many of the components are mounted in a particular way to reduce or control stray capacitance and inductance. After repair, portions of the instrument may require recalibration.

Push button Switches. The push button switches are not repairable and should be replaced if defective. Components which are mounted on the circuit board associated with the push button switch can be replaced using the normal replacement procedures.

Rotary Switches. Individual wafers or mechanical parts of rotary switches are normally not replaced. The availability of replacement switches, either wired or unwired, is detailed in the Electrical Parts List.

Circuit Boards. Use ordinary 60/40 solder and a 35- to 40-watt pencil type soldering iron on the circuit boards. The tip of the iron should be clean and properly tinned for best heat transfer to the solder joint. A higher wattage soldering iron may separate the etched wiring from the base material.

All of the components mounted on the Vertical and Inter-Channel Control circuit boards can be replaced without removing the boards from the instrument. Observe soldering precautions given under Soldering Techniques in this section. Replacement of soldered-in diodes. Grasp the diode lead between the body of the diode and the circuit board with a small pair of tweezers. Touch the tip of the soldering iron to the lead where it enters the circuit board. Do not lay the iron tip directly on the circuit board. Gently but firmly pull the diode lead from the hole in the circuit board. If removal of the lead does not leave a clean hole, apply a sharp object such as a toothpick or pointed tool while reheating the solder. Avoid using too much heat.

Replacement of soldered in diodes. Grasp the diode lead between the body of the diode and the circuit board with a small pair of tweezers. Touch the tip of the soldering iron to the lead where it enters the circuit board. Do not lay the iron tip directly on the circuit board. Gently but firmly pull the diode lead from the hole in the circuit board. If removal of the lead does not leave a clean hole, apply a sharp object such as a toothpick or pointed tool while

NOTE

Cleaning of the circuit board hold while the board is mounted the instrument is not recommended. Solder pushed through the hole toward the back side cannot always be cleared away unless the back side is accessible. Thus, clear the mounting holes only when the board is out of the instrument.

To place the new diode, bend the leads and trim to fit just through the board. Tin each lead while using the tweezers as a heat sink. Place the diode leads in the holes. Apply a small amount of solder, if necessary, to ensure a good bond. Use the tweezers as a heat sink and use only enough heat for a good connection.

Replacement of other soldered-in components. Grip the component lead with long-nose pliers. Touch the soldering iron to the lead at the solder connection. Do not lay the iron directly on the board, as it may damage the board. Refer to Fig. 5-2. When the solder begins to melt, pull the lead out gently. This should leave a clean hole in the board. If not, the hole can be cleaned by reheating the solder and placing a sharp object such as a toothpick or pointed tool into the hole to clean it out.

Bend the leads of the new component to fit the holes in the board. If the component is replaced while the board is mounted in the instrument, cut the leads so they will just protrude through the board. Pre-tin the leads of the component by applying the soldering iron and a small amount of solder to each (heat-shunted) lead. Insert the leads into the board until the component is firmly seated against the board. If it does not seat properly, heat the solder and gently pre press the component into place.

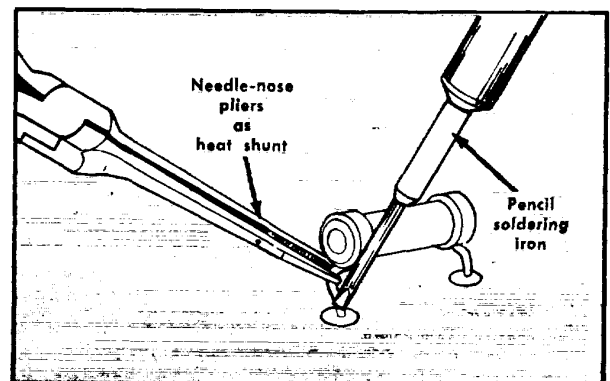

Apply the iron and a small amount of solder to the connection to make a firm solder joint. To protect heat sensitive components, hold the lead between the component body and the solder joint with a pair of long-nose pliers or other heat sink.

Clean the area around the soldered connection with a flux-remover solvent to maintain good environmental characteristics. Be careful not to remove information printed on the board.

Incandescent bulbs for lighting the push a button switches are soldered to the circuit board on the push button switches. Remove the screws and cover to expose the bulbs.

Metal Terminals. When soldering metal terminals (e.g., switch terminals, potentiometers, etc.), ordinary 60/40 solder can be used. The soldering iron should have a 40 to 75 watt rating with a 1/8 inch wide chisel-shaped tip.

Observe the following precautions when soldering metal terminals.

1. Apply only enough heat to make the solder flow freely.
2. Apply only enough solder to form a solid connection. Excess solder may impair the function of the part.
3. If a wire extends beyond the solder joint, skip off the excess.
4. Clean the flux from the solder joint with a flux remover solvent.

Circuit Board Replacement. If a circuit board is damaged and cannot be repaired, the entire assembly including all soldered-on components should be replaced. The part number given in the Mechanical Parts List is for a completely wired board.

Replace the Vertical and Inter-channel control circuit boards with attention to the screws which are spring mounted to the center circuit board. Be certain that the screws are gradually loosened so the circuit board assembly does not spring up at one end and cause damage. Loosen the screws one turn at a time to equalize stress caused by the springs. Check that pins are straight before replacement. Replace the circuit board with careful alignment of the holes over the pins with pressure on the area around the screws to overcome spring resistance for the initial screw

tightening, then tighten all the screw gradually, (as in the removal) one turn at a time tighten all screws finger tight.

The Interface assembly board can be removed as follows: first, loosen (or remove) the phillips head screws and locking nuts holding the fixed shoe on the left side of the 7S11 and lift the shoe away, then remove the six phillips head screws holding the Interface assembly board to the metal chassis. Remove the four phillips head screw holding the rear plastic connector guide. Loosen the set screw in the shaft coupling holding the VARIABLE control shaft to the control (switch pushed in). The Inter-Channel control circuit board must be covered for removal of pin connections at pin A, B and ground. Tag the wires with masking tape and mark for identification. Disconnect all pin-and-connector wire connections. Unsolder the leads at the sampling head connector, gently lifting them away from the board. Pull the assembly board from the 7S11 to the rear, watching the wires connected to the movable shoe for possible hang-up on the notches, and placing them so they bend outside the notches, and placing them so they bend outside the chassis holes.

Interface board replacement involves installation of the board, watching and placing the wires for least interference and final location. Install and tighten the four screws holding the rear plastic connector, Next, install and tighten the six chassis screws. Solder the sampling head connector pins and connect the wires. Install the fixed shoe connector into the slot and install the Inter-Channel control board. Reassemble the VARIABLE control shaft and coupling and tighten the set screw.

TROUBLESHOOTING

Introduction

The following information is provided to facilitate troubleshooting of the 7S11. Information contained in other sections should be used along with the following information to aid in locating the defective component. An understanding of the circuit operation is very helpful in locating troubles. See the circuit Description section if the operation of a particular circuit is not clear.

Troubleshooting Aids

Diagrams. Complete circuit diagrams are given on fold out pages in the Diagrams section. The component number and electrical value of each component in this instrument are shown on the diagrams. Each main circuit is assigned a series of component numbers. Table 5-1 lists the main circuits in the 7S11 and the series of component numbers assigned to each. Important voltages and waveforms are also shown on the diagrams. The portions of the circuit mounted on circuit boards are enclosed with a blue line.

Table 5-1.
Component Numbers

Component Numbers on diagrams	Diagram number	Circuit
101-149 1	1	Post Amp & Attenuators
201-299	2	Memory
301-399	3	Output Amplifier
401-499	4	Gate Generator
501-549	5	Readout Logic
601-649	7	Power Distribution & Decoupling

Troubleshooting Techniques

This troubleshooting procedure is arranged in an order which checks the simple trouble possibilities before proceeding with extensive troubleshooting. The first few checks ensure proper connection, operation and calibration. If the trouble is not located by these checks, the remaining steps aid in locating the defective component. When the defective component is located, it should be replaced, following the replacement procedures given in this section.

1. Check Control Settings. Incorrect control settings can indicate a trouble that does not exist. For example, incorrect setting of the VARIABLE control appears as incorrect gain, etc. If there is any question about the correct function or operation of any control, see the Operating Instructions section of this manual.
2. Check Associated Equipment Before proceeding with troubleshooting of the 7S11, check that the equipment used with the 7S11 is operating correctly. Check that the signal is properly connected and that the inter-connecting cables are not defective. Also, check the power source.
3. Visual Check. Visually check the portion of the instrument in which the trouble is located. Many trouble scan be located by visual indications such as unsoldered connections, broken wires, damaged circuit boards, damaged components, etc.
4. Check Instrument Calibration. Check the calibration of the instrument, or the affected circuit if the trouble exists in one circuit. The indicated trouble may only be a result of misadjustment or may be corrected by calibration. Complete instructions are given in the Calibration section of this manual.
5. Isolate the Trouble to a Circuit. To isolate trouble to a circuit, note the trouble symptom. The symptom often identifies the circuit in which the trouble is located. When double symptoms appear in more than one circuit, check effected circuits by taking voltage and waveforms readings.

Transistor Checks

Transistors should not be replaced unless they are actually defective. Transistor defects usually take the form of the transistor opening, shorting, or developing excessive leakage. To check a transistor for these and other defects, use a transistor curve display instrument such as a Tektronix Type 576 or 575. However, if a good transistor checker is not readily available, a defective transistor can be found by signal-tracing, by making in-circuit voltage checks, by measuring the transistor forward-to-back resistance using proper ohmmeter resistance ranges, or by using the substitution method. The location of all transistors is shown in the parts location figures later in this section.

To check transistors using a voltmeter, measure the emitter-to-base and emitter-to-collector voltages and determine if the voltages are consistent with the normal resistances and currents in the circuit (see Fig. 5-3). Note the lead configuration in Fig. 5-4.

When checking transistors by substitution, be sure that the voltages supplied to the transistor are normal before making the substitution. If a transistor is substituted with out first checking out the circuit, the new transistor may immediately be damaged by some defect in the circuit

Diode Checks

A diode can be checked for an open or shorted condition by measuring the resistance between terminals. With an ohmmeter scale having an internal source of about 1.5 volts, the resistance should be very high in one direction and very low when the leads are reversed.

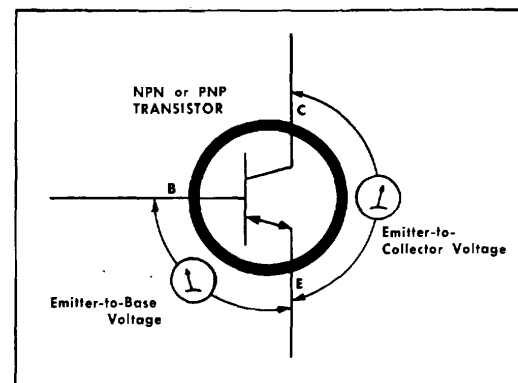

Fig. 5-3. In-circuit voltage checks NPN or PNP transistors

CAUTION

Do not use an ohmmeter scale that has a high internal current. High currents may damage the diode. Do not measure tunnel diodes with an ohmmeter use a dynamic tester (such as Tektronix Type 576 or 575 Transistor Curve Tracer).

Field Effect Transistors (FET)

Memory Amplifier field effect transistors in the 7511 should not be tested with an ohmmeter. Rather, if you suspect the dual FET, pull the unit out of the socket, rotate it 180° and re-insert it. The leads are arranged in a manner to permit the unit to be installed with the guide pin pointing either forward or backward. If there is no change in circuit operation, both sections of the dual FET are probably good.

Actual condition of either half of a dual FET can be checked using a Tektronix Type 576 Transistor Curve Tracer. The Gate corresponds to the Base, Drain to the Collector, and Source to the Emitter of an ordinary transistor at the curve tracer sockets.

Set the Type 576 Curve Tracer controls:

Vertical Current/Div	1 mA
Display Offset	0
Centerline Value	Div
Display Invert	Released
Zero	Released
Cal	Released
Horizontal Volts/Div	1 Collector
Max Peak Volts	15
Watts	0.1
Polarity	+ (NPN)
Mode	Norm
Number of Steps	10
Offset Mult	0.00
Step/Offset Amplitude	.05 V
Offset Zero	Pressed
Steps	Pressed
Step Family Rep	Pressed
Rate Norm	Pressed
Step Mult X	Released
Step/Offset Polarity Invert	Pressed
Variable Collector Supply	0
Emitter Grounded	Step Gen

Install the FET Test Fixture in the Type 576 Standard Test Fixture and the FET to be tested in the Test Fixture.

Turn the Variable Collector Supply control clockwise until about 10 volts is displayed horizontally.

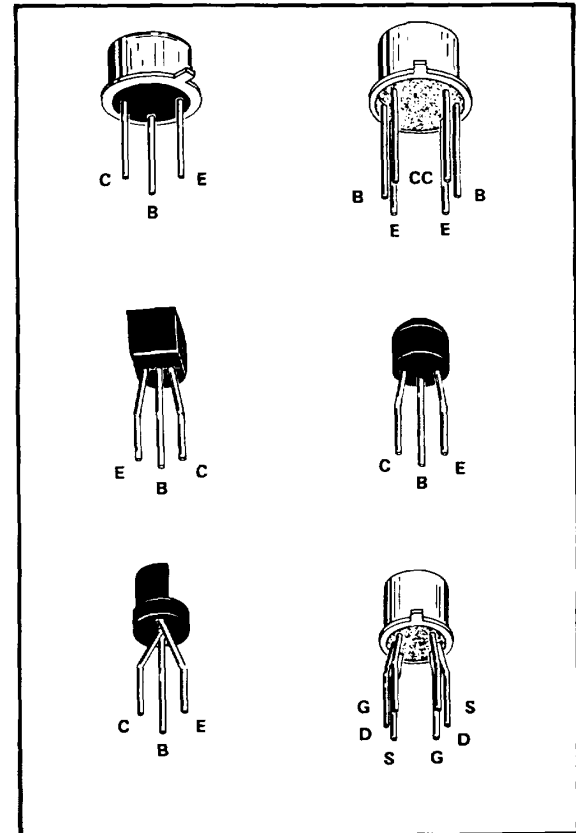

Fig. 5-4. Lead configuration for transistors used in the 7S11

Press the Step Generator Polarity Invert button for the Depletion mode of operation or release the button for the enhancement mode of operation.

Turn the Amplitude switch counter clockwise until a family of curves is displayed. Set the Peak Power Watts switch for a maximum collector supply power output of less than the maximum power rating of the FET under test.

Increase the collector supply voltage as follows:

- (1) Set the Variable collector supply control full counterclockwise;
- (2) Install the protective box and close the lid;
- (3) Set the Max Peak Volts switch to the desired voltage range
- (4) Turn the variable collector supply control clockwise until the desired collector supply voltage is obtained.

Turn the Amplitude switch counterclockwise for a higher drain current.

Small-signal gm of the FET is equal to the Vertical switch setting divided by the Amplitude switch setting (note the gm PER DIV READOUT), multiplied by the vertical separation of two curves of the displayed family.

Major Circuit and Parts Location

The remainder of this section includes photographs of sections of the 7S11. Major circuit areas are identified. All components mounted on circuit boards are identified by circuit numbers. All circuit board connections are identified by pin letters.

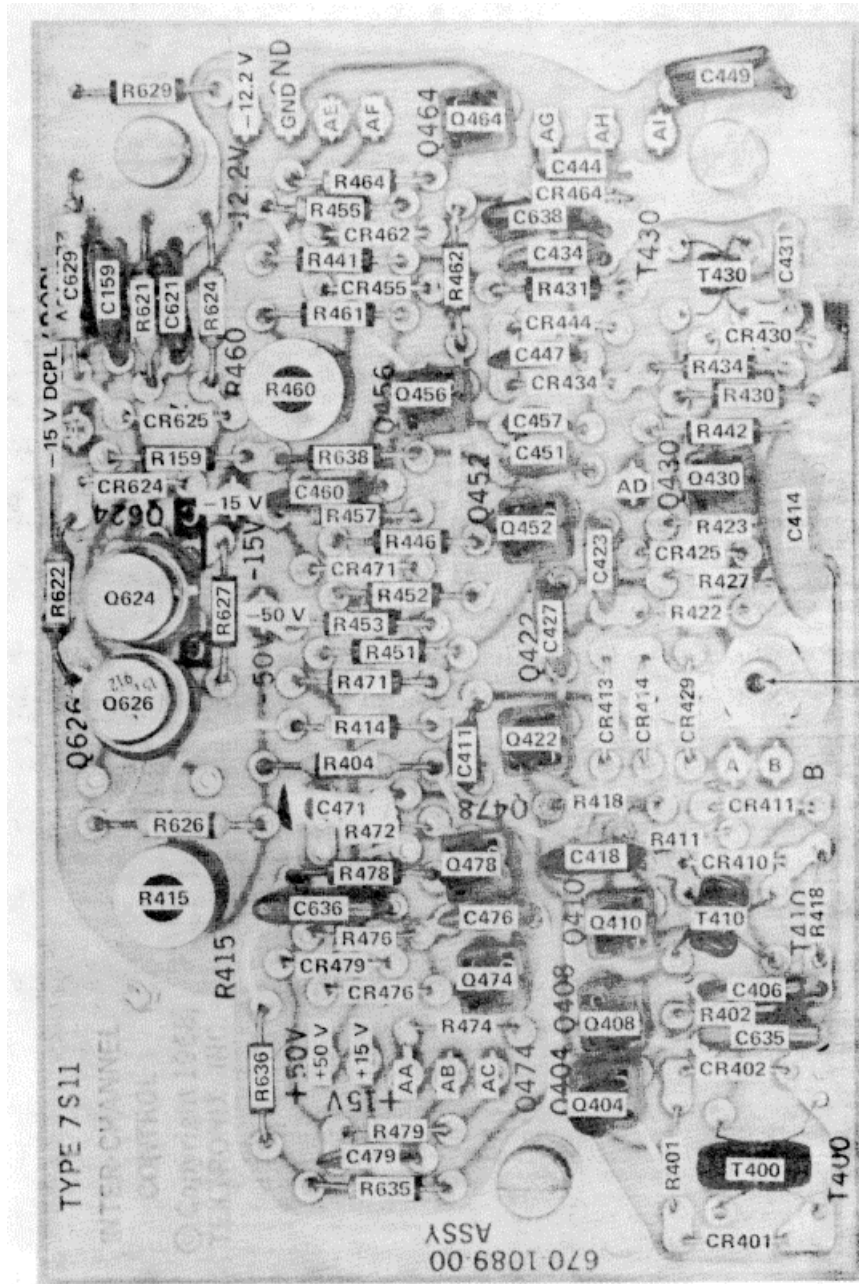

Fig. 5-6. Inter-Channel; Control circuit board.

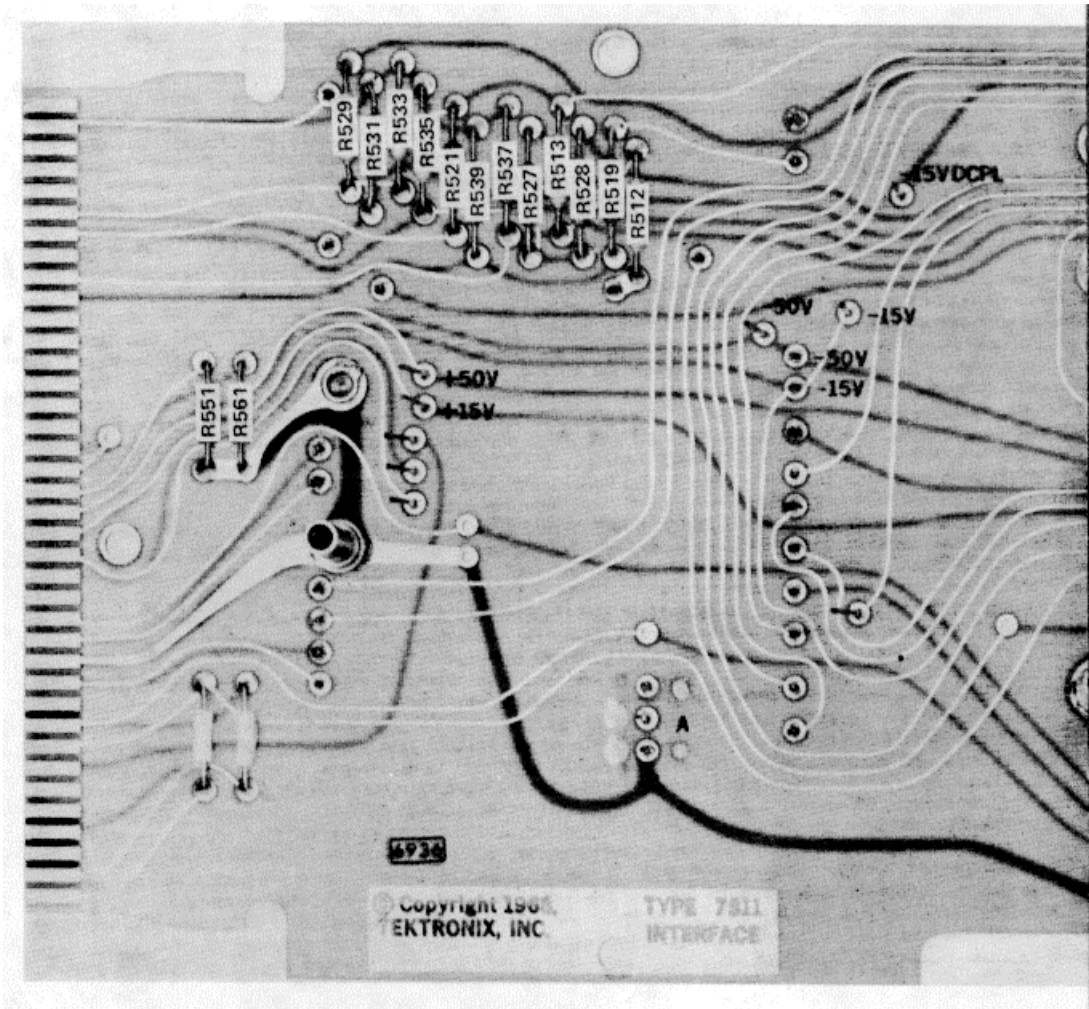

Fig. 5-7. Interface circuit board, left side

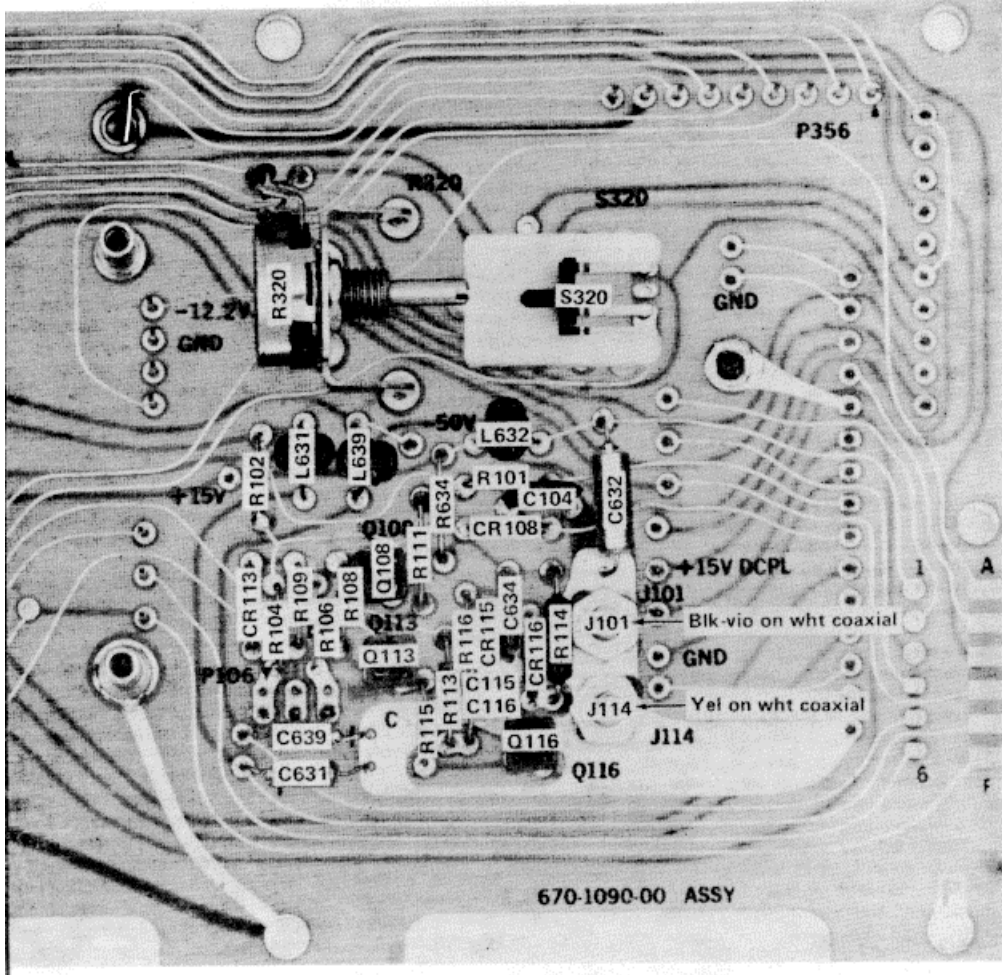

Fig. 5-8. Interface circuit board, right side.

5-11/5-12

SECTION 6 PERFORMANCE CHECK/CALIBRATION

Change information, if any, affecting this section will be found at the rear of the manual

Introduction

This procedure combines the 7S11 performance check and calibration procedures since a number of the steps are common to both procedures. After the "Preliminary Procedure", which is performed before the 7S11 is installed in the oscilloscope, the Performance Check Procedure (using the test equipment recommended and without access to internal controls or test points) includes all the steps that can be done on the 7S11 once it is installed in the oscilloscope. Notes in the text titled "PERFORMANCE CHECK ONLY" give instructions that pertain to the performance check procedure only and list the next step applicable to the performance check. All these steps herein pertain to the calibration procedure.

As an aid to the calibration of the instrument, a Short-Form Procedure is given prior to the complete procedure. To facilitate instrument calibration for the experienced calibrator, the Short-Form Procedure lists the calibration adjustments necessary for each step and the applicable tolerances. This procedure also includes the step number and title as listed in the complete Performance Check/Calibration Procedure and the page number where each step begins. Therefore, the Short-Form Procedure can be used as an index to locate a step in the complete procedure. This procedure can be reproduced and used as a permanent record of instrument calibration.

Completion of each step in the complete Performance Check/Calibration Procedure insures that this instrument meets the electrical specifications given in Section 1. Where possible, instrument performance is checked before an adjustment is made. For best overall instrument performance when performing a complete calibration procedure, make each adjustment to the exact setting even if the check is within the allowable tolerance.

NOTE

A waveforms shown in this procedure were taken with a Tektonix Oscilloscope Camera System. Limits, tolerances and waveforms in this procedure are given as calibration guides and should not be interpreted as instrument specifications except as specified Section 1.

TEST EQUIPMENT REQUIRED

General

The following test equipment and accessories, or its equivalent, is required for complete calibration of the 7S11. Specifications given are the minimum necessary for accurate calibration; therefore, some of the recommended equipment may have specifications that exceed those given.. All test equipment is assumed to be correctly calibrated and operating within the given specifications. If equipment is substituted, it must meet or exceed the specifications of the recommended equipment.

Special Tektronix Calibration fixtures are used in this procedure only where they facilitate calibration. These special calibration fixtures are available from Tektronix, Inc. Order by part number through your local Tektronix Field Office or representative.

Test Equipment

1. Oscilloscope, a 7504 or a 7704, in which to operate the 7S11.
2. Type S-1 Sampling Head.
3. 7T11 Sampling Sweep Unit.
4. Test oscilloscope with a differential comparator; minimum deflection factor required is 5 mV/div or less, risetime required is 20 ns or less. A 7A13 Differential Comparator and 7B50 Time Bas can be operated in the 7504 (or 7704) Oscilloscope required for the 7S11, or use a separate oscilloscope such as the Type 547 with the Type W Plug-In Unit.
5. 1X Probe, P6011. Tektronix Part No. 010-0193-00.
6. 50 Ω Amplitude Calibrator. Output impedance 50 Ω ; voltage range 0.012 to 1.2 volts square wave; accuracy within $\pm 0.3\%$. Tektronix Calibration Fixture 067-0508-00.

7. A special Variable Attenuator with GR 874 connectors. It consists of a 100 Ω potentiometer across a 50 Ω line, and does not have a guaranteed response. Tektronix Part No. 067-0511-00.

8. Normalizer Head, optional (recommended if more than one sampling head will be used with the 7S11) for Memory Gain and Memory Gate Width adjustments. Tektronix Calibration Fixture 067-0572-01.

9. DC Resistance Bridge (such as ESI 250 DA) for measuring 10 kΩ, accurate within ±0.5%.

NOTE

This test instrument is not required if the Preliminary Procedure is omitted.

10. 10X Probe, P6012. Tektronix Pat No. 010203-00.

11. 2 1/2 inch ground lead. Tektronix Part No. 175-0249-00

12. Adapter, BNC (F) to GR 874. Tektronix Part No. 017-0063-00.

13. Adapter, 3 mm (M) to BNC (F). Tektronix Part No. 015-1018-00, supplied with the 7T11.

14. 50 Ω coaxial cable about 4 feet long with BNC connectors, for example, RG58C/U cable, Tektronix Part No. 012-0057-01.

15. 50 Ω coaxial cable with GR 874 connectors, such as 5 ns signal delay RG58C/U cable, Tektronix Part No. 017-0512-00.

16. Screwdriver. Three-inch shaft, 3/32-inch bit for slotted screws. Tektronix Part No. 003-0192-00.

17. Extender, Tektronix Calibration Fixture 067589-00.

18. Special cable assembly, RF, about 36 inches in length with mini-coaxial connectors. Tektronix Part No. 012-0203-00.

19. Patch cord with insulated alligator clips.

SHORT-FORM PROCEDURE

7S11, Serial Number _____

Calibration Date _____

Calibrated By _____

1. Check -12.2-Volt Power Supply Page 6-5
-12.2 volts ± 0.24volt ; ripple 1 mV P-P or less.

2. Check Interdot Blanking Page 6-6

Blanking Pulse width between 0.75 μs and 2 μs at the 50% amplitude, SN B101608 and below. 7 μs to 9.5 μs at the 50% amplitude, SN B101609 and up.

3. Check Dot Response and , Page 6-7
Smoothing Adjust Gain

DOT RESPONSE control can set the display to unit loop gain in NORMAL operation; loop gain decreases to 0.3 or less of NORMAL in SMOOTH operation.

4. Adjust Memory Gate Width Page 6-7
(R460) and Memory Gain (C275) With Normalizer

Head Memory Gate Width control to given maximum trace separation and Memory Gain control for 5 division trace separation with the DOT RESPONSE control set at electrical midrange.

5. Adjust Memory Gate Width Page 6-8
(R460) and Memory Gain (C275) with Sampling Head

Memory Gate between 160 ns and 180 ns, 50% amplitude level; Memory Gain set for 5 division trace separation with a 400 mV error signal at test point 121.

6. Adjust Variable Balance (R305) Page 6-9
and Smoothing Balance (R245)

No trace movement with VARIABLE control rotation or when SMOOTH switch is pushed.

7. Check Deflection Factor, Page 6-10
Accuracies, Variable Control Range, and Adjust Gain

Unit/Div switch setting amplitude correct within 3% with the GAIN set any switch setting VARIABLE control at CAL; VARIABLE control increases the deflection amplitude 2.5 time or more at fully clockwise setting and decreases the deflection amplitude to 0.5 m less at fully counterclockwise setting.

REV B, OCT. 1975

8. Check Memory Overdrive Recovery Page 6-11

Baseline (unity loop gain indication) shift at 10 mV/div not more than 1 div with about 8 times the normal signal displayed.

9. Check Vertical Signal Out Page 6-11

Output is 200 X Units /Div $\frac{\text{Signal Input in volts}}{\text{Signal Input in volts}}$, $\pm 2\%$.

Output is 200 mV (within 3%) per displayed division in +UP or INVERT.

10. Check Vertical Gain Change in SMOOTH Page 6-11

Vertical gain change in SMOOTH operation within 3% of NORMAL operation

11. Check Memory Slash Page 6-11

Vertical amplitude of slash at 20 Hz is 0.1 division or less.

12. Check Delay Page 6-12

Displayed range of DELAY control is at least 10 ns.

13. Check/Adjust Real Time Sampling (R415) Page 6-12

Repetition rate is 47.5 kHz within 10%, frequency modulated; FM rate between 120 Hz and 440 Hz; FM deviation within 8% of the repetition rate.

14. Check DC Offset and Adjust Position (R325) Page 6-12

Displayed range of DC OFFSET control +1 volt and -1 volt or more; Offset voltage range at OFFSET OUT jack from at least +10 volts to -10 volts. Actual displayed offset = (0.1) (Offset Out) within 2%.

15. Check Real-Time Trigger Amplifier Output Page 6-14

(0.1) (Memory Output)

**PERFORMANCE CHECK/
CALIBRATION PROCEDURE**

General

The following procedure is arranged so the 7S11 can be calibrated with the least interaction of adjustments and reconnection of equipment A picture of the test

equipment required for each group of steps is given to aid in identification of the necessary equipment. The control settings and test equipment setup throughout this procedure continue from preceding step(s) unless noted otherwise.

NOTE

Control titles which are printed on the front panel of the 7S11 are capitalized in this procedure (e.g., DELAY. Internal adjustments are initial capitalized only (e.g., Position).

The following procedure uses the equipment listed under Test Equipment Required. If other equipment is substituted, control settings or calibration setup may need to be altered to meet the requirements of the equipment used. Detailed operating instructions for the test equipment are not given in this procedure. Refer to the instruction manual for the test equipment if more information is required.

NOTE

Many tolerances given in this procedure are guides to correct instrument operation and are not instrument specifications.

Preliminary Procedure

Before installing the 7511 in the oscilloscope, check the source resistance of the Offset Out and Vert Sig Out jacks.

NOTE

This preliminary Procedure may be omitted if this verification is not required.

The Offset Out jack resistance must be 10 kΩ $\pm 1\%$, (9.9 kΩ to 10.1 kΩ).

a. Ground test point 163, see Fig. 6-1. Use a DC resistance bridge and measure the DC source resistance at the OFFSET OUT jack.

b. Ground test point 264, see Fig. 6-1. Measure the DC source resistance at the VERT SIG OUT jack with the DC resistance bridge.

The Vert Sig Out jack resistance must be 10 kΩ $\pm 0.5\%$ (9.95 kΩ to 10.05 kΩ).

Performance Check

Install the 7T11 in the A HORIZ compartment of the 7504 Oscilloscope and the 7S11 (with a calibrated sampling head installed) in the RIGHT VERT compartment.

Begin the performance check with step 3.

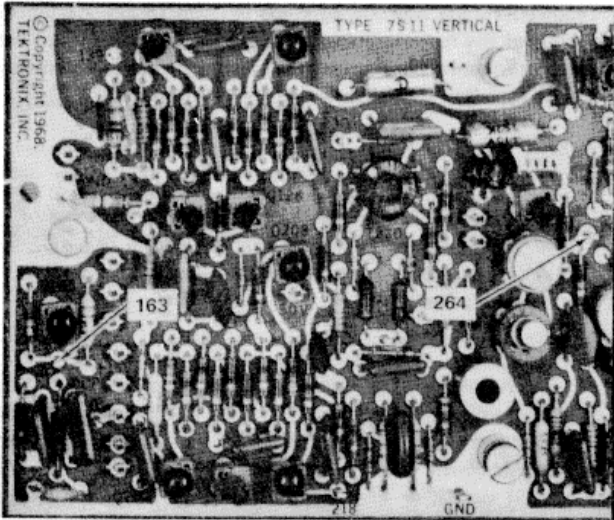

Fig. 6-1. Vertical circuit board location of grounded test points for output jack resistance measurement.

Calibration Procedure

a. Assemble the extender, the 7S11 and 7T11 at the 7504 Oscilloscope. Remove the minicoaxial connector at the top of the 7T11 (see Fig. 6-2) and insert the special mini-coaxial cable through the chassis (so the 7T11 can be installed in the oscilloscope) and connect it to the connector. Place the disconnected cable within the chassis and tape the connector to avoid contact with components. Remove the mini-coaxial connector on the 7S11 left side (Inter-Channel Control circuit board) and connect the special cable. This completes the oscillator control and strobe drive circuits. The 7S11 INT TRIG lamp will not be on when the 7T11 is at Int trigger.

b. Install the 7T11 in the A HORIZ compartment of the oscilloscope. Connect the 7S11 to the solid or flexible extender, then install the extender in the RIGHT VERT compartment.

c. Install the Type S-1 Sampling Head in the 7S11.

Both Procedures

a. Install the 7A13 in the Oscilloscope Left Vert compartment and the 7B50 in the B HORIZ compartment.

b. Make all power connections. Turn on the power to all equipment. Allow 20 minutes warmup time before proceeding. Set the controls as listed under Preliminary Control Settings.

Preliminary Control Settings

Set the 7S11 controls as follows:

DELAY	Midrange
+UP	Pushed in
DC OFFSET ± 1 V and FINE	Midrange
mVOLTS/DIV	50
VARIABLE	Pushed in
DOT RESPONSE	Midrange
NORMAL	Pushed in

Set the 7T11 controls as follows:

Time Position and Fine	Fully clockwise
Sequential	Pushed in
Sweep Range	5 μ s
Time/Div	0.5 μ s
Variable	Pushed in
Scan	Fully clockwise
Rep	Pushed in
Slope +	Pushed in
Trig Level	Midrange
Stability	Fully clockwise
Trig Amp X1	Pushed in
Ext 1 M Ω	Pushed in

Set the 7504 Oscilloscope controls as follows:

A Intensity	Midrange
Focus	Adjusted for well defined display
B Intensity	Midrange

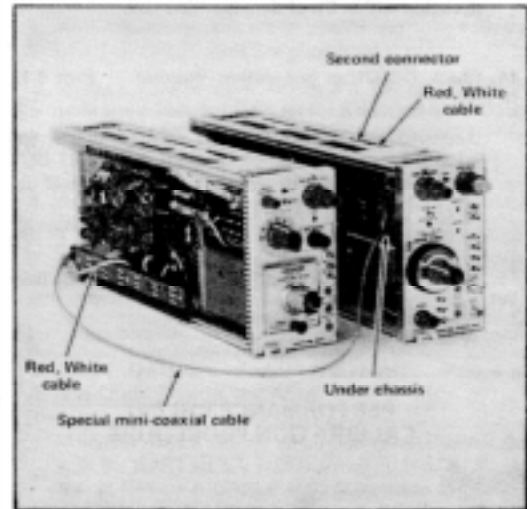

Fig. 6-2. Special connections for calibration.

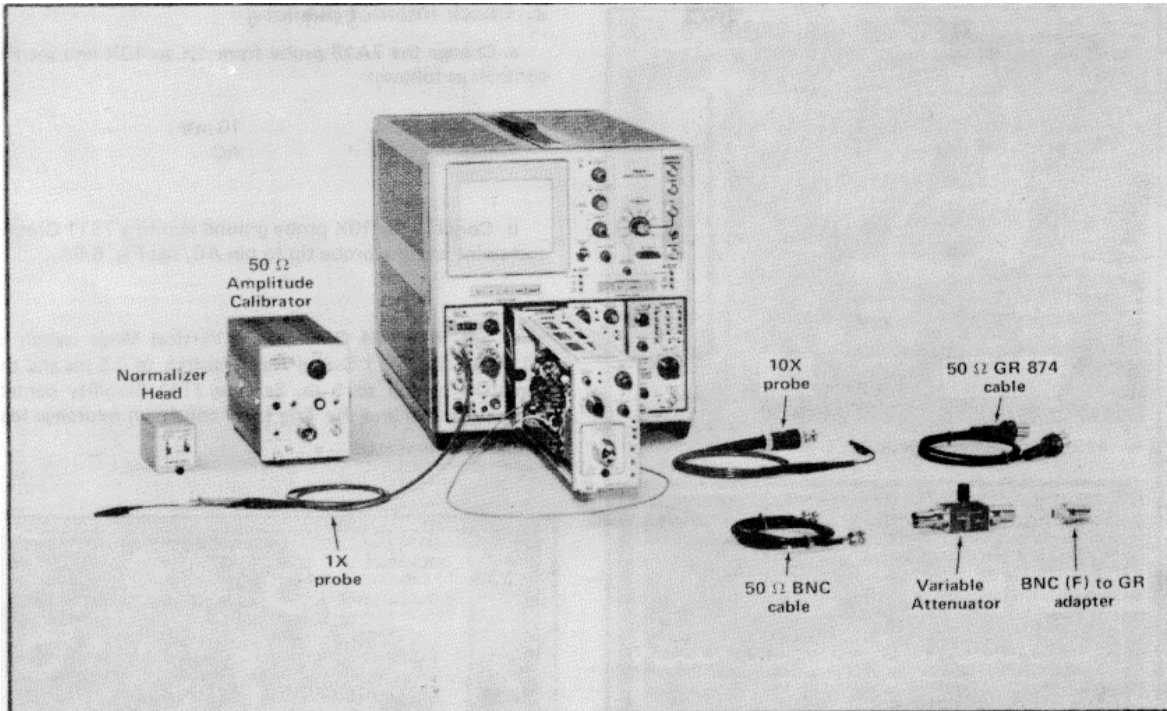

Fig. 6-3. Test equipment required.

Readout	As desired
Control Illum	As desired
Grat Illum	As desired
Calibrator	4 V (0.4 V into 50 Ω)
Rate	1 kHz

Set the 7A13 and 7B50 (test oscilloscope) controls as follows:

Comparison Voltage	-0.000 Volts
+Input	AC
Volts/Div	1 mV
BW	5 MHz
Time/D	10 ms
Trigger Mode	P-P Auto
Triggering Coupling	AC
Triggering Source	Line
Magnifier	X

Set the 50 Ω Amplitude Calibrator as follows:

Test-Operate	Operate
Volts	0.3

1. Check -12.2-Volt Power Supply

PERFORMANCE CHECK ONLY

Steps 1 and 2 are not applicable to the performance check. Set controls as given under Preliminary Control Settings and begin the performance check with step 3.

a. Test equipment required is shown in Fig. 6-3. Set the 7504 Oscilloscope Vertical Mode switch to Left and Horizontal Mode switch to B.

b. Connect a 1X probe from the + Input to Pin A at the sampling head connector, see Fig. 6-4.

NOTE

The -122-Volt power supply voltage and ripple tolerance are typical values provided as guides to correct instrument operation and are not instrument specifications. Actual values may exceed these values without loss of measurement accuracy if the instrument meets the specifications given in Section 1, as tested in this procedure.

2. Check Interdot Blanking

a. Change the 7A13 probe from 1X to 10X and set the controls as follows:

Volts/Div	10 mV
+Input	AC

b. Connect the 10X probe ground dip to a 7S11 Ground test point and the probe tip to pin AC, see Fig. 6-5A.

c. Set the 7504 Oscilloscope Vertical Mode switch to ALT. Set the 7T11 Sweep Range switch to 0.5 ms and the Time/Div switch to 5 μ s. Set the 7T11 Stability control fully clockwise and the Trig Level control at midrange (dot straight up).

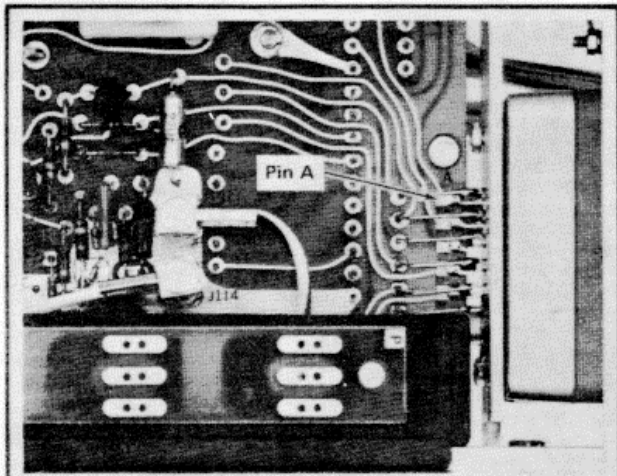

A. -12.2 volt test point, right side.

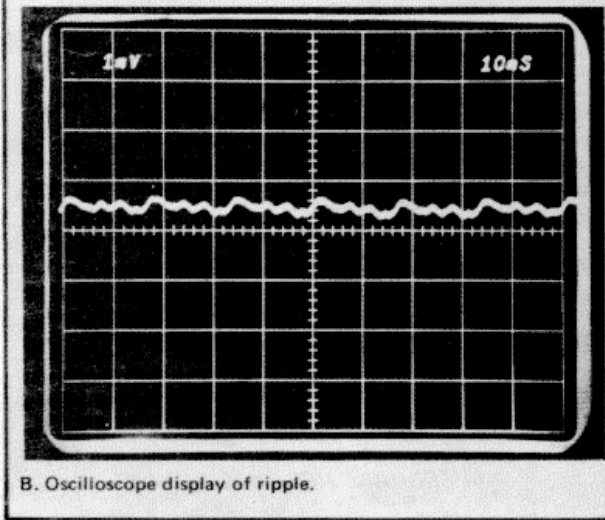

B. Oscilloscope display of ripple.

Fig. 6-4. Power supply checks.

c. Check that the ripple is not more than 1 mV peak to peak.

d. Set the 7A13 Volts/Div to 50 mV and the Comparison Voltage to 12.00. Set the + Input to GND and position the trace at graticule center.

e. Set the +Input to DC and the -Input to Vc. Adjust the Comparison Voltage to position trace at graticule center and check that voltage is -1.244 to -1.196.

f. Set +Input and -Input put to GND and remove the probe.

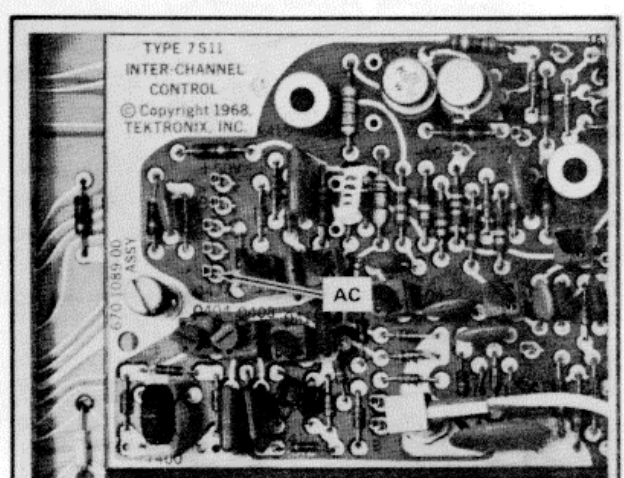

A. 7S11 left side

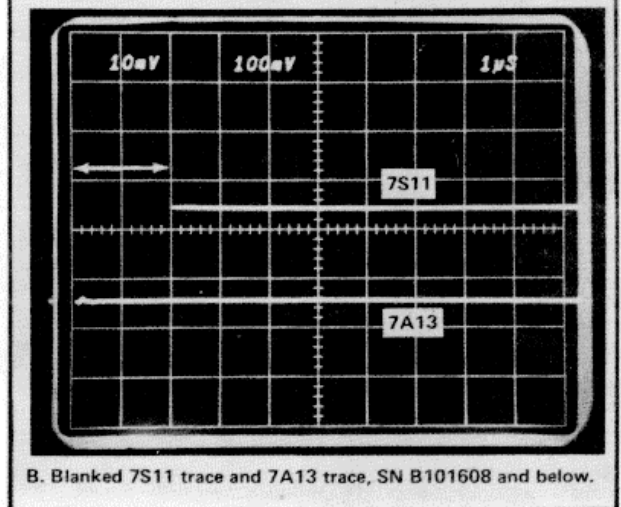

B. Blanked 7S11 trace and 7A13 trace, SN B101608 and below.

Fig. 6-5. Interdot blanking checks.

d. Set the 7B50 Time/Div switch to $1\ \mu\text{s}$ and adjust the Level/Slope control for a stable display similar to Fig. 6-5B.

e. Check the blanked trace (7S11) for $0.75\ \mu\text{s}$ to $2\ \mu\text{s}$, SN B101608 and below ($7\ \mu\text{s}$ to $9.5\ \mu\text{s}$, SN B101609 and up) as shown in Fig. 6-5B.

3. Check Dot Response and Smoothing

a. Connect the $50\ \Omega$ Amplitude Calibrator Output to the Sampling Head input connector through a $50\ \Omega$ coaxial cable and the Trigger Output to the 7T11 Trig Input connector through a $50\ \Omega$ coaxial cable and BNC to 3 mm adapter.

b. Set the 7504 Vertical Mode switch to Right, Horizontal Mode switch to A, and A Trigger source switch to Right.

c. Set the 7T11 Sweep Range switch to $50\ \mu\text{s}$ and the Time/Div switch to $2\ \mu\text{s}$. Push in the Ext $5\ \Omega$ S $2\ \text{V}$ Max switch. Obtain a stable display with the Stability control fully counterclockwise and the Trig Level control as needed. Center the positive level of the square wave on the graticule with the Time Position control.

d. Set the 7S11 GAIN control for exactly 6 divisions of display amplitude.

e. Observe the first dot at the front corner of the positive level as the DOT RESPONSE control is turned fully clockwise and fully counterclockwise, see Fig. 6-6A. Check that the first dot moves more than 1 division above and below the positive level.

f. Set the DOT RESPONSE control at unity loop gain, the first dot is at the same level as the positive level of the square wave.

g. Push the SMOOTH switch in and check that the first dot on the rising portion of the waveform is less than 1.8 divisions from the negative level (0.3 of the 6 division display amplitude, i.e., loop gain is reduced to 0.3 of unity loop gain). See Fig. 6-6B.

h. Push in the NORMAL switch. Set the 7T11 Scan control to about 9 o'clock.

4 Adjust Memory Gate Width (R460 and Memory Gain (C275) With Normalizer Head

PERFORMANCE CHECK ONLY

Steps 4, 5 and 6 are not applicable to a performance check. Set controls as given step and proceed with step 7.

NOTE

Steps 4 and 5 accomplish the same adjustments. If the Normalizer Head is used, time saved and step 5 can be disregarded.

a. Remove the Type S-1 Sampling Head and install the Normalizer Head, Tektronix Calibration Fixture 067-572-01.

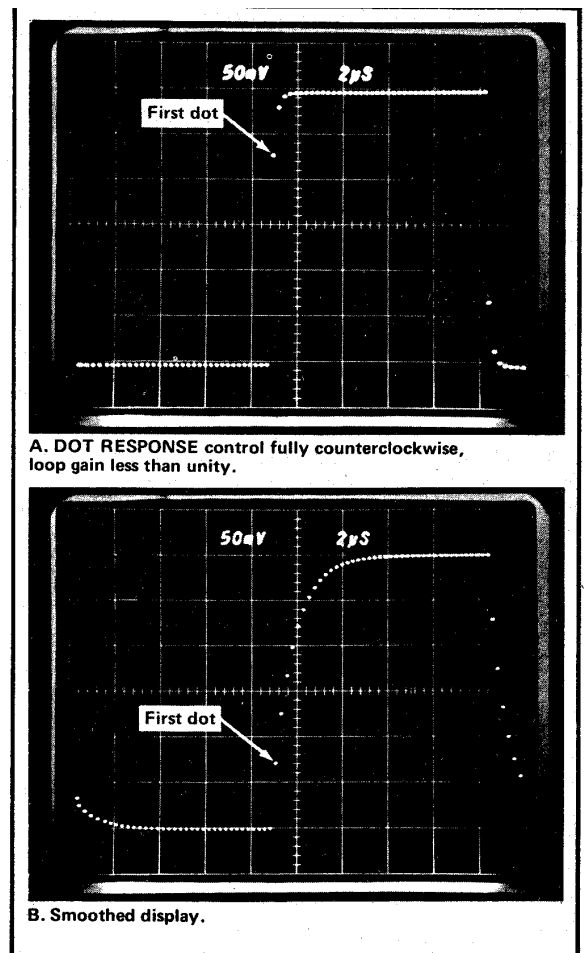

Fig. 6-6. Dot response and smooth operation check.

b Set the 7S11 Units/Div switch to 100. Set the Normalizer Head Units/Div Multiplier to X1 and the Units switch to Volts.

c. Set the 7T11 Sweep Range switch to 50 ms and the Time/Div switch to 5 ms. Set the Stability control fully clockwise and the Trig Level control for a free-running display.

d. Adjust the Memory Gate Width control, R460, for maximum vertical separation between traces. See Fig. 6-7 for control location.

e. Set the DOT RESPONSE control at electrical mid-range; turn the control fully clockwise, note separation, turn control fully counterclockwise and note separation. Average the two noted separations and set the DOT RESPONSE for the average separation. (The knob dot should be at 12 o'clock setting.)

f. Adjust Memory Gain control C275 for 5 divisions of vertical separation between traces.

g Remove the Normalizer lead. Install the Type S-1 Sampling Head.

5. Adjust Memory Gate Width (R460) and Memory Gain (C275) With Sampling Head

a. Connect the 50 Ω Amplitude Calibrator Output to the Sampling Head input connector through a 50 Ω GR 874 coaxial cable and variable attenuator. Set the Volts switch to 1.2.

b. Set the 7S11 Units/Div switch to 100. Set the 7T11 Sweep Range to 5 ms, the Time/Div switch to 0.5 ms, the Stability control fully clockwise and the Trig Level control for a free-running display.

c. Set the variable attenuator for an applied signal amplitude of 5 divisions. Turning the DOT RESPONSE control appears as extra lines, see Fig. 6-8A. Set the DOT RESPONSE control at electrical midrange; turn the control fully clockwise, note separation of the extra lines of dots, turn control fully counterclockwise and note separation. Average the two noted separations and set the extra lines of dots at the average separation with the DOT RESPONSE control. (Either the top or bottom trace can be used alone if the extra lines exceed the graticule area in separation by noting the maximum above and below movement of the extra lines from one trace and setting the lines at the average.)

d. Set the 7A13 Volts/Div switch to 100 mV and the BW switch to Full. Set the 7B50 Time/Div switch 0.1 μ s.

Set the 7504 Vertical Mode switch to Left, the Horizontal Mode switch to B, and the B Trigger Source switch to Left Vert.

e. Connect the 7A13 10X probe to test point 230, the Memory Gate Driver, see Fig 6-7.

f. Obtain a stable display and center the waveform. Check that the Memory Gate is between 160 ns and 180 ns wide at the 50% level see Fig. 6-8B

g. Adjust the Memory Gate Width control R460, Fig. 6-7, for a Memory Gate between 160 ns and 180 ns wide at the 50% amplitude level.

h. Connect the 7A13 10X probe to test point 121, the Post Amplifier Input, see Fig 6-7, and use a short ground lead (Tektronix Part No 175-0249-00) to minimize ringing. Set the 7A13 Volts/Div switch to 10 mV.

i. Connect a 1X probe from the 7B50 Ext Trig In connector to test point 230 and push the Ext Triggering Source switch.

j. Remove 040, see Fig. 6-7, and obtain a stable, double-triggered display in such a manner that there are two, most defined, waveform traces, one positive and one negative, as shown in Fig. 6-8C. If not, change the real-time oscillator frequency by adjusting R415.

k. Set the variable attenuator at the Sampling Head input connector for a display 400 mV peak to peak (200 mV peak to peak if not a Type S-1 Sampling Head), ignore ringing, and use a vertical graticule line to check the amplitude, about 80 ns to 100 ns from the start of ringing. See Fig. 6-8C.

l. Set the 7504 Vertical Mode switch to Right and the Horizontal Mode switch to A. Check that the bright traces are 5 divisions apart

m. Adjust the Memory Gain control C275, see Fig. 6-7, for 5 divisions separation (2.5 divisions if not a Type S-1), similar to Fig. 6-8A.

n. Remove the probes and install Q404. See Step 13 for R415 adjustment.

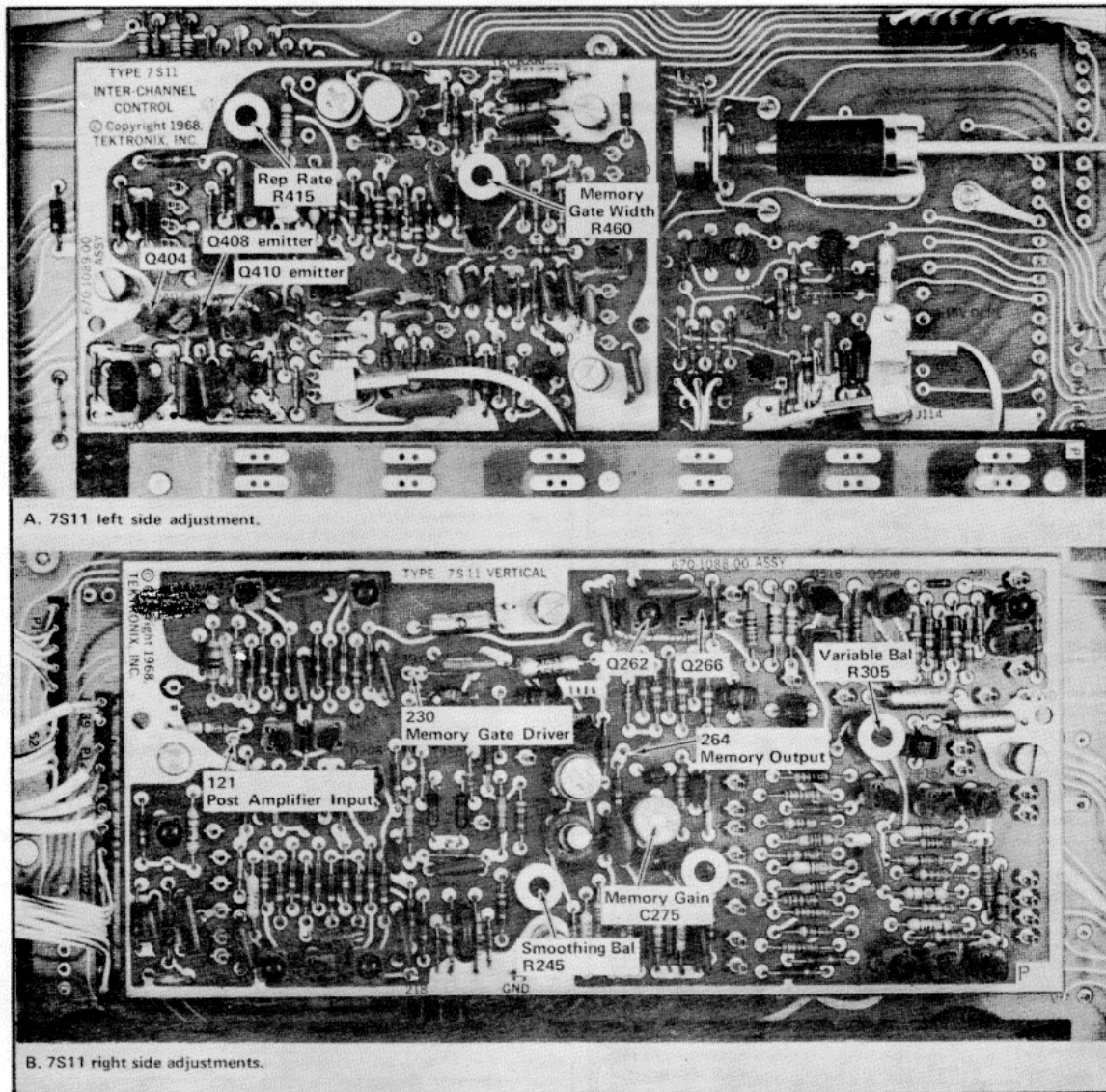

Fig. 6-7. Test points and adjustments, steps 4 through 13.

6. Adjust Variable Balance (R305) and Smoothing Balance (R245)

a. Remove Q262 and Q266, then short test point 264 to ground with a patch cord. See Fig. 6-7.

b. Release the VARIABLE Units/Div control and rotate the control throughout its range. Check that the trace moves no more than 0.2 division vertically.

c. Adjust Variable Balance control R305 for minimum trace shift as the VARIABLE control is rotated throughout its range. See Fig. 6-7 for location of control.

d. Return the VARIABLE control to the CAL IN position. Remove the patch cord and install transistors Q262 and Q266.

e. Push the SMOOTH switch in and check for no trace movement.

f. Adjust Smoothing Bal control R245 for no trace movement when either the NORMAL or SMOOTH switch is pushed.

g. Push in the NORMAL switch. Disconnect the variable attenuator and cable at the sampling head input connector.

7. Check Deflection Factor Accuracies, Variable Control Range and Adjust GAIN

a. Set the 7511 Units/Div switch to 100 and apply 0.6 volts from the 50 Ω Amplitude Calibrator to the sampling head input connector through a 50 Ω coaxial cable and connect a coaxial cable from the Amplitude Calibrator Trigger Output connector to the 7T11 Trig Input connector.

b. Push the 7T11 Ext 50 Ω 2 V Max switch, set the Sweep Range switch to 50 μs and the Time/Div switch to 5 μs. Obtain a stable display with the Trig Level control.

c. Adjust the front panel GAIN control for a display amplitude of 6 divisions.

Normal range of the GAIN control is from 6.4 divisions, control fully clockwise, to 5.6 divisions, control fully counterclockwise (minimum range).

d. Check all positions of the attenuator switch, as listed in Table 6-1, for a 6 division display amplitude within a tolerance of ±0.18 division.

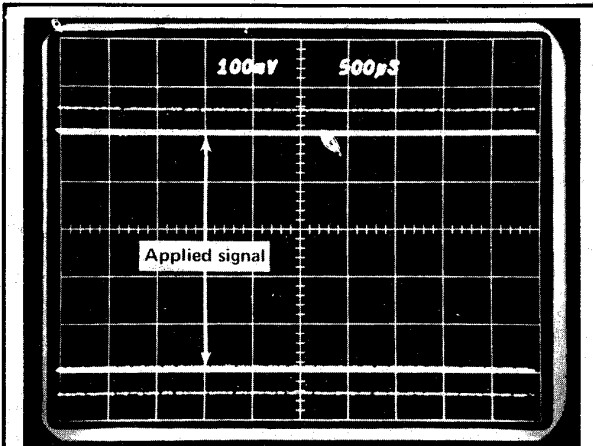

A. Result of DOT RESPONSE control turned clockwise.

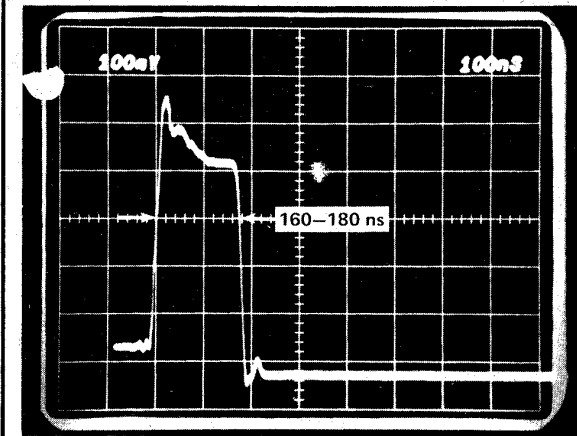

B. Memory Gate Width adjustment, test point 230 waveform.

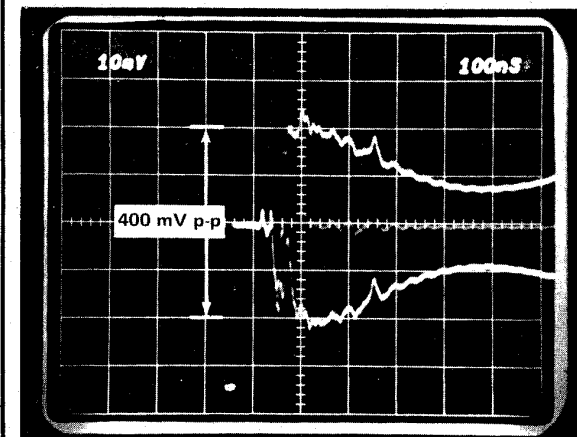

C. Post Amplifier Input, test point 121, Q404 removed, amplitude set with variable attenuator.

Fig. 6-8. Memory Gate Width and Memory Gain adjustments with sampling head.

Table 6-1.

Units/Div	50 Ω Amplitude Calibrator
200	1.2 V
100	.6 V
50	.3 V
20	.12V
10	.06 V
5	.03 V
2	.012 V

NOTE

Record deflections each case. If one range is above tolerance, GAIN can be reduced to bring all range within tolerance without need for checking the Feedback Attenuator resistor values.

e. Set the Units/Div switch to 200 and the 50 Amplitude Calibrator to 0.6 volts. Display amplitude is 3 divisions.

f. Push the VARIABLE control to release it from the CAL IN position. Turn the VARIABLE control fully counterclockwise and check the display amplitude for 1.5 divisions or less.

g. Turn the VARIABLE control fully clockwise and check the display amplitude for 7.5 divisions or more.

h. Return the VARIABLE control to the CAL IN position.

8. Check Memory Overdrive Recovery

a. Set the 50 Ω Amplitude Calibrator Output Volts to 0.03 and the 7S11 Unit/Div switch to 10. Set the 7T11 Stability control fully clockwise and adjust the Trig Level control for a free running display.

b. Set the DOT RESPONSE control so the display consists of two continuous lines 3 divisions apart (indication of unity loop gain).

c. Set the 50 Ω Amplitude Calibrator Output Volts to 0.3 and position the bottom of the display on the graticule with the DC OFFSET control.

d. Observe that the continuous line may become two lines, indicating that the loop gain has changed.

e. Check that the separation does not exceed 1 division.

9. Check Vertical Signal Out

a. Set the 7S11 Units/Div switch to 100 and set the 50 Ω Amplitude Calibrator Volts switch to 0.6.

b. Set the 7504 Vertical Mode switch to Left and the Horizontal Mode switch to B. Set the 7B50 Time/Div switch to 5 ms. Set the 7A13 controls as follows:

Comparison Voltage	+
+ Input	DC
Volts/Div	20 mV
-Input	Vc
R ¹ IN (internal switch S10)	∞

c. Connect the 1X probe from the 7A13 +Input to the 7S11 VERT SIG OUT jack. Position the bottom of the signal at the center of the graticule with the 7S11 DC OFF-SET control.

d. Set the 7A13 Comparison Voltage so the positive portion of the display (top of the square wave) is at the center of the graticule.

e. Check that the Comparison Voltage is 1.2 volts ±2% (1.176 to 1.224), which is 200 mV per division of display amplitude.

f. Disconnect the probe. Set the 7A13 -Input switch to GND.

10. Check Vertical Gain Change in SMOOTH

a. Set the 7504 Vertical Mode switch to Right and the Horizontal Mode switch to A.

b. Use the 600 mV from the 50 Ω Amplitude Calibrator at the 100 Units/Div switch setting from the preceding step.

c. Push the SMOOTH switch.

d. Check that the peak amplitude does not decrease more than 3% (0.2 division of the 6 division display). Ignore any rolloff at the leading portion of the display.

If the display amplitude changes more than minus 3%, the Memory amplifier internal gain (open loop gain) is lower than it should be. Check R248 and/or transistors 0242, 0252 and 0256.

e. Reset the NORMAL switch. Disconnect the input signal and trigger signal.

11. Check Memory Slash

a. Set the 7T11 Stability control fully clockwise and the Trigger Level Control for a free-running trace.

b. Turn the Trigger Level control counterclockwise to stop triggering. The trace will blank for about 3 seconds, then unblank; observe the dot vertical movement.

c. Check that the dot movement in the vertical direction does not exceed 2 divisions in 1 second (count one thousand and one).

PERFORMANCE CHECK ONLY

The remainder of the procedure requires access to internal test points and controls and is therefore part of the Calibration Procedure only.

12. Check Delay

- a. Set the 7504 Vertical Mode switch to Left and the Horizontal Mode switch to B. Connect the 1X probe at the 7B50 Ext Trig In connector.
- b. Set the 7A13 +Input to AC and the Volts/Div switch to 0.1 V. Connect the 10X probe at the +Input and the probe tip to test point 230, Memory Gate Driver.
- c. Set the 7T11 in a teal time mode (SWEEP RANGE switch in .5 ms; 5 ms or 50 ms position). Connect the 1X probe to the collector of 0422 (7S11).
- d. Set tie 7B50 Time/Div switch to 0.05 μ s and Triggering Source switch to Ext. Obtain a stable display, then push the Magnifier X10 switch. Observe the falling portion of the Memory Gate signal; the horizontal position is affected by the Triggering Level/Slope control.
- e. Turn the 7S11 DELAY control fully counterclockwise and check that the falling portion moves to the right at least 10 ns. See Fig. 6-9.
- f. Disconnect the probes. Install 0404.

13. Check/Adjust Real Time Sampling (R415)

- a. Set the 7A13 Volts/Div switch to 0.2 V, the 7B50 Triggering Source switch to Int, and the Time/Div switch to 10 μ s.
- b. Connect the 7A13 10X probe to test point 230, see Fig. 6-7.

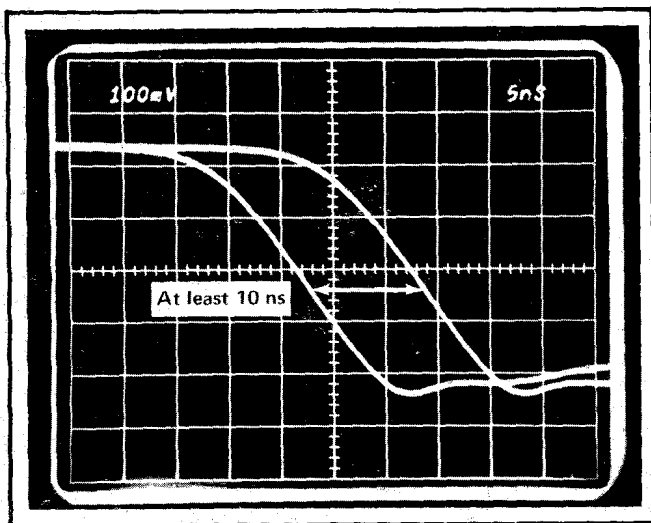

Fig. 6-9. Delay control range check.

- c. Obtain a stable display and check that the repetition rate is 47.5 kHz \pm 10%, displayed as a period of 19 μ s to 23 μ s, measured between pulse group centers. See Fig. 6-10A.
- d. Adjust Rep Rate control R415 for a period between 19 μ s and 23 μ s. See Fig. 6-7 for location. See NOTE in Real Time Sampling on page 2-7 regarding this adjustment for Type S-5 Sampling Head use.
- e. Change the 7B50 Time/Div to 2 μ s. Align the second pulse at the center graticule line with the Variable Time/Div control.
- f. Check that the FM deviation is within 5% and 15% of the repetition rate, determined by measuring the width of the pulses at graticule center and dividing by 5 divisions. See Fig. 6-10B.
- g. Set the 7B50 Variable Time/Div control to Calibrated and set the Time/Div switch to 1 ms.
- h. Place the 10X probe tip at the emitter of 0408. Obtain a stable display.
- i. Check that the FM rate is between 120 Hz and 440 Hz, displayed as a period between 8.3 ms and 2.3 ms. See Fig. 6-10C.
- j. Remove the probe tip.

14. Check DC Offset and Adjust Position (R325)

- a. Set the 7504 Vertical Mode switch to Right and the Horizontal Mode switch to A.
- b. Set the 7511 Unit/Div switch to 100. Connect the 50 Ω Amplitude Calibrator Output to the sampling head input connector through a 50 Ω coaxial cable. Set the Volts switch to 0.3. Connect the Trigger Output to the 7T11 Trig Input connector through a 50 Ω coaxial cable and BNC to 3 mm adapter.
- c. Set the 7T11 Sweep Range switch to 50 μ s and the Time/Div switch to 5 μ s. Set the Trig Level control for a stable display.
- d. Set the 7504 Vertical Mode switch to Chop. Set the 7A13 Comprison Voltage to -0000, Volts/Div switch to 50 mV, +Input switch to DC, -Input to Vc. The ^RIN is infinite (internal switch S10). Connect the 1X probe to the +Input. Connect the probe tip to the 7S11 OFFSET OUT

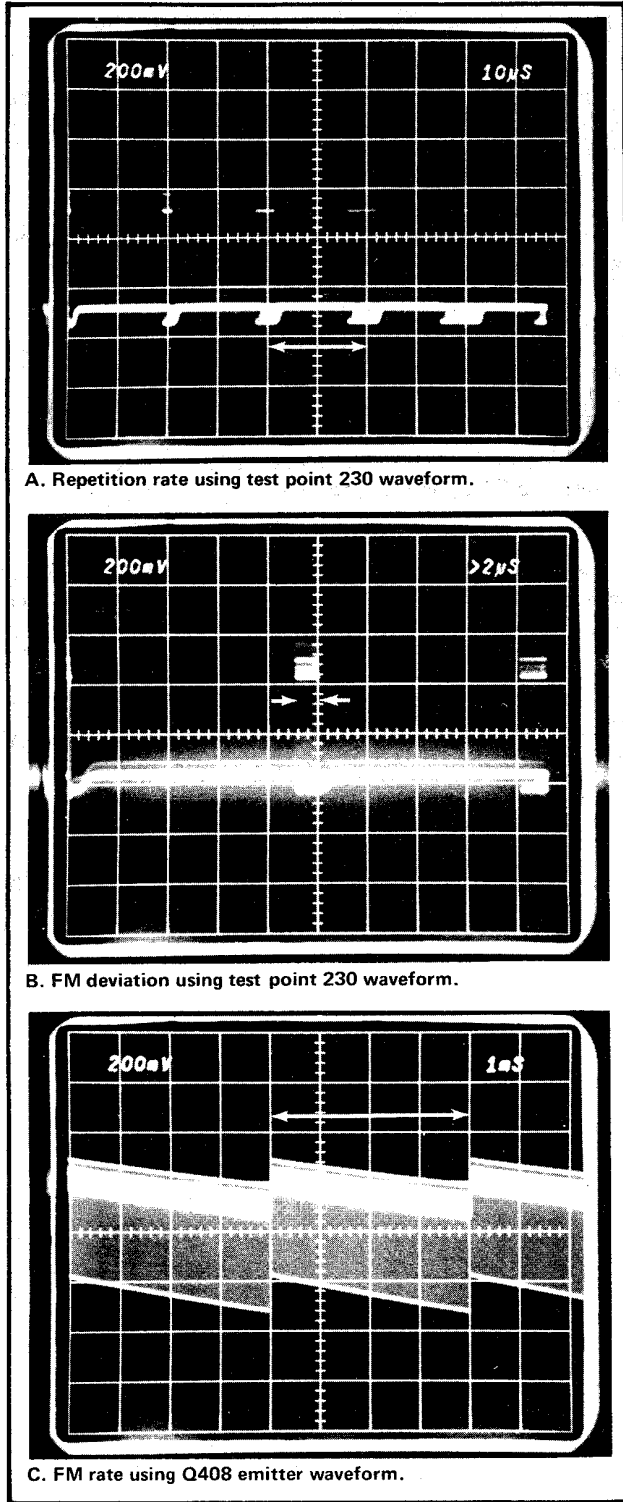

Fig. 6-10. Real-time sampling checks.

jack. Set the 7S11 DC OFFSET control for zero volts out; position the trace at graticule center.

e. Adjust Position control R325, shown in Fig. 6-11, to move the top of the displayed 7S11 signal to the center of the graticule.

f. Set the 7S11 Units/Div switch to 5 and use the Position control to again set the top of the displayed signal to the center of the graticule.

g. Turn the DC OFFSET control clockwise until the bottom of the 7S11 signal is displayed at the center of the graticule.

h. Measure the OFFSET OUT voltage. Set the 7A13 Comparison Voltage Fine control to return the trace to the center of the graticule. OFFSET OUT voltage must be 2.94 to 3.06 volts (3 volts \pm 2%).

i. Set the DC OFFSET control fully clockwise and check that the OFFSET OUT voltage is at least minus 10 volts.

j. Set the 7A13 Comparison Voltage to +, turn the 7S11 DC OFFSET control fully counterclockwise, and check for at least plus 10 volts at the OFFSET OUT jack.

k. Disconnect the square wave signal.

l. Set the 7S11 Unit/Div witch to 200 and set the 7T 11 Stability control fully clockwise for a free-running trace.

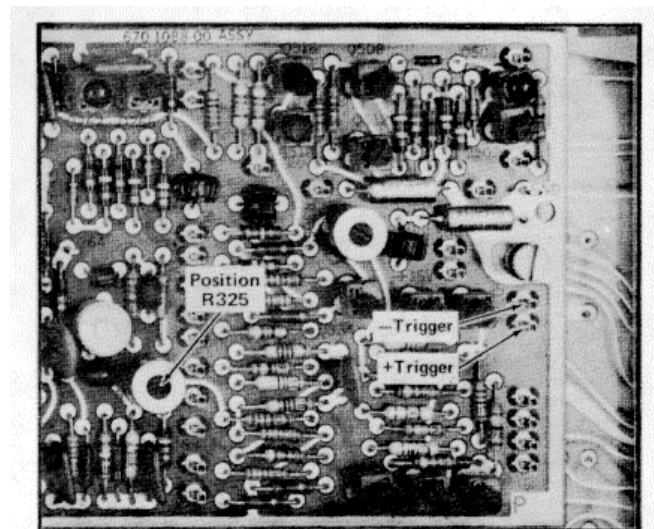

Fig. 6-11. Control and test point locations (7S11 right side) for DC OFFSET and real-time trigger checks.

m. Set the DC OFFSET control for zero volts at the OFFSET OUT jack. Set the Position control, R325, so the trace is 3 divisions below the center graticule line.

n. Turn the DC OFFSET control fully clockwise and check that the trace moves at least 5 divisions upward.

o. Reset the DC OFFSET control for zero volts at the OFFSET OUT jack. Set the Position control, R325, so the trace is 3 divisions above the center graticule line.

p. Turn the DC OFFSET control fully counterclockwise and check that the trace moves at least 5 divisions downward.

q. Reset the DC OFFSET control for zero volts at the OFFSET OUT jack.

r. Adjust the Position control so the trace is at the center graticule line.

Normal centering range of the Position control is at least +3 divisions to -3 divisions from graticule center.

s. Disconnect the 1X probe tip. Set the 7504 Vertical Mode switch to Right.

15. Check Real-Time Trilqer Amplifier Output

a. Connect the 50 Ω Amplitude Calibrator Output to the sampling head input connector through a 50 Ω , coaxial cable.

b. Turn the Stability control fully counterclockwise and set the Trig Level control for a stable display.

c. Set the 50 Ω , Amplitude Calibrator Volts switch to 0.12 and the 7S11 Units/Div switch to 20.

d. Set the 7504 Vertical Mode switch to Left, the 7A13 -Input to GND, and RiN (S10 internal) to 1 M Ω .

e. Measure the signal amplitude at +Trigger and -Trigger pins with the 1X probe and add the two amplitudes. See Fig. 6-11.

f. Check that the differential amplitude is 300 mV $\pm 10\%$.

g. Disconnect the square wave signal and the 1X probe.

**SECTION 7
ELECTRICAL PARTS LIST**

Ckt No.	Tektronix Part No.	Serial/Model Eff	No. Disc	Description
CHASSIS				
CAPACITORS				
C149	283-0103-00			180pF, Cer, 500V, 5%
CONNECTORS				
J100	131-0410-00			Cannon series #DM53741-5001
J120	131-0581-00			Receptacle, electrical
J165	131-0779-00			Jack
J166	131-0779-00			Jack
J269	131-0779-00			Jack
RESISTORS				
R143	311-0095-00			500 OHM, Var
R145A	321-0193-00			1k OHM, 0.125W, 1%
R145B	321-0231-00			2.49k OHM, 0.125W, 1%
R145C	321-0260-00			4.99k OHM, 0.125W, 1%
R145D	321-0289-00			10k OHM, 0.125W, 1%
R145E	321-0327-00			24.9k OHM, 0.125W, 1%
R145F	321-0356-00			49.9k OHM, 0.125W, 1%
R145G	321-0385-00			100k OHM, 0.125W, 1%
R147A	321-0450-01			475k OHM, 0.125W, 0.50%
R147B	321-0760-01			189.9k OHM, 0.125W, 0.50%
R147C	321-0759-01			95k OHM, 0.125W, 0.50%
R147D	321-0354-01			47.5k OHM, 0.125W, 0.50%
R147E	321-0757-01			18.99k OHM, 0.125W, 0.50%
R147F	321-0758-01			9.5k OHM, 0.125W, 0.50%
R147G	321-0258-01			4.75k OHM, 0.125W, 0.50%
R149	321-0354-01			47.5k OHM, 0.125W, 0.50%
R151 ¹	311-0965-00	B010100	B059999	10k OHM, Var
R151 ¹	311-1162-00	B060000	B089999	10k OKX, Var
R151	311-1591-00	B090000		10k OHM, Var
R153	315-0273-00			27k OHM, 0.25W, 5%
R154	315-0273-00			27k OHM, 0.25W, 5%
R156	315-0101-00			100 OHM, 0.25W, 5%
R157 ¹	311-0965-00	B010100	B059999	10k OHM, Var
R157 ¹	311-1162-00	B060000	B089999	10k OHM, Var
R157 ¹	311-1591-00	B090000		10k OHM, Var
R158	315-0821-00			820 OHM, 0.25W, 5%
R345	311-0258-00			100 OHM, Var
R440	311-0310-00			5k OHM, Var
R522	321-0402-00			150k OHM, 0.125W, 1%
R523	321-0344-00			37.4k OHM, 0.125W, 1%

¹R151 and R157 furnished as a unit.

CHASSIS (cont)

Ckt No.	Tektronix Part No.	Serial/Model Eff	No. Disc	Description
RESISTORS (cont)				
R524	321-0373-00			75k OHM, 0.125W, 1%
R525	321-0402-00			150k OHM, 0.125W, 1%
SWITCHES				
S146	262-0894-00			Rotary, Units/Div (Wired)
S146	260-1090-00			Rotary, Units/Div
VERTICAL Circuit Board Assembly				
	670-1088-00			Complete Board
CAPACITORS				
C120	283-0059-00			1uF, Cer, 25V, +80%-20%
C127	283-0051-00			0.0033uF, Cer, 100V, 5%
C134	283-0059-00			1uF, Cer, 25V, +80%-20%
C139	283-0000-00			0.001uF, Cer, 500 V, +100%-0%
C160	283-0026-00			0.2uF, Cer, 25V, +80%-20%
C161	283-0059-00			1uF, Cer, 25V, +80%-20%
C166	283-0000-00			0.001uF, Cer, 500V, +100%-0%
C201	283-0059-00			1uF, Cer, 25V, +80%-20%
C216	283-0059-00			1uF, Cer, 25V, +80%-20%
C219	283-0032-00			470pF, Cer, 500V, 5%
C221	283-0059-00			1uF, Cer, 25V, +80%-20%
C234	283-0059-00			1uF, Cer, 25V, +80%-20%
C239	283-0594-00			0.001uF, Mica, 100V, 1%
C245	283-0023-00			0.01uF, Cer, 10V, +80%-20%
C256	281-0579-00			21pF, Cer, 500V, 5%
C261	283-0059-00			1uF, Cer, 25V, +80%-20%
C267	283-0059-00			1uF, Cer, 25V, +80%-20%
C269	283-0103-00			180pF, Cer, 500V, 5%
C272	283-0026-00			0.2uF, Cer, 25V, +80%-20%
C274	283-0026-00			0.2uF, Cer, 25V, +80%-20%
C275	281-0092-00			9-34pF, Var, Cer
C276	283-0600-00			43pF, Mica, 500V, 5%
C341	283-0060-00			100pF, Cer, 200V, 5%
C602	283-0004-00			0.02uF, Cer, 150V
C603	290-0134-00			22uF, Elect. 15V, 20%
C604	290-0134-00			22uF, Elect., 15V, 20%
C605	283-0059-00			1uF, Cer, 25V, +80%-20%
C606	283-0059-00			1uF, Cer, 25V, +80%-20%
C607	290-0134-00			22uF, Elect., 15V, 20%

REV. MAY 1974

VERTICAL Circuit Board Assembly

Ckt No.	Tektronix Part No.	Serial/Model Eff	No. Disc	Description
CAPACITORS (cont)				
C608	290-0134-00			22uF, Elect., 15V, 20%
C609	283-0059-00			1uF, Cer, 25V, +80%-20%
DIODES				
CR128	152-0185-00			Silicon, replaceable by 1N4152
CR201	152-0185-00			Silicon, replaceable by 1N4152
CR206	152-0185-00			Silicon, replaceable by 1N4152
VR221	152-0226-00			Zener, 1N751A, 400 mW, 5.1V, 5%
CR224	152-0185-00			Silicon, replaceable by 1N4152
CR226	152-0185-00			Silicon, replaceable by 1N4152
CR232	152-0185-00			Silicon, replaceable by 1N4152
CR236	152-0185-00			Silicon, replaceable by 1N4152
CR237	152-0323-00			Silicon, Tek Spec
CR238	152-0185-00			Silicon, replaceable by 1N4152
CR239	152-0323-00			Silicon, Tek Spec
CR242	152-0185-00			Silicon, replaceable by 1N4152
CR257	152-0185-00			Silicon, replaceable by 1N4152
CR259	152-0185-00			Silicon, replaceable by 1N4152
CR272	152-0323-00			Silicon, Tek Spec
CR274	152-0323-00			Silicon, Tek Spec
CR506	152-0185-00			Silicon, replaceable by 1N4152
INDUCTORS				
L268	120-0402-00			Toroid, 3 turns single
L603	120-0382-00			Toroid, 14 turns single
L604	120-0382-00			Toroid, 14 turns single
L607	120-0382-00			Toroid, 14 turns single
L608	120-0382-00			Toroid, 14 turns single
TRANSISTORS				
Q123	151-0192-00			Silicon, replaceable by MPS 6521
Q128	151-0188-00			Silicon, 2N3906
Q133	151-0190-00			Silicon, 2N3904
Q136	151-0188-00			Silicon, 2N3906
Q163	151-0190-00			Silicon, 2N3904
Q204	151-0190-00			Silicon, 2N3904
Q208	151-0190-00			Silicon, 2N3904
Q212	151-0190-00			Silicon, 2N3904
Q214	151-0188-00			Silicon, 2N3906
Q242	151-1037-00			Silicon, Dual, FET
Q252	151-0261-00			Silicon, Dual, Tek Spec
Q256	151-0188-00			Silicon, 2N3906

VERTICAL Circuit Board Assembly (cont)

Ckt No.	Tektronix Part No.	Serial/Model Eff	No. Disc	Description
TRANSISTORS (cont)				
Q262	151-0190-00			Silicon, 2N3904
q266	151-0188-00			Silicon, 2N3906
Q314	151-0192-00			Silicon, replaceable by MPS 6521
Q334	151-0192-00			Silicon, replaceable by MPS 6521
Q344	151-0216-00			Silicon, replaceable by MPS 6523
Q354	151-0216-00			Silicon, replaceable by MPS 6523
Q362	151-0216-00			Silicon, replaceable by MPS 6523
Q366	151-0216-00			Silicon, replaceable by MPS 6523
Q502	151-0188-00			Silicon, 2N3906
Q506	151-0190-00			Silicon, 2N3904
Q508	151-0188-00			Silicon, 2N3906
Q512	151-0188-00			Silicon, 2N3906
Q516	151-0281-00			Silicon, Tek Spec
Q518	151-0281-00			Silicon, Tek Spec
RESISTORS				
R121	321-0093-00			90.9 OHM, 0.125W, 1%
R123	315-0183-00			18k OHM, 0.25W, 5%
R125	315-0752-00			7.5k OHM, 0.25W, 5%
R127	321-0154-00			392 OHM, 0.125W, 1%
R129	315-0512-00			5.1k OHM, 0.25W, 5%
R130	315-0101-00			100 OHM, 0.25W, 5%
R133	315-0101-00			100 OHM, 0.25W, 5%
R134	315-0153-00			15k OHM, 0.25W, 5%
R135	315-0153-00			15k OHM, 0.25W, 5%
R136	315-0101-00			100 OHM, 0.25W, 5%
R137	315-0101-00			100 OHM, 0.25W, 5%
R138	321-0263-00			5.36k OHM, 0.125W, 1%
R161	315-0101-00			100 OHM, 0.25W, 5%
R162	315-0101-00			100 OHM, 0.25W, 5%
R163	315-0123-00			12k OHM, 0.25W, 5%
R165	321-0316-00			19.1k OHM, 0.125W, 1%
R166	321-0289-00			10k OHM, 0.125W, 1%
R202	321-0391-00			115k OHM, 0.125W, 1%
R204	315-0183-00			18k OHM, 0.25W, 5%
R206	315-0122-00			1.2k OHM, 0.25W, 5%
R207	315-0101-00			100 OHM, 0.25W, 5%
R208	315-0512-00			5.1k OHM, 0.25W, 5%
R209	321-0306-00			15k OHM, 0.125W, 12
R211	315-0101-00			100 OHM, 0.25W, 5Z
R213	315-0101-00			100 OHM, 0.25W, 5%

REV. MAY 1974

VERTICAL Circuit Board Assembly (cont)

Ckt No.	Tektronix Part No.	Serial/Model Eff	No. Disc	Description
RESISTORS (cont)				
R214	315-0220-00			22 OHM, 0.25W, 5%
R216	315-0752-00			7.5k OHM, 0.25W, 5%
R218	315-0752-00			7.5k OHM, 0.25W, 5%
R219	315-0101-00			100 OHM, 0.25W, 5%
R221	321-0245-00			3.48k OHM, 0.125W, 1%
R222	321-0245-00			3.48k OHM, 0.125W, 1%
R224	321-0231-00			2.49k OHM, 0.125W, 1%
R226	321-0231-00			2.49k OHM, 0.125W, 1%
R229	315-0102-00			1k OHM, 0.25W, 5%
R231	315-0102-00			1k OHM, 0.25W, 5%
R234	315-0100-00			10 OHM, 0.25W, 5%
R242	321-0328-00			25.5k OHM, 0.125W, 1%
R244	315-0432-00			4.3k OHM, 0.25W, 5%
R245	311-0732-00	B010100	B060969	1k OHM, Var
R245	311-1263-00	B060970		1k OHM, Var
R246	315-0432-00			4.3k OHM, 0.25W, 5%
R248	315-0106-00			10 M OHM, 0.25W, 5%
R253	315-0101-00			100 OHM, 0.25W, 5%
R257	315-0241-00			240 OHM, 0.25W, 5%
R258	315-0241-00			240 OHM, 0.25W, 5%
R259	315-0243-00			24k OHM, 0.25W, 5%
R261	315-0101-00			100 OHM, 0.25W, 5%
R264	315-0101-00			100 OHM, 0.25W, 5%
R266	315-0101-00			100 OHM, 0.25W, 5%
R267	315-0101-00			100 OHM, 0.25W, 5%
R268	321-0745-03			25.05k OHM, 0.125W, 0.25%
R269	321-1310-03			16.7k OHM, 0.125W, 0.25%
R271	321-0360-00			54.9k OHM, 0.125W, 1%
R272	321-0283-00			8.66k OHM, 0.125W, 1%
R274	321-0283-00			8.66k OHM, 0.125W, 1%
R275	321-0360-00			54.9k OHM, 0.125W, 1%
R301	315-0105-00			1 M OHM, 0.25W, 5Z
R302	315-0512-00			5.1k OHM, 0.25W, 5%
R303	315-0512-00			5.1k OHM, 0.25W, 5%
R304	315-0105-00			1 M OHM, 0.25W, 5%
R305	311-0831-00			100k OH-, Var
R311	321-0207-00			1.4k OHM, 0.125W, 1%
R312	321-0234-00			2.67k OHM, 0.125W, 1%
R314	321-0194-00			1.02k OHM, 0.125W, 1%
R316	321-0371-00			71.5k OHM, 0.125W, 1%
R317	321-0372-00			73.2k OHM, 0.125W, 1%
R319	315-0243-00			24k OHM, 0.25W, 5%
R321	321-0251-00			4.02k OHM, 0.125W, 1%

VERTICAL Circuit Board Assembly (cont)

Ckt No.	Tektronix Part No.	Serial/Model Eff	No. Disc	Description
RESISTORS (cont)				
R322	321-0191-00			953 OHM, 0.125W, 1%
R325	311-0883-00			50k OHM, Var
R326	321-0191-00			953 OHM, 0.125W, 1%
R332	315-0684-00			680k OHM, 0.25W, 5%
R334	321-0194-00			1.02k OHM, 0.125W, 1%
R336	321-0371-00			71.5k OHM, 0.125W, 1%
R337	321-0372-00			73.2k OHM, 0.125W, 1%
R339	315-0243-00			24k OHM, 0.25W, 5%
R343	321-0238-00			29.4k OHM, 0.125W, 1%
R344	321-0146-00			324 OHM, 0.125W, 1%
R346	321-0209-00			1.47k OHM, 0.125W, 1%
R353	321-0238-00			2.94k OHM, 0.125W, 1%
R356	321-0209-00			1.47k OHM, 0.125W, 1%
R362	321-0222-00			2k OHM, 0.125W, 1%
R363	321-0251-00			4.02k OHM, 0.125W, 1%
R365	321-0251-00			4.02k OHM, 0.125W, 1%
R366	321-0222-00			2k OHM, 0.125W, 1%
R368	321-0150-00			357 OHM, 0.125W, 1%
R501	315-0683-00			68k OHM, 0.25W, 5%
R502	315-0104-00			100k OHM, 0.25W, 5%
R503	315-0474-00			470k OHM, 0.25W, 5%
R504	317-0105-00			1 M OHM, 0.125W, 5%
R505	315-0154-00			150k OHM, 0.25W, 5%
R506	321-0399-00			140k OHM, 0.125W, 1%
R508	321-0373-00			75k OHM, 0.125W, 1%
R509	315-0105-00			1 M OHM, 0.25W, 5%
'515	321-0223-00			2.05k OHM, 0.125W, 1%
R516	321-0299-00			12.7k OHM, 0.125W, 1%
R517	321-0346-00			39.2k OHM, 0.125W, 1%
R518	321-0346-00			39.2k OHM, 0.125W, 1%
R602	315-0101-00			100 OHM, 0.25W, 5%
R605	315-0101-00			100 OHM, 0.25W, 5%
R606	315-0101-00			100 OHM, 0.25W, 5%
R609	315-0101-00			100 OHM, 0.25W, 5%
TRANSFORMER				
T230	120-0547-00			Toroid, four 15 turn windings

REV. MAY 1974

INTER-CHANNEL CONTROL Circuit Board Assembly

Ckt No.	Tektronix Part No.	Serial/Model Eff	No. Disc	Description
	670-1089-00	B010100	B049999	Complete Board
	670-1089-01	B050000	B079999	Complete Board
	670-1089-02	B080000	B099999	Complete Board
	670-1089-03	B100000		Complete Board
CAPACITORS				
C159	283-0026-00			0.2uF, Cer, 25V, +80%-20%
C406	283-0059-00			1uF, Cer, 25V, +80%-20%
C411	283-0065-00			0.001uF, Cer, 100 V, 5%
C414	283-0081-00			0.1uF, Cer, 25V, +80%-20%
C418	283-0054-00			150pF, Cer, 200V, 5%
C423	283-0060-00			100pF, Cer, 200V, 5%
C427	283-0060-00			100pF, Cer, 200V, 5%
C431	283-0032-00			470pF, Cer, 500V, 5%
C432	283-0175-00	XB100000		10pF, Cer, 200V, 5%
C434	283-0109-00			27pF, Cer, 1000V, 5%
C444	283-0032-00			470pF, Cer, 500V, 5%
C447	283-0115-00			47pF, Cer, 200V, 5%
C449	283-0059-00			1uF, Cer, 25V, +80%-20%
C451	283-0032-00			470pF, Cer, 500V, 5%
C457	283-0103-00			180pF, Cer, 500V, 5%
C460	283-0109-00			27pF, Cer, 1000V, 5%
C471	281-0579-00	B010100	B099999	21pF, Cer, 500V, 5%
C471	281-0605-00	B100000		200pF, Cer, 500V, 5%
C476	283-0060-00	B010100	B099999X	100pF, Cer, 200V, 5%
C479	283-0060-00	B010100	B099999X	100pF, Cer, 200V, 5%
C621	283-0059-00			1uF, Cer, 25V, +80%-20%
C629	290-0134-00			22uF, Elect., 15V, 20%
C635	283-0059-00			1uF, Cer, 25V, +80%-20%
C636	283-0059-00			1uF, Cer, 25V, +80%-20%
C637	283-0059-00			1uF, Cer, 25V, +80%-20%
C638	283-0059-00			1uF, Cer, 25V, +80%-20%
DIODES				
CR401	152-0185-00			Silicon, replaceable by 1N4152
CR402	152-0185-00			Silicon, replaceable by 1N4152
CR403	152-0185-00			Silicon, replaceable by 1N4152
CR410	152-0185-00			Silicon, replaceable by 1N4152
CR411	152-0185-00			Silicon, replaceable by 1N4152
CR413	152-0185-00			Silicon, replaceable by 1N4152
CR414	152-0185-00			Silicon, replaceable by 1N4152

REV. MAY 1974

INTER-CHANNEL CONTROL Circuit Board Assembly (cont)

Ckt No.	Tektronix Part No.	Serial/Model Eff	No. Disc	Description
DIODES (cont)				
CR425	152-0185-00			Silicon, replaceable by 1N4152
CR429	152-0185-00			Silicon, replaceable by 1N4152
CR30	152-0185-00			Silicon, replaceable by 1N4152
CR434	152-0185-00			Silicon, replaceable by 1N4152
CR444	152-0185-00			Silicon, replaceable by 1N4152
CR455	152-0185-00			Silicon, replaceable by 1N4152
CR462	152-0185-00			Silicon, replaceable by 1N4152
CR464	152-0185-00			Silicon, replaceable by 1N4152
CR471	152-0185-00			Silicon, replaceable by 1N4152
CR474	152-0141-02	XB100000		Silicon, 1N4152
CR476	152-0185-00	B010100	B099999X	Silicon, replaceable by 1N4152
CR479	152-0185-00			Silicon, replaceable by 1N4152
CR624	152-0185-00			Silicon, replaceable by 1N4152
CR625	152-0185-00			Silicon, replaceable by 1N4152
CONNECTOR				
J449	131-0391-00	XB080000		Coax, male, 50 OHM
TRANSISTORS				
Q404	151-0190-00			Silicon, 2N3904
Q408	151-0190-00			Silicon, 2N3904
Q410	151-0190-00			Silicon, 2N3904
Q422	151-0188-00			Silicon, 2N3906
Q430	151-0190-00	B010100	B049999	Silicon, 2N3904
Q430	151-0269-00	B050000	B099999	Silicon, selected from SE 3005
Q430	151-0441-00	B100000		Silicon, selected from 2N2857
Q452	151-0188-00			Silicon, 2N3906
Q456	151-0190-00			Silicon, 2N3904
Q464	151-0188-00			Silicon, 2N3906
Q474	151-0190-00			Silicon, 2N3904
Q476	151-0190-00	XB100000		Silicon, 2N3904
Q477	151-0301-00	XB100000		Silicon, 2N2907
Q478	151-0190-00			Silicon, 2N3904
Q624	151-0261-00			Silicon, Dual, Tek Spec
Q626	151-0134-00			Silicon, replaceable by 2N2905
RESISTORS				
R159	315-0101-00			100 OHM, 0.25W, 5%
R401	317-0103-00			10k OHM, 0.125W, 5%
R402	317-0750-00			75 OHM, 0.125W, 5%
R404	321-0402-00			150k OHM, 0.125W, 1%
R410	317-0750-00			75 OHM, 0.125W, 5%

REV. MAY 1974

INTER-CHANNEL CONTROL Circuit Board Assembly (cont)

Ckt No.	Tektronix Part No.	Serial/Model Eff	No. Disc	Description
RESISTORS (cont)				
R411	317-0103-00			10k OHM, 0.125W, 5%
R414	315-0473-00			47k OHM, 0.25W, 5%
R415	311-0831-00	B010100	B059999	100k OHM, Var
R415	311-1272-00	B060000		100k OHM, Var
R418	317-0512-00			5.1k OHM, 0.125W, 5%
R422	317-0103-00			10k OHM, 0.125W, 5%
R423	317-0132-00			1.3k OHM, 0.125W, 5%
R427	317-0132-00			1.3k OHM, 0.125W, 5%
R430	315-0201-00			200 OHM, 0.25W, 5%
R431	315-0102-00			1k OHM, 0.25W, 5%
R434	315-0122-00	B010100	B049999	1.2k OHM, 0.25W, 5%
R434	315-0152-00	B050000		1.5k OHM, 0.25W, 5%
R441	315-0511-00			510 OHM, 0.25W, 5%
R442	315-0153-00			15k OHM, 0.25W, 5%
R446	315-0204-00			200k OHM, 0.25W, 5%
R451	315-0513-00			51k OHM, 0.25W, 5%
R452	315-0101-00			100 OHM, 0.25W, 5%
R453	315-0243-00			24k OHM, 0.25W, 5%
R455	315-0432-00			4.3k OHM, 0.25W, 5%
R457	315-0472-00			4.7k OHM, 0.25W, 5%
R460	311-0950-00	B010100	B059999	10k OHM, Var
R460	311-1268-00	B060000		10k OHM, Var
R461	315-0272-00			2.7k OHM, 0.25W, 5%
R462	315-0223-00			22k OHM, 0.25W, 5%
R464	315-0331-00			330 OHM, 0.25W, 5%
R471	315-0124-00			120k OHM, 0.25W, 5%
R472	317-0104-00			100k OHM, 0.125W, 5%
R474	317-0202-00	B010100	B099999	2k OHM, 0.125W, 5%
R474	317-0102-00	B100000		1k OHM, 0.125W, 5%
R475	317-0103-00	XB10000		10k OHM, 0.125W, 5%
R476	317-0153-00			15k OHM, 0.125W, 5%
R478	315-0362-00			3.6k OHM, 0.25W, 5%
R479	317-0511-00	B011000	B099999X	510 OHM, 0.125W, 5%
R621	321-0632-00			9.41k OHM, 0.125W, 0.25%
R622	321-0601-00			2.141k OHM, 0.125W, 0.25%
R624	321-0236-00			2.8k OHM, 0.125W, 1%
R626	321-0315-00			18.7k OHM, 0.125W, 1%
R627	315-0180-00			18 OHM, 0.25W, 5%
R629	315-0512-00			5.1k OH, 0.25W, 5%
R635	315-0470-00			47 OHM, 0.25W, 5%
R636	315-0101-00			100 OHM, 0.25W, 5%
R638	315-0101-00			100 OHM, 0.25W, 5%

INTER-CHANNEL CONTROL Circuit Board Assembly (cont)

Ckt No.	Tektronix Part No.	Serial/Model Eff	No. Disc	Description
TRANSFORMERS				
T400	120-0650-00			Toroid, 2 windings
T410	120-0487-00			Toroid, 5 turns bifilar
T430	120-0546-00			Toroid, 4 turns bifilar
INTERFACE Circuit Board Assembly				
	670-1090-00	B010100	B029999	Complete Board
	670-1090-01	B030000	B039999	Complete Board
	670-1090-02	B040000	B079999	Complete Board
	670-1090-03	B080000	B099999	Complete Board
	670-1090-04	B100000		Complete Board
CAPACITORS				
C104	283-0003-00			0.01uF, Cer, 150V, +80%-20%
C115	283-0072-01			0.01uF, Cer, 20%
C631	290-0327-00			0.56uF, Elect., 100V, 20%
C632	290-0134-00			22uF, Elect., 15V, 20%
C634	283-0059-00			1uF, Cer, 25V, +80%-20%
C639	290-0327-00			0.56uF, Elect., 100V, 20%
DIODES				
CR108	152-0185-00			Silicon, replaceable by 1N4152
CR113	152-0185-00			Silicon, replaceable by 1N4152
CR115	152-0185-00			Silicon, replaceable by 1N4152
CR116	152-0153-00			Silicon, Tek Spec
CR528	152-0185-00	XB040000		Silicon, replaceable by 1N4152
CONNECTORS				
J101	131-0391-00			Coaxial, 50 OHM, male
J114	131-0391-00			Coaxial, 50 OHM, male
INDUCTORS				
L631	120-0382-00			Toroid, 14 turns single
L632	120-0382-00			Toroid, 14 turns single
L639	120-0382-00			Toroid, 14 turns single
TRANSISTORS				
Q108	151-0188-00			Silicon, 2N3906
Q113	151-0188-00			Silicon, 2N3906
Q116	151-0207-00			Silicon, 2N3415

REV. MAY 1974

INTERFACE CIRCUIT Board Assembly (cont)

Ckt No.	Tektronix Part No.	Serial/Model Eff	No. Disc	Description
RESISTORS				
R101	317-0124-00			120k OHM, 0.125W, 5%
R102	317-0244-00			240k OHM, 0.125W, 5%
R104	317-0153-00			15k OHM, 0.125W, 5%
R106	317-0153-00			15k OHM, 0.125W, 5%
R107	317-0151-00	XB030000		150 OHM, 0.125W, 5%
R108	317-0302-00			3k OHM, 0.125W, 5%
R109	317-0152-00			1.5k OHM, 0.125W, 5%
R111	315-0203-00			20k OHM, 0.25W, 5%
R113	315-0122-00			1.2k OHM, 0.25W, 5%
R114	321-0206-00			1.37k OHM, 0.125W, 1%
R115	317-0431-00			430 OHM, 0.125W, 5%
R116	315-0390-00			39 OHM, 0.25W, 5%
R320	311-0585-00			15k OHM, Var
R512	321-0402-00			150k OHM, 0.125W, 1%
R513	321-0402-00			150k OHM, 0.125W, 1%
R519	321-0339-00			33.2k OHM, 0.125W, 1%
R521	321-0373-00			75k OHM, 0.125W, 1%
R527	321-0373-00			75k OHM, 0.125W, 1%
R528	321-0304-00			14.3k OHM, 0.125W, 1%
R529	321-0402-00			150k OHM, 0.125W, 1%
R531	321-0373-00			75k OHM, 0.125W, 1%
R533	321-0402-00			150k OHM, 0.125W, 1%
R535	321-0402-00			150k OHM, 0.125W, 1%
R537	321-0356-00			49.9k OHM, 0.125W, 1%
R539	321-0344-00			37.4k OHM, 0.125W, 1%
R551	315-0510-00			51 OHM, 0.25W, 5%
R561	315-0510-00			51 OHM, 0.25W, 5%
R634	315-0100-00			10 OHM, 0.25W, 5%
S320			Cal In	
+UP/INVERT Circuit Board Assembly				
	670-1148-00	B010100	B019999	Complete Board
	670-1148-01	B020000		Complete Board
BULBS				
DS302	150-0057-01	B010100	B019999	Incandescent, 7153AS15, selected
DS302	150-0048-01	B020000		Incandescent, #683, selected

¹See Mechanical Parts List for replacement parts.

+ UP/INVERT Circuit Board Assembly (cont)

Ckt No.	Tektronix Part No.	Serial/Model Eff	No. Disc	Description
SWITCHES				
S302A ¹				
S302B	670-1148-00	B010100	B019999	Pushbutton, + UP
S302A				INV
S302B	670-1148-01	B020000		Pushbutton, + UP
NORMAL/SMOOTH-INT TRIGGER Circuit Board Assembly				
	670-1149-00	B010100	B019999	Complete Board
	670-1149-01	B020000		Complete Board
BULBS				
DS116	150-0057-01	B01000	B019999	Incandescent, 7153AS15, selected
DS116	150-0048-01	B020000		Incandescent, #683, selected
DS141	150-0057-01	B010100	B019999	Incandescent, 7153AS15, selected
DS141	150-0048-01	B020000		Incandescent, #683, selected
RESISTORS				
R141	317-0222-00			2.2k OHM, 0.125W, 5%
R142	317-0681-00			680 OHM, 0.125W, 5%
SWITCHES				
S141A ¹				NORMAL
S141B	670-1149-00	B010100	B019999	Pushbutton, SMOOTH
S141C.				INT TRIG
S141A ¹				NORMAL
S141B	670-1149-01	B020000		Pushbutton, SMOOTH
S141C	INT TRIG			

¹See Mechanical Parts List for replacement parts.

**PART NUMBER -- NATIONAL STOCK NUMBER
CROSS REFERENCE INDEX**

PART NUMBER	FSCM	NATIONAL STOCK NUMBER	PART NUMBER	FSCM	NATIONAL STOCK NUMBER
120-0382-00	80009	5950-00-078-1510	151-0207-00	80009	5961-00-378-0355
120-0402-00	80009	5950-00-479-1621	151-0216-00	80009	5961-00-350-2246
120-0487-00	80009	5950-00-451-2440	151-0261-00	80009	5961-00-689-1455
120-0546-00	80009	5950-00-451-2443	151-0269-00	80009	5961-00-452-0515
120-0547-00	80009	5950-00-451-2444	151-0441-00	80009	5961-01-005-9744
120-0650-00	80009	5950-00-405-2717	152-0141-02	80009	5961-00-105-7681
131-0375-00	80009	5935-00-062-1320	152-0153-00	80009	5961-00-923-9773
131-039100	80009	5935-00-460-5639	152-0185-00	80009	5961-00-936-7604
131-0566-00	80009	5940-00-242-0676	152-0226-00	80009	5961-00-232-3297
131-0566-00	80009	6625-01-014-3446	152-0323-00	80009	5961-00-222-6190
131-0589-00	80009	5999-00-275-0213	210-0046-00	80009	5310-00-841-8117
131-0590-00	80009	5999-00-551-9434	210-0457-00	80009	5310-00-841-8106
131-0621-00	80009	5940-00-242-0536	210-0583-00	80009	5310-00-006-8168
131-0622-00	80009	5999-01-022-6616	210-0586-00	80009	5310-00-836-3520
131-0665-00	80009	5999-00-557-3659	210-0590-00	80009	5310-00-006-8167
131-0707-00	80009	5999-00-396-6331	211-0101-00	80009	5305-00-492-2145
131-0708-00	80009	5999-00-500-9657	211-0105-00	80009	5305-00-841-8060
131-0792-00	80009	5999-01-023-1578	211-0116-00	80009	5305-00-005-8245
136-0183-00	80009	5935-00-938-4734	213-0020-00	80009	5305-00-005-2487
136-0220-00	80009	5935-00-067-7311	213-0048-00	80009	5305-00-952-0172
136-0235-00	80009	5935-00-814-2209	213-0075-00	80009	5305-00-625-9541
136-0263-03	80009	5999-00-394-0381	213-0153-00	80009	5305-00-283-1909
150-0048-01	80009	6240-00-060-2941	214-0579-00	80009	5940-00-935-8313
150-0057-01	80009	6240-00-183-0669	214-1136-00	80009	5930-01-206-6724
151-0134-00	80009	5961-00-936-7589	214-1190-00	80009	6625-01-066-3336
151-0188-00	80009	5961-00-931-0372	281-0092-00	80009	5910-00-983-2624
151-0188-00	80009	5961-00-457-5187	281-0092-00	80009	5910-00-403-8872
151-0188-00	80009	5961-00-931-0372	281-0092-00	80009	5910-00-947-9500
151-0190-00	80009	5961-00-892-8706	281-0605-00	80009	5910-00-913-9920
151-0192-00	80009	5961-00-879-7461	283-0000-00	80009	5910-00-688-8702

**PART NUMBER - NATIONAL STOCK NUMBER
CROSS REFERENCE INDEX**

PART NUMBER	FSCM	NATIONAL STOCK NUMBER	PART NUMBER	FSCM	NATIONAL STOCK NUMBER
283-0003-00	80009	5910-00-801-1005	315-0104-00	80009	5905-00-434-5443
283-0004-00	80009	5910-00-577-1346	315-0122-00	80009	5905-00-445-3825
283-0023-00	80009	5910-00-914-3326	315-0123-00	80009	5905-00-445-3826
283-0026-00	80009	5910-00-954-9055	315-0152-00	80009	5905-00-445-3831
283-0032-00	80009	5910-00-113-2375	315-0183-00	80009	5905-00-445-3708
283-0051-00	80009	5910-00-900-1209	315-0201-00	80009	5905-00-445-3714
283-0054-00	80009	5910-00-879-6851	315-0204-00	80009	5905-00-445-3762
283-0059-00	80009	5910-00-932-7113	315-0220-00	80009	5905-00-445-3768
283-0060-00	80009	5910-00-835-6395	315-0223-00	80009	5905-00-436-9680
283-0065-00	80009	5910-00-465-4042	315-0272-00	80009	5905-00-436-9832
283-0072-01	80009	5910-00-460-9957	315-0273-00	80009	5905-00-436-9839
283-0081-00	80009	5910-00-782-7614	315-0331-00	80009	5905-00-437-0883
283-0103-00	80009	5910-00-485-4854	315-0390-00	80009	5905-00-436-9884
283-0175-00	80009	5910-00-158-5178	315-0470-00	80009	5905-00-437-0891
283-0594-00	80009	5910-00-066-0061	315-0473-00	80009	5905-00-437-0164
290-0134-00	80009	5910-00-752-4270	315-0510-00	80009	5905-00-437-0272
290-0134-00	80009	5910-00-807-7253	315-0511-00	80009	5905-00-437-0282
311-0095-00	80009	5905-00-476-0080	315-0512-00	80009	5905-00-437-0283
311-0258-00	80009	5905-00-910-0763	315-0683-00	80009	5905-00-496-9491
311-0310-00	80009	5905-00-841-7218	315-0752-00	80009	5905-00-437-0921
311-0732-00	80009	5905-00-177-7396	315-0821-00	80009	5905-00-437-0936
311-0831-00	80009	5905-00-138-1034	321-0150-00	80009	5905-00-105-7713
311-0883-00	80009	5905-00-483-3829	321-0154-00	80009	5905-00-434-5045
311-0950-00	80009	5905-00-220-3515	321-0193-00	80009	5905-00-434-5059
311-0965-00	80009	5905-00-451-4208	321-0206-00	80009	5905-00-434-5055
311-1162-00	80009	5905-00-170-9513	321-0207-00	80009	5905-00-879-7815
311-1263-00	80009	5905-00-048-6793	321-0222-00	80009	5905-00-426-7707
311-1268-00	80009	5905-00-566-3797	321-0231-00	80009	5905-00-021-6494
315-0100-00	80009	5905-00-434-5438	321-0260-00	80009	5905-00-922-9925
315-0101-00	80009	5905-00-102-5294	321-0260-00	80009	5905-00-426-7788
315-010200	80009	5905-00-434-5439	321-0260-00	80009	5905-00-922-925

**PART NUMBER - NANTIONAL STOCK NUMBER
CROSS REFERENCE INDEX**

PART NUMBER	FSCM	NATIONAL STOCK NUMBER	PART NUMBER	FSCM	NATIONAL STOCK NUMBER
321-0289-00	80009	5905-00-434-5068			
321-0299-00	80009	5905-00-105-9724			
321-0327-00	80009	5905-00-426-7760			
321-0344-00	80009	5905-00-441-7812			
321-0360-00	80009	5905-00-251-1438			
321-0385-00	80009	5905-00-426-7847			
321-0391-00	80009	5905-00-824-4175			
321-0399-00	80009	5905-00-472-7238			
321-0402-00	80009	5905-00-426-7856			
321-0745-03	80009	5905-00-195-2402			
321-1310-03	80009	5905-00-195-2401			
348-0235-00	80009	5999-00-434-2894			
352-0162-00	80009	5999-01-022-9144			
352-0163-00	80009	5935-00-599-8832			
352-0169-00	80009	5935-00-597-5054			
352-0169-02	80009	5935-00-030-5132			
352-0198-00	80009	5935-00-597-5055			
352-0201-00	80009	4920-00-553-3414			
354-0251-00	80009	5340-00-064-0015			
361-0007-00	80009	5365-00-816-0002			
366-1057-00	80009	5355-00-765-3932			
366-1064-00	80009	5355-00-419-4040			
366-1148-01	80009	5355-00-419-4014			
366-1168-00	80009	5355-00-422-2313			
376-0049-00	80009	5985-00-023-2363			
376-0051-00	80009	3010-00-363-4140			
426-0121-00	80009	5950-00-865-0278			

PARTS LIST ABBREVIATIONS

BHB	binding head brass	int	internal
BHS	binding head steel	lg	length or long
cap.	capacitor	met.	Meal
cer	ceramic	mtg hdw	mounting hardware
comp	composition	OD	outside diameter
comp	connector	OHB	oval head bras
CRT	cathode-ray tube	OHS	oval head steel
csk	countersunk	P/O	part of
DE	double end	PHB	pan head brass
dia	diameter	PHS	pan head steel
		plsk	plastic
div	division	PMC	paper, metal cased
elect.	electrolytic		
		poly	polystyene
EMC	electrolytic, metal cased	PT	paper, tubular
EMT	electolyic, mel tubulr	PTM	paper or plasic, tubula, molded
ext	external	RHB	round head brass
F & I	focus and intensity	RHS	round head steel
FHB	flat head brass	SE	single end
FHS	flat head steel	SN or S/N	serial number
Fil HB	fillister head brass	S or SW	switch
Fil HS	fillister head steel	TC	temperature compensated
h	height or high	THB	truss head brass
hex.	hexagonal	thk	thick
HHB	hex head brass	THS	truss head steel
HHS	hex head steel	tub.	Tubular
HSB	hex socket brass	vor	variable
HSS	hex socket steel	w	wide or width
ID	inside diometer	WW	wire-wound
inc	incandescent		

SECTION 8
DIAGRAMS
AND
MECHANICAL
PARTS ILLUSTRATIONS



Screwdriver adjustment.



Front- or rear-panel control or connector.



Refers to the indicated diagram.



Test point.



Blue line encloses components located on circuit board.



Connection made to circuit board with interconnecting pin.

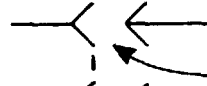

Connection made to circuit board with pin socket.

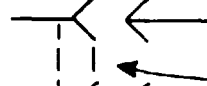

Coax connector.

VOLTAGE AND WAVEFORM TEST CONDITIONS

The typical voltage measurements were obtained under the following conditions unless noted otherwise on the individual diagrams

Voltmeter

Type	Multimeter	Units/Div	200
Sensitivity	20,000 ohm/volt	VARIABLE	CAL IN
Ranges	0.6 and 12 volts	+UP	Pushed in
Recommended type used for measuring the voltages shown on the diagrams)	Triplett Model 630-NA	DC OFFSET	Midrange, 0 volts at OFFSET OUT jack
		NORMAL	Pushed in
		Input signal	Termination or Coaxial cable connected. No input signal.

7S11 (right vertical compartment, calibrated Sampling Head installed)

7504

Vertical Mode	Left
Horizontal Mode	B
B Intensity	Optimum
A Trigger Source	Right Vert
B Trigger Source	Left Vert

7A13 (left vertical compartment, P6010, at +Input connector, 10X probe used for waveforms)

7T11 (right horizontal compartment)

Slope	+
Stability	Fully clockwise free run)
Sequential	Pushed in
Sweep Range	5 us
Time/Div	1 us
Int	Pushed in
Scan	Rep

7B50 (left horizontal compartment)

Volts	+	Mode	Auto
+Input	DC	Coupling	AC
Comparison Voltage	Center display on graticule	Source	Int
	See waveforms	Magnifier	X1
Volts/Div		Time/Div	See Waveforms

All voltages given on the diagrams are in volts. Waveforms shown are actual waveform photographs taken with a Tektronix Oscilloscope Camera System and Projected Graticule. Vertical deflection factor shown on waveform is the actual deflection factor from the input connector and does not include the 10X attenuation of the probe. The voltages and waveforms (shown in blue) on the diagrams are not absolute and may vary between instruments because of component tolerances, internal calibration, or front panel control settings. Voltage and time readouts are simulated in larger than normal type.

NOTE

The spring tension of the pin sockets ensures a good connection between the circuit board and pin. This spring tension may be damaged by suing the pin sockets as a connecting point for spring-loaded probe tip, alligator clips, etc

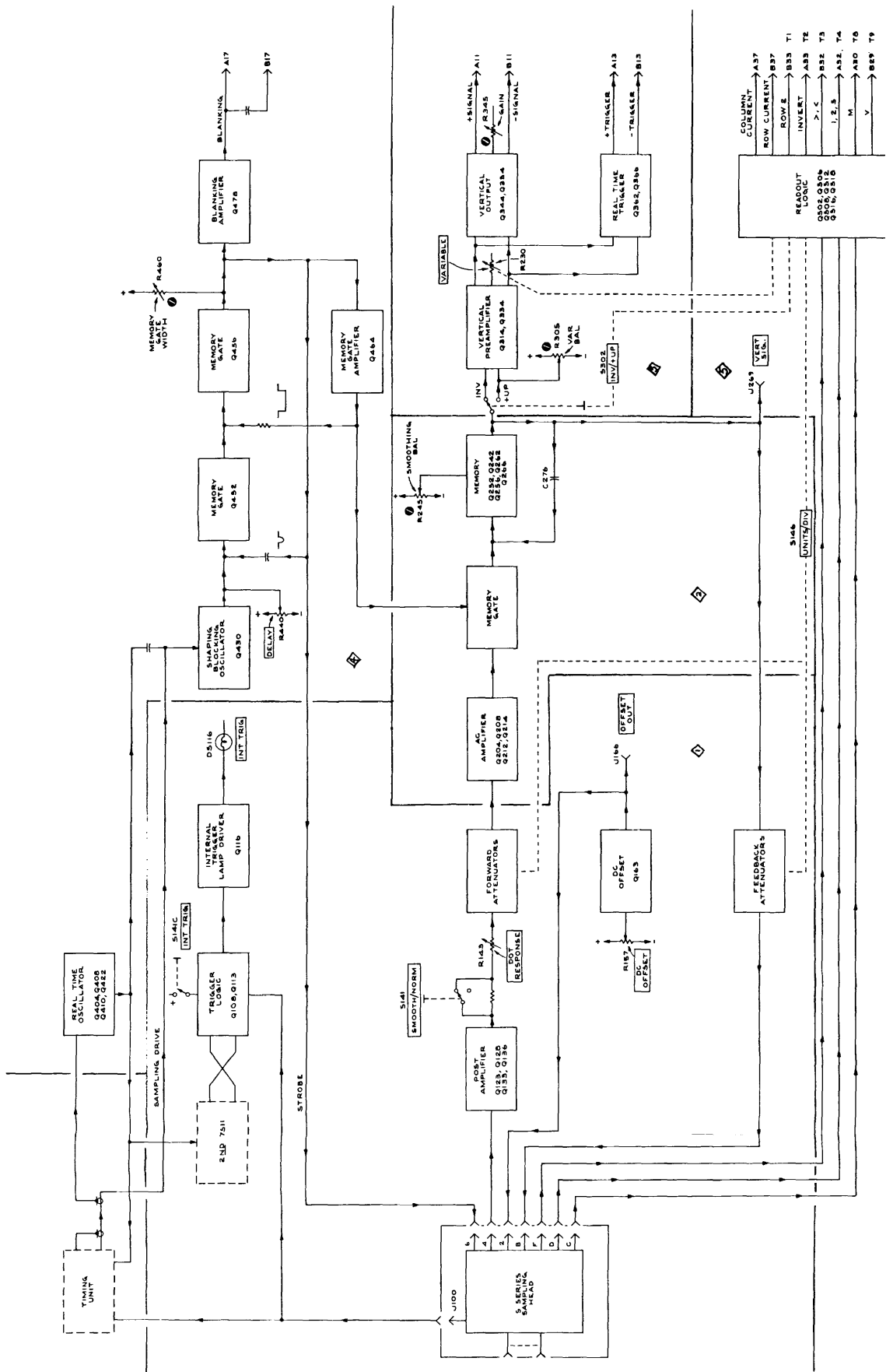

VOLTAGE & WAVEFORM CONDITIONS

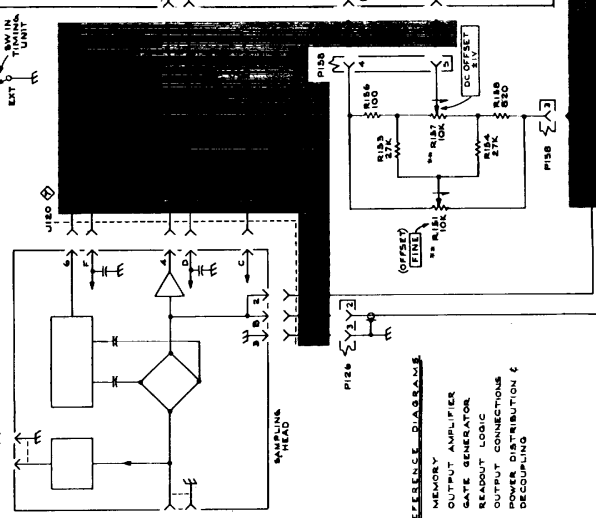
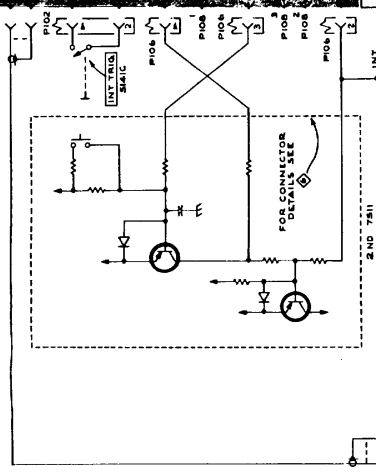
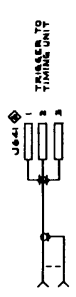

- REFERENCE DIAGRAM**
- ◇ MEMORY
 - ◇ OUTPUT AMPLIFIER
 - ◇ GATE GENERATOR
 - ◇ READOUT LOGIC
 - ◇ OUTPUT CONNECTIONS
 - ◇ DISTRIBUTION & DECOUPLING

- NOTES:**
- 1. S DENOTES LEADLESS CAPACITORS.
 - 2. S DENOTES LEADLESS SEMICONDUCTOR DISTRIBUTION LIST POWER TYPES.
 - 3. SEE PARTS LIST FOR SEMICONDUCTOR TYPES.
 - 4. R.F.S. FURNISHED AS A UNIT.



7511 SAMPLING UNIT

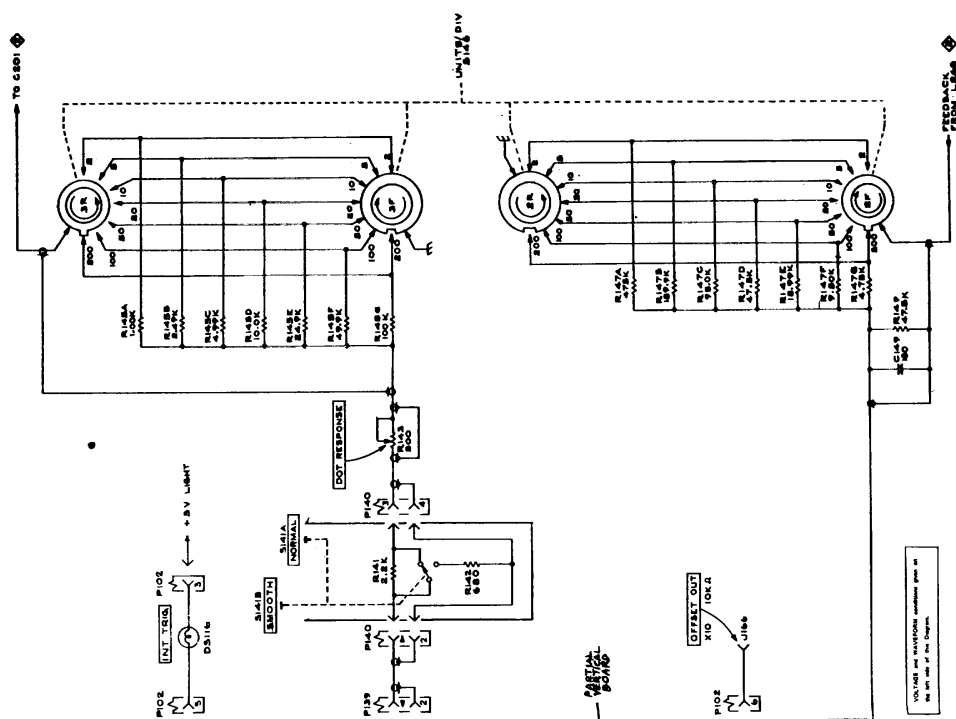
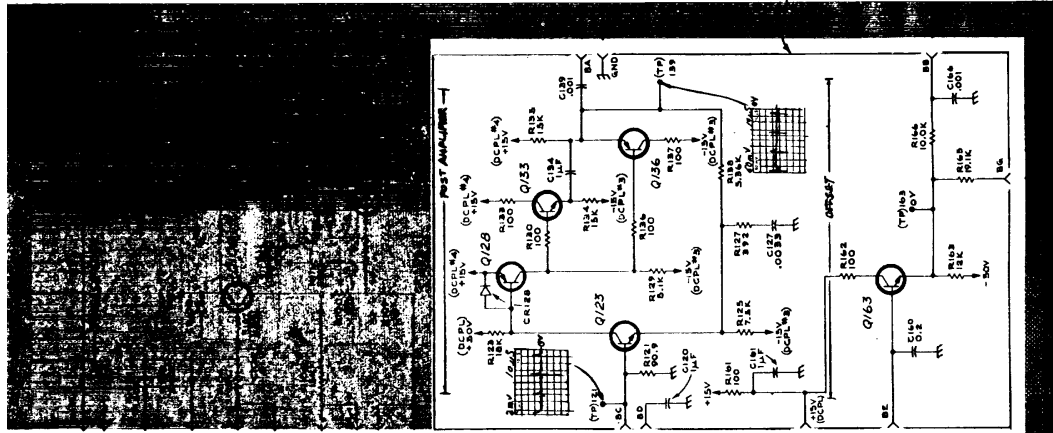

POST AMPLIFIER & ATTENUATORS

Y88
1171

AC AMP

MEMORY GATE

MEMORY

- REFERENCE DIAGRAMS
- ◇ POST AMPLIFIER & ATTENUATORS
 - ◇ OUTPUT AMPLIFIER
 - ◇ GATE GENERATOR
 - ◇ POWER DISTRIBUTION & DECOUPLING

NOTES:

1. SEE PARTS LIST FOR
2. FOR DECOUPLING & POWER
3. DISTRIBUTION SILEX

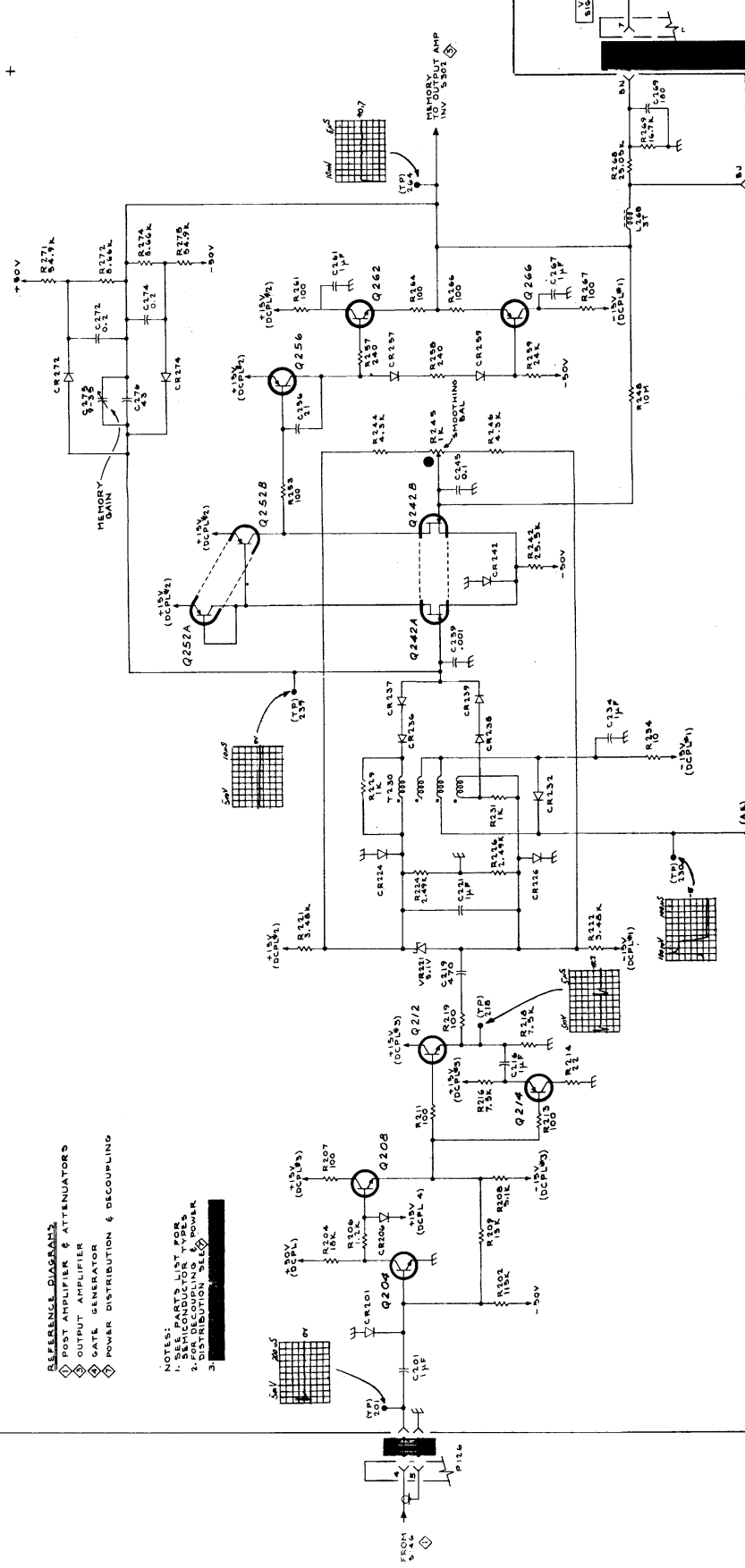

PARTIAL VERTICAL BOARD

MEMORY GATE DRIVER

FEEDBACK TO

MEMORY TO OUTPUT AMP

MEMORY

VERT. SIG. OUT

FROM

PI16

PI16

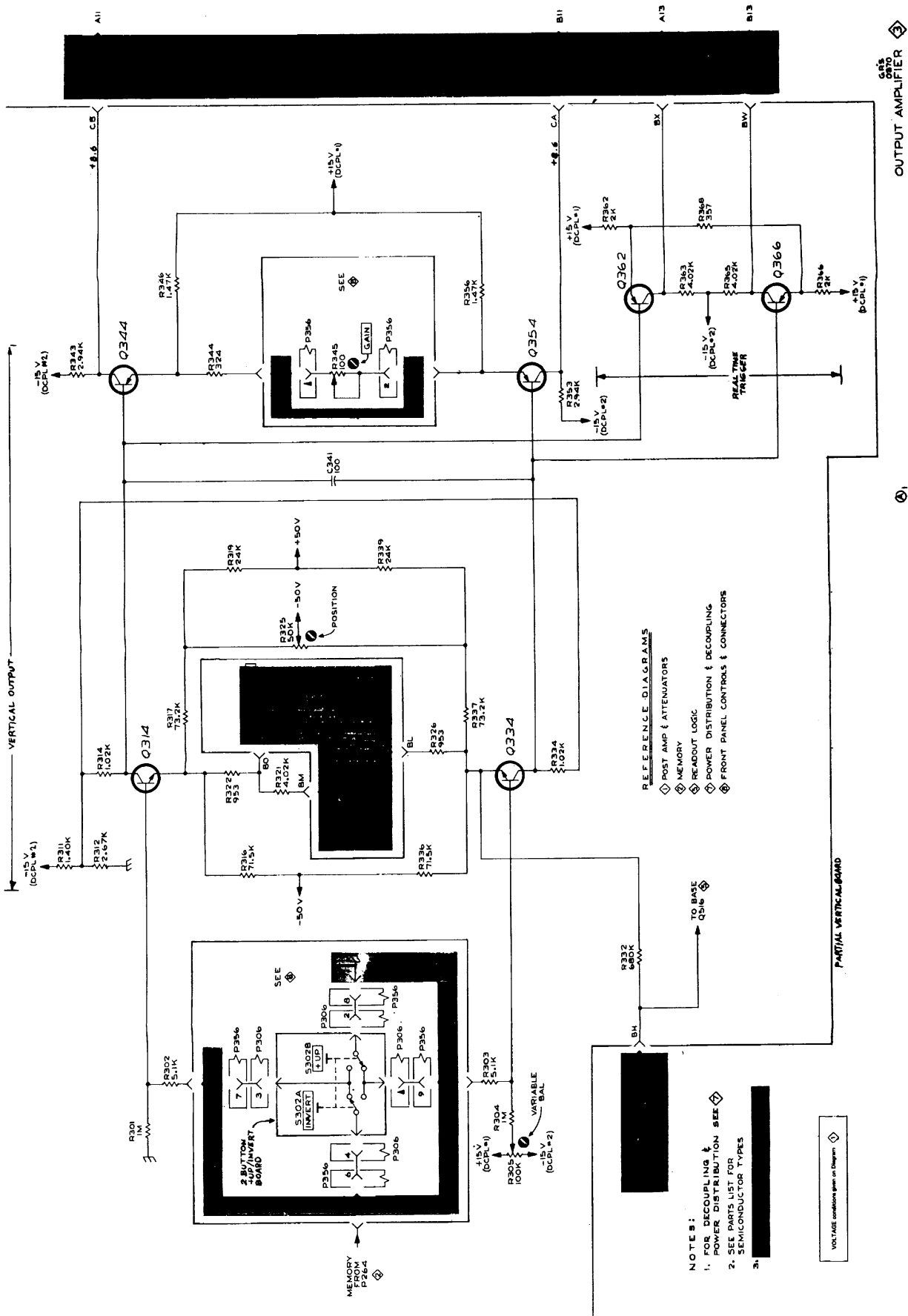

OUTPUT AMPLIFIER

- REFERENCE DIAGRAMS
- ◇ POST AMP & ATTENUATORS
 - ◇ MEMORY
 - ◇ READOUT LOGIC
 - ◇ POWER DISTRIBUTION & DECOUPLING
 - ◇ FRONT PANEL CONTROLS & CONNECTORS

- NOTE 9:
1. FOR DECOUPLING & POWER DISTRIBUTION SEE ◇
 2. SEE PARTS LIST FOR SEMICONDUCTOR TYPES
 3. [REDACTED]

VOLTAGE variations given on Diagram ◇

A11

B11

A13

B13

①

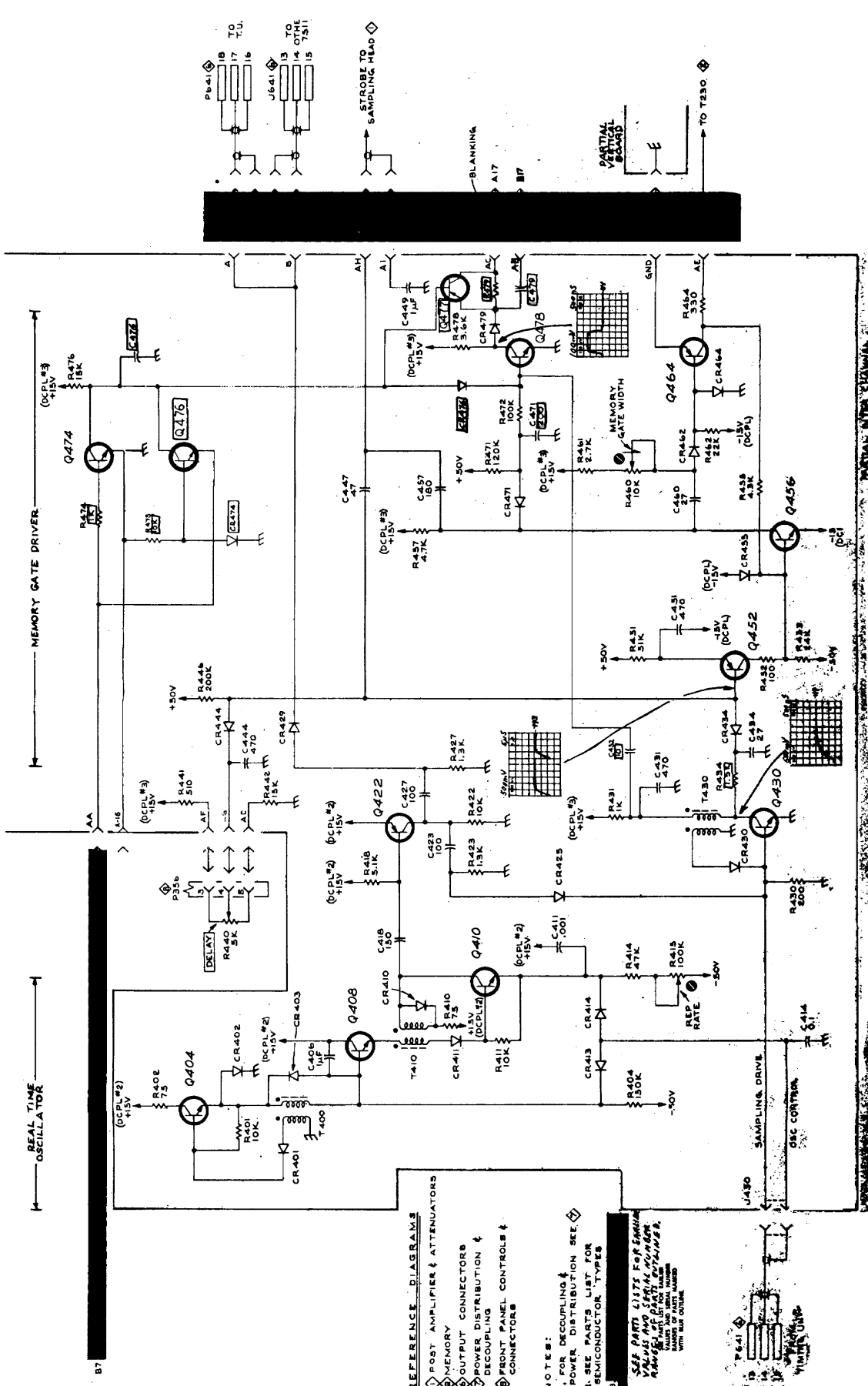

REFERENCE DIAGRAMS

- ◇ POST AMPLIFIER & ATTENUATORS
- ◇ MEMORY
- ◇ OUTPUT CONNECTORS
- ◇ POWER DISTRIBUTION & DECOUPLING
- ◇ FRONT PANEL CONTROLS & CONNECTORS

NOTES:

1. FOR DECOUPLING & POWER DISTRIBUTION SEE
2. SEE PARTS LIST FOR SEMICONDUCTOR TYPES

SEE PARTS LIST FOR EXACT VALUES AND SERIAL NUMBERS. VALUES ARE SUBJECT TO CHANGE WITHOUT NOTICE.

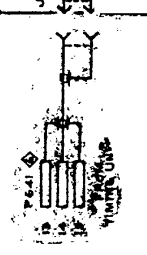

TO T230

TO T230

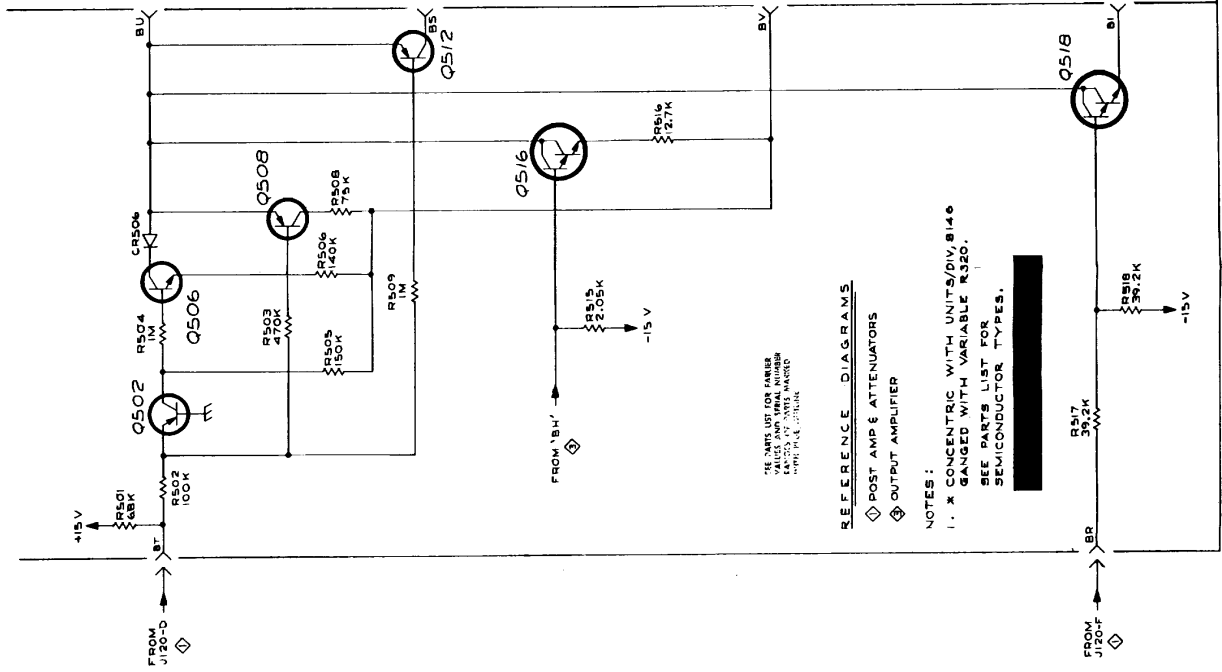

THE LIST FOR PARTS
 WHICH ARE NOT LISTED
 IN THIS LIST ARE
 LISTED IN THE
 PARTS LIST FOR THE
 COMPLETE UNIT.

REFERENCE DIAGRAMS

- ◇ POST AMP & ATTENUATORS
- ◇ OUTPUT AMPLIFIER

NOTES :

1. X CONCENTRIC WITH UNITS/DIV. 8146
 GANGED WITH VARIABLE R320.
 SEE PARTS LIST FOR
 SEMICONDUCTOR TYPES.

PARTIAL VERTICAL BOARD

7511 SAMPLING UNIT

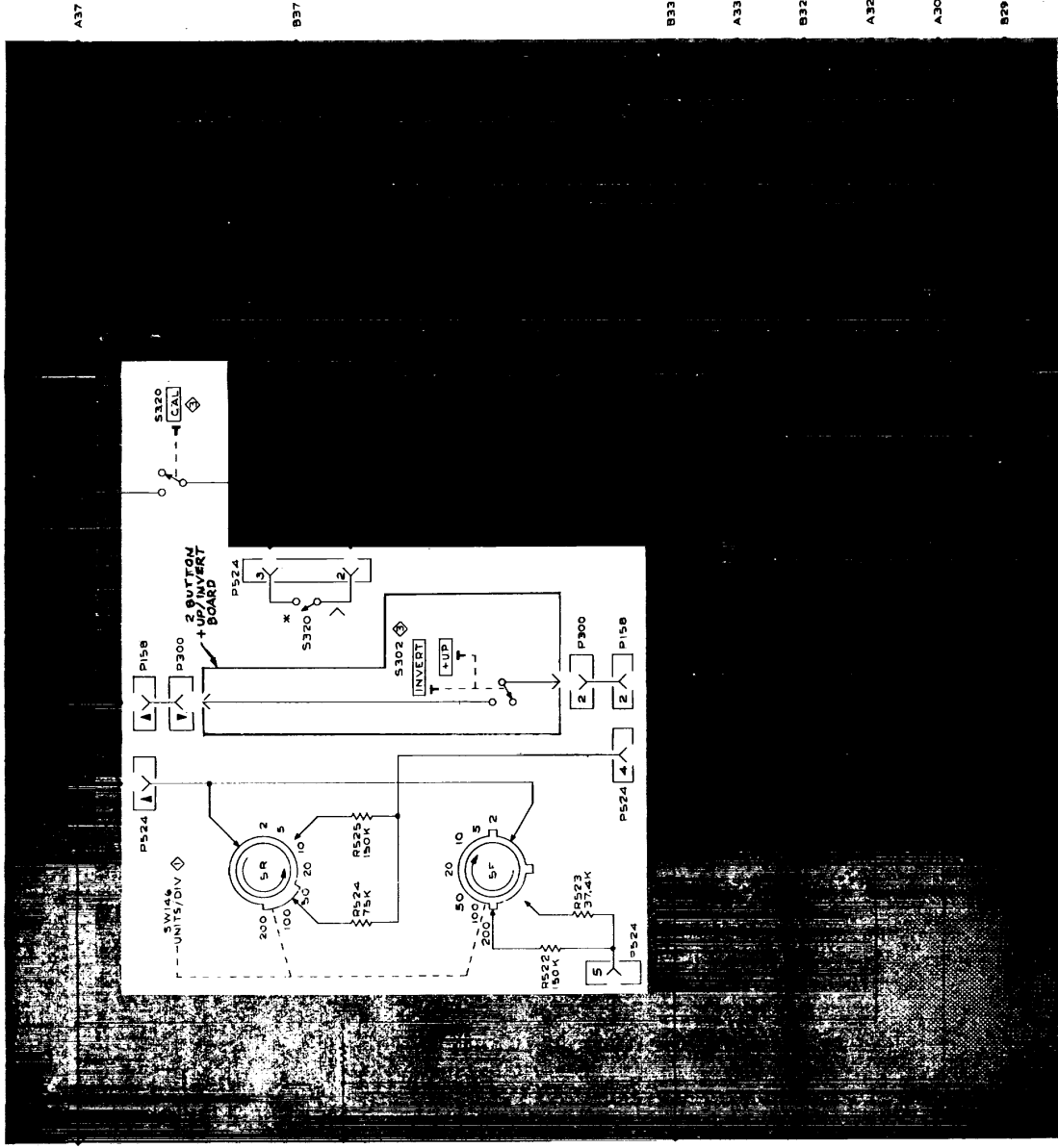

A37

B37

B33

A33

B32

A32

A30

B39

①

595
 110
 READOUT LOGIC

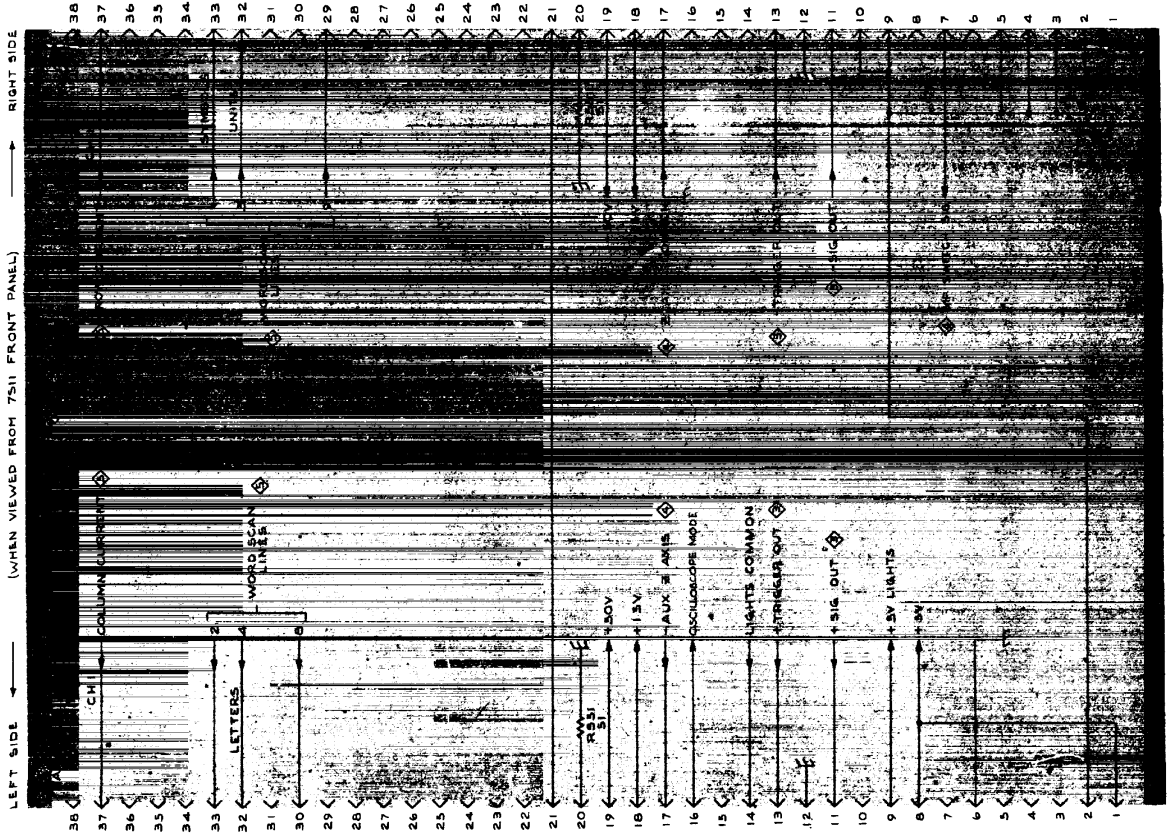

(WHEN VIEWED FROM 7511 FRONT PANEL)

LEFT SIDE

RIGHT SIDE

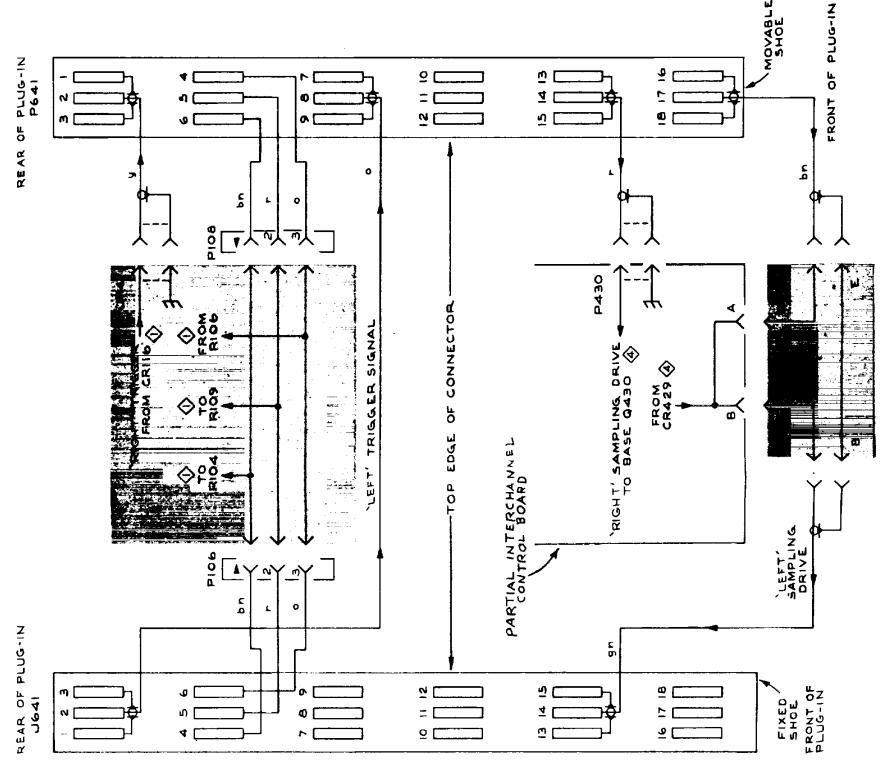

NOTE:

REFERENCE DIAGRAM

- ◇ POST AMPLIFIER ATTENUATORS
- ◇ OUTPUT AMPLIFIER
- ◇ GATE GENERATOR
- ◇ READOUT LOGIC

7511 SAMPLING UNIT

RMG
0370
REV. MAY 1974

OUTPUT CONNECTORS

④

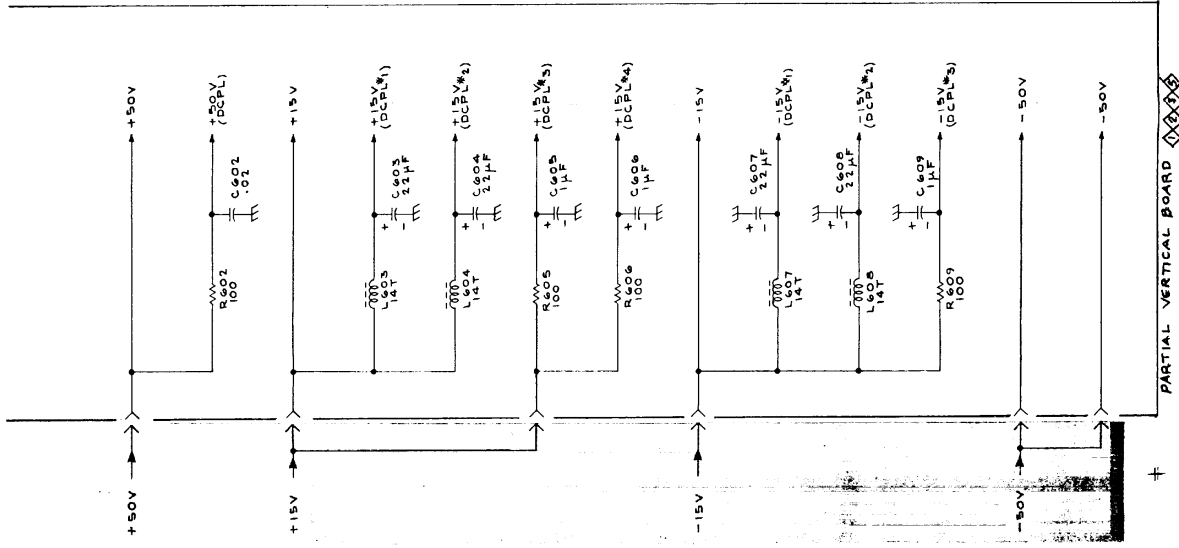

PARTIAL VERTICAL BOARD

7511 SAMPLING UNIT

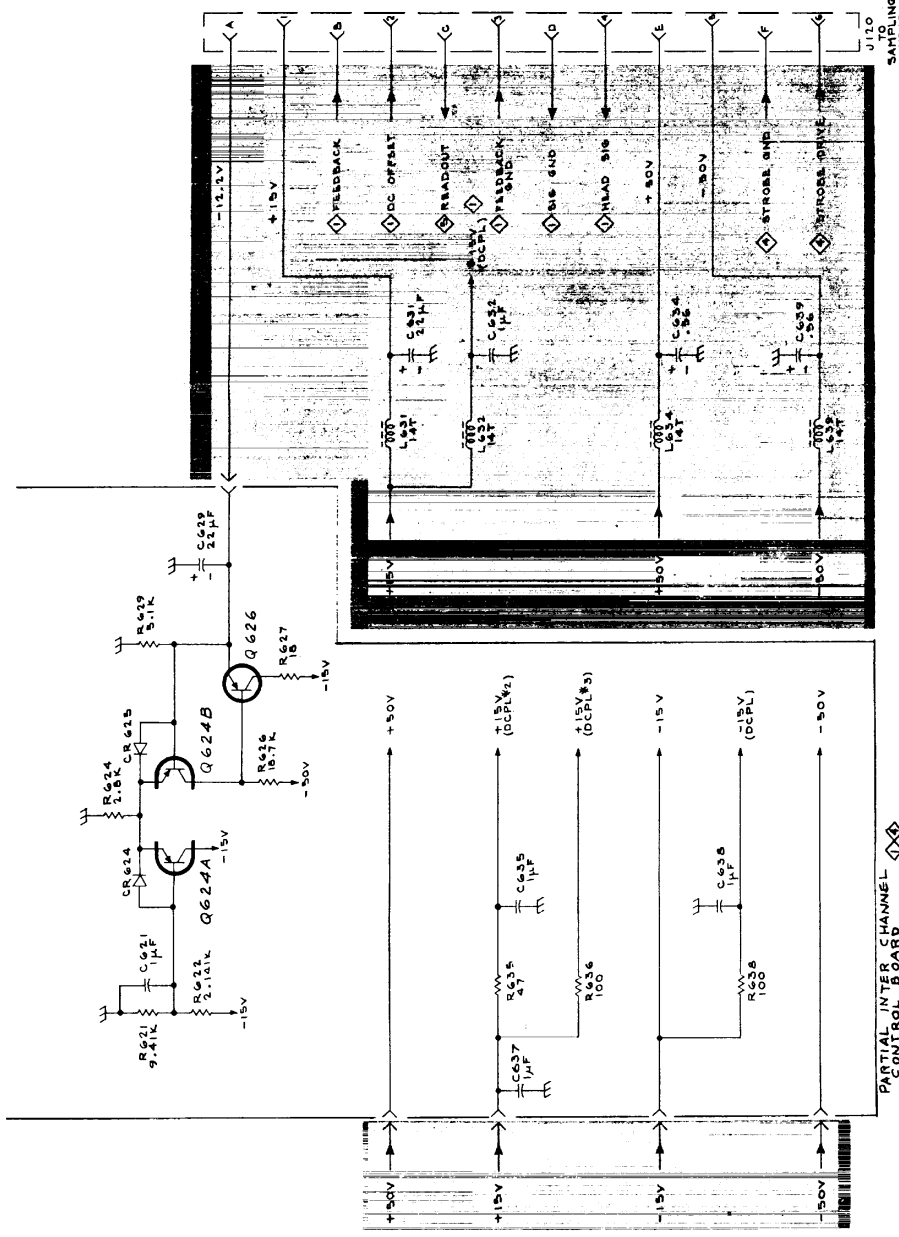

PARTIAL INTER CHANNEL CONTROL BOARD

NOTE: PARTS LIST FOR SEMICONDUCTOR TYPES.

- 1. POST AMPLIFIER & ATTENUATORS
- 2. MEMORY
- 3. OUTPUT AMPLIFIER
- 4. GATE GENERATOR
- 5. READOUT LOGIC

h9
0370

POWER DISTRIBUTION & DECOUPLING

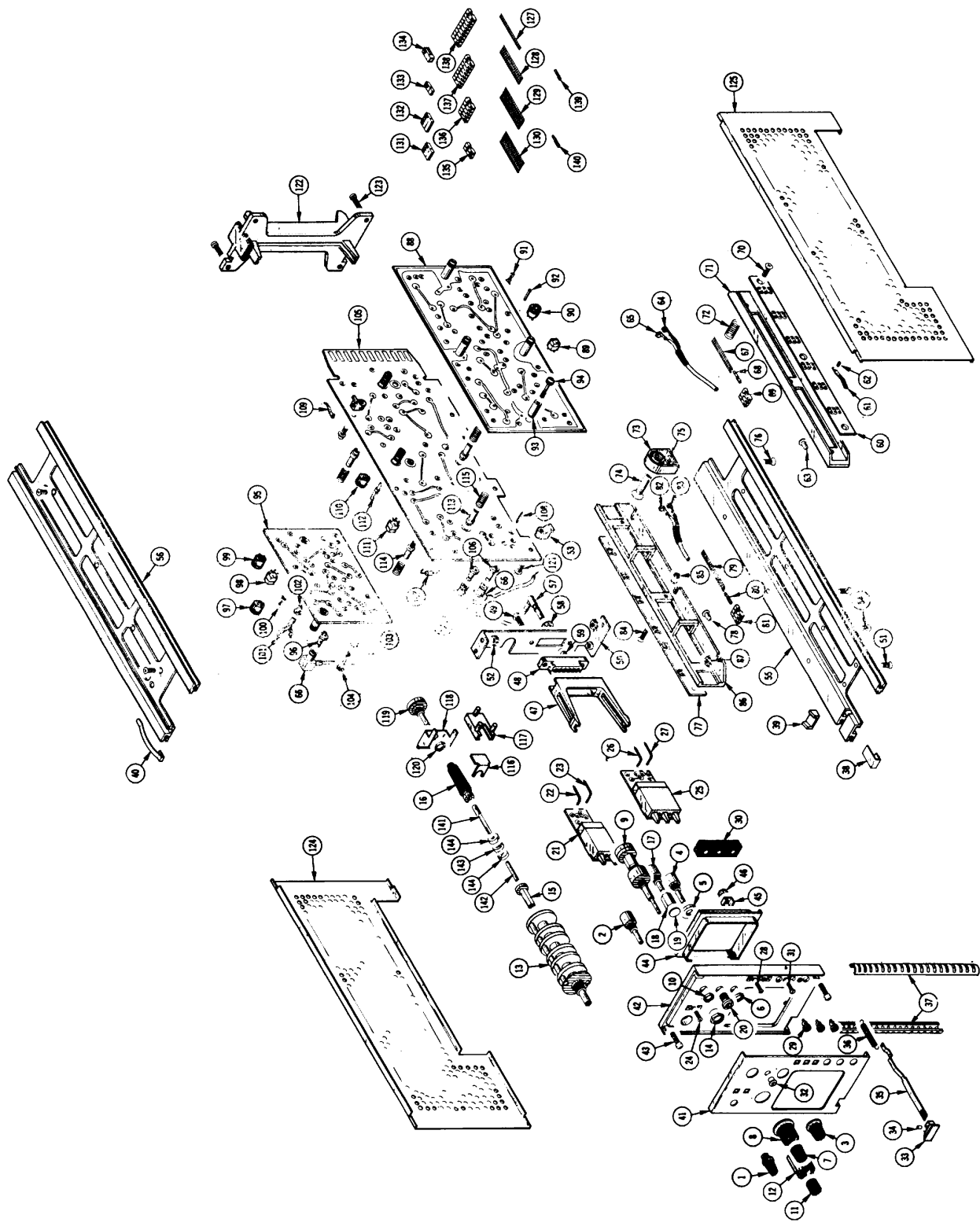

7511 SAMPLING UNIT

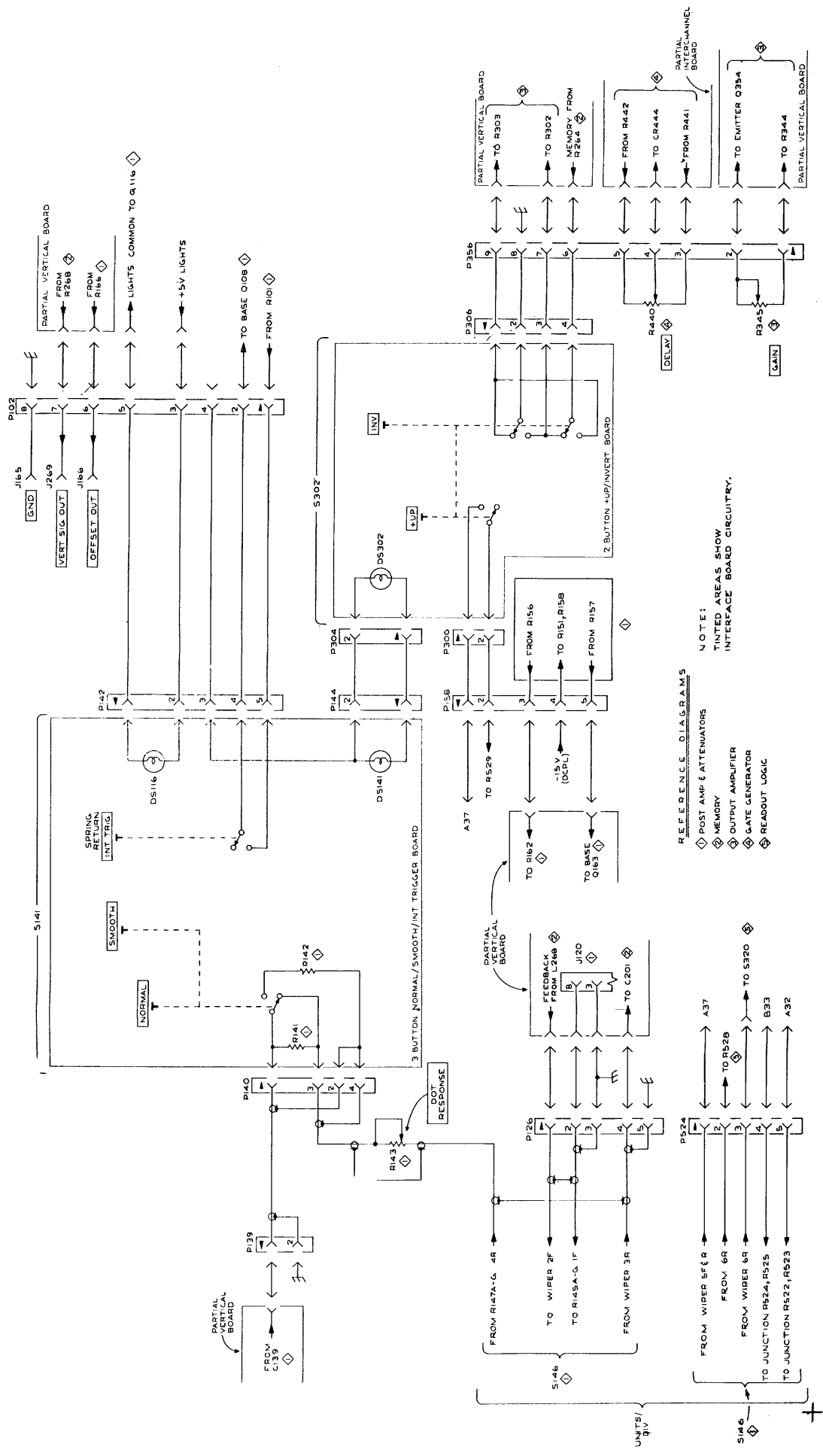

REFERENCE DESIGNATIONS
 POST AMP & ATTENUATORS
 MEMORY
 OUTPUT AMPLIFIER
 GATE GENERATOR
 READOUT LOGIC

NOTE:
 TINTED AREAS SHOW
 INTERFACE BOARD CIRCUITRY.

7S11 SAMPLING UNIT

FRONT PANEL CONTROLS & CONNECTORS

**SECTION 9
MECHANICAL PARTS LIST**

Replacement parts should be ordered from the Tektronix Field Office or Representative in your area. Changes to Tektronix products give you the benefit of improved circuits and components. Please include the instrument type number and serial number with each order for parts or service.

ABBREVIATIONS

BHB	binding head brass	h	height or high	OHB	oval head brass
BHS	binding head steel	hex.	hexagonal	OHS	oval head steel
CRT	cathode-ray tube	HHB	hex head brass	PHB	pan head brass
csk	countersunk	HHS	hex head steel	PHS	pan head steel
DE	double end	HSB	hex socket brass	RHS	round head steel
FHB	flat head brass	HSS	hex socket steel	SE	single end
FHS	flat head steel	ID	inside diameter	THB	truss head brass
Fil HB	fillister head brass	lg	length or long	THS	truss head steel
Fil HS	fillister head steel	OD	outside diameter	w	wide or width

FIGURE 1 EXPLODED

Fig. & Index No.	Tektronix Part No.	Serial/Model No. Eff	Disc	Qty	Q					Description
					1	2	3	4	5	
1-1	366-0392-02			1						KNOB, gray-DELAY
-2	-----			1						RESISTOR, variable
	-----			-						mounting hardware: (not included w/resistor)
	213-0020-00			1						SETSCREW, 6-32 x 0.125 inch, HSS
-3	366-1189-00			1						KNOB, gray-DOT RESPONSE
	-----			-						knob includes:
	213-0153-00			1						SETSCREW, 5-40 x 0.125 inch, HSS
-4	-----			1						RESISTOR, variable
	-----			-						mounting hardware: (not included w/resistor)
-5	361-0143-00			1						SPACER, ring
-6	210-0583-00			1						NUT, hex., 0.25-32 x 0.312 inch
-7	366-1064-00	B010100B059999		1						KNOB, gray-FINE
	366-1084-00	B060000		1						KNOB, gray-FINE
	-----			-						knob includes:
	213-0239-00			1						SETSCREW, 3-48 x 0.062 inch, HSS
-8	366-1148-00	B010100B029999		1						KNOB, gray-DC OFFSET
	366-1148-01	B030000B059999		1						KNOB, gray-DC OFFSET
	366-1101-00	B060000		1						KNOB, gray-DC OFFSET
	-----			-						knob includes:
	213-0153-00			2						SETSCREW, 5-40 x 0.125 inch, HSS
-9	-----			1						RESISTOR, variable
	-----			-						mounting hardware: (not included w/resistor)
-10	210-0583-00			1						NUT, hex., 0.25-32 x 0.312 inch
-11	366-1168-00			1						KNOB, red-VARIABLE
	-----			-						knob includes:
	213-0153-00			1						SETSCREW, 5-40 x 0.125 inch, HSS
-12	366-1057-00			1						KNOB, gray
	-----			-						knob includes:
	213-0153-00			1						SETSCREW, 5-40 x 0.125 inch, HSS

FIGURE 1 EXPLODED (cont)

Fig. & Index No.	Tektronix Part No.	Serial/Model No.		Qty	Description
		Eff	Disc		
1-13	262-0894-00 ----- 260-1090-00 -----			1 - 1 -	SWITCH, wired-mVolts/DIV switch includes: SWITCH, unwired mounting hardware: (not included w/switch)
-14	210-0590-00			1	NUT, hex., 0.375-32 x 0.437 inch
-15	124-1205-00 ----- 213-0075-00			1 - 1	ACTUATOR, switch actuator includes: SETSCREW, 4-40 x 0.094 inch, HSS
-16	214-1190-00 ----- 213-0075-00 213-0140-00			1 - 1 1	EXTENDER-RETRACTOR, knob extender-retractor includes: SETSCREW, 4-40 x 0.094 inch, HSS SETSCREW, 2-56 x 0.094 inch, HSS
-17	----- -----			1 -	RESISTOR, variable mounting hardware: (not included w/resistor)
-18	220-0510-00			1	NUT, hex., 0.25-32 x 0.312 inch
-19	210-0046-00			1	WASHER, lock, internal, 0.261 ID x 0.40 inch OD
-20	358-0409-00			1	BUSHING, 0.207 inch long
-21	670-1148-00 670-1148-01 ----- 380-0148-00 ----- 213-0181-00	B010100B019999 B020000		1 1 - 1 - 1	ASSEMBLY, circuit board- +UP/INVERT ASSEMBLY, circuit board- +UP/INVERT assembly includes: HOUSING, light mounting hardware: (not included w/housing) SCREW, thread forming #2 x 0.375 inch, PHS
-22	131-0589-00			6	TERMINAL, pin, 0.50 inch long
-23	131-0590-00 -----			2 -	TERMINAL, pin, 0.665 inch long mounting hardware: (not included w/assembly)
-24	211-0156-00			1	SCREW, 1-72 x 0.25 inch, 82° csk, FHS
-25	670-1149-00 670-1149-01 ----- 380-0154-00 ----- 213-0181-00	B010100B019999 B020000		1 1 - 1 - 1	ASSEMBLY, circuit board-NORMAL/SMOOTH INT TRIG ASSEMBLY, circuit board-NORMAL/SMOOTH INT TRIG assembly includes: HOUSING, light mounting hardware: (not included w/housing) SCREW, thread forming, #2 x 0.375 inch, PHS
-26	131-0589-00			9	TERMINAL, pin, 0.50 inch long
-27	131-0590-00 -----			2 -	TERMINAL, pin, 0.665 inch long mounting hardware: (not included w/assembly)
-28	211-0156-00			1	SCREW, 1-72 x 0.250 inch, 82° csk, FHS
-29	131-0779-00			3	JACK, tip
-30	352-0181-00 -----			1	HOLDER, tip jack, plastic -mounting hardware: (not included w/holder)
-31	213-0012-00			2	SCREW, thread cutting, 4-40 x 0.375 inch, FHS

REV. MAY 1974

FIGURE 1 EXPLODED (cont)

Fig. & Index No.	Tektronix Part No.	Serial/Model No.		Q t y	1	2	3	4	5	Description
		Eff	Disc							
1-32	358-0301-02			1						BUSHING, plastic
-33	366-1058-09			1						KNOB, latch
	-----			-						mounting hardware: (not included w/knob)
-34	214-1095-00			1						PIN, spring, split
-35	105-0076-00			1						RELEASE BAR, latch
-36	214-1280-00			1						SPRING, helical compression
-37	348-0235-00			1						SHIELDING GASKET
-38	214-1054-00			1						SPRING, flat, latch detent
-39	105-0075-00			1						BOLT, latch
-40	214-1061-00			1						SPRING, flat, sliding ground
-41	333-1218-00			1						PANEL, front
-42	386-1447-20			1						SUBPANEL, front
	-----			-						mounting hardware: (not included w/subpanel)
-43	213-0192-00			4						SCREW, thread forming, 6-32 x 0.50 inch, Fil HS
-44	200-0895-00			1						BEZEL, plastic
	-----			-						mounting hardware: (not included w/bezel)
-45	343-0153-00			4						CLAMP, rim clenching
-46	210-0457-00			4						NUT, keps, 6-32 x 0.312 inch
-47	351-0132-00			1						GUIDE-CLIP, plastic
-48	131-0581-00			1						CONNECTOR, receptacle, 12 contact, female
	-----			-						mounting hardware: (not included w/connector)
-49	213-0082-00			2						SCREW, thread cutting, 4-40 x 0.50 inch, PHS
	255-0249-00			ft						CHANNEL, plastic, 1 inch long
-50	407-0628-00			1						BRACKET, component
	-----			-						mounting hardware: (not included w/bracket)
-51	211-0101-00			4						SCREW, 4-40 x 0.25 inch, 100° csk, FHS
-52	210-0586-00			2						NUT, keps, 4-40 x 0.25 inch
-53	220-0547-01			6						NUT BLOCK, 0.25 inch long
	-----			-						mounting hardware for each: (not included w/nut block)
-54	211-0105-00			1						SCREW, 4-40 x 0.188 inch, 100° csk, FHS
-55	426-0499-06			1						FRAME SECTION, bottom
-56	426-0505-06			1						FRAME SECTION, top
-57	131-0410-00			1						CONNECTOR
	-----			-						mounting hardware: (not included w/connector)
-58	354-0331-00			1						RING, retaining
-59	343-0190-00			1						RETAINER, connector

FIGURE 1 EXPLODED (cont)

Fig. & Index No.	Tektronix Part No.	Serial/Model No.		Qty	Description
		Eff	Disc		
1-60	670-1165-00			1	ASSEMBLY, circuit board
	-----			-	assembly includes:
	388-1472-00			1	BOARD, circuit
-61	131-0839-00			6	CONTACT, electrical
-62	210-0702-00			18	EYELET, flat, flange
-63	131-0842-00			4	TERMINAL, lug
-64	131-0512-00			1	CONNECTOR, terminal, 0.315 inch long
-65	131-0755-00			1	CONNECTOR, terminal, 0.315 inch long
-66	131-0375-00			2	CONNECTOR, right angle, 50 Ω, female
-67	175-0826-00			FT	Wire, electrical, 3 wire ribbon, 1 inch long
-68	131-0621-00			3	CONNECTOR, terminal
-69	352-0199-00			1	HOLDER, terminal connector, 3 wire
	-----			-	mounting hardware: (not included w/assembly)
-70	211-0038-00			3	SCREW, 4-40 x 0.312 inch, 100° csk, FHS
-71	204-0411-00			1	BODY HALF, commutator, moving
-72	214-1035-00			3	SPRING, helical compression
-73	386-1679-00			3	SUPPORT, block, commutator half
-74	213-0230-00			3	SCREW, 4-40 x 0.25 inch, FHB
-75	220-0567-00			3	NUT PLATE
-76	211-0101-00			3	SCREW, 4-40 x 0.25 inch, 100° csk, FHS
-77	670-1166-00			1	ASSEMBLY, circuit board
	-----			-	assembly includes:
	388-1473-00			1	BOARD, circuit
-78	131-0842-00			2	TERMINAL, lug
-79	175-0826-00			ft	WIRE, electrical, 3 wire ribbon, 1 inch long
-80	131-0621-00			3	CONNECTOR, terminal
-81	352-0199-00			1	HOLDER, terminal connector, 3 wire
-82	131-0512-00			1	CONNECTOR, terminal, 0.315 inch long
-83	131-0755-00			1	CONNECTOR, terminal, 0.315 inch long
	-----			-	mounting hardware: (not included w/assembly)
-84	211-0038-00			3	SCREW, 4-40 x 0.312 inch, 100° csk, FHS
	210-0001-00			3	WASHER, lock, internal #2
-85	210-0405-00			3	NUT, hex., 2-56 x 0.187 inch
-86	204-0410-00			1	BODY HALF, commutator, stationary
	-----			-	mounting hardware: (not included w/body half)
	211-0038-00			3	SCREW, 4-40 x 0.312 inch, 100. csk, FHS
-87	210-0586-00			3	NUT, keps, 4-40 x 0.25 inch
-88	670-1088-00			1	ASSEMBLY, circuit board-VERTICAL
	-----			-	assembly includes:
	388-1305-00			1	BOARD, circuit
-89	136-0220-00			24	SOCKET, transistor, 3 pin square
-90	136-0235-00			2	SOCKET, semiconductor, 6 contact
-91	136-0263-03			39	SOCKET, pin terminal
-92	214-0579-00			10	PIN, test point
-93	361-0238-00			4	SPACER, sleeve
-94	211-0155-00			4	SCREW, 4-40 x 0.375 inch, PHS

FIGURE 1 EXPLODED (cont)

Fig. & Index No.	Tektronix Part No.	Serial/Model No.		Q t y	Description
		Eff	Disc		
1-95	670-1089-00	B010100	B049999	1	ASSEMBLY, circuit board-INTER-CHANNEL CONTROL
	670-1089-01	B050000	B079999	1	ASSEMBLY, circuit board-INTER-CHANNEL CONTROL
	670-1089-02	B080000	B090000	1	ASSEMBLY, circuit board-INTER-CHANNEL CONTROL
	670-1089-03	B100000		1	ASSEMBLY, circuit board-INTER-CHANNEL CONTROL
	-----			-	assembly includes:
-96	131-0391-00	B010100	B079999	1	CONNECTOR, 50 Ω , male
	131-0391-00	B080000		2	CONNECTOR, 50 Ω , male
-97	136-0183-00			1	SOCKET, transistor, 3 pin
-98	136-0220-00			10	SOCKET, transistor, 3 pin, square
-99	136-0235-00			1	SOCKET, semiconductor, 6 contact
-100	136-0263-03			19	SOCKET, pin terminal
-101	426-0121-00			1	MOUNT, toroid, plastic
-102	361-0007-00			1	SPACER, plastic, 0.188 inch long
-103	361-0238-00			3	SPACER, sleeve
-104	211-0155-00			3	SCREW, 4-40 x 0.375 inch, PHS
-105	670-1090-00	B010100	B029999	1	ASSEMBLY, circuit board-INTERFACE
	670-1090-01	B030000	B039999	1	ASSEMBLY, circuit board-INTERFACE
	670-1090-02	B040000	B079999	1	ASSEMBLY, circuit board-INTERFACE
	670-1090-03	B080000	B090000	1	ASSEMBLY, circuit board-INTERFACE
	670-1090-04	B100000		1	ASSEMBLY, circuit board-INTERFACE
	-----			-	assembly includes:
-106	131-0391-00			2	CONNECTOR, 50 Ω , male
-107	131-0566-00			2	LINK, terminal connecting
-108	131-0589-00			40	TERMINAL, pin, 0.46 inch long
	131-0590-00	B010100	B079999	48	TERMINAL, pin, 0.71 inch long
	131-0590-00	B080000		46	TERMINAL, pin, 0.71 inch long
	131-0593-00			4	TERMINAL, pin, 1.15 inches long
	131-0665-00			1	TERMINAL, pin, 0.88 inch long
	131-0827-00			1	TERMINAL, pin, 0.55 inch long
-109	131-0593-00			4	TERMINAL, pin, 1.15 inches long
-110	136-0183-00			1	SOCKET, transistor, 3 pin
-111	136-0220-00			2	SOCKET, transistor, 3 pin, square
-112	351-0155-00			5	GUIDE, terminal lead, plastic
-113	351-0188-00			7	GUIDE-POST, lock
-114	351-0185-00			1	GUIDE-POST, lock
-115	214-1140-00			8	SPRING, helical compression
-116	214-1136-00			1	ACTUATOR, slide switch
-117	351-0180-00			1	GUIDE, actuator, plastic
-118	407-0553-00			1	BRACKET, component
-119	-----			1	RESISTOR, variable
	-----			-	mounting hardware: (not included w/resistor)
-120	210-0583-00			1	NUT, hex., 0.25-32 x 0.312 inch
	-----			-	mounting hardware: (not included w/assembly)
-121	211-0116-00			6	SCREW, sems, 4-40 x 0.312 inch, PHB
-122	386-1402-00			1	PANEL, rear
	-----			-	mounting hardware: (not included w/panel)
-123	13-0192-00			4	SCREW, thread forming, 6-32 x 0.50 inch, Fil HS
-124	337-1238-00	B010100	B059999	1	SHIELD, electrical, left
	337-1238-01	B060000		1	SHIELD, electrical, left
-125	337-1247-00	B010100	B059999	1	SHIELD, electrical, right
	337-1247-01	B060000		1	SHIELD, electrical, right

FIGURE 1 EXPLODED (cont)

Fig. & Index No.	Tektronix Part No.	Serial/Model No.		Q t y	1	2	3	4	5	Description
		Eff	Disc							
1-126	131-0375-00	B010100B079999		1						CONNECTOR, right angle, 50 Ω, female
	131-0375-00	B080000		2						CONNECTOR, right angle, 50 Ω, female
-127	175-0825-00			ft						WIRE, electrical, 2 wire ribbon, 0.583 inch long
-128	175-0828-00			ft						WIRE, electrical, 5 wire ribbon, 4.146 inches long
-129	175-0131-00			ft						WIRE, electrical, 8 wire ribbon, 3.229 inches long
-130	175-0832-00			ft						WIRE, electrical, 9 wire ribbon, 3.708 inches long
-131	352-0162-00			1						HOLDER, terminal connector, 4 wire
-132	352-0163-00			1						HOLDER, terminal connector, 5 wire
-133	352-0169-00			1						HOLDER, terminal connector, 2 wire
	352-0169-02			2						HOLDER, terminal connector, 2 wire (red)
-134	352-0176-00			1						HOLDER, terminal connector, 4 wire (double row)
-135	352-0198-00			1						HOLDER, terminal connector, 2 wire (large)
-136	352-0201-00			3						HOLDER, terminal connector, 5 wire
-137	352-0204-00			1						HOLDER, terminal connector, 8 wire
-138	352-0205-00			1						HOLDER, terminal connector, 9 wire
-139	131-0707-00			1						CONNECTOR, terminal (for small wire)
	131-0708-00			1						CONNECTOR, terminal (for large wire)
-140	131-0621-00	B010100B020369		1						CONNECTOR, terminal (for small wire)
	131-0792-00	B020370		3						CONNECTOR, terminal
	131-0622-00			1						CONNECTOR, terminal (for large wire)
-141	384-0664-00			1						SHAFT, 1.05 inches long
-142	384-0679-00			1						SHAFT, 5/29 inches long
	376-0051-00			1						COUPLING
	-----			-						coupling includes:
-143	376-0049-00			1						COUPLING, plastic
-144	354-0251-00			2						RING, coupling
	213-0048-00			4						SETSCREW, 4-40 x 0.125 inch, HSS
										STANDARD ACCESSORIES
	070-0985-00			1						MANUAL, instruction (not shown)

MANUAL CHANGE INFORMATION

At Tektronix, we continually strive to keep up with latest electronic developments by adding circuit and component improvements to our instruments as soon as they are developed and tested.

Sometimes, due to printing and shipping requirements, we can't get these changes immediately into printed manuals. Hence, your manual may contain new change information on following pages.

A single change may affect several sections. Since the change information sheets are carried in the manual until all changes are permanently entered, some duplication may occur. If no such change pages appear following this page, your manual is correct as printed.

SERVICE NOTE

Because of the universal parts procurement problem, some electrical parts in your instrument may be different from those described in the Replaceable Electrical Parts List. The parts used will in no way alter or compromise the performance or reliability of this instrument. They are installed when necessary to ensure prompt delivery to the customer. Order replacement parts from the Replaceable Electrical Parts List.

CHANGE INFORMATION AND TEST EQUIPMENT

CALIBRATION TEST EQUIPMENT REPLACEMENT

Calibration Test Equipment Chart

This chart compares TM 500 product performance to that of older Tektronix equipment. Only those characteristics where significant specification differences occur, are listed. In some cases the new instrument may not be a total functional replacement. Additional support instrumentation may be needed or a change in calibration procedure may be necessary.

Comparison of Main Characteristics

DM 501 replaces 7D13		
PG 501 replaces 107	PG 501 -Retime less than 3.5 ns into 50 Ω	107 - Risetime less than 3.0 ns into 50 Ω.
108	PG 501 -5 V output pulse; 3.5 ns Risetime.	108 - 10 V output pulse, 1 ns Risetime.
111	PG 501 -Risetime less than 3.5 ns, 8 ns Pretrigger pulse delay.	111 - Risetime 0.5 ns; 30 to 250 ns Pretrigger Pulse delay.
114	PG 501 -±5 V output.	114 - ±10 V output. Short proof output.
115	PG 501 -Does not have Paired, Burst, Gated, or Delayed pulse mode; ±5 V dc Offset. Has 5 V output.	115 - Paired, Burst, Gated, and Delayed pulse mode; ±10 V output. Short-proof output.
PG 502 replaces 107		
108	PG 502 -5 V output	108 - V output.
111	PG 502 -Risetime less than 1 ns; 10 ns Pretrigger pulse delay	111 - Risetime 0.5 ns; 30 to 250 ns Pretrigger pulse delay.
114	PG 502 - ±5 V output	114 - ±10 V output. Short proof output
115	PG 502 -Does not have Paired, Burst, Gated, Delayed & Undelayed pulse mode; Has 5 V output.	115 - Paired, Burst, Gated, Delayed & Undelayed pulse mode; ±10 V output. Short-proof output.
2101	PG 502 -Does not have Paired or Delayed pulse Has ±5 V output	2101 -Paired and Delayed pulse, 10 V output
PG 506 replces 106	PG 506 -Positive-going trigger output signal at least 1 V; High Amplitude output, 60 V.	106 - Positive and Negative-going trigger output signal, 50 ns and 1 V; High Amplitude output, 100 V.
067-0502-01	PG 506 -Does not have chopped feature.	0502-01 -Comparator output can be alternately chopped to a reference voltage.
SG 503 replaces 190, 190A, 190B	SG 503 -Amplitude range 5 mV to 5.5 V p-p	190B -Amplitude range 40 mV to 10 V p-p.
191	SG 503 -Frequency range 250 kHz to 250 MHz.	191 -Frequency range 350 kHz to 100 MHz.
067-0532-01	SG 503 -Frequency range 250 kHz to 250 MHz	0532-01 -Frequency range 65 MHz to 500 MHz.
TG 501 replaces 180, 180A	TG 501 -Marker outputs, 5 sec to 1 ns Sinewave available at 5,22,and 1 ns Trigger output - saved to marker output from 5 sec through 100 ns. One time-mark can be generated at a time	180A -Marker outputs, 5 sec to 1 s. Sinewave available at 20, 10 and 2 ns. Trigger pulses 1, 10, 100 Hz, 1, 10, and 100 kHz. Multiple time-marks can be generated simultaneously.
181	TG 501 -Marker outputs, 5 sec to 1 ns. Sinewave available at 5, 2, and 1 ns.	181 -Marker output, 1, 10, 100, 1000, and 10,000 μs, plus 10 ns sinewave.
184	TG 501 -Marker outputs, 5 sec to 1 ns. Sine-Trigger output - slaved to marker output from 5 sec through 100 ns. One time-mark can be generated at a time.	184 -Marker outputs, 5 sec to 2 ns. Sinewave avaabe at 50, 20, 10, 5, and 2 ns Separate trigger pulses of 1 and .1 sec, 10, 1, and .1 ms; 10 and 1 μ's. Marker amplifier proves positive or negative time marks of 25 V min. Marker intervals of 1 and .1 sec; 10, 1, and .1 ms, 10 and 1 μs.
2901	TG 501 -Marker outputs, 5 sec 1 ns. Sinewave available at 5, 2, and 1 ns Trigger output - slaved to marker output from 5 sec though 100 ns. One time-mark can be generated at a time	2901 -Marker output 5 sec to 0.1 μ s. Sinewave available to 50, 10, and 5 ns. Separate trigger pulses, from 5 sec to 0.1 μs. Multiple timemarks can be generated simultaneously.

NOTE: All TM 500 generator outputs are short-proof. All TM 00 plug-in instruments require TM 500-Series Power Module.
REV. A, OCT 1975

**APPENDIX A
REFERENCES**

DA Pam 310-4	Index of Technical Publications: Technical Manuals, Technical Bulletins, Supply Manuals (types 7, 8, and 9), Supply Bulletins, and Lubrication Orders.
DA Pam 310-7	US Army Equipment Index of Modification Work Orders.
TM 38-750	The Army Maintenance Management System (TAMMS).
TM 750-244-2	Procedures for Destruction of Electronics Material to Prevent Enemy Use (electronics Command).

APPENDIX D MAINTENANCE ALLOCATION

Section I. INTRODUCTION

D-1. General

This appendix provides a summary of the maintenance operations for Vertical Amplifier AM-6787(P)/U. It authorizes categories of maintenance for specific maintenance function on reparable items and components and the tools and equipment required to perform each function. This appendix may be used as an aid in planning maintenance operations.

D-2. Maintenance Function

Maintenance function will be limited to and defined as follows:

a. *Inspect.* To determine the serviceability of an item by comparing its physical, mechanical, and/or electrical characteristics with established standards through examination.

b. *Test* To verify serviceability and to detect incipient failure by measuring the mechanical or electrical characteristics of an item and comparing those characteristics with described standards.

c. *Service.* Operations required periodically to keep an item in proper operating condition, i.e., to clean (decontaminate), to preserve, to drain, to paint, or to replenish fuel, lubricants, hydraulic fluids, or compressed air supplies.

d. *Adjust* To maintain, within prescribed limits, by bringing into proper or exact position, or by setting the operating characteristics to the specified parameters.

e. *Align.* To adjust specified variable elements of an item to bring about optimum or desired performance.

f. *Calibrate.* To determine and cause corrections to be made or to be adjusted on instruments or test measuring and diagnostic equipments used in precision measurement. Consists of comparisons of two instruments, one of which is a certified standard of known accuracy, to detect and adjust any discrepancy in the accuracy of the instrument being compared.

g. *Install* The act of emplacing, seating, or fixing into position an item, part, module (component or assembly) in a manner to allow the proper functioning of the equipment or system.

h. *Replace.* The act of substituting a serviceable like type part, subassembly, or module (component or assembly) for an unserviceable counterpart.

i. *Repair.* The application of maintenance services (inspect, test, service, adjust, align, calibrate, replace) or other maintenance actions (welding, grinding, riveting, straightening, facing, remachining, or resurfacing) to restore serviceability to an item by correcting specific damage, fault, malfunction, or failure in a part, subassembly, module (component or assembly), end item, or system.

j. *Overhaul* That maintenance effort (service/action) necessary to restore an item to a completely serviceable/operational condition as prescribed by maintenance standards (i.e., DMWR) in appropriate technical publications. Overhaul is normally the highest degree of maintenance perform by the Army. Overhaul does not normally return an item to like new condition.

k. *Rebuild* Consists of those services/actions necessary for the restoration of unserviceable equipment to a like new condition in accordance with original manufacturing standard. Rebuild is the highest degree of materiel maintenance applied to Army equipment. The rebuild operation includes the act of returning to zero those age measurements (hours, miles, etc.) considered in classifying Army equipments/components.

D-3. Column Entries

a. *Column 1, Group Number.* Column 1 lists group numbers, the purpose of which is to identify components, assemblies, subassemblies, and modules with the next higher assembly.

b. *Column 2, Component/Assembly.* Column 2 contain the noun names of components, assemblies, subassemblies, and modules for which maintenance is authorized.

c. *Column 3, Maintenance Function.* Column 3 lists the functions to be performed on the item listed in column 2. When items are listed without maintenance functions, it is solely for purpose of having the group numbers in the MAC and RPSTL coincide.

d. *Column 4, Maintenance Category.* Column 4 specifies, by the listing of a "work time" figure in the appropriate subcolumn(s), the lowest level of maintenance authorized to perform the function listed column 3. This figure represents the active time required to perform that maintenance function at the indicated category of maintenance. of the number or complexity of the tasks within the listed maintenance function vary at different maintenance categories, appropriate "work time" figures will be shown for each category. The number of task-hours specified by the "work time" figure represents the average time required to restore an item (assembly, subassembly, component, module, end item or system) to a serviceable condition under typical field operating condition. This time includes preparation time, troubleshooting time, and quality assurance/quality control time in addition to the time required to perform the specific tasks identified for the maintenance function authorized in the maintenance allocation chart. Subcolumns of column 4 are as follows:

- C - Operator/Crew
- 0 - Organizational

- F - Direct Support
- H - General Support
- D - Depot

e Column 5 Tools and Equipment. Column 5 specifies by code those common tool sets (not individual tools) and special tools, test, and support equipment required to perform the designated function.

f Column 6, Remarks. Not applicable.

D-4. Tool and Test Equipment Requirements (Sect. III)

a. Tool or Test Equipment Reference Code. The numbers in this column coincide with the numbers used in the tools and equipment column of the MAC. The numbers indicate the applicable tool or test equipment for the maintenance functions.

b Maintenance Category. The codes in this column indicate the maintenance category allocated the tool or test equipment.

c Nomenclature. This column lists the noun name and nomenclature of the tools and test equipment required to perform the maintenance functions.

d National/NATO Stock Number. This column lists the National/NATO stock number of the specific tool or test equipment.

e. Tool Number. This column lists the manufacturer's part number of the tool followed by the Federal Supply Code for manufacturers (5-digit) in parenthesis.

D-5. Remarks (Sect. IV)

Not applicable

(Next printed page is D-3)

**SECTION II. MAINTENANCE ALLOCATION CHART
FOR
VERTICAL AMPLIFIER AM-6787 (P)/U**

(1) GROUP NUMBER	(2) COMPONENT/ASSEMBLY	(3) MAINTENANCE FUNCTION	(4) MAINTENANCE CATEGORY					(5) TOOLS AND EQPT	(6) REMARKS
			C	O	F	H	D		
00 Visual		VERTICAL AMPLIFIER AM-6787(P)/U						Inspect	0.1
		Service		0.1					16
		Test				0.5			1 thru 15
		Adjust				0.5			1 thru 15
		Repair					1.0		15
		Overhaul					1.5		15
01 0.1	MPN 670-1088-00	VERTICAL CIRCUIT BOARD ASSEMBLY						Inspect	
		Replace				0.5			15
		Repair					0.5		15
		Overhaul					1.0		15
02	MPN 670-1089-00	-CHANNEL CONTROL ASSEMBLY						Inspect	
		Replace					0.5		15
		Repair					0.5		15
		Overhaul					1.0		15
03	MPN 670-1090-00	INTERFACE CIRCUIT ASSEMBLY						Inspect	
		Replace					0.5		15
		Repair					0.5		15
		Overhaul					1.0		15

**SECTION III TOOL AND TEST EQUIPMENT REQUIREMENTS
FOR
VERTICAL AMPLIFIER AM-6787(P)/U**

TOOL OR TEST EQUIPMENT REF CODE	MAINTENANCE CATEGORY	NOMENCLATURE NUMBER	NATIONAL/ NATO STOCK	TOOL NUMBER
1	H,D	ORSILLOSCOPE S-266(P)/U	6625 -015-6562	
2	H,D	SAMPLING HEAD TEKRONIX S-16625-00-470-33		
3	H,D	PIU SAMPLING TIME BASE TD-1161/U	6625-00-489-6450	
4	H,D	AMPLIFER DIFFERENTIAL COMPARATOR AM-6881/U	6625-00-478-0594	
5	H,D	PI TIME BASE TEKTRONIX 7B506625-00-327-6572		
6	H,D	DIGITAL VOLTMETER AN/USM-451	6625-01-060-6804	
7	H,D	TEST SET TRANSISTOR TS-1836D/U	6625-00-138-7320	
8	H,D	TEKTRONIX CALIBRATION FIXTURE 067-0508-00	6625-00-829-0882	
9	H,D	TEKTRONIX CALIBRATION FIXTURE 067-0572-01	6625-00-539-2745	
10	H,D	TEKTRONIX VARIABLE ATTENUATOR 067-0511-00	6625-00-145-2780	
11	H,D	1X PROBE	6625-00-119-7349	
12	H,D	10X PROBE		
13	H,D	EXTENDER BOARD, TEKTRONIX CALIBRATION FIXTURE 067-0589-00		
14	H,D	SPECIAL CABLE ASSEMBLY 012-0203-00		
15	H,D	TOOL KIT, ELECTRONIC EQUIPMENT TK-105/G	5180-610-8177	
16	C	TOOLS AND EQUIPMENT AVAILABLE TO THE REPAIR TECHNICIAN BECAUSE OF ASSIGNED MISSION.		

By Order of the Secretary of the Army:

EDWARD C. MEYER
General, United States Army
Chief of Staff

Official:

J.C. Pennington
Major General, United States Army
The Adjutant General

DISTRIBUTION:

To be distributed in accordance with Special List.

* U.S. GOVERNMENT PRINTING OFFICE: 1991-281-486/43236

RECOMMENDED CHANGES TO EQUIPMENT TECHNICAL PUBLICATIONS



THEN... JOT DOWN THE DOPE ABOUT IT ON THIS FORM, CAREFULLY TEAR IT OUT, FOLD IT AND DROP IT IN THE MAIL!

SOMETHING WRONG WITH THIS PUBLICATION?

FROM: (PRINT YOUR UNIT'S COMPLETE ADDRESS)

DATE SENT

PUBLICATION NUMBER

TM 11-5825-270-10

PUBLICATION DATE

23 Jul 81

PUBLICATION TITLE

Radio Frequency R-2176/FRN

BE EXACT... PIN-POINT WHERE IT IS

PAGE NO.

PARA-GRAPH

FIGURE NO.

TABLE NO.

IN THIS SPACE TELL WHAT IS WRONG AND WHAT SHOULD BE DONE ABOUT IT:

TEAR ALONG PERFORATED LINE

PRINTED NAME, GRADE OR TITLE, AND TELEPHONE NUMBER

SIGN HERE:

DA FORM 2028-2
1 JUL 79

PREVIOUS EDITIONS ARE OBSOLETE.

P.S.—IF YOUR OUTFIT WANTS TO KNOW ABOUT YOUR RECOMMENDATION MAKE A CARBON COPY OF THIS AND GIVE IT TO YOUR HEADQUARTERS.

