

TEKTRONIX AUTOMATED TEST SYSTEMS

S-3100 Series

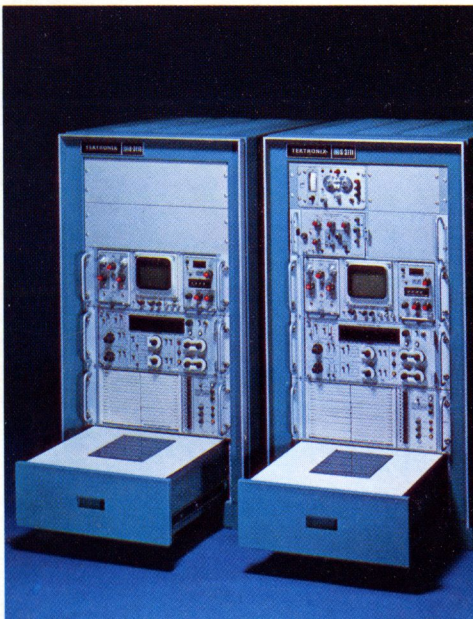
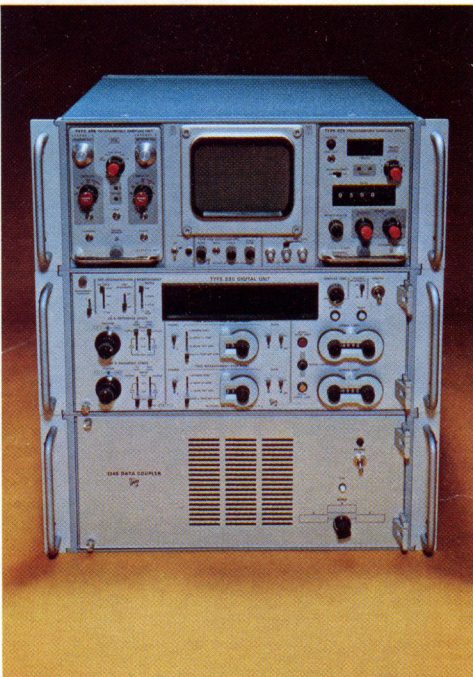
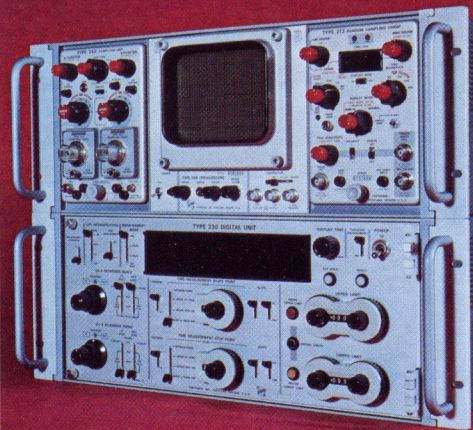

CONTENTS

Tektronix 3100 Series		CONTROL	R1330	29
Automated Test Equipment	1	R240	286/R287/288	29
Measurement Techniques	2	R250	286 Sampling Head Multiplex	
Tektronix Systems Fit Your		R241	Control Unit	30
Measurement Needs	3	241 Program Resequencer	R287 Multiplex Control Unit	30
BENCH TOP SYSTEM	4	R1340	R288 Multiplex Master Controller Unit	30
S-3101	5	STIMULUS	Probe Chopper	30
S-3105	7	R115	Probe Chopper/Signal Switcher	30
S-3110 S-3111	9	2005A	50-ohm Switching Matrix	30
S-3120	11	R116		
S-3130	13	R293	OPTIONS	
S-3150	15	R1140A	4010 Graphics Terminal	31
MEASUREMENT		FIXTURING	4610 Hard Copy Unit	31
R568	16	Input/Output Panel	RAB6375BA1 Reader/Punch	31
3S2/3T2	16	1841 Fixture Drawer	BUSINESS INFORMATION	
3S5/3S6	17	1831 Test Station	Systems Applications Engineers	32
Sampling Heads	18	Test Station Control Unit	Product Support	32
3T5/3T6	18	1840 Programmable Test Fixture	Ordering	32
R230	19	1801 and 1802 Programmable	For Customers Outside the United States	32
		Test Station	International Representatives and	
		1842 Test Fixture	Field Offices	Back Cover
			National Field Offices	Back Cover

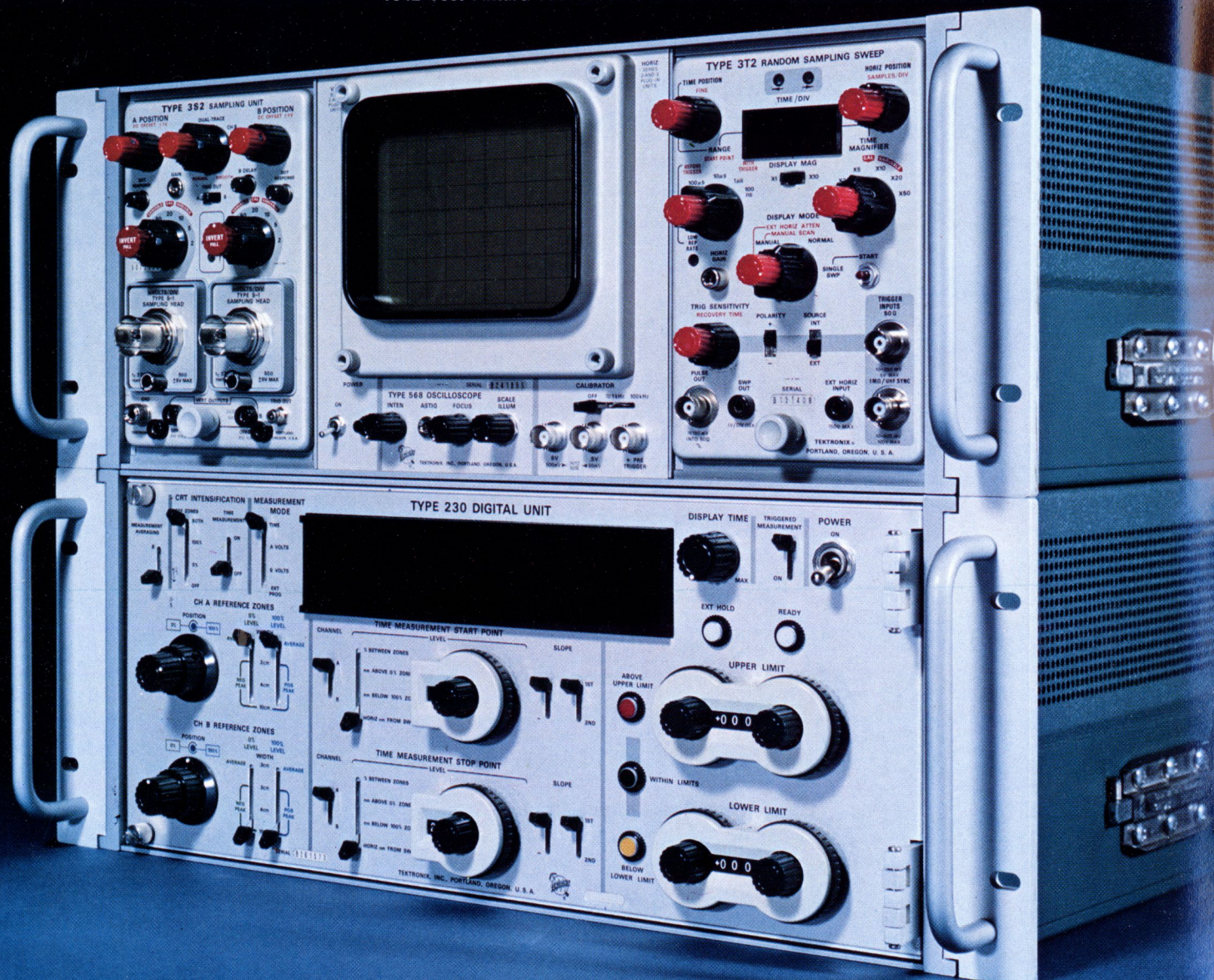

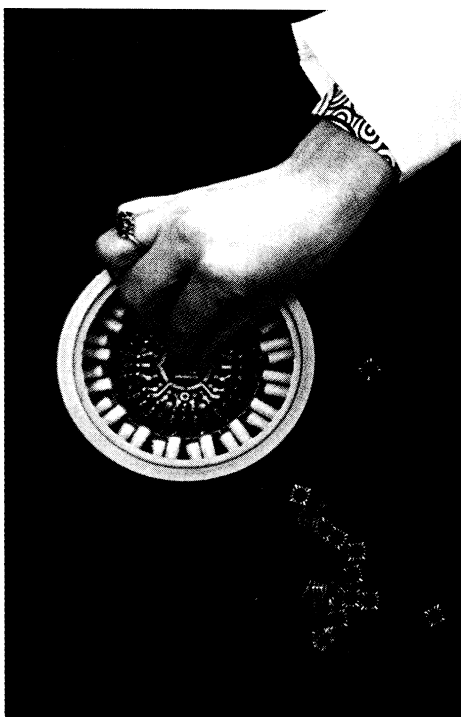

TEKTRONIX 3100 SERIES AUTOMATED TEST EQUIPMENT

The 3100-Series of Automated Test Equipment Systems has been designed to solve a wide range of your test and measurement problems. Each system may be tailored to your exact needs. Before selecting a TEKTRONIX system, you should determine your exact testing requirements. With your needs determined, you should examine this brochure to determine the system configuration you will require. At this point, contact your local Tektronix Systems Applications Engineer. The Systems AE is an expert in solving test and measurement problems. He will help you to determine the exact system required and will secure a price quotation for you. When your system is delivered, you will find that Tektronix backs its systems equipment with a one year parts and labor warranty and the technical support you require.

In the pages that follow, you will learn about the Measurement Systems Division at Tektronix and our automated measurement techniques, and gain an overview of our 3100-Series systems. Included is a series of descriptions of each basic system configuration, followed by a section describing each of the system components available. The last section describes systems options.

The back cover pulls out to show you, pictorially, the relationships between the various systems components and the functions of those components in a complete system. You may wish to refer to this diagram as you read the configuration section.

COMMITTED TO TECHNICAL EXCELLENCE

Since 1947, Tektronix has been building a reputation as a manufacturer of innovative, high quality test and measurement equipment. Many state-of-the-art developments have been the direct result of Tektronix research and development. "Committed to Technical Excellence" sums up our philosophy: build the finest, most advanced equipment on the market at a price that makes it practical to own.

Tektronix has progressed from a single line of oscilloscopes to a diverse range of over 200 test and measurement products. It was a logical progression, as our product lines expanded, to enter into the systems business. With the creation of the Measurement Systems Division, Tektronix embarked on a plan to become a major force in the automated systems test and measurement market. In this effort, we have taken our standards of technical excellence plus our policy of product expansion with us; and we are proud to be a part of this rapidly growing segment of the electronics industry.

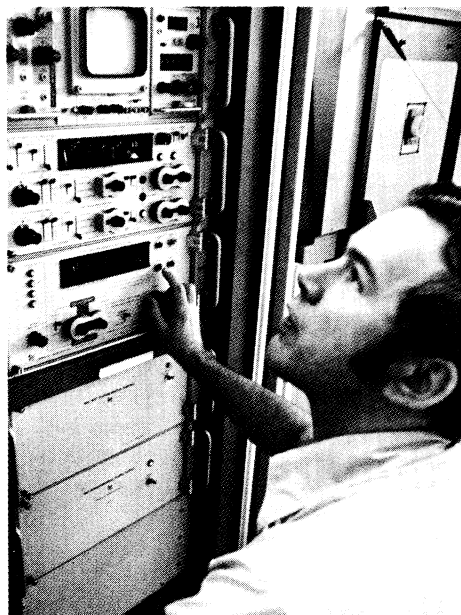
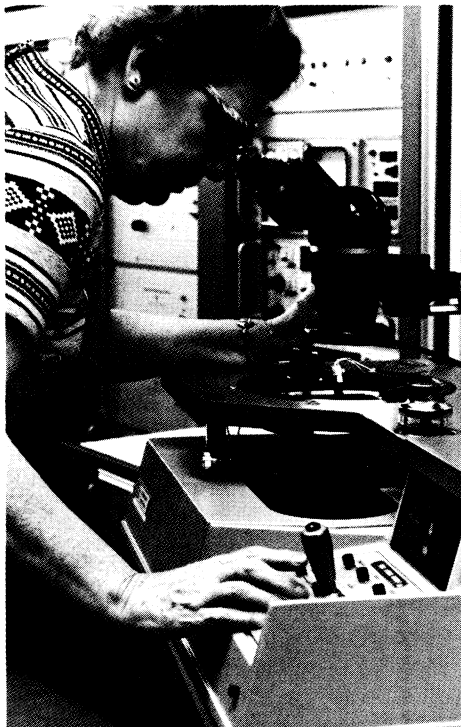

MEASUREMENT TECHNIQUES

A prime requisite for automated electronic component test equipment is the ability to measure, under program control, complex waveforms in terms of amplitude and time. The basic instrument used is the programmable sampling oscilloscope, which converts and displays information that occurs at high repetition rates into an equivalent low-repetition-rate display. Sampling permits the oscilloscope to have bandwidth not achievable with other techniques. Conversion of repetitive information by sampling not only provides conversion for analog display, but also forms the basis for further conversion of that information to digital form. The basic measurement package configuration is shown in the accompanying illustration.

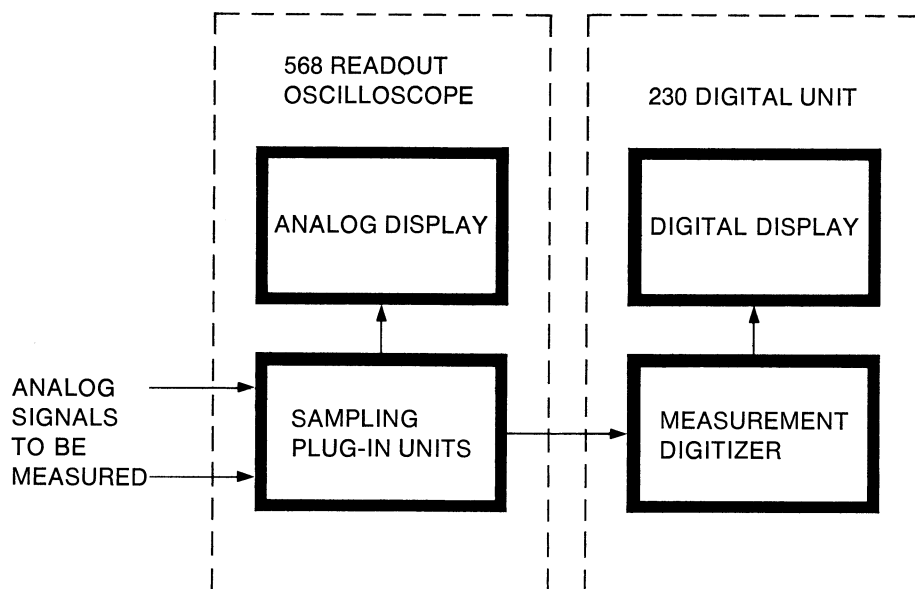

The 3100-Series automated measurement systems use a package consisting of a programmable readout oscilloscope (568), dual channel vertical sampling plug-ins (3S5/6), and delaying sweep time bases (3T5/6), plus a digital readout unit (230). (The primary function of the digital unit is to make digital measurements of sampled analog data.) Results are then compared with programmed limit values for automatic indication of whether the measurements are above, within, or below the predetermined limits.

The use of a precise number of displayed samples per crt horizontal division is fundamental to the digitizing process. Since the horizontal axis of the oscilloscope is scaled in equivalent time per division, the time between successive samples (or dots) in the display represents an equivalent time period. These equivalent time periods are used to form an equivalent time clock. For example, with 100 samples per division and an equivalent time per division of 1 ns, each successive sample represents 10 ps.

To perform a measurement, the digital unit stores voltage values from two zones on each of the two traces selected on the crt display. These memorized voltages are referenced and used to set comparator levels that are then used to start and stop a count of the equivalent time clock (from the horizontal sampling unit). Since measurements are performed between two absolute levels or percentages of those levels, systems based on a programmable readout oscilloscope/digital unit combination (568/230) can readily accommodate measurements such as:

- duration,
- period,
- rise time,
- fall time,
- overshoot,
- delay time,
- storage time,
- turn-off time,
- turn-on time,
- propagation delay,
- time to voltage level,
- time between voltage levels,
- diode forward and reverse recovery time,
- noise feed through.

Typically, when a system is used to make amplitude measurements, the readout oscilloscope/digital unit combination measures the voltage difference between two selected points on a waveform or between ground and the voltage at a selected point. Amplitude measurement requires storing two voltage values in the digital unit (in the same manner as in time measurements) and then making an analog-to-digital conversion of the difference. The following are typical examples of the possible measurements:

- input voltage,
- output voltage,
- set voltage,
- reset voltage,
- present voltage,
- offset voltage,
- breakdown voltage,
- saturation voltage,
- leakage current,
- peak-to-peak voltage.

memory and control

The digital unit and the programmable readout oscilloscope (with sampling units), can be operated manually or by program control to make measure-

ments. When these units are used in an automated measurement system, manual operations are completely replaced by some form of programming. In the TEKTRONIX systems, parallel lines are used to program the various instruments; a measurement is made by selecting a group of these lines.

In the smaller and less expensive 3100-Series systems, a 241 Programmer Unit (see page 23) selects a group by inserting diode logic in the lines. Up to 15 measurements can be programmed with the programmer unit, either by front panel control or remote control.

When a large number of measurements and tests are to be performed rapidly, a tape, disc, or other program storage device is used. A 240 Program Control Unit (see page 21) is used to manage the flow of program data while programs are being written, debugged, or executed. Also, up to three 250 Auxiliary Program Control Units (see page 22) can be used to increase programming capacity.

programming

Measurement programs may be created directly in a 241 Programmer Unit by installing diodes on removable circuit boards. Programs for the 240 Program Control Unit are stored in a disc memory or punched on paper or mylar tape.

data recording

Test results may be presented in the form of go/no go indications or used as sort commands to an automatic handler. When extensive measurement information requiring data logging must be collected, several choices are offered. For example, a printer may be added to the system to log program numbers and test measurement results. When it is desirable to store measurement results for off-line computer analysis, system options permit computer compatible data recording on either magnetic or punched paper tape.

stimulus

A wide choice of stimulus sources (such as dc voltages and currents, pulses, or computer words) may be added to a system. Stimulus sources in such a system may be either program controlled or manually set. The degree of automatic operation required is usually determined by the number of measurements to be made. Programming of stimulus sources is performed by the program control unit.

fixturing and device handling

Fixturing is a critical point in automated test equipment. Failure here will negate the best in measurement, control, and stimulus capabilities. TEKTRONIX fixturing presents the proper operating environment to the device under test (dut). The wide range of available fixturing enhances the ability of the 3100-Series systems to solve test and measurement problems. Fixturing consists of a socket (for the dut) plus test circuits, loads, measurement signal acquisition points, and switching circuits necessary to various dut's.

With any fixturing, measurement rates are greatly affected by the time required to insert and remove devices. Automatic device handlers are offered as options to minimize these delays. Also, fixturing is available to permit optional environmental chambers to be used when required.

TEKTRONIX systems permit several solutions to fixture problems. For example, many users require custom-designed test fixtures, particularly where experimental state-of-the-art devices must be tested. To facilitate user-built fixturing, a system may be equipped with a fixture drawer that brings all vital connections near a convenient mounting surface, or an optional alternative brings the same connections to a versatile input/output panel.

A full description of fixturing and device handling begins on page 27.

TEKTRONIX SYSTEMS FIT YOUR MEASUREMENT NEEDS

All 3100-Series systems are assembled with "building block" components. Many different systems configurations are possible. Each configuration shown in the following pages may be viewed as a suggestion. If one configuration will fill a high percentage of your needs, it is likely that one or more options may be added or substituted to build a system that will satisfy your exact needs.

A complete automated system may be divided into a block diagram of four functions.

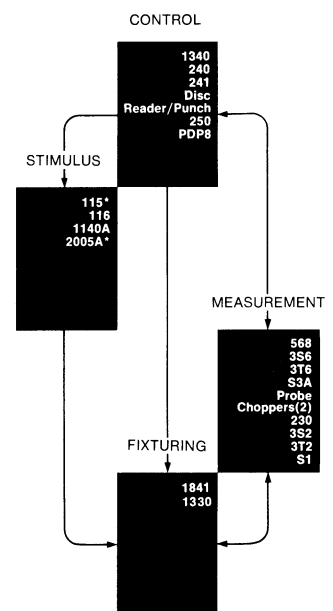

Each system and subsystem shown in this brochure is accompanied by a functional block diagram showing each recommended item of equipment. To help you to learn more about each item, a black band leads you to the pages containing detailed information. Remember... the following configurations are only the starting point to determine a system to meet your unique requirements.

BENCH TOP SYSTEM

The Bench Top System is a practical measurement combination with proven performance in accuracy and reliability. It is an inexpensive system that can serve many tasks. It has digital measurement and display features that relieve the operator of analog display interpretation

The system oscilloscope, in combination with its vertical and horizontal sampling units, forms a dual-channel sampler with a dc to 1-GHz bandpass and 350-ps risetime, and a sensitivity of 2 mV/div to 200 mV/div in seven calibrated steps. Internal and external trigger pickoff, dc offset, and five display modes provide for a variety of operations. The sampling time-base features random or sequential sampling operation. (Random sampling permits the user to view the leading edge of a signal without a delay line or pre-trigger.) The sweep time per division is displayed in the TIME/DIV window and extends from 100 μ s/div to 200 ps/div, expanding to 20 ps/div with the magnifier control. Versatile display and trigger mode combinations provide very extensive measurement capabilities.

The digital unit presents oscilloscope measurements in alphanumeric form, and can be used to measure any desired time or voltage parameter associated with the display on the oscilloscope. Voltage measurements may be made on either channel A or channel B. Time measurements may be made between any defined percentage points or voltage levels of a waveform. Thus, a risetime measurement may be made between 1-pct and 99-pct points, in 1-pct steps, between two voltage levels, or between a 1-pct point and a specific voltage level.

Measurement results are displayed in 4 digits with units of measure, decimal

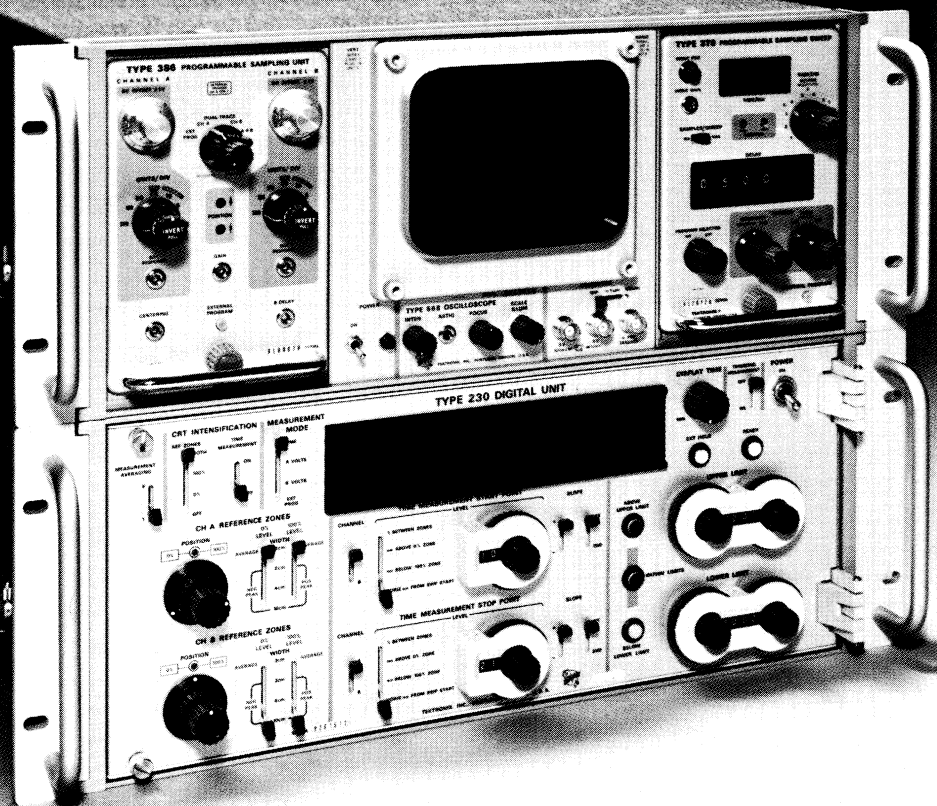
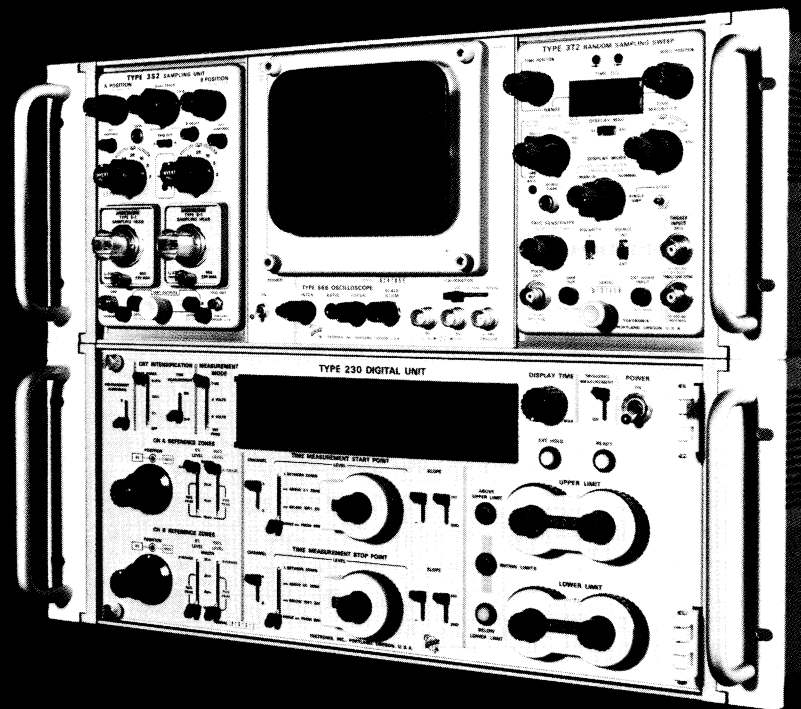

point, and polarity. Controls provide for upper and lower measurement limits. These limits function automatically for each digital reading and panel lights indicate whether results are above, below, or within limits. Thus, a measurement can be repeated many times, with the operator proceeding on the basis of limit indications rather than digital readings.

The Bench Top System consists of the following equipment:

- One—R568 Readout Oscilloscope, with
- One—3S2 Dual-Trace Vertical Sampling Unit,
- One—3T2 Random Sampling Time-Base Unit, and
- Two—S-1 Sampling Heads; and
- One—R230 Digital Unit.

S-3101

The S-3101 Measurement Subsystem is similar to the Bench Top System, but includes programmable plug-ins (the 3S6 Sampling Unit, and 3T6 Sampling Sweep Unit). It is intended for customer assembled systems that require a sophisticated measurement package. It is easily expandable in both function and capacity, with the capability to make time and amplitude measurements, and can be integrated into a test and measurement system permitting many measurements per second.

The S-3101 is part of the largest 3100-Series system, the S-3150 (see page 15), yet is not too complicated to fit many requirements between the bench of a research engineer and the production line of a quality control engineer. The salient features of this measurement package are high rate of measurement capability and digital readout. The digital readout is very repeatable and the easy-to-read digital display frees the operator from potentially difficult analog display interpretation. The digital unit may be controlled from the front panel or programmed externally.

The 3S6 and 3T6 programmable sampling units permit the entire

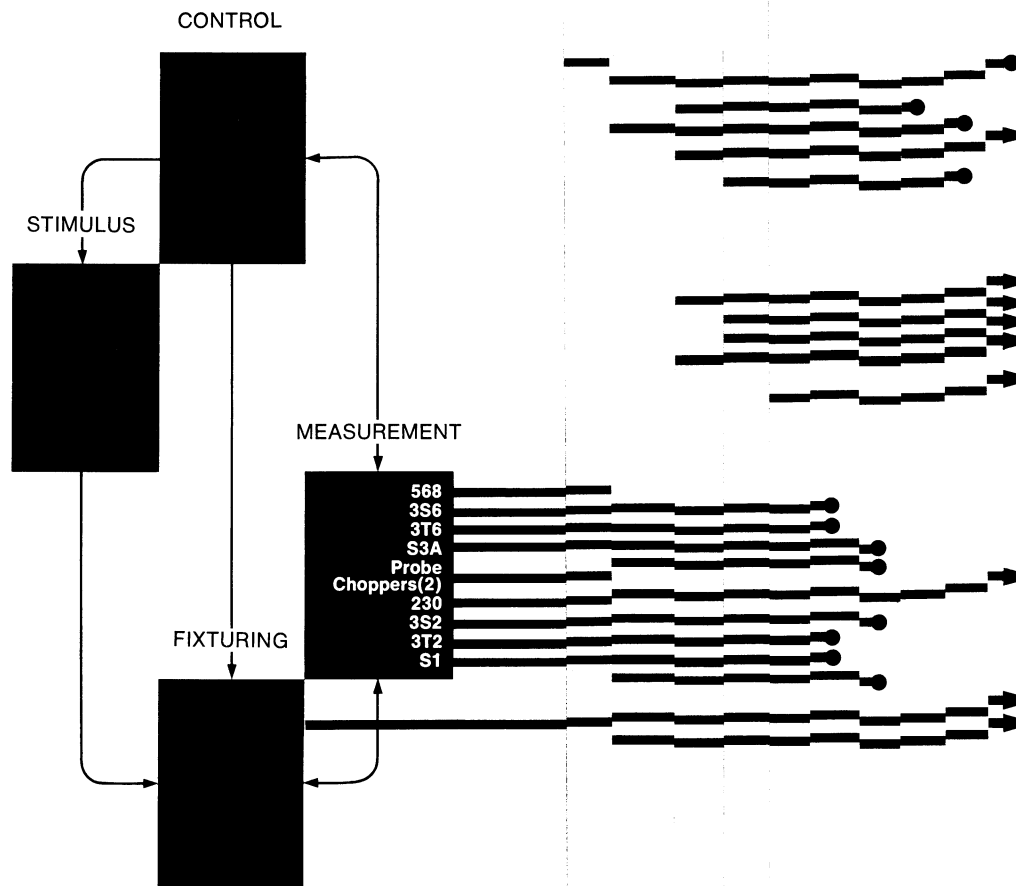

package to be externally programmed. In the 3S6 sampling unit, deflection factor, dc offset, and smoothing may be programmed. In the 3T6 sampling sweep unit, time per division and digital delay are programmable, and, since an automatic trigger circuit usable from dc to 100 MHz is included, no trigger programming is required.

The standard S-3101 is rackmountable for convenient cabinet housing, and consists of the following equipment:

- One—R568 Readout Oscilloscope, with
- One—3S6 Programmable Sampling Unit,
- One—3T6 Programmable Sampling Sweep Unit, and
- Two—S-3A Sampling Heads;
- Two—Dual Probe Choppers; and
- One—R230 Digital Unit.

Options for the S-3101 include: a single bay cabinet, the 3S5 Programmable Sampling Unit, and the 3T5 Programmable Sampling Sweep Unit. Other options permit the choice of sampling heads and 50-ohm probe choppers. Your local Tektronix Systems Applications Engineer would be pleased to discuss a configuration suited to your needs.

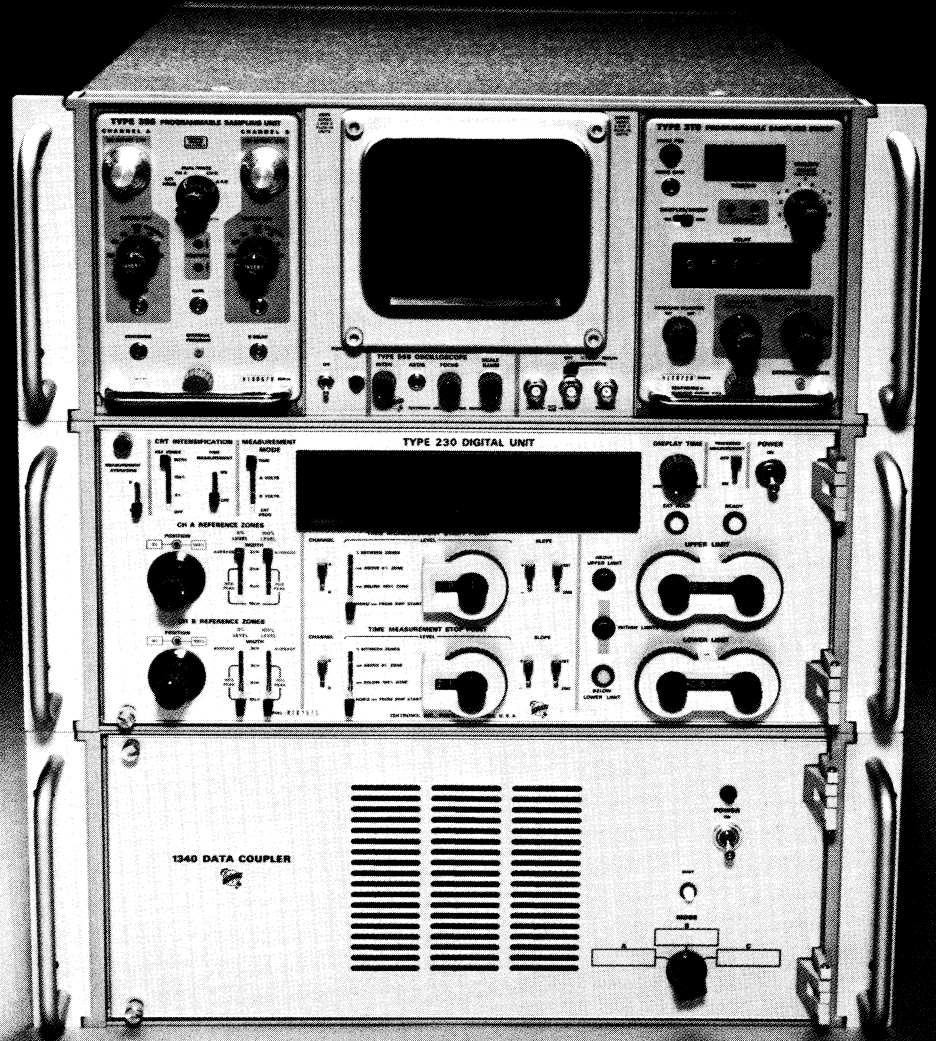
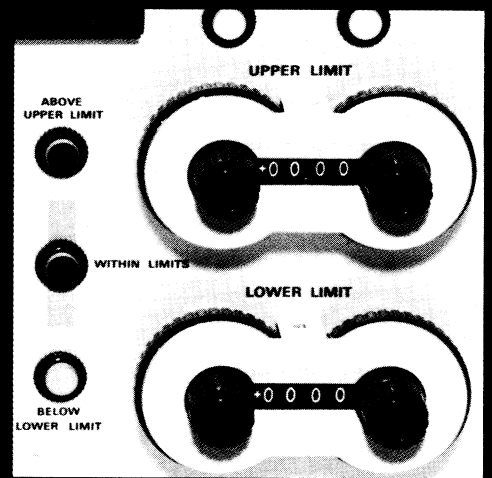

S-3105

The S-3105 Measurement Subsystem, like the S-3101, has programmable plug-ins, but includes an R1340 Data Coupler for interfacing to a digital controller. This subsystem is offered as a measurement package for customer assembled systems. The S-3105 is a versatile, inexpensive, digitally controlled measurement system that can be programmed through a variety of interfaces. One of these is the ASCII interface, which is easy to program with ASCII strings, and can also return results for specific analysis. This eliminates the requirement for a disc operating system and the need for a large core memory block. Thus, a proven measurement system and your selection of stimulus, fixturing, and handling can be interfaced and programmed easily through any accessible digital controller, without the requirement for a dedicated system controller.

The 1340 eliminates the need to develop special and generally complex interfaces for coupling programmable instrumentation to a large variety of digitally controlled systems. Future needs can easily be accommodated through the wide range of interface cards that plug into the 1340. These, and the ability of the 1330 Test Station Master Control Unit to multiplex up to four test stations, offer comprehensive operations. Thus, programming of remote test stations may be done in a number of communication ports (multiprogramming) and, in turn, connected to a central processor. Each of the test stations could be addressed and interfaced through an ASCII interface in the 1340. This offers the system designer the advantage of several real-time executive programs and time-sharing services. In this system, the maximum rate of the ASCII controller in the 1340 is 125k baud, with a clock supplied by either a graphics terminal or digital controller.

The S-3105 is not a complex system, but one that can be part of a sophisticated testing system, without requiring a long operator training program. It can be used for dynamic testing and

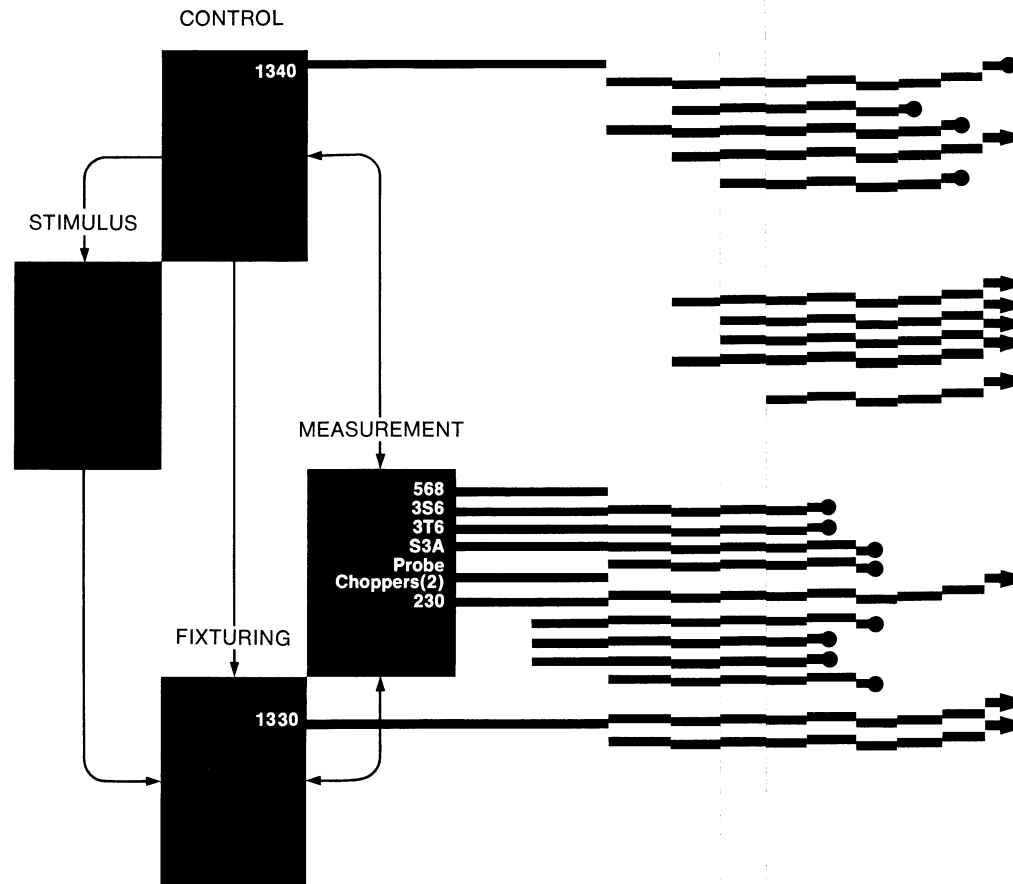

measuring with many controllers. The 1340 will accommodate interfaces for stimulus and interface programming. Your present fixturing can be expanded readily by using the various available sampling head multiplexers described in the fixturing section of this brochure, beginning on page 27. Data logging and waveform digitizing are examples of further capabilities, and all of the options that are compatible with the digital controller are further benefits to building the system to solve your test and measurement problems.

The standard S-3105 is rackmountable for convenient cabinet housing and consists of the following equipment:

- One—R568 Readout Oscilloscope, with
- One—3S6 Programmable Sampling Unit,
- One—3T6 Programmable Sampling Sweep Unit, and
- Two—S-3A Sampling Heads;
- Two—Dual Probe Choppers;
- One—R230 Digital Unit;
- One—R1340 Data Coupler; and
- One—R1330 Test Station Master Control Unit.

Many options are available; your local Tektronix Systems Applications Engineer would be pleased to discuss a configuration suited to your needs.

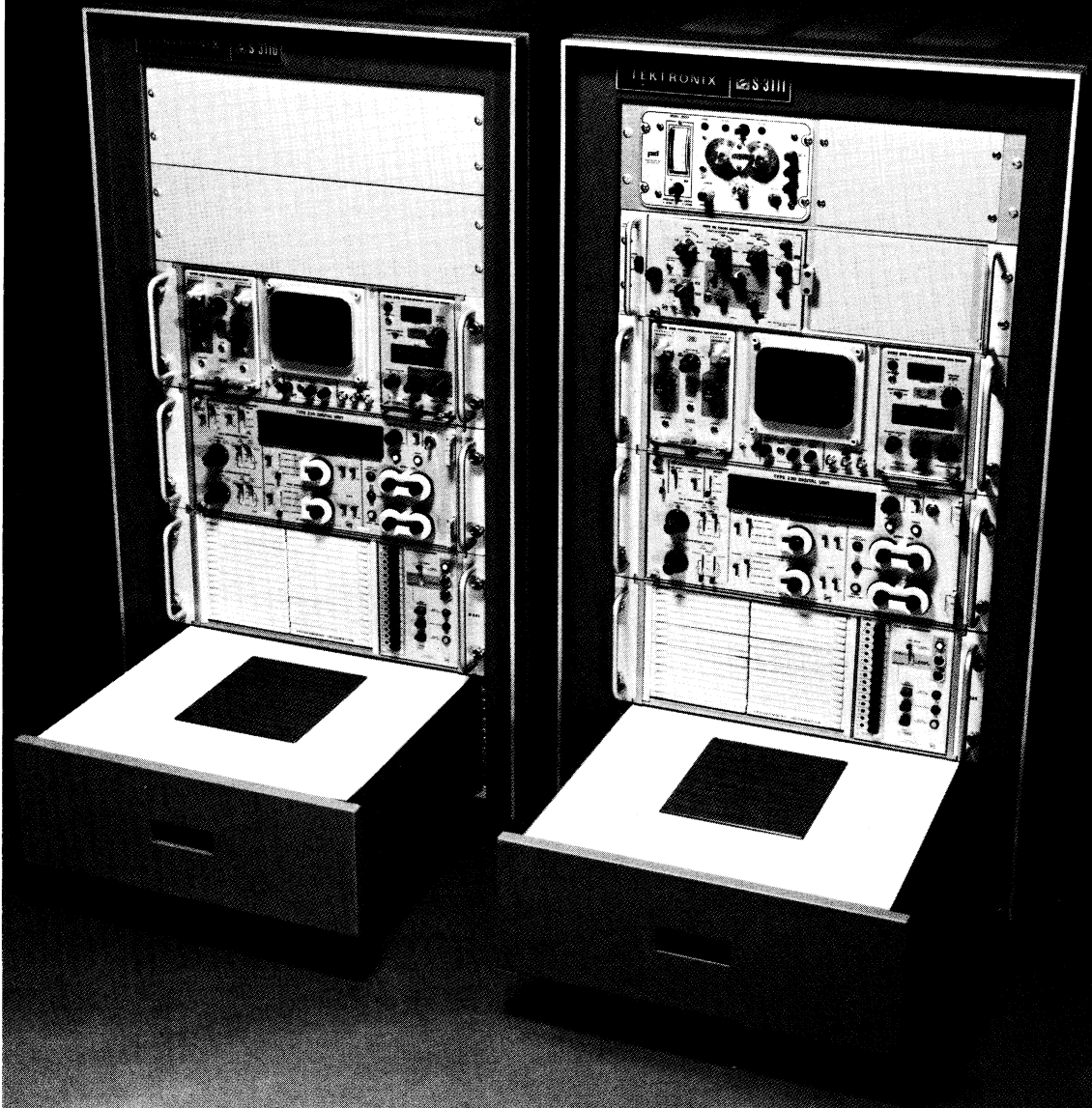
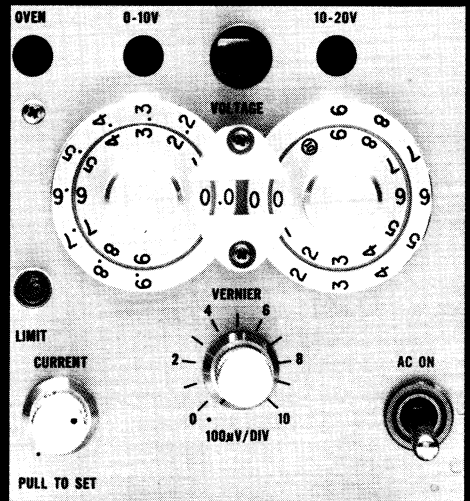
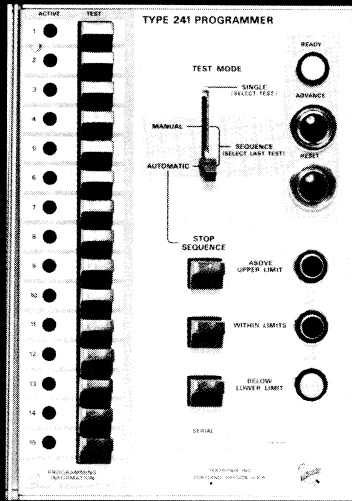

S-3110 S-3111

The S-3110 and S-3111 Automated Measurement Systems evolve from the S-3101 Measurement Subsystem. These systems measure and test the performance of many types of active devices under simulated operating conditions, and were designed to test such devices as diodes, transistors, integrated circuits, modules, and subassemblies. The systems will sequence up to 15 measurements in less than 150 ms. Available options increase the number of measurements to a maximum of 225. High and low measurement limits can be programmed for each measurement. The system can be set to stop a measuring sequence on any out of limit results.

The 1841 Fixture Drawer contains mounting for the sampling head probes, pulse generator inputs through 50-ohm coaxial cables, dc power supply inputs, and 14 buffered fixture lines through a 56-pin circuit board connector. An unwired test fixture card and a performance check-out card are included as standard accessories.

The S-3111 is similar to the S-3110, except that the stimulus capabilities of a non-programmable 115 Pulse Generator and a 2005A Power Supply are added for the S-3111. Both systems can use the R241 Program Control Unit (see page 23), which holds up to 15 diode-programmed measurement cards. Each card is configured by inserting diodes in any of up to 159 slots. This allows for complete programming of the 568 Oscilloscope, with plug-ins, and the 230 Digital Unit. Typically, 15 to 20 diodes will provide the necessary program conditions, and the diodes are easy to insert and remove with the special tool provided.

These systems are not limited to a single 241 Programmer; a second unit may be added serially to increase the measurement and testing capacity to 225. Also, with another option, the 241 Program Resequencer (see page 24),

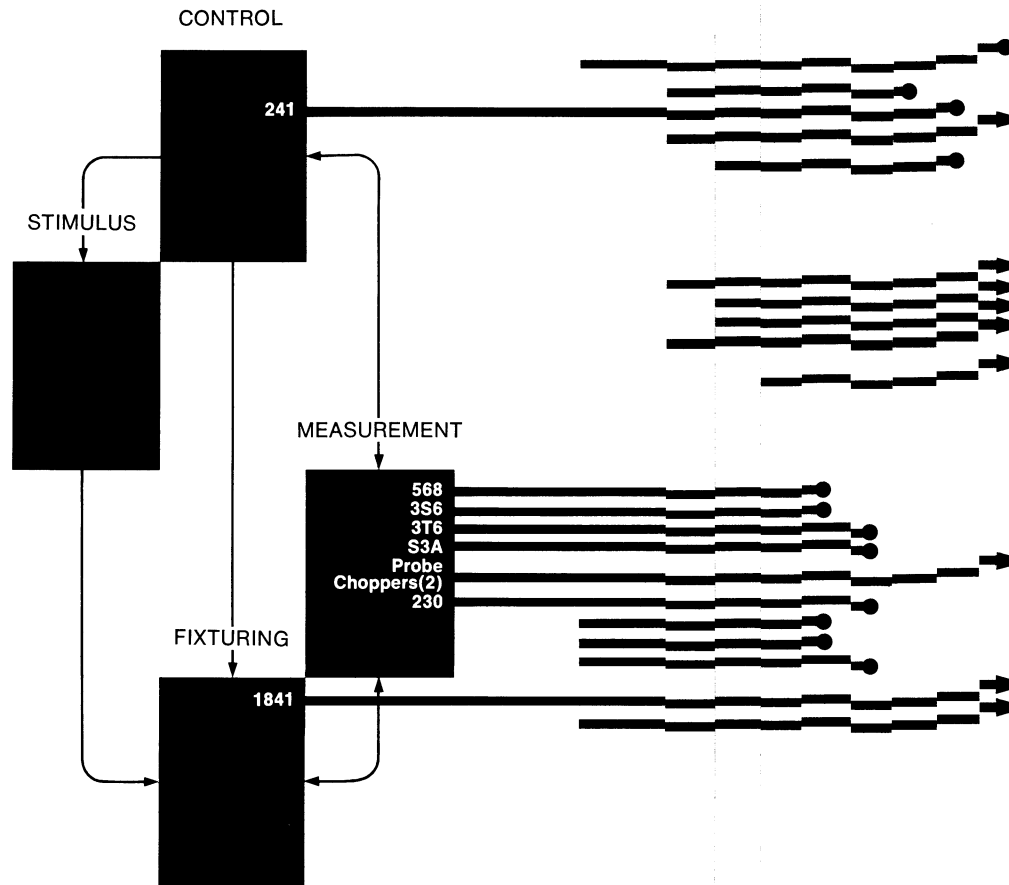

the system can repeat different tests (when less than 15) at different sets of pins, to a maximum of 150 tests. Fixtures may be customer supplied. A wide variety of fixture cards is available for the 1841 Fixture Drawer; these include cards for DTL, TTL, diode, and transistor devices. See page 27 for details.

The standard S-3110 consists of the following equipment:
 One—R568 Readout Oscilloscope, with
 One—3S6 Programmable Sampling Unit,
 One—3T6 Programmable Sampling Sweep Unit, and
 Two—S-3A Sampling Heads;
 One—R230 Digital Unit;
 One—R241 Programmer Unit;
 One—1841 Fixture Drawer;
 Two—Dual Probe Choppers; and
 One—44-inch high equipment cabinet.

Many options are available; your local Tektronix Systems Applications Engineer would be pleased to discuss a configuration suited to your needs.



S-3120

The S-3120 Automated Measurement System also uses the S-3101 measurement package, but linked with the R240 Program Control Unit and an eight-track disc memory. The use of a disc memory permits a total of 1600 tests to be stored and then performed at up to 100 tests per second, giving this system an increased capability not only in versatility, but in capability for the number of measurements stored.

The S-3120 is a boon to such activities as incoming inspection, quality control, and production testing. It is specifically designed to test devices that require long programs, but have stimulus requirements that do not change during the program.

The 240 permits programs to be written, debugged, and executed. This unit is used to program the measurement package (the 568 Oscilloscope, with plug-ins, and 230 Digital unit). The programming capability may be expanded with R250 Auxiliary Program Units. This allows for expansion to incorporate programmable power supplies, DVM's, counters, generators, fixturing, and special units.

The S-3120 consists of the following equipment:

- One—R568 Readout Oscilloscope, with
- One—3S6 Programmable Sampling Unit,
- One—3T6 Programmable Sampling Sweep Unit, and
- Two—S-3A Sampling Heads;
- One—R230 Digital Unit;
- One—R240 Program Control Unit;
- One—Disc Memory;
- One—RAB6375BA1 Paper Tape Reader/Punch;
- One—R115 MOD 814R Pulse Generator;
- Two—2005A Power Supplies;
- Two—Dual Probe Choppers; and
- One—Single-bay equipment cabinet with a pull-out drawer for a test station.

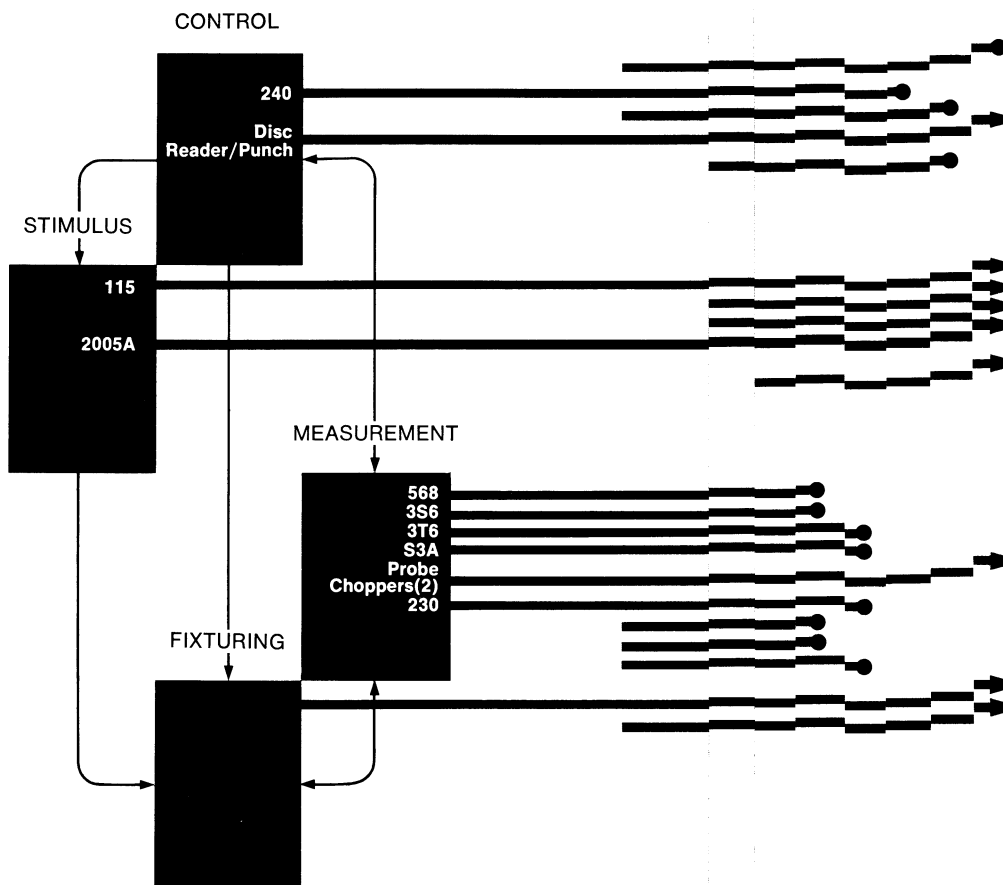

The S-3120 can accommodate a number of options that are compatible with both the S-3110 and S-3130 systems. For example, the 1841 Fixture Drawer (from the S-3110) is easily slotted into the S-3120 rack, as is a Reader/Punch, or a 1330 Test Station Master Control Unit (for multiple test station multiplexing).

Many options are available; your local Tektronix Systems Applications Engineer would be pleased to discuss a configuration suited to your needs.

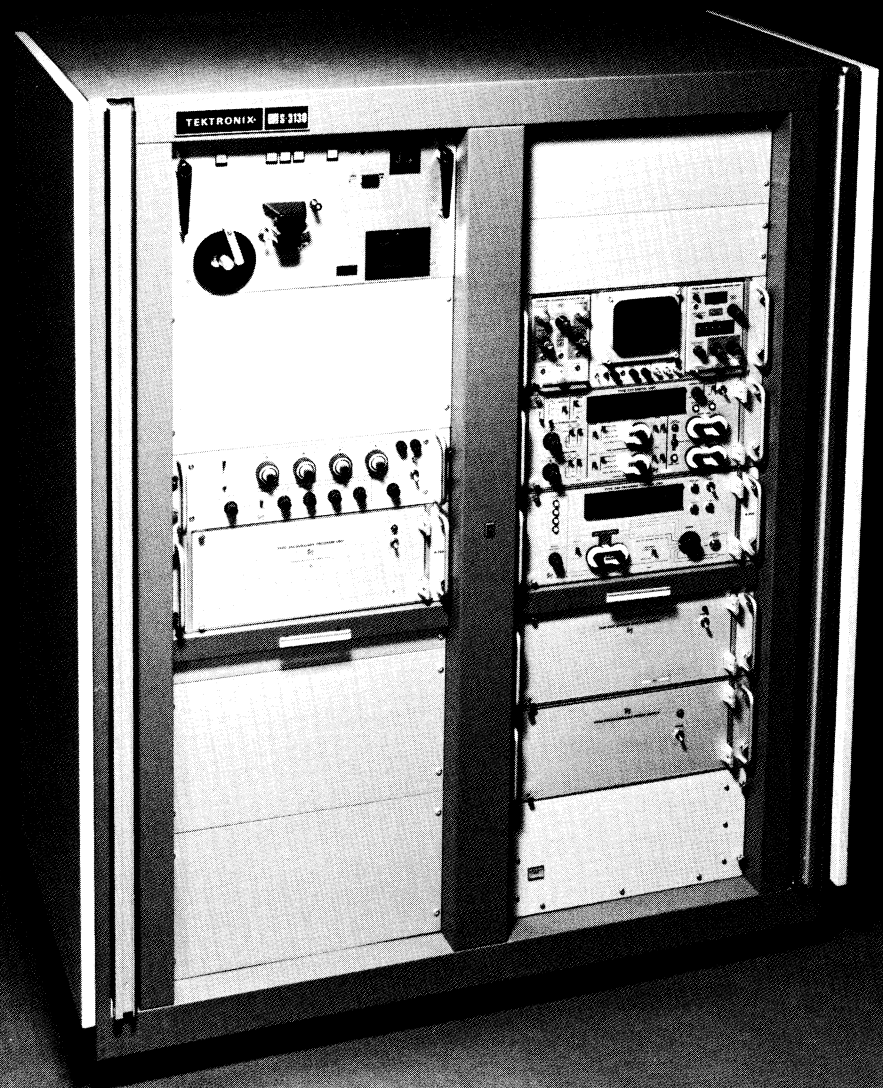
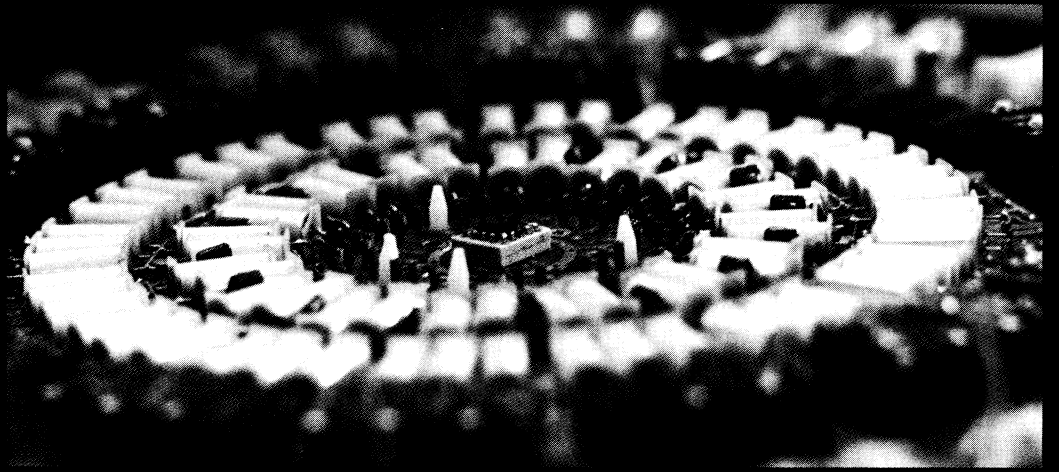

S-3130

The S-3130 uses a modular approach to system configuration, but surpasses the other 3100-Series systems because of its extreme flexibility in configuration and allowance for future expansion to maintain system performance. This completely automated test system is based on the S-3101 measurement subsystem and has a large range of options to accommodate testing requirements for many types of devices and subassemblies. From the programming standpoint, routines may easily be created, debugged, and modified using the front panel controls of the 240 Program Control Unit. Features of the 240 allow test programs to be created and stored in the disc memory, or on punched paper tape, or both. Other options for the system include excellent fixturing, signal generators, power supplies, input/output devices, digital multimeters, counters, etc. All of these are completely programmable and can include user-supplied equipment.

Thus, the S-3130 system, in your format, can store up to 1600 measurements on the disc memory and can perform at up to 100 measurements per second. Diagnostic routines, sorting, and classifying on test results are some of the tasks that can also be performed in addition to "normal" tests and measurements. When adding special units and other options, the 240 Program Control Unit capability may be expanded with the addition of R250 Auxiliary Program Units.

The varied fixturing that may be incorporated in the S-3130 is not limited to one test point or station; inclusion of the optional 1330 Master Station Control Unit will allow up to four test stations to be multiplexed to the test system. The test system may be operator controlled at the test station with a Test Station Control Unit. These test stations may be part of an environmental chamber, and may include automatic handling, probes, and sorters.

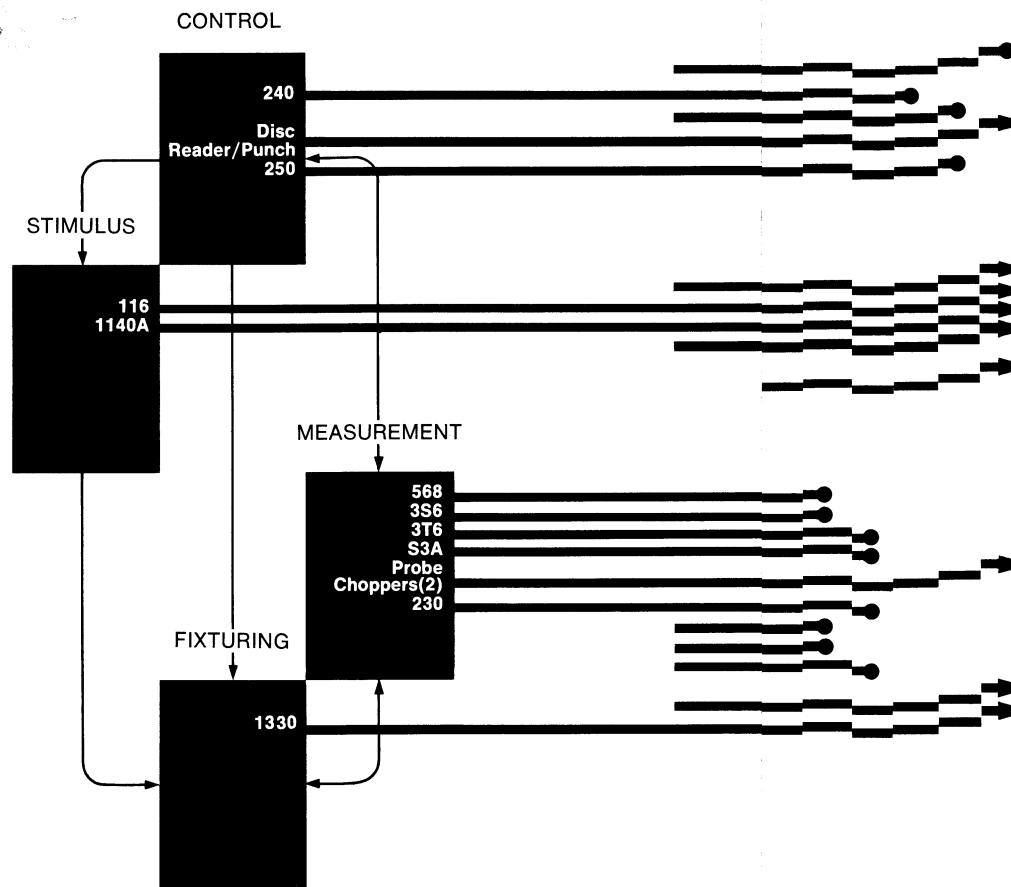

The S-3130 consists of the following equipment:

- One—R568 Readout Oscilloscope, with
- One—3S6 Programmable Sampling Unit,
- One—3T6 Programmable Sampling Sweep Unit, and
- Two—S-3A Sampling Heads;
- One—R230 Digital Unit;
- One—R240 Program Control Unit;
- One—R250 Auxiliary Program Unit;
- One—R116 MOD 703L Programmable Pulse Generator;
- One—R1140A Programmable Power Supply;
- One—Disc Memory;
- One—RAB6375BA1 Paper Tape Reader/Punch;
- One—R1330 Test Station Master Control Unit;
- Two—Dual Probe Choppers; and
- One—Two-bay cabinet with an operator table for a test station.

Many options are available; your local Tektronix Systems Applications Engineer would be pleased to discuss a configuration suited to your needs.

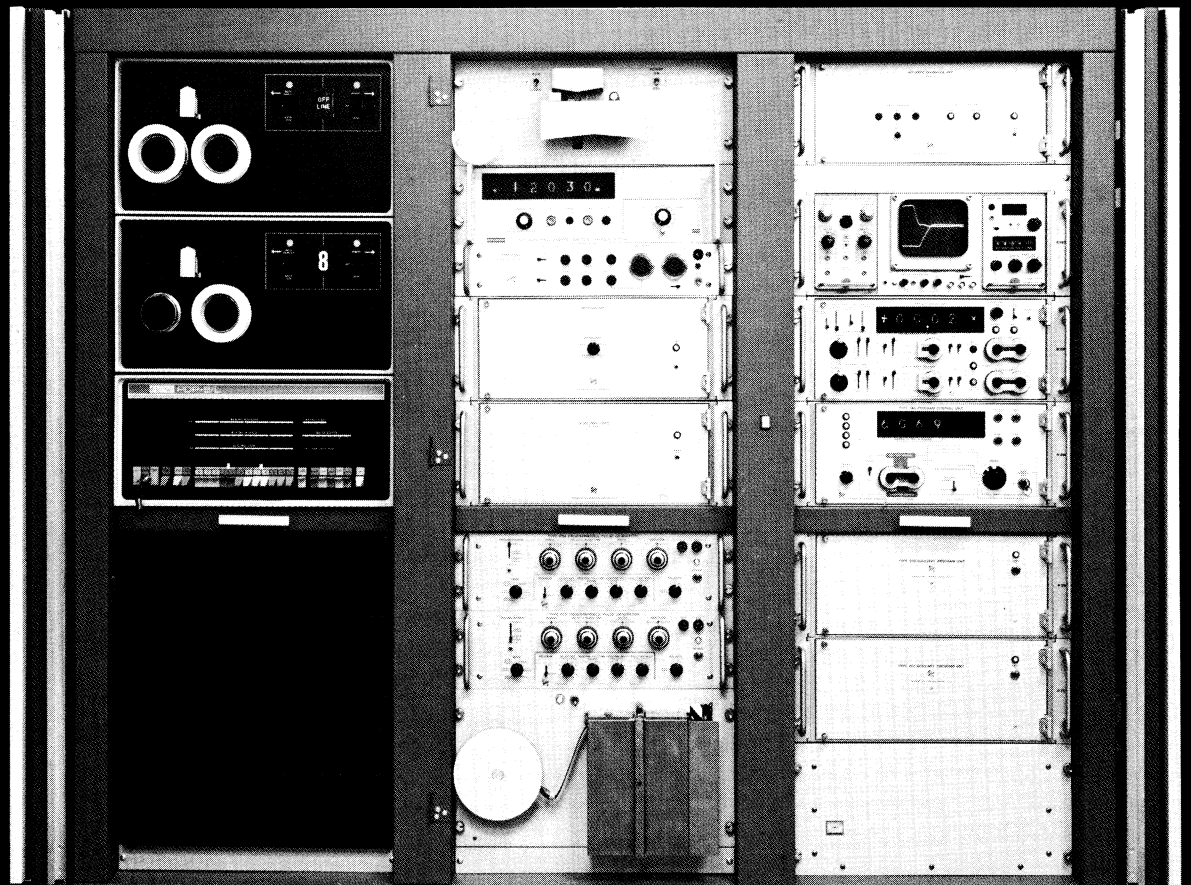

S-3150

Completely automated, but still operator oriented for production testing, the S-3150 combines the virtues of the S-3101 measurement package with a programmable fixture and the sophistication of a digital controller. It features high-speed dynamic, dc, and (optional) functional testing capabilities for various IC families (DTL, TTL, MECL, etc.). The S-3150, with its wide variety of options, can be tailored to specific needs. The measurement system is self-contained and, once programmed, will perform tests on a go/no-go basis or on a diagnostic basis at rates of 100 measurements per second.

A DEC PDP-8/L Controller is used for on-line data acquisition, off-line data reduction, and in writing programs using the TEKTEST I software. The controller generates patterns for the function test option. The system provides:

- (1) Fixture Flexibility—The 1801 and 1802 fixtures provide I/O testing for devices using up to 16 pins. Since the I/O functions can be separated, 36-pin devices can be accommodated. Only load boards need be changed for most logic families; most changes within a family are under program control (loads, power supplies, and stimuli).
- (2) DC Capability—Dc currents and voltages may be measured to within a 1-pct subsystem specification.
- (3) Data Acquisition—Computer-controlled data acquisition with no loss in test rate.
- (4) Programming—A special interactive computer program (TEKTEST I) generates measurement system programs from the keyboard.

The plain English TEKTEST I program interacts with the 240 Program Control Unit through the teletype keyboard, and enables new systems programmers to begin writing test programs with minimum training. Experienced programmers can generate and debug new programs rapidly since the computer saves much of the labor associated with machine coding. Because the S-3150 uses a disc memory for program storage, the measurement system may be used for go/no-go and diagnostic testing while the controller is used for batch data reduction, interactive program compilation, or other non-system-related computer activities.

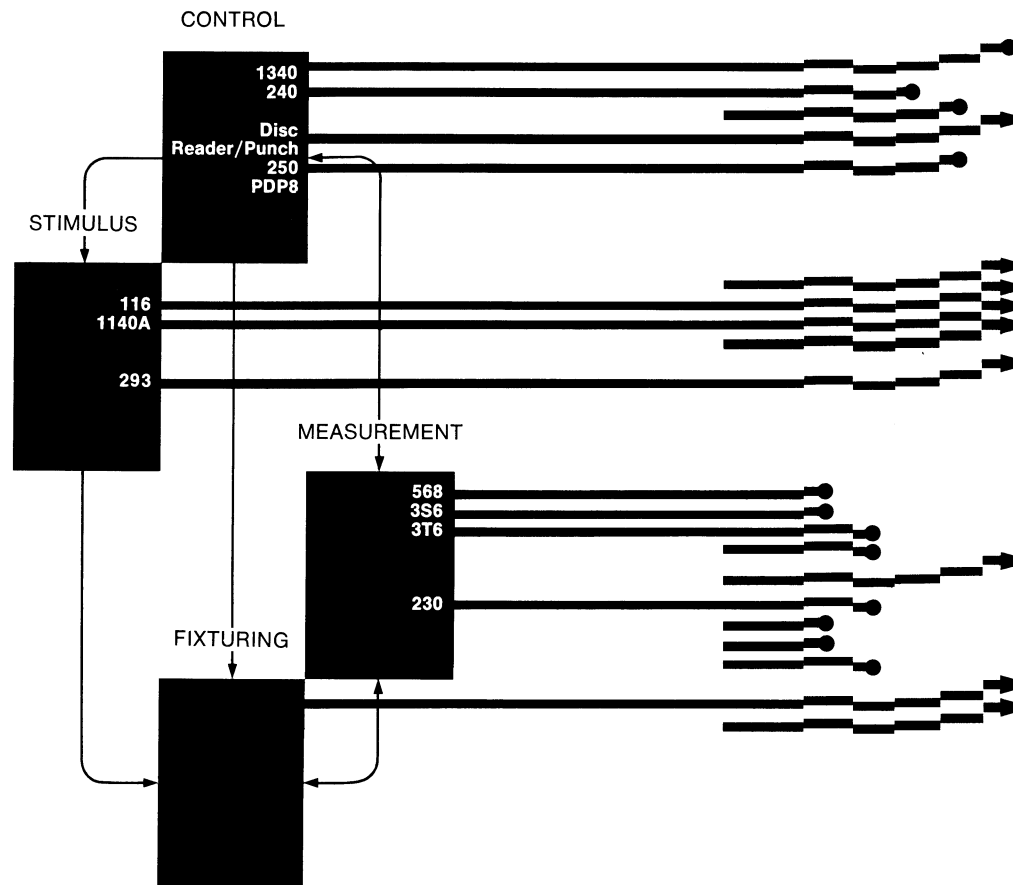

The S-3150 includes:

- One—R568 Readout Oscilloscope, with
- One—3S6 Programmable Sampling Unit; and
- One—3T6 Programmable Sampling Sweep Unit;
- One—R230 Digital Unit;
- One—Automatic Calibration Unit;
- One—R240 Program Control Unit;
- Two—R250 Auxiliary Program Units;
- Two—R116 MOD 703L Programmable Pulse Generators;
- One—R293 MOD 703M Programmable Pulse Generator;
- One—R1140A Programmable Power Supply;
- One—Disc Memory;
- One—RAB6375A1 Paper Tape Reader/Punch;
- One—R1340 Data Coupler;
- One—PDP-8/L Controller (with 24k core memory);
- One—ASR33 Teletype*;
- Two—DEC TD8-EM Tape Units*;
- One—Programmable Test Station (with 16 Sampling Heads); and
- One—Three-bay equipment cabinet.

All of these units are cabinet mounted, except the Programmable Test Station, which is located at one side, and the Teletype, which is free standing at the other side. One of two types of programmable test stations may be used: the 1801 for manual testing, and the 1802 for ambient and environmental automatic handlers and manual testing. In each case, the test station is a console containing a programmable test fixture. One to four test stations may be included in an S-3150 system (see page 28. for details).

* DEC peripheral units

MEASUREMENT

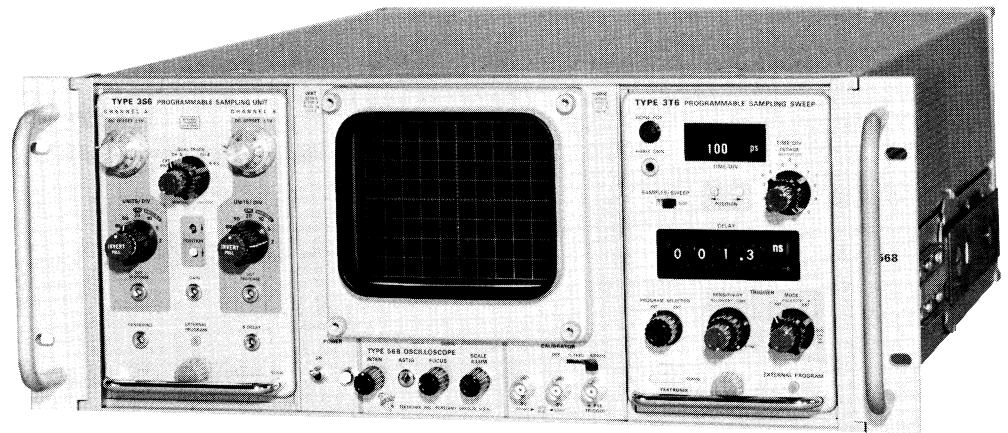

R568

The R568 Readout Oscilloscope performs the signal acquisition function in a 3100-Series system. A connector on the rear panel provides all logic and signal interconnection between the 568 and the 230 Digital Unit. A calibrator circuit provides squarewave outputs through front-panel connectors for adjusting compensation of probes and for checking vertical and horizontal gain of the plug-in units.

Features

- **CRT**—Glass envelope, rectangular face, 3.5-kV accelerating potential, P2 phosphor standard (P7, P11, and P31 optional without extra charge), 8- by 10-div edge-lighted internal graticule.
- **Calibrator**—5 V and 0.5 V into 100 k Ω or more, or 500 mV and 50 mV into 50 Ω ; 100-kHz or 1-kHz repetition rate.

3S2/3T2

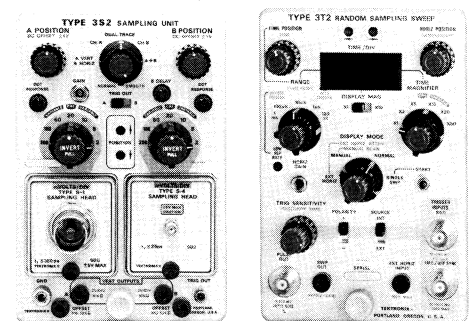

The 3S2 Dual Trace Sampling Plug-In Unit permits changing system measurement capabilities as needs change. Calibrated deflection factors of 2 mV/div to 200 mV/div are provided, and bandwidth extends from dc to as high as 14 GHz, dependent upon the sampling head used. Sampling heads can be either plugged into the 3S2 directly or attached by a cable for remote use. When used with the 3T2 Random Sampling Time Base, the triggering event may be displayed without the use of delay lines or a pretrigger signal.

Features

- **Bandwidth**—Dc up to 14 GHz (depends on sampling head).
- **Risetime**—Depends on sampling head (as low as 25 ps with S-4 sampling head).

The 3T2 Random Sampling Time Base provides for normal displays while eliminating the need for a delay line or pretrigger signal. With the 3T2, the leading edge of fast pulse displays may be placed anywhere within the first five divisions at all sweep speeds from 20 ps/div to 100 μ s/div. The triggering signal may occur before or after the displayed pulse by as much as 50 ns at the fastest sweep speed, increasing to 500 μ s at the slowest sweep speed. Sweep time indications are provided on a lighted panel.

Features

- **Display Modes**—Single, normal, manual, and external horizontal.
- **Samples/Division**—Continuously variable (fixed at 100/div when used with 230 Digital Unit).
- **External Trigger Input Impedance**—50 Ω and 1 M Ω .

3S5/3S6

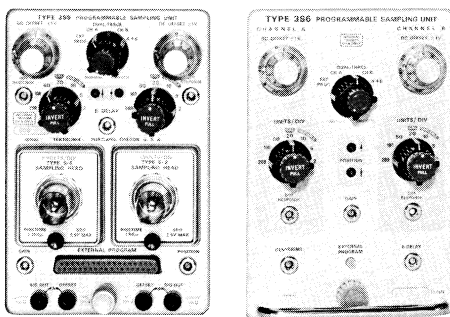

The 3S5 and 3S6 Dual-Trace Sampling Units extend the automated measurement capabilities of the 568/230 measurement package by allowing remote programming of deflection factor, dc offset, and smoothing. External programming of the 3S5 is accomplished by either a front- or rear-panel connector. The 3S6 has program and signal inputs on the rear.

Sampling heads feature a choice of measurement capabilities and may be mixed or matched to meet specific measurement needs. A front-panel control allows adjustment of the

inter-channel time relationship to compensate for external delays.

Features

- **Deflection Factor**—2 mV/div to 200 mV/div in 7 calibrated steps (1-2-5 sequence). (Each step is accurate within 3% in normal mode, within 4% smoothed. Each vertical channel is programmed with 3 program lines or by manual front-panel controls.)
- **DC Offset Range**—+ 1 V to - 1 V. (Signals between limits are displayed at 2 mV/div, are continuously variable, and are calibrated with front-panel controls. These between-limits signals are also accurate within 10 mV of the same offset voltage obtained in the external program mode, and are programmable between +995 mV and -995 mV in 5-mV steps. The programmable accuracy is within 2% or 5 mV, whichever is greater, of the programmed value. Programming is accomplished with nine program lines per channel, plus one program line per channel for + or - polarity.)
- **B-Delay Range**—Channel B display continuously positionable in time from +5 ns to -5 ns with respect to channel A. (Up to a 3-foot difference in signal cables can be accommodated.)
- **Programming**—Twenty-seven program lines plus ground; used to externally program all measurement functions. (The 3S5 and 3S6 use negative logic with true being ground or less than 2 V, and false being open or more than 6 V.)
- **Display Modes**—A only, B only, dual trace, and algebraic addition of A and B signals. (In the external program mode, dual-trace operation is automatically provided. Independent controls for each channel permit positioning and inverting displays.)

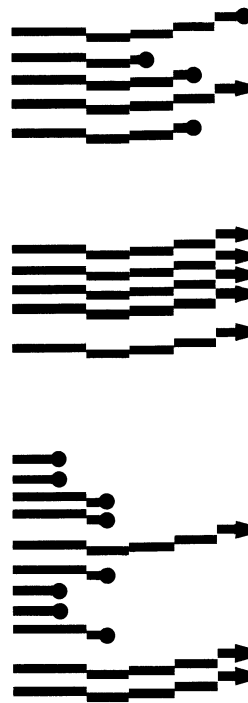

MEASUREMENT

Sampling Heads

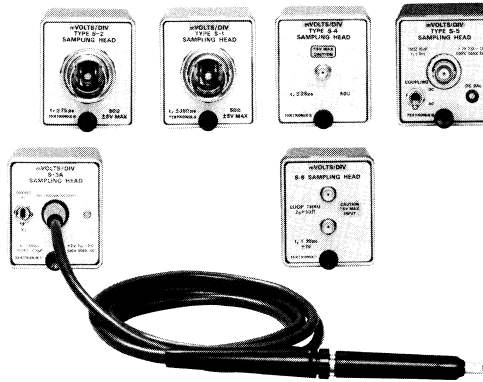

A variety of sampling heads provide for a choice of measurement capabilities. Heads may be mixed or matched to meet specific needs. In each sampling head, a front-panel control allows adjustment of the inter-channel time relationship to compensate for external delays. Sampling heads used with the 3S5 Dual Trace Sampling Unit may be plugged into the unit directly or located remotely on optional 3- or 6-foot sampling head extender cables; those used with the 3S6 Dual-Trace Sampling Unit are located remotely on included 6-foot extender cables that connect to the rear of the 568 Readout Oscilloscope.

Sampling Head	Rise-time	Input	Minimum Deflection Factor	Displayed Noise
S-1	350 ps	50 Ω , GR874	2 mV/div	≤ 2 mV
S-2	75 ps	50 Ω , GR874	2 mV/div	≤ 6 mV
S-3A	350 ps	100 Ω , 2.3 pF	2 mV/div	≤ 3 mV
S-4	25 ps	50 Ω , SMA	2 mV/div	≤ 5 mV
S-5	1 ns	1 M Ω , 15 pF	2 mV/div	≤ 500 μ V
S-6	30 ps	50 Ω , SMA	2 mV/div	≤ 5 mV

3T5/3T6

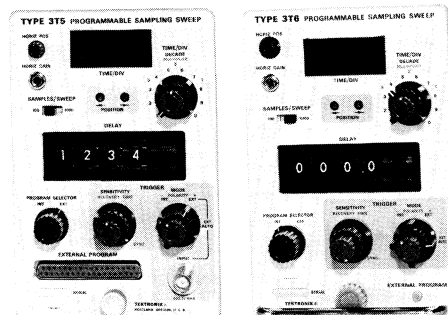

The 3T5 and 3T6 Programmable Time Base Units are externally programmable units that extend the automatic measurement capabilities of the 568/230 measurement package. The 3T5 and 3T6 may also be controlled manually, using the front-panel controls. Real-time sampling (1 ms/div to 500 ms/div), and digital delay are provided. An external automatic trigger mode eliminates the need for adjustments over a wide range of trigger signal characteristics.

Features

- **Sweep Time/Div**—100 ps/div to 500 ms/div in 30 calibrated steps (1-2-5 sequence). (Accuracy is within 3% [within 5% from 100 ps/div to 500 ps/div], except for non-linearities at the beginning of the sweep. Sweep time is switch selected or programmed by bcd code.)
- **Samples/Sweep**—1 sample/sweep, externally programmed only; 100 or 1,000 samples/sweep, switch selected or programmed by bcd code. (Sample rate may be programmed to scan quickly, 100 samples/sweep, when not making a measurement, then provide maximum resolution, 1,000 samples/sweep, when making a measurement.)
- **Delay Range**—0 to 999.9 ns in 100-ps increments from 100 ps/div to 500 ps/div; 0 to 9.999 μ s in 1-ns increments from 1 ns/div to 1 μ s/div; 0 to 999.9 μ s in 100-ns increments from 2 μ s/div to 500 μ s/div. (Range is switch selected or programmed by bcd 16-bit code.)
- **Delay Jitter**—0.1 div or less at all sweep speeds (independent of amount of delay).
- **Triggering**—Sources: internal, if sampling unit contains a trigger pick-off; external, 50- Ω terminated input. Jitter: external automatic, pulse, 30 ps or less with 300 mV pulse, 2 ns or less wide; sinewave, 200 ps or less with 300 mV peak-to-peak signal at 30 MHz.

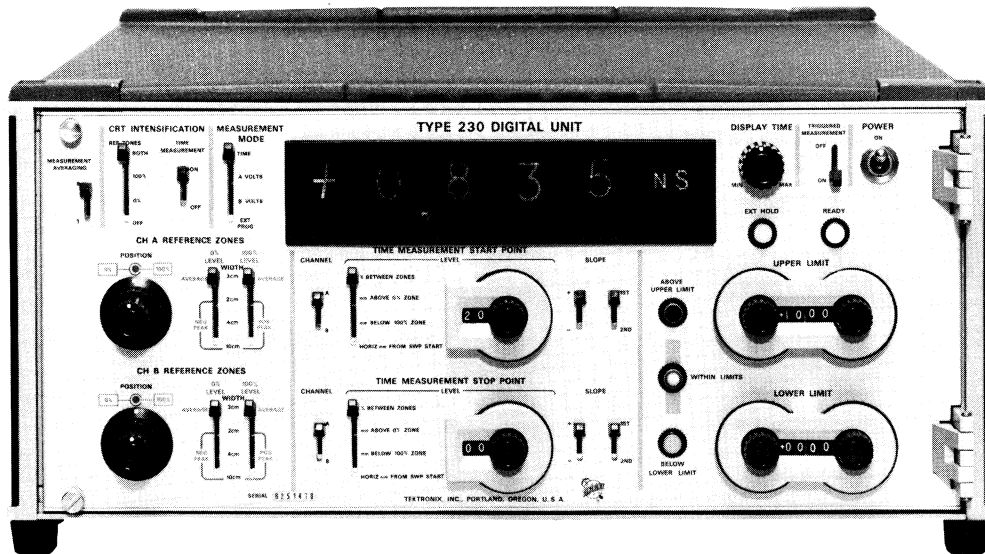

R230

The R230 Digital Unit measures and indicates, in digital form, the signals displayed on the 568 Readout Oscilloscope. The 230 features flexible measurement capabilities (up to 100 measurements per second), easy programming, bcd data outputs, and solid-state design with extensive use of integrated circuits. A wide variety of repetitive pulse measurements of signals displayed on the 568 can be performed by the 230. The digital indications can represent voltage measurements, time difference measurements between similar pulses, and time difference measurements between voltages or percentages of pulse amplitudes. The 230 can be programmed externally for use in high-speed automatic measurement systems by using such units as the 240 Program Control Unit or the 241 Programmer, or by using the 1340 Data Coupler for digital control. Data output connectors provide convenient outputs for measurement results in bcd code.

Four basic measurement functions (channel A volts, channel B volts, time, and external program) can be selected by the 230. Voltage measurements are made on either channel A or channel B between the 0- and 100-pct reference zones. Signal polarity is determined and read out automatically on the digital readout. Time measurements are made on either channel A or channel B, or between the two channels. All of the front-panel functions required to make voltage and time measurements can be easily programmed externally. The variety and flexibility of measurements

possible with external programming are even greater than those possible through use of the 230 front-panel controls, and measurements and limits can be changed more rapidly.

digital readout

The measurements made by the 230 are read out directly on six character indicator tubes. Decimal point and unit of measure (nanosecond, microsecond, millisecond, second, millivolt, volt) are automatically presented. The polarity of the measurement is also read out automatically.

display times

The digital readout display time may be varied from 10 ms to 10 s. The EXTERNAL HOLD indicator lights when the measured data are being held in storage until a recording device has had sufficient time to record the measurement. In triggered measurement operation, a measurement is started after receipt of a trigger (+ or -) and after the display time has been completed. The READY indicator lights to signify a ready condition for a trigger.

reference zones

The 0-pct and the 100-pct zones establish the reference points from which all measurements are made, and may be set in 1/2 division steps anywhere on the signal display. The reference zones can be brightened on the oscilloscope display with the CRT intensification reference zone switch, which brightens both zones, the 100-pct zone only, 0-pct zone only, or disables the zone intensification.

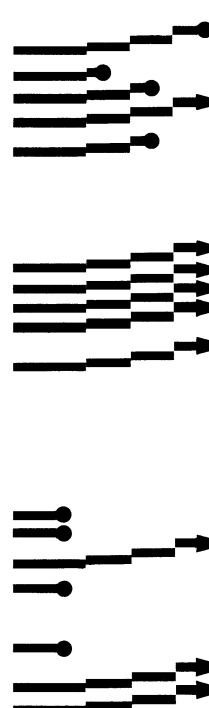

MEASUREMENT

The 0-pct and 100-pct zone controls determine the start position of the zones to any $\frac{1}{2}$ division point from the start of the sweep by means of a 20-position switch. Zone width controls select the width of each reference zone and select the type of voltage reading; average or peak. With the LEVEL WIDTH switches set to the AVERAGE .3 cm position, the memory is in the average mode; with the switches set to any of the other positions, the memory is in peak mode and will provide for peak values on the display.

time measurement start and stop points

Time measurements are made between selected start and stop points. These points are selected to start and stop on either the channel A signal or the channel B signal, on the first or second positive-going or negative-going slope, and at some selected point above 0-pct or below 100-pct or a finite time from the sweep start, or at a selected percentage point between zones.

resolution

Time measurements are performed by gating and counting clock pulses during the measurement. The time measurement start and stop comparators have a pick-off resolution capability of one $\frac{1}{100}$ of a division. This gives the 230 the ability to scale a 1-division display in 1-pct steps. Measurement averaging permits the value of a displayed measurement to be the arithmetic average of eight measurements or of only one measurement.

limit controls

The limit controls allow selection of the upper and lower measurement limits. Visual results of the measurement are then provided by three panel indicators that signify if the results are above, within, or below the selected limits. The 230 may be programmed to stop an externally programmed measurement sequence on any limit result.

external readout

Data outputs are available on the rear panel of the 230 to permit the recording

of measurement polarity, displayed digits, units of measure, decimal point, and measurement limit results.

external programming

All measurement functions can be programmed by ground closures. Suitable programming devices include the 241 Programmer and the 240 Program Control Unit.

When using the 3T5 or 3T6 Programmable Sampling Sweep Units under external program control, the 230 can provide sweep speed-up commands to increase sweep speeds. When so programmed, the time base runs at high speed (10 dots/division) between the zones and after the measurement, and at slow speed (100 dots/division) during the areas of interest. After the fourth zone on a memory charging sweep and after completion of the measurement on the second sweep, the sweep is automatically terminated by the 230.

Measurement speed for multiple measurements on a given signal can be increased by externally programming the position of the 0-pct and/or 100-pct reference zones start point to a fictitious point (12 cm) outside the display area. Whenever a particular zone position is programmed to 12 cm, that particular memory is inhibited from being discharged. If all zones are thus programmed, several different measurements may be made without a memory charging sweep. Use of this feature provides that a typical measurement that would ordinarily require 26 sweeps would require only 14.

Features

- **Mode Start Points**—(1) percentage between 0-% and 100-% zones, (2) millimeters above 0-% zone, (3) millimeters below 100-% zone, and (4) horizontal millimeters from sweep start.
- **Voltage Measurement Types**—Dc and pulse, with respect to ground (using signal choppers).

CONTROL

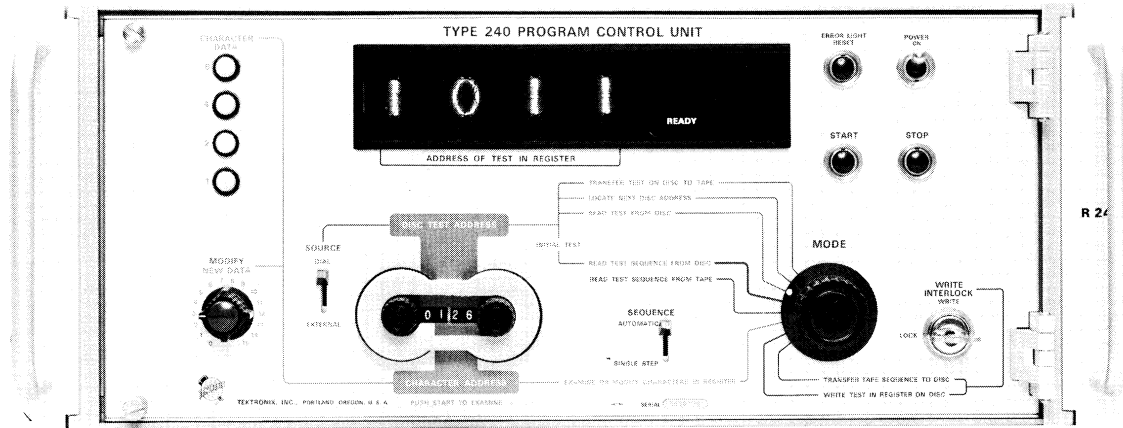

R240

The R240 Program Control Unit provides for automated measurements using the 568 Readout Oscilloscope with the 3T5 or 3T6 and 3S5 or 3S6 programmable plug-in units and the 230 Digital Unit. The 240 accepts program data from a disc memory or from a punched paper tape reader. Programs may be originated or modified manually from the front panel of the 240. If other equipment requires external programming, a 250 Auxiliary Program Unit may be added to the 240.

Measurement rates in excess of 100 measurements per second are achieved; and sorting, classifying, and diagnostic test routines are performed using the disc memory. The disc memory also permits random access to a library of up to 1600 independent measurements. This feature permits a computer or other control device to have complete control over the test measurements, making calculations from the test data and using the disc memory for further measurements and sorting at the maximum test rates.

The punched paper tape reader provides a maximum measurement rate of 5 measurements per second, and is also used for loading measurement programs into the disc memory. The 240 may be used without the disc memory or punched paper tape reader by providing program data externally. Data sources include paper or magnetic

tape readers and digital controllers.

The 240 has a fixed word length that is normally used to program the measurement address, the 568 Readout Oscilloscope, and the 230 Digital Unit. One of eight function modes may be selected by a front-panel switch, and performed after receipt of a start command from an external source or the front panel. The functions are as follows:

- **Transfer Test On Disc To Tape**—Loads the 240 with program data from the disc memory, as selected by the test address. When the 240 register is full, the program data are shifted to the tape punch. When the tape punch has punched a complete program, the 240 is returned to a ready condition.
- **Located Next Disc Address**—Locates the next disc address after a measurement has been made. Programs on the disc are spaced to achieve fast access time. Measurement rates are in excess of 100 per second.
- **Read Test From Disc**—Loads a register with program data from the selected disc sector and commands the 568/230 to make a measurement. After measurement, the 240 returns to the ready condition.
- **Read Test Sequence From Disc**—Loads a register with program data

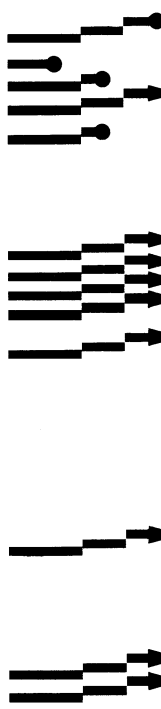

CONTROL

from the selected disc sector and commands the 568/230 to make a measurement. After measurement, a command from the 230 loads the register with data from the disc sector selected by the next test address. The automatic sequencing continues until the 240 completes all measurements. In this mode, the 240 can be programmed to branch to a new measurement sequence and stop the sequence on out-of-limits measurements. For example, when making a risetime measurement, an above-limit risetime can stop the sequence and a below-limit risetime can branch to a new measurement sequence for reclassifying the component. Out-of-limit measurements are normally programmed to repeat as a check for measurement error.

- **Read Test Sequence From Tape**— Loads a register with program data from the punched tape reader and commands the 230 to make measurements continuously until the 240 receives a stop signal. The punched tape reader can program the 240 to stop the sequence on out-of-limit measurements. Out-of-limit measurements are normally programmed to repeat as a check for measurement error.
- **Examine Or Modify Characters in Register**— Displays, on character data indicators, the data that are in a selected shift register cell. Characters are selected by character address switches and can be modified with the use of a new-data switch and the modify pushbutton.
- **Write Test in Register On Disc**— Permits new or modified program data in the register to be written on a selected disc sector. A write interlock prevents accidental writing and changing of data written on the disc memory.
- **Transfer Tape Sequence To Disc**— Loads the register with new program data from the punched paper tape reader and writes the program data on a selected disc sector.

R250

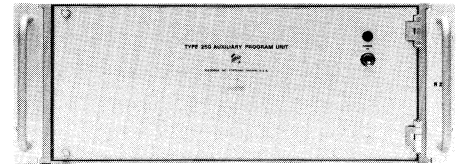

The R250 Auxiliary Program Unit expands the programming capabilities of the 240 Program Control Unit, permitting programming of pulse generators, power supplies, test fixtures, automatic handlers, and other devices required for automated measurement systems. The 250 provides program buffering, digital-to-analog conversion, and patch panel capabilities. One 250 provides 192 program lines; two 250's provide 384 program lines.

Internal power supplies are available for external programming requirements. The 250 requires 12 program assembly cards and cables for operation. Program assembly cards consist of one shift register card and two program (standard, resistance, or conductance) cards in any combination.

Systems engineering is required with the program boards to determine the proper interface from the 250 to the auxiliary equipment to be programmed. Two program boards are selected and wired to each shift register card to obtain the necessary program functions.

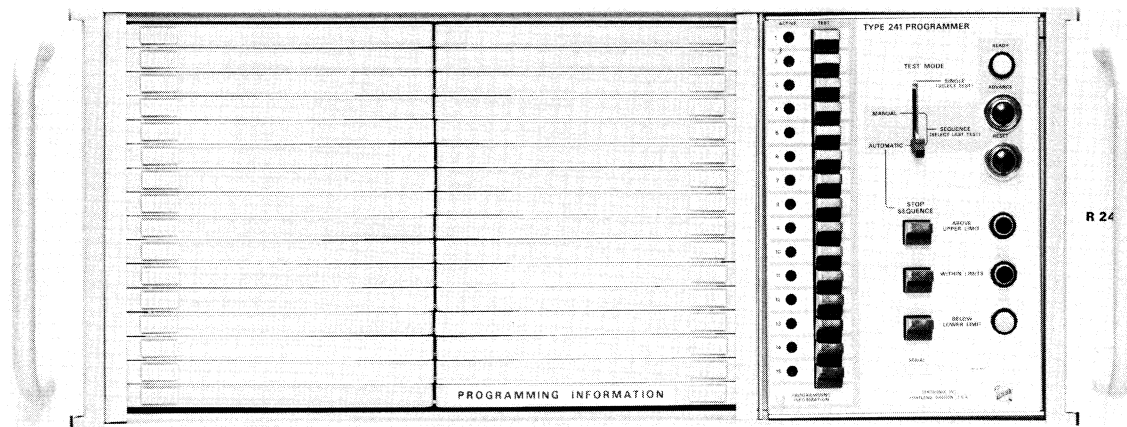

R241

The R241 Programmer uses diode programming to sequence the programmable functions of the 568 Read-out Oscilloscope and 230 Digital Unit and includes an additional 14 lines available for programming other equipment. Up to 15 programmed measurements may be selected manually by front panel pushbuttons or by external control lines. Automatic or manual sequencing of up to 15 measurements is provided with front panel or external control. In the automatic sequence mode, out-of-limit conditions can stop the measurement sequence if desired.

Each program card controls one measurement and has a 159-bit capacity. Programs are easy to set up. A special tool is supplied to make insertion and removal of diodes quick and easy. Program cards are labeled to permit a person having minimum training to program the boards. Typically, insertion of only 15 to 20 diodes is required for a particular measurement.

Program cards are accessible from the front panel and may be easily removed, rearranged, or exchanged for others that are intended for different tests. A storage area in the back of the 241 provides storage space for up to 15 additional program cards. A storage drawer holds extra diodes and the diode insertion tool.

Operating modes are defined as follows:

- **Single Test Mode**—Any program card/measurement can be selected in any order by a row of numbered pushbuttons on the front panel. Fifteen external control lines permit external selection of any measurement in any order by an external ground closure.
- **Manual Sequence Mode**—Up to 15 measurements may be stepped through manually with the front panel ADVANCE pushbutton or by an external ground closure. Less than 15 measurements may be manually sequenced without including the undesired tests.
- **Automatic Sequence Mode**—In the automatic sequence mode, up to 15 measurements may be sequenced at a high rate. Measurement limits may be programmed and out-of-limit conditions can stop the measurement sequence if desired. Limit indicators on the front panel denote the status of each test and the condition that may have interrupted the automatic sequence. The ADVANCE pushbutton advances the 241 to the next measurement in the sequence; the RESET pushbutton returns the 241 to a ready condition. Both of these functions can be controlled externally by ground closures. Less than 15 measurements may be automatically sequenced without including the undesired tests.

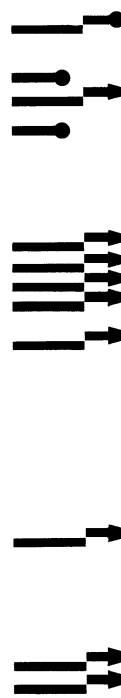

CONTROL

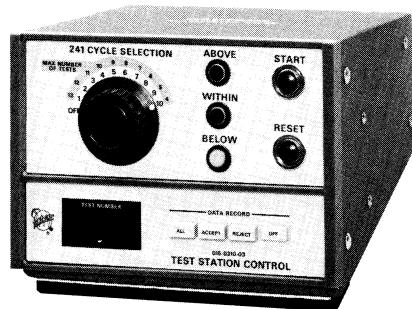

241 Program Resequencer

The 241 Program Resequencer extends the standard 241 Programmer capability of 15 measurements to 150, and consists of a rackmount Interface Unit and a desk-top Test Station Control Unit, which is placed near the system fixture drawer. The control unit contains the measurement start and reset switches, test result indicators, and a sequence selector switch. A 10 x 32 diode read-only memory (rom) located in the control unit provides 32 extra program output lines.

The 241 Programmer uses up to 15 program cards, which are activated by 15 external control lines. The outputs of the program cards are in parallel; if two program cards are energized simultaneously, the outputs are OR'ed together. Thus, one card can program the 568/230 measurement package while the parallel card can use the 14 spare control lines for fixture programming. The Resequencer will hold a fixture control card energized while enabling the 568/230 control cards in sequence. In many applications of integrated circuit testing, a small group of measurements is repeated over a variety of dut input/output configurations. The Resequencer permits this type of operation. For example, four 568/230 control cards could be used to make t_{pdo} , t_{pdl} , V_{oh} , and V_{ol} measurements on each of 10 programmed fixture configurations for a total of 40 measurements.

A slightly different mode of operation is possible using the 10 x 32 line rom. The Test Station Control Unit may be set so that the rom is sequenced separately. Using this mode, the rom may be used to program each of 10 fixture configurations, while the 241 Programmer is caused to sequence once through 5 measurement program cards for each fixture program, giving a total of 150 measurements.

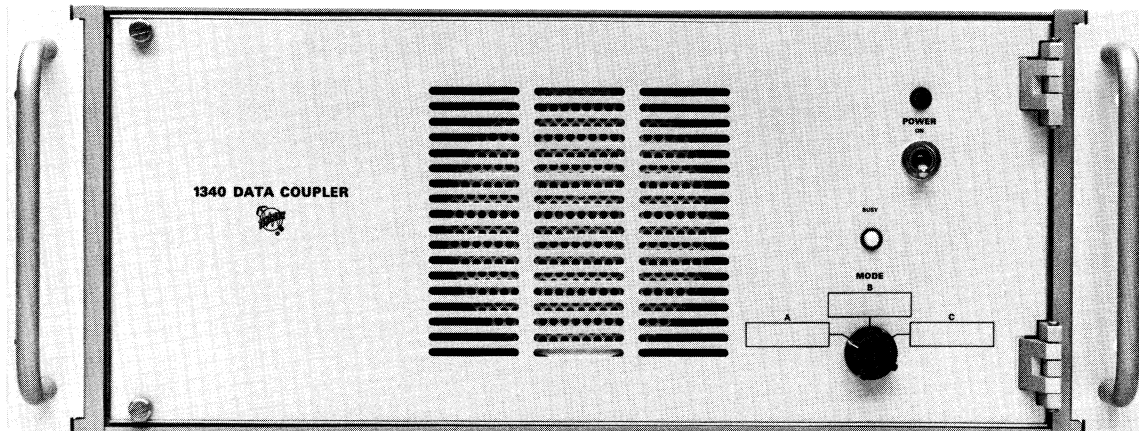

R1340

The R1340 Data Coupler is a multi-purpose unit that interfaces a variety of digital instruments in a TEKTRONIX Automated Test System, and consists of a rackmount cabinet containing a power supply, access for 12 plug-in circuit cards (interfaces), and wired connectors for 18 interconnecting cables. The plug-in interfaces are options that can be determined by the customer requirement and system configuration. There is a variety of interfaces for specific functions.

A common TTL bus within the 1340 makes all data and control information available to each card when it is interfaced to a controller, data logger, or other data source. Standard "handshaking" logic is provided for data transfer. Flexible input and output circuits allow several choices for logic levels to be hand-wire-selected before the interface boards are installed.

The 1340 can support various interfaces for many controllers (such as computers) to a system in two methods. The first of these methods permits bidirectional data exchange between a controller and the system. The second method is for use with a system controlled by a 240 Program Control Unit, where a 240 test address is selected by the controller.

For examples of some 1340 interfaces, see the following list.

- **Special Purpose**
 - Waveform Digitizer
 - Reference Signals for Auto-Calibration with AUTOCAL Software
 - Programmable Clock
- **Control and General Purpose**
 - PDP-8L Controller—32-Bit Output
 - Data Logging—16-Bit In/Out
 - IBM 1826 Controller—32-Bit Input
 - ASCII Data—32-Bit Out/Echo
 - PDP-11 Controller for second 1340
 - HP-2100 Controller
- **Specific Device Data Exchange**
 - 230/240 Program and Data
 - Paper Tape Reader/Punch
 - 3S6 Program
 - 3T6 Program
 - 1140A Program
 - 230 Program and Data
 - HP DMA Data Link
 - 1840 Program
 - WAVETEK® 157 Program
 - S-3260 Station Control Unit

Interfaces to other digital multimeters, counters, and signal generators are also available.

STIMULUS

R115

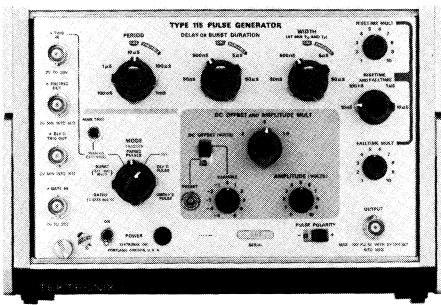

The R115 Pulse Generator features output connectors on the rear panel. The following functions may be set from the front panel: 10-ns to 100- μ s separate and variable rise times and fall times, 100-ns to 10-ms pulse periods, 50-ns to 500- μ s pulse delay or burst time, 50-ns to 500- μ s pulse width, +5-V to -5-V dc offset and up to \pm 10-V amplitude into 50 ohms.

2005A

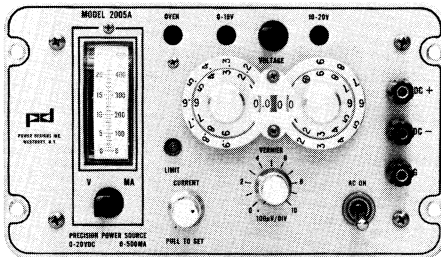

The 2005A Power Supply is manufactured by Power Designs, Inc., and is a precision supply mounted in a rack adapter that also permits adding a second supply at a later date. The supply features a digitally selected operating range from 0 to 20 V, 0 to 500 mA; accuracy is within 0.1-pct \pm 1 mV; load and line regulation is better than 0.0005-pct or 100 μ V; noise and ripple are less than 100 μ V p-p, and stability is less than 100 μ V drift per 8 hours.

R116

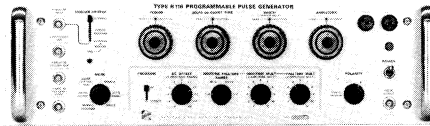

The R116 Programmable Pulse Generator is a broad-range unit intended primarily for applications where various combinations of pulse amplitude, width, polarity, and other features are required in rapid sequence. All functions and parameters are easily programmable. The 116 may also be operated manually from calibrated front-panel controls for initial test setup and for applications not requiring external programming.

Accuracy of the remote programming is the same as the corresponding front panel control plus 2-pct. For example, the period that has a basic accuracy of \pm 3-pct from the front panel would have a maximum error of \pm 5-pct when it is remotely programmed. Accuracy of remote programming may be improved by calibrating the instrument for remote programming rather than for front-panel operations.

Operating modes are:

- **Single**—Undelayed pulses.
- **Delayed Single**—Pulses occurring at the end of the delay time.
- **Double**—Pairs of pulses (one occurring at the time of the normal undelayed pulse, one occurring at the end of the delay time, 100-ns minimum pulse separation).
- **Burst**—Output pulses obtained for the duration of the burst time when initiated by external triggering pulse (pulses occur at internal repetition rate).
- **Gated Output**—Output pulses obtained for the duration of the input gate (pulses are synchronous with the input gate and occur at the repetition rate set by the period control).
- **Remote Program**—Permits remote programming of the operating mode.

R293

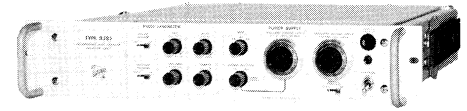

The R293 Programmable Pulse Generator and Power Supply is a combination unit that is used in testing switching time and charge storage parameters of semiconductor devices, testing switching and propagation times of micrologic circuits, or in any other applications requiring fast-rise and fast-fall pulses.

Features

- **Pulse Amplitude**—6 to 12 V.
- **Pulse Width**—2 to 250 ns (into 50 Ω).
- **Repetition Rate**—From below 10 kHz to approximately 100 kHz.
- **Risetime**— \leq 1 ns (into 50 Ω).

R1140A

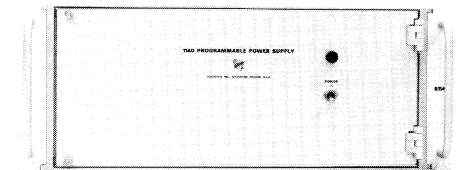

The R1140A Programmable Power Supply provides one current and four voltage outputs for use in high-speed automated test systems. Each supply is independently programmable with separate strobes and data latches. The current supply has programmable voltage limits to protect test devices if the load changes. All voltage supplies feature manual switch-selected or programmable current limits. No over-voltage spikes appear during program transitions, even when changing polarity. Four-wire (Kelvin) voltage supply leads ensure accurate voltage at load. All outputs are inhibited during power turn-on, ensuring correct output after stabilization, with no overshoot during turn-on.

FIXTURING

The focal point of a testing and measuring system is the device interface, or fixturing—for, no matter how well the control and stimulus products perform, unless the capabilities of these products are directed appropriately to the device under test (dut), the results will be disappointing. Tektronix has developed “fixturing,” just as all areas of system products have been developed, to perform to the highest standards. Numerous test fixtures are available, from a fixture drawer (containing in/out facilities, sampling heads, test fixture mounting, and extra provisions for items such as probe choppers) to separate programmable test stations (containing sampling heads, multiplexers, 50-ohm switching matrix, and a dc subsystem). The following pages include examples of test fixtures that are already in use by system customers. However, your local Tektronix Systems Applications Engineer would be pleased to discuss with you any new format to solve your particular testing problem. The fixtures described are arranged in order of complexity, the least complex first.

Input/Output Panel

The Input/Output Panel is supplied when specialized fixturing is not part of a system. This panel provides mounting for the S-3A Sampling Heads, a trigger input connector, power supply output connectors, pulse generator output, and a program connector that has 14 spare lines for programming peripheral equipment or fixturing.

1841 Fixture Drawer

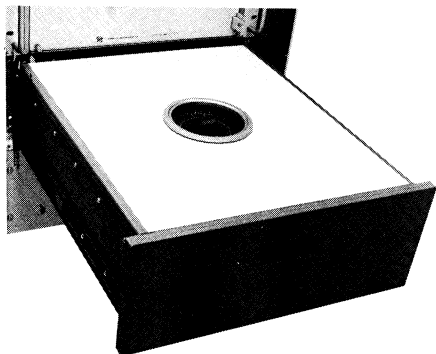

The 1841 is a rackmounted test station that has access to the internal buffer lines for fixture reed switches and facilities for the following described test fixtures. Provisions for both sampling heads and probe choppers are included, as are two pulse generator and four power supply connectors. A system control foot switch (start/reset) is also included with the fixture drawer. Devices that may be tested include basic logic DTL, TTL, RTL, CMOS, and Scottky TTL circuits. Optional cards and fixtures are as follows:

- **Unwired Fixture Card**—Allows optional socket and circuits to be installed by the user for testing non-standard devices. Two coaxial connectors for pulse generator inputs and two oscilloscope probe connectors are provided.
- **Buffer Circuit Fixture**—Check-out card; uses indicators to visually verify buffer line energizing.
- **DTL Test Fixture Card**—Accepts DTL device oriented adapter cards for testing 14-pin devices and provides switchable loads and high impedance input/output paths. Two probe inputs, two generator inputs, and two voltage inputs are provided, as is the capability to disable the V_{CC} supply between tests. The test fixture is installed in the drawer and contains all necessary reed switches; adapter cards for devices may be exchanged without disturbing coaxial cables or power supply leads.
- **TTL Text Fixture Card**—Accepts TTL device oriented adapter cards for testing 16-pin devices and provides for 50-ohm input and high impedance output loads. Rise times are on the order of 1 ns. Two probe inputs, two generator inputs, and two voltage inputs are provided, as is the capability to disable the V_{CC} supply between tests. The test fixture is installed in the drawer and contains all necessary reed switches; adapter cards for devices may be exchanged without disturbing coaxial cables or power supply leads.

- **Diode Test Fixture Card**—Accepts diode adapter cards and contains the necessary coaxial input/output connectors to ensure a 50-ohm environment for the dut. Diode parameters that can be measured easily are forward turn-on current, reverse-recovery current, reverse-recovery time, and stored charge.
- **Transistor Test Fixture Card**—This card is similar to the diode test fixture card, but includes the necessary coaxial input/output connectors and transistor sockets for accommodating three-lead devices. Measurements that can be made are delay time, storage time, turn-off time, rise time, fall time, and saturation voltage.
- **System Performance Checkout Fixture Card**—Used to verify system performance, this fixture allows checkout of such system components as digital voltmeters, power supplies, signal generators, etc. In checking those components, the 568/230 measurement package is used; therefore, the 568 and 230 are also checked.

1831 Test Station



The 1831 is a 42-inch wide table with the same fixture unit as in the 1841 Fixture Drawer. Provisions for two sampling heads and probe choppers are included. Pulse generator and power supply input connectors are also included, as are 32 programmable fixture lines for use with either the fixture cards or special fixturing.

FIXTURING

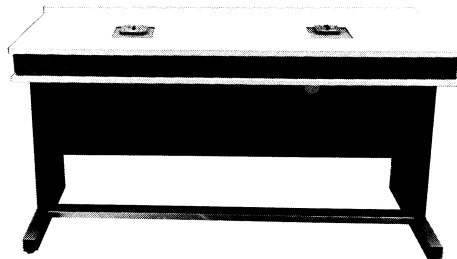

1832 Dual Test Station

The 1832 has provisions for two test fixtures mounted in a 60-inch table. All features of the 1831 Test Station apply. The 286 Sampling Head Multiplexer may be installed. Fixture buffer lines are supplied through the 1330 Test Station Master Control Unit from the 250 Auxiliary Program Unit.

Test Station Control Unit

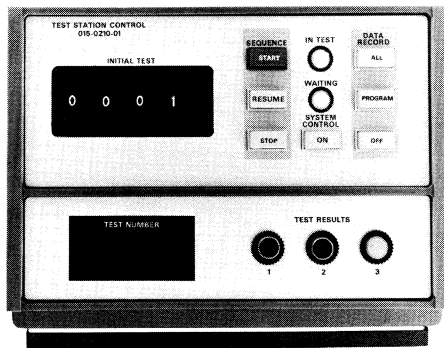

The standard Test Station Control Unit can be used with any test station, and provides system stop/start control, address of the test sequence, system status indicators, and test result indicators. This unit is small and portable, is equipped with a magnetic base, and may be located anywhere on the test station.

1840 Programmable Test Fixture

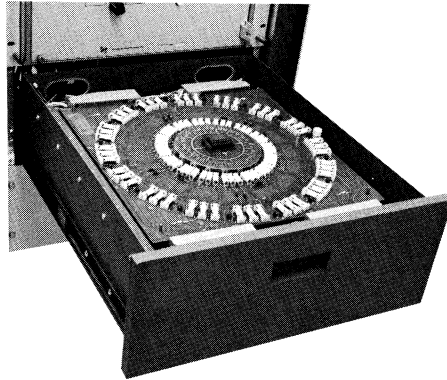

The 1840 is either rackmounted or mounted in a drawer. A Type A Load Board, furnished with the fixture, allows automatic testing of devices with up to 16 active pins. An optional Type B Load Board allows automatic testing of devices with up to 32 active pins. Inexpensive plug-on socket cards for each load board permit unique circuit configurations for each device tested. Devices with 16 pins or fewer usually require socket card change only when unique load circuits are used.

The Type A Load Board has 16 sectors, with each sector connectable as either an input or an output. Inputs may be connected to one of three possible power supplies or one of two possible pulse generators. Outputs may be connected to one of three pluggable loads and/or one of two sampling oscilloscope probes.

The Type B Load Board allows the sectors to be split, providing 16 inputs and 16 outputs. Inputs are connected to one of three power supplies, one of two pulse generators, or one of two sampling oscilloscope probes. Outputs may be connected to one of three loads, one of two pulse generators, or one of two sampling oscilloscope probes.

Features

Input Risetime—3 ns.

Output Risetime—3 ns.

Output Capacitance of Each Pin—Without load programmed, 20 pF for Type A Load Board and 25 pF for Type B Load Board; with one load area programmed, 25 pF for Type A Load Board and 30 pF for Type B Load Board.

Control options include using the 1840 with one of several automated test systems as listed below:

Option 1—In a 3100-Series system using two 241 Programmers and the 241 Program Resequencer. One 241 is used to program the measurement package and provides 10 enable lines to the 1840. The second 241 uses all 159 lines to program the 1840.

Option 2—In an S-3120 or S-3130 system with a 250 Auxiliary Program Unit. The 250 is used to program the 1840 for greater fixturing flexibility than Option 1.

Option 3—In a digitally controlled system using the 1340 Data Coupler. This option offers the highest degree of fixturing flexibility currently available with the 1840.

1801 and 1802 Programmable Test Station



Identical testing capability is available in two test stations: the 1801 for manual testing, the 1802 for ambient or environmental automatic handlers and manual

testing. The 1801 programmable test station is a console containing a programmable test fixture designed to test integrated circuits with up to 40 leads. The 1802 programmable test station is electrically the same as the 1801, but the test fixture is remotely located for use with environmental or other special purpose equipment. All test station operations are controlled by the measurement system during the test sequence. Each lead of the integrated circuit under test can be independently connected to power supplies, signal sources, load networks, and measurement probes.

A family of several easily interchangeable plug-on test socket cards facilitates socket replacement. Two load-board types are standard with each test station. The Type A Load Board accepts 8-, 10-, 12-, 14-, and 16-pin devices; the Type B Load Board accepts 24-, 36-, and 40-pin devices. The load board has facilities for mounting three programmable loads. Load modules may be interchanged when switching from one device family to another, or when unusual load networks are required.

Each programmable test station includes: 1 R287 Multiplex Control Unit; 4 286 Sampling Head Multiplex Units; 16 S-3A Sampling Heads; 1 50-Ohm Switching Matrix (2 to 16 lines); a dc subsystem; 8 control logic boards; 2 load boards (A and B); 20 socket cards; and a probe board, including choppers and required cables.

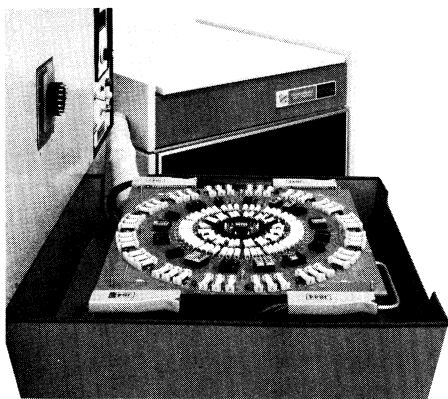

Features

- **Input Risetime**— ≤ 1 ns
- **Output Risetime**— ≤ 1 ns
- **Output Capacitance of Each Pin**—Without load programmed, 20 pF for Type A Load Board and 25 pF for Type B Load Board; with one load area programmed, 25 pF for Type A Load Board and 30 pF for Type B Load Board.

1842 Test Fixture

The 1842 is a high-speed test fixture mounted in a drawer. This fixture has 18 input and 18 output channels and may be used to test integrated circuits requiring sub-nanosecond risetimes and resolution, and to test circuit boards that require a very high degree of isolation. A Type C Load Board is used with the 1842.

Two 50-ohm lines from sampling heads (or other measurement instruments) may be connected to any 2 of the 16 sectors using the test fixture output channels and a 16-to-2 line switching matrix. The risetime of these signal paths is approximately 800 ps. Also, 16 sampling heads may be used, one connected to each sector, providing a risetime of approximately 250 ps.

In addition, two auxiliary sectors (17 and 18) are provided, each with an input and an output channel. These two channels are connectable on the socket card (by strapping) to any two dut pins. Since these paths are not connected through a switching matrix, the risetime is approximately 250 ps.

Programming options permit the use of the 1842 with any one of several automated test systems:

Option 1—In a system that has two 241 Programmers and a 241 Program Resequencer.

Option 2—In a system with a 250 Auxiliary Program Unit. This option offers more flexibility than Option 1 because of the greater number of program lines available.

R1330

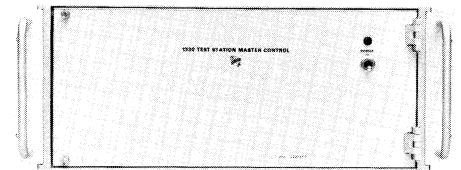

The R1330 Test Station Master Control Unit provides for interface between automated test systems and such equipment as test stations and control units. These interfaces may be customer-selected functions suitable for either a single or a multiple test station system. Optional interface functions include digital voltmeter, counter, printer, and power supply control, plus data logging. Further interfaces can be developed according to system and test station requirements. This provides a versatile unit for selecting functions to suit individual customer requirements.

A basic 1330 configuration consists of a 1330 wired to accommodate all standard interface boards, and includes a station master control interface, a junction panel wired for a single test station, and all necessary cables to interface this test station to the measurement system. This basic configuration can easily be expanded to serve up to four test stations.

286/R287/R288

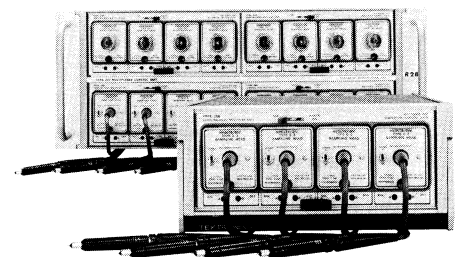

The Sampling Head Multiplexer allows the signals from as many as 64 test points to be measured by a two-input sampling unit. The measurements are made from a sampling head coupled to each test point. The signals sensed by

FIXTURING

these sampling heads are then electronically switched (multiplexed) into the sampling unit, two signals at a time. Up to 64 sampling heads may be multiplexed with no degradation in rise-time or noise specifications.

Three programmers may be used to program sampling head multiplexers: the 241 Programmer, the 240 Program Control Unit, or the 250 Auxiliary Program Unit. The programmer provides head selection commands to control the operation of the 286, 287, and 288.

286 Sampling Head Multiplex Unit

The 286 Sampling Head Multiplex Unit is the basic unit of a sampling head multiplexer system, and can operate four sampling heads. When operated singly, a 286 receives head selection commands directly from the program control unit.

R287 Multiplex Control Unit

The R287 controls up to four 286's, thus allowing the multiplexing of up to 16 sampling heads. The 286's are installed in compartments in the 287. If only one 287 is being operated, it receives head selection commands directly from the external programmer and signal data directly from the sampling unit. A 287 may be controlled by a 288.

R288 Multiplex Master Controller Unit

The R288 controls up to 4 287's, thus allowing the multiplexing of up to 64 sampling heads. To conserve space, the circuits of one 287 are built into each 288. The 288 controls the 287 circuits within its own physical unit and up to three other 287's. The 288 receives head selection commands from the external programmer, and signal data from the sampling unit.

Probe Chopper Probe Chopper/Signal Switcher

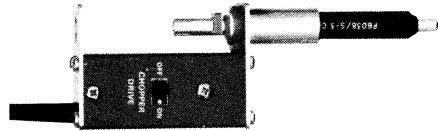

The Probe Chopper connects a sampling oscilloscope input, through a reed relay, to a ground potential under program control. The Probe Chopper/Signal Switcher has two applications: to provide a 50-ohm input sampling oscilloscope with a clean reference ground, and to switch between two 50-ohm lines in any 50-ohm system.

Two versions of the Probe Chopper are provided: one for 100- kilohms S-3A direct sampling probes and one for the 10-megohms (FET input) probe that drives a 50-ohm oscilloscope.

All Probe Choppers have a common connector on the end of a 10-foot cable. The connector mates to systems that use a 230 Digital Unit or a 1340 Data Coupler. All chopper types are compatible with either unit. The choice of a chopper is a function of the input circuit used by the sampling oscilloscope vertical channel. Each model contains a local ON-OFF switch. When used with a manually operated 230 Digital Unit, this permits the operator to choose whether or not the system chopper drive operates.

In a less complex system, the 230 Digital Unit controls the time of chopper reed closure. In a computer-controlled system, synchronization of the chopper reed closure is under program control so that data are taken at the desired time for data input.

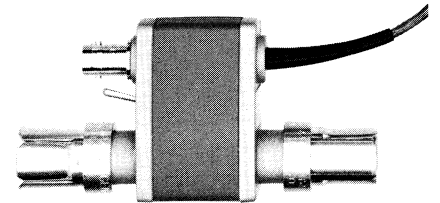

Probe chopper quads are available for operating with multiplexed systems that use the 286, 287, or 288 multiplexer units. One quad is needed for each 286. Chopper drive signals are multiplexed by the 287 or 288 when more than one quad chopper is used.

50-Ohm Switching Matrix

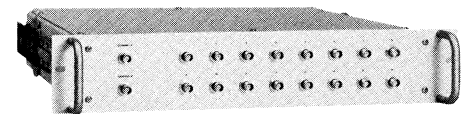

Primarily intended for accessing pins of a given device under test, the 50-Ohm Switching Matrix offers high quality signal paths for automated test systems and operates as either a 16-to-2 or a 2-to-16 line switcher. All that is needed to operate the switcher is a dc power supply and eight line binary programming plus two enable lines, one line for each of the two input-output paths.

OPTIONS

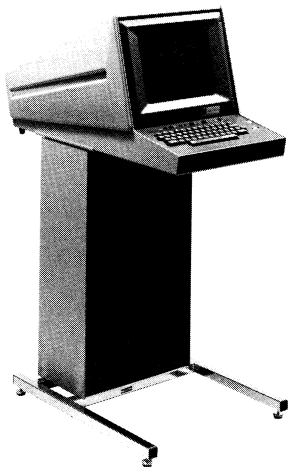

4010

The 4010 Display Terminal is a graphic input/output device of extensive capacity and flexibility. The storage display tube holds up to 35 lines of alphanumeric data at one time (74 characters per line, a maximum of 2590 characters). A conventional stand-alone pedestal design at comfortable desk height or a separate keyboard and display on the desk top can be selected, as can a rackmount unit.

Data input at the 4010 console is through a TTY-style keyboard, featuring 63 printing characters (including upper case English alphabet and numerals), and standard ASCII control characters. Conveniently located rocker switches immediately above the keyboard select local or on-line operation and (on the 4010-1) command hard copies from the optional 4610 Hard Copy Unit. Independently operated thumb-wheel controls position the graphic-input mode.

Three major operating modes can be selected from the keyboard or the controller. In alphanumeric mode (ALPHA), 35 lines of up to 74 characters each constitutes a full display screen. Since most displayed lines of alphanumeric data tend to be short, a margin 1 position after the 35th display line moves the left-hand margin to screen center. A second column of data may be displayed on the right of the screen. A pulsating rectangular cursor identi-

fies the next character print position. Two graphic operating modes are offered in graphic display (GRAF) mode, the terminal produces clear, accurate vector displays in response to controller commands. In graphic input (GIN) mode, complete operator/controller interactivity is permitted. A cross-hair cursor is displayed on the screen in GIN mode, and the screen coordinates of the cross-hair position are sent to the controller whenever a character key is pressed.

Features

Display Medium—Direct view storage crt.

Display Area—7.5 inches wide by 5.6 inches high.

Alphanumeric Mode

Format—74 characters per line, 35 lines, 2590 characters full screen.

Character Set—63 printing characters (TTY ASCII Code).

Graphic Display Mode

Vectors Only—Drawing time of 2.6 ms.

Addressable Points—1024 X, 1024 Y points.

Viewable Points—1024 X, 780 Y points.

Graphic Input Mode

Thumb-wheel controlled cross-hair cursor, 3 through 1020 X, 0 through 780 Y.

Minibus Extender

—Up to five peripherals can be added to the 4010 or 4010-1 with a minibus extender.

4610

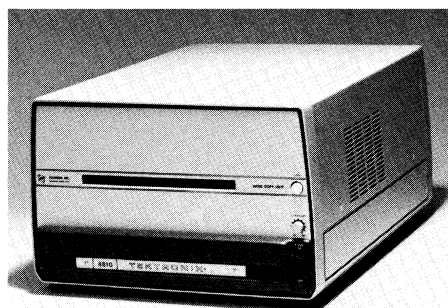

The 4610 Hard Copy Unit quickly and simply makes permanent copies of information displayed on the screen of

the 4010 Display Terminal. Using dry silver paper, the 4610 makes high-quality permanent black and white copies in only a few seconds. The copies are dry and easy to write on with pen or pencil. Operation is initiated in any of three ways: a switch on the 4610, a switch on the terminal, or a command through the terminal from the controller.

Features

Copy Size—8.5 by 11 in.

Copy Time—18 s.

Resolution—Essentially same as terminal display.

RAB6375RA1

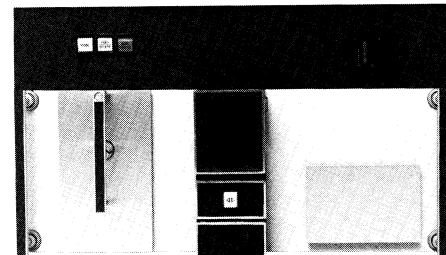

The RAB6375 Reader/Punch greatly expands the program capability of a system with limited memory capacity. With the RAB6375, programs that would otherwise consume valuable memory space are stored in permanent off-line form, ready at any time to be read into active storage. Reading speed is 200 characters per second. Also, unprocessed data may be recorded in punched tape form and read into active storage at appropriate times. The RAB6375 provides that programs and data normally filed in a time-shared or in-house computer system can be converted to 8-channel punched tape and used for file maintenance through the 4010 Display Terminal. An additional function is that record tapes of programs normally stored in a disc memory may be made as a safeguard.

The RAB6375 uses standard, easily obtained 1-inch paper or paper mylar tapes in a thickness range of 0.003 to 0.004 inch.

BUSINESS INFORMATION

Tektronix, Inc.

Tektronix began with a handful of employees working in one small garage like building. The original lone item they were producing was an oscilloscope, a model which was even then the best of its kind. Sales for the first profitable year, 1948, totaled a humble \$257,000.

Today Tektronix has over 11,500 employees designing and manufacturing more than 200 products including lines of oscilloscopes, information display products, automated measuring systems, television products, calculators, and spectrum analyzers.

The home office located in Beaverton, Oregon has surpassed its original one small building many times over, until today it is a 300-acre industrial park with over 2 million square feet dedicated to design and manufacturing. Field offices and service centers are in key locations all over the world.

Systems Applications Engineers

Systems Applications Engineers will help you select the product best suited for your present and future needs. Ask him about any systems or products described in this booklet, or for other products described in our general catalog. You will find a listing of these Field Offices with resident Systems Applications Engineers on the fold-out portion of the back cover.

Product Support

It is our intent to consistently provide unexcelled product service and support at competitive prices.

Your Applications Engineer is fully prepared to respond to your technical and business requirements. He has a strong technical background and extensive product and business training. Constant communication with Beaverton-based technical and software support personnel enables him to remain current on new products and services. Call upon him for assistance any time you have questions about Tektronix, Inc. and its products.

Ordering

An Applications Engineer will provide you with information on prices, terms of sale, shipping estimates and best method of transportation for all systems accessories, and replacement parts.

If you require service, replacement parts, a warranty question resolved, or other help, please notify the Tektronix facility through which you ordered your system.

For Customers Outside The United States

To provide you with personal assistance in ordering as well as servicing products, we have established Field Offices and technically qualified Tektronix distributors in many countries throughout the world. The Tektronix office or distributor in your country will be pleased to help you select the system that best suits your requirements in performance, and provide you with prompt ordering service. For the office or distributor nearest you see the International listing on the fold-out portion of the back cover.



The Choice is Yours...

The 3100-Series of Automated Test Equipment Systems has been designed to solve a wide range of your test and measurement problems. Each system may be tailored to your exact needs. Before selecting a TEKTRONIX system, you should determine your exact testing requirements. With your needs determined, call a Systems Applications Engineer to assist you in configuring a system to meet your unique test and measurement requirements.

Your Systems AE is an expert in solving test and measurement problems. From the products shown here he can assemble the system that is best for you and secure a price quotation. The address and phone number of the Systems Application Engineer nearest you is located on the back of this fold out.

Fixturing

A capabilities description and specifications for each unit shown here begins on page 27.

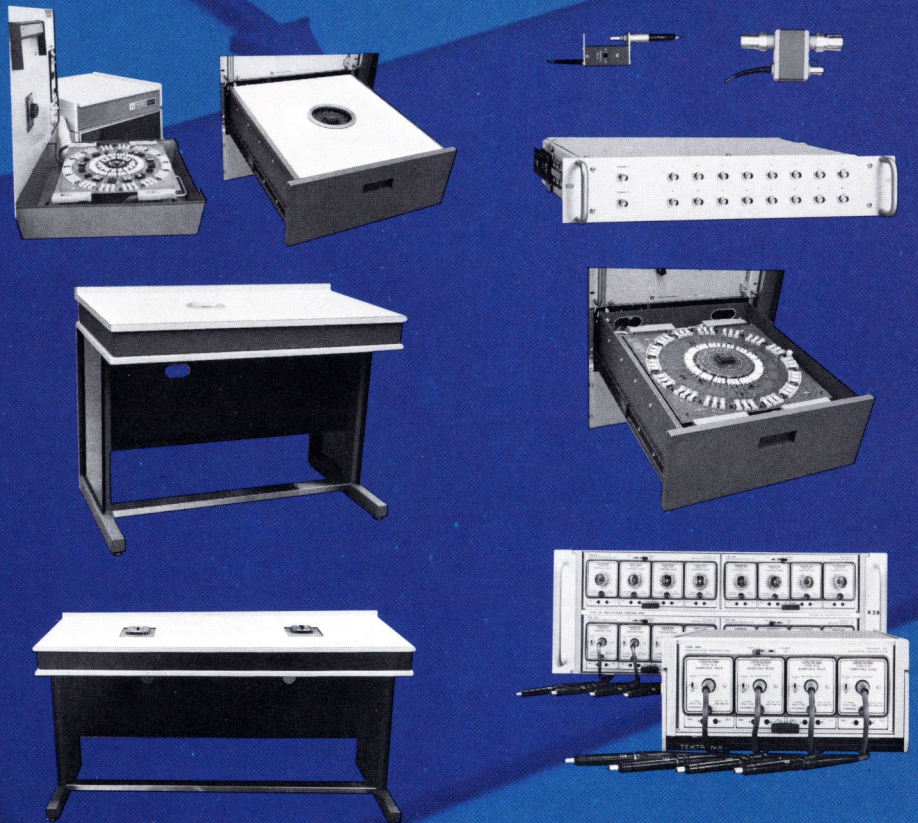

Stimulus

A capabilities description and specifications for each unit shown here begins on page 26.

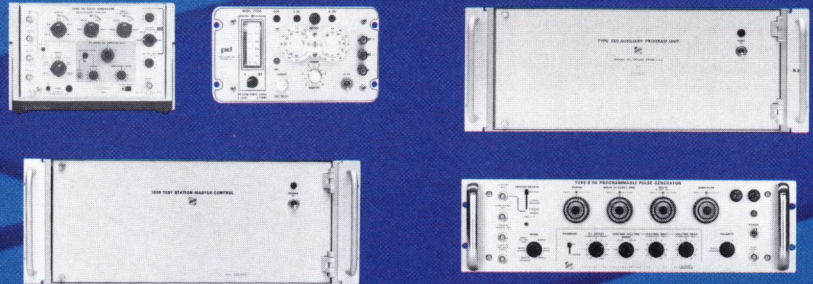

Measurement

A capabilities description and specifications for each unit shown here begins on page 16.

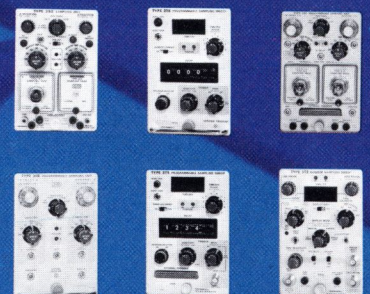
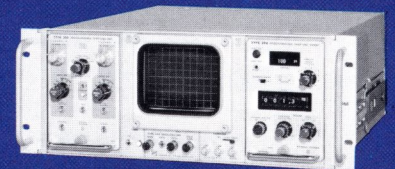
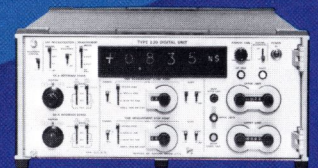
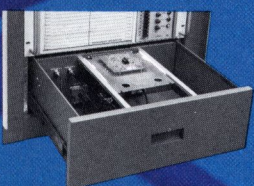
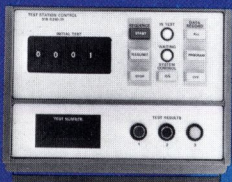

Control

A capabilities description and specifications for each unit shown here begins on page 21.

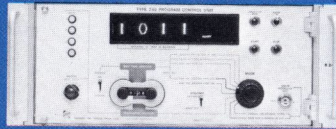
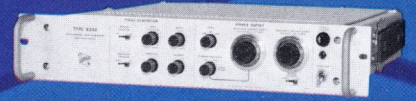
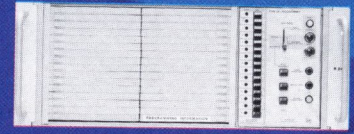
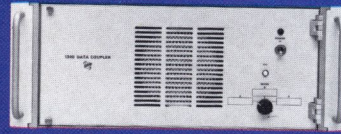



TEKTRONIX®
committed to
technical excellence

