

User Manual



TDS 520 & 540 Digitizing Oscilloscopes 070-8317-01

This document supports Version 2 firmware.

**Please check for change information at the rear
of this manual.**

First Printing: March 1992
Last Revised: November 1992

Copyright © Tektronix, Inc. 1991, 1992. All rights reserved.

Tektronix products are covered by U.S. and foreign patents, issued and pending. Information in this publication supercedes that in all previously published material. Specifications and price change privileges reserved.

Printed in the U.S.A.

Tektronix, Inc., P.O. Box 1000, Wilsonville, OR 97070-1000

TEKTRONIX and TEK are registered trademarks of Tektronix, Inc.

Microsoft is a registered trademark of Microsoft Corporation

IBM is a registered trademark of International Business Machines

GPIB-PCII and GPIB-PCIIA are registered trademarks of National Instruments Corporation

Epson is a registered trademark of Epson America, Inc.

Interleaf is a trademark of Interleaf, Inc.

PostScript is a registered trademark of Adobe Systems Incorporated

WARRANTY

Tektronix warrants that the products that it manufactures and sells will be free from defects in materials and workmanship for a period of three (3) years from the date of shipment. If a product proves defective during this warranty period, Tektronix, at its option, either will repair the defective product without charge for parts and labor, or will provide a replacement in exchange for the defective product.

In order to obtain service under this warranty, Customer must notify Tektronix of the defect before the expiration of the warranty period and make suitable arrangements for the performance of service. Customer shall be responsible for packaging and shipping the defective product to the service center designated by Tektronix, with shipping charges prepaid. Tektronix shall pay for the return of the product to Customer if the shipment is to a location within the country in which the Tektronix service center is located. Customer shall be responsible for paying all shipping charges, duties, taxes, and any other charges for products returned to any other locations.

This warranty shall not apply to any defect, failure or damage caused by improper use or improper or inadequate maintenance and care. Tektronix shall not be obligated to furnish service under this warranty a) to repair damage resulting from attempts by personnel other than Tektronix representatives to install, repair or service the product; b) to repair damage resulting from improper use or connection to incompatible equipment; c) to repair any damage or malfunction caused by the use of non-Tektronix supplies; or d) to service a product that has been modified or integrated with other products when the effect of such modification or integration increases the time or difficulty of servicing the product.

THIS WARRANTY IS GIVEN BY TEKTRONIX IN LIEU OF ANY OTHER WARRANTIES, EXPRESS OR IMPLIED. TEKTRONIX AND ITS VENDORS DISCLAIM ANY IMPLIED WARRANTIES OF MERCHANTABILITY OR FITNESS FOR A PARTICULAR PURPOSE. TEKTRONIX' RESPONSIBILITY TO REPAIR OR REPLACE DEFECTIVE PRODUCTS IS THE SOLE AND EXCLUSIVE REMEDY PROVIDED TO THE CUSTOMER FOR BREACH OF THIS WARRANTY. TEKTRONIX AND ITS VENDORS WILL NOT BE LIABLE FOR ANY INDIRECT, SPECIAL, INCIDENTAL, OR CONSEQUENTIAL DAMAGES IRRESPECTIVE OF WHETHER TEKTRONIX OR THE VENDOR HAS ADVANCE NOTICE OF THE POSSIBILITY OF SUCH DAMAGES.

This apparatus has been designed and tested in accordance with IEC Publication 348, Safety Requirements for Electronic Measuring Apparatus, and has been supplied in a safe condition. This manual contains some information and warnings which have to be followed by the user to ensure safe operation and to retain the apparatus in safe condition.

The apparatus has been designed for indoor use. It may occasionally be subjected to temperatures between $+5^{\circ}\text{C}$ and -10°C without degradation of its safety.



This is the User Manual for the TDS 520 and TDS 540 Digitizing Oscilloscopes.

If you are a new user, try the *Tutorial* section to become familiar with the operation of your digitizing oscilloscope.

The *Concepts* section covers basic principles of the operation of the oscilloscope. These articles help you understand why your instrument works the way it does.

Use the *In Detail* section to learn how to perform specific tasks. See page 3-1 for a complete list of tasks covered in that section.

The *Appendices* provide an option and accessories listing, product specification, and other useful information.

Related Manuals

The following documents are related to the use or service of the digitizing oscilloscope.

- The *TDS Family Programmer Manual* (Tektronix part number 070-8318-03) describes using a computer to control the digitizing oscilloscope through the GPIB interface.
- The *TDS 520 & 540 Reference* (Tektronix part number 070-8316-01) gives you a quick overview of how to operate your digitizing oscilloscope.
- The *TDS Family Option 2F Instruction Manual* (Tektronix part number 070-8582-00) describes use of the Advanced DSP Math option (for TDS oscilloscopes equipped with that option only).
- The *TDS Family Option 13 Instruction Manual* (Tektronix part number 070-8567-00) describes using the optional Centronics® and RS-232 interfaces for obtaining hardcopy (for TDS oscilloscopes equipped with that option only).
- The *TDS 520 & TDS 540 Performance Verification* (Tektronix part number 070-8603-00) tells how to verify the performance of the digitizing oscilloscope.
- The *TDS 520 Service Manual* (Tektronix part number 070-8312-01) and the *TDS 540 Service Manual* (070-8314-01) provide information for maintaining and servicing your digitizing oscilloscope to the module level.

Conventions

In the *Tutorial* and *In Detail* sections, you will find various procedures which contain steps of instructions for you to perform. To keep those instructions clear and consistent, this manual uses the following conventions:

- Names of front panel controls and menu labels appear in boldface print.
- Names also appear in the same case (initial capitals, all uppercase, etc.) in the manual as is used on the oscilloscope front panel and menus. Front panel names are all upper case letters, for example, **VERTICAL MENU**, **CH 1**, etc.
- Instruction steps are numbered. The number is omitted if there is only one step.
- When steps require that you make a sequence of selections using front panel controls and menu buttons, an arrow (→) marks each transition between a front panel button and a menu, or between menus. Also, whether a name is a main menu or side menu item is clearly indicated: Press **VERTICAL MENU** → **Coupling** (main) → **DC** (side) → **Bandwidth** (main) → **100 MHz** (side).

Using the convention just described results in instructions that are graphically intuitive and simplifies procedures. For example, the instruction just given replaces these five steps:

1. Press the front panel button **VERTICAL MENU**.
 2. Press the main menu button **Coupling**.
 3. Press the side-menu button **DC**.
 4. Press the main menu button **Bandwidth**
 5. Press the side menu button **100 MHz**
- Sometimes you may have to make a selection from a popup menu: Press **TRIGGER MENU** → **Type** (main) → **Edge** (popup). In this example, you repeatedly press the main menu button **Type** until **Edge** is highlighted in the pop-up menu.



Contents

Product Description	v
Safety	vi
Start Up	viii

Tutorial

Overview	1-1
Example 1: Displaying a Waveform	1-2
Example 2: Multiple Waveforms	1-8
Example 3: Automated Measurements	1-12
Example 4: Saving Setups	1-18

Concepts

Overview	2-1
Triggering	2-2
Acquisition	2-7
Scaling and Positioning Waveforms	2-13
Measurements	2-17

In Detail

Overview	3-1
At a Glance	3-2
Acquisition Modes	3-11
Autoset	3-18
Cursor Measurements	3-20
Delayed Triggering	3-25
Display Modes	3-31
Edge Triggering	3-36
Hardcopy	3-40

Help	3-48
Horizontal Control	3-49
Limit Testing	3-53
Logic Triggering	3-58
Measurement System	3-66
Probe Accessories	3-77
Probe Cal	3-84
Probe Compensation	3-90
Probe Selection	3-92
Pulse Triggering	3-99
Remote Communication	3-106
Saving and Recalling Setups	3-110
Saving and Recalling Waveforms	3-112
Selecting Channels	3-115
Signal Path Compensation	3-117
Status	3-119
Triggering	3-120
Vertical Control	3-124
Waveform Math	3-127
Zoom	3-130

Appendices

Appendix A: Options and Accessories	A-1
Appendix B: Specification	A-9
Appendix C: Algorithms	A-25
Appendix D: Packaging for Shipment	A-39
Appendix E: Factory Initialization Settings	A-41

Glossary & Index

Change Information

Product Description

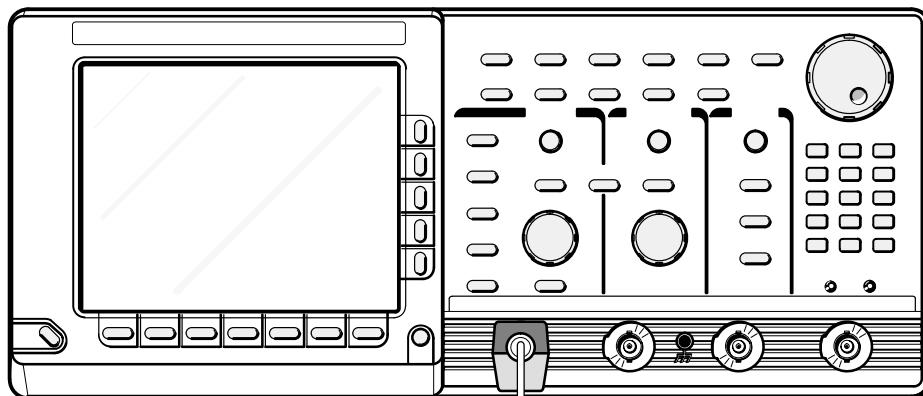

Your Tektronix digitizing oscilloscope is a superb tool for acquiring, displaying, and measuring waveforms. Its performance addresses the needs of both benchtop lab and portable applications with the following features:

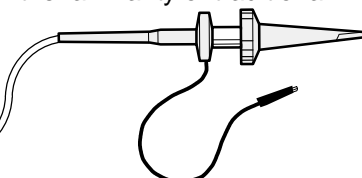

- 500 MHz maximum analog bandwidth.
- 1 Gigasample/second maximum digitizing rate (TDS 540); 500 Megasamples/second maximum digitizing rate (TDS 520).
- Four-channel acquisition—the TDS 540 offers four full-featured channels; the TDS 520 offers two full-featured channels and two channels with limited vertical scale selections: 100 mV, 1 V, and 10 V.
- Waveform Math—Invert a single waveform and add, subtract, and multiply two waveforms. On instruments equipped with option 2F, integrate or differentiate a single waveform or perform an FFT (fast fourier transform) on a waveform to display its magnitude or phase versus its frequency.
- Eight-bit digitizers.
- Up to 15,000-point record length per channel (50,000-point optional).
- Full GPIB software programmability. GPIB hardcopy output. On instruments equipped with option 13, hardcopy output using the RS-232 or Centronics ports.
- Complete measurement and documentation capability.
- Intuitive graphic icon operation blended with the familiarity of traditional horizontal and vertical knobs.
- On-line help at the touch of a button.



Please take a moment to review these safety precautions. They are provided for your protection and to prevent damage to the digitizing oscilloscope. This safety information applies to all operators and service personnel.

Symbols and Terms

These two terms appear in manuals:

-  statements identify conditions or practices that could result in damage to the equipment or other property.
-  statements identify conditions or practices that could result in personal injury or loss of life.

These two terms appear on equipment:

- *CAUTION* indicates a personal injury hazard not immediately accessible as one reads the marking or a hazard to property including the equipment itself.
- *DANGER* indicates a personal injury hazard immediately accessible as one reads the marking.

This symbol appears in manuals:



Static-Sensitive Devices

These symbols appear on equipment:



DANGER
High Voltage



Protective
ground (earth)
terminal



ATTENTION
Refer to
manual

Specific Precautions

Observe all of these precautions to ensure your personal safety and to prevent damage to either the digitizing oscilloscope or equipment connected to it.

Power Source

The digitizing oscilloscope is intended to operate from a power source that will not apply more than 250 V_{rms} between the supply conductors or between either supply conductor and ground. A protective ground connection, through the grounding conductor in the power cord, is essential for safe system operation.

Grounding the Digitizing Oscilloscope

The digitizing oscilloscope is grounded through the power cord. To avoid electric shock, plug the power cord into a properly wired receptacle where earth ground has been verified by a qualified service person. Do this before making connections to the input or output terminals of the digitizing oscilloscope.

Without the protective ground connection, all parts of the digitizing oscilloscope are potential shock hazards. This includes knobs and controls that may appear to be insulators.

Use the Proper Power Cord

Use only the power cord and connector specified for your product. Use only a power cord that is in good condition.

Use the Proper Fuse

To avoid fire hazard, use only the fuse specified in the parts list for your product, matched by type, voltage rating, and current rating.

Do Not Remove Covers or Panels

To avoid personal injury, do not operate the digitizing oscilloscope without the panels or covers.

Electric Overload

Never apply a voltage to a connector on the digitizing oscilloscope that is outside the voltage range specified for that connector.

Do Not Operate in Explosive Atmospheres

The digitizing oscilloscope provides no explosion protection from static discharges or arcing components. Do not operate the digitizing oscilloscope in an atmosphere of explosive gases.



Start Up

Before you use the digitizing oscilloscope, ensure that it is properly installed and powered on.

Operation

To properly install and power on the digitizing oscilloscope, do the following:

Installation

1. Be sure you have the appropriate operating environment. Specifications for temperature, relative humidity, altitude, vibrations, and emissions are included in *Appendix B: Specification* at the rear of this manual.
2. Leave space for cooling. Do this by verifying that the air intake and exhaust holes on the sides of the cabinet (where the fan operates) are free of any airflow obstructions. Leave at least 2 inches (5.1 cm) free on each side.

WARNING

To avoid electrical shock, be sure that the power cord is disconnected before checking the fuse.

3. Check the fuse to be sure it is the proper type and rating (Figure i). You can use either of two fuses. Each fuse requires its own cap (see Table i). The digitizing oscilloscope is shipped with the UL approved fuse installed.
4. Check that you have the proper electrical connections. The digitizing oscilloscope requires 90 to 250 VAC_{rms}, continuous range, 47 Hz to 63 Hz, and may require up to 300 W.
5. Connect the proper power cord from the rear-panel power connector (Figure i) to the power system.

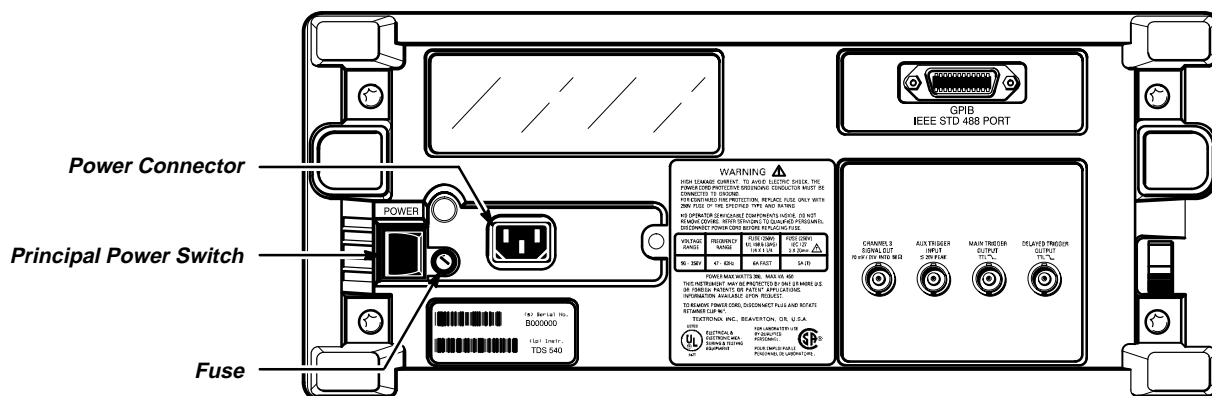

Figure i: Rear Panel Controls Used in Start Up

Table i: Fuse and Fuse Cap Part Numbers

Fuse	Fuse Part Number	Fuse Cap Part Number
.25 inch x 1.25 inch (UL 198.6, 3AG): 6 A FAST, 250 V.	159-0013-00	200-2264-00
5 mm x 20 mm (IEC 127): 5 A (T), 250 V.	159-0210-00	200-2265-00

Power On

1. Check that the rear-panel principal power switch is on (Figure i). The principal power switch controls all AC power to the instrument.
2. If the oscilloscope is not powered on (the screen is blank), push the front-panel **ON/STBY** button to toggle it on (Figure ii).

The **ON/STBY** button controls power to most of the instrument circuits. Power continues to go to certain parts even when this switch is set to STBY.

Once the digitizing oscilloscope is installed, you can leave the principal power switch on and use the **ON/STBY** button as the power switch.

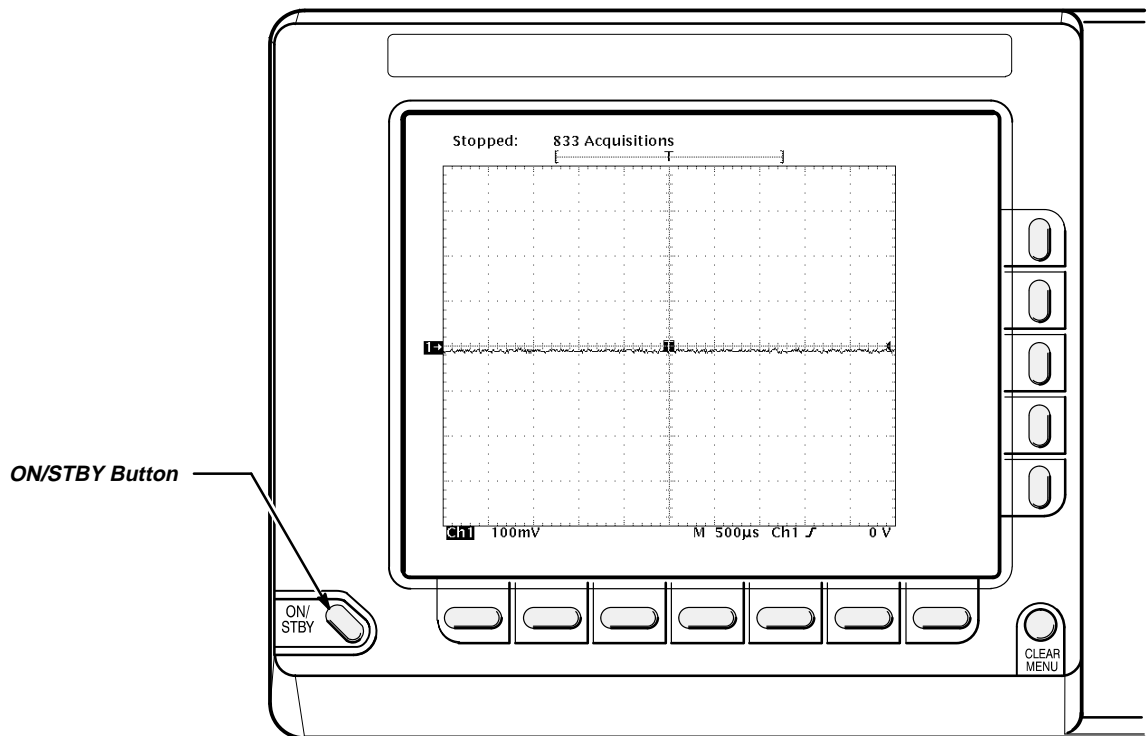

Figure ii: ON/STBY Button

Self Test

The digitizing oscilloscope automatically performs power-on tests each time it is turned on. It will come up with a display screen that states whether or not it passed self test. (If the self test passed, the status display screen will be removed after a few seconds.)

Check the self test results.

If the self test fails, call your local Tektronix Service Center. Depending on the type of failure, you may still be able to use the oscilloscope before it is serviced.

Power Off

Press the **ON/STBY** switch to turn off the oscilloscope.

Before You Begin

Now that you have set up your oscilloscope for operation, you should know about two features that help to ensure maximum accuracy for your most critical measurements, *Signal Path Compensation* and *Probe Cal.*

Signal Path Compensation (SPC) lets you compensate your oscilloscope for the current ambient temperature, helping to ensure maximum possible accuracy for your most critical measurements. See *Signal Path Compensation* on page 3-117 for a description of and operating information on this key feature.

Probe Cal lets you compensate any channel of your oscilloscope for the effect of the probe on gain accuracy and offset accuracy. Like SPC, *Probe Cal* helps ensure maximum possible accuracy for your most critical measurements. See *Probe Cal* on page 3-84 for a description of and operating information on this feature.

Tutorial

Overview

This section contains four examples that show you how to operate the basic functions of the digitizing oscilloscope. Use the *At a Glance* section (starting on page 3-2) to help you locate the correct knobs, buttons, and menus.

- *Example 1* teaches you how to reset the digitizing oscilloscope, display and adjust waveforms, and use the autoset function.
- *Example 2* explains how to add, control, and delete multiple waveforms.
- *Example 3* introduces you to the automated measurement system.
- *Example 4* discusses saving and recalling the digitizing oscilloscope setups.

Before you perform these examples, read *Conventions* on page ii. If you decide to skip this tutorial, use the *Concepts* and *In Detail* sections to learn about the digitizing oscilloscope arrangement and specific functions.

Setting Up for the Examples

All the examples use the same setup. Once you perform this setup, you do not have to change the signal connections for any of the other examples.

Remove all probes and signal inputs from the input BNC connectors along the lower right of the front panel. Then, using one of the probes supplied with the digitizing oscilloscope, connect from the **CH 1** connector to the **PROBE COMPENSATION** connectors (Figure 1-1).

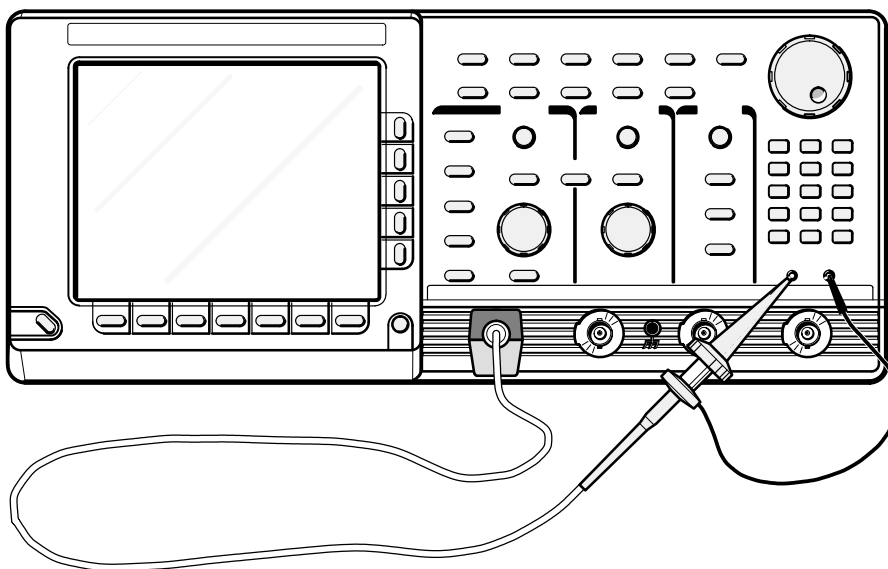

Figure 1-1: Connecting a Probe for the Examples



Example 1: Displaying a Waveform

In this first example you learn about resetting the digitizing oscilloscope, displaying and adjusting a waveform, and using the autoset function.

Resetting the Digitizing Oscilloscope

All examples in the tutorial begin by resetting the digitizing oscilloscope to a known factory default state. Reset the oscilloscope when you begin a new task and need to “start fresh” with known default settings.

1. Press the save/recall **SETUP** button to display the Setup menu (Figure 1-2).

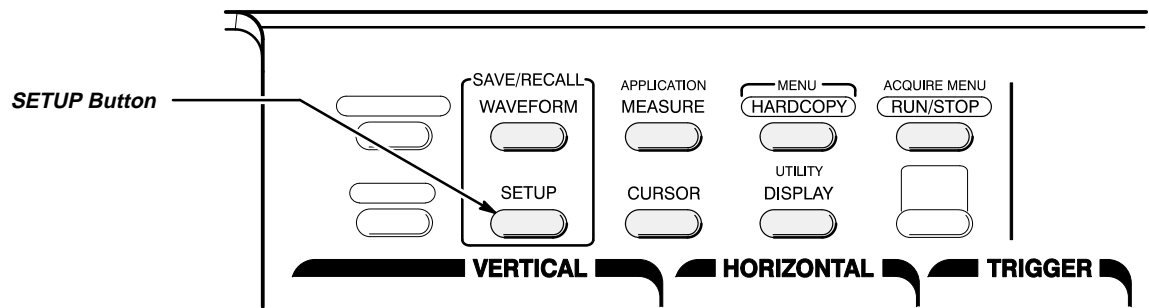

Figure 1-2: SETUP Button Location

The digitizing oscilloscope displays *main menus* along the bottom of the screen. Figure 1-3 shows the Setup main menu.

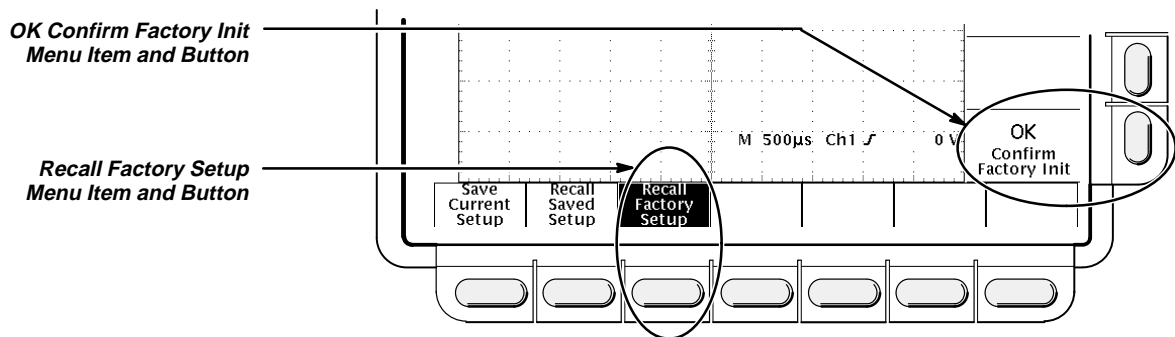

Figure 1-3: The Displayed Setup Menu

2. Press the button directly below the **Recall Factory Setup** menu item.

The display shows *side menus* along the right side of the screen. The buttons to select these side menu items are to the right of the side menu.

Because an accidental instrument reset could destroy a setup that took a long time to create, the digitizing oscilloscope asks you to verify the **Recall Factory Setup** selection (see Figure 1-3).

3. Press the button to the right of the **OK Confirm Factory Init** side menu item.

NOTE

*This manual uses the following notation to represent the sequence of selections you made in steps 1, 2 and 3: Press save/recall **SET-UP** → **Recall Factory Setup** (main) → **OK Confirm Factory Init** (side).*



Note that a clock icon appears on screen. The oscilloscope displays this icon when performing operations that take longer than several seconds.

4. Press **SET LEVEL TO 50%** (see Figure 1-4) to be sure the oscilloscope triggers on the input signal.

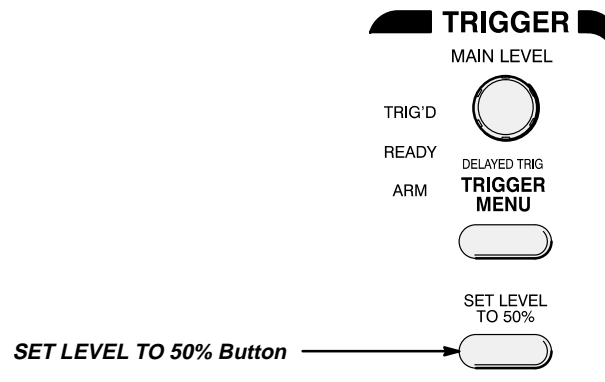

Figure 1-4: Trigger Controls

Display Elements

Figure 1-5 shows the display that results from the instrument reset. There are several important points to observe:

- The *trigger level bar* shows that the waveform is triggered at a level near 50% of its amplitude (from step 4).
- The *trigger position indicator* shows that the trigger position of the waveform is located at the horizontal center of the graticule.
- The *channel reference indicator* shows the vertical position of channel 1 with no input signal. This indicator points to the ground level for the channel when its vertical offset is set to 0 V in the vertical menu; when vertical offset is *not* set to 0 V, it points to the vertical offset level.
- The *trigger readout* shows that the digitizing oscilloscope is triggering on channel 1 (**Ch1**) on a rising edge, and that the trigger level is about 200-300 mV.
- The *time base readout* shows that the main time base is set to a horizontal scale of 500 μ s/div.
- The *channel readout* indicates that channel 1 (**Ch1**) is displayed with DC coupling. (In AC coupling, ~ appears after the volts/div readout.) The digitizing oscilloscope always displays channel 1 at reset.

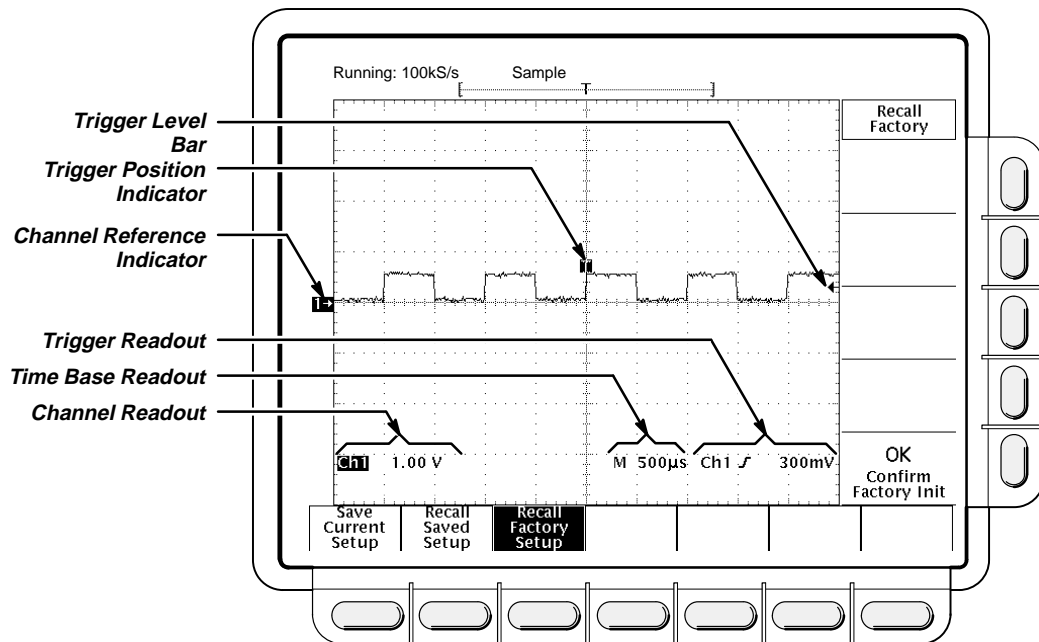

Figure 1-5: The Display After Factory Initialization

Right now, the channel, time base, and trigger readouts appear in the graticule area because a menu is displayed. You can press the **CLEAR MENU** button at any time to remove any menus and to move the readouts below the graticule.

Adjusting the Waveform Display

The display shows the probe compensation signal. It is a 1 kHz square wave of approximately 0.5 V amplitude. You can adjust the size and placement of the waveform using the front-panel knobs.

Figure 1-6 shows the main **VERTICAL** and **HORIZONTAL** sections of the front panel. Each has **SCALE** and **POSITION** knobs.

1. Turn the vertical **SCALE** knob clockwise. Observe the change in the displayed waveform and the channel readout at the bottom of the display.

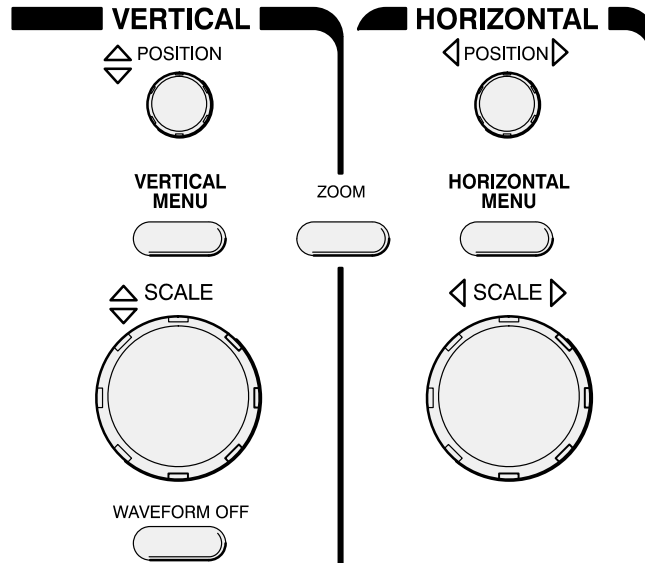

Figure 1-6: The **VERTICAL** and **HORIZONTAL** Controls

2. Turn the vertical **POSITION** knob first one direction, then the other. Observe the change in the displayed waveform. Then return the waveform to the center of the graticule.
3. Turn the horizontal **SCALE** knob one click clockwise. Observe the time base readout at the bottom of the display. The time base should be set to 200 $\mu\text{s}/\text{div}$ now, and you should see two complete waveform cycles on the display.

Using Autoset

When you first connect a signal to a channel and display it, the signal displayed may not be scaled and triggered correctly. Use the autoset function and you should quickly get a meaningful display.

When you reset the digitizing oscilloscope, you see a clear, stable display of the probe compensation waveform. That is because the probe compensation signal happens to display well at the default settings of the digitizing oscilloscope.

Example 1: Displaying a Waveform

1. To create an unstable display, slowly turn the trigger **MAIN LEVEL** knob (see Figure 1-7) first one direction, then the other. Observe what happens when you move the trigger level above the highest part of the displayed waveform. Leave the trigger level in that untriggered state.
2. Press **AUTOSET** (see Figure 1-8) and observe the stable waveform display.

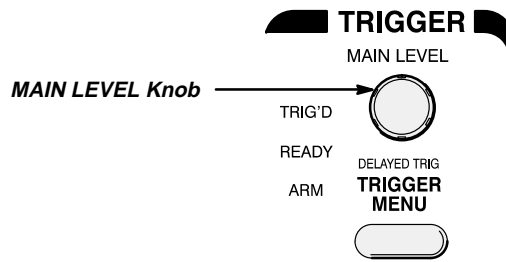

Figure 1-7: TRIGGER Controls

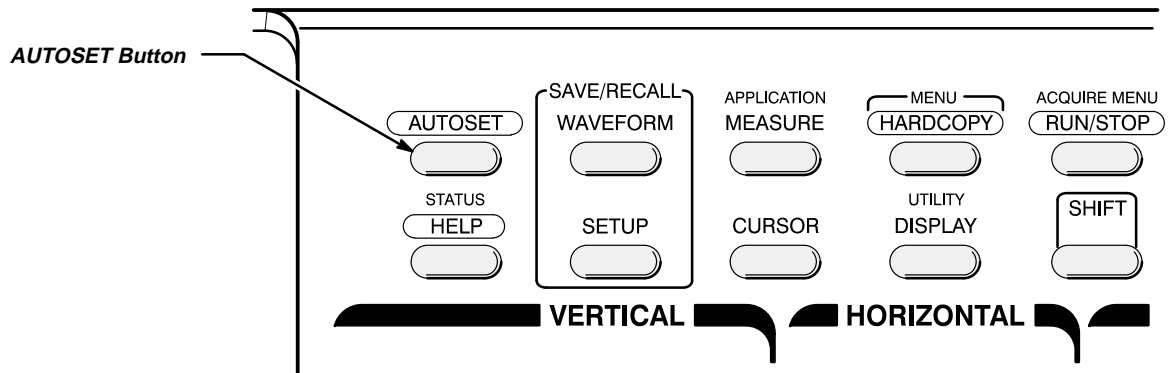

Figure 1-8: AUTOSET Button Location

Figure 1-9 shows the display after pressing **AUTOSET**. If necessary, you can adjust the waveform now by using the knobs discussed earlier in this example.

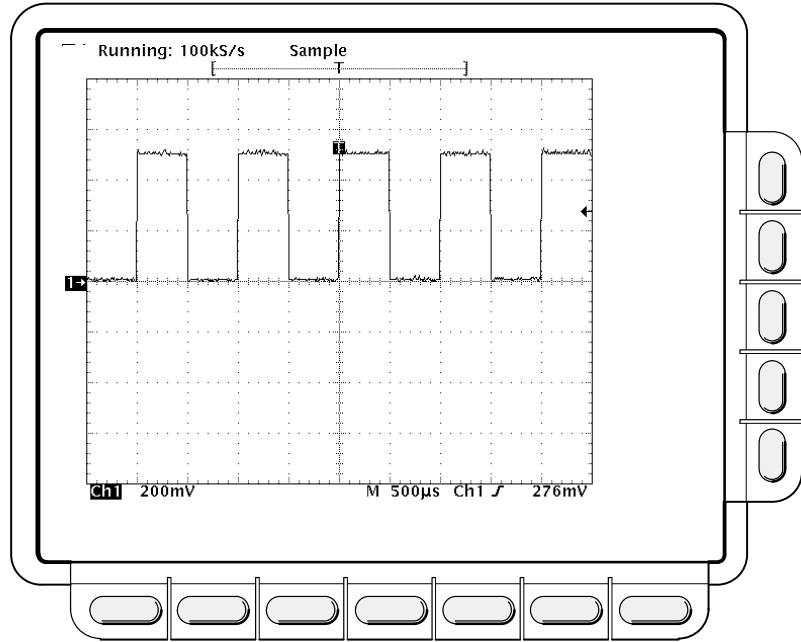

Figure 1-9: The Display After Pressing Autoset

NOTE

If the corners on your displayed signal look rounded or pointed (see Figure 1-10), then you may need to compensate your probe. The Probe Compensation section on page 3-90 explains how to do that.



Figure 1-10: Display Signals Requiring Probe Compensation



Example 2: Multiple Waveforms

In this example you learn how to display and control more than one waveform at a time.

Adding a Waveform

The **VERTICAL** section of the front panel contains the channel selection buttons. On the TDS 640 Digitizing Oscilloscope, these are **CH 1**, **CH 2**, **CH 3**, **CH 4**, and **MORE** (Figure 1-11); on the TDS 620, they are **CH 1**, **CH 2**, **AUX 1**, **AUX 2**, and **MORE**.

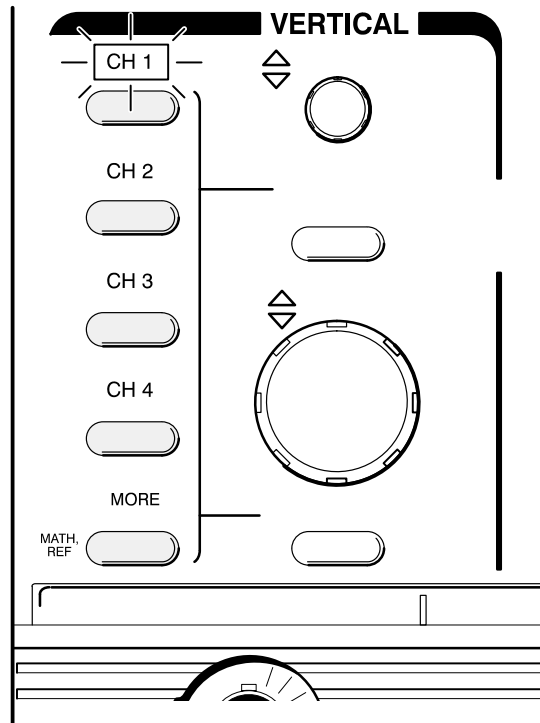

Figure 1-11: The Channel Buttons and Lights (TDS 540 Shown)

Each of the channel (**CH**) buttons has a light above its label. Right now, the **CH 1** light is on. That light indicates that the vertical controls are set to adjust channel 1.

The following steps adds a waveform to the display.

1. If you are not continuing from the previous example, follow the instructions on page 1-1 under the heading “Setting Up for the Examples.”

2. Press **SETUP** → **Recall Factory Setup** (main) → **OK Confirm Factory Init** (side).
3. Press **AUTOSET**.
4. Press **CH 2**.

The display shows a second waveform, which represents the signal on channel 2. Since there is nothing connected to the **CH 2** input connector, this waveform is a flat line.

There are several other important things to observe:

- The channel readout on the display now shows the settings for both **Ch1** and **Ch2**.
 - There are two channel indicators at the left edge of the graticule. Right now, they overlap.
 - The light next to the **CH 2** button is now on, and the **CH 1** light is off. Because the knobs control only one channel at a time, the vertical controls are now set to adjust channel 2.
 - The trigger readout still indicates that the trigger is detecting trigger events on **Ch1**. The trigger source is not changed simply by adding a channel. (You can change the trigger source by using the **TRIGGER MENU** button to display the trigger menu.)
5. Turn the vertical **POSITION** knob clockwise to move the channel 2 waveform up on the graticule. You will notice that the channel reference indicator for channel 2 moves with the waveform.
 6. Press **VERTICAL MENU** → **Coupling** (main).

The **VERTICAL MENU** button displays a menu that gives you control over many vertical channel parameters (Figure 1-12). Although there can be more than one channel displayed, the vertical menu and buttons only adjust the selected channel.

Each menu item in the Vertical menu displays a side menu. Right now, the **Coupling** item in the main menu is highlighted, which means that the side menu shows the coupling choices. At the top of the side menu, the menu title shows the channel affected by the menu choices. That always matches the lighted channel button.

7. Press Ω (side) to toggle the selection to **50 Ω** . That changes the input coupling of channel 2 from 1 M Ω to 50 Ω . The channel readout for channel 2 (near the bottom of the graticule) now shows an Ω indicator.

Example 2: Multiple Waveforms

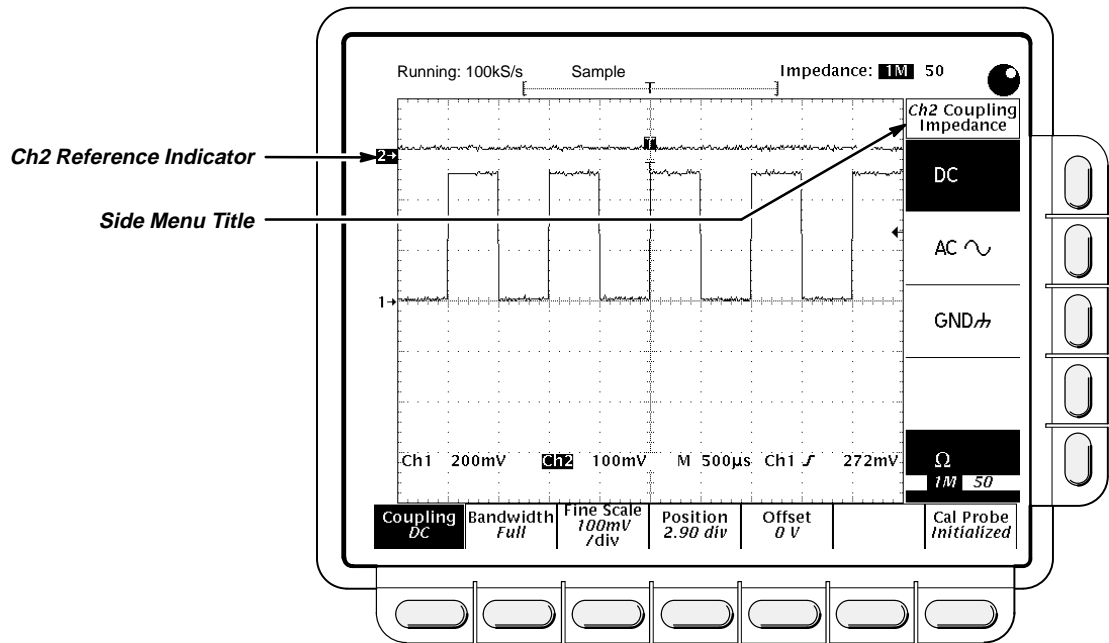

Figure 1-12: The Vertical Main Menu and Coupling Side Menu

Changing Controls to Another Channel

Pressing a channel (**CH**) button sets the vertical controls to that channel. It also adds the channel to the display if that waveform is not already displayed.

1. Press **CH 1**.

Observe that now the side menu title shows **Ch1** (Figure 1-13), and that the light above **CH 1** is lit. The highlighted menu item in the side menu has changed from the **50 Ω** channel 2 setting to the **1 MΩ** impedance setting of channel 1.

2. Press **CH 2** → **Ω** (side) to toggle the selection to **1 MΩ**. That returns the coupling impedance of channel 2 to its initial state.

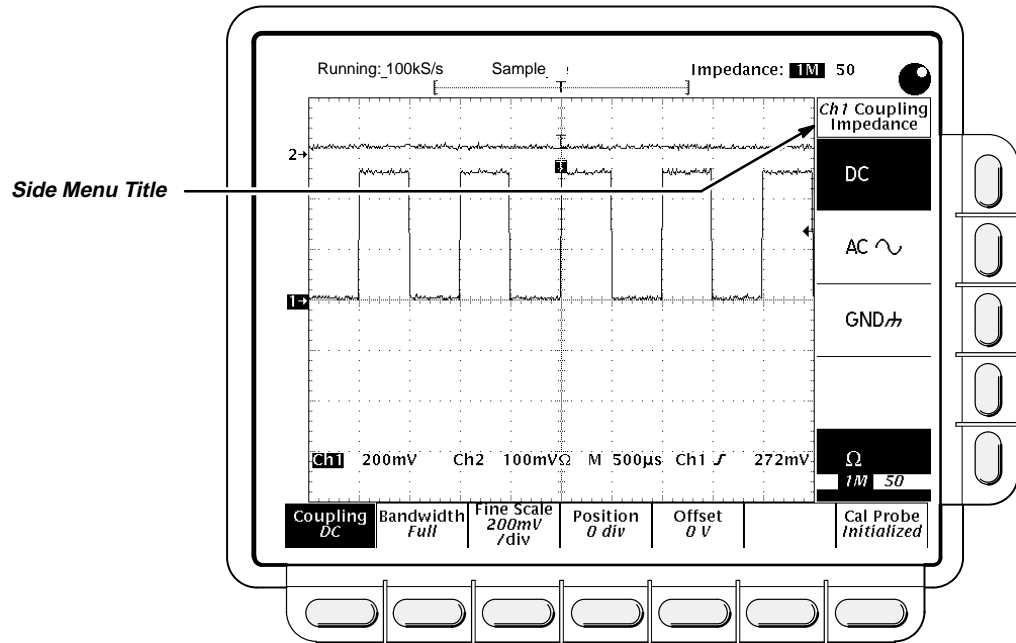

Figure 1-13: The Menus After Changing Channels

Removing a Waveform

Pressing the **WAVEFORM OFF** button removes the waveform for the currently selected channel. If the waveform you want to remove is not already selected, select that channel using the channel (**CH**) button.

1. Press **WAVEFORM OFF** (under the vertical **SCALE** knob).

Since the **CH 2** light was on when you pressed the **WAVEFORM OFF** button, the channel 2 waveform was removed.

The channel (**CH**) lights now indicate channel 1. Channel 1 has become the selected channel. When you remove the last waveform, all the **CH** lights are turned off.

2. Press **WAVEFORM OFF** again to remove the channel 1 waveform.



Example 3: Automated Measurements

In this example you learn how to use the automated measurement system to get numeric readouts of important waveform characteristics.

Displaying Automated Measurements

To use the automated measurement system, you must have a stable display of your signal. Also, the waveform must have all the segments necessary for the measurement you want. For example, a rise time measurement requires at least one rising edge, and a frequency measurement needs at least one complete cycle.

1. If you are not continuing from the previous example, follow the instructions on page 1-1 under the heading "Setting Up for the Examples."
2. Press **SETUP** → **Recall Factory Setup** (main) → **OK Confirm Factory Init** (side).
3. Press **AUTOSET**.
4. Press **MEASURE** to display the Measure main menu (see Figure 1-14).

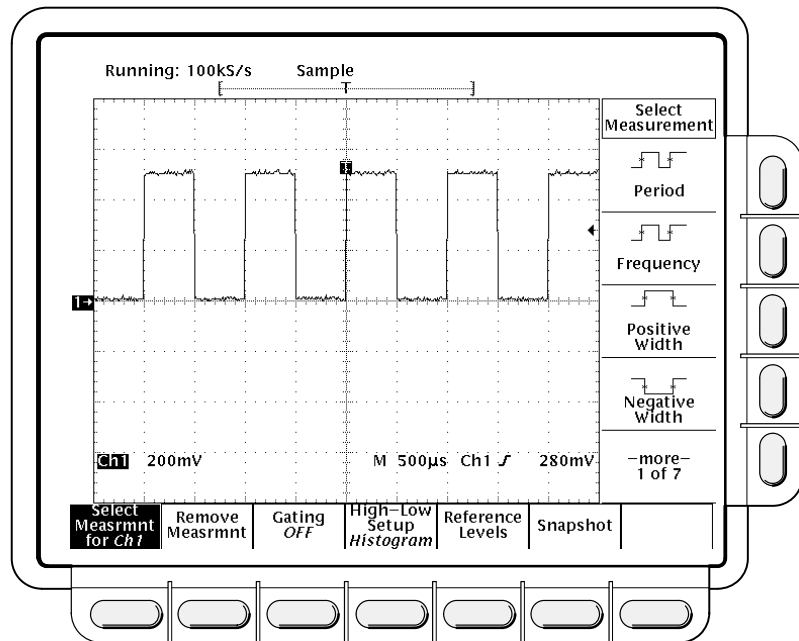

Figure 1-14: Measure Main Menu and Select Measurement Side Menu

5. If it is not already selected, press **Select Measrmt** (main). The readout for that menu item indicates which channel the measurement will be taken from. All automated measurements are made on the selected channel.

The Select Measurement side menu lists some of the measurements that can be taken on waveforms. There are many different measurements available; up to four can be taken and displayed at any one time. Pressing the button next to the **–more–** menu item brings up the other measurement selections.



6. Press **Frequency** (side). If the **Frequency** menu item is not visible, press **–more–** (side) repeatedly until the **Frequency** item appears. Then press **Frequency** (side).

Observe that the frequency measurement appears within the right side of the graticule area. The measurement readout includes the notation **Ch1**, meaning that that measurement is taken on the channel 1 waveform. (To take a measurement on another channel, select that channel, and then select the measurement.)

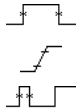

7. Press **Positive Width** (side) → **–more–** (side) → **Rise Time** (side) → **Positive Duty Cycle** (side).

All four measurements are displayed. Right now, they cover a part of the graticule area, including the displayed waveforms.

8. To move the measurement readouts outside the graticule area, press **CLEAR MENU** (see Figure 1-15).

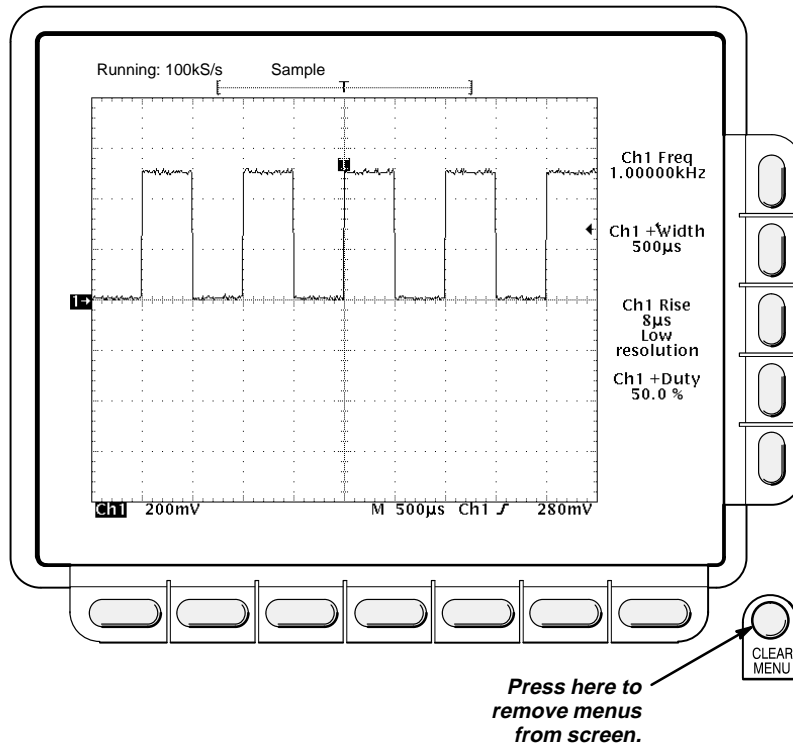

Figure 1-15: Four Simultaneous Measurement Readouts

Removing Measurement Readouts

The Measure menu lets you remove measurements you no longer want displayed. You can remove any one measurement, or you can remove them all with a single menu item.

Press **MEASURE** → **Remove Measrmt** (main) → **Measurement 1**, **Measurement 2**, and **Measurement 4** (side) to remove those measurements. Leave the rise time measurement displayed.

Changing the Measurement Reference Levels



By default, the measurement system will use the 10% and 90% levels of the waveform for taking the rise time measurement. You can change these values to other percentages or change them to absolute voltage levels.

To examine the current values, press **Reference Levels** (main) → **High Ref** (side).

The General Purpose Knob

The general purpose knob, the large knob with the indentation, is now set to adjust the high reference level (Figure 1-16).

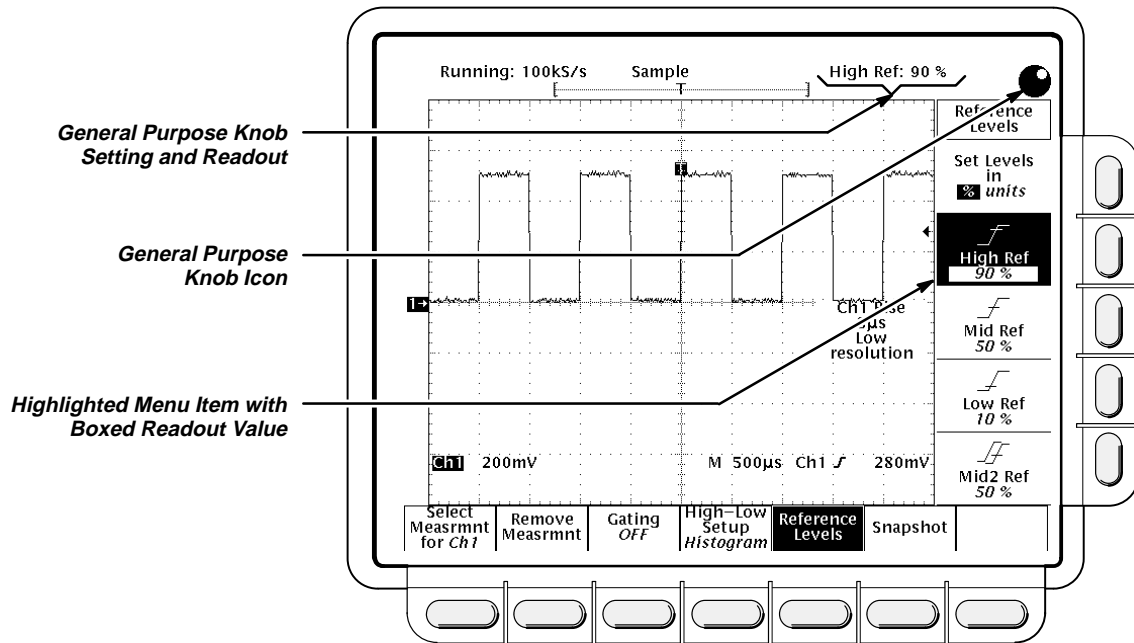

Figure 1-16: General Purpose Knob Indicators

There are several important things to observe on the screen:

- The knob icon appears at the top of the screen. That indicates that the general purpose knob has just been set to adjust a parameter.
- The upper right corner of the screen shows the readout **High Ref: 90%**.
- The **High Ref** side menu item is highlighted, and a box appears around the 90% readout in the **High Ref** menu item. The box indicates that the general purpose knob is currently set to adjust that parameter.

Turn the general purpose knob left and right, and then use it to adjust the high level to 80%. That sets the high measurement reference to 80%.

Hint: To make large changes quickly with the general purpose knob, press the **SHIFT** button before turning the knob. When the light above the **SHIFT** button is lit and the display says **Coarse Knobs** in the upper-right corner, the general purpose knob speeds up significantly.

The Numeric Keypad

Any time the general purpose knob is set to adjust a numeric parameter, you can enter the value as a number using the keypad instead of using the knob. Always end the entry of a number by pressing the **ENTER** (↵).

The numeric keypad also provides multipliers for engineering exponents, such as **m** for milli, **M** for mega, and **μ** for micro. To enter these multiplier values, press the **SHIFT** button, then press the multiplier.

Example 3: Automated Measurements



1. Press **Low Ref** (side).
2. On the numeric keypad, press the **2**, the **0**, and the **ENTER** (↵) buttons, which sets the low measurement reference to 20%. Observe that the rise-time value has changed.
3. Press **Remove Measrmt** (main) → **All Measurements** (side). That returns the display to its original state.

Displaying a Snapshot of Automated Measurements

You have seen how to display up to four individual automated measurements on screen. You can also pop up a display of almost all of the automated measurements available in the **Select Measrmnts** side menus. This snapshot of measurements is taken on the waveform currently selected using the channel selection buttons.

As when displaying individual measurements, you must have a stable display of your signal, and that signal must have all the segments necessary for the measurement you want.

1. Press **Snapshot** (main) to pop up a snapshot of all available single waveform measurements. (See Figure 1-17).

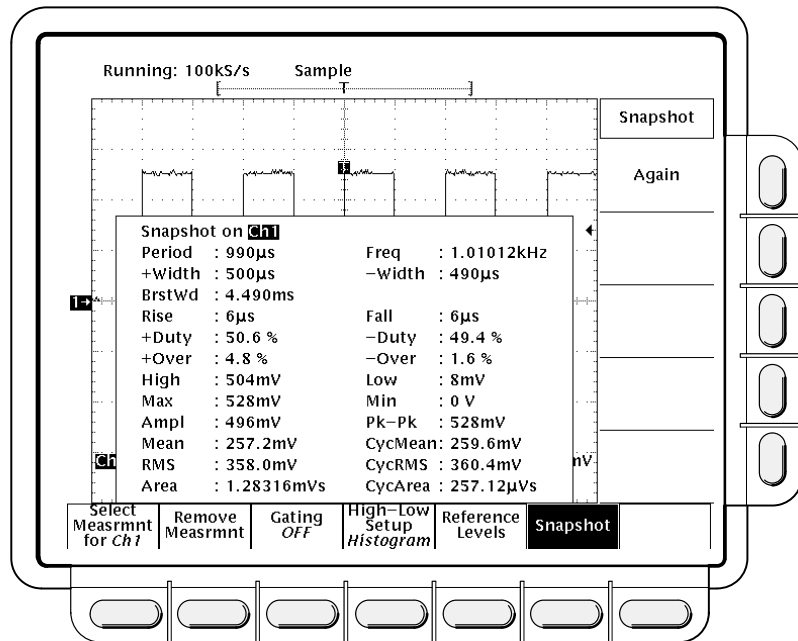

Figure 1-17: Snapshot of Channel 1

The snapshot display includes the notation **Ch 1**, meaning that the measurements displayed are taken on the channel 1 waveform. You take a snapshot of a waveform in another channel by first selecting that channel using the channel selection buttons.

Example 3: Automated Measurements

The snapshot measurements do not continuously update. Snapshot executes a one-time capture of all measurements and does not update those measurements unless it is performed again.

2. Press **Again** (side) to do another snapshot and update the snapshot measurements.
3. Press **Remove Measrmnt** (main) to remove the snapshot display. (You can also press **CLEAR MENU**, but a new snapshot will be executed the next time you display the Measure menu.)

Example 4: Saving Setups

This example shows you how to save all the settings of the digitizing oscilloscope and how to recall the setup later to quickly re-establish the previously saved state. The oscilloscope provides several storage locations where you can save the setups.

Besides being able to save several complete setups, the digitizing oscilloscope remembers all the parameter settings when you power it off. That feature lets you power on and continue where you left off without having to reconstruct the state of the digitizing oscilloscope.

Saving a Setup

First, you need to create an instrument setup you want to save. The next several steps establish a two-waveform display with a measurement on one waveform. The setup created is complex enough that you might prefer not to go through all these steps each time you want that display.

1. If you are not continuing from the previous example, follow the instructions on page 1-1 under the heading “Setting Up for the Examples.”
2. Press **SETUP** → **Recall Factory Setup** (main) → **OK Confirm Factory Init** (side).
3. Press → **AUTOSET**.
4. Press **MEASURE** → **Select Measrmnt** (main) → **Frequency** (side). (Press the **–more–** side menu item if the **Frequency** selection does not appear in the side menu.)
5. Press **CH 2** → **CLEAR MENU**.
6. Press **SETUP** → **Save Current Setup** (main) to display the Setup main menu (see Figure 1-18).



Note that the setup locations shown in the side menu are labeled either **user** or **factory**. If you save your current setup in a location labeled **user**, you will overwrite the user setup previously stored there. If you work in a laboratory environment where several people share the digitizing oscilloscope, check with the other users before you overwrite their setup. Setup locations labeled **factory** have the factory setup stored as a default and can be used to store current setups without disturbing previously stored setups.

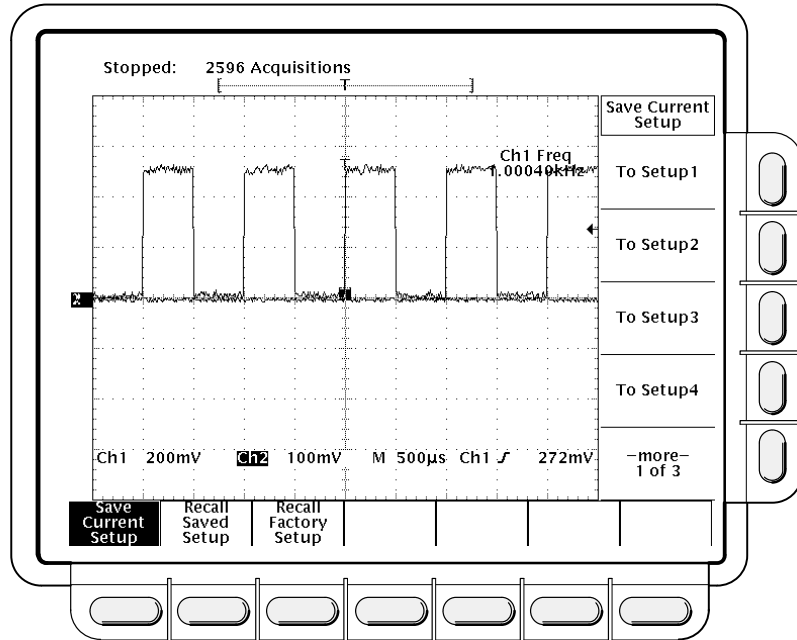

Figure 1-18: Save/Recall Setup Menu

7. Press one of the **To Setup** side menu buttons to store the current instrument settings into that setup location. Remember which setup location you selected for use later.

There are more setup locations than can be listed at one time in the side menu. The **-more-** side menu item gives you access to all the setup locations.

Once you have saved a particular setup, you can change the settings as you wish, knowing that you can come back to that setup at any time.



8. Press **MEASURE** → **Positive Width** (side) to add that measurement to the display.

Recalling a Setup

To recall the setup, Press **SETUP** → **Recall Saved Setup** (main) → **Recall Setup** (side) for the setup location you used in the last exercise. The positive width measurement is now removed from the display because you selected it after you saved the setup.

This completes the tutorial. You can restore the default settings by pressing **SETUP** → **Recall Factory Setup** (main) → **OK Confirm Factory Init** (side).

Example 4: Saving Setups

Concepts



Overview

Understanding the basic concepts of your digitizing oscilloscope will help you use it effectively. This section explains the following concepts:

- The **triggering** system, which establishes conditions for acquiring signals. Properly set, triggers can convert displays from unstable jumbles or blank screens into meaningful waveforms. See *Triggering* on page 2-2.
- The **acquisition** system, which converts analog data into digital form. See *Acquisition* on page 2-7.
- The **waveform scaling and positioning** system, which changes the dimensions of the waveform display. Scaling waveforms involves increasing or decreasing their displayed size. Positioning means moving them up, down, right, or left on the display. See *Scaling and Positioning Waveforms* on page 2-13.
- The **measurement** system, which provides numeric information on the displayed waveforms. You can use graticule, cursor and automated measurements. See *Measurements* on page 2-17.

At the end of each topic, *For More Information* will point you to sources where more information can be found.

To explore these topics in more depth and to read about topics not covered in this section, see *In Detail*. Page 3-1 lists the topics covered.

Triggering

This section describes the edge trigger of the main trigger system and explores, in a general sense, the topic of triggering. This oscilloscope also has logic and pulse triggers in the main trigger system and a delayed trigger system. They are described in Section 3.

Triggers determine when the digitizing oscilloscope starts acquiring and displaying a waveform. They help create meaningful waveforms from unstable jumbles or blank screens (see Figure 2-1).

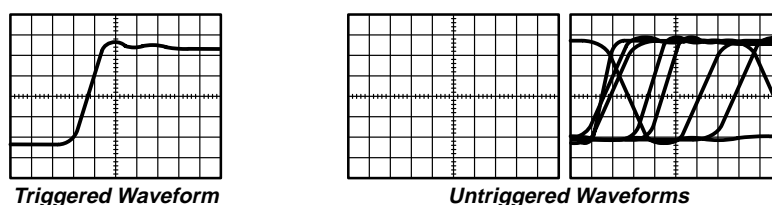

Figure 2-1: Triggered Versus Untriggered Displays

The trigger event establishes the time-zero point in the waveform record, and all points in the record are located in time with respect to that point. The digitizing oscilloscope continuously acquires and retains enough sample points to fill the pretrigger portion of the waveform record (that part of the waveform that is displayed *before*, or to the left of, the triggering event on screen).

When a trigger event occurs, the digitizing oscilloscope starts acquiring samples to build the posttrigger portion the waveform record (displayed *after*, or to the right of, the trigger event). Once a trigger is recognized, the digitizing oscilloscope will not accept another trigger until the acquisition is complete.

The basic trigger is the edge trigger. An edge trigger event occurs when the trigger *source* (the signal that the trigger circuit monitors) passes through a specified voltage *level* in a specified direction (the trigger *slope*).

Trigger Sources

You can derive your trigger from various sources.

- **Input channels**—the most commonly used trigger source is any one of the four input channels. The channel you select as a trigger source will function whether it is displayed or not.

AC 

- **AC Line Voltage**—this trigger source is useful when you are looking at signals related to the power line frequency. Examples include devices such as lighting equipment and power supplies. Because the digitizing oscilloscope generates the trigger, you do not have to input a signal to create it.
- **Auxiliary Trigger**—this trigger source is useful in digital design and repair. For example, you might want to trigger with an external clock or with a signal from another part of the circuit. To use the auxiliary trigger, connect the external triggering signal to the Auxiliary Trigger input connector on the oscilloscope rear panel (TDS 540 only).

Types

The digitizing oscilloscope provides three types of triggers for the main trigger system: edge, pulse, and logic. These triggers are described in individual articles found in the section *In Detail*. A brief definition of each type follows:



- **Edge**—the “basic” trigger. You can use it with both analog and digital test circuits. An edge trigger event occurs when the trigger *source* (the signal the trigger circuit is monitoring) passes through a specified voltage *level* in the specified direction (the trigger *slope*).
- **Pulse**—special trigger primarily used on digital circuits. Three classes of pulse triggers are *width*, *runt*, and *glitch*. Pulse triggering is available on the main trigger only.
- **Logic**—special trigger primarily used on digital logic circuits. You select Boolean operators for the trigger sources. Triggering occurs when the Boolean conditions are satisfied. There are two kinds of logic triggers, *state* and *pattern*. (Logic triggers are available the main trigger system only.)

Trigger Modes

The trigger mode determines how the oscilloscope behaves in the absence of a trigger event. The digitizing oscilloscope provides two different trigger modes, *normal* and *automatic*.

- **Normal**—this trigger mode lets the oscilloscope acquire a waveform only when it is triggered. If no trigger occurs, the oscilloscope will not acquire a waveform. (You can push **FORCE TRIGGER** to force the oscilloscope to make a single acquisition.)
- **Automatic**—this trigger mode (auto mode) lets the oscilloscope acquire a waveform even if a trigger does not occur. Auto mode uses a timer that starts after a trigger event occurs. If another trigger event is not detected before the timer times out, the oscilloscope forces a trigger anyway. The length of time it waits for a trigger event depends on the time base setting.

Be aware that auto mode, when forcing triggers in the absence of valid triggering events, does not sync the waveform on the display. In other words, successive acquisitions will not be triggered at the same point on the waveform; therefore, the waveform will appear to roll across the screen. Of course, if valid triggers occur the display will become stable on screen.

Since auto mode will force a trigger in the absence of one, it is useful in observing signals where you are only concerned with monitoring amplitude level. Although the unsynced waveform may “roll” across the display, it will not disappear as it would in normal trigger mode. Monitoring of a power supply output is an example of such an application.

Holdoff

When a trigger event is recognized, the oscilloscope disables the trigger system until acquisition is complete. In addition, the trigger system remains disabled during the holdoff period that follows each acquisition. You can set holdoff time to help ensure a stable display.

For example, the trigger signal can be a complex waveform with many possible trigger points on it. Though the waveform is repetitive, a simple trigger might get you a series of patterns on the screen instead of the same pattern each time.

Digital pulse trains are good examples (see Figure 2-2). Each pulse looks like any other, so many possible trigger points exist. Not all of these will result in the same display. The holdoff period allows the digitizing oscilloscope to trigger on the correct edge, resulting in a stable display.

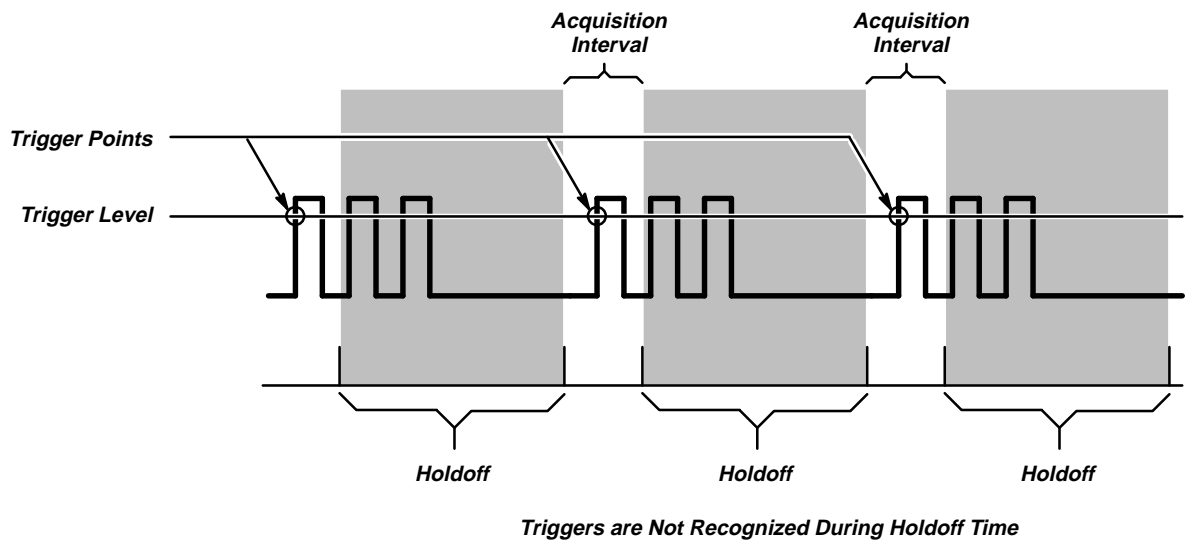

Figure 2-2: Trigger Holdoff Time Ensures Valid Triggering

Holdoff is settable from 0% (minimum holdoff available) to 100% (maximum available). To see how to set holdoff, see *Mode & Holdoff* on page 3-39. The minimum and maximum holdoff varies with the horizontal scale. See *Holdoff, Variable, Main Trigger* on page A-23 of Appendix B for the typical minimum and maximum values.

Coupling

Trigger coupling determines what part of the signal is passed to the trigger circuit. Available coupling types include AC, DC, Low Frequency Rejection, High Frequency Rejection, and Noise Rejection:

DC

- *DC coupling* passes all of the input signal. In other words, it passes both AC and DC components to the trigger circuit.

AC 

- *AC coupling* passes only the alternating components of an input signal. (AC components above 10 Hz are passed if the source channel is in 1 M Ω coupling; above 200 kHz are passed in 50 Ω coupling.) It removes the DC components from the trigger signal.



- *High frequency rejection* removes the high frequency portion of the triggering signal. That allows only the low frequency components to pass on to the triggering system to start an acquisition. High frequency rejection attenuates signals above 30 kHz.



- *Low frequency rejection* does the opposite of high frequency rejection. Low frequency rejection attenuates signals below 80 kHz.



- *Noise Rejection* lowers trigger sensitivity. It requires additional signal amplitude for stable triggering, reducing the chance of falsely triggering on noise.

Trigger Position

The adjustable *trigger position* defines where on the waveform record the trigger occurs. It lets you properly align and measure data within records. The part of the record that occurs *before* the trigger is the pretrigger portion. The part that occurs *after* the trigger is the posttrigger portion.



To help you visualize the trigger position setting, the top part of the display has an icon indicating where the trigger occurs in the waveform record. You select in the Horizontal menu what percentage of the waveform record will contain pretrigger information.



Many users find displaying pretrigger information a valuable troubleshooting technique. For example, if you are trying to find the cause of an unwanted glitch in your test circuit, it may prove valuable to trigger on the glitch and make the pretrigger period large enough to capture data before the glitch. By analyzing what happened before the glitch, you may uncover clues about the source of it.

Slope and Level

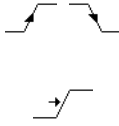

The slope control determines whether the oscilloscope finds the trigger point on the rising or the falling edge of a signal (see Figure 2-3).

You set trigger slope by selecting **Slope** in the Main Trigger menu and then selecting from the rising or falling slope icons in the side menu that appears.

The level control determines where on that edge the trigger point occurs (see Figure 2-3).

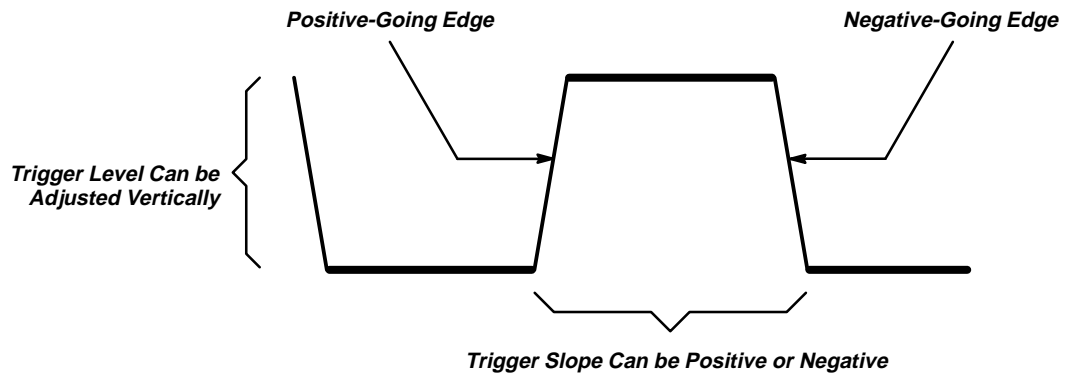

Figure 2-3: Slope and Level Controls Help Define the Trigger

The digitizing oscilloscope lets you set the main trigger level with the trigger **MAIN LEVEL** knob.

Delayed Trigger

As mentioned earlier in this section there is also a delayed trigger system that provides an edge trigger (no pulse or logic triggers). When using the delayed time base, you can also delay the acquisition of a waveform for a user-specified time or a user-specified number of delayed trigger events (or both) after a main trigger event.

For More Information

See *Delayed Triggering*, on page 3-25.

See *Edge Triggering*, on page 3-36.

See *Horizontal Controls*, on page 3-49.

See *Logic Triggering*, on page 3-58.

See *Pulse Triggering*, on page 3-99.

See *Triggering*, on page 3-120.

Acquisition

Acquisition is the process of sampling the analog input signal, converting it into digital data, and assembling it into waveform record. The oscilloscope creates a digital representation of the input signal by sampling the voltage level of the signal at regular time intervals (Figure 2-4).

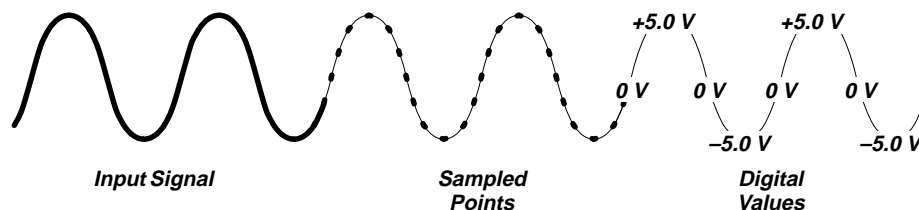

Figure 2-4: Acquisition: Input Analog Signal, Sample, and Digitize

The sampled points are stored in memory along with corresponding timing information. You can use this digital representation of the signal for display, measurements, or further processing.

You specify how the digitizing oscilloscope acquires data points and assembles them into the waveform record.

Sampling and Digitizing

The trigger point marks time zero in a waveform record. All record points before the trigger event make up the pretrigger portion of the the waveform record. Every record point after the trigger event is part of the posttrigger portion. All timing measurements in the waveform record are made relative to that trigger event.

Each time it takes a sample, the oscilloscope digitizer produces a numeric representation of the signal. The number of samples may be larger than the number of points in your waveform record. In fact, the oscilloscope may take several samples for each record point (Figure 2-5).

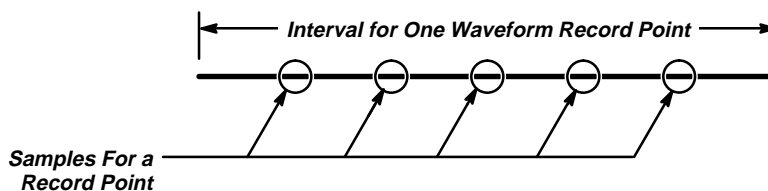

Figure 2-5: Several Points May be Acquired for Each Point Used

The digitizer can use the extra samples to perform additional processing, such as averaging or looking for minimum and maximum values.

The digitizing oscilloscope creates a waveform record containing a user-specified number of data points. Each record point represents a certain voltage level that occurs a determined amount of time from the trigger event.

Record Length

The number of points that make up the waveform record is defined by the record length. You can set the record length in the Horizontal menu. The digitizing oscilloscope provides record lengths of 500, 1,000, 2,500, 5,000, and 15,000 points.

You can order option 1M that provides a maximum record length of 50,000 points. That option is available only at the time of original purchase; it cannot be installed later.

Sampling Methods

Sampling is the process of converting the analog input signal to digital data for display and processing. The two general methods of sampling are *real-time* and *equivalent-time*.

Real-Time Sampling—In real-time sampling, the oscilloscope digitizes all the points it acquires after one trigger event (see Figure 2-6). Use real-time sampling to capture single-shot or transient events.

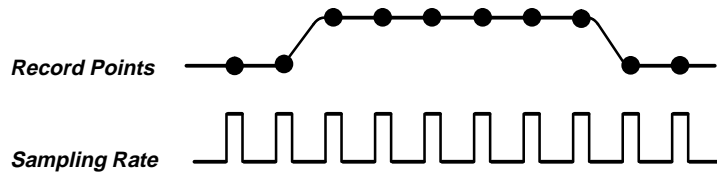

Figure 2-6: Real-Time Sampling

Two factors that affect real-time sampling on the digitizing oscilloscope are *interleaving* and *interpolation*.

Interleaving refers to the ability of the digitizing oscilloscope to attain higher digitizing speeds by combining the efforts of several digitizers. For example, if you want to digitize on all channels at one time (four on the TDS 540 and two on the TDS 520), each of those channels can digitize at a maximum real-time speed of 250 Megasamples/second (per channel).

If you use two channels, the TDS 540 oscilloscope can combine the efforts of two digitizers to each channel and acquire at 500 Megasamples/second (per channel).

If you focus on only one channel at the maximum possible real-time rate, the TDS 520 oscilloscope can acquire at 500 Megasamples/second using both its digitizers, while the TDS 540 oscilloscope can combine all four digitizers and acquire at 1 Gigasample/second.

Depending on how many channels you are using and the speed of the time base, at some point the digitizing oscilloscope will not be able to get enough samples to create a waveform record. (See the discussion on page 2-10 for more details about when that happens.) At that point, the digitizing oscilloscope will create the waveform record in one of two ways depending on whether you have limited the oscilloscope to real-time sampling or enabled equivalent-time sampling (you make that choice in the Acquisition menu).

If you have restricted it to real-time sampling, the digitizing oscilloscope uses a process called interpolation to create the intervening points in the waveform record. There are two options for interpolation: linear or $\sin(x)/x$.

Linear interpolation computes record points between actual acquired samples by using a straight line fit. It assumes all the interpolated points fall in their appropriate point in time on that straight line. Linear interpolation is useful for many waveforms such as pulse trains.

Sin(x)/x interpolation computes record points using a curve fit between the actual values acquired. It assumes all the interpolated points fall along that curve. That is particularly useful when acquiring more rounded waveforms such as sine waves. Actually, it is appropriate for general use, although it may introduce some overshoot or undershoot in signals with fast rise times.

NOTE

When using either type of interpolation, you may wish to set the display style so that the real samples are displayed intensified relative to the interpolated samples. The instructions under Display Style on page 3-31 explain how to turn on intensified samples.

Equivalent-Time Sampling—The digitizing oscilloscope only uses equivalent-time sampling if you have enabled the equivalent-time option in the Acquisition menu and the oscilloscope is not able to get enough samples with which to create a waveform record.

In equivalent-time (ET) sampling the oscilloscope acquires samples over many repetitions of the event (Figure 2-7). It should only be used on repetitive signals.

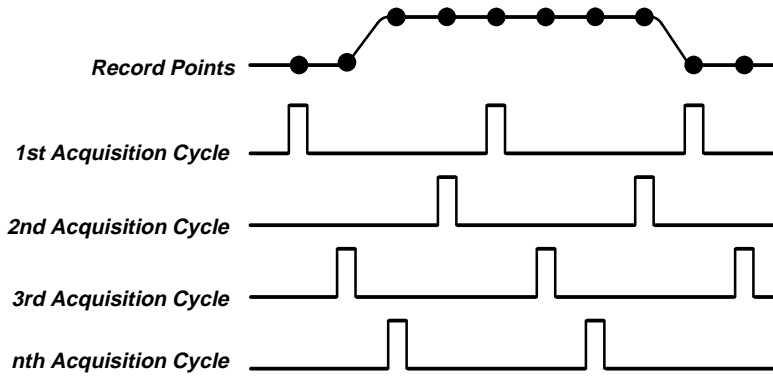

Figure 2-7: Equivalent-Time Sampling

The oscilloscope takes a few samples with each trigger event and eventually constructs a waveform record using the samples from multiple acquisitions. That feature lets you accurately acquire signals with frequencies much higher than the digitizing oscilloscope real-time bandwidth.

The digitizing oscilloscope uses a type of equivalent-time sampling called *random equivalent-time sampling*. Although the samples are taken sequentially in time, they are random with respect to the trigger. That is because the oscilloscope sample clock runs asynchronously with respect to the input signal and the signal trigger. The oscilloscope takes samples independent of the trigger position and displays them based on the time difference between the sample and the trigger.

Selecting Sampling Mode

The sampling speeds and the number of channels you choose affect the mode the digitizing oscilloscope uses to sample waveforms. Basically, if the time base is 200 ns or slower, the digitizing oscilloscope uses real-time sampling for creating waveform records.

When the time base is faster than 50 ns, the digitizing oscilloscope creates waveform records using equivalent-time sampling or interpolation. For speeds between 200 ns and 20 ns, the digitizing oscilloscope creates waveform records differently depending on the number of input channels and type of oscilloscope you are using (see Table 2-1).

**Table 2-1: Sampling Mode Selection —
100 ns/Div to 50 ns/Div**

Instrument and Number of Channels	100 ns/Div	50 ns/Div
TDS 540, any 1 channel	Real-time	Real-time
TDS 540, any 2 channels	Real-time	Equivalent-time or interpolated real-time
TDS 540, 3 or more channels	Equivalent-time or interpolated real-time	Equivalent-time or interpolated real-time
TDS 520, any 1 channel	Real-time	Equivalent-time or interpolated real-time
TDS 520, any 2 chan- nels	Equivalent-time or interpolated real-time	Equivalent-time or interpolated real-time

Acquisition Modes

The digitizing oscilloscope supports five acquisition modes.

- *Sample*
- *Peak Detect*
- *Hi Res*
- *Envelope*
- *Average*

Sample acquisition mode, which acquires in real time, is the mode most commonly used. You can read about Sample and the other acquisition modes in *Acquisition Modes*, beginning on page 3-11.

Bandwidth

Bandwidth refers to the range of frequencies that an oscilloscope can acquire and display accurately (that is, with less than 3 dB attenuation).

You can set different bandwidths with the digitizing oscilloscope. Lower bandwidth settings let you eliminate the higher frequency components of a signal. The TDS 500 offers **Full** (500 MHz), **100 MHz**, and **20 MHz** bandwidth settings.

Coupling

You can couple your input signal to the digitizing oscilloscope three ways. You can choose between AC, DC, or Ground (GND). You also can set the input impedance.

DC

- DC coupling shows both the AC and DC components of an input signal.

AC 

- AC coupling shows only the alternating components of an input signal.

Acquisition

GND 

- Ground (GND) coupling disconnects the input signal from the acquisition.

Ω

- Input impedance lets you select either 1 M Ω or 50 Ω impedance.

NOTE

If you select 50 Ω impedance with AC coupling, the digitizing oscilloscope will not accurately display frequencies under 200 kHz.

For More Information

See *Scaling and Positioning Waveforms*, on page 2-13.

See *Acquisition Modes*, on page 3-11.



Scaling and Positioning Waveforms

Scaling and positioning waveforms means increasing or decreasing their displayed size and moving them up, down, right, and left on the display.

Two display icons, the channel reference indicator and the record view, help you quickly see the position of the waveform in the display (see Figure 2-8). The channel reference icon points to the ground of the waveform record when offset is set to 0 V. This is the point about which the waveform contracts or expands when the vertical scale is changed. The record view, at the top of the display, indicates where the trigger occurs and what part of the waveform record is displayed.

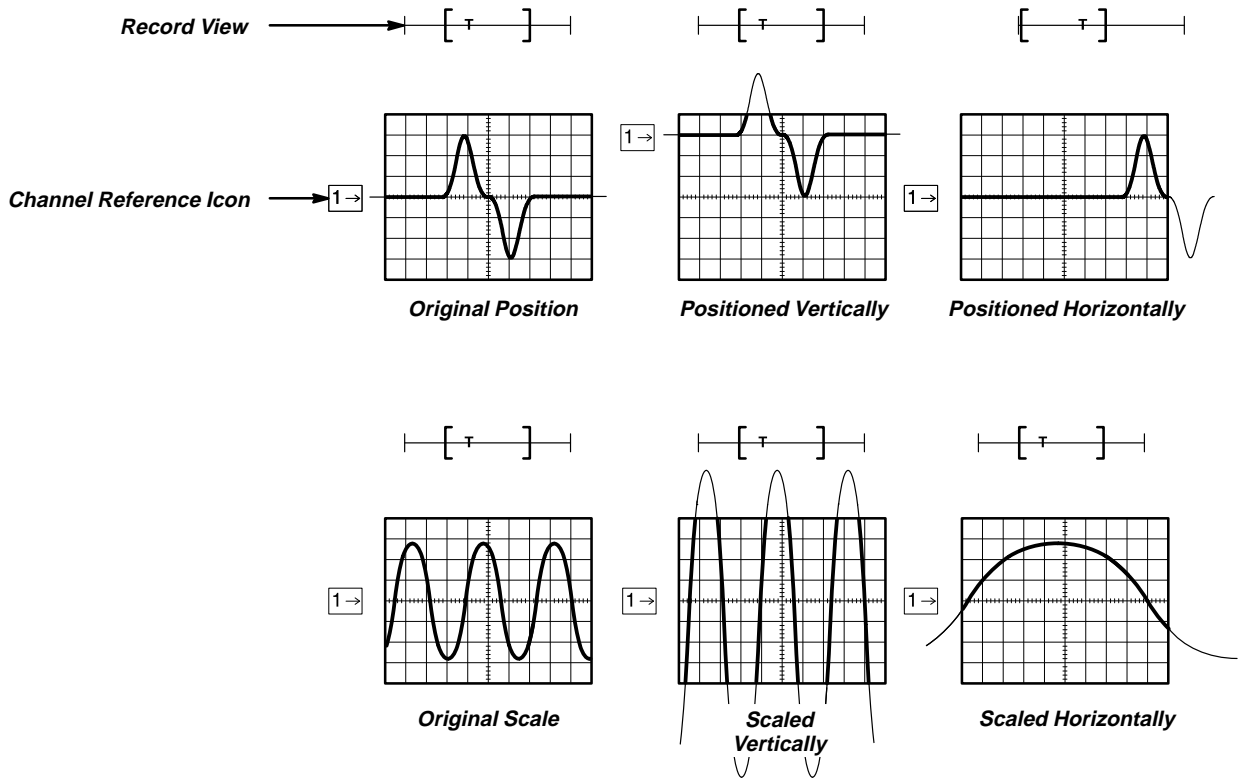

Figure 2-8: Scaling and Positioning

Vertical System

You can adjust the vertical position of the selected waveform by moving it up or down on the display. For example, when trying to compare multiple waveforms, you can put one above another and compare them, or you can overlay the two waveforms on top of each other. To move the selected waveform turn the vertical **POSITION** knob.

You can also alter the vertical scale. The digitizing oscilloscope shows the scale (in volts per division) for each active channel toward the bottom left of the display. As you turn the vertical **SCALE** knob clockwise, the value decreases resulting in higher resolution because you see a smaller part of the waveform. As you turn it counter-clockwise the scale increases allowing you to see more of the waveform but with lower resolution.

Besides using the position and scale knobs, you can set the vertical scale and position with exact numbers. You do that with the Vertical menu **Fine Scale** and **Position** selections and the general purpose knob and/or the keypad.

Offset

Vertical offset changes where the channel reference indicator is shown with respect to the graticule. Offset adds a voltage to the reference indicator without changing the scale. That feature allows you to move the waveform up and down over a large area without decreasing the resolution.

Offset is useful in cases where a waveform has a DC bias. One example is looking at a small ripple on a power supply output. You may be trying to look at a 100 mV ripple on top of a 15 V supply. The range available with offset can prove valuable as you try to move and scale the ripple to meet your needs.

Horizontal System

Adjusting the horizontal position of waveforms moves them right or left on the display. That is useful when the record length of the waveform is so large (greater than 500 points) that the digitizing oscilloscope cannot display the entire waveform record at one time. You can also adjust the scale of the waveform. For example, you might want to see just one cycle of a waveform to measure the overshoot on its rising edge.

You adjust the horizontal scale of the displayed waveform records using the horizontal **SCALE** knob and the horizontal position using the horizontal **POSITION** knob.

The digitizing oscilloscope shows the actual scale in the bottom right of the display. The scale readout shows the time per division used. Since all live waveforms use the same time base, the digitizing oscilloscope only displays one value for all the active channels.

Aliasing

When *aliasing* happens, you see a waveform with a frequency lower than the actual waveform being input or a waveform is not stable even though the light next to **TRIG'D** is lit. Aliasing occurs because the oscilloscope cannot sample the signal fast enough to construct an accurate waveform record (Figure 2-9).

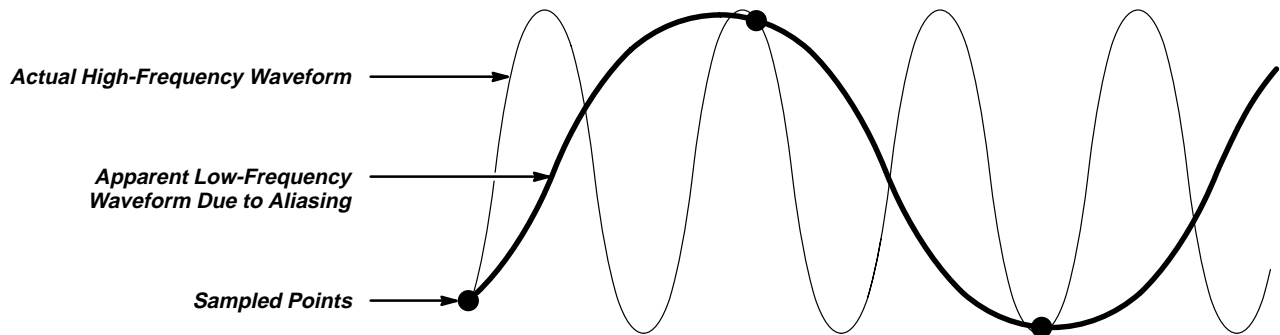

Figure 2-9: Aliasing

One simple way to check for aliasing is to slowly change the horizontal scale (time per division setting). If the shape of the displayed waveform changes drastically, you may have aliasing.

In order to represent a signal accurately and avoid aliasing, you must sample the signal more than twice as fast as the highest frequency component. For example, a signal with frequency components of 500 MHz would need to be sampled at a rate faster than 1 Gigasamples/second.

There are various ways to prevent aliasing. Try adjusting the horizontal scale, or simply press the **AUTOSET** button. You can also counteract some aliasing by changing the acquisition mode in the Acquisition menu. For example, if you are using the sample mode and suspect aliasing, you may want to change to the peak detect mode. Since the peak detect mode searches for samples with the highest and lowest values, it can detect faster signal components over time.

Delayed Time Base

You can set a main time base and a delayed time base. Each time base has its own trigger. There are two types of delayed time base acquisitions, with each based on its triggering relationship to the main time base. These are delayed runs after main and delay triggerable (after time, events, or both) acquisitions.

The delayed time base is useful in catching events that follow other events. See *Triggering* on page 2-2 for more information on the delayed trigger.

Zoom

You can use zoom to see more detail without changing the acquired signal. When you press the **ZOOM** button, a portion of the waveform record can be expanded or compressed on the display, but the record points stay the same.

Zoom is very useful when you wish to temporarily expand a waveform to inspect small feature(s) on that waveform. For example, you might use zoom to temporarily expand the front corner of a pulse to inspect its aberrations. Use zoom to expand it horizontally and vertically. After you are finished, you can return to your original horizontal scale setting by pressing one menu button. (The zoom feature is also handy if you have acquired a waveform while using the fastest time per division and want to further expand horizontally.)

Autoset

Autoset lets you quickly obtain a stable waveform display. It automatically adjusts a wide variety of settings including vertical and horizontal scaling. Other settings affected include trigger coupling, type, position, slope, mode, and display intensities. *Autoset* on page 3-18 describes in detail what autoset does.

For More Information

See *Autoset*, on page 3-18.

See *Delayed Triggering*, on page 3-25.

See *Horizontal Control*, on page 3-49.

See *Vertical Control*, on page 3-124.

See *Zoom*, on page 3-130.

Measurements

The digitizing oscilloscope not only displays graphs of voltage versus time, it also can help you measure the displayed information (see Figure 2-10).

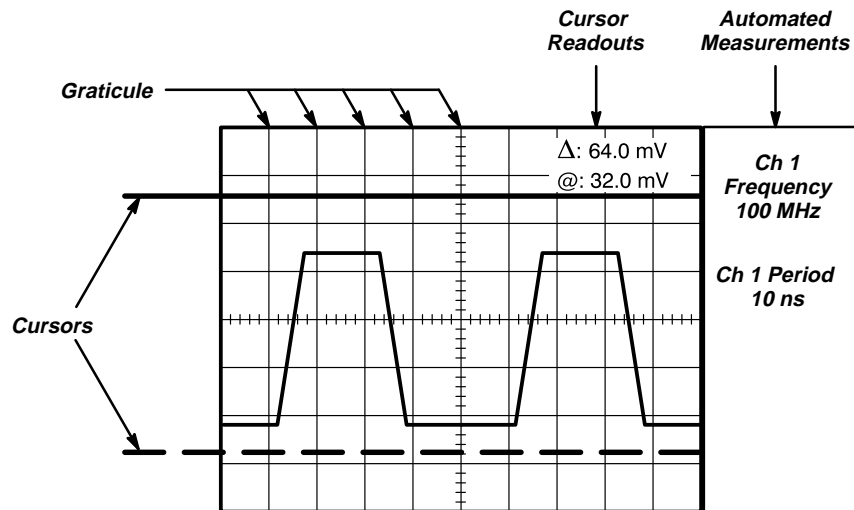

Figure 2-10: Graticule, Cursor and Automated Measurements

Measurement Sources

The oscilloscope provides three measurement classes. They are: graticules, cursors, and automated measurements.

Graticule Measurements

Graticule measurements provide you with quick, visual estimates. For example, you might look at a waveform amplitude and say “it is a little more than 100 mV.”

You can perform simple measurements by counting the number of major and minor graticule divisions involved and multiplying by the scale factor.

For example, if you counted five major vertical graticule divisions between a minimum and maximum values of a waveform and knew you had a scale factor of 100 mV/division, then you could easily calculate your peak-to-peak voltage:

$$5 \text{ divisions} \times 100 \text{ mV/division} = 500 \text{ mV.}$$

Cursor Measurements

Cursors are fast and easy-to-understand measurements. You take measurements by moving the cursors and reading their numeric values from the on screen readouts, which update as you adjust their positions.

Cursors appear in pairs. One part of the pair is *active* and the other *inactive*. You move the active cursor (the solid line) using the general purpose knob. The **TOGGLE** button lets you select (toggle) which cursor bar is active or inactive. The inactive cursor is a dashed line on the display.

To get the cursor menu, press the **CURSOR** button. There are three kinds of cursors available in that menu:

- *Horizontal bar cursors* measure vertical parameters (typically volts).
- *Vertical bar cursors* measure horizontal parameters (typically time or frequency).
- *Paired cursors* measure both vertical parameters (typically volts) and horizontal parameters (typically time or frequency).

There are also two modes for cursor operation available in the cursor menu—*independent* and *tracking*. (See Figure 2-11.)

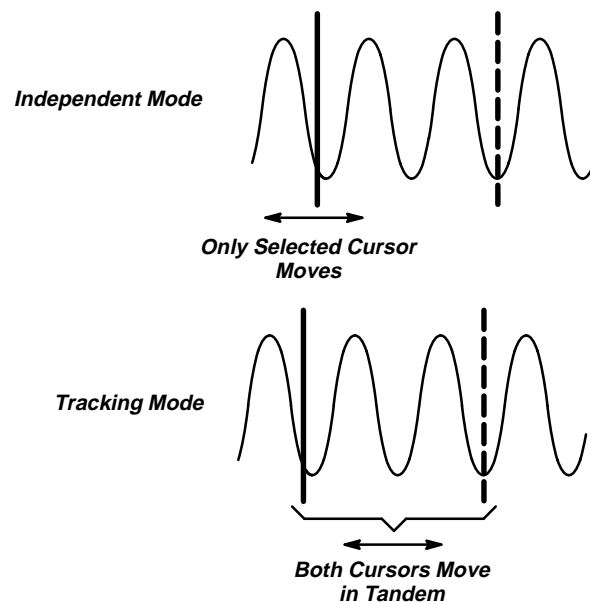

Figure 2-11: Cursor Modes

- *Independent mode* cursors operate as was earlier described; that is, you move *one* cursor at a time (the active cursor) using the general purpose knob, and you use the **TOGGLE** button to toggle which cursor bar is active.

- *Tracking mode* cursors operate in tandem: you move *both* cursors at the same time using the general purpose knob. To adjust the solid cursor relative to the dashed cursor, you push the **TOGGLE** button to suspend cursor tracking and use the general purpose knob make the adjustment. A second push toggles the cursors back to tracking.

You can read more detailed information about how to use cursors in *Cursor Measurements* beginning on page 3-20.

Automated Measurements

You make automated measurements merely by pressing a few buttons. The digitizing oscilloscope does all the calculating for you. Because these measurements use the waveform record points, they are more accurate than cursor or graticule measurements.

Press the **MEASURE** button for the automated measurement menus. These menus let you make *amplitude* (typically in volts; sometimes in %), *time* (typically in seconds or hertz), and *area* (in volt-seconds) measurements. You can select and display up to four measurements at a time. (See Table 3-5 on page 3-66 for a list of all the automatic measurements and their definitions.)

You can make automated measurements on the entire waveform record or just on a specific part. The gating selection in the Measurement menu lets you use the vertical cursors to limit the measurement to a section of the waveform record.

The snapshot selection in the Measurement menu lets you display almost all of the measurements at once. You can read about snapshot under *Snapshot of Measurements* on page 3-75.

Automated measurements use readouts to show measurement status. These readouts are updated as the oscilloscope acquires new data or if you change settings.

For More Information

See *Appendix C: Algorithms*, on page A-25, for details on how the digitizing oscilloscope calculates each automatic measurement.

See *Cursor Measurements*, on page 3-20, for more information on cursor measurements.

See *Measurement System*, on page 3-66, for more information on automatic measurements.

See the *TDS Family Option 2F Instruction Manual* (if your oscilloscope is equipped with that option) for using cursors to measure Fast Fourier Transformed, integrated, or differentiated math waveforms.

See *Tutorial Example 3: Automated Measurements*, on page 1-12.

See *Waveform Math*, on page 3-127, for using cursors to measure math waveforms.

In Detail



Overview

This section describes the details of operating the digitizing oscilloscope.

The first part, *At a Glance*, shows you how the oscilloscope is organized and gives some general operating instructions. It also contains an overview of all the main menus. This part includes the following illustrations: *Front Panel Map*, *Rear Panel Map*, *Display Map*, *Basic Menu Operation*, and *Menu Map*.

The second part contains an alphabetical list of tasks you can perform with the digitizing oscilloscope. Use this section to answer specific questions about instrument operation. The following tasks are included.

- Acquisition Modes
- Autoreset
- Cursor Measurements
- Delayed Triggering
- Display Modes
- Edge Triggering
- Hardcopy
- Help
- Horizontal Control
- Limit Testing
- Logic Triggering
- Measurement System
- Probe Accessories
- Probe Cal
- Probe Compensation
- Pulse Triggering
- Probe Selection
- Remote Communication
- Saving and Recalling Setups
- Saving and Recalling Waveforms
- Selecting Channels
- Signal Path Compensation
- Status
- Triggering
- Vertical Control
- Waveform Math
- Zoom

Many of these tasks list steps you perform to accomplish the task. You should read *Conventions* on page ii of *Welcome* before reading about these tasks.

At a Glance

The *At a Glance* section contains illustrations of the display, the front and rear panels, and the menu system. These will help you understand and operate the digitizing oscilloscope. This section also contains a visual guide to using the menu system.

Front Panel Map— Left Side

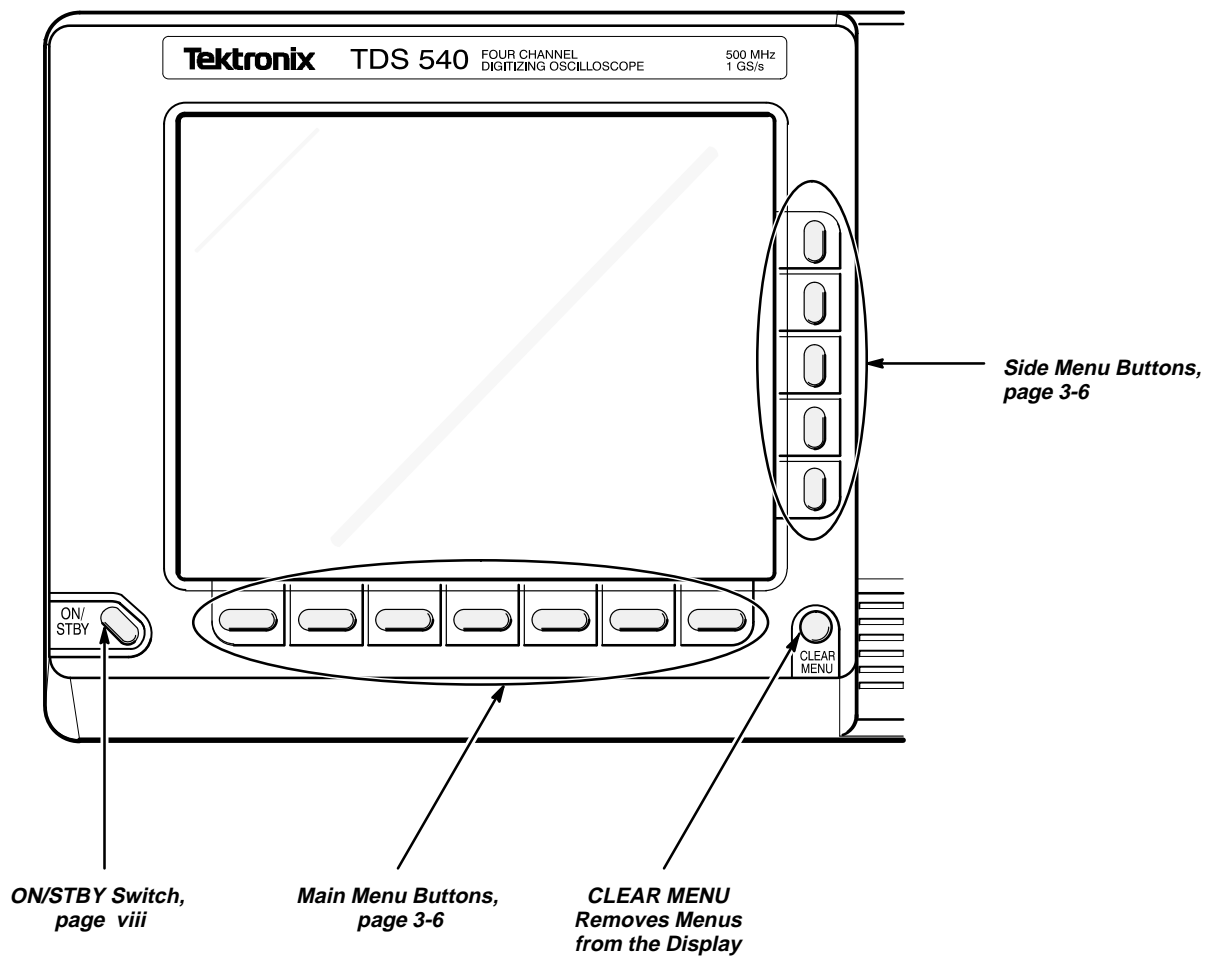

Front Panel Map — Right Side

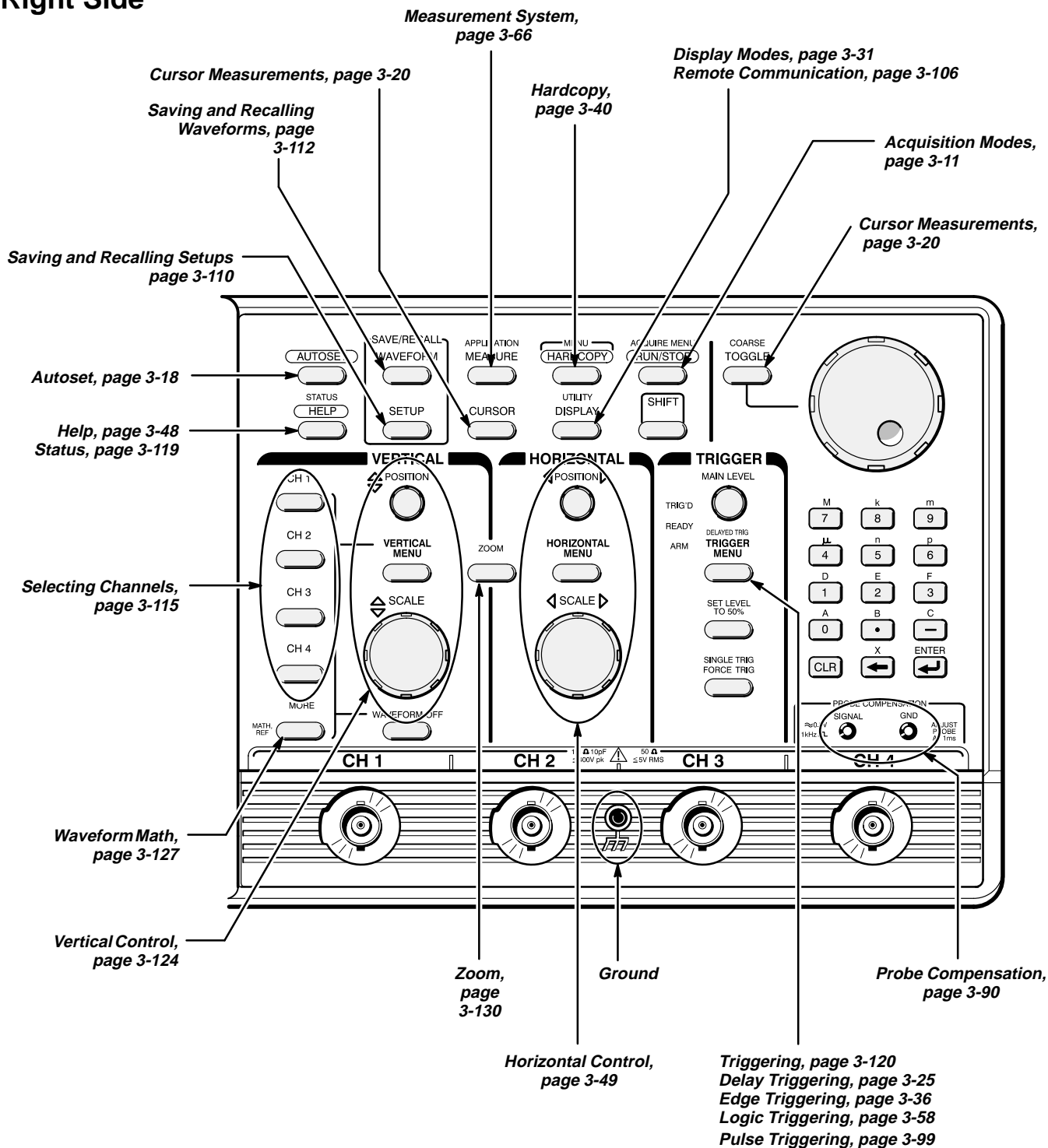

Rear Panel Map

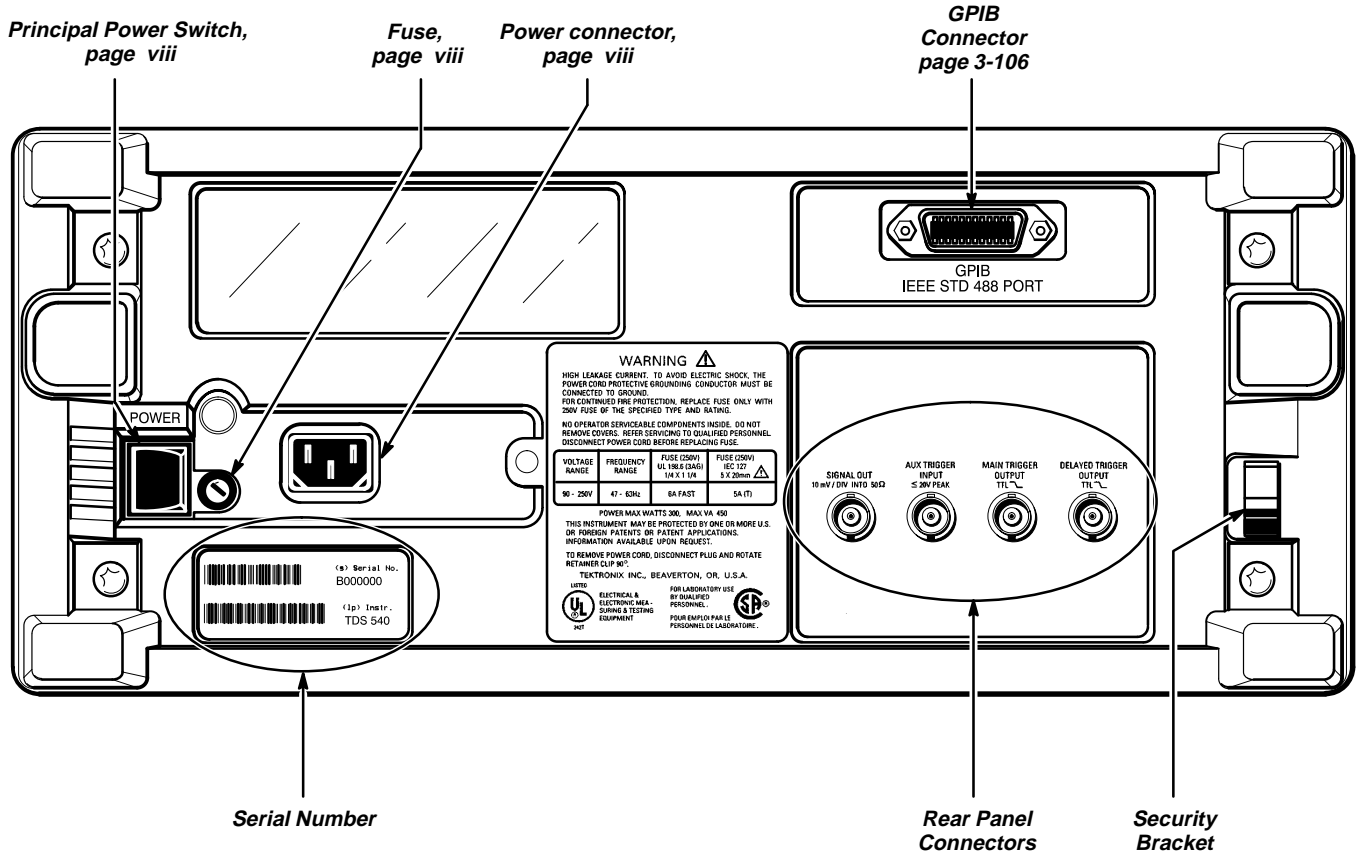

- SIGNAL OUT –**
(Provides analog signal output)
- AUX TRIGGER INPUT –**
(Provides auxiliary trigger signal input)
- MAIN TRIGGER OUTPUT –**
(Provides main trigger (TTL) output)
- DELAYED TRIGGER OUTPUT –**
(Provides delayed trigger (TTL) output)

Display Map

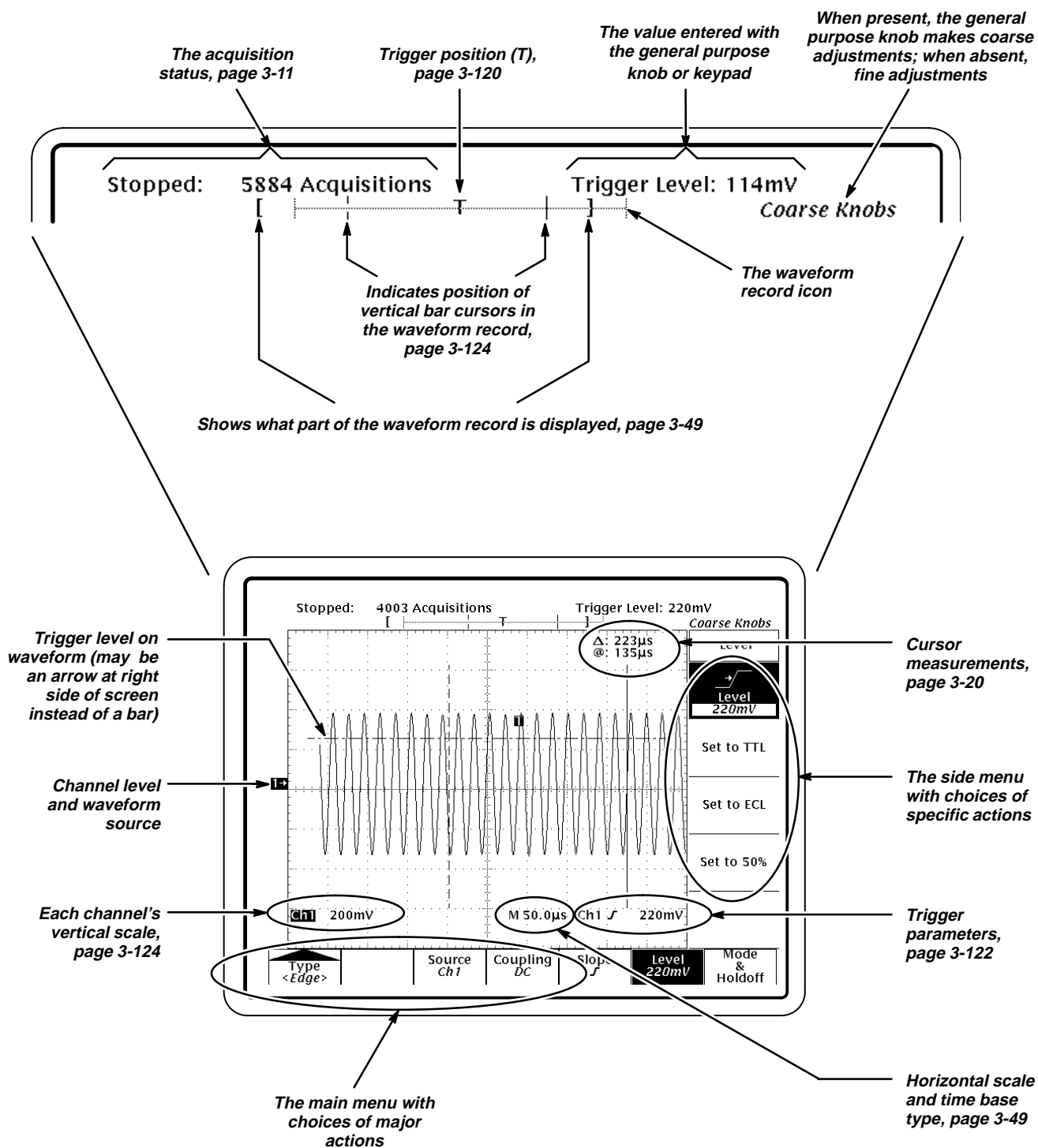

To Operate a Menu

1. Press front-panel menu button.
(Press SHIFT first if button label is blue.)

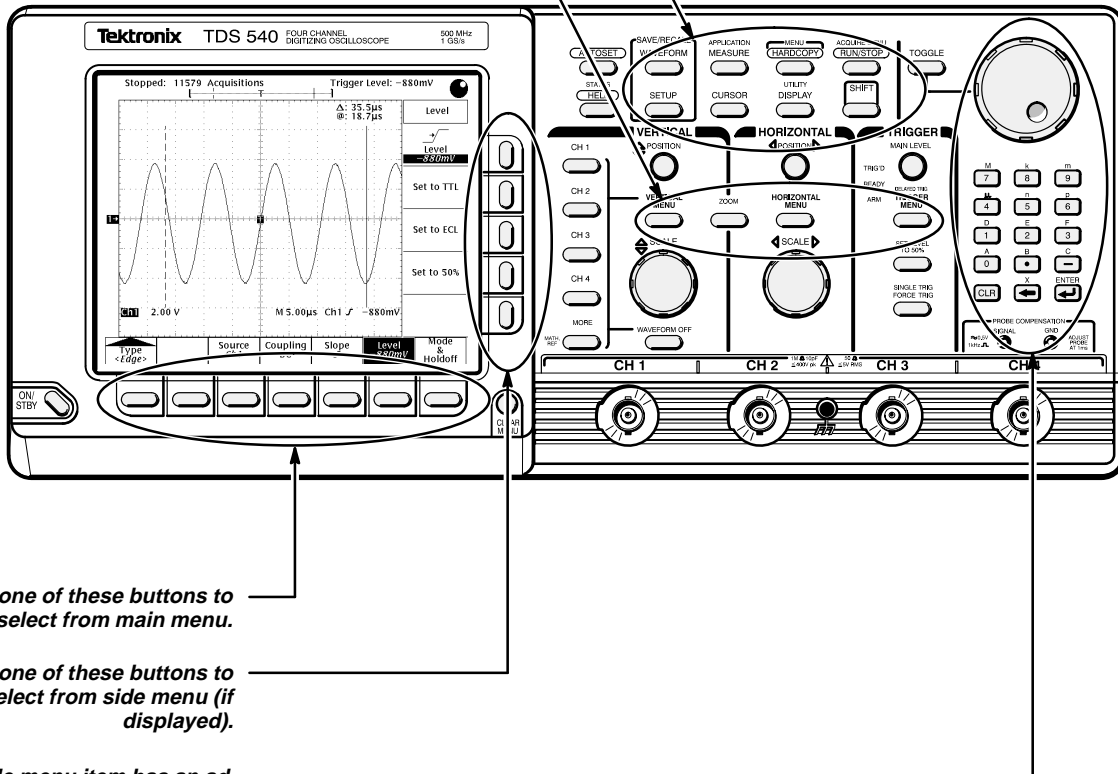

2. Press one of these buttons to select from main menu.

3. Press one of these buttons to select from side menu (if displayed).

4. If side menu item has an adjustable value (shown in reverse video), adjust it with the general purpose knob or keypad.

To Operate a Pop-Up Menu

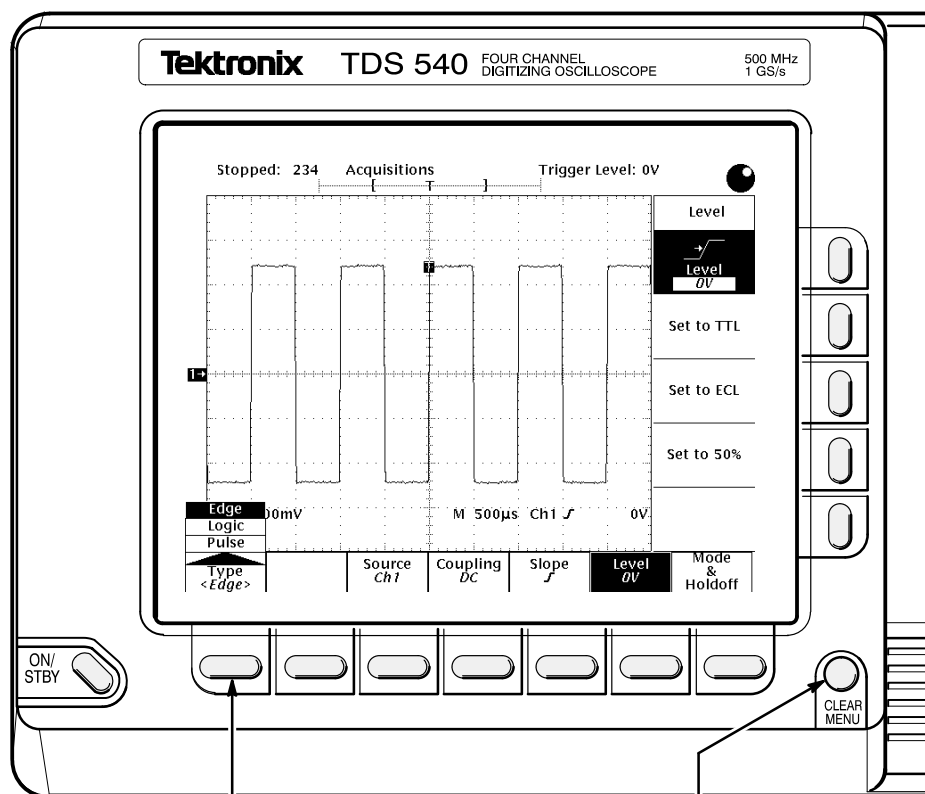

Press to display pop-ups.

Press it again to make selection.

A pop-up selection changes the other main menu titles.

Press here to remove menus from screen.

Menu Map

Press these buttons:

To bring up these menus:

Acquire Menu
(see page 3-11)

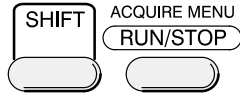

Mode <i>Sample</i>	Repetitive Signal <i>ON</i>	Stop After <i>R/S button</i>		Limit Test Setup	Limit Test Sources	Create Limit Test Template
-----------------------	-----------------------------------	---------------------------------	--	---------------------	-----------------------	----------------------------------

Application Menu
(see the Programmer manual for more details)

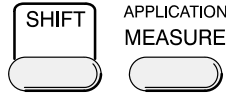

--	--	--	--	--	--	--

Cursor Menu
(see page 3-20)



Function <i>OFF</i>	Mode <i>Indep</i>	Time Units <i>seconds</i>				
------------------------	----------------------	---------------------------------	--	--	--	--

Delayed Trigger Menu
(see page 3-25)

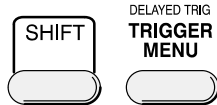

	Delay by <i>Time</i>	Source <i>Ch 1</i>	Coupling <i>DC</i>	Slope <i>f</i>	Level <i>-30mV</i>	
--	-------------------------	-----------------------	-----------------------	-------------------	-----------------------	--

Display Menu
(see page 3-31)



Style <i>Vectors</i>	Intensity	Readout Options	Filter <i>Sin(x)/x</i>	Graticule <i>Full</i>	Format <i>VT</i>	
-------------------------	-----------	--------------------	---------------------------	--------------------------	---------------------	--

Hardcopy Menu
(see page 3-40)

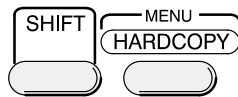

Format <i>Interleaf</i>	Layout <i>Portrait</i>	Port <i>GPIO</i>	Clear Spool			
----------------------------	---------------------------	---------------------	----------------	--	--	--

Horizontal Menu
(see page 3-49)



Time Base <i>Main</i>	Trigger Position <i>50%</i>	Record Length <i>500</i>	Horiz Scale <i>(/div)</i>	Horiz Pos		
--------------------------	-----------------------------------	--------------------------------	---------------------------------	--------------	--	--

Press these buttons:

To bring up these menus:

Main Trigger Menu – Edge
(see page 3-36)



Type <Edge>	Source Ch1	Coupling DC	Slope F	Level -30mV	Mode & Holdoff
----------------	---------------	----------------	------------	----------------	----------------------

Main Trigger Menu – Logic
(see page 3-58)



Type <Logic>	Class <Pattern>	Define Inputs	Define Logic AND	Trigger When Goes TRUE	Set Thresholds	Mode & Holdoff
-----------------	--------------------	------------------	------------------------	------------------------------	-------------------	----------------------

Main Trigger Menu –Pulse
(see page 3-99)



Type <Pulse>	Class <Glitch>	Source Ch1	Polarity & Width	Glitch Accept	Level 240.0mV	Mode & Holdoff
-----------------	-------------------	---------------	------------------------	------------------	------------------	----------------------

Measure Menu
(see page 3-66)



Select Measrmt for Ch1	Remove Measrmt	Gating OFF	High-Low Setup Histogram	Reference Levels	Snapshot	
------------------------------	-------------------	---------------	--------------------------------	---------------------	----------	--

More Menu
(see page 3-127)



Math1 Ch1+Ch2	Math2 Ch1-Ch2	Math3 inv(Ch1)	Ref1	Ref2	Ref3	Ref4
------------------	------------------	-------------------	------	------	------	------

Save/Recall Setup Menu
(see page 3-110)



Save Current Setup	Recall Saved Setup	Recall Factory Setup				
--------------------------	--------------------------	----------------------------	--	--	--	--

Save/Recall Waveform Menu
(see page 3-112)

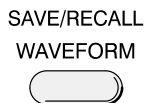

Save Waveform Math1	Recall Waveform	Delete Refs				
---------------------------	--------------------	----------------	--	--	--	--

Status Menu
(see page 3-119)

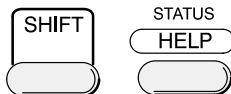

Status Snapshot
System
Trigger
Waveforms
I/O

Press these buttons:

To bring up these menus:

Utility Menu – Calibration
(see page 3-117)

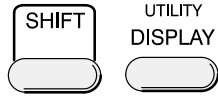

System <Cal>	Signal Path Pass	Voltage Reference Pass	Frequency Response Pass	Pulse Trigger Pass		
-----------------	---------------------	---------------------------	----------------------------	-----------------------	--	--

Utility Menu – Config
(see pages 3-111 and 3-43)

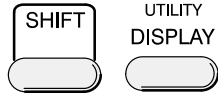

System <Config>	Tek Secure Erase Memory	Set Date & Time				
--------------------	----------------------------	--------------------	--	--	--	--

Utility Menu – Diagnostics
(see the Service manual)

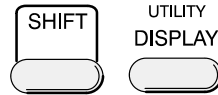

System <Diag/Err>	Area <All Areas>	Tests Select All	Execute	Loop Once		Error Log
----------------------	---------------------	---------------------	---------	--------------	--	--------------

Utility Menu – I/O
(see page 3-106)

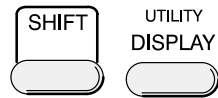

System <I/O>	Port <GPIB>	Configure Talk/Listen				
-----------------	----------------	--------------------------	--	--	--	--

Vertical Channel Menu
(see page 3-124)

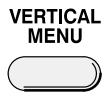

Coupling bc	Bandwidth Full	Fine Scale 10.0mV /div	Position 0 div	Offset 0 V		Cal Probe Initialized
----------------	-------------------	------------------------------	-------------------	---------------	--	--------------------------

Zoom Menu
(see page 3-130)



Zoom
OFF
ON
Horizontal Lock Live
Reset Zoom Factors



Acquisition Modes

The acquisition system has several options for converting analog data into digital form. The Acquisition menu lets you determine the acquisition mode, whether or not to permit equivalent time sampling, and how to start and stop acquisitions.

Description of Modes

The digitizing oscilloscope supports five acquisition modes.

- *Sample*
- *Peak Detect*
- *Hi Res*
- *Envelope*
- *Average*

The Sample, Peak Detect, and Hi Res modes operate in real-time on a single trigger event, provided the digitizing oscilloscope can acquire enough samples for each trigger event. Envelope and Average modes operate on multiple acquisitions. The digitizing oscilloscope averages or envelopes several waveforms on a point-by-point basis.

Figure 3-1 illustrates the different modes and lists the benefits of each. It will help you select the appropriate mode for your application.

Sample Mode



In Sample mode, the oscilloscope creates a record point by saving the first sample (of perhaps many) during each acquisition interval. (An acquisition interval is the time covered by the waveform record divided by the record length.) This is the default mode.

Peak Detect Mode



Peak Detect mode alternates between saving the highest sample in one acquisition interval and lowest sample in the next acquisition interval. That mode only works with real-time, non-interpolated sampling.

If you set the time base so fast that it requires real-time interpolation or equivalent-time sampling, the mode automatically changes from Peak Detect to Sample, although the menu selection will not change.

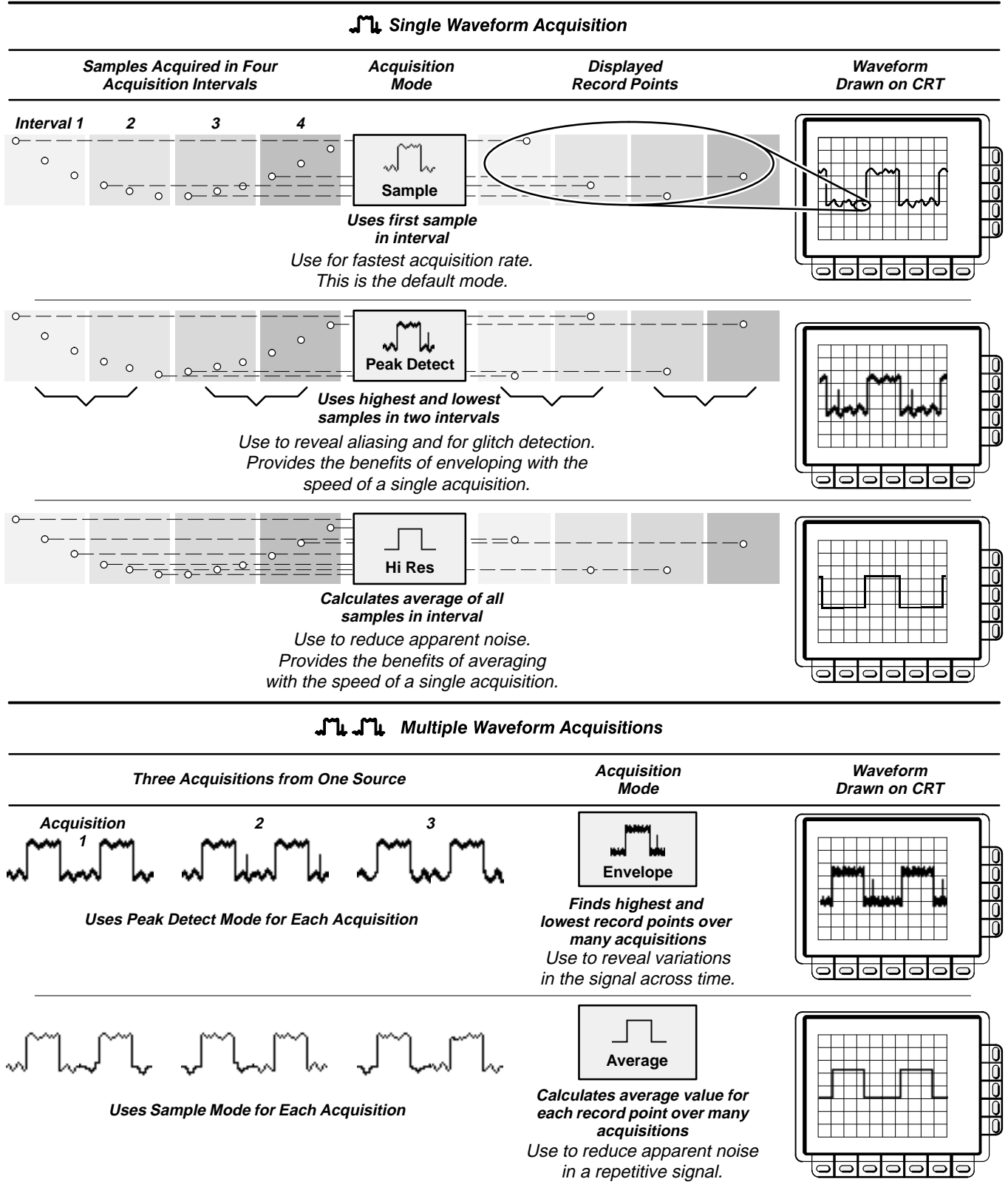

Figure 3-1: How the Acquisition Modes Work

Hi Res Mode



In Hi Res mode, the digitizing oscilloscope averages all samples taken during an acquisition interval to create a record point. That average results in a higher-resolution, lower-bandwidth waveform.

This mode only works with real-time, non-interpolated sampling. If you set the time base so fast that it requires real-time interpolation or equivalent-time sampling, the mode automatically becomes Sample, although the menu selection will not change.

A key advantage of Hi Res is its potential for increasing resolution regardless of the input signal. Table 3-1 and the equations shown below illustrate how you can obtain up to 15 significant bits with Hi res mode. Note that the resolution improvements are limited to speeds slower than 400 ns/div. Also, resolutions above 15 bits are not allowed by internal hardware and computation limitations.

$$S_i = \text{Sampling Interval for TDS 500} = 4 \text{ ns}$$

$$\Delta t = \text{Sample Interval} = \frac{\text{Time/Div}}{\text{Number Of Points/Div}} = \frac{5 \mu\text{s/Div}}{50 \text{ Points/Div}} = 100 \text{ ns}$$

$$N_d = \text{Number of points per decimation interval} = \frac{\Delta t}{S_i} = 25$$

$$\text{Resolution Enhancement (bits)} = 0.5 \times \text{LOG}_2(N_d) \approx 2 \text{ extra bits}$$

Table 3-1: Additional Resolution Bits

Time Base Speed	Bits of Resolution
400 ns and faster	8 bits
1 μs to 2 μs	9 bits
5 μs to 10 μs	10 bits
20 μs to 50 μs	11 bits
100 μs to 200 μs	12 bits
500 μs	13 bits
1 ms to 2 ms	14 bits
5 ms and slower	15 bits

Envelope Mode



Envelope mode lets you acquire and display a waveform record that shows the extremes in variation over several acquisitions. You specify the number of acquisitions over which to accumulate the data. The oscilloscope saves the highest and lowest values in two adjacent intervals similar to the Peak Detect mode. But Envelope mode, unlike Peak Detect, gathers peaks over many trigger events.

After each trigger event, the oscilloscope acquires data and then compares the min/max values from the current acquisition with those stored from previous acquisitions. The final display shows the most extreme values for all the acquisitions for each point in the waveform record.

Average Mode



Average mode lets you acquire and display a waveform record that is the averaged result of several acquisitions. This mode reduces random noise. The oscilloscope acquires data after each trigger event using Sample mode. It then averages the record point from the current acquisition with those stored from previous acquisitions.

Acquisition Readout

The acquisition readout at the top of the display (Figure 3-2) shows the state of the acquisition system (running or stopped). The “running” state shows the sample rate and acquisition mode. The “stopped” state shows the number of acquisitions acquired since the last stop or major change.

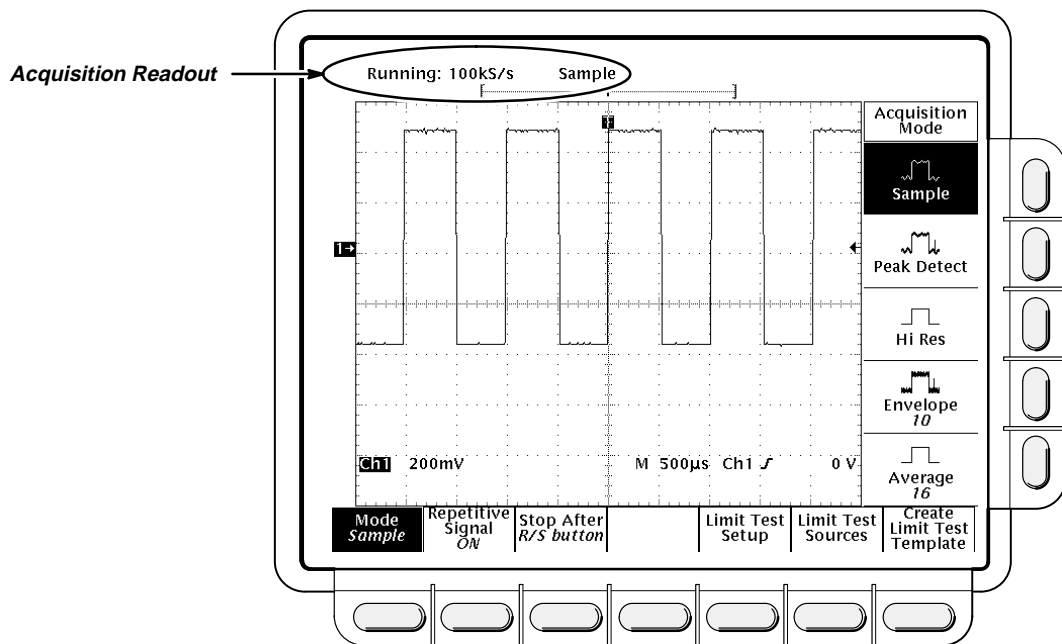

Figure 3-2: Acquisition Menu and Readout

Operation

To bring up the acquisition menu (Figure 3-2) press **SHIFT ACQUIRE MENU**.

Acquisition Mode

To choose how the digitizing oscilloscope will create points in the waveform record:

Press **SHIFT ACQUIRE MENU** → **Mode** (main) → **Sample, Peak Detect, Hi Res, Envelope, or Average** (side).

When you select **Envelope** or **Average**, you can enter the number of waveform records to be enveloped or averaged using the keypad or the general purpose knob.

NOTE

If you selected the longest record length available in the Horizontal menu, then you cannot select Hi Res as your acquisition mode. This is because Hi Res mode uses twice the acquisition memory that the other acquisition modes use. If Hi Res and the longest horizontal record length were allowed to be selected at the same time, the oscilloscope would run out of memory.

Repetitive Signal

To limit the digitizing oscilloscope to real-time sampling or let it choose between real-time or equivalent-time sampling:

Press **SHIFT ACQUIRE MENU** → **Repetitive Signal** (main) → **ON or OFF** (side).

- **OFF (Real Time Only)** uses both the real time and the equivalent time features of the digitizing oscilloscope.
- **OFF (Real Time Only)** limits the digitizing oscilloscope to real time sampling. If the digitizing oscilloscope cannot accurately get enough samples for a complete waveform, the oscilloscope will use the interpolation method selected in the display menu to fill in the missing record points. That is, it will use either the linear or $\sin(x)/x$ interpolation algorithm.

See *Acquisition* on page 2-7 for details about sampling.

Stop After

You can choose to acquire exactly one waveform sequence or to acquire waveforms continuously under manual control.

Press **SHIFT ACQUIRE MENU** → **Stop After** (main) → **RUN/STOP button only, Single Acquisition Sequence, or Limit Test Condition Met** (side) (see Figure 3-3).

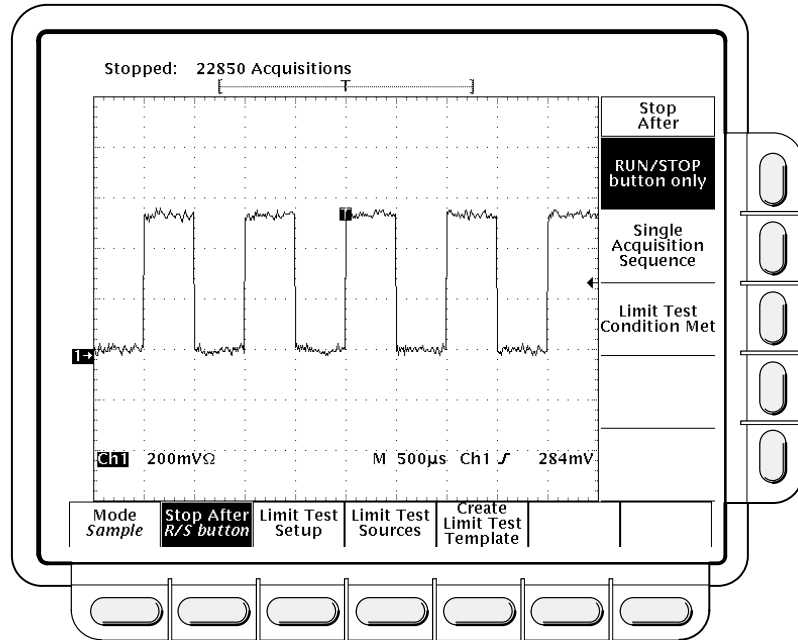

Figure 3-3: Acquire Menu—Stop After

- **RUN/STOP button only** (side) lets you start or stop acquisitions by toggling the **RUN/STOP** button. Pressing the **RUN/STOP** button once will stop the acquisitions. The upper left hand corner in the display will say **Stopped** and show the number of acquisitions. If you press the button again, the digitizing oscilloscope will resume taking acquisitions.
- Press **Single Acquisition Sequence** (side). That selection lets you run a single sequence of acquisitions by pressing the **RUN/STOP** button. In Sample, Peak Detect, or Hi Res mode, the instrument will acquire a waveform record with the first valid trigger event and stop.

In Envelope or Average mode, the digitizing oscilloscope will make the specified number of acquisitions to complete the averaging or enveloping task.

If the oscilloscope is in equivalent-time mode and you press **Single Acquisition Sequence** (side), it will continue to recognize trigger events and acquire samples until the waveform record is filled.

Hint: To quickly select Single Acquisition Sequence without displaying the Acquire and Stop After menus, press **SHIFT FORCE TRIG**. Now the **RUN/STOP** button operates as just described. (You still must display the Acquire menu and then the Stop After menu to leave Single Acquisition Sequence operation.)

- **Limit Test Condition Met** (side) lets you acquire waveforms until waveform data exceeds the limits specified in the limit test. Then acquisition stops. At that point, you can also specify other actions for the oscilloscope to take, using the selections available in the **Limit Test Setup** main menu.

NOTE

*In order for the digitizing oscilloscope to stop acquisition when limit test conditions have been met, limit testing must be turned **ON**, using the **Limit Test Setup** main menu.*

Setting up limit testing requires several more steps. You can create the template waveform against which to compare incoming waveforms, using the **Create Limit Test Template** main menu item. You can then specify that the comparison is to be made, and the channel to compare against the template, using the **Limit Test Sources** main menu item.

**For More
Information**

See *Acquisition*, on page 2-7.

See *Limit Testing*, on page 3-53.



Autoset

The autoset function lets you quickly obtain and display a stable waveform of usable size. Autoset automatically sets up the front panel controls based on the characteristics of the input signal. It is much faster and easier than a manual control-by-control setup.

Autoset makes adjustments in these areas:

- Acquisition
- Display
- Horizontal
- Trigger
- Vertical

NOTE

Autoset may change vertical position in order to position the waveform appropriately. It always sets vertical offset to 0 V.

Operation

1. Press the Channel Selection button (such as **CH 1**) corresponding to your input channel to make it active.
2. Press **AUTOSET**.

If you use autoset when one or more channels are displayed, the digitizing oscilloscope selects the lowest numbered channel for horizontal scaling and triggering. Vertically, all channels in use are individually scaled.

If you use autoset when no channels are displayed, the digitizing oscilloscope will turn on channel one (**CH 1**) and scale it.

Autoset Defaults

Table 3-2 on the following page lists the autoset defaults.

Table 3-2: Autoset Defaults

Control	Changed by Autoset to
Selected channel	Numerically lowest of the displayed channels
Acquire Mode	Sample
Acquire Repetitive Signal	On
Acquire Stop After	RUN/STOP button only
Display Style	Vectors
Display Intensity—Overall	If less than 50%, set to 75%
Display Format	YT
Horizontal Position	Centered within the graticule window
Horizontal Scale	As determined by the signal frequency
Horizontal Time Base	Main Only
Horizontal Record Length	Unchanged
Limit Test	Off
Trigger Position	Unchanged
Trigger Type	Edge
Trigger Source	Numerically lowest of the displayed channels (the selected channel)
Trigger Level	Midpoint of data for the trigger source
Trigger Slope	Positive
Trigger Coupling	DC
Trigger Holdoff	0
Vertical Scale	As determined by the signal level
Vertical Coupling	DC unless AC was previously set. AC remains unchanged.
Vertical Bandwidth	Full
Vertical Offset	0 volts
Zoom	Off

Cursor Measurements

Use the cursors to measure the difference (either in time or voltage) between two locations in a waveform record.

Description

Cursors are made up of two markers that you position with the general purpose knob. You move one cursor independently or both cursors in tandem, depending on the cursor mode. As you position the cursors, readouts on the display report measurement information.

There are three cursor types: *horizontal bar*, *vertical bar*, and *paired* (Figure 3-4).

Horizontal bar cursors measure vertical parameters (typically volts).

Vertical bar cursors measure horizontal parameters (typically time or frequency).

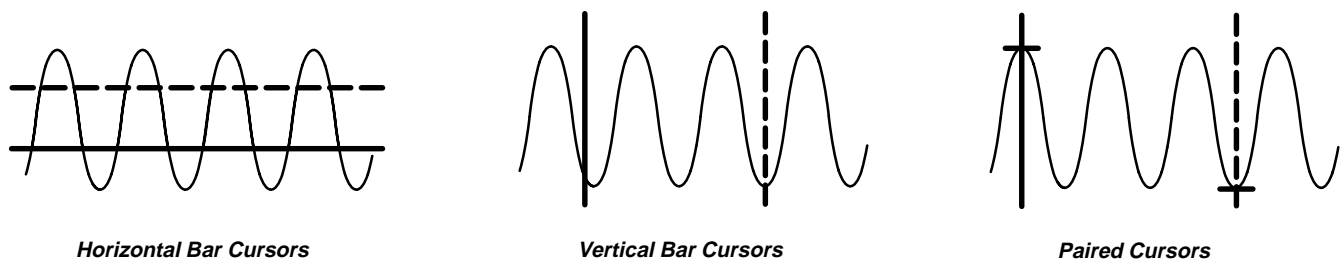

Figure 3-4: Cursor Types

Paired cursors measure both vertical parameters (typically volts) and horizontal parameters (typically time) simultaneously.

Look at Figure 3-4. Note that each of the two paired cursors has a long vertical bar paired with a short horizontal bar. The short horizontal bars measure vertical parameters (typically volts); the long vertical bars measure horizontal parameters (typically time or frequency). (See *Cursor Readouts* on page 3-21 for more information.)

NOTE

When cursors measure certain math waveforms, the measurement may not be of time, frequency, or voltage. Cursor measurement of those math waveforms that are not of time, frequency or voltage is described in *Waveform Math*, which begins on page 3-127. For those oscilloscopes equipped with Option 2F, the advanced DSP math option, the instruction manual shipped with the option describes the use of cursors to measure such waveforms and the measurement units that result.

There are two cursor modes: *independent* and *tracking*.

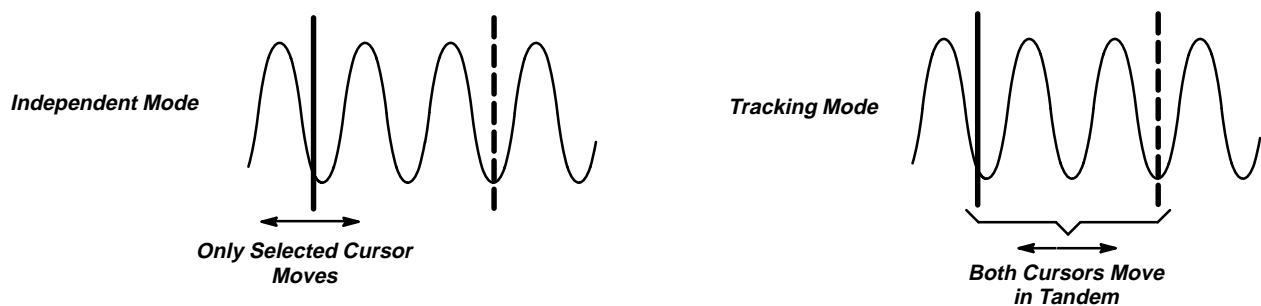

Figure 3-5: Cursor Modes

In independent mode you move only one cursor at a time using the general purpose knob. The active, or selected, cursor is a solid line. Press **TOGGLE** to change which cursor is selected.

In tracking mode you normally move both cursors in tandem using the general purpose knob. The two cursors remain a fixed distance (time or voltage) from each other. Press **TOGGLE** to temporarily suspend cursor tracking. You can then use the general purpose knob to adjust the distance of the solid cursor relative to the dashed cursor. A second push toggles the cursors back to tracking.

Cursor Readouts

The cursor readout shows the absolute location of the selected cursor and the difference between the selected and non-selected cursor. The readouts differ depending on whether you are using **H Bars** or **V Bars**.

- **H Bars:** the value after Δ shows the voltage difference between the cursors. The value after @ shows the voltage of the selected cursor relative to ground (see Figure 3-6).
- **V Bars:** the value after Δ shows the time (or frequency) difference between the cursors. The value after @ shows the time (frequency) of the selected cursor relative to the trigger point.

- Paired:** the value after one Δ shows the voltage difference between the two short horizontal bars; the other Δ shows the time (or frequency) difference between the two long vertical bars. The value after @ shows the voltage at the short horizontal bar of the selected cursor relative to ground (see Figure 3-7).

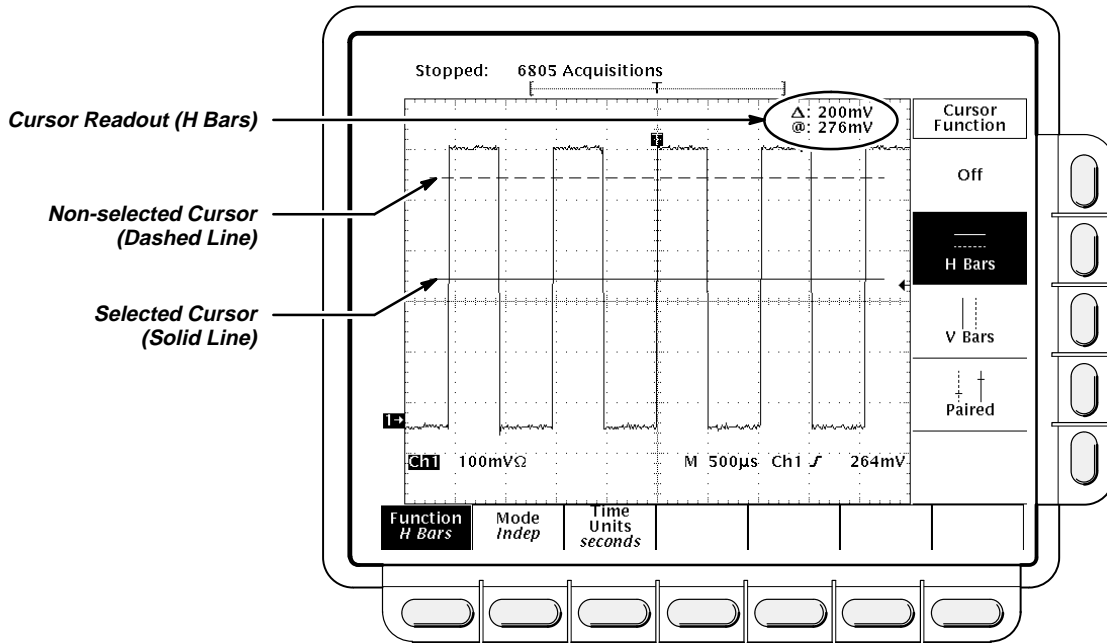

Figure 3-6: H Bars Cursor Menu and Readouts

Paired cursors can only show voltage differences when they remain on screen. If the paired cursors are moved off screen horizontally, **Edge** will replace the voltage values in the cursor readout.

Operation

To take cursor measurements, press **CURSOR** to display the Cursor menu (Figure 3-6).

Function

Select the type of cursors you want using the **Function** menu item:

Press **CURSOR** → **Function** (main) → **H Bars**, **V Bars**, **Paired**, or **Off** (side).

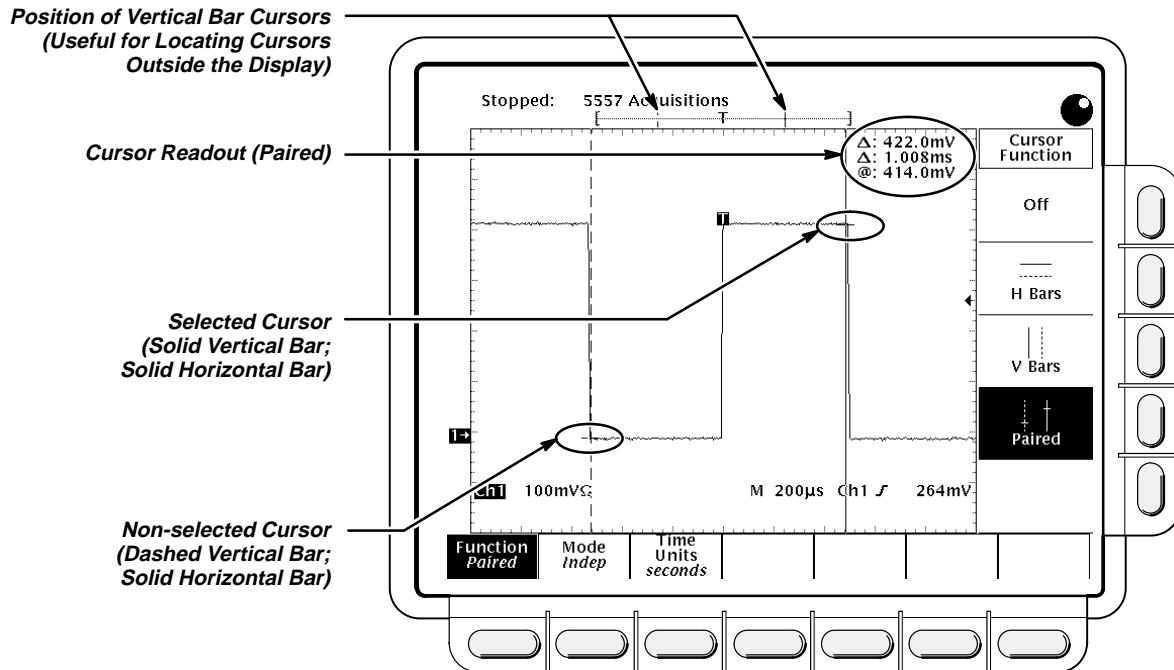

Figure 3-7: Paired Cursor Menu and Readouts

Mode

Select the cursor mode you want using the **Mode** menu item.

- Press **CURSOR** → **Mode** (main) → **Independent** or **Tracking** (side):
 - **Independent** makes each cursor positionable without regard to the position of the other cursor.
 - **Tracking** makes both cursors positionable in tandem; that is, both cursors move in unison and maintain a fixed horizontal or vertical distance between each other.
- Use the general purpose knob to move the selected (active) cursor if **Independent** was selected in step 1. Press **TOGGLE** to change which cursor is active and moves. A solid line indicates the active cursor and a dashed line the inactive cursor.

or

Use the general purpose knob to move both cursors in tandem if **Tracking** was selected in step 1. Press **TOGGLE** to temporarily suspend cursor tracking; then use the general purpose knob to adjust the distance of the solid cursor relative to the dashed cursor. Press **TOGGLE** again to resume tracking. A solid line indicates the adjustable cursor and a dashed line the fixed cursor.

Time Units

You can choose to display vertical bar cursor results in units of time or frequency.

Press **CURSOR** → **Time Units** (main) → **seconds** or **1/seconds (Hz)** (side).

Cursor Speed

You can change the cursors speed by pressing **SHIFT** before turning the general purpose knob. The cursor moves faster when the **SHIFT** button is lighted and the display reads **Coarse Knobs** in the upper right corner.

For More Information

See *Measurements*, on page 2-17.

See *Waveform Math*, on page 3-127, for information on cursor units with multiplied waveforms.

See the *TDS Family Option 2F Instruction Manual*, if your oscilloscope is equipped with the advanced DSP math option, for information on cursor units with integrated, differentiated, and FFT waveforms.

Delayed Triggering

The TDS 500 Series oscilloscopes provide a main time base and a delayed time base. The delayed time base, like the main time base, requires a trigger signal and an input source dedicated to that signal. You can only use delay with the edge trigger and certain classes of pulse triggers.

There are two different ways to delay the acquisition of waveforms: *delayed runs after main* and *delayed triggerable*. Only delayed triggerable uses the delayed trigger system.

Delayed runs after main looks for a main trigger, then waits a user-defined time, and then starts acquiring (see Figure 3-8).

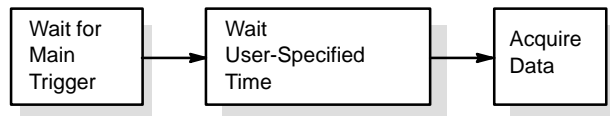

Figure 3-8: Delayed Runs After Main

Delayed triggerable looks for a main trigger and then, depending on the type of delayed trigger selected, makes one of the three types of delayed triggerable mode acquisitions listed below (see Figure 3-9).

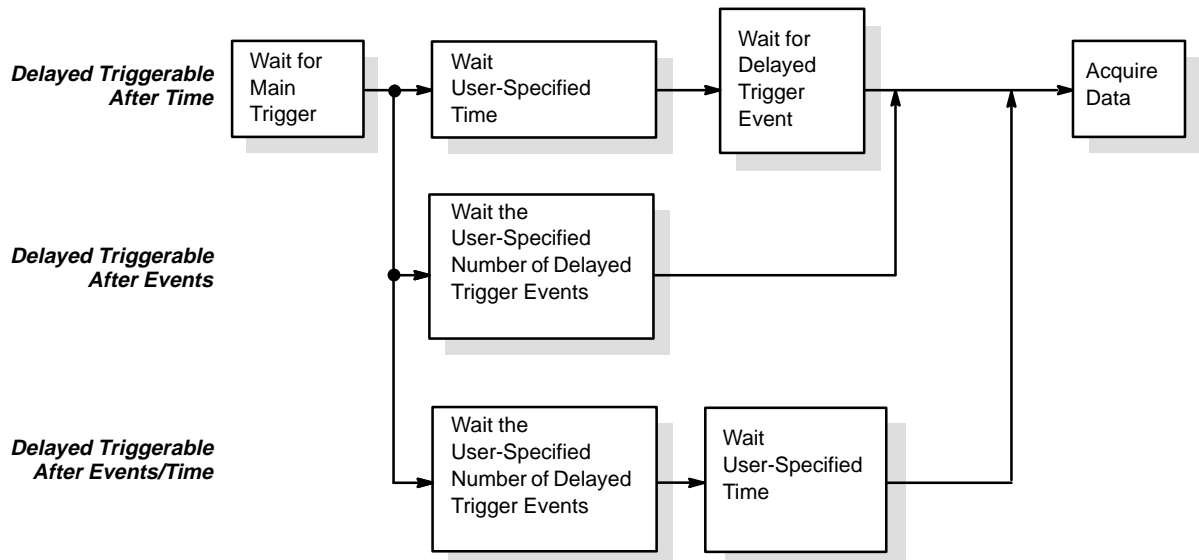

Figure 3-9: Delayed Triggerable

- *After Time* waits the user-specified time, then waits for the next delayed trigger event, then acquires.
- *After Events* waits for the specified number of delayed trigger events and then acquires.
- *After Events/Time* waits for the specified number of delayed trigger events, then waits the user-specified time, then acquires.

The digitizing oscilloscope is always acquiring samples to fill the pretrigger part of the waveform record. When and if delay criteria are met, it takes enough posttrigger samples to complete the delayed waveform record and then displays it. Refer to Figure 3-10 for a more detailed look at how delayed records are placed in time relative to the main trigger.

NOTE

When using the delayed triggerable mode, the digitizing oscilloscope provides a conventional edge trigger for the delayed time base. The delayed time base will not trigger if the main trigger type (as defined in the Main Trigger menu) is logic, if the main trigger type is edge with its source set to auxiliary (TDS 540), or if the main trigger type is pulse with the runt trigger class selected.

Operation

You use the Horizontal menu to select and define either delayed runs after main or delayed triggerable. Delayed triggerable, however, requires further selections in the Delayed Trigger menu.

Delayed Runs After Main

1. Press **HORIZONTAL MENU** → **Time Base** (main) → **Delayed Only** (side) → **Delayed Runs After Main** (side). Use the general purpose knob or the keypad to set the delay time.

If you press **Intensified** (side), you display an intensified zone on the main timebase record that shows where the delayed timebase record occurs relative to the main trigger. For Delayed Runs After Main mode, the start of the intensified zone corresponds to the start of the delayed timebase record. The end of the zone corresponds to the end of the delayed record.

To learn how to define the intensity level of the normal and intensified waveform, see *Display Modes* on page 3-31.

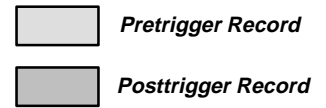

Delayed Runs After Main

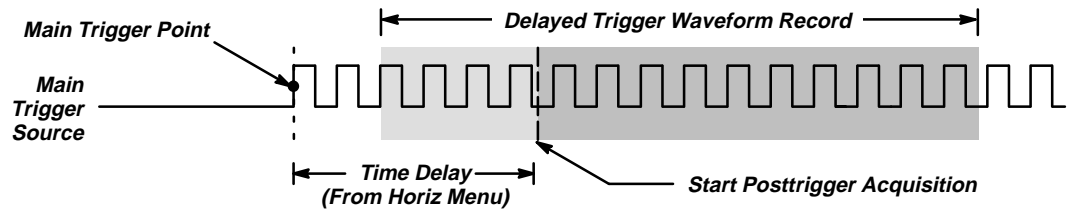

Delayed Triggerable By Events

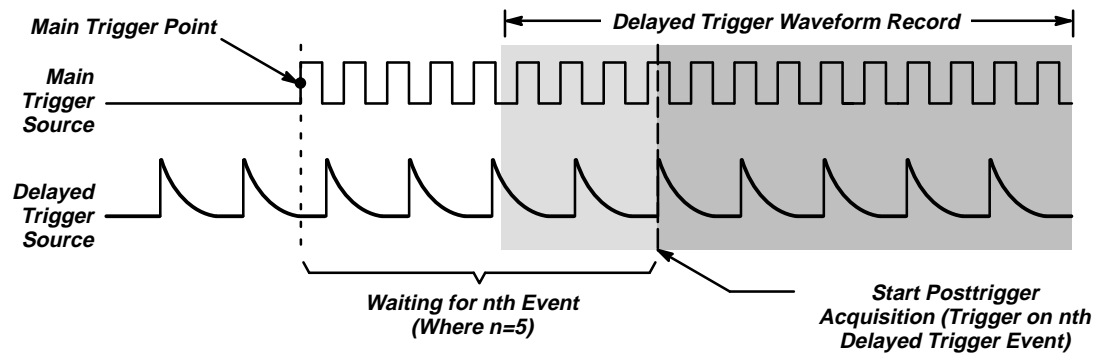

Delayed Triggerable By Time

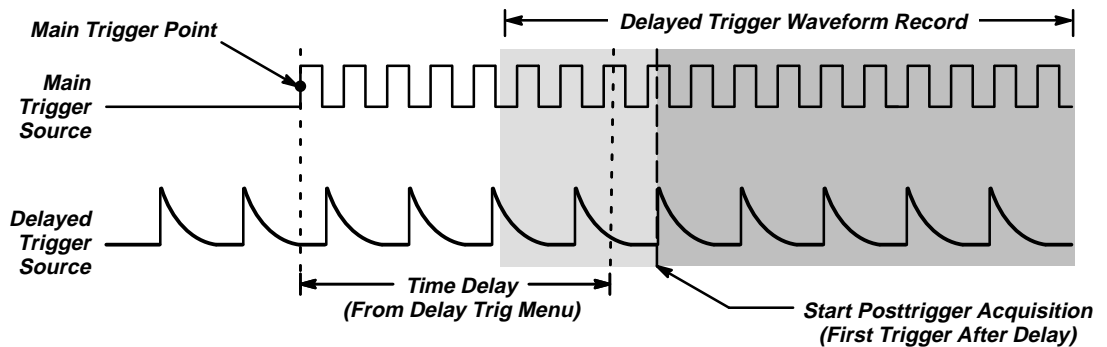

Delayed Triggerable By Events/Time

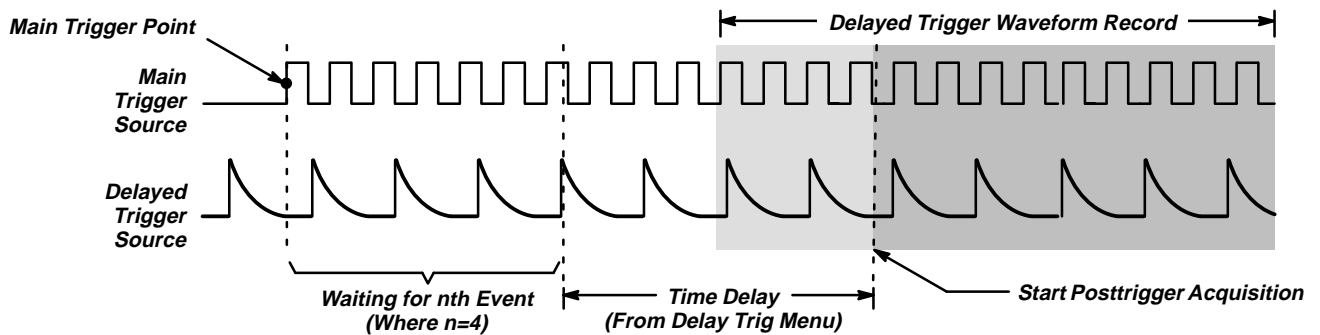

Figure 3-10: How the Delayed Triggers Work

Delayed Triggerable

You must make sure that the Main Trigger menu settings are compatible with Delayed Triggerable.

1. Press **TRIGGER MENU**.
2. If **Type** is set to **Logic**, press **Type** (main) to toggle it to either **Edge** or **Pulse** as fits on your application. Logic type is incompatible with Delayed Triggerable.
3. If **Source** is set to **Auxiliary** (applies to TDS 540 models only), press **Source** (main). Select any source other than Auxiliary from the side menu according to your application.
4. Press **HORIZONTAL MENU** → **Time Base** (main) → **Delayed Only** (side) → **Delayed Triggerable** (side).

NOTE

The Delayed Triggerable menu item is not selectable unless incompatible Main Trigger menu settings are eliminated. (See the steps at the beginning of this procedure.) If such is the case, the Delayed Triggerable menu item is dimmer than other items in the menu.

By pressing **Intensified** (side), you can display an intensified zone that shows where the delayed timebase record *may* occur (a valid delay trigger event must be received) relative to the main trigger on the main timebase. For Delayed Triggerable After mode, the start of the intensified zone corresponds to the possible start point of the delayed timebase record. The end of the zone continues to the end of main timebase, since a delayed time base record may be triggered at any point after the delay time elapses.

To learn how to define the intensity level of the normal and intensified waveform, see *Display Modes* on page 3-31.

Now you need to bring up the Delayed Trigger menu so you can define the delayed trigger event.

5. Press **SHIFT DELAYED TRIG** → **Delay by** (main) → **Triggerable After Time, Events, or Events/Time** (side) (Figure 3-11).
6. Enter the delay time or events using the general purpose knob or the keypad. If you selected **Events/Time**, use **Time** (side) and **Events** (side) to switch between setting the time and the number of events.

Hint: You can go directly to the Delayed Trigger menu (see step 5). By selecting one of Triggerable After Time, Events, or Events/Time, the oscilloscope automatically switches to Delayed Triggerable in the Horizontal menu. You will still need to display the Horizontal menu if you wish to leave Delayed Triggerable.

The **Source** menu lets you select which input will be the delayed trigger source.

- Press **Source** (main) → **Ch1, Ch2, Ch3 (Ax1 on the TDS 520), Ch4 (Ax2 on the TDS 520), or Auxiliary (TDS 540 only)** (side).

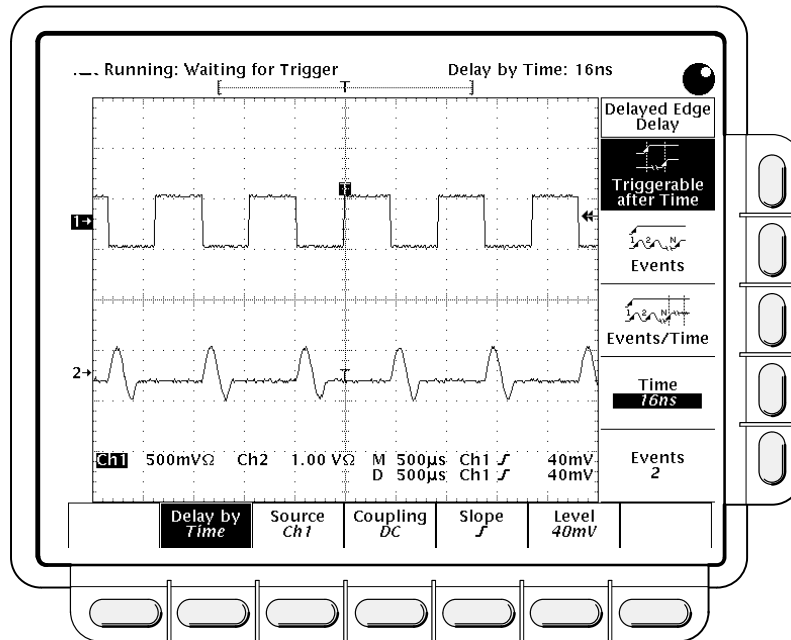

Figure 3-11: Delayed Trigger Menu

- Press **Coupling** (main) → **DC, AC, HF Rej, LF Rej, or Noise Rej** (side) to define how the input signal will be coupled to the delayed trigger. For descriptions of these coupling types, see *Triggering* on page 2-2.
- Press **Slope** (main) to select the slope that the delayed trigger will occur on. Choose between the rising edge and falling edge slopes.

When using Delayed Triggerable mode to acquire waveforms, two trigger bars are displayed. One trigger bar indicates the level set by the main trigger system; the other indicates the level set by the delayed trigger system.

- Press **Level** (main) → **Level, Set to TTL, Set to ECL, or Set to 50%** (side).
 - **Level** lets you enter the delayed trigger level using the general purpose knob or the keypad.
 - **Set to TTL** fixes the trigger level at +1.4 V.
 - **Set to ECL** fixes the trigger level at -1.3 V.

NOTE

When you set the Vertical **SCALE** smaller than 200 mV, the oscilloscope reduces the **Set to TTL** or **Set to ECL** trigger levels below standard TTL and ECL levels. That happens because the trigger level range is fixed at ± 1.3 V center. At 100 mV (the next smaller setting after 200 mV) the trigger range is ± 0.5 V which is smaller than the typical TTL (+1.4 V) or ECL (-1.3 V) level.

- **Set to 50%** fixes the delayed trigger level to 50% of the peak-to-peak value of the delayed trigger source signal.

**For More
Information**

See *Triggering*, on page 2-2.

See *Triggering*, on page 3-120.

Display Modes

The digitizing oscilloscope can display waveform records in different ways. The Display menu lets you adjust the oscilloscope display style, intensity level, graticule, and format.

Operation

Press **DISPLAY** to show the Display menu.

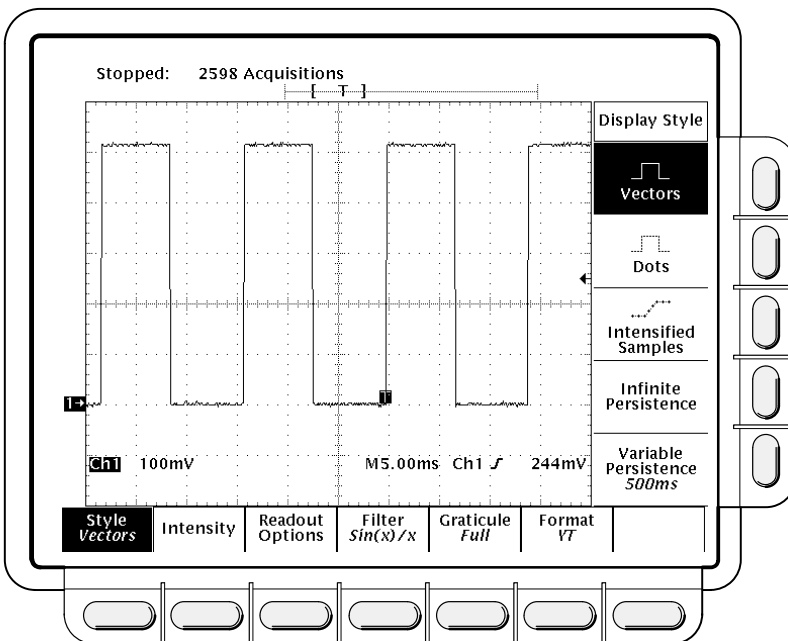

Figure 3-12: Display Menu—Style

Display Style

Press **DISPLAY** → **Style** (main) → **Vectors**, **Intensified Samples**, **Dots**, **Infinite Persistence**, or **Variable Persistence** (side) (Figure 3-12).

- **Vectors** has the display draw vectors (lines) between the record points.
- **Dots** display waveform record points as dots.
- **Intensified Samples** also displays waveform record points as dots. However, the points actually sampled are displayed intensified relative to the interpolated points. (The contrast between real and interpolated points is set to a fixed value.)

In addition to choosing Intensified Samples in the side menu, the oscilloscope must be interpolating (equivalent time must be off) or Zoom must be on with its horizontal expansion greater than 1X. See interpolation on page 2-9; see Zoom beginning on page 3-130.

- **Variable Persistence** lets the record points accumulate on screen over many acquisitions and remain displayed only for a specific time interval. In that mode, the display behaves like that of an analog oscilloscope. You enter the time for that option with the keypad or the general purpose knob.
- **Infinite Persistence** lets the record points accumulate until you change some control (such as scale factor) causing the display to be erased.

Intensity

Intensity lets you set overall, text/graticule, and waveform intensity (brightness) levels. To set the contrast intensity of the delay portion of a waveform:

Press **DISPLAY** → **Intensity** (main) → **Overall, Text/Grat, Waveform**, or **Contrast** (side). Enter the intensity percentage values with the keypad or the general purpose knob.

All intensity adjustments operate over a range from 20% (close to fully off) to 100% (fully bright).

Contrast operates over a range from 100% (no contrast) to 250% (intensified portion at full brightness).

NOTE

The Intensified setting for Timebase in the horizontal menu causes a zone on the waveform to be intensified relative to the rest of the waveform. If the contrast is set to 100%, you won't be able to distinguish the intensified portion from the rest of the waveform because both are the same brightness.

Display Readout

Readout options control whether the trigger indicator, trigger level bar, and current date and time appear on the display. The options also control what style trigger level bar, long or short, is displayed.

1. Press **DISPLAY** → **Readout** (main).
2. Toggle **Display 'T' @ Trigger Point** (side) to select whether or not to display 'T' indicating the trigger point. You can select **ON** or **OFF**. (The trigger point indicates the position of the trigger in the waveform record.)

3. Toggle **Trigger Bar Style** (side) to select either the short or the long trigger bar or to turn the trigger bar off. (See Figure 3-13. Note that both styles are shown for illustrating purposes, but you can only display one style at a time.)

The trigger bar is only displayed if the trigger source is an active, displayed waveform. Also, two trigger bars are displayed when delay triggerable acquisitions are displayed—one for the main and one for the delayed timebase. The trigger bar is a visual indicator of the trigger level.

Sometimes, especially when using the hardcopy feature, you may wish to display the current date and time on screen. For more information about displaying and setting date and time, see *Date/Time Stamping Your Hardcopy* on page 3-43.)

4. Press **Display Date/Time** (side) to turn it on or off. Push **Clear Menu** to see the current date and time. (Note that if the date and time have not been set since the oscilloscope was last powered on, a message will be displayed with instructions for setting date and time.)

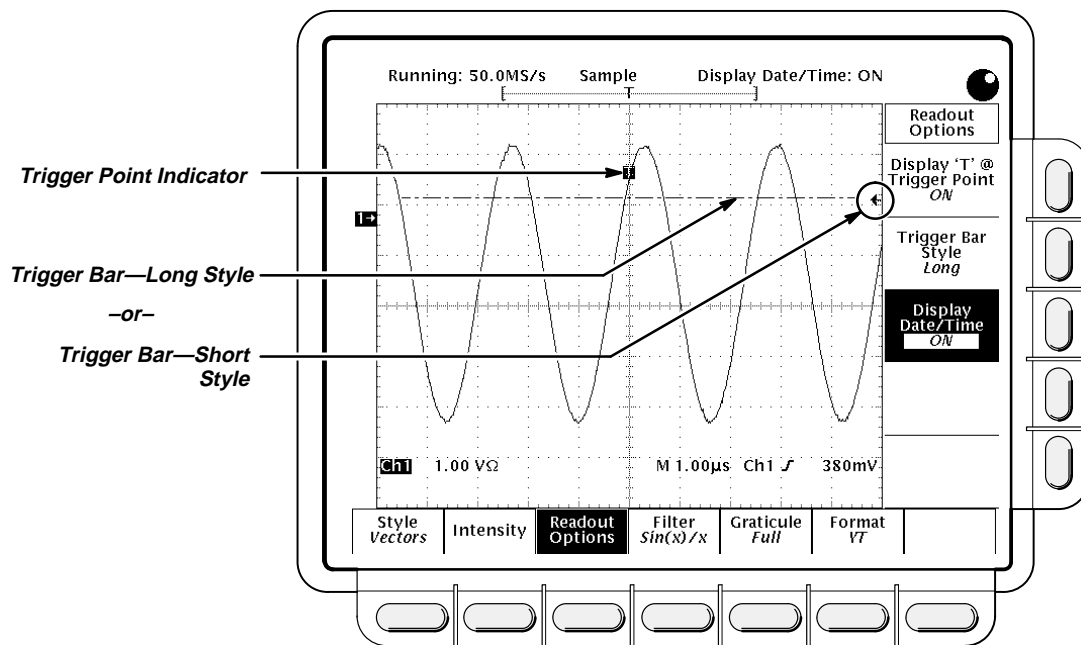

Figure 3-13: Trigger Point and Level Indicators

Filter Type

The display filter types are $\sin(x)/x$ interpolation and linear interpolation. For more information see the *Concepts* section, page 2-9.

Press **DISPLAY** → **Filter** (main) → **Sin(x)/x Interpolation** or **Linear Interpolation** (side).

NOTE

When the horizontal scale is set to rates faster than 50 ns/div, or when using the ZOOM feature to expand waveforms horizontally, interpolation occurs. (The filter type, linear or $\sin(x)/x$, depends on which is set in the Display menu.) Otherwise, interpolation is not needed. See Sampling and Digitizing on page 2-7 in the section Concepts for a discussion of sampling including interpolation.

Graticule Type

To change the graticule:

Press **DISPLAY** → **Graticule** (main) → **Full**, **Grid**, **Cross Hair**, or **Frame** (side).

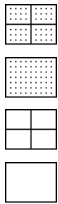

- **Full** provides a grid, cross hairs and a frame.
- **Grid** displays a frame and a grid.
- **Cross Hair** provides cross hairs and a frame.
- **Frame** displays just a frame.

Format

There are two kinds of format: YT and XY.



YT is the conventional oscilloscope display format. It shows a signal voltage (the vertical axis) as it varies over time (the horizontal axis).



XY format compares the voltage levels of two waveform records point by point. That is, the digitizing oscilloscope displays a graph of the voltage of one waveform record against the voltage of another waveform record. This mode is particularly useful for studying phase relationships.

To set the display axis format:

Press **DISPLAY** → **Format** (main) → **XY** or **YT** (side).

When you choose the XY mode, the input you have selected is assigned to the X-axis and the digitizing oscilloscope automatically chooses the Y-axis input (see Table 3-3).

Table 3-3: XY Format Pairs

X-Axis Channel (User Selectable)	Y-Axis Channel (Fixed)
Ch 1	Ch 2
Ch 3 (TDS 540) (Aux 1 on the TDS 520)	Ch 4 (TDS 540) (Aux 2 on the TDS 520)
Ref 1	Ref 2
Ref 3	Ref 4

For example, if you press the **CH 1** button, the digitizing oscilloscope will display a graph of the channel 1 voltage levels on the X-axis against the channel 2 voltage levels on the Y-axis. That will occur whether or not you are displaying the channel 2 waveform in YT format. If you later press the **WAVE-FORM OFF** button for either channel 1 or 2, the digitizing oscilloscope will delete the XY graph of channel 1 versus channel 2.

Since selecting **YT** or **XY** affects only the display, the horizontal and vertical scale and position knobs and menus control the same parameters regardless of the mode selected. Specifically, in XY mode, the horizontal scale will continue to control the time base and the horizontal position will continue to control which portion of the waveforms are displayed.

XY format is a dot-only display, although it can have persistence. The **Vector** style selection has no effect when you select XY format.

You cannot display Math waveforms in XY format. They will disappear from the display when you select XY.

For More Information

See *Acquisition* on page 2-7.

Edge Triggering

An *edge trigger* event occurs when the trigger source passes through a specified voltage level in a specified direction (the trigger slope). You will likely use edge triggering for most of your measurements.

You can select the edge source, coupling, slope, level, and mode (auto or normal).

Edge Trigger Readouts

The Trigger readout shows some key trigger parameters (Figure 3-14).

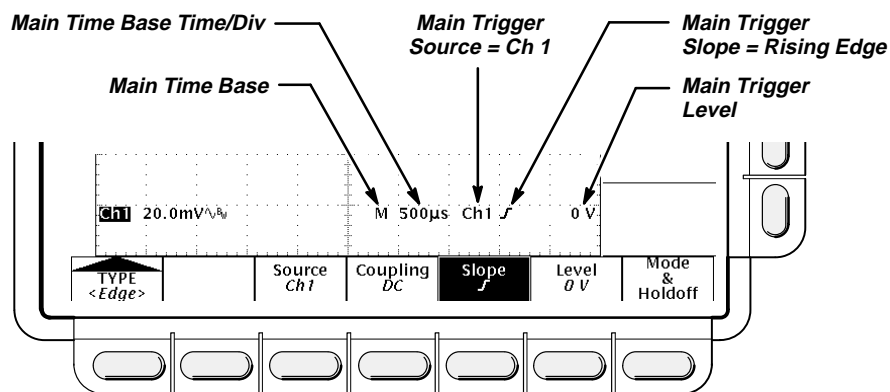

Figure 3-14: Edge Trigger Readouts

Operation

The Edge Trigger menu lets you select the source, coupling, slope, trigger level, mode, and holdoff.

To bring up the Edge Trigger menu:

Press **TRIGGER MENU** → **Type** (main) → **Edge** (pop-up) (see Figure 3-15).

Source

To select which source you want for the trigger:

Press **TRIGGER MENU** → **Type** (main) → **Edge** (pop-up) → **Source** (main) → **Ch1**, **Ch2**, **Ch3** (**Ax1** on the TDS 520), **Ch4** (**Ax2** on the TDS 520), **AC Line**, or **Auxiliary** (side).

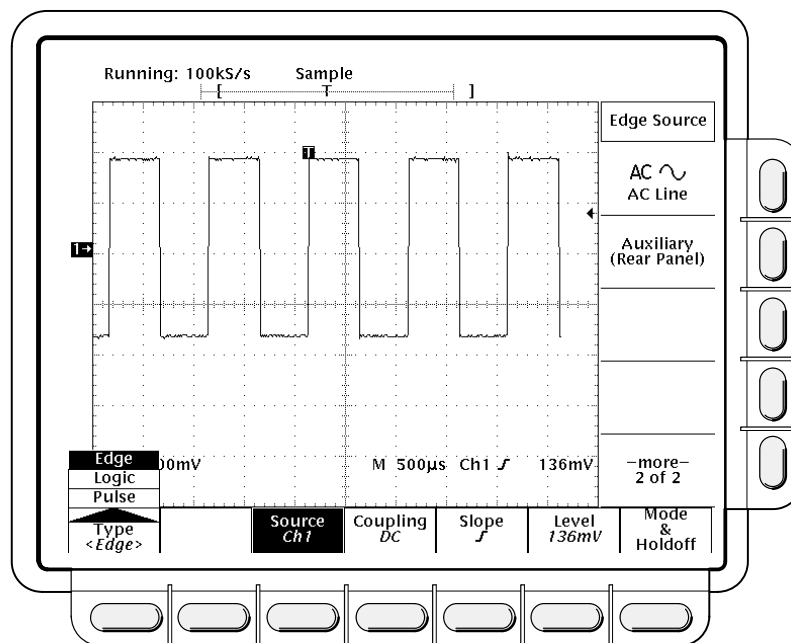

Figure 3-15: Main Trigger Menu—Edge Type

Coupling

To select the coupling you want:

Press **TRIGGER MENU** → **Type** (main) → **Edge** (pop-up) → **Coupling** (main) → **DC**, **AC**, **HF Rej**, **LF Rej**, or **Noise Rej** (side).

DC

AC ~

HF Rej

LF Rej

- **DC** passes all of the input signal. In other words, it passes both AC and DC components to the trigger circuit.
- **AC** passes only the alternating components of an input signal (above 30 Hz). It removes the DC component from the trigger signal.
- **HF Rej** removes the high frequency portion of the triggering signal. That allows only the low frequency components to pass on to the triggering system to start an acquisition. High frequency rejection attenuates signals above 30 kHz.
- **LF Rej** does the opposite of high frequency rejection. Low frequency rejection attenuates signals below 80 kHz.
- **Noise Rej** provides lower sensitivity. It requires additional signal amplitude for stable triggering, reducing the chance of falsely triggering on noise.

Slope

To select the slope that the edge trigger will occur on:

1. Press the **TRIGGER MENU** → **Type** (main) → **Edge** (pop-up) → **Slope** (main) to select the slope that the edge trigger will have.
2. Alternatives for slope are the rising and falling edges.



Level

Press the **TRIGGER MENU** → **Type** (main) → **Edge** (pop-up) → **Level** (main) → **Level**, **Set to TTL**, **Set to ECL**, or **Set to 50%** (side).

- **Level** lets you enter the trigger level using the general purpose knob or the keypad.
- **Set to TTL** fixes the trigger level at +1.4 V.
- **Set to ECL** fixes the trigger level at -1.3 V.

NOTE

*When you set the volts/div smaller than 200 mV, the oscilloscope reduces the **Set to TTL** or **Set to ECL** trigger levels below standard TTL and ECL levels. That happens because the trigger level range is fixed at 200 mV center. At 100 mV (the next smaller setting after 200 mV) the trigger range is 100 mV, which is smaller than the typical TTL (+1.4 V) or ECL (-1.3 V) level.*

- **Set to 50%** fixes the trigger level to approximately 50% of the peak-to-peak value of the trigger source signal.

Mode & Holdoff

You can change the holdoff time and select the trigger mode using this menu item. See *Triggering* on page 2-2 for more details.

1. Press the **TRIGGER MENU** → **Mode & Holdoff** (main) → **Auto** or **Normal** (side).
 - In **Auto** mode the oscilloscope acquires a waveform after a specific time has elapsed even if a trigger does not occur. The amount of time the oscilloscope waits depends on the time base setting.
 - In **Normal** mode the oscilloscope acquires a waveform only if there is a valid trigger.
2. To change the holdoff time, press **Holdoff** (side). Enter the value in % using the general purpose knob or the keypad.

If you want to enter a large number using the general purpose knob, press the **SHIFT** button before turning the knob. When the light above the **SHIFT** button is on and the display says **Coarse Knobs** in the upper right corner, the general purpose knob speeds up significantly.

Holdoff is settable from 0% (minimum holdoff available) to 100% (maximum available). See *Holdoff, Variable, Main Trigger* on page A-23 of Appendix B for the typical minimum and maximum values.

Holdoff is automatically reset to 0% when you change the main time base time/division setting. However, it is not reset if you change the delayed time base time/division (that is, when the time base setting in the Horizontal menu is **Intensified** or **Delayed Only**).

For More Information

See *Triggering*, on page 2-2.

See *Triggering*, on page 3-120.



Hardcopy

You can get a copy of the digitizing oscilloscope display by using the hardcopy feature. Depending on the output format you select, you create either an image or a plot. Images are direct bit map representations of the digitizing oscilloscope display. Plots are vector (plotted) representations of the display.

Hardcopy Formats

Different hardcopy devices use different formats. The digitizing oscilloscope supports the following formats:

- HP Thinkjet
- HP Deskjet
- HP Laserjet
- HPGL Color Plot
- Epson®
- Interleaf®
- Tag Image File Format (TIFF®)
- PC Paintbrush® (PCX®)
- Microsoft Windows® file format (BMP®)
- Encapsulated Postscript® (Image, Mono Plot, and Color Plot)

Some formats, particularly Interleaf, Postscript, TIFF, PCX, BMP, and HPGL, are compatible with various desktop publishing packages. That means you can paste files created from the oscilloscope directly into a document on any of those desktop publishing systems.

EPS Mono and Color formats are compatible with the Tektronix Phaser Color Printer, HPGL is compatible with the Tektronix HC100 Plotter, and Epson is compatible with the Tektronix HC200 Printer.

Operation

Before you make a hardcopy, you need to set up communications and hardcopy parameters. This discussion assumes that the hardcopy device is already connected to the GPIB port on the rear panel. If that is not the case see *Connection Strategies* on page 3-44.

Setting Communication Parameters

To set up the communication parameters:

Press **SHIFT UTILITY** → **System** (main) → **I/O** (pop-up) → **Configure** (main) → **Hardcopy (Talk Only)** (side) (see Figure 3-16).

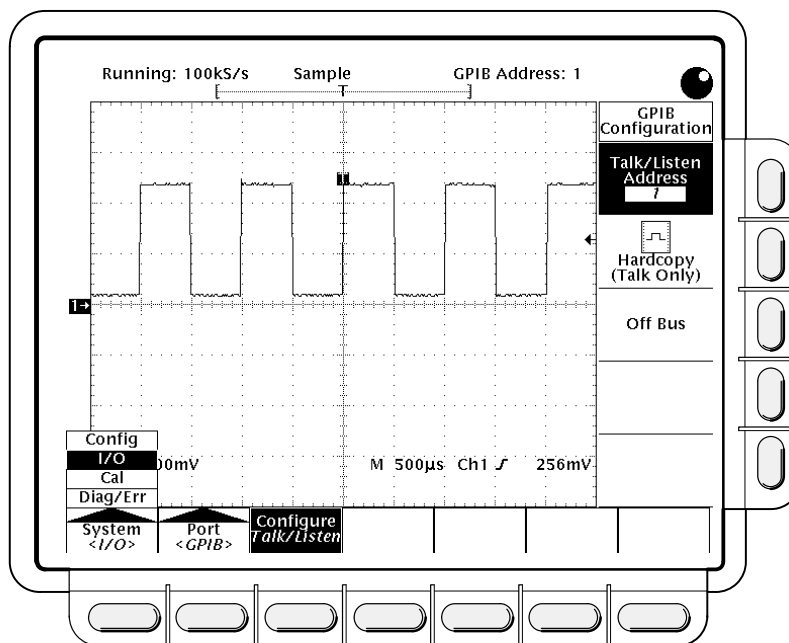

Figure 3-16: Utility Menu—System I/O

Setting Hardcopy Parameters

To specify the hardcopy format, layout, and type of port using the hardcopy menu:

1. Press **SHIFT HARDCOPY MENU** to bring up the Hardcopy menu.
2. Press **Format** (main) → **Thinkjet, Deskjet, Laserjet, Epson, Interleaf, TIFF, PCX, BMP, EPS Image, EPS Mono, EPS Color** (EPS stands for Encapsulated Postscript), or **HPGL** (side). (Press **-more-** (side) to see all of these format choices.)
3. Press **SHIFT HARDCOPY MENU** → **Layout** (main) → **Landscape** or **Portrait** (side) (see Figure 3-17).
4. Press **SHIFT HARDCOPY MENU** → **Port** (main) to specify the output channel to send your hardcopy through. Unless your instrument is equipped with Option 13, the only choice is **GPIB**. (If your instrument is equipped with Option 13, see the *TDS Family Option 13 Instruction Manual* for setting up hardcopy over the RS-232 and Centronics ports.)

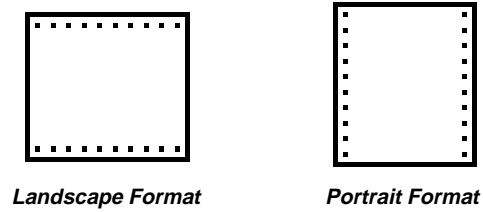

Figure 3-17: Hardcopy Formats

Printing the Hardcopy

You can print a single hardcopy or send additional hardcopies to the spool (queue) while waiting for earlier hardcopies to finish printing. To print your hardcopy(ies):

Press **HARDCOPY** to print your hardcopy.

While the hardcopy is being sent to the printer, the oscilloscope will display the message “Hardcopy in process—Press HARDCOPY to abort.”

To stop and discard the hardcopy being sent, press **HARDCOPY** again *while* the hardcopy in process message is still on screen.

To add additional hardcopies to the printer spool, press **HARDCOPY** again *after* the hardcopy in process message is removed from the screen.

You can add hardcopies to the spool until it is full. When the spool is filled by adding a hardcopy, the message “Hardcopy in Process—Press HARDCOPY to abort” remains displayed. You can abort the *last* hardcopy sent by pressing the button while the message is still displayed. When the printer empties enough of the spool to finish adding the last hardcopy it does so and then removes the message.

To remove all hardcopies from the spool:

Press **SHIFT HARDCOPY MENU** → **Clear Spool** (main) → **OK Confirm** **Clear Spool** (side).

This oscilloscope takes advantage of any unused RAM when spooling hardcopies to printers. The size of the spool is, therefore, variable. The number of hardcopies that can be spooled depends on three variables:

- the amount of unused RAM
- the hardcopy format chosen
- the complexity of the display

Although not guaranteed, usually about 2.5 hardcopies can be spooled before the oscilloscope must wait to send the rest of the third copy.

Date/Time Stamping Your Hardcopy

You can display the current date and time on screen so that it appears on the hardcopies you print. To date and time stamp your hardcopy:

1. Press **DISPLAY** → **Readout Options** (main) → **Display Date and Time** (side) to toggle the setting to **On**.
2. If you have not set the date and time since the instrument was last powered on, a message instructing you to will be displayed. If that is the case, skip steps 3 and 4 and continue with step 5.
3. Press **Clear Menu** to remove the menu from the display so the date and time can be displayed. See Figure 3-18. (The date and time is removed from the display when menus are displayed.)
4. Press **HARDCOPY** to print your date/time stamped hardcopy.

If you need to set the date and time of the oscilloscope:

5. Press **SHIFT UTILITY** → **Config** (pop-up) → **Set Date & Time** (main) → **Year, Day Month, Hour, or Minute**.

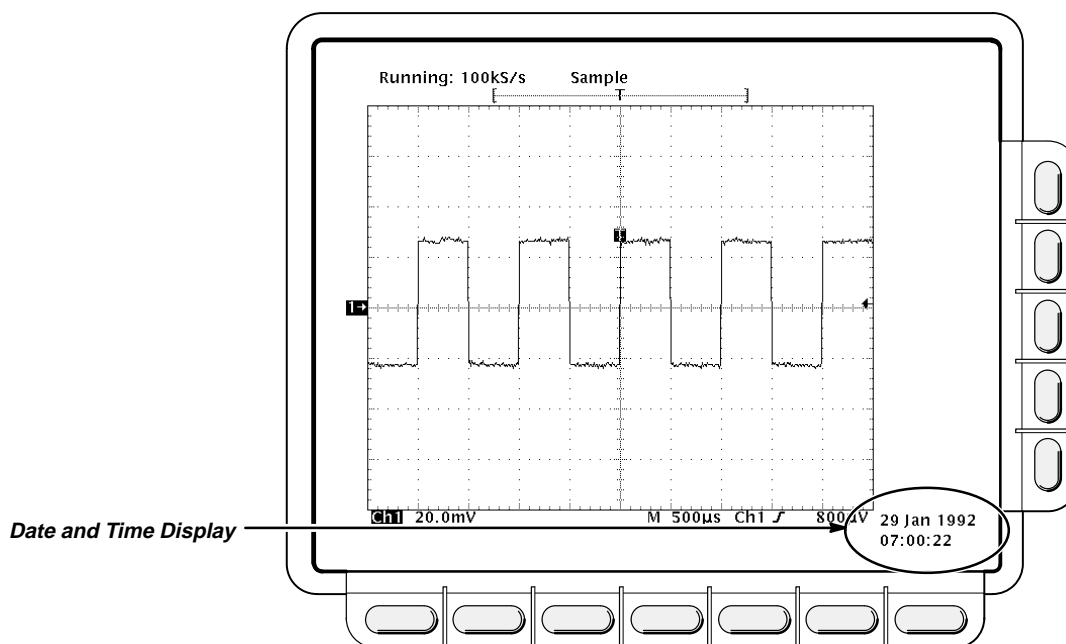

Figure 3-18: Date and Time Display

6. Use the general purpose knob or the keypad to set the parameter you have chosen to the value desired. (The format when using the keypad is day.month. For example, use 23.6 for the 23rd of June.)
7. Repeat steps 5 and 6 to set other parameters as desired.
8. Press **OK Enter Date/Time** (side) to put the new settings into effect. This sets the seconds to zero.

NOTE

*When setting the clock, you can set to a time slightly later than the current time and wait for it to catch up. When current time catches up to the time you have set, pressing **Ok Enter Date/Time** (side) synchronizes the set time to the current time.*

The date and time are not backed up by a battery. To use the date and time stamp, you must set it each time you power up the digitizing oscilloscope.

9. Press **CLEAR MENU** to see the date/time displayed with the new settings.
10. Press **HARDCOPY** to print your date/time stamped hardcopy.

Connection Strategies

The ability of the digitizing oscilloscope to print a copy of its display in many formats (see page 3-40) gives you flexibility in choosing a hardcopy device. It also makes it easier for you to place oscilloscope screen copies into a desktop publishing system.

However, since the digitizing oscilloscope has only a GPIB interface port and many hardcopy devices have only RS-232 or Centronics ports, you need a connection strategy for sending the hardcopy data from the digitizing oscilloscope to the printer or plotter. Three such strategies exist:

NOTE

If your instrument is equipped with Option 13, your oscilloscope has an RS-232 port and a Centronics port in addition to the GPIB port. See the TDS Family Option 13 Instruction Manual for setting up to hardcopy directly through the RS-232 and Centronics ports.

- Use a printer/plotter with a GPIB connector.
- Use a GPIB-to-Centronics or GPIB-to-RS-232 converter box.
- Send the data to a computer with both GPIB and RS-232 or Centronics ports.

Using a GPIB-Based Hardcopy Device

You can connect the digitizing oscilloscope directly to a GPIB-based hardcopy device (see Figure 3-19). An example of a GPIB hardcopy device is the Tektronix HC100 Plotter.

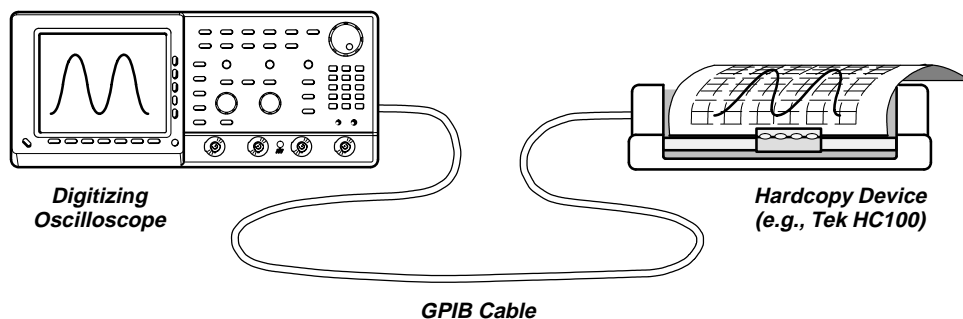

Figure 3-19: Connecting the Digitizing Oscilloscope Directly to the Hardcopy Device

Using a GPIB-to-Centronics or GPIB-to-RS-232 Converter

You can put a GPIB-to-Centronics or GPIB-to-RS-232 interface converter box between the digitizing oscilloscope and the RS-232 or Centronics hardcopy device (see Figure 3-20). For example, a National Instruments GPIB-PRL (a GPIB-to-Centronics converter) will permit you to make screen prints on a Tektronix HC200 Dot Matrix printer with just a Centronics port.

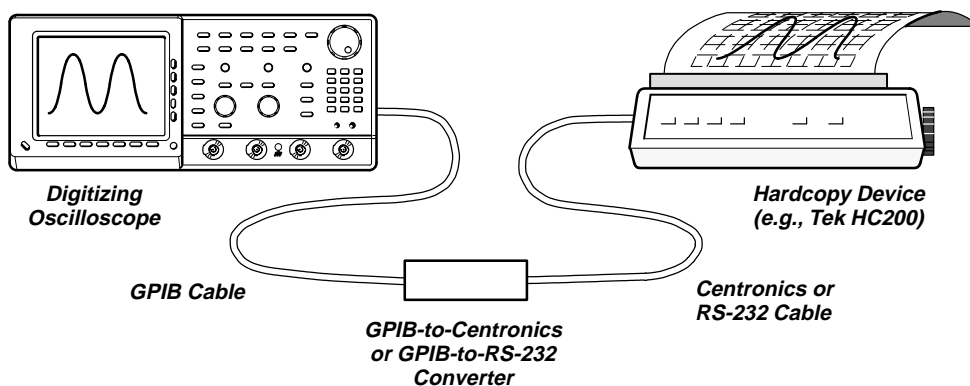

Figure 3-20: Connecting the Digitizing Oscilloscope and Hardcopy Device Via a Converter

Using a Controller

You can put a controller with two ports between the digitizing oscilloscope and the hardcopy device (see Figure 3-21). One port must be a GPIB and the other must be either an RS-232 or a Centronics port.

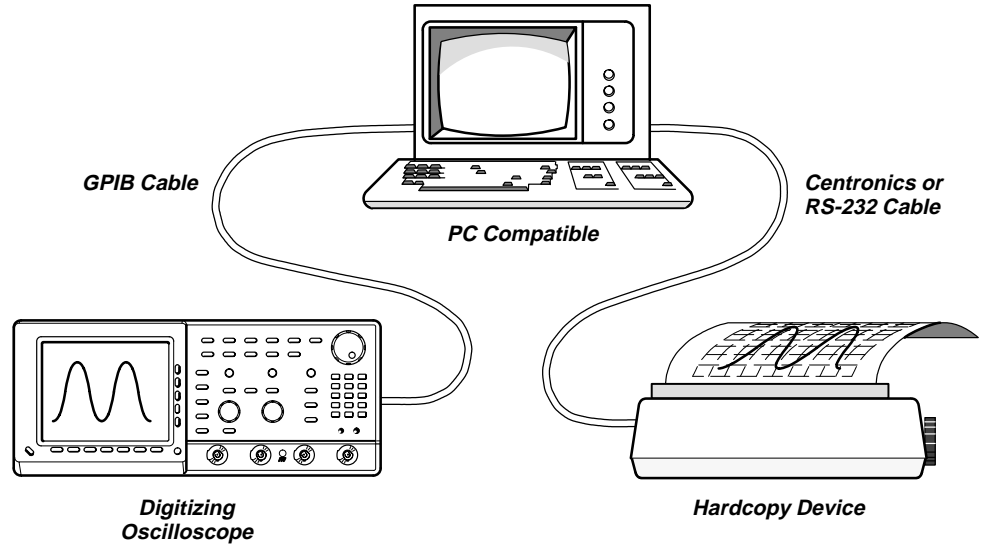

Figure 3-21: Connecting the Digitizing Oscilloscope and Hardcopy Device Via a PC

If your controller is PC-compatible and it uses the Tektronix GURU or S3FG210 (National Instruments GPIB-PCII/IIA) GPIB package, you can operate this setup as follows:

1. Use the MS-DOS *cd* command to move to the directory that holds the software that came with your GPIB board. For example, if you installed the software in the GPIB-PC directory, type: **cd GPIB-PC**
2. Run the IBIC program that came with your GPIB board. Type: **IBIC**
3. Type: **IBFIND DEV1** where "DEV1" is the name for the digitizing oscilloscope you defined using the IBCONF.EXE program that came with the GPIB board.

NOTE

If you defined another name then, of course, use it instead of "DEV1". Also, remember that the device address of the digitizing oscilloscope as set with the IBCONF.EXE program should match the address set in the digitizing oscilloscope Utility menu (typically, use "1").

4. Type: **IBWRT "HARDCOPY START"** Be sure the digitizing oscilloscope Utility menu is set to **Talk/Listen** and not **Hardcopy (Talk Only)** or you will get an error message at this step. Setting the digitizing oscilloscope Utility menu was described in the start of this Hardcopy section under the heading *Setting Communication Parameters*.

5. Type: **IBRDF <Filename>** where <Filename> is a valid DOS file name you want to call your hardcopy information. It should be ≤ 8 characters long with up to a 3 character extension. For example, you could type *"ibrdf screen1"*.
6. Exit the IBIC program by typing: **EXIT**
7. Type: **COPY <Filename> <Output port> ** where <Filename> is the name you defined in step 5 and <Output port> is the PC output port your hardcopy device is connected to (such as LPT1 or LPT2). Copy the data from your file to your hardcopy device. First, ensure your printer or plotter is properly attached to your PC. Then copy the file. For example, if your file is called *screen1* and your printer is attached to the *lpt1* parallel port, type *"copy screen1 lpt1: /B"*.

Your hardcopy device should now print a picture of the digitizing oscilloscope screen.

For More Information

See *Remote Communication*, on page 3-106.

See the *TDS Family Option 13 Instruction Manual*, Tektronix part number 070-8567-00 (Option 13 equipped instruments only).

Help

The on-line help system provides brief information about each of the digitizing oscilloscope controls.

Operation

To use the on-line help system:

Press **HELP** to provide on-screen information on any front panel button, knob or menu item (see Figure 3-22).

When you press that button, the instrument changes mode to support on-line help. Press **HELP** again to return to regular operating mode. Whenever the oscilloscope is in help mode, pressing any button (except **HELP** or **SHIFT**), turning any knob, or pressing any menu item displays help text on the screen that discusses that control.

The menu selections that were displayed when **HELP** was first pressed remain on the screen. On-line help is available for each menu selection displayed at the time the **HELP** button was first pressed. If you are in help mode and want to see help on selections from non-displayed menus, you first exit help mode, display the menu you want information on, and press **HELP** again to re-enter help mode.

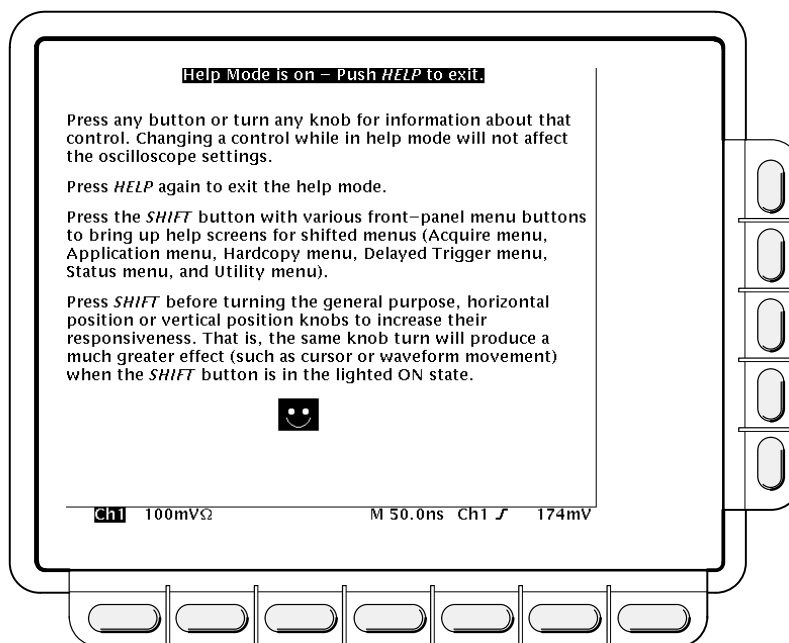

Figure 3-22: Initial Help Screen

Horizontal Control

You can control the horizontal part of the display (the time base) using the horizontal menu and knobs.

Horizontal Knobs

By changing the horizontal scale, you can focus on a particular portion of a waveform. By adjusting the horizontal position, you can move the waveform right or left to see different portions of it. That is particularly useful when you are using larger record sizes and cannot view the entire waveform on one screen.

To change the horizontal scale and position, use the horizontal **POSITION** and horizontal **SCALE** knobs (see Figure 3-23). These knobs manage the time base and horizontal waveform positioning on the screen. When you use either the horizontal **SCALE** or **POSITION** knobs, you will affect all the waveform records displayed.

When you use either the horizontal **SCALE** or **POSITION** knobs, you will affect all the waveform records displayed. If you want the **POSITION** knob to move faster, press the **SHIFT** button. When the light above the shift button is on and the display says **Coarse Knobs** in the upper right corner, the **POSITION** knob speeds up significantly.

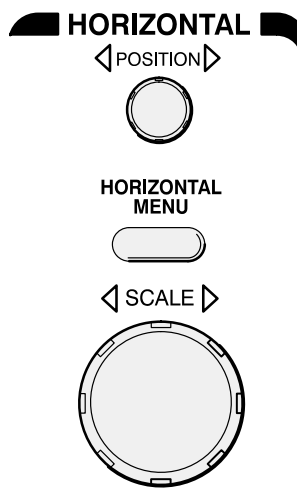

Figure 3-23: Horizontal Controls

Horizontal Readouts

At the top of the display, the *Record View* shows the size and location of the waveform record and the location of the trigger relative to the display (see Figure 3-24). The *Time Base readout* at the lower right of the display shows the time/division settings and the time base (main or delayed) being referred to (see Figure 3-24).

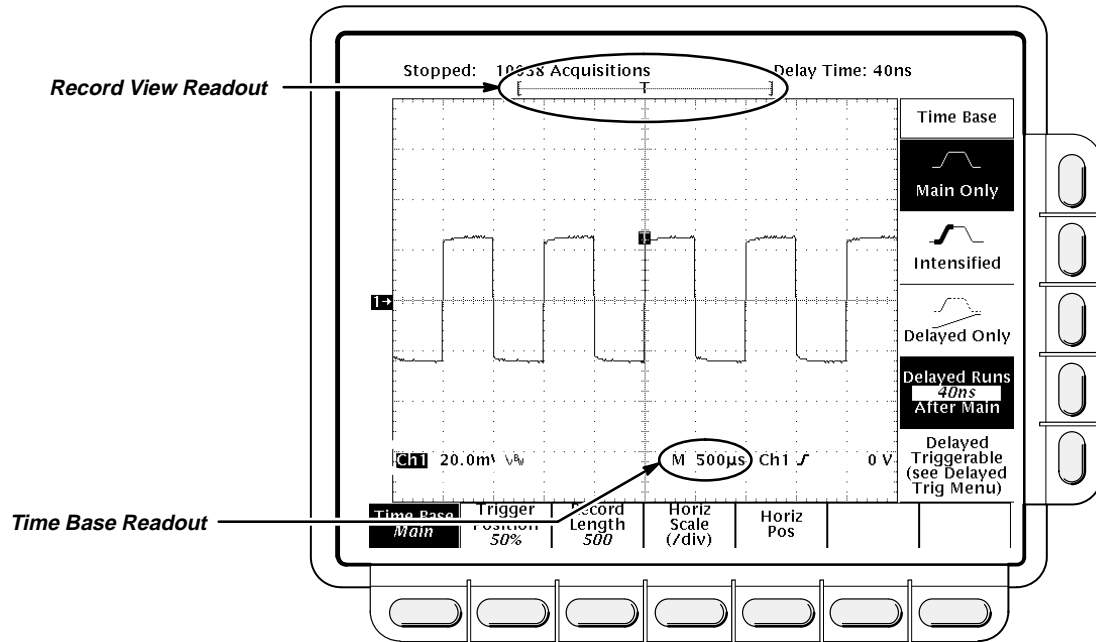

Figure 3-24: Record View and Time Base Readouts

Horizontal Menu

The Horizontal menu lets you select either a main or delayed view of the time base for acquisitions. It also lets you set the record length, set the trigger position, and change the position or scale.

Main and Delayed Time Base

To select between the Main and Delayed views of the time base:

Press **HORIZONTAL MENU** → **Time Base** (main) → **Main Only**, **Intensified**, or **Delay Only** (side).

By pressing **Intensified**, you display an intensified zone that shows where the delayed trigger record length could occur relative to the main trigger. The start of the intensified zone corresponds to the possible start point of the delayed trigger. The end of the zone corresponds to the end of the waveform record.

To learn how to change the intensity of the normal and intensified waveform, see *Display Modes* on page 3-31.

You also can select **Delayed Runs After Main** or **Delayed Triggerable**. For more information on how to use these two menu items, see *Delayed Triggering* on page 3-25.

Trigger Position

To define how much of the record will be pretrigger and how much posttrigger information using the **Trigger Position** menu item:

Press **HORIZONTAL MENU** → **Trigger Position** (main) → **Set to 10%**, **Set to 50%**, or **Set to 90%** (side), or press **Pretrigger** (side) and use the general purpose knob or the keypad.

Record Length

To set the waveform record length, press **HORIZONTAL MENU** → **Record Length** (main). The side menu lists various discrete record length choices.

NOTE

If you selected the longest record length available in the Horizontal menu, then you cannot select Hi Res as your acquisition mode. This is because Hi Res mode uses twice the acquisition memory that the other acquisition modes use. If Hi Res and the longest horizontal record length were allowed to be selected at the same time, the oscilloscope would run out of memory.

Horizontal Scale

To change the horizontal scale (time per division) numerically in the menu instead of using the Horizontal **SCALE** knob:

Press **HORIZONTAL MENU** → **Horiz Scale** (main) → **Main Scale** or **Delayed Scale** (side) and use the keypad or the general purpose knob to change the scale values.

Horizontal Position

You can set the horizontal position to specific values in the menu instead of using the Horizontal **POSITION** knob.

Press **HORIZONTAL MENU** → **Horiz Pos** (main) → **Set to 10%**, **Set to 50%** or **Set to 90%** (side) to choose how much of the waveform will be displayed to the left of the display center.

You can also control whether changing the horizontal position setting affects all displayed waveforms, just the live waveforms, or only the selected waveform. The Horizontal Lock setting in the Zoom menu determines which waveforms the horizontal position knob adjusts whether zoom is on or not. Specifically, it acts as follows:

Horizontal Control

- **None**—only the waveform currently selected can be zoomed and positioned horizontally
- **Live**—all channels (including **AUX** channels for the TDS 520 Oscilloscope) can be zoomed and positioned horizontally at the same time
- **All**—all waveforms displayed (channels, math, and/or reference) can be zoomed and positioned horizontally at the same time

See *Zoom*, on page 3-130 for the steps to set the horizontal lock feature.

For More Information

See *Scaling and Positioning Waveforms*, on page 2-13.

See *Delayed Triggering*, on page 3-25.

See *Zoom*, on page 3-130.



Limit Testing

Limit testing provides a way to automatically compare each incoming waveform against a template waveform. You set an envelope of limits around a waveform and let the digitizing oscilloscope find waveforms that fall outside those limits. When it finds such a waveform, the digitizing oscilloscope can generate a hardcopy, ring a bell, stop and wait for your input, or any combination of these actions.

When you use the limit testing feature, the first task is to create the limit test template from a waveform. Next, specify the channel to compare to the template. Then you specify the action to take if incoming waveform data exceeds the set limits. Finally, turn limit testing on so that the parameters you have specified will take effect.

Operation

To access limit testing:

Press **SHIFT ACQUIRE MENU** to bring up the Acquire menu.

Create Limit Test Template

To use an incoming or stored waveform to create the limit test template, first select a source.

1. Press **Create Limit Test Template** (main) → **Template Source** (side) → **Ch1, Ch2, Math1, Math2, Math3, Ref1, Ref2, Ref3, or Ref4** (side). (See Figure 3-25).

NOTE

*The template will be smoother if you acquire the template waveform using **Average** acquisition mode. If you are unsure how to do this, see Acquisition Modes on page 3-15.*

Once you have selected a source, select a destination for the template.

2. Press **Template Destination** (side) → **Ref1, Ref2, Ref3, or Ref4**.

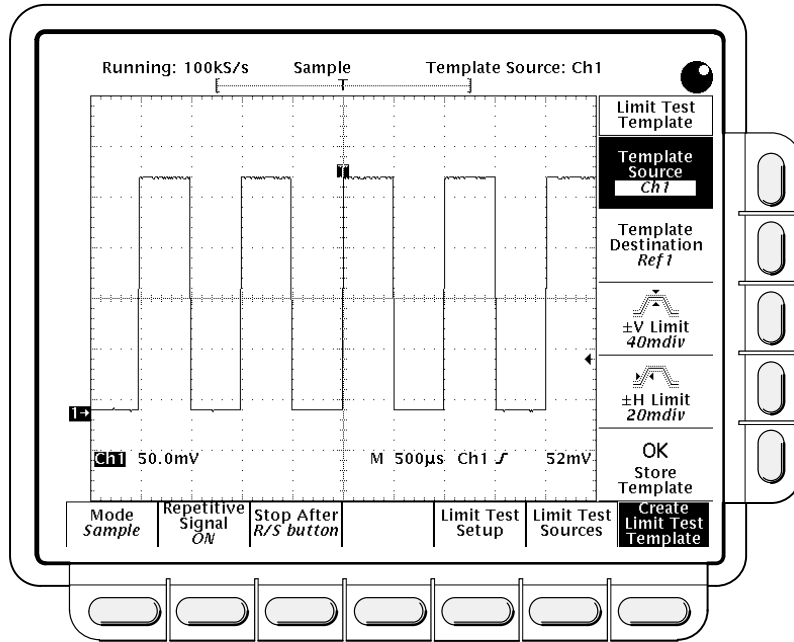

Figure 3-25: Acquire Menu—Create Limit Test Template

Now create the envelope by specifying the amount of variation from the template that you will tolerate. Tolerance values are expressed in fractions of a major division. They represent the amount by which incoming waveform data can deviate without having exceeded the limits set in the limit test. The range is from 0 (the incoming waveform must be exactly like the template source) to 5 major divisions of tolerance.

3. Press **Limit** (side). Enter the vertical (voltage) tolerance value using the general purpose knob or keypad.
4. Press **Limit** (side). Enter the horizontal (time) tolerance value using the general purpose knob or keypad.
5. When you have specified the limit test template as you wish, press **OK Store Template** (side). This action stores the specified waveform in the specified destination, using the specified tolerances. Until you have done so, the template waveform has been defined but not created.

If you wish to create another limit test template, store it in another destination to avoid overwriting the template you have just created.

If you wish to view the template you have created, press the **MORE** button. Then press the button corresponding to the destination reference memory you have used. The waveform appears on the display.

NOTE

*To view the waveform data as well as the template envelope, use the **Dots** display style (see Display Modes on page 3-31).*

Limit Test Sources

Now specify the channel that will acquire the waveforms to be compared against the template you have created.

1. Press **SHIFT ACQUIRE MENU** → **Limit Test Sources** (main) → **Compare Ch1 to, Compare Ch2 to, Compare Ch3 to, or Compare Ch4 to** (side).
2. Once you have selected one of the four channels as a waveform source from the side menu, press the same side menu button to toggle to one of the reference memories in which you have stored a template (or use the general purpose knob).

Valid selections are any of the four reference waveforms **Ref1** through **Ref4** or **None**. Choosing **None** turns limit testing off for the specified channel.

NOTE

Specify the same reference memory you chose as the template destination if you wish to use the template you just created.

If you have created more than one template, you can compare one channel to one template and the other channel to another template.

Limit Test Setup

Now specify the action to take if waveform data exceeds the limits set by the limit test template.

1. Press **SHIFT ACQUIRE MENU** → **Limit Test Setup** (main) to bring up a side menu of possible actions.
2. Ensure that the side button corresponding to the desired action reads **ON**.
 - If you want to send a hardcopy command when waveform data exceeds the limits set, toggle **Hardcopy if Condition Met** (side) to **ON**. (Don't forget to set up the hardcopy system. See *Hardcopy* on page 3-40 for details.)
 - If you want the bell to ring when waveform data exceeds the limits set, toggle **Ring Bell if Condition Met** (side) to **ON**.
 - If you want the digitizing oscilloscope to stop when waveform data exceeds the limits set, toggle **Stop After Limit Test Condition Met** (side) to **ON**.

NOTE

*The button labeled **Stop After Limit Test Condition Met** corresponds to the **Limit Test Condition Met** menu item in the **Stop After** main menu. You can turn this button on in the **Limit Test Setup** menu, but you cannot turn it off. In order to turn it off, press **Stop After** and specify one of the other choices in the **Stop After** side menu.*

Now that you have set the instrument up for limit testing, you must turn limit testing on in order for any of these actions to take effect.

3. Ensure that **Limit Test** (side) reads **ON**. If it reads **OFF**, press **Limit Test** (side) once to toggle it to **ON**.

When you set **Limit Test** to **ON**, the digitizing oscilloscope compares incoming waveforms against the waveform template stored in reference memory according to the settings in the **Limit Test Sources** side menu.

Single and Multiple Waveforms

You can compare a single waveform against a single template, more than one waveform against a single template, or more than one waveform with each one compared against its own template. How Limit Test operates depends on which type of these comparisons you choose.

Single Waveform Comparisons

When making a single waveform versus a single template comparison, consider the following operating characteristics:

- The waveform will be repositioned horizontally to move the first sample in the waveform record that is outside of template limits to center screen.
- The position of the waveform template will track that of the waveform.

Multiple Waveform Comparisons

When comparing one or more waveforms, each against a common template or against its own template, consider the following operating characteristics:

- You should set **Horizontal Lock** to **None** in the Zoom side menu (push **ZOOM** and toggle **Horizontal Lock** to **None**).
- With horizontal lock set as just described, the oscilloscope will reposition each waveform horizontally to move the first sample in the waveform record that is outside of template limits to center screen.
- If you are comparing each waveform to its own template, the position of each waveform template will track that of its waveform.

- If you are comparing two or more waveforms to a common template, that template will track the position of the failed waveform. If more than one waveform fails *during the same acquisition*, the template will track the position of the waveform in the highest numbered channel (CH 4 or Aux 2, depending on the TDS model number of your digitizing oscilloscope).

For More Information

See *Acquisition*, on page 2-7.

See *Acquisition Modes*, on page 3-11.

See *Display Modes*, on page 3-31.

See *Zoom*, on page 3-130.

Logic Triggering

There are two classes of logic triggering: pattern and state.

A *pattern* trigger occurs when the logic inputs to the logic function you select cause the function to become TRUE (or at your option FALSE). When you use a pattern trigger, you define:

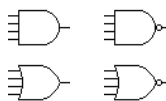

- The precondition for each logic input—logic high, low, or don't care (the logic inputs are channels 1, 2, 3, and 4 for the TDS 540 and 1, 2, Aux 1, and Aux 2 for the TDS 520)
- The Boolean logic function—select from AND, NAND, OR, and NOR
- The condition for triggering—whether the trigger occurs when the Boolean function becomes TRUE (logic high) or FALSE (logic low), and whether the TRUE condition is time qualified (see page 3-63).

A *state* trigger occurs when the logic inputs to the logic function cause the function to be TRUE (or at your option FALSE) *at the time* the clock input changes state. When you use a state trigger, you define:

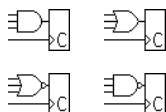

- The precondition for each logic input, channels 1, 2, and 3 for the TDS 540 (1, 2, and Ax1 on the TDS 520)
- The direction of the state change for the clock input, channel 4 (Aux 2 for the TDS 520)
- The Boolean logic function—select from clocked AND, NAND, OR, and NOR
- The condition for triggering—whether the trigger occurs when the Boolean function becomes TRUE (logic high) or FALSE (logic low)

Table 3-4 on page 3-60 lists the preconditions required for each logic function to issue a pattern or state logic trigger.

Logic Trigger Readouts

At the bottom of the display, the Trigger readout shows some of the key parameters of the logic trigger. (See Figure 3-26).

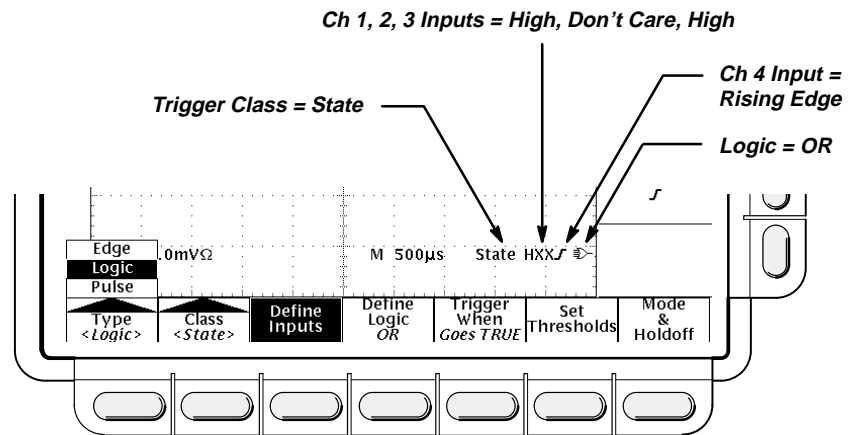

Figure 3-26: Logic Trigger Readouts

NOTE

When **Logic** is the selected trigger type, the threshold levels that help determine triggering are set for each channel individually in the **Set Thresholds** menu. Therefore, the **Trigger Level** readout will disappear on the display and the **Trigger Level** knob can be used to set the threshold level while the **Main Trigger** menu is set to **Logic**.









Definitions

Table 3-4 lists the definitions for the four types logic function available. Keep in mind the following operating modes for the two classes, pattern and state, of logic triggers as you apply the definitions.

Pattern—At the end of trigger holdoff, the oscilloscope samples the inputs from all the channels. The oscilloscope then triggers if the conditions defined in Table 3-4 are met. (**Goes TRUE** or **Goes FALSE** must be set in the **Trigger When** menu. The other settings in that menu are described in *Define a Time Qualified Pattern Trigger* on page 3-63.)

State—At the end of trigger holdoff, the oscilloscope waits until the edge of channel 4 on the TDS 540 (or Aux 2 on the TDS 520) transitions in the specified direction. At that point, the oscilloscope samples the inputs from the other channels and triggers if the conditions defined in Table 3-4 are met.

Table 3-4: Logic Triggers

Pattern	State	Definition ^{1,2}
 AND	 Clocked AND	If <i>all</i> the preconditions selected for the logic inputs ³ are true, then the oscilloscope triggers.
 NAND	 Clocked NAND	If <i>not all</i> of the preconditions selected for the logic inputs ³ are true, then the oscilloscope triggers.
 OR	 Clocked OR	If <i>any</i> of the preconditions selected for the logic inputs ³ are true, then the oscilloscope triggers.
 NOR	 Clocked NOR	If <i>none</i> of the preconditions selected for the logic inputs ³ are true, then the oscilloscope triggers.

¹Note that for State class triggers, the definition must be met at the time the clock input changes state. See the descriptions for Pattern and State on this page.

²The definitions given here are correct for the Goes True setting in the Trigger When menu. If that menu is set to Goes False, swap the definition for AND with that for NAND and for OR with NOR for both pattern and state classes.

³The logic inputs are channels 1, 2, 3, and 4 for the TDS 540 and 1, 2, and Aux 1 and Aux 2 for the TDS 520 when using Pattern Logic Triggers. For State Logic Triggers, channel 4 (Aux 2 for the TDS 520) becomes the clock input, leaving the remaining channels as logic inputs.

Operations Common to Pattern and State

The Logic Trigger menu (Figure 3-27) lets you select when to trigger (true or false), set the thresholds for each channel, select the mode (auto or normal), and adjust the holdoff.

Press **TRIGGER MENU** → **Type** (main) → **Logic** (pop-up) → **Class** (main) → **Pattern** or **State** (pop-up).

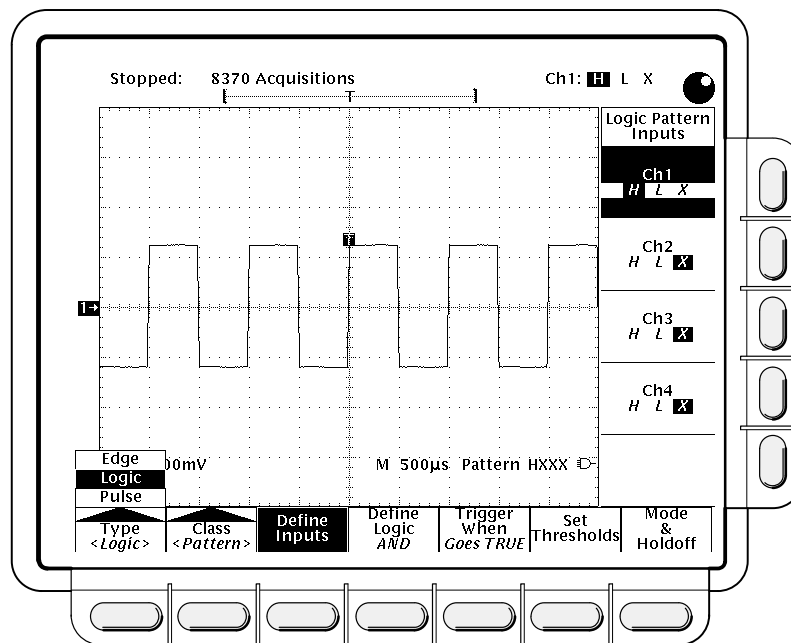

Figure 3-27: Logic Trigger Menu

Trigger When

This menu item lets you determine if the oscilloscope will trigger when the logic condition is met (**Goes TRUE**) or when the logic condition is not met (**Goes FALSE**). (The **True when less than** and **True when greater than** menu items are only used for pattern logic triggering and are covered on page 3-63.)

Press **TRIGGER MENU** → **Type** (main) → **Logic** (pop-up) → **Class** (main) → **Pattern** or **State** (pop-up) → **Trigger When** (main) → **Goes TRUE** or **Goes FALSE** (side).

Set Thresholds

To set the logic threshold for each channel:

1. Press **TRIGGER MENU** → **Type** (main) → **Logic** (pop-up) → **Class** (main) → **Pattern** or **State** (pop-up) → **Set Thresholds** (main) → **Ch1** or **Ch2** (side). On the TDS 540 you can also select **Ch3** or **Ch4** (side). On the TDS 520 you can select **Ax1** or **Ax2** (side).
2. Use the **MAIN TRIGGER LEVEL** knob, the general purpose knob, or the keypad to set each threshold.

Mode & Holdoff

You can change the holdoff time and select the trigger mode using this menu item.

1. Press **TRIGGER MENU** → **Type** (main) → **Logic** (pop-up) → **Class** (main) → **Pattern** or **State** (pop-up) → **Mode & Holdoff** (main) → **Auto** or **Normal** (side).
 - In **Auto** mode the oscilloscope acquires a waveform after a specific time has elapsed even if a trigger does not occur. The amount of time the oscilloscope waits depends on the time base setting.
 - In **Normal** mode the oscilloscope acquires a waveform only if there is a valid trigger.
2. Press **Holdoff** (side). Enter the value in percent using the general purpose knob or the keypad.

Depending on whether you chose the class **Pattern** or **State**, there are different menus for defining the channel inputs and the combinational logic.

Pattern Operations

When you select **Pattern**, the oscilloscope will trigger on a specified logic combination of the four input channels. See page 3-60 for details on operations common to both pattern and state triggers.

Define Inputs

To set the logic state for each of the input channels (**Ch1**, **Ch2**, ...):

1. Press **TRIGGER MENU** → **Type** (main) → **Logic** (pop-up) → **Class** (main) → **Pattern** (pop-up) → **Define Inputs** (main) → **Ch1**, **Ch2**, **Ch3**, and **Ch4** (side). (On the TDS 520, **Ch3** and **Ch4** are replaced by **Ax1** and **Ax2**.)
2. Repeatedly press each input selected in step 1 to toggle it to either High (**H**), Low (**L**), and Don't Care (**X**) for each channel. (You can also use the general purpose knob.)

Define Logic

To choose the logic function you want applied to the input channels (see page 3-59 for definitions of the logic functions for both pattern and state triggers):

Press **TRIGGER MENU** → **Type** (main) → **Logic** (pop-up) → **Class** (main) → **Pattern** (pop-up) → **Define Logic** (main) → **AND**, **OR**, **NAND**, or **NOR** (side).

Define a Time Qualified Pattern Trigger

You can also time qualify a pattern logic trigger. That is, you specify a time that the boolean logic function (AND, NAND, OR, or NOR) must be TRUE (logic high). You also choose the type of time qualification (greater or less than the time limit specified) as well as the time limit using the Trigger When menu selection.

1. Press **TRIGGER MENU** → **Type** (main) → **Logic** (pop-up) → **Class** (main) → **Pattern** (pop-up) → **Trigger When** (main) → **True for less than** or **True for more than** (side).
2. Use the knob and keypad to set the time in the side menu.

When you select **True for less than** and specify a time using the general purpose knob, the input conditions you specify must drive the logic function high (TRUE) for less than the time you specify. Conversely, **True for more than** requires the boolean function to be TRUE for longer than the time you specify.

Note the position of the trigger indicator in Figure 3-28. Triggering occurs at the point the logic function you specify is determined to be true within the time you specify. The digitizing oscilloscope determines the trigger point in the following manner:

- It waits for the logic condition to become true
- It starts timing and waits for the logic function to become false
- It compares the times and, if the time TRUE is longer (for **True for more than**) or shorter (for **True for less than**), then it triggers a waveform display *at the point the logic condition became false*. This time can be, and usually is, different from the time set for **True for more than** or **True for less than**.

In Figure 3-28, the delay between the vertical bar cursors is the time the logic function is TRUE. Since this time is more (216 μ s) than that set in the **True for more than** menu item (150 μ s), the oscilloscope issues the trigger at that point, not at the point at which it has been true for 216 μ s.

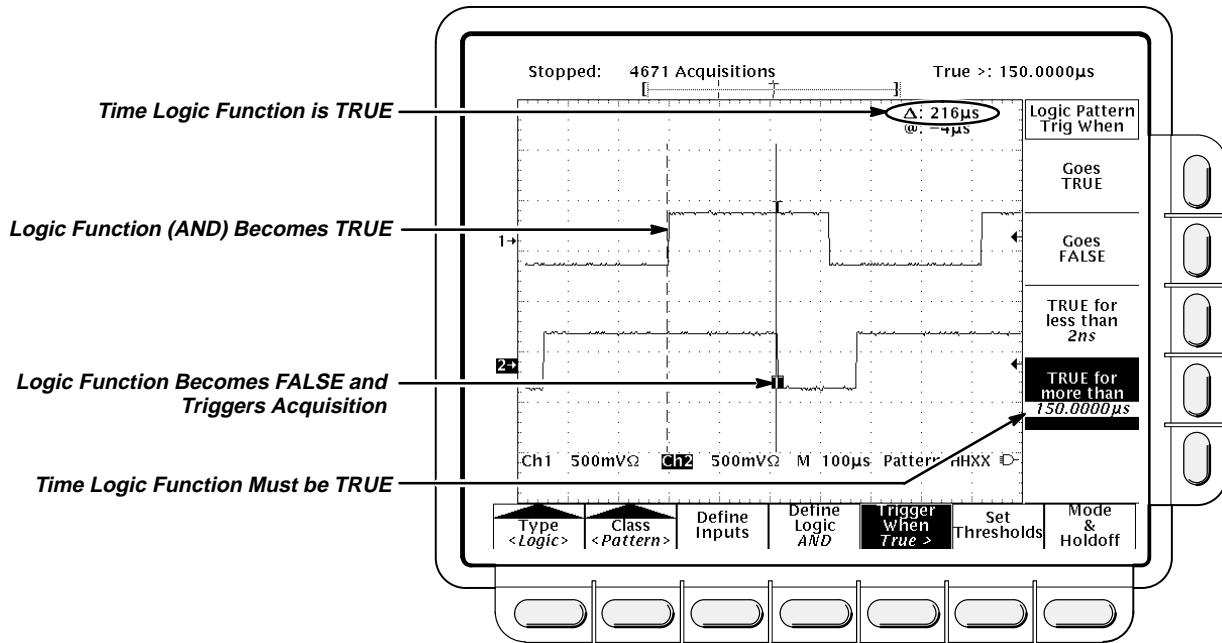

Figure 3-28: Logic Trigger Menu—Time Qualified TRUE

State Operations

When you select **State** logic triggering, the oscilloscope uses channel 4 on the TDS 540 (or Ax 2 on the TDS 520) as a clock for a logic circuit made from the rest of the channels. See page 3-60 for details on operations common to both pattern and state triggers.

The state trigger logic works as follows: the oscilloscope waits until the fourth channel meets the selected slope and voltage threshold. It then checks the logic function applied to the first three channels, and if the function condition is as specified in the the **Trigger When** menu (**Goes TRUE** or **Goes FALSE**) a trigger occurs.

Define Inputs

To set the logic state for each of the input channels (**Ch1**, **Ch2**, ...):

1. Press **TRIGGER MENU** → **Type** (main) → **Logic** (pop-up) → **Class** (main) → **State** (pop-up) → **Define Inputs** (main).
2. Choose either High (**H**), Low (**L**), or Don't Care (**X**) (side) for the first three channels. The choices for **Ch4** (or **Ax2** on the TDS 520) are rising edge and falling edge.

Define Logic

To choose the type of logic function you want applied to the input channels:

Press **TRIGGER MENU** → **Type** (main) → **Logic** (pop-up) → **Class** (main) → **State** (pop-up) → **Define Logic** (main) → **AND, OR, NAND, or NOR** (side).

For More Information

See *Triggering*, on page 2-2.

See *Triggering*, on page 3-120.



Measurement System

There are various ways to measure properties of waveforms. You can use graticule, cursor, or automatic measurements. This section describes *automatic measurements*; cursors and graticules are described elsewhere. (See *Cursor Measurements* on page 3-20 and *Measurements* on page 2-17.)

Automatic measurements are generally more accurate and quicker than, for example, manually counting graticule divisions. The oscilloscope will continuously update and display these measurements. (There is also a way to display all the measurements at once—see *Snapshot of Measurements* on page 3-75.)

Automatic measurements calculate waveform parameters from acquired data. Measurements are performed over the entire waveform record or the region specified by the vertical cursors, if gated measurements have been requested. (See page 3-71 for a discussion of gated measurements.) They are not performed just on the displayed portions of waveforms.

The TDS 500 Series Digitizing Oscilloscopes provide you with 25 automatic measurements (see Table 3-5).

Definitions

The following are brief definitions of the automated measurements in the digitizing oscilloscope (for more details see *Appendix C: Algorithms*, page A-25).

Table 3-5: Measurement Definitions







Name	Definition
 Amplitude	Voltage measurement. The high value less the low value measured over the entire waveform or gated region. $\text{Amplitude} = \text{High} - \text{Low}$
 Area	Voltage over time measurement. The area over the entire waveform or gated region in volt-seconds. Area measured above ground is positive; area below ground is negative.
 Cycle Area	Voltage over time measurement. The area over the first cycle in the waveform, or the first cycle in the gated region, in volt-seconds. Area measured above ground is positive; area below ground is negative.
 Burst Width	Timing measurement. The duration of a burst. Measured over the entire waveform or gated region.
 Cycle Mean	Voltage measurement. The arithmetic mean over the first cycle in the waveform, or the first cycle in the gated region.
 Cycle RMS	Voltage measurement. The true Root Mean Square voltage over the first cycle in the waveform, or the first cycle in the gated region.

Table 3-5: Measurement Definitions (Cont.)



















Name	Definition
 Delay	Timing measurement. The time between the MidRef crossings of two different traces, or the gated region of the traces.
 Fall Time	Timing measurement. Time taken for the falling edge of the first pulse in the waveform or gated region to fall from a High Ref value (default = 90%) to a Low Ref value (default = 10%) of its final value.
 Frequency	Timing measurement for the first cycle in the waveform or gated region. The reciprocal of the period. Measured in Hertz (Hz) where 1 Hz = 1 cycle per second.
 High	The value used as 100% whenever High Ref, Mid Ref, and Low Ref values are needed (as in fall time and rise time measurements). Calculated using either the min/max or the histogram method. The <i>min/max</i> method uses the maximum value found. The <i>histogram</i> method uses the most common value found above the mid point. Measured over the entire waveform or gated region.
 Low	The value used as 0% whenever High Ref, Mid Ref, and Low Ref values are needed as in fall time and rise time measurements. May be calculated using either the min/max or the histogram method. With the min/max method it is the minimum value found. With the histogram method, it refers to the most common value found below the mid point. Measured over the entire waveform or gated region.
 Maximum	Voltage measurement. The maximum amplitude. Typically the most positive peak voltage. Measured over the entire waveform or gated region.
 Mean	Voltage measurement. The arithmetic mean over the entire waveform or gated region.
 Minimum	Voltage measurement. The minimum amplitude. Typically the most negative peak voltage. Measured over the entire waveform or gated region.
 Negative Duty Cycle	Timing measurement of the first cycle in the waveform or gated region. The ratio of the negative pulse width to the signal period expressed as a percentage.
	$\text{NegativeDutyCycle} = \frac{\text{NegativeWidth}}{\text{Period}} \times 100\%$
 Negative Overshoot	Voltage measurement. Measured over the entire waveform or gated region.
	$\text{NegativeOvershoot} = \frac{\text{Low} - \text{Min}}{\text{Amplitude}} \times 100\%$
 Negative Width	Timing measurement of the first pulse in the waveform or gated region. The distance (time) between MidRef (default 50%) amplitude points of a negative pulse.
 Peak to Peak	Voltage measurement. The absolute difference between the maximum and minimum amplitude in the entire waveform or gated region.
 Phase	Timing measurement. The amount one waveform leads or lags another in time. Expressed in degrees, where 360° = 1 cycle.

Table 3-5: Measurement Definitions (Cont.)

Name	Definition
 Period	Timing measurement. Time it takes for the first complete signal cycle to happen in the waveform or gated region. The reciprocal of frequency. Measured in seconds.
 Positive Duty Cycle	Timing measurement of the first cycle in the waveform or gated region. The ratio of the positive pulse width to the signal period expressed as a percentage.
$PositiveDutyCycle = \frac{PositiveWidth}{Period} \times 100\%$	
 Positive Over-shoot	Voltage measurement over the entire waveform or gated region.
$PositiveOvershoot = \frac{Max - High}{Amplitude} \times 100\%$	
 Positive Width	Timing measurement of the first pulse in the waveform or gated region. The distance (time) between MidRef (default 50%) amplitude points of a positive pulse.
 Rise time	Timing measurement. Time taken for the leading edge of the first pulse in the waveform or gated region to rise from a Low Ref value (default = 10%) to a High Ref value (default = 90%) of its final value.
 RMS	Voltage measurement. The true Root Mean Square voltage over the entire waveform or gated region.

Measurement Display

The readout area for measurements is on the right side of the waveform window. You can display and continuously update as many as four measurements at any one time. When menus are displayed, the readouts appear in the graticule area. If the menu area is empty, then the readouts are displayed to the far right (see Figure 3-29).

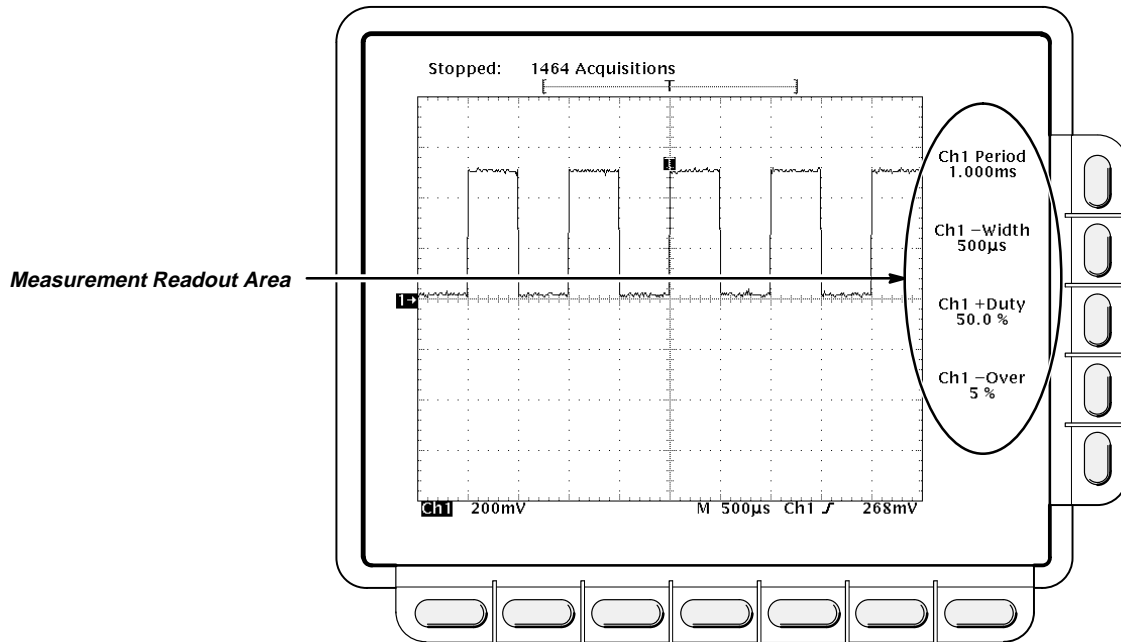

Figure 3-29: Measurement Readouts

Operation

To use the automatic measurements you first need to obtain a stable display of the waveform to be measured. Pressing **AUTOSET** may help. Once you have a stable display, press **MEASURE** to bring up the Measure menu (Figure 3-30).

Selecting a Measurement

Measurements are made on the selected waveform. The measurement display tells you the channel the measurement is being made on.

1. Press **MEASURE** → **Select Measrmnt** (main).
2. Select a measurement from the side menu.

The following are hints on making automatic measurements:

- You can only take a maximum of four measurements at a time. To add a fifth, you must remove one or more of the existing measurements.

- To vary the source for measurements, simply select the other channel and then choose the measurements you want.
- Be careful when taking automatic measurements on noisy signals. You might measure the frequency of the noise and not the desired waveform.

Your digitizing oscilloscope helps identify such situations by displaying a *low signal amplitude* or *low resolution* warning message.

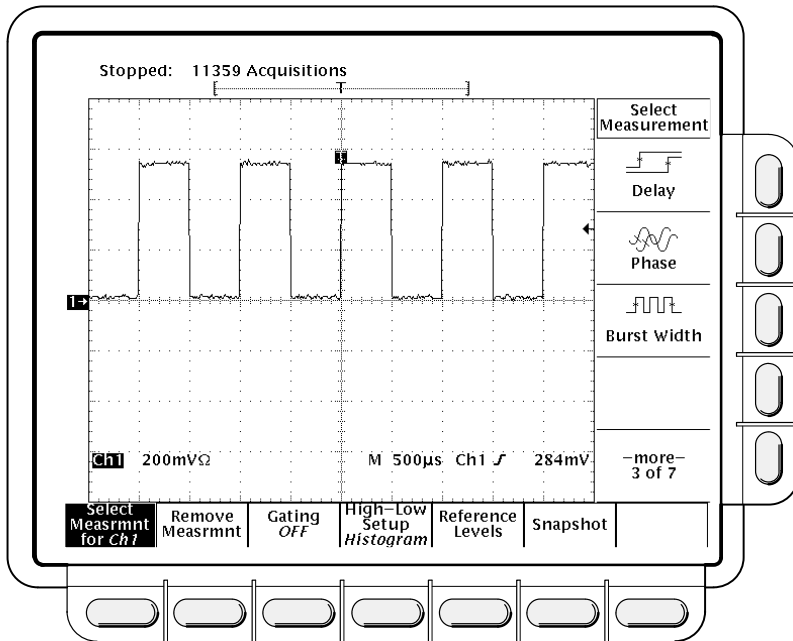

Figure 3-30: Measure Menu

Removing Measurements

The **Remove Measrmt** selection provides explicit choices for removing measurements from the display according to their readout position.

Measurement 1 is the top readout. Measurement 2 is below it, and so forth. Once a measurement readout is displayed in the screen area, it stays in its position even when you remove any measurement readouts above it. To remove measurements:

1. Press **MEASURE** → **Remove Measrmt** (main).
2. Select the measurement to remove from the side menu. If you want to remove all the measurements at one time, press **All Measurements** (side).

Gated Measurements

The gating feature lets you limit measurements to a specified portion of the waveform. When gating is **Off**, the oscilloscope makes measurements over the entire waveform record.

When gating is activated, vertical cursors are displayed. Use these cursors to define the section of the waveform you want the oscilloscope to measure. This is called the *gated region*.

1. Press **MEASURE** → **Gating** (main) → **Gate with V Bar Cursors** (side) (see Figure 3-31).

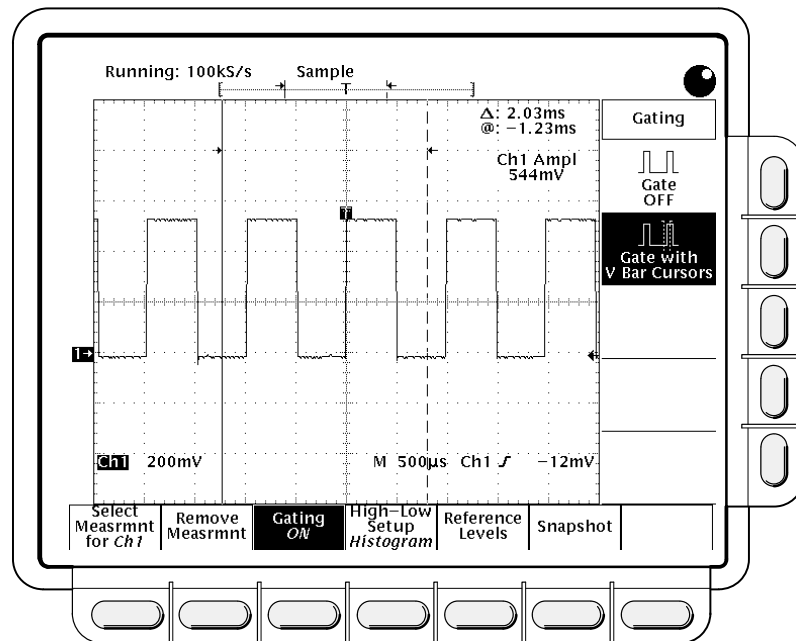

Figure 3-31: Measure Menu—Gating

2. Using the general purpose knob, move the selected (the active) cursor. Press **TOGGLE** to change which cursor is active.

Displaying the cursor menu and turning V Bar cursors off will *not* turn gating off. (Gating arrows remain on screen to indicate the area over which the measurement is gated.) You must turn gating off in the Gating side menu.

NOTE

Cursors are displayed relative to the selected waveform. If you are making a measurement using two waveforms, this can be a source of confusion. If you turn off horizontal locking and adjust the horizontal position of one waveform independent of the other, the cursors appear at the requested position with respect to the selected waveform. Gated measurements remain accurate, but the displayed positions of the cursors change when you change the selected waveform.

High-Low Setup

The **High-Low Setup** item provides two choices for how the oscilloscope determines the High and Low levels of waveforms. These are *histogram* and *min-max*.

- Histogram sets the values statistically. It selects the most common value either above or below the mid point (depending on whether it is defining the high or low reference level). Since this statistical approach ignores short term aberrations (overshoot, ringing, etc.), histogram is the best setting for examining pulses.
- Min-max uses the highest and lowest values of the waveform record. This setting is best for examine waveforms that have no large, flat portions at a common value, such as sine wave and triangle waves—almost any waveform except for pulses.

To use the high-low setup:

Press **MEASURE** → **High-Low Setup** (main) → **Histogram** or **Min-Max** (side). If you select **Min-Max**, you may also want to check and/or revise values using the Reference Levels main menu.

Reference Levels

Once you define the reference levels, the digitizing oscilloscope will use them for all measurements requiring those levels. To set the reference levels:

1. Press **MEASURE** → **Reference Levels** (main) → **Set Levels** (side) to choose whether the References are set in % relative to High (100%) and Low (0%) or set explicitly in the units of the selected waveform (typically volts). See Figure 3-32. Use the general purpose knob or keypad to enter the values.
 - % is the default selection. It's useful for general purpose applications.
 - **Units** is helpful for setting precise values. For example, if you're trying to measure specifications on an RS-232-C circuit, you can set the levels precisely to RS-232-C specification voltage values by defining the high and low references in units.

2. Press **High Ref**, **Mid Ref**, **Low Ref**, or **Mid2 Ref** (side).

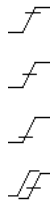

- **High Ref**—Sets the high reference level. The default is 90%.
- **Mid Ref**—Sets the middle reference level. The default is 50%.
- **Low Ref**—Sets the low reference level. The default is 10%.
- **Mid2 Ref**—Sets the middle reference level used on the second waveform specified in the Delay or Phase Measurements. The default is 50%.

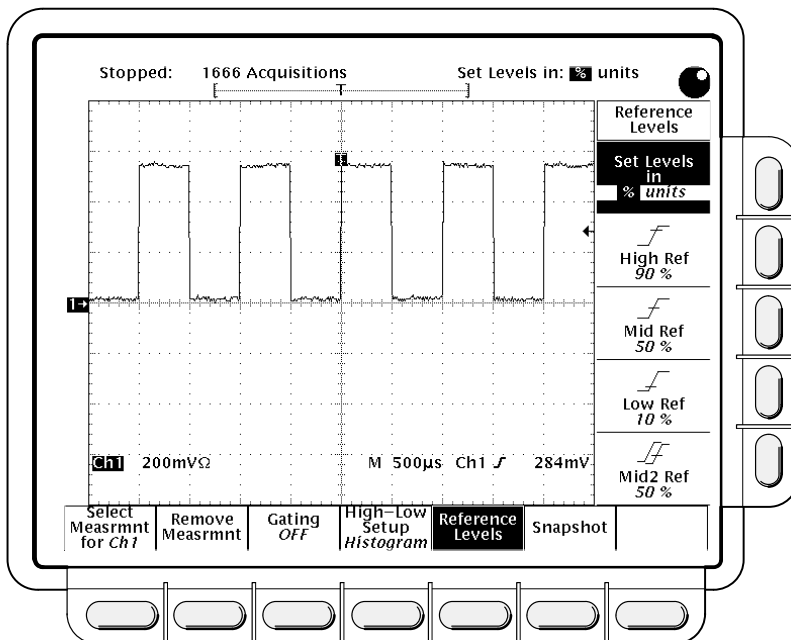

Figure 3-32: Measure Menu—Reference Levels

Delay Measurement

The delay measurement lets you measure from an edge on the selected waveform to an edge on another waveform. You access the Delay Measurement menu through the Measure main menu:

Press **MEASURE** → **Select Measrmt** (main) → **Delay** (side). This brings up the Measure Delay main menu (Figure 3-33).

Delay to—To select the waveform you want to measure *to*, use the the main menu item **Delay to**. The waveform you are measuring *from* is the selected waveform.

1. Press **MEASURE** → **Select Measrmt** (main) → **Delay** (side) → **Delay To** (main) → **Measure Delay to**.

2. Press **Measure Delay to** (side) repeatedly or turn the general purpose knob to choose the delay *to* waveform. The choices are **Ch1, Ch2, Ch3, Ch4** (on the TDS 540); **Ch1, Ch2, Ax1, Ax2** (on the TDS 520); and **Math1, Math2, Math3, Ref1, Ref2, Ref3, and Ref4** (both models).

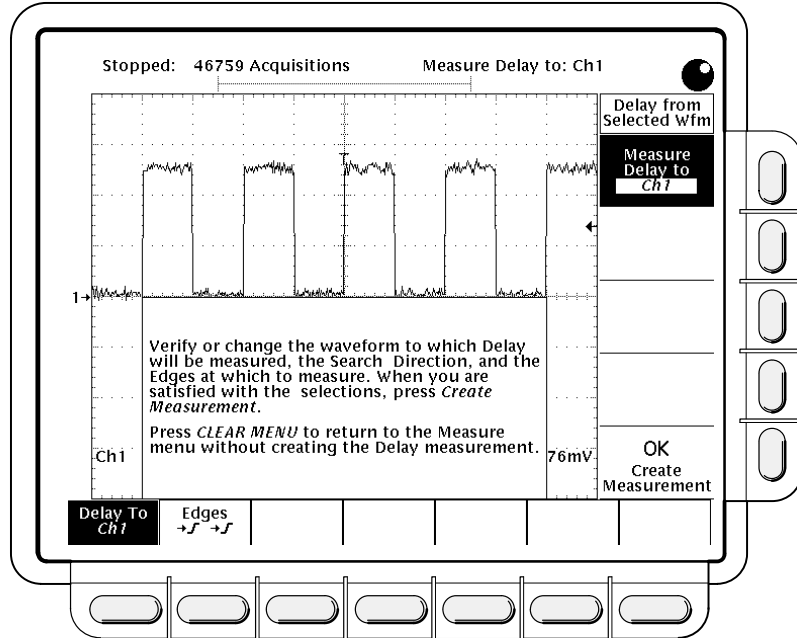

Figure 3-33: Measure Delay Menu—Delay To

Delay Edges—The main menu item **Edges** lets you specify which edges you want the delayed measurement to be made between.

Press **MEASURE** → **Select Measrmt** (main) → **Delay** (side) → **Delay To** (main) → **Edges** (side). A side menu of delay edges and directions will appear. Choose from one of the combinations displayed on the side menu.

The upper waveform on each icon represents the *from* waveform and the lower one represents the *to* waveform.

The direction arrows on the choices let you specify a forward search on both waveforms or a forward search on the *from* waveform and a backwards search on the *to* waveform. The latter choice is useful for isolating a specific pair of edges out of a stream.

Creating the Delay Measurement—Once you have specified the waveforms you are measuring between and which edges to use, you need to notify the digitizing oscilloscope to proceed with the measurement.

Press **Delay To** (main) → **OK Create Measurement** (side).

To exit the Measure Delay menu without creating a delay measurement, press **CLEAR MENU**, which returns you to the Measure menu.

Snapshot of Measurements

Sometimes you may want to see all of the automated measurements on screen at the same time. To do so, use Snapshot. Snapshot executes all of the single waveform measurements available on the selected waveform *once* and displays the results. (The measurements are not continuously updated.) All of the measurements listed in Table 3-5 on page 3-66 except for Delay and Phase are displayed. (Delay and Phase are dual waveform measurements and are not available with Snapshot.)

The readout area for a snapshot of measurements is a pop up display that covers about 80% of the graticule area when displayed (see Figure 3-34). You can display a snapshot on any channel or ref memory, but only one snapshot can be displayed at a time.

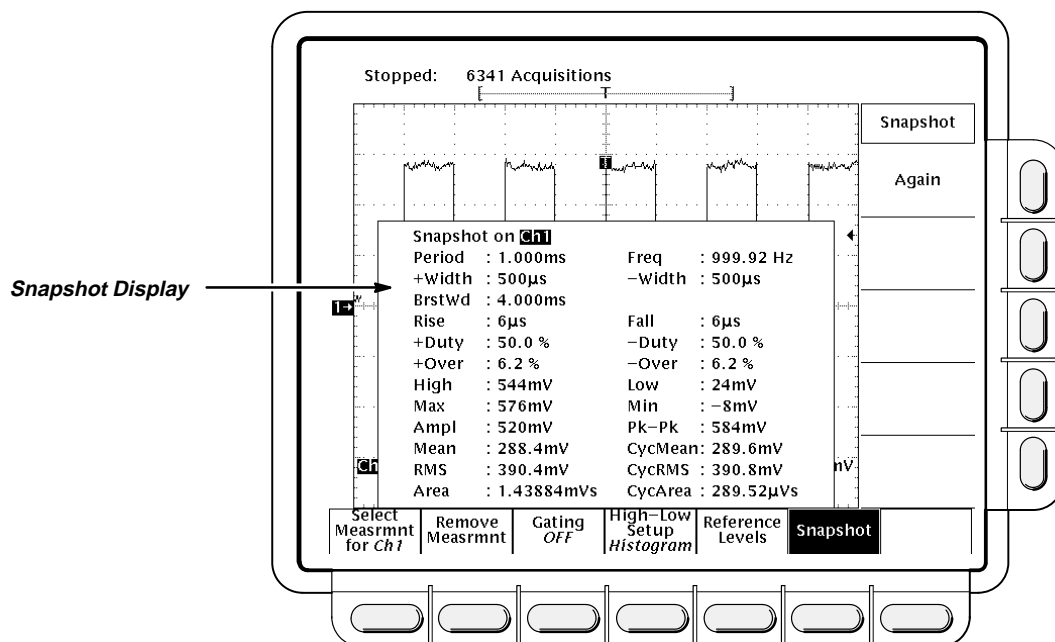

Figure 3-34: Snapshot Menu and Readout

To use snapshot, obtain a stable display of the waveform to be measured. Pressing **AUTOSET** may help.

1. Press **MEASURE** → **SNAPSHOT** (main).

2. Press either **SNAPSHOT** (main) or **AGAIN** (side) to take another snapshot.
3. Push **Remove Measrmt.**

Considerations When Taking Snapshots

Be aware of the following items when using snapshot:

- Be sure to display the waveform properly before taking a snapshot. Snapshot does not warn you if a waveform is improperly scaled (clipped, low signal amplitude, low resolution, etc.).
- To vary the source for taking a snapshot, simply select another channel, math, or ref memory waveform and then execute snapshot again.
- A snapshot is taken on a single waveform acquisition (or acquisition sequence). The measurements in the snapshot display are not continuously updated.
- Be careful when taking automatic measurements on noisy signals. You might measure the frequency of the noise and not the desired waveform.
- Note that pushing any button in the main menu (except for Snapshot) or any front panel button that displays a new menu removes the snapshot from display.
- Use High-Low Setup (page 3-72), Reference Levels (page 3-72), and Gated Measurements (page 3-71) with snapshot exactly as you would when you display individual measurements from the **Select Measrmt** menu.

For More Information

See *Appendix C: Algorithms*, on page A-25.

See *Measurements*, on page 2-17.

See *Tutorial Example 3: Automated Measurements*, on page 1-12.

Probe Accessories

The probe you use and how you connect it to a signal source affect the oscilloscope acquisition of the waveform record. Two important factors are ground lead inductance (introduced by the probe) and the physical layout of your circuit and component devices.

Ground Lead Inductance

For an amplitude measurement to be meaningful, you must give the measurement some point of reference. The probe offers you the capability for referencing the voltage at its tip to ground. To make your measurement as accurate as possible, the probe ground lead should be connected to the ground reference.

However, when you touch your probe tip to a circuit, you are introducing new resistance, capacitance, and inductance into the circuit (Figure 3-35).

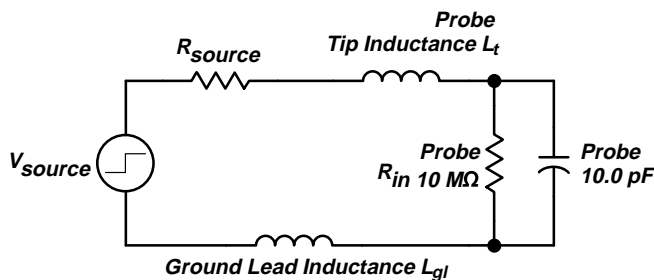

Figure 3-35: A Probe Adds Resistance, Capacitance, and Inductance

For most circuits, the high input resistance of a passive probe has a negligible effect on the signal. The series inductances represented by the probe tip and ground lead, however, can result in a parasitic resonant circuit that may “ring” within the bandwidth of the oscilloscope. Figure 3-36 shows the effect of the same signal through the same probe with different ground leads.

Ringing and rise time degradation may be hidden if the frequency of the induced ringing is beyond the bandwidth of the oscilloscope. If you know the self-inductance (L) and capacitance (C) of your probe and ground lead, you can calculate the approximate resonant frequency (f_0) at which that parasitic circuit will resonate:

$$f_0 = \frac{1}{2\pi \times \sqrt{LC}}$$

Reducing the ground lead inductance will raise the resonant frequency. Ideally, the inductance is low enough that the resulting frequency is above the frequency at which you want to take measurements. For that purpose, the probes include several accessories to help reduce ground lead inductance.

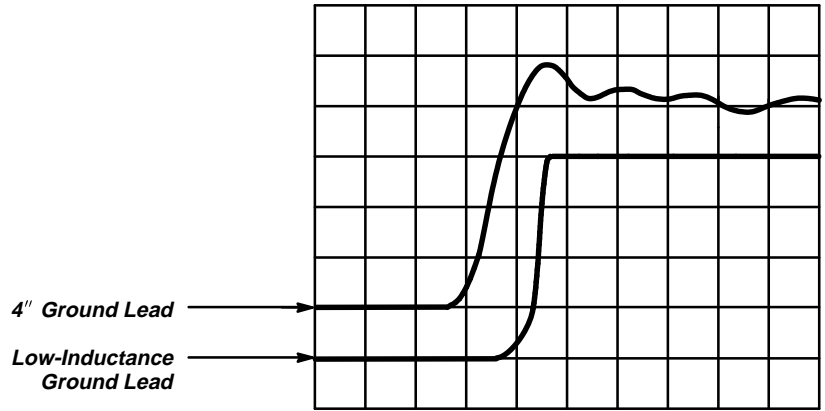

Figure 3-36: Signal Variation Introduced by Probe Ground Lead (1 ns/division)

Standard Probe Accessories

The following descriptions explain how to use many of the accessories that came with your probe. Figure 3-37 shows both standard and optional probe accessories and how they attach to your probe.

These accessories either reduce ground lead inductance or make it physically easier to probe different kinds of circuits.

Standard probe accessories include the following items.

Retractable Hook Tip

The retractable hook tip attaches to your signal test point for hands-free operation of the probe. The hook tip attaches to components having leads, such as resistors, capacitors, and discrete semiconductors. You can also grip stripped wire, jumpers, busses, and test pins with the retractable hook.

For maximum flexibility with the hook tip, use one of the six-inch ground leads. For precise measurements at high frequency, however, long ground leads may have too much inductance. In these cases you can use one of the low-inductance probe tip configurations instead.

To remove the hook tip, simply pull it off the probe. Reinstall it by pushing it firmly onto the ribbed ferrule of the probe tip (see Figure 3-37).

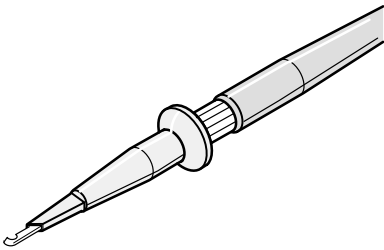

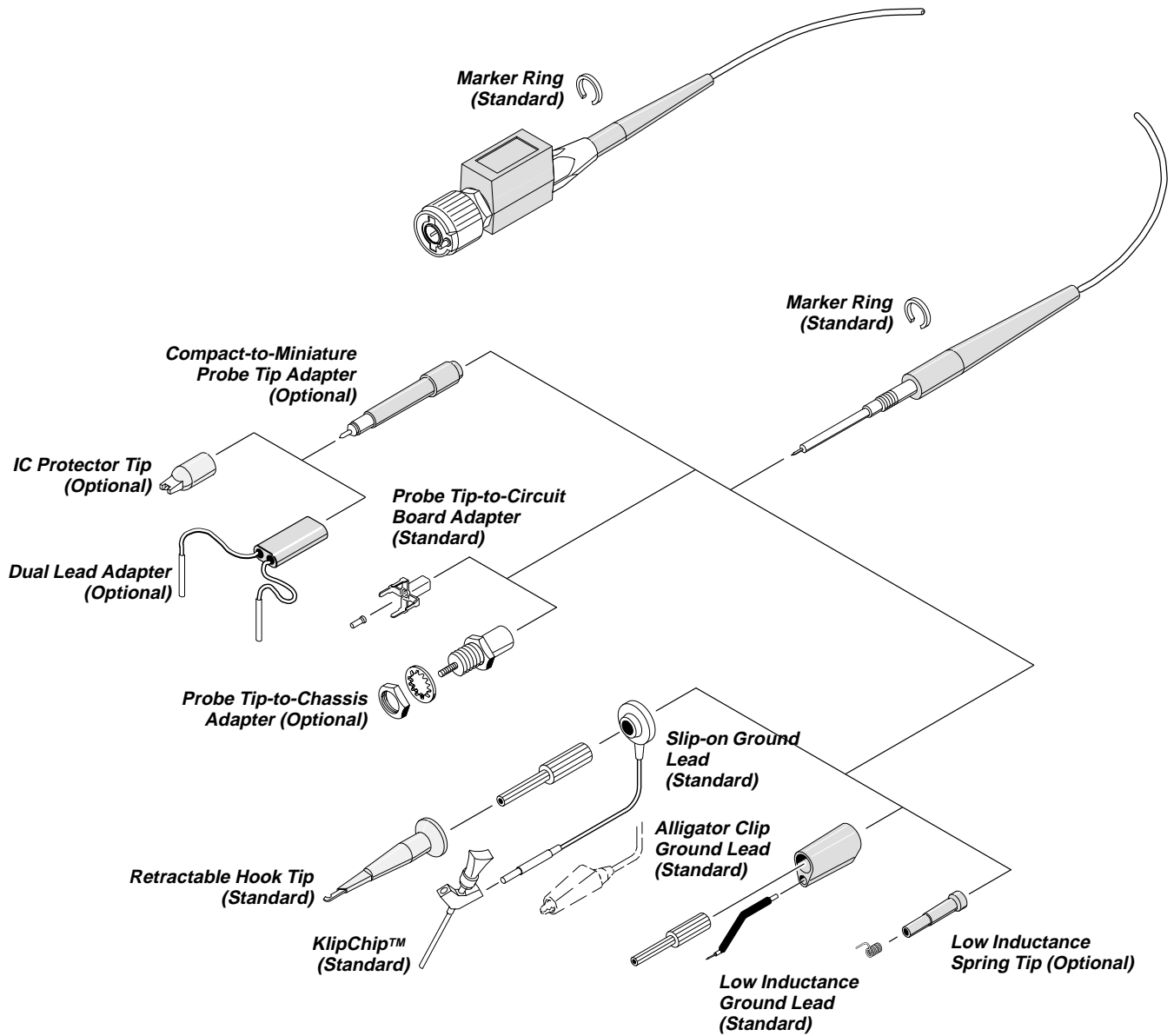
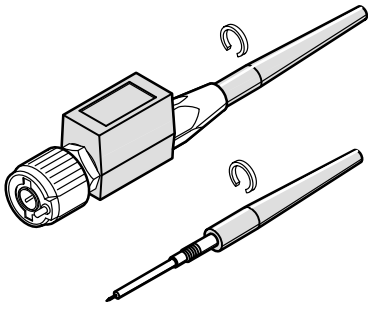

Figure 3-37: Probe Accessories

Probe Accessories



Marker Rings

The marker rings help you keep track of individual probes and signal sources when you have a complicated test setup. Use the marker rings whenever you want to identify a particular probe.

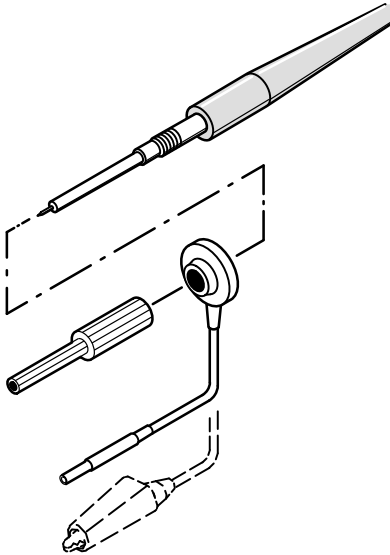

Long Ground Leads

Use long ground leads when a long reach is important and high-frequency information is not. Long ground leads are ideal for quick troubleshooting when you are looking for the presence or absence of a signal and are not concerned with the precision of the measurement.

Because of the high inductance associated with long ground leads, you should not use them for precise measurements above approximately 30 MHz (or for pulses with rise times less than about 11 ns).

You can choose between a ground lead terminated with an alligator clip and a lead terminated with a square-pin receptacle.

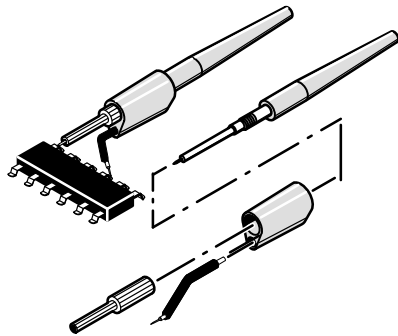

Low-Inductance Ground Lead

Low-inductance ground leads reduce ground lead inductance. Compared to a typical six-inch ground lead with an inductance of approximately 140 nH, the low-inductance tip assembly has an inductance of approximately 32 nH. That means that your measurements will be relatively free of probe-related high-frequency degradation up to approximately 250 MHz.

The low-inductance tip has a partially insulated flexible ground pin that allows you to ground the probe and still have a limited amount of reach with the probe tip. Because the ground lead simply contacts the ground reference (instead of clipping onto it) you can move the probe around your device under test with ease. The assembly is well-suited to densely populated circuit boards and multi-pin connectors.

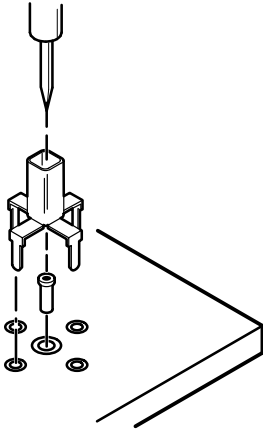

Probe-Tip-to-Circuit Board Adapters

The probe-tip-to-circuit board adapters let you design minimum inductance test points into your next circuit board. That adapter provides maximum performance for the probe, because it virtually eliminates the probe's ground inductance effects.

Instructions for installing the probe tip-to-circuit board adapters are packaged with the adapters. For the best performance and ease of testing, Tektronix strongly recommends that you incorporate the probe tip-to-circuit board adapters (or the probe tip-to-chassis adapters described below) into your next design.

To use your probe with these adapters, unscrew and remove the ribbed ferrule. Use the probe tip directly with the adapter.

SMT KlipChip™

The SMT KlipChip provides hands-free attachment to a physically small signal or ground source. The low profile of the KlipChip allows you to grasp surface-mounted devices that the full-size retractable hook tip can't grip.

You can use the KlipChip as a ground attachment, as a signal attachment, or to attach both to a ground and a signal.

- For a ground attachment, use the long ground lead (described on page 3-80) terminated with a pin receptacle and connect the termination to the pin in one of the KlipChip shoulders.
- For a signal attachment, use a single-lead adapter (similar to the dual-lead adapter described on page 3-83) and connect the termination to the pin in one of the KlipChip shoulders.
- For both ground and signal attachment, combine two KlipChips with a dual-lead adapter, or use a single-lead adapter and a long ground lead.

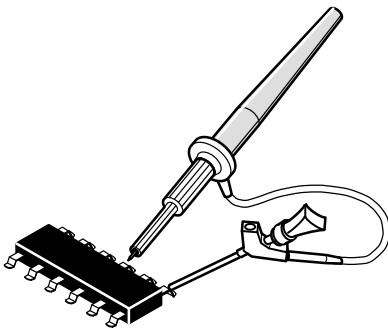

Optional Probe Accessories

Optional probe accessories that you can order include the following:

Low-Inductance Spring Tips

The low-inductance spring tips can be used whenever you are measuring devices with fixed spacings. The spring-tip is ideal for repetitive production use. Select different length springs to match device spacings on a variety of components. Because the spring-tip ground lead simply contacts the ground reference (instead of clipping onto it) you can move the probe around your device-under-test with ease.

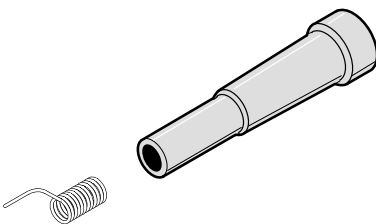

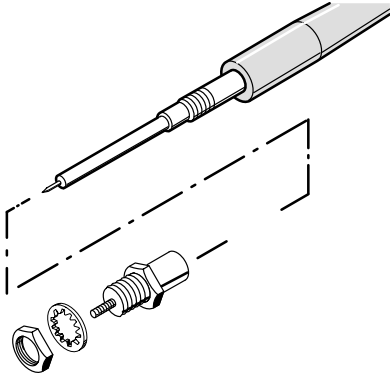

Probe-Tip-to-Chassis Adapter

The probe-tip-to-chassis adapter makes your test point accessible without removing instrument covers or panels. It provides an easy-access, low-inductance test point anywhere on your circuit. The probe-tip-to-chassis adapter has the same low inductance properties as the probe-tip-to-circuit board adapter described previously.

To use your probe with these adapters, unscrew and remove the ribbed ferrule.

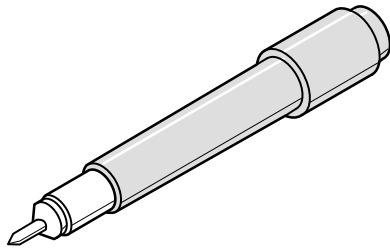

Compact-to-Miniature Probe Tip Adapter

The compact-to-miniature probe tip adapter allows you to use accessories that are designed to accept a larger probe tip. These accessories include the IC protector tip, single- and dual-lead adapters, and others.

To install the adapter, unscrew and remove the ribbed ferrule and screw the adapter on in its place. (The IC protector tip discussed below is installed on the adapter tip when shipped. Remove the protector tip by pulling it off before using the adapter with other accessories.)

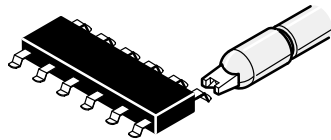

IC Protector Tip

The IC protector tip simplifies probing inline IC packages. The shape of the IC protector guides the probe tip to the IC pin and prevents accidental shorting of pins by the probe tip. It is used with the compact-to-miniature probe tip adapter. When using that tip, the spacing (pitch) between leads should be greater than or equal to 0.100 inches (100 mils).

Because the IC protector tip prevents you from using the low-inductance tips, you will have to use one of the longer ground leads. For that reason you should take into account ground lead inductance effects on measurements at frequencies greater than about 30 MHz.

Dual-Lead Adapter

The dual-lead adapter makes an easy connection to 0.025 diameter connector pins (Figure 3-38). One lead connects to a ground reference pin, and the other to the signal pin. The adapter prevents burring and pin damage that can result when a retractable hook tip is used on soft pins. A single-lead adapter is also available. These adapters can also be used with the SMT KlipChip to provide access to very small signal and ground test points.

Although the dual-lead adapter is an improvement over the long ground leads in terms of added inductance, measurements at frequencies greater than 30 MHz may require using one of the low-inductance ground leads. Because of the length of the signal lead, the dual-lead configuration is also more susceptible to signal crosstalk than other tip configurations.

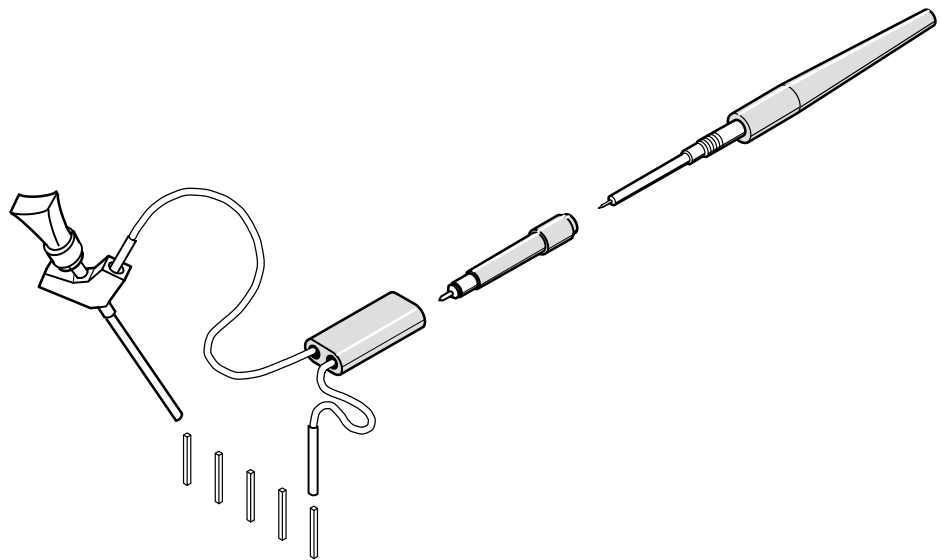

Figure 3-38: Dual-Lead Adapter



Probe Cal

This oscilloscope lets you compensate the entire signal path, from probe tip to digitized signal, to improve the gain and offset accuracy of the probe. By executing *Probe Cal* on a channel with its probe installed, you can optimize the oscilloscope capability to make accurate measurements using that channel and probe.

Run a Probe Cal anytime you wish to ensure that the measurements you make are made with the most accuracy possible. You should also run a Probe Cal if you have changed to a different probe since the last Probe Cal was performed.

NOTE

Earlier TDS 520 & 540 Oscilloscopes may not be equipped with the hardware needed to operate Probe Cal. To determine if your oscilloscope has Probe Cal, display the Vertical menu. If the menu label Cal Probe is less bright than the other labels in that menu, Probe Cal is not installed.

Probe Cal vs. Probe Type

Some types of probes can be gain compensated, some can be offset compensated, and some can be compensated for both. *Some probes cannot be compensated.*

If your probe has an attenuation factor of greater than 20X, it cannot be compensated. If you attempt to compensate such a probe you will get an error message.

The digitizing oscilloscope cannot compensate probes whose gain and/or offset errors are too great ($> 2\%$ gain and/or > 50 mV offset). If these errors are within specified limits for your probe, you may wish to use another probe. If they are not within specification, you may want to have your probe checked by service personnel.

NOTE

Probe Cal is not recommended with the P6139A passive probe. This probe typically has little gain and offset error, and therefore, the improvement in performance after a Probe Cal is not worth the time needed to do the Probe Cal. Probe Cal makes significant performance improvements when performed with active probes or older passive probes.

Operation

If you are installing an *active* probe, such as the P6205, there are no prerequisites to performing this procedure. Start at step 1.

If you are compensating for a *passive* probe with this procedure you must first compensate the low frequency response of the probe. First, do steps 1 and 2 below, and then perform the instructions found under *Probe Compensation* on page 3-90. Then continue with step 3 of this procedure.

1. Install the probe on the input channel on which it is to be used.
2. Power on the digitizing oscilloscope and allow a 20 minute warm-up before doing this procedure.
3. Press **SHIFT UTILITY** → **System** (main) → **Cal** (pop-up).
4. Look at the status label under **Signal Path** in the main menu. If the status does not read **Pass**, perform a signal path compensation (*Signal Path Compensation*, page 3-117), and then continue with this procedure.
5. Press the front-panel button corresponding to the input channel on which you installed the probe.
6. Press **VERTICAL MENU** → **Cal Probe** (main).



Your oscilloscope will detect the type of probe you have installed and display screen messages and menu choices for compensation of probe gain, offset, or both (see Figure 3-39). The following steps will have you run probe gain, offset, or both depending on the probe the oscilloscope detects.

7. If the message on screen is *Probe Offset Compensation* rather than *Probe Gain Compensation*, skip to step 15.
8. Connect the probe tip to **PROBE COMPENSATION SIGNAL**; connect the probe ground lead to **PROBE COMPENSATION GND**.
9. Press **OK Compensate Gain** (side).
10. Wait for gain compensation to complete (one to three minutes).



When gain compensation completes, the following actions occur:

- The clock icon will disappear.
- If offset compensation is required for the probe installed, the *Probe Offset Compensation* message will replace the *Probe Gain Compensation* message.
- If gain compensation did not complete successfully, you may get a “Probe is not connected” message (examine the probe connections to digitizing oscilloscope, be sure the probe tip is properly installed in its retractor, etc., and repeat step 9).
- If gain compensation did not complete successfully, you may get the message “Compensation Error.” This error implies that the probe gain (2% error) and/or offset (50 mV) is too great to be compensated. You can substitute another probe and continue. You may want to have your probe checked by service personnel.

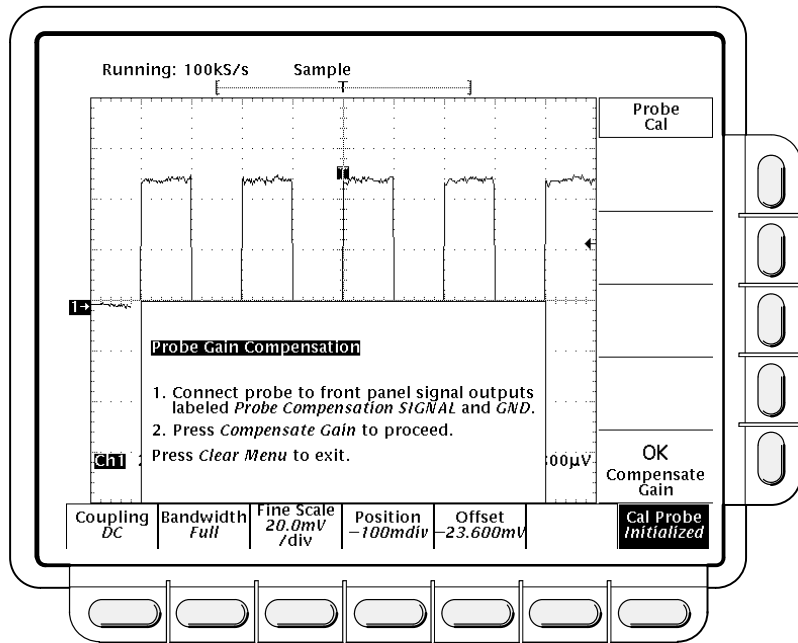

Figure 3-39: Probe Cal Menu and Gain Compensation Display

11. If the Probe *Offset* Compensation message is displayed, continue with step 15; otherwise, continue with step 12.
12. If the Compensation Error message is displayed, continue with step 13; otherwise continue with step 18.
13. Press **SHIFT UTILITY** → **System** (main) → **Diag/Err** (pop-up) → **Error Log** (main). If there are too many error messages to be seen on screen, rotate the general purpose knob clockwise to scroll to the last message.
14. Note the compensation error amount. Skip to step 19.
15. Disconnect the probe from any signal you may have connected it to. Leave the probe installed on its channel.
16. Press **OK Compensate Offset** (side).
17. Wait for offset compensation to complete (one to three minutes).



When offset compensation completes, the following occurs:

- The clock icon will disappear.
 - If offset compensation did not complete successfully, you may get the message “Compensation Error.” This error implies that the probe offset scale (10% error) and/or offset (50 mV) is too great to be compensated. You can substitute another probe and continue. You might want to have your probe checked by service personnel. You can also check the error log by doing steps 13 through 14.
18. After the clock icon is removed, verify the word **Initialized** changed to **Pass** under **Cal Probe** in the main menu. (See Figure 3-39.)

19. If desired, repeat this procedure beginning at step 1 to compensate for other probe/channel combinations. But before you do so, be sure you take note of the following requirements:
 - Remember to first low frequency compensate any passive probe you connect (see *Prerequisites* at the beginning of this procedure).
 - Remember to connect all but simple passive probes to the oscilloscope for a twenty minute warm up before running Probe Cal.

Usage

The following topic contain information you should consider when using input channels that have stored a Probe Cal.

Changing Probes After a Probe Cal

If a Probe Cal has never been performed on an input channel or if its stored Probe Cal data is erased using the *Re-use Probe Calibration Data* menu (discussed later), the oscilloscope displays *Initialized* status in its vertical menu. It also displays initialized whenever you remove a probe from an input.

If you execute a successful Probe Cal on an input channel, the oscilloscope stores the compensation data it derived in non-volatile memory. Therefore, this data is available when you turn the oscilloscope off and back on, when you change probes, etc.

When you install a probe or power on the oscilloscope with probes installed, the oscilloscope tests the probe at each input. Depending on the probe it finds on each input, it takes one of the following actions:

- If the probe has a complex oscilloscope interface (it can convey additional information, such as a unique identification number), the oscilloscope determines whether it is the same probe for which data was stored. If it is, the oscilloscope sets status to pass; if not, it sets the status to *Initialized*.
- If a probe has a simple oscilloscope interface, the oscilloscope can usually determine if it has a different probe attenuation factor than that stored for the last Probe Cal. It can also determine if the last Probe Cal was for a probe with a complex interface. If either is the case, the probe installed is different from that stored for the last Probe Cal. Therefore, the oscilloscope sets the status to *Initialized*.
- If a probe has a simple oscilloscope interface and the probe attenuation factor is the same as was stored at the last Probe Cal, the oscilloscope cannot determine whether it is the same probe. Therefore, it displays the *Re-use Probe Calibration data?* menu (see Figure 3-40).

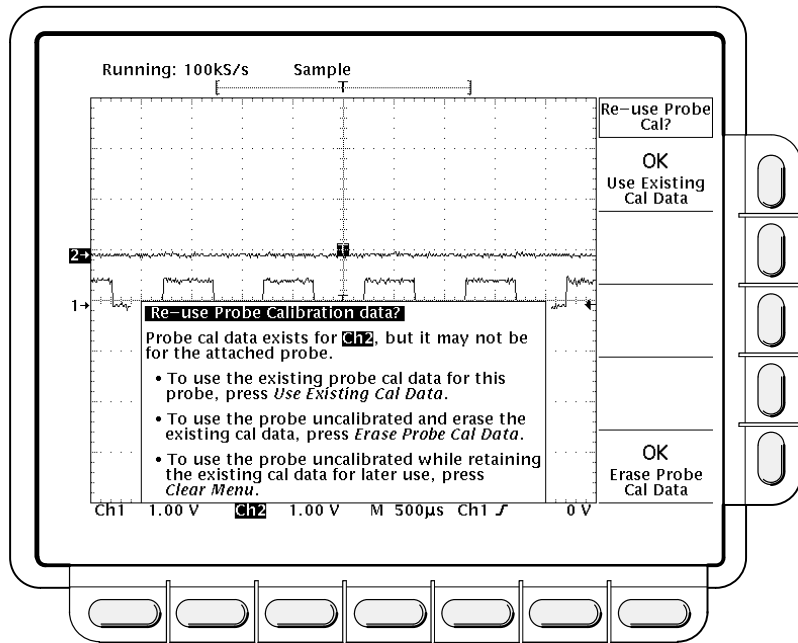

Figure 3-40: Re-use Probe Calibration Data Menu

If the *Re-use Probe Calibration data?* menu is displayed, you can choose one of the following options:

- Press **OK Use Existing Data** (side) to *use* the Probe Cal data last stored to compensate the probe.
- Press **OK Erase Probe Cal Data** (side) to *erase* the Probe Cal data last stored and use the probe uncompensated.
- Press **CLEAR MENU** on the front panel to *retain* the Probe Cal data last stored and use the probe uncompensated.

NOTE

*If the Re-use Probe Calibration data menu is displayed, do not select **OK Use Existing Data** if the probe currently installed is not of the same impedance stored for the Probe Cal. For example, if the last Probe Cal stored for a channel was done with a passive 50 Ω probe installed, don't install a passive 1 MΩ probe and select **OK Use Existing Data** if the menu appears. If you do so, most of any signal you attempt to measure will not be coupled to the input channel because of the probe to oscilloscope impedance mismatch.*

Table 3-6 shows the action the oscilloscope takes based on the probe connected and user operation performed.

Table 3-6: Probe Cal Status

Probe Cal'd? ¹	User Action	Type Probe Connected ²			
		Simple Interface ³		Complex Interface ⁴	
No	Doesn't Matter	<i>Initialized</i>		<i>Initialized</i>	
Yes	Power off	<i>Initialized</i> (probe data is retained)		<i>Initialized</i> (probe data is retained)	
Yes	Power on	Can't detect different probe: <i>Probe Calibration Data</i> menu	Display <i>Re-use</i>	Cal'd Probe:	<i>Pass</i>
		Different probe:	<i>Initialized</i>	Different probe:	<i>Initialized</i>
Yes	Disconnect Probe	<i>Initialized</i>		<i>Initialized</i>	
Yes	Connect Probe	Can't detect different probe: <i>Probe Calibration Data</i> menu	Display <i>Re-use</i>	Cal'd Probe:	<i>Pass</i>
		Different probe:	<i>Initialized</i>	Different probe:	<i>Initialized</i>

¹Refers to a channel input that was *successfully* compensated at the time Probe Cal was last executed for the input channel.

²If no probe is connected, the probe status in the vertical main menu is always *initialized*.

³A probe with a simple interface is a probe that can convey very limited information information to the oscilloscope. Most passive probes (including those shipped with this instrument) have simple interfaces.

⁴A probe with a complex interface is a probe that can convey additional information. For instance, it might automatically set the oscilloscope input channel impedance to match the probe, send the oscilloscope a unique probe identification number, etc. Some optical probes and most active probes (such as the optional accessory P6205) have complex interfaces.

Probe Compensation

Passive probes require compensation to ensure maximum distortion-free input to the digitizing oscilloscope and to avoid high frequency amplitude errors (see Figure 3-41).

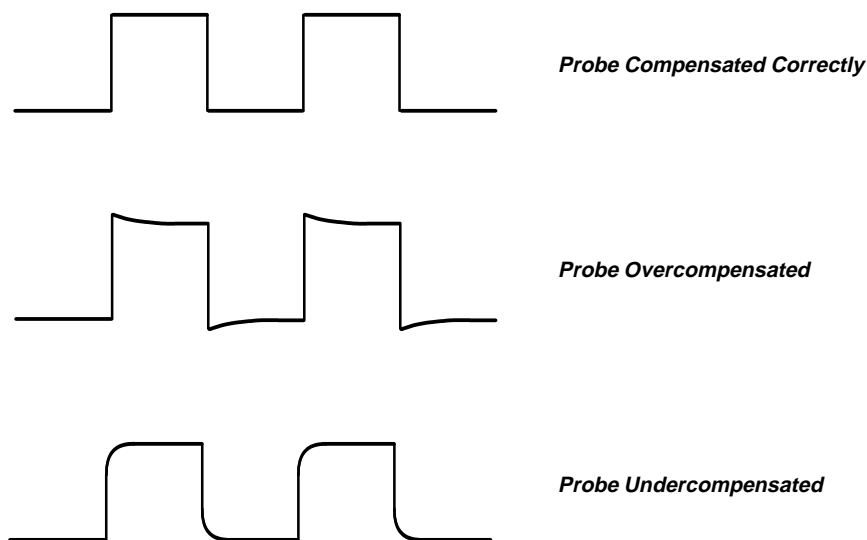

Figure 3-41: How Probe Compensation Affects Signals

Operation

To compensate your probe:

1. Connect the probe to the probe compensation signal on the front panel.
2. Press **AUTOSET**.

NOTE

When you connect an active probe to the oscilloscope (such as the P6205), the input impedance of the oscilloscope automatically becomes 50 Ω . If you then connect a high resistance passive probe (like the P6139A) you need to set the input impedance back to 1 M Ω . Step 4 explains how to change the input impedance.

You now need to limit the bandwidth and change the acquisition mode.

3. Press **VERTICAL MENU** \rightarrow **Bandwidth** (main) \rightarrow **20 MHz** (side).

4. If you need to change the input impedance, press **Coupling** (main). Then toggle the side menu selection Ω to get the correct impedance.
5. Press **SHIFT ACQUIRE MENU** → **Mode** (main) → **Hi Res** (side).
6. Adjust the probe until you see a perfectly flat top square wave on the display. Figure 3-42 shows where the adjustment is located.

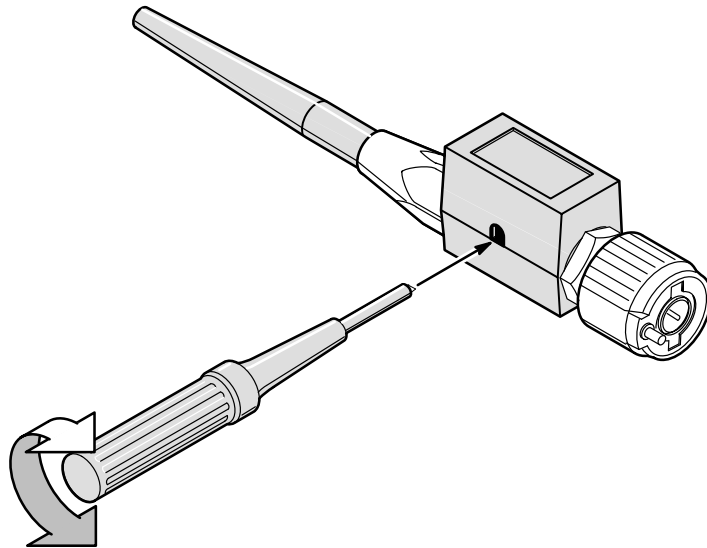

Figure 3-42: P6139A Probe Adjustment

**For More
Information**

See *Probe Accessories*, on page 3-77.

See *Probe Selection*, on page 3-92.



Probe Selection

The probes included with your digitizing oscilloscope are useful for a wide variety of tasks. However, for special measurement situations you sometimes need different probes. This section helps you select the right probe for the job.

Once you have decided the type of probe you need, use Table 3-7 (page 3-7) to determine the specific probe compatible with your TDS 500 Digitizing Oscilloscope. Or use Table 3-8 (page 3-8) if you want to select the probe by application.

There are five major types of probes: passive, active, current, optical, and time-to-voltage probes. Most of these types are discussed here; see your Tektronix Products Catalog for more information.

Passive Voltage Probes

Passive voltage probes measure voltage. They employ passive circuit components such as resistors, capacitors, and inductors. There are three common classes of passive voltage probes:

- *General purpose (high input resistance)*
- *Low impedance (Z_0)*
- *High voltage*

General Purpose (High Input Resistance) Probes

High input resistance probes are considered “typical” oscilloscope probes. The P6139A probes included with the digitizing oscilloscope are passive probes. The high input resistance of passive probes (typically 10 M Ω) provides negligible DC loading and makes them a good choice for accurate DC amplitude measurements.

However, their 8 pF to 12 pF (over 60 pF for 1X) capacitive loading can distort timing and phase measurements. Use high input resistance passive probes for measurements involving:

- Device characterization (above 15 V, thermal drift applications)
- Maximum amplitude sensitivity using 1X high impedance
- Large voltage range (between 15 and 500 V)
- Qualitative or go/no-go measurements

Low Impedance (Z_0) Probes

Low impedance probes measure frequency more accurately than general purpose probes, but they make less accurate amplitude measurements. They offer a higher bandwidth to cost ratio.

These probes must be terminated in a $50\ \Omega$ scope input. Input capacitance is much lower than high Z passive probes, typically $1\ \text{pF}$, but input resistance is also lower (500 to $5000\ \Omega$ typically). Although that DC loading degrades amplitude accuracy, the lower input capacitance reduces high frequency loading to the circuit under test. That makes Z_0 probes ideal for timing and phase measurements when amplitude accuracy is not a major concern.

Z_0 probes are useful for measurements up to $40\ \text{V}$.

High Voltage Probes

High voltage probes have attenuation factors in the 100X to 1000X range. The considerations that apply to other passive probes apply to high voltage probes with a few exceptions. Since the voltage range on high voltage probes varies from $1\ \text{kV}$ to $20\ \text{kV}$ (DC + peak AC), the probe head design is mechanically much larger than for a passive probe. High voltage probes have the added advantage of lower input capacitance (typically $2\text{-}3\ \text{pF}$).

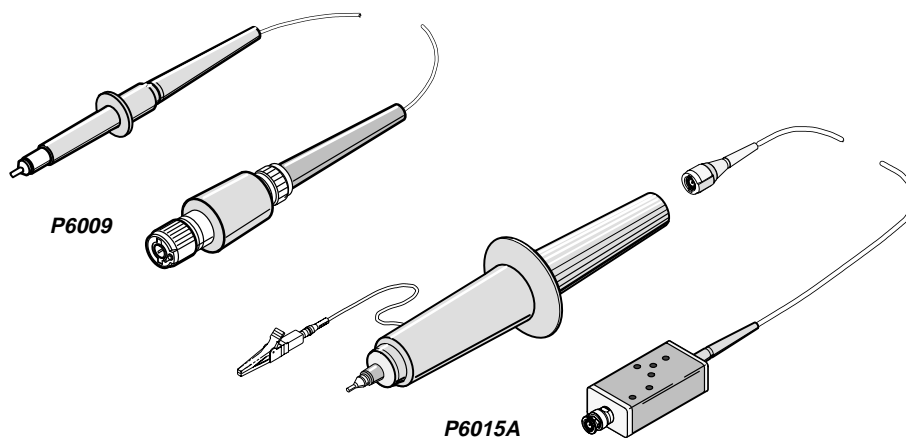

Figure 3-43: The P6009 and P6015A High Voltage Probes

Active Voltage Probes

Active voltage probes, sometimes called “FET” probes, use active circuit elements such as transistors. There are three classes of active probes:

- *High speed active*
- *Differential active*
- *Fixtured active*

Active voltage measuring probes use active circuit elements in the probe design to process signals from the circuit under test. All active probes require a source of power for their operation. Power is obtained either from an external power supply or from the oscilloscope itself.

NOTE

When you connect an active probe to the oscilloscope (such as the P6205), the input impedance of the oscilloscope automatically becomes 50 Ω. If you then connect a passive probe (like the P6139A) you need to set the input impedance back to 1 MΩ. Vertical Control on page 3-124 explains how to change the input impedance.

High Speed Active Probes

Active probes offer low input capacitance (1 to 2 pF typical) while maintaining the higher input resistance of passive probes (10 kΩ to 10 MΩ). Like Zo probes, active probes are useful for making accurate timing and phase measurements. However, they do not degrade the amplitude accuracy. Active probes typically have a dynamic range of 20 to 100 V.

Differential Probes

Differential probes determine the voltage drop between two points in a circuit under test. Differential probes let you simultaneously measure two points and to display the difference between the two voltages.

Active differential probes are stand-alone products designed to be used with 50 Ω inputs. The same characteristics that apply to active probes apply to active differential probes.

Fixtured Active Probes

In some small-geometry or dense circuitry applications, such as surface mounted devices (SMD), a hand-held probe is too big to be practical. You can instead use fixtured (or probe card mounted) active probes (or buffered

amplifiers) to precisely connect your instrument to your device-under-test. These probes have the same electrical characteristics as high speed, active probes but use a smaller mechanical design.

Current Probes

Current probes enable you to directly observe and measure current waveforms, which can be very different from voltage signals. Tektronix current probes are unique in that they can measure from DC to 1 GHz.

Two types of current probes are available: one that measures AC current only and AC/DC probes that utilize the Hall effect to accurately measure the AC and DC components of a signal. AC-only current probes use a transformer to convert AC current flux into a voltage signal to the oscilloscope and have a frequency response from a few hundred Hertz up to 1 GHz. AC/DC current probes include Hall effect semiconductor devices and provide frequency response from DC to 50 MHz.

Use a current probe by clipping its jaws around the wire carrying the current that you want to measure. (Unlike an ammeter which you must connect in series with the circuit.) Because current probes are non-invasive, with loading typically in the milliohm to low Ω range, they are especially useful where low loading of the circuit is important. Current probes can also make differential measurements by measuring the results of two opposing currents in two conductors in the jaws of the probe.

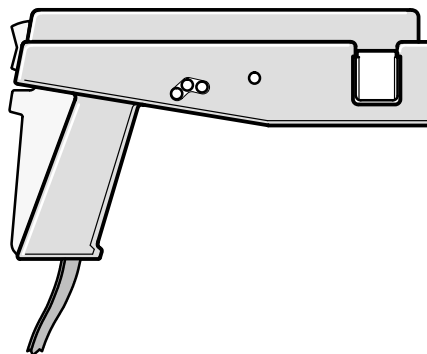

Figure 3-44: A6303 Current Probe Used in the AM 503S Opt. 03

Optical Probes

Optical probes let you blend the functions of an optical power meter with the high-speed analog waveform analysis capability of an oscilloscope. You have the capability of acquiring, displaying, and analyzing optical and electrical signals simultaneously.

Applications include measuring the transient optical properties of lasers, LEDs, electro-optic modulators, and flashlamps. You can also use these probes in the development, manufacturing, and maintenance of fiber optic control networks, local area networks (LANs), fiber-based systems based on the FDDI and SONET standard, optical disk devices, and high-speed fiber optic communications systems.

NOTE

When you connect an optical probe to the oscilloscope, the input impedance of the oscilloscope automatically becomes 50 Ω . If you then connect a high input resistance passive probe you need to set the input impedance back to 1 M Ω . Vertical Control on page 3-124 explains how to change the input impedance.

Time-to-Voltage Converter

The instantaneous time-interval to voltage converter (TVC) continuously converts consecutive timing measurements to a time-interval versus time waveform.

Timing variations typically appear as left-to-right motion, or jitter, on an oscilloscope. Time base or trigger holdoff adjustments may improve display stability, but they do not show timing dynamics. The TVC untangles the often confusing waveforms and delivers a coherent real-time view.

The TVC adds three measurement functions to the voltage versus time capability of your oscilloscope: time delay versus time, pulse-width versus time, and period versus time.

Probes by Type

Table 3-7 lists TDS 500 compatible probes classified by type.

Table 3-7: TDS 500 Compatible Probes

Probe Type	Tektronix Model	Description
Passive, high impedance voltage	P6139A (std.)	10X, 500 MHz
	P6101A	1X, 15 MHz
Passive, low impedance Zo	P6156	10X, 3.5 GHz, for 50 Ω inputs (1X, 20X, 100X optional)
Passive, high voltage	P6009	100X, 1.5 kV, DC + peak AC
	P6015A	1000X, 20 kV, DC + peak AC
Active, high speed voltage	P6204	DC to 1 GHz FET. DC Offset capability (requires Tektronix 1103 TekProbe Power Supply for offset capability)
Active, high speed voltage	P6205	DC to 750 MHz FET
Active, differential voltage	P6046	1X/10X, DC to 100 MHz
Active, fixtured voltage	A6501 P6501 Opt. 02	Buffer Amplifier, 1 GHz, 1 M Ω , 10X Microprobe with TekProbe Power Cable, 750 MHz, 1 M Ω , 10X
Current	AM 503S	AC/DC. Uses A6302 Current Probe.
	AM 503S Opt. 03	AC/DC. Uses A6303 Current Probe.
	P6021	AC. 120 Hz to 60 MHz.
	P6022	AC. 935 kHz to 120 MHz.
	CT-1/CT-2	Designed for permanent or semi-permanent in-circuit installation CT-1: 25 kHz to 1 GHz, 50 Ω input CT-2: 1.2 kHz to 200 MHz, 50 Ω input
	CT-4	Current Transformer for use with AM 503S and P6021. Peak pulse 1 kA, 0.5Hz to 20 MHz with AM 503S
Logic Word Trigger	P6408	16 channel, one qualifier channel, TTL compatible, +5V power supply required
Optical (Opto-Electronic Converters)	P6701A	500 to 950 nm, DC to 850 MHz, 1 V/mW
	P6703A	1100 to 1700 nm, DC to 1 GHz, 1 V/mW
	P6711	500 to 950 nm, DC to 250 MHz, 5 V/mW
	P6713	1100 to 1700 nm, DC to 300 MHz, 5 V/mW
Time-to-Voltage Converter	TVC 501	Time delay, pulse width and period measurements

Probes by Application

Another way to classify probes is by application. Different applications demand different probes. Use Table 3-8 to select a probe for your application.

Table 3-8: Probes by Application

Probe Type	Telecommunications & High-Speed Logic	Industrial Electronics	Consumer/Computer Electronics	High Energy Pulsed Power	Certification, Regulatory, & Compliance Testing
Passive, high-impedance voltage	P6139A ¹ P6101A ¹	P6139A ^{1,2} P6101A ^{1,2}	P6139A ^{1,2,3} P6101A ¹	P6139A ^{1,2,3} P6101A ^{1,2}	P6139A ^{1,2,3} P6101A ^{1,2}
Active, high-speed digital voltage	P6205 ^{2,3} P6204 ^{2,3}	P6205 ^{2,3}	P6205 ^{2,3} P6204 w/1103 power supply ^{2,3}	P6205 ^{2,3}	P6205 ^{2,3}
Low impedance Zo (low capacitance)	P6156 ^{1,2,3}		P6156 ^{1,2,3}		
Passive, high voltage	P6009 ^{1,2}	P6009 ^{1,2,3} P6015A ^{1,2,3}	P6009 ^{1,2}	P6009 ^{1,2,3} P6015A ^{1,2,3}	P6009 ^{1,2,3} P6015A ^{1,2,3}
Active, differential voltage	P6046 ^{2,3}	P6046 ^{2,3}	P6046 ^{2,3}		
Current	AM 503S ^{2,3} P6021 ^{1,2}	AM 503S ^{2,3} P6021 ^{1,2} CT4 ^{1,2}	AM 503S ^{2,3} P6021 ^{1,2}	AM 503S ^{2,3} P6021 ^{1,2}	AM 503S ^{2,3} P6021 ^{1,2} CT1/ ^{2,3} CT4 ^{1,2}
Fixtured	A6501 ^{2,3} P6501 ^{2,3}		A6501 ^{2,3} P6501 ^{2,3}		
Logic Word Trigger	P6408 ^{2,3}		P6408		
Optical	P6701A ^{2,3} P6703A ^{2,3} P6711 ^{2,3} P6713 ^{2,3}		P6701A ^{2,3} P6703A ^{2,3} P6711 ^{2,3} P6713 ^{2,3}		P6701A ^{2,3} P6703A ^{2,3} P6711 ^{2,3} P6713 ^{2,3}
Time-to-voltage converter	TVC 501 ^{2,3}	TVC 501 ^{2,3}	TVC 501 ^{2,3}	TVC 501 ^{2,3}	

¹Qualitative signal evaluation—use when a great deal of accuracy is not required, such as when making go/no go measurements.

²Functional testing—use when the device under test is being compared to some standard.

³Quantitative Signal Evaluation—use when detailed evaluation is needed.

Pulse Triggering

Pulse triggering can be very useful. For example, you might be testing a product with a glitch in the power supply. The glitch appears once a day. So instead of sitting by and waiting for it to appear, you can use the pulse triggering to automatically capture your data.

There are three classes of pulse triggering: glitch, runt, and width.

- A *glitch* trigger occurs when the trigger source detects a pulse narrower (or wider) in width than some specified time. It can trigger on glitches of either polarity. Or you can set the glitch trigger to reject glitches of either polarity.
- A *runt* trigger occurs when the trigger source detects a short pulse that crosses one threshold but fails to cross a second threshold before re-crossing the first. You can set the oscilloscope to detect positive or negative runt pulses.
- A *width* trigger occurs when the trigger source detects a pulse that is inside or, optionally, outside some specified time range (defined by the upper limit and lower limit). The oscilloscope can trigger on positive or negative width pulses.

Figure 3-45 shows the pulse trigger readouts. Table 3-9 on page 3-100 describes the choices for the pulse triggers.

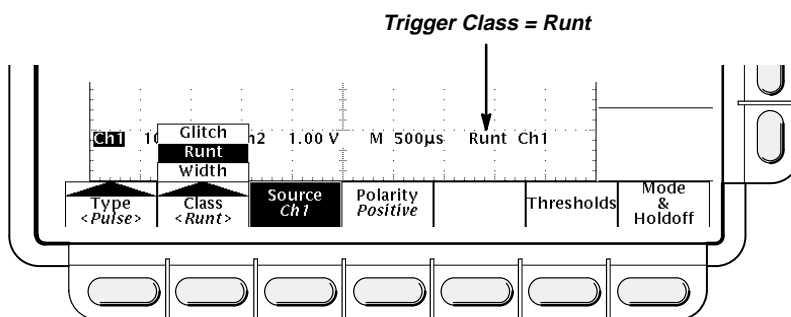









Figure 3-45: Pulse Trigger Readouts

Table 3-9: Pulse Trigger Definitions

Name	Definition
 Glitch positive	Triggering occurs if the oscilloscope detects positive spike widths less than the specified glitch time.
 Glitch negative	Triggering occurs if the oscilloscope detects negative spike widths less than the specified glitch time.
 Glitch either	Triggering occurs if the oscilloscope detects positive or negative widths less than the specified glitch time.
 Runt positive	Triggering occurs if the oscilloscope detects a positive pulse that crosses one threshold going positive but fails to cross a second threshold before recrossing the first going negative.
 Runt negative	Triggering occurs if the oscilloscope detects a negative going pulse that crosses one threshold going negative but fails to cross a second threshold before recrossing the first going positive.
 Runt either	Triggering occurs if the oscilloscope detects a positive or negative going pulse that crosses one threshold but fails to cross a second threshold before recrossing the first.
 Width positive	Triggering occurs if the oscilloscope finds a positive pulse with a width between, or optionally outside, the user-specified lower and upper time limits.
 Width negative	Triggering occurs if the oscilloscope finds a negative pulse with a width between, or optionally outside, the user-specified lower and upper time limits.

Operations Common to Glitch, Runt, and Width

The pulse trigger menus let you define the pulse source, select the mode (auto or normal), and adjust the holdoff. To bring up the Pulse Trigger menu:

Press **TRIGGER MENU** → **Type** (main) → **Pulse** (pop-up) → **Class** (main) → **Glitch, Runt, or Width** (pop-up) (see Figure 3-46).

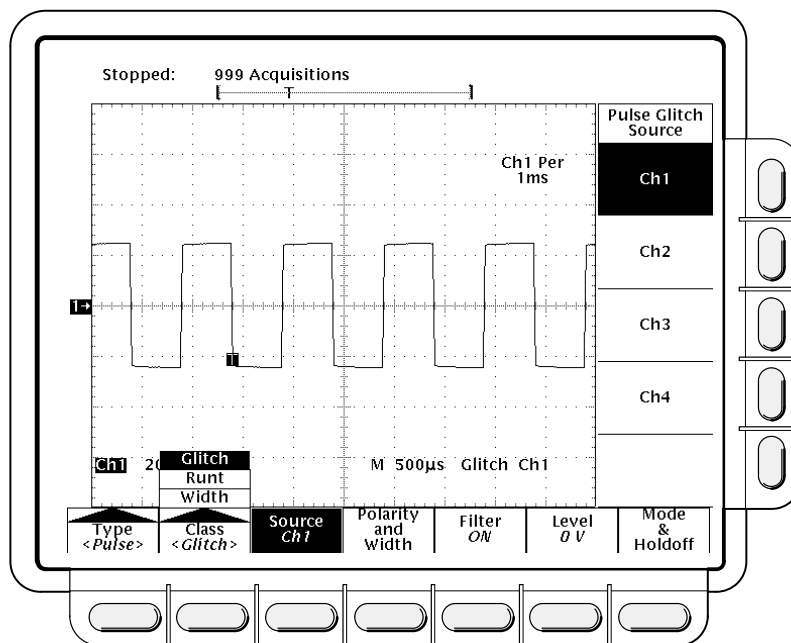

Figure 3-46: Main Trigger Menu—Glitch Class

Source

Use this main menu item to specify which channel becomes the pulse trigger source.

Press **TRIGGER MENU** → **Type** (main) → **Pulse** (pop-up) → **Source** (main) → **Ch1** or **Ch2** (side). On the TDS 540 you can also press **Ch3** or **Ch4** (side). On the TDS 520 you can select **Ax1** or **Ax2** (side).

Mode & Holdoff

To change the holdoff time and select the trigger mode:

1. Press **TRIGGER MENU** → **Type** (main) → **Pulse** (pop-up) → **Mode and Holdoff** (main) → **Auto** or **Normal** (side).
 - In **Auto** mode the oscilloscope acquires a waveform after a specific time has elapsed even if a trigger does not occur. The amount of time the oscilloscope waits depends on the time base setting.

- In **Normal** mode the oscilloscope acquires a waveform only if there is a valid trigger. (You can force a single acquisition by pressing **FORCE TRIGGER**.)
2. To change the holdoff time, press **Holdoff** (side). Use the general purpose knob or the keypad to enter the value in percent.

Glitch Operations

When you select the pulse class **Glitch**, the oscilloscope will trigger on a pulse narrower (or wider) in width than some specified time.

Polarity & Width

This menu item lets you define the glitch in terms of polarity (positive, negative, or either) and width.

1. Press **TRIGGER MENU** → **Type** (main) → **Pulse** (pop-up) → **Polarity and Width** (main) → **Positive, Negative, or Either** (side).
 - Glitch **Positive** looks at positive-going pulses.
 - Glitch **Negative** looks at negative-going pulses.
 - Glitch **Either** looks at both positive and negative pulses.
2. Press **Width** (side) and set the glitch width using the general purpose knob or keypad.



Glitch (Accept or Reject)

To specify whether to trigger on glitches or filter out glitches using the **Glitch** main menu item, press **TRIGGER MENU** → **Type** (main) → **Pulse** (pop-up) → **Class** (main) → **Glitch** (pop-up) → **Glitch** (main) → **Accept Glitch** or **Reject Glitch** (side).

If you choose **Accept Glitch**, the oscilloscope will trigger only on pulses narrower than the width you specified. If you select **Reject Glitch**, it will trigger only on pulses wider than the specified width.

Level

To set the trigger level with the **Level** main menu (or the front panel trigger **LEVEL** knob), press **TRIGGER MENU** → **Type** (main) → **Pulse** (pop-up) → **Level** (main) → **Level, Set to TTL, Set to ECL, or Set to 50%** (side).

- If you select **Level**, enter a value with the general purpose knob or the keypad.
- If you select **Set to TTL**, the trigger level is set to the TTL switching threshold.
- If you select **Set to ECL**, the trigger level is set to the ECL switching threshold.

- If you select **Set to 50%**, you cause the digitizing oscilloscope to search for the point halfway between the peaks of the trigger source signal and set the trigger level to that point.

Runt Operation

When you select the pulse class **Runt**, the oscilloscope will trigger on a short pulse that crosses one threshold but fails to cross a second threshold before recrossing the first. To set up runt triggering:

1. Press **TRIGGER MENU** → **Type** (main) → **Pulse** (pop-up) → **Class** (main) → **Runt** (pop-up) → **Source** (main) → **Ch1, Ch2, Ch3 (Ax1 for the TDS 520), or Ch4 (Ax2 for the TDS 520)** (side). (See Figure 3-47.)
2. Press **Polarity** (main) → **Positive, Negative, or Either** (side).
3. Press **Thresholds** (main) and set the upper and lower thresholds for runt detection with the side menu selections and the keypad or the general purpose knob.

Polarity

Use this menu item to specify the direction of the runt pulse.

Press **TRIGGER MENU** → **Type** (main) → **Pulse** (pop-up) → **Class** (main) → **Runt** (pop-up) → **Polarity** (main) → **Positive, Negative, or Either** (side).

- **Positive** looks for positive-going runt pulses.
- **Negative** looks for negative-going runt pulses.
- **Either** looks for both positive and negative runt pulses.

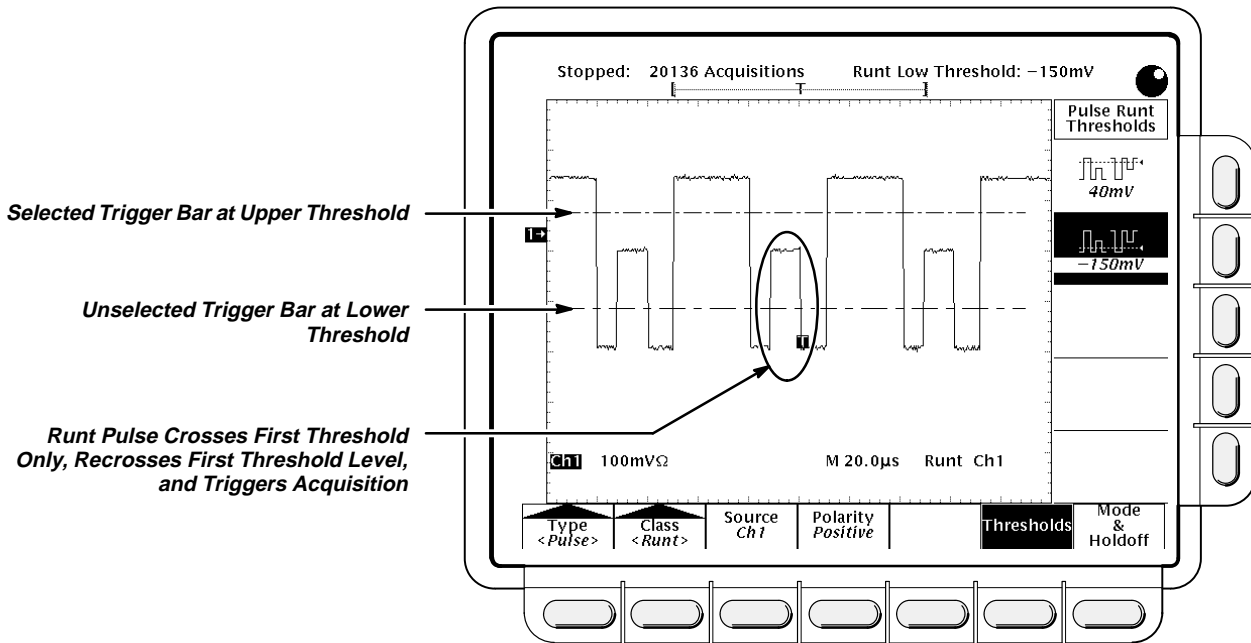

Figure 3-47: Main Trigger Menu—Runt Class

Thresholds

To set the two threshold levels used in detecting a runt pulse:

1. Press **TRIGGER MENU** → **Type** (main) → **Pulse** (pop-up) → **Class** (main) → **Runt** (pop-up) → **Thresholds** (main).
2. Use the general purpose knob or keypad to set the values for the high and low thresholds.

Hint: To use the Trigger Bar feature to set the threshold levels on the pulse train, press **DISPLAY** → **Readout Options** (main) → **Trigger Bar Style** (side) until **Long** appears in that menu item.

Note the position of the trigger indicator in Figure 3-47. Triggering occurs at the point the pulse returns over the first (lower) threshold going negative without crossing the second threshold level (upper). Be aware of the following considerations when using Runt triggering:

- When **Positive** is set in the **Polarity** side menu, the *lower* threshold must be first crossed going *positive*, then recrossed going *negative* without crossing the *upper* threshold at all.
- When **Negative** is set in the **Polarity** side menu, the *upper* threshold must be first crossed going *negative*, then recrossed going *positive* without crossing the *lower* threshold at all.
- When **Either** is set in the **Polarity** side menu, *one* threshold must be first crossed going in *either* direction, then recrossed going in the *opposite* direction without crossing the *other* threshold at all.

- Regardless of the polarity setting, triggering occurs at the point the runt pulse *recrosses* its first threshold.

Width Operation

When you select the pulse class **Width**, the oscilloscope will trigger on a pulse narrower (or wider) than some specified *range* of time (defined by the upper limit and lower limit).

Polarity

To define whether the pulses are positive or negative:

Press **TRIGGER MENU** → **Type** (main) → **Pulse** (pop-up) → **Class** (main) → **Width** (pop-up) → **Polarity** (main) → **Positive** or **Negative** (side).

Trig When

This menu item lets you establish the range of widths (in units of time) the trigger source will search for and whether to trigger on pulses that are outside this range or ones that fall within the range.

1. Press **TRIGGER MENU** → **Type** (main) → **Pulse** (pop-up) → **Class** (main) → **Width** (pop-up) → **Trig When** (main).
2. Press **Within Limits** (side) if you want the oscilloscope to trigger on pulses that fall within the specified range. If you want it to trigger on pulses that are outside the range, then press **Out of Limits** (side).
3. To set the range of pulse widths in units of time press **Upper Limit** (side) and **Lower Limit** (side). Enter the values with the general purpose knob or keypad. The **Upper Limit** is the maximum valid pulse width the trigger source will look for. The **Lower Limit** is the minimum valid pulse width. The oscilloscope will always force the **Lower Limit** to be less than or equal to the **Upper Limit**.

Level

To set the trigger level with the **Level** main menu:

Press **TRIGGER MENU** → **Type** (main) → **Pulse** (pop-up) → **Class** (main) → **Width** (pop-up) → **Level** (main) → **Level**, **Set to TTL**, **Set to ECL**, or **Set to 50%** (side).

For More Information

See *Triggering*, on page 2-2.

See *Triggering*, on page 3-120.

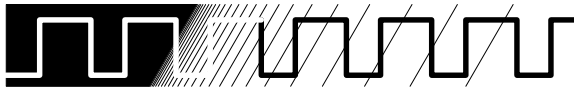

Remote Communication

You may want to integrate your oscilloscope into a system environment and remotely control your oscilloscope or exchange measurement or waveform data with a computer. You can control your oscilloscope remotely via the IEEE Std 488.2-1987 (GPIB) interface.

GPIB Protocol

GPIB enables data transfers between instruments that support the GPIB protocols. It provides:

- Remote instrument control
- Bidirectional data transfer
- Device compatibility
- Status and event reporting

Besides the base protocols, Tektronix has defined codes and formats for messages to travel over GPIB. Each device that follows these codes and formats, such as the TDS 520 and TDS 540, supports standard commands. Use of instruments that support these commands can greatly simplify development of GPIB systems.

GPIB Interface Requirements

You can connect GPIB networks in many configurations if you follow these rules:

- No more than 15 devices, including the controller, can be on a single bus.
- Connect one device load every two meters (about six feet) of cable length to maintain bus electrical characteristics. (Generally, each instrument represents one device load on the bus.)
- The total cumulative cable length must not exceed 20 meters (about 65 feet).
- At least two-thirds of the device loads must be turned on when you use your network.
- There must be only one cable path from each device to each other device on your network (see Figure 3-48) and you must not create loop configurations.

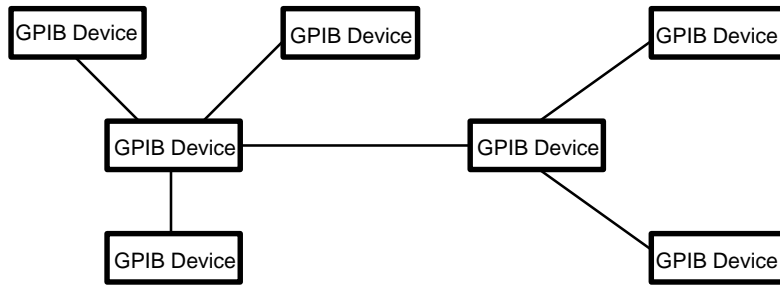

Figure 3-48: Typical GPIB Network Configuration

Cables—An IEEE Std 488.1-1987 GPIB cable (available from Tektronix, part number 012-0991-00) is required to connect two GPIB devices.

Connector—A 24-pin GPIB connector is located on the oscilloscope rear panel. The connector has a D-type shell and conforms to IEEE Std 488.1-1987. You can stack GPIB connectors on top of each other (see Figure 3-49).

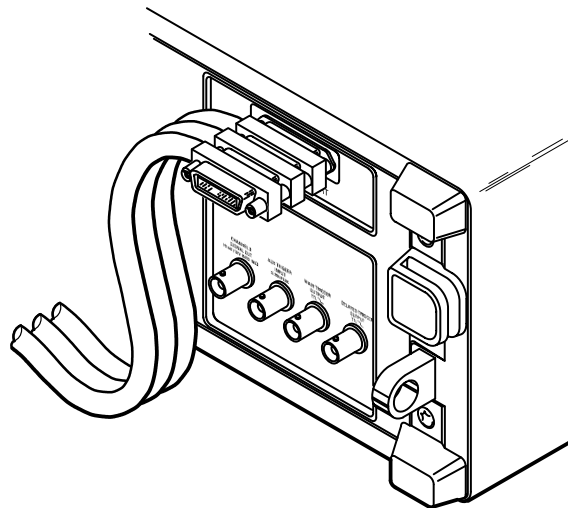

Figure 3-49: Stacking GPIB Connectors

GPIB Parameters

In the Utility menu you need to define two important GPIB parameters: *mode* and *address*. You need to set the mode to talker/listener, talk only, or off the bus. You also need to specify the primary communication address.

Operation

To set up remote communications, ensure that your oscilloscope is physically cabled to the controller and that the oscilloscope parameters are correctly set. Plug an IEEE Std 488.2-1987 GPIB cable into the GPIB connector on the oscilloscope rear panel and into the GPIB port on your controller (see Figure 3-50).

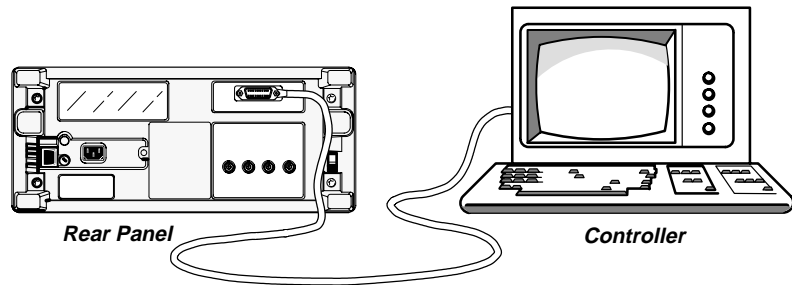

Figure 3-50: Connecting the Digitizing Oscilloscope to a Controller

To set remote communications parameters:

Press **SHIFT UTILITY** → **System** (main) → **I/O** (pop-up).

Port Selection

Now you need to configure the port to match the controller (see Figure 3-51).

Press **SHIFT UTILITY** → **System** (main) → **I/O** (pop-up) → **Port** (main) → **GPIB** (pop-up) → **Configure** (main) → **Talk/Listen Address**, **Hardcopy (Talk Only)**, or **Off Bus** (side)

- Choose **Talk/Listen Address** for normal, controller-based system operation. Use the general purpose knob or the keypad to define the address.
- Use **Hardcopy (Talk Only)** to use the hardcopy port of your digitizing oscilloscope. Once the port is configured this way, the oscilloscope will send the hardcopy data to any listeners on the bus when the **HARDCOPY** button is pressed.

If the port is configured any other way and the **HARDCOPY** button is pressed, an error will occur and the digitizing oscilloscope will display a message saying the selected hardcopy port is currently unavailable.

- Use **Off Bus** to disconnect the digitizing oscilloscope from the bus.

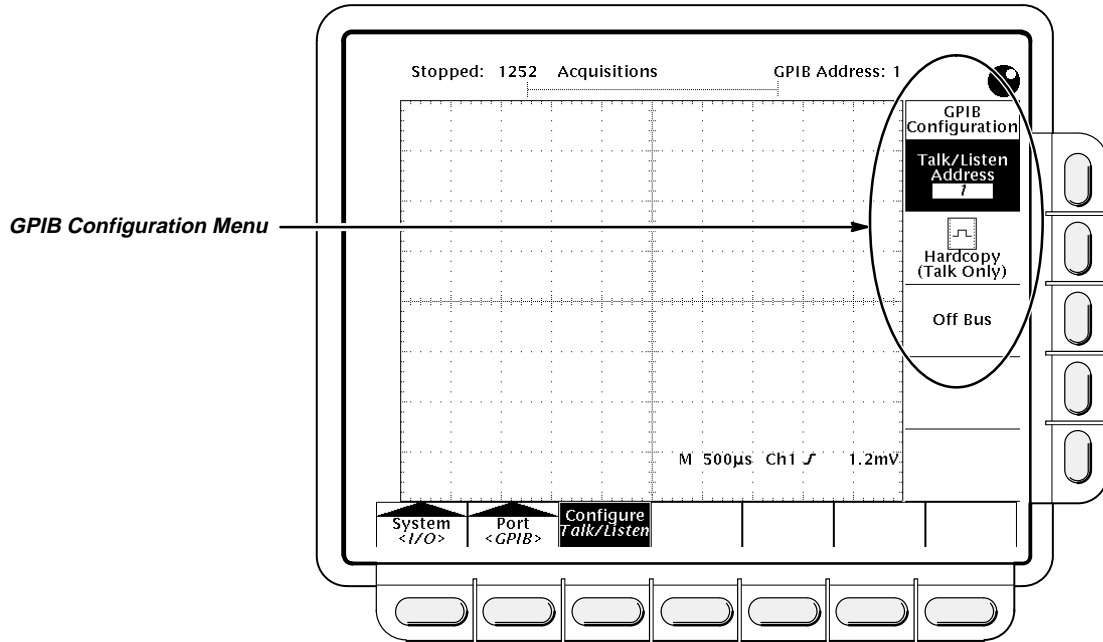

Figure 3-51: Utility Menu

For More Information

See *Hardcopy*, on page 3-40.

See the *TDS Family Programmer Manual*, Tektronix part number 070-8318-0.

See the *TDS Family Option 13 Instruction Manual*, Tektronix part number 070-8567-00 (Option 13 equipped instruments only).

Saving and Recalling Setups

You may want to save and reuse setups for many reasons. For example, after changing the setting during the course of an experiment, you may want to quickly return to your original setup. You can save and recall up to ten instrument setups from internal oscilloscope memory. The information is retained even when you turn the oscilloscope off or unplug it.

Operation

To save the current setup of the digitizing oscilloscope:

1. Press **SETUP** → **Save Current Setup** (main).



Before doing step 2 that follows, note that if you choose a setup location labeled **user**, you will overwrite the user setup previously stored there. You can store setups in setup locations labeled **factory** without disturbing previously stored setups.

2. Choose one of the ten storage locations from the side menu **To Setup 1**, **To Setup 2**, ... (see Figure 3-52). Now the current setup is stored in that location.

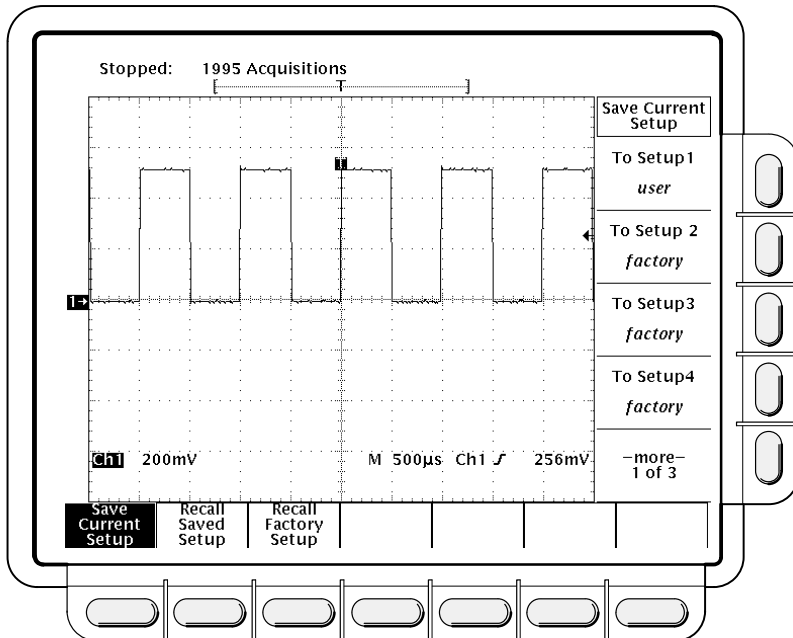

Figure 3-52: Save/Recall Setup Menu

Recalling a Setup

To recall a setup, press **SETUP** → **Recall Saved Setup** (main) → **(Recall Setup 1, Recall Setup 2 ...** (side).

Recalling a setup will not change the menu that is currently displayed. If you recall a setup that is labeled **factory** in the side menu, you will recall the factory setup. (The conventional method for recalling the factory setup is described below.)

Recalling the Factory Setup

To reset your oscilloscope to the factory defaults:

Press **SETUP** → **Recall Factory Setup** (main) → **OK Confirm Factory Init** (side).

See *Factory Initialization Settings* on page A-41 for a list of the factory defaults.

Deleting All Setups and Waveforms—Tek Secure[®]

Sometimes you might use the digitizing oscilloscope to acquire waveforms that are confidential. Furthermore, before returning the oscilloscope to general usage, you might want to remove all such waveforms and any setups used to acquire them. (Be sure you *want* to remove *all* waveforms and setups, because once they are removed, you cannot retrieve them.) To use Tek Secure to remove all stored setups and waveforms:

Press **SHIFT UTILITY** → **System** (main) → **Config** (pop-up) → **Tek Secure Erase Memory** (main) → **OK Erase Ref & Panel Memory** (side).

Executing Tek Secure accomplishes the following tasks:

- Replaces all waveforms in reference memories with zero sample values.
- Replaces the current front panel setup and all setups stored in setup memory with the factory setup.
- Calculates the checksums of all waveform memory and setup memory locations to verify successful completion of setup and waveform erasure.
- If the checksum calculation is unsuccessful, displays a warning message; if the checksum calculation is successful, displays a confirmation message.

For More Information

See *Tutorial Example 4: Saving Setups*, on page 1-18.

See *Factory Initialization Settings*, on page A-41.



Saving and Recalling Waveforms

You can store a waveform in any of the four internal reference memories of the digitizing oscilloscope. That information is retained even when you turn the oscilloscope off or unplug it. You can save any combination of different size waveform records as long as they total no more than 50,000 record points.

The digitizing oscilloscope can display up to 11 (9 on the TDS 520) waveforms at one time. That includes waveforms from the four (two on the TDS 520) input channels, four reference waveforms, and three math waveforms.

You will find saving waveforms useful when working with many waveforms and channels. If you have more waveforms than you can display, you can save one of the waveforms and then stop acquiring it. That lets you display another waveform without forcing you to lose the first one.

Operation

To save a waveform, do the following steps:

1. Select the channel that has the waveform you want to save.



Before doing step 2 that follows, note that if you choose a reference memory location labeled **active** (see Figure 3-53), you will overwrite the waveform that was previously stored there. You can store waveforms in reference locations labeled **empty** without disturbing previously stored waveforms.

2. Press save/recall **WAVEFORM** → **Save Waveform** (main) → **Ref1**, **Ref2**, **Ref3**, or **Ref4** (side).

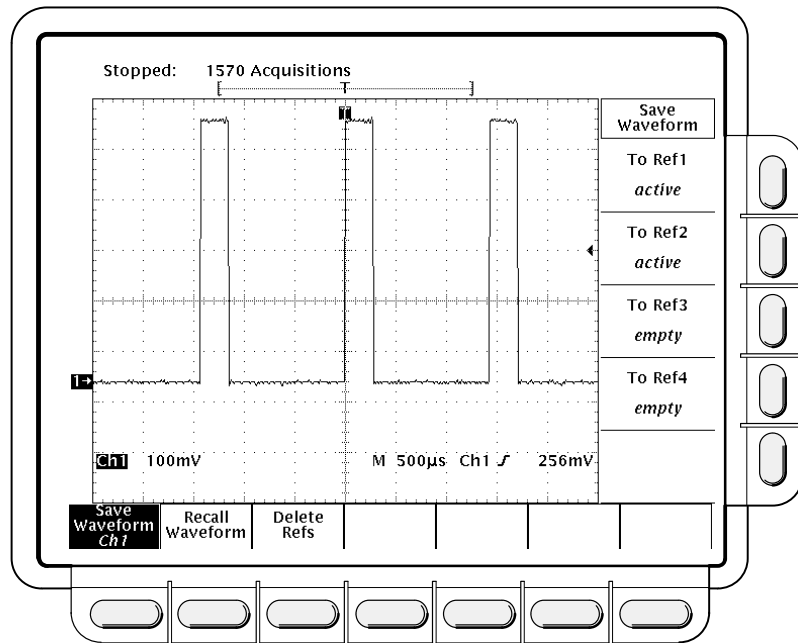

Figure 3-53: Save Waveform Menu

Deleting Waveforms

If the digitizing oscilloscope runs out of memory when you try to save a waveform, it displays a message. When this occurs, you will need to delete waveform(s) to make room. Press save/recall **WAVEFORM** → **Delete Refs** (main) → **Delete Ref1**, **Delete Ref2**, **Delete Ref3**, **Delete Ref4**, or **Delete All Refs**.

Deleting All Waveforms and Setups

The simultaneous removal of all stored waveforms and setups using the feature called Tek Secure is described under *Saving and Recalling Setups*. See “Deleting All Setups and Waveforms” on page 3-111.

Recalling a Waveform

To recall a waveform:

Press **MORE** → **Ref1**, **Ref2**, **Ref3**, or **Ref4** (main).

Note that in Figure 3-54, the main menu item **Ref2**, **Ref3**, and **Ref4** appear shaded while **Ref1** does not. References that are empty appear shaded in the More main menu.

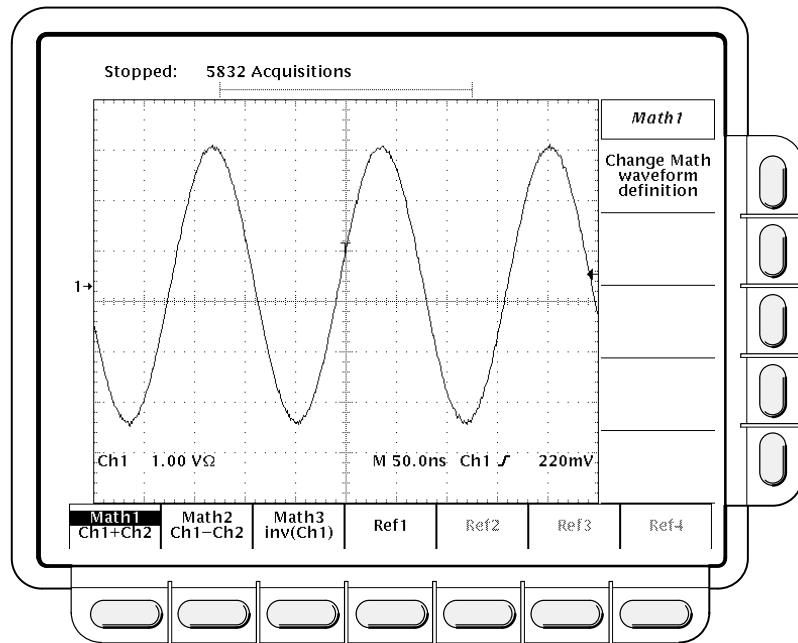

Figure 3-54: More Menu

For More Information

See *Selecting Channels*, on page 3-115.

Selecting Channels

The *selected channel* is the channel that the digitizing oscilloscope applies all waveform-specific activities to (such as measurements or vertical scale and position).

Channel Readout and Reference Indicator

The channel readout shows the selected channel in inverse video in the lower left corner of the display. The channel reference indicator for the selected channel appears along the left side of the display. See Figure 3-55.

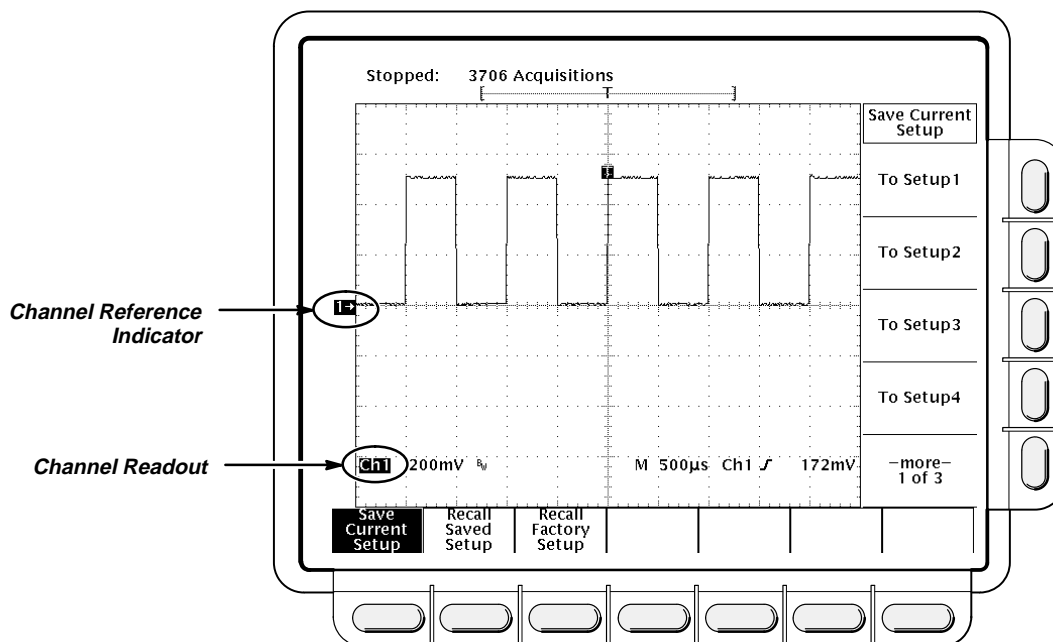

Figure 3-55: The Channel Readout

Channel Selection Buttons

Selecting channels on the TDS 500 series oscilloscopes is straightforward and easy.

The *channel selection* buttons are on the right of the display and are labeled **CH 1**, **CH 2**, **CH 3 (AUX 1)** on the TDS 520, **CH 4 (AUX 2)** on the TDS 520, and **MORE**. They determine which channel is selected. The **MORE** button allows you to select internally stored *Math* and *Ref* waveforms for display and manipulation.

The selected channel is indicated by the lighted LED above each button.

Operation

To selecting a channel:

Pressing **CH 1**, **CH 2**, **CH 3 (AUX 1)** on the TDS 520), or **CH 4 (AUX 2)** on the TDS 520) turns the channel on if it is not already on.

You do not use the channel selection buttons when triggering. Instead you select the trigger source in the Main Trigger menu or Delayed Trigger menu.

Removing Waveforms From the Display

The **WAVEFORM OFF** button turns OFF the display of the selected channel waveform. It will also remove from the display any automated measurements being made on that waveform.

When you turn off a waveform, the digitizing oscilloscope automatically selects the next highest priority waveform. Figure 3-56 shows how the oscilloscope prioritizes waveforms.

1. CH1
2. CH2
3. CH3 (or AUX 1 on the TDS 520)
4. CH4 (or AUX 2 on the TDS 520)

5. MATH1
6. MATH2
7. MATH3

8. REF1
9. REF2
10. REF3
11. REF4

Figure 3-56: Waveform Selection Priority

If you are turning off more than one waveform and you start by turning off a channel waveform, all channels will be turned off before going to the MORE waveforms. If you start by turning off the MORE waveforms, all the MORE waveforms will be turned off before going to the channel waveforms.

If you turn off a channel that is a trigger source, it continues to be the trigger source even though the waveform is not displayed.

For More Information

See *Saving and Recalling Waveforms*, on page 3-112.

See *Waveform Math*, on page 3-127.

Signal Path Compensation

This oscilloscope lets you compensate the internal signal path used to acquire the waveforms you acquire and measure. By executing the signal path compensation feature (SPC), you can optimize the oscilloscope capability to make accurate measurements based on the ambient temperature.

Run an SPC anytime you wish to ensure that the measurements you make are made with the most accuracy possible. You should also run an SPC if the temperature has changed more than 5°C since the last SPC was performed.

NOTE

When making measurements at volts/division settings less than or equal to 5 mV, you should run SPC at least once per week. Failure to do so may result in the oscilloscope not meeting warranted performance levels at those volts/div settings. (Warranted characteristics are listed in Appendix B.)

Operation

1. Power on the digitizing oscilloscope and allow a 20 minute warm-up before doing this procedure.
2. Disconnect any input signals you may have connected from all four input channels.



When doing steps 3 and 4, do not turn off the oscilloscope until signal-path compensation completes. If you interrupt (or lose) power to the instrument while signal-path compensation is running, a message is logged in the oscilloscope error log. If such a case occurs, rerun signal-path compensation.

3. Press **SHIFT UTILITY** → **System** (main) → **Cal** (pop-up) → **Signal Path** (main) → **OK Compensate Signal Paths** (side).
4. Wait for signal path compensation to complete (one to three minutes). While it progresses, a “clock” icon (shown at left) is displayed on-screen. When compensation completes, the status message will be updated to *Pass* or *Fail* in the main menu.
5. Verify the word **Pass** appears under **Signal Path** in the main menu. (See Figure 3-57.)



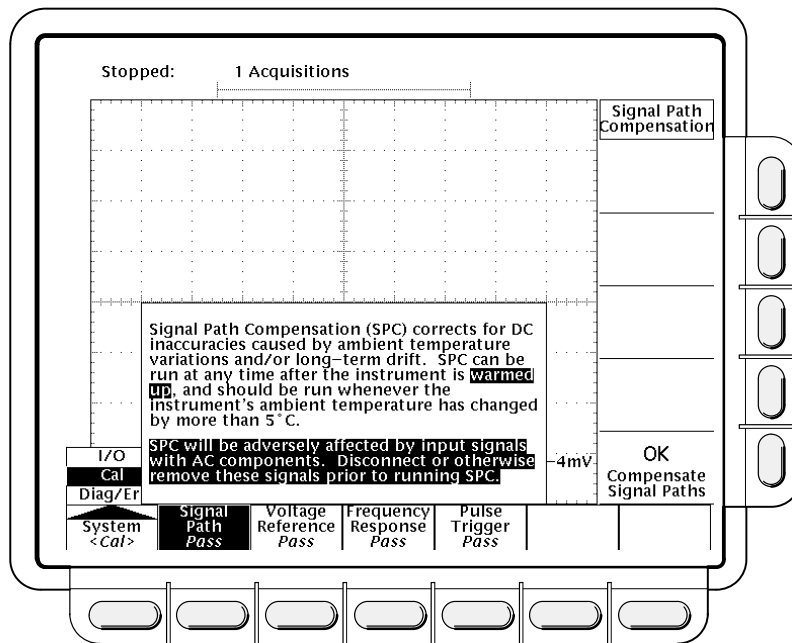

Figure 3-57: Performing a Signal Path Compensation

Status

The Status menu lets you see information about the oscilloscope state.

Operation

To operate the Status menu:

Press **SHIFT STATUS** → **System**, **Trigger**, **Waveforms**, or **I/O** (side).

- **System** displays information about the Horizontal, Zoom, Acquisition, Display, Measure, and Hardcopy systems (Figure 3-58). This display also tells you the firmware version.
- **Trigger** displays parameter information about the triggers.
- **Waveforms** displays information about the various waveforms, including live, math, and reference.
- **I/O** displays information about the I/O port(s).

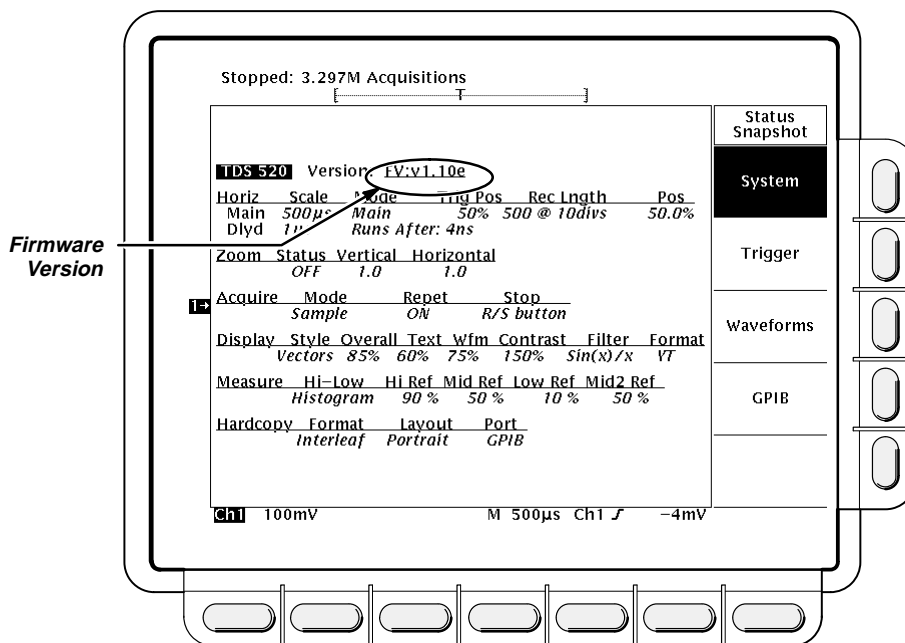

Figure 3-58: Status Menu—System

Triggering

Triggers determine when the digitizing oscilloscope starts acquiring and displaying a waveform. The TDS 500 series has three types of triggers: edge, logic, and pulse.

Although these three triggers are unique, they have some common characteristics that can be defined and modified using the Trigger menu, buttons, and knob. This article discusses these common characteristics.

To learn about the general concept of triggering, see *Triggering* in the *Concepts* section. To learn more about using specific triggers and using the delayed trigger system, see *For More Information* on page 3-123.

Trigger Button and Knobs

The trigger buttons and knob let you quickly adjust the trigger level or force a trigger (see Figure 3-59).

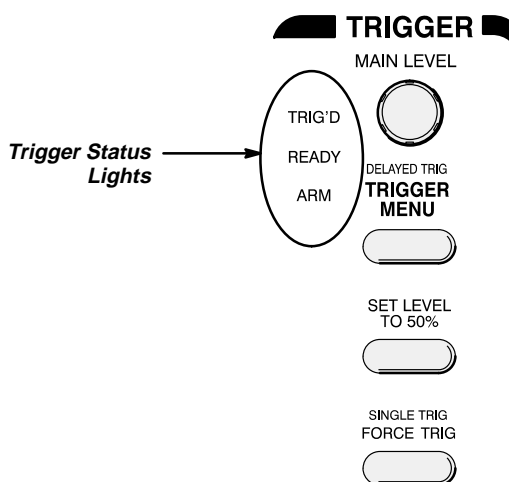

Figure 3-59: TRIGGER Controls and Status Lights

MAIN LEVEL Knob

The **MAIN LEVEL** knob lets you manually change the trigger level when triggering in Edge mode or certain threshold levels when triggering in Logic or Pulse modes. It adjusts the trigger level (or threshold level) instantaneously no matter what menu, if any, is displayed.

To Set to 50%

You can quickly obtain an edge or pulse trigger (except for the Runt class) by pressing **SET LEVEL TO 50%**. The oscilloscope sets the trigger level to the halfway point between the peaks of the trigger signal.

You can also set the level to 50% in the Trigger menu under the main menu item **Level** if Edge or Pulse (except for Runt class) is selected.

Note that the **MAIN LEVEL** knob and menu items apply only to the main trigger level. To modify the delayed trigger level, use the **Level** item in the Delayed Trigger menu.

Force Trigger

By pressing the **FORCE TRIG** front panel button you can force the oscilloscope to immediately start acquiring a waveform record even without a trigger event. Forcing a trigger is useful when in normal trigger mode and the input signal is not supplying a valid trigger. By pressing **FORCE TRIG**, you can quickly confirm that there is a signal present for the oscilloscope to acquire. Once that is established, you can determine how to trigger on it (press **SET LEVEL TO 50%**, check trigger source setting, etc.).

The oscilloscope recognizes and acts upon **FORCE TRIG** even when you press it before the end of pretrigger holdoff. However, the button has no effect if the acquisition system is stopped.

Single Trigger

If your goal is to act on the next valid trigger event and then stop, press **SHIFT FORCE TRIG**. Now you can initiate the single sequence of acquisitions by pressing the **RUN/STOP** button.

To leave Single Trig mode, press **SHIFT ACQUIRE MENU → Stop After** (main) → **RUN/STOP Button Only** (side).

See the description under “Stop After” on page 3-15 for further discussion of single sequence acquisitions.

Readouts

The digitizing oscilloscope has display readouts and status lights dedicated to monitoring the trigger circuitry.

Trigger Status Lights

There are three status lights in the Trigger control area (Figure 3-59) indicating the state of the trigger circuitry. The lights are labeled **TRIG'D**, **READY**, and **ARM**.

- When **TRIG'D** is lighted, it means the digitizing oscilloscope has recognized a valid trigger and is filling the posttrigger portion of the waveform.

- When **READY** is lighted, it means the digitizing oscilloscope can accept a valid trigger event and it is waiting for that event to occur.
- When **ARM** is lighted, it means the trigger circuitry is filling the pretrigger portion of the waveform record.
- When both **TRIG'D** and **READY** are lighted, it means the digitizing oscilloscope has recognized a valid main trigger and is waiting for a delayed trigger. When it recognizes a delayed trigger it will fill in the posttrigger portion of the delayed waveform.

Trigger Display Readout

At the bottom of the display, the Trigger readout shows some of the key trigger parameters (Figure 3-60). The readouts are different for edge, logic and pulse triggers.

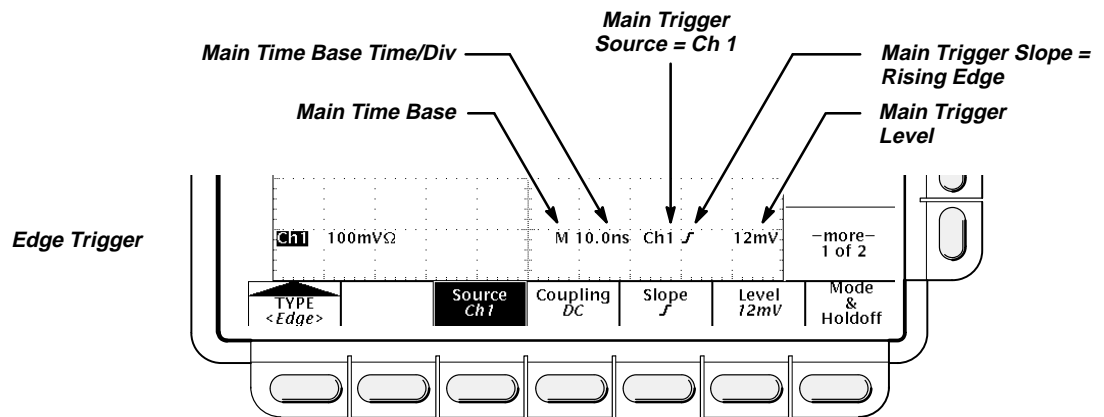

Figure 3-60: Example Trigger Readouts

The record view at the top of the display shows the location of the trigger signal in the waveform record and with respect to the display (see Figure 3-61).

Trigger Position and Level Indicators

In addition to the numerical readouts of trigger level, there are also graphic indicators of trigger position and level which you can optionally display. These indicators are the trigger point indicator, the long trigger level bar, and the short trigger level bar. Figure 3-61 shows the trigger point indicator and short-style trigger level bar.

The trigger point indicator shows position. It can be positioned horizontally off screen, especially with long record length settings. The trigger level bar shows only the trigger level, and it remains on screen regardless of the horizontal position as long as the channel providing the trigger source is displayed.

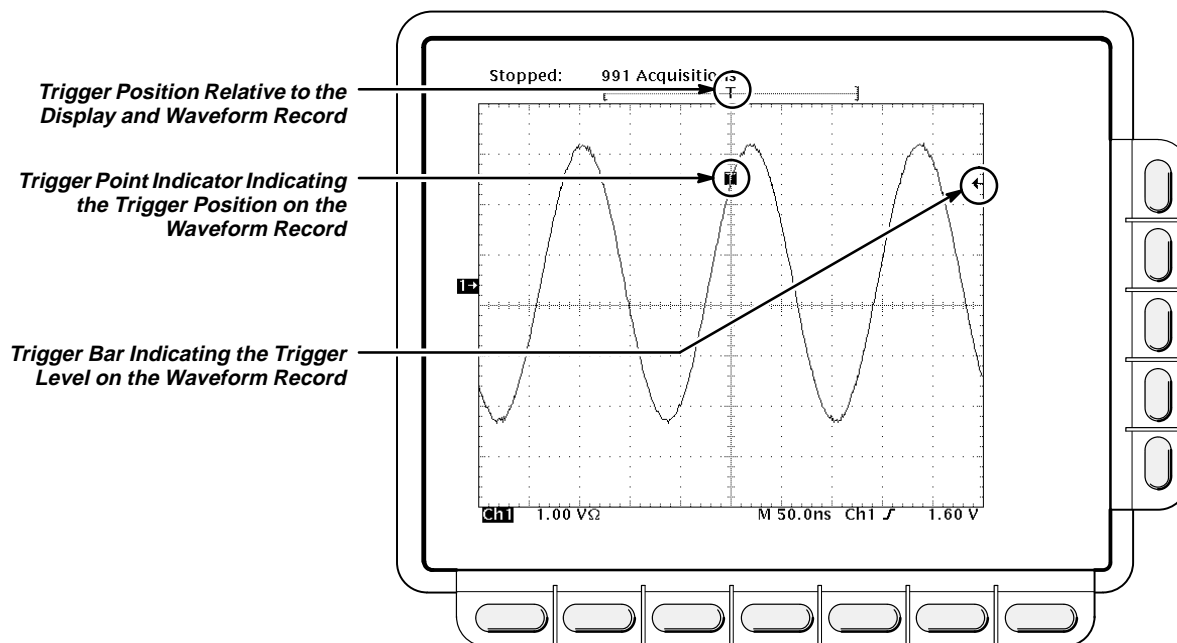

Figure 3-61: Record View, Trigger Position, and Trigger Level Bar Readouts

Both the trigger point indicator and level bar are displayed from the Display menu. See *Display Readout* on page 3-32 for more information.

Trigger Menu

Each trigger type (edge, logic, and pulse) has its own main trigger menu, which is described in a separate part of this section (see *For More Information*).

To select the trigger type, press **TRIGGER MENU** → **Type** (main) → **Edge**, **Logic**, or **Pulse** (pop-up).

For More Information

See *Delay Triggering*, on page 3-25.

See *Edge Triggering*, on page 3-36.

See *Logic Triggering*, on page 3-58.

See *Pulse Triggering*, on page 3-99.

See *Triggering*, on page 2-2.



Vertical Control

You can control the vertical position and scale of the selected waveform using the vertical menu and knobs.

Vertical Knobs

By changing the vertical scale, you can focus on a particular portion of a waveform. By adjusting the vertical position, you can move the waveform up or down on the display. That is particularly useful when you are comparing two or more waveforms.

To change the vertical scale and position, use the vertical **POSITION** and vertical **SCALE** knobs. The vertical controls only affect the selected waveform.

The **POSITION** knob simply adds screen divisions to the reference point of the selected waveform. Adding divisions moves the waveform up and subtracting them moves the waveform down. You also can adjust the waveform position using the offset option in the Vertical menu (discussed later in this article).

If you want the **POSITION** knob to move faster, press the **SHIFT** button. When the light above the **SHIFT** button is on and the display says **Coarse Knobs** in the upper right corner, the **POSITION** knob speeds up significantly.

Vertical Readouts

The *Vertical readout* at the lower part of the display shows each displayed channel (the selected channel is in inverse video), and its volts/division setting (see Figure 3-62).

Vertical Menu

The Vertical menu (Figure 3-62) lets you select the coupling, bandwidth, and offset for the selected waveform. It also lets you numerically change the position or scale instead of using the vertical knobs.

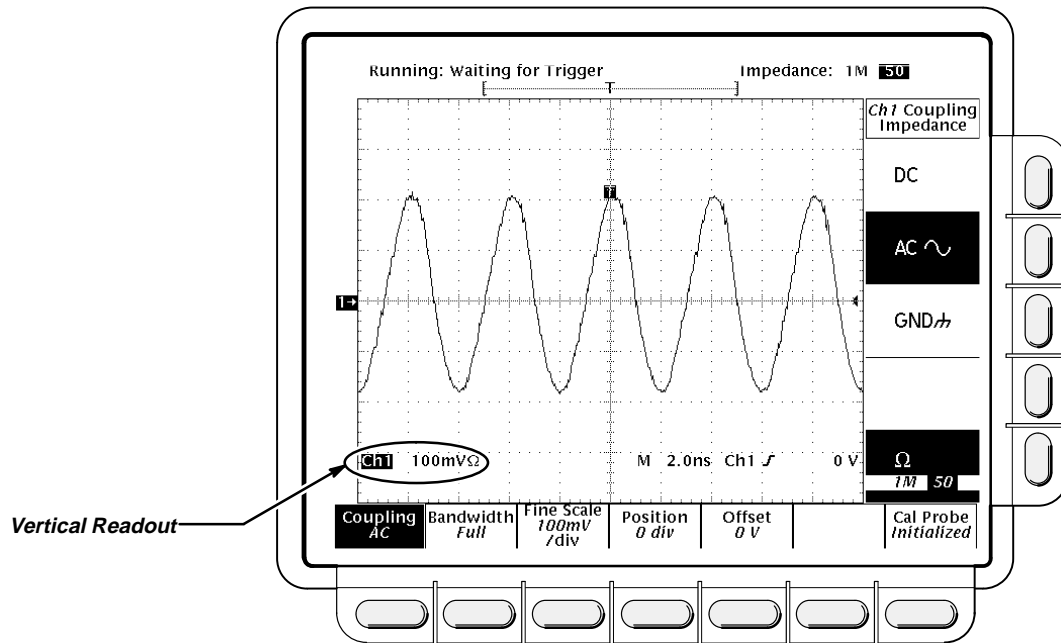

Figure 3-62: Vertical Readouts and Channel Menu

Coupling

To choose the type of coupling for attaching the input signal to the vertical attenuator for the selected channel and to set its input impedance:

Press **VERTICAL MENU** → **Coupling** (main) → **DC**, **AC**, **GND**, or Ω (side).

- | | |
|---|--|
| <p>DC</p> <p>AC ~</p> <p>GND ⏏</p> <p>Ω</p> | <ul style="list-style-type: none"> ■ DC coupling shows both the AC and DC components of an input signal. ■ AC coupling shows only the alternating components of an input signal. ■ Ground (GND) coupling disconnects the input signal from the acquisition. ■ Input impedance lets you select either 1 MΩ or 50 Ω impedance. |
|---|--|

NOTE

If you select 50 Ω impedance with AC coupling, the digitizing oscilloscope will not accurately display frequencies under 200 kHz.

Also, when you connect an active probe to the oscilloscope (such as the P6205), the input impedance of the oscilloscope automatically becomes 50 Ω . If you then connect a passive probe (like the P6139A) you need to set the input impedance back to 1 M Ω .

Bandwidth

To eliminate the higher frequency components, change the bandwidth of the selected channel:

Press **VERTICAL MENU** → **Bandwidth** (main) → **Full**, **100 MHz**, or **20 MHz** (side).

Fine Scale

Press **VERTICAL MENU** → **Fine Scale** (main) to make fine adjustments to the vertical scale using the general purpose knob or the keypad.

Position

Press **VERTICAL MENU** → **Position** (main) to let the general purpose knob control the vertical position. Press **Set to 0 divs** (side) if you want to reset the reference point of the selected waveform to the center of the display.

Offset

Offset lets you subtract DC bias from the waveform, so the oscilloscope can acquire the exact part of the waveform you are interested in.

Offset is useful when you want to examine a waveform with a DC bias. For example, you might be trying to look at a small ripple on a power supply output. It may be a 100 mV ripple on top of a 15 V supply. With offset range you can display the ripple and scale it to meet your needs.

To use offset, press **VERTICAL MENU** → **Offset** (main). Use the general purpose knob to control the vertical offset. Press **Set to 0 V** (side) if you want to reset the offset to zero.

For More Information

See *Acquisition*, on page 2-7.

See *Scaling and Positioning Waveforms*, on page 2-13.

Waveform Math

You can mathematically manipulate your waveforms. For example, you might have a waveform clouded by background noise. You can obtain a cleaner waveform by subtracting the background noise from your original waveform.

This manual describes the standard waveform math features (invert, add, subtract, and multiply). See the *TDS Family Option 2F Instruction Manual*, if your oscilloscope is equipped with that option.

Operation

To perform waveform math, press the **MORE** button to bring up the More menu (Figure 3-63). The More menu allows you to display, define, and manipulate three math functions.

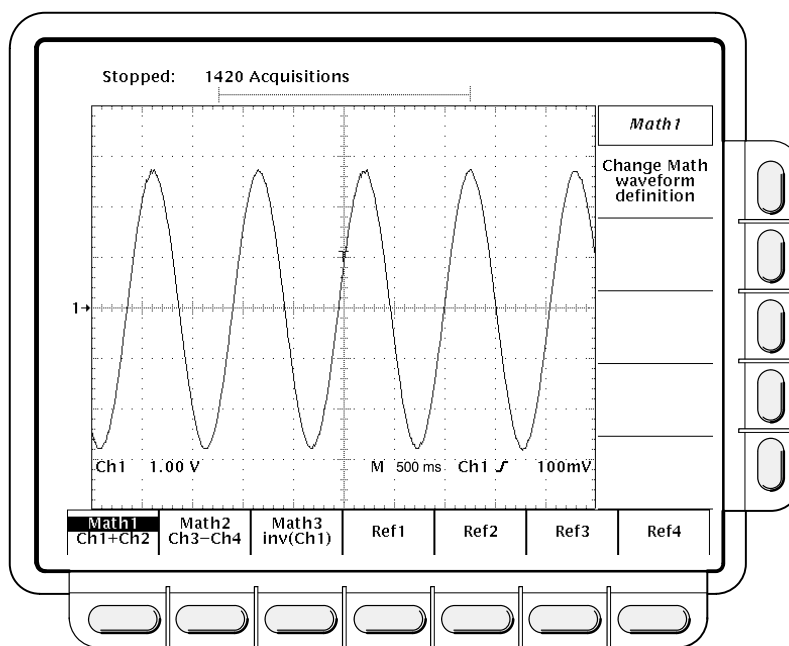

Figure 3-63: More Menu

Math1, Math2, and Math3

1. Press **MORE** → **Math1**, **Math2**, or **Math3** (main) to select the waveform that you want to display or change.

NOTE

If your digitizing oscilloscope is equipped with Option 2F, Advanced DSP Math, the menu item **FFT** will be at the same brightness as the menu items **Single Wfm Math** and **Dual Wfm Math**; otherwise, **FFT** will be dimmed. See the TDS Family Option 2F Instruction Manual for information on FFTs and other advanced math waveforms.

2. Press **Change Math waveform definition** (side) → **Single Wfm Math** or **Dual Wfm Math** (main) to alter the present math waveform definition (see Figure 3-64).

The single and dual waveform operations are described separately in the following topics.

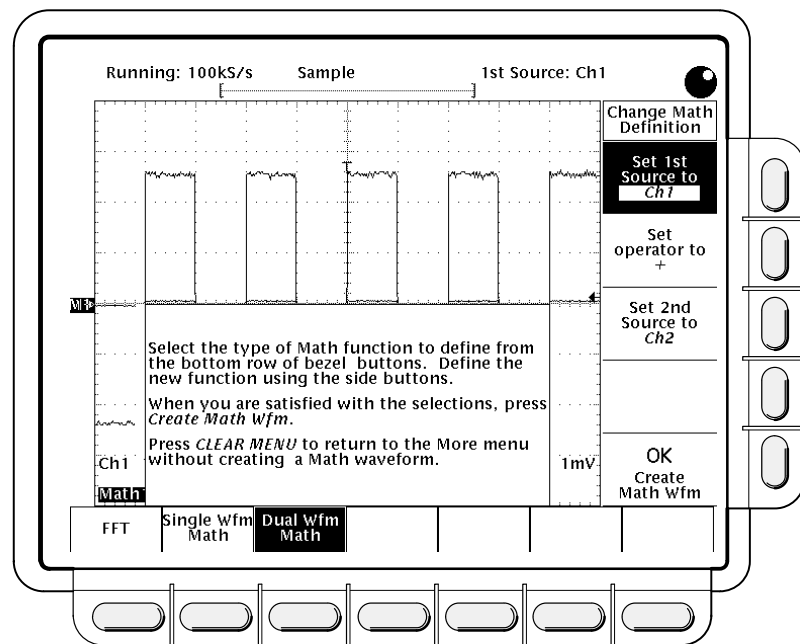

Figure 3-64: Dual Waveform Math Main and Side Menus

Single Wfm Math

1. Press **MORE** → **Math1**, **Math2**, or **Math3** (main) → **Set Function to** (side) → **inv** (invert).
2. To define the source waveform toggle **Set Single Source to** (side) or select that item and use the general purpose knob.
3. When you are ready to perform the function, press **OK Create Math Wfm** (side).

Dual Wfm Math

1. Select the sources with **MORE** → **Math1**, **Math2**, or **Math3** (main) → **Set 1st Source to** and **Set 2nd Source to** (side). Enter the sources by toggling the appropriate channel selection button or by using the general purpose knob.
2. To enter the math operator press **Set operator to** (side). Toggle the button or use the general purpose knob. Supported operators are **+**, **-**, and *****.
3. Press **OK Create Math Wfm** (side) to perform the function.

NOTE

*If you select *, for multiply, in step 2, the cursor feature will measure amplitude in the units volts squared **VV** rather than in volts **V**.*

For More Information

If your oscilloscope is equipped with option 2F, you can also create integrated, differentiated, and Fast Fourier Transform waveforms. If your oscilloscope is equipped with that option, see the *TDS Family Option 2F Instruction Manual*.



At times, you may want to expand or compress a waveform on the display without changing the acquisition parameters. You can do that with the zoom feature.

Zoom and Interpolation

When you zoom in on a waveform on the display, you expand a portion of it. The digitizing oscilloscope may need to show more points for that portion than it has acquired. If it needs to do this, it interpolates. The instrument can interpolate in either of two ways: *linear* or *sin(x)/x*. (The interpolation methods are described on page 2-9.)

When you zoom, the display redraws the waveforms using the interpolation method you selected in the Display menu (linear interpolation or *sin(x)/x*). If you selected *sin(x)/x* (the default), it may introduce some overshoot or undershoot to the waveform edges. If that happens, change the interpolation method to linear, following the instructions on page 3-131.

To differentiate between the real and interpolated samples, set the display style to **Intensified Samples**.

Operation

When you turn on the zoom feature, the vertical and horizontal scale and vertical position knobs now control the displayed size and position of waveforms, allowing them to be expanded and repositioned on screen. They cease to affect waveform acquisition, but you can alter acquisition by using the corresponding menu items. Zoom mode does not change the way horizontal position operates.

To use zoom, do the following steps:

1. Press **ZOOM → ON** (side). The **ZOOM** front-panel button should light up.
2. Choose which waveforms to zoom by toggling **Horizontal Lock** (side) or by using the general purpose knob.
 - **None**—only the waveform currently selected can be magnified and positioned horizontally (Figure 3-65).
 - **Live**—all channels (including **AUX** channels for the TDS 520 Oscilloscope) can be magnified and positioned horizontally at the same time. (Waveforms displayed from an input channel are live; math and reference waveforms are not live.)
 - **All**—all waveforms displayed (channels, math, and/or reference) can be magnified and positioned horizontally at the same time.

NOTE

Although zoom must be turned on to control which waveforms zoom affects, the setting for **Horizontal Lock** affects which waveforms the horizontal control positions whether zoom is on or off. The rules for the three settings are as is listed in step 2.

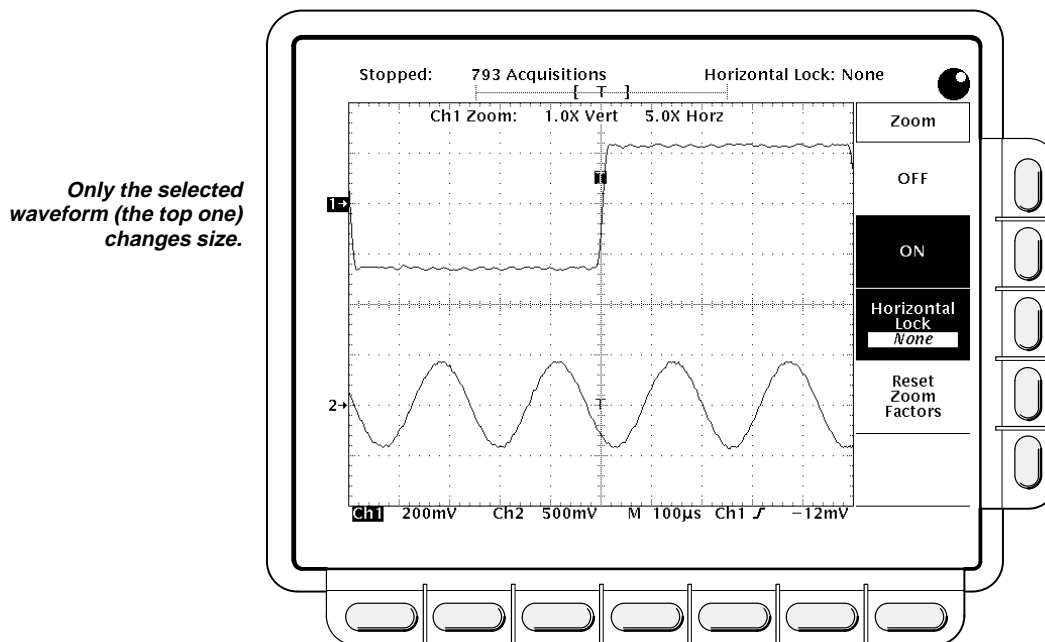

Figure 3-65: Zoom Mode with Horizontal Lock Set to None

Setting Interpolation

To change the interpolation method used:

Press **DISPLAY** → **Filter** (main) → **Sin(x)/x Interpolation** or **Linear Interpolation** (side).

Reset Zoom

To reset all zoom factors to their defaults (Table 3-10), press **ZOOM → Reset Zoom Factors** (side).

Table 3-10: Zoom Defaults

Parameter	Setting
Zoom Vertical Position	0
Zoom Vertical Gain	1X
Zoom Horizontal Position	Tracking Horizontal Position
Zoom Horizontal Gain	1X

Press **ZOOM → Off** (side) to return to normal oscilloscope (non-zoom) operation.

For Further Information

See *Acquisition*, on page 2-7.

See *Display Modes*, on page 3-31.

Appendices



Appendix A: Options and Accessories

This section describes the various options as well as the standard and optional accessories that are available for the TDS 520 and TDS 540 Digitizing Oscilloscopes.

Options

The following options are available:

Options A1–A5: International Power Cords

Besides the standard North American, 110 V, 60 Hz power cord, Tektronix ships any of five alternate power cord configurations with the oscilloscope when ordered by the customer.

Table A-1: International Power Cords

Option	Power Cord
A1	Universal European—220 V, 50 Hz
A2	UK—240 V, 50 Hz
A3	Australian—240 V, 50 Hz
A4	North American—240 V, 60 Hz
A5	Switzerland—220 V, 50 Hz

Option B1: Service Manual

When Option B1 is ordered, Tektronix ships a service manual with the oscilloscope.

Option 1K: K218 Scope Cart

With this option, Tektronix ships the K218 Scope Cart, which allows easy transportation of the oscilloscope in most lab environments.

Option 1M: 50,000 Point Record Length

This option provides a maximum record length of 50,000 points per acquisition (50,000/channel).

Warranty-Plus Service Options

The following options add to the services available with the standard warranty. (The standard warranty appears following the title page in this manual.)

- **Option M2:** When Option M2 is ordered, Tektronix provides five years of warranty/remedial service.
- **Option M3:** When Option M3 is ordered, Tektronix provides five years of warranty/remedial service and four oscilloscope calibrations.
- **Option M8:** When Option M8 is ordered, Tektronix provides four calibrations and four performance verifications, one of each in the second through the fifth years of service.

Option 1P: HC100 4 Pen Plotter

With this option, Tektronix ships a four-color plotter designed to make waveform plots directly from the digitizing oscilloscope without requiring an external controller. It handles A4 and US letter size media.

Option 1R: Rackmounted Digitizing Oscilloscope

Tektronix ships the digitizing oscilloscope, when ordered with Option 1R, configured for installation in a 19 inch wide instrument rack. Customers with instruments not configured for rackmounting can order a rackmount kit (016-1136-00 for field conversions).

Instructions for rackmounting the digitizing oscilloscope are shipped with the option 1R.

Option 13: RS-232/Centronics Hardcopy Interface

With this option, Tektronix ships the oscilloscope equipped with a RS-232 and a Centronics interface that can be used to obtain hardcopies of the oscilloscope screen.

Option 2F: Advanced DSP Math

With this option, the oscilloscope can compute and display three advanced math waveforms: integral of a waveform, differential of a waveform, and an FFT (Fast Fourier Transform) of a waveform.

Option 22: Additional Probes—(TDS 520 only)

With this option, Tektronix ships two additional probes identical to the two standard-accessory P6139A probes normally shipped with the instrument. This provides one probe for each front-panel input.

Option 23: Active Probes

With this option, Tektronix ships two active high speed voltage probes (the P6205 10X FET).

Option 9C: Certificate of Calibration and Test Data Report

Tektronix ships a Certificate of Calibration which states this instrument meets or exceeds all warranted specifications and has been calibrated using standards and instruments whose accuracies are traceable to the National Institute of Standards and Technology, an accepted value of a natural physical constant or a ratio calibration technique. The calibration is in compliance with US MIL-STD-45662A. This option also includes a test data report for the instrument.

Standard Accessories

The following standard accessories are included with the digitizing oscilloscope:

Table A-2: Standard Accessories

Accessory	Part Number
User Manual	070-8317-01
Programmer Manual	070-8318-03
Reference	070-8316-01
Performance Verification	070-8603-00
Front Cover	200-3696-00
U.S. Power Cord	161-0230-01
Probes, TDS 520 (quantity two), 10X Passive TDS 540 (quantity four), 10X Passive	P6139A (single unit)

Probe Accessories

These are accessories to the standard probe listed previously (P6139A). Except for the probe-tip-to-circuit board adapter, they can also be ordered separately.

Table A-3: Probe Accessories

Accessory	Part Number
Retractable Hook Tip	013-0107-06
Body Shell, tip cover	204-1049-00

Table A-3: Probe Accessories (Cont.)

Accessory	Part Number
Probe-Tip-to-Circuit Board Adapter (quantity two standard, optionally available in package of 25 as 131-5031-00)	No customer orderable part number for double unit
Six-inch Slip-On Ground Lead	196-3113-02
Low Inductance Ground Lead	195-4240-00
Marker Rings Set (quantity eighteen rings which includes two each of nine colors)	016-0633-00
Ground Collar	343-1003-01
Six-inch Alligator Clip Ground Lead	196-3305-00
Screwdriver: adjustment tool, metal tip	003-1433-00
SMT KlipChip™	206-0364-00
Accessory Pouch	016-0708-00

Optional Accessories

You can also order the following optional accessories:

Table A-4: Optional Accessories

Accessory	Part Number
TDS 520 Service Manual	070-8312-01
TDS 540 Service Manual	070-8314-01
Plotter (GPIB and Centronics Standard)	HC100
Oscilloscope Cart	K218
Rack Mount Kit (for field conversion)	016-1136-00
Oscilloscope Camera	C9
Oscilloscope Camera Adapter	016-1154-00
Soft-Sided Carrying Case	016-0909-01
Transit Case	016-1135-00
GPIB Cable (1 meter)	012-0991-01
GPIB Cable (2 meter)	012-0991-00

Accessory Probes

The following optional accessory probes are recommended for use with your digitizing oscilloscope:

- P6101A 1X, 15 MHz, Passive probe.
- P6156 10X, 3.5 GHz, Passive, low capacitance, (low impedance Zo) probe. Provides 100X, when ordered with Option 25.
- P6009 Passive, high voltage probe, 100X, 1500 VDC + Peak AC.
- P6015A Passive high voltage probe, 1000X, 20 kVDC + Peak AC (40 kV peak for less than 100 ms).
- P6205 750 MHz probe bandwidth. Active (FET) voltage probe.
- P6204 Active, high speed digital voltage probe. FET. DC to 1 GHz. DC offset. 50 Ω input. Use with 1103 TekProbe Power Supply for offset control.
- P6046 Active, differential probe, 1X/10X, DC to 100 MHz, 50 Ω input.
- A6501 Buffer Amplifier (active fixtured), 1 GHz, 1 M Ω , 10X.
- P6501 Option 02: Microprobe with TekProbe power cable (active fixtured), 750 MHz, 1 M Ω , 10X.
- AM 503S—DC/AC Current probe system, AC/DC. Uses A6302 Current Probe.
- AM 503S Option 03: DC/AC Current probe system, AC/DC. Uses A6303 Current Probe.
- P6021 AC Current probe. 120 Hz to 60 MHz.
- P6022 AC Current probe. 935 kHz to 120 MHz.
- CT-1 Current probe—designed for permanent or semi-permanent in-circuit installation. 25 kHz to 1 GHz, 50 Ω input.
- CT-2 Current probe—designed for permanent or semi-permanent in-circuit installation. 1.2 kHz to 200 MHz, 50 Ω input.
- CT-4 Current Transformer—for use with the AM 503S (A6302) and P6021. Peak pulse 1 kA. 0.5 Hz to 20 MHz with AM 503S (A6302).
- P6701A Opto-Electronic Converter, 500 to 950 nm, DC to 850 MHz 1 V/mW.
- P6703A Opto-Electronic Converter, 1100 to 1700 nm, DC to 1 GHz 1 V/mW.
- P6711 Opto-Electronic Converter, 500 to 950 nm, DC to 250 MHz 5 V/mW.
- P6713 Opto-Electronic Converter, 1100 to 1700 nm, DC to 300 MHz. 5 V/mW.
- TVC 501 Time-to-voltage converter. Time delay, pulse width and period measurements.

Probe Accessories

The following optional accessories are recommended for use with the standard probe listed under *Standard Accessories*.

Table A-5: Probe Accessories

Accessory	Part Number
Connector, BNC: BNC to Probe Tip Adapter	013-0226-00
Connector, BNC: 50 Ω, BNC to Probe Tip Adapter	013-0227-00
Connector, Probe: Package of 100, compact	131-4244-00
Connector, Probe: Package of 25, compact	131-5031-00
Screwdriver Adjustment Tool, Package of five	003-1433-01
Compact-to-Miniature Probe Tip Adapter	013-0202-02
Probe Tip Holder: (holds three tips)	352-0670-00
Three-inch Slip-On Ground Lead	196-3113-03
Probe Holder: Black ABS	352-0351-00
IC Protector Tip, Package of 10	015-0201-07
IC Protector Tip, Package of 100	015-0201-08
Marker Ring Set: Two each of nine colors	016-0633-00
SMT KlipChip™: 20 Adapters	SMG50
Low-Inductance Spring-Tips: Two each of five different springs and insulator	016-1077-00
Bayonet Ground Assembly	013-0085-00
Probe Tip-to-Chassis Adapter	131-0258-00

NOTE

The next four items below can only be used with the Compact-to-Miniature Probe Tip Adapter.

Dual-Lead Adapter	015-0325-00
BNC-to-Probe Tip Adapter	013-0084-01
G.R.-to-Probe Tip Adapter, 50 Ω	017-0088-00
Bayonet Ground Assembly	013-0085-00

Accessory Software

The following optional accessories are Tektronix software products recommended for use with your digitizing oscilloscope:

Table A-6: Accessory Software

Software	Part Number
EZ-Test Program Generator	S45F030
Wavewriter: AWG and waveform creation	S3FT400
TekTMS: Test management system	S3FT001
LabWindows	S3FG910

Warranty Information

Check for the full warranty statements for this product, the probes, and the products listed above on the first page after the title page of each product manual.



Appendix B: Specification

This appendix begins with a general description of the traits of the TDS 520 and TDS 540 Digitizing Oscilloscope. Three subsections follow, one for each of three classes of traits: *nominal traits*, *warranted characteristics*, and *typical characteristics*.

General Product Description

The Tektronix TDS 520 and 540 Digitizing Oscilloscopes are both portable, four-channel instruments suitable for use in a variety of test and measurement applications and systems. Key differences between the two models are as follows:

- The TDS 540 supplies four full-featured vertical channels. The TDS 520 supplies two full-featured channels; the remaining two channels are auxiliary channels with fewer vertical scale factors.
- The TDS 540 acquires all four channels simultaneously; the TDS 520 can acquire any two channels at the same time.
- The TDS 540 has a maximum digitizing rate of 1 Gigasample/second with an analog bandwidth of 500 MHz; the TDS 520 has a maximum digitizing rate of 500 Megasample/second with an analog bandwidth of 500 MHz.

Key features they have in common are:

- Real time sampling, plus equivalent-time sampling on repetitive signals or interpolation of points sampled on non-repetitive signals. Both equivalent time and interpolation can increase the apparent sample rate on the waveform when maximum real-time rates are reached.
- Five acquisition modes: peak-detect, high-resolution, sample, envelope, and average modes
- Three horizontal display modes: main only, main intensified, and delayed only.
- Selectable record lengths of 500 to 15,000 points. A 50,000-point record length is available with the 1M option.
- Extensive triggering capabilities: such as edge, logic, and glitch.
- Full programmability and printer/plotter output.
- Advanced functions like continuously updated measurements.
- Specialized display modes, such as infinite and variable persistence.
- A unique graphical user interface (GUI), an on-board help mode, and a logical front-panel layout which combine to deliver a new standard in usability.

- Measurement aids, such as three types of cursors for making parametric measurements on displayed waveforms and Measure, which can automatically extract parameters from a signal and display them on screen.
- Our proprietary digital signal processor, the DSP. This dedicated processor supports advanced analysis of your waveforms when doing such compute-intensive tasks as interpolation, waveform math, and signal averaging. It also teams with a custom display system to deliver specialized display modes.
- Four nonvolatile REF (reference) memories for storing waveforms.
- The digitizing oscilloscope is fully controllable and capable of sending and receiving waveforms over its GPIB interface (IEEE Std 488.1-1987).
- Hardcopy output (no system controller is required) in variety of popular output formats.
- Flexible display options to control the intensity of the display elements, style of waveform display (vectors or dots, intensified or non-intensified samples, and infinite or variable persistence), and display format (XY or YT and graticule type).
- Zoom, for magnifying waveform features you wish to examine up close.

Nominal Traits

This subsection contains a collection of tables that list the various *nominal traits* that describe the TDS 520 and 540 Digitizing Oscilloscopes. (Traits that differ according to model or only apply to one model are preceded by the appropriate model number, TDS 520 or TDS 540, in the tables.) Included are electrical and mechanical traits.

Nominal traits are described using simple statements of fact such as “Four, all identical” for the trait “Input Channels, Number of,” rather than in terms of limits that are performance requirements.

Table A-7: Nominal Traits—Signal Acquisition System

Name	Description								
Bandwidth Selections	20 MHz, 100 MHz, and FULL (500 MHz)								
TDS 540: Digitizers, Number of	Four, all identical								
TDS 520: Digitizers, Number of	Two, both identical								
Digitized Bits, Number of	8 bits ¹								
TDS 540: Input Channels, Number of	Four, all identical								
TDS 520: Input Channels, Number of	Two full-featured (CH 1 and CH 2), plus two limited, auxiliary inputs (AUX 1 and AUX 2)								
Input Coupling ²	DC, AC, or GND								
Input Impedance Selections	1 M Ω or 50 Ω								
TDS 540: Ranges, Offset, All Channels	<table border="0"> <thead> <tr> <th>Volts/Div Setting</th> <th>Offset Range</th> </tr> </thead> <tbody> <tr> <td>1 mV/div–99.5 mV/div</td> <td>Ⓜ V</td> </tr> <tr> <td>100 mV/div–995 mV/div</td> <td>Ⓜ V</td> </tr> <tr> <td>1 V/div–10 V/div</td> <td>Ⓜ V</td> </tr> </tbody> </table>	Volts/Div Setting	Offset Range	1 mV/div–99.5 mV/div	Ⓜ V	100 mV/div–995 mV/div	Ⓜ V	1 V/div–10 V/div	Ⓜ V
Volts/Div Setting	Offset Range								
1 mV/div–99.5 mV/div	Ⓜ V								
100 mV/div–995 mV/div	Ⓜ V								
1 V/div–10 V/div	Ⓜ V								
TDS 520: Ranges, Offset, CH 1 and CH 2	Same as is listed for the TDS 540								
TDS 520: Ranges, Offset, AUX 1 and AUX 2	<table border="0"> <thead> <tr> <th>Volts/Div Setting</th> <th>Offset Range</th> </tr> </thead> <tbody> <tr> <td>100 mV/div</td> <td>Ⓜ V</td> </tr> <tr> <td>1 V/div</td> <td>Ⓜ V</td> </tr> <tr> <td>10 V/div</td> <td>Ⓜ V</td> </tr> </tbody> </table>	Volts/Div Setting	Offset Range	100 mV/div	Ⓜ V	1 V/div	Ⓜ V	10 V/div	Ⓜ V
Volts/Div Setting	Offset Range								
100 mV/div	Ⓜ V								
1 V/div	Ⓜ V								
10 V/div	Ⓜ V								
Range, Position	Ⓜ divisions								

¹Displayed vertically with 25 digitization levels (DLs) per division and 10.24 divisions dynamic range with zoom off. A DL is the smallest voltage level change that can be resolved by the 8-bit A-D Converter, with the input scaled to the volts/division setting of the channel used. Expressed as a voltage, a DL is equal to 1/25 of a division times the volts/division setting.

²The input characteristics (*Input Coupling, Input Impedance Selections, etc.*) apply to both full-featured and auxiliary inputs except where otherwise specified.

Table A-7: Nominal Traits—Signal Acquisition System (Cont.)

Name	Description
TDS 540: Range, Sensitivity, All Channels	1 mV/div to 10 V/div ³
TDS 520: Range, Sensitivity, CH 1 and CH 2	Same as listed for the TDS 540
TDS 520: Range, Sensitivity, AUX 1 and AUX 2	100 mV/div, 1 V/div, and 10 V/div ⁴

³The sensitivity ranges from 1 mV/div to 10 V/div in a 1–2–5 sequence of coarse settings. Between a pair of adjacent coarse settings, the sensitivity can be finely adjusted. The resolution of such a fine adjustment is 1% of the more sensitive of the pair. For example, between 50 mV/div and 100 mV/div, the volts/division can be set with 0.5 mV resolution.

⁴There is no fine adjustment between the three sensitivity selections for AUX 1 and AUX 2.

Table A-8: Nominal Traits—Time Base System

Name	Description		
TDS 540: Range, Sample-Rate ^{1,3}	Number of Channels On	Sample-Rate Range	
	1	5 Samples/s–1 GSample/s	
	2	5 Samples/s–500 MSamples/s	
	3 or 4	5 Samples/s–250 MSamples/s	
TDS 520: Range, Sample-Rate ^{1,3}	Input Channel	Number of Channels On	Sample-Rate Range
	CH 1 or CH 2	1	5 Samples/s–500 MSamples/s
	CH 1 or CH 2	2	5 Samples/s–250 MSamples/s
	AUX 1 or AUX 2	Doesn't matter	5 Samples/s–250 MSamples/s
Range, Equivalent Time or Interpolated Waveform Rate ^{2,3}	500 MSamples/s to 100 GSamples/s (2 ns/Sample to 1 ps/Sample)		
Range, Seconds/Division	500 ps/div to 10 s/div		
Range, Time Base Delay Time	16 ns to 250 seconds		
Record Length Selection ⁴	500 points, 1000 points, 2500 points, 5000 points, 15000 points. A record length 50000 points is available with Option 1M.		

¹The range of real-time rates, expressed in samples/second, at which a digitizer samples signals at its inputs and stores the samples in memory to produce a record of time-sequential samples

²The range of waveform rates for equivalent time or interpolated waveform records.

³The Waveform Rate (WR) is the equivalent sample rate of a waveform record. For a waveform record acquired by real-time sampling of a single acquisition, the waveform rate is the same as the real-time sample rate; for a waveform created by interpolation of real-time samples from a single acquisition or by equivalent-time sampling of multiple acquisitions, the waveform rate is faster than the real time sample rate. For all three cases, the waveform rate is $1/(\text{Waveform Interval})$ for the waveform record, where the waveform interval (WI) is the time between the samples in the waveform record.

⁴The maximum record length of 15,000 points (50,000 points with Option 1M) is selectable with all acquisition modes except Hi Res. In Hi Res, the maximum record length is 5,000 points (15,000 points with Option 1M).

Table A-9: Nominal Traits—Triggering System

Name	Description		
Range, Delayed Trigger Time Delay	16 ns to 250 seconds		
Range, Events Delay	2 to 10,000,000		
Range (Time) for Pulse-Glitch or Pulse-Width Triggering	2 ns to 1 s		
Ranges, Trigger Level or Threshold	Source	Range	
	Any Channel	☒	screen
	Auxiliary (TDS 540 only)	☒ V	
	Line	☒ V	

Table A-10: Nominal Traits—Display System

Name	Description
Video Display Resolution	640 pixels horizontally by 480 pixels vertically in a display area of 5.2 inches horizontally by 3.9 inches vertically
Waveform Display Graticule	Single Graticule: 401 × 501 pixels/8 × 10 divisions, where divisions are 1 cm by 1 cm
Waveform Display Grey Scale	Sixteen levels in infinite-persistence and variable persistence display styles

Table A-11: Nominal Traits—Interfaces, Output Ports, and Power Fuse

Name	Description
Interface, GPIB	GPIB interface complies with IEEE Std 488.1-1987 and IEEE Std 488.2-1987
Interface, RS-232 (Option 13 only)	RS-232 interface complies with EIA/TIA 574
Interface, Centronics (Option 13 only)	Centronics interface complies with Centronics interface standard C332-44 Feb 1977, REV A
Logic Polarity for Main- and Delayed-Trigger Outputs	Negative TRUE. High to low transition indicates the trigger occurred.
Fuse Rating	Either of two fuses ¹ may be used: a 0.25" × 1.25" (UL 198.6, 3AG): 6 A FAST, 250 V, or a 5 mm × 20 mm, (IEC 127): 5 A (T), 250 V

¹Each fuse type requires its own fuse cap.

Table A-12: Nominal Traits—Mechanical

Name	Description
Cooling Method	Forced-air circulation with no air filter
Construction Material	Chassis parts constructed of aluminum alloy; front panel constructed of plastic laminate; circuit boards constructed of glass-laminate. Cabinet is aluminum and is clad in Tektronix Blue vinyl material.
Finish Type	Tektronix Blue vinyl-clad aluminum cabinet
Weight	<p>Standard digitizing oscilloscope 12.3 kg (27 lbs), with front cover. 20.0 kg (44 lbs), when packaged for domestic shipment</p> <p>Rackmount digitizing oscilloscope 12.3 kg (27 lbs) plus weight of rackmount parts, for the rack-mounted digitizing oscilloscope (Option 1R). 20.5 kg (45 lbs), when the rackmounted digitizing oscilloscope is packaged for domestic shipment</p> <p>Rackmount conversion kit 2.3 kg (5 lbs), parts only; 3.6 kg (8 lbs), parts plus package for domestic shipping</p>
Overall Dimensions	<p>Standard digitizing oscilloscope Height: 193 mm (7.6 in), without the accessories pouch installed Width: 445 mm (17.5 in), with handle Depth: 432 mm (17.1 in), with front cover installed</p> <p>Rackmount digitizing oscilloscope Height: 178 mm (7.0 in) Width: 483 mm (19.0 in) Depth: 558.8 mm (22.0 in)</p>

Warranted Characteristics

This subsection lists the various *warranted characteristics* that describe the TDS 540 and 520 Digitizing Oscilloscopes. (Characteristics that differ according to model or only apply to one model are preceded by the appropriate model number, TDS 520 or TDS 540, in the tables.) Included are electrical and environmental characteristics.

Warranted characteristics are described in terms of quantifiable performance limits which are warranted.

NOTE

*In these tables, those warranted characteristics that are checked in the Performance Verification manual, appear in **boldface type** under the column **Name**.*

As stated above, this subsection lists only warranted characteristics. A list of *typical characteristics* starts on page A-21.

Performance Conditions

The electrical characteristics found in these tables of warranted characteristics apply when the oscilloscope has been adjusted at an ambient temperature between +20°C and +30°C, has had a warm-up period of at least 20 minutes, and is operating at an ambient temperature between 0°C and +50°C (unless otherwise noted).

Table A-13: Warranted Characteristics—Signal Acquisition System

Name	Description	
Accuracy, DC Gain	± %	
Accuracy, DC Voltage Measurement, Averaged³	Measurement Type	DC Accuracy
	Average of ≥ 16 waveforms	± 1.0% × (reading – Net Offset ¹) + Offset Accuracy + 0.06 div)
	Delta volts between any two averages of ≥ 16 waveforms ²	± 1.0% × reading + 0.1 div + 0.3 mV)

¹Net Offset = Offset – (Position x Volts/Div). Net Offset is the voltage level at the center of the A-D converter dynamic range. Offset Accuracy is the accuracy of this Voltage level.

²The samples must be acquired under the same setup and ambient conditions.

³To ensure the most accurate measurements possible, run an SPC calibration first. When using the TDS 520 and/or TDS 540 Digitizing Oscilloscope at a Volts/Div setting ≤ 5 mV/div, an SPC calibration should be run once per week to ensure that instrument performance levels meet specifications.

Table A-13: Warranted Characteristics—Signal Acquisition System (Cont.)

Name	Description	
TDS 540: Accuracy, Offset	Volts/Div Setting	Offset Accuracy
	1 mV/div – 99.5 mV/div	± 0.1 div) Offset ¹ + 1.5 mV
	100 mV/div – 995 mV/div	± 0.1 div) Offset ¹ + 15 mV
	1 V/div – 10 V/div	± 0.1 div) Offset ¹ + 150 mV
TDS 520: Accuracy, Offset (CH 1 and CH 2)	Same as is listed for the TDS 540	
TDS 520: Accuracy, Offset (AUX 1 and AUX 2)	± Offset ¹ + 0.1 div)	
Analog Bandwidth, DC-50 Ω Coupled	Volts/Div	Bandwidth²
	5 mV/div – 10 V/div	DC – 500 MHz
	2 mV/div – 4.98 mV/div	DC – 350 MHz
	1 mV/div – 1.99 mV/div	DC – 250 MHz
Cross Talk (Channel Isolation)	≥ 100:1 at 100 MHz and ≥ 30:1 at the rated bandwidth (see above) for any two channels having equal volts/division settings	
Delay Between Channels, Full Bandwidth, Equivalent Time	≤ 250 ps for any two channels with equal volts/division and coupling settings	
Input Impedance, DC-1 MΩ Coupled	1 MΩ ±	± pF
Input Impedance, DC-50 Ω Coupled	50 Ω ± with VSWR ≤ 1.3:1 from DC – 500 MHz	
Input Voltage, Maximum, DC-1 MΩ, AC-1 MΩ, or GND Coupled	±	MHz
Input Voltage, Maximum, DC-50 Ω or AC-50 Ω Coupled	5 V _{rms} , with peaks less than or equal to ± V	
Lower Frequency Limit, AC Coupled	≤ 10 Hz when AC-1 MΩ Coupled; ≤ 200 kHz when AC-50 Ω coupled ³	

¹Net Offset = Offset – (Position x Volts/Div). Net Offset is the voltage level at the center of the A-D converter's dynamic range. Offset Accuracy is the accuracy of this voltage level.

²The limits given are for the ambient temperature range of 0°C to +30°C. Reduce the upper bandwidth frequencies by 2.5 MHz for each °C above +30°C.

³The AC Coupled Lower Frequency Limits are reduced by a factor of 10 when 10X, passive probes are used.

Table A-14: Warranted Characteristics—Time Base System

Name	Description										
Accuracy, Long Term Sample Rate and Delay Time	± 5 ppm over any ≥ 1 ms interval										
TDS 540: Accuracy, Delta Time Measurement	<p>For single-shot acquisitions using sample or high-resolution acquisition modes:</p> <table border="0"> <thead> <tr> <th data-bbox="647 470 954 529">Channels On/Bandwidth Selected</th> <th data-bbox="1065 470 1398 499">Measurement Accuracy^{1,2}</th> </tr> </thead> <tbody> <tr> <td data-bbox="647 537 943 567">1 or 2 channels/100 MHz</td> <td data-bbox="1065 525 1422 583">$\pm (1 \text{ WI} + 25 \text{ ppm of Reading} + 500 \text{ ps})$</td> </tr> <tr> <td data-bbox="647 596 927 625">3 or 4 channels/20 MHz</td> <td data-bbox="1065 596 1422 655">$\pm (1 \text{ WI} + 25 \text{ ppm of Reading} + 1.3 \text{ ns})$</td> </tr> </tbody> </table> <p>For repetitive acquisitions using average acquisition mode with ≥ 8 averages:</p> <table border="0"> <thead> <tr> <th data-bbox="647 772 954 831">Channels On/Bandwidth Selected</th> <th data-bbox="1065 772 1398 802">Measurement Accuracy^{1,2}</th> </tr> </thead> <tbody> <tr> <td data-bbox="647 840 1016 869">1 to 4 Channels/Full Bandwidth</td> <td data-bbox="1065 827 1422 886">$\pm (1 \text{ WI} + 25 \text{ ppm of Reading} + 200 \text{ ps})$</td> </tr> </tbody> </table>	Channels On/Bandwidth Selected	Measurement Accuracy ^{1,2}	1 or 2 channels/100 MHz	$\pm (1 \text{ WI} + 25 \text{ ppm of Reading} + 500 \text{ ps})$	3 or 4 channels/20 MHz	$\pm (1 \text{ WI} + 25 \text{ ppm of Reading} + 1.3 \text{ ns})$	Channels On/Bandwidth Selected	Measurement Accuracy ^{1,2}	1 to 4 Channels/Full Bandwidth	$\pm (1 \text{ WI} + 25 \text{ ppm of Reading} + 200 \text{ ps})$
Channels On/Bandwidth Selected	Measurement Accuracy ^{1,2}										
1 or 2 channels/100 MHz	$\pm (1 \text{ WI} + 25 \text{ ppm of Reading} + 500 \text{ ps})$										
3 or 4 channels/20 MHz	$\pm (1 \text{ WI} + 25 \text{ ppm of Reading} + 1.3 \text{ ns})$										
Channels On/Bandwidth Selected	Measurement Accuracy ^{1,2}										
1 to 4 Channels/Full Bandwidth	$\pm (1 \text{ WI} + 25 \text{ ppm of Reading} + 200 \text{ ps})$										
TDS 520: Accuracy, Delta Time Measurement	<p>For single-shot acquisitions using sample or high-resolution acquisition modes on CH 1 and/or CH 2:</p> <table border="0"> <thead> <tr> <th data-bbox="647 999 954 1058">Channels On/Bandwidth Selected</th> <th data-bbox="1065 999 1398 1029">Measurement Accuracy^{1,2}</th> </tr> </thead> <tbody> <tr> <td data-bbox="647 1066 878 1096">1 channel/100 MHz</td> <td data-bbox="1065 1054 1422 1113">$\pm (1 \text{ WI} + 25 \text{ ppm of Reading} + 500 \text{ ps})$</td> </tr> <tr> <td data-bbox="647 1125 878 1155">2 channels/20 MHz</td> <td data-bbox="1065 1125 1422 1184">$\pm (1 \text{ WI} + 25 \text{ ppm of Reading} + 1.3 \text{ ns})$</td> </tr> </tbody> </table> <p>For repetitive acquisitions using average acquisition mode with ≥ 8 averages:</p> <table border="0"> <thead> <tr> <th data-bbox="647 1302 954 1360">Channels On/Bandwidth Selected</th> <th data-bbox="1065 1302 1398 1331">Measurement Accuracy^{1,2}</th> </tr> </thead> <tbody> <tr> <td data-bbox="647 1369 1016 1398">1 to 2 Channels/Full Bandwidth</td> <td data-bbox="1065 1356 1422 1415">$\pm (1 \text{ WI} + 25 \text{ ppm of Reading} + 200 \text{ ps})$</td> </tr> </tbody> </table>	Channels On/Bandwidth Selected	Measurement Accuracy ^{1,2}	1 channel/100 MHz	$\pm (1 \text{ WI} + 25 \text{ ppm of Reading} + 500 \text{ ps})$	2 channels/20 MHz	$\pm (1 \text{ WI} + 25 \text{ ppm of Reading} + 1.3 \text{ ns})$	Channels On/Bandwidth Selected	Measurement Accuracy ^{1,2}	1 to 2 Channels/Full Bandwidth	$\pm (1 \text{ WI} + 25 \text{ ppm of Reading} + 200 \text{ ps})$
Channels On/Bandwidth Selected	Measurement Accuracy ^{1,2}										
1 channel/100 MHz	$\pm (1 \text{ WI} + 25 \text{ ppm of Reading} + 500 \text{ ps})$										
2 channels/20 MHz	$\pm (1 \text{ WI} + 25 \text{ ppm of Reading} + 1.3 \text{ ns})$										
Channels On/Bandwidth Selected	Measurement Accuracy ^{1,2}										
1 to 2 Channels/Full Bandwidth	$\pm (1 \text{ WI} + 25 \text{ ppm of Reading} + 200 \text{ ps})$										

¹For input signals ≥ 5 divisions in amplitude and a slew rate of ≥ 2.0 divisions/ns at the delta time measurement points. Signal must have been acquired at a volts/division setting ≥ 5 mV/division.

²The WI (waveform interval) is the time between the samples in the waveform record. Also, see the footnotes for *Sample Rate Range* and *Equivalent Time or Interpolated Waveform Rates* in Table A-8 on page A-13.

Table A-15: Warranted Characteristics—Triggering System

Name	Description		
Accuracy (Time) for Pulse-Glitch or Pulse-Width Triggering	Time Range	Accuracy	
	2 ns to 1 μ s	\pm	ns)
	1.02 μ s to 1 s	\pm	setting)
Accuracy, Trigger Level or Threshold, DC Coupled ¹	Trigger Source	Accuracy	
	Any Channel	\pm	Offset ²) + 0.3 div \times volts/div setting + Offset Accuracy)
	Auxiliary (TDS 540 only)	\pm	100 mV)
TDS 520: Sensitivity, Edge-Type Trigger, DC Coupled ³	Trigger Source	Sensitivity	
	CH 1 and CH 2		0.35 division from DC to 50 MHz, increasing to 1 division at 500 MHz
	AUX 1 and AUX 2		0.55 division from DC to 50 MHz, increasing to 1.5 division at 500 MHz
TDS 540: Sensitivity, Edge-Type Trigger, DC Coupled ³	Trigger Source	Sensitivity	
	Any Channel		0.35 division from DC to 50 MHz, increasing to 1 division at 500 MHz
	Auxiliary		0.25 volts from DC to 50 MHz
Width, Minimum Pulse and Rearm, for Pulse Triggering	Pulse Class	Minimum Pulse Width	Minimum Rearm Width
	Glitch	2 ns	2 ns + 5% of Glitch Width Setting 2.5 ns
	Runt	2.5 ns	2 ns + 5% of Width Upper Limit Setting
	Width	2 ns	

¹For input signals having rise and fall times of ≥ 20 ns.

²Net Offset = Offset – (Position \times Volts/Div). Net Offset is the voltage level at the center of the A-D converter's dynamic range. Offset Accuracy is the accuracy of this voltage level.

³The minimum sensitivity for obtaining a stable trigger. A stable trigger results in a uniform, regular display triggered on the selected slope. The trigger point must not switch between opposite slopes on the waveform, and the display must not "roll" across the screen on successive acquisitions. The TRIG'D LED stays constantly lighted when the SEC/DIV setting is 2 ms or faster but may flash when the SEC/DIV setting is 10 ms or slower.

Table A-16: Warranted Characteristics—Output Ports, Probe Compensator, and Power

Name	Description	
TDS 540: Logic Levels, Main- and Delayed-Trigger Outputs	Characteristic	Limits
	Vout (HI)	≥ 2.5 V open circuit; ≥ 1.0 V into a 50 Ω load to ground
	Vout (LO)	≤ 0.7 V into a load of ≤ 4 mA; ≤ 0.25 V into a 50 Ω load to ground

Table A-16: Warranted Characteristics—Output Ports, Probe Compensator, and Power

Name	Description
Output Voltage and Frequency, Probe Compensator	Characteristic
	Limits
	Voltage
	TDS 520 (B021799 and below); TDS 540 (B022999 and below):
	0.5 V (base-top) \square 1 M Ω load; 0.25 V (base-top) \square into a 50 Ω load
	TDS 520 (B021800 and above); TDS 540 (B023300 and above):
	0.5 V (base-top) \square 50 Ω load to ground
	Frequency 1 kHz \square
TDS 540: Output Voltage, Channel 3 Signal Out	20 mV/division \square into a 1 M Ω load; 10 mV/division \square 50 Ω load
Source Voltage	90 to 250 VAC _{rms} , continuous range
Source Frequency	47 Hz to 63 Hz
Power Consumption	\leq 300 W (450 VA)

Table A-17: Warranted Characteristics—Environmental, Safety, and Reliability

Name	Description
Atmospherics	Temperature: 0°C to +50°C, operating; -40°C to +75°C, non-operating Relative humidity: 0 to 95%, at or below +40°C; 0 to 75%, +41°C to 50°C Altitude: To 15,000 ft. (4570 m), operating; to 40,000 ft. (12190 m), non-operating
Dynamics	Random vibration: 0.31 g rms, from 5 to 500 Hz, 10 minutes each axis, operating; 3.05 g rms, from 5 to 500 Hz, 10 minutes each axis, non-operating
Emissions	Meets or exceeds the requirements of the following standards: MIL-STD-461C CE-03, part 4, curve #1, RE-02, part 7 VDE 0871, Category B FCC Rules and Regulations, Part 15, Subpart J, Class A
User-Misuse Simulation	Electrostatic Discharge Susceptibility: Up to 8 kV with no change to settings or impairment of normal operation; up to 15 kV with no damage that prevents recovery of normal operation

Typical Characteristics

This subsection contains tables that lists the various *typical characteristics* that describe the TDS 520 and 540 Digitizing Oscilloscope. (Characteristics that differ according to model or only apply to one model are preceded by the appropriate model number, TDS 520 or TDS 540, in the tables.)

Typical characteristics are described in terms of typical or average performance. Typical characteristics are not warranted.

This subsection lists only typical characteristics. A list of warranted characteristics starts on page A-16.

Table A-18: Typical Characteristics—Signal Acquisition System

Name	Description	
Accuracy, DC Voltage Measurement, Not Averaged	Measurement Type	DC Accuracy
	Any Sample	Ⓜ 1.0% × (reading – Net Offset ¹) + Offset Accuracy + 0.13 div + 0.6 mV
	Delta Volts between any two samples ²	Ⓜ 1.0% × reading + 0.26 div + 1.2 mV)
TDS 540: Frequency Limit, Upper, 100 MHz Bandwidth Limited (All Channels)	100 MHz	
TDS 520: Frequency Limit, Upper, 100 MHz Bandwidth Limited (CH 1 and CH 2 only)	Same as listed for the TDS 540	
TDS 540: Frequency Limit, Upper, 20 MHz Bandwidth Limited (All Channels)	20 MHz	
TDS 520: Frequency Limit, Upper, 20 MHz Bandwidth Limited (CH 1 and CH 2 only)	Same as listed for the TDS 540	

¹Net Offset = Offset – (Position × Volts/Div). Net Offset is the voltage level at the center of the A-D converter's dynamic range. Offset Accuracy is the accuracy of this voltage level.

²The samples must be acquired under the same setup and ambient conditions.

Table A-18: Typical Characteristics—Signal Acquisition System (Cont.)

Name	Description				
Nonlinearity	<1 DL, differential; ≤ 1 DL, integral, independently based				
TDS 540: Step Response Settling Errors	Volts/Div Setting	Step Amplitude	Settling Error (%)³		
			20 ns	100 ns	20 ms
	1 mV/div–99.5 mV/div	≤ 2 V	≤ 0.5	≤ 0.2	≤ 0.1
	100 mV/div–995 mV/div	≤ 20 V	≤ 1.0	≤ 0.5	≤ 0.2
	1 V/div–10 V/div	≤ 200 V	≤ 1.0	≤ 0.5	≤ 0.2
TDS 520: Step Response Settling Errors (CH 1 and CH 2 only)	Same as is listed for the TDS 540				
Calculated Rise Time ⁴	Volts/Div Setting	Rise Time			
	5 mV/div–10 V/div	800 ps			
	2 mV/div–4.98 mV/div	1.2 ns			
	1 mV/div–1.99 mV/div	1.6 ns			

³The values given are the maximum absolute difference between the value at the end of a specified time interval after the mid-level crossing of the step, and the value one second after the mid-level crossing of the step, expressed as a percentage of the step amplitude.

⁴The numbers given are valid 0°C to +30°C and will increase as the temperature increases due to the degradation in bandwidth. Rise time is calculated from the bandwidth. It is defined by the following formula:

$$Rise\ Time\ (ns) = \frac{400}{BW\ (MHz)}$$

Note that if you measure rise time, you must take into account the rise time of the test equipment (signal source, etc.) that you use to provide the test signal. That is, the measured rise time (RT_m) is determined by the instrument rise time (RT_i) and the rise time of the test signal source (RT_{gen}) according to the following formula:

$$RT_m^2 = RT_i^2 + RT_{gen}^2$$

Table A-19: Typical Characteristics—Time Base System

Name	Description
Aperture Uncertainty	≤ (50 ps + 0.03 ppm × Record Duration) rms, for real-time or interpolated records having duration ≤ 1 minute; ≤ (50 ps + 0.06 × WI ¹) rms, for equivalent time records

¹The WI (waveform interval) is the time between the samples in the waveform record. Also, see the footnotes for *Sample Rate Range* and *Equivalent Time or Interpolated Waveform Rates* in Table A-8 on page A-13.

Table A-20: Typical Characteristics—Triggering System

Name	Description	
TDS 540: Input, Auxiliary Trigger	The input resistance is $\geq 1.5 \text{ k}\Omega$; the maximum safe input voltage is $\frac{1}{2}$ AC).	
Error, Trigger Position, Edge Triggering	Acquire Mode	Trigger-Position Error^{1,2}
	Sample, Hi-Res, Average	$\frac{1}{2}$ WI + 1 ns)
	Peak Detect, Envelope	$\frac{1}{2}$ ns)
Holdoff, Variable, Main Trigger	<p>Minimum: For any horizontal scale setting, <i>minimum</i> holdoff is $10 \times$ that setting, but is never less than $1 \mu\text{s}$ or more than 5 s.</p> <p>Maximum: For any horizontal scale setting, <i>maximum</i> holdoff is at least 2 times the minimum holdoff for that setting, but is never more than 10 times the minimum holdoff for that setting.</p>	
Lowest Frequency for Successful Operation of “Set Level to 50%” Function	30 Hz	
Sensitivity, Edge Trigger, Not DC Coupled ³	Trigger Coupling	Typical Signal Level for Stable Triggering
	AC	Same as DC-coupled limits ⁴ for frequencies above 60 Hz. Attenuates signals below 60 Hz.
	Noise Reject	Three and one half times the DC-coupled limits. ⁴
	High Frequency Reject	One and one half times times the DC-coupled limits ⁴ from DC to 30 kHz. Attenuates signals above 30 kHz.
	Low Frequency Reject	One and one half times the DC-coupled limits ⁴ for frequencies above 80 kHz. Attenuates signals below 80 kHz.

¹The trigger position errors are typically less than the values given here. These values are for triggering signals having a slew rate at the trigger point of $\frac{1}{2}$ division/ns.

²The waveform interval (WI) is the time between the samples in the waveform record. Also, see the footnote for the characteristics *Sample Rate Range* and *Equivalent Time or Interpolated Waveform Rates* in Table A-8 on page A-13.

³The minimum sensitivity for obtaining a stable trigger. A stable trigger results in a uniform, regular display triggered on the selected slope. The trigger point must not switch between opposite slopes on the waveform, and the display must not “roll” across the screen on successive acquisitions. The TRIG'D LED stays constantly lighted when the SEC/DIV setting is 2 ms or faster but may flash when the SEC/DIV setting is 10 ms or slower.

⁴See the characteristic *Sensitivity, Edge-Type Trigger, DC Coupled* in Table A-15, which begins on page A-19.

Table A-20: Typical Characteristics—Triggering System

Name	Description
Sensitivities, Logic-Type Trigger Events-Delay, DC Coupled ⁵	1.0 division, from DC to 100 MHz with a minimum slew rate of 25 div/ μ s at the trigger level or the threshold crossing
Sensitivities, Pulse-Type Runt Trigger ⁵	1.0 division, from DC to 200 MHz with a minimum slew rate of 25 div/ μ s at the trigger level or the threshold crossing
Sensitivities, Pulse-Type Trigger Width and Glitch ⁵	1.0 division with a minimum slew rate of 25 div/ μ s at the trigger level or the threshold crossing. For <5 nsec pulse width or rearm time, 2 divisions are required.
TDS 520: Sensitivity, Derating Aux Channel Trigger	All trigger sensitivity specifications are derated by 50% for AUX 1 and AUX 2 inputs.
Width, Minimum Pulse and Rearm, for Logic Triggering or Events Delay ⁶	5 ns

⁵The minimum signal levels required for stable logic or pulse triggering of an acquisition or for stable counting of a DC coupled events delay signal. (Stable counting of events is counting that misses no events.)

⁶The minimum pulse width and rearm width required for logic-type triggering or events delaying to occur.

Table A-21: Typical Characteristics—Data Handling

Name	Description
Time, Data-Retention, Nonvolatile Memory ^{1,2}	5 years

¹The time that reference waveforms, stored setups, and calibration constants are retained when there is no power to the digitizing oscilloscope.

²Data is maintained by small lithium-thionyl-chloride batteries internal to the memory ICs. The amount of lithium is so small in these ICs that they can typically be safely disposed of with ordinary garbage in a sanitary landfill.



Appendix C: Algorithms

The Tektronix TDS Series Digitizing Oscilloscope can take 25 automatic measurements. By knowing how the instrument makes these calculations, you may better understand how to use your instrument and how to interpret your results.

Measurement Variables

The TDS Series Digitizing Oscilloscope uses a variety of variables in its calculations. These include:

High, Low

High is the value used as the 100% level in measurements such as fall time and rise time. For example, if you request the 10% to 90% rise time, then the oscilloscope will calculate 10% and 90% as percentages with *High* representing 100%.

Low is the value used as the 0% level in measurements such as fall time and rise time.

The exact meaning of *High* and *Low* depends on which of two calculation methods you choose from the Measure menu's **High-Low Setup** item. These are *Min-max* and *Histogram*.

Min-Max Method—defines the 0% and the 100% waveform levels as the lowest amplitude (most negative) and the highest amplitude (most positive) samples. The min-max method is useful for measuring frequency, width, and period for many types of signals. Min-max is sensitive to waveform ringing and spikes, however, and does not always measure accurately rise time, fall time, overshoot, and undershoot.

The min-max method calculates the High and Low values as follows:

$$High = Max$$

and

$$Low = Min$$

Histogram Method—attempts to find the highest density of points above and below the waveform's midpoint. It attempts to ignore ringing and spikes when determining the 0% and 100% levels. This method works well when measuring square waves and pulse waveforms.

The oscilloscope calculates the histogram-based *High* and *Low* values as follows:

1. It makes a histogram of the record with one bin for each digitizing level (256 total).
2. It splits the histogram into two sections at the halfway point between *Min* and *Max* (also called *Mid*).
3. The level with the most points in the upper histogram is the *High* value, and the level with the most points in the lower histogram is the *Low* value. (Choose the levels where the histograms peak for *High* and *Low*.)

If *Mid* gives the largest peak value within the upper or lower histogram, then return the *Mid* value for both *High* and *Low* (this is probably a very low amplitude waveform).

If more than one histogram level (bin) has the maximum value, choose the bin farthest from *Mid*.

This algorithm does not work well for two-level waveforms with greater than about 100% overshoot.

HighRef, MidRef, LowRef, Mid2Ref

The user sets the various reference levels, through the Measure menu's **Reference Level** selection. They include:

HighRef—the waveform's high reference level. Used in fall time and rise time calculations. Typically set to 90%. You can set it from 0% to 100%.

MidRef—the waveform's middle reference level. Typically set to 50%. You can set it from 0% to 100%.

LowRef—the waveform's low reference level. Used in fall and rise time calculations. Typically set to 10%. You can set it from 0% to 100%.

Mid2Ref—the middle reference level for a second waveform (or the second middle reference of the same waveform). Used in delay time calculations. Typically set to 50%. You can set it from 0% to 100%.

Other Variables

The oscilloscope also measures several values itself that it uses to help calculate measurements.

RecordLength—is the number of data points in the time base. You set it with the Horizontal menu **Record Length** item.

Start—is the location of the start of the measurement zone (X-value). It is 0.0 samples unless you are making a gated measurement. When you use gated measurements, it is the location of the left vertical cursor.

End—is the location of the end of the measurement zone (X-value). It is $(RecordLength - 1.0)$ samples unless you are making a gated measurement. When you use gated measurements, it is the location of the right vertical cursor.

Hysteresis—The hysteresis band is 10% of the waveform amplitude. It is used in *MCross1*, *MCross2*, and *MCross3* calculations.

For example, once a crossing has been measured in a negative direction, the waveform data must fall below 10% of the amplitude from the *MidRef* point before the measurement system is armed and ready for a positive crossing. Similarly, after a positive *MidRef* crossing, waveform data must go above 10% of the amplitude before a negative crossing can be measured. Hysteresis is useful when you are measuring noisy signals, because it allows the digitizing oscilloscope to ignore minor fluctuations in the signal.

MCross Calculations

MCross1, MCross2, and MCross3—refer to the first, second, and third *MidRef* cross times, respectively. See Figure A-1.

The polarity of the crossings does not matter for these variables, but the crossings alternate in polarity; that is, *MCross1* could be a positive or negative crossing, but if *MCross1* is a positive crossing, *MCross2* will be a negative crossing.

The oscilloscope calculates these values as follows:

1. Find the first *MidRefCrossing* in the waveform record or the gated region. This is *MCross1*.
2. Continuing from *MCross1*, find the next *MidRefCrossing* in the waveform record (or the gated region) of the opposite polarity of *MCross1*. This is *MCross2*.
3. Continuing from *MCross2*, find the next *MidRefCrossing* in the waveform record (or the gated region) of the same polarity as *MCross1*. This is *MCross3*.

MCross1Polarity—is the polarity of first crossing (no default). It can be rising or falling.

StartCycle—is the starting time for cycle measurements. It is a floating-point number with values between 0.0 and $(RecordLength - 1.0)$, inclusive.

$$StartCycle = MCross1$$

EndCycle—is the ending time for cycle measurements. It is a floating-point number with values between 0.0 and $(RecordLength - 1.0)$, inclusive.

$$EndCycle = MCross3$$

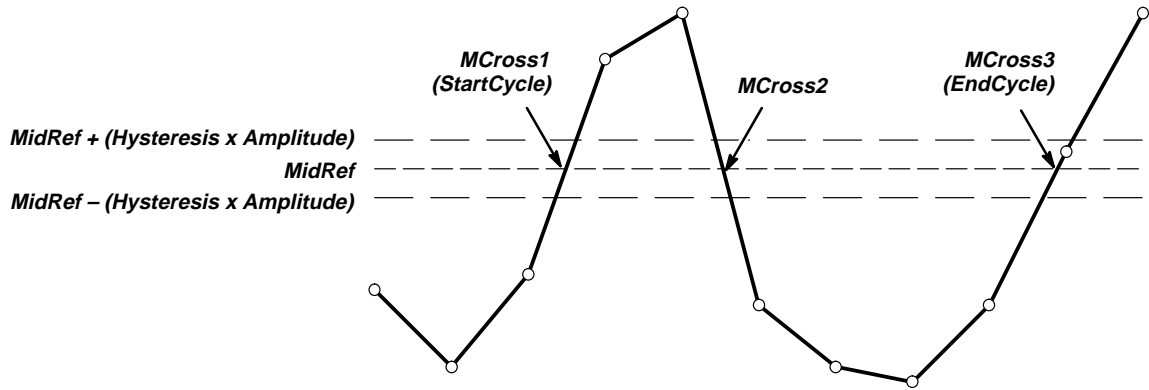

Figure A-1: MCross Calculations

Waveform[<0.0 ... RecordLength-1.0>]—holds the acquired data.

TPOS—is the location of the sample just before the trigger point (the time reference zero sample). In other terms, it contains the domain reference location. This location is where time = 0.

TSOFF—is the offset between *TPOS* and the actual trigger point. In other words, it is the trigger sample offset. Values range between 0.0 and 1.0 samples. This value is determined by the instrument when it receives a trigger. The actual zero reference (trigger) location in the measurement record is at $(TPOS+TSOFF)$.

Measurement Algorithms

The automated measurements are defined and calculated as follows.

Amplitude



$$Amplitude = High - Low$$

Area



The arithmetic area for one waveform. Remember that one waveform is not necessarily equal to one cycle. For cyclical data you may prefer to use the cycle area rather than the arithmetic area.

if $Start = End$ then return the (interpolated) value at $Start$.

Otherwise,

$$Area = \int_{Start}^{End} Waveform(t) dt$$

For details of the integration algorithm, see page A-35.

Cycle Area



Amplitude (voltage) measurement. The area over one waveform cycle. For non-cyclical data, you might prefer to use the Area measurement.

If $StartCycle = EndCycle$ then return the (interpolated) value at $StartCycle$.

$$CycleMean = \int_{StartCycle}^{EndCycle} Waveform(t) dt$$

For details of the integration algorithm, see page A-35.

Burst Width



Timing measurement. The duration of a burst.

1. Find $MCross1$ on the waveform. This is $MCrossStart$.
2. Find the last $MCross$ (begin the search at $EndCycle$ and search toward $StartCycle$). This is $MCrossStop$. This could be a different value from $MCross1$.
3. Compute $BurstWidth = MCrossStop - MCrossStart$

Cycle Mean



Amplitude (voltage) measurement. The mean over one waveform cycle. For non-cyclical data, you might prefer to use the Mean measurement.

If $StartCycle = EndCycle$ then return the (interpolated) value at $StartCycle$.

$$CycleMean = \frac{\int_{StartCycle}^{EndCycle} Waveform(t) dt}{(EndCycle - StartCycle) \times SampleInterval}$$

For details of the integration algorithm, see page A-35.

Cycle RMS



The true Root Mean Square voltage over one cycle.

If $StartCycle = EndCycle$ then $CycleRMS = Waveform[Start]$.

Otherwise,

$$CycleRMS = \sqrt{\frac{\int_{StartCycle}^{EndCycle} (Waveform(t))^2 dt}{(EndCycle - StartCycle) \times SampleInterval}}$$

For details of the integration algorithm, see page A-35.



Delay

Timing measurement. The amount of time between the *MidRef* and *Mid2Ref* crossings of two different traces, or two different places on the same trace.

Delay measurements are actually a group of measurements. To get a specific delay measurement, you must specify the target and reference crossing polarities, and the reference search direction.

Delay = the time from one *MidRef* crossing on the source waveform to the *Mid2Ref* crossing on the second waveform.

Delay is not available in the Snapshot display.



Fall Time

Timing measurement. The time taken for the falling edge of a pulse to drop from a *HighRef* value (default = 90%) to a *LowRef* value (default = 10%).

Figure A-2 shows a falling edge with the two crossings necessary to calculate a Fall measurement.

1. Searching from *Start* to *End*, find the first sample in the measurement zone greater than *HighRef*.
2. From this sample, continue the search to find the first (negative) crossing of *HighRef*. The time of this crossing is *THF*. (Use linear interpolation if necessary.)
3. From *THF*, continue the search, looking for a crossing of *LowRef*. Update *THF* if subsequent *HighRef* crossings are found. When a *LowRef* crossing is found, it becomes *TLF*. (Use linear interpolation if necessary.)
4. $FallTime = TLF - THF$

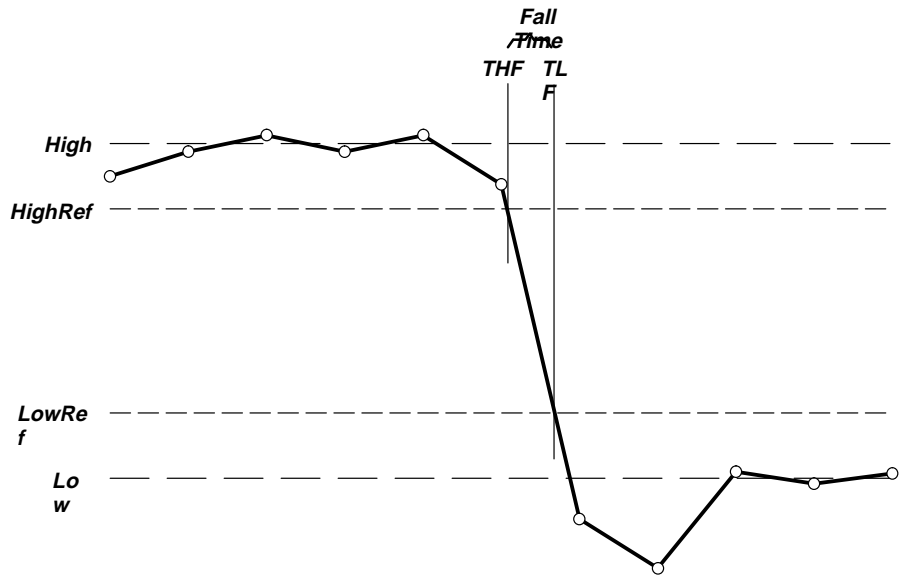

Figure A-2: Fall Time

Frequency



Timing measurement. The reciprocal of the period. Measured in Hertz (Hz) where 1 Hz = 1 cycle per second.

If *Period* = 0 or is otherwise bad, return an error.

$$\text{Frequency} = 1/\text{Period}$$

High



100% (highest) voltage reference value. (See “High, Low” earlier in this section)

Using the min-max measurement technique:

$$\text{High} = \text{Max}$$

Low



0% (lowest) voltage reference value calculated. (See “High, Low” earlier in this section)

Using the min-max measurement technique:

$$\text{Low} = \text{Min}$$

Maximum



Amplitude (voltage) measurement. The maximum voltage. Typically the most positive peak voltage.

Examine all *Waveform[]* samples from *Start* to *End* inclusive and set *Max* equal to the greatest magnitude *Waveform[]* value found.

Mean



The arithmetic mean for one waveform. Remember that one waveform is not necessarily equal to one cycle. For cyclical data you may prefer to use the cycle mean rather than the arithmetic mean.

if *Start = End* then return the (interpolated) value at *Start*.

Otherwise,

$$Mean = \frac{\int_{Start}^{End} Waveform(t) dt}{(End - Start) \times SampleInterval}$$

For details of the integration algorithm, see page A-35.

Minimum



Amplitude (voltage) measurement. The minimum amplitude. Typically the most negative peak voltage.

Examine all *Waveform[]* samples from *Start* to *End* inclusive and set *Min* equal to the smallest magnitude *Waveform[]* value found.

Negative Duty Cycle



Timing measurement. The ratio of the negative pulse width to the signal period expressed as a percentage.

NegativeWidth is defined in **Negative Width**, below.

If *Period = 0* or undefined then return an error.

$$NegativeDutyCycle = \frac{NegativeWidth}{Period} \times 100\%$$

Negative Overshoot



Amplitude (voltage) measurement.

$$NegativeOvershoot = \frac{Low - Min}{Amplitude} \times 100\%$$

Note that this value should never be negative (unless High or Low are set out-of-range).

Negative Width



Timing measurement. The distance (time) between *MidRef* (default = 50%) amplitude points of a negative pulse.

If *MCross1Polarity* = '–'

then

$$\text{NegativeWidth} = (\text{MCross2} - \text{MCross1})$$

else

$$\text{NegativeWidth} = (\text{MCross3} - \text{MCross2})$$

Peak to Peak



Amplitude measurement. The absolute difference between the maximum and minimum amplitude.

$$\text{PeaktoPeak} = \text{Max} - \text{Min}$$

Period



Timing measurement. Time taken for one complete signal cycle. The reciprocal of frequency. Measured in seconds.

$$\text{Period} = \text{MCross3} - \text{MCross1}$$

Phase



Timing measurement. The amount of phase shift, expressed in degrees of the target waveform cycle, between the *MidRef* crossings of two different waveforms. Waveforms measured should be of the same frequency or one waveform should be a harmonic of the other.

Phase is a dual waveform measurement; that is, it is measured from a target waveform to a reference waveform. To get a specific phase measurement, you must specify the target and reference sources.

Phase is determined in the following manner:

1. The first *MidRefCrossing* (*MCross1Target*) and third (*MCross3*) in the source (target) waveform are found.
2. The period of the target waveform is calculated (see "Period" above).
3. The first *MidRefCrossing* (*MCross1Ref*) in the reference waveform crossing in the same direction (polarity) as that found *MCross1Target* for the target waveform is found.
4. The phase is determined by the following:

$$\text{Phase} = \frac{\text{MCross1Ref} - \text{MCross1Target}}{\text{Period}} \times 360$$

If the target waveform leads the reference waveform, phase is positive; if it lags, negative.

Phase is not available in the Snapshot display.

Positive Duty Cycle



Timing measurement. The ratio of the positive pulse width to the signal period, expressed as a percentage.

PositiveWidth is defined in **Positive Width**, following.

If *Period* = 0 or undefined then return an error.

$$PositiveDutyCycle = \frac{PositiveWidth}{Period} \times 100\%$$

Positive Overshoot



Amplitude (voltage) measurement.

$$PositiveOvershoot = \frac{Max - High}{Amplitude} \times 100\%$$

Note that this value should never be negative.

Positive Width



Timing measurement. The distance (time) between *MidRef* (default = 50%) amplitude points of a positive pulse.

If *MCross1Polarity* = '+'

then

$$PositiveWidth = (MCross2 - MCross1)$$

else

$$PositiveWidth = (MCross3 - MCross2)$$

Rise Time



Timing measurement. Time taken for the leading edge of a pulse to rise from a *LowRef* value (default = 10%) to a *HighRef* value (default = 90%).

Figure A-3 shows a rising edge with the two crossings necessary to calculate a Rise Time measurement.

1. Searching from *Start* to *End*, find the first sample in the measurement zone less than *LowRef*.
2. From this sample, continue the search to find the first (positive) crossing of *LowRef*. The time of this crossing is the low rise time or *TLR*. (Use linear interpolation if necessary.)

3. From *TLR*, continue the search, looking for a crossing of *HighRef*. Update *TLR* if subsequent *LowRef* crossings are found. If a *HighRef* crossing is found, it becomes the high rise time or *THR*. (Use linear interpolation if necessary.)
4. $RiseTime = THR - TLR$

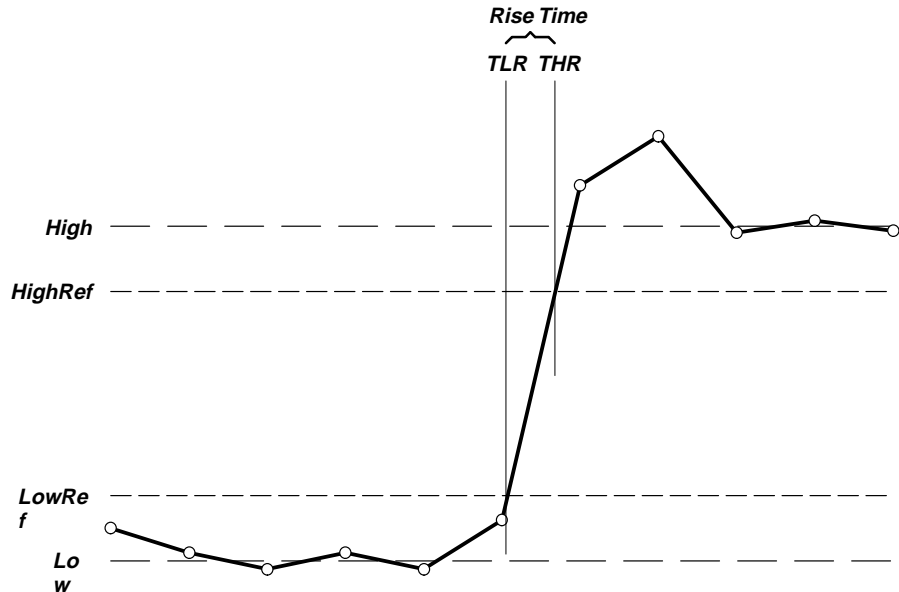

Figure A-3: Rise Time

RMS:



Amplitude (voltage) measurement. The true Root Mean Square voltage.

If $Start = End$ then $RMS =$ the (interpolated) value at $Waveform[Start]$.

Otherwise,

$$RMS = \sqrt{\frac{\int_{Start}^{End} (Waveform(t))^2 dt}{(End - Start) \times SampleInterval}}$$

For details of the integration algorithm, see below.

Integration Algorithm

The integration algorithm used by the digitizing oscilloscope is as follows:

$$\int_A^B W(t)dt \text{ is approximated by } \int_A^B \hat{W}(t)dt \text{ where:}$$

$W(t)$ is the sampled waveform

$\hat{W}(t)$ is the continuous function obtained by linear interpolation of $W(t)$

A and B are numbers between 0.0 and $RecordLength-1.0$

If A and B are integers, then:

$$\int_A^B \hat{W}(t) dt = s \times \sum_{i=A}^{B-1} \frac{W(i) + W(i + 1)}{2}$$

where s is the sample interval.

Similarly,

$$\int_A^B (W(t))^2 dt \text{ is approximated by } \int_A^B (\hat{W}(t))^2 dt \text{ where:}$$

$W(t)$ is the sampled waveform

$\hat{W}(t)$ is the continuous function obtained by linear interpolation of $W(t)$

A and B are numbers between 0.0 and $RecordLength-1.0$

If A and B are integers, then:

$$\int_A^B (\hat{W}(t))^2 dt = s \times \sum_{i=A}^{B-1} \frac{(W(i))^2 + W(i) \times W(i + 1) + (W(i + 1))^2}{3}$$

where s is the sample interval.

Measurements on Envelope Waveforms

Time measurements on envelope waveforms must be treated differently from time measurements on other waveforms, because envelope waveforms contain so many apparent crossings. Unless otherwise noted, envelope waveforms use either the minima or the maxima (but not both), determined in the following manner:

1. Step through the waveform from *Start* to *End* until the sample min and max pair *DO NOT* straddle *MidRef*.
2. If the pair $> MidRef$, use the minima, else use maxima.

If all pairs straddle *MidRef*, use maxima. See Figure A-4.

The Burst Width measurement always uses both maxima and minima to determine crossings.

Missing or Out-of-Range Samples

If some samples in the waveform are missing or off-scale, the measurements will linearly interpolate between known samples to make an “appropriate” guess as to the sample value. Missing samples at the ends of the measurement record will be assumed to have the value of the nearest known sample.

When samples are out of range, the measurement will give a warning to that effect (for example, “CLIPPING”) if the measurement could change by extending the measurement range slightly. The algorithms assume the samples recover from an overdrive condition instantaneously.

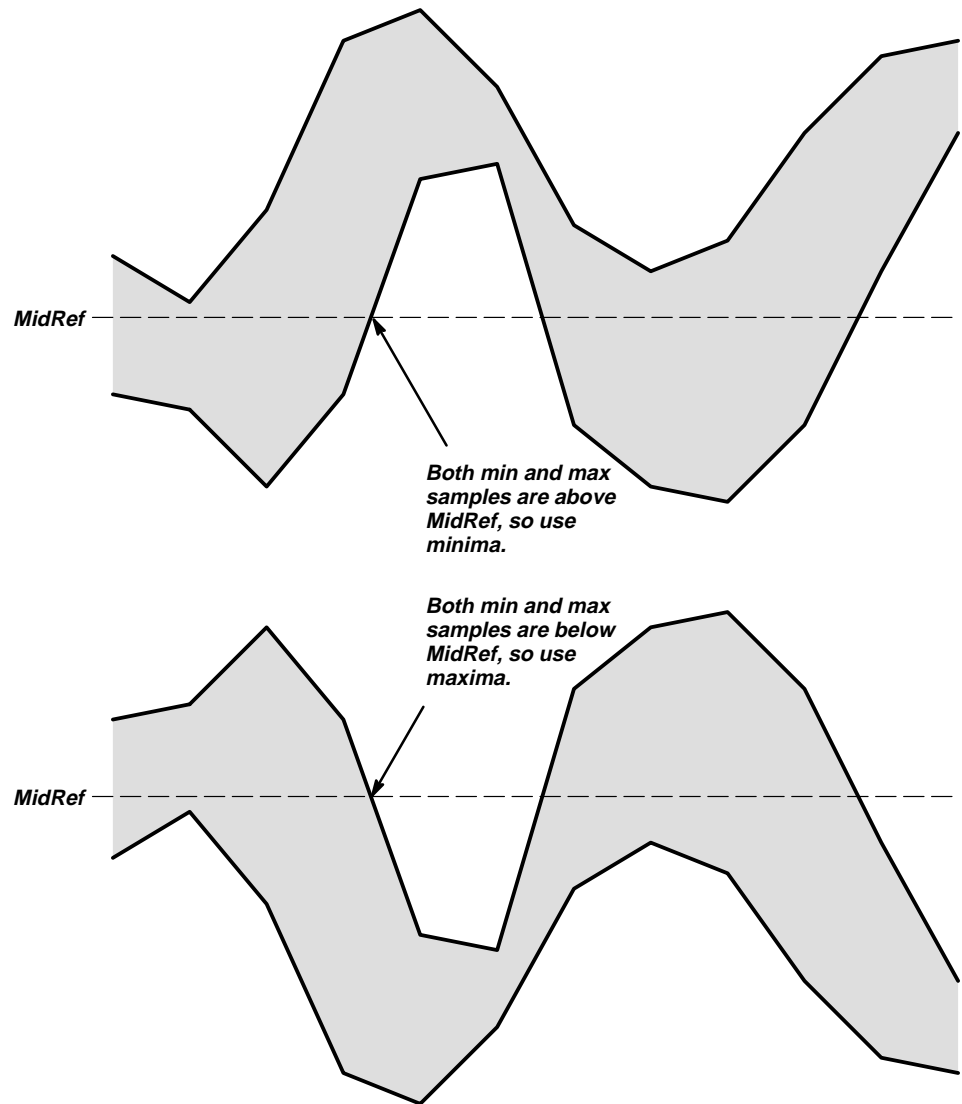

Figure A-4: Choosing Minima or Maxima to Use for Envelope Measurements

For example, if *MidRef* is set directly, then *MidRef* would not change even if samples were out of range. However, if *MidRef* was chosen using the % choice from the Measure menu’s **Set Levels in % Units** selection, then *MidRef* could give a “CLIPPING” warning.

NOTE

When measurements are displayed using Snapshot, out of range warnings are NOT available. However, if you question the validity of any measurement in the snapshot display, you can select and display the measurement individually and then check for a warning message.



Appendix D: Packaging for Shipment

If you ship the digitizing oscilloscope, pack it in the original shipping carton and packing material. If the original packing material is not available, package the instrument as follows:

1. Obtain a corrugated cardboard shipping carton with inside dimensions at least 15 cm (6 in) taller, wider, and deeper than the digitizing oscilloscope. The shipping carton must be constructed of cardboard with 170 kg (375 pound) test strength.
2. If you are shipping the digitizing oscilloscope to a Tektronix field office for repair, attach a tag to the digitizing oscilloscope showing the instrument owner and address, the name of the person to contact about the instrument, the instrument type, and the serial number.
3. Wrap the digitizing oscilloscope with polyethylene sheeting or equivalent material to protect the finish.
4. Cushion the digitizing oscilloscope in the shipping carton by tightly packing dunnage or urethane foam on all sides between the carton and the digitizing oscilloscope. Allow 7.5 cm (3 in) on all sides, top, and bottom.
5. Seal the shipping carton with shipping tape or an industrial stapler.

Appendix E: Packaging for Shipment



Appendix E: Factory Initialization Settings

The factory initialization settings provide you a known state for the digitizing oscilloscope.

Settings

Factory initialization sets values as shown in Table A-22.

Table A-22: Factory Initialization Defaults

Control	Changed by Factory Init to
Acquire mode	Sample
Acquire repetitive signal	ON (Enable ET)
Acquire stop after	RUN/STOP button only
Acquire # of averages	16
Acquire # of envelopes	10
Channel selection	Channel 1 on, all others off
Cursor H Bar 1 position	10% of graticule height (-3.2 divs from the center)
Cursor H Bar 2 position	90% of the graticule height (+3.2 divs from the center)
Cursor V Bar 1 position	10% of the record length
Cursor V Bar 2 position	90% of the record length
Cursor mode	Independent
Cursor function	Off
Cursor time units	Seconds
Delayed edge trigger coupling	DC
Delayed edge trigger level	0 V
Delayed edge trigger slope	Rising
Delayed edge trigger source	Channel 1
Delay trigger average #	16
Delay trigger envelope #	10

Table A-22: Factory Initialization Defaults (Cont.)

Control	Changed by Factory Init to
Delay time	15.152 ns
Delay events, triggerable after main	2
Delayed, delay by ...	Delay by Time
Delayed, time base mode	Delayed Runs After Main
Display clock	No Change
Display format	YT
Display graticule type	Full
Display intensity – contrast	125%
Display intensity – text	60%
Display intensity – waveform	80%
Display intensity – overall	85%
Display interpolation filter	Sin(x)/x
Display style	Vectors
Display trigger bar style	Short
Display trigger “T”	On
Display variable persistence	500 ms
Edge trigger coupling	DC
Edge trigger level	0.0 V
Edge trigger slope	Rising
Edge trigger source	Channel 1
Horizontal – delay trigger position	50%
Horizontal – delay trigger record length	500 points (10 divs)
Horizontal – delay time/division	50 μ s
Horizontal – main trigger position	50%
Horizontal – main trigger record length	500 points (10 divs)
Horizontal – main time/division	500 μ s
Horizontal – time base	Main only

Table A-22: Factory Initialization Defaults (Cont.)

Control	Changed by Factory Init to
Limit Testing	Off
Limit Testing – hardcopy if condition met	Off
Limit Testing – ring bell if condition met	Off
Logic pattern trigger Ch4 (Ax2) input	X (don't care)
Logic state trigger Ch4 (Ax2) input	Rising edge
Logic trigger input (pattern and state)	Channel 1 = H (high), Channels 2 & 3 (Ax1) = X (don't care)
Logic trigger threshold (all channels) (pattern and state)	1.4 V (when 10X probe attached)
Logic trigger class	Pattern
Logic trigger logic (pattern and state)	AND
Logic trigger triggers when ... (pattern and state)	Goes TRUE
Main trigger holdoff	0%
Main trigger mode	Auto
Main trigger type	Edge
Math1 definition	Ch 1 + Ch 2
Math2 definition	Ch 1 – Ch 2 (FFT of Ch 1 for Option 2F instruments)
Math3 definition	Inv of Ch 1
Measure Delay to	Channel 1 (Ch1)
Measure Delay edges	Both rising and forward searching
Measure High-Low Setup	Histogram
Measure High Ref	90% and 0 V (units)
Measure Low Ref	10% and 0 V (units)
Measure Mid Ref	50% and 0 V (units)
Measure Mid2 Ref	50% and 0 V (units)

Table A-22: Factory Initialization Defaults (Cont.)

Control	Changed by Factory Init to
Pulse glitch trigger polarity	Positive
Pulse runt high threshold	2.0 V
Pulse runt low threshold	0.0 V
Pulse runt trigger polarity	Positive
Pulse trigger class	Glitch
Pulse trigger filter state	On (Accept glitch)
Pulse trigger glitch width	2.0 ns
Pulse trigger level	0.8 V
Pulse trigger source (Glitch, runt, and width)	Channel 1 (Ch1)
Pulse width trigger when ...	Within limits
Pulse width upper limit	2.0 ns
Pulse width lower limit	2.0 ns
Pulse width trigger polarity	Positive
Saved setups	No change
Saved waveforms	No change
Vertical bandwidth (all channels)	Full
Vertical coupling (all channels)	DC
Vertical impedance (termination) (all channels)	1 M Ω
Vertical offset (all channels)	0 V
Vertical position (all channels)	0 divs.
Vertical volts/div. (all channels)	100 mV/div.
Zoom horizontal (all channels)	1.0X
Zoom horizontal lock	All
Zoom horizontal position (all channels)	50% = 0.5 (the middle of the display)
Zoom state	Off
Zoom vertical (all channels)	1.0X
Zoom vertical position (all channels)	0 divs.

Glossary & Index

AC 

AC coupling

A type of signal transmission that blocks the DC component of a signal but uses the dynamic (AC) component. Useful for observing an AC signal that is normally riding on a DC signal.

Accuracy

The closeness of the indicated value to the true value.

Acquisition

The process of sampling signals from input channels, digitizing the samples into data points, and assembling the data points into a waveform record. The waveform record is stored in memory. The trigger marks time zero in that process.

Acquisition interval

The time duration of the waveform record divided by the record length. The digitizing oscilloscope displays one data point for every acquisition interval.

Active cursor

The cursor that moves when you turn the general purpose knob. It is represented in the display by a solid line. The @ readout on the display shows the absolute value of the active cursor.

Aliasing

A false representation of a signal due to insufficient sampling of high frequencies or fast transitions. A condition that occurs when a digitizing oscilloscope digitizes at an effective sampling rate that is too slow to reproduce the input signal. The waveform displayed on the oscilloscope may have a lower frequency than the actual input signal.



Amplitude

The High waveform value less the Low waveform value.



AND

A logic (Boolean) function in which the output is true when and only when all the inputs are true. On the digitizing oscilloscope, that is a trigger logic pattern and state function.



Area

Measurement of the waveform area taken over the entire waveform or the gated region. Expressed in volt-seconds. Area above ground is positive; area below ground is negative.

Attenuation

The degree the amplitude of a signal is reduced when it passes through an attenuating device such as a probe or attenuator. That is, the ratio of the input measure to the output measure. For example, a 10X probe will attenuate, or reduce, the input voltage of a signal by a factor of 10.

Automatic trigger mode

A trigger mode that causes the oscilloscope to automatically acquire if triggerable events are not detected within a specified time period.

Autoset

A function of the oscilloscope that automatically produces a stable waveform of usable size. Autoset sets up front-panel controls based on the characteristics of the active waveform. A successful autoset will set the volts/div, time/div, and trigger level to produce a coherent and stable waveform display.



Average acquisition mode

In this mode the oscilloscope acquires and displays a waveform that is the averaged result of several acquisitions. That reduces the apparent noise. The oscilloscope acquires data as in the sample mode and then averages it according to a specified number of averages.



Bandwidth

The highest frequency signal the oscilloscope can acquire with no more than 3 dB ($\times .707$) attenuation of the original (reference) signal.



Burst width

A timing measurement of the duration of a burst.

Channel

One type of input used for signal acquisition. The TDS 540 has four channels; the TDS 520 has two.

Channel Reference Indicator

The indicator on the left side of the display that points to the position around which the waveform contracts or expands when vertical scale is changed. This position is ground when offset if set to 0 V; otherwise, it is ground plus offset.

Coupling

The association of two or more circuits or systems in such a way that power or information can be transferred from one to the other. You can couple the input signal to the trigger and vertical systems several different ways.

Cursors

Paired markers that you can use to make measurements between two waveform locations. The oscilloscope displays the values (expressed in volts or time) of the position of the active cursor and the distance between the two cursors.



Cycle area

A measurement of waveform area taken over one cycle. Expressed in volt-seconds. Area above ground is positive; area below ground is negative.



Cycle mean

An amplitude (voltage) measurement of the arithmetic mean over one cycle.

**Cycle RMS**

The true Root Mean Square voltage over one cycle.

DC

DC coupling

A mode that passes both AC and DC signal components to the circuit. Available for both the trigger system and the vertical system.

**Delay measurement**

A measurement of the time between the middle reference crossings of two different waveforms.

Delay time

The time between the trigger event and the acquisition of data.

Digitizing

The process of converting a continuous analog signal such as a waveform to a set of discrete numbers representing the amplitude of the signal at specific points in time. Digitizing is composed of two steps: sampling and quantizing.

Display system

The part of the oscilloscope that shows waveforms, measurements, menu items, status, and other parameters.

Edge Trigger

Triggering occurs when the oscilloscope detects the source passing through a specified voltage level in a specified direction (the trigger slope).

**Envelope acquisition mode**

A mode in which the oscilloscope acquires and displays a waveform that shows the variation extremes of several acquisitions.

Equivalent-time sampling (ET)

A sampling mode in which the oscilloscope acquires signals over many repetitions of the event. The TDS 500 Series Digitizing Oscilloscopes use a type of equivalent time sampling called *random equivalent time sampling*. It utilizes an internal clock that runs asynchronously with respect to the input signal and the signal trigger. The oscilloscope takes samples continuously, independent of the trigger position, and displays them based on the time difference between the sample and the trigger. Although the samples are taken sequentially in time, they are random with respect to the trigger.

**Fall time**

A measurement of the time it takes for trailing edge of a pulse to fall from a HighRef value (typically 90%) to a LowRef value (typically 10%) of its amplitude.

**Frequency**

A timing measurement that is the reciprocal of the period. Measured in Hertz (Hz) where 1 Hz = 1 cycle per second.



Gated Measurements

A feature that lets you limit automated measurements to a specified portion of the waveform. You define the area of interest using the vertical cursors.

General purpose knob

The large front-panel knob with an indentation. You can use it to change the value of the assigned parameter.

Glitch positive trigger

Triggering occurs if the oscilloscope detects positive spike widths less than the specified glitch time.

Glitch negative trigger

Triggering occurs if the oscilloscope detects negative spike widths less than the specified glitch time.

Glitch either trigger

Triggering occurs if the oscilloscope detects either positive or negative spike widths less than the specified glitch time.

GPIB (General Purpose Interface Bus)

An interconnection bus and protocol that allows you to connect multiple instruments in a network under the control of a controller. Also known as IEEE 488 bus. It transfers data with eight parallel data lines, five control lines, and three handshake lines.

Graticule

A grid on the display screen that creates the horizontal and vertical axes. You can use it to visually measure waveform parameters.

Ground (GND) coupling

Coupling option that disconnects the input signal from the vertical system.

Hardcopy

An electronic copy of the display in a format useable by a printer or plotter.

Hi Res acquisition mode

An acquisition mode in which the digitizing oscilloscope averages all samples taken during an acquisition interval to create a record point. That average results in a higher-resolution, lower-bandwidth waveform. That mode only works with real-time, non-interpolated sampling.

High

The value used as 100% in automated measurements (whenever high ref, mid ref, and low ref values are needed as in fall time and rise time measurements). May be calculated using either the min/max or the histogram method. With the min/max method (most useful for general waveforms), it is the maximum value found. With the histogram method (most useful for pulses), it refers to the most common value found above the mid point. See *Appendix C: Algorithms* for details.

Holdoff, trigger

A specified amount of time after a trigger signal that elapses before the trigger circuit will accept another trigger signal. That helps ensure a stable display.

**Horizontal bar cursors**

The two horizontal bars that you position to measure the voltage parameters of a waveform. The oscilloscope displays the value of the active (moveable) cursor with respect to ground and the voltage value between the bars.

Interpolation

The way the digitizing oscilloscope calculates values for record points when the oscilloscope cannot acquire all the points for a complete record with a single trigger event. That condition occurs when the oscilloscope is limited to real time sampling and the time base is set to a value that exceeds the effective sample rate of the oscilloscope. The digitizing oscilloscope has two interpolation options: *linear* or *sin(x)/x interpolation*.

Linear interpolation calculates record points in a straight-line fit between the actual values acquired. Sin(x)/x computes record points in a curve fit between the actual values acquired. It assumes all the interpolated points fall in their appropriate point in time on that curve.

Intensity

Display brightness.

Interleaving

The way the digitizing oscilloscope attains high digitizing speeds by combining the efforts of several channels' digitizers. For example, if you want to digitize on all channels at one time (four on the TDS 540 and two on the TDS 520), each of those channels can digitize at a maximum real-time speed of 250 megasamples per second.

Knob

A rotary control.

**Logic state trigger**

The oscilloscope checks for defined combinatorial logic conditions on channels 1, 2, and 3 on a transition of channel 4 that meets the set slope and threshold conditions. If the conditions of channels 1, 2, and 3 are met then the oscilloscope triggers.

**Logic pattern trigger**

The oscilloscope triggers depending on combinatorial logic the condition of channels 1, 2, 3, and 4. Allowable conditions are AND, OR, NAND, NOR.

**Low**

The value used as 0% in automated measurements (whenever high ref, mid ref, and low ref values are needed as in fall time and rise time measurements). May be calculated using either the min/max or the histogram method. With the min/max method (most useful for general waveforms), it is the minimum value found. With the histogram method (most useful for pulses), it refers to the most common value found below the mid point. See *Appendix C: Algorithms* for details.

Main menu

A group of related controls for a major oscilloscope function that the oscilloscope displays across the bottom of the screen.

Main menu buttons

Bezel buttons under the main menu display. They allow you to select items in the main menu.

**Maximum**

Amplitude (voltage) measurement of the maximum amplitude. Typically the most positive peak voltage.

**Mean**

Amplitude (voltage) measurement of the arithmetic mean over the entire waveform.

**Minimum**

Amplitude (voltage) measurement of the minimum amplitude. Typically the most negative peak voltage.

**NAND**

A logic (Boolean) function in which the output of the AND function is complemented (true becomes false, and false becomes true). On the digitizing oscilloscope, that is a trigger logic pattern and state function.

**Negative duty cycle**

A timing measurement representing the ratio of the negative pulse width to the signal period, expressed as a percentage.

**Negative overshoot measurement**

Amplitude (voltage) measurement.

$$\text{NegativeOvershoot} = \frac{\text{Low} - \text{Min}}{\text{Amplitude}} \times 100\%$$

**Negative width**

A timing measurement of the distance (time) between two amplitude points—falling-edge *MidRef* (default 50%) and rising-edge *MidRef* (default 50%)—on a negative pulse.

Normal trigger mode

A mode on which the oscilloscope does not acquire a waveform record unless a valid trigger event occurs. It waits for a valid trigger event before acquiring waveform data.

**NOR**

A logic (Boolean) function in which the output of the OR function is complemented (true becomes false, and false becomes true). On the digitizing oscilloscope, that is a trigger logic pattern and state function.

**OR**

A logic (Boolean) function in which the output is true if any of the inputs are true. Otherwise the output is false. On the digitizing oscilloscope, that is a trigger logic pattern and state function.

Oscilloscope

An instrument for making a graph of two factors. These are typically voltage versus time.

**Peak Detect acquisition mode**

A mode in which the oscilloscope saves the minimum and maximum samples over two adjacent acquisition intervals. For many glitch-free signals, that mode is indistinguishable from the sample mode. (Peak detect mode works with real-time, non-interpolation sampling only.)

**Peak-to-Peak**

Amplitude (voltage) measurement of the absolute difference between the maximum and minimum amplitude.

**Period**

A timing measurement of the time covered by one complete signal cycle. It is the reciprocal of frequency and is measured in seconds.

**Phase**

A timing measurement between two waveforms of the amount one leads or lags the other in time. Phase is expressed in degrees, where 360° Waveforms measured should be of the same frequency or one waveform should be a harmonic of the other.

Pixel

A visible point on the display. The oscilloscope display is 640 pixels wide by 480 pixels high.

Pop-up Menu

A sub-menu of a main menu. Pop-up menus temporarily occupy part of the waveform display area and are used to present additional choices associated with the main menu selection. You can cycle through the options in a pop-up menu by repeatedly pressing the main menu button underneath the pop-up.

**Positive duty cycle**

A timing measurement of the ratio of the positive pulse width to the signal period, expressed as a percentage.

**Positive overshoot**

Amplitude (voltage) measurement.

$$\text{PositiveOvershoot} = \frac{\text{Max} - \text{High}}{\text{Amplitude}} \times 100\%$$

**Positive width**

A timing measurement of the distance (time) between two amplitude points—rising-edge *MidRef* (default 50%) and falling-edge *MidRef* (default 50%)—on a positive pulse.

Posttrigger

The specified portion of the waveform record that contains data acquired after the trigger event.

Pretrigger

The specified portion of the waveform record that contains data acquired before the trigger event.

Probe

An oscilloscope input device.

Quantizing

The process of converting an analog input that has been sampled, such as a voltage, to a digital value.

Probe compensation

Adjustment that improves low-frequency response of a probe.

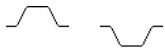
**Pulse trigger**

A trigger mode in which triggering occurs if the oscilloscope finds a pulse, of the specified polarity, with a width between, or optionally outside, the user-specified lower and upper time limits.

Real-time sampling

A sampling mode where the digitizing oscilloscope samples fast enough to completely fill a waveform record from a single trigger event. Use real-time sampling to capture single-shot or transient events.

Record length

The specified number of samples in a waveform.

Reference memory

Memory in a oscilloscope used to store waveforms or settings. You can use that waveform data later for processing. The digitizing oscilloscope saves the data even when the oscilloscope is turned off or unplugged.

**Rise time**

The time it takes for a leading edge of a pulse to rise from a *LowRef* value (typically 10%) to a *HighRef* value (typically 90%) of its amplitude.

**RMS**

Amplitude (voltage) measurement of the true Root Mean Square voltage.

Runt trigger

A mode in which the oscilloscope triggers on a runt. A runt is a pulse that crosses one threshold but fails to cross a second threshold before recrossing the first. The crossings detected can be positive, negative, or either.

**Sample acquisition mode**

The oscilloscope creates a record point by saving the first sample during each acquisition interval. That is the default mode of the acquisition.

Sample interval

The time interval between successive samples in a time base. For real-time digitizers, the sample interval is the reciprocal of the sample rate. For equivalent-time digitizers, the time interval between successive samples represents equivalent time, not real time.

Sampling

The process of capturing an analog input, such as a voltage, at a discrete point in time and holding it constant so that it can be quantized. Two general methods of sampling are: *real-time sampling* and *equivalent-time sampling*.

Selected waveform

The waveform on which all measurements are performed, and which is affected by vertical position and scale adjustments. The light over one of the channel selector buttons indicates the current selected waveform.

Side menu

Menu that appears to the right of the display. These selections expand on main menu selections.

Side menu buttons

Bezel buttons to the right of the side menu display. They allow you to select items in the side menu.

Slope

The direction at a point on a waveform. You can calculate the direction by computing the sign of the ratio of change in the vertical quantity (Y) to the change in the horizontal quantity. The two values are rising and falling.

Tek Secure

This feature erases all waveform and setup memory locations (setup memories are replaced with the factory setup). Then it checks each location to verify erasure. This feature finds use where this digitizing oscilloscope is used to gather security sensitive data, such as is done for research or development projects.

Time base

The set of parameters that let you define the time and horizontal axis attributes of a waveform record. The time base determines when and how long to acquire record points.

Toggle button

A button that changes which of the two cursors is active.

Trigger

An event that marks time zero in the waveform record. It results in acquisition and display of the waveform.



Trigger level

The vertical level the trigger signal must cross to generate a trigger (on edge mode).



Vertical bar cursors

The two vertical bars you position to measure the time parameter of a waveform record. The oscilloscope displays the value of the active (moveable) cursor with respect to trigger and the time value between the bars.

Waveform

The shape or form (visible representation) of a signal.

Waveform interval

The time interval between record points as displayed.



XY format

A display format that compares the voltage level of two waveform records point by point. It is useful for studying phase relationships between two waveforms.



YT format

The conventional oscilloscope display format. It shows the voltage of a waveform record (on the vertical axis) as it varies over time (on the horizontal axis).



Numbers

- 1/seconds (Hz), Cursor menu, 3-24
- 100 MHz, Vertical menu, 3-126
- 20 MHz, Vertical menu, 3-126

A

- AC coupling, 2-5, G-1
- AC line voltage, trigger input, 2-3
- AC, Main Trigger menu, 3-37
- Accept Glitch, Main Trigger menu, 3-102
- Accessories, A-1–A-8
 - Optional, A-4
 - Probes, A-3, A-5–A-8
 - Software, A-7–A-8
 - Standard, A-3, A-6, A-7
- Accuracy, G-1
- Acquire menu, 3-14, 3-53
 - Average, 3-15
 - Average mode, 3-53
 - Compare Ch1 to, 3-55
 - Compare Ch2 to, 3-55
 - Create Limit Test Template, 3-53
 - Envelope, 3-15
 - H Limit, 3-54
 - Hardcopy if Condition Met, 3-55
 - Hi Res, 3-15
 - Limit Test, 3-56
 - Limit Test Condition Met, 3-56
 - Limit Test Setup, 3-55, 3-56
 - Limit Test Sources, 3-55
 - Mode, 3-15
 - OFF (Real Time Only), 3-15
 - OK Store Template, 3-54
 - ON (Enable ET), 3-15
 - Peak Detect, 3-15
 - Repetitive Signal, 3-15
 - Ring Bell if Condition Met, 3-55
 - RUN/STOP, 3-16
 - Sample, 3-15
 - Single Acquisition Sequence, 3-16
 - Stop After, 3-15, 3-56
 - Stop After Limit Test Condition Met, 3-55
 - Template Source, 3-53
 - V Limit, 3-54
- ACQUIRE MENU button, 3-14, 3-53
- Acquisition, 2-7–2-12, 3-18, G-1
 - Interval, G-1
 - Modes
 - Average, 3-14
 - Envelope, 3-13
 - Hi Res, 3-13
 - Peak detect, 3-11
 - Sample, 3-11
 - Readout, 3-14
- Active cursor, G-1
- Active voltage probes, 3-94–3-95
- active, Saved waveform status, 3-112
- Algorithms, A-25–A-38
- Aliasing, 2-15, G-1
- Amplitude, 3-66, G-1
- AND, G-1
- AND, Main Trigger menu, 3-62, 3-65
- Area, 3-66, G-1
- Attenuation, G-2
- Auto, Main Trigger menu, 3-39, 3-62, 3-101
- Automated Measurements, Snapshot of, 1-16
- Automated measurements, 1-12, 2-19, 3-66
- Automatic trigger mode, 2-3, G-2
- Autoset, 1-5, 2-16, 3-18–3-19, G-2
- AUTOSET button, 1-6, 3-18, 3-84, 3-117
- Auxiliary trigger, 2-3
- Average acquisition mode, 3-14, G-2
- Average mode, Acquire menu, 3-53
- Average, Acquire menu, 3-15

B

- Bandwidth, v, 2-11, G-2
- Bandwidth, Vertical menu, 3-126
- Bayonet ground assembly, A-6
- Before you begin, x
- BMP, 3-40
- BMP, Hardcopy menu, 3-41
- Burst width, 3-66
- Button
 - ACQUIRE MENU, 3-14, 3-53
 - AUTOSET, 1-6, 2-15, 3-18, 3-84, 3-117
 - CLEAR MENU, 1-4, 1-13, 1-14, 3-2, 3-7, 3-75
 - CURSOR, 2-18, 3-22
 - DELAYED TRIG, 2-6, 3-28
 - DISPLAY, 3-31
 - FORCE TRIG, 3-121
 - HARDCOPY, 3-41, 3-108
 - HELP, 3-48
 - HORIZONTAL MENU, 2-6, 3-26
 - MEASURE, 3-69
 - MORE, 3-113, 3-115, 3-127
 - ON/STBY, ix, 3-2
 - Save/recall SETUP, 1-2, 3-110
 - Save/recall WAVEFORM, 3-112
 - SET LEVEL TO 50%, 3-121
 - SINGLE TRIG, 3-16, 3-121
 - STATUS, 3-119
 - TOGGLE, 2-18, 3-23, G-10
 - TRIGGER MENU, 3-36, 3-60, 3-101, 3-103, 3-123
 - UTILITY, 3-41, 3-108
 - VERTICAL MENU, 1-9
 - WAVEFORM OFF, 1-11, 3-35, 3-116
 - ZOOM, 2-16, 3-130
- Buttons
 - CH1, CH2 ..., 3-115
 - Channel selection, 1-8, 3-115
 - Main menu, 3-2
 - Side menu, 3-2

C

Cables, 3-107, 3-108

Cal Probe, Vertical menu, 3-84

Cart, Oscilloscope, A-1

CAUTION
statement in manuals, *vi*
statement on equipment, *vi*

Centronics, **Port** (optional), 3-41, 3-44, 3-106

Certificate of Calibration and Test Data Report, A-3

CH1, CH2 ... buttons, 3-115

Ch1, Ch2 ..., Delayed Trigger menu, 3-29

Ch1, Ch2 ..., Main Trigger menu, 3-36, 3-61, 3-62, 3-64, 3-101, 3-103

Change Math waveform definition, More menu, 3-128

Channel, 3-115–3-116, G-2
Readout, 3-5, 3-115
Reference indicator, 3-5
Selection buttons, 1-8, 3-115
Trigger input, 2-2–2-6

Channel readout, 3-5

Channel reference indicator, G-2

Circuit loading, G-2

Class, Main Trigger menu, 3-60, 3-101, 3-103

CLEAR MENU button, 1-4, 1-13, 1-14, 3-2, 3-7, 3-75

Compact-to-miniature probe tip adapter, 3-82, A-6

Compare Ch1 to, Acquire menu, 3-55

Compare Ch2 to, Acquire menu, 3-55

Compensation, 3-90

Configure, Utility menu, 3-41, 3-108

Connector
BNC, A-6
GPIB, 3-4, 3-107

Contrast, Display menu, 3-32

Conventions, ii

Coupling, 1-9
AC, 2-5
DC, 2-5

Ground, G-4

Input Signal, 2-11–2-12

Trigger, 2-5

Coupling, Delayed Trigger menu, 3-29

Coupling, Main Trigger menu, 3-37

Coupling, Vertical menu, 3-125

Create Limit Test Template, Acquire menu, 3-53

Create Measrmt, Measure Delay menu, 3-75

Cross Hair, Display menu, 3-34

Current probes, 3-95

Cursor
Horizontal bar, 2-18, 3-20
Measurements, 2-18
Mode, 2-18–2-19
Independent, 2-18–2-19
Tracking, 2-19
Paired, 2-18, 3-20
Vertical bar, 2-18, 3-20

CURSOR button, 3-22

Cursor menu, 3-22
1/seconds (Hz), 3-24
Function, 3-22, 3-23
H Bars, 3-22, 3-23
Independent, 3-23
seconds, 3-24
Time Units, 3-24
Tracking, 3-23

Cursor readouts, 3-21

Cursor speed, 3-24

Cursors, 2-18, 3-20–3-24, G-2

Cycle area, 3-66, G-3

Cycle mean, 3-66, G-3

Cycle RMS, 3-66, G-3

D

DANGER, statement on equipment, *vi*

Date/Time
On hardcopies, 3-43
To set, 3-43

DC coupling, 2-5, G-3

DC, Main Trigger menu, 3-37

Define Inputs, Main Trigger menu, 3-62, 3-64

Define Logic, Main Trigger menu, 3-62, 3-65

Delay by Events, Delayed Trigger menu, 3-28

Delay by Time, Delayed Trigger menu, 3-28

Delay by, Delayed Trigger menu, 3-28

Delay measurement, 3-73, G-3

Delay time, G-3

Delay To, Measure Delay menu, 3-73

Delayed Only, Horizontal menu, 3-26

Delayed Runs After Main, 2-6

Delayed Runs After Main, Horizontal menu, 3-26, 3-51

Delayed Scale, Horizontal menu, 3-51

DELAYED TRIG button, 2-6, 3-28

Delayed trigger, 2-6, 3-25–3-30

Delayed Trigger menu, 3-28–3-30
Ch1, Ch2 ..., 3-29
Coupling, 3-29
Delay by, 3-28
Delay by Events, 3-28
Delay by Time, 3-28
Falling edge, 3-29
Level, 3-29
Rising edge, 3-29
Set to 50%, 3-30
Set to ECL, 3-29
Set to TTL, 3-29
Slope, 3-29
Source, 3-29

Delayed Triggerable, 2-6

Delayed Triggerable, Horizontal menu, 3-28, 3-51

Delete Refs, Save/Recall Waveform menu, 3-113

Deskjet, 3-40

Deskjet, Hardcopy menu, 3-41

Differences – TDS 520 and TDS 540, *v*

Differential active probes, 3-94

Digitizing, G-3

Digitizing rate, *v*

Display, 3-5, 3-18
Options, 3-31–3-35
Record View, 3-122
System, G-3

Display 'T' @ Trigger Point, Display menu, 3-32

DISPLAY button, 3-31

Display menu, 3-31
Contrast, 3-32
Cross Hair, 3-34
Display 'T' @ Trigger Point, 3-32
Dots, 3-31
Dots style, 3-54
Filter, 3-33
Format, 3-34
Frame, 3-34
Full, 3-34
Graticule, 3-34
Grid, 3-34
Infinite Persistence, 3-32
Intensified Samples, 3-31
Intensity, 3-32
Linear interpolation, 3-33
Overall, 3-32
Readout, 3-32
Sin(x)/x interpolation, 3-33
Style, 3-31
Text/Grat, 3-32
Trigger Bar, 3-33
Variable Persistence, 3-32
Vectors, 3-31
Waveform, 3-32
XY, 3-34
YT, 3-34

Dots, 3-31

Dots style, Display menu, 3-54

Dots, Display menu, 3-31

Dual Wfm Math, More menu, 3-128

Dual-lead adapter, 3-83

Duty cycle, 1-13, G-6, G-7

E

Edge trigger, 2-3, 3-36, G-3
Readout, 3-36, 3-59

Edge, Main Trigger menu, 3-36, 3-123

Edges, Measure Delay menu, 3-74

Either, Main Trigger menu, 3-102, 3-103

empty, Saved waveform status, 3-112

Encapsulated Postscript, 3-40

Envelope acquisition mode, 3-13, G-3

Envelope, Acquire menu, 3-15

EPS Color, Hardcopy menu, 3-41

EPS Image, Hardcopy menu, 3-41

EPS Mono, Hardcopy menu, 3-41
Epson, 3-40

Epson, Hardcopy menu, 3-41

Equivalent-time sampling, 2-9

Equivalent-time sampling, random, G-3

F

Factory initialization settings, A-41–A-44

factory, Saved setup status, 3-110

Fall time, 3-67, G-4

Falling edge, Delayed Trigger menu, 3-29

Falling edge, Main Trigger menu, 3-38, 3-64

Filter, Display menu, 3-33

Fine Scale, Vertical menu, 3-126

Firmware version, 3-119

Fixtured active probes, 3-94

FORCE TRIG button, 3-121

Format, Display menu, 3-34

Format, Hardcopy menu, 3-41

Frame, Display menu, 3-34

Frequency, 1-13, 3-67, G-4

Front panel, 3-3

Full, Display menu, 3-34

Full, Vertical menu, 3-126

Function, Cursor menu, 3-22, 3-23

Fuse, *viii*, 3-4

G

Gated Measurements, 3-71, G-4

Gating, Measure menu, 3-71

General purpose (high input resistance) probes, 3-92

General purpose knob, 1-14, 3-6, G-4

Glitch trigger, 3-99, 3-100, G-4

Glitch, Main Trigger menu, 3-101, 3-102

Goes FALSE, Main Trigger menu, 3-61

Goes TRUE, Main Trigger menu, 3-61

GPIB, 3-4, 3-106–3-109, G-4

GPIB, Hardcopy menu, 3-41

GPIB, Utility menu, 3-108

Graticule, 3-34, G-4
Measurements, 2-17

Graticule, Display menu, 3-34

Grid, Display menu, 3-34

Ground coupling, G-4

Ground lead inductance, 3-77

I/O, Status menu, 3-119

H

H Bars, Cursor menu, 3-22, 3-23

H Limit, Acquire menu, 3-54

Hardcopy, 3-40–3-47, G-4

Hardcopy (Talk Only), Utility menu, 3-41

HARDCOPY button, 3-41, 3-108

Hardcopy if Condition Met, Acquire menu, 3-55

Hardcopy Interface, Optional RS-232/Centronic, A-2

Hardcopy menu
BMP, 3-41
Clear Spool, 3-41
Deskjet, 3-41
EPS Color, 3-41
EPS Image, 3-41
EPS Mono, 3-41
EPS PCX, 3-41
Epson, 3-41
Format, 3-41
GPIB, 3-41
HPGL, 3-41
Interleaf, 3-41

Landscape, 3-41
Laserjet, 3-41
Layout, 3-41
Port, 3-41
Portrait, 3-41
Thinkjet, 3-41
TIFF, 3-41
Hardcopy, Utility menu, 3-108
HELP button, 3-48
 Help system, 3-48
HF Rej, Main Trigger menu, 3-37
 Hi Res acquisition mode, 3-13, G-4
Hi Res, Acquire menu, 3-15
 High, 3-67, G-5
 High frequency rejection, 2-5
High Ref, Measure menu, 3-73
 High speed active probes, 3-94
 High voltage probes, 3-93–3-94
High-Low Setup, Measure menu, 3-72
Histogram, Measure menu, 3-72
Holdoff, Main Trigger menu, 3-62, 3-101
 Holdoff, trigger, 2-4, G-5
Horiz Pos, Horizontal menu, 3-51
Horiz Scale, Horizontal menu, 3-51
 Horizontal, 3-18
 Bar cursors, 2-18, 3-20, G-5
 Control, 3-49–3-52
 Menu, 2-6
 Position, 3-49
 POSITION knob, 2-14
 Readouts, 3-50
 Scale, 3-49
 SCALE knob, 1-5, 2-14
 System, 1-5, 2-14
 Horizontal menu, 3-26
 Delayed Only, 3-26
 Delayed Runs After Main, 3-26, 3-51
 Delayed Scale, 3-51
 Delayed Triggerable, 3-28, 3-51
 Horiz Pos, 3-51
 Horiz Scale, 3-51
 Intensified, 3-26, 3-28
 Main Scale, 3-51
 Record Length, 3-51
 Set to 10%, 3-51
 Set to 50%, 3-51

Set to 90%, 3-51
 Time Base, 3-26, 3-50
 Trigger Position, 3-51
HORIZONTAL MENU button, 2-6, 3-26

Horizontal **POSITION** knob, 3-49
 Horizontal Readouts, 3-50
 Horizontal **SCALE** knob, 3-49
 HPGL, 3-40
HPGL, Hardcopy menu, 3-41

I

I/O, Utility menu, 3-41, 3-108
 IC protector tip, 3-82
 Icons, v
 Independent Mode, Cursor, 2-18–2-19
Independent, Cursor menu, 3-23
Infinite Persistence, Display menu, 3-32
 Installation, viii–ix
Intensified Samples, Display menu, 3-31
Intensified, Horizontal menu, 3-26, 3-28
 Intensity, 3-32, G-5
Intensity, Display menu, 3-32
 Interleaf, 3-40
Interleaf, Hardcopy menu, 3-41
 Interleaving, 2-8, G-5
 Interpolation, 2-9, 3-33, G-5

K

Keypad, 1-15, 3-6
 Knob, G-5
 General purpose, 1-14, 3-6, G-4
 Horizontal **POSITION**, 1-5, 2-14, 3-49
 Horizontal **SCALE**, 1-5, 2-14, 3-49
 MEASURE, 2-19
 Trigger **MAIN LEVEL**, 1-6, 2-6

Vertical **POSITION**, 1-5, 2-14, 3-124
 Vertical **SCALE**, 1-5, 2-14, 3-124

L

Landscape, Hardcopy menu, 3-41
 Laserjet, 3-40
Laserjet, Hardcopy menu, 3-41
Layout, Hardcopy menu, 3-41
Level, Delayed Trigger menu, 3-29
Level, Main Trigger menu, 3-38, 3-102, 3-105
 Level, Trigger, 2-6
LF Rej, Main Trigger menu, 3-37
Limit Test Condition Met, Acquire menu, 3-56
Limit Test Setup, Acquire menu, 3-55, 3-56
Limit Test Sources, Acquire menu, 3-55
Limit Test, Acquire menu, 3-56
 Limit testing, 3-53–3-57
 Linear interpolation, 2-9, 3-33, G-5
Linear interpolation, Display menu, 3-33
 Logic trigger, 2-3, 3-60
 Definitions, 3-60
 Pattern, 3-59, G-6
 State, 3-59, G-5
 Logic triggering, 3-58–3-65
Logic, Main Trigger menu, 3-123
 Long ground leads, 3-80
 Low, 3-67, G-6
 Low frequency rejection, 2-5
 Low impedance Z_0 probes, 3-92
Low Ref, Measure menu, 3-73
 Low-inductance ground lead, 3-80
 Low-inductance spring-tips, 3-81, A-6

M

Main menu, G-6

Main menu buttons, 3-2, G-6

Main Scale, Horizontal menu, 3-51

Main Trigger Menu

Falling edge, 3-38

Rising edge, 3-38

Main Trigger menu, 3-9, 3-36, 3-60,
3-101, 3-103, 3-123

AC, 3-37

Accept Glitch, 3-102

AND, 3-62, 3-65

Auto, 3-39, 3-62, 3-101

Ch1, Ch2 ..., 3-36, 3-61, 3-62,
3-64, 3-101, 3-103

Class, 3-60, 3-101, 3-103

Coupling, 3-37

DC, 3-37

Define Inputs, 3-62, 3-64

Define Logic, 3-62, 3-65

Edge, 3-36, 3-123

Either, 3-102, 3-103

Falling edge, 3-64

Glitch, 3-101, 3-102

Goes FALSE, 3-61

Goes TRUE, 3-61

HF Rej, 3-37

Holdoff, 3-62, 3-101

Level, 3-38, 3-102, 3-105

LF Rej, 3-37

Mode & Holdoff, 3-39, 3-62, 3-101

NAND, 3-62, 3-65

Negative, 3-102, 3-103

Noise Rej, 3-37

NOR, 3-62, 3-65

Normal, 3-39, 3-62, 3-101

OR, 3-62, 3-65

Pattern, 3-60

Polarity, 3-103

Polarity and Width, 3-102

Positive, 3-102, 3-103

Pulse, 3-101, 3-103, 3-123

Reject Glitch, 3-102

Rising edge, 3-64

Runt, 3-103

Set Thresholds, 3-61

Set to 50%, 3-38, 3-103, 3-121

Set to ECL, 3-38, 3-102

Set to TTL, 3-38, 3-102

Slope, 3-38

Source, 3-36, 3-101, 3-103

State, 3-60, 3-64

Thresholds, 3-103

Trigger When, 3-61, 3-63

True for less than, 3-63

True for more than, 3-63

Type, 3-36, 3-101, 3-103, 3-123

Width, 3-102

Marker rings, 3-80, A-6

Math Waveform

Differential, A-2

FFT, A-2

Integral, A-2

Optional Advanced, A-2

Math waveforms, 3-127

Math1/2/3, More menu, 3-127

Maximum, 3-67, G-6

Mean, 3-67, G-6

MEASURE button, 3-69

Measure Delay menu

Create Measrmnt, 3-75

Delay To, 3-73

Edges, 3-74

Measure Delay To, 3-73

OK Create Measurement, 3-75

Measure Delay To, Measure Delay
menu, 3-73

Measure menu, 3-9, 3-69, 3-75

Gating, 3-71

High Ref, 3-73

High-Low Setup, 3-72

Histogram, 3-72

Low Ref, 3-73

Mid Ref, 3-73

Mid2 Ref, 3-73

Min-Max, 3-72

Reference Levels, 3-72

Remove Measrmnt, 3-70, 3-76

Select Measrmnt, 3-69, 3-73

Set Levels in % units, 3-72

Snapshot, 3-75

Measurement

Amplitude, 3-66, G-1

Area, 3-66, G-1

Burst width, 3-66, G-2

Cycle area, 3-66, G-3

Cycle mean, 3-66, G-3

Cycle RMS, 3-66, G-3

Delay, 3-73, G-3

Duty cycle, 1-13, G-6, G-7

Fall time, 3-67

Frequency, 1-13, 3-67, G-4

Gated, G-4

High, 3-67, G-5

Low, 3-67, G-6

Maximum, 3-67, G-6

Mean, 3-67, G-6

Minimum, 3-67, G-6

Negative duty cycle, 3-67

Negative overshoot, 3-67

Negative width, 3-67

Overshoot, G-8

Peak to peak, 3-67, G-7

Period, 3-68, G-7

Phase, 3-67, G-7

Positive duty cycle, 3-68

Positive overshoot, 3-68

Positive width, 3-68

Propagation delay, 3-67

Readout, 3-69

Reference levels, 1-14

Rise time, 1-13, 3-68, G-8

RMS, 3-68, G-8

Undershoot, G-6

Width, 1-13, G-6, G-8

Measurements, 2-17–2-20, 3-66–3-76

Algorithms, A-25–A-38

Automated, 1-12, 2-19

Cursor, 2-18, 3-20

Gated, 3-71

Graticule, 2-17

Snapshot of, 3-75

Measurement Accuracy, Ensuring
maximum, 3-84–3-89,
3-117–3-118

Memory, Waveform, 3-113

Menu

Acquire, 3-14, 3-53

Cursor, 3-22

Delayed Trigger, 3-28–3-30

Display, 3-31

Horizontal, 2-6, 3-26

Main, 3-5

Main Trigger, 3-9, 3-36, 3-60,
3-101, 3-103, 3-123

Measure, 3-9, 3-69, 3-75

More, 3-9, 3-113, 3-127

Operation, 3-6

Pop-up, 3-7, G-7

Pulse trigger, 3-9

Save/Recall, 3-110

Save/Recall Setup, 3-9

Save/Recall Waveform, 3-9, 3-112

Setup, 1-2

Status, 3-9, 3-119

Utility, 3-10, 3-40, 3-108

Mid Ref, Measure menu, 3-73

Mid2 Ref, Measure menu, 3-73

Min-Max, Measure menu, 3-72

Minimum, 3-67, G-6

Mode, Cursor, 2-18–2-19

Mode & Holdoff, Main Trigger menu, 3-39, 3-62, 3-101

Mode, Acquire menu, 3-15

Model number location, 3-2

MORE button, 3-54, 3-113, 3-115, 3-127

More menu, 3-9, 3-113, 3-127

Change Math waveform definition, 3-128

Dual Wfm Math, 3-128

Math1/2/3, 3-127

OK Create Math Waveform, 3-128

Reference waveform status, 3-113

Set 1st Source to, 3-129

Set 2nd Source to, 3-129

Set Function to, 3-128

Set operator to, 3-129

Set Single Source to, 3-128

Single Wfm Math, 3-128

N

NAND, G-6

NAND, Main Trigger menu, 3-62, 3-65

Negative duty cycle, 3-67

Negative overshoot, 3-67

Negative width, 3-67

Negative, Main Trigger menu, 3-102, 3-103

Noise Rej, Main Trigger menu, 3-37

NOR, G-7

NOR, Main Trigger menu, 3-62, 3-65

Normal trigger mode, 2-3, G-7

Normal, Main Trigger menu, 3-39, 3-62, 3-101

O

OFF (Real Time Only), Acquire menu, 3-15

Off Bus, Utility menu, 3-108

Offset, Vertical, 2-14, 3-126

Offset, Vertical menu, 3-126

OK Create Math Wfm, More menu, 3-128

OK Create Measurement, Measure Delay menu, 3-75

OK Erase Ref & Panel Memory, Utility menu, 3-111

OK Store Template, Acquire menu, 3-54

ON (Enable ET), Acquire menu, 3-15

ON/STBY button, ix, 3-2

Optical probes, 3-96

Options, A-1–A-8

OR, G-7

OR, Main Trigger menu, 3-62, 3-65

Oscilloscope, G-7

Overall, Display menu, 3-32

Overshoot, G-8

P

Packaging, A-39

Paired cursor, 2-18, 3-20

Passive voltage probes, 3-92–3-93

Pattern trigger, 3-58, 3-62

Pattern, Main Trigger menu, 3-60

PCX, 3-40

PCX, Hardcopy menu, 3-41

Peak detect acquisition mode, 3-11, G-7

Peak Detect, Acquire menu, 3-15

Peak to peak, 3-67, G-7

Period, 3-68, G-7

Persistence, 3-32

Phase, 3-67, G-7

Pixel, G-7

Plotter, HC100, A-2

Polarity and Width, Main Trigger menu, 3-102

Polarity, Main Trigger menu, 3-103

Pop-up menu, 3-7, G-7

Port, Hardcopy menu, 3-41

Port, Utility menu, 3-108

Portrait, Hardcopy menu, 3-41

Position, Vertical, 2-14, 3-124

Position, Vertical menu, 3-126

Positive duty cycle, 3-68

Positive overshoot, 3-68

Positive width, 3-68

Positive, Main Trigger menu, 3-102, 3-103

Postscript, 3-40

Posttrigger, G-8

Power connector, viii

Power cords, A-1

Power off, x

Power on, ix–x

Pretrigger, G-8

Principal power switch, ix, 3-4

Probe accessories

Bayonet ground assembly, A-6

Compact-to-miniature probe tip adapter, 3-82, A-6

Dual-lead adapter, 3-83

IC protector tip, 3-82

Long ground leads, 3-80

Low-inductance ground lead, 3-80

Low-inductance spring-tips, 3-81, A-6

Marker rings, 3-80, A-6

Probe tip-to-chassis adapter, 3-82, A-6

Probe tip-to-circuit board adapters, 3-81

Retractable hook tip, 3-78

SMT KlipChip, 3-81, A-6

Probe Cal, x, 3-84–3-89

Probe tip-to-chassis adapter, 3-82, A-6

Probe tip-to-circuit board adapters, 3-81

Probes

Accessories, 3-78–3-83, A-3, A-5–A-8

Active, A-3

Active voltage, 3-94–3-95

Additional, A-2

By applications, 3-97, 3-98

Compensation, 1-5, 3-90, G-8

Connection, 1-1, 3-77–3-83

Current, 3-95

Definition, G-8

Differential active, 3-94

Fixtured active, 3-94

General purpose (high input resistance), 3-92

- High speed, 3-94
- High voltage, 3-93–3-94
- Low impedance Z_0 , 3-92
- Optical, 3-96
- Passive, 3-90
- Passive voltage, 3-92–3-93
- Selection, 3-92–3-98
- Time-to-voltage converter, 3-96

Propagation delay, 3-67

Pulse trigger, 2-3, 3-99

Pulse Trigger menu, 3-9

Pulse, Main Trigger menu, 3-101, 3-103, 3-123

Q

Quantizing, G-8

R

Rack mounting, A-2

Readout

- Acquisition, 3-14
- Channel, 3-5, 3-115
- Cursors, 3-5
- Edge trigger, 3-36, 3-59
- General purpose knob, 3-5
- Measurement, 2-19, 3-69
- Record view, 3-5
- Snapshot, 3-75
- Time base, 3-5
- Trigger, 3-5, 3-122
- Trigger Level Bar, 3-32
- Trigger Point, 3-32

Readout, Display menu, 3-32

Real time sampling, 2-8

Real-time sampling, G-8

Rear panel, 3-4, 3-108

Recall, Setups, 3-110–3-111

Recall Factory Setup, Save/Recall Setup menu, 3-111

Recall Saved Setup, Save/Recall Setup menu, 3-111

Recalling, Waveforms, 3-112

Record length, v , 2-8, 3-51, A-1, G-8

Record Length, Horizontal menu, 3-51

Record View, 2-13, 3-50, 3-122

Record view, 3-5

Ref1, Ref2, Ref3, Ref4, Reference waveform status, 3-113

Ref1, Ref2, Ref3, Ref4, Save/Recall Waveform menu, 3-113

Reference levels, 1-14, 3-72

Reference Levels, Measure menu, 3-72

Reference memory, G-8

Reject Glitch, Main Trigger menu, 3-102

Remote communication, 3-106–3-109

Remove Measrmt, Measure menu, 3-70, 3-76

Repetitive Signal, Acquire menu, 3-15

Reset Zoom Factors, Zoom menu, 3-132

Retractable hook tip, 3-78

Ring Bell if Condition Met, Acquire menu, 3-55

Rise time, 1-13, 3-68, G-8

Rising edge, Delayed Trigger menu, 3-29

Rising edge, Main Trigger menu, 3-38, 3-64

RMS, 3-68, G-8

RS-232, **Port** (optional), 3-106

RS-232, **Port** (optional), 3-41, 3-44

RUN/STOP, Acquire menu, 3-16

Runt trigger, 3-99, 3-100, 3-103, G-9

Runt, Main Trigger menu, 3-103

S

Safety, *vi*
Symbols, *vi*

Sample acquisition mode, 3-11, G-9

Sample interval, G-9

Sample, Acquire menu, 3-15

Sampling, 2-8, G-9

Sampling and acquisition mode, 2-10

Save, Setups, 3-110–3-111

Save Current Setup, Save/Recall Setup menu, 3-110

Save Waveform, Save/Recall Waveform menu, 3-112

Save/Recall **SETUP** button, 3-110

Save/recall **SETUP** button, 1-2

Save/Recall Setup menu, 3-9, 3-110

- factory** status, 3-110
- Recall Factory Setup**, 3-111
- Recall Saved Setup**, 3-111
- Save Current Setup**, 3-110
- user** status, 3-110

Save/Recall **WAVEFORM** button, 3-112

Save/Recall Waveform menu, 3-9, 3-112

- active** status, 3-112
- Delete Refs**, 3-113
- empty** status, 3-112
- Ref1, Ref2, Ref3, Ref4**, 3-113
- Save Waveform**, 3-112

Saving, Waveforms, 3-112

Saving and recalling setups, 1-18, 3-110

Saving and recalling waveforms, 3-112

seconds, Cursor menu, 3-24

Security bracket, 3-4

Select Measrmt, Measure menu, 3-69, 3-73

Selected waveform, G-9

Selecting channels, 3-115

Self test, x

Set 1st Source to, More menu, 3-129

Set 2nd Source to, More menu, 3-129

Set Function to, More menu, 3-128

SET LEVEL TO 50% button, 3-121

Set Levels in % units, Measure menu, 3-72

Set operator to, More menu, 3-129

Set Single Source to, More menu, 3-128

Set Thresholds, Main Trigger menu, 3-61

Set to 10%, Horizontal menu, 3-51
Set to 50%, Delayed Trigger menu, 3-30
Set to 50%, Horizontal menu, 3-51
Set to 50%, Main Trigger menu, 3-38, 3-103, 3-121
Set to 90%, Horizontal menu, 3-51
Set to ECL, Delayed Trigger menu, 3-29
Set to ECL, Main Trigger menu, 3-38, 3-102
Set to TTL, Delayed Trigger menu, 3-29
Set to TTL, Main Trigger menu, 3-38, 3-102
Set to Zero, Vertical menu, 3-126
Setup menu, 1-2
Setups, Save and recall, 3-110–3-111
Shipping, A-39
Side menu, G-9
Side menu buttons, 3-2, G-9
Signal Path Compensation, *x*, 3-117–3-118
Sin(x)/x interpolation, 2-9, 3-33, G-5
Sin(x)/x interpolation, Display menu, 3-33
Single Acquisition Sequence, Acquire menu, 3-16
SINGLE TRIG button, 3-16, 3-121
Single Wfm Math, More menu, 3-128
Single-shot sampling, 2-8
Slope, G-9
Slope, Delayed Trigger menu, 3-29
Slope, Main Trigger menu, 3-38
Slope, Trigger, 2-6
SMT KlipChip, 3-81, A-6
Snapshot, Readout, 3-75
Snapshot of Measurements, 1-16, 3-75
Snapshot, Measure menu, 3-75
Software, *v*
Software version, 3-119
Source, Delayed Trigger menu, 3-29
Source, Main Trigger menu, 3-36, 3-101, 3-103
Spooler, Hardcopy, 3-42

Start up, *viii*
State trigger, 3-64
State, Main Trigger menu, 3-60, 3-64
STATUS button, 3-119
Status menu, 3-9, 3-119
Firmware version, 3-119
I/O, 3-119
System, 3-119
Trigger, 3-119
Waveforms, 3-119
Stop After Limit Test Condition Met, Acquire menu, 3-55
Stop After, Acquire menu, 3-15, 3-56
Style, Display menu, 3-31
Switch, principal power, *ix*, 3-4
System, Status menu, 3-119
System, Utility menu, 3-41, 3-108

T

Talk/Listen Address, Utility menu, 3-108
TDS 520 and 540 differences, *v*
Tek Secure, 3-111, G-9
Tek Secure Erase Memory, Utility menu, 3-111
Temperature compensation, 3-117–3-118
Template Source, Acquire menu, 3-53
Text/Grat, Display menu, 3-32
Thinkjet, 3-40
Thinkjet, Hardcopy menu, 3-41
Thresholds, Main Trigger menu, 3-103
TIFF, 3-40
TIFF, Hardcopy menu, 3-41
Time base, G-9
Time Base, Horizontal menu, 3-26, 3-50
Time Units, Cursor menu, 3-24
Time-to-voltage converter, 3-96
TOGGLE button, 2-18, 3-23, G-10
Tracking Mode, Cursor, 2-19
Tracking, Cursor menu, 3-23
Trigger, 2-2–2-6, 3-18, G-10
AC Line Voltage, 2-3
Auxiliary, 2-3
Coupling, 2-5
Delay, 2-6
Delayed, 3-25–3-30
Edge, 2-3, 3-36, G-3
Glitch, 3-99, 3-100, G-4
Holdoff, 2-4
Level, 2-6, G-10
Logic, 2-3, 3-58–3-65
Mode, 2-3
Pattern, 3-58, 3-62
Position, 2-5, 3-51
Pulse, 2-3, 3-99
Readout, 3-122
Runt, 3-99, 3-100, 3-103, G-9
Slope, 2-2, 2-6
Source, 2-2
State, 3-64
Status Lights, 3-121
Types, 3-123
Width, 3-99, 3-105
Trigger Bar, 3-5
Trigger Bar Style, Display menu, 3-33
Trigger Level Bar, Readout, 3-32
Trigger **MAIN LEVEL** knob, 1-6, 2-6, 3-120
TRIGGER MENU button, 3-36, 3-60, 3-101, 3-103, 3-123
Trigger Point, Readout, 3-32
Trigger Position, Horizontal menu, 3-51
Trigger Status Lights, 3-121
Trigger When, Main Trigger menu, 3-61, 3-63
Trigger, Status menu, 3-119
True for less than, Main Trigger menu, 3-63
True for more than, Main Trigger menu, 3-63
Type, Main Trigger menu, 3-36, 3-101, 3-103, 3-123

U

Undershoot, G-6

user, Saved setup status, 3-110
UTILITY button, 3-41, 3-108
Utility Menu
 OK Erase Ref & Panel Memory, 3-111
 Tek Secure Erase Memory, 3-111
Utility menu, 3-10, 3-40, 3-108
 Configure, 3-41, 3-108
 GPIB, 3-108
 Hardcopy, 3-108
 Hardcopy (Talk Only), 3-41
 I/O, 3-41, 3-108
 Off Bus, 3-108
 Port, 3-108
 System, 3-41, 3-108
 Talk/Listen Address, 3-108

V

V Limit, Acquire menu, 3-54
Variable Persistence, Display menu, 3-32
Vectors, 3-31
Vectors, Display menu, 3-31
Vertical, 3-18
 Bar cursors, 2-18, 3-20, G-10
 Control, 3-124–3-126
 Offset, 2-14, 3-126
 Position, 2-14, 3-124
 POSITION knob, 2-14
 Readout, 3-124
 Scale, 3-124
 SCALE knob, 1-5, 2-14

 System, 1-5, 2-14
Vertical Menu, **Cal Probe**, 3-84
Vertical menu
 100 MHz, 3-126
 20 MHz, 3-126
 Bandwidth, 3-126
 Coupling, 3-125
 Fine Scale, 3-126
 Full, 3-126
 Offset, 3-126
 Position, 3-126
 Set to Zero, 3-126
VERTICAL MENU button, 1-9
Vertical **POSITION** knob, 3-124
Vertical Readout, 3-124
Vertical **SCALE** knob, 3-124

W

WARNING, statement in manual, vi
Waveform, G-10
 Interval, G-10
 Math, 3-127–3-129
 Off priority, 3-116
Waveform memory, 3-113
WAVEFORM OFF button, 1-11, 3-35, 3-116
Waveform, Display menu, 3-32
Waveforms, Math, 3-127
Waveforms, Status menu, 3-119

Width, 1-13, G-6, G-8
Width trigger, 3-99, 3-105
Width, Main Trigger menu, 3-102

X

XY, Format, 3-34–3-35
XY format, G-10
XY, Display menu, 3-34

Y

YT, Format, 3-34–3-35
YT format, G-10
YT, Display menu, 3-34

Z

Zoom, 3-130–3-132
ZOOM button, 3-130
Zoom feature, 2-16
Zoom menu
 Reset Zoom Factors, 3-132
 Zoom Off, 3-132
Zoom Off, Zoom menu, 3-132

DESCRIPTION

Product Group 55

Effective for All Serial Numbers

Add this insert to page A-17,
Table A-13: Warranted Characteristics–Signal Acquisition System

Name	Description	
Analog Bandwidth, DC-50 Ω Coupled	Volts/Div 1 mV/div	Channel 2 Bandwidth¹ DC – 200 MHz

¹The limits given are for the ambient temperature range of 0°C to +30°C. Reduce the upper bandwidth frequencies by 2.5 MHz for each °C above +30°C.

