

Service Manual



TSG 90 PATHFINDER™ NTSC Signal Generator

070-8706-01

Warning

The servicing instructions are for use by qualified personnel only. To avoid personal injury, do not perform any servicing unless you are qualified to do so. Refer to all safety summaries prior to performing service.

Copyright © Tektronix, Inc. All rights reserved.

Tektronix products are covered by U.S. and foreign patents, issued and pending. Information in this publication supercedes that in all previously published material. Specifications and price change privileges reserved.

Tektronix, Inc., P.O. Box **500, Beaverton, Oregon 97077**

TEKTRONIX and TEK are registered trademarks of Tektronix, Inc.

WARRANTY

Tektronix warrants that this product will be free from defects in materials and workmanship for a period of one (1) year from the date of shipment. If any such product proves defective during this warranty period, Tektronix, at its option, either will repair the defective product without charge for parts and labor, or will provide a replacement in exchange for the defective product.

In order to obtain service under this warranty, Customer must notify Tektronix of the defect before the expiration of the warranty period and make suitable arrangements for the performance of service. Customer shall be responsible for packaging and shipping the defective product to the service center designated by Tektronix, with shipping charges prepaid. Tektronix shall pay for the return of the product to Customer if the shipment is to a location within the country in which the Tektronix service center is located. Customer shall be responsible for paying all shipping charges, duties, taxes, and any other charges for products returned to any other locations.

This warranty shall not apply to any defect, failure or damage caused by improper use or improper or inadequate maintenance and care. Tektronix shall not be obligated to furnish service under this warranty a) to repair damage resulting from attempts by personnel other than Tektronix representatives to install, repair or service the product; b) to repair damage resulting from improper use or connection to incompatible equipment; c) to repair any damage or malfunction caused by the use of non-Tektronix supplies; or d) to service a product that has been modified or integrated with other products when the effect of such modification or integration increases the time or difficulty of servicing the product.

THIS WARRANTY IS GIVEN BY TEKTRONIX WITH RESPECT TO THIS PRODUCT IN LIEU OF ANY OTHER WARRANTIES, EXPRESSED OR IMPLIED. TEKTRONIX AND ITS VENDORS DISCLAIM ANY IMPLIED WARRANTIES OF MERCHANTABILITY OR FITNESS FOR A PARTICULAR PURPOSE. TEKTRONIX' RESPONSIBILITY TO REPAIR OR REPLACE DEFECTIVE PRODUCTS IS THE SOLE AND EXCLUSIVE REMEDY PROVIDED TO THE CUSTOMER FOR BREACH OF THIS WARRANTY. TEKTRONIX AND ITS VENDORS WILL NOT BE LIABLE FOR ANY INDIRECT, SPECIAL, INCIDENTAL, OR CONSEQUENTIAL DAMAGES IRRESPECTIVE OF WHETHER TEKTRONIX OR THE VENDOR HAS ADVANCE NOTICE OF THE POSSIBILITY OF SUCH DAMAGES.

Contents

Warranty	i
List of Figures	iv
List of Tables	iv
Safety Summary	vi
Specifications	1-1
Introduction	1-1
Reference Documentation	1-1
Performance Conditions	1-2
Safety Standards	1-2
Specification Tables	1-3
Waveform Illustrations	1-9
Operating Information	2-1
Controls, Indicators, and Connectors	2-2
Controls	2-2
Shift/Shift Lock	2-2
Lockout	2-3
Bars and Other Signals	2-3
ID On/Off and ID Menu	2-3
ID Edit and ID Position	2-3
Tone On/Off and Tone Menu	2-4
Recall and Store	2-4
Indicators	2-5
Connectors	2-5
Performance Verification and Adjustment Procedures	3-1
Required Test Equipment	3-1
Performance Verification Checklist	3-2
Oscillator Frequency	3-2
Test Signals	3-2
Audio Outputs	3-3
Performance Verification Procedures	3-4
Oscillator Frequency	3-4
Test Signals	3-4
Audio Outputs	3-6
Adjustment Checklist	3-9
Adjustment Procedures	3-10
Maintenance	4-1
Battery Hints	4-1
Preventive Maintenance	4-1
Cleaning	4-1
Static-Sensitive Components	4-2
Troubleshooting Aids	4-2
Foldout Pages	4-2
Diagrams	4-3
Circuit Board Illustrations	4-3
Numbering	4-3

Diagnostics	4-4
Diagnostic Menu	4-4
Corrective Maintenance	4-5
Obtaining Replacement Parts	4-5
Torque Specifications	4-5
Replacing Assemblies	4-5
Back Cover Removal and Replacement	4-5
Connector Panel Removal and Replacement	4-6
Main Board and LCD Removal and Replacement	4-6
Keypad Removal	4-6
Keypad Replacement	4-6
Replaceable Electrical Parts List	5-1
Diagrams/Circuit Board Illustrations	6-1
Replaceable Mechanical Parts List	7-1

List of Figures

Figure 1-1: SMPTE Color Bar Components	1-9
Figure 1-2: 75% Color Bars	1-10
Figure 1-3: Red Field	1-10
Figure 1-4: SIN(X)/X	1-11
Figure 1-5: 5-Step Staircase (Gray Scale)	1-11
Figure 1-6: 0 IRE Flat Field	1-12
Figure 1-7: 50 IRE Flat Field	1-12
Figure 1-8: Black Burst	1-13
Figure 1-9: Field Square Wave	1-13
Figure 1-10: Multiburst	1-14
Figure 1-11: Convergence Components	1-14
Figure 1-12: NTC7 Composite	1-15
Figure 1-13: NTC7 Combination	1-15
Figure 1-14: FCC Composite	1-16
Figure 1-15: Matrix	1-16
Figure 1-16: Safe Area	1-17

List of Tables

Table 1-1: General Video Test Signal Characteristics	1-3
Table 1-2: Video Test Signals	1-4
Table 1-3: Character Identification	1-6

Table 1-4: Audio Tone	1-7
Table 1-5: Power Supply	1-7
Table 1-6: Physical Characteristics	1-7
Table 1-7: Environmental Characteristics	1-8
Table 3-1: Required Test Equipment	3-1

Safety Summary

This summary contains general safety information for operating and servicing personnel. Specific warnings and cautions are given throughout the manual where they apply, but may not appear in this summary.

Terms

In this manual

CAUTION statements identify conditions or practices that can damage the equipment or other property.

WARNING statements identify conditions or practices that can cause injury or loss of life.

As marked on equipment

CAUTION indicates an injury hazard not immediately accessible as one reads the marking, or a hazard to the equipment or other property.

DANGER indicates an injury hazard immediately accessible as one reads the marking.

Symbols

In this manual



This symbol shows where applicable cautionary or other information is to be found.

As marked on equipment



DANGER — High voltage.



Protective ground (earth) terminal.



ATTENTION — refer to manual.

Power Source

This product is intended to operate from a power source that applies no more than 250 volts RMS between the supply conductors or between either supply conductor and ground.

Ground the product

This product is grounded through the grounding conductor of the power module power cord. To avoid electrical shock, plug the power cord into a properly wired receptacle before connecting to the product input or output terminals. A protective ground connection by way of the grounding conductor in the power cord is essential for safe operation.

Danger arising from loss of ground

If the protective connection to ground is lost, all accessible conductive parts (including knobs and controls that may appear to be insulated) can render an electric shock.

Use the proper fuse

Use only the fuse of correct type, voltage rating, and current rating, as specified in the parts list for the product. Refer fuse replacement to qualified personnel.

Do Not operate in an explosive atmosphere

Do not operate this product in an explosive atmosphere unless it has been specifically certified for such operation.

Do Not operate without covers

To avoid injury, do not operate the product without its covers and panels properly installed.

Do Not service alone

Do not service or adjust this product unless another person capable of rendering first aid and cardio-pulmonary resuscitation is present.



Specifications

Specifications

Introduction

The material in this section is organized into two main groupings: the specification tables and the supporting figures. The specification tables include:

- NTSC general signal characteristics and test signal specifications.
- Signal level specifications.
- Power supply, physical, and environmental specifications.

The supporting figures (waveform diagrams and related data) follow the specification tables.

Reference Documentation

The following documents were used as references in the preparation of this specification:

Product Classification Environmental Test Summary, 13 June 1977;
Tektronix Standard 062-2853-00

Electromagnetic Compatibility Environmental Test, 31 March 1977;
Tektronix Standard 062-2866-00

Recommendations and reports of the CCIR, 1978; Transmission of Sound
Broadcasting and Television Signals Over Long Distances (CMTT)

IEEE Standard Dictionary of Electrical Terms, Second Edition (1977); IEEE
Standard 100-1977

Safety Standard for Electrical and Electronic Test, Measuring Controlling
and Related Equipment, February 1988; ANSI/ISA-S82.01

International Electrotechnical Commission Standard "Safety Requirements
for Electronic Measuring Apparatus;" IEC 348

Canadian Standards Association Electrical Standard for Electrical and
Electronic Measuring and Testing Equipment; CAN/CSA C22.2 No. 231

Standard for Electrical and Electronic Measuring and Testing Equipment,
Second Edition, July 21, 1980

Performance Conditions

The Performance Requirements are valid within the environmental limits shown in Table 1–7 if the instrument is calibrated in an ambient temperature of 23° C, after a warm-up time of 20 minutes.

Safety Standards

The following safety standards apply to the TSG 90:

- ANSI/ISA-S82.01
- IEC 348
- CAN/CSA C22.2 No. 231
- UL 1244

NOTE. *Shielded cables were used in the certification of this instrument; therefore, shielded cables are recommended to be used when operating. (EC 92)*

Specification Tables

Table 1–1: General Video Test Signal Characteristics

Characteristic	Performance Requirements	Supplemental Information
Luminance Amplitude Accuracy	$\pm 1\%$ of 714.3 mV (100 ± 1 IRE)	
Chrominance-to-Luminance Gain	$\pm 2\%$ of 714.3 mV (100 ± 2 IRE)	1% typical.
Blanking Level	0 V \pm 50 mV	
Rise Time Accuracy	$\pm 10\%$	Except where otherwise specified
Burst Amplitude	285.7 mV (40 IRE) \pm 2%	
Sync Amplitude	285.7 mV (40 IRE) \pm 2%	
Sync Rise Time	140 ns \pm 20 ns	
Output Impedance		75 Ω
Return Loss		≥ 36 dB at 4.2 MHz
Subcarrier Stability	3.579545 MHz \pm 10 Hz	Over a temperature range of 0 to +45 °C. Annual adjustment required.
Signal-to-Noise Ratio		≥ 60 dB; Signal passed through a continuous random noise measurement low pass filter, $F_c=5$ MHz.
Chrominance-to-Luminance Delay	≤ 15 ns	10 ns typical. Measured with the NTC7 Composite signal.
SCH Phase	$0^\circ \pm 5^\circ$	
Frequency Response	Flat within $\pm 2\%$ to 4.2 MHz	
Field Tilt	$\leq 0.5\%$	
Line Tilt	$\leq 0.5\%$	
5-Step Linearity Error	$\leq 1\%$	Relative step matching.
Differential Gain	$\leq 1\%$	
Differential Phase	$\leq 1^\circ$	
2T Pulse K-Factor	$\leq 0.5\%$	Ringings $\leq 1.5\%$ peak.
Luminance Rise Time	Digitally derived	250 ns \pm 25 ns, except where otherwise specified.
Chrominance Rise Time	Digitally derived	400 ns \pm 40 ns, except where otherwise specified.
Burst Rise Time	Digitally derived	400 ns \pm 40 ns
Line Timing	Digitally derived	See Figures 1–1 through 1–16
Front Porch Duration	Digitally derived	1.5 μ s \pm 0.1 μ s
Line Blanking Interval	Digitally derived	10.9 μ s \pm 0.2 μ s; measured at the 20 IRE point of active video.
Breezeway Duration	Digitally derived	600 ns \pm 100 ns
Line Sync Duration	Digitally derived	4.7 μ s \pm 100 ns (at half-amplitude)
Vertical Serration Duration	Digitally derived	4.7 μ s \pm 100 ns (at half-amplitude)
Equalizing Pulse Duration	Digitally derived	2.3 μ s \pm 100 ns (at half-amplitude)
Burst Delay from Sync Duration	Digitally derived	5.308 μ s \pm 35 ns (19 cycles of subcarrier) 2.51 μ s \pm 0.1 μ s (9 cycles of subcarrier)

Table 1-2: Video Test Signals

Characteristic	Performance Information		
<i>SMPTE Bars</i>	See Figure 1-1		
Rise Times			
Luminance	140 ns ± 25 ns		
Chrominance			
-I	250 ns ± 25 ns		
Q	833 ns ± 80 ns		
Field Timing			
Color Bars	Lines 21-182; See Figure 1-1a		
Reverse Blue Bars	Lines 183-202; See Figure 1-1b		
IYQB	Lines 203-262; See Figure 1-1c		
	Luminance Amplitude (Pedestal, mV)	Subcarrier Amplitude (peak-to-peak, mV)	Subcarrier Phase (degrees)
White	549.1	00.0	00.0
Yellow	492.6	443.3	167.1
Cyan	400.9	626.6	283.5
Green	344.5	585.2	240.7
Magenta	258.2	585.2	60.7
Red	201.7	626.6	103.5
Blue	110.1	443.3	347.1
-I	53.6	285.7	303.0
Q	53.6	285.7	33.0
<i>75% Color Bars</i>	Full Field Color Bars; 75% Amplitude, 7.5% Setup with a 100 IRE White Flag. See Figure 1-2.		
<i>SNG Color Bars (Opt J only)</i> <i>SNB021565 & above</i> <i>Lines 21 - 163</i> <i>Lines 164 - 198</i> <i>Lines 199 - 209</i> <i>Lines 210 - 162</i>	30 IRE Flat Field Color Bars of 0 Setup SMPTE Color Bars IYQB of 0 Setup SMPTE Color Bars 30 IRE Flat Field		
<i>Red Field</i>	See Figure 1-3		
Luminance Pedestal	201.74 mV (28.3 IRE)		
Chrominance Amplitude	626.66 mV _{pp} (87.8 IRE)		
Chrominance Phase	103.5°		
<i>(SIN X)X</i> Spectrum	See Figure 1-4 -3 dB at 4.75 MHz		
<i>5-Step Staircase</i> Amplitude	See Figure 1-5 714.3 mV (100 IRE)		
<i>0 IRE Flat Field (STD only)</i>	See Figure 1-6; 0 mV, no burst		
<i>50 IRE Flat Field</i> Amplitude	See Figure 1-7 357.2 mV		
<i>Black Burst</i> Amplitude	See Figure 1-8 53.57 mV (7.5 IRE)		

Table 1-2: (Cont.) Video Test Signals

Characteristic	Performance Information
<i>Field Square Wave</i>	See Figure 1-9
Field Timing	
Lines (White)	Lines 70–213
Lines at Blanking	All remaining active lines
Amplitude	714.3 mV (100 IRE)
<i>Multiburst</i>	See Figure 1-10
Amplitudes	
White Reference Bar	500 mV (70 IRE)
Packets	428.6 mV _{p-p} (60 IRE), Equal width packets
Pedestal	285.7 mV (40 IRE)
Burst Frequencies	0.5, 1.0, 2.0, 3.0, 3.58, and 4.2 MHz
Packet Rise Time	
0.5 MHz	140 ns typical (sine-squared shaped packets)
All Other Packets	400 ns typical (sine-squared shaped packets)
<i>Convergence</i>	See Figure 1-11
Amplitude	549.3 mV (76.9 IRE)
Pattern	Crosshatch: 14 horizontal lines and 17 vertical lines per field
Pulse HAD	225 ns ± 25 ns
<i>NTC7 Composite</i>	See Figure 1-12
Bar	
Amplitude	714.3 mV (100 IRE)
Rise Time	125 ns ± 25 ns
2T Pulse	
Amplitude	714.3 mV (100 IRE)
HAD	250 ns ± 25 ns
Modulated Sin ² Pulse	
Phase	60.8° ± 1°
Amplitude	714.3 mV (100 IRE), measured at peak amplitude
HAD	1.563 μs ± 150 ns
Modulate 5-Step Staircase	
Luminance	642.9 mV (90 IRE)
Chrominance	285.7 mV (40 IRE)
<i>NTC7 Combination</i>	See Figure 1-13
Multiburst	
Amplitudes	
White Bar	714.3 mV (100 IRE)
Packets	357.2 mV _{p-p} (50 IRE)
Pedestal	357.2 mV (50 IRE)
Burst Frequencies	0.5, 1.0, 2.0, 3.0, 3.58, and 4.2 MHz
Packet Rise Times	
0.5 and 1.0 MHz	140 ns typical (sine-squared shaped packets)

Table 1-2: (Cont.)Video Test Signals

Characteristic	Performance Information
All Other Packets	400 ns typical (sine-squared shaped packets)
Modulated Pedestal	
Pedestal Amplitude	357.2 mV (50 IRE)
Chrominance Amplitudes	142.9 mV (20 IRE), 285.7 mV (40 IRE), and 571.4 mV (80 IRE)
Phase	90°
Rise Time	400 ns ± 40 ns
<i>FCC Composite</i>	See Figure 1-14
Bar	
Amplitude	714.3 mV (100 IRE)
Rise Time	250 ns ± 25 ns
2T Pulse	
Amplitude	714.3 mV (100 IRE)
HAD	250 ns ± 25 ns
Modulated Sin ² Pulse	
Phase	60.8° ± 1°
Amplitude	714.3 mV (100 IRE)
HAD	1.563 μs ± 150 ns
Modulate 5-Step Staircase	
Luminance	571.4 mV (80 IRE)
Chrominance	285.7 mV (40 IRE)
Rise Time	375 ns ± 37.5 ns
<i>Matrix</i>	See Figure 1-15
<i>Safe Area</i>	See Figure 1-16
Amplitude	549.1 mV (76.9 IRE)
Safe Title	
Horizontal Bar	Lines 45 and 238
Vertical Timing	14.925 and 56.525 μs
Safe Action	
Horizontal Bar	Lines 33 and 250
Vertical Timing	12.325 and 59.125 μs

Table 1-3: Character Identification

Characteristic	Information
Number of Characters Displayed	Two lines of up to 16 characters per line
Display Position	Movable over the Safe Action area of the field. The first line may also be displayed in the Vertical Blanking Interval.
Character Amplitude	Black: 53.6 mV (7.5 IRE) White: 642.9 mV (90 IRE)

Table 1-4: Audio Tone

Characteristic	Performance Requirements	Supplemental Information
Amplitude	0, +4, or +8 dBu into 600 Ω	
Amplitude Accuracy	± 0.25 dBu	
Frequency		50, 63, 125, 250, and 400 Hz; 1, 2, 4, 8, 10, 12.5, 16, and 20 kHz; Sweep
Frequency Accuracy		± 0.5 Hz
Sweep		1 kHz for 5 seconds, followed by 0.5 seconds at each of the following frequencies: 50, 63, 80, 100, 125, 160, 200, 250, 315, 400, 500, 630, and 800 Hz; then 1, 1.25, 1.6, 2, 2.5, 3.15, 4, 5, 6.3, 8, 10, 12.4, 16, and 20 kHz.
Distortion (THD)	$\leq 1\%$ (20 kHz bandwidth)	$\leq 0.4\%$ typical
Audio ID "click" (click ON)	Channel 1, 1 click Channel 2, 2 clicks	Channel click outputs are offset for positive channel identification.

Table 1-5: Power Supply

Characteristic	Performance Requirements	Supplemental Information
DC Input Range	9 to 15 Vdc	
Supply Accuracy		+5 V ± 250 mV, -5 V ± 250 mV
Hum		Typical: 25 mV _{p-p}
Noise		≤ 50 mV (5 MHz bandwidth)
Fuse		1 A fast blow, 32 V min
Power Limit without adapter with adapter		2.25 W 4.0 W
Power Consumption Audio and Back light off Audio and Back light on		Typical: 1.25 W 1.44 W

Table 1-6: Physical Characteristics

Characteristic	Performance Information
Height	5.6 cm (2.2 in)
Width	9.1 cm (3.6 in)
Depth	19.1 cm (7.5 in)
Net Weight TSG 90 TSG 90 with battery pack	0.48 kg (1.06 lb) 0.68 kg (1.5 lb)
Shipping Weight (with AC adapter)	1.50 kg (3.31 lb)

Table 1-7: Environmental Characteristics

Characteristic	Performance Information
Temperature Operating Storage	0° C to +50° C (32 to +122° F) -30° C to +65° C (-22 to +149° F), excluding batteries
Altitude Operating (battery) Operating (with AC adapter) Storage	to 15,000 feet (4572 m) to 14,000 feet (4267 m) to 50,000 feet (15420 m)
Transportation	Meets the requirements of NTSB Test Procedure 1A, Category II (24 inch drop)

Waveform Illustrations

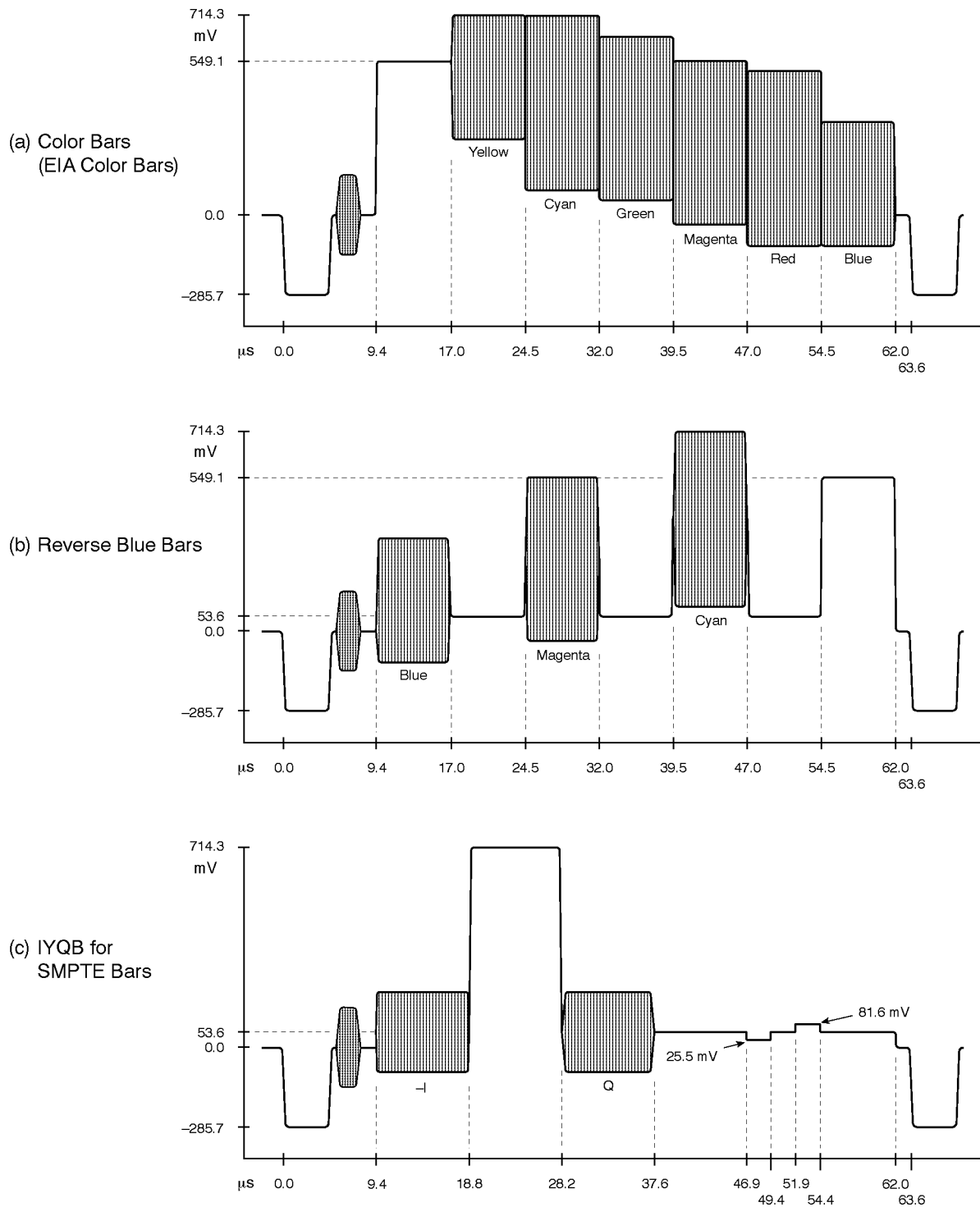

Figure 1-1: SMPTE Color Bar Components

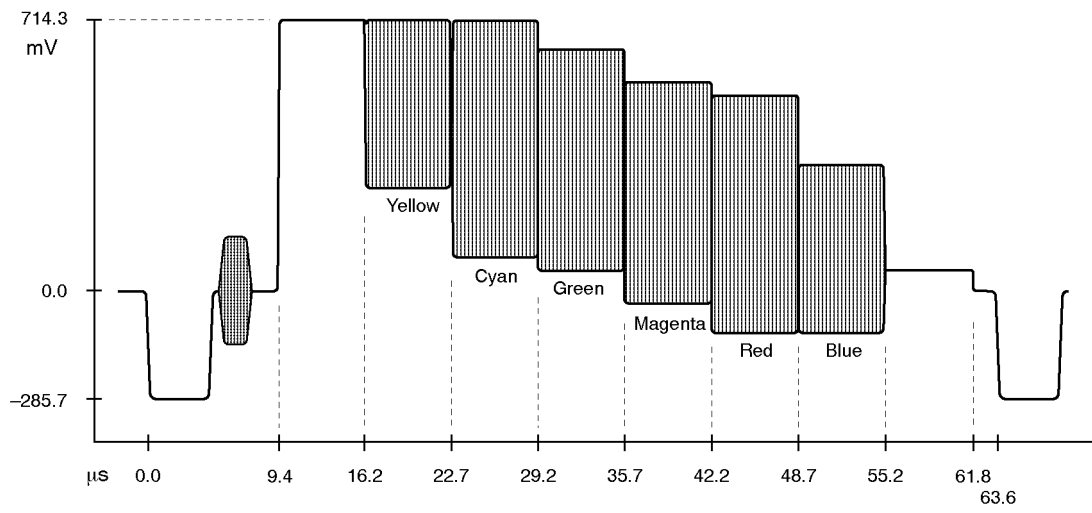

Figure 1-2: 75% Color Bars

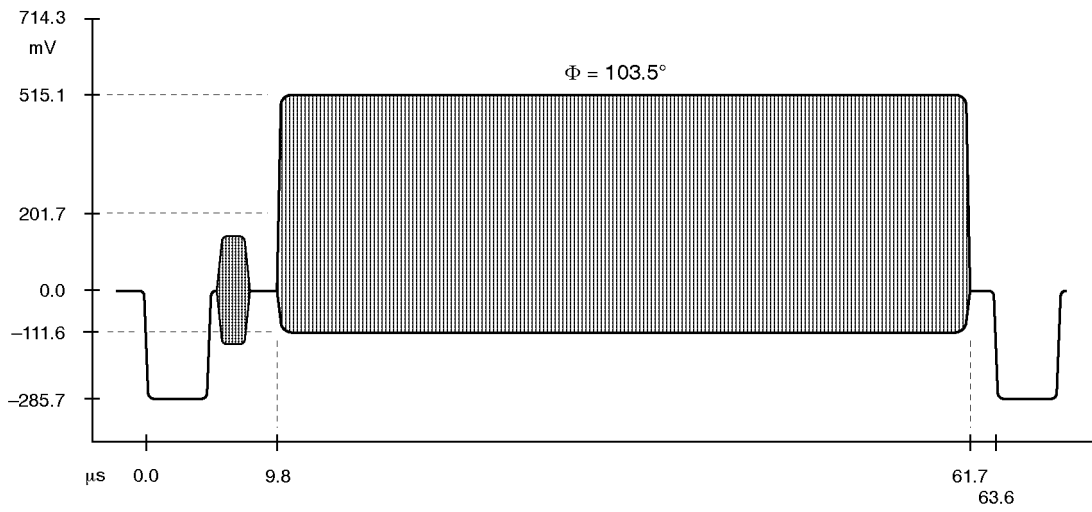

Figure 1-3: Red Field

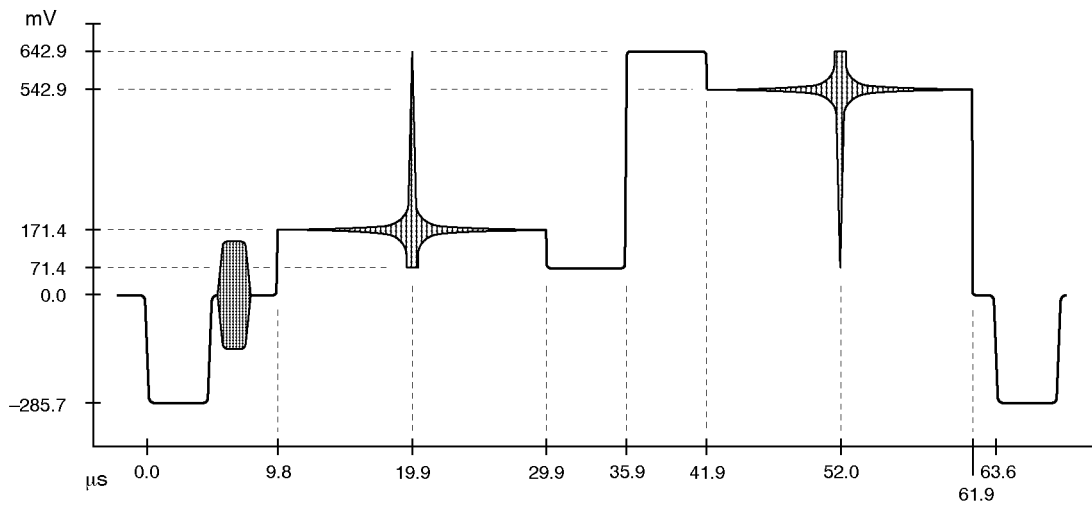

Figure 1-4: SIN(X)/X

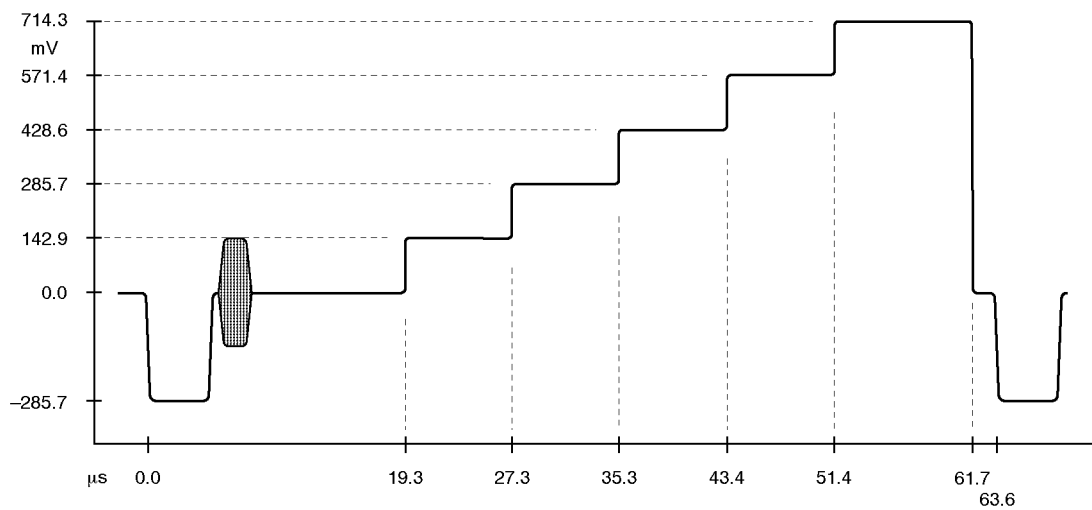

Figure 1-5: 5-Step Staircase (Gray Scale)

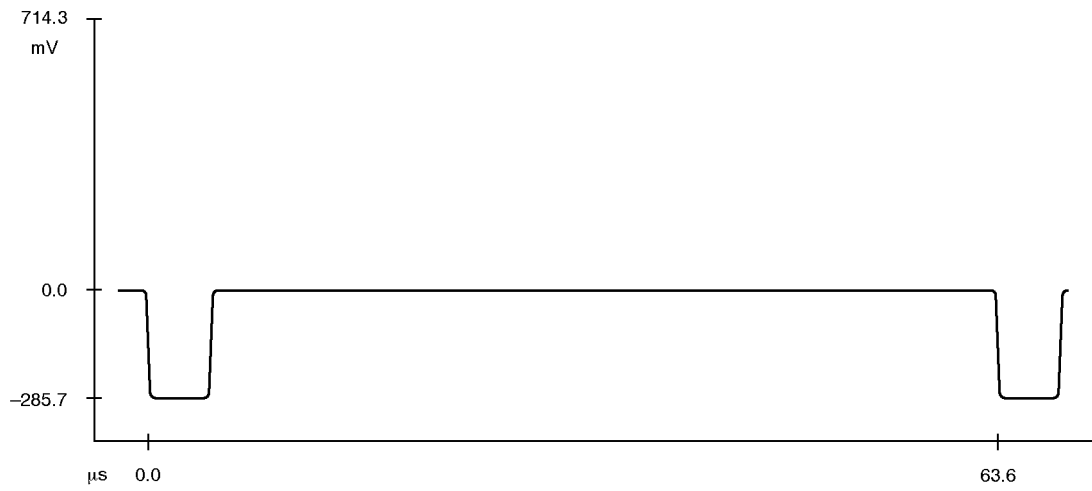

Figure 1-6: 0 IRE Flat Field

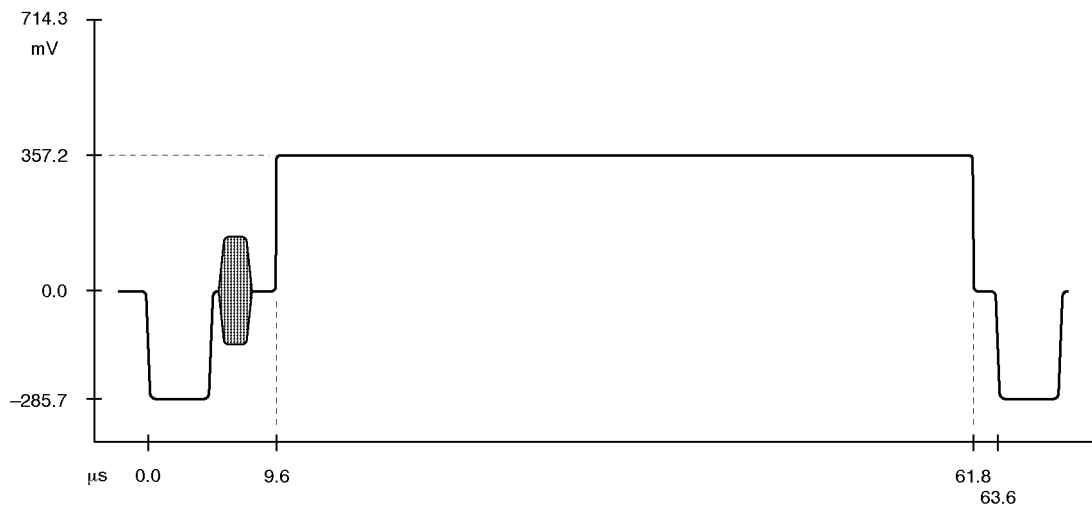

Figure 1-7: 50 IRE Flat Field

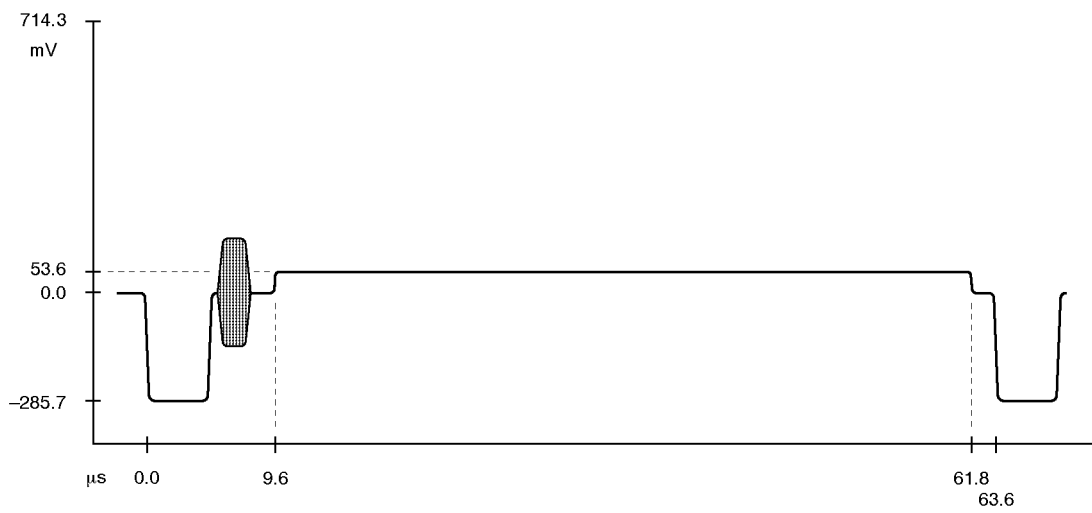

Figure 1-8: Black Burst

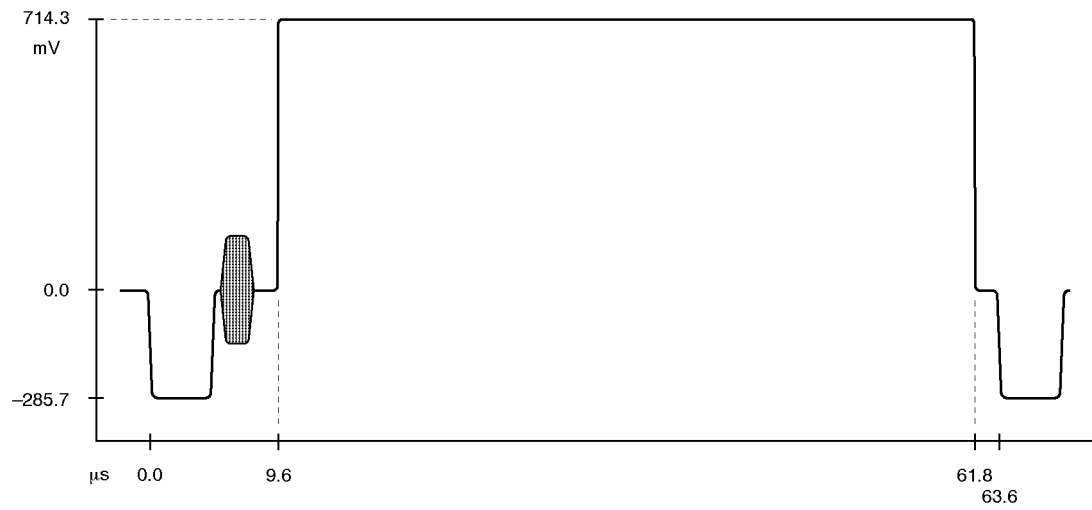

Figure 1-9: Field Square Wave

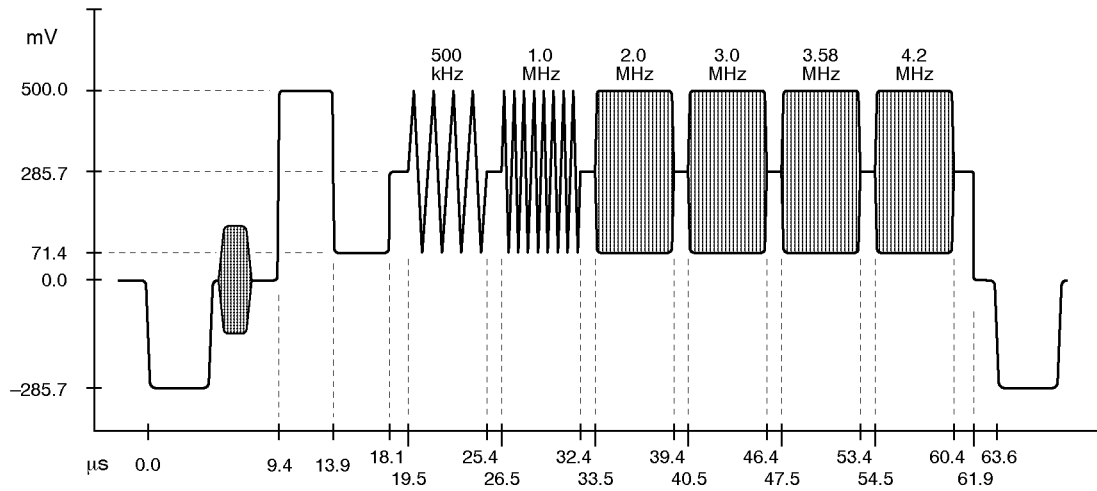

Figure 1-10: Multiburst

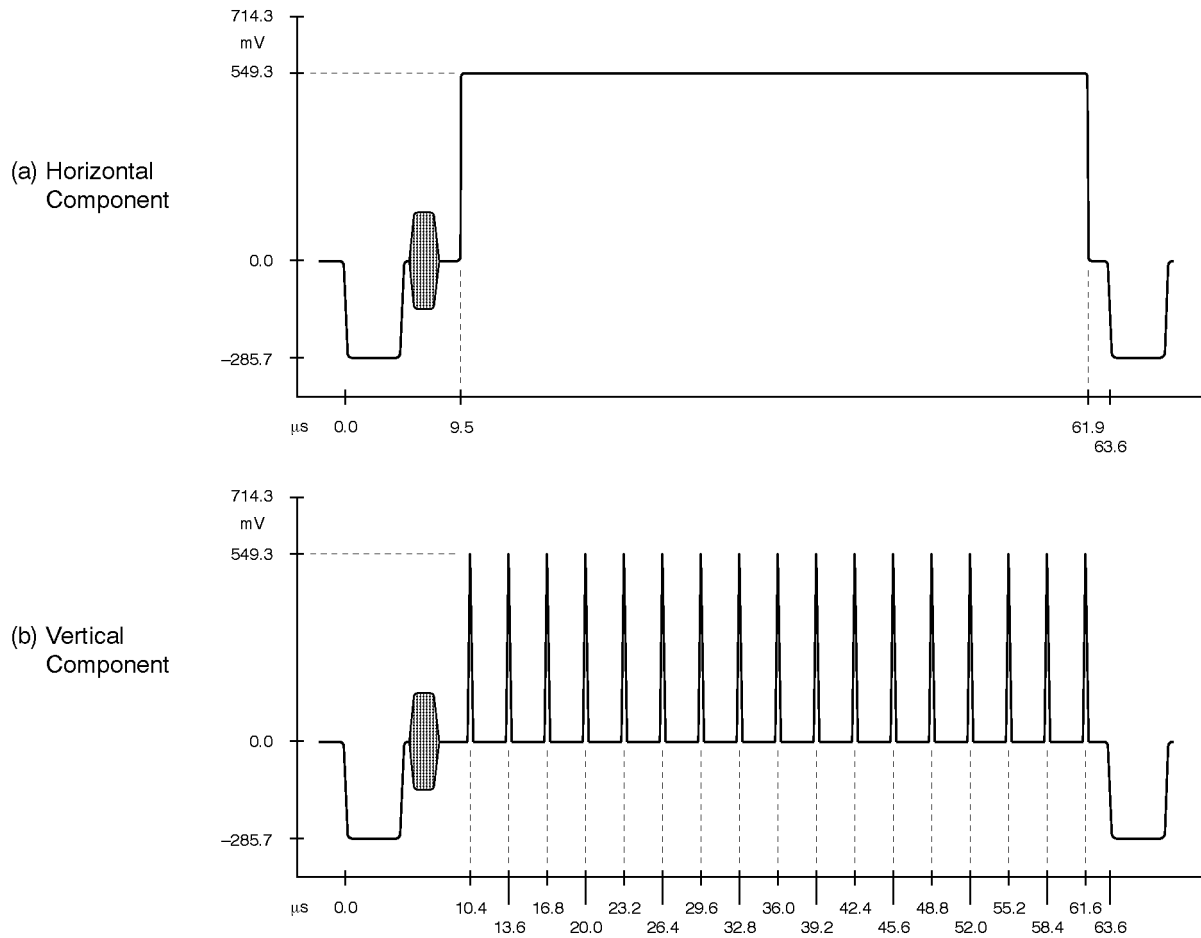

Figure 1-11: Convergence Components

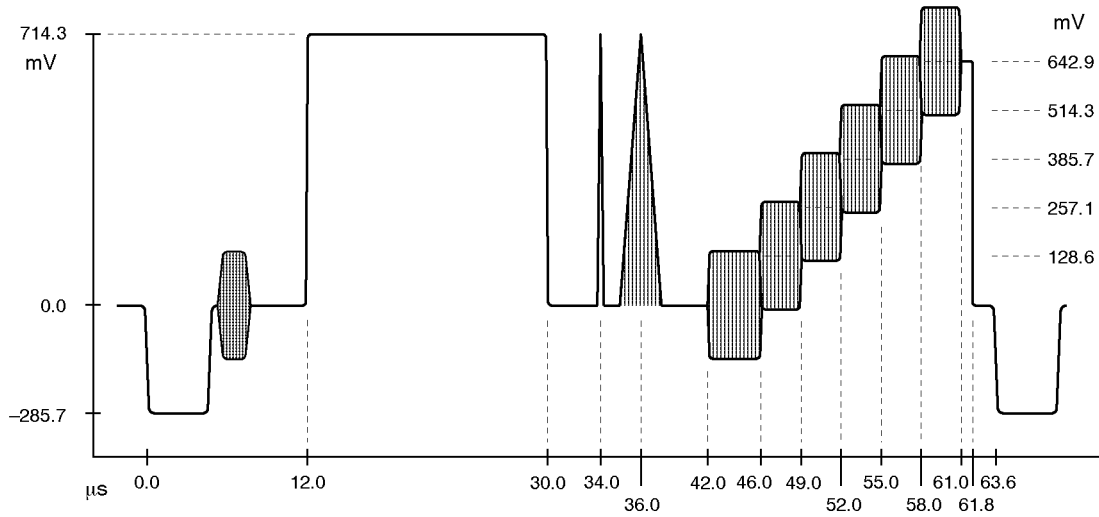

Figure 1-12: NTC7 Composite

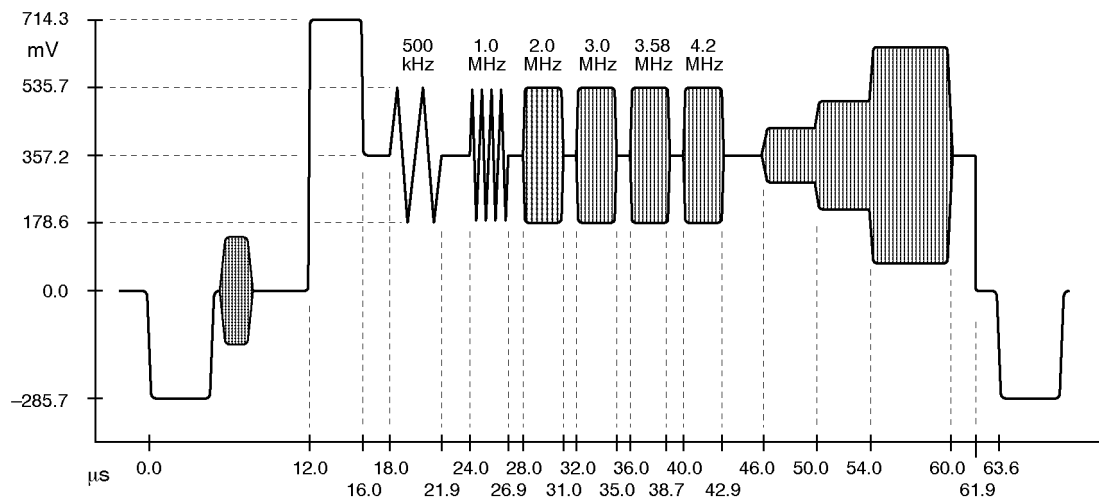

Figure 1-13: NTC7 Combination

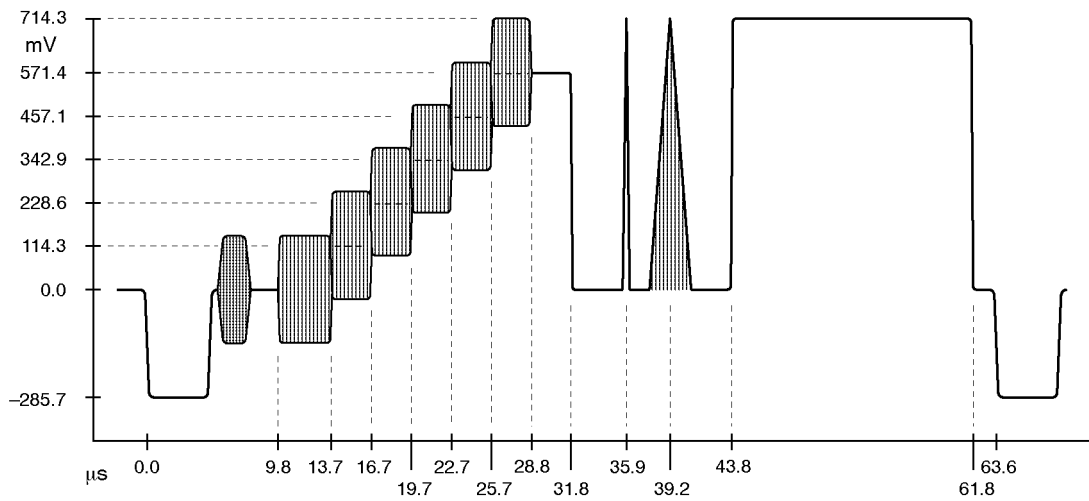
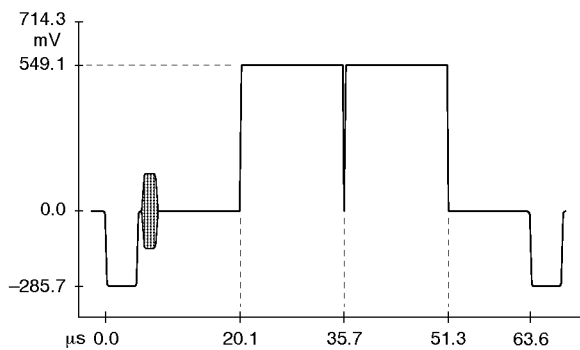

Figure 1-14: FCC Composite

Lines:

21	NTC7 Composite
69	
70	NTC7 Combination
117	
118	Color Bars
165	
166	SIN(x)/x
213	
214	50 IRE Flat Field
262	

Figure 1-15: Matrix



Lines 33, 45, 238, and 250

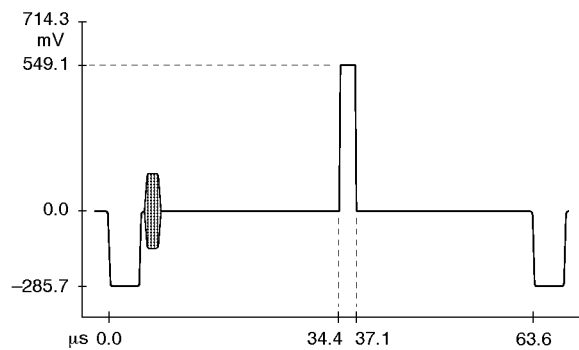

Line 141

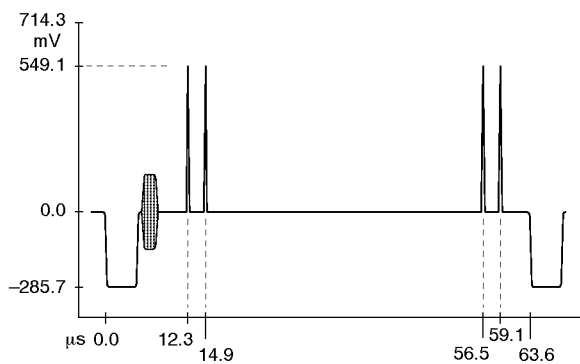

Lines 69–132 and 149–213

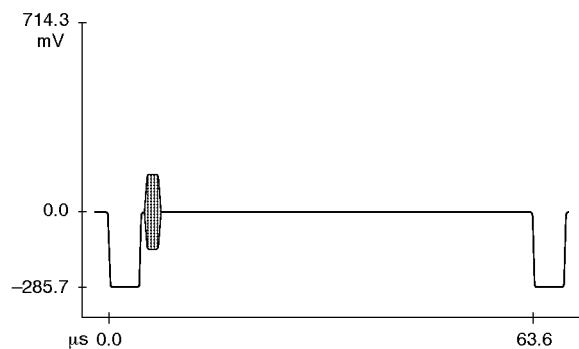

All remaining lines

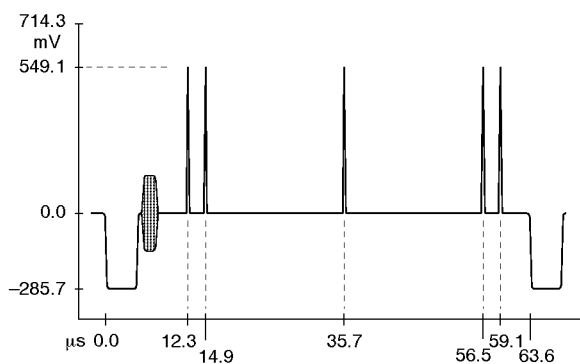

Lines 133–140 and 142–148

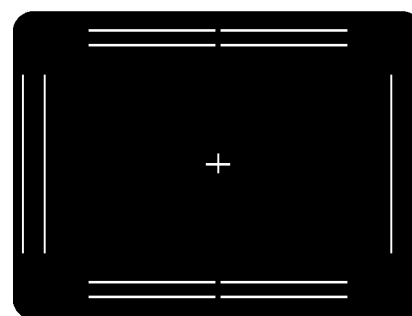

Safe Area display

Figure 1–16: Safe Area



Operating Information

Operating Information

The TEKTRONIX TSG 90 PATHFINDER TV Signal Generator is designed for ease of operation and outstanding portability. It provides a complement of 16 NTSC test signals, including the Safe Area signal. It also provides 13 selectable audio frequencies from 50 Hz to 20 kHz, a 50 Hz to 20 kHz audio sweep, and an audio click channel ID. The two stereo AUDIO outputs may be set to one of three selectable amplitudes: 0 dBu, +4 dBu, or +8 dBu.

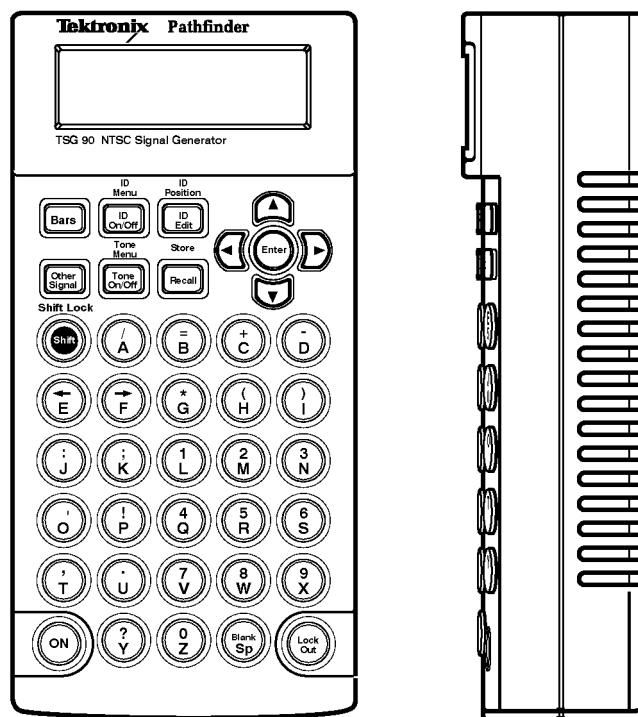

The PATHFINDER provides character ID capability, as well, storing up to eight messages consisting of two 16 character lines of text. Any one of these text messages may be inserted into the video test signal, or up to four of them may be cycled in a continuous loop (displaying for 1 to 9 seconds each) in any order. These messages may be displayed anywhere in the safe action area of the picture, or the first line of the message may be moved into the vertical interval.

In addition to the eight text messages, the PATHFINDER can also store as many as four complete front-panel configurations (User Presets), which can include menu selections, text messages, and tone and cycle information.

The PATHFINDER is DC powered, using either an AC adapter with 12V output (18V maximum open circuit), eight AA batteries, or a 9.6V NiCad battery pack (optional accessory). In-instrument charging capability, utilizing the AC adapter,

is provided for the NiCad battery pack only. If eight AA NiCad batteries are used, a separate charger must be provided.

Controls, Indicators, and Connectors

Controls The controls for the PATHFINDER consists of a keypad, which has buttons to make operational selections and entering menus; alphanumeric buttons for text entry and test signal selection; and arrow buttons for maneuvering through the menus and positioning text on screen. There is an enter button in the center of the arrow keys, used in menu selections. There is also a Shift/Shift Lock button, an ON button, and a Lock Out button.

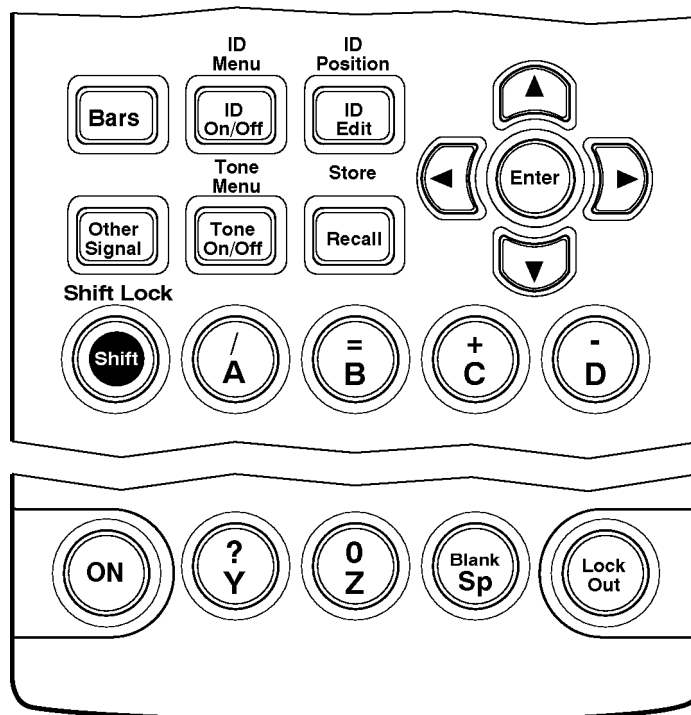

Shift/Shift Lock. The Shift/Shift Lock button is used to access the upper (shifted) nomenclature associated with each of the buttons, including itself. When Shift is pressed, a reverse video S is displayed in the lower right corner of the LCD display, indicating that the next keystroke will use the shifted nomenclature. If the next keystroke is the Shift button again, then the keypad is locked into the shift mode and all keystrokes will use the shifted nomenclature. The LCD display shows a reverse video SL, indicating that shift lock is active. Shift Lock is cancelled by pressing the Shift button a third time.

Lockout. The Lockout button is used to disable the keypad. While locked out, pressing any key (except Lock Out or ON) produces the message press Lock Out on the LCD display and has no other effect. While in Lock Out mode, a lock symbol (padlock icon) appears in the lower right corner of the LCD display.

Bars and Other Signals. The Bars and Other Signals buttons are used, along with the alphanumeric keys, for selecting test signals. This occurs in the Signal Select mode; the default operating mode for the PATHFINDER. The PATHFINDER powers-up in this mode, and returns to it after exiting any of the other modes. While in the Signal Select mode, the Bars button selects SMPTE Bars and 75% Bars, and the Other Signals button scrolls through the remaining test signals. The arrow keys will also scroll forward and backward through the signal list. In addition, the alphanumeric keys may be used to select signals directly, eliminating the need to scroll through all the signals to get to the one you want:

Standard

A=SMPTE Bars	I=Field Square Wave
B=75% Bars	J=50 IRE Flat Field
C=Multiburst	K=0 IRE No Burst
D=NTC7 Composite	L=Black Burst
E=NTC7 Combination	M=SIN X/X
F=FCC Composite	N=Convergence
G=5 Step	O=Matrix
H=Red Field	P=Safe Area

Option 1J (SN B021565 & above)

A=SMPTE Bars	I=Red Field
B=75% Bars	J=Field Square Wave
C=SNG Bars	K=50 IRE Flat Field
D=Multiburst	L=Black Burst
E=NTC7 Composite	M=SIN X/X
F=NTC7 Combination	N=Convergence
G=FCC Composite	O=Matrix
H=5 Step	P=Safe Area

ID On/Off and ID Menu. The ID On/Off button toggles the character ID messages (captions) on and off. The LCD display will read **ID=off**, **ID=on** for a single text ID message, or **ID=cyc** if cycle has been turned on in the ID Menu. The ID Menu is accessed by pressing the Shift button before pressing the ID On/Off

button. The ID Menu allows the ID cycle to be turned on or off, sets the display time for the captions, and selects which of the stored ID messages to cycle in what order.

ID Edit and ID Position. Pressing the ID Edit button enters a mode where the current ID text can be edited. Editing occurs off-line, in an edit buffer, so any displayed messages are not affected. When finished editing, pressing the Enter button saves the ID from the edit buffer as the current ID, and the new text is inserted into the video signal, unless the ID cycle function is in use.

The ID Position mode (Shift-ID Edit) allows positioning of the message on screen. The H and V readouts on the LCD display allow the operator to determine where the message is being positioned, even if there is no video display available. The H value shows how many letter spaces from the left edge the message starts. The V value shows the character line that the first line of text occupies. If the first line of text is placed into the vertical interval, the LCD display will read V=vert.

Tone On/Off and Tone Menu. The Tone On/Off button toggles the audio tone on and off. When Tone is On, the LCD display will display the selected audio level (i.e. **Tone=4dB**). The Tone Menu (Shift-Tone On/Off) is used to select the tone frequency, select the audio level (0, +4, or +8 dBu), and to turn the audio click on and off.

The tone frequency menu will select one of 13 fixed frequencies between 50 Hz and 20 kHz, or a 50 Hz–20 kHz audio sweep. This sweep signal is composed of 27 separate frequencies, more than double the number of specified fixed frequencies. While in the tone frequency menu, with sweep selected (displayed on the LCD readout), pressing the ENTER key will stop the sweep and the PATHFINDER will continue to output the frequency it was producing when the ENTER key was pressed. The display will change from **SWEEP 50–20K** to **SWEEP PAUSED**. This is useful for checking a problem noticed at a particular frequency while sweeping, and also allows the use of frequencies not specifically addressed in the Tone Menu. Pressing the ENTER key again will restart the sweep.

Recall and Store. The Recall button allows the user to recall one of eight user defined IDs or four user presets. In this mode, the left/right arrows select the ID or preset number, and pressing ENTER will then recall it. The up and down arrow buttons may be used to view the 2nd line of the text message before recalling.

Store is used to store the current ID text, with an assigned ID number, or it will store the current text and instrument settings as a User Preset.

- Indicators** All functions of the PATHFINDER are indicated by the LCD display. This backlit display has two 16-character lines, to display all information necessary for operation, signal selection, text editing, selecting and positioning text messages, and making menu selections.
- Connectors** The PATHFINDER has four connectors: one 75 Ω BNC connector for the video output, two XLR connectors for audio output, and one DC power jack for the AC Adapter input.



Performance Verification and Adjustment Procedures

Performance Verification and Adjustment Procedures

This section consists of a detailed performance verification procedure to verify the operation of the PATHFINDER, and an adjustment procedure to return the PATHFINDER to in-spec operation.

The order of these procedures has been chosen to minimize changes in equipment setup. Performance parameters may be checked in any order. As some of the calibration steps are interactive, care must be taken when adjusting individual parameters to ensure that all others remain within specification.

A performance verification checklist begins on page 3–2.

Performance verification procedure instructions begin on page 3–4.

An adjustment checklist appears on page 3–9.

Adjustment instructions begin on page 3–10.

Required Test Equipment

The following list of equipment represents the minimum required for the Performance Verification and Adjustment procedures. While alternate equipment may be used, it is not recommended. Alternate equipment must meet the minimum specifications for the listed equipment. Use of inadequate equipment may result in faulty measurements or calibration.

Table 3–1: Required Test Equipment

Item	Information/Requirements	Example
NTSC Video Measurement Set	For measuring and displaying line- and field-rate waveforms. Must be capable of making differential phase and gain measurements.	Tektronix 1780 Video Measurement Set.
Frequency Counter	Must be accurate to within 2.5 Hz out of 5 MHz.	Tektronix DC503A; plugs into a TM503 power mainframe.
NTSC Video Signal Generator	Must be capable of being gen-locked to the PATHFINDER Video output, and must have a Subcarrier output.	Tektronix TSG170A.

Table 3-1: (Cont.) Required Test Equipment

Item	Information/Requirements	Example
Audio Distortion Analyzer	Must be capable of testing power output over a range of 0 to 8 dBm. Must be capable of detecting THD of 0.01% or less.	Tektronix AA501.
Audio Connector-to-Triple Banana Cable		ITT Pamona Electronics, Model 4953-J-36. Must be configured to match the PATHFINDER audio output: Pin 1, shield; pin 2, +; and pin 3, -.
Noise Measurement Filter	Continuous random noise, 5 MHz, low-pass filter.	Tektronix p/n 015-0213-00.
BNC Coaxial Cables	75 impedance. (Qty 2)	Tektronix p/n 012-0074-00.
End-Line Termination	75Ω, 0.025% termination with BNC connector.	Tektronix p/n 011-0102-01.

Performance Verification Checklist

Use the following checklist if you are familiar with the operation of the TSG 90 as well as video and audio performance verification techniques. Step-by-step instructions for all of the procedures begin on page 3-4.

Oscillator Frequency

NOTE. After initial delivery or long storage, allow a two-hour warm-up time to re-age the crystal. Thereafter, 20 minute warm-up time is sufficient.

1. Check Subcarrier Frequency
 - Subcarrier of genlocked generator= 3.579545 MHz ± 10 Hz

Test Signals

2. Check Blanking Level
 - 0 V ± 50 mV
3. Check Sync Amplitude
 - 285.7 mV ± 5.7 mV (40 IRE ± 0.8 IRE)
4. Check Burst Amplitude
 - 285.7 mV ± 5.7 mV (40 IRE ± 0.8 IRE)

5. Check 5-Step Linearity
 - Max diff step difference <1%
6. Check Luminance Amplitude Accuracy
 - 714 mV \pm 7.14 mV (100 IRE \pm 1 IRE)
7. Check Rise Time
 - 140 ns \pm 20 ns, 10% to 90%
8. Check SCH Phase
 - SCH Phase = 0° \pm 5°
9. Check Chrominance-to-Luminance Delay and Gain
 - Delay \leq 15 ns, Gain \leq 2%
10. Check K-Factor
 - 2T pulse K-Factor \leq 0.5%
11. Check Differential Phase and Gain
 - Diff phase \leq 1°
 - Diff gain \leq 1%
12. Check Line Tilt
 - Line tilt \leq 3.57 mV (0.5 IRE)
13. Check Field Tilt
 - Field tilt \leq 3.57 mV (0.5 IRE)
14. Check Multiburst Frequency Response
 - Flat Packets, equal amplitude \pm 2%

Audio Outputs

15. Check Total Harmonic Distortion
 - Channel 1 \leq 1%
 - Channel 2 \leq 1%
16. Check Audio Output Amplitude
 - 0 dBu = 0 dBu \pm 0.25 dBu at 1 kHz, both channels
 - 4 dBu = 4 dBu \pm 0.25 dBu at 1 kHz, both channels
 - 8 dBu = 8 dBu \pm 0.25 dBu at all possible frequencies, both channels

Performance Verification Procedures

Oscillator Frequency

NOTE. After initial delivery or long storage, allow a two-hour warm-up time to re-age the crystal. Thereafter, a 20 minute warm-up time is sufficient.

1. Check Subcarrier Frequency
 - a. Connect the PATHFINDER Video Output to the genlock input of the NTSC Test Signal Generator with a 75Ω coaxial cable. Terminate the genlock input in 75Ω , if required.
 - b. Connect the NTSC Test Signal Generator subcarrier output to the Frequency Counter A input, using a 75Ω coaxial cable.
 - c. Connect a reference, such as WWV, to the B input of the Frequency Counter.
 - d. Set the Frequency Counter for a ratio of A/B, and set the AVG to 106.
 - e. CHECK — that the measured oscillator frequency is $3.579545 \text{ MHz} \pm 10 \text{ Hz}$.

Test Signals

2. Check Blanking Level
 - a. Connect the PATHFINDER Video output to the 1780 A Input and terminate the loop-through in 75Ω .
 - b. View the Ch A signal on the 1780 waveform display.
 - c. Select the 5-Step signal from the PATHFINDER (press G).
 - d. CHECK — that the test signal DC level is at $0 \text{ V} \pm 50 \text{ mV}$.
3. Check Sync Amplitude
 - a. Continue from the preceding step, with the PATHFINDER 5-Step signal on the 1780 waveform Ch A.
 - b. Using the WFM + CAL function of the 1780, match the DC level of the lower displayed waveform to the sync tip of the upper waveform.
 - c. CHECK — that the sync amplitude is $285.7 \text{ mV} \pm 5.7 \text{ mV}$ ($40 \text{ IRE} \pm 0.8 \text{ IRE}$).

4. Check Burst Amplitude
 - a. Using the 1780 WFM + CAL function, match the top of the burst on the lower displayed waveform to the bottom of the burst on the upper waveform.
 - b. CHECK — that the burst amplitude is $285.7 \text{ mV} \pm 5.7 \text{ mV}$ (40 IRE ± 0.8 IRE).
5. Check 5-Step Linearity
 - a. Continuing from the preceding step, set the 1780 to view the signal using the differentiated step filter.
 - b. CHECK — that the difference between the highest and lowest spikes (differentiated steps) is $<1\%$.
6. Check Luminance Amplitude Accuracy
 - a. Using the 1780 WFM + CAL function, match the top of the 5-Step waveform on the lower display to the DC level on the upper waveform.
 - b. CHECK — that the 5-Step amplitude is $714 \text{ mV} \pm 7.14 \text{ mV}$ (100 IRE ± 1 IRE).
7. Check Rise Time
 - a. Set the 1780 to view the sync pulse.
 - b. Set the voltage cursors to the the 10% and 90% points of the sync transitions.
 - c. CHECK — that the rise and fall times (between 10% and 90%) of the sync pulse are $140 \text{ ns} \pm 20 \text{ ns}$.
8. Check SCH Phase
 - a. Set the 1780 to measure SCH Phase.
 - b. CHECK — that the SCH Phase of the PATHFINDER Video Output is $0^\circ \pm 5^\circ$.
9. Check Chrominance-to-Luminance Delay and Gain
 - a. Select the NTC7 Composite signal from the PATHFINDER (press D).
 - b. Set the 1780 to view the bottom of the modulated pulse.
 - c. Use the Chroma/Luma measurement mode of the 1780 to measure both Y/C delay and gain.
 - d. CHECK — that the Chroma/Luma delay is $\leq 15 \text{ ns}$, and the gain is $\leq 2\%$.

10. Check K-Factor

- a. With the NTC7 Composite signal still displayed, set the 1780 for K-Factor measurement.
- b. CHECK — that the PATHFINDER K-Factor is $\leq 0.5\%$.

11. Check Differential Phase and Gain

- a. Set the 1780 Vectorscope mode to measure differential phase. Use the double trace method, if possible.
- b. CHECK — for differential phase of $\leq 1^\circ$.
- c. Set the 1780 Vectorscope mode to measure differential gain. Use the double trace method, if possible.
- d. CHECK — for differential gain of $\leq 1\%$.

12. Check Line Tilt

- a. With the NTC7 Composite signal still displayed, set the 1780 waveform display to show the White bar.
- b. CHECK — using the 1780 voltage cursors, that the tilt from the beginning to the end of the White bar is ≤ 3.57 mV (0.5 IRE), ignoring the first and last μ s.

13. Check Field Tilt

- a. Select the Field Square Wave from the PATHFINDER (Press I).
- b. Set the 1780 waveform display to show one field.
- c. CHECK — using the 1780 voltage cursors, that the tilt from the beginning to the end of the White bar is ≤ 3.57 mV (0.5 IRE), ignoring the first and last three lines.

14. Check Multiburst Frequency Response

- a. Select the Multiburst signal from the PATHFINDER (press C).
- b. CHECK — using the 1780 voltage cursors that the packets are flat and of equal amplitude, $\pm 2\%$, to 4.2 MHz.

Audio Outputs

15. Check Total Harmonic Distortion (THD)

- a. Connect the PATHFINDER Audio Channel 2 to the AA501 Audio Distortion analyzer. Attach a 600Ω resistor between the analyzer's + and - terminals to represent the system load.

- b. Set the distortion analyzer to measure THD.
- c. Set the Tone Frequency, Amplitude, and ID Click with these steps:
 - Open the Tone Menu by pressing SHIFT–TONE ON/OFF (press the two keys simultaneously).
 - Use the ◀ and ▶ keys to set the TONE FREQ to 50 Hz.
 - Move to the TONE LEVEL selection with the ▼ key.
 - Use the ◀ and ▶ keys to set the TONE LEVEL to 0 dBu.
 - Move to the CLICK ON/OFF selection with the ▼ key.
 - Use the ◀ and ▶ keys, if necessary, to turn the Click OFF.
- d. CHECK — that the Channel 2 THD is $\leq 1\%$.
- e. Use the ▲ key to move back up to the TONE LEVEL selection. Change the PATHFINDER Tone Amplitude to +4 dBu (use the ◀ and ▶ keys).
- f. CHECK — that the Channel 2 THD is $\leq 1\%$.
- g. Change the TONE LEVEL to 8 dBu.
- h. CHECK — that the Channel 2 THD is $\leq 1\%$.
- i. Move the audio cable from the PATHFINDER Audio CH 2 connector to the Audio CH 1 connector.
- j. CHECK — that the Channel 1 THD is $\leq 1\%$.
- k. Change the TONE LEVEL to +4 dBu.
- l. CHECK — that the Channel 1 THD is $\leq 1\%$.
- m. Finally, change the TONE LEVEL to 0 dBu.
- n. CHECK — that the Channel 1 THD is $\leq 1\%$.

16. Check Audio Output Amplitude

- a. Set the PATHFINDER Frequency to 1 kHz and the Audio Level to 0 dBu with these steps (as necessary):
 - Open the Tone Menu by pressing SHIFT–TONE ON/OFF (press the two keys simultaneously).
 - Use the ◀ and ▶ keys to set the TONE FREQ to 1 kHz.
 - Move to the TONE LEVEL selection with the ▼ key.
 - Use the ◀ and ▶ keys to set the TONE LEVEL to 0 dBu.

- b. CHECK — that the Audio Output is 0 dBu \pm 0.25 dBu.
- c. Set the PATHFINDER Audio Level to +4 dBu (use the ◀ and ▶ keys).
- d. CHECK — that the Audio Output is +4 dBu \pm 0.25 dBu.
- e. Set the PATHFINDER Audio Level to +8 dBu:
- f. Go back up to the TONE FREQ menu item (press the ▲ key) and select the appropriate frequencies in turn to CHECK — that the Audio Output is +8 dBu \pm 0.25 dBu at each of the following frequencies:
 - 50 Hz 4 KHz
 - 63 Hz 8 KHz
 - 125 Hz 10 KHz
 - 250 Hz 12.5 KHz
 - 400 Hz 16 KHz
 - 1 KHz 20 KHz
 - 2 KHz
- g. Move the audio cable from the PATHFINDER Audio CH 1 output to the Audio CH 2 output.
- h. CHECK — that the Audio Output is +8 dBu \pm 0.25 dBu at each of the following frequencies:
 - 20 KHz 1 KHz
 - 16 KHz 400 Hz
 - 12.5 KHz 250 Hz
 - 10 KHz 125 Hz
 - 8 KHz 63 Hz
 - 4 KHz 50 Hz
 - 2 KHz
- i. Set the Tone Frequency to 1 kHz and the Tone Level to +4 dBu.
- j. CHECK — that the CH 2 Audio Output is +4 dBu \pm 0.25 dBu.
- k. Set the PATHFINDER Audio Level to 0 dBu.
- l. CHECK — that the Audio Output is 0 dBu \pm 0.25 dBu.

- m. Reset the PATHFINDER Tone Frequency, Amplitude, and Click to their normal operating (pre-step 15) states.

Adjustment Checklist

Use the following checklist if you are familiar with TSG 90 operation and adjustment. Step-by-step instructions for all of the procedures begin on the next page.

1. Adjust Subcarrier Frequency
 - Set frequency as close to 3.579545 MHz as possible (± 0.5 Hz).
2. Adjust Audio Output Amplitude
 - Click — off; diagnostic menu, 0 dBu
 - Adjust Tone Level, R53, for 0 dBu ± 0.05 dBu
 - Change diagnostic menu to 4 dBu
 - Adjust to 4 dBu ± 0.05 dBu with the ◀ and ▶ keys
 - Change diagnostic menu to 8 dBu
 - Adjust to 8 dBu ± 0.05 dBu with the ◀ and ▶ keys
3. Adjust Test Signal Gain
 - 5-step signal, set 1780 for WFM + CAL= 714 mV
 - Adjust Gain, R52, so waveforms just touch
4. Adjust Test Signal DC Offset
 - Adjust DC Offset, R7, so 0 IRE point of 5 step is 0 V ± 2.0 mV
5. Adjust Frequency Response, 2T Ringing, and SINX/X Compensation

NOTE. *Interactive steps, repeat until best overall response is obtained.*

- Adjust filters L4, L5, L6, L7, and L8 for flat, equal amplitude multiburst packets
 - Adjust L7 and L8 for symmetrical ringing, overshoot $\leq 0.05\%$
 - Adjust (SINX)/X Compensation, C6, for flat mod pulse base
6. Adjust LCD Contrast
 - Adjust R1 so that unused LCDs are just barely turned off

Adjustment Procedures

Remove the PATHFINDER back cover before proceeding; see the instructions on page 4–5. Power the instrument with the AC adapter while making adjustments.

1. Adjust Subcarrier Frequency

- a. Connect the PATHFINDER Video Output to the NTSC Test Signal Generator genlock input with a 75 Ω coaxial cable. Terminate the genlock input in 75 Ω , if necessary.
- b. Connect the NTSC Test Signal Generator subcarrier output to the Frequency Counter A input, using a 75 Ω coaxial cable.
- c. Connect a reference, such as WWV, to the B input of the Frequency Counter.
- d. Set the Frequency Counter for a ratio of A/B, and set the AVG to 106.
- e. ONLY IF NECESSARY remove the round metal foil tape cover from the oscillator, Y1.
- f. ADJUST — the subcarrier frequency to 3.579545 MHz \pm 0.5 Hz.

NOTE. *The subcarrier frequency specification is \pm 10 Hz, but it is recommended that this adjustment be made as close to 3.579545 MHz as possible to maximize performance.*

The crystal may drift after adjustment. Leave the PATHFINDER powered up for 20 minutes after adjustment, then recheck the frequency to verify that it has remained within spec.

- g. Reinstall the metal foil tape cover on the oscillator.

2. Adjust Audio Output Amplitude

- a. Connect the PATHFINDER Audio CH 2 to the AA501 Audio Distortion analyzer. Attach a 600 Ω resistor to the analyzer's + and – terminals to represent the system load.
- b. Set the PATHFINDER Tone Frequency and Click with these steps:
 - Open the Tone Menu by pressing SHIFT–TONE ON/OFF (press the two keys simultaneously)
 - Use the ◀ and ▶ keys to set the TONE FREQ to 1 kHz.
 - Move to the CLICK ON/OFF selection with the ▼ key.
 - Use the ◀ and ▶ keys, if necessary, to turn the Click OFF.

- c. Enter the diagnostic menu and go to TONE LVL0 with these steps:
 - Turn the PATHFINDER OFF and then ON while holding the LOCKOUT button down.
 - Press the ▲ key repeatedly to reach the TONE LVL0 selection (menu item 5).
 - d. ADJUST — R53 Tone Level for $0 \text{ dBu} \pm 0.05 \text{ dBu}$.
 - e. Press the ▼ key once to select TONE LVL4 in the diagnostic menu.
 - f. Use the ◀ and ▶ keys to ADJUST the audio level to $+4.00 \pm 0.05 \text{ dBu}$.
 - g. Go to TONE LVL8 in the diagnostic menu (press the ▼ key once).
 - h. Use the ◀ and ▶ keys to ADJUST the audio level to $+8.00 \pm 0.05 \text{ dBu}$.
 - i. Reset the Audio Tone Frequency and Click to their previous states (through the Tone Menu).
3. Adjust Test Signal Gain
 - a. Connect the PATHFINDER Video Output to the 1780 A Input and terminate the loop-through in 75Ω .
 - b. Set the 1780 for waveform display of Ch A.
 - c. Select the 5-Step signal from the PATHFINDER (press G).
 - d. Select the WFM + CAL function of the 1780 and set CAL to 714 mV.
 - e. ADJUST — GAIN, R52, so that the top of the lower waveform just touches the DC level of the upper waveform.
 4. Adjust Test Signal DC Offset
 - a. Set the 1780 Coupling to GND and adjust the monitor trace to a convenient ground reference.
 - b. Change the 1780 input coupling to DC.
 - c. ADJUST — DC OFFSET, R7, to set the 0 IRE point of the 5-Step signal to the established ground reference $\pm 2 \text{ mV}$.
 - d. Repeat steps 3 and 4 as necessary for best results.
 5. Adjust Frequency Response, 2T Ringing, and (SIN X)/X Compensation

NOTE. Step 5 contains several interactive adjustments. Repeat this step until the best overall response is obtained.

- a. Select the Multiburst signal from the PATHFINDER (press C).
 - b. Set the 1780 to view all of the multiburst packets on a line.
 - c. ADJUST — L4, L5, L6, L7, and L8 to make the frequency packets flat, and equal amplitude from one packet to another. Use the 1780 WFM + CAL function to confirm that all packets are of equal amplitude $\pm 1.5\%$.
 - d. Select the NTC7 Composite signal from the PATHFINDER (press D).
 - e. Set the 1780 to view the bottom of the modulated and 2T pulses. Magnify as necessary to view the ringing.
 - f. ADJUST — L7 and L8 for symmetrical ringing. Use the 1780 K-Factor graticule to verify that the ringing (overshoot) is $\leq 0.5\%$ of peak.
 - g. ADJUST — SIN X/X Correction, C6, to make the bottom of the Modulated Pulse as flat as possible.
 - h. Return to part a and repeat this step. Continue to repeat this step until the best overall response is obtained.
6. Adjust LCD Contrast
- a. Press the BARS button, to make sure that the LCD backlight is on.
 - b. ADJUST — LCD Contrast, R1, counterclockwise until the unused LCD segment rectangles appear, then adjust R1 clockwise until they just disappear. Stop adjusting R1 before the intensity of the displayed LCD characters is affected.



Maintenance

Maintenance

Battery Hints

For optimal battery life and capacity, use the rechargeable NiCad battery pack (Tektronix p/n 119-4488-00) in full charge/discharge cycles. In other words, fully discharge the battery pack before recharging, and then charge the battery pack until fully charged, approximately 16 hours. A new battery pack will take a few charge/discharge cycles to reach full capacity.

Setting the Battery Type and the Auto Power Down functions in the diagnostic menu also have an impact on battery life. The battery types are disposable (Alkaline) or rechargeable (NiCad). Setting the battery type changes the voltage level that causes the battery low message to be displayed, and also changes the cut-off voltage for instrument operation.

The Auto Power Down function, when enabled, shuts the PATHFINDER off when there is no keypress for approximately 10 minutes, to conserve battery life. Auto Power Down is indicated, when enabled, by a rotating line in the upper right corner of the display.

Preventive Maintenance

Under average conditions, the PATHFINDER should have preventive maintenance performed about every 2000 hours. This is approximately one year of operation. Preventive maintenance includes cleaning, visual inspection, a performance verification and, if necessary, adjustment. See Section 3 for performance verification and adjustment procedures.

Cleaning

Clean the instrument often enough to prevent dust and dirt from accumulating in or on it. Dirt can provide high-resistance electrical leakage paths between conductors or components in a humid environment.



CAUTION. *The PATHFINDER case is made of molded plastic. Do not allow water to get inside of any enclosed assembly or component. Do not clean any plastic materials with organic cleaning solvents, such as benzene, toluene, xylene, acetone, or similar compounds, because they may damage the plastic.*

Static-Sensitive Components

The PATHFINDER contains electrical components that are susceptible to damage from static discharge. Static voltages of 1 kV to 30 kV are common in unprotected environments.



CAUTION. *Static discharge can damage any semiconductor component in this instrument.*

Observe the following precautions to avoid static damage:

- Minimize handling of static-sensitive components.
- Transport and store static-sensitive components or assemblies in their original containers, on a metal rail, or on conductive foam. Label any package that contains static-sensitive assemblies or components.
- Discharge the static voltage from your body by wearing a wrist strap while handling these components. Servicing static-sensitive assemblies or components should only be performed at a static-free workstation by qualified personnel.
- Nothing capable of generating or holding a static charge should be allowed on the workstation surface.
- Keep the component leads shorted together whenever possible.
- Pick up components by the body, never by the leads.
- Do not slide the components over any surface.
- Avoid handling components in areas that have a floor or work surface covering capable of generating a static charge.
- Use a soldering iron that is connected to earth ground.
- Use only special antistatic, suction-type or wick-type desoldering tools.

Troubleshooting Aids

The following is miscellaneous information about schematics, circuit board illustrations, component numbering, and assembly numbering.

NOTE. *No repair should be attempted during the warranty period.*

Foldout Pages

The foldout pages at the back of the manual contain block and schematic diagrams and circuit board illustrations.

Diagrams The circuit number and electrical value of each component is shown on the schematic diagrams. The first page in the Diagrams section explains the schematic symbols and notations found on the diagrams. The Replaceable Electrical Parts list gives a complete description of each component. Circuit boards and assemblies are shown with a heavy border, for identification. If the border does not completely encircle the schematic then that schematic only portrays part of the circuitry on that board or assembly. The name and assembly number of the circuit board are shown along the border as well as the serial number range that the schematic represents.

NOTE. Check the Change Information section at the rear of the manual for inserts describing corrections and modifications to the instrument and manual.

Circuit Board Illustrations Electrical components, connectors, and test points are identified on circuit board illustrations located on the inside fold of the corresponding circuit diagram or the back of a preceding diagram.

Numbering The circuit board assemblies are assigned assembly numbers starting with A1. Circuit boards have been assigned an assembly number so that they may be ordered from Tektronix, Inc. They are as follows:

- A1 Main Board Assembly
- A2 Keypad Board Assembly
- A3 LCD Board Assembly

The part numbers for ordering these boards are listed first in the Replaceable Electrical Parts list (EPL), in Section 5.

The EPL is arranged in assembly-by-assembly order, as designated in ANSI Standard Y32.16-1975. Each component is assigned a circuit number according to its location within a circuit, which is shown in the parts list by combining the assembly number and the circuit number.

EXAMPLE: R123 on assembly A2 would be listed in the EPL as A2R123.

In the EPL, assemblies are listed first, followed by circuit board-mounted parts in alphanumeric order. Parts mounted on the chassis are listed at the end of the EPL.

NOTE. The complete part number shown in the parts list should be used when ordering replacement parts.

Diagnostics

The PATHFINDER contains no automated diagnostic routines. There is one diagnostic selection found in the diagnostics menu: LCD Diag. This menu is accessed by holding the LOCKOUT button down while turning the PATHFINDER ON.

Diagnostic Menu	AUTO POWER DOWN	Use the ◀ and ▶ keys to enable/disable the Auto Power Down function. When enabled, the PATHFINDER will power down after 10 minutes of inactivity (no keystrokes). Enabled status is indicated by a rotating line in the upper-right corner of the LCD display.
	BATTERY TYPE	Use the ◀ and ▶ keys to select between RECHARGEABLE and DISPOSABLE battery types. This selection sets the voltage at which the BATTERY LOW message appears and the lowest voltage on which the instrument will operate. Be sure to set this selection to RECHARGEABLE when using NiCad batteries, and DISPOSABLE when alkaline batteries are installed.
	FACTORY RESET	Pressing the ENTER button when this selection is displayed will reset the PATHFINDER to the factory default settings. This includes stored text and user presets. <i>CAUTION: ALL USER-MADE SELECTIONS AND PRESETS WILL BE LOST.</i>
	LCD DIAG	This selection is used to check the proper operation of the LCD display. Pressing the ◀ button will turn all the LCD segments on, and pressing the ▶ button will turn all the segments off.
	TONE LVL0	This selection is used to calibrate the PATHFINDER 0 dBu tone level. The setting requires adjusting an internal potentiometer. See the adjustment procedure in Section 3 for instructions.
	TONE LVL4	This selection is used to calibrate the PATHFINDER +4 dBu tone level. See the adjustment procedure in Section 3.
	TONE LVL8	This selection is used to calibrate the PATHFINDER +8 dBu tone level. See the adjustment procedure in Section 3.

Corrective Maintenance

Corrective maintenance deals with obtaining replacement parts, torque specifications, and component replacement.

Obtaining Replacement Parts

Replacement parts are available from or through the local Tektronix, Inc., field office or representative.

When ordering parts be sure to include the following information in your order:

1. Instrument type (and option numbers, if any).
2. Instrument serial number.
3. Description of the part, as it appears in the electrical or mechanical parts list.
4. The Tektronix part number.

If a part that has been ordered is replaced with a new or improved part, the local Tektronix field office or representative will contact you concerning any change in the part number. After repair, the circuits may need readjustment.

Torque Specifications

Only #4 screws are used in the PATHFINDER to secure the case halves together. **DO NOT USE MORE THAN 3 INCH POUNDS OF TORQUE ON THESE SCREWS.**

Replacing Assemblies



WARNING. *Disconnect the AC adapter and batteries before replacing any components.*

Back Cover Removal and Replacement

Follow this procedure to remove and replace the back cover of the PATHFINDER:

1. Remove the four screws securing the back cover to the front cover.
2. Gently separate the back cover about 1 inch from the PATHFINDER, taking care to not pull the rear panel (connector panel) away with it.
3. Disconnect the battery cable from J10. Make sure to pull on the connector housing to do this, not the wires. The back cover is now free and may be moved away from the instrument.
4. Replacement is the reverse of removal.

**Connector Panel
Removal and Replacement**

Follow this procedure to remove and replace the connector (“rear”) panel of the PATHFINDER:

1. With the back cover removed, disconnect the VIDEO and both AUDIO connector cables from J7, J8, and J9. Again, pull on the connector housing, not on the wires.
2. Slide the assembly up away from the front panel.
3. Replacement is the reverse of removal.

**Main Board and LCD
Removal and Replacement**

Follow this procedure to remove and replace the Main board and LCD of the PATHFINDER:

1. After removing the rear panel, use a pair of needle-nose pliers to gently pull the J2 housing up away from the instrument. Pull straight up, lifting the Main board at the same time. Do NOT bend the connector housing.
2. When J2 pulls free, lift the Main board and the LCD display away from the case.
3. To separate the Main board and LCD display module, disconnect the LCD display cable from J6, and gently pull the two assemblies apart at J1. The rubber board spacers should remain attached to the LCD display.
4. Replacement is the reverse of removal.

Keypad Removal

Follow this procedure to remove the PATHFINDER keypad:

1. Once the Main board is out of the way, lift the plastic spacer board out of the PATHFINDER. This is held in place only by a friction fit.
2. Lift the Keypad board out of the PATHFINDER. This too is held in place by a friction fit.
3. Peel the rubber keypad out of the front panel.

Keypad Replacement

Follow this procedure to replace the PATHFINDER keypad:

1. Place the Keypad board with the pins of the connector towards the workbench.
2. Place the rubber keypad on top of the Keypad board, positioning it so that the ON button is in the corner closest the connector.
3. Adjust the rubber keypad so that the fingers on its back side fit through the corresponding holes in the Keypad board.

4. Holding the keypad and Keypad board with the buttons up, slide the front case onto them, aligning the rubber buttons with the holes for them in the front case as you do so. The Keypad board is a friction fit in the front case half, so you must apply some slight pressure to fully seat the assemblies into the case.
5. Place the assembled front case and keypad face down on the workbench and press the plastic spacer board into place. Align the cutout in the spacer board with the connector. The plastic fingers will be facing up.



Replaceable Electrical Parts

Replaceable Electrical Parts

This section contains a list of the components that are replaceable for the TSG 90. Use this list to identify and order replacement parts. There is a separate Replaceable Electrical Parts list for each instrument.

Parts Ordering Information

Replacement parts are available from or through your local Tektronix, Inc., Field Office or representative.

Changes to Tektronix instruments are sometimes made to accommodate improved components as they become available and to give you the benefit of the latest circuit improvements. Therefore, when ordering parts, it is important to include the following information in your order.

- Part number
- Instrument type or model number
- Instrument serial number
- Instrument modification number, if applicable

If a part you have ordered has been replaced with a new or improved part, your local Tektronix, Inc., Field Office or representative will contact you concerning any change in part number.

Change information, if any, is located at the rear of this manual.

Using the Replaceable Electrical Parts List

The tabular information in the Replaceable Electrical Parts list is arranged for quick retrieval. Understanding the structure and features of the list will help you find all of the information you need for ordering replaceable parts.

Cross Index–Mfr. Code Number to Manufacturer

The Mfg. Code Number to Manufacturer Cross Index for the electrical parts list is located immediately after this page. The cross index provides codes, names, and addresses of manufacturers of components listed in the electrical parts list.

Abbreviations

Abbreviations conform to American National Standards Institute (ANSI) standard Y1.1.

List of Assemblies

A list of assemblies can be found at the beginning of the electrical parts list. The assemblies are listed in numerical order. When the complete component number of a part is known, this list will identify the assembly in which the part is located.

Column Descriptions

Component No. (Column 1) The component circuit number appears on the diagrams and circuit board illustrations, located in the diagrams section. Assembly numbers are also marked on each diagram and circuit board illustration, in the Diagram section and on the mechanical exploded views, in the mechanical parts list. The component number is obtained by adding the assembly number prefix to the circuit number.

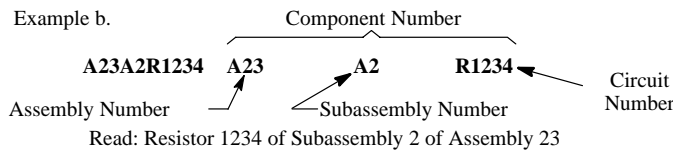
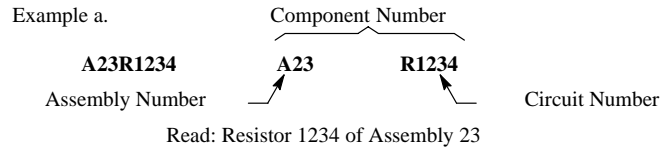

The electrical parts list is arranged by assemblies in numerical sequence (A1, with its subassemblies and parts, precedes A2, with its subassemblies and parts).

Mechanical subparts to the circuit boards are listed in the electrical parts list. These mechanical subparts are listed with their associated electrical part (for example, fuse holder follows fuse).

Chassis-mounted parts and cable assemblies have no assembly number prefix and are located at the end of the electrical parts list.

Tektronix Part No. (Column 2) Indicates part number to be used when ordering replacement part from Tektronix.

Serial/Assembly No. (Column 3 and 4) Column three (3) indicates the serial or assembly number at which the part was first used. Column four (4) indicates the serial or assembly number at which the part was removed. No serial or assembly number entered indicates part is good for all serial numbers.

Name and Description (Column 5) An item name is separated from the description by a colon (:). Because of space limitations, an item name may sometimes appear as incomplete. Use the U.S. Federal Catalog handbook H6-1 for further item name identification.

The mechanical subparts are shown as *ATTACHED PARTS* / *END ATTACHED PARTS* or *MOUNTING PARTS* / *END MOUNTING PARTS* in column five (5).

Mfr. Code (Column 6) Indicates the code number of the actual manufacturer of the part. (Code to name and address cross reference can be found immediately after this page.)

Mfr. Part No. (Column 7) Indicates actual manufacturer's part number.

CROSS INDEX – MFR. CODE NUMBER TO MANUFACTURER

Mfr. Code.	Manufacturer	Address	City, State, Zip Code
04222	AVX CERAMICS	19TH AVE SOUTH	MYRTLE BEACH SC 29577
04713	DIV OF AVX CORP MOTOROLA INC	P O BOX 867 5005 E MCDOWELL RD	PHOENIX AZ 85008-4229
09023	SEMICONDUCTOR PRODUCTS SECTOR CORNELL-DUBILIER ELECTRONICS	2652 DALRYMPLE ST	SANFORD NC 27330
1ES66	DIV FEDERAL PACIFIC ELECTRIC CO MAXIM INTEGRATED PRODUCTS INC	120 SAN GABRIEL DRIVE	SUNNYVALE CA 94086
22526	BERG ELECTRONICS INC (DUPONT)	857 OLD TRAIL RD	ETTERS PA 17319
24165	SPRAGUE ELECTRIC CO	267 LOWELL ROAD	HUDSON NH 03051
32997	BOURNS INC TRIMPOT DIV	1200 COLUMBIA AVE	RIVERSIDE CA 92507-2114
57668	ROHM CORP	8 WHATNEY PO BOX 19515	IRVINE CA 92713
58050	TEKA PRODUCTS INC	45 SALEM ST	PROVIDENCE RI 02907
60395	XICOR INC	851 BUCKEYE CT	MILPITAS CA 95035-7408
71400	BUSSMANN DIV OF COOPER INDUSTRIES INC	114 OLD STATE RD PO BOX 14460	ST LOUIS MO 63178
75915	LITTELFUSE INC SUB TRACOR INC	800 E NORTHWEST HWY	DES PLAINES IL 60016-3049
78189	ILLINOIS TOOL WORKS INC SHAKEPROOF DIV	ST CHARLES ROAD	ELGIN IL 60120
80009	TEKTRONIX INC	14150 SW KARL BRAUN DR PO BOX 500	BEAVERTON OR 97077-0001
91637	DALE ELECTRONICS INC	2064 12TH AVE PO BOX 609	COLUMBUS NE 68601-3632
93907	TEXTRON INC CAMCAR DIV	600 18TH AVE	ROCKFORD IL 61108-5181
TK1134	TUSONIX INC	2155 N FORBES BLVD	TUCSON AZ 85705
TK1920	TOKIN OF AMERICA	2261 FORTUNE DR	SAN JOSE CA 95131

Replaceable Electrical Parts

Component Number	Tektronix Part Number	Serial / Assembly Number Effective	Serial / Assembly Number Discontinued	Name & Description	Mfr. Code	Mfr. Part Number
A1	671-2585-00	B010100	B010456	CIRCUIT BD ASSY:MAIN	80009	671-2585-00
A1	671-2585-01	B010457	B020729	CIRCUIT BD ASSY:MAIN	80009	671-2585-01
A1	671-2585-02	B020730	B021355	CIRCUIT BD ASSY:MAIN	80009	671-2585-02
A1	671-2585-03	B021356	B021854	CIRCUIT BD ASSY:MAIN	80009	671-2585-03
A1	671-2585-04	B021855	B023288	CIRCUIT BD ASSY:MAIN	80009	671-2585-03
A1	671-2585-05	B023289		CIRCUIT BD ASSY:MAIN (STANDARD ONLY)	80009	671-2585-03
A1	671-2896-00	B010100	B010456	CIRCUIT BD ASSY:MAIN	80009	671-2896-00
A1	671-2896-01	B010457	B020729	CIRCUIT BD ASSY:MAIN	80009	671-2896-01
A1	671-2896-02	B020730	B021355	CIRCUIT BD ASSY:MAIN	80009	671-2896-02
A1	671-2896-03	B021356	B021564	CIRCUIT BD ASSY:MAIN	80009	671-2896-03
A1	671-2896-04	B021565	B023288	CIRCUIT BD ASSY:MAIN	80009	671-2896-04
A1	671-2896-05	B023289		CIRCUIT BD ASSY:MAIN (OPTION 1J ONLY)	80009	671-2896-05
A2	671-2586-00	B010100	B021651	CIRCUIT BD ASSY:KEYBOARD	80009	671-2586-00
A2	671-2586-01	B021652		CIRCUIT BD ASSY:KEYBOARD	80009	671-2586-01
A3	119-4506-00	B010100	B023288	DISPLAY,MODULE:	80009	119-4506-00
A3	119-5566-00	B023289		DISPLAY,MODULE:	80009	119-5566-00
A1	671-2585-00	B010100	B010456	CIRCUIT BD ASSY:MAIN	80009	671-2585-00
A1	671-2585-01	B010457	B020729	CIRCUIT BD ASSY:MAIN	80009	671-2585-01
A1	671-2585-02	B020730	B021355	CIRCUIT BD ASSY:MAIN	80009	671-2585-02
A1	671-2585-03	B021356		CIRCUIT BD ASSY:MAIN (STANDARD ONLY)	80009	671-2585-03
A1	671-2896-00	B010100	B010456	CIRCUIT BD ASSY:MAIN	80009	671-2896-00
A1	671-2896-01	B010457	B020729	CIRCUIT BD ASSY:MAIN	80009	671-2896-01
A1	671-2896-02	B020730	B021355	CIRCUIT BD ASSY:MAIN	80009	671-2896-02
A1	671-2896-03	B021356	B021564	CIRCUIT BD ASSY:MAIN	80009	671-2896-03
A1	671-2896-04	B021565		CIRCUIT BD ASSY:MAIN (OPTION 1J ONLY)	80009	671-2896-04
	131-5527-00			*ATTACHED PARTS* JACK,POWER DC:	80009	131-5527-00
				END ATTACHED PARTS		
A1C1	283-5267-00			CAP,FXD,CER:MLC:1UF,+80%-20%,25V,Y5V,1206; SMD,T&R	80009	283-5267-00
A1C2	283-5114-00			CAP,FXD,CER:MLC:0.1UF,10%,50V,X7R,1206;SMD, 8MM T&R	04222	12065C104KAT1A
A1C4	283-5114-00			CAP,FXD,CER:MLC:0.1UF,10%,50V,X7R,1206;SMD, 8MM T&R	04222	12065C104KAT1A
A1C5	283-5114-00			CAP,FXD,CER:MLC:0.1UF,10%,50V,X7R,1206;SMD, 8MM T&R	04222	12065C104KAT1A
A1C7	283-5107-00			CAP,FXD,CER:MLC:22PF,5%,100V,NPO,1206;SMD, 8MM T&R	04222	12061A220JAT1A
A1C8	283-5267-00			CAP,FXD,CER:MLC:1UF,+80%-20%,25V,Y5V,1206; SMD,T&R	80009	283-5267-00
A1C9	283-5267-00			CAP,FXD,CER:MLC:1UF,+80%-20%,25V,Y5V,1206; SMD,T&R	80009	283-5267-00
A1C10	283-5267-00			CAP,FXD,CER:MLC:1UF,+80%-20%,25V,Y5V,1206; SMD,T&R	80009	283-5267-00
A1C11	283-5267-00			CAP,FXD,CER:MLC:1UF,+80%-20%,25V,Y5V,1206; SMD,T&R	80009	283-5267-00
A1C12	283-5260-00			CAP,FXD,CER:MLC:10UF,+80%-20%,25V,Z5U,5.9X2. 7MM,SM2210,SMD,T&R	TK1920	1E106ZY5UC205MT
A1C14	283-0352-00	671-2585-00	671-2585-01	CAP,FXD,CER DI:86PF,5%,100V	TK1134	8121BXXXP380860J
A1C14	283-0352-00	671-2896-00	671-2896-01	CAP,FXD,CER DI:86PF,5%,100V	TK1134	8121BXXXP380860J
A1C15	283-5267-00			CAP,FXD,CER:MLC:1UF,+80%-20%,25V,Y5V,1206; SMD,T&R	80009	283-5267-00
A1C16	283-5267-00			CAP,FXD,CER:MLC:1UF,+80%-20%,25V,Y5V,1206; SMD,T&R	80009	283-5267-00

Replaceable Electrical Parts

Component Number	Tektronix Part Number	Serial / Assembly Number		Name & Description	Mfr. Code	Mfr. Part Number
		Effective	Discontinued			
A1C17	283-5114-00			CAP,FXD,CER:MLC;0.1UF,10%,50V,X7R,1206;SMD,8MM T&R	04222	12065C104KAT1A
A1C18	283-5114-00			CAP,FXD,CER:MLC;0.1UF,10%,50V,X7R,1206;SMD,8MM T&R	04222	12065C104KAT1A
A1C29	283-5114-00			CAP,FXD,CER:MLC;0.1UF,10%,50V,X7R,1206;SMD,8MM T&R	04222	12065C104KAT1A
A1C30	283-5114-00			CAP,FXD,CER:MLC;0.1UF,10%,50V,X7R,1206;SMD,8MM T&R	04222	12065C104KAT1A
A1C31	283-5114-00			CAP,FXD,CER:MLC;0.1UF,10%,50V,X7R,1206;SMD,8MM T&R	04222	12065C104KAT1A
A1C32	283-5114-00			CAP,FXD,CER:MLC;0.1UF,10%,50V,X7R,1206;SMD,8MM T&R	04222	12065C104KAT1A
A1C33	283-5267-00			CAP,FXD,CER:MLC;1UF,+80%-20%,25V,Y5V,1206;SMD,T&R	80009	283-5267-00
A1C34	283-1055-00			CAP,FXD,MICA:1270 PF 1%, 100 V, 0.34 X 0.31, RDL, T&A	80009	283-1055-00
A1C35	283-0644-01			CAP,FXD,MICA DI:150PF,1%,500V	80009	283-0644-01
A1C36	283-0642-01			CAP,FXD,MICA DI:33PF,2%,500V	09023	CDA10ED330G03
A1C37	283-0674-00			CAP,FXD,MICA DI:85PF,1%,500V	80009	283-0674-00
A1C38	283-0647-01			CAP,FXD,MICA DI:70PF,1%,500V,T&A	09023	CDA15ED700F03
A1C39	283-0646-00			CAP,FXD,MICA DI:170PF,1%,500V,.380H X .460L;RDL	80009	283-0646-00
A1C40	283-0689-00			CAP,FXD,MICA DI:550PF,1%,300V	80009	283-0689-00
A1C41	283-0672-00			CAP,FXD,MICA DI:200PF,1%,500V	80009	283-0672-00
A1C42	283-0689-00			CAP,FXD,MICA DI:550PF,1%,300V	80009	283-0689-00
A1C43	283-0689-00			CAP,FXD,MICA DI:550PF,1%,300V	80009	283-0689-00
A1C44	283-5267-00			CAP,FXD,CER:MLC;1UF,+80%-20%,25V,Y5V,1206;SMD,T&R	80009	283-5267-00
A1C45	283-5267-00			CAP,FXD,CER:MLC;1UF,+80%-20%,25V,Y5V,1206;SMD,T&R	80009	283-5267-00
A1C48	283-5114-00			CAP,FXD,CER:MLC;0.1UF,10%,50V,X7R,1206;SMD,8MM T&R	04222	12065C104KAT1A
A1C49	283-5003-00			CAP,FXD,CER:MLC;0.01UF,10%,50V,X7R,1206;SMD,8MM T&R	80009	283-5003-00
A1C50	283-5197-00			CAP,FXD,CER:MLC;330PF,5%,100V,NPO,1206;SMD,8MM T&R	04222	12061A331JAT1A
A1C53	290-5003-00			CAP,FXD,TANT:47UF,20%,10V,0.287 X 0.169;7343,SMD,13MM,T&R	80009	290-5003-00
A1C54	290-5003-00			CAP,FXD,TANT:47UF,20%,10V,0.287 X 0.169;7343,SMD,13MM,T&R	80009	290-5003-00
A1C55	290-5009-00			CAP,FXD,TANT:15UF,20%,25V,0.287 X 0.169;7343,SMD,T&R	24165	293D156X0025D2T
A1C56	290-5009-00			CAP,FXD,TANT:15UF,20%,25V,0.287 X 0.169;7343,SMD,T&R	24165	293D156X0025D2T
A1C57	283-5114-00			CAP,FXD,CER:MLC;0.1UF,10%,50V,X7R,1206;SMD,8MM T&R	04222	12065C104KAT1A
A1C58	283-5114-00	671-2585-00	671-2585-00	CAP,FXD,CER:MLC;0.1UF,10%,50V,X7R,1206;SMD,8MM T&R	04222	12065C104KAT1A
A1C58	283-5211-00	671-2585-01		CAP,FXD,CER:MLC;4700PF,10%,50V,X7R;1206,8MM T&R	80009	283-5211-00
A1C58	283-5114-00	671-2896-00	671-2896-00	CAP,FXD,CER:MLC;0.1UF,10%,50V,X7R,1206;SMD,8MM T&R	04222	12065C104KAT1A
A1C58	283-5211-00	671-2896-01		CAP,FXD,CER:MLC;4700PF,10%,50V,X7R;1206,8MM T&R	80009	283-5211-00
A1CR1	152-5027-00			DIO,RECT:SCHTKY;40V,1A;MBRS140,SMB J-LEAD,12MM TR	80009	152-5027-00
A1CR2	152-5027-00			DIO,RECT:SCHTKY;40V,1A;MBRS140,SMB J-LEAD,12MM TR	80009	152-5027-00
A1CR3	152-5018-00			DIO,SIG:ULTRA FAST;100V,0.74VF,4NS,2.0PF,SER-PR;MMBD1203-H,SOT-23,8MM T&R	80009	152-5018-00

Replaceable Electrical Parts

Component Number	Tektronix Part Number	Serial / Assembly Number		Name & Description	Mfr. Code	Mfr. Part Number
		Effective	Discontinued			
A1CR4	152-5027-00			DIO,RECT:SCHTKY;40V,1A;MBRS140,SMB J-LEAD,12MM TR	80009	152-5027-00
A1CR15	152-0141-02	671-2585-00	671-2585-01	DIO,SIG:ULTRA FAST;40V,150MA,4NS,2PF;1N4152,DO-35,T&R	80009	152-0141-02
A1CR15	152-0141-02	671-2896-00	671-2896-01	DIO,SIG:ULTRA FAST;40V,150MA,4NS,2PF;1N4152,DO-35,T&R	80009	152-0141-02
A1F1	159-0245-00	671-2585-00	671-2585-02	FUSE,WIRE LEAD:1A,125V,FAST	75915	R251001T1
A1F1	159-0153-00	671-2585-03		FUSE,WIRE LEAD:1.5A,125V,FAST BLOW	71400	A1 1/2
A1F1	159-0245-00	671-2896-00	671-2896-02	FUSE,WIRE LEAD:1A,125V,FAST	75915	R251001T1
A1F1	159-0153-00	671-2896-03		FUSE,WIRE LEAD:1.5A,125V,FAST BLOW	71400	A1 1/2
A1J1	131-5542-00			CONN,BOX:	80009	131-5542-00
A1J1	131-5542-01			CONN,BOX:	80009	131-5542-01
	210-0586-00			*MOUNTING PARTS* NUT,PL, ASSY WA:4-40 X 0.25,STL CD PL (QUANTITY 2)	78189	211-041800-00
	211-0101-00			SCR,MACH:4-40 X 0.25,FLH,100 DEG,STL (QUANTITY 2) *END MOUNTING PARTS*	93907	ORDER BY DESCR
A1J2	131-5543-00			CONN,BOX:	80009	131-5543-00
A1J2	131-5543-01			CONN,BOX:	80009	131-5543-01
	210-0586-00			*MOUNTING PARTS* NUT,PL,ASSY WA:4-40 X 0.25,STL CD PL (QUANTITY 2)	78189	211-041800-00
	211-0101-00			SCR,MACH:4-40 X 0.25,FLH,100 DEG,STL (QUANTITY 2) *END MOUNTING PARTS*	93907	ORDER BY DESCR
A1J6	131-4794-00			PCB,;MALE,STR,1 X 2,0.1 CTR,0.235 MLG X 0.112 TAIL,30GOLD,0.035 DIA	58050	082-3644-SS10
A1J7	131-4794-00			PCB,;MALE,STR,1 X 2,0.1 CTR,0.235 MLG X 0.112 TAIL,30GOLD,0.035 DIA	58050	082-3644-SS10
A1J8	131-2919-01			PCB,;MALE,STR,1 X 4,0.1 CTR,0.235 MLG X 0.112 TAIL,30 GOLD,0.035 DIA	58050	082-3644-SS10
A1J9	131-2919-01			PCB,;MALE,STR,1 X 4,0.1 CTR,0.235 MLG X 0.112 TAIL,30 GOLD,0.035 DIA	58050	082-3644-SS10
A1J10	131-5240-00			PCB,;MALE,STR,1 X 5,0.1 CTR,0.230 MLG X 0.120 TAIL,30 GOLD (QUANTITY 5 PINS USED)	58050	082-3644-SS10
A1L4	114-0494-00			COIL:IDCTR,TRNTBL,2.2-3.2UH	80009	114-0494-00
A1L5	114-0494-00			COIL:IDCTR,TRNTBL,2.2-3.2UH	80009	114-0494-00
A1L6	114-0494-00			COIL:IDCTR,TRNTBL,2.2-3.2UH	80009	114-0494-00
A1L7	120-1941-00			XFMR:Z-92079	80009	120-1941-00
A1L8	114-0495-00			COIL:IDCTR,TRNTBL,0.66-098UH	80009	114-0495-00
A1L9	120-1938-00			XFMR:Z-91389E	80009	120-1938-00
A1L10	108-5018-00	671-2585-00	671-2585-00	COIL,RF:IDCTR;FXD,4.7UH,20%,Q=50,SRF=45MH Z,DCR=1.0 OHM,IMAX=315MA;1812 PKG,12MM	80009	108-5018-00
A1L10	108-5015-00	671-2585-01		COIL,RF:IDCTR;FXD,100UH,10%,Q=40,SRF=8.0MH Z,DCR=8 OHM,IMAX=110MA;1812 PKG,12MM T&R	80009	108-5015-00
A1L10	108-5018-00	671-2896-00	671-2896-00	COIL,RF:IDCTR;FXD,4.7UH,20%,Q=50,SRF=45MH Z,DCR=1.0 OHM,IMAX=315MA;1812 PKG,12MM	80009	108-5018-00
A1L10	108-5015-00	671-2896-01		COIL,RF:IDCTR;FXD,100UH,10%,Q=40,SRF=8.0MH Z,DCR=8 OHM,IMAX=110MA;1812 PKG,12MM T&R	80009	108-5015-00
A1L11	120-1939-00			XFMR:Z-92266	80009	120-1939-00
A1Q1	151-5066-00			XSTR,SIG:MOS,N-CH;60V,0.115A,7.5 OHM;2N7002,TO-236/SOT-23,8MM T&R	80009	151-5066-00
A1Q2	151-5066-00			XSTR,SIG:MOS,N-CH;60V,0.115A,7.5 OHM;2N7002,TO-236/SOT-23,8MM T&R	80009	151-5066-00
A1Q3	151-5066-00			XSTR,SIG:MOS,N-CH;60V,0.115A,7.5 OHM;2N7002,TO-236/SOT-23,8MM T&R	80009	151-5066-00
A1Q4	151-5066-00			XSTR,SIG:MOS,N-CH;60V,0.115A,7.5 OHM;2N7002,TO-236/SOT-23,8MM T&R	80009	151-5066-00

Replaceable Electrical Parts

Component Number	Tektronix Part Number	Serial / Assembly Number		Name & Description	Mfr. Code	Mfr. Part Number
		Effective	Discontinued			
A1Q5	151-5066-00			XSTR,SIG:MOS,N-CH:60V,0.115A,7.5 OHM;2N7002,TO-236/SOT-23,8MM T&R	80009	151-5066-00
A1Q6	151-5044-00			XSTR,PWR:BIPOLAR,PNP;100V,3.0A,3.0MHZ,AMPL:MJD32C,TO-252/DPAK,16MM T&R	04713	MJD32RL
A1R1	311-5036-00			RES,VAR,TRMR:CERMET;5K OHM,25%,0.25W,4MM SQ,TOP ADJ;SMD,T&R	80009	311-5036-00
A1R2	307-5041-00			RES NTWK,FXD,FI:4.7K OHM,2%,0.125W	32997	4816P-002-472
A1R6	321-5113-00			RES,FXD:THK FILM;75 OHM,1%,0.125W,TC=100 PPM;1206,T&R	80009	321-5113-00
A1R7	311-5036-00			RES,VAR,TRMR:CERMET;5K OHM,25%,0.25W,4MM SQ,TOP ADJ;SMD,T&R	80009	311-5036-00
A1R8	321-5029-00			RES,FXD:THK FILM;8.25K OHM,1%,0.125W,TC=100 PPM;1206,T&R	80009	321-5029-00
A1R9	321-5007-00			RES,FXD:THK FILM;121 OHM,1%,0.125W,TC=100 PPM;1206,T&R	80009	321-5007-00
A1R10	321-5015-00			RES,FXD:THK FILM;562 OHM,1%,0.125W,TC=100 PPM;1206,T&R	80009	321-5015-00
A1R11	321-5022-00			RES,FXD:THK FILM;2.21K OHM,1%,0.125W,TC=100 PPM;1206,T&R	80009	321-5022-00
A1R13	321-5113-00			RES,FXD:THK FILM;75 OHM,1%,0.125W,TC=100 PPM;1206,T&R	80009	321-5113-00
A1R14	321-5113-00			RES,FXD:THK FILM;75 OHM,1%,0.125W,TC=100 PPM;1206,T&R	80009	321-5113-00
A1R15	317-0512-00	671-2585-00	671-2585-01	RES,FXD,CMPSN:5.1K OHM,5%,0.125	80009	317-0512-00
A1R15	317-0512-00	671-2896-00	671-2896-01	RES,FXD,CMPSN:5.1K OHM,5%,0.125	80009	317-0512-00
A1R16	321-5000-00			RES,FXD:THK FILM;10 OHM,1%,0.125W,TC=100 PPM;1206,T&R	57668	MCR18EZHF10E
A1R18	321-5032-00	671-2585-00	671-2585-00	RES,FXD:THK FILM;15.0K OHM,1%,0.125W,TC=100 PPM;1206,T&R	80009	321-5032-00
A1R18	321-5033-00	671-2585-01		RES,FXD:THK FILM;18.2K OHM,1%,0.125W,TC=100 PPM;1206,T&R	80009	321-5033-00
A1R18	321-5032-00	671-2896-00	671-2896-00	RES,FXD:THK FILM;15.0K OHM,1%,0.125W,TC=100 PPM;1206,T&R	80009	321-5032-00
A1R18	321-5033-00	671-2896-01		RES,FXD:THK FILM;18.2K OHM,1%,0.125W,TC=100 PPM;1206,T&R	80009	321-5033-00
A1R20	321-5315-00			RES,FXD,FILM;24.9 OHM,1%,0.125W,SMD,1206	91637	24.9 OHM
A1R21	321-5315-00			RES,FXD,FILM;24.9 OHM,1%,0.125W,SMD,1206	91637	24.9 OHM
A1R22	321-5029-00	671-2585-00	671-2585-00	RES,FXD:THK FILM;8.25K OHM,1%,0.125W,TC=100 PPM;1206,T&R	80009	321-5029-00
A1R22	321-5031-00	671-2585-01		RES,FXD:THK FILM;12.1K OHM,1%,0.125W,TC=100 PPM;1206,T&R	80009	321-5031-00
A1R22	321-5029-00	671-2896-00	671-2896-00	RES,FXD:THK FILM;8.25K OHM,1%,0.125W,TC=100 PPM;1206,T&R	80009	321-5029-00
A1R22	321-5031-00	671-2896-01		RES,FXD:THK FILM;12.1K OHM,1%,0.125W,TC=100 PPM;1206,T&R	80009	321-5031-00
A1R23	321-5030-00			RES,FXD:THK FILM;10.0K OHM,1%,0.125W,TC=100 PPM;1206,T&R	80009	321-5030-00
A1R24	321-5030-00			RES,FXD:THK FILM;10.0K OHM,1%,0.125W,TC=100 PPM;1206,T&R	80009	321-5030-00
A1R25	321-5022-00			RES,FXD:THK FILM;2.21K OHM,1%,0.125W,TC=100 PPM;1206,T&R	80009	321-5022-00
A1R26	321-5000-00			RES,FXD:THK FILM;10 OHM,1%,0.125W,TC=100 PPM;1206,T&R	57668	MCR18EZHF10E
A1R28	321-5048-00			RES,FXD:THK FILM;332K OHM,1%,0.125W,TC=100 PPM;1206,T&R	80009	321-5048-00
A1R29	321-5047-00			RES,FXD:THK FILM;100K OHM,1%,0.125W,TC=100 PPM;1206,T&R	80009	321-5047-00
A1R30	321-5030-00			RES,FXD:THK FILM;10.0K OHM,1%,0.125W,TC=100 PPM;1206,T&R	80009	321-5030-00
A1R32	321-5027-00			RES,FXD:THK FILM;5.62K OHM,1%,0.125W,TC=100 PPM;1206,T&R	80009	321-5027-00

Replaceable Electrical Parts

Component Number	Tektronix Part Number	Serial / Assembly Number		Name & Description	Mfr. Code	Mfr. Part Number
		Effective	Discontinued			
A1R33	321-5023-00			RES,FXD:THK FILM;2.74K OHM,1%,0.125W,TC=100 PPM;1206,T&R	80009	321-5023-00
A1R34	321-5023-00			RES,FXD:THK FILM;2.74K OHM,1%,0.125W,TC=100 PPM;1206,T&R	80009	321-5023-00
A1R35	321-5027-00			RES,FXD:THK FILM;5.62K OHM,1%,0.125W,TC=100 PPM;1206,T&R	80009	321-5027-00
A1R36	321-5024-00	671-2585-00	671-2585-00	RES,FXD:THK FILM;3.32K OHM,1%,0.125W,TC=100 PPM;1206,T&R	80009	321-5024-00
A1R36	321-5021-00	671-2585-01		RES,FXD:THK FILM;1.82K OHM,1%,0.125W,TC=100 PPM;1206,T&R	80009	321-5021-00
A1R36	321-5024-00	671-2896-00	671-2896-00	RES,FXD:THK FILM;3.32K OHM,1%,0.125W,TC=100 PPM;1206,T&R	80009	321-5024-00
A1R36	321-5021-00	671-2896-01		RES,FXD:THK FILM;1.82K OHM,1%,0.125W,TC=100 PPM;1206,T&R	80009	321-5021-00
A1R37	321-5024-00	671-2585-00	671-2585-00	RES,FXD:THK FILM;3.32K OHM,1%,0.125W,TC=100 PPM;1206,T&R	80009	321-5024-00
A1R37	321-5021-00	671-2585-01		RES,FXD:THK FILM;1.82K OHM,1%,0.125W,TC=100 PPM;1206,T&R	80009	321-5021-00
A1R37	321-5024-00	671-2896-00	671-2896-00	RES,FXD:THK FILM;3.32K OHM,1%,0.125W,TC=100 PPM;1206,T&R	80009	321-5024-00
A1R37	321-5021-00	671-2896-01		RES,FXD:THK FILM;1.82K OHM,1%,0.125W,TC=100 PPM;1206,T&R	80009	321-5021-00
A1R38	321-5029-00	671-2585-00	671-2585-00	RES,FXD:THK FILM;8.25K OHM,1%,0.125W,TC=100 PPM;1206,T&R	80009	321-5029-00
A1R38	321-5031-00	671-2585-01		RES,FXD:THK FILM;12.1K OHM,1%,0.125W,TC=100 PPM;1206,T&R	80009	321-5031-00
A1R38	321-5029-00	671-2896-00	671-2896-00	RES,FXD:THK FILM;8.25K OHM,1%,0.125W,TC=100 PPM;1206,T&R	80009	321-5029-00
A1R38	321-5031-00	671-2896-01		RES,FXD:THK FILM;12.1K OHM,1%,0.125W,TC=100 PPM;1206,T&R	80009	321-5031-00
A1R39	321-5032-00	671-2585-00	671-2585-00	RES,FXD:THK FILM;15.0K OHM,1%,0.125W,TC=100 PPM;1206,T&R	80009	321-5032-00
A1R39	321-5033-00	671-2585-01		RES,FXD:THK FILM;18.2K OHM,1%,0.125W,TC=100 PPM;1206,T&R	80009	321-5033-00
A1R39	321-5032-00	671-2896-00	671-2896-00	RES,FXD:THK FILM;15.0K OHM,1%,0.125W,TC=100 PPM;1206,T&R	80009	321-5032-00
A1R39	321-5033-00	671-2896-01		RES,FXD:THK FILM;18.2K OHM,1%,0.125W,TC=100 PPM;1206,T&R	80009	321-5033-00
A1R40	321-5030-00			RES,FXD:THK FILM;10.0K OHM,1%,0.125W,TC=100 PPM;1206,T&R	80009	321-5030-00
A1R41	321-5315-00			RES,FXD,FILM:24.9 OHM,1%,0.125W,SMD,1206	91637	24.9 OHM
A1R42	321-5030-00			RES,FXD:THK FILM;10.0K OHM,1%,0.125W,TC=100 PPM;1206,T&R	80009	321-5030-00
A1R43	321-5315-00			RES,FXD,FILM:24.9 OHM,1%,0.125W,SMD,1206	91637	24.9 OHM
A1R44	321-5169-00			RES,FXD:THK FILM;475K OHM,1%,0.125W,TC=100 PPM;1206,T&R	91637	CRCW1206-47502FT
A1R45	321-5030-00			RES,FXD:THK FILM;10.0K OHM,1%,0.125W,TC=100 PPM;1206,T&R	80009	321-5030-00
A1R50	321-5000-00	671-2585-00	671-2585-00	RES,FXD:THK FILM;10 OHM,1%,0.125W,TC=100 PPM;1206,T&R	57668	MCR18EZHF10E
A1R50	321-5010-00	671-2585-01		RES,FXD:THK FILM;221 OHM,1%,0.125W,TC=100 PPM;1206,T&R	80009	321-5010-00
A1R50	321-5000-00	671-2896-00	671-2896-00	RES,FXD:THK FILM;10 OHM,1%,0.125W,TC=100 PPM;1206,T&R	57668	MCR18EZHF10E
A1R50	321-5010-00	671-2896-01		RES,FXD:THK FILM;221 OHM,1%,0.125W,TC=100 PPM;1206,T&R	80009	321-5010-00
A1R51	321-5030-00			RES,FXD:THK FILM;10.0K OHM,1%,0.125W,TC=100 PPM;1206,T&R	80009	321-5030-00
A1R52	311-5033-00			RES,VAR,TRMR:CERMET;500 OHM,25%,0.25W,4MM SQ, TOP ADJ;SMD,T&R	32997	3314J-1-501G

Replaceable Electrical Parts

Component Number	Tektronix Part Number	Serial / Assembly Number		Name & Description	Mfr. Code	Mfr. Part Number
		Effective	Discontinued			
A1R53	311-5038-00	671-2585-00	671-2585-03	RES,VAR,TRMR:CERMET;20K OHM,25%,0.25W,4MM SQ,TOP ADJ;SMD,T&R	80009	311-5038-00
A1R53	311-5040-00	671-2585-04		RES,VAR,TRMR:CERMET;10K OHM,25%,0.25W,4MM SQ,TOP ADJ;SMD,T&R	32997	3314J-1-103E
A1R53	311-5038-00	671-2896-00	671-2896-03	RES,VAR,TRMR:CERMET;20K OHM,25%,0.25W,4MM SQ,TOP ADJ;SMD,T&R	80009	311-5038-00
A1R53	311-5040-00	671-2896-04		RES,VAR,TRMR:CERMET;10K OHM,25%,0.25W,4MM SQ,TOP ADJ;SMD,T&R	32997	3314J-1-103E
A1R54	321-5026-00			RES,FXD:THK FILM;4.75K OHM,1%,0.125W,TC=100 PPM;1206,T&R	80009	321-5026-00
A1R55	321-5026-00			RES,FXD:THK FILM;4.75K OHM,1%,0.125W,TC=100 PPM;1206,T&R	80009	321-5026-00
A1R56	321-5015-00			RES,FXD:THK FILM;562 OHM,1%,0.125W,TC=100 PPM;1206,T&R	80009	321-5015-00
A1R57	321-5000-00			RES,FXD:THK FILM;10 OHM,1%,0.125W,TC=100 PPM;1206,T&R	57668	MCR18EZHF10E
A1R58	321-5001-00			RES,FXD:THK FILM;12.1 OHM,1%,0.125W,TC=100 PPM;1206,T&R	57668	MCR18EZHF12E1
A1R63	321-5030-00	671-2585-04		RES,FXD:THK FILM;10.0K OHM,1%,0.125W,TC=100 PPM;1206,T&R	80009	321-5030-00
A1R63	321-5030-00	671-2896-04		RES,FXD:THK FILM;10.0K OHM,1%,0.125W,TC=100 PPM;1206,T&R	80009	321-5030-00
A1U1	156-6491-00			IC, MEM:	80009	156-6491-00
A1U2	160-9402-00	671-2585-00	671-2585-01	IC, DGTL:PRGM	80009	160-9402-00
A1U2	160-9402-01	671-2585-02		IC, DGTL:CMOS,MICROCMPT;8-BIT,2 T,USART,A/D,16K OTP,1,25MHZ;78CP14,PLCC68	80009	160-9402-01
A1U2	160-9402-00	671-2896-00	671-2896-01	IC, DGTL:PRGM	80009	160-9402-00
A1U2	160-9402-01	671-2896-02	671-2896-03	IC, DGTL:CMOS,MICROCMPT;8-BIT,2 T,USART,A/D,16K OTP,1,25MHZ;78CP14,PLCC68	80009	160-9402-01
A1U2	160-9781-00	671-2896-04		IC, DGTL:CMOS,MICROCMPT;8-BIT,2 T,USART,A/D,16K OTP,1,25 MHZ;78CP14,PLCC68	80009	160-9781-00
A1U4	156-6272-01			IC, MEM:CMOS,EEPROM;256 X 8,SER:24C02,SO8.15,T&R	60395	X24C02S8 T&R
A1U5	160-9403-00	671-2585-00		IC, DGTL:PRGM	80009	160-9403-00
A1U5	160-9572-00	671-2896-00	671-2896-03	IC, MEM:27HC642-35DC	80009	160-9572-00
A1U5	160-9572-01	671-2896-04		IC, MEM:CMOS,EPROM;8K X 8,35NS,DIP24.3	80009	160-9572-01
A1U6	160-9405-00			IC, DGTL:PRGM	80009	160-9405-00
A1U7	160-9404-00	671-2585-00		IC, DGTL:PRGM	80009	160-9404-00
A1U7	160-9571-00	671-2896-00	671-2896-03	IC, MEM:CMOS,EPROM;64K X 8,150NS;27C512,PLCC32	80009	160-9571-00
A1U7	160-9571-01	671-2896-04		IC, MEM:CMOS,EPROM;64K X 8,150NS;27C512,PLCC32	80009	160-9571-01
A1U8	156-6591-00			IC, DGTL:CMOS,PLD	80009	156-6591-00
A1U11	156-6560-00			IC, LIN:BIPOLAR,OP-AMP;CUR FDBK,100MHZ,H OUT CUR:OPA603AU,SO16.300	80009	156-6560-00
A1U12	156-6518-00			IC, MISC:CMOS,WAVEFORM GENERATOR;DIG PROJ	80009	156-6518-00
A1U13	156-6519-00			IC, LIN:BIPOLAR,OP-AMP;DUAL	04713	MC33102D
A1U14	156-6561-00			IC, CONV. BIPOLAR,D/A;10 BIT,60MHZ,CURRENT OUT	80009	156-6561-00
A1U15	156-6560-00			IC, LIN:BIPOLAR,OP-AMP;CUR FDBK,100MHZ,H OUT CUR:OPA603AU,SO16.300	80009	156-6560-00
A1U16	156-6562-00			IC, MEM:X9C103S8	80009	156-6562-00
A1U17	156-6519-00			IC, LIN:BIPOLAR,OP-AMP;DUAL	04713	MC33102D
A1U18	156-6520-00			IC, LIN:CMOS,SW-REGULATOR;PWM,CURRENT MODE	1ES66	MAX738CWE
A1U20	156-5588-00			IC, LIN:BIPOLAR,V REF:2.5V, 1%;MC1403,SO8.150,TUBE	80009	156-5588-00
A1U21	156-5155-00			IC, DGTL:HCMOS,GATE;HEX INV;74HC04,SO14.150,TUBE	80009	156-5155-00

Replaceable Electrical Parts

Component Number	Tektronix Part Number	Serial / Assembly Number		Name & Description	Mfr. Code	Mfr. Part Number
		Effective	Discontinued			
A1U22	156-5076-00			IC,DGTL:CMOS,FLIP FLOP:DUAL D-TYPE;4013B,SO14.150,TUBE	80009	156-5076-00
A1Y1	119-4503-00			OSC:14.31818MHZ	80009	119-4503-00
A2	671-2586-00	B010100	B021651	CIRCUIT BD ASSY:KEYBOARD	80009	671-2586-00
A2	671-2586-01	B021652		CIRCUIT BD ASSY:KEYBOARD	80009	671-2586-01
A2J1	131-0787-00	671-2586-00	671-2586-00	TERM,PIN:	22526	47359-001
A2J1	131-5781-00	671-2586-01		CONN,HDR:PCB;MALE,STR,2 X 10,0.1 CTR,0.380 MLG X 0.09 TAIL,GLD (QUANTITY 20)	80009	131-5781-00
A2J2						
A3	119-4506-00			DISPLAY,MODULE:	80009	119-4506-00
W1	174-3002-00			CABLE ASSY:WITH/XLR 131-3207-00	80009	174-3002-00
W2	174-3002-00			CABLE ASSY:WITH/XLR 131-3207-00	80009	174-3002-00



Diagrams/Circuit Board Illustrations

Section 6

Diagrams/Circuit Board Illustrations

Symbols

Graphic symbols and class designation letters are based on ANSI Standard Y32.2–1975.

Logic symbology is based on ANSI Y32.14–1973 in terms of positive logic. Logic symbols depict the logic function performed and may differ from the manufacturer's data.

Overline, parenthesis, or leading slash indicate a low asserting state.

Example: $\overline{\text{ID CONTROL}}$, (ID CONTROL), or /ID CONTROL.

Abbreviations are based on ANSI Y1.1–1972.

Other ANSI standards that are used in the preparation of diagrams by Tektronix, Inc. are:

Y14.15, 1966 — Drafting Practices.

Y14.2, 1973 — Line Conventions and Lettering.

Y10.5, 1968 — Letter Symbols for Quantities Used in Electrical Science and Electrical Engineering.

American National Standard Institute
1430 Broadway, New York, New York 10018

Component Values

Electrical components shown on the diagrams are in the following units unless noted otherwise:

Capacitors Values one or greater are in picofarads (pF).
 Values less than one are in microfarads (μF).

Resistors Ohms (Ω).

The following information and special symbols may appear in this manual.

Assembly Numbers

Each assembly in the instrument is assigned an assembly number (e.g., A20). The assembly number appears on the diagram (in circuit board outline), circuit board illustration title, and lookup table for the schematic diagram.

The Replaceable Electrical Parts List is arranged by assembly number in numerical sequence; the components are listed by component number. Example:

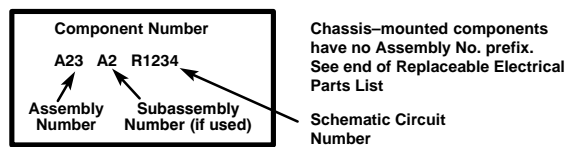

Grid Coordinates

The schematic diagram and circuit board component location illustration have grids. A lookup table with the grid coordinates is provided for ease of locating the component. Only the components illustrated on the facing diagram are listed in the lookup table.

When more than one schematic diagram is used to illustrate the circuitry on a circuit board, the circuit board illustration will only appear opposite the first diagram; the lookup table will list the diagram number of other diagrams that the other circuitry appears on.

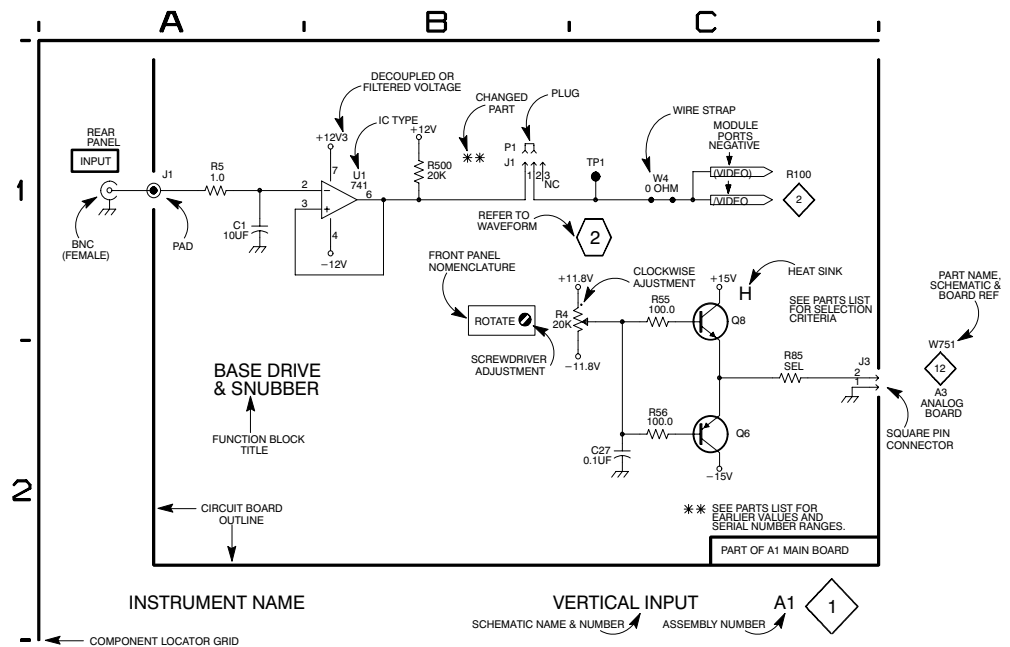

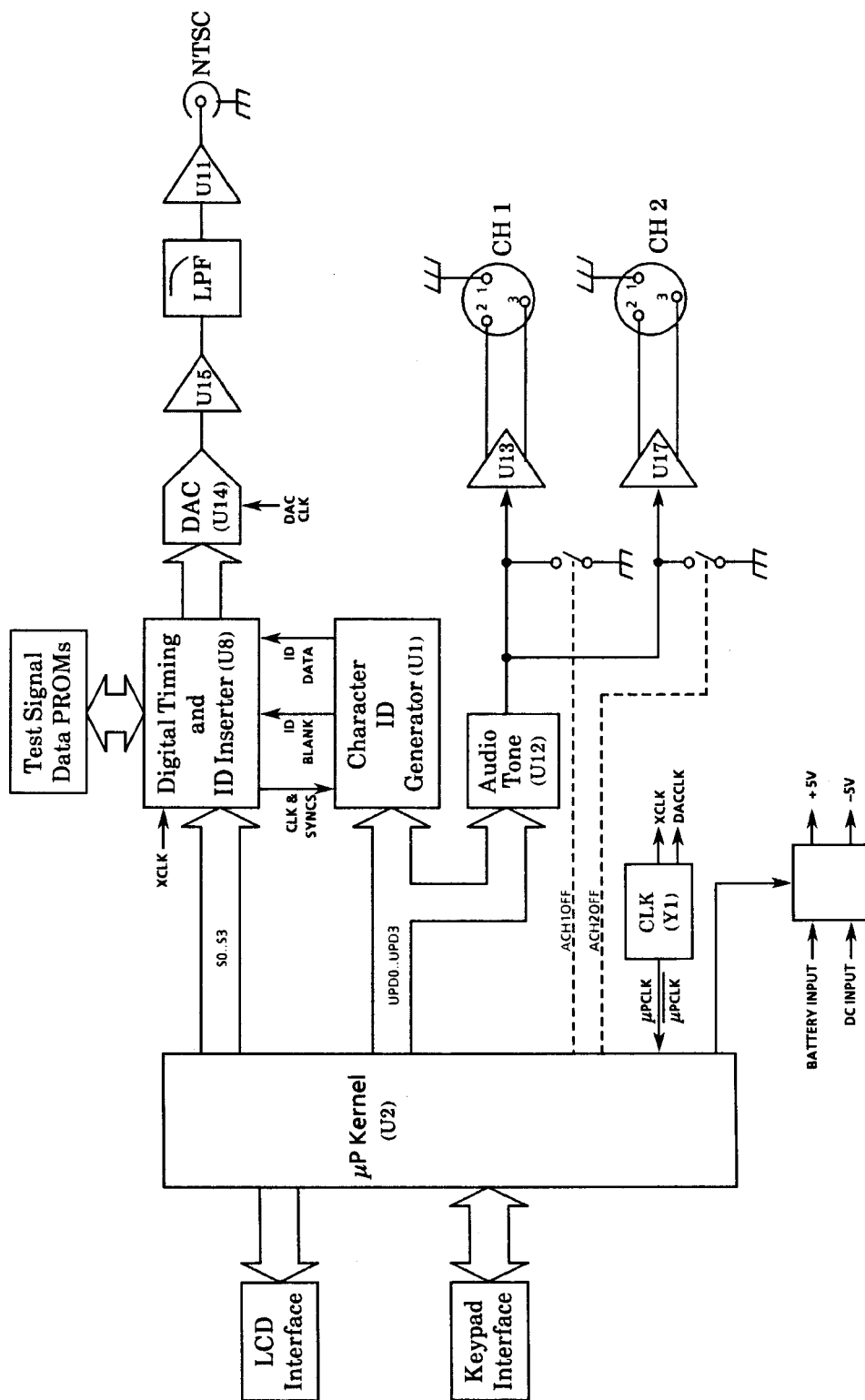

TSG 90 Block Diagram

**Schematic Diagram A2 <1>
Key Board Component Locator Chart**

The schematic diagram has an alpha-numeric grid to assist in locating parts within that diagram.

Assembly A2.

Comp No	Diag Loc	Bd Loc	Comp No	Diag Loc	Bd Loc	Comp No	Diag Loc	Bd Loc
J1	H1	B6	S14	D3	C4	S29	C4	B5
			S15	D3	C3	S30	D4	C5
S1	A1	A1	S16	D2	C3	S31	D3	C4
S2	A1	A1	S17	D2	C2	S32	D3	C3
S3	A2	A2	S18	D1	C1	S33	D2	C3
S4	A2	A3	S19	D1	C1	S34	D2	C2
S5	A3	A3	S20	D1	B1			
S6	A3	A4				S35	D1	C2
S7	A4	A5	S21	C1	B1	S36	C1	B1
S8	A4	C1	S22	B1	A1	S37	C2	B2
S9	B4	A5	S23	B1	A1	S38	C2	B3
S10	C4	B5	S24	B2	A2	S39	C3	B3
			S25	B2	A3	S40	C3	B4
S11	D4	C5	S26	B3	A3	S41	G2	A5
S12	D4	C5	S27	B3	A4			
S13	D4	C5	S28	B4	A5			

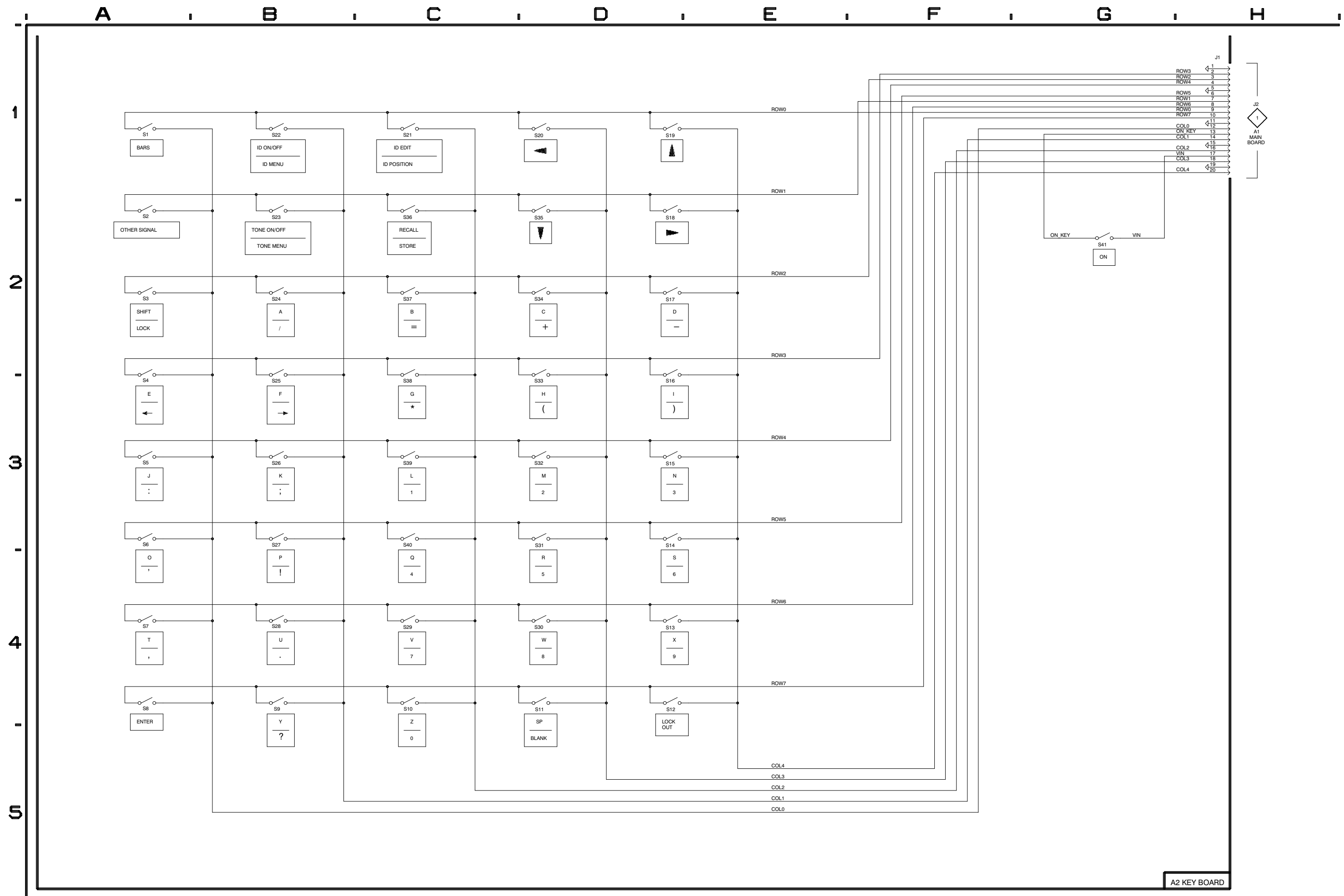

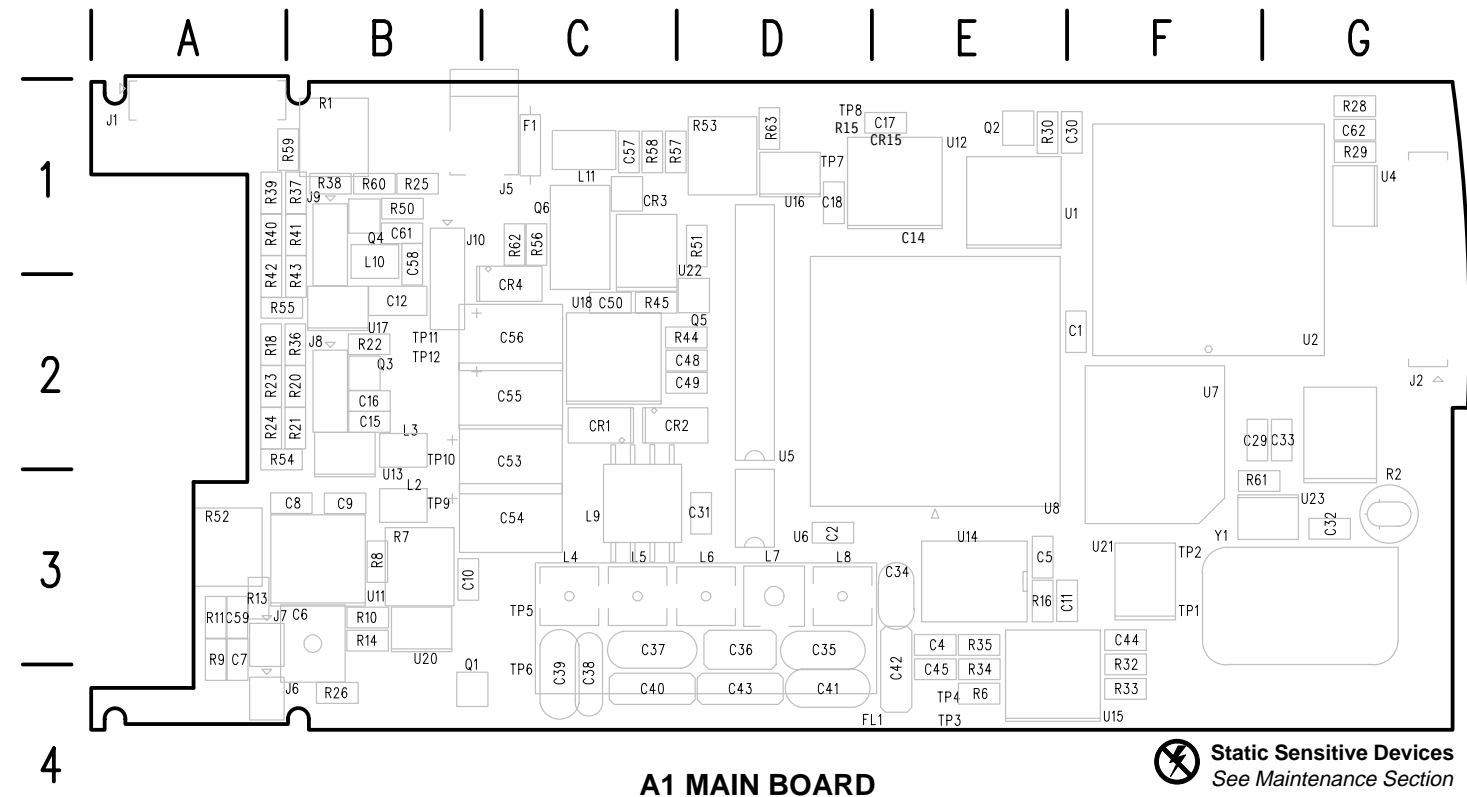

A1 MAIN BOARD Component Locator (Partial Assembly A1 also shown on schematic A1< 2 >)
The schematic diagram has an alpha-numeric grid to assist in locating parts within that diagram.

Comp No	Diag No	Diag Loc	Bd Loc	Comp No	Diag No	Diag Loc	Bd Loc	Comp No	Diag No	Diag Loc	Bd Loc	Comp No	Diag No	Diag Loc	Bd Loc	Comp No	Diag No	Diag Loc	Bd Loc				
C1	1	F5	F2	C41	2	D1	D4	J7	2	H1	A3	R11	2	G2	A3	R44	2	E5	C2	U5	1	H5	D2
C2	1	G5	D3	C42	2	D2	E4	J8	2	H3	B2	R13	2	H1	A3	R45	2	C5	C2	U6	1	D4	D3
C4	2	C1	E3	C43	2	E1	D4	J9	2	H3	B1	R14	2	G1	B3	R50	2	D3	B1	U7	1	H3	F3
C5	2	B2	E3	C44	2	C1	F3	J10	2	A5	B1	R15	2	B3	D1	R51	2	C5	D1				
C6	2	G2	B3	C45	2	C1	E4					R16	2	A1	E3	R52	2	G1	A3	U8	1	E3	E3
C7	2	G2	A4					L2	2	G4	B3	R18	2	F2	A2	R53	2	B3	C1	U11	2	G1	B3
C8	2	G1	B3	C48	2	E5	D2	L3	2	G5	B2	R54	2	G3	A2	R54	2	G3	A2	U12	2	C3	E1
C9	2	G1	B3	C49	2	F5	D2	L4	2	E1	C3	R20	2	G3	B2	R55	2	G4	A2	U13A	2	F3	B3
C10	2	B2	B3	C50	2	F5	C2	L5	2	E1	C3	R21	2	H3	B2	R56	2	B5	C1	U13B	2	G3	B3
C11	2	A1	F3	C53	2	F5	C2	L6	2	D1	D3	R22	2	E3	B2	R57	2	C5	C1	U14	2	B1	E3
				C54	2	F4	C3	L7	2	D1	D3	R23	2	G3	A2	R58	2	C5	C1	U15	2	C1	F4
C12	2	E3	B2	C55	2	C5	C2	L8	2	D2	D3	R24	2	G3	A2	R63**	2	B3	C1	U16	2	B3	D1
C14	2	C3	D1	C56	2	C5	C2	L9	2	F5	D2	R25	1	G1	B1					U17A	2	F3	B2
C15	2	F3	B2	C57	2	B5	C1	L10	2	D3	B1	R26	1	H2	B4	TP1	1	A3	F3				
C16	2	F3	B2	C58	2	E3	B2	L11	2	B5	C1	R28	1	A2	G1	TP2	1	A4	F3	U17B	2	G4	B2
C17	2	D3	D1	C59	2	H1	A3					R29	1	A2	G1	TP3	2	C1	E4	U18	2	E5	C2
C18	2	D3	D1					Q1	1	H2	B4	R30	1	A2	E1	TP4	2	C1	E4	U20	2	A2	B3
C29	1	C3	F2	CR1	2	F5	C2	Q2	1	B2	E1	R32	2	B1	F4	TP5	2	F1	C3	U21A	1	B4	F3
C30	1	G2	F1	CR2	2	F5	C2	Q3	2	F3	B2	R33	2	B1	F4	TP6	2	F1	C4	U21B	1	B4	F3
C31	1	H5	D3	CR3	2	B5	C1	Q4	2	F4	B1	R34	2	C1	E4	TP7	2	D3	D1	U21C	1	B4	F3
C32	1	A4	F3	CR7	2	E5		Q5	2	C5	D2	R35	2	B1	E3	TP8	2	D3	D1	U21D	1	B4	F3
C33	1	B3	G2	CR4	2	D4	C2	Q6	2	B5	C1	R36	2	F3	B2	TP9	2	G4	B3	U21E	1	B4	F3
				CR15	2	C3	D1					R37	2	F3	B1	TP10	2	G4	B2	U21F	1	B4	F3
C34	2	D2	E3					R1	1	G1	B1	R38	2	E3	B1	TP11	2	G5	B2	U22A	2	D5	D2
C35	2	D1	D3	F1	2	B5	C1	R2	1	B1	G3	R39	2	F3	A1	TP12	2	G5	B2	U22B	2	D4	D2
C36	2	E1	D3					R6	2	C1	E4												
C37	2	E1	C3	J1	1	H1	A1	R7	2	G2	B3	R40	2	G4	A1	U1	1	F1	F1	Y1	1	A3	G3
C38	2	E1	C4	J2	1	A1	G2	R8	2	G2	B3	R41	2	G3	B1	U2	1	C2	F2				
C39	2	E1	C4	J5	2	A5	B1	R9	2	G2	A4	R42	2	G4	A2	U4	1	D3	G1				
C40	2	E1	C4	J6	1	H2	A4	R10	2	G2	B3	R43	2	H4	B2								

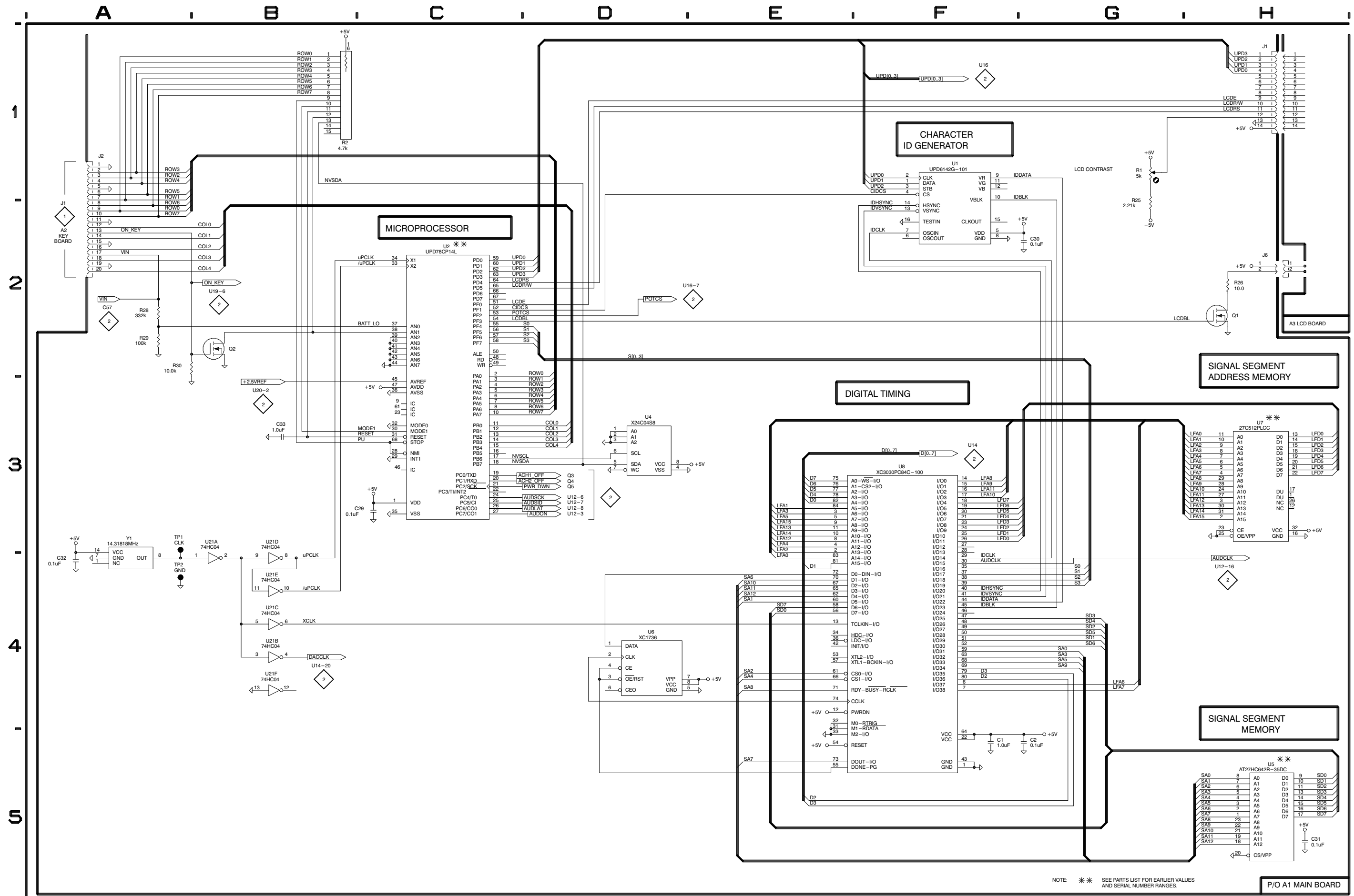

NOTE: ** SEE PARTS LIST FOR EARLIER VALUES AND SERIAL NUMBER RANGES.

P/O A1 MAIN BOARD

**Schematic Diagram A1 < 2 >
Main Board Component Locator Chart**

The schematic diagram has an alpha-numeric grid to assist in locating parts within that diagram.

Assembly A1. Partial Assembly A1 also shown on Schematic A1 < 1 >.

Comp No	Diag Loc	Bd Loc	Comp No	Diag Loc	Bd Loc	Comp No	Diag Loc	Bd Loc
C4	C1	E3	J5	A5	B1	R39	F3	A1
C5	B2	E3	J7	H1	A3	R40	G4	A1
C6	G2	B3	J8	H3	B2	R41	G3	B1
C7	G2	A4	J9	H3	B1			
C8	G1	B3	J10	A5	B1	R42	G4	A2
C9	G1	B3				R43	H4	B2
C10	B2	B3	L2	G4	B3	R44	E5	C2
C11	A1	F3	L3	G5	B2	R45	C5	C2
C12	E3	B2	L4	E1	C3	R50	D3	B1
C14	C3	D1	L5	E1	C3	R51	C5	D1
			L6	D1	D3	R52	G1	A3
C15	F3	B2	L7	D1	D3	R53	B3	C1
C16	F3	B2	L8	D2	D3	R54	G3	A2
C17	D3	D1	L9	F5	D2	R55	G4	A2
C18	D3	D1	L10	D3	B1	R56	B5	C1
C34	D2	E3	L11	B5	C1	R57	C5	C1
C35	D1	D3				R58	C5	C1
C36	E1	D3	Q3	F3	B2	R63**	B3	C1
C37	E1	C3	Q4	F4	B1			
C38	E1	C4	Q5	C5	D2	TP3	C1	E4
C39	E1	C4	Q6	B5	C1	TP4	C1	E4
C40	E1	C4				TP5	F1	C3
C41	D1	D4	R6	C1	E4	TP6	F1	C4
			R7	G2	B3	TP7	D3	D1
C42	D2	E4	R8	G2	B3	TP8	D3	D1
C43	E1	D4	R9	G2	A4	TP9	G4	B3
C44	C1	F3	R10	G2	B3	TP10	G4	B2
C45	C1	E4	R11	G2	A3	TP11	G5	B2
C48	E5	D2	R13	H1	A3	TP12	G5	B2
C49	F5	D2	R14	G1	B3			
C50	F5	C2				U11	G1	B3
C53	F5	C2	R15	B3	D1	U12	C3	E1
C54	F4	C3	R16	A1	E3	U13A	F3	B3
C55	C5	C2	R18	F2	A2	U13B	G3	B3
C56	C5	C2	R20	G3	B2	U14	B1	E3
C57	B5	C1	R21	H3	B2	U15	C1	F4
C58	E3	B2	R22	E3	B2	U16	B3	D1
C59	H1	A3	R23	G3	A2	U17A	F3	B2
			R24	G3	A2	U17B	G4	B2
CR1	F5	C2	R32	B1	F4	U18	E5	C2
CR2	F5	C2				U20	A2	B3
CR3	B5	C1	R33	B1	F4	U22A	D5	D2
CR4	D4	C2	R34	C1	E4	U22B	D4	D2
CR7	E5		R35	B1	E3			
			R36	F3	B2			
CR15	C3	D1	R37	F3	B1			
			R38	E3	B1			
F1	B5	C1						

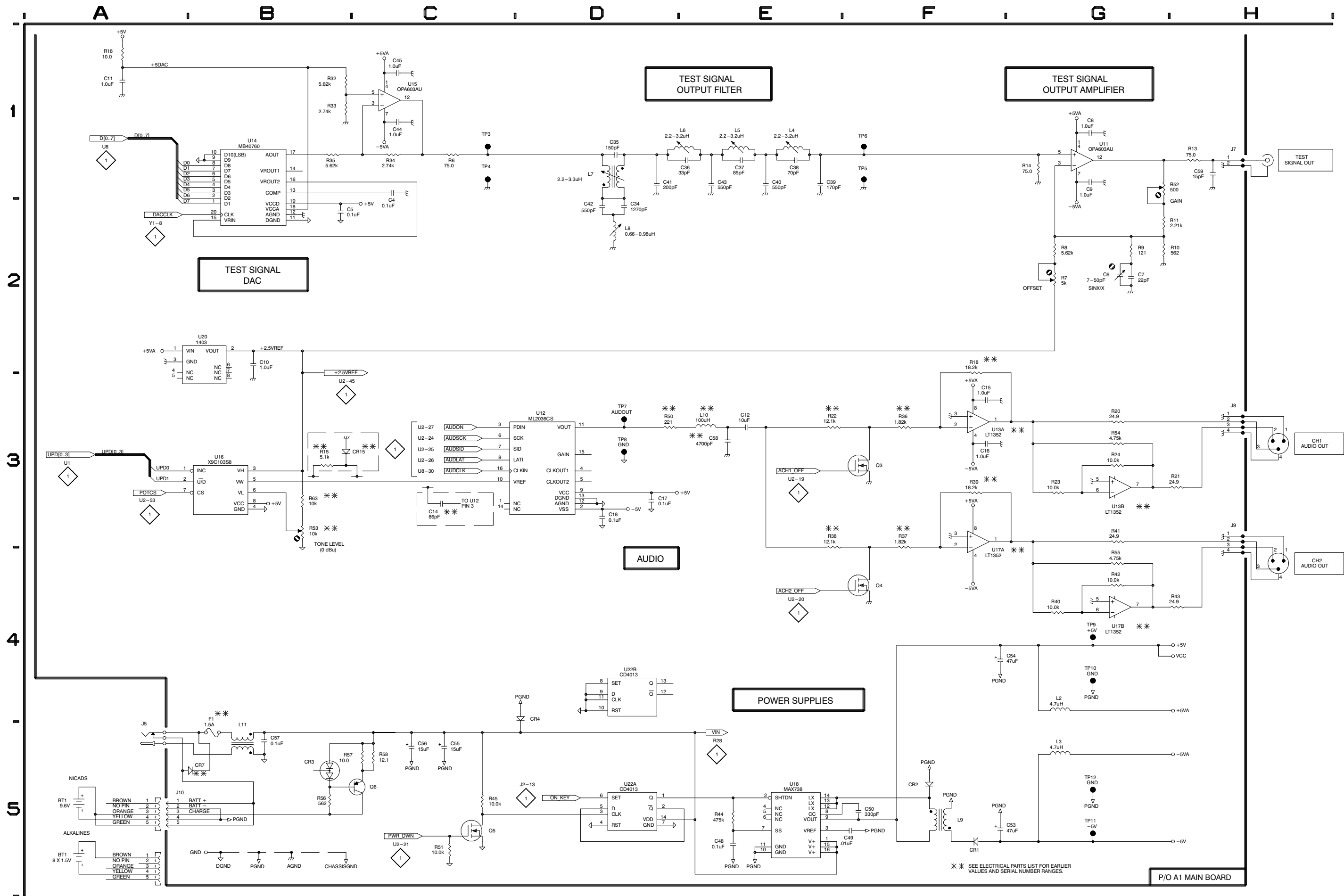



Replaceable Mechanical Parts

Replaceable Mechanical Parts

This section contains a list of the components that are replaceable for the TSG 90. Use this list to identify and order replacement parts. There is a separate Replaceable Mechanical Parts list for each instrument.

Parts Ordering Information

Replacement parts are available from or through your local Tektronix, Inc., Field Office or representative.

Changes to Tektronix instruments are sometimes made to accommodate improved components as they become available and to give you the benefit of the latest circuit improvements. Therefore, when ordering parts, it is important to include the following information in your order.

- Part number
- Instrument type or model number
- Instrument serial number
- Instrument modification number, if applicable

If a part you have ordered has been replaced with a new or improved part, your local Tektronix, Inc., Field Office or representative will contact you concerning any change in part number.

Change information, if any, is located at the rear of this manual.

Using the Replaceable Mechanical Parts List

The tabular information in the Replaceable Mechanical Parts list is arranged for quick retrieval. Understanding the structure and features of the list will help you find all of the information you need for ordering replaceable parts.

Cross Index–Mfr. Code Number to Manufacturer

The Mfg. Code Number to Manufacturer Cross Index for the mechanical parts list is located immediately after this page. The cross index provides codes, names, and addresses of manufacturers of components listed in the mechanical-parts list.

Abbreviations

Abbreviations conform to American National Standards Institute (ANSI) standard Y1.1.

Chassis Parts

Chassis-mounted parts and cable assemblies are located at the end of the Replaceable Electrical Parts list.

Column Descriptions

Figure & Index No. (Column 1)	Items in this section are referenced by figure and index numbers to the illustrations.																																																												
Tektronix Part No. (Column 2)	Indicates part number to be used when ordering replacement part from Tektronix.																																																												
Serial No. (Column 3 and 4)	Column three (3) indicates the serial number at which the part was first used. Column four (4) indicates the serial number at which the part was removed. No serial number entered indicates part is good for all serial numbers.																																																												
Qty (Column 5)	This indicates the quantity of mechanical parts used.																																																												
Name and Description (Column 6)	<p>An item name is separated from the description by a colon (:). Because of space limitations, an item name may sometimes appear as incomplete. Use the U.S. Federal Catalog handbook H6-1 for further item name identification.</p> <p>Following is an example of the indentation system used to indicate relationship.</p> <table border="0" style="margin-left: 20px;"> <tr> <td style="padding-right: 5px;">1</td> <td style="padding-right: 5px;">2</td> <td style="padding-right: 5px;">3</td> <td style="padding-right: 5px;">4</td> <td style="padding-right: 5px;">5</td> <td>Name & Description</td> </tr> <tr> <td></td> <td></td> <td></td> <td></td> <td></td> <td>Assembly and/or Component</td> </tr> <tr> <td></td> <td></td> <td></td> <td></td> <td></td> <td>Mounting parts for Assembly and/or Component</td> </tr> <tr> <td></td> <td></td> <td></td> <td></td> <td></td> <td>*MOUNTING PARTS*/*END MOUNTING PARTS*</td> </tr> <tr> <td></td> <td></td> <td></td> <td></td> <td></td> <td>Detail Part of Assembly and/or Component</td> </tr> <tr> <td></td> <td></td> <td></td> <td></td> <td></td> <td>Mounting parts for Detail Part</td> </tr> <tr> <td></td> <td></td> <td></td> <td></td> <td></td> <td>*MOUNTING PARTS*/*END MOUNTING PARTS*</td> </tr> <tr> <td></td> <td></td> <td></td> <td></td> <td></td> <td>Parts of Detail Part</td> </tr> <tr> <td></td> <td></td> <td></td> <td></td> <td></td> <td>Mounting parts for Parts of Detail Part</td> </tr> <tr> <td></td> <td></td> <td></td> <td></td> <td></td> <td>*MOUNTING PARTS*/*END MOUNTING PARTS*</td> </tr> </table> <p>Mounting Parts always appear in the same indentation as the Item it mounts, while the detail parts are indented to the right. Indented items are part of and included with, the next higher indentation. Mounting parts must be purchased separately, unless otherwise specified.</p>	1	2	3	4	5	Name & Description						Assembly and/or Component						Mounting parts for Assembly and/or Component						*MOUNTING PARTS*/*END MOUNTING PARTS*						Detail Part of Assembly and/or Component						Mounting parts for Detail Part						*MOUNTING PARTS*/*END MOUNTING PARTS*						Parts of Detail Part						Mounting parts for Parts of Detail Part						*MOUNTING PARTS*/*END MOUNTING PARTS*
1	2	3	4	5	Name & Description																																																								
					Assembly and/or Component																																																								
					Mounting parts for Assembly and/or Component																																																								
					MOUNTING PARTS/*END MOUNTING PARTS*																																																								
					Detail Part of Assembly and/or Component																																																								
					Mounting parts for Detail Part																																																								
					MOUNTING PARTS/*END MOUNTING PARTS*																																																								
					Parts of Detail Part																																																								
					Mounting parts for Parts of Detail Part																																																								
					MOUNTING PARTS/*END MOUNTING PARTS*																																																								
Mfr. Code (Column 7)	Indicates the code number of the actual manufacturer of the part. (Code to name and address cross reference can be found immediately after this page.)																																																												
Mfr. Part Number (Column 8)	Indicates actual manufacturer's part number.																																																												

CROSS INDEX – MFR. CODE NUMBER TO MANUFACTURER

Mfr. Code.	Manufacturer	Address	City, State, Zip Code
06090	RAYCHEM CORP	300 CONSTITUTION DRIVE	MENLO PARK CA 94025-1111
12327	FREEWAY CORP	9301 ALLEN DR	CLEVELAND OH 44125-4632
73743	FISCHER SPECIAL MFG CO	111 INDUSTRIAL RD	COLD SPRING KY 41076-9749
80009	TEKTRONIX INC	14150 SW KARL BRAUN DR PO BOX 500	BEAVERTON OR 97077-0001
93907	TEXTRON INC CAMCAR DIV	600 18TH AVE	ROCKFORD IL 61108-5181

Replaceable Mechanical Parts

Fig. & Index No.	Tektronix Part No.	Serial Number		Qty	12345	Name & Description	Mfr. Code	Mfr. Part No.
		Effective	Dscont					
1-1	614-0913-00			1		KIT ASSEMBLY:BATTERY HOLDER SUB ASSEMBLY *MOUNTING PARTS*	80009	614-0913-00
-2	211-0097-00			4		SCREW,MACHINE:4-40 X 0.312,PNH,STL *END MOUNTING PARTS*	93907	ORDER BY DESCR
-3	348-1347-00			4		PAD,CUSHIONING:TSG90	80009	348-1347-00
-4	200-4075-00			1		DOOR,BATTERY:POLYCARBONATE	80009	200-4075-00
-5	333-4065-00			1		PANEL,REAR:POLYCARBONATE	80009	333-4065-00
-6	131-0955-03			1		CONN,RF JACK: *ATTACHED PARTS*	80009	131-0955-03
-7	210-0590-00			1		NUT,PLAIN,HEX:0.375-32 X 0.438 BRS CD PL	73743	28269-402
-8	210-0255-00			1		TERMINAL,LUG:0.391 ID,LOCKING,BRS CD PL	12327	ORDER BY DESCR
	174-3001-00			1		CABLE ASSY:WITH/BNC 131-0955-03	80009	174-3001-00
	162-0531-00			1		INSUL SLVG,ELEC:HT SHRINK,0.165 ID *END ATTACHED PARTS*	06090	VERSAFIT
-9	-----			1		CIRCUIT BD ASSY: (SEE A1 REPL)		
-10	426-2475-00			1		SPACER,BOARD:POLYCARBONATE	80009	426-2475-00
-11	-----			1		CIRCUIT BD ASSY: (SEE A2 REPL)		
-12	119-4487-00		B022754	1		KEYPAD:SILICONE RUBBER	80009	119-4487-00
-12	119-4487-01	B022755		1		KEYPAD:SILICONE RUBBER	80009	119-4487-00
-13	361-1636-00			2		SPACER:SANTOPREN	80009	361-1636-00
-14	-----			1		DISPLAY,MODULE: (SEE A3 REPL)		
-15	614-0915-00			1		KIT ASSEMBLY:378-2073-00,202-0320-00 STANDARD ACCESSORIES	80009	614-0915-00
	016-1229-00			1		CASE,CARRYING:TSG90	80009	016-1229-00
	063-1449-00			1		MANUAL,TECH:OPERATOR,TSG90,CARD	80009	063-1449-00
-16	119-4538-00			1		POWER SUPPLY:NORTH AMERICAN-UL/CSA (STANDARD ONLY)	80009	119-4538-00
	119-4539-00			1		POWER SUPPLY:JAPANESE-T-MAEK (OPTION 1J ONLY)	80009	119-4539-00
						OPTIONAL ACCESSORIES		
-17	119-4488-00			1		BAT PACK ASSY:	80009	119-4488-00
	070-8706-01			1		MANUAL,TECH:SERVICE,TSG90	80009	070-8706-01

FIG. 1 EXPLODED VIEW

