

PARTIAL A8 SWEEP BOARD PARTIAL

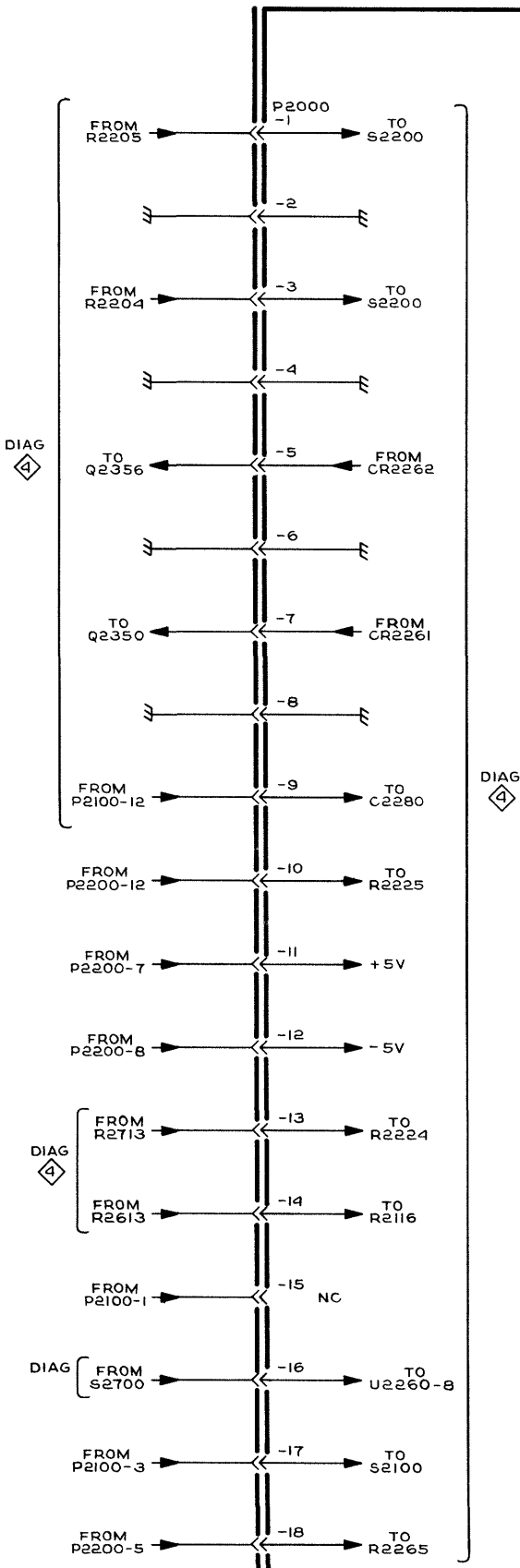

A6 HORIZONTAL BOARD

PARTIAL A7 TRIGGER BOARD

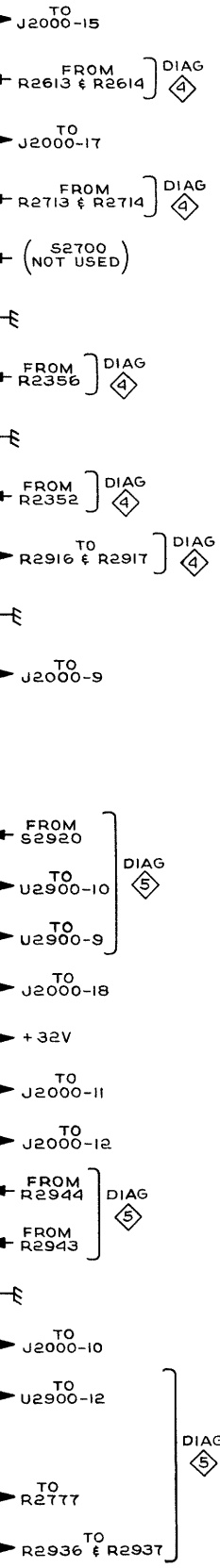
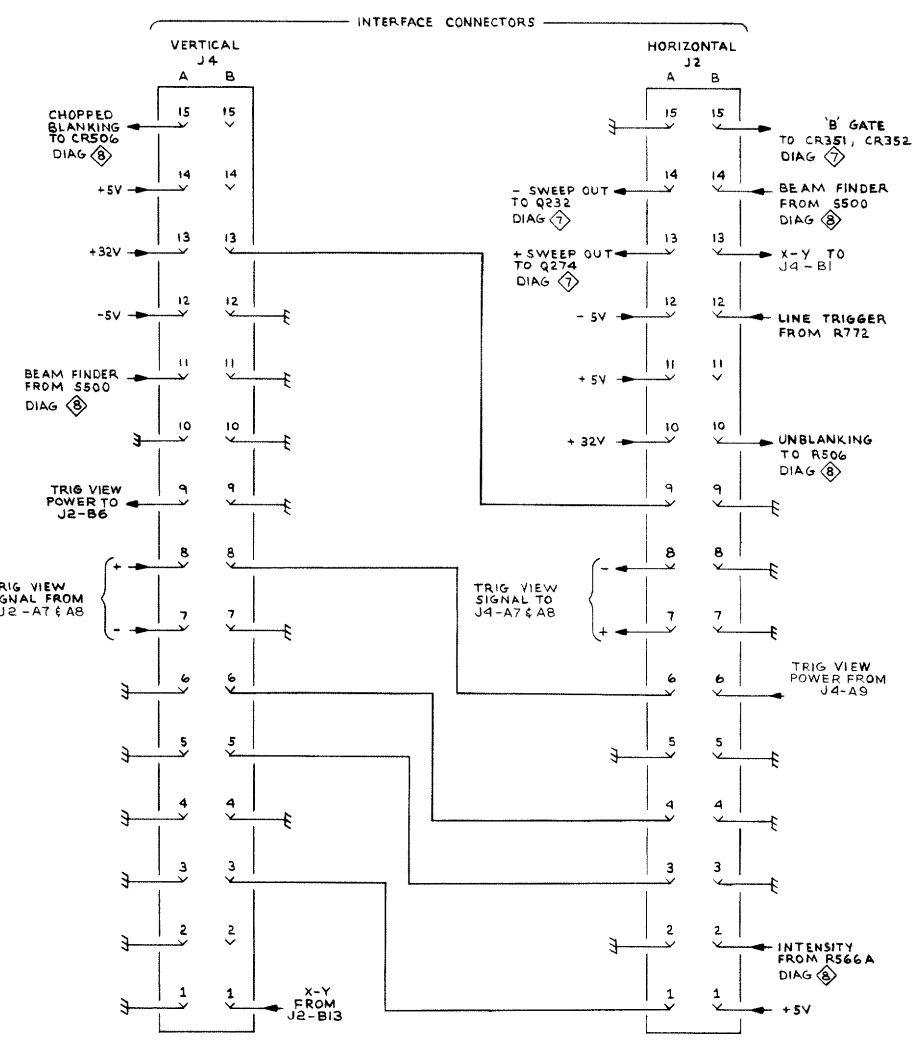
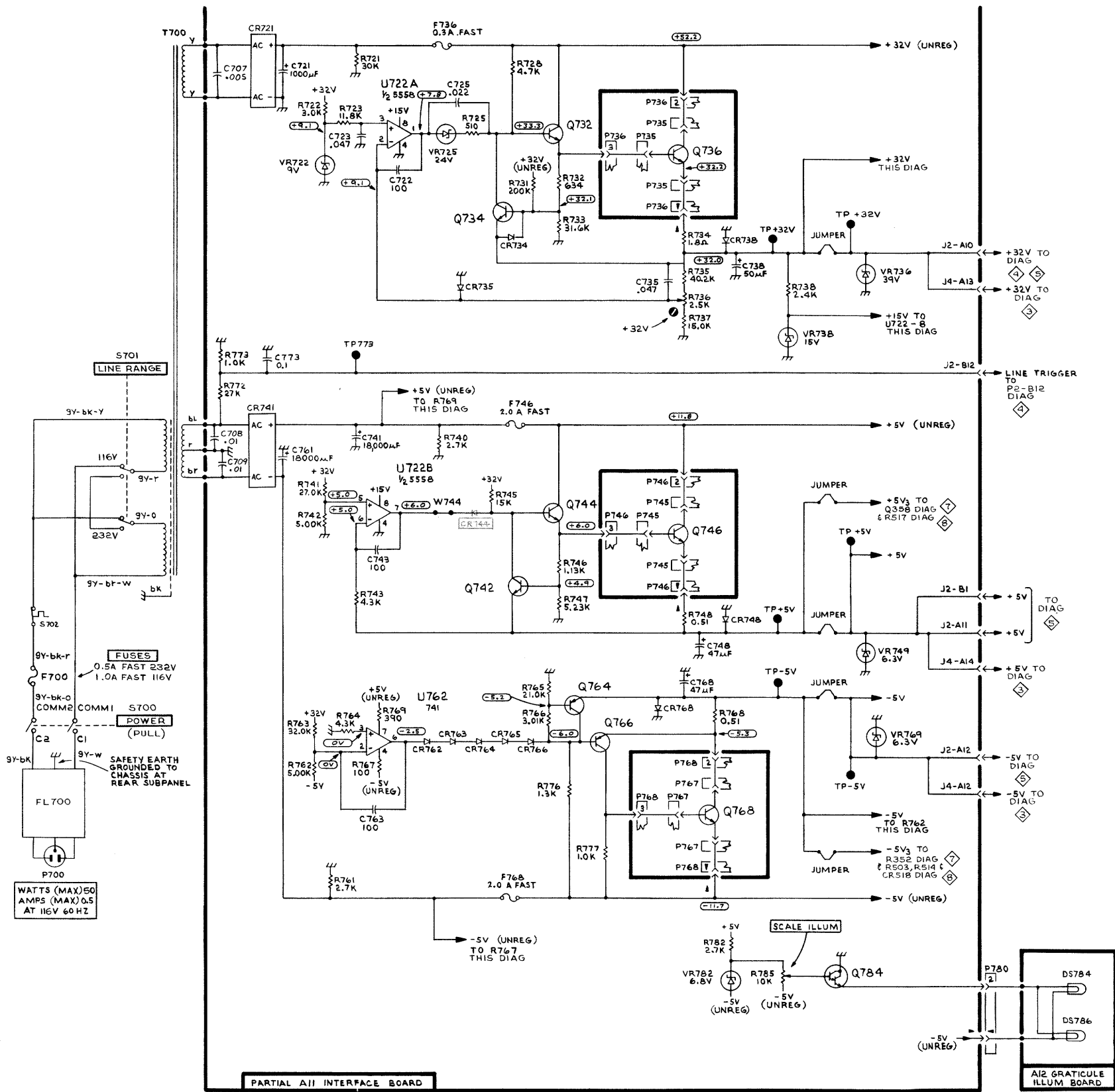
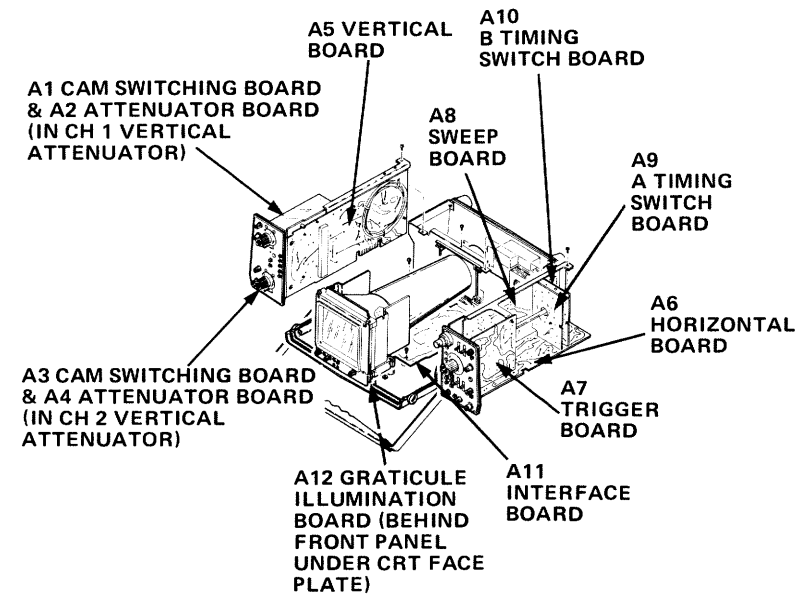

SEE PARTS LIST FOR EARLIER VALUES AND SERIAL NUMBER RANGES OF PARTS OUTLINED OR DEPICTED IN GREY.

POWER SUPPLY & INTERFACE CONNECTORS

465M

2287-106
REV B FEB 1981

Refer to Waveform and Voltage Test Conditions.

56

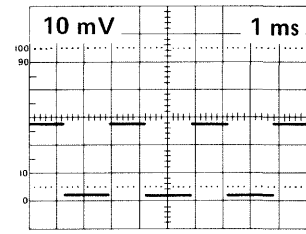

Instrument HORIZ MODE to A INTEN

56

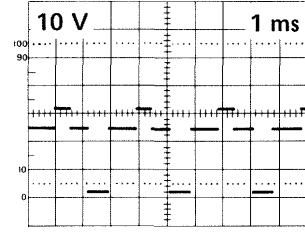

57

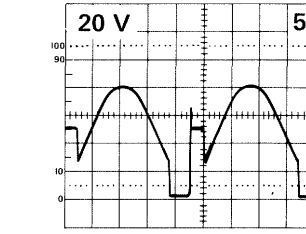

Test scope trigger SOURCE to CH 1

58

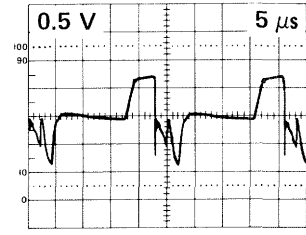

Test scope trigger SOURCE to CH 1

59

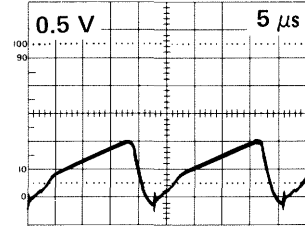

Test scope trigger SOURCE to CH 1

60

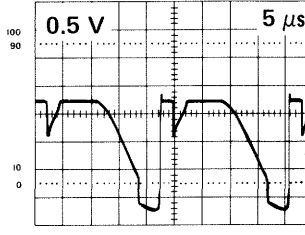

Test scope trigger SOURCE to CH 1

2237-120

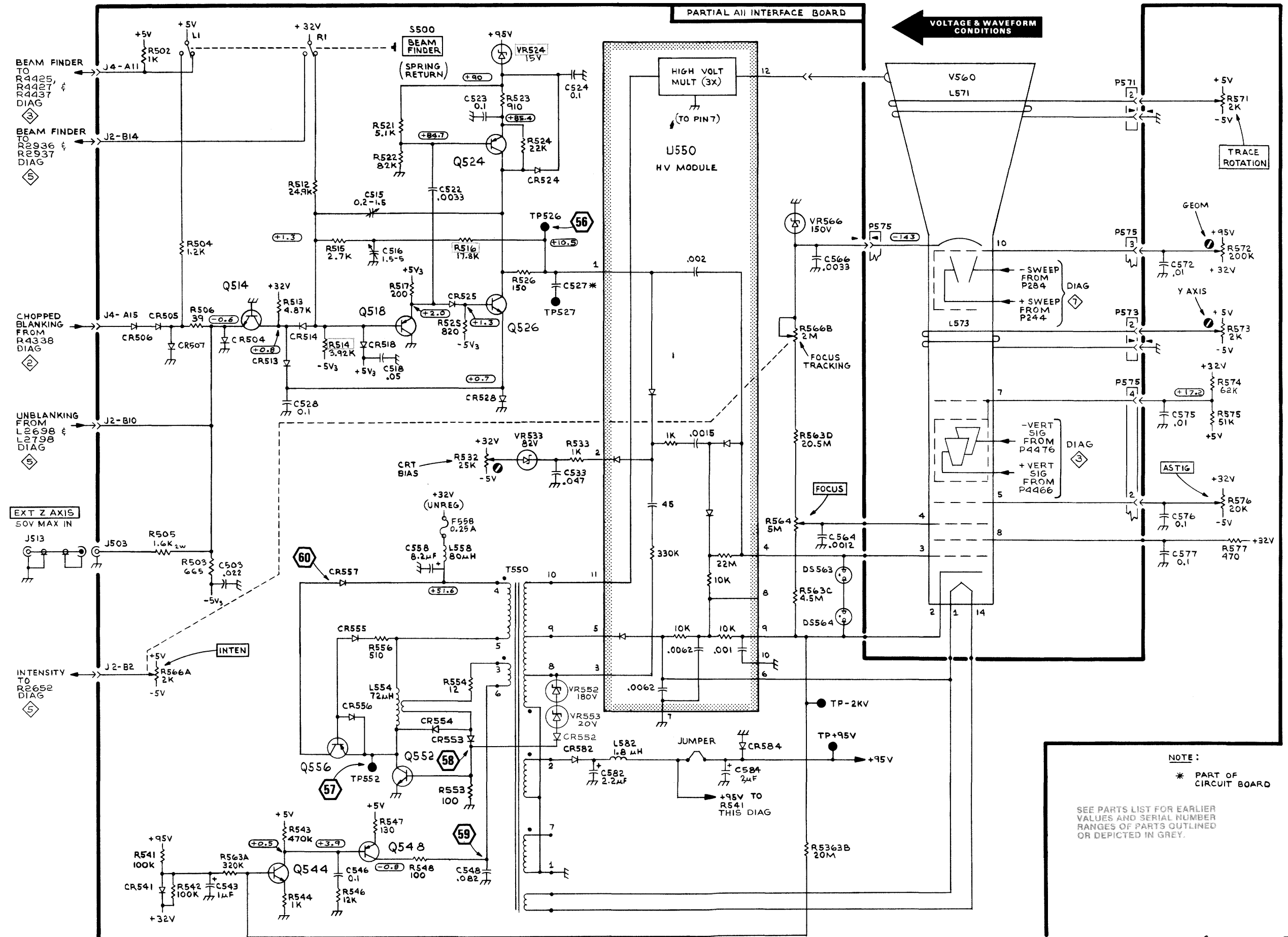
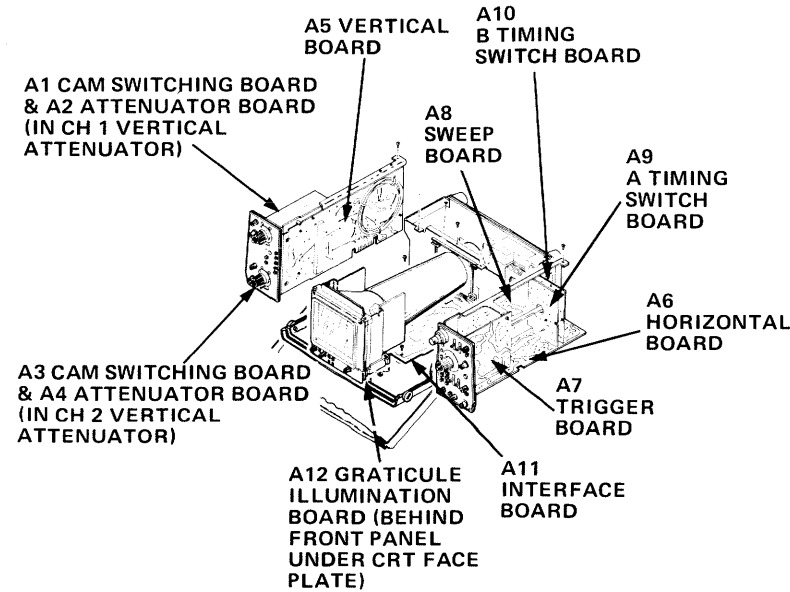

465M

2237-105
REV B FEB 1981

CRT & Z AXIS

FO-10 (Front)
FO-10 (Rear Blank)

CART & Z AXIS (FO-10)

8

NOTE:
* PART OF
CIRCUIT BOARD

SEE PARTS LIST FOR EARLIER
VALUES AND SERIAL NUMBER
RANGES OF PARTS OUTLINED
OR DEPICTED IN GREY.

Refer to Waveform and Voltage Test Conditions.

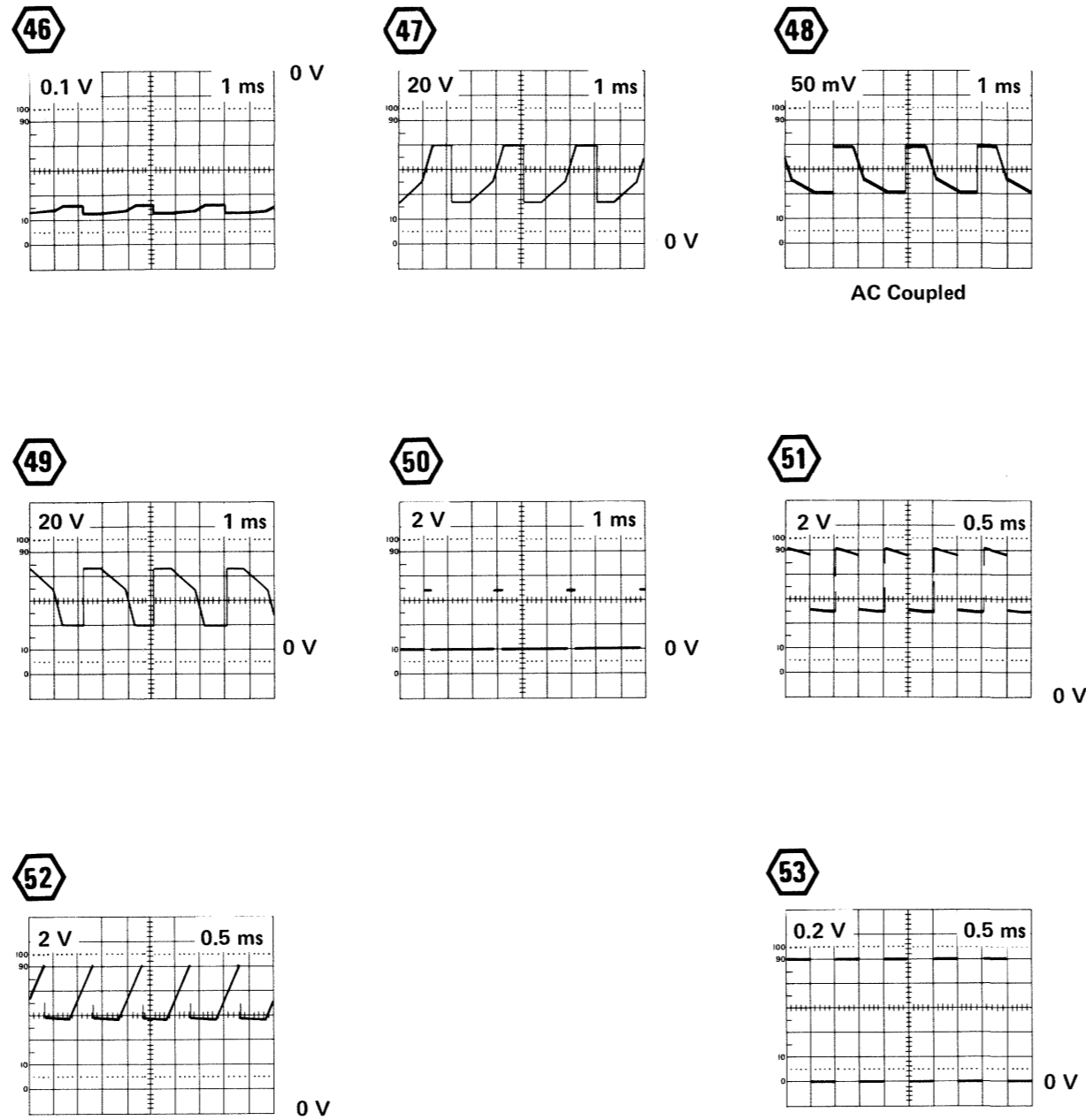

2237-119

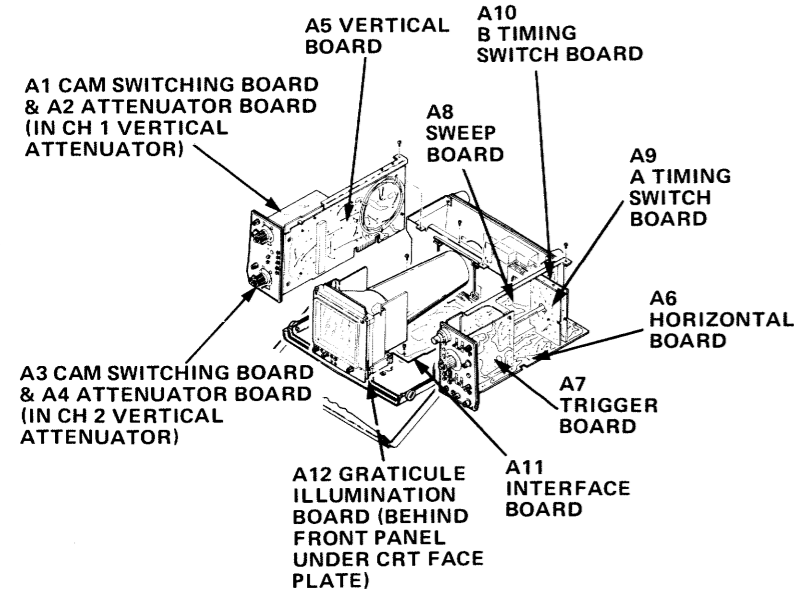

465M

2157-104
REV B FEB 1981

HORIZONTAL AMPLIFIER, +B GATE & CALIBRATOR

FO-9 (Front)
FO-9 Rear Blank

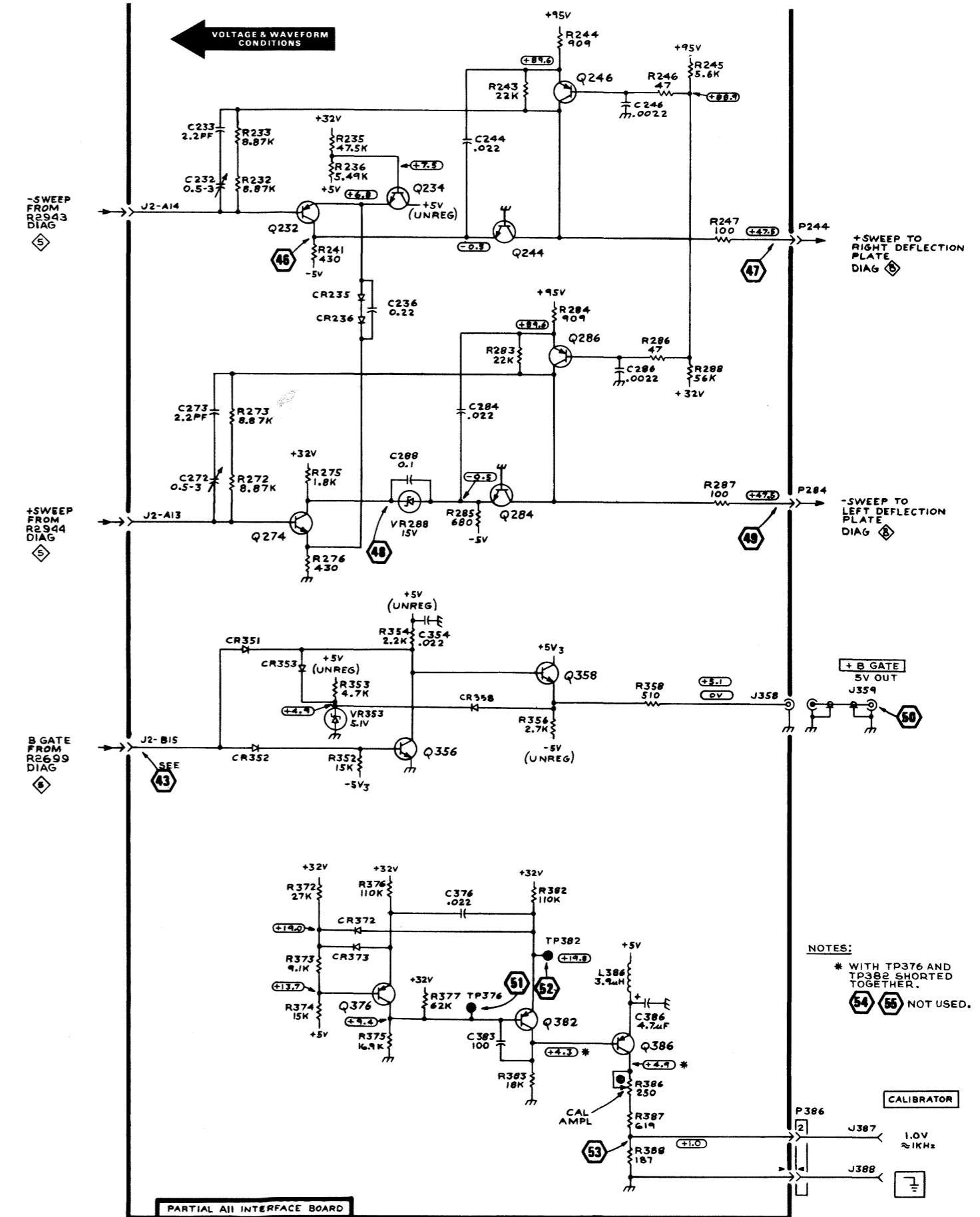

HORIZ AMPL, +B GATE & CALIBRATOR (FO-9)

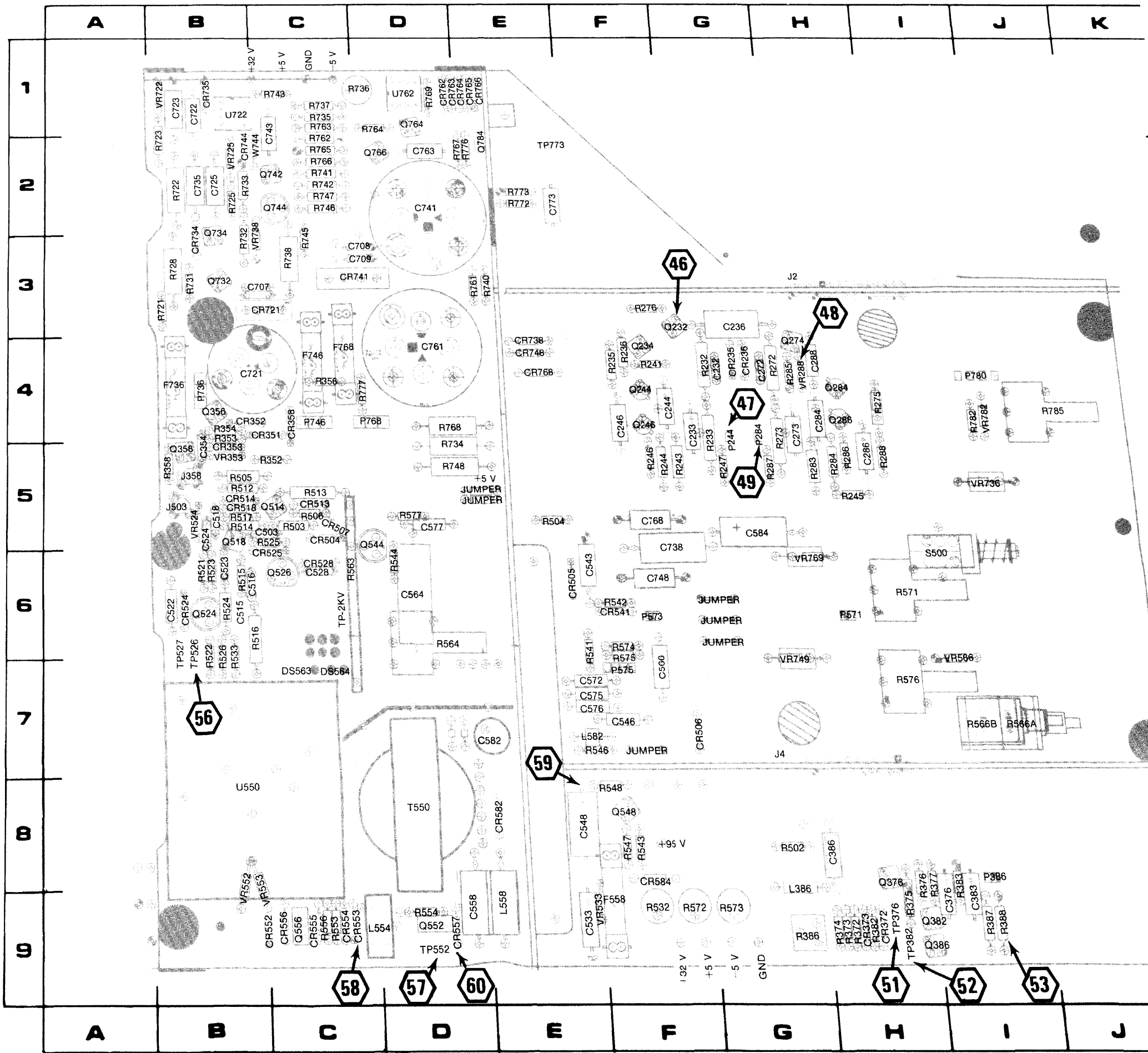
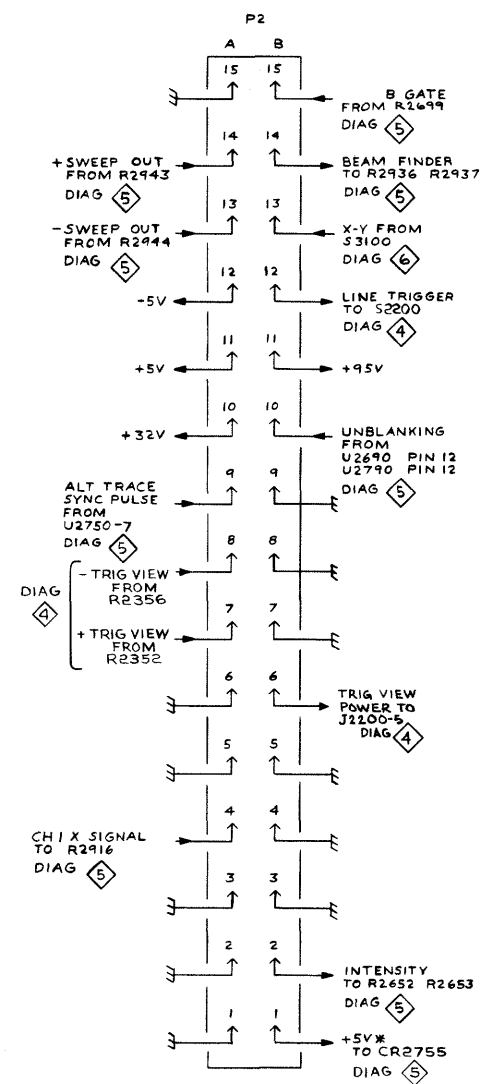

Figure 6-14. A11 Interface board component locations.

CKT NO	GRID LOC	CKT NO	GRID LOC	CKT NO	GRID LOC	CKT NO	GRID LOC	CKT NO	GRID LOC	CKT NO	GRID LOC	CKT NO	GRID LOC	CKT NO	GRID LOC
C232	4G	C721	4B	CR557	9D	P571	6H	R235	4F	R506	5C	R723	2B	TP376	9H
C233	4G	C722	1B	CR582	8E	P573	6F	R236	4F	R512	5B	R725	2B	TP382	9H
C236	3G	C723	1B	CR584	8F	P575	7F	R241	4F	R513	5C	R728	3B	TP526	6B
C244	4F	C725	2B	CR721	3C	P736	4B	R243	5F	R514	5B	R731	3B	TP527	6B
C246	4F	C735	2B	CR734	3B	P746	4C	R244	5F	R515	6B	R732	3B	TP552	9D
C272	4G	C738	5F	CR735	1B	P768	4D	R245	5H	R516	6B	R733	2B	TP773	2E
C273	4H	C741	2D	CR738	4E	P780	4I	R246	5F	R517	5B	R734	5D		
C284	4H	C743	1C	CR741	3C			R247	5G	R521	6B	R735	1C	U550	8B
C286	5H	C748	6F	CR744*	2B	Q232	3G	R272	4G	R522	6B	R736	1D	U722	1B
C288	4H	C761	4D	CR748	4E	Q234	4F	R273	4G	R523	6B	R737	1C	U762	1C
C354	5B	C763	2D	CR762	1D	Q244	4F	R275	4H	R524	6B	R738	3C		
C376	9I	C768	5F	CR763	1E	Q246	4F	R276	3F	R525	5C	R740	3E	VR288	4H
C383	9I	C773	2E	CR764	1E	Q274	4H	R283	5H	R526	6B	R741	2C	VR353	5B
C386	8G			CR765	1E	Q284	4H	R284	5H	R532	9F	R742	2C	VR524	5B
C503	5C	CR235	4G	CR766	1E	Q286	4H	R285	4H	R533	6B	R743	1C	VR533	9E
C515	6B	CR236	4G	CR768	4E	Q356	4B	R286	5H	R541	6F	R745	3C	VR552	8B
C516	6B	CR351	4C			Q358	5B	R287	5G	R542	6F	R746	2C	VR553*	8B
C518	5B	CR352	4B	DS563	7C	Q376	8G	R288	5H	R543	8F	R747	2C	VR566	7I
C522	6B	CR353	5B	DS564	7C	Q382	9H	R352	5C	R544	6D	R748	5D	VR722	1B
C523	6B	CR358	4C			Q386	9H	R353	4B	R546	7F	R761	3E	VR725	2B
C524	5B	CR372	9H	F558	9F	Q514	5C	R354	4B	R547	8F	R762	2C	VR736	5I
C528	6C	CR373	9H	F736	4B	Q518	5B	R356	4C	R548	8F	R763	1C	VR738	3C
C533	9E	CR504	5C	F746	4C	Q524	6B	R358	5B	R553	9C	R764	1D	VR749	7G
C543	6F	CR505	6E	F768	4C	Q526	6C	R372	9H	R554	9D	R765	2C	VR769	6H
C546	7F	CR506	7F			Q544	5D	R373	9H	R556	9C	R766	2C	VR782	4I
C548	8E	CR507	5C	J2	3H	Q548	8F	R374	9H	R563	6C	R767	2E		
C558	9D	CR513	5C	J4	7G	Q552	9D	R375	9H	R564	6D	R768	4D	W744*	2C
C564	6D	CR514	5B	J358	5B	Q556	9C	R376	8H	R566A	7I	R769	1D		
C566	7F	CR518	5B	J503	5B	Q732	3B	R377	8H	R566B	7I	R772	2E		
C572	7F	CR524	6B			Q734	2B	R382	9H	R571	6I	R773	2E		
C575	7F	CR525	6C	L386	9G	Q742	2C	R383	9I	R572	9F	R776	2E		
C576	7F	CR528	6C	L554	9C	Q744	2C	R386	9G	R573	9G	R777	4D		
C577	5D	CR541	6F	L558	9E	Q764	1D	R387	9I	R574	6F	R782	4I		
C582	7E	CR552	9B	L582	7E	Q766	2D	R388	9I	R575	6F	R785	4J		
C584	5G	CR553	9C			Q784	2E	R502	8G	R576	7H				
C707	3C	CR554	9C	P244	4G			R503	5C	R577	5D	S500	6I		
C708	3D	CR555	9C	P284	4G	R232	4G	R504	5E	R721	3B				
C709	3D	CR556	9C	P386	9I	R233	4G	R505	5B	R722	2B	T550	8D		

*See Parts List for
serial number ranges.

INTERFACE CONNECTOR



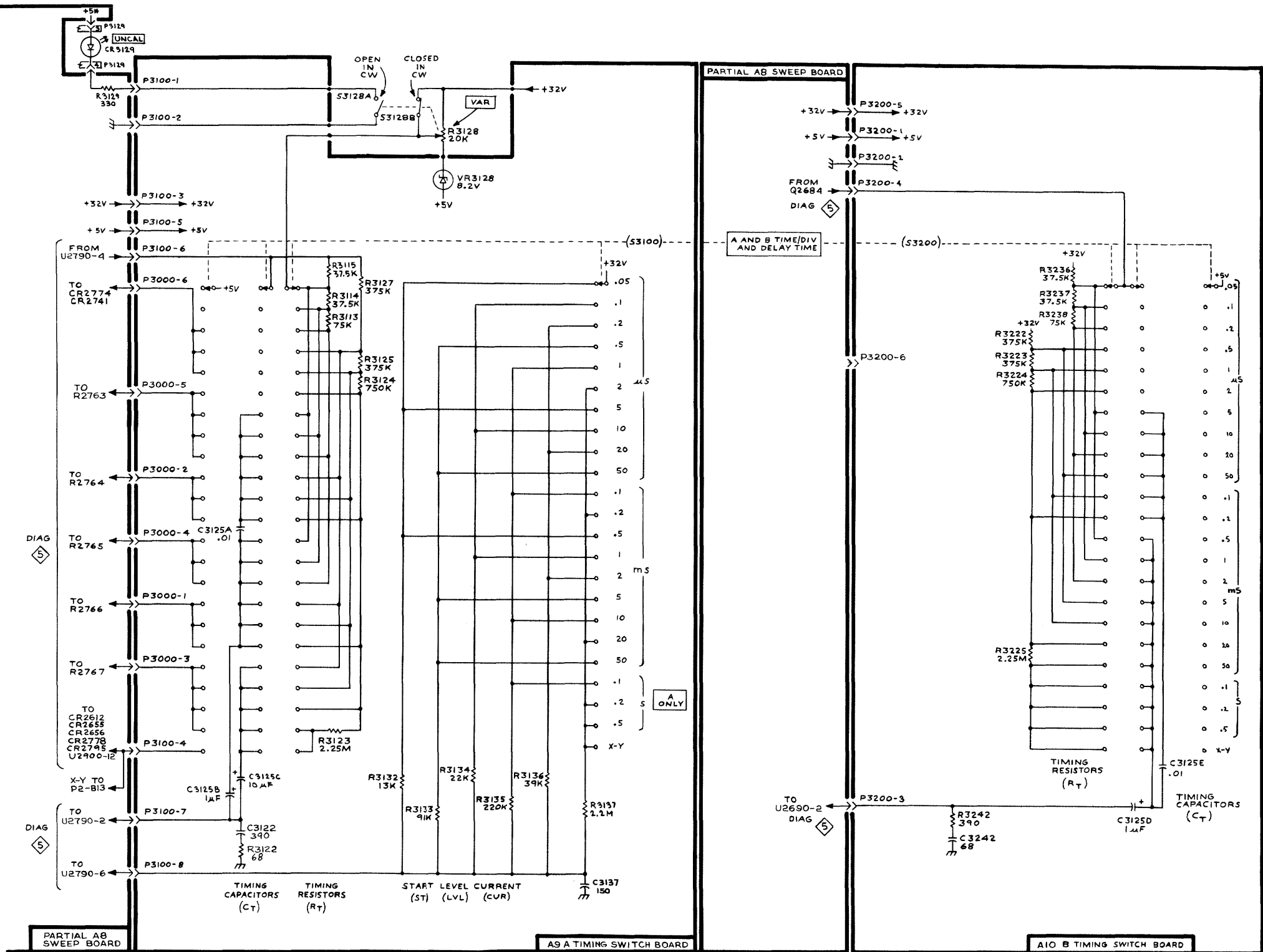

2237-103
REV B FEB 1981

A & B TIMING SWITCH & INTERFACE CONNECTOR

FO-8 (Front)
FO-8 Rear Blank

Refer to Waveform and Voltage Test Conditions.

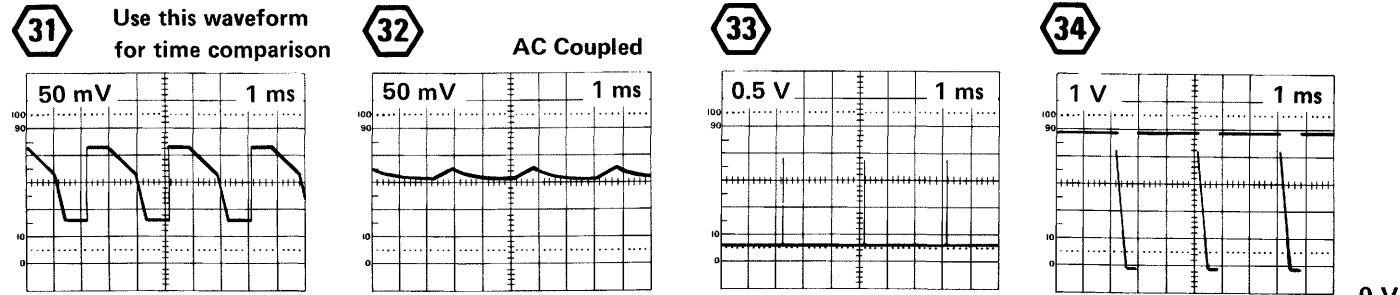

AC Coupled

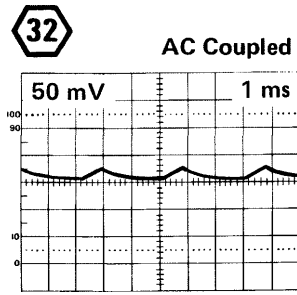

Amplitude of waveform increases as time between end of holdoff and triggering increases.

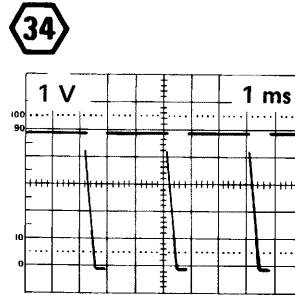
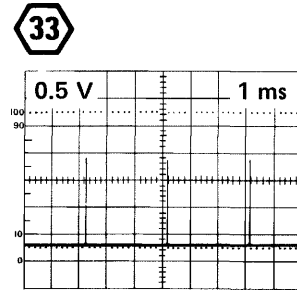

0 V

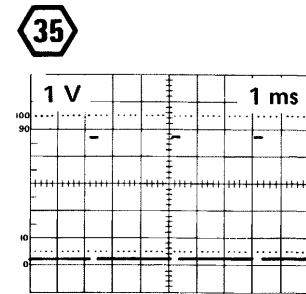

Instrument HORIZ MODE set to A or A INTEN. In B DLY'D or MIX, TP2797 is at -5 V dc.

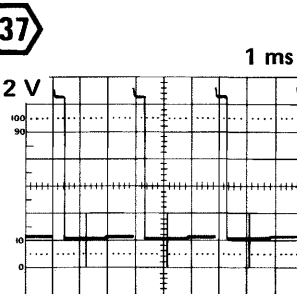
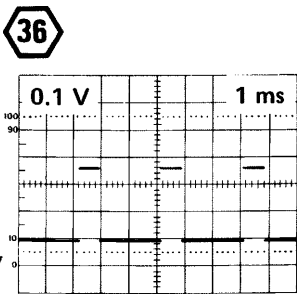

Slight positive step at -0.6 V only present in MIX. Positive spike at -0.6 V is higher in A INTEN and B DLY'D modes.

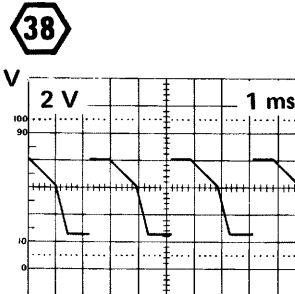

Position of transition between A and B sweep rates dependent on setting of instrument DELAY TIME POS control.

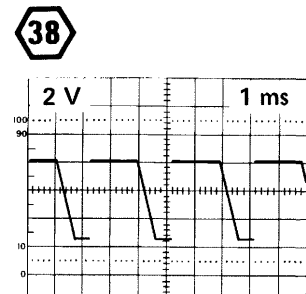

Instrument HORIZ MODE to B DLY'D. Beginning of sweep ramp dependent on setting of instrument DLEAY TIME POS control.

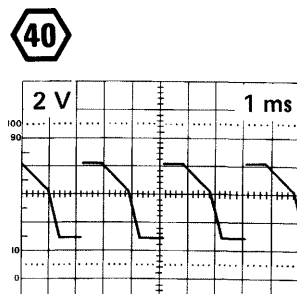
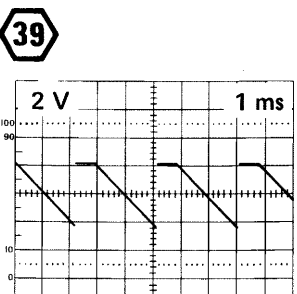

Instrument HORIZ MODE set to B DLY'D.

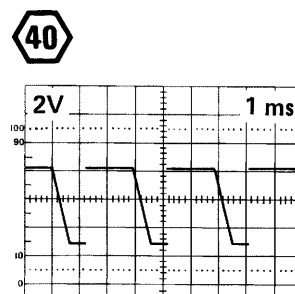

With instrument HORIZ MODE set to A or A INTEN, TP2697 goes to -5 V dc.

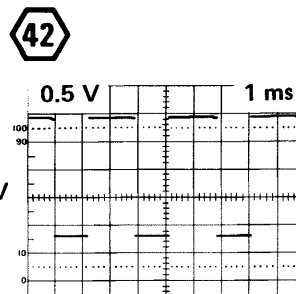
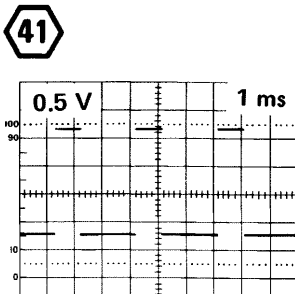

LO when **41** **42** are both LO

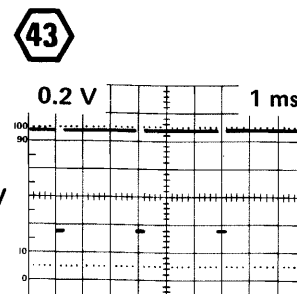

0 V

2237-118

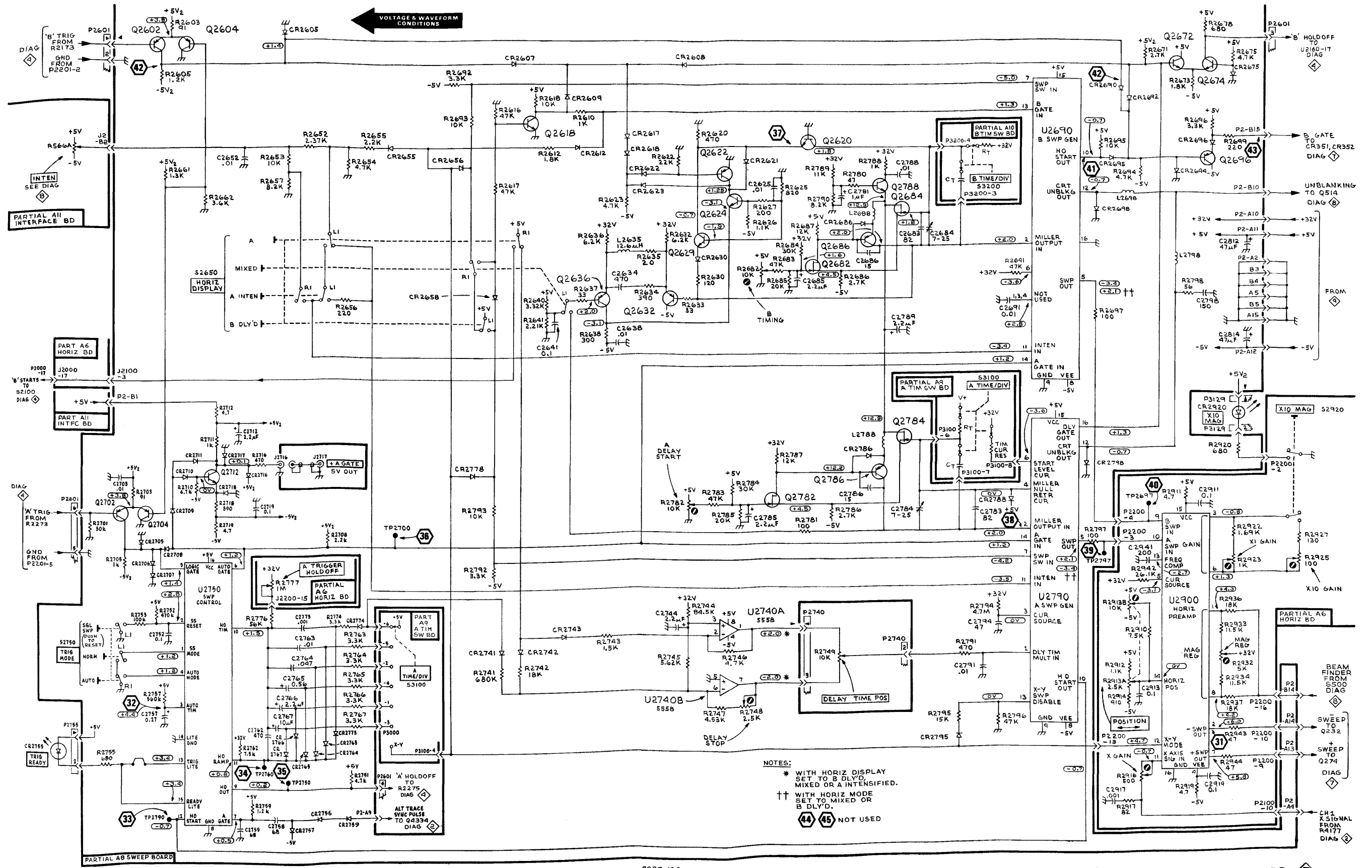

465M

2237-102
REV B FEB 1981

SWEEP & HORIZONTAL PREAMPLIFIER

FO-7 (Front)
FO-7 (Rear Blank)

SWEEP & HORIZ PREAMPLIFIER

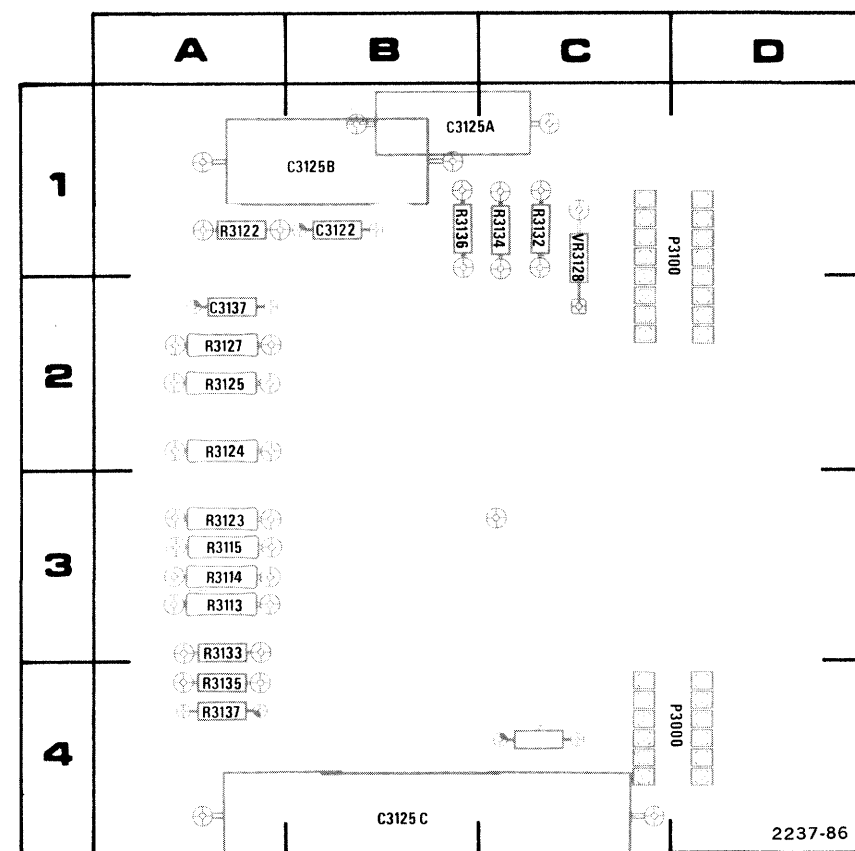
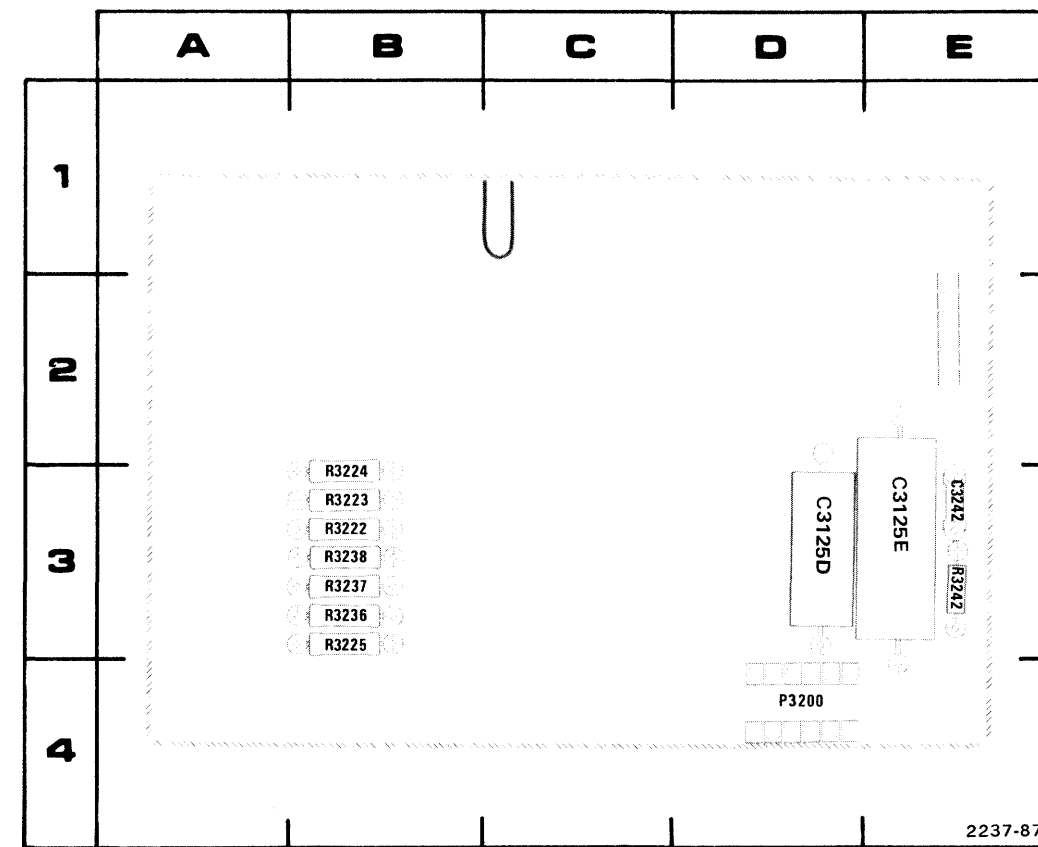

Figure 6-12. A9 Timing Switch bd (A Sweep) component locations.

CKT NO	GRID LOC	CKT NO	GRID LOC	CKT NO	GRID LOC
C3122	1B	R3113	3A	R3132	1C
C3125A	1B	R3114	3A	R3133	3A
C3125B	1B	R3115	3A	R3134	1C
C3125C	4B	R3122	1A	R3135	4A
C3137	2A	R3123	3A	R3136	1B
		R3124	2A	R3137	4A
P3000	4D	R3125	2A		
P3100	1D	R3127	2A	VR3128	1C



FOR LOCATION OF R3129, SEE A8 SWEEP BOARD

Figure 6-13. A10 Timing Switch bd (B Sweep) component locations.

CKT NO	GRID LOC	CKT NO	GRID LOC	CKT NO	GRID LOC
C3242	3E	R3222	3B	R3237	3B
C3125D	3D	R3223	3B	R3238	3B
C3125E	3E	R3224	3B	R3242	3E
		R3225	3B		
P3200	4D	R3236	3B		

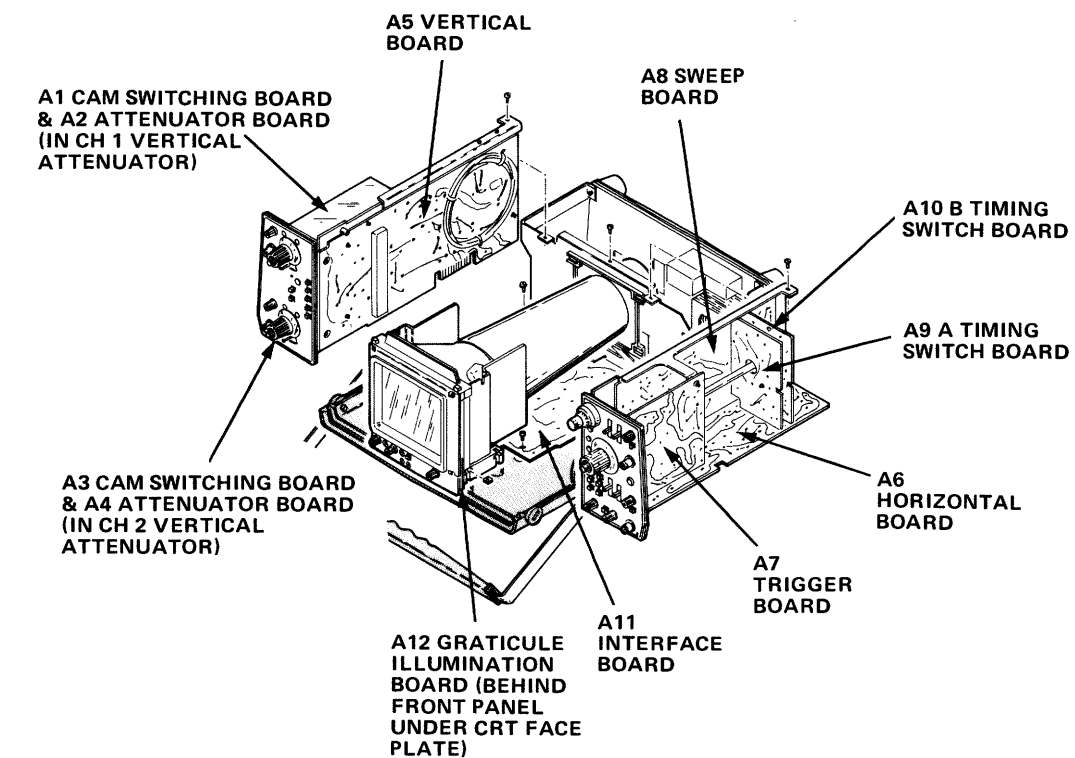

Refer to Waveform and Voltage Test Conditions.

23

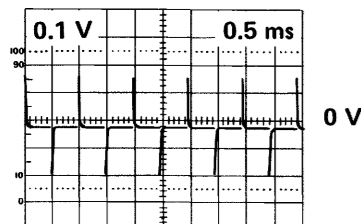

0 volt point depends on setting of instrument vertical POSITION control.

24

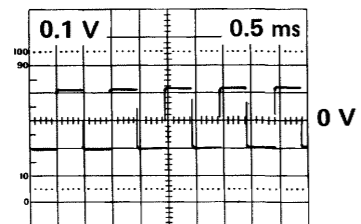

0 volt reference depends on setting of instrument LEVEL control. No signal with instrument coupling to LF REJ.

25

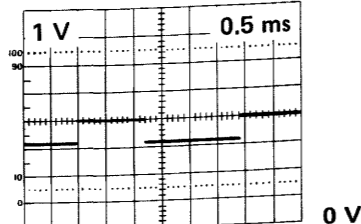

26

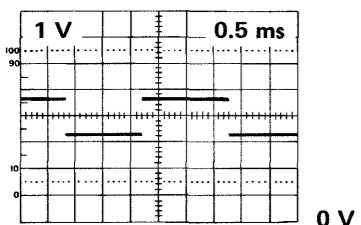

27

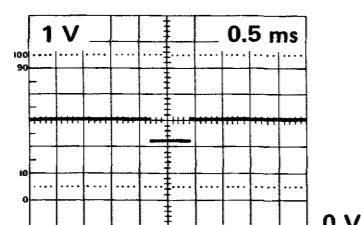

28

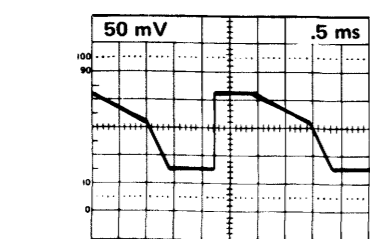
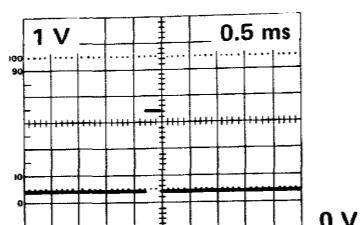

Sweep ramp from pin 2 of U2900 for time comparison.

2237-117

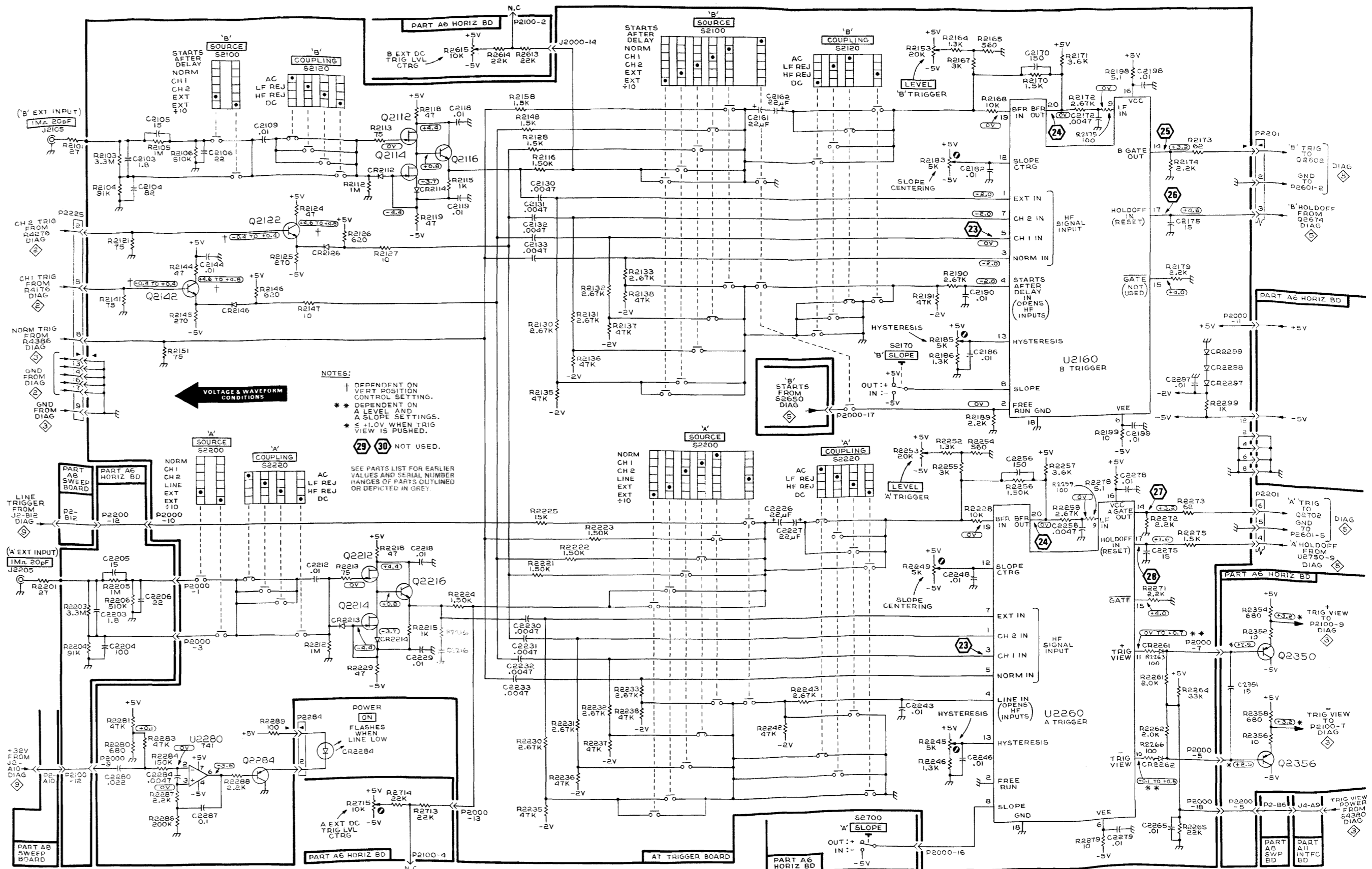

NOTES:
 † DEPENDENT ON VERT POSITION CONTROL SETTING.
 * DEPENDENT ON A LEVEL AND A SLOPE SETTINGS.
 * S +1.0V WHEN TRIG VIEW IS PUSHED.
 29 30 NOT USED.

VOLTAGE & WAVEFORM CONDITIONS

2237-101
 REV A SEPT 1980

TRIGGER AMPLIFIER

FO-6 (Front)

465M

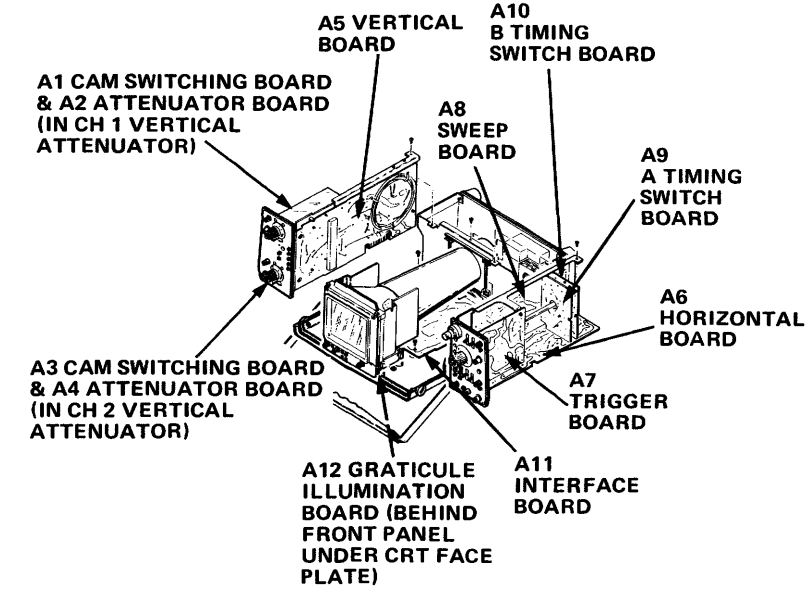
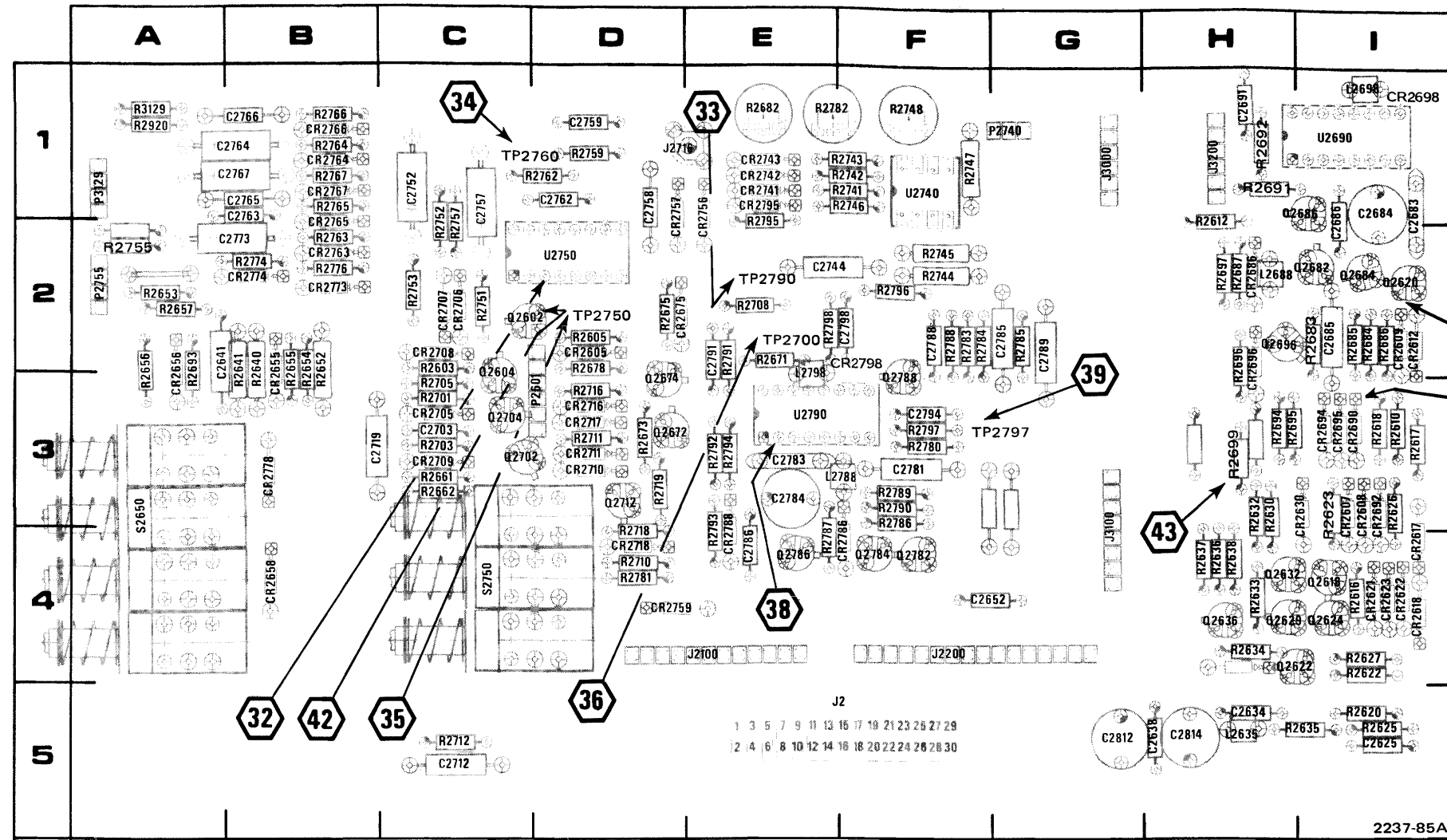

†On back of board.

Figure 6-11. A8 Sweep board component locations.

CKT NO	GRID LOC	CKT NO	GRID LOC	CKT NO	GRID LOC	CKT NO	GRID LOC	CKT NO	GRID LOC	CKT NO	GRID LOC	CKT NO	GRID LOC	CKT NO	GRID LOC	CKT NO	GRID LOC	CKT NO	GRID LOC	CKT NO	GRID LOC	CKT NO	GRID LOC	CKT NO	GRID LOC	CKT NO	GRID LOC	CKT NO	GRID LOC	CKT NO	GRID LOC
C2625	5I	C2758	1D	C2791	2E	CR2655	2B	CR2710	3D	CR2773	2B	L2688	2H	Q2629	4H	R2603	2C	R2634	4H	R2673	3D	R2699	3H	R2746	1F	R2776	2B	R2795	2E	U2740	1F
C2634	5H	C2759	1D	C2794	3F	CR2656	2A	CR2711	3D	CR2774	2B	L2698	1I	Q2632	4H	R2605	2D	R2635	5I	R2675	2D	R2701	3C	R2747	1F	R2780	3F	R2796	2F	U2750	2D
C2638	5H	C2762	1D	C2798	2F	CR2658	3B	CR2716	3D	CR2778	3B	L2788	3F	Q2636	4H	R2610	3I	R2636	4H	R2678	2D	R2703	3C	R2748	1F	R2781	4D	R2797	3F	U2790	3E
C2641	2A	C2763	1B	C2812	5G	CR2675	2D	CR2717	3D	CR2786	4F	L2798	3E	Q2672	3D	R2612	1H	R2637	4H	R2682	1E	R2705	3C	R2751	2C	R2782	1E	R2798	1E		
C2652	4F	C2764	1B	C2814	5H	CR2686	2H	CR2718	4D	CR2788	4E			Q2674	3D	R2616	4I	R2638	4H	R2683	2I	R2708	2E	R2752	2C	R2783	2F	R2920	1A		
C2683	1I	C2765	1B	CR2605	2D	CR2690	3A	CR2741	1E	CR2795	1E	P2601	3D	Q2682	2I	R2617	3I	R2640	3B	R2684	2I	R2710	4D	R2753	2C	R2784	2F	R3129	1A		
C2684	1I	C2766	1B	CR2607	3I	CR2692	3I	CR2742	1E	CR2798†		P2740	1G	Q2684	2I	R2618	3I	R2641	3B	R2685	2I	R2711	3D	R2755	2A	R2785	2G				
C2685	2I	C2767	1B	CR2608	3I	CR2694	3I	CR2743	1E			P2755	2A	Q2686	1I	R2620	5I	R2652	2B	R2686	2I	R2712	5C	R2757	2C	R2786	3F	S2650	3A		
C2686	1I	C2773	2B	CR2609	2I	CR2695	3I	CR2756	1E	J2	5E	P3129	1A	Q2696	2H	R2622	4I	R2653	2A	R2687	2H	R2716	3D	R2759	1D	R2787	4E	S2750	4C		
C2691	1H	C2781	3F	CR2612	2I	CR2696	2H	CR2757	2D	J2100	4E	J2100	4E	Q2702	3C	R2623	3I	R2654	2B	R2691	1H	R2718	4D	R2762	1D	R2788	2F				
C2703	3C	C2783	3E	CR2698†	4I	CR2759	4D	J2200	4F	J2200	4F			Q2602	2C	Q2704	3C	R2625	5I	R2655	2B	R2692	1H	R2719	3D	R2763	2B	R2789	3F	TP2700	2E
C2712	5C	C2784	3E	CR2618	4I	CR2705	3C	CR2763	2B	J2716	1D	J3000	1G	Q2604	3C	Q2712	3D	R2626	3I	R2656	2A	R2693	2A	R2741	1F	R2764	1B	R2790	3F	TP2750	2C
C2719	3B	C2785	2G	CR2621	4I	CR2706	2C	CR2764	1B	J3000	1G	J3000	1G	Q2618	4I	Q2782	4F	R2627	4I	R2657	2A	R2694	3H	R2742	1F	R2765	1B	R2791	2E	TP2760	1C
C2744	1E	C2786	4E	CR2622	4I	CR2707	2C	CR2765	2B	J3100	3G	J3100	3G	Q2620	2I	Q2784	4F	R2630	3H	R2661	2C	R2695	3H	R2743	1F	R2766	1B	R2792	3E	TP2790	2E
C2752	1C	C2788	2F	CR2623	4I	CR2708	2C	CR2766	1B	J3200	1H	J3200	1H	Q2622	4H	Q2786	4E	R2632	3H	R2662	3C	R2696	2H	R2744	2F	R2767	1B	R2793	4E		
C2757	1C	C2789	2G	CR2630	3I	CR2709	3C	CR2767	1B	L2635	5H	L2635	5H	Q2624	4I	Q2788	3F	R2633	4H	R2671	2E	R2697	2H	R2745	2F	R2774	2B	R2794	3E	U2690	1I

Refer to Waveform and Voltage Test Conditions.

14

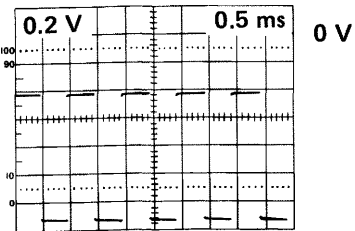

0 volt point depends on setting of instrument vertical POSITION control.

15

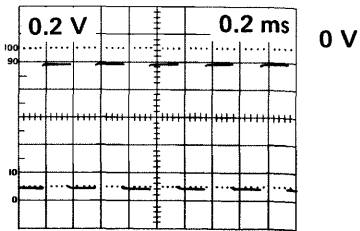

0 volt point depends on setting of instrument vertical POSITION control.

16

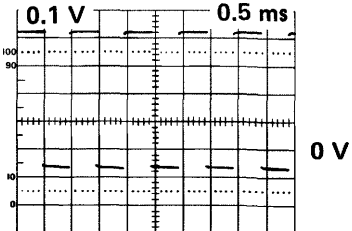

0 volt point depends on setting of instrument vertical POSITION control.

17

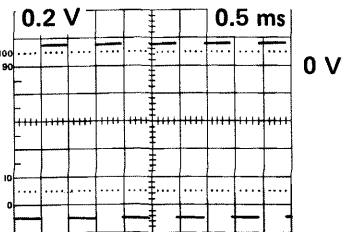

0 volt point depends on setting of instrument vertical POSITION control.

18

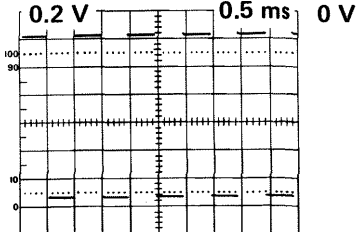

0 volt point depends on setting of instrument vertical POSITION control.

19

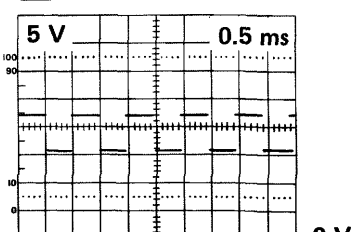

0 volt point depends on setting of instrument vertical POSITION control.

20

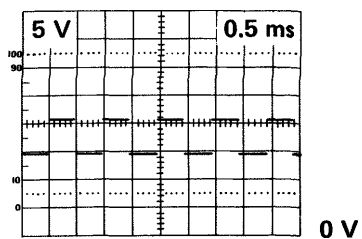

0 volt point depends on setting of instrument vertical POSITION control.

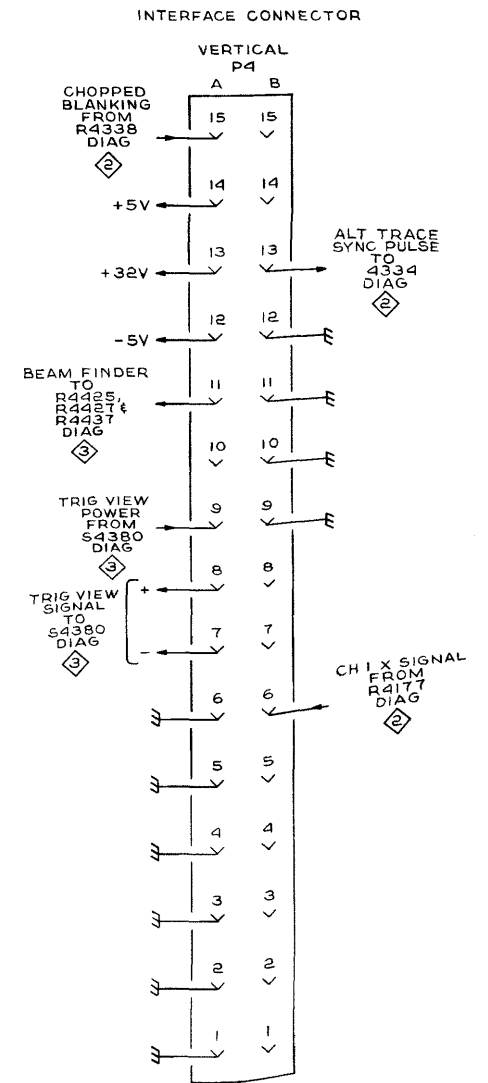

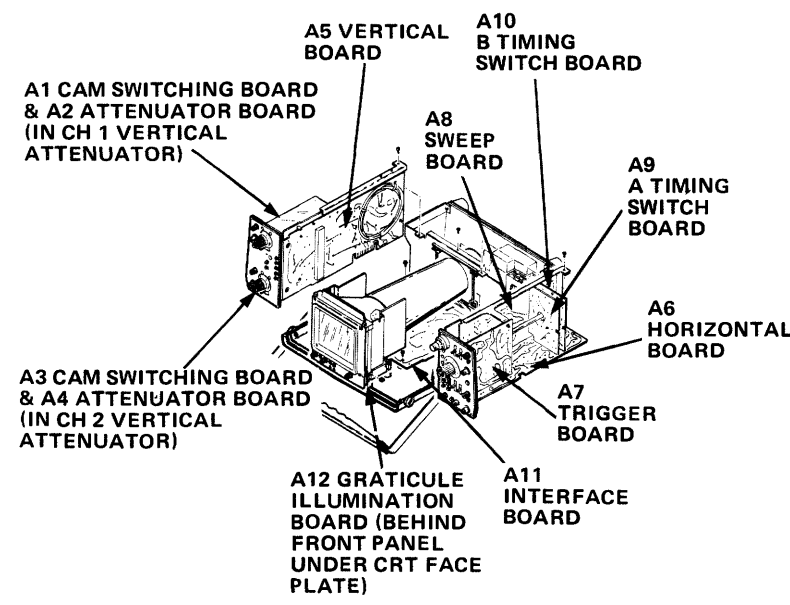
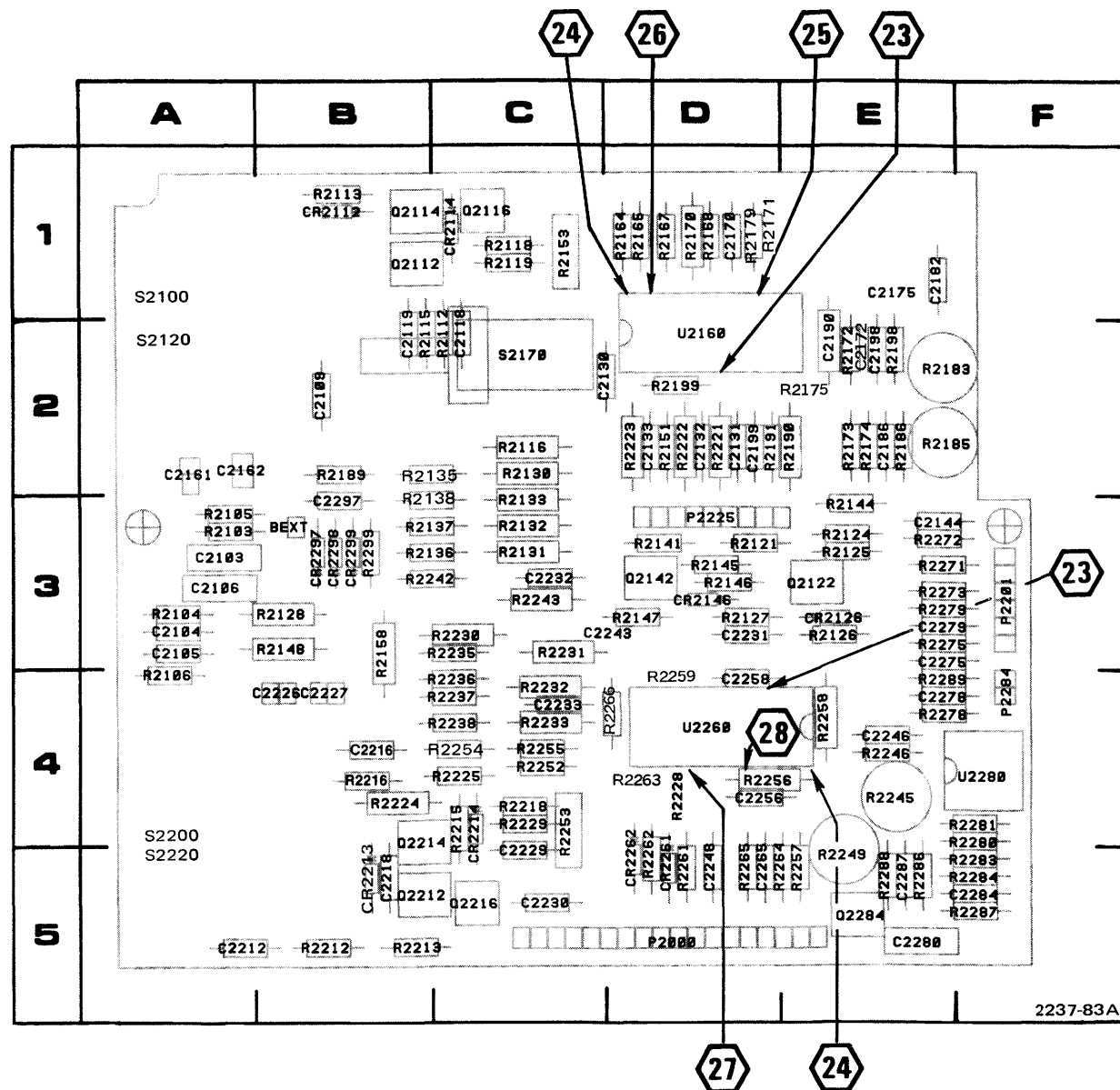

§ Connected from A7 to bnc connector.
 †On back of board.
 *See Parts List for serial number ranges.

Figure 6-9. A7 Trigger board (SN B021600 & above) component locations.

CKT NO	GRID LOC	CKT NO	GRID LOC	CKT NO	GRID LOC	CKT NO	GRID LOC	CKT NO	GRID LOC	CKT NO	GRID LOC	CKT NO	GRID LOC	CKT NO	GRID LOC	CKT NO	GRID LOC	CKT NO	GRID LOC	CKT NO	GRID LOC	CKT NO	GRID LOC	CKT NO	GRID LOC	CKT NO	GRID LOC	
C2103	3A	C2172	2E	C2232	3C	CR2112	1B	P2284	4F	R2105	3A	R2131	3C	R2158	3B	R2189	2B	R2228	4D	R2252	4C	R2272	3E	S2100	1A	C2103		
C2104	3A	C2175	1E	C2233	4C	CR2114	1C			R2106	4A	R2132	3C	R2164	1D	R2190	2E	R2229	4C	R2253	4C	R2273	3E	S2120	2A	C2104		
C2105	3A	C2182	1E	C2243	3D	CR2126	3E	Q2112	1B	R2112	2C	R2133	3C	R2165	1D	R2191	2D	R2230	3C	R2254	4C	R2275	3E	S2200	4A	C2105		
C2106	3A	C2186	3E	C2246	4E	CR2146	3D	Q2114	1B	R2113	1B	R2135	2B	R2167	1D	R2198	2E	R2231	3C	R2255	4C	R2278	4E	S2220	5A	C2106		
C2109	2B	C2190	2E	C2248	5D	CR2213	5B	Q2116	1C	R2115	2B	R2136	3B	R2168	1D	R2199	2D	R2232	4C	R2256	4D	R2279	3E	S2170	2C	C2109		
C2118	2C	C2198	2E	C2256	4D	CR2214	4C	Q2122	3E	R2116	2C	R2137	3B	R2170	1D	R2212	5B	R2233	4C	R2257	5E	R2280	4F			C2118		
C2119	2B	C2199	2D	C2258	4D	CR2261	5D	Q2142	3D	R2118	1C	R2138	3B	R2171	1D	R2213	5B	R2235	3C	R2258	4E	R2281	4F	U2160	2D	C2119		
C2130	2C	C2212	5A	C2265	5D	CR2262	5D	Q2212	5B	R2119	1C	R2141	3D	R2172	2E	R2215	4C	R2236	4C	R2259	4D	R2283	5F	U2260	4D	C2130		
C2131	2D	C2216*	4B	C2275	3E	CR2297	3B	Q2214	4B	R2121	3D	R2144	3E	R2173	2E	R2216*	4B	R2237	4C	R2261	5D	R2284	5F	U2280	4F	C2131		
C2132	2D	C2218	5B	C2278	4E	CR2298	3B	Q2216	5C	R2124	3E	R2145	3D	R2174	2E	R2218	4C	R2238	4C	R2262	5D	R2286	5E			C2132		
C2133	2D	C2226	4B	C2279	3E	CR2299	3B	Q2284	5E	R2125	3E	R2146	3D	R2175	2E	R2221	2D	R2242	3B	R2263	4D	R2287	5F			C2133		
C2144	3E	C2227	4B	C2280	5E					R2126	3E	R2147	3D	R2179	1D	R2222	2D	R2243	3C	R2264	5D	R2288	5E			C2144		
C2161	2A	C2229	5C	C2284	5F	P2000	5D	R2101§		R2127	3D	R2148	3B	R2183	2E	R2223	2D	R2245	4E	R2265	5D	R2289	4E			C2161		
C2162	2A	C2230	5C	C2287	5E	P2201	3F	R2103	3A	R2128	3B	R2151	2D	R2185	2E	R2224	4B	R2246	4E	R2266	4D	R2299	3B			C2162		
C2170	1D	C2231	3D	C2297	3B	P2225	3D	R2104	3A	R2130	2C	R2153	1C	R2186	2E	R2225	4C	R2249	5E	R2271	3E					C2170		

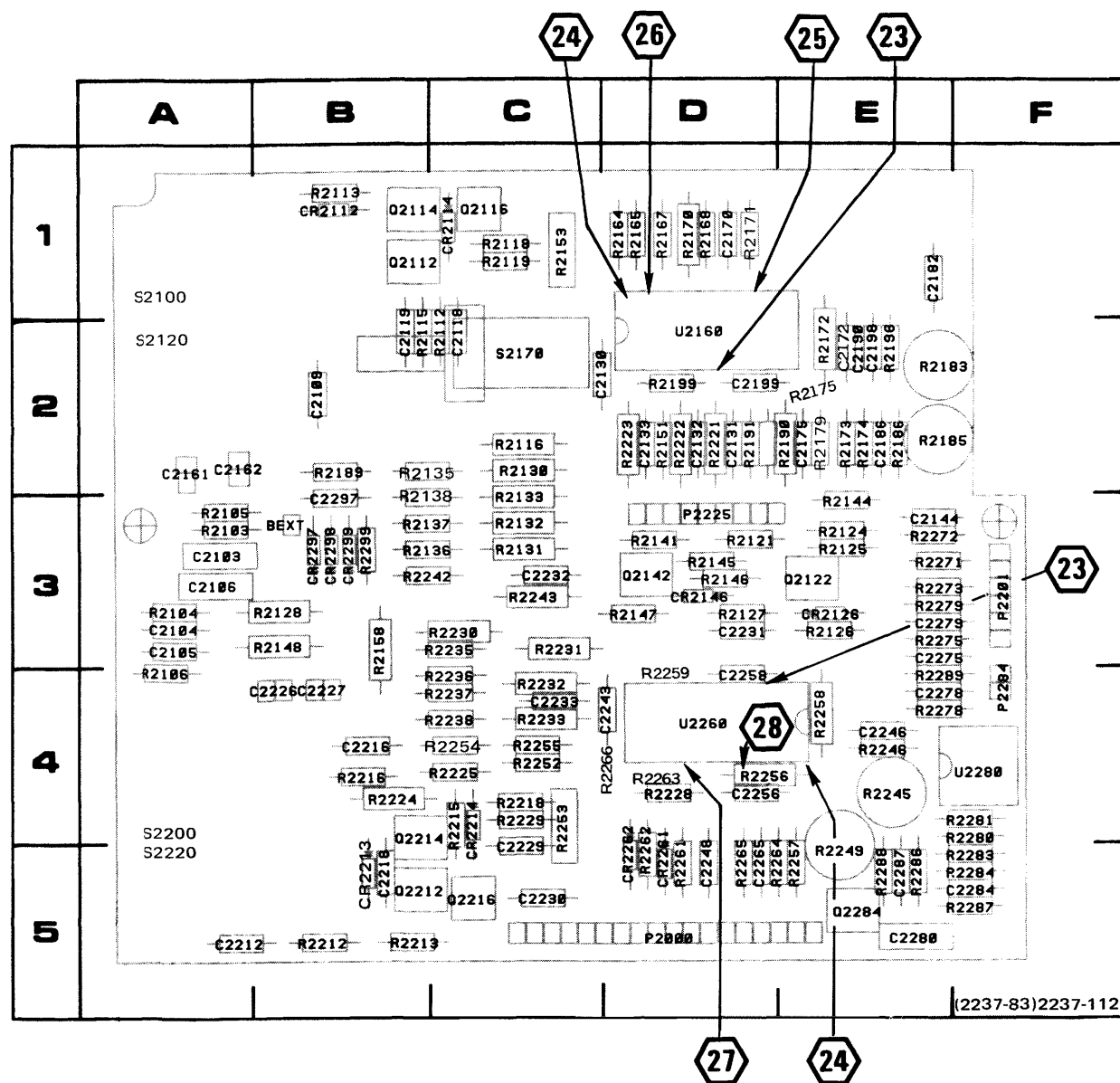
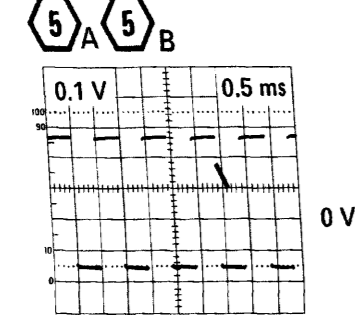
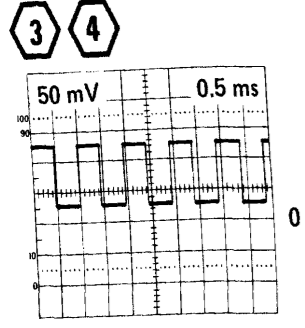

Figure 6-10. A7 Trigger board (below SN B021600) component locations.

GRID LOC	CKT NO	GRID LOC	CKT NO	GRID LOC	CKT NO	GRID LOC	CKT NO	GRID LOC	CKT NO	GRID LOC	CKT NO	GRID LOC	CKT NO	GRID LOC	CKT NO	GRID LOC	CKT NO	GRID LOC	CKT NO	GRID LOC
3A	C2186	3E	C2258	4D	CR2297	3B	R2101§		R2131	3C	R2167	1D	R2213	5B	R2238	4C	R2265	5D	S2100	1A
3A	C2190	2E	C2265	5D	CR2298	3B	R2103	3A	R2132	3C	R2168	1D	R2215	4C	R2242	3B	R2266†		S2120	2A
3A	C2198	2E	C2275	3E	CR2299	3B	R2104	3A	R2133	3C	R2170	1D	R2216	4B	R2243	3C	R2271	3E	S2200	4A
3A	C2199	2D	C2278	4E			R2105	3A	R2135	2B	R2171	1D	R2218	4C	R2245	4E	R2272	3E	S2220	5A
2B	C2212	5A	C2279	3E	P2000	5D	R2106	4A	R2136	3B	R2172	2E	R2221	2D	R2246	4E	R2273	3E	S2170	2C
2C	C2216	4B	C2280	5E	P2201	3F	R2112	2C	R2137	3B	R2173	2E	R2222	2D	R2249	5E	R2275	3E		
2B	C2218	5B	C2284	5F	P2225	3D	R2113	1B	R2138	3B	R2174	2E	R2223	2D	R2252	4C	R2278	4E	U2160	2D
2C	C2226	4B	C2287	5E	P2284	4F	R2115	2B	R2141	3D	R2175	2E	R2224	4B	R2253	4C	R2279	3E	U2260	4D
2D	C2227	4B	C2297	3B			R2116	2C	R2144	3E	R2179	2E	R2225	4C	R2254	4C	R2280	4F	U2280	4F
2D	C2229	5C					Q2112	1B	R2118	1C	R2145	3D	R2183	2E	R2228	4D	R2255	4C	R2281	4F
2D	C2230	5C	CR2112	1B	Q2114	1B	R2119	1C	R2146	3D	R2185	2E	R2229	4C	R2256	4D	R2283	5F		
3E	C2231	3D	CR2114	1C	Q2116	1C	R2121	3D	R2147	3D	R2186	2E	R2230	3C	R2257	5E	R2284	5F		
2A	C2232	3C	CR2126	3E	Q2122	3E	R2124	3E	R2148	3B	R2189	2B	R2231	3C	R2258	4E	R2286	5E		
2A	C2233	4C	CR2146	3D	Q2142	3D	R2125	3E	R2151	2D	R2190	2E	R2232	4C	R2259†		R2287	5F		
1D	C2243	4D	CR2213	5B	Q2212	5B	R2126	3E	R2153	1C	R2191	2E	R2233	4C	R2261	5D	R2288	5E		
2E	C2246	4E	CR2214	4C	Q2214	4B	R2127	3D	R2158	3B	R2198	2E	R2235	3C	R2262	5D	R2289	4E		
1E	C2248	5D	CR2261	5D	Q2216	5C	R2128	3B	R2164	1D	R2199	2D	R2236	4C	R2263†		R2299	3B		
1E	C2256	4D	CR2262	5D	Q2284	5E	R2130	2C	R2165	1D	R2212	5B	R2237	4C	R2264	5D				

Refer to Waveform and Voltage Test Conditions.



0 volt point depends on setting of instrument vertical POSITION control.

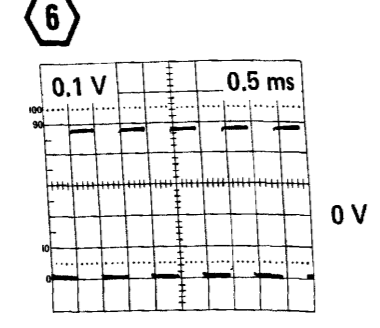

0 volt point depends on setting of instrument vertical POSITION control.

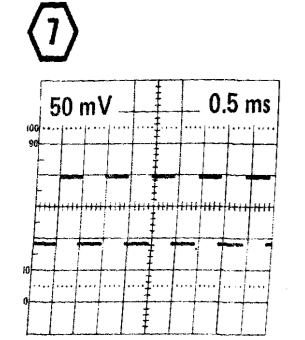

AC Coupled

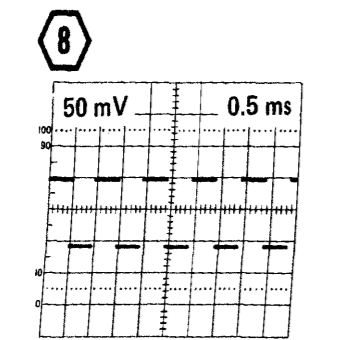

AC Coupled

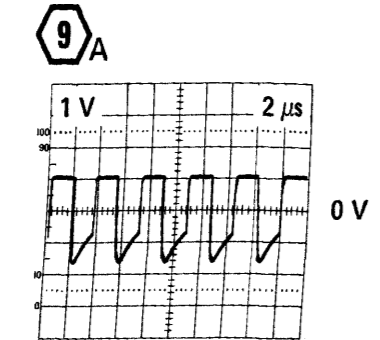

Instrument VERT MODE to CHOP
Test oscilloscope trigger SOURCE to CH 1

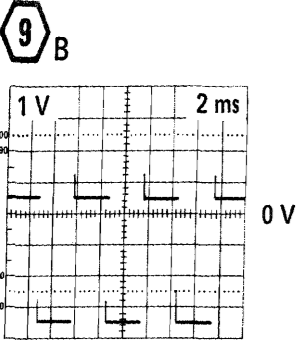

Instrument VERT MODE to ALT

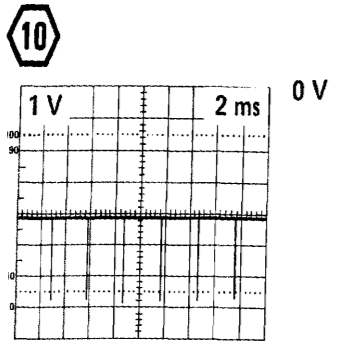

Instrument VERT MODE to ALT

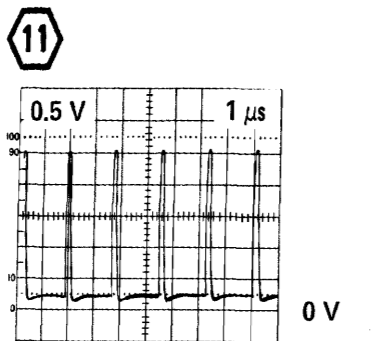

Instrument VERT MODE to CHOP
Test oscilloscope trigger SOURCE to CH 1

2237-115

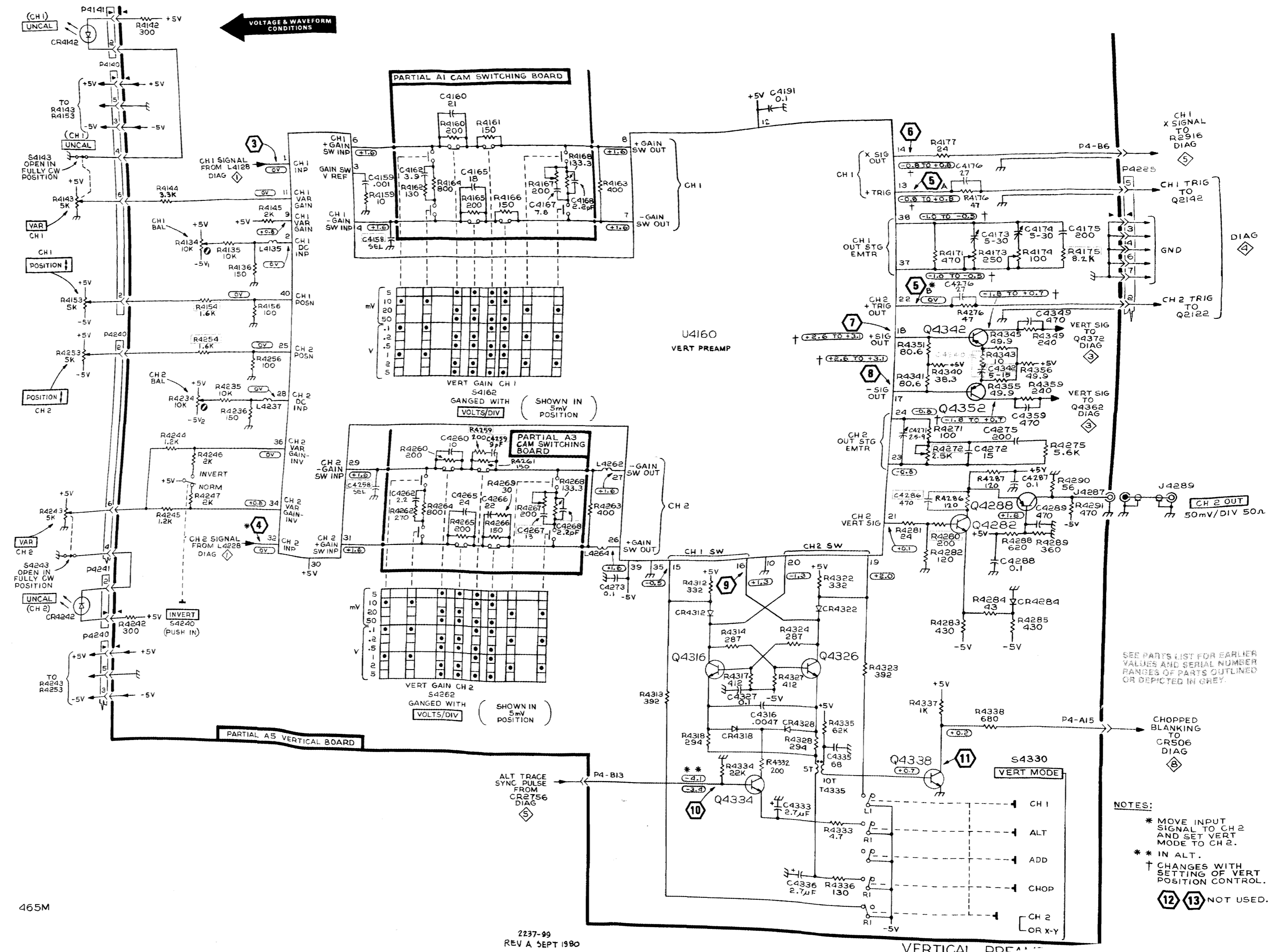

465M

2237-99
REV A SEPT 1980

VERTICAL PREAMPLIFIER

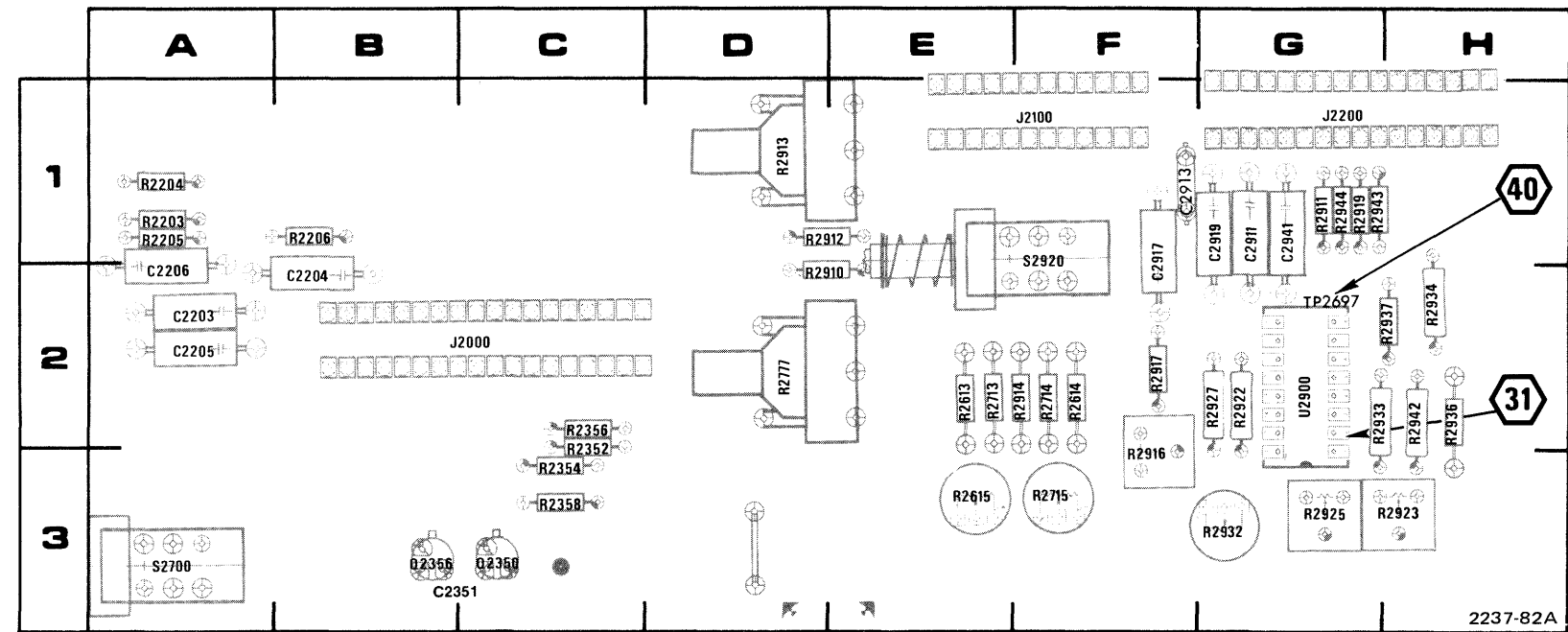

CKT NO	GRID LOC	CKT NO	GRID LOC	CKT NO	GRID LOC	CKT NO	GRID LOC	CKT NO	GRID LOC	CKT NO	GRID LOC
C2203	2A	J2000	2C	R2205	1A	R2715	3F	R2922	2G	R2943	1G
C2204	2B	J2100	1F	R2206	1B	R2777	2D	R2923	3H	R2944	1G
C2205	2A	J2200	1G	R2352	3C	R2910	2D	R2925	3G		
C2206	2A			R2356	2C	R2911	1G	R2927	2G	S2700	3A
C2351	3B	Q2350	3C	R2358	3C	R2912	1D	R2932	3G	S2920	1F
C2911	1G	Q2356	3B	R2613	2E	R2913	1D	R2933	2G		
C2913	1F			R2614	2F	R2914	2F	R2934	2H	U2900	2G
C2917	1F	R2201§		R2615	3E	R2916	3F	R2936	2H		
C2919	1G	R2203	1A	R2713	2E	R2917	2F	R2937	2H		
C2941	1G	R2204	1A	R2714	2F	R2919	1G	R2942	2H		

§ Connected from A6 to bnc connector

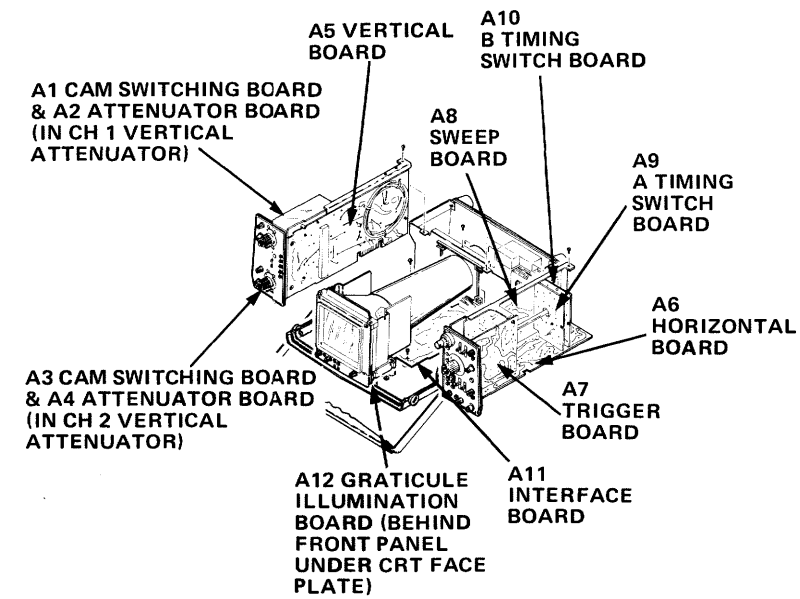

Refer to Waveform and Voltage Test Conditions.

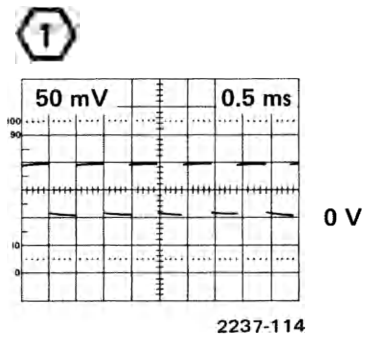

VOLTAGE & WAVEFORM
CONDITIONS

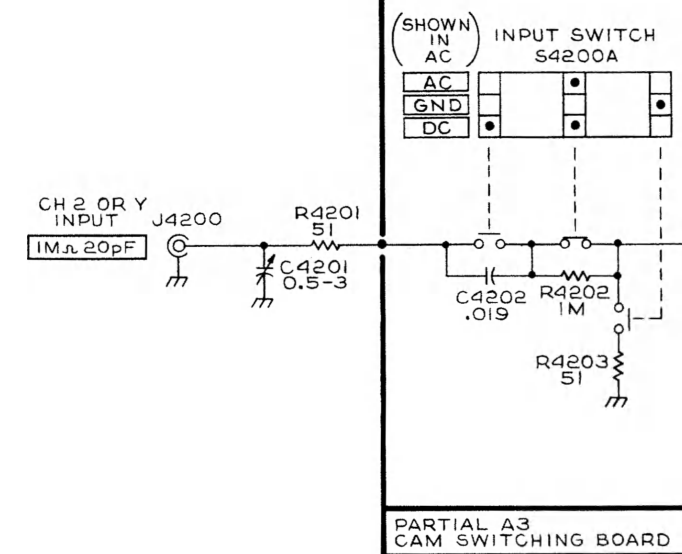
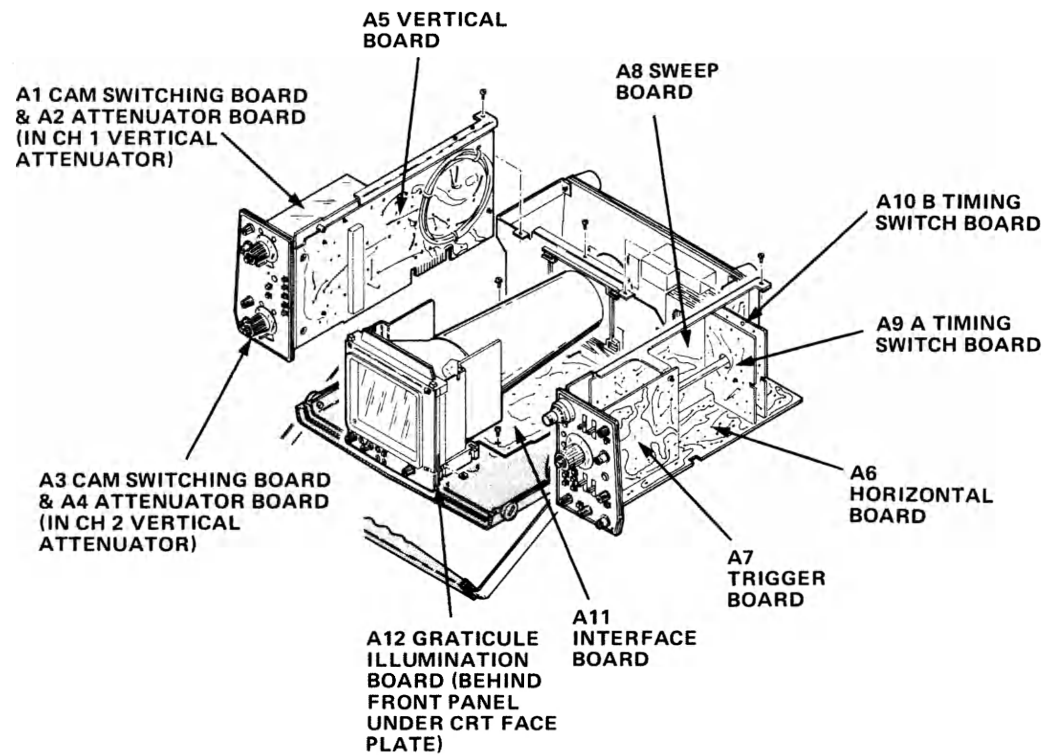
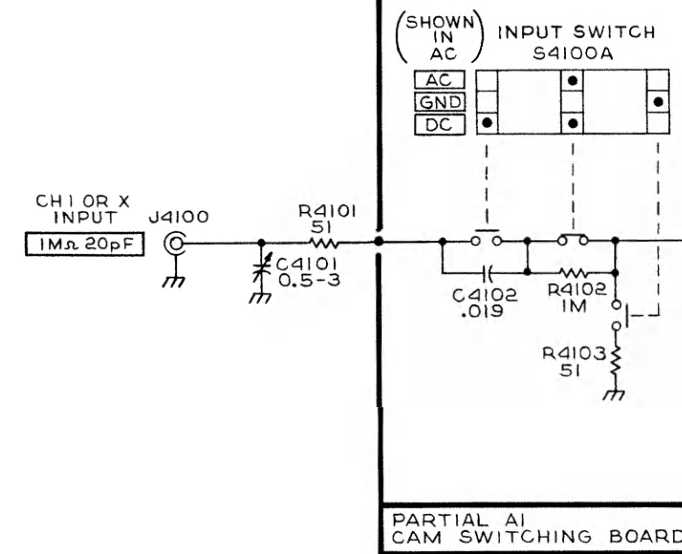

VOLTS/DIV (SHOWN IN 5mV POSITION)
S4100B

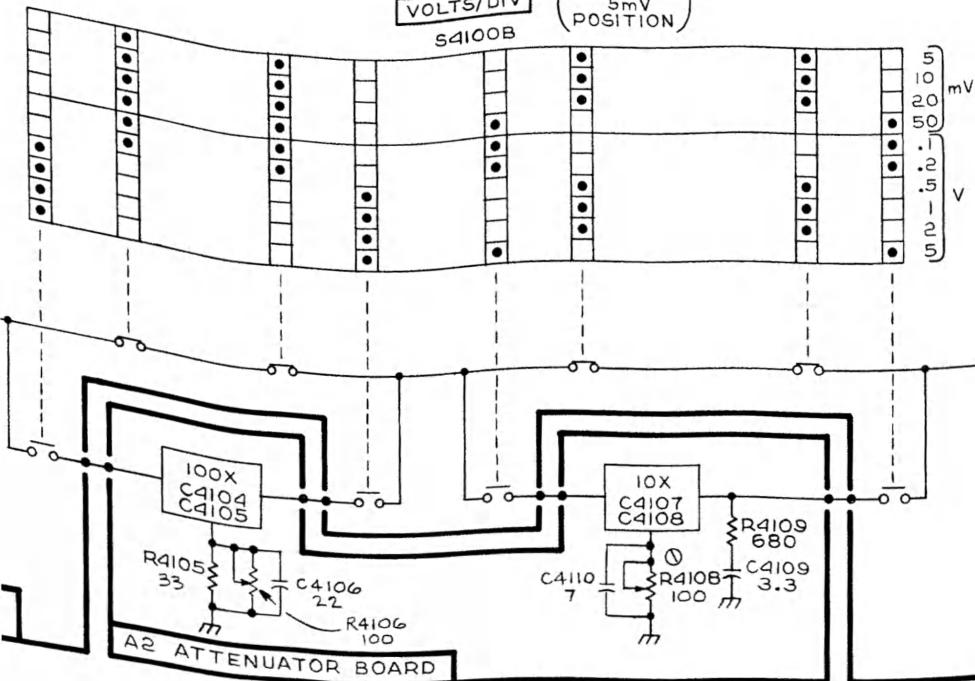

VOLTS/DIV (SHOWN IN 5mV POSITION)
S4200B

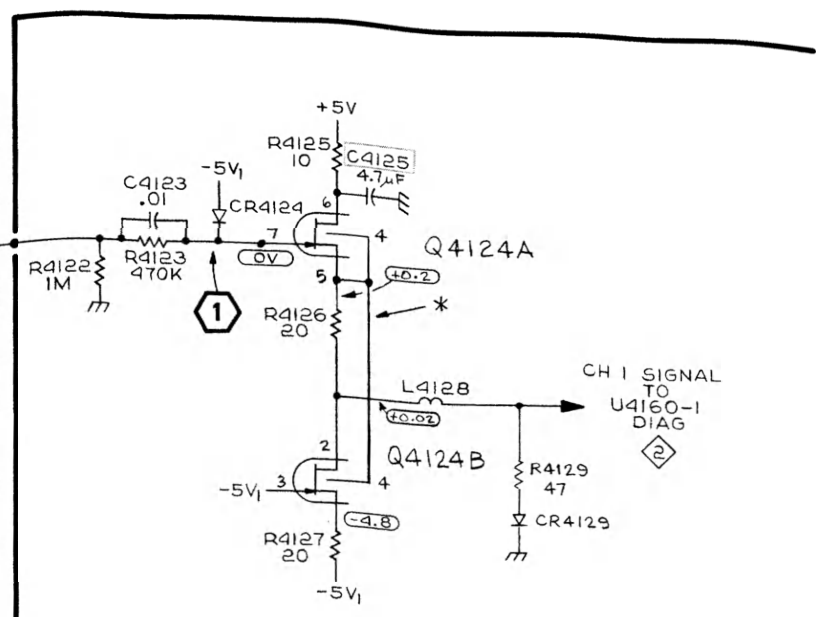
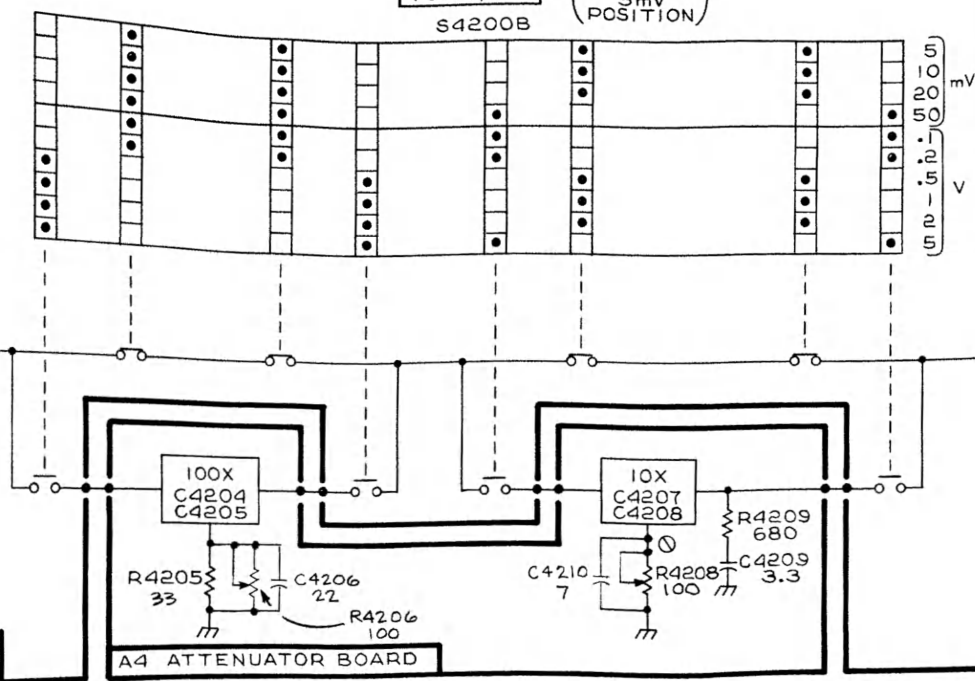

SEE PARTS LIST FOR EARLIER VALUES AND SERIAL NUMBER RANGES OF PARTS OUTLINED OR DEPICTED IN GREY.

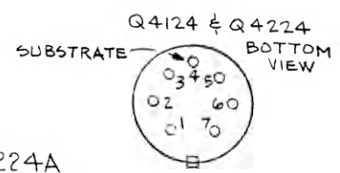
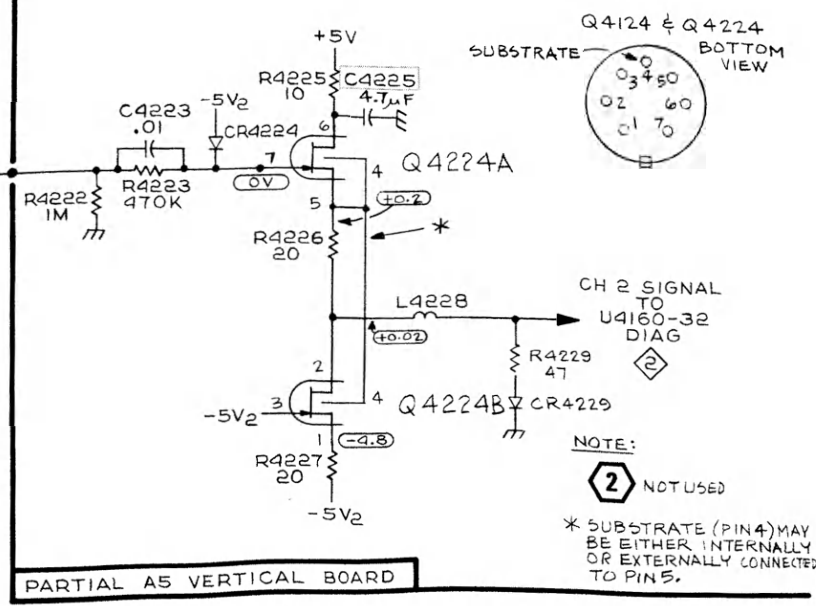
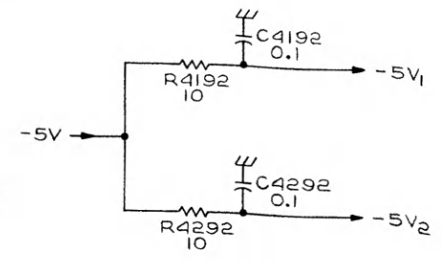

NOTE:
② NOT USED

* SUBSTRATE (PIN4) MAY BE EITHER INTERNALLY OR EXTERNALLY CONNECTED TO PIN 5.

PARTIAL A5 VERTICAL BOARD

CH1 & CH2 INPUT ①

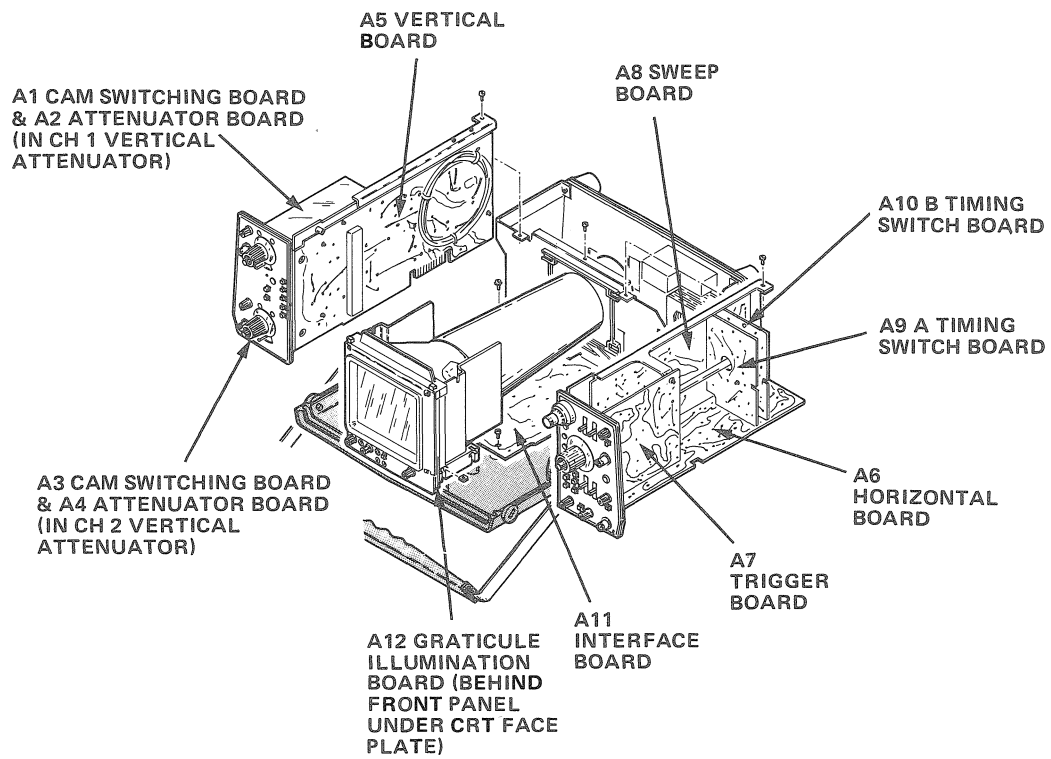

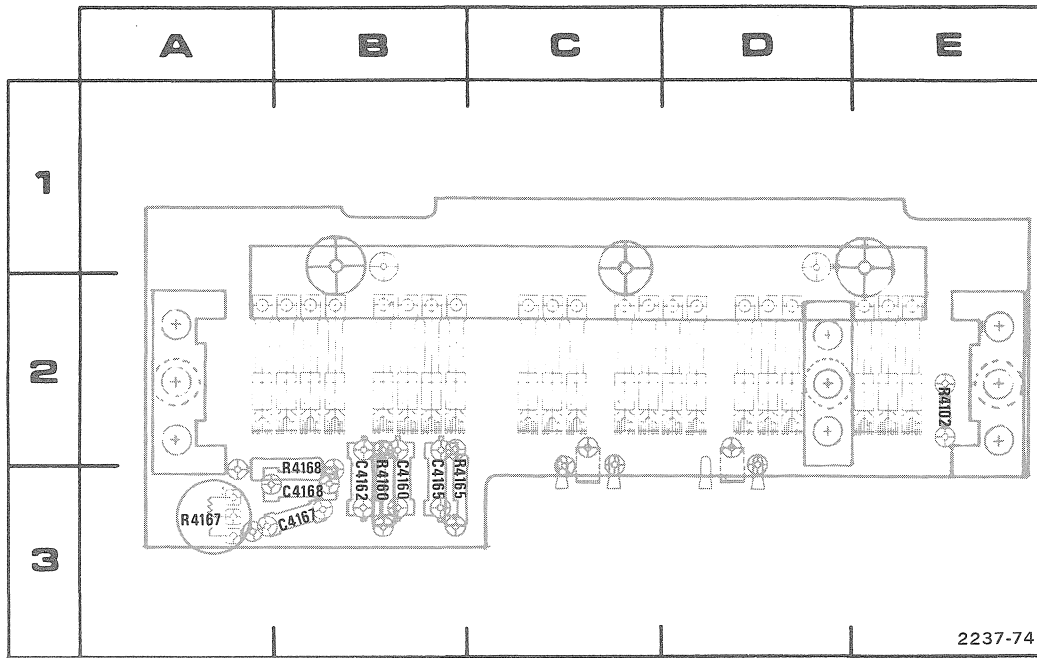

2237-74

Figure 6-3. A1 Cam Switching board (top) component locations.

CKT NO	GRID LOC	CKT NO	GRID LOC	CKT NO	GRID LOC	CKT NO	GRID LOC	CKT NO	GRID LOC
C4160	3B	C4165	3B	C4168	3B	R4160	3B	R4167	3A
C4162	3B	C4167	3B	R4102	2E	R4165	3B	R4168	3B

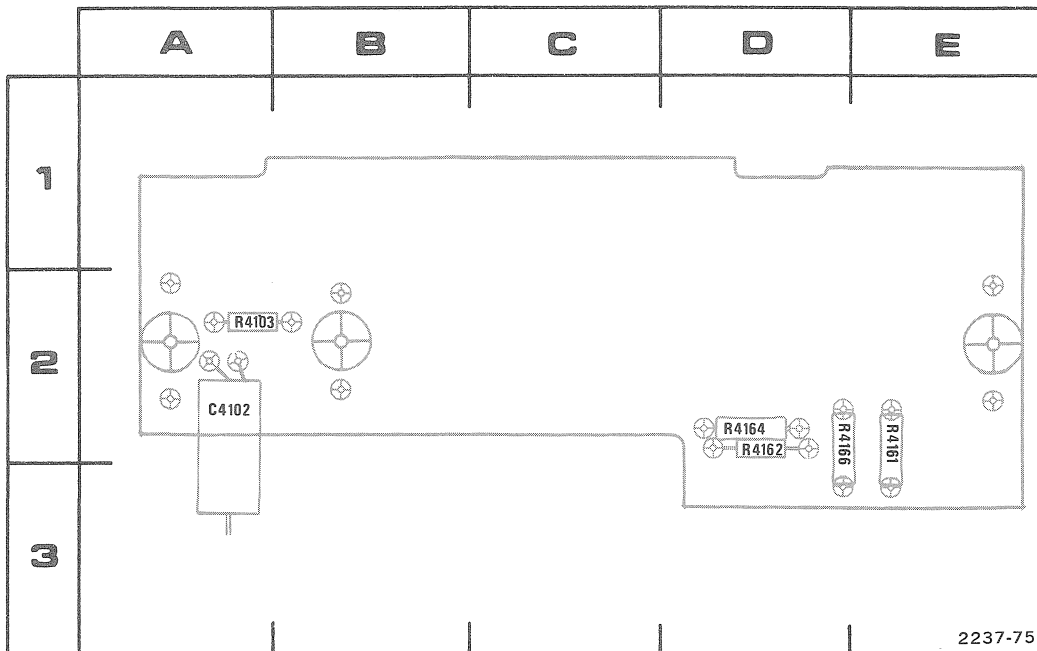

2237-75

Figure 6-4. A1 Cam Switching board (bottom) component locations.

CKT NO	GRID LOC	CKT NO	GRID LOC	CKT NO	GRID LOC
C4102	2A	R4161	2E	R4164	2D
R4103	2A	R4162	2D	R4166	2D

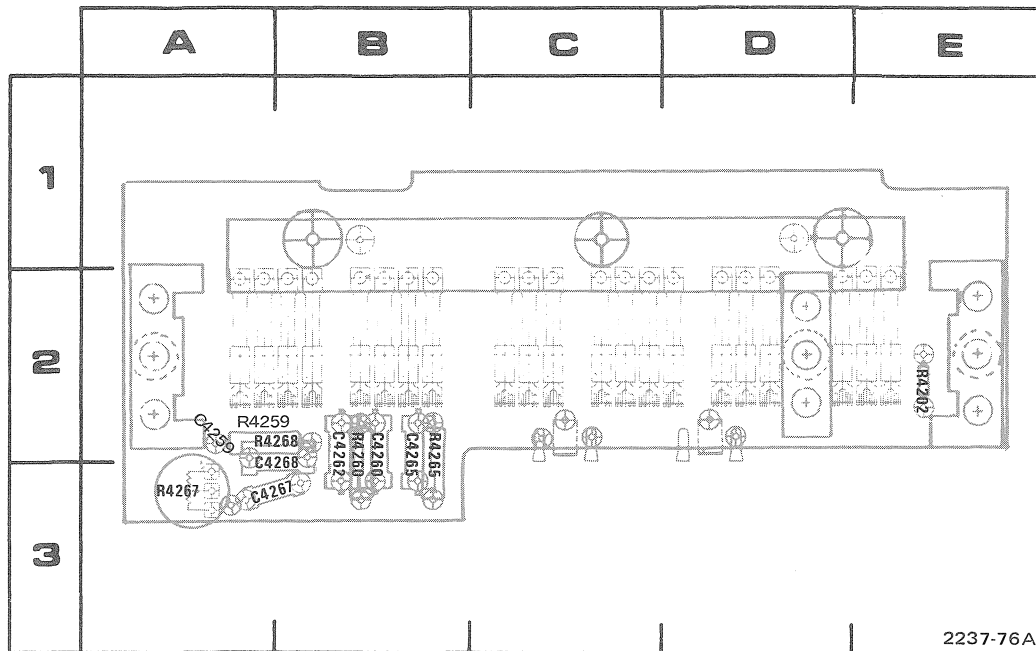

Figure 6-5. A3 Cam Switching board (top) component locations.

CKT NO	GRID LOC	CKT NO	GRID LOC	CKT NO	GRID LOC	CKT NO	GRID LOC	CKT NO	GRID LOC
C4259	2A	C4265	2B	C4268	2A	R4260	2B	R4267	3A
C4260	2B	C4267	3A	R4202	2E	R4265	2B	R4268	2A
C4262	2B			R4259	2A				

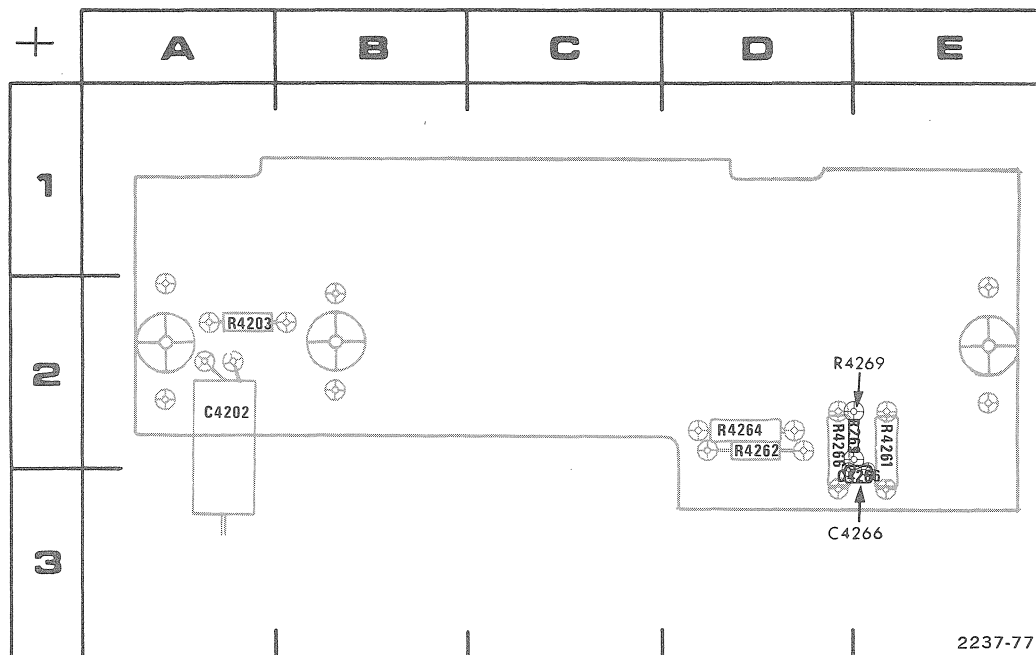

Figure 6-6. A3 Cam Switching board (bottom) component locations.

CKT NO	GRID LOC	CKT NO	GRID LOC	CKT NO	GRID LOC	CKT NO	GRID LOC
C4202	2A	R4203	2A	R4262	2D	R4266	2D
C4266	3E	R4261	2E	R4264	2D	R4269	2E

DIAGRAMS AND CIRCUIT BOARD ILLUSTRATIONS

Symbols and Reference Designators

Electrical components shown on the diagrams are in the following units unless noted otherwise:

- Capacitors = Values one or greater are in picofarads (pF).
Values less than one are in microfarads (μ F).
- Resistors = Ohms (Ω).

Graphic symbols and class designation letters are based on ANSI Standard Y32.2-1975.

Logic symbology is based on ANSI Y32.14-1973 in terms of positive logic. Logic symbols depict the logic function performed and may differ from the manufacturer's data.

The overline on a signal name indicates that the signal performs its intended function when it goes to the low state.

Abbreviations are based on ANSI Y1.1-1972.

Other ANSI standards that are used in the preparation of diagrams by Tektronix, Inc. are:

- Y14.15, 1966 Drafting Practices.
- Y14.2, 1973 Line Conventions and Lettering.
- Y10.5, 1968 Letter Symbols for Quantities Used in Electrical Science and Electrical Engineering.

The following special symbols may appear on the diagrams:

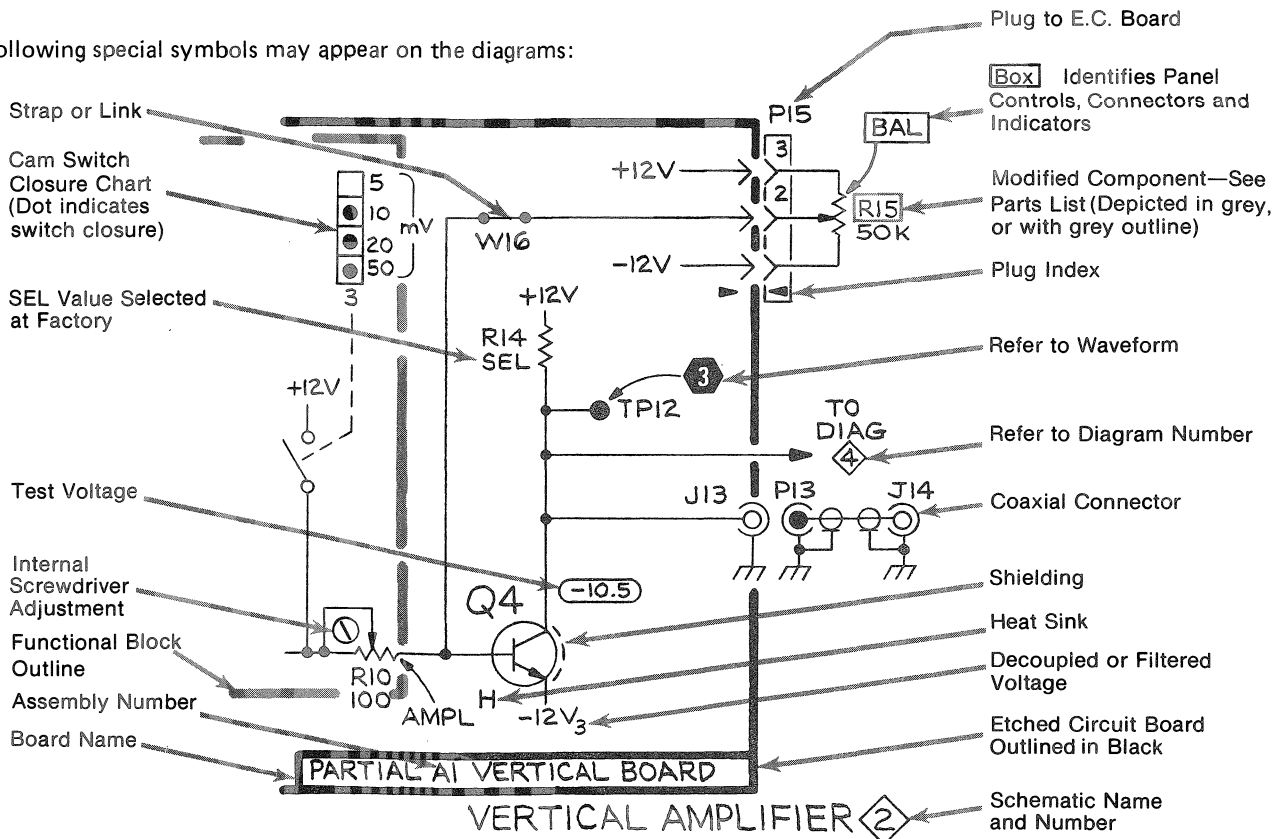

Figure 6-1. Schematic symbols.

(3) An explanation of the symbols used on the diagrams is shown in Figure 6-1.

6-3. WAVEFORMS AND VOLTAGE TEST CONDITIONS.

a. Waveform Conditions. The following test setup is used for all waveforms, except as noted. This uniform setup simplifies troubleshooting. The test oscilloscope trigger setup allows time comparison (horizontally) between the waveforms. Use an AN/USM-425(V)1, Tektronix 465M, or equivalent for waveforms.

(1) Instrument Setup.

(a) Connect a P6104 Probe (10X) to CH 1 input and the probe tip to the CALIBRATOR.

(b) Set the instrument controls as follows:

VOLTS/DIV (both)	.2
AC-GND-DC (both)	DC
VERT MODE	CH 1
HORIZ DISPLAY	MIXED
SOURCE (both)	CH 1
SLOPE (both)	OUT: +
A TIME/DIV	.2 ms
B TIME/DIV	50 μ s
LEVEL (both)	For a stable mixed display

(2) Test Oscilloscope Setup.

(a) Connect a 50 ohm unterminated BNC cable between the A EXT Trigger input of the test oscilloscope and the +A GATE of the oscilloscope under test.

(b) Set the test oscilloscope controls as follows:

A Coupling	Dc
A Slope	Out: +
A Source	Ext \div 10
Vert Mode	CH 1
CH1 ac-gnd-dc	Dc
A Level	Adjust so Trig Ready indicator is lit. Push Trig View to verify triggering on the positive slope.

b. Voltage Conditions. The voltages were taken between the indicated test point and chassis ground using a Tektronix DM 501A digital multimeter. Any change from the following setup may change some of the indicated voltages. Set controls as follows (where controls are duplicated, set both controls the same):

VOLTS/DIV	5 m
AC-GND-DC	GND
POSITION (Vertical)	Midrange
VERT MODE	CH 2
DELAY TIME POS	5.00
HORIZ DISPLAY	A
TIME/DIV	1 ms
POSITION (Horizontal)	Midrange
INTEN	Fully counterclockwise
FOCUS	Fully counterclockwise
SCALE ILLUM	Midrange
TRIG MODE	NORM
COUPLING	AC
SOURCE	CH 1
SLOPE	+
LEVEL	Midrange

NOTE

These settings place the instrument in a quiescent operating state for making dc voltage measurements.

SECTION VI DIAGRAMS

6-1. INTRODUCTION. This section contains diagrams and associated data for maintaining the instrument. Included are front and rear panel control, connector, and indicator layouts; schematic diagrams with voltages and waveforms, and circuit board layouts with grid chart component locators.

6-2. ARRANGEMENT.

a. Schematic Diagrams. Schematic diagrams are drawn to group circuit functions; therefore, any one diagram may include portions of any number of circuit boards or assemblies. To aid in tracing circuits from one diagram to another, each diagram is identified with a name and a number in a diamond shaped box. Circuits going from one diagram to another identify the destination component and destination diagram number.

b. Symbols and Reference Designators.

(1) Electrical components shown on the diagrams are in the following units unless noted otherwise.

Capacitors	Values one or greater are in picofarads (pF). Values less than one are in microfarads (μ F).
Resistors	Ohms (Ω).

(2) Table 6-1 is a partial listing of prefix letters used as reference designators. These are used to identify components or assemblies on the diagrams. A complete listing is contained in MIL STD 16 and also in the ANSI standard.

Table 6-1. Reference Designators

REFERENCE DESIGNATOR	DESCRIPTION	REFERENCE DESIGNATOR	DESCRIPTION
A	Assembly, separable or repairable (circuit board, etc.)	LR	Inductor/resistor combination
AT	Attenuator, fixed or variable	M	Meter
B	Motor	P	Connector, movable portion
BT	Battery	Q	Transistor or silicone-controlled rectifier
C	Capacitor, fixed or variable	R	Resistor, fixed or variable
CB	Circuit breaker	RT	Thermistor
CR	Diode, signal or rectifier	S	Switch or contactor
DL	Delay line	T	Transformer
DS	indicating device (lamp)	TC	Thermocouple
E	Spark Gap, Ferrite bead	TP	Test point
F	Fuse	U	Assembly, inseparable or nonrepairable (integrated circuit, etc.)
FL	Filter	V	Electron tube
H	Heat dissipating device (heat sink, heat radiator, etc.)	VR	Voltage regulator (zener diode, etc.)
HR	Heater	W	Wirestrap or cable
HY	Hybrid circuit	Y	Crystal
J	Connector, stationary portion	Z	Phase shifter
K	Relay		
L	Inductor, fixed or variable		