

4/27/79

TEKTRONIX®

178
577/D1/D2
OPERATORS

INSTRUCTION MANUAL

Tektronix, Inc.
P.O. Box 500
Beaverton, Oregon 97077

Serial Number _____

WARRANTY

All TEKTRONIX instruments are warranted against defective materials and workmanship for one year. Any questions with respect to the warranty should be taken up with your TEKTRONIX Field Engineer or representative.

All requests for repairs and replacement parts should be directed to the TEKTRONIX Field Office or representative in your area. This will assure you the fastest possible service. Please include the instrument Type Number or Part Number and Serial Number with all requests for parts or service.

Specifications and price change privileges reserved.

Copyright © 1977 by Tektronix, Inc., Beaverton, Oregon. Printed in the United States of America. All rights reserved. Contents of this publication may not be reproduced in any form without permission of Tektronix, Inc.

U.S.A. and foreign Tektronix products covered by U.S. and foreign patents and/or patents pending.

TEKTRONIX is a registered trademark of Tektronix, Inc.

TABLE OF CONTENTS

	Page
SECTION 1	CHARACTERISTICS
	Introduction 1-1
	Electrical 1-2
	Environmental 1-5
	Physical 1-5
SECTION 2	OPERATING INSTRUCTIONS
	Introduction 2-1
	How The 178 Tests Linear IC 2-1
	Functions Of Front-panel Controls, Indicators, And Connectors 2-4
	Device Cards 2-9
	Function Switch Operation 2-10
	Connecting To The DUT 2-11
	Connecting To The 178 2-11
	Compensation And Other External Networks 2-11
	Useful Accessories 2-11
	First Time Operation 2-12
APPENDIX A	TESTING THE LM324 QUAD OPERATIONAL AMPLIFIER
APPENDIX B	TESTING THE LM302 VOLTAGE FOLLOWER
APPENDIX C	TESTING THE 727 TEMPERATURE CONTROLLED DIFFERENTIAL PREAMPLIFIER
APPENDIX D	TESTING THE LM380 AUDIO POWER AMPLIFIER
APPENDIX E	TESTING SINGLE-SUPPLY QUAD COMPARATORS
APPENDIX F	TESTING QUAD COMPARATORS—MC3302P
APPENDIX G	TESTING THE 741 OPERATIONAL AMPLIFIER
APPENDIX H	TESTING THE 3900 NORTON AMPLIFIER
CHANGE INFORMATION	

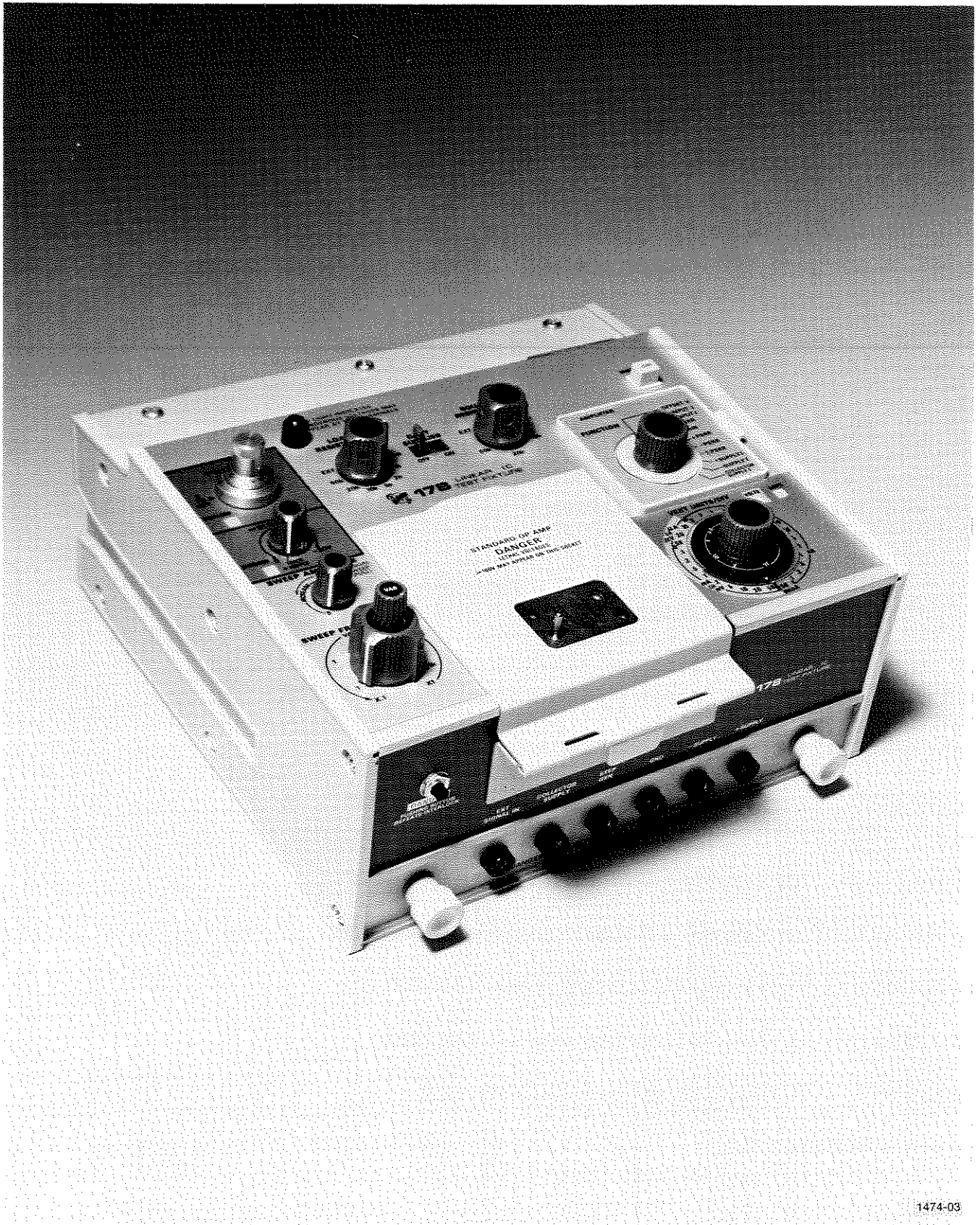

1474-03

Fig. 1-1. 178 Linear IC Curve Tracer.

CHARACTERISTICS

Introduction

The 178 Linear IC Test Fixture is a plug-in device for use with the 577-D1 or 577-D2 Curve Tracer Systems. The 577-178 combination, with the D1 Display Unit module, is designed to measure the parameters of operational amplifiers, comparators, differential amplifiers, and regulators. The D2 Display Unit may be used, but since it lacks display storage the results may not be satisfactory because of the low frequencies necessary to test many devices.

The 178 Linear IC Test Fixture features a sweep generator, positive and negative power supplies, part of the vertical measuring system, a feedback loop for the device under test (dut), and switching capabilities to facilitate testing of various parameters under diverse conditions.

The sweep generator provides sinusoidal output with the frequency variable from 0.01 Hz to 1 kHz. The sweep generator output is used to force the dut output or the positive and negative supplies (either in-phase or out-of-phase), or to sweep the dut inputs.

The dc voltage levels of both positive and negative supplies are independently adjustable from 0 to 30 volts. The negative supply can be made to track (have the same absolute value as) the positive supply amplitude. The maximum current capability of the positive and negative supplies can be limited by potentiometers on the dut card. If the load current attempts to exceed the set limits, the supply current limits and a lamp for each supply indicates the condition.

Any one of the four pairs of source resistors within the 178 can be used in series with the dut card amplifier inputs; also any value of external source resistance can be added to the dut card. The dut card amplifier output can be loaded with one of seven values of internal load resistance from the 178; also any value of external load resistance can be added to the dut card in parallel with the 50 k Ω of resistance provided on the card.

The vertical measurement system is capable of measuring either voltage or current. The choice of voltage or current measurement is determined by the position of the FUNCTION switch and is indicated by the AMPS or VOLTS lamp.

The vertical deflection factor switch has 28 positions ranging from 50 p/div to 50 m/div (unmagnified) in a 1-2-5 sequence. All 28 positions are used for current measurements, but only the range from 10 μ /div to 50 m/div can be used for voltage measurements. Any attempt to measure voltage using vertical deflection factors less than 10 μ V/div (unmagnified) causes the VOLTS indicator light to turn off, indicating an unusable switch position.

Vertical deflection factor is increased by 10 when the vertical POSITION X10 VERT MAG knob on the 577 is pulled to its outward position; the increase is indicated by the lamp behind the VERT UNITS/DIV knob skirt. This lamp also turns off if an unusable switch position is selected.

A FUNCTION selector switch provides 11 test positions. All positions are useful to test operational amplifiers.

Horizontal deflection factors range from 50 mV/div to 200 V/div (unmagnified), and are selected from the COLLECTOR VOLTS segment of the 577 HORIZ VOLTS/DIV switch.

The Standard Op Amp card can be used to test single, dual, and quad operational amplifiers. It can also be used to test single and dual comparators and differential amplifiers. Regulator cards are used to test three-terminal regulator parameters. These regulator cards are optional accessories and are described on separate data sheets. Integrated circuit pins must be connected to the cards by using adapter sockets and patch cords.

An offset ZERO pushbutton provides a crt display zero reference and nulls offset voltage for certain measurements that would otherwise be off screen. Offset is usually reset automatically when the setting of the FUNCTION switch is changed. Offset must be reset manually when switching between 1 and .5 mV/div and between .1 mV and 50 μ V/div.

The stored display on the D1 Display Unit is erased whenever the FUNCTION switch is changed, except when switching between +INPUT I and -INPUT I, +PSRR and -PSRR, and +SUPPLY I and -SUPPLY I.

ELECTRICAL CHARACTERISTICS

Characteristic	Performance Requirements	Supplemental Information
Vertical Deflection Factors		
Input Current (In +Input I and -Input I Functions)	50 pA/div to .2 mA/div in a 1-2-5 sequence unmagnified, 5 pA/div to 20 μ A/div with 10X magnifier on.	
Accuracy ^a	Within $\pm 3\% \pm 50$ pA, unmagnified. Within $\pm 4\% \pm 50$ pA with 10X magnifier on.	
Voltage ^b	10 μ V/div to 50 mV/div in a 1-2-5 sequence, unmagnified.	
	1 μ V/div to 5 mV/div with 10X magnifier on.	
GAIN and OFFSET V Functions Accuracy ^b	Within $\pm 3\%$, unmagnified; $\pm 4\%$ with 10X magnifier on.	
CMRR Function Accuracy	Within $\pm 3\% + \frac{100 K}{\text{Gain} - K} \% \pm \frac{150}{K} \mu\text{V}/V_{\text{cm}}$.	
	Within $\pm 4\% + \frac{100 K}{\text{Gain} - K} \% \pm \frac{150}{K} \mu\text{V}/V_{\text{cm}}$ with 10X magnifier on (1 μ V/div to 5 μ V/div); see footnotes b and c.	
PSRR Function Accuracy	Within $\pm 3\% + \frac{100 K}{\text{Gain} - K} \%$.	
	Within $\pm 4\% + \frac{100 K}{\text{Gain} - K} \%$ with 10X magnifier on (1 μ V/div to 5 μ V/div); see footnotes b and c.	
Power Supply		
Current	1 nA/div to 50 mA/div in a 1-2-5 sequence, unmagnified. 0.1 nA/div to 5 mA/div with 10X magnifier on.	
Current Mode Accuracy ^a	Within $\pm 3\% \pm 1$ nA unmagnified; $\pm 4\% \pm 1$ nA with 10X magnifier on.	

^aAccuracies are the highest percentage of on-screen values.

^bVertical magnification is not recommended for .5 mV/div through 50 mV/div unmagnified settings.

^cDUT gain with small signal out near zero volts with 50 k Ω load:

K = 10 for 50 mV/div to 1 mV/div, K = 100 for .5 mV/div to 100 μ V/div, and K = 1000 for 50 μ V/div to 10 μ V/div to 10 μ /div. V_{cm} = Common-mode voltage.

ELECTRICAL CHARACTERISTICS (cont)

Characteristic	Performance Requirements	Supplemental Information
Collector Supply		
Current	1 nA/div to 50 mA/div in a 1-2-5 sequence, unmagnified . 0.1 nA/div to 5 mA/div with 10X magnifier on.	
Current Mode Accuracy ^a	Within $\pm 3\% \pm 1$ nA, unmagnified. $\pm 4\% \pm 1$ nA with 10X magnifier on.	
Positive and Negative Supplies		
Voltage	Adjustable from 0 to 30 V.	Both supplies can be adjusted from the +SUPPLY control. Negative supply can be independently adjusted using the uncalibrated -SUPPLY control.
Accuracy	Within $\pm 2\% \pm 100$ mV.	The -SUPPLY voltage is within $\pm 1\%$ (absolute) of the +SUPPLY voltage when the -SUPPLY control is in the TRACK +SUPPLY position.
Current	At least 150 mA	Adjustable current limiting.
Sweep Generator		
Frequency	0.1 Hz to 1 kHz, sinusoidal signal. Five ranges, 0.1, 1, 10, 100, and 1000 Hz with X.1 to X1 variable.	Ranges overlap at X.1 end of variable.
Accuracy	Within $\pm 5\%$ in calibrated (X1) position.	
Amplitude (In OFFSET and GAIN Functions)	Adjustable from 0 V to 30 V $\pm 3\%$ maximum peak.	Adjustable, depends on function. The voltage should be limited to the output capability of the dut.
Common-mode Voltage in INPUT I and CMRR Function	0 V to 30 V $\pm 3\%$ maximum peak. In the 1 mV/div to 50 mV/div ranges, the values are 10% lower.	Limited to the power supply voltages (clipped).
Power Supply Voltage in PSRR and SUPPLY I Functions		See Positive and Negative Supplies.
Manual Sweep		The Generator output may be manually set to any dc level (uncalibrated) within its amplitude range (depends on the setting of the FUNCTION switch).

^aAccuracies are the highest percentage of on-screen values.

ELECTRICAL CHARACTERISTICS (cont)

Characteristic	Performance Requirements	Supplemental Information
Source Resistance Resistances		<p>Four pairs; 50 Ω, 10 kΩ, 20 kΩ, and 50 kΩ.</p> <p>When the VERT UNITS/DIV switch is set to 1 mV/DIV through 50 mV/DIV, the indicated values increase by 500 Ω. External resistors can be used.</p>
Tolerance		±1% ±10 Ω.
Load Resistance Resistance		Seven resistances; 100 Ω, 1 kΩ, 2 kΩ, 5 kΩ, 10 kΩ, 20 kΩ, and 50 kΩ.
Tolerance		<p>±3% except when using the 50 mV, 20 mV, and 10 mV positions of the VERT UNIT/DIV switch. The tolerance for the 50 kΩ then becomes ±30%, for the 20 kΩ ±14%, 10 kΩ ±7%, and 5 kΩ ±3% when the dut output voltage swing is 2.5 V or less. The maximum tolerance decreases exponentially as the output swing is increased and is less than ±3% when the output is swinging ±30 volts.</p>

ENVIRONMENTAL CHARACTERISTICS

Characteristic	Performance Requirement	Supplemental
Temperature		
Specified Operating		+10° C (+50° F) to +40° C (+104° F).
Useful Operating		0° C (+32° F) to +50° C (+120° F).
Non-operating		-40° C (-40° F) to +65° C (+149° F).
Altitude		
Operating		To 10,000 feet (3000 meters).
Transportation		12-inch (30 cm) package drop. Qualified under the National Safe Transit Committee procedure 1A.

PHYSICAL CHARACTERISTICS

Characteristic	Performance Requirement	Supplemental
Dimensions		
Height		4.5 inches (11.4 cm).
Width		7.9 inches (20.1 cm).
Depth		7.8 inches (19.8 cm).
Weight		
Net		3.3 pounds (1.5 kg).

Standard Accessories

Refer to the Replaceable Mechanical Parts list for a listing of the standard accessories.



OPERATING INSTRUCTIONS

Introduction

In the applications for which it was designed, the versatile curve tracer is an unexcelled measurement tool. The ability to plot a characteristic curve rather than obtain a numerical answer to measurements makes the curve tracer almost indispensable in laboratories, on the production line, and in incoming inspection groups. The curve it plots shows how and why parameters change throughout the operating range of a device. The curve tracer crt thus becomes a window on effects that remain hidden from test sets that provide only numerical or go/no-go answers.

How The 178 Tests Linear IC

Operational amplifiers make up the greatest single class of linear integrated circuits. In order to test amplifiers, the 178 Linear IC Test Fixture uses a closed-loop technique. This technique is a departure from standard curve tracer techniques where device parameters are obtained in open-loop configurations. The essential difference between the two test configurations is seen by comparing two simplified diagrams, Figs. 2-1 and 2-2. In theory, either configuration could be used to determine the device-under-test (dut) gain (A), where:

$$A = \frac{\Delta \text{output volts}}{\Delta \text{input volts}}$$

The 178 uses the closed-loop approach because of its greater inherent stability and ease of operation when testing very high gain devices.

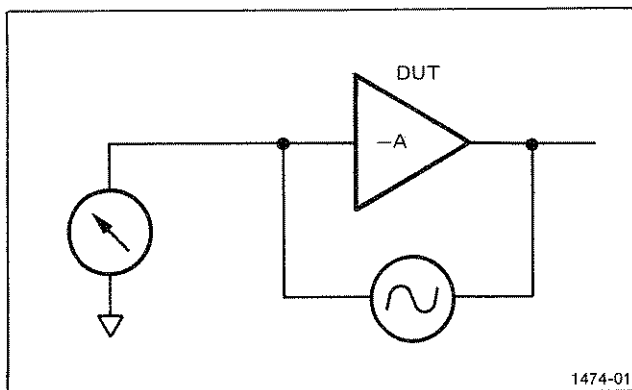

Fig. 2-1. Simplified closed-loop test of an inverting amplifier.

In the closed-loop test of Fig. 2-1, a test signal is applied between the dut input and output. Because of the dut gain, its input voltage changes little compared with its output voltage. The small signal at the input is measured while the generator, in effect, applies an easily controlled signal to the dut output. Conversely, in the open-loop test of Fig. 2-2, a small signal applied to the dut input produces a less-controllable signal that is measured at its output.

Measuring Parameters. Operational amplifier parameters are obtained from the crt display on the TEKTRONIX 577-178 much as parameters of transistors and diodes are obtained with conventional curve tracers. The operator first reads the crt display and then makes any necessary calculations. In the closed-loop test just described, the dut small input signal, or dependent variable, is displayed on the vertical axis of the crt. The large amplitude test signal at the dut output, or independent variable, is displayed on the horizontal axis. Gain is obtained by dividing a change in output voltage (horizontal) by the corresponding change in input voltage (vertical). Fig. 2-3 is such a crt display of an amplifier gain curve or transfer characteristic measured at essentially dc (actually 0.05 Hz). Zero volts on both axes is at center screen. Considering points A and B, for an output swing from -10 volts to +10 volts, the input voltage is seen to change 200 microvolts. The gain of this amplifier is 100,000 (or 100 dB), obtained by dividing output voltage by input voltage.

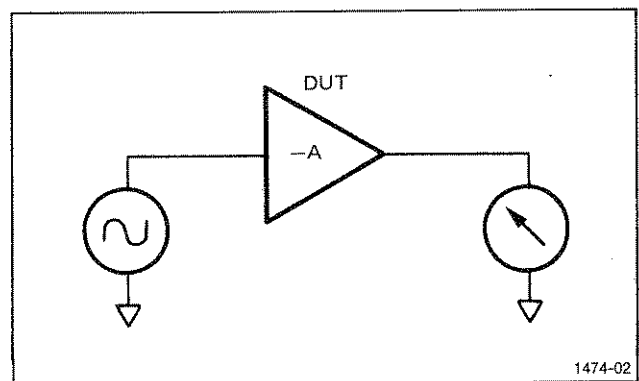

Fig. 2-2. Hypothetical open-loop test of an inverting amplifier.

Operating Instructions—178 577/D1/D2 Operators

The vertical deflection of the curve shown in Fig. 2-3 is the voltage at the amplifier inverting input and is therefore positive for negative output voltage. The curve occupies the second and fourth quadrants. The vertical lines going off-screen are caused when the output of the operational amplifier (dut) reaches its limits. At that point the sweep generator test signal no longer moves the dut output, but is applied to the input, causing large, off-screen excursions.

What A Curve Tracer Shows. The process previously described for measuring gain is not as quick as jotting down a number flashed to the operator by a tester numerical readout. However, it is important to look beyond the test speed and compare the kind of information provided by a linear IC curve tracer and other types of integrated circuit testers.

A tester that provides a numerical answer is likely to measure large signal gain by making two "point" measurements; for example, from point A to point B as shown in Fig. 2-3. A curve tracer measurement, by contrast, not only shows points A and B, but how the amplifier responds at all points between.

In Fig. 2-3, the curve between points A and B contains the information theoretically expected of an ideal amplifier; linear, constant slope with no spurious excursions. It is thus easy to assume that the input voltage is well behaved in all such devices and need not be checked. This misunderstanding can be dispelled by examining four other gain curves.

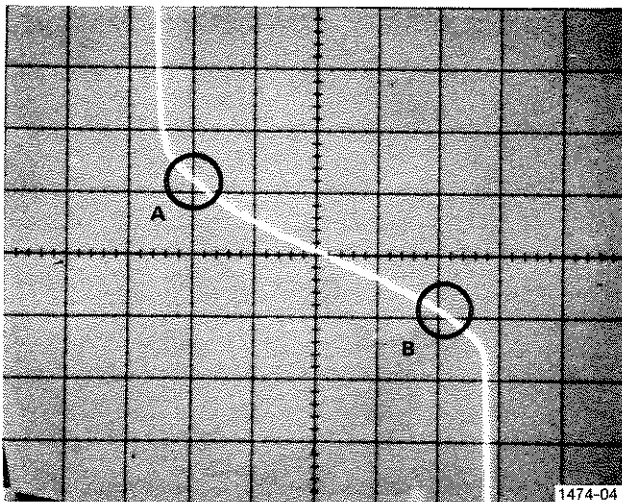

Fig. 2-3. Typical displays of Op Amp characteristics.

Figures 2-4 through 2-7 show characteristics that go from point A to point B, but not in the anticipated ideal manner. These are not unusual amplifiers that were built especially to demonstrate a point, but commonly available integrated circuit amplifiers. The "unusual" response is the ideal curve in Fig. 2-3. Most devices either do not produce ideal dc transfer characteristics or their application (operating conditions) distorts the characteristics beyond recognition.

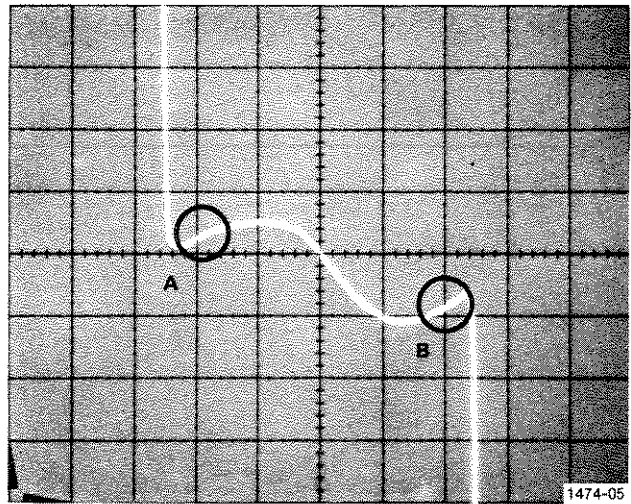

Fig. 2-4. Typical displays of Op Amp characteristics.

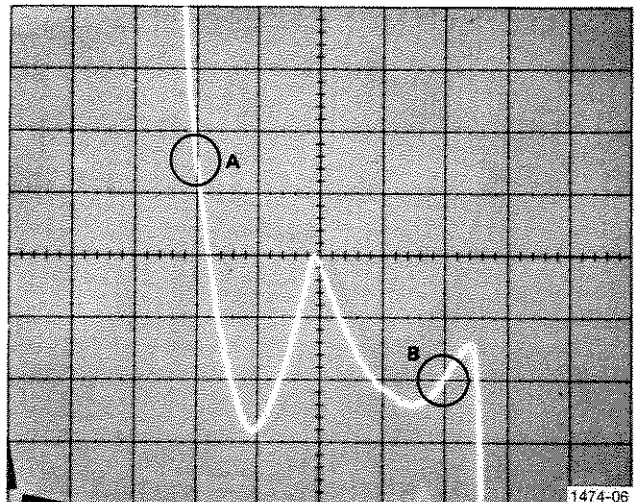

Fig. 2-5. Typical displays of Op Amp characteristics.

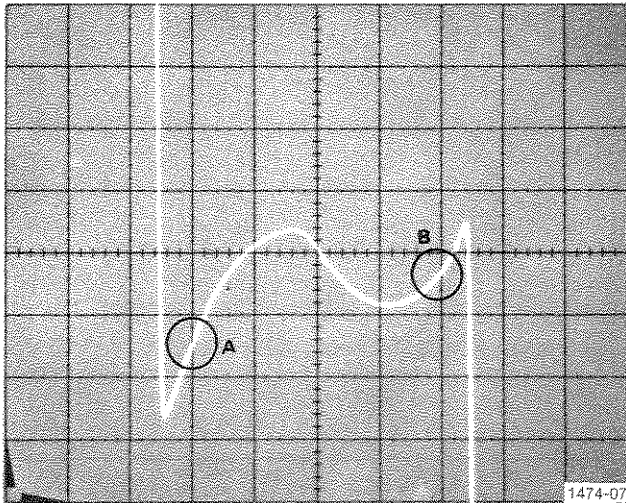

Fig. 2-6. Typical displays of Op Amp characteristics.

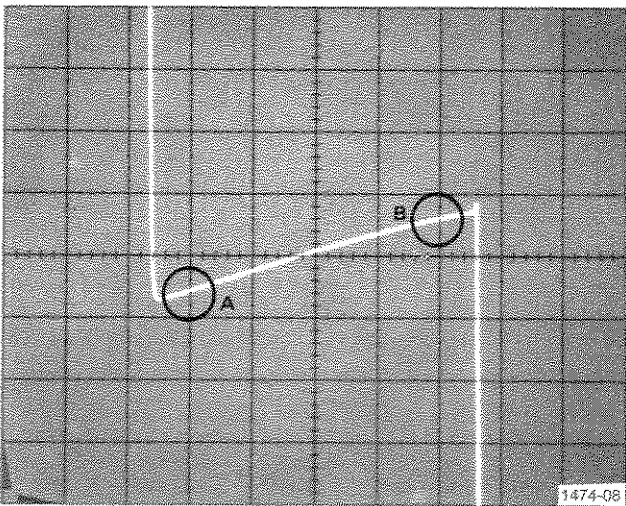

Fig. 2-7. Typical displays of Op Amp characteristics.

Interpreting The Information. Many applications make use of an operational amplifiers extremely high dc gain. Three such uses are transducer amplifiers, voltage regulator amplifiers, and D to A converters. In these applications, a high gain is usually relied on to reduce errors and keep the circuit performance dependent mainly upon precise, passive components that make up a feedback network.

One way to evaluate how well an operational amplifier performs in such a dc application is to determine how much its differential input voltage changes during normal operating conditions. To reduce error, this change should be small compared to the signal being amplified; just how small depends upon how much is admissible error. Theoretically, the gain of an amplifier determines how much its input changes to produce a given change in output:

$$V(\text{in}) = \frac{V(\text{out})}{\text{Gain}}$$

In a world of ideal amplifiers, where all curves look like Fig. 2-3, knowledge of an amplifiers gain is reasonably adequate for intelligent circuit design or component selection. From gain and the required output voltage change, a circuit designer can determine how much error signal will appear at the output of the amplifier. As Figs. 2-4 and 2-7 show, however, the real world is seldom ideal. These figures demonstrate that the published gain may not always be very meaningful or useful, especially at dc or very low frequencies. Here, thermal effects often mask or completely overshadow changes due to actual gain. From some of these figures, it would be difficult to communicate how their respective dut perform in terms of a gain parameter; it would even be difficult to say what the gain could be. Therefore, a higher gain amplifier does not necessarily perform better or give less dc error than some other lower gain amplifier.

Consider Fig. 2-4. Measuring large-signal gain from point A to point B tells nothing about how the input changes between these points. The large-signal gain of 106 dB (200,000) suggests that the total input voltage excursions over a ± 10 -volt operating range is $100 \mu\text{V}$. However, the 577-178 display clearly shows that the actual excursion is $160 \mu\text{V}$. More significant may be the voltage excursion for small signals. The gain curve begins to approximate a straight line for small signals, making small-signal gain a more meaningful parameter for evaluating amplifier performance in some cases. Consider, for example, a small voltage signal near zero output, as in Fig. 2-4. The input voltage excursion is great for reletively small output voltage changes. The computed dc gain for these small signals is only 50,000, far worse than the large signal gain of 200,000 measured from point A to point B. Thus, these examples clearly illustrate the inadequacy of the use of gain for specifying or predicting an amplifiers behavior at or near dc conditions.

FUNCTIONS OF FRONT-PANEL CONTROLS, INDICATORS, AND CONNECTORS

To form a curve tracer system, the 178 Linear IC Test Fixture must be operated in a TEKTRONIX 577 Mainframe that also contains a D1 (storage) or D2 (non-storage) Display Module. Since the controls of all three of these system components must be manipulated when running curves on the device-under-test (dut), the functions of the controls on the 577 and display unit are included with the 178 controls in the following discussions.

Figure 2-8 is provided for rapid location and identification of controls. Each group of controls is numbered and each group number corresponds to the numbered heading in the following text.

Function Selector—Group 1

The eleven-position FUNCTION switch selects the points to be monitored by the vertical and horizontal display axes, and selects the point driven by the sweep generator. The specified operation of the FUNCTION switch depends in part on the device card used in the 178. Not all the eleven positions are used with every device card type. Each device card type uses a separate, interchangeable nomenclature panel that shows the functions of each switch position. A detailed description of the functions of each card is included with the card specification.

Sweep Generator—Group 2

The sweep generator provides sinusoidal waveforms to various control points to facilitate plotting the characteristics curves of the dut. The control points depend on the device card selected and the FUNCTION switch setting. In many test functions, the sweep generator varies the output voltage of the dut. In others, the input common-mode voltage or the regulated supply voltages (+SUPPLY and -SUPPLY) are varied.

Though small-signal gain can be a useful parameter in some applications, it is not a satisfactory substitute for a complete gain curve. For example, finding where the small-signal gain is best or worst would require many measurements over an amplifier's entire range. This information can be determined at a glance from the complete gain curve that is normally traced on the 577-178.

Adjusting the Frequency. The SWEEP FREQUENCY control adjusts the sweep generator frequency from 0.1 Hz to 1 kHz. Five calibrated frequency steps (1, 10, 100, and 1 kHz) are provided. The VARIABLE control provides continuous adjustment from 0.1 to 1.0 times the selected decade value.

Adjusting the Amplitude. The SWEEP AMPLITUDE control adjusts the sweep generator amplitude voltage from zero to its maximum value (which depends on the function being swept by the sweep generator). Amplifier output voltages and input common-mode voltages can be swept up to ± 30 volts or to the limits of the dut, whichever is smaller. The regulated power supply voltages can be swept from zero to the voltage selected by the power supply controls (+SUPPLY and -SUPPLY).

Manual Amplitude control. To manually control the sweep generator output, pull out on the SWEEP AMPLITUDE control. The output may be set anywhere within the voltage range described under Adjusting the Amplitude. The SWEEP FREQUENCY control is inoperative in this mode.

Regulated Power Supplies—Group 3

There are two adjustable regulated power supplies, one positive and one negative, in the 178. The adjustment range is 0 to 30 volts, with 150 mA current capability. Adjustable current limiting for each supply is provided on the device card. Overload lamps in the supply control area indicate when the current limit is reached.

Adjusting the Voltage. The supply voltages can be adjusted independently or from a single control. When the -SUPPLY control is in the TRACK +SUPPLY position, the voltage of both supplies is controlled by the +SUPPLY control, a three-turn calibrated dial. Adjustment accuracy is $\pm 2\%$, ± 100 mV. When the -SUPPLY control is not in TRACK +SUPPLY, the -SUPPLY is independently adjustable by the -SUPPLY control.

In some positions of the FUNCTION switch (+PSRR, -PSRR, \pm PSRR, +SUPPLY I, and -SUPPLY I), the supply voltages are also controlled by the sweep generator.

Calibrated Adjustment of the Negative Supply. The -supply output can be calibrated, independent of the +supply, by preceeding as follows:

Put the -SUPPLY control in TRACK +SUPPLY and adjust the +SUPPLY control to the voltage required for the -supply. Turn the SWEEP AMPLITUDE control fully counterclockwise. Turn the FUNCTION switch to -SUPPLY I (displays the supply voltage on the horizontal axis; see the section on Deflection Factor Adjustment, Group 7, for more information). Note, exactly, the horizontal position of the spot. Now turn the -SUPPLY control clockwise until the spot returns to the same horizontal position (the supply voltage).

IDENTIFICATION OF CONTROLS

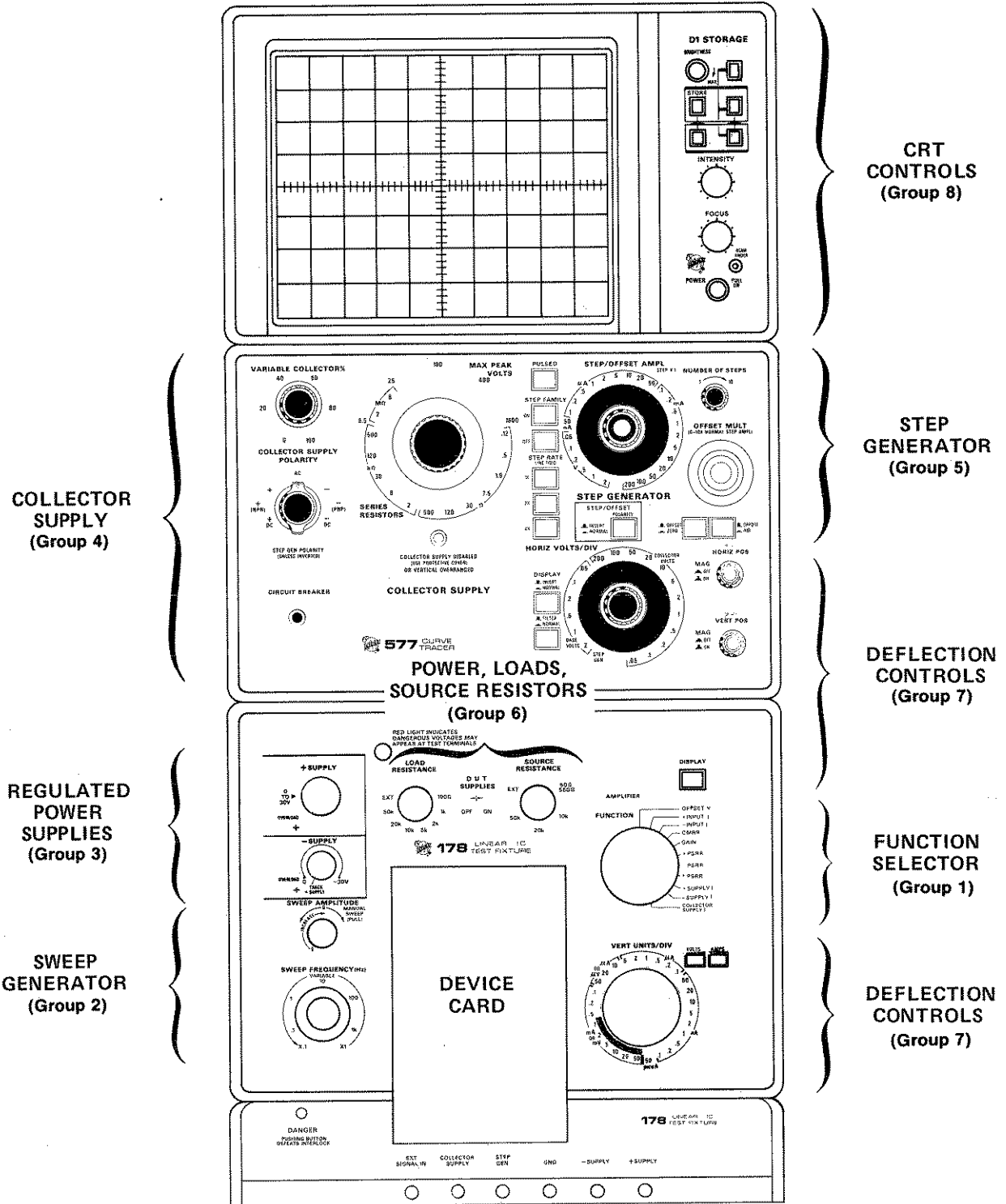

1474-09

Fig. 2-8. 178 Front-panel controls.

Operating Instructions—178 577/D1/D2 Operators

Calibrated Adjustment of Current Limiting. Current limiting for the regulated supplies is located on the device card. Calibrated adjustment can be made in the following manner: Turn to the appropriate SUPPLY I function, either plus or minus, that displays the supply current on the vertical axis (see the section on adjusting the deflection factors, in Group 7, for more information). Ground the supply that you wish to adjust (use a jumper either on the device card or on the 178 front panel). The vertical display indicates the short-circuit current. Turn the appropriate I Limit on the device card to set the required limits. See the section on Device Cards for further details.

Collector Supply—Group 4

The collector supply is located in the 577 mainframe. Only two voltage ranges are available to the 178; either 25 volts or 100 volts as selected by the Max Peak Volts switch.

NOTE

The Collector Supply is not used for most 178 functions. When not in use, set the 577 Max Peak Volts switch to 6.5 and Collector Supply Polarity to either +dc or -dc.

Safety Interlock. A safety interlock helps to protect the operator from dangerous voltages. A pushbutton (Interlock Defeat) on the 178 front panel must be pressed to enable the collector supply when the Max Peak Volts switch is set to 100.

Waveform and Polarity. The Collector Supply Polarity switch selects waveform and polarity of the collector supply output. The ac position selects line-frequency alternating voltages. The + or - polarities select full-wave rectified line frequency waveform of the polarity indicated.

The +dc and -dc positions add filtering to the rectified waveform, providing dc voltage. The ripple amplitude on the dc voltage depends (in part) on the load current.

Voltage Adjustment. The Variable Collector % continuously adjusts the collector supply voltage from approximately zero to the maximum indicated by the Max Peak Volts switch.

Power Limiting. The Series Resistors switch selects the collector supply impedance to limit power to the dut. The maximum peak power that the dut can dissipate is read from the scale coupled to the Max Peak Volts and Series Resistors switches (pull the Max Peak Power-Watts knob to unlock from the Max Peak Volts switch).

Maximum peak power also depends on the setting of the Variable Collector % control (adjusting the Variable Collector % to 50% voltage reduces the the maximum peak power to 25% of the indicated value). The actual peak power dissipated by the dut is usually less than the maximum value indicated by the Max Peak Power-Watts switch.

DUT power dissipation can reach the maximum value indicated only when the dut static resistance is equal to the series resistance of the collector supply. If the dut voltage drop is either a small or large percentage of the open circuit voltage of the collector supply, the power dissipated by the dut is less than the maximum value.

The average dut power dissipation is usually about one-half of its peak power when the waveform is either ac or full-wave rectified line frequency.

Supply Disable Indicator Lamp. The yellow lamp in the collector supply area of the 577 front panel indicates when the supply is turned off. Several conditions can turn off the collector supply:

1. The 178 DUT SUPPLIES switch is turned off.
2. An unusable collector supply voltage range is selected (6.5, 400, or 1600 volts).
3. The 100 V range is selected, but the Safety Interlock Defeat button (on the 178 front panel) is not pressed.
4. The vertical deflection signal is greatly over-range (approximately 20 divisions of deflection). The over-range mode of operation works only when the 178 is in a current-measuring function; i.e., input current, supply current, or collector supply current.

Step Generator—Group 5

The step generator, located in the 577 mainframe, is a regulated voltage or current supply having two main modes of operation. In the stepping mode, the generator provides discrete steps of voltage or current that are synchronized with the collector supply. In the offset mode, the generator provides continuously variable dc (voltage or current). The two modes may be selected independently. When operated together, their outputs are additive.

For most 178 functions, the step generator is not used. When not in use, press the Step Single Family button to turn off the stepping function.

Selecting the Mode of Operation. To select the stepping mode, press the Step Family Rep button. To select the offset mode, release the Offset Zero button. Successive pressing of the Step Family Single button triggers a single set of steps.

Voltage and Current Adjustment. The primary voltage or current adjustment is made by turning the Step/Offset Ampl control. The value indicated by the Step/Offset Ampl control is the amplitude of a single step.

Releasing the Step X.1 button (concentric with the Step/Offset Ampl control) reduces step amplitude by a factor of 10. A corresponding scale factor change takes place and is indicated on the Step/Offset Ampl knob skirt.

The Step/Offset Ampl control, along with the Offset Mult control (a ten-turn calibrated dial) adjusts the amplitude of the ac voltage or current in the offset mode of operation. The Offset Mult control varies the dc amplitude from zero to the equivalent of 20 normal steps.

Releasing the Step X.1 button does not affect the Offset voltage or current. However, since the scale factor of the Step/Offset Ampl control changes with the Step X.1 button position, the maximum dc amplitude of the Offset Mult is read as 100 small steps, rather than 10 normal steps.

Polarity. The polarity of the step generator is primarily set by the Collector Supply Polarity switch. The steps have the same polarity as the collector supply (positive steps when the ac position is selected).

The polarity of the dc voltage or current in the offset mode may be the same or of opposite polarity as the steps. Releasing the Aid button selects the polarity opposite the step (opposing offset). The aiding polarity of operation has greater current capability than opposing polarity. When using the offset mode alone, the Aid button is normally pressed.

The step polarity selected by the Collector Supply Polarity can be inverted. Releasing the Step/Offset Polarity Norm Pushbutton, produces steps that have polarity opposite that of the collector supply (or negative steps when the ac position is selected).

Number Of Steps. Turning the Number Of Steps control selects from one to ten normal amplitude steps. When the Step X.1 button is released, the Number Of Steps control selects up to about 95 small-amplitude steps.

Step Rate. The three Step Rate buttons select the frequency at which the steps change from one level to the next. The normal rate (press NORM button) is twice the line frequency or one change for each full-wave rectified collector sweep. The change from one step level to the next occurs at the beginning of each collector sweep when the sweep voltage is zero.

Pressing the Slow button selects line frequency, and pressing the Fast button selects 4X line frequency. At the fast rate, one-half the step changes occur at the peak of the collector-sweep waveform. Pressing both the Fast and Slow buttons produces the normal rate, but all step changes occur at the peak of collector sweeps. Selecting pulsed operation (described later) affects the operation of some of the step rates.

Pulsed Operation. Pushing the Pulsed 300 μ s button selects pulsed operation of the stepping mode. The offset mode of operation is unaffected by this selection; in the Offset mode, the dc level (voltage or current) is constant and the 300 μ s pulse is added to the dc level. In pulsed operation, the steps occur as 300 μ s duration pulses and the amplitude level is zero except during the pulse. The pulse amplitude is set by the Step/Offset Ampl switch.

The collector supply goes automatically into dc operation when the pulsed operation is selected, except for two conditions: first, if the Fast rate button is pushed, the collector supply operates with a sweep waveform, (the Fast rate is not available in pulsed operation and the actual step rate is the normal rate). Second, when the Collector Supply Polarity is in the ac position, the collector supply will not go into dc operation if the Pulsed 300 μ s button is pressed.

Power, Loads, and Source Resistances—Group 6

Disconnecting DUT Power Supplies. In its OFF position, the DUT SUPPLIES switch disconnects all dut power sources, including the +SUPPLY, the -SUPPLY, the collector supply, and the step generator.

Adjusting the Source Resistance. The SOURCE RESISTANCE control selects one pair of four input resistor pairs; 50 Ω (550 Ω with the VERT UNITS/DIV switch in the 1 mV to 50 mV/div range), 10 k Ω , 20 k Ω , or 50 k Ω . External resistances may be selected in the EXT position. The external resistors must be mounted on the dut card and are in series with 50 Ω (550 Ω when the VERT UNITS/DIV switch is in the 1 mV to 50 mV/div range), which is the minimum resistance available. All input voltage measurements are made on the source side of the input resistance.

Not all device cards use external source resistors. Device card specifications indicate when the SOURCE RESISTANCE switch is inoperative.

Adjusting the Load Resistance. The LOAD RESISTANCE control selects one of seven load resistors; 100 Ω , 1 k Ω , 2 k Ω , 5 k Ω , 10 k Ω , 20 k Ω , or 50 Ω . External resistance may be selected in the EXT position. The external resistance must be mounted on the dut card and is always in parallel with 50 k Ω , which is the maximum resistance available. Not all device cards use external load resistors. The device card specifications indicate when the LOAD RESISTANCE switch is inoperative.

Deflection Controls—Group 7

All deflection controls are located on the 577 mainframe (see "Operating Information" in the 577 service manual) except the VERT UNITS/DIV and DISPLAY ZERO, which are located on the 178 Test Fixture.

Positioning. The Position controls labeled with a vertical arrow (Vertical Position) and a horizontal arrow (Horizontal Position) adjust the position of the display on the crt. If no trace or spot is displayed, the display may be positioned off-screen or the intensity may be set too low (see "Display Controls, Group 8, later in this section for use of the Beam Finder and Intensity controls).

Adjusting the Vertical Deflection Factor. The VERT UNITS/DIV control on the 178 selects the vertical deflection factor. The deflection factor is either voltage or current per division depending on the FUNCTION switch position; indicator lamps show either VOLTS or AMPS. A X10 magnifier is activated on either or both axes by pulling out on the appropriate 577 Position control knob. Magnification changes the deflection factor by 10 times.

A section of the VERT UNITS/DIV control is devoted to low-current deflection factors only. If this current-only sector is selected when the VOLTS indicator lamp is lighted, the knob skirt lamp automatically turns off.

The voltage measurement range is $10\ \mu\text{V}/\text{div}$ to $50\ \text{mV}/\text{div}$ ($1\ \mu\text{V}/\text{div}$ to $5\ \text{mV}/\text{div}$ with X10 vertical magnifier on). The current measurement range is $50\ \text{pA}/\text{div}$ to $50\ \text{mA}/\text{div}$ ($5\ \text{pA}/\text{div}$ to $5\ \text{mA}/\text{div}$ with X10 vertical magnifier on). Not all of the current range is useful on all current measuring positions selectable by the FUNCTION switch (see the functional description for the particular device card being used). When the vertical magnifier is used, the corresponding deflection factor change is indicated on the VERT UNITS/DIV control.

Adjusting the Horizontal Deflection Factor. The Horiz Volts/div control (on the 577 mainframe) selects the horizontal deflection factor. Most measurements require the Horiz Volts/Div control to be in the Collector Volts segment of its range, unless otherwise stated by the functional description for the device card being used.

The deflection factor range is $50\ \text{mV}/\text{div}$ to $200\ \text{V}/\text{div}$ (from $5\ \text{mV}/\text{div}$ to $20\ \text{V}/\text{div}$ with X10 horizontal magnifier on), although the highest voltage positions are not useful with the 178 Test Fixture. When the horizontal magnifier is selected, the corresponding deflection factor change is indicated on the Horiz Volts/div control knob skirt.

Inverting the Display. Releasing the upper Norm (Display Invert) button inverts the polarity of both vertical and horizontal displays.

Filtering the Vertical Signal. Releasing the lower NORM (Display Filter) button adds a low-pass filter to the vertical deflection signal to remove unwanted noise. The pass-band of the filter is very low and can add phase shift to the display unless the test frequency approaches dc. Use care when using the filter, the results may need a little interpreting.

Display Controls—Group 8

The crt controls are located on the D1 or D2 Display Module.

Adjusting the Intensity and Focus Controls. The Intensity and Focus controls adjust the brightness and spot size (trace width) of the display. Adjust them for the best display.

Finding Off-screen Displays. Press the Beam Finder button to provide on-screen displays. If no spot or trace is visible, turn the Intensity control slowly clockwise while holding the Beam Finder button in. The resulting compressed display shows which direction the display is off-screen.

Using Storage. Pressing the buttons labeled Upper and Lower in the Store area of the Display Module selects the storage mode for the upper and lower halves of the graticule.

Pressing the Upper and Lower buttons in the Erase area selects the half of the graticule to be erased. With both Upper and Lower buttons pressed in, the entire screen can be erased. To erase either the selected half or the entire screen, press the Erase button.

The brightness of a stored display is controlled by the Brightness control. For extended retention of a stored display, reduce the brightness to minimum and turn up only for viewing. For normal operation and retention times, leave the Brightness control at Max.

The Brightness control operates only when the Variable Collector % control is turned to zero or the collector supply is disabled, as indicated by the yellow lamp.

DEVICE CARDS

A selection of device cards provides test configurations most suited to several classes of devices. Device Cards provide a means of making electrical connections to the dut, and in most cases, also provide some circuitry. Few classes of linear IC devices have standardized pin configurations; for this reason and for greatest flexibility, most device cards employ patch cords to connect dut terminals to the 178.

Many device cards include a universal interconnections system that accepts various dut sockets. A number of sockets are available from Tektronix, Inc. (see the Tektronix Products Catalog) to connect to common IC case styles, such as the 16-pin or 14-pin dual in-line package or the 8-pin or 10-pin round package. These and other sockets are available directly from Amphenol/Barnes. 16-pin and 14-pin dual in-line zero-insertion sockets are also available. Order from Textool Products, Inc., 1410 West Pioneer Drive, Irving, Texas 75061. Order ZIP DIP adapter 214-2665-0-061 for the 14-pin dual in-line package, and ZIP DIP adapter 216-2812-0-061 for the 16-pin dual in-line package.

The operation of the FUNCTION selector on the 178 front panel depends upon the device card used and the description of each card includes operation of the FUNCTION selector. Interchangeable nomenclature overlays for the FUNCTION selector permit individual labeling of the selector positions for each device card type.

Standard Operational Amplifier Card

The standard op amp card (included with the 178, see Fig. 2-9) is designed to test devices that require two power supplies (plus and minus), have two (differential) high impedance inputs, and have a single output. Testing other types of devices is treated in the Applications Section of this manual.

The basic measurements that can be made using the standard op amp card are summarized in Table 2-1. A detailed procedure illustrating measurement techniques is available in the First Time Operation section given later in this manual.

Table 2-1

Function	Vertical Display	Horizontal Display and Sweep Generator Controlling Point
OFFSET V	Differential Input Volts	Output Volts
+INPUT I	+Input Bias Current	Common-Mode Volts
-INPUT I	-Input Bias Current	Common-Mode Volts
CMRR	Δ Differential Input V ^a	Common-Mode Volts
GAIN	Δ Differential Input V ^a	Output Volts
+PSRR	Δ Differential Input V ^a	+Supply Volts
-PSRR	Δ Differential Input V ^a	-Supply Volts
\pm PSRR	Δ Differential Input V ^a	+Supply Volts and -Supply Volts ^b
+SUPPLY I	+Supply Current	+Supply Volts
-SUPPLY I	-Supply Current	-Supply Volts
COLLECTOR SUPPLY I	Collector Supply Current	Collector Supply Volts

^a Δ Input V is the relative change in input voltage only. There is no information about the amount of offset voltage that exist.

^bThe Sweep Generator controls both the +Supply and -Supply. The horizontal display, however, is only the +Supply.

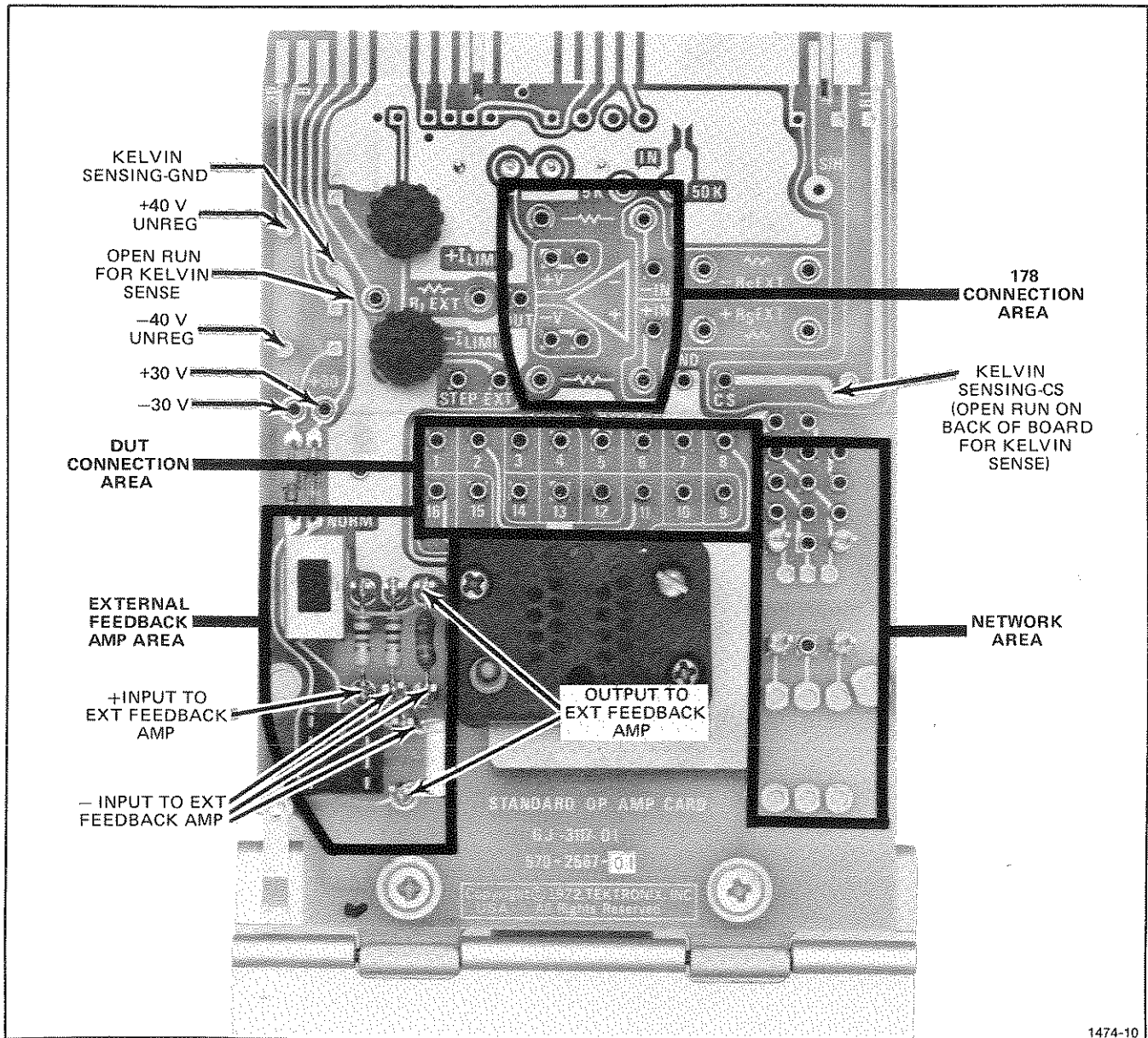

Fig. 2-9. The Standard Op Amp Card.

FUNCTION Switch Operation

With the standard op amp card and the corresponding FUNCTION switch subpanel overlay installed, the 178 provides the following measurement functions:

Offset Voltage. Offset voltage is the differential input voltage required to maintain output voltage at zero. The maximum measurable offset voltage using the standard op amp card is 800 mV. However, this large amount of offset voltage is not fully compatible with other measurement functions when a change in input voltage (Δ Input V) is displayed. In these functions, the amount of permitted

offset voltage depends upon the vertical deflection factor (see Table 2-2).

Table 2-2

Vertical Deflection Factor (Δ Input V)	Maximum Permitted Offset Voltage
10 μ V to 50 μ V/div	25 mV
100 μ V to 500 μ V/div	200 mV
1 mV to 50 mV/div	2 V

Input I. Input I is the bias current at each of the amplifier input terminals with the amplifier output voltage at zero.

Gain. Gain is the change in operational amplifier output voltage divided by the corresponding change in differential input voltage. For an output voltage swing of ± 10 volts, the measureable range of gain with the standard op amp card is approximately 34 dB (50) to over 126 dB (2 million). Lower gains may be measured at less output voltage change.

CMRR. Common-mode Rejection Ratio is the change in common-mode voltage divided by the change in differential input voltage while the output voltage is maintained at zero. The measureable range of cmrr is the same as the range for gain with the standard op amp card.

PSRR. Power Supply Rejection Ratio is the change in power supply voltage divided by the change in differential input voltage while the output is maintained at zero. For a power supply swing of 5 volts, the measureable range of psrr with the standard op amp card is approximately 22 dB (12.5) to over 114 dB (500,000).

Supply I. This is the supply current that the dut draws with its output voltage at zero.

Collector Supply I. This is an auxiliary test function. The collector supply is not utilized for most operational amplifier measurements.

Connecting To The DUT

The small sockets in the dut connection area are labeled from 1 through 16 (see Fig. 2-9). These sockets connect to corresponding pins of a dut socket that is plugged into the lower connector block.

Connecting To The 178

Five small sockets in the 178 connection area are located close to the operational amplifier symbol. These sockets must be connected to the corresponding terminals of the dut by using patch cords. The regulated supplies are labeled V+ and V-. Sockets connecting to the dut differential inputs are labeled +IN and -IN. The socket connecting to the dut output is labeled OUT.

External resistors, both source (R_S) and load (R_L), may be installed between the sockets so marked. These resistors remain unconnected until the EXT position of the SOURCE RESISTANCE or LOAD RESISTANCE switches is selected. Use the bifurcated pin terminals for easy placement and removal of external components. Two other resistors shown between the dut input and output are for optional external feedback components.

Other 178 connections on the card include:

CS = Collector Supply
STEP = Step Generator
EXT = External signal input (from front panel)
GND = Ground

Kelvin sensing of the collector supply voltage (horizontal display) on the most clockwise position of the FUNCTION switch (COLLECTOR SUPPLY I) is possible by using the terminals indicated in Fig. 2-9. Besides connecting to these indicated terminals, the small foils that connect to the collector supply and ground must be cut.

Compensation And Other External Networks

External components, for compensation or other purposes, can be conveniently added in the network area shown in Fig. 2-9. Use the included pin terminals for easy installation and removal of components. Once in place, a network may be connected to either the dut connection area or the 178 area with patch cords.

Useful Accessories

In addition to the standard accessories supplied with the 178, the following items are recommended for use in setting up tests on items requiring unusual hookups.

2-inch patch cords (red)—Order 10 each Tektronix Part No. 012-0200-00

4-inch patch cords (yellow)—Order 10 each Tektronix Part No. 012-0310-00

Hard-wired Op Amp Card—Order 1 each Tektronix Part No. 013-0150-01

(The hard-wired Op Amp card is a blank card with etched circuit runs but without components)

Transistor Adapter—Order 1 each Tektronix Part No. 013-0128-00

(This three-terminal adapter plugs into the GND, STEP GEN, and COLLECTOR SUPPLY terminals on the 178 front panel. The adapter accepts TO-5 and TO-18 transistor types that may be tested in the COLLECTOR SUPPLY I position of the FUNCTION switch.)

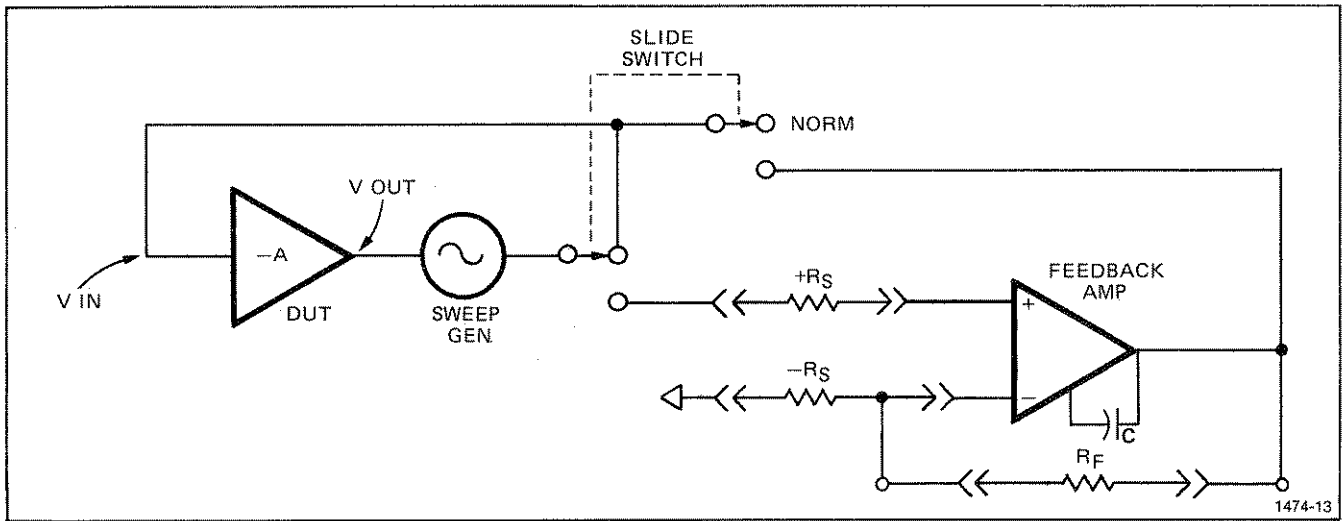

Fig. 2-10. Block diagram of the feedback amplifier.

External Feedback Amplifier

Additional gain may be added to the closed-loop test configuration by switching in the external feedback amplifier that is diagrammed in Fig. 2-10. This added gain can be useful for testing low gain amplifiers; for example, in a test function such as cmrr or psrr, where the dut output voltage should be held at zero. In these functions, the external feedback amplifier maintains the dut output voltage closer to zero than would be possible if the loop gain were provided by only a low-gain dut. If the output of a low-gain dut is not held close to zero, an error signal appears at the input. This error signal, due to gain, adds to the input signal, due to cmrr or psrr, and produces an erroneous measurement. As a rule of thumb, this low-dut-gain error may be significant whenever gain is more than 20 dB below cmrr or psrr.

Fig. 2-10 is a simplified block diagram of the feedback amplifier with the 178 in the gain function. The components must be added by the user to set the gain for his particular needs. Capacitor C_f must be added to prevent loop gain from exceeding unity at high frequencies. Typically the $R_f \times C_f$ time constant should be about 0.01 second.

FIRST-TIME OPERATION

The operational amplifier is the most common amplifying device packaged as an integrated circuit. By using the standard op amp card (standard accessory), the 178 can be used to test a large variety of operational amplifiers. Amplifiers that require compensation can be tested with the standard op amp card and 178 once the appropriate external components are added to provide loop stability at unity gain.

The following procedures demonstrate the 178, using the standard op amp card to test a 741 operational amplifier (or similar device). The objective of the procedure is to familiarize the operator with the 178, some basic operational amplifier parameters, and how the 178 measures these parameters.

Operational Amplifier Terminology

The graphic symbol for an operational amplifier is shown in Fig. 2-11; normally, only input and output terminals are shown. The power-supply terminals and the standard amplifier terminology are included for convenience.

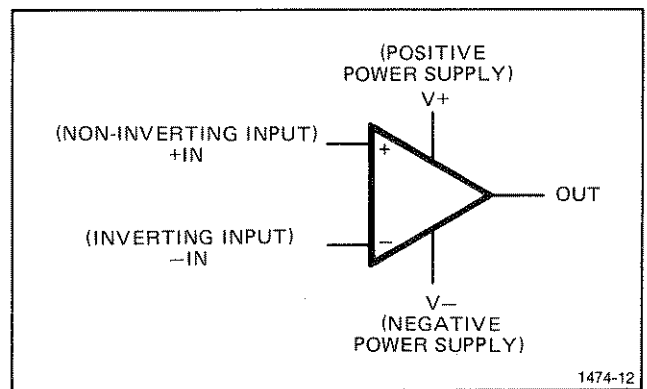

Fig. 2-11. Operational amplifier symbology.

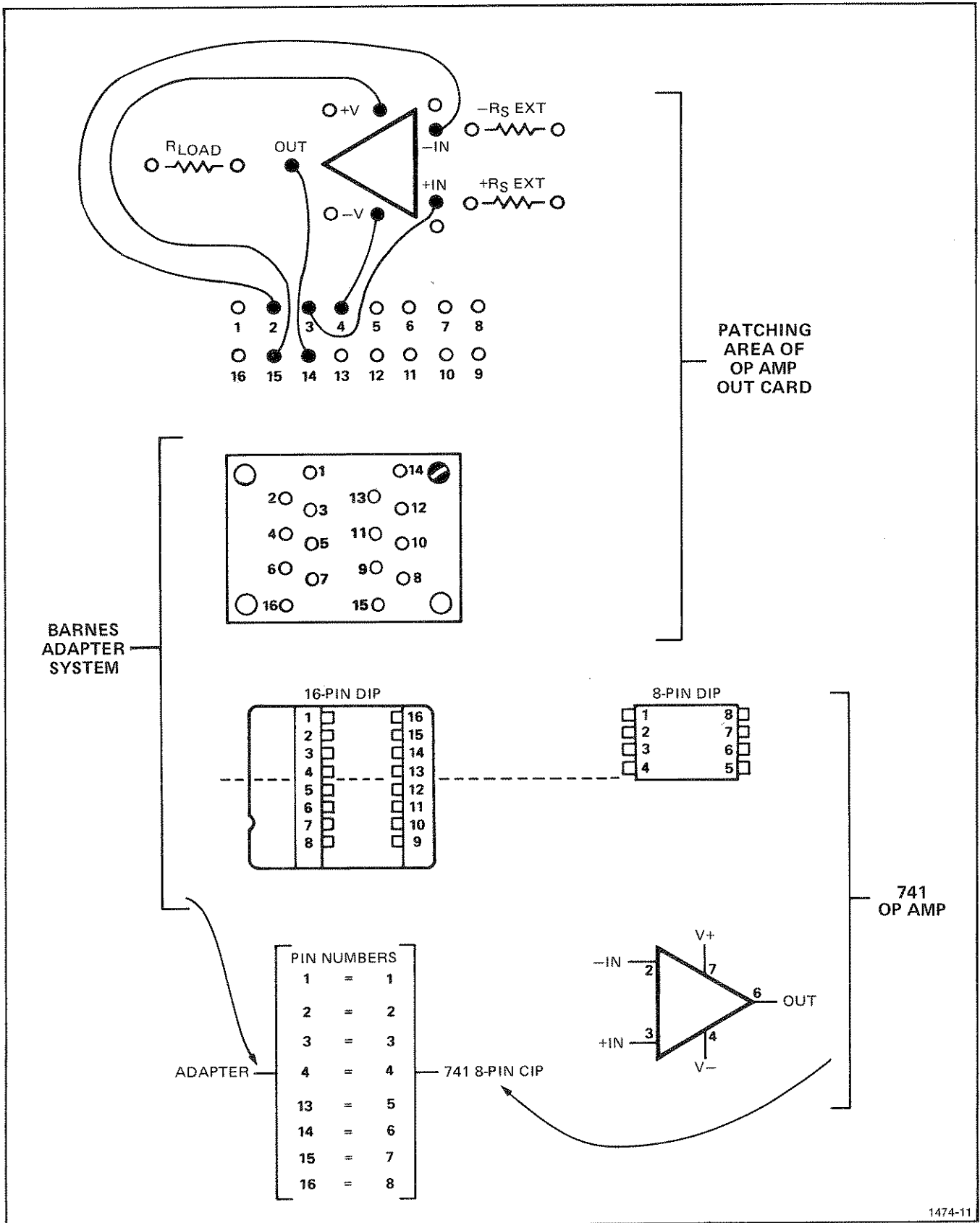

Fig. 2-12. 8-pin DUT plugged into the 16-pin adapter socket.

Operating Instructions—178 577/D1/D2 Operators

The minimum number of connections to an operational amplifier is five (multiple amplifiers in a common package usually share the power-supply connections, see Fig. 2-12). Some amplifiers require the addition of one or more passive components, often a single capacitor, to achieve stability. Such compensation usually requires connections to one or more terminals in addition to the five mentioned. Internally compensated operational amplifiers do not normally require external compensation.

Connecting To The Device Under Test (DUT)

The standard op amp card is equipped with a two-piece socket system that adapts to several styles of IC packages. The base of the system is a 16-pin socket. Standard equipment includes a 16-pin socket for 16-pin dual-in-line packages. A major benefit of the socket system is uniform pin numbering on the card. The 16 connections on the base socket are numbered on the dut card and always correspond to the pin numbers of all adapter sockets.

To provide the greatest flexibility in connecting to a dut, patch cords are used on the card. Patch cords permit connecting the dut terminals to the 178 for any dut pin arrangement. This capability is especially beneficial when there is little standardization of pin connections.

Patching The DUT Card For The 741

Remove the adapter socket and swing the card cover away from the card. The card may be removed from the instrument or left plugged in when patching from the device card to the adapter socket. Always switch the DUT SUPPLIES switch to OFF before placing or changing patch cords or inserting the card into the 178.

If the dut has the same number of pins as the adapter socket, the patch cord connections may be made directly. If the dut has fewer pins than the adapter socket, then the dut pin numbers do not correspond to the socket pin numbers on the card and pin-number substitutions must be made. Figure 2-12 illustrates an 8-pin DIP device plugged into a 16-pin socket, with corresponding pin numbers shown.

Setting Current Limits

Two small potentiometers located on the standard op amp card independently adjust the current limits for the positive and negative regulated supplies. The adjustment range is approximately 10 mA (counterclockwise) to 150 mA (clockwise). The typical setting for a 741 op amp test is 1/4 turn clockwise from the minimum-current position (ccw). This adjustment is not critical. A method for accurate current limit adjustment is found in the "Function of Controls" section under Regulated Power Supplies,—Group 3, earlier in this manual.

Switch the DUT SUPPLIES switch to OFF and install the op amp card in the 178. Always switch the DUT SUPPLIES to OFF when patching or when removing or replacing the dut card in the 178.

Initial Setup—Obtaining A Display

For convenience, the controls shown in Fig. 2-8 are grouped as follows: group 1, the unused controls; group 2, the occasionally used controls that may produce difficulties (if not set to their normal position); and group 3, the controls that most directly affect the setup and obtaining a display.

Group 1 Controls. Though the controls for the collector supply and step generator are not used, proper setting of these controls prevent interference with normal measurements. Set the Max Peak Volts switch to 6.5; at other settings of the Max Peak Volts switch, the yellow light remains lighted. Set the Max Peak Power—Watts to .15 or .6 (to change power settings, pull out on the Max Peak Power—Watts switch and turn while in the pulled position). At .15 and .6 watt settings, the vertical overrange circuitry will not cause the yellow light to flash under certain conditions (see Function of Controls, Collector Supply, for more details).

Set the Variable Collector % fully counterclockwise and Collector Supply Polarity to either +DC or -DC to reduce unwanted noise pickup at higher sensitivities. Additional noise reduction is obtained by setting controls in the step generator. Press the Step Family Single pushbutton to turn off the step generator and push to release the Pulse 300 μ s pushbutton to lock out the pulsed mode.

Group 2 Controls. These controls should be set to the normal mode of operation. They are occasionally changed from their normal settings, but cause the least difficulty if the initial setup is made as follows:

1. Pull the Power switch ON.
2. Place the Display Filter and Display Invert in the normal mode (Norm button in).
3. Set the Brightness control (located only on the D1 Display Unit module) fully clockwise to the Max position. If the Brightness control is not set to Max, the display can appear chopped or segmented. Use this control only for long retention of stored displays.
4. Set the Intensity control for a visible spot (push the Beam Finder button is necessary).
5. Push the Upper and Lower Store pushbuttons in. The Erase pushbuttons permit erasing the corresponding areas of the screen.

Group 3 Controls. The initial display is obtained in the offset function (turn the FUNCTION switch of OFFSET V). In this mode, the operational amplifier output voltage is displayed horizontally and the input voltage is displayed vertically. Since measurement is made at the dut inverting input terminal (the non-inverting terminal is grounded), the crt display actually shows input voltage inverted. All input voltage measurements in other functions are also inverted. Set up the equipment as follows:

1. Set the +SUPPLY control to 15 V (or other specific voltage within the rating of the dut). Set the -SUPPLY control to TRACK +SUPPLY (fully counterclockwise). Be sure the detent is engaged. In this mode, both supplies are controlled by the +SUPPLY control.
2. Set the LOAD RESISTANCE to 50 k and the SOURCE RESISTANCE to 50 Ω .
3. Turn the SWEEP AMPLITUDE control fully counterclockwise (zero amplitude). Be sure that this control is pushed in (not in manual mode). Set the SWEEP FREQUENCY control to 10 Hz with the VARIABLE fully clockwise (X1).
4. Set the VERT UNITS/DIV to 10 mV/div and the Horiz Volts/Div selector (on the 577 mainframe) to 5 V/div, collector. Note the lighter shaded arc along a portion of the VERT UNITS/DIV knob skirt. This arc represents the limits of voltage measurements from 10 μ V/div to 50 mV/div. Current measurements use all switch positions. Whether voltage or current is displayed on the vertical axis depends on the setting of the FUNCTION selector. In the voltage functions, the VOLTS lamp goes out if the VERT UNITS/DIV switch is not within the lighter-shaded arc.
5. While holding the DISPLAY ZERO button (on the 178) pressed, adjust the Position controls to move the spot to graticule center. The instrument is now ready to obtain an offset function display. In this display, the operational amplifier differential voltage is displayed on the vertical axis and the output voltage on the horizontal axis.
6. Install the dut in the adapter socket and move the DUT SUPPLIES switch to ON. A spot should appear near the center of the graticule. Turn the SWEEP AMPLITUDE control clockwise to increase the sweep generator output. The spot should expand to a horizontal trace (adjust for about two divisions of deflection each side of graticule center).

The instrument is now ready to measure operational amplifier parameters. If the proper display is not obtained, try the following recheck procedure. If the proper display is obtained, go on to the Measuring Offset Voltage procedure that follows the numbered steps below.

Troubleshooting the Setup

1. Check the operational amplifier connections on the device card to determine:
 - a. That the proper pin numbers are connected to the essential 178 terminals (+V, -V, +IN, -IN, and OUT).
 - b. That the dut is installed properly in the test socket, i.e., the dut pin numbers correspond to the socket pin numbers.
 - c. That allowance was made for pin number equivalents if the dut has fewer pins than the test socket.
2. Recheck the Group 3 control settings with special attention to:
 - a. Horiz Volts/Div selector (in Collector Volts segment, not Base), and the deflection factor is correct (5, not 0.5 volts).
 - b. SOURCE RESISTANCE is not in EXT. EXT disconnects the inputs unless resistors are added to the device card.
 - c. VERT UNITS/DIV selector is not in the current only section of its range and the correct sensitivity is selected (go to 50 mV/div).
 - d. DUT SUPPLIES switch is ON.
3. Try another operational amplifier.

Measuring Offset Voltage

Offset voltage is defined as the input voltage (differential voltage at the input terminals) required to obtain a voltage zero at the amplifier output. The preceding steps prepared the 178 to measure offset voltage. The display shows the amplifier input voltage on the vertical axis (inverted) and the output voltage on the horizontal axis.

Before actually making a measurement from the display, it may be necessary to become familiar with the operation of several controls and their effects on the measurements.

Op Amp Output Operating Range. In the offset function, the SWEEP AMPLITUDE control adjusts the operational amplifier output voltage excursion. Actually, the sweep generator indirectly controls the operational amplifier output by causing the feed back-loop (the operational amplifier is part of the feedback loop) to control the operational amplifier input voltage.

Operating Instructions—178 577/D1/D2 Operators

Slowly turn the SWEEP AMPLITUDE control and note its affect on the horizontal display. Increase the SWEEP AMPLITUDE until vertical lines appear at both ends of the horizontal display. These vertical lines mark the limits of the operational amplifier output swing. The vertical lines are produced by the feedback driving the input beyond the operational amplifier operating range or to the point at which the amplifier loses gain. This range should be somewhat less than the power supply voltage.

Reduce the regulated supply voltage by slowly turning the +SUPPLY control counterclockwise. Notice that the output operating range decreases. Reset the +SUPPLY control to 15 volts.

Slow Sweep Frequency And Storage. It is quite often necessary to measure operational amplifier parameters at very low frequencies. The convenience of a storage display unit becomes apparent at these low frequencies.

Adjust the SWEEP AMPLITUDE control so that the vertical excursion at each end of the horizontal trace (where the amplifier reaches its output limits) is small.

Set the SWEEP FREQUENCY control to .1 Hz with the VARIABLE fully clockwise (X1). (Many operational amplifier measurements are made at .1 Hz or lower.) Press the Erase button to prepare the screen for storage. Note that the storage mode provides a flicker-free, easy-to-view trace from a slow-moving spot.

Use the Erase button to clear the screen of unwanted displays. The display is automatically erased between some of the FUNCTION switch positions. This procedure leaves the use of the erase and storage function to the operator's discretion.

Manual Operation. Manual sweep operation is demonstrated next, although this mode of operation is used infrequently.

In manual sweep, the sweep generator is replaced with a manually-operated potentiometer. Pull out on the SWEEP AMPLITUDE control and rotate the control in both directions. Note that the operational amplifier output can be set to any desired voltage within its operating range. Push the SWEEP AMPLITUDE control in and reset the control to display a small vertical excursion at each end of the trace.

Larger vertical excursions, or overdriving the inputs, does not damage a well-designed operational amplifier; however, large vertical excursions cause the moving spot to spend excessive time off-screen in the more sensitive measurements.

Op Amp Offset Voltage. The display can now be used to measure offset voltage. Increase the vertical sensitivity (turn the VERT UNITS/DIV control clockwise until the largest on-screen vertical deflection is obtained). Offset is measured on the vertical axis where the output voltage passes through zero (see Fig. 2-13). The vertical deflection is the differential voltage between the operational amplifier input terminals.

Push the DISPLAY ZERO button to check for zero in the display. Position the spot to graticule center as necessary. Any trace tilt is due to amplifier gain, which is covered in the following text.

A loop may be displayed due to phase shift within the operational amplifier. The amplitude of the loop can be reduced by either reducing the sweep frequency (turn the SWEEP FREQUENCY VARIABLE counterclockwise), or by reducing the sweep amplitude. To eliminate looping, manually position the op amp output voltage to zero in the horizontal axis (see Manual Operation, previously described).

Gain Measurement Considerations

Op Amp Gain. Operational amplifier gain is defined as the change in output voltage divided by the change in the differential voltage at the input terminals. Gain is one measure of how faithfully an amplifier processes a signal when operating within a feedback loop. High-gain amplifiers introduce less distortion or error (from the ideal response dictated by the feedback network) than do low-gain amplifiers.

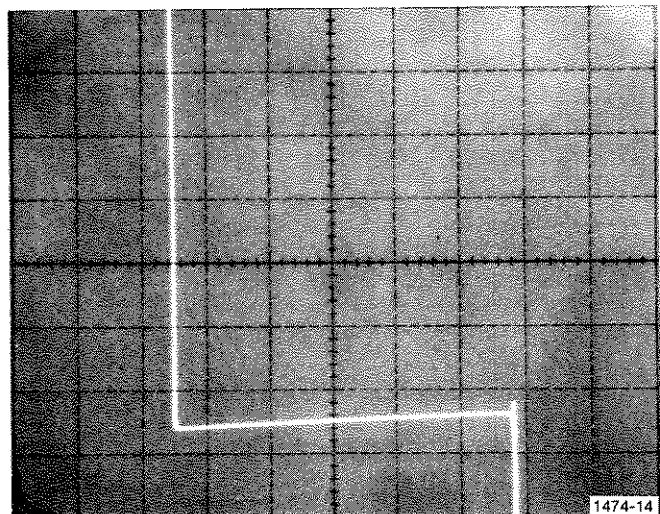

Fig. 2-13. Illustration of typical offset voltage measurement.

As the output voltage of an operational amplifier changes, the input voltage of a low-gain amplifier changes more than the input voltage of a high-gain amplifier. The change in input voltage due to feedback (Δ Input V), has the same effect on the overall circuit as an input signal of the same amplitude. Therefore, the effective input signal is input signal minus (Δ Input V). If the change in input voltage is small with respect to the signal (as it should be in a practical circuit), the error introduced due to gain is approximately the ratio of input voltage to signal.

$$\% \text{ error} \approx \frac{100 \times \Delta \text{ Input V}}{\text{signal}}$$

If the operational amplifier feedback network provides amplification, new terms must be substituted into the above ratio from the following relationships, where ΔV_o is the change in operational amplifier output voltage.

$\Delta V_o = \text{Network Gain} \times \text{Signal}$, and
 $\Delta V_o = \text{Operational amplifier Gain} \times \Delta \text{ Input V}$
 Therefore, by substitution,

$$\% \text{ error} = \frac{100 \times \text{Network Gain}}{\text{Op Amp Gain}}$$

Measurement of operational amplifier gain can be made by using the same type display as in the Offset function. However, since the offset voltage of the amplifier is usually quite large relative to the input voltage change, the vertical deflection factor cannot be made sensitive enough to measure gain and maintain an on-screen display. This problem is solved by switching the FUNCTION switch to the GAIN position. In the GAIN position, offset voltage is nulled and the vertical deflection factor can be decreased to display the slope of the input voltage curve.

Automatic Offset Null. With the FUNCTION switch in the GAIN position, momentarily press the DISPLAY ZERO pushbutton. In the GAIN function, the circuit configuration is essentially the same as in the OFFSET function, except that an electronic sample-and-hold circuit is added in the operational amplifier feedback loop. When the DISPLAY ZERO pushbutton is pressed, the sample-and-hold circuit detects and nulls any offset voltage in the amplifier. When the DISPLAY ZERO pushbutton is released, the sample-and-hold circuit remembers and maintains this offset null. The automatic nulling occurs in the 178 and is not related to any Offset Null terminals on the operational amplifier.

The display in the GAIN function is the same as in OFFSET function except that the trace should pass nearly through graticule center. The display is uncalibrated in the absolute sense, as the display provides information only about changes in input voltage. The voltage location of zero is lost when the sample-and-hold circuit nulls offset voltage.

Switch the VERT UNITS/DIV to display about three divisions vertically. Press the DISPLAY ZERO pushbutton (reset the sample-and-hold circuit) to maintain the display on the screen. Make frequent use of the DISPLAY ZERO pushbutton in all functions that measure Δ Input V (GAIN, CMRR, and all PSRR positions). It is often necessary to reset the sample-and-hold circuit after changing the VERT UNITS/DIV switch, after changing the FUNCTION switch, or after prolonged operation in which the sample-and-hold circuit may drift. Only occasional reminders to reset the DISPLAY ZERO will be made for the remainder of this procedure.

It is not necessary that resetting the sample-and-hold causes the trace to pass through the screen center. The 178 is designed to provide an on-screen trace for amplifiers with 25 mV or less of offset. Use the vertical Position control (on the 577) for minor adjustments to facilitate measurement.

Phase Shift. In high-gain operational amplifiers, phase shift can occur even at extremely low frequencies. Phase shift results in a vertical separation of the positive-going and negative-going traces on the display. At high vertical sensitivities, even small amounts of phase shift become apparent.

With the VERT UNITS/DIV selector set for three or more divisions of deflection and the SWEEP FREQUENCY selector at .1 Hz, some phase shift may be displayed. Increase the frequency to 1 Hz or higher and observe the phase shift. Return to .1 Hz; if excessive phase shift exists at this frequency, use the VARIABLE to further reduce the frequency.

Noise. All operational amplifiers exhibit some degree of noise. In making gain measurements, the effect of noise is to broaden the trace and thereby make exact measurements more difficult. If the noise is so great that the center of the trace cannot easily be determined, turn on the DISPLAY Filter in the 577. The Display Filter eliminates all but the lowest frequency noise components from the display, thus reducing trace width.

Push the Display Filter Norm pushbutton to release the button to the out position. The noise reduction in the displayed trace should be noticeable unless the amplifier is exceptionally noise free. Notice that some phase shift may be introduced by the filter. The shift effects of the filter may be easily observed by displaying both the filtered and unfiltered traces in the storage mode. The operator can then decide (from the display) whether the filter aids or hinders measurements for these particular measurement conditions. Reducing the sweep frequency reduces phase shift caused by the display filter.

To prevent the filter from inadvertently causing future erroneous measurements, push the Display Filter Norm pushbutton in once a measurement has been made (before proceeding to new functions or operating conditions). Check the effects of the filter on phase shift before each use.

Measuring Op Amp Gain. Set the VERT UNITS/DIV for an on-screen display of three divisions or greater. Set the SWEEP FREQUENCY for acceptably small phase shift looping. Select an appropriate change in horizontal deflection and measure the corresponding vertical deflection (see Fig. 2-14). The operational amplifier gain is the change in output voltage (horizontal) divided by the corresponding change in input voltage (vertical). The gain is inversely proportional to the slope of the trace; the flatter the trace, the higher the gain. See the Applications section for additional gain information.

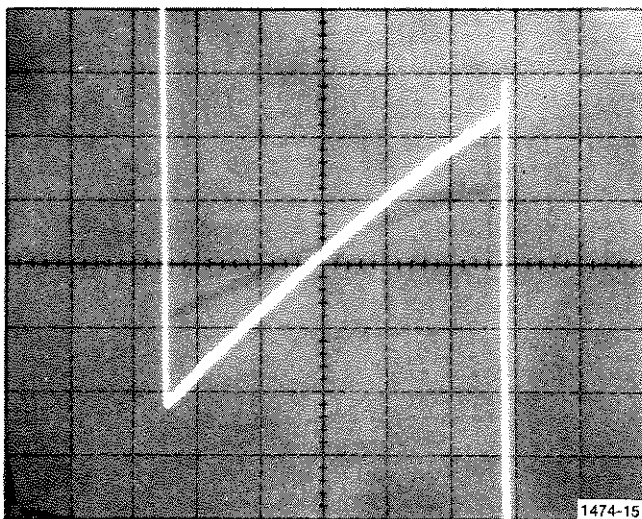

Fig. 2-14. Illustration of Op Amp gain calculation.

Measuring Common-Mode Rejection Ratio

Common-mode rejection ratio (cmrr) is a measure of the ability of an operational amplifier to ignore changes in the common-mode voltage at the input. Ideally, an amplifier should respond only to the input voltage (differential voltage between the input terminals) and be insensitive to common-mode voltage (average voltage between input terminals). If the common-mode voltage changes on an operational amplifier, the effect is the same as though a slight change in input voltage occurred. CMRR is obtained by dividing the change in common-mode voltage by the change in input voltage required to hold the amplifier output voltage constant. In the 178, the amplifier output voltage is held at zero during cmrr measurements.

Checking Common-Mode Operating Range. Turn the FUNCTION selector to the CMRR position. Set the SWEEP FREQUENCY control to 1 Hz and the VARIABLE control fully clockwise. Press the DISPLAY ZERO pushbutton if the display is off-screen. Set the VERT UNITS/DIV switch so that some portion of the trace is relatively horizontal. In this function, the horizontal deflection is the common-mode voltage (the average voltage between the input terminals). The vertical axis displays the change in input voltage between the input terminals. The sweep generator drives the common-mode voltage in CMRR function. Turn the SWEEP AMPLITUDE control counterclockwise and notice the affect on horizontal deflection. Turn the SWEEP AMPLITUDE control clockwise until both ends of the display go off screen.

In CMRR function, the output voltage of the operational amplifier is held at zero. The display is less subject to the effects of the phase shift noted when checking the amplifier in the GAIN position of the FUNCTION switch. To verify that the cmrr check is less susceptible to phase shift than the gain check, increase the sweep frequency until phase shift becomes apparent. When checking cmrr, set the frequency low enough to where the effects of phase shift are minimized.

The operational amplifier common-mode operating range is that range of common-mode voltage at which the operational amplifier is insensitive to changes. The crt graphically displays this range. The flattest portion of the trace indicates the least sensitivity to common-mode voltage (the best cmrr). The display shows relative performance over a range of common-mode voltages. Reduce the power supply voltages (+SUPPLY control counterclockwise) and notice the decrease in common-mode operating range. Common-mode range, therefore, depends on supply voltage. Return the +SUPPLY control to the original setting (15 volts).

Choose an area of interest in the common-mode operating range. Decrease the VERT UNITS/DIV switch setting until the trace has an easily measured slope or vertical deflection. CMRR is measured by selecting the appropriate change in horizontal deflection and measuring the corresponding vertical deflection. The operational amplifier cmrr is the change in common-mode voltage (horizontal) divided by the change in input voltage (vertical). CMRR is inversely proportional to the slope of the trace; the flatter the trace, the better or higher the cmrr. CMRR is discussed further in the Applications section.

Measuring Power-supply Rejection Ratio

Power-supply Rejection Ratio (psrr) is a measure of the ability of the operational amplifier to ignore changes in the power supply voltages. An ideal amplifier does not respond to changes in the power-supply voltages. If the power-supply voltage changes in the imperfect op amp, the effect can be related to an equivalent change in the input voltage. PSRR is obtained by dividing the change in power-supply voltage by the change in input voltage required to hold the output voltage constant. In the 178, the operational amplifier output and common-mode voltage are both held at zero during the psrr measurement.

The 178 provides three PSRR functions. PSRR can be measured from variations in the positive power supply (+PSRR), for the variations in the negative power supply (-PSRR), or for out-of-phase variations in both power supplies (\pm PSRR). In the \pm PSRR function, the positive supply voltage increases (more positive) while the negative supply increases (more negative) and vice versa.

In PSRR functions, the horizontal deflection is the power-supply voltage, positive in +PSRR, negative in -PSRR, and positive only in \pm PSRR, although both supplies are sweeping. The amplitude and frequency of the power supply variations are controlled by the sweep generator controls. The vertical deflection in all PSRR functions is the change in the operational amplifier input voltage. Because of the similarity of all PSRR functions, only one is presented.

Turn the FUNCTION selector to \pm PSRR. The display shows the input voltage variations (vertical) as a function of the supply voltage (horizontal). Decrease the vertical sensitivity if vertical deflection is excessive. Press DISPLAY ZERO if necessary. Turn the SWEEP AMPLITUDE control fully counterclockwise and note that the horizontal display indicates the supply voltage as set by the +SUPPLY control. Turn the SWEEP AMPLITUDE clockwise enough to conveniently measure horizontal deflection. Increase the vertical sensitivity (if necessary) to measure the corresponding vertical deflection. PSRR is the change in power-supply voltage (horizontal) divided by the change in input voltage. PSRR is inversely proportional to the slope of the trace.

Increase the sweep amplitude until the trace goes off-screen near zero. (At this point the operational amplifier input can no longer hold the output voltage at zero). The power-supply voltage at which the trace goes off-screen is the minimum operating supply with both common-mode and output voltages of the amplifier held at zero. (This operating condition is unrealistic for most applications.

Measuring Input Currents

Input bias current is that current flowing into either the +IN or -IN terminals. Input Offset current is the difference in the +IN current and the -IN current. Normally, these currents are specified at zero common-mode voltage. The 178 displays input bias current of the operational amplifiers (vertical) as a function of common-mode voltage (horizontal), thus permitting input voltage bias-current measurements at zero common-mode over the common-mode operating range. The amplifier output voltage is held at zero during bias current measurements.

Op Amp Bias Current. Turn the FUNCTION selector to +INPUT I. Turn the VERT UNITS/DIV switch until sufficient deflection is obtained to make a measurement. In a current-measuring function, all positions of the VERT UNITS/DIV switch are usable (in voltage functions, only those positions in the light-shaded arc are usable). The current measured in this function is the current into the non-inverting (+) input terminal.

Once input-bias current is measured at the desired common-mode voltage, or range of voltages, turn the FUNCTION switch to -INPUT I; current into the inverting (-) terminals can now be displayed and measured. In the most sensitive positions, it is necessary to remove the operational amplifier from the test socket to check zero-current level.

Op Amp Input Offset Current. When the input bias currents have been determined for both input terminals, the input offset current can be obtained by finding the difference. The display is not automatically erased when the FUNCTION switch is moved from the +INPUT I to -INPUT I position. Both curves can be viewed simultaneously. Finer resolution is required to measure input offset current. Use the following procedure:

1. Turn the FUNCTION switch to +INPUT I. Vertically position the trace to graticule center by using the vertical Position control. Pull out on the vertical Position control to magnify the vertical display. Note that the deflection factor has changed by a factor of 10 and the new deflection factor is indicated on the VERT UNITS/DIV knob skirt.

If necessary, reposition the trace vertically to place the display on-screen. Push the Erase pushbutton to clear the storage screen.

Operating Instructions—178 577/D1/D2 Operators

2. Switch to the $-INPUT$ I function. If well positioned, both traces of bias current are displayed at 10 times the normal resolution. Input offset current, the current represented by the distance between the two traces, is measured at the desired common-mode voltage. If the second trace ($-INPUT$ I) is not displayed on screen, reposition the trace, erase the display, and repeat both functions.

If the device has excessively large input offset current, it may be necessary to reduce the vertical sensitivity or make the measurement at the normal (unmagnified) deflection factor.

Measuring Supply Current

Supply current, as measured in the $+SUPPLY$ I and $-SUPPLY$ I positions of the FUNCTION selector, is that current to the $+V$ or $-V$ supply terminals of the operational amplifier. The output voltage terminal is held at zero when measuring supply current. With the amplifier output voltages held at zero, and with insignificant current to the input terminal, the currents to the supply terminals have equal magnitude (but opposite sign). Since the currents have equal magnitude, testing either current provides all the necessary information. Two separate positions are provided on the FUNCTION switch for use with device cards other than the standard op amp card. When testing the supply current functions, the horizontal display represents the power-supply voltage, and the vertical display indicates the supply current.

The measure operational amplifier supply current, turn the SWEEP AMPLITUDE control fully counterclockwise. Switch the VERT UNITS/DIV selector to 10 mA/div. Turn the FUNCTION selector to $+SUPPLY$ I. The display should be a spot. The horizontal deflection of the spot is equal to the supply voltage. Decrease the VERT UNITS/DIV setting to produce an easily measured vertical deflection. The vertical deflection is representative of the supply current.

Decrease the supply voltage using the $+SUPPLY$ voltage control while in stored mode. The stored display shows how supply current varies with supply voltage. Return the $+SUPPLY$ voltage to its original setting and retain the stored display.

Next, slowly turn the SWEEP AMPLITUDE control clockwise to display another trace. This trace probably does not correspond to the stored trace obtained previously. The second trace shows how power-supply current varies while only the positive supply voltage changes (controlled by the sweep generator) while the negative supply remains constant. It is important to keep in mind the difference in these two traces.

Appendix A

TESTING THE LM324 QUAD OPERATIONAL AMPLIFIER

ELECTRICAL CHARACTERISTICS

Parameter	Characteristic			
	Min	Typ	Max	Units
1. Input Offset Voltage		2	7	mV dc
2. Output Voltage Swing ($R_L = 2 \text{ k}\Omega$)	0		V+ -1.5	V dc
3. +Input Bias Current ^a		45	500	nA dc
4. -Input Bias Current ^a		45	500	nA dc
5. Input Offset Current		± 5	± 50	nA dc
6. Input CMRR		85		dB
7. Input Common-mode Range ^b	0		V+ -1.5	V dc
8. Large Signal Voltage Gain ($R_L = 2 \text{ k}\Omega$)		100		V/mV
9. PSRR (dc)		100		dB
10. Supply Current		0.8	2	mA dc
11. Output Current Sink	10	20		mA dc
12. Output Current Source	20	40		mA dc

Absolute Maximum Ratings

13. Supply Voltage, V+	32 V dc, or + and -16 V dc
14. Differential Input Voltage	32 V dc
15. Input Voltage	-0.3 V dc to +32 V dc
16. Output Short-circuited to Ground ^c	Continuous

Description

The LM324 consists of four independent, internally frequency compensated, high-gain operational amplifiers that are designed to operate from a single power supply. Operation from split (+ and -) power supplies is possible and the low power-supply drain is independent of the power-supply voltage. The LM324 uses a 14-pin, dual-in-line package.

Preliminary

The following procedure is designed for use with the Standard Op Amp card-178-577 combination. If a Multiple Op Amp card is available, it may be used in lieu of the Standard Op Amp card (dut card).

Initial control settings are given in the following text. Do not change these control settings unless so directed by the information under "Control Changes" at the beginning of each step. Turn off the DUT SUPPLIES switch at the end of each step. Turn off the power to the 577 when removing and replacing the dut card.

At the start of each step, turn the DUT SUPPLIES switch on. Press and hold the DISPLAY—ZERO pushbutton while centering the display with the 577 Horizontal and Vertical Position controls. This establishes the zero reference point for the test. When the display is centered, release the DISPLAY—ZERO pushbutton. Unless it is desired to store the trace of the previous step, press the 577 Erase pushbutton. Proceed with the test.

^aDirection of input current is out of the IC due to the PNP input stage. This current is independent of the output state, so no loading exists on the input lines.

^bNeither the common-mode voltage nor the input-signal voltage (either input) should be permitted to go negative by more than 0.3 V. The upper limit of common-mode voltage is V+ less 1.5 V, but either (or both) inputs may go to +30 V dc without damage.

^cThe maximum output current is approximately 40 mA and is independent of the magnitude of V+. At supply voltages exceeding +15 V dc, continuous short circuits (output to V+) can exceed the power-dissipation ratings and cause eventual destruction.

Initial Control Settings

577

Display	Store (if comparison of op amp sections is desired)
Variable Collector %	0
Collector Polarity	+
Max Peak Volts	6.5
Max Peak Power—Watts	.6
All dark gray knobs and buttons in except:	
Step Family Single	press
Offset Zero	out
Step/Offset Ampl	.1 V
Offset Mult	10
Pulsed 300 μ s	out
Horiz Volts/Div	1 V Collector
Horizontal Position	centered
Vertical Position	centered

178

DUT SUPPLIES	OFF
LOAD RESISTANCE	2 k Ω
SOURCE RESISTANCE	50 Ω
+ SUPPLY	5 V
SWEEP AMPLITUDE	ccw
SWEEP FREQUENCY	0.1 Hz
FUNCTION	OFFSET V
VERT UNITS/DIV	1 mV

DUT Card

External Feedback Amplifier (EXT FBA) switch	Norm
+Current Limit	CW
-Current Limit	CCW
Patch for the first amplifier section of the dut (see Fig. A-1)	

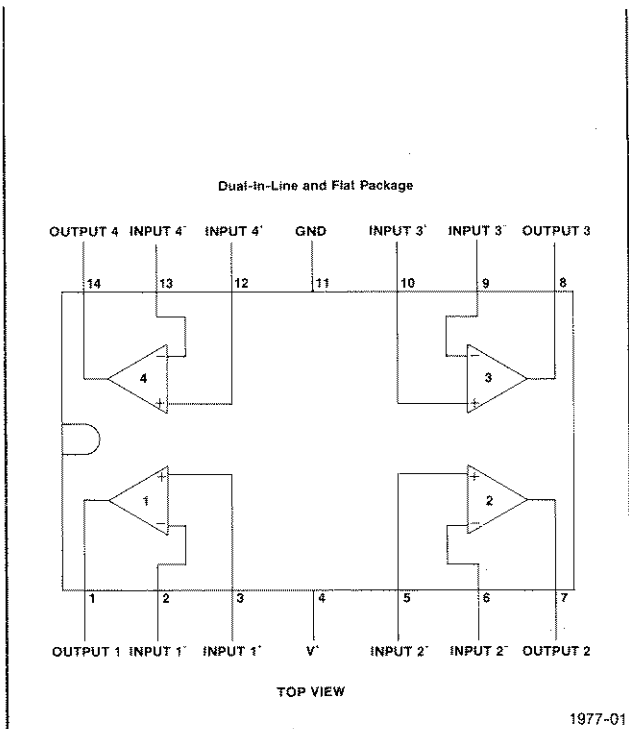
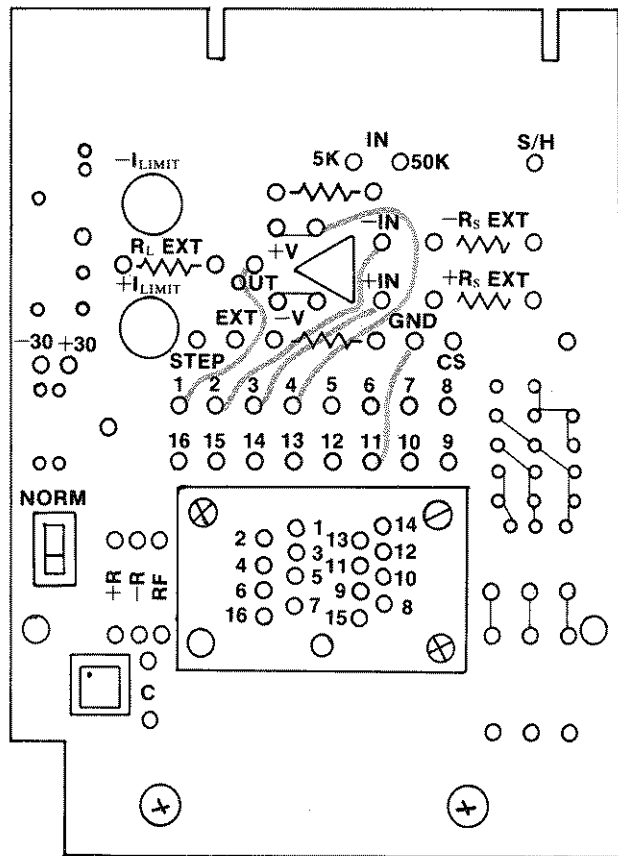

Fig. A-1. Connection diagram of the LM324.

TEST PROCEDURE

1. Check Input Offset Voltage and Output Voltage Swing

a. Turn the SWEEP AMPLITUDE control slowly clockwise until the display indicates the +Power Supply level has been reached (right edge of the display moves straight down screen, see Fig. A-2).

b. Check that the maximum vertical deflection from graticule center is ≤ 3.5 divisions, or ≤ 7 mV. The vertical deflection represents input offset voltage.

c. Check that the maximum horizontal deflection from graticule center is ≈ 3.5 divisions, or ≈ 3.5 volts. The horizontal deflection represents output voltage swing.

d. Check the remaining amplifier sections of the dut by making the necessary patch cord changes and following the foregoing procedure.

2. Check +Input Bias Current

Control Changes:

178

SWEEP AMPLITUDE	ccw
FUNCTION	+INPUT I
VERT UNITS/DIV	.1 μA

DUT Card

Patch for the first amplifier section.

a. Turn the 178 SWEEP AMPLITUDE control slowly clockwise until the display sweeps horizontally through 5 volts (5 divisions).

b. Check that the vertical deflection is ≤ 5 divisions from graticule center (≤ 500 nA, see Fig. A-3). Change the VERT UNITS/DIV switch setting if better resolution is needed.

c. Repeat this test for the remaining amplifier sections of the dut.

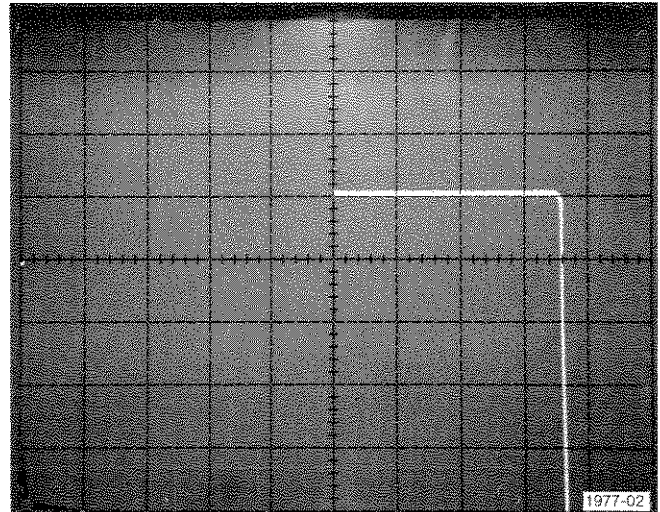

Fig. A-2. Display of input offset voltage and output voltage swing.

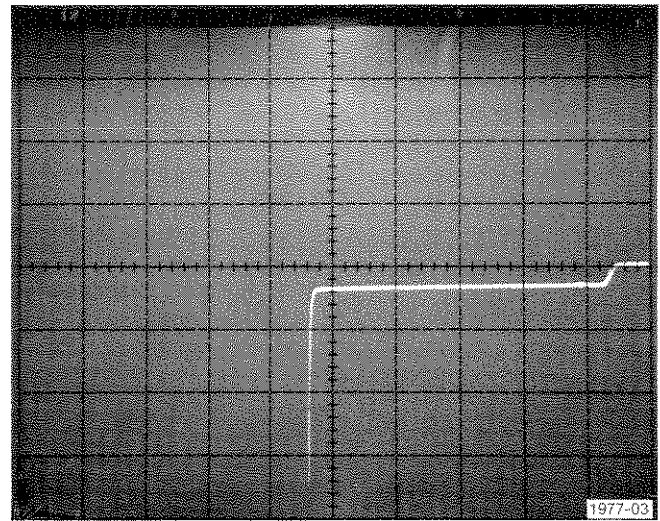

Fig. A-3. Check of LM324 + input bias current.

3. Check —Input Bias Current

Control Changes:

178

SWEEP AMPLITUDE fully ccw
FUNCTION —INPUT I

DUT Card

Patch for the first amplifier section.

a. Turn the SWEEP AMPLITUDE control slowly clockwise until the display sweeps horizontally through 5 volts.

b. Check that the vertical display is ≤ 5 divisions from the zero reference point (≤ 500 nA, see Fig. A-4).

c. Repeat this test for the remaining sections of the dut.

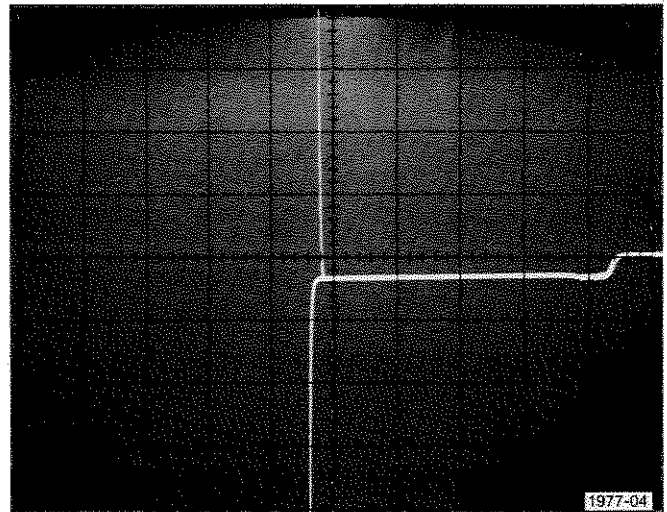

Fig. A-4. Check of LM324 — input bias current.

4. Check Input Offset Current

Control Changes:

577

X10 Vertical Magnification pull
Vertical Position control center display

178

SWEEP AMPLITUDE fully ccw
VERT UNITS/DIV $.2 \mu A$

DUT Card

Patch for the first amplifier section.

a. Set the SWEEP AMPLITUDE control for 5 divisions of horizontal deflection.

b. Press the Erase button once, then store the display.

c. Change the FUNCTION switch to +INPUT I.

d. Compare the new display with the stored display.

e. Check that the input offset (vertical separation between the two displays i.e., +INPUT I and —INPUT I) is ≤ 2.5 divisions (≤ 50 nA, see Fig. A-5). If greater resolution is needed, change the VERT UNITS/DIV switch to a more sensitive setting and repeat this test.

f. Repeat the test for the remaining amplifier sections of the dut.

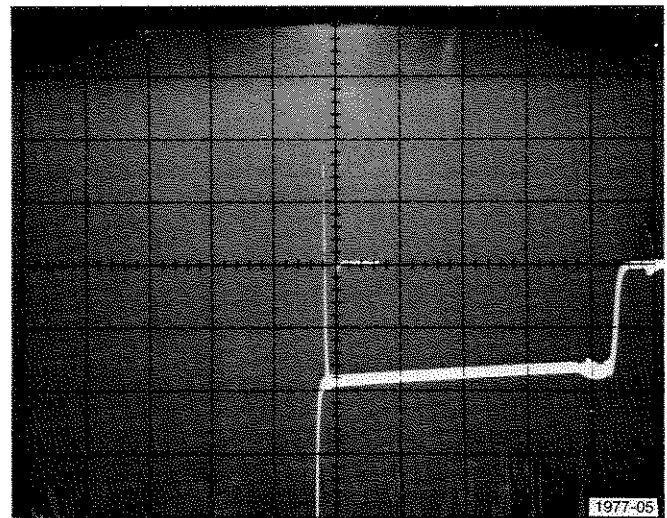

Fig. A-5. Display of input offset current.

5. Check Input Common-mode Rejection Ratio and Input Common-mode Range

Control Changes:

577

X10 Vertical Magnification in

178

FUNCTION	CMRR
VERT UNITS/DIV	.2 mV
SWEEP AMPLITUDE	ccw

DUT Card

Patch for the first amplifier section of the dut.

a. Increase the SWEEP AMPLITUDE setting until the display indicates maximum swing of common-mode voltage (see Fig. A-6).

b. Calculate the input common-mode rejection ratio, i.e., the ratio of horizontal deflection to vertical deflection (slope) as in the following example:

$$\frac{1 \text{ V (horizontal)}}{.1 \text{ mV (vertical)}} = 10,000 = 80 \text{ dB}$$

(CMRR for the LM324 is typically 85 dB)

c. Set the VERT UNITS/DIV switch to 1 mV.

d. Check the input common-mode range (horizontal voltage swing to the knee of the curve). The minimum voltage range should be 1.5 volts less than V+.

e. Repeat for the remaining sections of the dut.

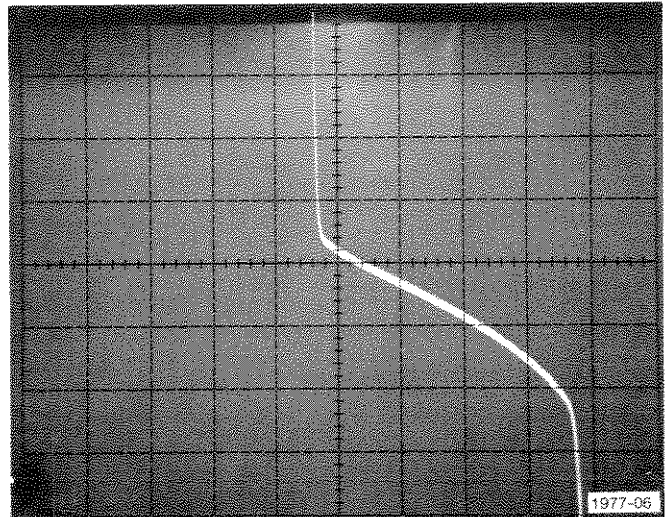

Fig. A-6. Display of input common mode rejection ratio and common mode range.

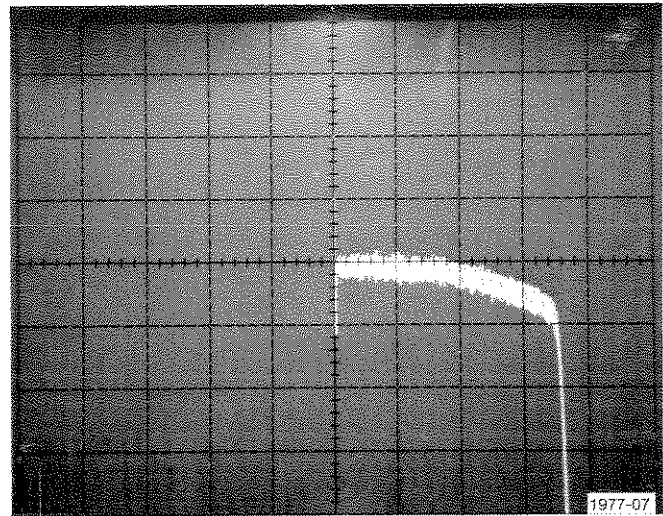

Fig. A-7. Display of large scale voltage gain.

6. Check Large-signal Voltage Gain

Control Changes:

178

FUNCTION	GAIN
VERT UNITS/DIV	20 μ V

DUT Card

Patch for the first amplifier section of the dut.

a. Set the SWEEP AMPLITUDE control until the horizontal deflection is 10 divisions.

b. Press the Erase pushbutton and store the first sweep after erasing.

c. Calculate the gain from the horizontal voltage change between the start of the sweep and the knee of the curve (see Fig. A-7).

d. Repeat for the remaining sections of the dut.

7. Check Power Supply Rejection Ratio

Control Changes:

178

FUNCTION	+PSRR
VERT UNITS/DIV	20 μ V
SWEEP AMPLITUDE	ccw

- Press DISPLAY—ZERO.
- Turn the SWEEP AMPLITUDE control slowly clockwise until 5 volts of sweep is displayed horizontally.
- Calculate the power supply rejection ratio (PSRR, see Fig. A-8). PSRR is power supply voltage swing (horizontal deflection) divided by the change in input voltage due to power supply variation (vertical deflection).
- Repeat this test for the remaining sections of the dut.

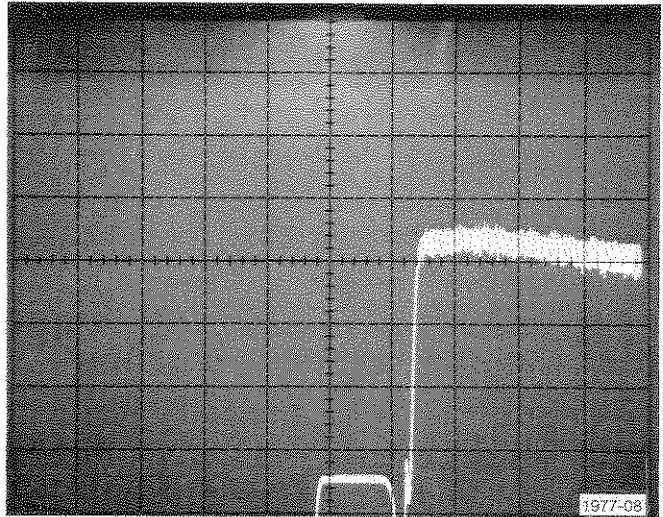

Fig. A-8. Display of power supply rejection ratio.

8. Check Maximum Supply Current

Control Changes:

178

FUNCTION	+SUPPLY I
VERT UNITS/DIV	.5 mA
SWEEP AMPLITUDE	ccw

- Turn the SWEEP AMPLITUDE control to give a horizontal deflection representative of a voltage swing from 0 to 5 volts.
- Check that the supply current is ≤ 4 vertical divisions for a horizontal sweep of 5 volts (see Fig. A-9).
- Repeat this test for the remaining sections of the dut.

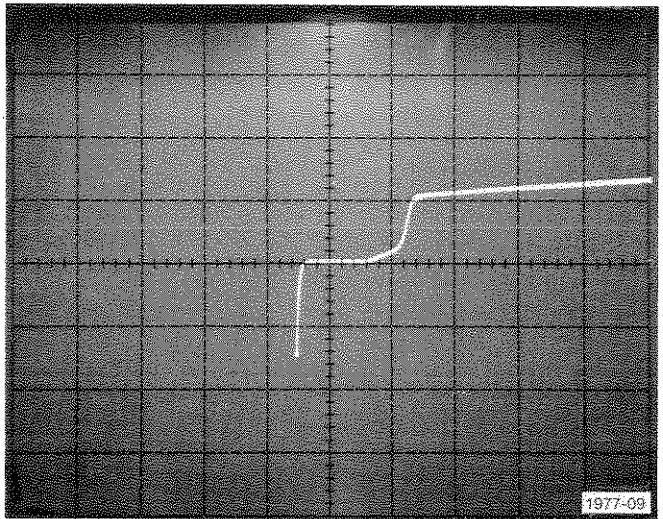

Fig. A-9. Display of maximum supply current.

9. Check Output Current Sink

Control Changes:

577

Horizontal Position	display centered
Vertical Position	display centered
Offset Zero	out
Step/Offset Ampl	1 V
Collector Supply Polarity	+DC
Offset Mult	2.5 V

178

LOAD RESISTANCE	EXT
SOURCE RESISTANCE	EXT
FUNCTION	COLLECTOR SUPPLY I
SWEEP AMPLITUDE	ccw
VERT UNITS/DIV	10 mA

DUT Card

Patch for the first amplifier section of the dut.

a. Turn the Variable Collector % control slowly clockwise until the display shows 2 divisions of vertical deflection (20 mA, see Fig. A-10). See the device specifications for minimum and maximum sink current ratings.

b. Repeat this test for the remaining sections of the dut.

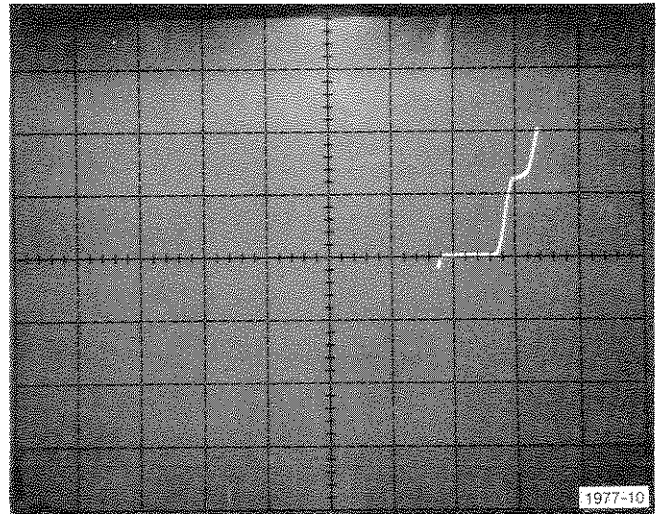

Fig. A-10. Display of output current sink.

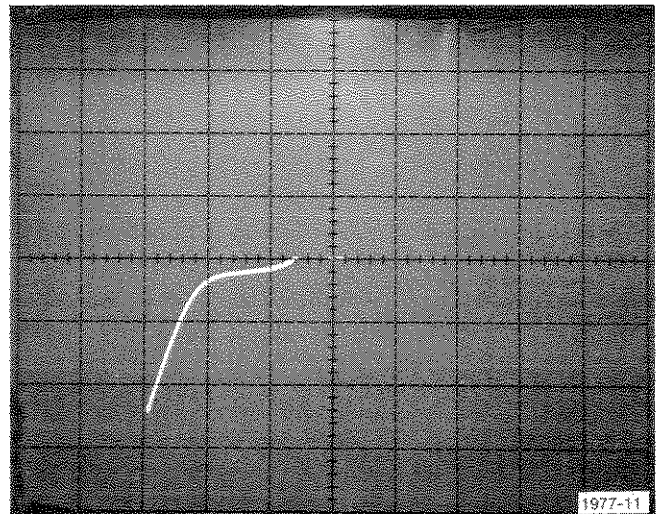

Fig. A-11. Display of output current source.

10. Check Output Current Source

Control Changes:

577

Collector Supply Polarity	-
Variable Collector %	0

178

VERT UNITS/DIV	20 mA
----------------	-------

DUT Card

Patch for the first section of the dut.

a. Turn the DUT SUPPLIES switch off. Remove the patch cords for $-R_sEXT$ and $+R_sEXT$ on the DUT Card.

b. Connect the right jack of $-R_sEXT$ to GND. Connect the right jack of $+R_sEXT$ to STEP.

c. Set the DUT SUPPLIES switch to ON.

d. Turn the Variable Collector % control clockwise until the sweep reaches a voltage of zero.

e. Check the output current source on the vertical axis of the display as shown in Fig. A-11.

f. Repeat this test for the remaining sections of the dut.



Appendix B

TESTING THE LM302 VOLTAGE FOLLOWER

ELECTRICAL CHARACTERISTICS¹

Parameter	Conditions	Min	Typ	Max	Units
Input Offset Voltage	$T_A = 0^\circ\text{C}$				V
Input Bias Current	$T_A = 25^\circ\text{C}$		10	30	nA
Input Resistance	$T_A = 25^\circ\text{C}$	10^9	10^{12}	Ω	
Input Capacitance			3.0		pF
Large Signal Voltage Gain	$T_A = 25^\circ\text{C}$, $V_S = \pm 15\text{V}$, $V_{\text{OUT}} = \pm 10\text{V}$, $R_L = 8\text{ k}\Omega$	0.9985	0.9995	1.0	V/V
Output Resistance	$T_A = 25^\circ\text{C}$		0.8	2.5	Ω
Supply Current	$T_A = 25^\circ\text{C}$		3.5	5.5	mA
Input Offset Voltage				20	mV
Temperature Drift ^b			20		$\mu\text{V}/^\circ\text{C}$
Input Bias Current	$T_A = T_A\text{ MAX}$		3.0	15	nA
	$T_A = T_A\text{ MIN}$		20	50	nA
Output Voltage Swing ^c	$V_S = \pm 15\text{ V}$, $R_L = 10\text{ k}\Omega$ ± 10 (Note 5)		V		
Supply Current ^d	$T_A\ 125^\circ\text{C}$		4.0		mA
Supply Voltage ^e Rejection Ratio	$\pm 12\text{ V} \leq V_S$ $\leq \pm 18\text{ V}$	60			dB

LM302 Absolute Maximum Ratings

Supply Voltage	$\pm 18\text{ V}$
Power Dissipation (see footnote ^b)	500 mW
Input Voltage (see footnote ^c)	$\pm 15\text{ V}$
Output Short Circuit Duration (see footnote ^d)	Indefinite
Operating Temperature Range	0°C to 70°C

¹These specifications apply for $\pm 5\text{ V} \leq V_S \leq \pm 18\text{ V}$ and $0^\circ\text{C} \leq T_A \leq 70^\circ\text{C}$ for the LM302 unless otherwise specified.

^bThe maximum junction temperature of the LM302 is 85°C . For operating at elevated temperatures, devices in the TO-5 package must be derated based on a thermal resistance of 150°C/W , junction to ambient, or 45°C/W , junction to case. For the flat package, the derating is based on a thermal resistance of 185°C/W when mounted on a 1/16 inch thick epoxy glass board with ten, 0.03 inch wide, 2 ounce copper conductors. The thermal resistance of the dual-in-line package is 100°C/W , junction to ambient.

^cIncreased output swing under load can be obtained by connecting an external resistor between the booster and V- terminals. See curve.

^dFor the LM302, continuous short circuit is allowed for 70°C case or 55°C ambient temperature, it is necessary to insert a resistor greater than $2\text{ k}\Omega$ in series with the input when the amplifier is driven from low impedance sources to prevent damage when the output is shorted.

^eFor supply voltages less than $\pm 15\text{ V}$, the absolute maximum input voltage is equal to the supply voltage.

Appendix B—178 577/D1/D2 Operators

The LM302 is a high-gain operational amplifier designed specifically for unity-gain voltage follower applications. The required input current is low and input impedance is relatively high. The input transistors are operated near zero collector-to-base voltage to virtually eliminate high-temperature leakage currents. The device can therefore be operated in a temperature stabilized component oven to get extremely low input currents and low offset voltage drift.

Initial Control Settings

577

Variable Collector %	0
Collector Polarity	+
Max Peak Volts	6.5
Series Resistance	2 k Ω
Step Family	Single
Step Rate	Norm
Step Offset Amp	1 V
Step Offset Polarity	in
Number of Steps	1
Offset Multiplier	0.0
Offset Zero	in
Offset Aid	in
Pulsed 300 μ s	out
Step X .1	in
Display Invert	in
Display Filter	in
Horiz Volts/Div	5 V Collector Volts
X10 Horiz Mag	off
X10 Vert Mag	off
Horiz Position	centered
Vert Position	centered

178

DUT SUPPLIES	OFF
LOAD RESISTANCE	2 k Ω
SOURCE RESISTANCE	50 Ω
+SUPPLY	15 V
-SUPPLY	15 V (TRACK +SUPPLY)
SWEEP AMPLITUDE	fully ccw
SWEEP FREQUENCY	.1 Hz
DISPLAY ZERO	----
FUNCTION	Offset V
VERT UNITS/DIV	50 mV

DUT Card

Patch as shown in Fig. B-1.

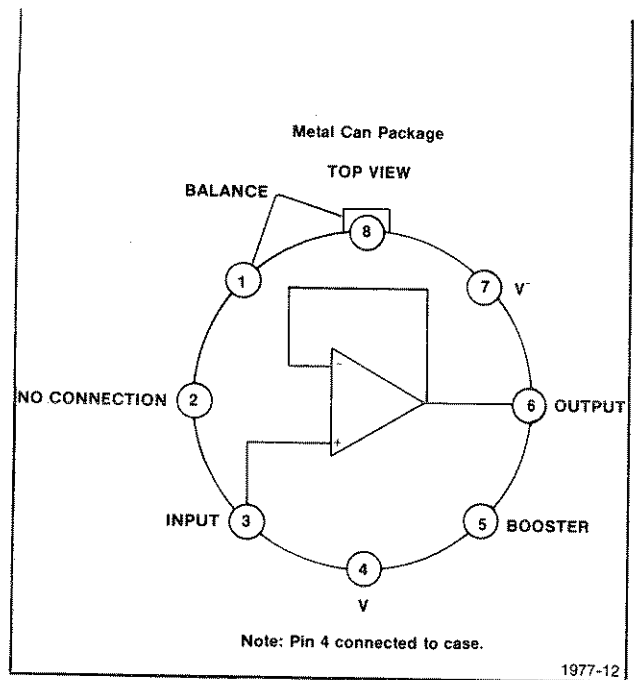
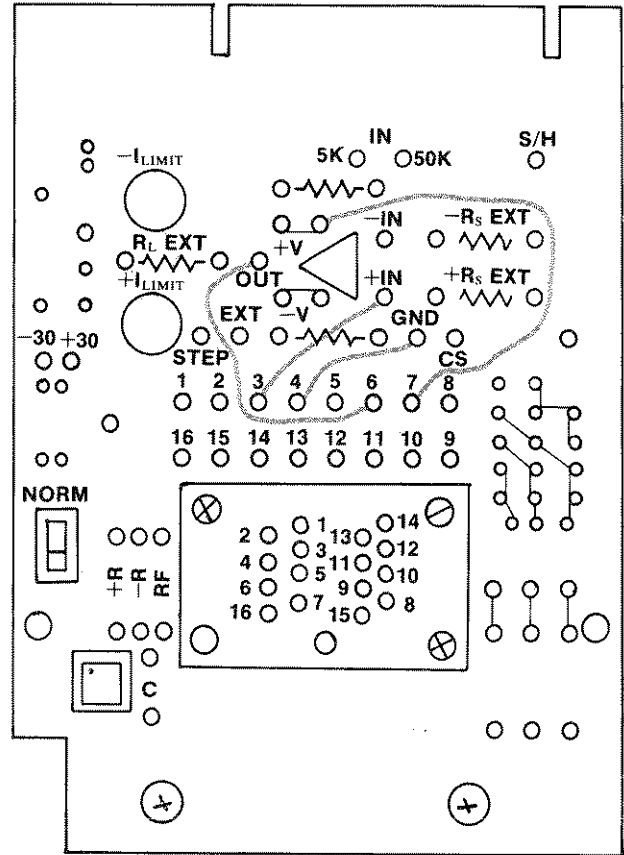

Fig. B-1. Base and patching diagram for LM302.

TEST PROCEDURE

1. Check + Input Bias Current

a. Press and hold the DISPLAY—ZERO button while centering the display with the 577 Position controls. Release the DISPLAY—ZERO button and press the 577 Erase button.

b. Adjust the SWEEP AMPLITUDE control for 4 divisions of horizontal deflection.

c. Check that the input current does not exceed 30 nA (3 vertical divisions, see Fig. B-2).

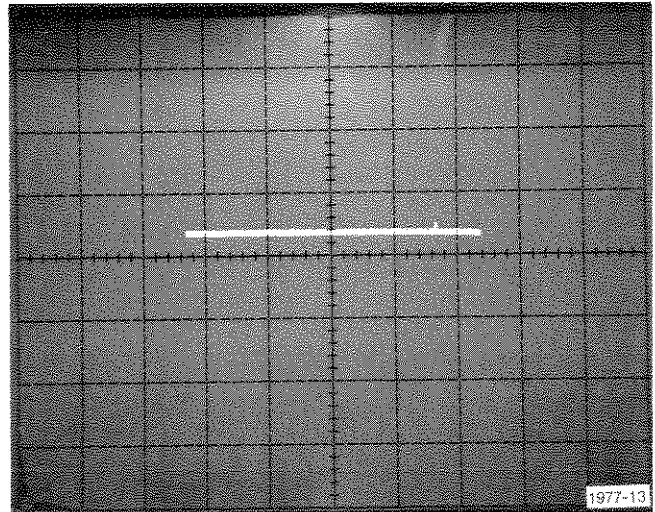

Fig. B-2. + Input bias current display.

2. Check + Power Supply Rejection Ratio

Reset the controls as follows:

178

LOAD RESISTANCE	2 kΩ
SOURCE RESISTANCE	10 kΩ
FUNCTION	+PSRR
VERT UNITS/DIV	20 mV

a. Press and release the 178 DISPLAY—ZERO button.

b. Press the 577 Erase button.

c. Turn the SWEEP AMPLITUDE control clockwise for approximately 3 divisions of horizontal deflection.

d. Calculate + Power Supply Rejection Ratio by dividing the change in input voltage by the change in + Power Supply Volts, for example:

$$+PSRR = \frac{\Delta\text{Vert}}{\Delta\text{Horiz}} \text{ as shown in Fig. B-3.}$$

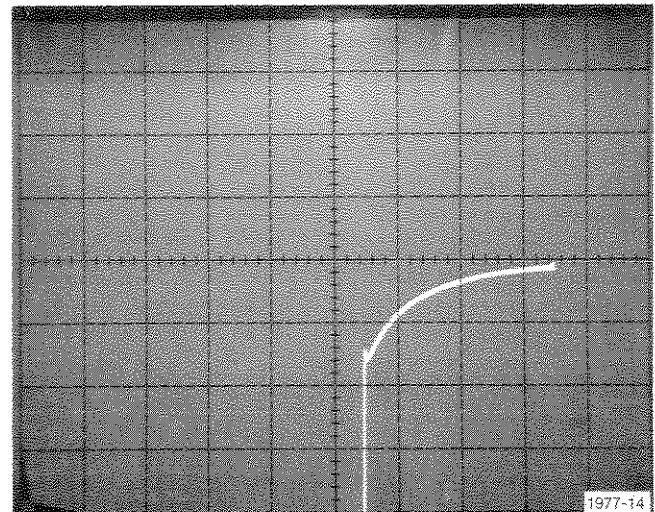

Fig. B-3. Display of + power supply rejection ratio (+psrr).

3. Check the - Power Supply Rejection Ratio

Reset the controls as follows:

178

FUNCTION	-PSRR
----------	-------

a. Press and release the 178 DISPLAY—ZERO button.

b. Press the 577 Erase button.

c. From the display, calculate the - Power Supply Rejection Ratio in the same manner that +PSRR was calculated in Step 2. See Fig. B-4.

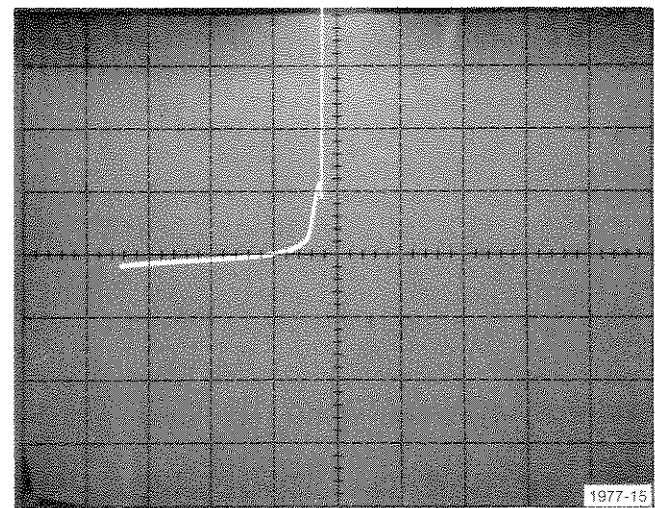

Fig. B-4. Display of - power supply rejection ratio (-psrr).

Appendix B—178 577/D1/D2 Operators

4. Check the \pm Power Supply Rejection Ratio

- Reset the 178 FUNCTION switch to \pm PSRR.
- Press and release the 178 DISPLAY—ZERO button.
- Press the 577 Erase button.
- Calculate \pm PSRR using the same methods as used in Steps 2 and 3 for calculating +PSRR and -PSRR. See Fig. B-5.

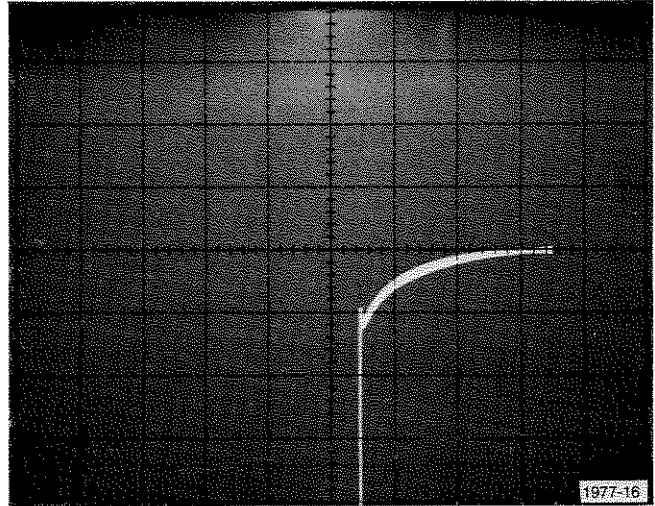

Fig. B-5. Display of \pm power supply rejection ratio (\pm psrr).

5. Check + Supply Current

Reset the controls as follows:

577
Horiz Volts/Div 5

178
DUT Supplies off
SWEEP AMPLITUDE fully ccw
SWEEP FREQUENCY 1 Hz
FUNCTION + SUPPLY I
VERT UNITS/DIV 5 mA/div

- Turn the DUT SUPPLIES on.
- Press and hold the 178 DISPLAY—ZERO button while centering the display with the 577 Vert and Horiz Position controls.
- Release the 178 DISPLAY—ZERO button.
- Turn the 178 SWEEP AMPLITUDE CONTROL cw for 3 divisions of deflection.
- Press the 577 Erase button. The display that returns should resemble Fig. B-6. The display shown represents approximately 4 mA of supply current.

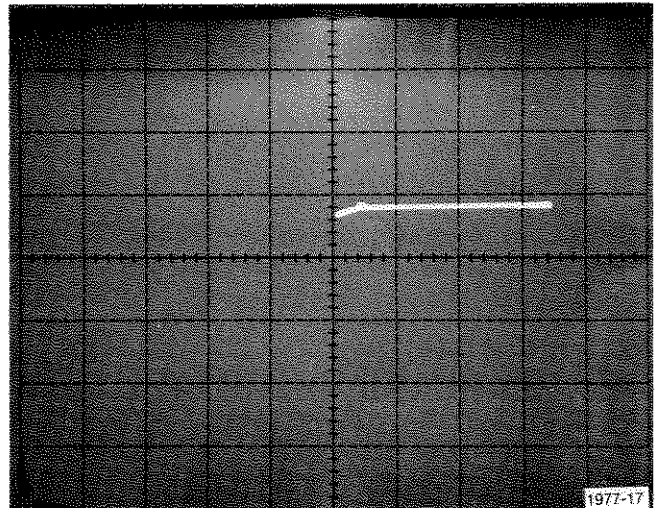

Fig. B-6. Display of + supply current.

6. Check - Supply Current

- Change the 178 FUNCTION switch to - SUPPLY I.
- Repeat parts b through e of Step 5 above (see Fig. B-7).

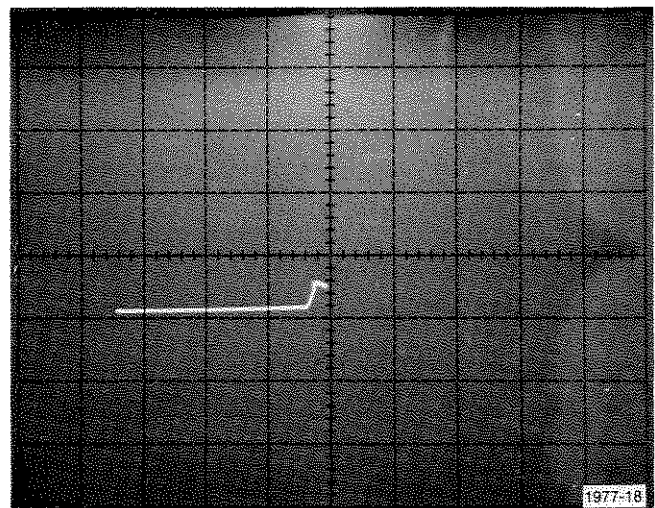

Fig. B-7. Display of - supply current.

Appendix C

TESTING THE 727 TEMPERATURE CONTROLLED DIFFERENTIAL PREAMPLIFIER

ELECTRICAL CHARACTERISTICS

Parameter	Conditions ^a	Min	Typ	Max	Units
Input Offset Voltage	$R_s \leq 50 \Omega$		2.0	10	mV
Input Offset Current			2.5	15	nA
Input Bias Current			12	40	nA
Input Offset Voltage Drift	$R_s \leq 50 \Omega, -55^\circ \text{C} \leq T_A \leq +125^\circ \text{C}$		0.6	1.5	$\mu\text{V}/^\circ \text{C}$
Input Offset Current Drift	$-55^\circ \text{C} \leq T_A \leq +125^\circ \text{C}$		15		$\text{pA}/^\circ \text{C}$
Input Bias Current Drift	$-55^\circ \text{C} \leq T_A \leq +125^\circ \text{C}$		15		$\text{pA}/^\circ \text{C}$
Differential Input Resistance		300		M Ω	
Common Mode Input Resistance		1000		M Ω	
Input Voltage Range		± 12	± 13		V
Supply Voltage Rejection Ratio	$R_s \leq 100 \text{ k}\Omega$		80		$\mu\text{V}/\text{V}$
Common Mode Rejection Ratio	$R_s \leq 100 \text{ k}\Omega$	80	100		dB
Output Resistance			1.0	4.0	k Ω
Output Common Mode Voltage		-6.0	-5.0	-4.0	V
Differential Output Voltage Swing		± 5.0	± 7.0	± 10	V
Output Sink Current		10	30	80	μA
Differential Load Rejection			5.0	10	$\mu\text{V}/\mu\text{A}$
Differential Voltage Gain		60	100	250	
Low Frequency Noise	BW=10 Hz to kHz, $R_s \leq 50 \Omega$		3.0		μV_{rms}
Amplifier Supply Current	$T_A = +25^\circ \text{C}$		1.0	2.0	mA
Heater Supply Current	$T_A = +25^\circ \text{C}$		10	15	mA

^aV+ = 15 V, R_{ADJ} = 330 k Ω , unless otherwise specified.

Appendix C—178 577/D1/D2 Operators

The 727 is a monolithic, fixed gain, differential-input differential-output amplifier. It is mounted in a high thermal-resistance package and can be held at a constant temperature by internal, active regulator circuitry. The high gain and low standby dissipation of the regulator circuit give tight temperature control over a wide ambient temperature range. The device is intended for use as a self-contained input stage in very low drift dc amplifiers.

Preliminary

Initial control settings are given in the following text. Do not change these control settings unless so directed by the information under "Control Changes" at the beginning of each step. Turn off the DUT SUPPLIES switch at the end of each step. Turn off the power to the 577 when removing and replacing the Standard Op Amp card (dut card).

At the start of each step, turn the DUT SUPPLIES switch on. Press and hold the DISPLAY—ZERO pushbutton while centering the display with the 577 Horizontal and Vertical position controls. This establishes the zero reference point for the test. When the display is centered, release the DISPLAY—ZERO pushbutton. Unless it is desired to store the trace of the previous step, press the 577 Erase pushbutton. Proceed with the test.

Initial Control Settings

577

Display	Store (if comparison of the op amp sections is desired).
Variable Collector %	0
Collector Polarity	+
Max Peak Volts	6.5
Max Peak Power—Watts	.6
All dark gray knobs and buttons in except:	
Step Family Single	press
Offset Zero	out
Step/Offset Ampl	.1 V
Offset Mult	10
Pulsed 300 μ s	out
Horiz Volts/Div	5 V Collector
Horizontal Position	centered
Vertical Position	centered

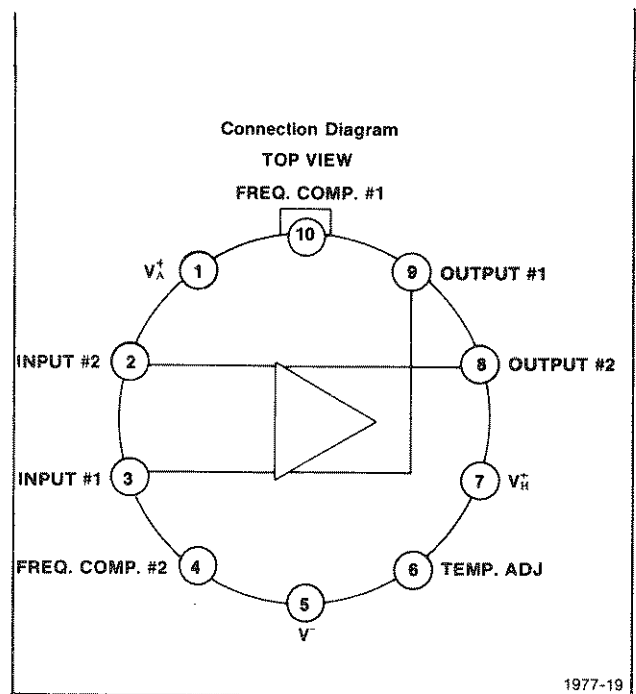
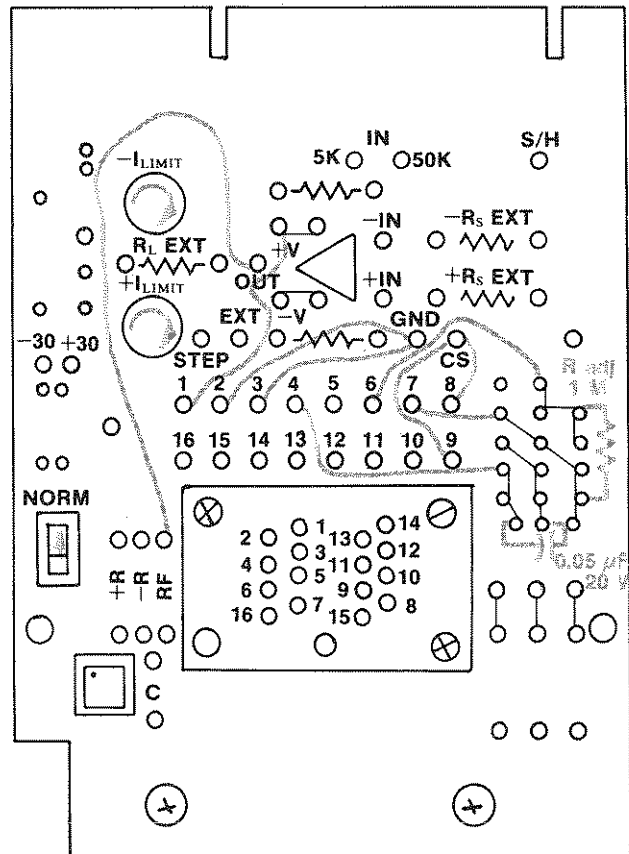

Fig. C-1. Basing and patching diagram for the 727.

178

DUT SUPPLIES	OFF
LOAD RESISTANCE	2 kΩ
SOURCE RESISTANCE	50 Ω
+SUPPLY	5 V
−SUPPLY	TRACK + SUPPLY
SWEEP AMPLITUDE	ccw
SWEEP FREQUENCY	.1 Hz
FUNCTION	OFFSET V
VERT UNITS/DIV	1 mV

DUT Card

Ext FBA Switch	Norm
+Current Limit	cw
−Current Limit	cw

Patch the card as shown in Fig. C-1.

TEST PROCEDURE

1. Check Input Offset Voltage

a. Turn the SWEEP AMPLITUDE control slowly clockwise until the display indicates that the power supply levels have been reached; i.e., the left edge of the display moves straight up the screen and the right edge moves straight down (see Fig. C-2).

b. Check the input offset voltage. The maximum for this example is 10 mV, which is represented by a vertical deflection of 5 divisions from graticule center.

2. Check +Input Bias Current

Control Changes:

178

FUNCTION	+INPUT I
VERT UNITS/DIV	20 nA

a. Press the Erase pushbutton on the 577 and the DISPLAY—ZERO on the 178.

b. Check that the vertical display is ≤ 3.75 divisions from graticule center (= 75 nA, see Fig. C-3). Change the VERT UNITS/DIV switch setting if better resolution is needed.

3. Check −Input Bias Current

a. Change the FUNCTION switch to −INPUT I.

b. Press the Erase button.

c. Check that the vertical display is ≤ 3.75 divisions from the graticule center (≤ 500 nA, see Fig. C-4).

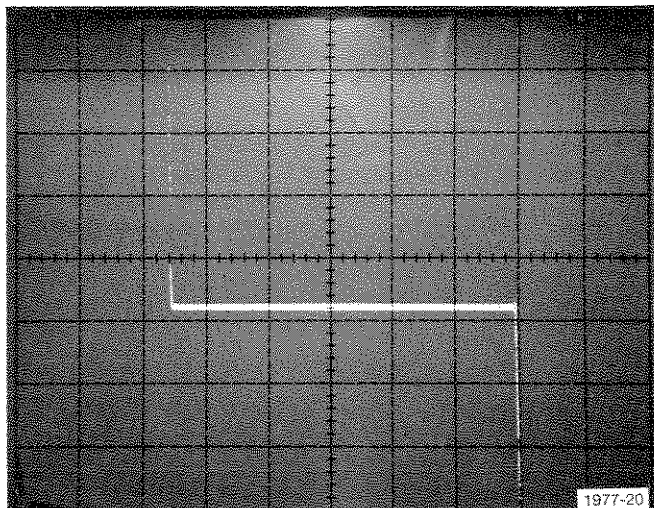

Fig. C-2. Display of input offset voltage.

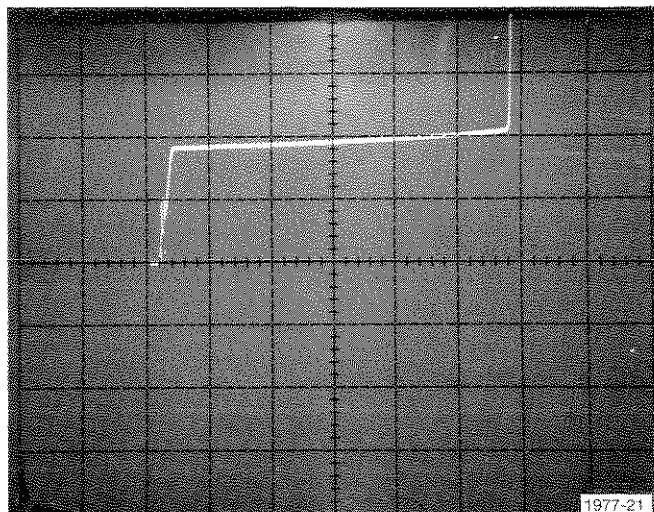

Fig. C-3. + Input bias current display.

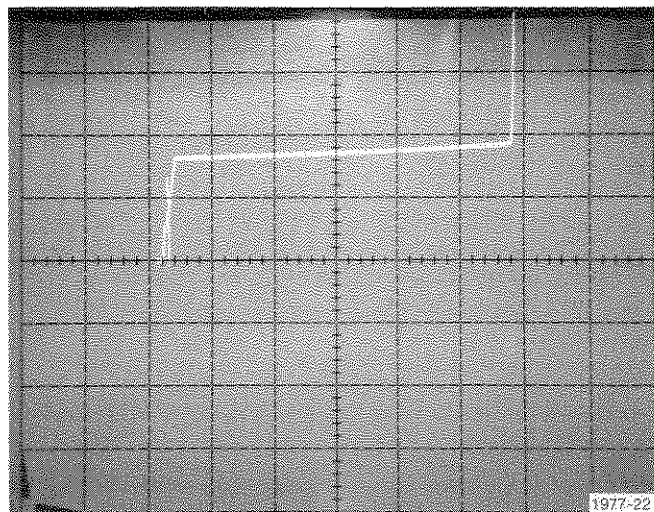

Fig. C-4. − Input bias current display.

4. Check Input Offset Current

- a. Repeat Steps 2 and 3 and store the displays.
- b. Check that the input offset (vertical separation between the +Input Bias Current and the -Input Bias Current) is ≤ 1.25 divisions, or ≤ 25 nA. If greater resolution is needed, change the VERT UNITS/DIV switch to a more sensitive setting and repeat Steps 2, 3, and 4 (see Fig. C-5).

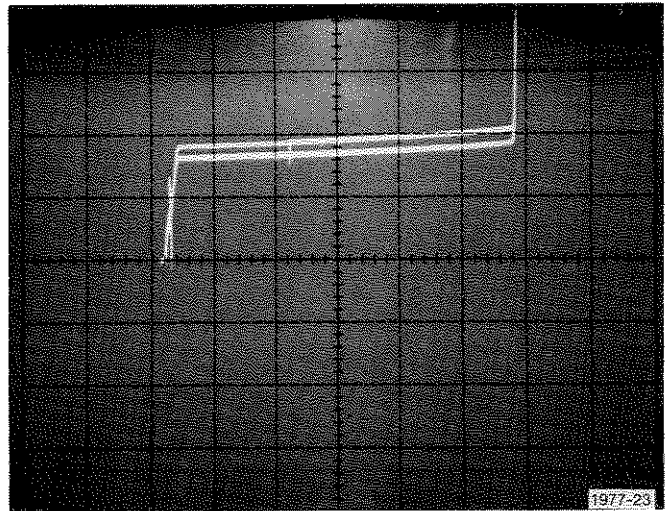

Fig. C-5. Display of input offset current.

5. Check Input Voltage Range

Check that the horizontal excursion of the trace in Step 4 is not less than 2.2 divisions (+12 V and -12 V) each side of the centerline (see Fig. C-5).

6. Check Input Common-mode Rejection Ratio

Control Changes:

178

FUNCTION	CMRR
VERT UNITS/DIV	50 μ V

- a. Erase the display.
- b. On the new display that appears, check the input common-mode rejection ratio; i.e., the ratio of horizontal deflection to vertical deflection (slope), as in the following example:

$$\frac{5 \text{ V/div (horizontal deflection factor)}}{50 \mu\text{V/div (vertical deflection factor)}} = 100,000 = 100 \text{ dB}$$

The typical input CMRR for the 727 is 100 dB (see Fig. C-6).

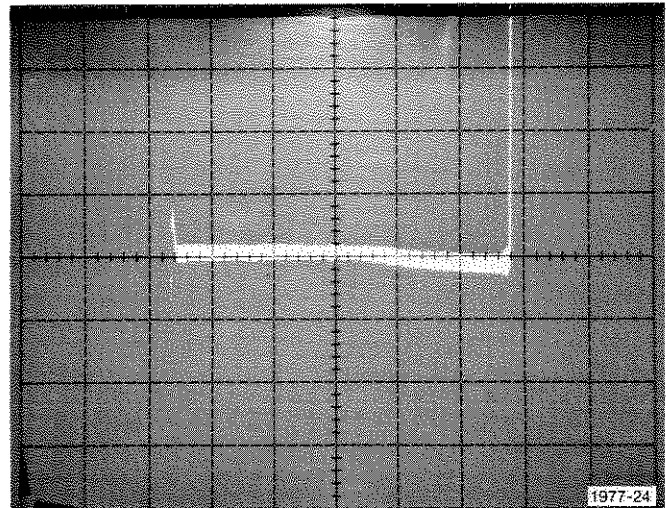

Fig. C-6. Input common mode rejection ratio display.

7. Check Power Supply Rejection Ratio (+ and - PSRR)

Control Changes:

178

FUNCTION	\pm PSRR
VERT UNITS/DIV	.2 mV

- a. Check the power supply rejection ratio (\pm PSRR, see Fig. C-7). \pm PSRR is the power supply voltage swing (horizontal deflection) divided by the change in input voltage due to power supply variation (vertical deflection); e.g.,

$$\frac{5 \text{ V/div horizontal deflection factor}}{.2 \text{ mV/div vertical deflection factor}} = 40 \mu\text{V/V}$$

Specifications for the 727 list 80 μ V/V as typical; Fig. C-7 shown 16 μ V/V for the device tested in writing this procedure.

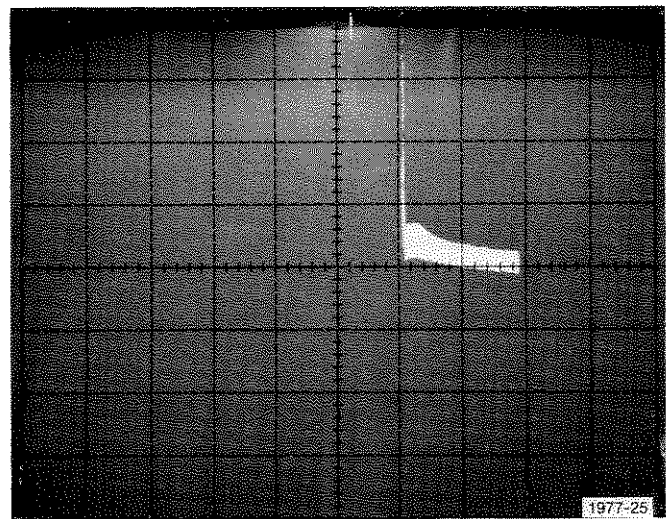

Fig. C-7. Power supply rejection ratio (+ and - psrr).

8. Check Output Common-mode Voltage

Control Changes:

	577
Variable Collector %	0 (ccw)
Collector Supply Polarity	ac
Max Peak Volts	6.5
Series Resistors	120 kΩ
Horiz Volts/Div	2 collector volts

178

FUNCTION Switch
VERT UNITS/DIV

COLLECTOR SUPPLY I
50 mV

DUT Card

Patch the card for a 727 as shown in Fig. C-8.

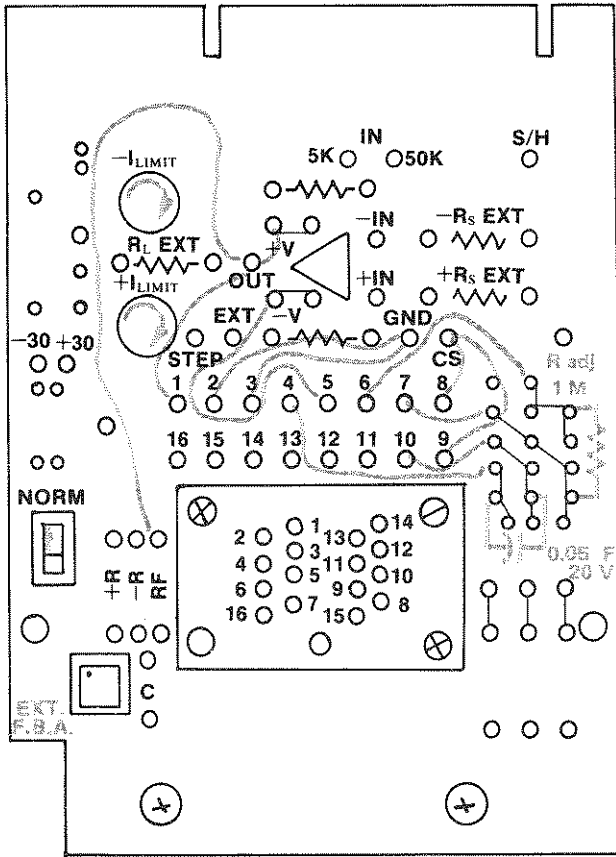

1977-26

Fig. C-8. Setup for checking output common mode voltage and output sink current of a 727.

a. Once the card is patched as shown, insert it into the 178. Turn on the 577 and set the DUT SUPPLIES switch to ON. Establish the zero reference point as described under "Preliminary" heading at the beginning of this procedure.

b. Note that when the DISPLAY—ZERO pushbutton is pressed and released, the dot on the crt graticule moves to a spot about 3 divisions to the left of graticule center, representing about 6 volts. The minimum output common-mode voltage specified for the 727 is -7 volts, the maximum is -4 volts, and -5 volts is listed as being typical (see Fig. C-9).

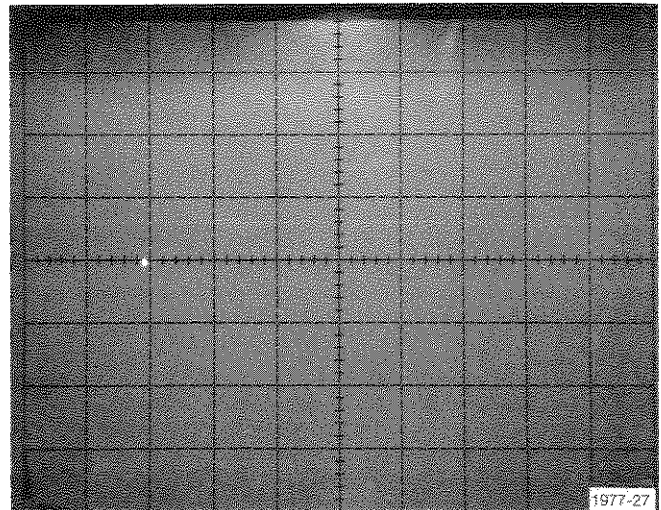

Fig. C-9. Display of output common-mode voltage.

9. Check Output Sink Current

a. Reset the 178 VERT UNITS/DIV switch to $50 \mu\text{A}$.

b. The 1-division of vertical deflection in Fig. C-10 shows that the device used for this test had an output sink current of $50 \mu\text{A}$, about the middle of the specified range (10 to $80 \mu\text{A}$).

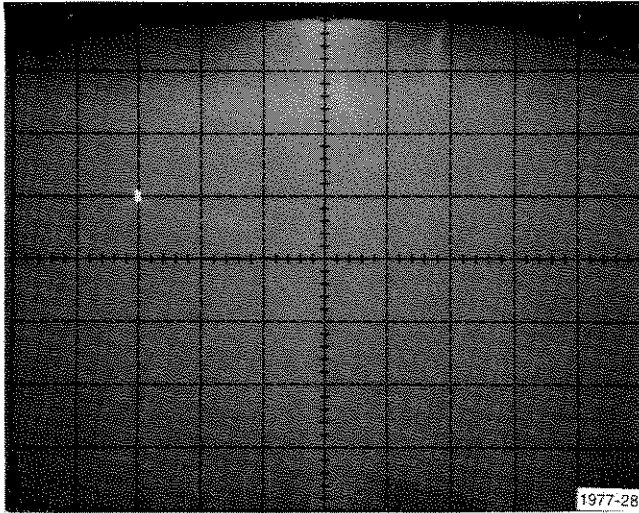

Fig. C-10. Display of output sink current.

c. Turn the Variable Collector % control slowly clockwise until a knee appears on the trace as shown in Fig. C-11. The current represented by the knee of the curve is the maximum that the particular device under test is capable of passing, in this case about $90 \mu\text{A}$.

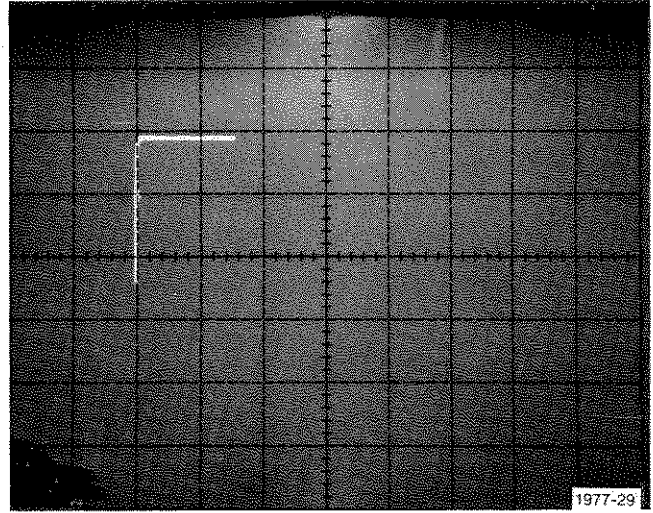

Fig. C-11. Display of maximum output sink current.

Appendix D

TESTING THE LM380 AUDIO POWER AMPLIFIER

ELECTRICAL CHARACTERISTICS^a

Parameter	Min	Typ	Max	Units	Test Conditions
Output Power (P_{out} , RMS)	2.5			W	$R_L = 8\Omega$ THD = 3% (see footnotes b & c)
Gain (A_v)	40	50	60	V/V	
Output Voltage Swing (V_{out})		14		V_p	$R_L = 8\Omega$, 150 mA max.
Input Resistance (Z_{in})		150 k Ω		Ω	
Total Harmonic Distortion (THD)		0.2		%	(see footnotes c & d)
Power Supply Rejection Ratio (PSRR)		38		dB	(see footnote e)
Supply Voltage (V_+)	8		22	V	
Bandwidth (BW)		100 k Ω		Hz	$P_{out}=2W$, $R_L=8\Omega$
Quiescent Supply Current (I_Q)		7	25	mA	
Quiescent Output Voltage ($V_{out, Q}$)	8	9.0	10	V	
Bias Current (I_{BIAS})		100		nA	Inputs floating
Short Circuit Current (I_{sc})		1.3	1.3	A	
Input Voltage			± 0.5	V	
Package Dissipation, 14 Pin DIP		5.0	W	(see footnote f)	
Package Dissipation, 8 Pin DIP		660	mW	(see footnote g)	
Operating Temperature	0		+70	$^{\circ}C$	
Junction Temperature		+150	$^{\circ}C$		
Lead Temperature (soldering, 10 sec)		+300	$^{\circ}C$		

^a $V_+ = 18 V$ and $T_A = 25^{\circ}C$ unless otherwise specified.

^bWith device Pins 3, 4, 5, 10, 11, and 12 soldered into a 1/16" epoxy glass board with 2 ounce copper foil with a minimum surface area of 6 square inches.

^cIf oscillation exists under some load conditions, add a 2.7 Ω and 0.1 μF series network from Pin 8 to GND.

^d $C_{BYPASS} = 0.47 \mu F$ from Pin 1 to ground.

^eRejection ratio referred to the output with $C_{BYPASS} = 5 \mu F$.

^fPins 3, 4, 5, 10, 11, and 12 at $25^{\circ}C$, derate $25^{\circ}C/W$ above $25^{\circ}C$ case.

^gFor operating at elevated temperatures, the device must be derated based on a $150^{\circ}C$ maximum junction temperature and a thermal resistance of $187^{\circ}C/W$ junction to ambient.

General Description

The LM380 is a power audio amplifier for consumer applications. Gain is internally fixed at about 34 dB. The output is automatically self-centering to one half the supply voltage but the inputs can be ground referenced. The output is short-circuit proof with internal thermal limiting.

Initial Control Settings

	577
Variable Collector %	0
Collector Supply Polarity	+
Max Peak Volts	6.5
Max Peak Power Watts	.15
Step Family	Single
Step/Offset Ampl	1 V
Step/Offset Polarity	Out
Number of Steps	ccw
Offset Multiplier	9.00
Offset—Zero	Out
Oppose—Aid	In
Pulsed—300 μ s	Out
Step X.1	In
Display Invert—Norm	In
Display Filter—Norm	In
Horiz Volts/Div	5 Collector Volts
X10 Horiz Mag	In
X10 Vert Mag	In

	178
DUT SUPPLIES	Off
LOAD RESISTANCE	100 Ω
SOURCE RESISTANCE	Ext.
+SUPPLY	18.0 V
-SUPPLY	Set to zero
SWEEP AMPLITUDE	ccw
SWEEP FREQUENCY	10 Hz
FUNCTION	Offset Volts
VERT UNITS/DIV	50 mV

DUT Card

Slide Switch Down (out of the NORM position)

See Fig. D-1 for the jumper connections and the discrete circuit components required for the test.

Preliminary

Initial control settings are given in the following text. Do not change these control settings unless so directed by the information under "Control Changes" at the beginning of each step. Turn off the DUT SUPPLIES switch at the end of each step. Turn off the power to the 577 when removing and replacing the dut card.

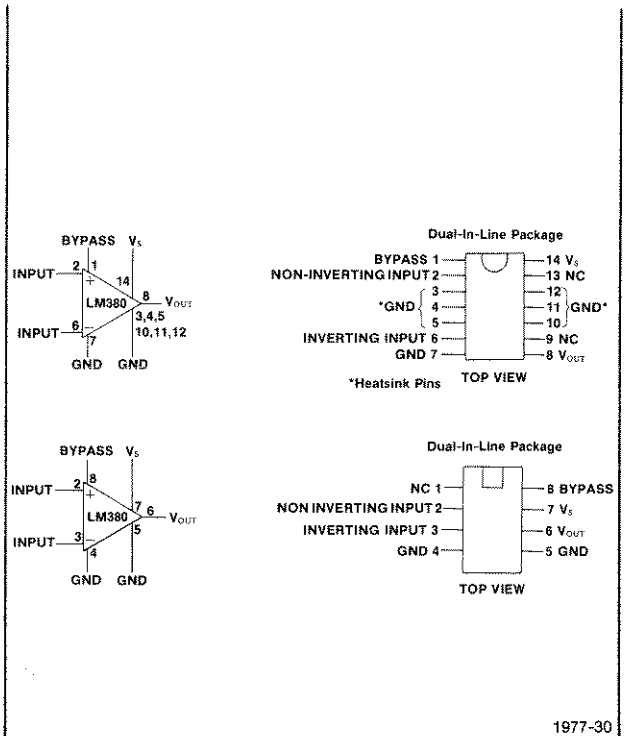
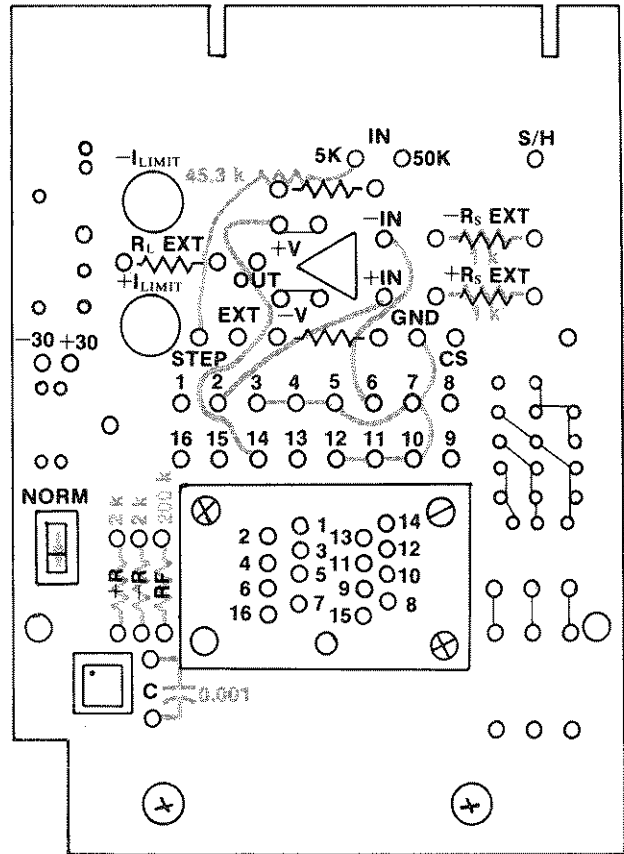

Fig. D-1. LM380 block and connection diagrams.

At the start of each step, turn the DUT SUPPLIES switch on. Press and hold the DISPLAY—ZERO pushbutton while centering the display with the 577 Horizontal and Vertical position controls. This establishes the zero reference point for the test. When the display is centered, release the DISPLAY—ZERO pushbutton. Unless it is desired to store the trace of the previous step, press the 577 Erase pushbutton. Proceed with the test.

TEST PROCEDURE

1. Check Input Offset Voltage

a. With all controls set as given in the initial control settings, establish the zero reference point as listed in the Preliminary Procedure. Turn on the DUT SUPPLIES switch.

b. Turn the Offset Mult control on the 577 to bring the display back to the zero reference line established in the Preliminary Procedure (see Fig. D-2).

c. Check that the Offset Mult dial reads between 8 and 10 volts; the specification sheet calls for 9 ± 1 V.

2. Check Gain

Control Changes:

178

FUNCTION	GAIN
DISPLAY—ZERO	Press
SWEEP AMPLITUDE	Turn clockwise for 5 divisions of vertical deflection.

Calculate the gain by dividing Δ horizontal by Δ vertical. The specified limits are 40 to 60 V/V (see Fig. D-3).

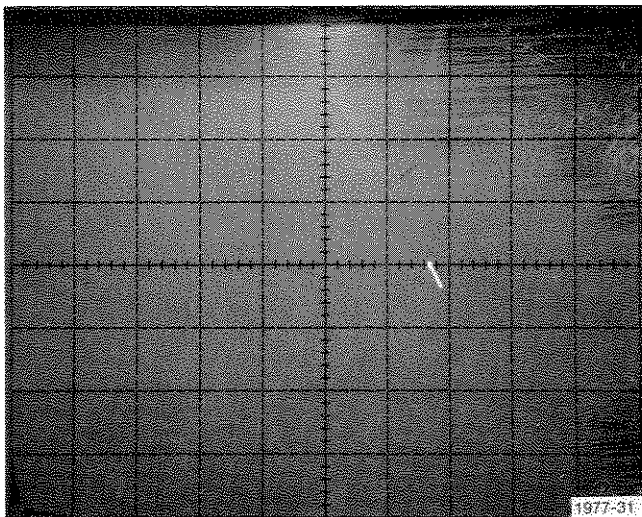

Fig. D-2. Typical input offset voltage display.

3. Check Input Resistance

Control Changes:

178

FUNCTION Switch	+Input I
VERT UNITS/DIV Switch	20 μ A
DISPLAY ZERO	Press
SWEEP AMPLITUDE	1/3 turn from zero

Calculate the input resistance by dividing Δ horizontal by Δ vertical; 150 k Ω is listed as typical (see Fig. D-4).

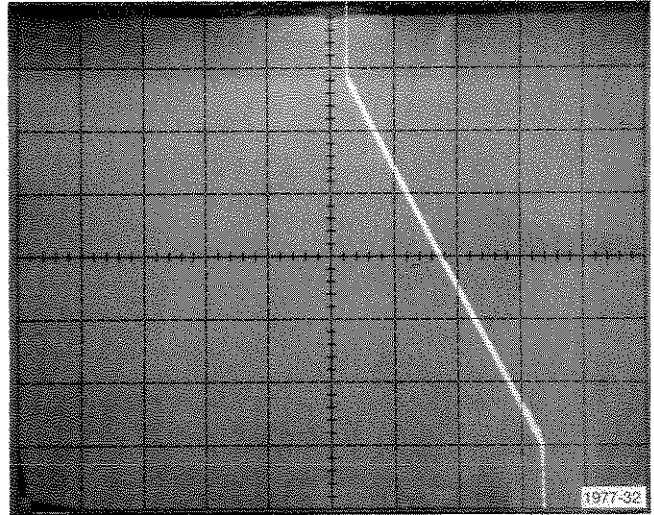

Fig. D-3. Gain curve for the LM380.

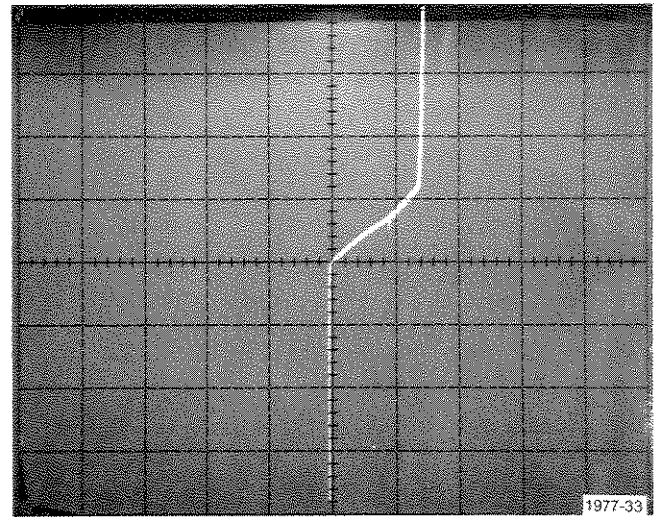

Fig. D-4. Display of the LM380 input resistance.

4. Check Power Supply Rejection Ratio (PSRR)

Control Changes:

178

+SUPPLY	22 V
FUNCTION Switch	+PSRR
VERT UNITS/DIV	50 mV
SWEEP FREQUENCY	1 Hz
DISPLAY ZERO	Press

Calculate PSRR by dividing Δ horizontal by Δ vertical; 38 dB is typical (see Fig. D-5).

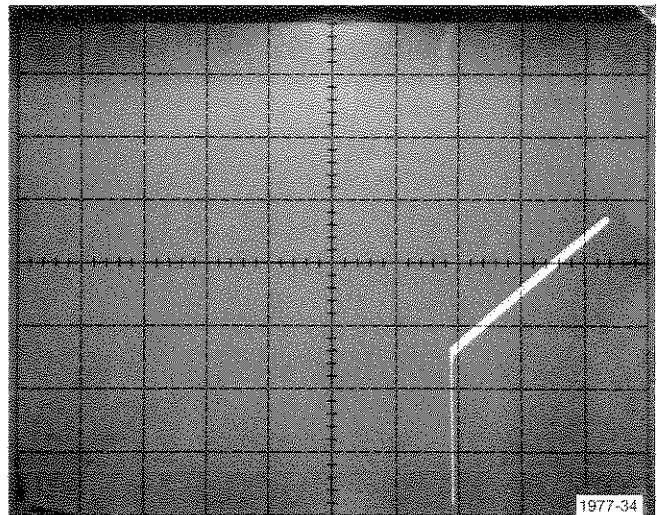

Fig. D-5. Display showing power supply rejection ratio of the LM380.

5. Check Quiescent Supply Current

Control Changes:

178

FUNCTION Switch	+SUPPLY I
SWEEP AMPLITUDE	fully ccw
VERT UNITS/DIV	10 mA
DISPLAY ZERO	Press

a. Note the vertical displacement of the trace from the zero reference point (see Fig. D-6).

b. Calculate the quiescent supply current by multiplying the vertical deflection factor (10 mA) as set by the VERT UNITS/DIV switch times the actual vertical deflection of the trace.

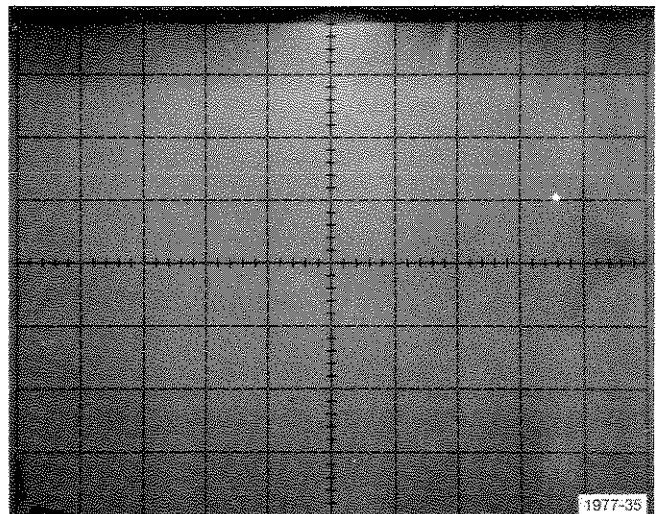

Fig. D-6. Display showing the quiescent supply current of the LM380.

6. Check the Bias Current

Control Changes:

577

Horiz Volts/Div	.1 Collector volts
-----------------	--------------------

178

SWEEP AMPLITUDE	0
FUNCTION Switch	+INPUT I
SWEEP FREQUENCY	10 Hz
VERT UNITS/DIV	.1 mV
DUT SUPPLIES Switch	OFF

a. Press in and hold the DISPLAY—ZERO pushbutton while centering the trace both horizontally and vertically. Release the DISPLAY—ZERO pushbutton.

b. Turn on the DUT SUPPLIES switch and turn the SWEEP AMPLITUDE control clockwise to give 8 divisions of deflection.

c. Set the VERT UNITS/DIV switch to 50 nA. Pull out on the 577 Horizontal Position control to set X10 horizontal magnification.

d. Press the DISPLAY—ZERO pushbutton and again center the display.

e. Turn the SWEEP FREQUENCY switch to .1 Hz and press the 577 Erase switch.

f. Check the bias current by reading the vertical displacement of the trace from the exact center of the graticule (see Fig. D-7). Typical bias current for the LM380 is listed as 100 nA.

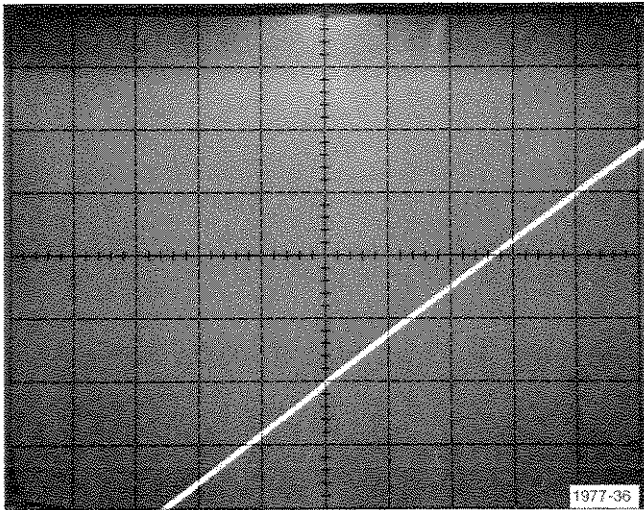

Fig. D-7. Display of the bias current of the LM380.

7. Check Supply Voltage

Control Changes:

577

Horiz Volts/Div	5 V
X10 Horiz Mag	Off (in)
Step Offset Ampl	5 μ A

178

VERT UNITS/DIV	50 mV
SWEEP FREQUENCY	cw—1 Hz
SWEEP AMPLITUDE	ccw
+SUPPLY	22 V
FUNCTION Switch	+PSRR

- Press and release the DISPLAY—ZERO pushbutton.
- Turn the SWEEP AMPLITUDE control clockwise to give a 3-division horizontal shift of the trace.
- Note that the trace sweeps down to 8 volts and up to 22 volts. The specified limits are 8 volts minimum and 22 volts maximum.



Appendix E

TESTING SINGLE SUPPLY QUAD COMPARATORS

ELECTRICAL CHARACTERISTICS^a

Parameter	Conditions	Min	Typ	Max	Units
Input Offset Voltage	At output switch point ($V_O \approx 1.4$ V dc, $V_{REF} = 1.4$ V dc, and $R_S = 0$.)		± 2	± 5	mV dc
Input Bias Current ^b	$I_{IN(+)}$ or $I_{IN(-)}$ with output in linear range		25	250	nA dc
Input Offset Current	$I_{IN(+)}$ or $-I_{IN(-)}$		± 5	± 50	nA dc
Input Common-mode Voltage Range ^c		0		$V+ - 1.5$	V dc
Supply Current	$R_L = \infty$ on all comparators		0.8	2	mA dc
Voltage Gain	$R_L = 15$ k Ω		200		V/mV
Output Sink Current	$V_{IN(-)} = +1$ V dc, $V_{IN(+)} = 0$, and $V_O = +1.5$ V dc	6	16		mA dc
Saturation Voltage	$V_{IN(-)} = +1$ V dc, $V_{IN(+)} = 0$, and $I_{SINK} = 3$ mA		250	400	mV dc
Output Leakage Current	$V_{IN(+)} = +1$ V dc, $V_{IN(-)} = 0$, and $V_{OUT} = 5$ V dc		0.2		mA dc

ABSOLUTE MAXIMUM RATINGS

Supply Voltage ($v+$)	36 V dc
Differential Input Voltage	36 V dc
Output Short-Circuit To GND ^d	continuous

^a $V+ = +5$ V dc and $T_A = +25^\circ$ C unless otherwise noted.

^bThe direction of the input current is out of the IC due to the PNP input stage. This current is essentially constant, independent of the state of the output, so no loading change exists on the reference or input lines.

^cDo not allow the input common-mode voltage or either input signal voltage to go negative by more than 0.3 V. The upper end of the common-mode voltage range is $V+ - 1.5$ V, but either or both inputs can go to +30 V dc without damage.

^dShort circuits from the output to $V+$ can cause excessive heating and eventual destruction. The maximum output current is approximately 20 mA; independent of the magnitude of $V+$.

Appendix E—178 577/D1/D2 Operators

The LM339 and LM2901 are used as the models in the following procedure, but by taking into account slight differences in specifications, the procedure can also be used to test the LM139, LM139A, LM239, LM239A, LM339A, and LM3901.

The foregoing listed comparators consist of four independent voltage comparators in a 14-pin, dual-in-line IC package. They are designed to operate from a single power supply over a wide range of voltages. Their input common mode voltage range includes ground, even though they operate from a single power supply voltage.

Like most comparators, these can easily oscillate if the output lead is inadvertently allowed to capacitively couple to the inputs via stray capacitance. Oscillation shows up when the device under test (dut) is in its linear region, which is where most of the electrical characteristics are checked. When connecting the patch cords to the dut terminal jacks, keep the input patch cords away from the output patch cords. Keeping the input resistance on 50 Ω , to reduce the feedback signal levels, and adding a 0.1 μF capacitor from V+ to the output terminal on the card stops most oscillations. It is usually unnecessary to use a bypass capacitor across the power supplies.

The procedure for adjusting the minus supply must be followed closely, both to prevent destruction of the dut, and to get the required reference voltages. The +input reference voltage is established by connecting the ground terminal (pin 12 on the device, pin 14 of the dut card) to the -supply (V-) on the Op Amp card, and setting the -supply negative by the amount needed for the +input reference voltage. The positive supply (V+) must be reduced by the same amount to keep the proper voltage across the dut.

This procedure is written for a test setup using the Standard Op Amp card; however, if a great many devices must be tested, the use of a Multiple Op Amp card (Tektronix Part No. 013-0155-00) is recommended.

Preliminary

Initial control settings are given in the following text. Do not change these control settings unless so directed by the information under "Control Changes" at the beginning of each step. Turn off the DUT SUPPLIES switch at the end of each step. Turn off the power to the 577 when removing and replacing the Standard Op Amp card (dut card).

At the start of each step, turn the DUT SUPPLIES switch on. Press and hold the DISPLAY—ZERO pushbutton while centering the display with the 577 Horizontal and Vertical position controls. This establishes the zero reference point for the test. When the display is centered, release the DISPLAY—ZERO pushbutton. Unless it is desired to store the trace of the previous step, press the 577 Erase pushbutton. Proceed with the test.

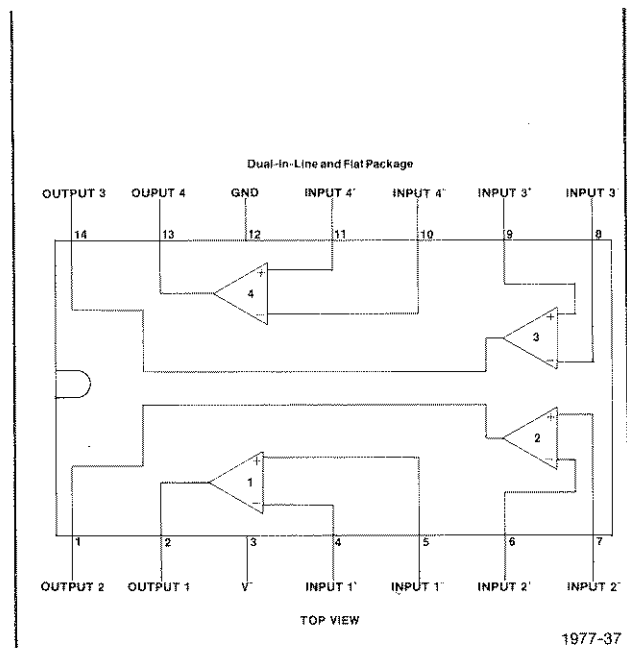
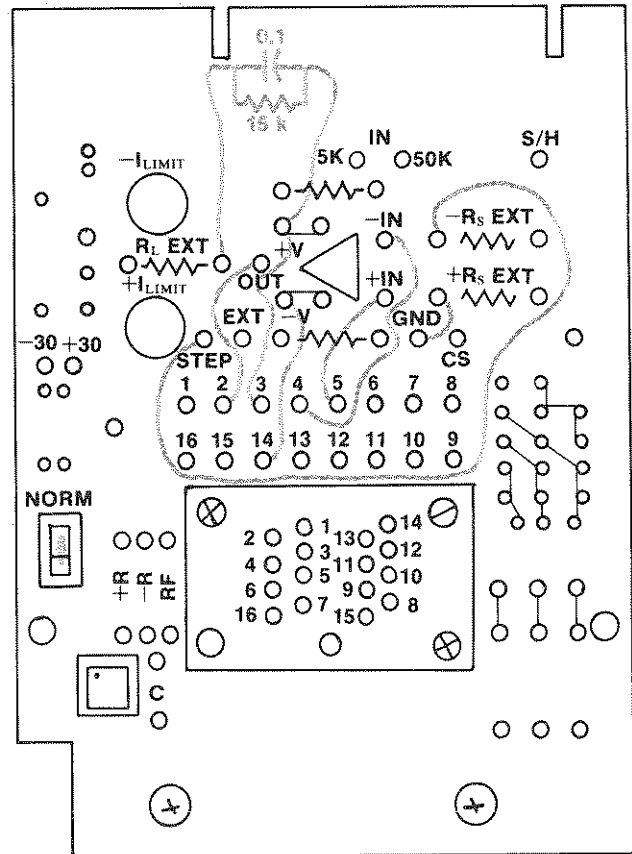

Fig. E-1. Patching the out card for testing the LM339.

Initial Control Settings

577

Variable Collector %	fully ccw
Collector Supply Polarity	+ DC
Step Family	Single
Pulsed 300 μ s	out
Display Invert	in
Display Filter	in
Horiz Volts/Div	.5 collector volts
X10 Horizontal Mag	in
X10 Vertical Mag	in
Max Peak Volts	6.5
Max Peak Power Watts	.15

178

DUT SUPPLIES	OFF
LOAD RESISTANCE	50 k Ω
SOURCE RESISTANCE	50 Ω
+SUPPLY	3.5 V
SWEEP AMPLITUDE	fully ccw
SWEEP FREQUENCY	1.0 Hz
FUNCTION	-SUPPLY
VERT UNITS/DIV	2 mV

DUT Card

Patch for the first comparator section (see Fig. E-1).

NOTE

If a Multiple Op Amp card is available for use, set the Norm switch to Norm and the Amplifier selector switch to 1.

TEST PROCEDURE

1. Check Input Offset Voltage

a. Set the -SUPPLY control to show -1.4 V on the crt (2.8 divisions left from the zero reference point established when the DISPLAY—ZERO pushbutton was pressed).

b. Set the FUNCTION switch to OFFSET V. Turn the SWEEP AMPLITUDE control clockwise not more than one-quarter turn.

c. Check that the right edge of the horizontal trace is ≤ 2.5 divisions vertically from the center reference; i.e., ± 5 mV (see Fig. E-2).

d. Repeat this step for the remaining sections of the device under test (dut).

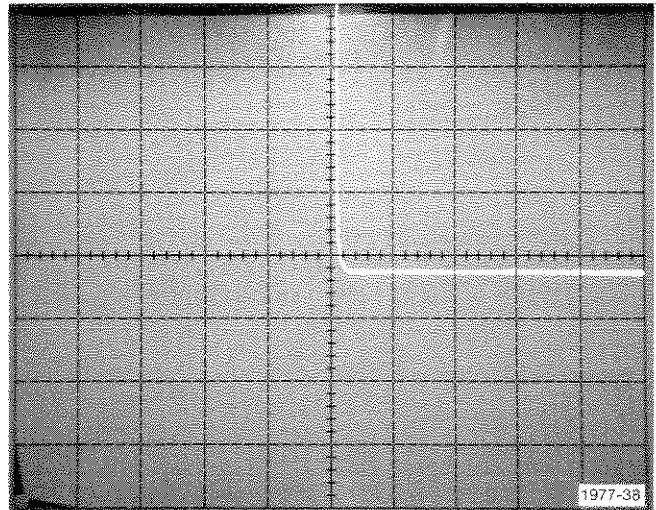

Fig. E-2. Input offset voltage.

2. Check Input Bias Current

Control Changes:

577
 Storage On
 178
 SWEEP FREQUENCY .1 Hz
 FUNCTION +INPUT I
 VERT UNITS/DIV 50 nA

DUT Card

Patch for the first comparator section.

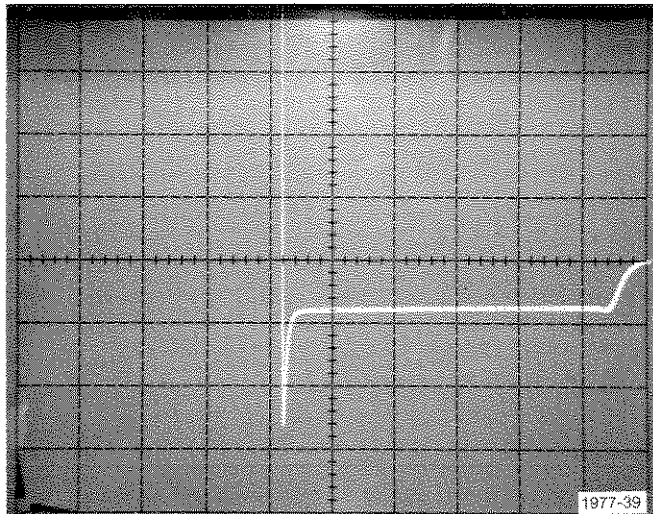

Fig. E-3. + Input bias current.

a. Pull the SWEEP AMPLITUDE control for manual sweep. Turn this control to put the spot at the rightmost graticule line. Push the control back down. Press the 577 Erase button.

b. Check that the horizontal portion of the trace deflects vertically 5 divisions from the display zero reference point; this represents a +Input Bias Current ≤ 250 nA (see Fig. E-3).

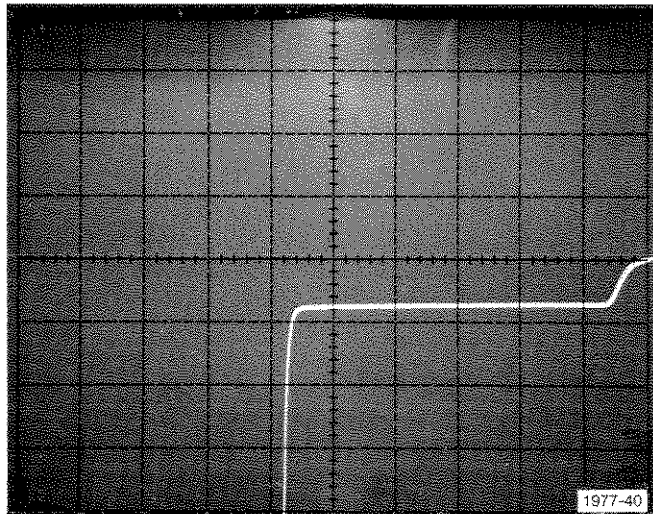

Fig. E-4. - Input bias current.

c. Set the 178 FUNCTION switch to -INPUT I. Press Erase.

d. Check that the display displacement from the zero reference point indicates ≤ 250 nA of -Input Bias Current (see Fig. E-4).

e. Change the VERT UNITS/DIV switch to 20 nA and press Erase. Store the -Input Bias Current trace, then turn the FUNCTION switch to +INPUT I. Store this trace also.

f. Check that the Input Offset Current is ≤ 50 nA dc (one division of display gap minimum, the opening between the +INPUT I and the -INPUT I displays is the Input Offset Current, See Fig. E-5).

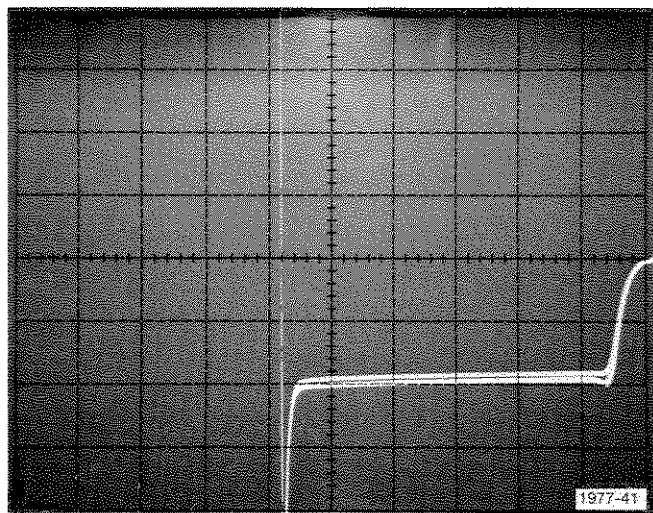

Fig. E-5. + and - input bias current.

g. Repeat this step for the remaining sections of the dut.

3. Check Input Common-mode Voltage Range (CMVR)

Control Changes:

178

SWEEP AMPLITUDE	Fully ccw
FUNCTION	CMRR
VERT UNITS/DIV	50 mV

DUT Card

Patch for the first comparator section.

a. Pull up the SWEEP AMPLITUDE control on the 178 and press the Erase button on the 577.

b. Store the display while slowly turning the SWEEP AMPLITUDE control from full ccw to the point where the spot reaches the display zero reference point.

c. Check that the Input Common-mode Voltage Range crosses a value 1.5 volts less than $V+$ ($V+ = 3.5$ volts for this test). The specified limit is $3.5\text{ V} - 1.5\text{ V}$, or 2 V . The display must be flat at the 2 V point (four divisions right of the display zero reference point, see Fig. E-6).

d. Repeat this step for the remaining sections of the dut.

4. Check Common-mode Rejection Ratio (CMRR)

This characteristic is not given in the device specifications, but can be checked by the same method used for CMVR in Step 3. Increase the vertical sensitivity (typically 0.1 mV) to obtain a slope in the linear range, and set R_L to EXT. Connect a $15\text{ k}\Omega$ resistor and $0.1\text{ }\mu\text{F}$ capacitor from R_L EXT (right terminal socket) to $V+$ as shown in Fig. E-7. The resistor and capacitor are used in Step 5 also.

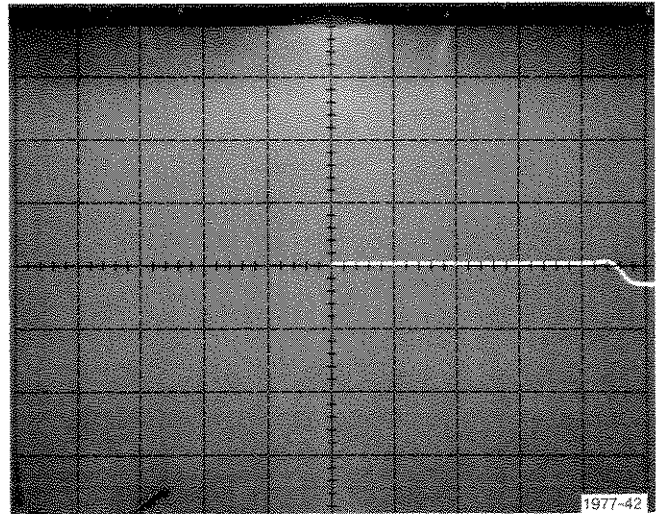

Fig. E-6. Input common-mode voltage range.

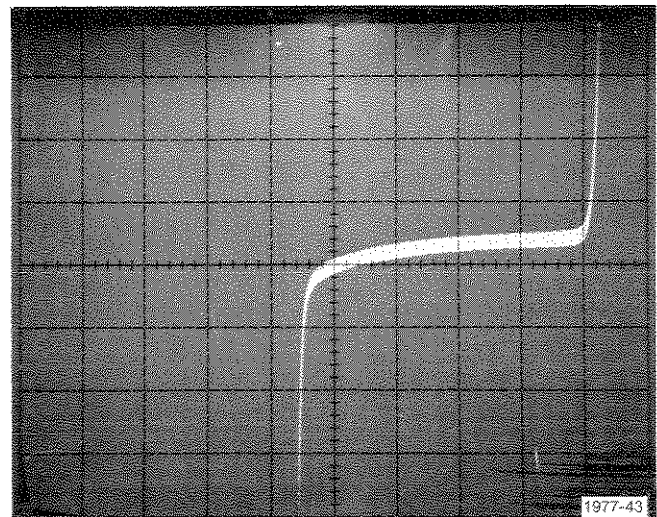

Fig. E-7. Common-mode rejection ratio.

5. Check Voltage Gain

Control Changes:

	178	
DUT SUPPLIES		Off
LOAD RESISTANCE		EXT
SWEEP AMPLITUDE		Fully ccw and pressed down
SWEEP FREQUENCY		10 Hz
FUNCTION		GAIN
VERT UNITS/DIV		20 μ V

DUT Card

Patch for the first comparator section. If Step 4 was not performed, connect a resistor and capacitor as explained in Step 4.

- a. Turn the SWEEP AMPLITUDE control until the sweep reaches the right edge of the crt.
- b. Check the Voltage Gain using the following formula:

$$\text{Gain} = \frac{\text{Output V}}{\text{Input V}} = \frac{\Delta\text{Horizontal}}{\Delta\text{Vertical}}$$

The typical gain given in the specification for this device is 200,000 V/V—see Fig. E-8.

- c. Repeat this step for the remaining comparator sections.

6a. Check +Supply Current

Control Changes:

	577	
Horiz Volts/Div		1 Collector Volt

	178	
LOAD RESISTANCE		50 k Ω
SWEEP AMPLITUDE		Fully ccw
FUNCTION		+SUPPLY I
VERT UNITS/DIV		.5 mA

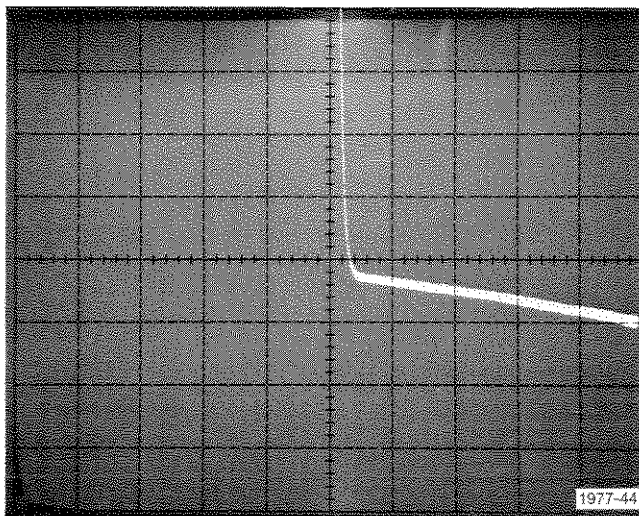

Fig. E-8. Voltage gain.

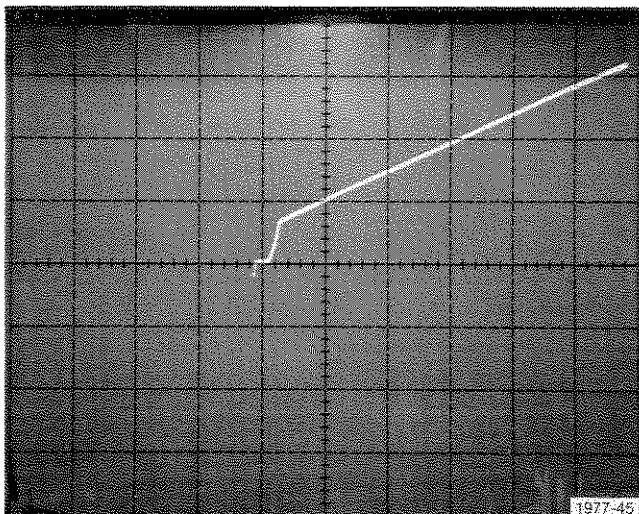

Fig. E-9. + supply current.

DUT Card

Patch for comparator section 1.

- a. Check that the crt display represents a supply current of ≤ 2 mA (≤ 4 vertical divisions from the graticule center, see Fig. E-9).
- b. Repeat this step for the remaining sections of the dut.

6b. Check +Supply Current

This step checks the supply current as graphed under "Typical Performance Characteristics" in the manufacturer's specification sheets.

Control changes:

577

Horiz Volts/Div 5 Collector volts

178

LOAD RESISTANCE 50 kΩ
 +SUPPLY 30 V
 SWEEP FREQUENCY .1 Hz
 FUNCTION +SUPPLY I
 VERT UNITS/DIV .5 mA

- Press and hold in the DISPLAY—ZERO button while positioning the spot on the crt left one division from the graticule center.
- Increase the setting of the SWEEP AMPLITUDE control until the display sweeps from approximately the zero reference to 30 V.
- Check the resulting display (see Fig. E-10) against the manufacturer's specification sheets.
- Repeat this Step for the remaining sections of the dut.

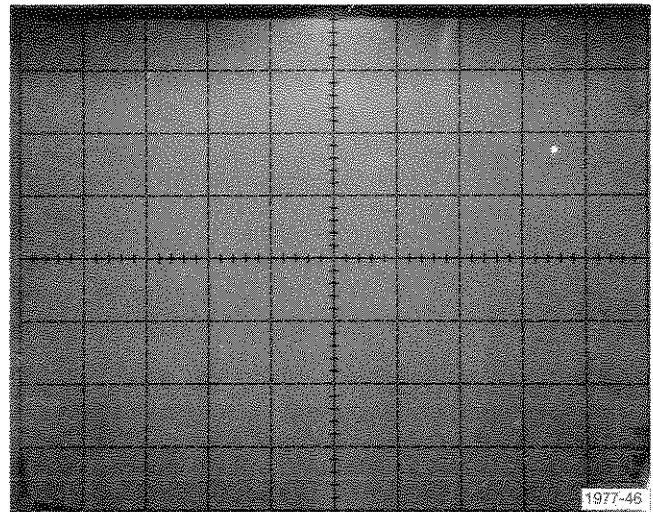

Fig. E-10. Graphing + supply current.

7. Check Output Sink Current

Control Changes:

577

Variable Collector % 0
 Collector Supply Polarity +DC
 Max Peak Power Watts .6
 Series Resistors 500
 Step Family press Single button
 Step/Offset Ampl 1 volt
 Step/Offset Polarity normal
 Offset Mult 1.00
 Offset Zero out
 Offset Aid in
 Pulsed 300 μs out
 Step X.1 in
 Horiz Volts/Div .5 collector volts

178

LOAD RESISTANCE EXT
 SOURCE RESISTANCE EXT
 +SUPPLY set for 5 volts
 FUNCTION COLLECTOR SUPPLY I
 VERT UNITS/DIV 10 mA

DUT Card

Set the - limit control fully clockwise.

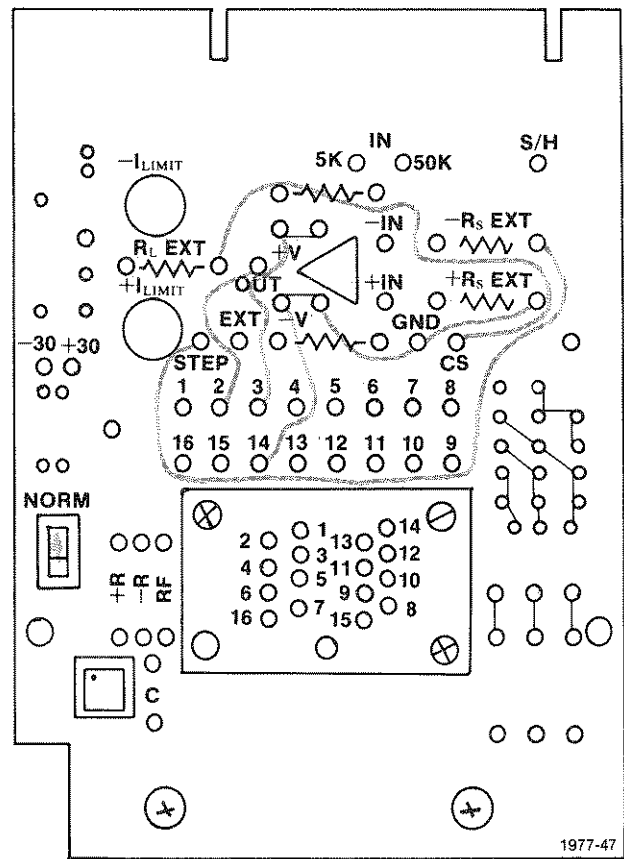

Fig. E-11. Setup for checking output sink current.

Remove the 15 kΩ resistor from the RL EXT terminals.

Connect a jumper from the CS connection to the right terminal jack of the pair labeled RL EXT.

Patch for comparator section 1 in accordance with Fig. E-11.

Appendix E—178 577/D1/D2 Operators

a. Increase the Variable Collector % setting until the display shows 1.5 volts (three divisions to the right of the display zero reference).

b. Check the Output Sink Current, represented by the vertical deflection from the display zero reference (see Fig. E-12). The specification sheet lists 16 mA as being typical for Output Sink Current.

NOTE

If the Variable Collector % control setting is increased to 5 volts, the short circuit current (to V+) can be checked (see Fig. E-13). The deflection factor is changed to 1 V/div for this test; see "Absolute Maximum Ratings" given in the Electrical Characteristics table for this device.

c. Repeat this test for the remaining sections of the dut.

8. Check Saturation Voltage

Control Changes:

577

Storage	erase
Variable Collector %	fully ccw
Horiz Volts/Div	.1 collector volts

178

VERT UNITS/DIV	1 mA
----------------	------

DUT Card

Patch for comparator section 1.

a. Increase the setting of the Variable Collector % until the display shows 3 divisions of vertical deflection from the display zero reference point.

b. Check the Saturation Voltage as represented by the crt display. The display should show ≤ 4 horizontal divisions from the display zero reference point (see Fig. E-14).

c. Repeat this step for the remaining sections of the dut.

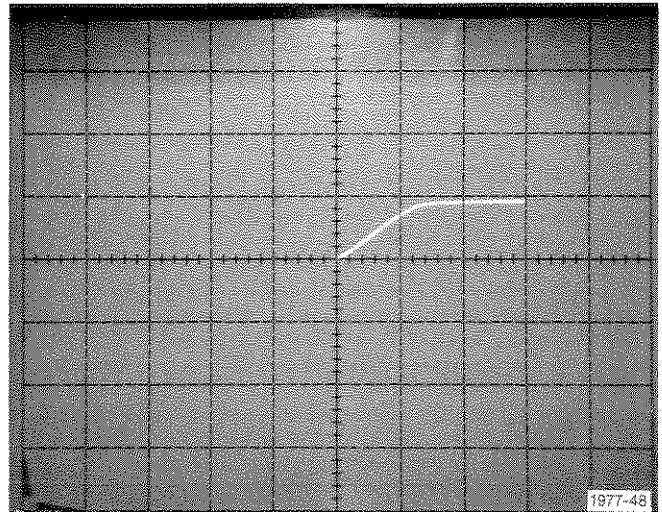

Fig. E-12. Output sink current.

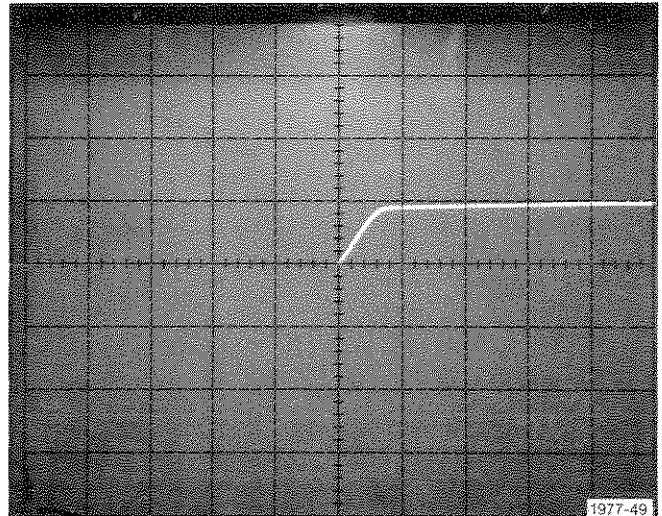

Fig. E-13. Short circuit current.

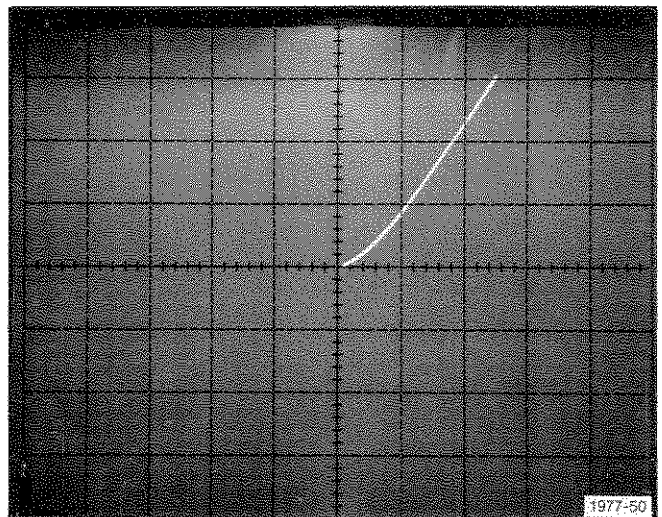

Fig. E-14. Saturation voltage.

9. Check Output Leakage Current

Control Changes:

577
 Variable Collector % fully ccw
 Display Filter out
 Horiz Volts/Div 1 collector volt

178
 DUT SUPPLIES OFF
 VERT UNITS/DIV 50 pA

DUT Card

Patch for the first comparator section. Connect the STEP connector to the left +R_s EXT terminal. Connect GND to the left -R_s EXT terminal. Remove the patch cord from the output (pin 2 for the first section) of the comparator section under test. Connect the CS terminal to the comparator output connector (see Fig. E-15). Remove the dut from the socket.

- a. Set the DUT SUPPLIES switch to ON.
- b. Increase the setting of the Variable Collector % control on the 577 to 5 volts.
- c. Press Erase, then set the reference by turning the 577 Position controls to position the spot to graticule center.
- d. Set the DUT SUPPLIES switch to OFF.
- e. Put the dut back in the socket and set the DUT SUPPLIES switch to ON.
- f. Check the Output Leakage Current as represented by the amount of vertical trace shift from the reference point established in part c above. Typical leakage current is 0.1 nA dc (see Fig. E-16).
- g. Repeat this step for the remaining sections of the dut.

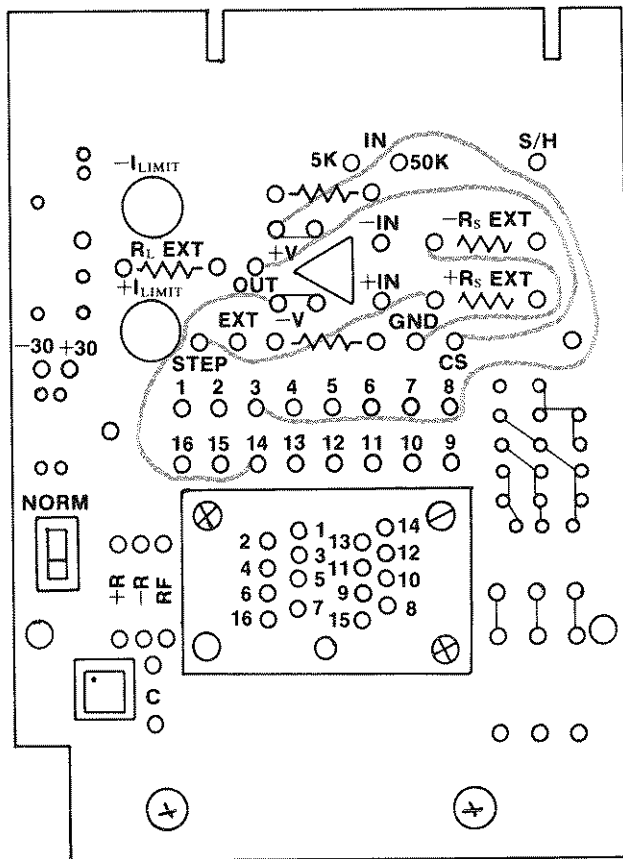

1977-51

Fig. E-15. Patching for checking output leakage current.

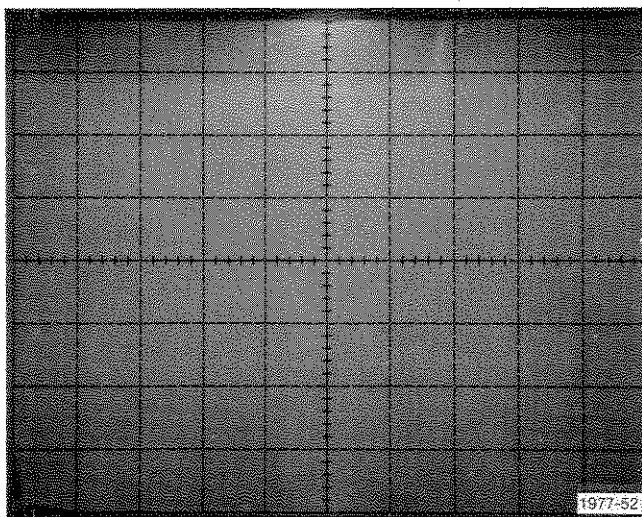

Fig. E-16. Output leakage current.

Appendix F

TESTING QUAD COMPARATORS— MC3302P

ELECTRICAL CHARACTERISTICS^a

Characteristic	Conditions	Min	Typ	Max	Units
Input Offset Voltage (V_{IO})	$V_{ref} = 1.2$ V dc		3.0	20 ^a	mV dc
				40 ^b	mV dc
Input Bias Current (I_{IB})			30	500 ^a 1000 ^b	
Input Offset Current (I_{IO})			3.0		nA dc
Input Common-mode Voltage Range (V_{ICR})	$V+ = +18$ V dc	0		+26	V dc
Supply Current (I_{CC})	Total of four Comparators ($I_S = 0$, $V+ = +5.0$ to $+28$ V dc)		0.7	1.5	mA dc
Voltage Gain (A_{VOL})	$R_L = 15$ k Ω	2,000	30,000		V/V
Output Sink Current (I_{SINK})	$V+ = +5$ V dc $V_{OL} = 400$ mV		6 ^a		mA dc
Input Differential Voltage Range (V_{IDR})	$V_{OL} 800$ mV	$2^b \pm V+$			mA dc
Output Leakage Current (I_{OL})	Output Voltage High			1.0	μ A dc
Output Voltage Low Logic State (V_{OL})	$I_S = 2.0$ mA, $V+ = +5$ to $+28$ V dc		150	400	mV dc

ABSOLUTE MAXIMUM RATINGS

Supply Voltage ($V+$)		+28	V dc
Output Sink Current ^c		20	mA
Differential Input Voltage		$\pm V+$	
Common-mode Input ^d Voltage Range		-0.3	$+V+$ V dc

^a $T_A = 25^\circ\text{C}$ unless otherwise noted.

^b T_A range from -40 to $+85^\circ\text{C}$.

^cRequires an external resistor, (R_L) to limit current to less than maximum rating.

^dIf either (+) or (-) input of any comparator goes more than several tenths of a volt below ground, a parasitic transistor turns "on", causing high current and possibly faulty outputs.

Description

The MC3302P devices consist of four independent voltage comparators. They operate from a single power supply over a wide range of voltages. These comparators also have the characteristics that the input common-mode voltage range includes ground, even though it operates from a single power supply voltage.

Preliminary

Initial control settings are given in the following text. Do not change these control settings unless so directed by the information under "Control Changes" at the beginning of each step. Turn off the DUT SUPPLIES switch at the end of each step. Turn off the power to the 577 when removing and replacing the Standard Op Amp card (dut card).

At the start of each step, turn the DUT SUPPLIES switch on. Press and hold the DISPLAY—ZERO pushbutton while centering the display with the 577 Horizontal and Vertical position controls. This establishes the zero reference point for the test. When the display is centered, release the DISPLAY—ZERO pushbutton. Unless it is desired to store the trace of the previous step, press the 577 Erase pushbutton. Proceed with the test.

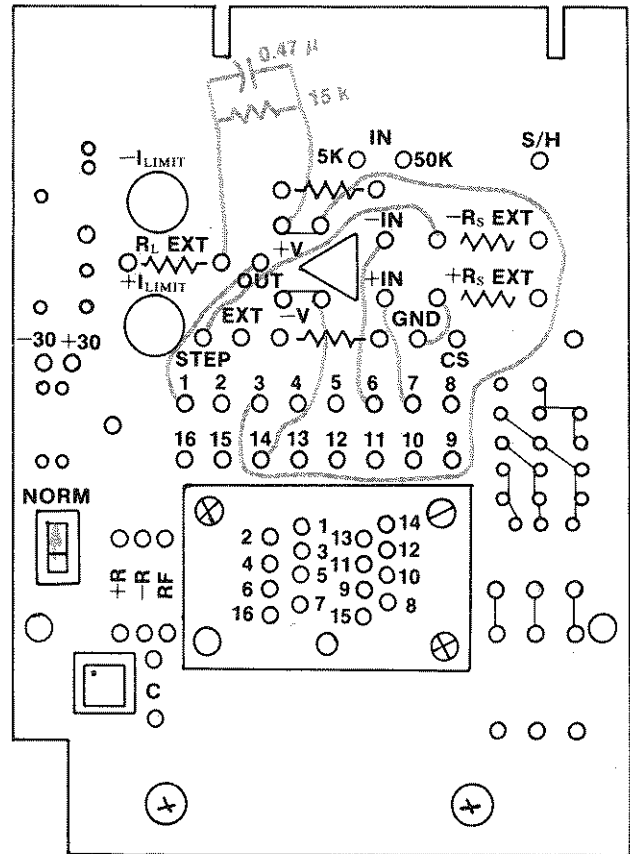

Control Settings

577

Variable Collector %	fully ccw
Collector Polarity	+ dc
Step Family	single
Pulsed 300 μs	out
Display Invert	in
Display Filter	in
Offset Polarity	in
Offset Zero	out
Step/Offset Ampl	1 volt
Aid button	in
Horiz Volts/Div	1.0 collector volt
X10 Horiz Mag	in
X10 Vert Mag	in
Max Peak Volts	6.5
Max Peak Power Watts	.15

178

DUT SUPPLIES	OFF
+SUPPLY	13.8 volts
LOAD RESISTANCE	50 kΩ
SOURCE RESISTANCE	50 Ω
SWEEP AMPLITUDE	fully ccw
SWEEP FREQUENCY	1.0 Hz
FUNCTION	—SUPPLY
VERT UNITS/DIV	5 mV

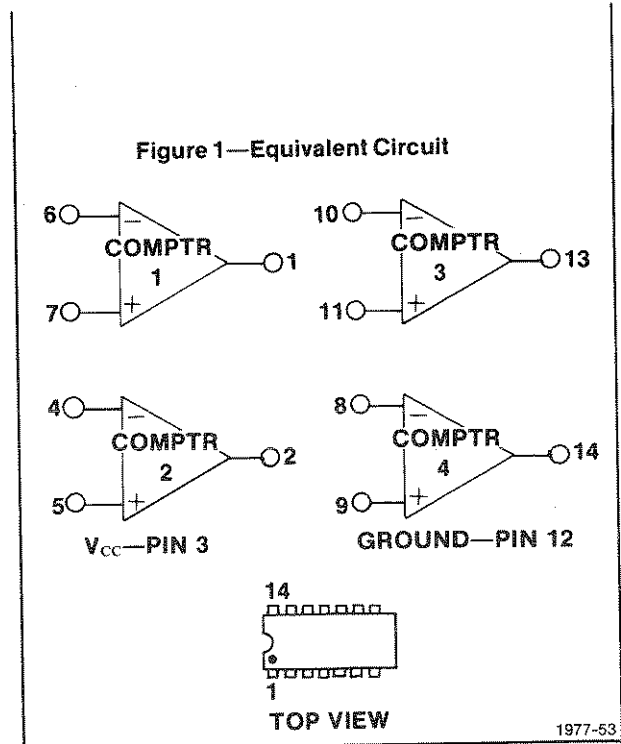

Fig. F-1. Patching the Standard Op Amp Card to test the MC3302P.

DUT Card

NORM Switch NORM

Patch the card for the first comparator section of the dut as shown in Fig. F-1.

TEST PROCEDURE

1. Check Input Offset Voltage

a. Set the -SUPPLY control to give 1.2 divisions left deflection (1.2 V) from the display zero reference point previously established as described under the "Preliminary" heading.

b. Set the FUNCTION switch to OFFSET V and turn the DUT SUPPLIES switch to ON. Turn the SWEEP AMPLITUDE control clockwise not more than 1/4 turn.

c. Check that the right edge of the horizontal trace is less than 4 vertical divisions (± 20 mV) from the display zero reference (see Fig. F-2).

d. Patch the Standard Op Amp card (dut card) for the next comparator section and repeat this test for the remaining sections of the dut.

2. Check Input Bias Current

Control Changes:

577

Storage on

178

SWEEP AMPLITUDE 0
 SWEEP FREQUENCY 10 Hz
 FUNCTION +INPUT I
 VERT UNITS/DIV 0.2 μ A
 LOAD RESISTANCE EXT
 -SUPPLY Control leave it at
 the setting
 obtained in
 Step 1.

DUT Card

Patch for the first comparator section.

a. Set the SWEEP AMPLITUDE control to give approximately 6 divisions of sweep on the crt, then set the SWEEP FREQUENCY control to .1 Hz. Press the Storage Erase pushbutton.

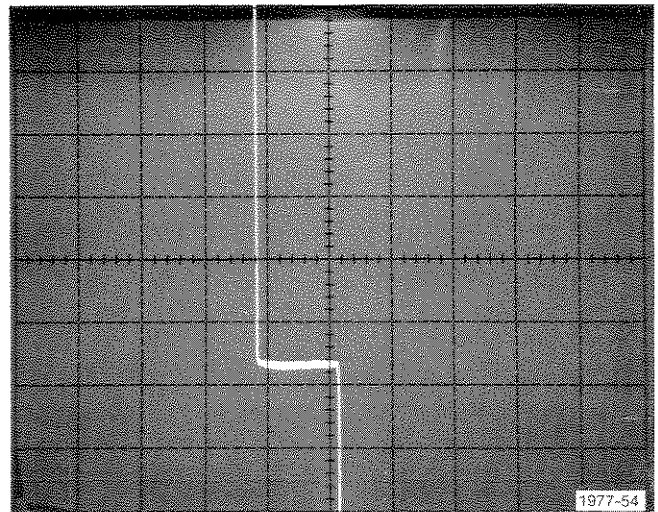

Fig. F-2. Typical display of input offset voltage.

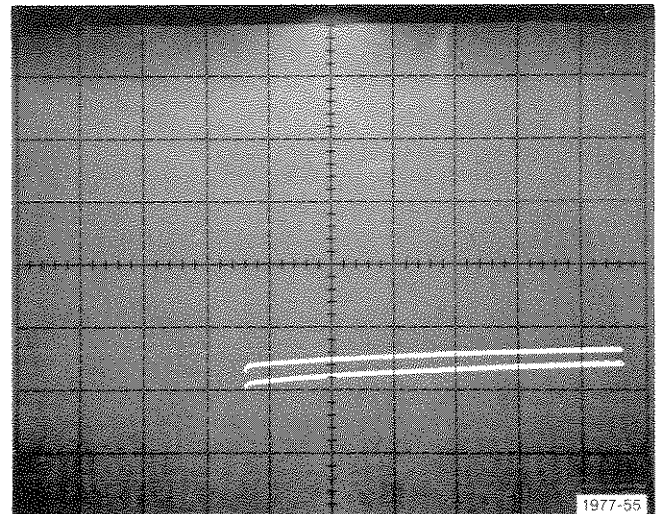

Fig. F-3. Typical display of input bias current.

b. Check the display to see that the +Input Bias Current is ≤ 500 nA (≤ 2.5 divisions of vertical deflection from the display zero reference point, see Fig. F-3).

c. Set the 178 FUNCTION switch to -INPUT I.

d. Check the display to see that the -Input Bias Current is ≤ 500 nA (≤ 2.5 divisions of vertical deflection from the display zero reference).

e. Repeat this step for the remaining sections of the dut.

3. Check Input Common-mode Voltage Range (CMVR)

Control Changes:

577

Horizontal Volts/Div 10 collector volts
 Variable Collector % 0

178

LOAD RESISTANCE 50 kΩ
 +SUPPLY 26.8 V
 SWEEP AMPLITUDE fully ccw
 FUNCTION CMRR
 VERT UNITS/DIV 50 mV
 -SUPPLY leave it at the setting obtained in Step 1.

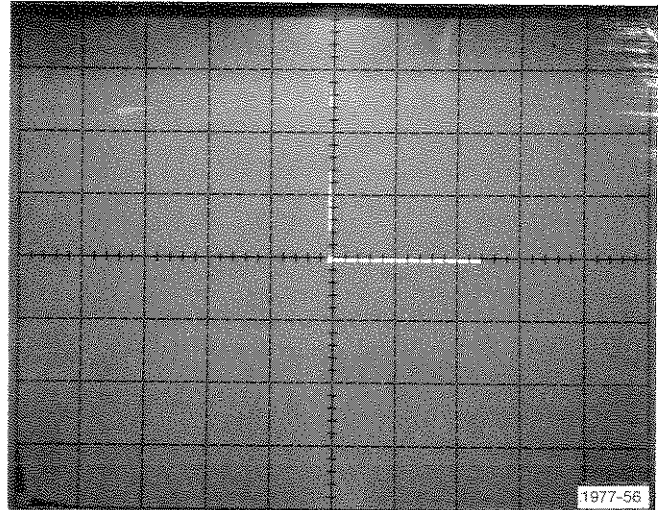

Fig. F-4. Typical display of common-mode voltage range.

DUT Card

Patch for the first comparator section.

a. Pull the SWEEP AMPLITUDE control outward to switch it to manual sweep. Check that the DUT SUPPLIES switch is on. Press the Storage Erase button on the 577.

b. Store the display while slowly turning the SWEEP AMPLITUDE control from fully ccw to fully cw.

c. Since the specified CMVR for this device is 2 volts less than V+, check that the limit of CMVR is 24.8 volts in accordance with Fig. F-4 in the following text. The display must still be flat at 24.8 volts (2.48 divisions to the right of the display zero reference point).

d. Repeat the foregoing procedure for the remaining sections of the dut. Remember that the DISPLAY—ZERO pushbutton must be pressed and the display zero reference re-established at the start of each test.

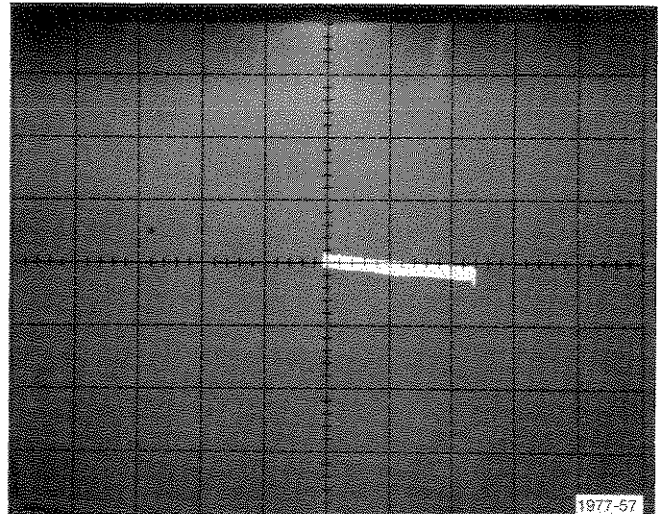

Fig. F-5. Typical display of common-mode rejection ratio.

b. Connect a 15 kΩ resistor and 0.1 μF capacitor from the right R_LEXT terminal socket to the V+ socket.

4. Check Common-mode Rejection Ratio (CMRR)

This can be checked by using the same setup and methods listed in Step 3 by modifying the procedure as follows:

a. Increase the vertical sensitivity (e.g., to 2 mV) to obtain a slope in the linear range. Set the LOAD RESISTANCE switch to EXT.

$$\begin{aligned} \text{CMRR} &= \frac{\Delta \text{differential input voltage}}{\Delta \text{common-mode input voltage}} \\ &= \frac{\Delta \text{vertical signal}}{\Delta \text{horizontal signal}} \end{aligned}$$

(from the 178, see Fig. F-5).

5. Check Voltage Gain

Control Changes:

	577
Horiz Volts/Div	5 collector volts
	178
DUT SUPPLIES	OFF
LOAD RESISTANCE	EXT
SWEEP AMPLITUDE	fully ccw and pressed down
SWEEP FREQUENCY	.1 Hz
FUNCTION	GAIN
VERT UNITS/DIV	.1 mV
+SUPPLY	13.8 V

DUT Card

Patch for the first comparator section.

a. Set the DUT SUPPLIES switch to ON. Press the Storage Erase button on the 577, then press the DISPLAY—ZERO pushbutton on the 178.

b. Turn the SWEEP AMPLITUDE control slowly clockwise until the sweep provides a usable measurement area (see Fig. F-6).

c. Calculate the voltage gain as follows:

$$\text{Gain} = \frac{\text{Output V}}{\text{Input V}} = \frac{\Delta\text{Horizontal}}{\Delta\text{Vertical}}$$

(from the 178).

d. Repeat the foregoing test for the remaining sections of the dut. Remember to press the DISPLAY—ZERO button at the start of each test.

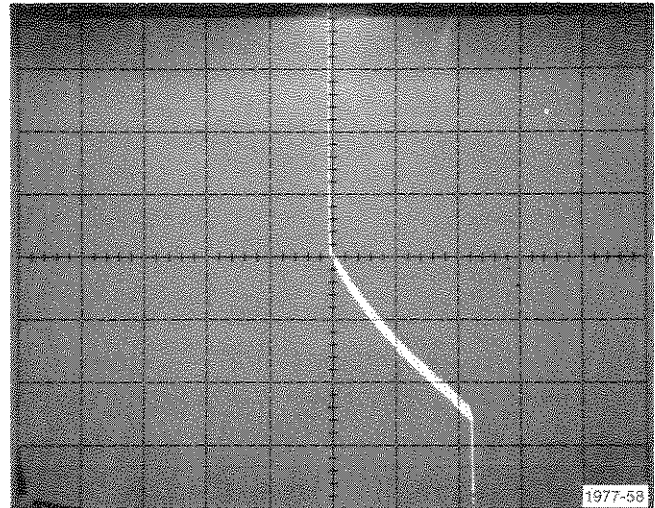

Fig. F-6. Typical display of voltage gain of MC3302P.

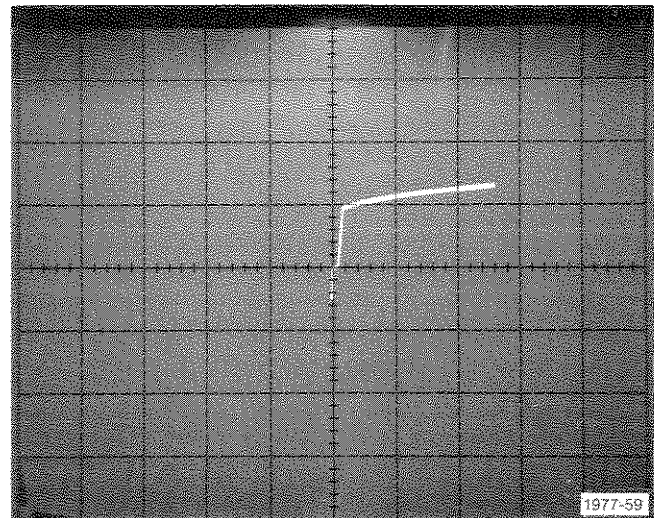

Fig. F-7. Display of MC3302P supply current.

6. Check + Supply Current

Control Changes:

	577
Horiz Volts/Div	10 collector volts
	178
LOAD RESISTANCE	50 kΩ
SWEEP AMPLITUDE	fully ccw
FUNCTION	+SUPPLY I
VERT UNITS/DIV	.5 mA
+SUPPLY	26.8 V

DUT Card

Patch for the first comparator section.

a. Check that the displayed Supply Current is 1.5 mA (+3 divisions or less above the display zero reference, see Fig. F-7).

b. Repeat the check for the remaining sections of the dut.

7. Check Output Sink Current

Control Changes:

577	
Max Peak Volts	25
Max Peak Power Watts	.6
Horiz Volts/Div	0.2 collector volts

178	
LOAD RESISTANCE	EXT
SOURCE RESISTANCE	EXT
+SUPPLY	5 V
SWEEP AMPLITUDE	fully ccw
FUNCTION	COLLECTOR SUPPLY I
VERT UNITS/DIV	5 mA
-SUPPLY	0

DUT Card

-Limit cw

Patch the card for the first comparator section.

a. Remove the 15 kΩ resistor from the R_LEXT jacks. Connect a jumper from the CS jack to the right-hand R_LEXT jack. Connect V- (pin 12 of the device, pin 14 of the socket) to GND (see Fig. F-8).

b. Establish the zero reference point and erase the display.

c. Increase the Variable Collector % control setting until 0.4 volt is reached (2 divisions to the right of the zero reference point established in part b above, see Fig. F-9).

d. Check the Output Sink Current, as represented by the vertical deflection from the display zero reference.

e. Repeat this check for the remaining sections of the dut.

8. Check Saturation Voltage

Control Changes:

577	
Storage	Erase
Variable Collector %	fully ccw
Horiz Volts/Div	.1 collector volts

178	
VERT UNITS/DIV	1 mA

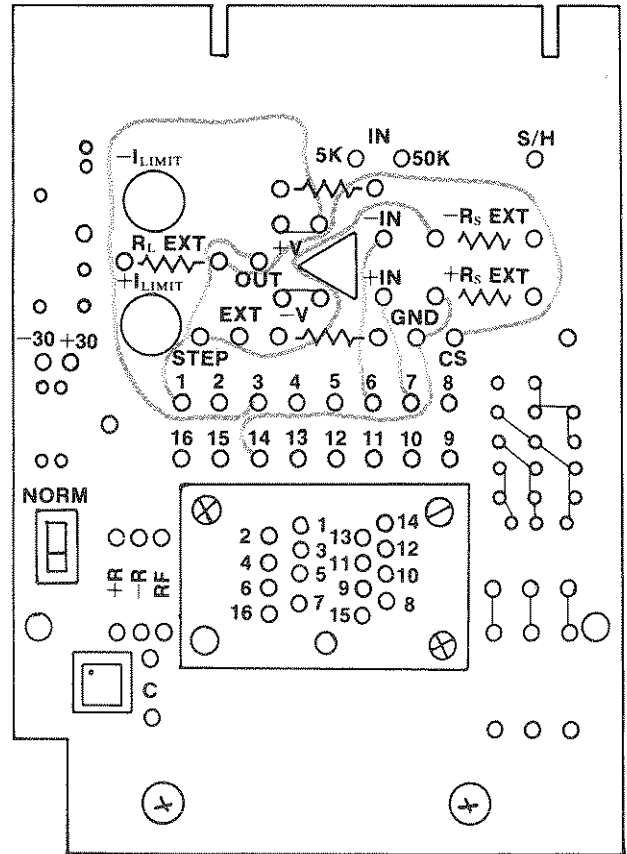

1977-60

Fig. F-8. Patching the Standard Op Amp Card for the output sink current test.

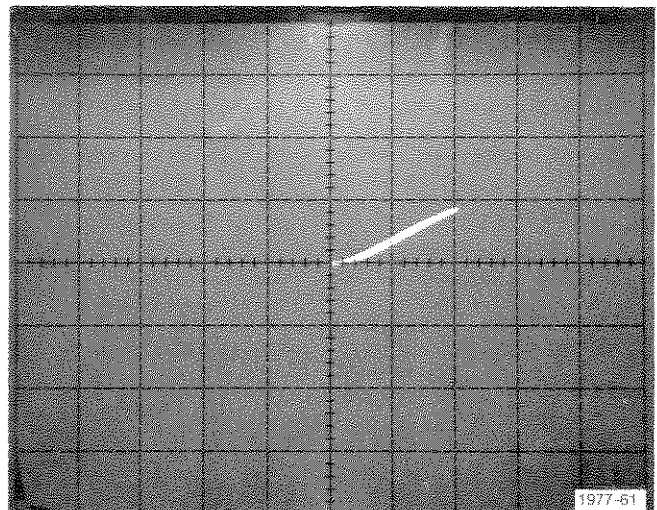

Fig. F-9. Typical output sink current display.

DUT Card

Patch for first comparator section.

- a. Increase the setting of the Variable Collector % control to shift the display 2 divisions (2 mA) vertically from the zero reference point.
- b. Press and hold the DISPLAY—ZERO pushbutton while positioning the spot to graticule center.
- c. Check that the horizontal deflection of the display (representing saturation voltage) is ≤ 4 divisions from the zero reference point established in part a above (see Fig. F-10).
- d. Repeat this step for the remaining sections of the dut.

9. Check Output Leakage Current

Control Changes:

577

Variable Collector %	fully ccw
Display Filter	out
Horiz Volts/Div	1 collector volt

178

DUT SUPPLIES	OFF
VERT UNITS/DIV	50 mV

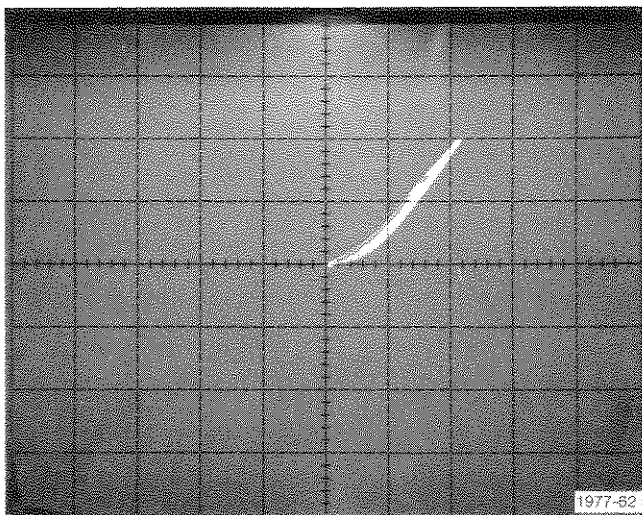

Fig. F-10. Display of saturation voltage.

DUT Card

Patch for the first comparator section.

- a. Connect the Step jack to the left-hand +R_sEXT jack. Connect the left -R_sEXT jack to GND.
- b. Remove the patch cord from the output of the comparator section under test. Connect the CS jack to the output of the comparator. Remove the dut from the test socket.
- c. Set the DUT SUPPLIES switch to ON.
- d. Increase the Variable Collector % to 5 V (5 horizontal divisions).
- e. Set the zero reference point as in previous steps.
- f. Set the DUT SUPPLIES switch to OFF.
- g. Put the dut back in the socket and set the DUT SUPPLIES switch to ON.
- h. Set the VERT UNITS/DIV switch to 50 pA and check the output leakage current (the amount of vertical shift from the display zero reference established in part e). The specified limit for the MC3302P is 1 μ A maximum—see Fig. F-11.
- i. Repeat the foregoing procedure for the remaining comparator sections of the dut.

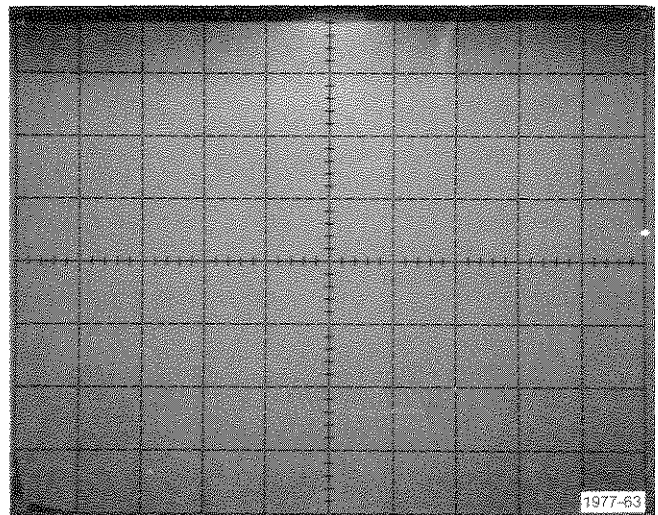

Fig. F-11. Display of output leakage current check.

Appendix G

TESTING THE 741 OPERATIONAL AMPLIFIER

741C ELECTRICAL CHARACTERISTICS
($V_s \pm 15\text{ V}$, $T_A 25^\circ\text{C}$ unless otherwise specified)

Parameter	Min	Typ	Max	Units	Test Conditions
Input Offset Voltage		2.0	6.0	mV	$R_s \leq 10\text{ k}\Omega$
Input Offset Current		20	200	nA	
Input Bias Current		80	500	nA	
Input Resistance	0.3	2.0		$M\Omega$	
Offset Voltage Adjustment Range		± 15		mV	
Input Voltage Range	± 12	± 13		V	
Common Mode Rejection Ratio	70	90		dB	$R_s \leq 10\text{ k}\Omega$
Supply Voltage Rejection Ratio		10	150	$\mu\text{V/V}$	$R_s \leq 10\text{ k}\Omega$
Large-Signal Voltage Gain	20,000	200,000			$R_L \geq 2\text{ k}\Omega$, $V_{\text{OUT}} \pm 10\text{ V}$
Output Voltage	± 12 ± 10	± 14 ± 13		V V	$R_L \geq 10\text{ k}\Omega$ $R_L \geq -\Omega$
Common Mode Input Resistance		No Spec.			
Supply Current		1.7 nA	2.8	mA	
Output Short Circuit Current		25		mA	

The 741 is an operational amplifier constructed on a single silicon chip. It is intended for a wide range of analog operations. High common mode voltage range and absence of latch-up tendencies make it well suited for use as a voltage follower. The high gain and wide range of operating voltages make it useful in integrator, summing amplifier, and general feedback applications. The 741 is short-circuit protected and external components for frequency compensation are usually unnecessary.

Preliminary

Initial control settings are given in the following text. Do not change these control settings unless so directed by

the information under "Control Changes" at the beginning of each step. Turn off the DUT SUPPLIES switch at the end of each step. Turn off the power to the 577 when removing and replacing the Standard Op Amp card (dut card).

At the start of each step, turn the DUT SUPPLIES switch on. Press and hold the DISPLAY—ZERO pushbutton while centering the display with the 577 Horizontal and Vertical position controls. This establishes the zero reference point for the test. When the display is centered, release the DISPLAY—ZERO pushbutton. Unless it is desired to store the trace of the previous step, press the 577 Erase pushbutton. Proceed with the test.

Initial Control Settings

577

Variable Collector %	0
Collector Polarity	+
Max Peak Volts	6.5 V
Max Peak Power Watts	.15
Step Family	Single
Step Rate	Norm
Step/Offset Ampl	1 V
Step Offset Polarity	in
Number of Steps	1
Offset Mult	0.0
Offset Zero	in
Offset Aid	in
Pulsed 300 μ s	out
Step X.1	in
Display Invert	in
Display Filter	in
Horiz Volts/Div	5 collector volts
X10 Horiz Mag	off
X10 Vert Mag	off
Horiz Pos	centered
Vert Pos	centered

178

DUT SUPPLIES	OFF
LOAD RESISTANCE	2 k Ω
SOURCE RESISTANCE	10 k Ω
+SUPPLY	15 V
-SUPPLY	15 V (TRACK +SUPPLY)
SWEEP AMPLITUDE	fully ccw
SWEEP FREQUENCY	.1 Hz
DISPLAY ZERO	press and release
FUNCTION	OFFSET V
VERT UNITS/DIV	2 mV

Standard Op Amp Card (DUT Card)

External Feedback Amplifier	
switch	Norm
+Current Limit	ccw
-Current Limit	ccw

Patch for the 741 op amp, see Fig. G-1.

Install an AMPHENOL—BARNES 16-pin DIP adapter socket into the DUT Card. Install the eight-pin type 741C Op Amp into the upper half of the adapter socket.

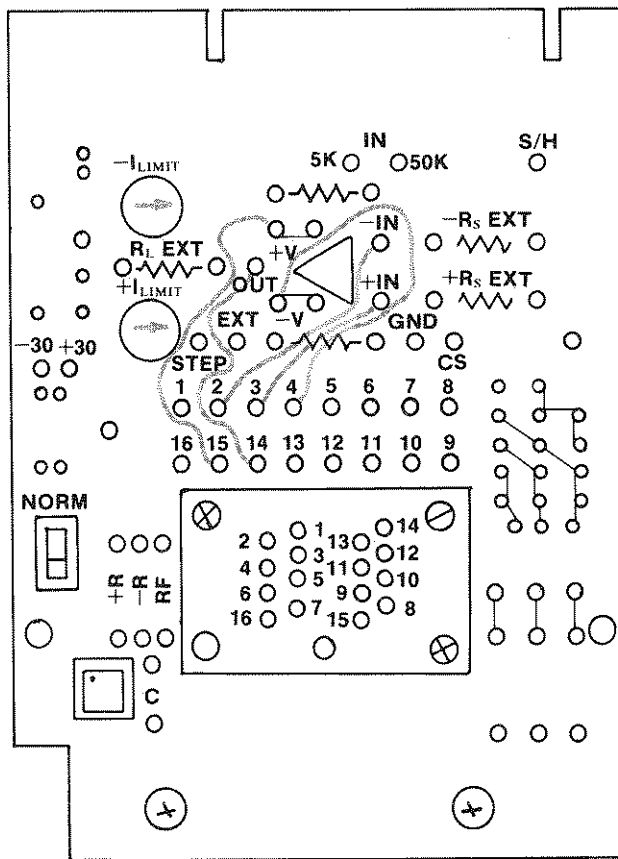

1977-64

Fig. G-1. Setting up the Standard Op Amp Card for testing the 741. See manufacturer's data sheets for basing.

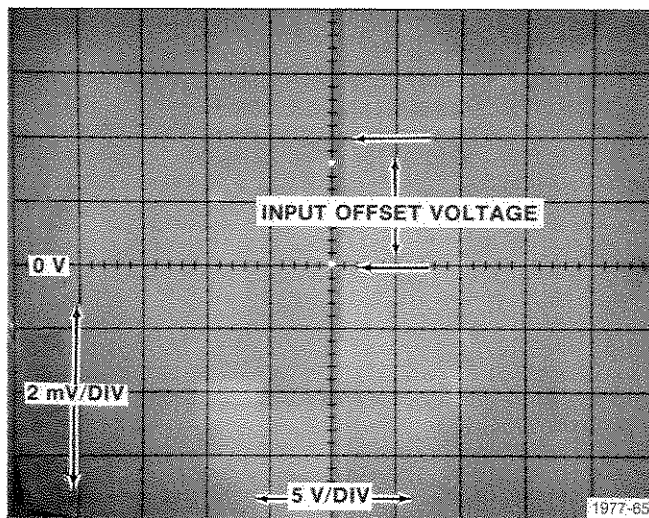

1977-65

Fig. G-2. Typical display of input offset voltage.

TEST PROCEDURE

1. Check Input Offset Voltage

a. Turn on the DUT SUPPLIES switch. Press and hold the DISPLAY—ZERO pushbutton while centering the display with the 577 Horiz and Vert position controls. With the zero reference point thus established, release the DISPLAY—ZERO pushbutton.

b. Check that the vertical display is 6 mV (± 3 divisions) from the display zero reference (see Fig. G-2).

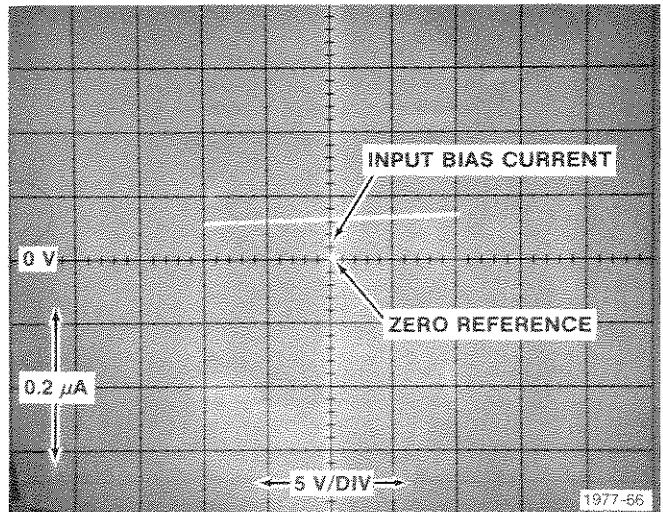

Fig. G-3. Typical display of input bias current.

2. Check Input Bias Current

Control Changes:

	577
Erase/Store	Store
	178
SOURCE RESISTANCE	50 Ω
FUNCTION	+INPUT I
VERT UNITS/DIV	.2 μA
SWEEP AMPLITUDE	Adjust clockwise for 4 divisions of horizontal deflection.

a. Establish the zero reference point as previously described.

b. Check that the vertical deflection of the trace is ≤ 2.5 divisions from vertical center at the horizontal center (see Fig. G-3). Reset the VERT UNITS/DIV switch if better resolution is needed.

c. Change the FUNCTION switch to -INPUT I and repeat parts a and b above.

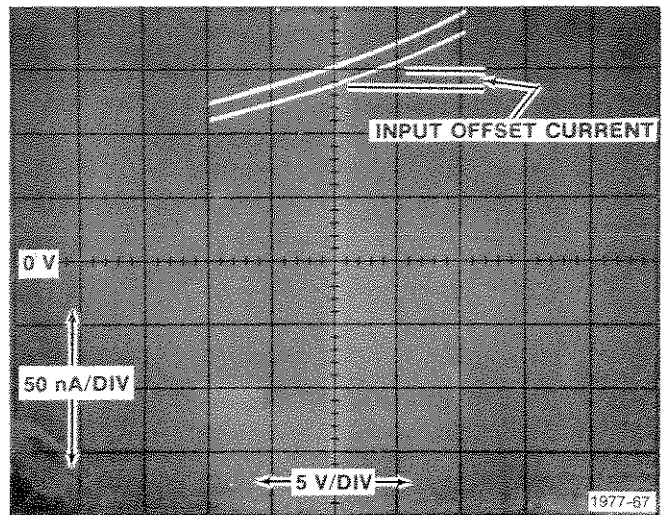

Fig. G-4. Input offset current.

3. Check Input Offset Current

Control Changes:

	577
X10 Vert Mag	pull
Vert Pos	center the display

178

VERT UNITS/DIV .5 μA

a. Erase once, then store the display.
b. Change the 178 FUNCTION switch to +INPUT I.

c. Compare the two displays.

d. Check that the input offset current (represented by the vertical separation between the +INPUT I and -INPUT I traces) is 4 divisions. If greater resolution is needed, change the VERT UNITS/DIV switch to a more sensitive position and repeat the test. The display should resemble that of Fig. G-4.

See the 2017

4. Check Common-mode Rejection Ratio

577
 X10 Vert Mag in
 178
 SOURCE RESISTANCE 10 kΩ
 SWEEP AMPLITUDE fully ccw
 FUNCTION CMRR
 VERT UNITS/DIV .5 mV

a. Increase the setting of the SWEEP AMPLITUDE control until the display indicates maximum swing of common-mode voltage.

b. Calculate the common-mode rejection ratio (CMRR) as follows:

$$CMRR = \frac{\text{common mode input voltage}}{\text{differential input voltage}} = \frac{\Delta \text{horizontal}}{\Delta \text{vertical}}$$

$$= 20 \log_{10} \frac{\Delta H}{\Delta V} \text{ (db)}$$

The CMRR of a type 741 is typically 90 dB. In this example, CMRR is measured from +10 to -10 volts on the common-mode input; i.e., ±10 volts on the horizontal axis of the display (see Fig. G-5).

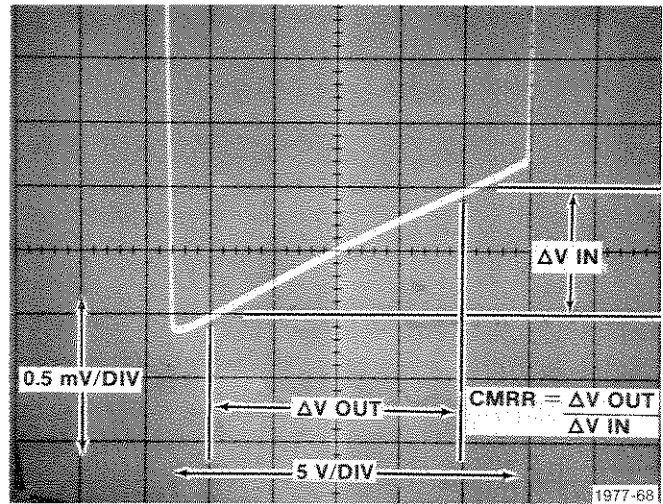

Fig. G-5. Common mode rejection ratio.

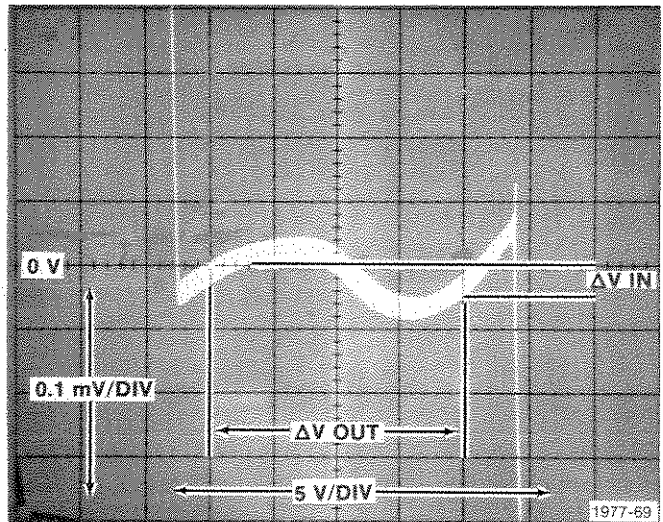

Fig. G-6. Typical gain curve.

5. Check Gain

Control Changes:

178
 SOURCE RESISTANCE 50 Ω
 FUNCTION GAIN
 VERT UNITS/DIV .1 mV

a. Press the DISPLAY—ZERO pushbutton, then erase the display.

b. From the display that returns, calculate gain as follows:

$$\text{gain} = \frac{E_{\text{out}}}{E_{\text{in}}} = \frac{\Delta \text{horizontal}}{\Delta \text{vertical}}$$

The gain (typically 200,000 for a 741) in this example is measured from +10 volts to -10 volts at the output (see Fig. G-6).

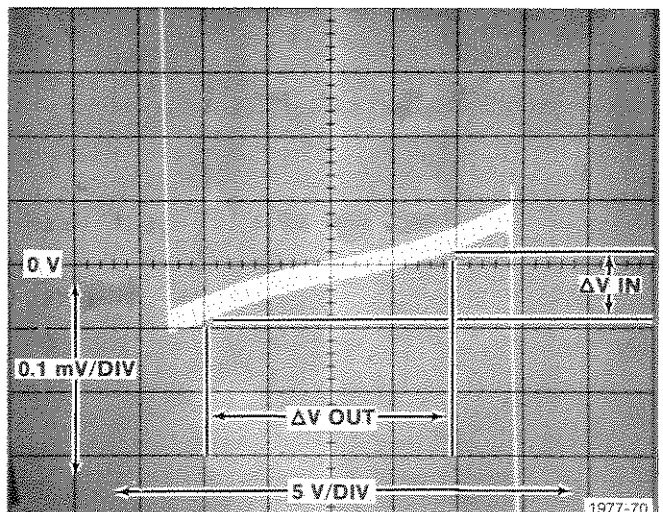

Fig. G-7. Output voltage swing.

6. Check Output Voltage Swing

- a. Set the LOAD RESISTANCE switch to 2 kΩ.
- b. Press the DISPLAY—ZERO and Erase pushbuttons.
- c. Check the output voltage swing. This is measured by noting the voltage as represented by the extremes of the horizontal deflection (see Fig. G-7).
- d. Set the LOAD RESISTANCE switch to 10 kΩ and again note the amount of horizontal deflection at the extremes of the sweep. The minimum output voltage swing listed in the specifications is ±10 volts for a load resistance of 2 kΩ, ±12 volts when R_L is 10 kΩ.

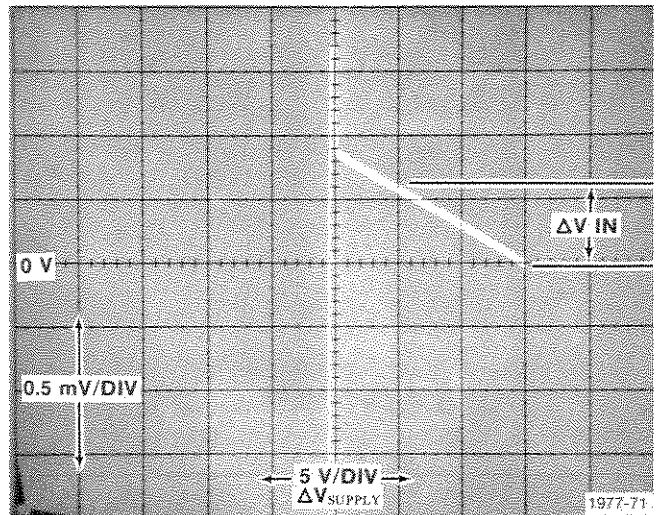

Fig. G-8. + Supply rejection ratio.

7. Check + Power Supply Voltage Rejection Ratio

Control Changes:

178

LOAD RESISTANCE	2 kΩ
SOURCE RESISTANCE	10 Ω <i>50</i>
FUNCTION	+PSRR
VERT UNITS/DIV	.5 mV

- a. Press the DISPLAY—ZERO and Erase pushbuttons. The display that returns provides the necessary information for calculating the +power supply voltage rejection ratio (+PSRR).

b. Calculate +PSRR as follows:

$$+PSRR = \frac{\Delta \text{input voltage}}{\Delta \text{+power supply voltage}} = \frac{\Delta \text{vertical}}{\Delta \text{horizontal}}$$

(see Fig. G-8).

150 μV/volt
nom 10 μV/volt

- c. Change the 178 FUNCTION switch to -PSRR. Press the DISPLAY—ZERO and Erase pushbuttons. From the display that returns, calculate the -PSRR in the same manner that +PSRR was calculated in part b above (see Fig. G-9).

- d. Change the 178 FUNCTION switch to ±PSRR and calculate ±PSRR from the resulting display (see Fig. G-10).

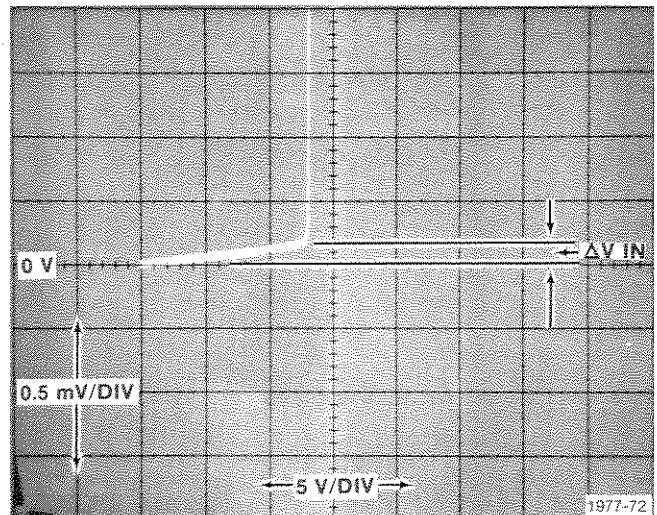

Fig. G-9. - Supply rejection ratio.

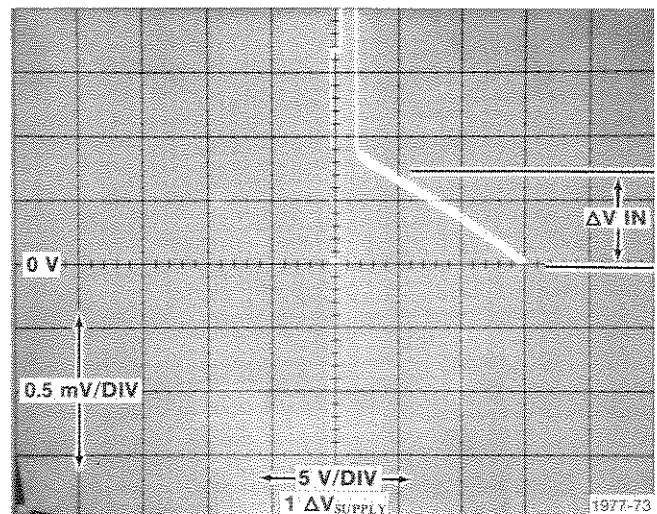

Fig. G-10. ± Supply rejection ratio.

8. Check Common-mode Input Resistance

Control Changes:

178

SOURCE RESISTANCE 50 Ω
 FUNCTION +INPUT I
 VERT UNITS/DIV 5 nA

- Store the +input current trace.
- Turn the Intensity down until the sweep disappears.
- Set the FUNCTION switch to -INPUT I.
- Increase the intensity to store this trace also.
- Calculate the common-mode input resistance as follows:

$$CMIR = \frac{\Delta \text{input voltage}}{\Delta \frac{+ \text{input current} - (- \text{input current})}{2}}$$

(see Fig. G-11).

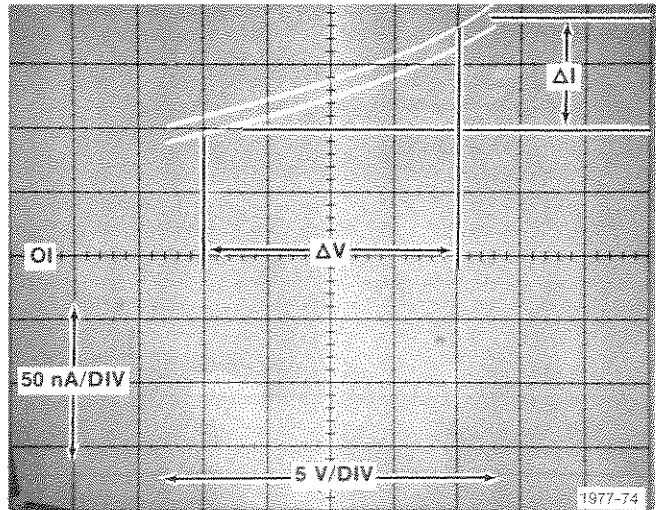

Fig. G-11. Common mode input resistance.

9. Check Input Resistance

Control Changes:

577

Horiz Volts/Div .1 volt collector

178

FUNCTION -INPUT I
 VERT UNITS/DIV 10 nA

- Patch the +IN jack to GND on the DUT Card.
- Press the 178 DISPLAY—ZERO pushbutton.
- Adjust the SWEEP AMPLITUDE control to give a display that is 10 divisions horizontally.
- Press the Erase pushbutton.

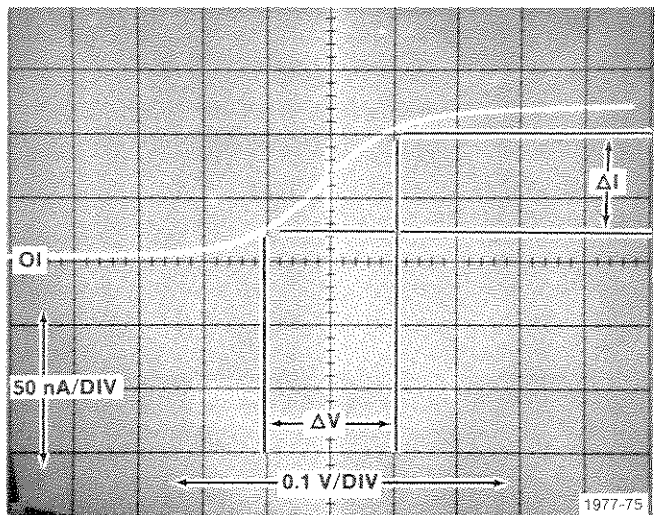

Fig. G-12. Input resistance.

- Calculate the input resistance as follows:

$$R_{in} = \frac{\Delta \text{input volts}}{\Delta \text{input current}} = \frac{\Delta \text{horizontal}}{\Delta \text{vertical}}$$

(see Fig. G-12).

- Remove the patchcord from the +IN jack and GND.

10. Check Supply Current

Control Changes:

	577
Horiz Volts/Div	5
	178
DUT SUPPLIES	OFF
SWEEP AMPLITUDE	fully ccw
FUNCTION	+SUPPLY I
VERT UNITS/DIV	1 mA

- a. Turn the 178 SWEEP AMPLITUDE control clockwise to give 3 divisions of deflection on the crt trace.
- b. Press the 577 Erase pushbutton. The display that returns should resemble that of Fig. G-13.
- c. Check that the supply current as represented by the vertical deflection of the trace is within the specifications given in the text that precedes Step 1 of these tests.

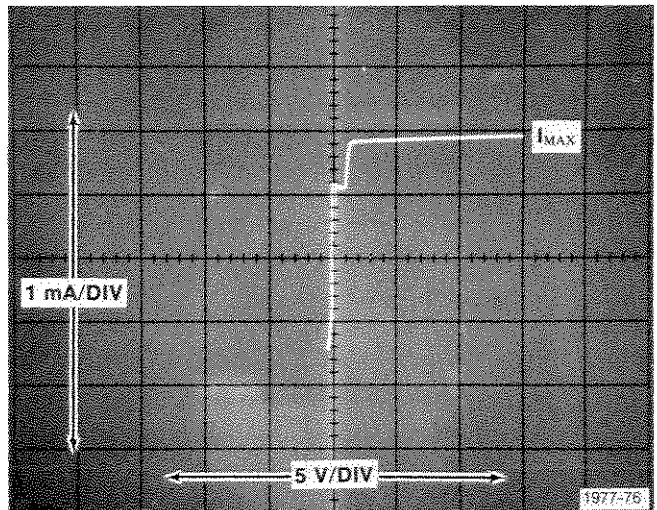

Fig. G-13. Check supply current.

11. Check Output Short Circuit Current

Control Changes:

	577
Store	off
Collector Polarity	ac
Series Resistance	1.9 Ω
Horiz Pos	centered
Vert Pos	centered

Collector 25V

	178
LOAD RESISTANCE	50 k Ω
SWEEP AMPLITUDE	fully ccw
VERT UNITS/DIV	10 mA

- a. Patch the right end of the external load resistor ($R_{L,EXT}$) to the collector sweep (CS) jack.
- b. Establish the zero reference point.

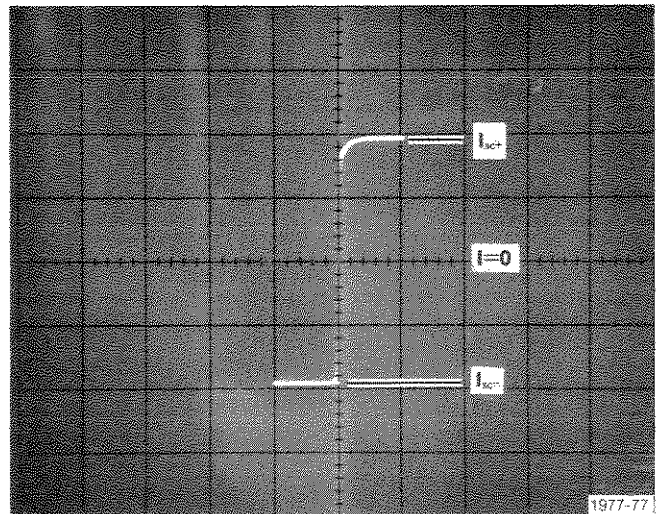

Fig. G-14. Output short circuit current.

- c. Set the 178 LOAD RESISTANCE control to EXT.
- d. Turn the 577 Variable Collector % clockwise to give 2 divisions of horizontal deflection.
- e. Check that the display resembles that of Fig. G-14 and is within specifications.

12. Check Offset Voltage Adjustment Range

Control Changes:

178

SWEEP AMPLITUDE fully ccw
 SWEEP FREQUENCY 1 Hz
 FUNCTION OFFSET V
 VERT UNITS/DIV 5 mV

DUT Card

Patch as shown in Fig. G-15.

Check the OFFSET adjustment range by adjusting the offset potentiometer from one extreme of rotation to the other. Note the extreme points of the vertical deflection. They should be about + and - 15 millivolts from zero (see Fig. G-16). *TYPICAL - NOT SPECIFIED*

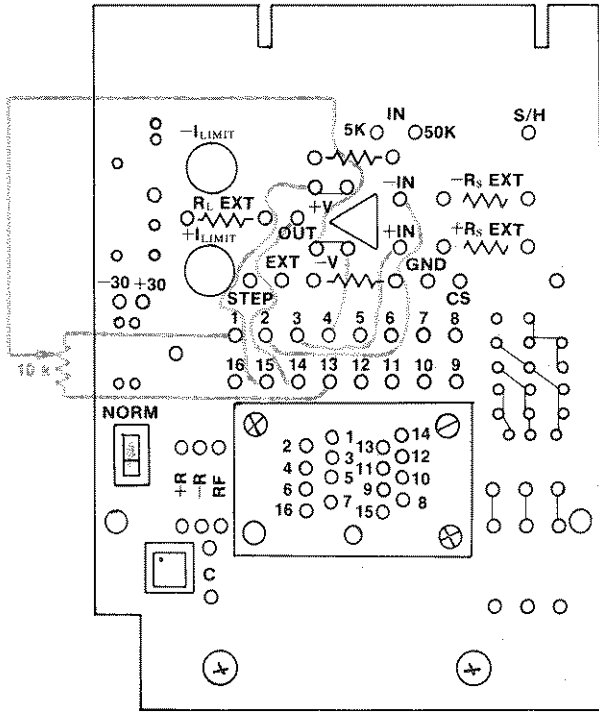

1977-78

Fig. G-15. Patching the Standard Op Amp Card for measuring offset voltage adjustment range.

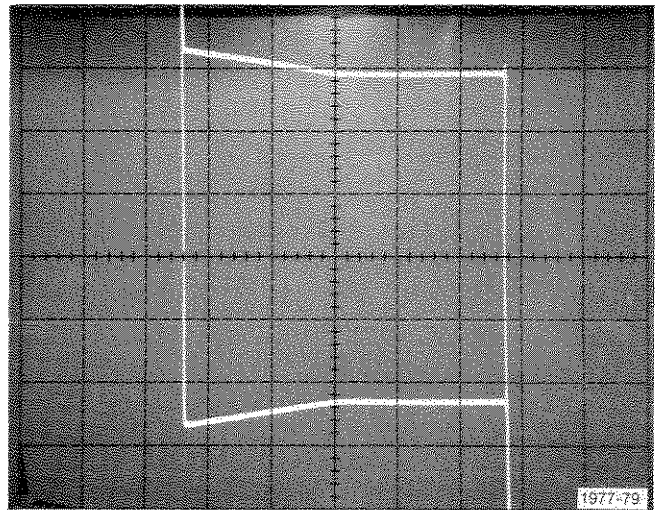

Fig. G-16. Display of offset voltage adjustment range measurement.

Appendix H

TESTING THE 3900 NORTON AMPLIFIER

Description

The 3900 consists of four independent, dual-input, internally compensated amplifiers that are designed to operate from a single supply voltage. The amplifiers provide large output voltage swings and make use of a current mirror to achieve the non-inverting input function. The 3900 uses a 14-pin, dual-in-line package.

At the start of each step, turn the DUT SUPPLIES switch on. Press and hold the DISPLAY—ZERO pushbutton while centering the display with the 577 Horizontal and Vertical position controls. This establishes the zero reference point for the test. When the display is centered, release the DISPLAY—ZERO pushbutton. Unless it is desired to store the trace of the previous step, press the 577 Erase pushbutton. Proceed with the test.

ELECTRICAL CHARACTERISTICS (V+ = +15 V dc and T_A = 25° C)

Parameter	Characteristic			
	Min	Typ	Max	Units
1. Open Loop Voltage Gain (f = 100 Hz)	1200	2800		V/V
2. Supply Current (R _L = 50 kΩ)		6.2	10	mA dc
3. Power-supply Rejection Ratio (f = 100 Hz)			70	dB
4. Mirror Gain (+I _{in} = 200 μA)	0.9	1	1.1	μA/μA
5. Mirror Current ^a		10	500	μA dc

^aInput V_{BE} match between the non-inverting and inverting inputs occurs for a mirror-current (non-inverting input) of approximately 10 μA. This is, therefore, a typical design center for many circuits.

Preliminary

Initial control settings are given in the following text. Do not change these control settings unless so directed by the information under "Control Changes" at the beginning of each step. Turn off the DUT SUPPLIES switch at the end of each step. Turn off the power to the 577 when removing and replacing the Standard Op Amp card (dut card).

Initial Control Settings

577	
Collector Supply Polarity	+DC
Variable Collector %	ccw
Max Peak Volts	6.5
Max Peak Power—Watts	.6 or lower
All dark gray knobs and buttons in except:	
Step X.1	out
Step Family Single	press
Offset Zero	in
Step/Offset Ampl	5 μA
Offset Aid	in
Pulsed 300 μA	out
Horiz Volts/Div	5 Collector Volts

178	
+SUPPLY	14.3
—SUPPLY	out of detent, ccw
VERT UNITS/DIV	5 mV
LOAD RESISTANCE	50 kΩ
SOURCE RESISTANCE	50 Ω
SWEEP FREQUENCY	.1 Hz
SWEEP AMPLITUDE	1/2 turn from full cw
FUNCTION	OFFSET V

DUT Card

External Feedback	
Amplifier Switch	Norm
Patch cords arranged as in Fig. H-1.	

TEST PROCEDURE

The diagram shown in Fig. H-1 gives the test circuit setup connections on the Standard Op Amp card (dut card) used for testing the 3900 Norton amplifier.

The circuitry between the V⁻ supply and the ground terminal of the dut is used to hold the V⁻ terminal at one diode drop below ground to permit the inputs to be at real ground level. The divider gives high resolution to the V⁻ supply. The external feedback amplifier (HA-911) is used for stability (in the follower mode). The non-inverting input of the dut is fed by the step generator of the 577 to force the mirror current desired.

The 200 kΩ resistor between -30 volts and the 5 K IN (see Fig. H-1) connectors is used to set the device output at +7.5 volts in the quiescent condition.

Set the V⁺ supply to 14.3 volts instead of 15 volts to adjust for the -0.7 volt at the ground terminal; however, this voltage is not critical. The diodes at the inverting input are to protect the device during the mirror current test if the 178 sweep amplitude should not be at zero.

1. Check Gain in Offset Voltage

a. Turn the -SUPPLY control until the gain curve is displayed (see Fig. H-2).

b. Calculate the gain from the display:

$$\text{Gain} = \frac{\Delta \text{output voltage}}{\Delta \text{input voltage}} = \frac{\Delta \text{horizontal}}{\Delta \text{vertical}}$$

c. Check the remaining op amp sections of the dut.

2. Check Power Supply Rejection Ratio (PSRR)

Control Changes:

	178	
SWEEP AMPLITUDE		fully ccw
FUNCTION Switch		+PSRR

DUT Card

Patch for the first op amp section of the DUT.

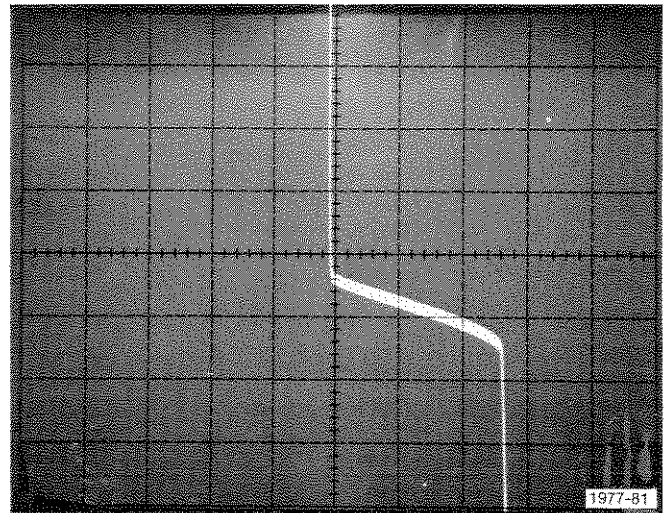

Fig. H-2. Typical gain in offset voltage display.

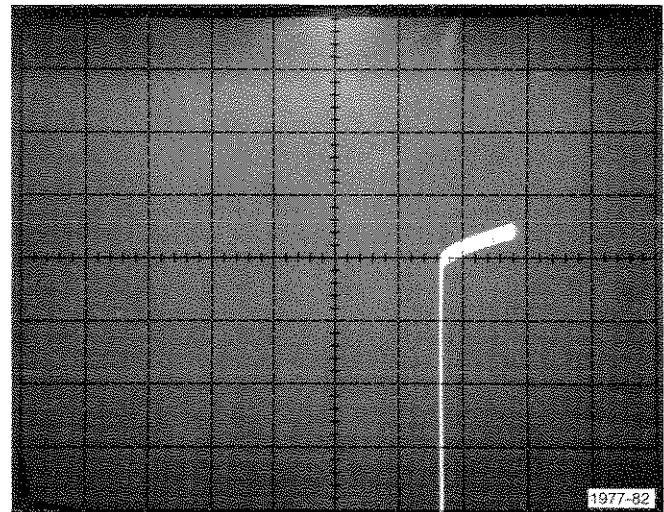

Fig. H-3. Typical display of power supply rejection ratio measurement.

a. Press the DISPLAY—ZERO pushbutton. Turn the SWEEP AMPLITUDE control clockwise until the trace goes down off-screen (see Fig. H-3).

b. Calculate PSRR as follows:

$$\begin{aligned} \text{PSRR} &= \frac{\Delta + \text{supply voltage}}{\Delta \text{input voltage caused by the supply voltage change}} \\ &= \frac{\Delta \text{horizontal}}{\Delta \text{vertical}} \end{aligned}$$

c. Repeat this step for the remaining sections of the dut.

3. Check Positive Supply Current

Control Changes:

178

FUNCTION Switch +SUPPLY I
SWEEP AMPLITUDE fully ccw

DUT Card

Patch for the first amplifier section.

a. Press the DISPLAY—ZERO pushbutton. Turn the SWEEP AMPLITUDE control until the trace reaches screen center (see Fig. H-4).

b. Check—that the positive supply current changes as a function of the +supply voltage change.

c. Repeat this step for the remaining sections of the dut.

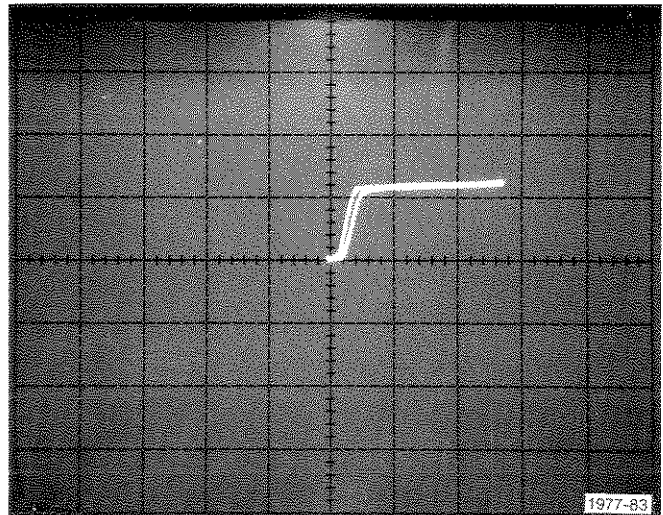

Fig. H-4. Measurement of positive supply current.

4. Check Mirror Current

Control Changes:

577

Horiz Volts/Div 50 mV, collector

178

SWEEP AMPLITUDE fully cw
SWEEP FREQUENCY .1 Hz
FUNCTION +INPUT I
VERT UNITS/DIV 10 μ A

DUT Card

Patch for the first amplifier section.

a. Press the Erase button.

b. Adjust the -SUPPLY control for 2 μ A to 40 μ A (0.2 division to 4 \pm 0.5 divisions vertical display recommended).

c. Turn the SWEEP AMPLITUDE control slowly clockwise to approximately 1/8 turn or less (not more than 1/4 turn clockwise from the detent in any case) until the effect of sweep is seen on the display.

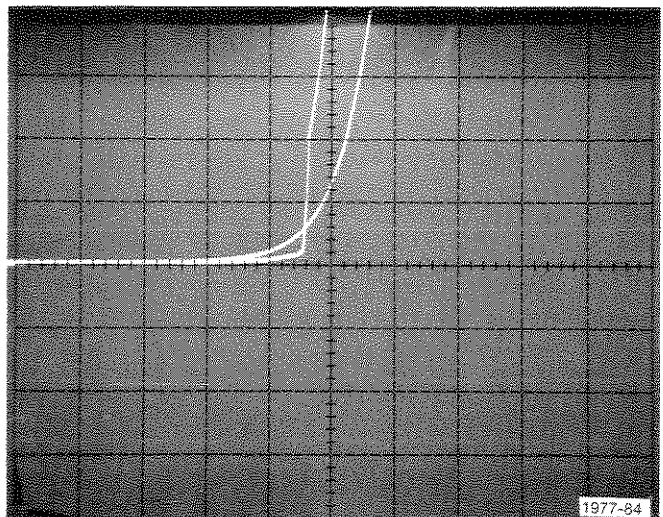

Fig. H-5. Typical display of mirror current measurement.

d. Store the display, then turn the Intensity control clockwise (decrease the intensity).

e. Set the FUNCTION switch to -INPUT I.

f. Increase the intensity to store the -Input I curve.

NOTE

The point at which -Input I and +Input I cross is the mirror current input V_{BE} match (see the note in the mirror current specification). See Fig. H-5 for a typical display.

g. Check the remaining sections of the dut in the same manner.

NOTE

If for any reason the SWEEP AMPLITUDE control must be turned more than 1/4 turn clockwise from the detent, place 500 Ω resistors in the - $R_{S}EXT$ and + $R_{S}EXT$ jacks and switch the SOURCE RESISTANCE to EXT to stay within input current specifications.

5. Check Mirror Gain

Control Changes:

577

Horiz Volts/Div	Step Gen
Step/Offset Ampl	5 μ A/Step with Step X.1 out
Step/Offset Zero	in
Step Family	Rep
Step Rate	Norm
Number of Steps	cw

178

FUNCTION	-INPUT I
VERT UNITS/DIV	.1 mA (More vertical sensitivity may be needed for better resolution)
SWEEP AMPLITUDE	0
SWEEP FREQUENCY	100 Hz
SOURCE RESISTANCE	EXT

DUT Card

Patch the card for the first amplifier section and insert the dut into the socket adapter.

a. Adjust the -SUPPLY control clockwise to put the display off screen. Then turn the -SUPPLY control counterclockwise until the display start is at graticule center horizontally and vertically (see Fig. H-6). The -SUPPLY control must not be less than 1/4 turn clockwise from the detent.

b. Erase the display and re-store. Mirror gain is calculated as:

$$\text{Mirror gain} = \frac{\Delta\text{horizontal}}{\Delta\text{vertical}}$$

with the mirror current at 200 μ A (i.e., 40 steps at 5 μ A/step, see Fig. H-6).

c. Check the remaining sections of the dut in the same manner.

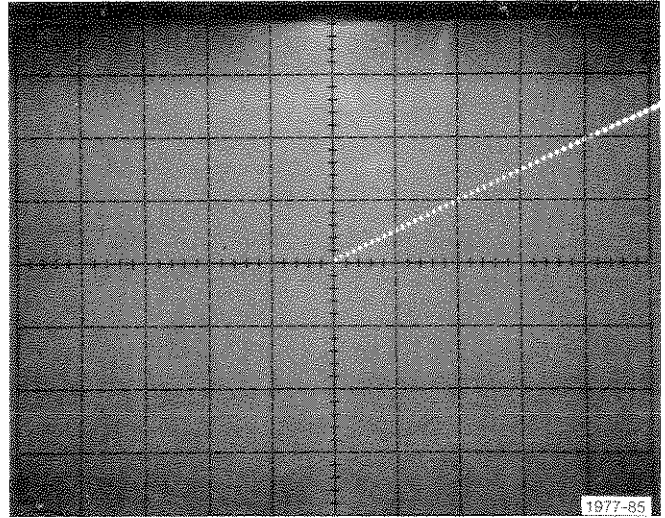

Fig. H-6. Typical display of mirror gain measurement.

