

Customer Information from Tektronix, Inc.,
P.O. Box 500, Beaverton, Oregon 97005

Editor: Gordon Allison,
Graphic Designer: Tom Jones

Contents

3 30 Hz resolution at gigahertz frequencies—a new direction in spectrum analysis

Low incidental FM and excellent stability permit exacting measurements in the areas of spectral purity and close-in distortion.

8 CRT READOUT—nicety or necessity?

CRT READOUT offers many benefits to the scope user. Provision is made to insert your own data.

10 Flexible disc measurements simplified by digital delay

A digital delay plug-in for 7000-Series Oscilloscopes, used in the Delay-by-Events mode, takes the jitter out of rotating disc measurements.

13 Servicing the 465 Portable Oscilloscope

Some troubleshooting hints and typical problems you may encounter in servicing the 465 Oscilloscope.

Cover: A close-up view of the display of the 7L13 Spectrum Analyzer. The CRT Readout displays the Spectrum Analyzer control settings. Center frequency is 1521 MHz, frequency span is 200 Hz/div, resolution is 30 Hz and the video filter is set at 10 Hz. The reference level at the top of the screen is -20 dBm and the vertical deflection factor is 10 dB/div.

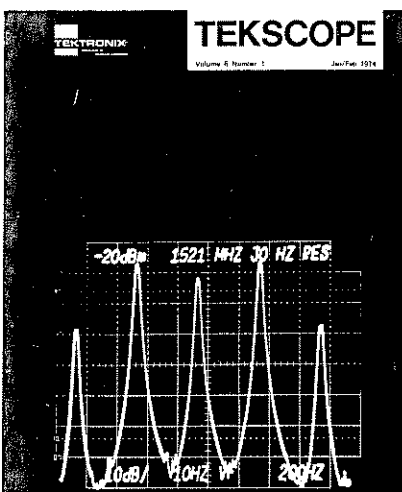



F. Telewski

30 Hz resolution at gigahertz frequencies—a new direction in spectrum analysis

For some years the needs of high-frequency spectrum analysis in the area of DC to 2GHz have been satisfied by a number of instruments whose incidental FM was in the order of 200 Hz. While these instruments have served well they do not permit exacting measurements in the areas of spectral purity and close-in distortion. As a result, the user is often compelled to adopt alternate test procedures which require the use of down-converters and low-frequency spectrum analyzers or wave

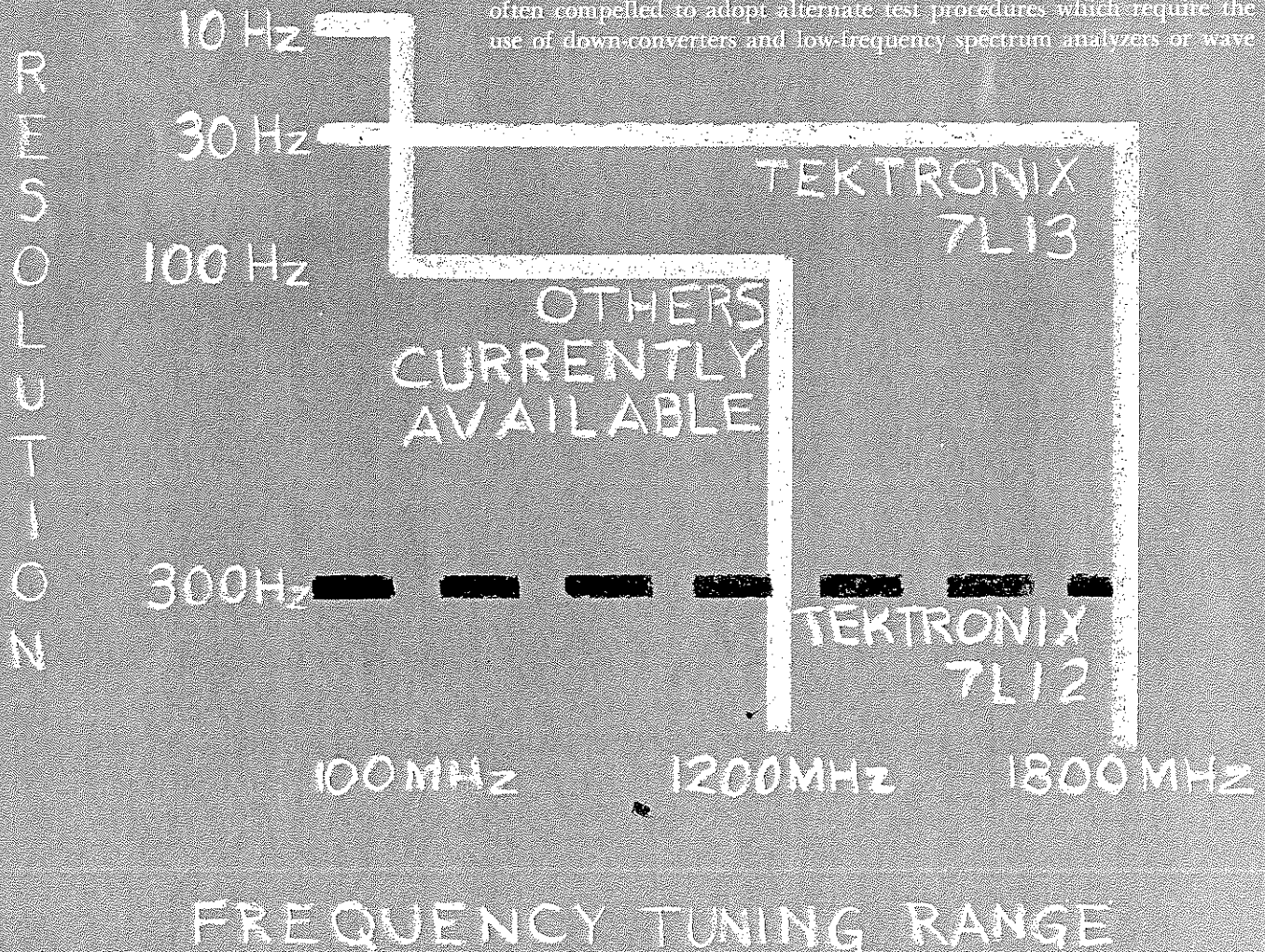

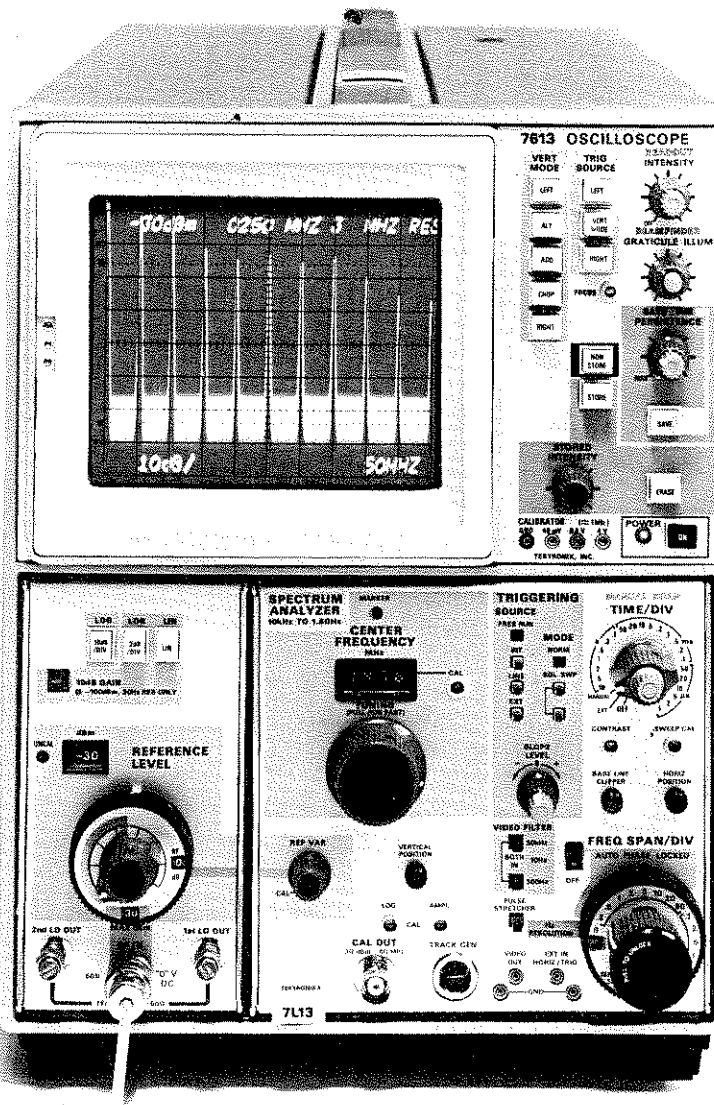

analyzers. The cumbersome nature of these measurement systems coupled with the tightening of signal specifications by governmental regulatory agencies has created a need for a high performance, high-frequency spectrum analyzer.

Performance Goals

At inception, the 7L13 program aimed at reducing internal FM and drift by an order of magnitude with commensurate improvement in resolution capability. Keeping in mind that most spectrum analyzers are already somewhat difficult to operate, these improvements could not be accomplished at the expense of operational ease. Indeed, additional improvements in operational simplicity should be sought.

First Local Oscillator

It is the local oscillator system that determines the performance achievable in most spectrum analyzers. An examination of the oscillator system reveals that there are basically two oscillators under consideration. These are the 1st L.O. (2.1 - 3.9 GHz) and the 2nd L.O.

(2.2 GHz) as shown in Fig. 1. The 3rd L.O. being crystal-derived at 95 MHz contributes negligible FM ($\ll 1$ Hz p-p) to the system.

It is common practice, as the frequency span is reduced, to phase lock the 1st L.O. to a fixed crystal reference oscillator, thus stabilizing it while shifting the sweep function to the 2nd L.O. The rate of the crystal reference oscillator determines the range over which the 2nd L.O. must be swept in order to complete the frequency coverage between the discrete lock points. Hence, a low-frequency reference is desirable from the viewpoint of design ease in the 2nd L.O. system.

The choice of a crystal reference rate is compromised by the high phase noise associated with low-frequency references. The increase in noise arises from the requirement for a higher multiplication rate of the fundamental oscillator, whose behavior is characterized by the following equation:

$$DEG_{dB} = 20 \log M,$$

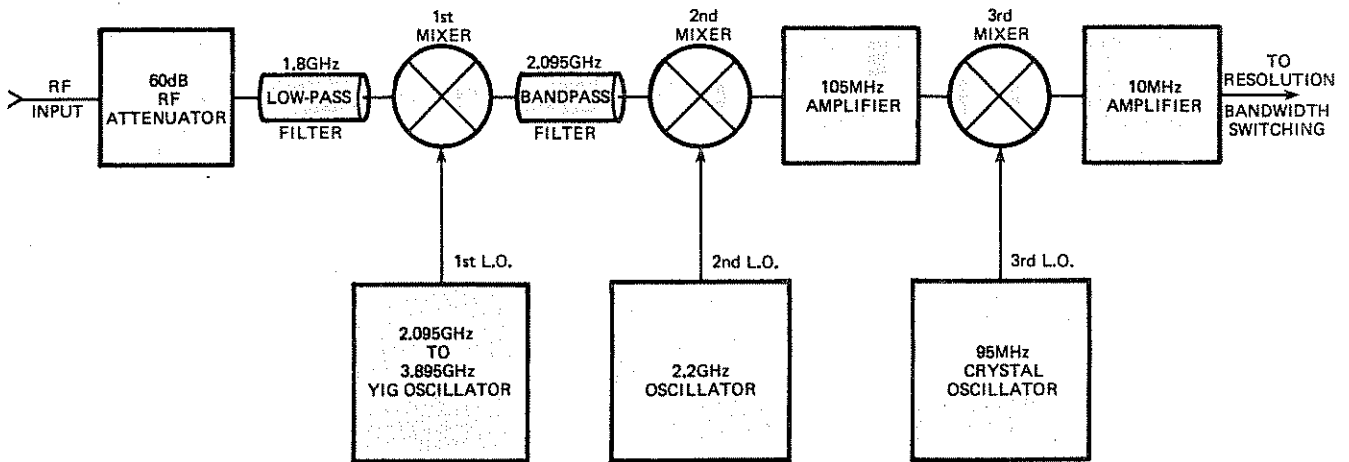

Fig. 1. Frequency conversion system of the 7L13.

Where: DEG is the degradation in spectral purity in dB and M is the multiplication factor. From the standpoint of phase noise it is desirable to choose a high rate for the crystal reference oscillator; however, conflicting requirements result. A 1-MHz reference rate is chosen as medium ground for the 1st L.O. reference. This permits a reasonable 2nd L.O. tuning range of 3 MHz as well as satisfying the phase noise constraint.

There is a unique bandwidth for any oscillator servo system which will yield optimum spectral purity. This bandwidth is determined by considering the relative spectra of the reference oscillator and the voltage-tuned oscillator (VTO) which is to be locked. In the 1st L.O. servo loop, the loop bandwidth is chosen such that the excellent line-width properties of the crystal reference are translated to the YIG VTO. The broad noise pedestal associated with the same reference is rejected in favor of the faster falling noise sidebands of the YIG VTO. The FM performance of this system, when operating in the lock mode, is in the 1 Hz p-p area.

2nd Local Oscillator

The 2nd L.O. usually consists of a varactor-tuned oscillator operating in the region of 1.5 to 2.5 GHz. Examination of the properties of this oscillator type indicates that under reasonable circumstances, 200 Hz is the minimum residual FM that can be expected as guaranteed performance without resorting to external stabilization techniques.

Improving the performance of the 2nd L.O. becomes a problem of designing an oscillator at a frequency where the desired stability and tuning range can be achieved. In this case a voltage-tuned oscillator operating from 16 to 19 MHz, and whose residual FM is approximately 1 Hz p-p, meets the requirements of a reference for the 2nd L.O. system. The stability properties of this reference oscillator are translated to 2.2

GHz by a type-two frequency servo system as indicated in Fig. 2. The unstable 2.2 GHz oscillator, collector tunable over a ± 1.5 MHz range, is heterodyned with a crystal-derived 2182.5-MHz (FM < 1 Hz p-p) signal. The product at 17.5 (± 1.5) MHz is phase compared

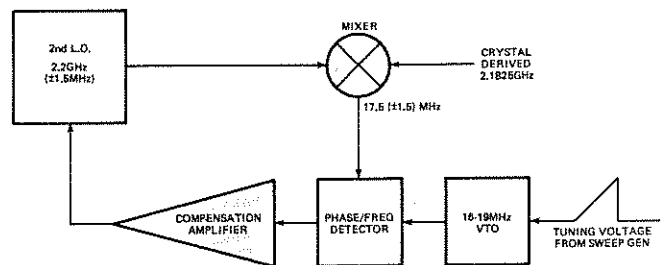

Fig. 2. Second L.O. stabilization system.

with the 16 to 19 MHz reference oscillator and the resultant error signal is amplified and fed back to the collector of the 2.2 GHz oscillator. Thus, the 2.2 GHz L.O. is synthesized in such a manner that it replicates the product of the 16 to 19 MHz oscillator and the 2182.5 MHz crystal-derived source within the bandwidth of the servo system. The complete 2nd L.O. system of the 7L13 exhibits a typical incidental FM of 1 Hz p-p.

A major distinction in the operation of the 2nd L.O. servo system (as opposed to the 1st L.O. loop) is that it is functional in all modes of 7L13 operation. The 2.2 GHz oscillator is never allowed to assume a free running mode and is under the control of the 16 to 19 MHz VTO from the time the instrument is turned on. Consequently, there is no mention of a 2nd L.O. lock mode on the analyzer front panel, and the stabilization of the 2nd L.O. in no way complicates the use of the instrument.

30 Hz Resolution Filter

In order to exploit the extraordinary stability of which the 7L13 local oscillator system is capable, a 30-Hz resolution position was made available to the user. In light of the fact that the widest resolution bandwidth in the instrument is 3 MHz, a center frequency of 10 MHz is chosen for the final IF. In order to keep system complexity to a minimum, this requires that the 30-Hz resolution filter be at 10 MHz as well.

This filter is of the well known lower sideband ladder design (Fig. 3). It employs three quartz resonators whose unloaded Q is in excess of one million and has a nominal 60:6 dB shape factor of 10:1. These resonators, when exposed to temperature variations encountered in the instrument ($0^{\circ} > 50^{\circ}\text{C}$), are prone to alter their center frequency by a large fraction of the filter bandwidth. In order that the 30 Hz filter be able to maintain its bandpass characteristics under conditions of varying temperature, the quartz resonators are required to have matched temperature-versus-frequency properties.

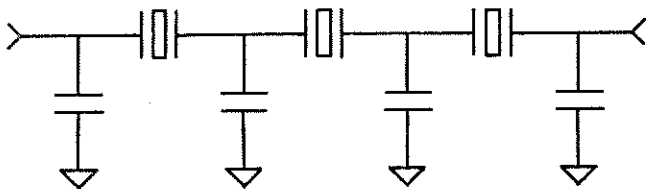

Fig. 3. Simplified circuit of the 30-Hz crystal filter.

Frequency Readout and Tuning

The availability of high linearity (typically .1%) YIG-tuned oscillators prompted the use of a digital frequency readout. This is accomplished by a digital voltmeter (DVM) which monitors the tune voltage of the 1st L.O. The frequency information obtained from the DVM is multiplexed and displayed both on the front panel, by a light-emitting diode display, and on the analyzer screen via the Tektronix CRT READOUT system. This permits the user to measure frequency to an accuracy of $\pm (5 \text{ MHz} + 20\%$ of the frequency span per division); 20% of a division being as close as one can typically judge the signal position, taking into account the effects of observation and the geometry of the display.

Simplification of operation was achieved through the development of a single-knob tuning scheme. Previous analyzers have often had two or more tuning knobs; and depending upon what mode the analyzer was operating in, inadvertent adjustments of the wrong tuning knob could cause severe frequency disturbances in the instrument. This problem is eliminated in the

7L13 through a mechanism employing two magnetic clutches and a self-centering potentiometer. When this system is operated in spans where the 1st L.O. is stabilized, the 2nd L.O. potentiometer clutch is engaged. Starting from a centered position, it prohibits one from achieving lock with the 2nd L.O. tuning control against one stop. Further, access to the 1st L.O. potentiometer is denied the user by disengaging the 1st L.O. potentiometer clutch so that he cannot mistakenly tune the 1st L.O., break lock, and lose his display. When returning to spans which do not require 1st L.O. stabilization, the clutches alternate state returning the 2nd L.O. potentiometer to its centered position and permitting tuning of the 1st L.O.

Convenience Features

We have come to expect such user conveniences as absolute amplitude calibration, freedom from spurious, automatic frequency stabilization, coupled span and resolution controls, display warning indicators and such in our high performance spectrum analyzers; and indeed they are all present in the 7L13. The 7L13 goes a step beyond and introduces the concept of full parameter readout to spectrum analysis (Fig. 4). All pertinent information, i.e., center frequency, resolution bandwidth, span, video filtering, vertical scale factor and power reference level may be viewed at a glance or permanently recorded by a photo of the display.

Performance

The graph of frequency tuning range versus resolution on page 3 shows the performance of the 7L13 and other instruments currently available. As is evident, the 7L13 represents a significant breakthrough in the area of high resolution, high-frequency spectrum analysis. The 7L13 has achieved a high degree of synergism with respect to spectral purity, resolution and drift. The instrument is not limited by the cleanliness of its oscillator system, as is so often the case with other high-frequency analyzers. As Fig. 5 shows, the shape of the 30-Hz resolution filter is clearly defined for well over 60 dB. This performance, familiar to users of low-frequency spectrum analyzers, is uncommon above a few hundred megahertz and due largely to the very conservative 10-Hz FM specification of the 7L13.

Resolution is a significant feature of a spectrum analyzer. Fig. 4 illustrates a 1476-MHz carrier, amplitude modulated at 50-Hz rate with both sidebands distinctly resolved. Fig. 6 shows the same carrier modulated at a 400-Hz rate along with residual 180-Hz line-related modulation on the carrier source 60 dB down.

The question of how long a given stable signal will remain on the display may be resolved by the drift specification. Just how well the 7L13 conforms to its 2

kHz/hr drift specification is evident in Fig. 7. This time-lapse photograph, made at hourly intervals, reveals a total drift of 4 kHz in 6 hours with 1.2 kHz occurring in the first hour.

All of the foregoing performance features of the 7L13 would lose much of their impact if the analyzer were not highly immune to intermodulation distortion. It is this property which in large part determines whether the display on the analyzer is real. Returning to Fig. 5, one can see that, in this 2-tone test at 1555 MHz with 500-Hz tone separation, there are no visible 3rd-order intermodulation products.

In general, it is instruments like the 7L13 which will ease the burden of making critical spectral measurements at high frequencies. And this ability will set the direction for future improvements in communication equipment performance.

Acknowledgments

As with any program embodying the complexity of the 7L13, there are more people involved than can be listed. All should feel a sense of satisfaction from their role in the development of this instrument. The principle contributors, other than the author as project manager, were electrical design: Mike McMahon and Jack Reynolds; mechanical project engineer: Leighton Whitsett; mechanical design: Jack McCabe and Jim Wolf.

*Telewski, "Freq. Stab. Tech.," TEKSCOPE, Jan. 72, pp. 10-11.

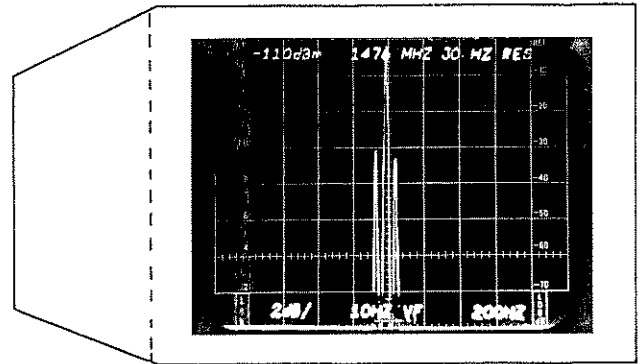

Fig. 4. 1476-MHz carrier modulated at 50 Hz. Note full parameter readout.

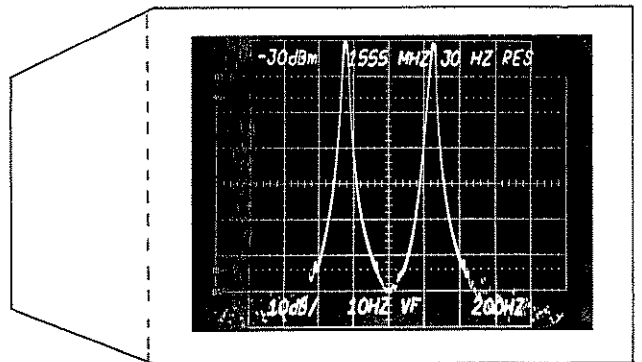

Fig. 5. Two-tone test at 1555 MHz shows freedom from distortion along with spectral purity and resolution filter shape.

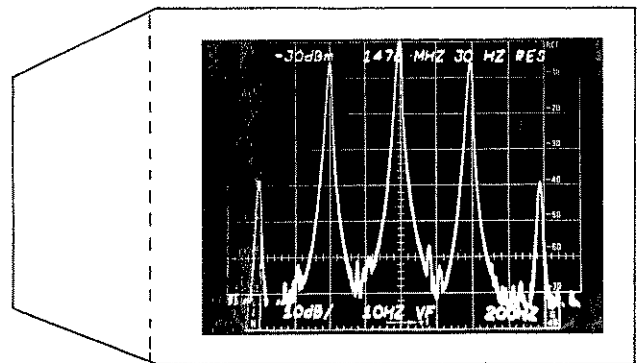

Fig. 6. 1476-MHz carrier 100% AM modulated at a 400-Hz rate.

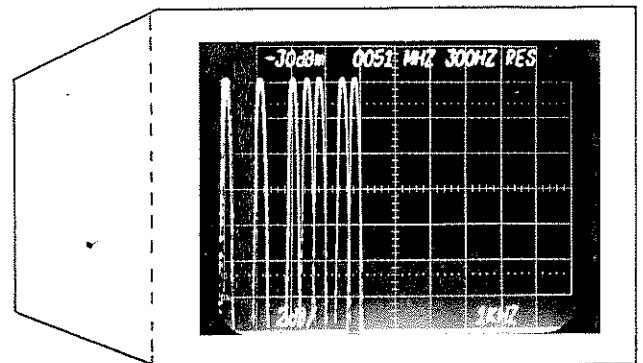

Fig. 7. Time-lapse photo taken over a 6-hour period shows excellent drift characteristics of the 7L13.

CRT READOUT— nicety or necessity?

When the 7000-Series Oscilloscopes were being conceived much discussion centered around a scheme to present alphanumeric information on the CRT along with the waveform. Would the benefits derived justify the engineering effort required? What about the added cost to the customer who didn't need or want readout? These and related questions consumed hours of discussion.

The question of added cost for those not needing readout was neatly resolved by placing the bulk of the readout circuitry on a single printed circuit board. Easily installed or removed, readout could be included at the time the instrument was ordered, or added later at the customer's preference. Only time could adequately answer the question of whether the benefits would justify the effort required.

How It Works

Here, briefly, is how the readout system works. The system uses an electronic character generating circuit which time shares the CRT with the normal scope functions. The characters are formed by a series of X and Y analog currents developed by Character Generating

I.C.'s. A set of 50 different characters are provided, with the capability to add others as the need arises. Included are all of the numerals, most of the alphabet in upper case, the symbols, p , n , μ , m and other special symbols.

To minimize coding complexity an analog coding scheme was developed in which data is encoded by means of resistors and switch closures. This data is generated in the plug-in by connecting these resistors between time-slot pulses and data output lines via the appropriate switch. The coding scheme includes two channels for each plug-in so that dual trace amplifiers and delaying/delayed time bases can be accommodated. A maximum of eight words can be displayed, corresponding to two channels for each of four plug-ins. The position of each word on the CRT is fixed and related to the plug-in from which it comes. Each channel will display one word having up to ten characters. The characters are normally written without redundant spaces, but spaces can be called for in the code if desired. Only those channels in use have their readout displayed.

Some Benefits of Readout

Now, what are some of the benefits afforded by CRT READOUT? To those whose work entailed photographing the waveform a major benefit was immediately apparent. The vertical deflection factors and sweep rates could be recorded right on the film with the

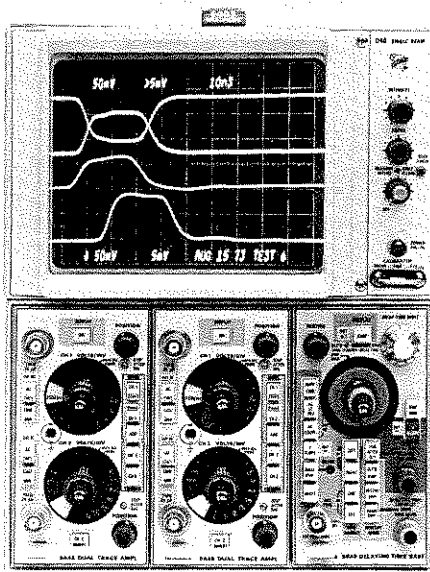

The 5403 Oscilloscope features 60-MHz bandwidth, plug-ins and CRT READOUT.

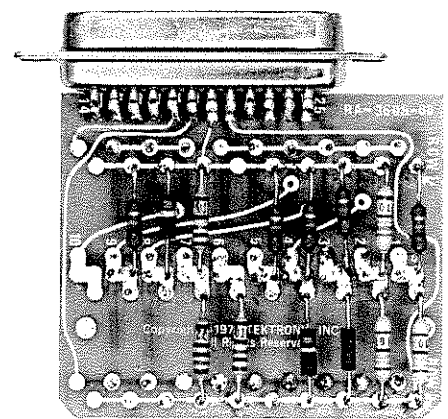
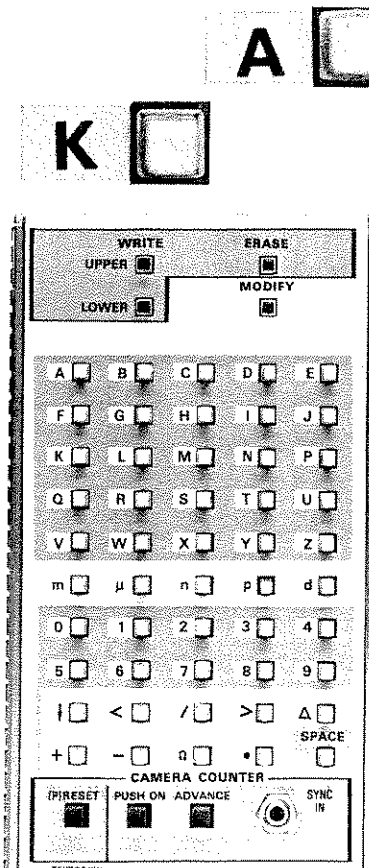

Optional readout programming board for the 5403.



7M13 Readout Unit for the 7000-Series.

displayed waveform. This would be a real convenience and time saver.

Another major benefit was the reduction of operator error in making measurements. More than one piece of research has had to be redone because of faulty data due to probe attenuation or uncalibrated knob settings going unnoticed. With CRT READOUT, the scale factor at the probe tip is automatically indicated when the proper probe is used. An uncalibrated knob setting is denoted by displaying < or > before the reading, e.g., <500 mV.

And then came a major breakthrough in oscilloscope capability. With the introduction of the 7D14 plug-in the oscilloscope became a 500 MHz digital counter!; the CRT READOUT serving as the display for the counter. And the oscilloscope/counter combination opened the door to previously difficult or impossible measurements. For example, selectively-gated counter measurements could now be made easily and accurately.

Another digital plug-in added digital voltmeter and temperature measuring capabilities. A digital delay plug-in provided a digital delaying time base and the ability to delay by a selected number of events. Spectrum analysis was included with reference level, dB/div, frequency span, resolution and other calibrated parameters all displayed by CRT READOUT.

Another significant measurement capability was introduced with the Digital Processing Oscilloscope. This instrument marries the oscilloscope to a computer or

desk-top calculator. Here, again, CRT READOUT plays a vital role in displaying the parameters of the signal displayed on the screen, which may be considerably different from the signal fed to the oscilloscope input.

Getting a Word In

It didn't take long for customers to voice a need for putting their own words in the readout—information like the date, test number or the engineer's name. To accommodate these needs a "typewriter" plug-in was developed. The 7M13 Readout Unit provides a front-panel keyboard to write alphanumeric and a selection of symbols. Two ten-character words can be written on the CRT screen, one at the top and one at the bottom, in the position associated with the selected plug-in slot.

CRT READOUT In a Low Cost Scope

Because of its proven value, CRT READOUT is also included in the new 5400 Series, a line of low-cost, 60 MHz, plug-in oscilloscopes. Here again provision is made to insert two ten-character words of your own choice in the readout via a 25-pin connector on the rear panel of the scope. An optional plug-in program board makes it easy to build your own words.

Summary

CRT READOUT has proven to be much more than just a convenience, it is the key that opens the door to new measurements for the oscilloscope user. Just what the total benefits will be remains to be determined. We're still discovering new ones right along. ☺

'Tekscope, January 1973, "A new world of measurements for the oscilloscope."

TEST 10

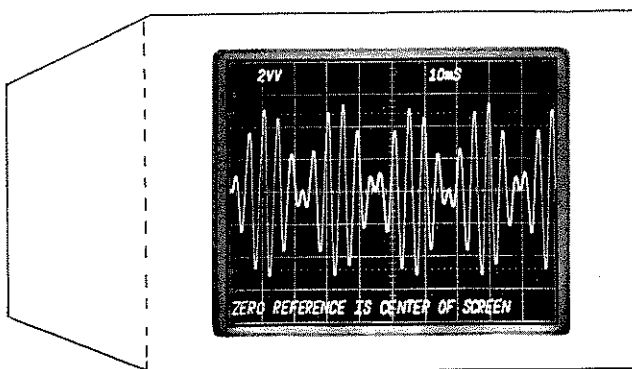

The readout in this photo was programmed by the computer in a Digital Processing Oscilloscope system. The double V indicates the waveform is the resultant of two voltage signals multiplied together.

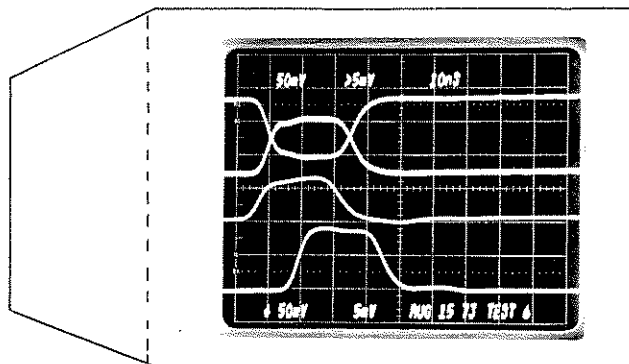

This photo was dated and identified as Test 6 using the optional readout programming board in the 5403.

B  20mV

Teknique

Flexible disc measurements simplified by digital delay

Signals from a flexible disc and its associated circuitry can be measured using a conventional delaying sweep. However, jitter caused by small speed variations in the rotating disc can make the display difficult to interpret. And when you consider that there may be 100,000 data bits on a single track you can appreciate the difficulty of locating a particular bit. The 7D11 Digital Delay Plug-in eases the task considerably.

The 7D11 can be used in any 7000-Series Oscilloscope having CRT READ-OUT. The plug-in has two basic modes of operation. The first is a Delay-by-Time mode, where a highly accurate internal clock is the time base from which delays are derived. Digital delays from 100 nanoseconds to 1 second,

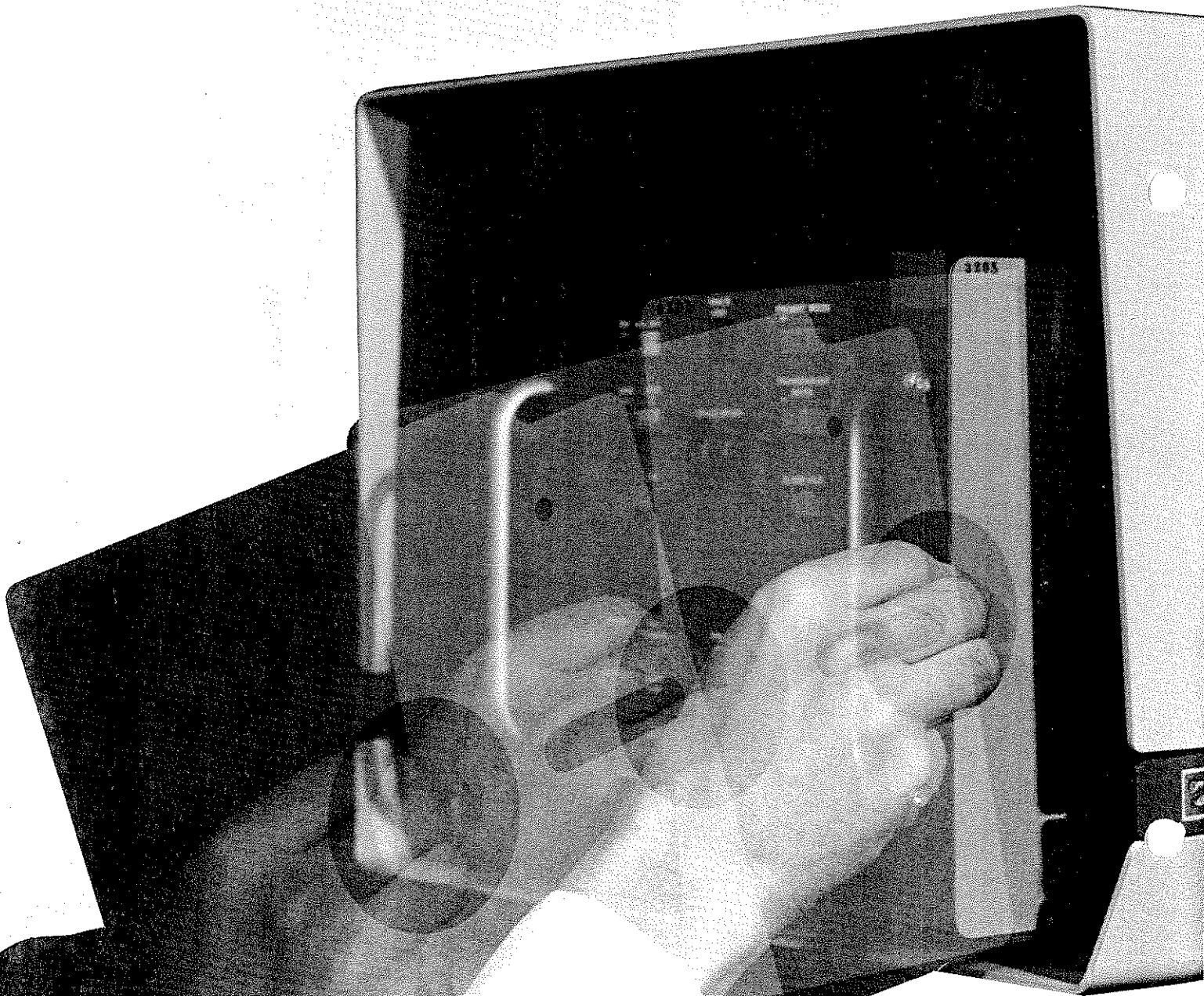

in 100-ns increments, are available in this mode. A helical-controlled analog delay provides an additional 0 to 100 ns of delay providing time delay resolution up to 1 ns.

The second mode of operation, Delay-by-Events, is the mode we're most interested in for this application. In this mode the 7D11 counts arbitrary trigger events, and delivers an output (notifies the delayed sweep) when the preselected number of events is reached. The unit can count events from 1 to 10,000,000 occurring at rates up to 50 MHz, and the events can be periodic, aperiodic, and contain instability such as jitter and drift.

To determine when to start counting the selected number of events, we need to provide a related synchronization pulse to the Events Start Trigger input of the 7D11. This could be the origin pulse, or, perhaps, a sector pulse from the flexible disc, depending on the measurement to be made.

Now let's take a look at some measurements on the flexible disc system. We will be working with the Memorex 651 Flexible Disc Drive. This system uses a disc speed of ≈ 375 RPM. Depending on user requirements, the data may be organized on the disc in multiple records per track (sector) or single record per track (index) format. There are 32 sectors and 64 tracks on the disc. Fig. 1 shows the format for each mode of operation.

The clock frequency used is 250 kHz. The clock is recorded on the track along with the data to permit accurate readout of data with variations in disc speed. Fig. 2 shows the relationship between the index and sector pulses, and the clock and data pulses. The READ

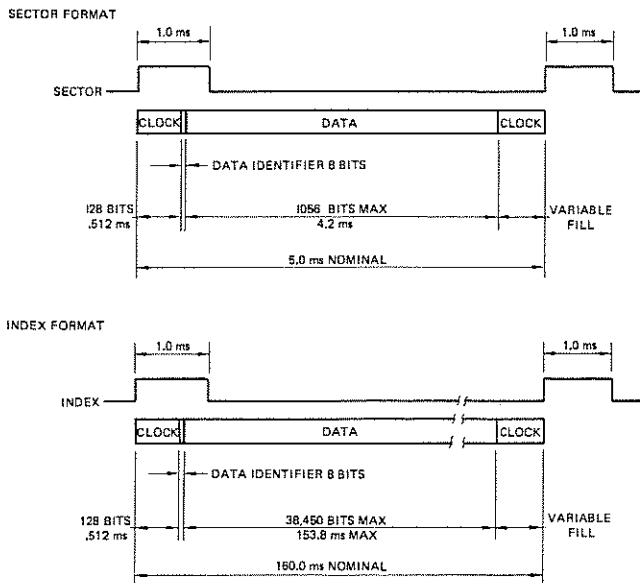

Fig. 1. Formats for data organized for multiple record per track (sector) and single record per track (index).

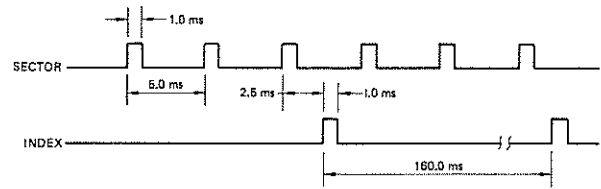

Fig. 2 (a) Timing relationship between the index and sector pulses.

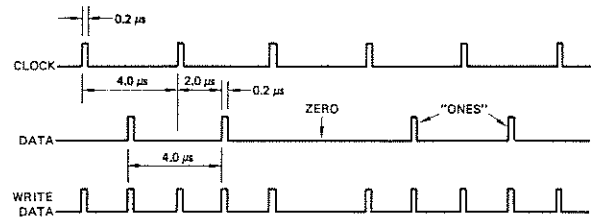

Fig. 2 (b) WRITE data timing and signal waveforms.

head reads the combined clock and data pulses recorded on the disc. The READ logic amplifies and separates them into two outputs: separated clock signals and separated data signals.

Signal Variations from Track to Track

One of the problems encountered in using a disc is the change in amplitude of the signal on the disc as you move from an outer track to an inner track. Fig. 3 (a) is the signal from Track 00 and 3 (b) the signal from Track 63. The bottom waveform in each photo is the analog signal from the READ head; the top waveform is the signal converted to a negative-going TTL-compatible pulse. You will note the events count is 1247. This indicates we have triggered the EVENTS START from one sector pulse and delayed out to permit us to view the start of data in the next sector. The shift of the data to the left in Fig. 3 (b) is due to the fixed spacing between the WRITE and READ heads causing us to miss more of the 136 bits between the start of the sector pulse and the start of data as we move toward the center

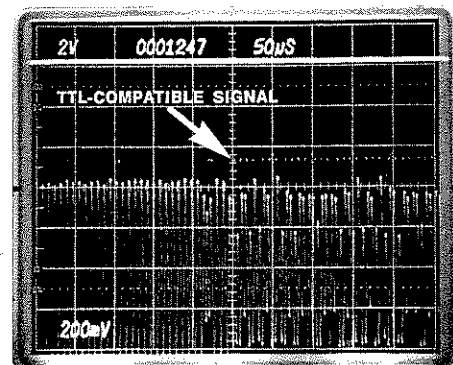

Fig. 3 (a) The lower trace is raw data from the READ head while reading Track 00. Upper trace is signal reconstituted in TTL-compatible format.

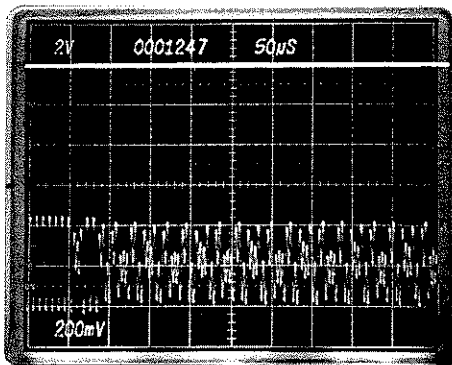

Fig. 3 (b) Same signal source as in Fig. 3(a) read from Track 63.

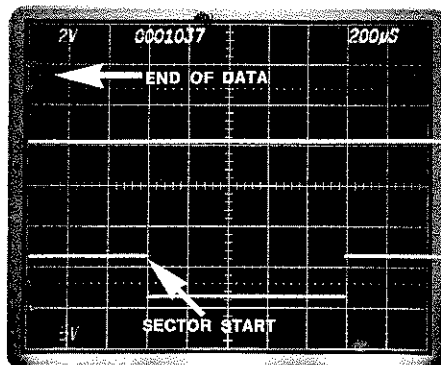

Fig. 5. Time interval from end of data in one sector to start of next sector pulse is easily viewed with the 7D11.

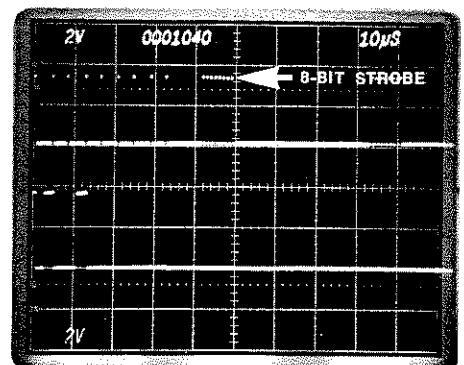

Fig. 7. An events count of 1040 takes us near the end of a sector to view the 8-bit strobe pulse moving data from the shift register to the computer terminal.

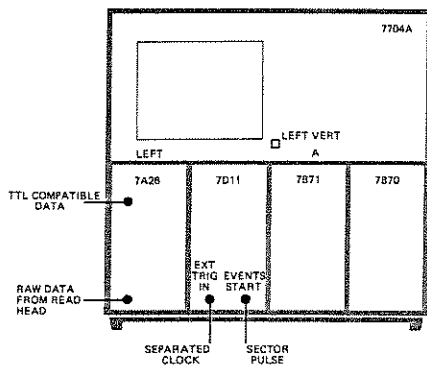

Fig. 4. Setup for making measurements displayed in Figs. 3(a) and 3(b).

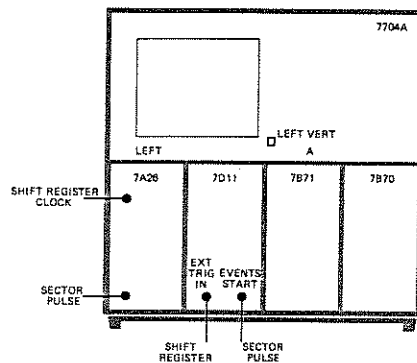

Fig. 6. Setup for making measurement displayed in Fig. 5.

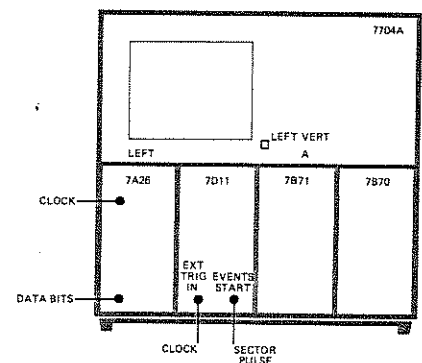

Fig. 8. Setup for making measurement displayed in Fig. 7.

of the disc. The setup to make this measurement is shown in Fig. 4.

Another point of interest in the system is the interval from end of data to the start of the next sector. This is shown in Fig. 5. The upper trace shows the data ending 100 μ s from the start of the sweep. The lower trace shows the next sector pulse starting approximately 500 μ s later. The events count of 1037 was selected to place the leading edge of the sector pulse conveniently on the vertical graticule line. Fig. 6 shows the 7704A setup for this measurement.

The photo in Fig. 7 shows some interesting sets of signals in the system. There are 1048 data bits recorded per sector. An events count of 1040 was selected so we could view the last data in the sector and check for the 8-bit strobing pulse that would transfer the data from the shift register to the computer terminal. The following 8-bit strobe pulse transfers the shift register to the next character. Fig. 8 shows the setup for this display.

Summary

These are just a few examples of the use of the 7D11 Digital Delay unit in making measurements in a flexible disc system. It provides a convenient means of locating and viewing any of the thousands, or in some cases, millions of bits of data present in the disc system.

Other digital plug-ins such as the 7D12 A/D Converter and the 7D15 Universal Counter/Timer are also valuable aids in making accurate voltage and timing measurements in a disc system.

Servicing the 465 portable oscilloscope

The first thing you need to know in servicing a product is how to get the cabinet off. This is less than obvious in much of the packaging used today. You will find it takes a little longer to remove the 465 cabinet than you're accustomed to with the 453. But there's a good reason. The 465 is six pounds lighter than the 453A. And part of the weight reduction is achieved by using the cabinet to mechanically strengthen the package. This is accomplished by extending the cabinet slightly beyond the rear panel of the instrument. When the rear ring assembly, with the feet attached, is installed and tightened down it compresses the cabinet and pulls on the main chassis member, stressing both of them. This stress adds strength to the package.

The best procedure for removing the cabinet is to put the front cover in place, set the instrument on the front cover and remove the six screws holding the rear ring assembly. Four of these serve as mounting screws for the rear feet. The cabinet is then slid off vertically. When replacing the cabinet on

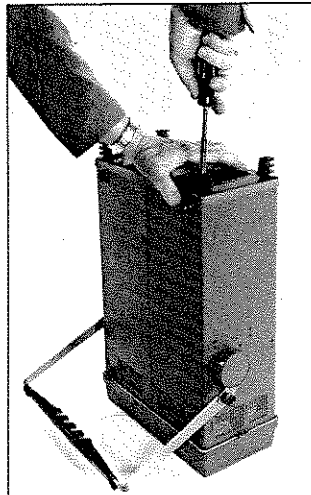
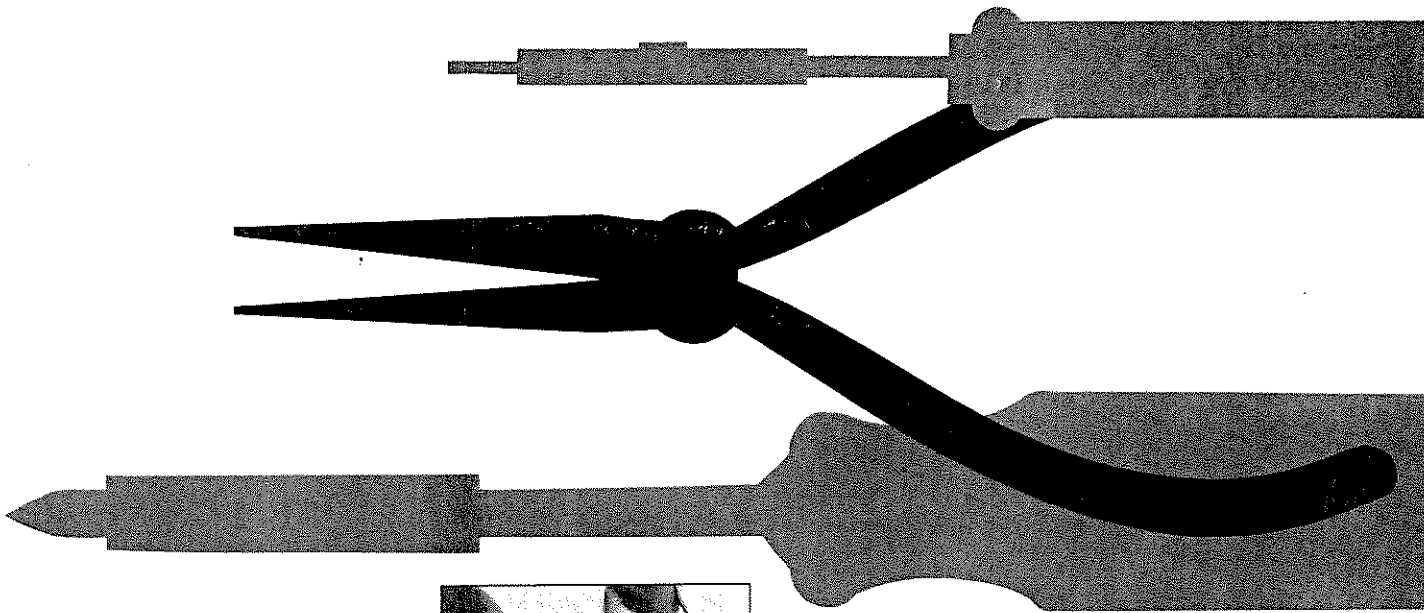

Fig. 1. The 465 cabinet is removed by loosening six screws on the rear panel.

earlier instruments, take care that the cabinet clears the components on the trigger-view board. In later instruments this circuitry is laid out on the trigger board.

It would be well at this point to make sure the instruction manual you are using matches the instrument you are servicing. Tektronix has always followed the policy of modifying the circuitry to improve performance and reliability as the occasion arises. Modification information is added in the back of the manual to keep it current with the instruments being shipped.

The Power Supplies

When a problem area is not readily apparent from front panel indications, a good place to start troubleshooting is the power supply. Temporarily-high line voltage sometimes causes the line fuse to blow. In instruments below SN B080000, circuits powered from the +120 V supply are protected from high line voltage by Q54 (Q1514 in some instruments). Should the line voltage exceed a given level, Q54 conducts placing a short across the transformer secondary and blowing the line fuse. When replacing the fuse you should use the specified value to prevent damage to the circuits protected by Q54. If the line voltage in your facility tends to fluctuate in the upward direction you may set the line Range Selector Switch Bar to the high position. The front-panel low-line light will come on should the line voltage fall below the lower limit of the regulating range selected.

Another problem you may encounter in the low-voltage supply is CR1512 shorting and taking out C1542. The cure for this is to remove CR1512. Do not discard this diode as it can be used in a modification to improve the high-voltage supply reliability.

The high-voltage supply is often difficult for many of us to troubleshoot. Here are some hints on servicing these circuits in the 465. The first step is to isolate the problem area. There are three major areas of concern: the high-voltage oscillator and DC-error amplifier, the over-voltage protection circuit, and the secondary load including the CRT and the high-voltage multiplier. By disconnecting the appropriate circuit the high voltage should come up. Try the following sequence:

1. Remove the CRT socket — this eliminates the CRT.
2. Disconnect CR1412—this eliminates the over-voltage protection circuit.
3. Remove Q1416 and place an 820 Ω to 1 k Ω resistor between the collector and emitter pins. This allows \approx 8 ma of turn-on bias current to start the oscillator. If this does nothing, replace C1416 and C1419. (C1419 should be replaced anytime the high-voltage oscillator Q1418 is shorted.)

If at this point the high-voltage reading at TP1423 is \approx 400 volts, the high-voltage multiplier is most likely defective. In newer instruments this can be quickly checked by lifting the dummy resistor that connects the multiplier ground. Arcing from this point to adjacent circuitry sometimes occurs when this ground strap is lifted. For earlier instruments you will have to remove the vertical preamp board and the multiplier cover to get to the high-voltage transformer and multiplier connection. Lift the transformer lead and CR1421 from the mounting post on the multiplier, connect them together and dress them away from the mounting post to prevent arcing across. If the negative high-voltage supply comes up now, the multiplier is defective. A defective multiplier will also sometimes cause high-voltage fuse F1419 to blow.

Another condition that can effect the high voltage is leakage in diodes CR1482, CR1483, CR1487 or CR1488. These are in the CRT grid bias supply and can turn the beam on hard or turn it off so you have no intensity. Another point to check is pin 12 on the CRT; this should be +150 V. Leakage in C1427 may pull this point down in some instruments between SN B080000 and B130000.

Check to see whether R1427, which parallels C1427, has a zener diode in parallel with it. If not, your instrument doesn't have the high-voltage reliability modification and it should be installed. It consists of adding or changing just four components:

1. CR1476 located near Q1474 should be replaced by CR1512 which you removed from the low-voltage supply.
2. A 0.1 μ F, 200 V capacitor should be added from the cathode of CR1476 to ground.
3. A 180 V zener, Tektronix part number 152-0289-00, should be paralleled with R1427 with the cathode to ground.
4. Lift the cathode end of CR1427 and add a 1.8 k Ω , $\frac{1}{4}$ W, 5% resistor between the cathode and the point to which it was soldered on the circuit board. This completes the modification.

The Sweep Circuit

The sweep circuit contains several feedback circuits and is difficult to troubleshoot unless you break the feedback loop. A convenient means of doing this is to pull the Disconnect Amplifier, Q1024. This causes one sweep to be generated and often provides a rapid clue as to what portion of the circuitry is in trouble.

The horizontal amplifier circuitry is push-pull and can be checked by the usual method of shorting the two sides by means of a jumper. Another useful technique is to swap transistors in each stage and see if the problem changes sides accordingly.

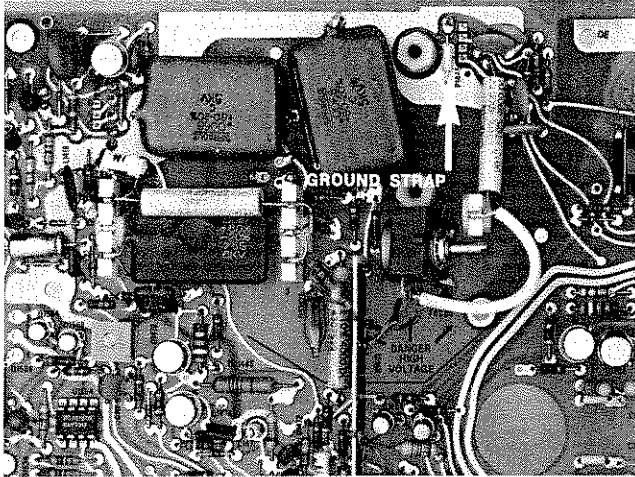

Fig. 2. A portion of the interface board showing location of the high voltage multiplier ground strap and other components.

The Vertical Amplifier

If you have occasion to service several 465's you may note that some units have an integrated circuit output amplifier while others use discrete components. The front panel BEAM FINDER control provides a rapid means of detecting trouble in this circuitry. Pressing the BEAM FINDER button should bring the trace on-screen vertically. If it doesn't, look for the problem in the output amplifier circuitry.

Moving to the preamp, one of the more elusive problems you may encounter is an intermittent contact between transistors and their sockets. What usually happens, is the transistor is pulled from the socket, tested and found to be O.K. When the transistor is put back into the socket, the problem disappears. The basic cause seems to be a tendency for the contacts to "wick up" rosin and solder during the automatic flow soldering process. A change has been made in manufacturing procedures to overcome this tendency. If you suspect that you have this problem, you can clean the socket with isopropyl alcohol, using a wire to loosen the rosin inside. A camel hair brush works best in applying the isopropyl and a syringe is handy for blowing out dirt particles.

Another question often asked is how to get the transistor pairs used in the preamp, properly mounted in their heat sinks. The easiest way is to first insert the transistors in their sockets and then slip the heat sink loosely over them. Next, extract the transistors and heat sink together by gripping the heat sink firmly with a pair of pliers, and pulling. Continue to hold firmly with the pliers while tightening the screw in the heat sink. Then reinsert the transistors in their sockets.

While we're in the preamp area, another condition sometimes occurs that appears to be drift in the vertical attenuator compensation. In most cases this results from the technique used in making the adjustment. The

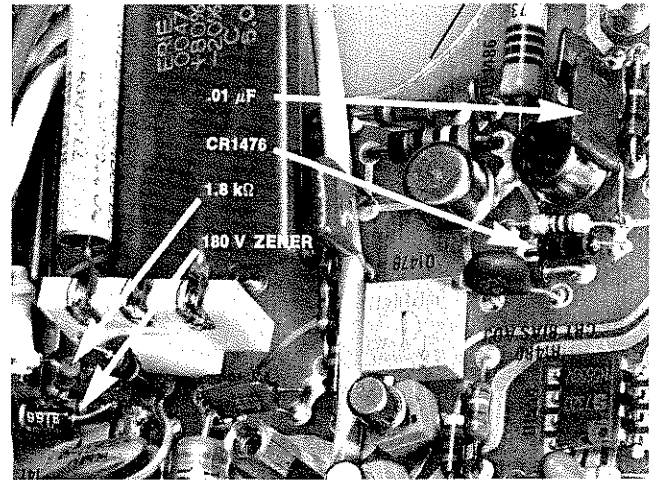

Fig. 3. A portion of the interface board showing the high-voltage reliability modification installed.

compensation capacitors have a spring that provides tension. When making the adjustment it will help to "rock it in" to remove the torque portion of the spring tension. Just overshoot the desired setting a little and then back off to the proper point.

Mechanical Considerations

One of the unique components used in the 465 is the cam switch developed by Tektronix. These are relatively trouble-free but occasionally require cleaning of the contacts. Isopropyl can be used for this purpose. Here again you will find a camel hair brush handy. Do not use cotton swabs as they are prone to snag on contacts, damaging them.

Special care is needed when working on the vertical attenuator cam switches. The polyphenylene oxide boards are brittle and easily damaged by using too much force when tightening the screws holding the cam switch. Two fingers on the screwdriver will provide enough torque. These boards also are easily damaged by heat so when soldering on them, use a small iron and get on and off quickly.

Cleaning the Instrument

The same procedures and materials used to clean other Tektronix instruments can be used for the 465. For washing the entire instrument a solution of one part Kelite to twenty parts water can be used. For spot cleaning, especially in the area of the vertical attenuator boards, you should use isopropyl alcohol. Carbon-based solvents will damage the polyphenylene oxide boards used for the attenuators. This is also important to keep in mind when using spray coolants in this area. ☞

INSTRUMENTS FOR SALE

360 Indicator, 126 Power Supply with cabinet, \$145. Robert Kaplan, Ebasco Services Inc., 2 Rector St., New York, NY 10006. (212) 344-4400.

317, (2) 321A's. Lindsay Acuff, Cleveland Electric Co., 557 Marietta St. 1 N.W., Atlanta, GA. 30313. (404) 524-8422.

434 w/cart and accessories, unused. Roy Madison, 1606 18th Ave., PO Box 1088, Tuscaloosa, AL 35401. (205) 345-2990.

453A MOD127C in mint condition. \$1750. Charles Boister, Box 2376, Apt. H-203, 635 Baker St., Costa Mesa, CA 92626. (714) 557-0792.

453, three years old, \$1250. Fred Lindsey, Vallejo, CA. After 5:00 PM. (707) 644-7037. 503, good condition. \$200. Ray Lefebvre, Electrical Eng., Louisiana State Univ., Baton Rouge, LA 70803. (504) 388-5241.

514D (7), 514AD, 511AD, 531 fair condition. Best offer. W. A. McConnell, Dutchess Community College, Poughkeepsie, NY 12601. (914) 471-4500, Ext. 268.

517, less power supply. Will trade for 530/540 Series vertical plug-in. Dr. Shuster, Box U125, University of Conn., Storrs, Conn. 06268.

517A w/power supply, no cables. As is \$135. Type B plug-in, 122 preamp, 280 trigger. E.C. Fether, 8713 Marble Dr., El Paso, TX 79904. (915) 755-0226.

527 Waveform Monitor, MOD132. Thomas O'Brien, 2194 Coker Ave., Charleston, SC 29412. (803) 556-8824 (home), (803) 792-3030 (business).

531A, \$400; 533, \$450; B, \$50; CA, \$165. Exc. condition. Kurt Dinsmore, Box 67, Richardson, TX 75080. (214) 271-2431 or (214) 238-0591, evenings.

543B, 1A2 plug-in, good cond. \$800 or best offer. Pat Young, (415) 654-6855.

545A w/cart, 2 ea. Best offer. Neria Yomtoubian, Master Specialties, 1640 Monrovia, Costa Mesa, CA 92627. (714) 642-2427, Ext. 218.

545A, RM 35A, 1A1, CA and two ea. 541's. Howard Baugh, Wyle Computer Products, Inc., 128 Maryland St., El Segundo, CA. (213) 678-4251.

547, 1A1, 1A5, like new, best offer. Paul Fincik, Automation Sys., Inc., 7031 Marcelle St., Paramount, CA 90723. (213) 634-5810.

INSTRUMENTS FOR SALE

549, 1A1. Maurice Bruneau, Nashua Corp., 44 Franklin St., Nashua, NH 03060. (603) 883-7711, Ext. 506.

549, \$1000. Mike Surratt, OECO Corp., 712 S.E. Hawthorne, Portland, OR 97214. (503) 232-0161, Ext. 349.

561A/3A75/2B67, like new. Jack Gerylo, 5707 Santa Fe St., San Diego, CA 92109. (714) 453-4013.

661/5T4/4S1, clean, like new. Want Collins 30S1 linear or equiv. dollar value. Ed Valentine, Top-O-Hill Rd., Wappingers Falls, NY 12590. (914) 297-3461.

661/4S1/5T1, excellent cond. Sell or trade for real time scope around 10 MHz. George Capasso, 25 Quarry Dr., Wappingers Falls, NY 12590. (914) 297-7538.

357, 3T7 TDR plug-ins, never used. \$950. Art Eberle, Columbia Gas Systems, 1600 Dublin Rd., Columbus, OH 43212. (614) 486-3681, Ext. 461.

2B67 and 3A74 to trade for 3B3 or 3B4 and 3A6. H. L. Beazell, 104 Key West Dr., Charlottesville, VA 22901.

202-2 Cart, \$100; E Plug-in, \$60. Neil Perling, 2803 Kipling, Palo Alto, CA (415) 321-2714 or Walt Sonnenstuhl, 41 Moraga Way, Orinda, CA 94563.

C-31 Camera, excellent condition. Reasonable. Mr. Sinclair, 160 E. 84th St., N.Y., NY 10028. (516) 234-0200 (days); (212) 861-9862 (evenings).

549 w/1A1. Bob Schmidhammer, Metric Data System, Rochester, NY. (716) 325-6550.

515, good condition, \$300. Hal Greenlee, 430 Island Beach Blvd., Merritt Island, FL 32952. (305) 853-9991 (business), 636-0805, (home).

R5103N/D12, three 5A24N's. Almost new. Best offer. Maurice Asa, Box 2947, Rockridge Station, Oakland, CA 94618. (415) 654-2665.

2601, 26A1, 26A2, 26G3. John Foster, N/J Electronics, P.O. Box 577, Laramie, WY 82071.

211 (15). Richard Strickler, Storage Technology Corp., 2270 S. 88th St., Louisville, CO 80027. (303) 666-6581.

TELEQUIPMENT DM64, new. \$1,000 or best offer. Alpha Labs, Inc., 2115 No. Piedras, El Paso, TX 79930. (915) 566-2927.

INSTRUMENTS FOR SALE

C-27R Camera, Polaroid roll film back and bezel. Good condition. \$375. (203) 848-8614 after 7:00 P.M.

546 (2), like new, \$1250 ea.; 543 w/CA, \$750. Consider good cash offer. Ivan Sundstrom, 695 E. 43rd, Eugene, OR 97405. (503) 686-2380 evenings, weekends.

531A/CA/D. Wayne Siebern, St. Joseph Power & Light, 520 Francis, St. Joseph, MO. (816) 238-0025.

516, excellent condition. \$500. Dave Friedman. (213) 837-3089.

564B w/2B67, 3A6, scope cart and C-27 Camera, new. Also 585A with 53/54G and scope cart. 661 w/4S1 and 5T1 and scope cart. Excellent condition. Chemistry Dept., Univ. of Bridgeport. (203) 384-0711, Ext. 382.

(3) 5103's. \$450 ea. or best offer. Also (3) 5B10N's, (3) 5A18N's and (1) 5A21N. Jon Orloff, Elektros Inc., 10500 S.W. Cascade Dr., Tigard, OR 97223. (503) 620-2830.

INSTRUMENTS WANTED

160 Power Supply in working condition. Prof. Winthrop Smith, U46 University of Connecticut, Storrs, CT. (203) 486-4918. 321A. Marvin Loftness, 115 W. 20th, Olympia, WA 98501. (206) 357-8336.

422, 465 or any portable scope. H. O. Van Zandt, 18 Chandele Dr., Hampshire, IL 60140. (312) 683-3690.

453 or 454. S. L. Shannon, G.T.W.R.R. Radio Shop, 105 Hampton, Battle Creek, MI 49016.

520 or 520A. Al Dodds, Applied Video Electronics, Inc., P.O. Box 25, Brunswick, OH 44212. (216) 225-4443.

555 with time bases, C-12 or C-27 Cameras. A. C. Smith, Jr., High Voltage Lab., Cornell Univ., 909 Mitchell St., Ithaca, NY 14850.

2-2A60's. Darwin Carner, General Electric, 3001 E. Lake Rd., Erie, PA 16501. (814) 455-5466, Ext. 2635.

2A63. Roy Schreffler, Box 531, Knox, PA 16232.

Plug-in vertical amplifiers for TELEQUIPMENT D43 scope. Wm. A. Richards, 46 Alderwood Lane, Rochester, NY 14615.

TELEQUIPMENT D67, D85. 453 or 422. Also 3B3 plug-in. Hal Greenlee, 430 Island Beach Blvd., Merritt Island, FL 32952. (305) 853-9991 (business), 636-0805 (home).

A-2923

TEKTRONIX, INC.
P.O. BOX 500
BEAVERTON, OR. 97005

BULK RATE
U.S. POSTAGE
PAID
Tektronix, Inc.

69C1272G
MR FRANK CROOK
MILGO ELECTRONICS
STANDARDS LABS
7620 N W 36TH AVE
MIAMI FL 33147