

# Instruction Book

for the

## WESTON MODEL 772, TYPE 6

SUPER SENSITIVE ANALYZER

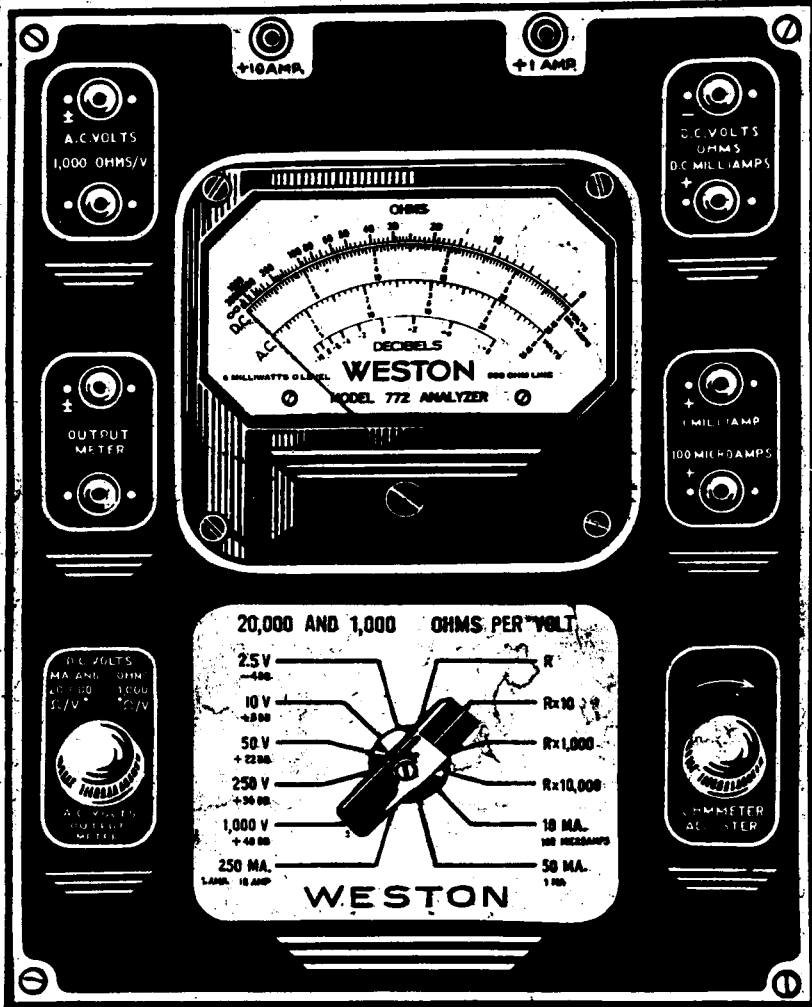

WESTON ELECTRICAL INSTRUMENT CORPORATION

Newark 5, New Jersey, U.S.A.

to. Switch  
ugs between  
x 10. Read-  
taken with

# Instructions for Model 772, Type 6 Analyzer

## I. DESCRIPTION OF THE ANALYZER

**1.1 — General.** This model 772 analyzer has been specifically designed to place in the hands of the service man an ultra sensitive and complete analyzer for all types of service work. In designing this equipment every possible extra cost has been eliminated and the design kept as clean and free as possible from gadgets and other unnecessary frills. All the equipment with the exception of the batteries for the ohmmeter is mounted directly on the metal panel, this panel mounting directly in the instrument carrying case. The complete analyzer is of rugged construction and with reasonable care should give many years of accurate service.

**1.2 — Instrument.** The heart of any piece of test equipment is the electrical measuring instrument. If this particular part is not carefully and accurately designed and constructed no matter how many other parts are used in the equipment the device cannot give accurate readings. The instrument in the Model 772 is of the 4¼" type having a movement considerably larger than that used in the 301 size meters. The meter is purposely designed with a large open face so that light will be admitted to the scale from all sides giving maximum visibility of the scale. In addition a large scale plate is used with a long pointer length so that maximum scale arc length is available. The instrument is equipped with a tubular type pointer having an extended knife edge covering all of the arcs. Considerable work has been done on the design of the scale to increase ease of readability and to make possible a maximum accuracy. The d.c. scale which is the most important of the voltage and current measurements consists of a 100 line or division arc. A large instrument of this type makes possible such a finely divided scale. Directly above this d.c. scale appears an ohm scale extending from 0 to 3000. This arc has been carefully divided to give accurate ohm readings. The a.c. and db scales have been calibrated in red to differentiate them from the d.c. Note that all a.c. voltages, no matter what range is used, are read on a single arc. Painstaking research in the laboratory has resulted in a newly developed rectifier and associated circuit which makes possible the measuring of a low voltage on the 2.5 range and a higher voltage on the 10-50-250 or 1000 range with equal accuracy using a single arc.

**1.3 — Panel.** The panel for this instrument has been carefully worked out to provide simplicity of operation along with modern appearance. Brief instructions for each of the controls are etched directly in the panel so that once the general operation of the tester is understood no further instructions need be referred to. The molded bakelite pin jacks used in this model are of a new and highly efficient design. When working with sensitivities of 20,000 ohms per volt, leakage paths in the mechanical structure of the tester must be kept at a minimum. It is easy to see that on the 1000 volt d.c. range 20

megohms of adjusted resistance is required. If, therefore, a shunt leakage path of even 200 megohms should appear across any of the pin jacks then a 10% error in reading might occur. It is, therefore, vital that these jacks should be of the best molded bakelite and they have been designed with a very long leakage path. The phosphor bronze clip in the jack is mounted from the back end and, therefore, the leakage path across the jack is from the panel all the way down to the base of the jack at the back to the insert or approximately ½". Ten active jacks appear on the panel, the two above the meter being available for the 10 and 1 amp. range and for mounting the type 666, selector block. The use of this block as a part of the analyzer equipment will be covered later on in the instructions. The two upper right-hand jacks labelled d.c. volts, ohms, and d.c. milliamperes are used for all of the d.c. volt ranges, all of the ohm ranges and for all of the d.c. milli-ampere ranges appearing on the switch. There are available then from these jacks the following:

D.C. Volts		D.C.
20,000 Ohms per Volt		Milliamperes
or 1,000 Ohms per Volt	Ohms	
	2.5	0 — 3000
	10	0 — 30,000
	50	0 — 3 megohms
	250	0 — 30 megohms
	1000	

**1.31—**All d.c. volt ranges are available at two sensitivities. This dual sensitivity arrangement is of considerable help, where data taken on 1,000 ohm per volt instruments has been listed. The two sensitivities are available from the small 3-position functional switch to the left of the range switch. This control is equipped with a small bakelite knob having two index dots spaced 180° apart. For 20,000 ohm per volt sensitivity, index the upper dot on the knob to the left-hand position or, in other words, rotate the control to the extreme counterclockwise position. For 1000 ohms per volt the upper dot should be indexed to the right or to the extreme clockwise position. For a.c. volts, this control is indexed with the lower dot in the center position. Readings on the 20,000 ohms per volt sensitivity are of considerable advantage on high resistance circuits as the maximum current drain is 50 microamperes. This makes possible far more accurate readings of grid bias, screen and plate voltage in all types of equipment where high resistance circuits are used.

**1.32—OHMS.** Four ohmmeter ranges provide accurate resistance measurements from ¼ ohm to 30 megohms. Before taking resistance readings, be sure the 3-position functional switch is set to either the left-hand or right-hand index position. Ohmmeter readings cannot be taken when this switch is indexed for a.c. volts. It can, however, be in either of the two ohmmeter positions without any effect on the ohmmeter accuracy. Plug one end of the test leads into the jacks marked D.C. Volts-Ohms-D.C. Milliamps and touch the free ends to the circuit being measured. For readings from ¼ ohm to 100 ohms, the Selector Switch should be in the R position. For readings between 100 and 1,000 ohms set the Switch to R x 10. Readings from 1,000 ohms to 1 megohm are taken with

the switch set to R x 1,000 and for measurements up to 30 megohms the R x 10,000 range is used. Before making resistance measurements and when changing ranges the operator should short the test leads and rotate the OHMMETER ADJUSTER until the pointer indicates exactly full scale. The accuracy of the readings obtained depends largely upon the care with which this setting is made. The d.c. battery potential on the three lower ohm ranges is 1.5 volts. On the R x 10,000 range 15 volts is used. This means that the ohm ranges can be used on all types of low voltage condensers and other low voltage equipment to measure leakage, resistance, etc. When the ohmmeter ranges are used it must be kept in mind that the "+" pin jack is connected to the negative end of the internal ohmmeter battery. This means that when testing electrolytic condensers for leakage, the negative side of the condenser should be connected to the panel jack marked +. This information is important to observe correct polarity and to obtain the resistance of the condenser under correct polarity conditions.

**1.33—AMPERES, MILLIAMPERES AND MICRO-AMPERES.** Eight d.c. current ranges are available. To take current readings, plug the test leads into the jacks marked D.C. VOLTS-OHMS-D.C. MILLIAMPS and set the switch to the 10, 50 or 250 milli-ampere range as required. If readings below these values are needed, the - test lead should be left in its jack but the + lead should be plugged into the 1 MILLIAMP or 100 MICROAMPS jack. The circuit should be checked before connecting the meter into these last two ranges. This is especially true on the 100 microampere range where the instrument is sensitive enough to read all kinds of leakage and shunt currents. When taking readings on the 1 MILLIAMP or 100 MICROAMPS ranges, the range switch should be set to the 1 MILLIAMP or 100 MICROAMP positions respectively. If readings above 250 MILLIAMPS are required, set the range switch to 250 MILLIAMPS-1 AMPERE-10 AMPERES position and move the + lead to the 10 amp. or 1 amp. pin jack. Note that for all d.c. measurements the functional switch to the left of the range switch should always be in one of the D.C. VOLTS-MILLIAMPS or OHMS positions. Readings of 50 microamperes full scale may be taken when this extreme sensitivity is required. This is accomplished by plugging the test leads into the D.C. VOLTS-OHMS-D.C. MILLIAMPS jacks and setting the rotary switch to the 2.5 volt position. The instrument is now converted into a 50 microampere high resistance microammeter and readings may be taken directly and accurately in terms of 50 microamps full scale. Some resistance is still in this circuit due to the 2.5 volt range but this is advantageous as it tends to protect the meter from heavy overloads. Note that when taking readings on this 50 microampere range, the first full division on the scale is .5 microampere.

THE 10 AMPERE, 1 AMPERE, 1 MIL. AND 100 MICROAMPERE RANGES HAVE PURPOSELY BEEN BROUGHT OUT TO PIN JACKS SO THAT WHEN CHANGING POSITIONS ON THE ROTARY SWITCH THE METER WILL NOT BE SUBJECT TO SEVERE OVERLOADS IN PASSING THROUGH THESE RANGES.

**1.34—A.C. VOLTS.** Five a.c. volt ranges are available for the same full scale values as the d.c. ranges. All of these a.c. ranges operate at 1000 ohms per

volts. This sensitivity is entirely sufficient for the most sensitive a.c. readings and is far preferred to higher sensitivity as much more accurate readings can be obtained. When the current density in an instrument rectifier gets far below a 1 mil. or 1000 ohm per volt value, its temperature and resistance characteristics become very critical and therefore, standard 1000 ohms per volt a.c. ranges are supplied. A new rectifier and associated circuit permits a single a.c. arc for all voltage ranges and has decreased the error due to temperature to 2% from 40° F. to 114° F. Note that when taking readings on a.c. or across the output meter jacks, the 3-position functional switch in the lower left-hand corner must be indexed to the A.C. VOLTS-OUTPUT METER position. Accurate readings can be taken on the a.c. ranges over a wide band of frequencies extending over the complete audio spectrum. The meter has a substantially flat frequency characteristic up to 7000 cycles and at this point starts to drop off at approximately 5% per thousand cycles. This slight error is generally considered negligible as it is far smaller than the errors introduced by even the best of transformers and other such equipment. NOTE THAT ALL A.C. READINGS ARE TAKEN ON A SINGLE ARC LOCATED BETWEEN THE D.C. AND DB. SCALE.

**1.35—DECIBELS.** Total db range from -14 to +54 is available in 5 steps. The zero power level is based on a 6 mw. level in a 500 ohm line. To take readings of decibels place the test leads in the a.c. volt jacks and index the functional switch in the lower left-hand corner in the A.C. VOLTS-OUTPUT METER position. Set the selector switch to the power level desired and take readings on the decibel arc, adding or subtracting to the indication the figure engraved on the panel directly under the voltage range selected. For example: If the selector switch is set on 50 V and the meter reads -2 db, add +22, the figure engraved under the 50 Volt position, and the power level is +20 db.

**1.36—OUTPUT METER.** The output meter jacks should be used only when d.c. must be kept out of the circuit. A blocking condenser of .2 microfarad is connected in series with these jacks protecting the meter from d.c. current. It is not advisable to take actual volt readings on these jacks except on the higher ranges. While the readings on each of the volt switch positions will be approximately the same as the readings appearing across the a.c. volt jacks, the reactance of the condenser will add vectorially to the resistors in the meter circuit and therefore will cause a slight drop in instrument reading. Likewise reactance of the condenser will vary with frequency and therefore accurate readings of a.c. volts should not be made using these jacks but should be taken with the leads connected to the a.c. volt jacks.

**1.4 — Batteries.** This tester requires 3 batteries. A 1.5 volt flashlight cell (Burgess No. 2 or Eveready No. 950 unicell) is used for the R, R x 10, and R x 1000 ranges. This cell should be replaced when it is no longer possible to bring the pointer to top scale or zero mark on these three ranges. Two 7.5 volt batteries (Burgess No. 5540 or equivalent) are used only with the R x 10000 range. These cells should be changed when it is no longer possible to bring the pointer to zero mark on this range. To replace the unicell, place the thumb over the positive battery end of the clamp pressing toward the battery, and pull up



1-B' Batt - 15.0V

the wire ring clip. Replace the unicell and refasten the ring clip by placing the open end over the two projections at the negative end and snap the closed end over the thumb clamp at the positive end.

50	volt range —	1 megohm
250	volt range —	5 megohms
1000	volt range —	20 megohms

When replacing the two 7.5 volt batteries, the connections are as follows:

Connect the two in series by connecting the black lead on one to the + terminal on the other. The remaining black lead should then be connected to the binding post on the negative end of the 1.5 volt battery clamp. The free red lead from the tester panel should then be connected to the remaining + post to obtain 15 volts.

**1.5 — Case.** This tester is equipped with a sturdily constructed wooden case which will stand considerable abuse. The wood is finished in a natural color, no stain being used so that scratches incurred during normal service will not show to any appreciable extent. However, should the case become marred it may easily be touched up by using clear lacquer on the section affected or by rubbing up with any good furniture polish.

**1.6 — Test Leads.** One standard pair of test leads is supplied with this instrument. These may be used at all times in conjunction with the tester proper or with the Model 666 Selector Block. If the leads are lost or broken, they may be replaced by ordering Test Leads Nos. 70033 and 70034.

**1.7 — Instruction Book** One copy of this instruction book is supplied with each tester. In the latter section of the book abundant data is available in regard to the operation of the tester as well as some information on circuit analysis or receiver or amplifier trouble shooting. This book should be kept inside of the tester when it is being transported so that it will be available for immediate use at any time, should questions arise as to the most efficient operation of the tester.

## Test Procedure

### II. SELECTION OF RANGES

#### 2.1 — D. C. Volts

- Plug red test lead in the + jack marked D.C. VOLTS-OHMS-MA. Plug black test lead in — jack.
- Set the 3-position functional switch to either the 1000 ohm per volt or the 20,000 ohm per volt position, depending upon the voltmeter sensitivity desired.
- Rotate range switch to any one of 5 ranges required.
- Take reading on black d.c. 100 line arc using figuring that goes with this arc. Multiply by 1, 10, or 100 in accord with the switch range being used.

NOTE: All ranges are available at 1,000 and 20,000 ohms per volt. The current that the voltmeter draws may be calculated on the basis of 1 milliamp or 50 microamperes respectively.

- The resistance of the high sensitivity voltage ranges are as follows:

2.5	volt range —	50,000 ohms
10	volt range —	200,000 ohms

#### 2.2 — Ohms

- Plug test leads in D.C. VOLTS-OHMS-MA. jacks.
- Set functional switch in either left or right-hand ohm position.
- Rotate range switch to ohm range desired.
 

R range	0 —	3,000 ohms
R x 10	0 —	30,000 ohms
R x 1000	0 to 3	megohms
R x 10,000	0 to 30	megohms
- Short test leads and set pointer to top mark by rotating OHMMETER ADJUSTER.
- Take ohm readings on top arc using multiplying factor in accord with the switch position.

#### 2.3 — D. C. Current

- Plug leads in D.C. VOLTS-OHMS-MA. jacks.
- Set functional switch to either left or right-hand MA. position.
- Rotate range switch to milliampere range desired. (250, 50 or 10 MA.)
- Take readings on 100 line d.c. arc.

For 1 milliampere or 100 microamperes: <sup>P4</sup> 70-2

- Leave black lead in — jack.
- Plug red lead in + 1 MA. or + 100 MICRO-AMPERES jack as required.
- Set range switch in 10MA—1MA—.1MA position.
- Take reading on 100 line d.c. arc. <sup>0.20</sup> <sub>bat 2</sub>

For 50 microamperes:

- Set up tester for d.c. volts.
- Rotate range switch to 2.5 volt position.
- Take readings of 50 microamperes full scale on d.c. arc.

For 10 Amp. or 1 Amp.:

- Leave black lead in — pin jack.
- Set range switch to 250MA—1Amp.—10Amp. position.
- Plug red lead in + 10 Amp or + 1 Amp pin jacks as required.
- Take reading on 100 line d.c. arc.

#### 2.4 — A. C. Volts

- Plug leads into A.C. VOLT jacks.
- Set functional switch to the center position marked A.C. VOLTS-OUTPUT METER.
- Rotate range switch to any one of the five volt ranges.
- Read on red arc for all volt ranges.

#### 2.5 — Output Meter

- Plug test leads in OUTPUT METER jacks.
- Set functional switch to A.C. VOLTS-OUTPUT METER position.

- c. Rotate range switch to any one of the five volt ranges desired.
- d. Readings will be relative as condenser in circuit will cause error on low ranges.

NOTE: A .2 mfd. series condenser is built in the analyzer protecting the instrument from d.c. Do not use output jacks on d.c. circuits having potentials much over 400 volts, as this is the working voltage of the condenser.

### 2.6—Decibels

- a. Plug leads into A.C. VOLT jacks.
- b. Set functional switch to A.C. VOLTS-OUTPUT METER position.
- c. Rotate range switch to any one of the five volt positions.
- d. Read on the red decibel scale.
- e. Subtract or add to the meter indication the figure engraved on the panel just below the volt range selected.



View Showing Model 666 Socket Selector Block Mounted on Model 772 Analyzer

Figure 2

from the block jacks to any of the tester jacks. IF THE TUBE ELECTRODE POSITIONS ARE NOT KNOWN, REFERENCE SHOULD BE MADE TO THE TUBE BASE DATA CONNECTION CHART, A COPY OF WHICH IS ENCLOSED. These charts tie any tube base to the numbers on the selector block.

THIS METHOD IS ESPECIALLY VALUABLE AS A CURRENT JACK IN EACH CIRCUIT ALLOWS INSERTION OF ANY MILLIAMPERE RANGE IN ANY ELECTRODE CIRCUIT. CURRENT READINGS ARE VITAL AS THEY TELL JUST WHAT THE TUBES ARE DRAWING.

Convenient point to point resistance checks are also valuable and can be most easily made across the readily available selector block jacks. Note the picture of the analyzer set-up for measurements of plate current on a type 6-A-8 tube.

## IV. UNUSUAL MEASUREMENTS MADE WITH THE MODEL 772 ANALYZER

4.1 — Measurements of grid, plate, screen and cathode voltage can be made with far better accuracy on a 20,000 ohm per volt analyzer than on those with lower sensitivity. The high resistances used in these circuits will cause large voltage drops when an instrument of low sensitivity is inserted in the circuit. Power detectors using high resistance cathode circuits are difficult to measure for exact bias as the current in these circuits is quite small. By using the 50 volt range on the Model 772 such voltage can be accurately measured in the vicinity of 20 volts which is often required for power detection. When making a measurement of this type only 20 microamperes would be drawn by the meter,

## III. MODEL 772 ANALYZER WITH MODEL 666 SOCKET SELECTOR

3.1 — This tester has been designed for use as an analyzer using Weston's well known method of socket selector analysis. The 10 amp. and 1 amp. pin jacks directly above the instrument are correctly spaced to fit the pins on the base of the Model 666 Selector block. By fitting the block in position and using the small jumper leads supplied with the block, voltage, current, resistance, decibels and output readings can be taken rapidly and accurately on any type of tube base irregardless of its pin arrangement and electrode position. When the selector unit is used there will be no requirements necessitating the use of the 10 amp. and 1 amp. current ranges, and hence the placing of the selector block on these pin jacks will not limit the use of the two high current ranges. The tester case has been provided with a compartment at the top for carrying this block and its set of skirted adapters. These adapters carry over the tube pin numbering on each type of base in accord with the standard Weston and RMA. tube base charts which are supplied with the socket selector unit. The adapters fit into the holes in the wooden block mounted in the bottom of this compartment.

3.2 — To obtain readings set the socket selector block in position using the two above mentioned jacks, as shown in figure 2. Select the adapter that has the base corresponding to that of the tube under test. These adapters are color coded so that they can be picked out rapidly.

- 4 prong—red
- 5 prong—green
- 6 prong—blue
- small 7 prong—light brown
- large 7 prong—black
- 8 prong—orange
- 8 prong loktal—dark brown
- 7 prong miniature—black

Place the skirted adapter in the selector block and the plug adapter on the end of the analyzer plug. Remove the tube on which measurements are to be taken from the chassis and insert plug. Place the tube in the block socket. If the operator is familiar with the tube electrode positions, measurements of current, voltage or resistance on any electrode may be rapidly made by connecting the jumper cables

this being a fraction of the current in the cathode circuit of these tubes. In general, for making all types of voltage measurement, the instrument can be handled like any other voltmeter but if there is any doubt in the serviceman's mind as to the greatly increased value of this sensitivity, an easy test can be made by taking measurements on a 250,000 ohm plate circuit of the resistance coupled to it. A comparison is shown below, giving the readings that would be obtained on this modern analyzer as against the old 125 ohm per volt and later 1000 ohm per volt types.

4.2 — Measurements of rectified diode current are of vital importance in making tests of a.v.c and diode detector receivers. Diode currents seldom run over 100 microamperes except on very strong signals and, therefore, measurements as low as 1 microampere will be very valuable. Diagrams showing the method of taking these measurements in a typical diode detector and a.v.c circuit is shown in figure 3. If the one megohm resistor is used in the a.v.c circuit, the a.v.c bias can be read directly on the instrument by converting each reading in microamperes directly to volts, as one microampere through a megohm will give a reading of

one volt. Note that the 100 microampere range is used for some readings as its resistance is quite low i.e., in the order of 1250 ohms. For more sensitive readings the 2.5 volt position can be used for reading 50 microamperes, but the 50,000 ohms in this circuit will sometimes upset the a.v.c and detector circuits. With either of these ranges note that accurate readings can be taken down to .5 microampere.

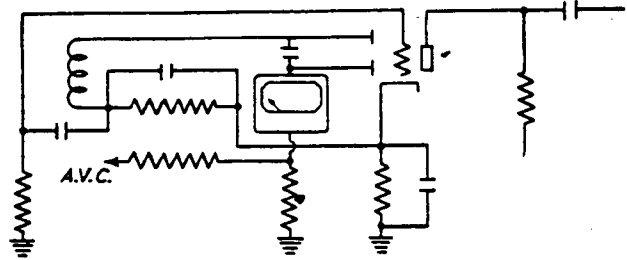

Meter in A. V. C. Diode Circuit to Check A. V. C. Action

Figure 3

EFFECT OF DIFFERENT METER SENSITIVITIES ON A TYPICAL RESISTANCE COUPLED PLATE CIRCUIT

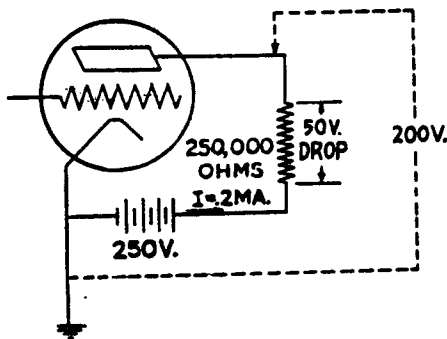

Normal Operation No Meter In Circuit

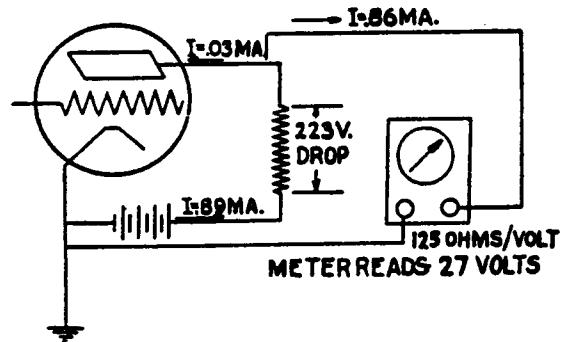

Conditions Using 125 Ohms Per Volt Meter

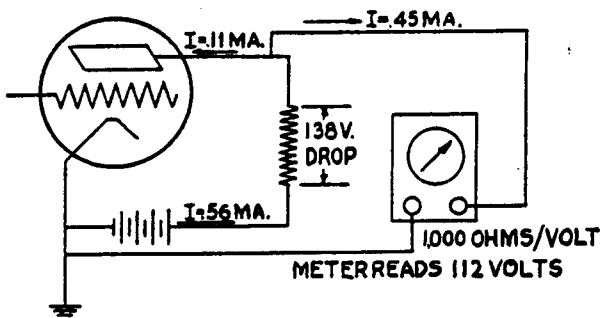

Conditions Using 1,000 Ohms Per Volt Meter

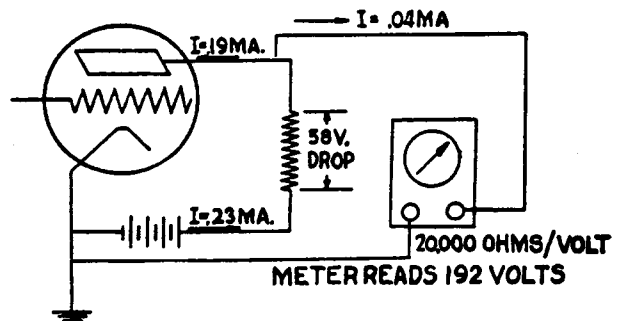

Conditions Using 20,000 Ohms Per Volt Meter

Meter Range—250 Volts Full Scale in All Cases

# DECIBEL READINGS

Power Level DB	Volts—Based on 6 M.W. at 0 DB in		Power Ratio' to 0 DB	Power 6 MW at 0 DB Watts	Voltage Ratio to 0 DB
	500 ohms	800 ohms			
-10	0.5477	.6000	0.1000	0.0006000	0.31623
- 9	0.6145	.6732	0.1259	0.0007553	0.35481
- 8	0.6895	.7554	0.1585	0.0009509	0.39811
- 7	0.7737	.8475	0.1995	0.0011972	0.44668
- 6	0.8681	.9509	0.2512	0.0015071	0.50119
- 5	0.9740	1.0670	0.3162	0.0018975	0.56234
- 4	1.0928	1.1972	0.3981	0.0023886	0.63096
- 3	1.2262	1.3433	0.5012	0.0030071	0.70795
- 2	1.3758	1.5071	0.6310	0.0037857	0.79433
- 1	1.5437	1.6910	0.7943	0.0047660	0.89125
0	1.7321	1.8974	1.0000	0.0060000	1.00000
+ 1	1.9434	2.1289	1.2589	0.0075535	1.1220
+ 2	2.1805	2.3886	1.5849	0.0095093	1.2589
+ 3	2.4466	2.6801	1.9953	0.0119716	1.4125
+ 4	2.7451	3.0071	2.5110	0.0150713	1.5849
+ 5	3.0801	3.3741	3.1623	0.0189747	1.7783
+ 6	3.4559	3.7867	3.9811	0.0238865	1.9953
+ 7	3.8776	4.2477	5.0119	0.030071	2.2387
+ 8	4.3507	4.7660	6.3096	0.037857	2.5119
+ 9	4.8816	5.3475	7.9433	0.047660	2.8184
10	5.4772	6.0000	10.0000	0.060000	3.1623
11	6.1455	6.7321	12.589	0.075535	3.5481
12	6.8954	7.5536	15.849	0.095093	3.9811
13	7.7368	8.4752	19.953	0.119716	4.4668
14	8.6808	9.5094	25.119	0.150713	5.0119
15	9.7400	10.670	31.623	0.189747	5.6234
16	10.9285	11.972	39.811	0.238865	6.3096
17	12.2620	13.433	50.119	0.30071	7.0795
18	13.7582	15.071	63.096	0.37857	7.9433
19	15.4369	16.910	79.433	0.47660	8.9125
20	17.3205	18.974	100.000	0.60000	10.0000
21	19.434	21.289	125.89	0.75535	11.220
22	21.805	23.886	158.49	0.95093	12.589
23	24.466	26.801	199.53	1.19716	14.125
24	27.451	30.071	251.19	1.50713	15.849
25	30.801	33.741	316.23	1.89747	17.783
26	34.559	37.867	398.11	2.38865	19.953
27	38.776	42.477	501.19	3.0071	22.387
28	43.507	47.660	630.96	3.7857	25.119
29	48.816	53.475	794.33	4.7660	28.184
30	54.772	60.000	1000.00	6.0000	31.623
31	61.455	67.321	1258.9	7.5535	35.481
32	68.954	75.536	1584.9	9.5093	39.811
33	77.368	84.752	1995.3	11.9716	44.668
34	86.808	95.094	2511.9	15.0713	50.119
35	97.400	106.70	3162.3	18.9747	56.234
36	109.285	119.72	3981.1	23.8865	63.096
37	122.620	134.33	5011.9	30.071	70.795
38	137.582	150.71	6309.6	37.857	79.433
39	154.369	169.10	7943.3	47.660	89.125
40	173.205	189.74	10000.0	60.000	100.000
41	194.34	212.89	12589.2	75.535	112.20
42	218.05	238.86	15848.9	95.093	125.89
43	244.66	268.01	19952.6	119.716	141.25
44	274.51	300.71	25118.9	150.713	158.49
45	308.01	337.41	31622.8	189.747	177.83
46	345.59	378.67	39810.7	238.865	199.53
47	387.76	424.77	50118.7	300.71	223.87
48	435.07	476.60	63095.7	378.57	251.19
49	488.16	534.75	79432.7	476.60	281.84
50	547.72	600.00	100000.0	600.00	316.25

4.3 — Condenser leakage measurements are very valuable in segregating shorted or leaky condensers. The sensitive ohm ranges on the Model 772 make these tests very easy. Measurements of paper condensers should always be made using the top or R x 10,000 range. All paper condensers should not show any appreciable leakage on this range due to the fact that leakage lower than 50 megohms is liable to indicate moisture in the condenser which may result later on in a final breakdown. Electrolytic condensers should in most cases be measured on the R x 1000 range as their resistance is always a finite value somewhere in the low megohm group. A true advantage of a sensitive ohmmeter of this type is shown here where a maximum potential on any range of only 15 volts d.c. is used to obtain the high megohm readings. Any ohm test can, therefore, be taken on any electrolytic condenser regardless of its voltage rating as it will never be exceeded on this model. In general electrolytic condensers used in power supplies should be rejected if their leakage resistance is below 400,000 ohms. Any value much below this will cause heating in the condenser which may in turn result in further injury and final breakdown. On by-pass condensers used on cathode circuits of the 5, 10 and 25 microfarad types with voltage ratings as low as 50 volts, considerably lower resistance readings may be obtained, and where they are shunted by cathode resistors having low values they will probably function alright. However, any electrolytic condenser should have a resistance of at least 100,000 ohms to function correctly in receiver circuits. The condenser should be connected with its + terminal to the — terminal on the tester.

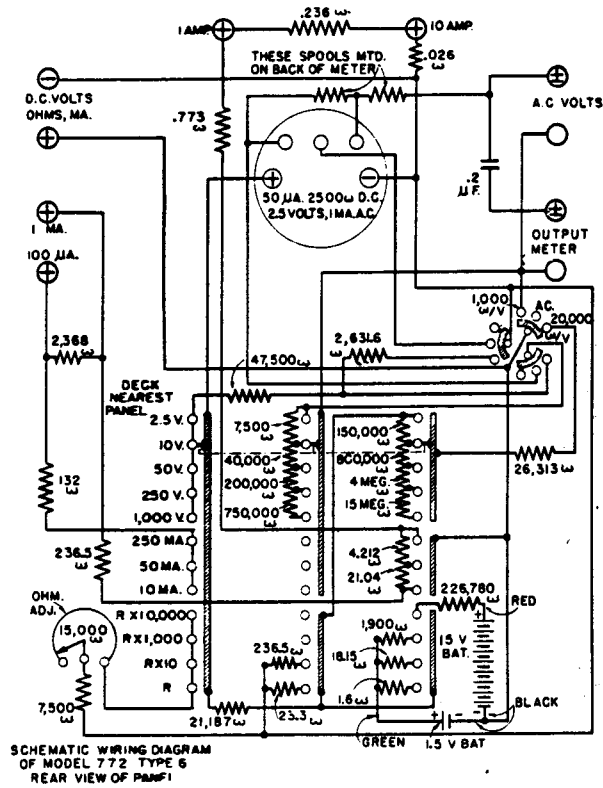

Wiring Diagram for Model 772 Analyzer

4.4 — A multiplier for the top d.c. ohm range can be made if even higher ohm readings are desired. The extreme sensitivity of the tester makes it possible and by adding 60 volts of "B" battery (anything from 50 to 70 volts will do) in series with the ohm jacks shown in the circuit below a 5 to 1 multiplier giving readings up to 150 megohms may be used. It should be noted that a 1 megohm resistor is used and to obtain accurate readings this resistor should be adjusted to 1%. If the voltage in the battery allows adjustment of the pointer to top mark when the leads are shorted together, the readings on this top range will multiply exactly by 5 if the external resistor used has been accurately adjusted and is so constructed that it will hold its accuracy through moisture and temperature variations. This additional 5 to 1 multiplier is often valuable in measuring paper condensers for leakage as estimates of as high as 200 and 250 megohms can be made by watching the pointer. Top reading on this range would be 150 megohms.

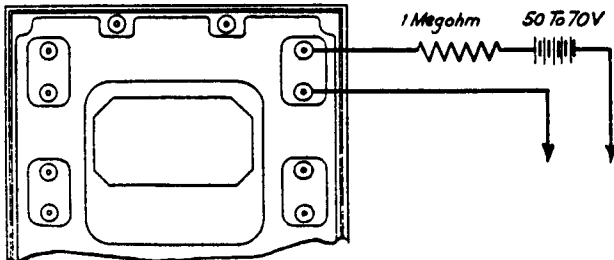

Figure 4

4.5 — For those who wish to determine a power level in a 600 ohm line, and for those who wish to refer to a power level table, we add a word of explanation for the use of the Decibel table given in this book. For example on a 600 ohm line with the selector switch in the 10 volt position and a.c. Volt pin jacks connected across the line, a reading of 4.24 might be obtained. This is read on the red a.c. scale. Referring to db readings on the previous page the column headed "VOLTS—BASED ON 6 MILLIWATTS AT 0 DB." should be located. Under this heading two individual columns should be noted, one entitled "500 OHMS" and the other "600 OHMS." As the particular line in question is a 600 ohm line the operator should run his finger down this column and locate the nearest reading to 4.24. This happens to be the 18th figure in this column, the exact reading here being 4.2477. Referring horizontally to the left-hand column entitled "POWER LEVEL IN DB" a reading of + 7 will be noted. The level on this line is, therefore, + 7 db. or, 7 db. above zero level of 6 milliwatts. If the line in question happens to be a 500 ohm line, the db. scale on the instrument may be used or the 2nd column from the left should be referred to. If the power ratio to zero db. is required or the actual power in watts in this particular line is to be determined, then the figure in 4th or 5th column should be located.

## CAPACITY MEASUREMENTS WITH MODEL 772

4.6 — Capacity measurements can be made with the Model 772 Analyzer by making use of a small power transformer having 2.5, 10 and 50 volt secondary windings. If only one range of capacity is desired or if a transformer is available with only one of

Circuit for Rx50,000 Used on Top or Rx10,000 Ohm Switch Position



these potential windings, readings can be taken on just one single a.c. range. The capacity coverage on the three lower volt ranges of the Model 772 are as follows:

- 2.5 volts a.c. — .01 to 10 microfarads
- 10 volts a.c. — .005 — 2.0 microfarads
- 50 volts a.c. — .0004 — 1.0 microfarads

To make these measurements the wiring diagram as shown below should be followed.

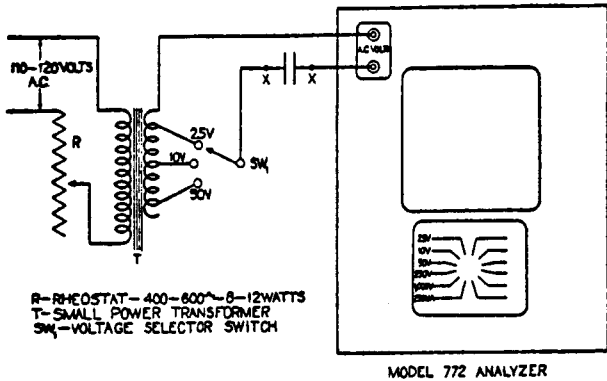

1. Connect the transformer through a 400 to 600 ohm rheostat directly across a normal 110 to 120 volt 60 cycle a.c. line.
2. Set up a three point switch or some method of making connection to each of the three secondary taps mentioned above and wire the common of this switch to one test lead and connect the other test lead as shown to one of the a.c. volt jacks.
3. Rotate the range switch on the Model 772 to correspond to the voltage taps as used on this external transformer.

4. Short the test leads "XX" and adjust the series rheostat R until the pointer on the Model 772 instrument indicates exactly full scale.
5. The test leads should then be connected across the condenser to be measured and a voltage reading taken on the a.c. arc 2.5 volt range. This particular range is used for all capacity readings irrespective of the applied voltage to simplify the curves.
6. Refer to the three curves below reading up from the bottom of the left-hand side of the chart to the voltage reading as obtained on the Model 772. Read across horizontally to the voltage range used and projecting down from this point the capacity in microfarads can be obtained directly.

### Example

- a. Set the transformer tap switch to the 2.5 volt tap.
- b. Rotate the Model 772 switch to the 2.5 volt position making sure that the functional switch is indexed to the center or A.C. VOLTS position.
- c. Short the test leads and adjust the rheostat R for full scale meter deflection.
- d. Connect the test leads across the condenser and a reading of say 1.8 volts is obtained.
- e. Read up on the axis labelled "Indication on 2.5 Volt A.C. Arc" to the reading equal to 1.8 volts and project across to the 2.5 volt curve. Reading down from the point the capacity as measured is 1.1 microfarads.

While this may seem slightly complicated at first, after taking readings on two or three condensers, the procedure will become quite simple and after a little practice capacity readings can be taken quite easily, rapidly and with reasonable accuracy in this way.

### MICROFARADS

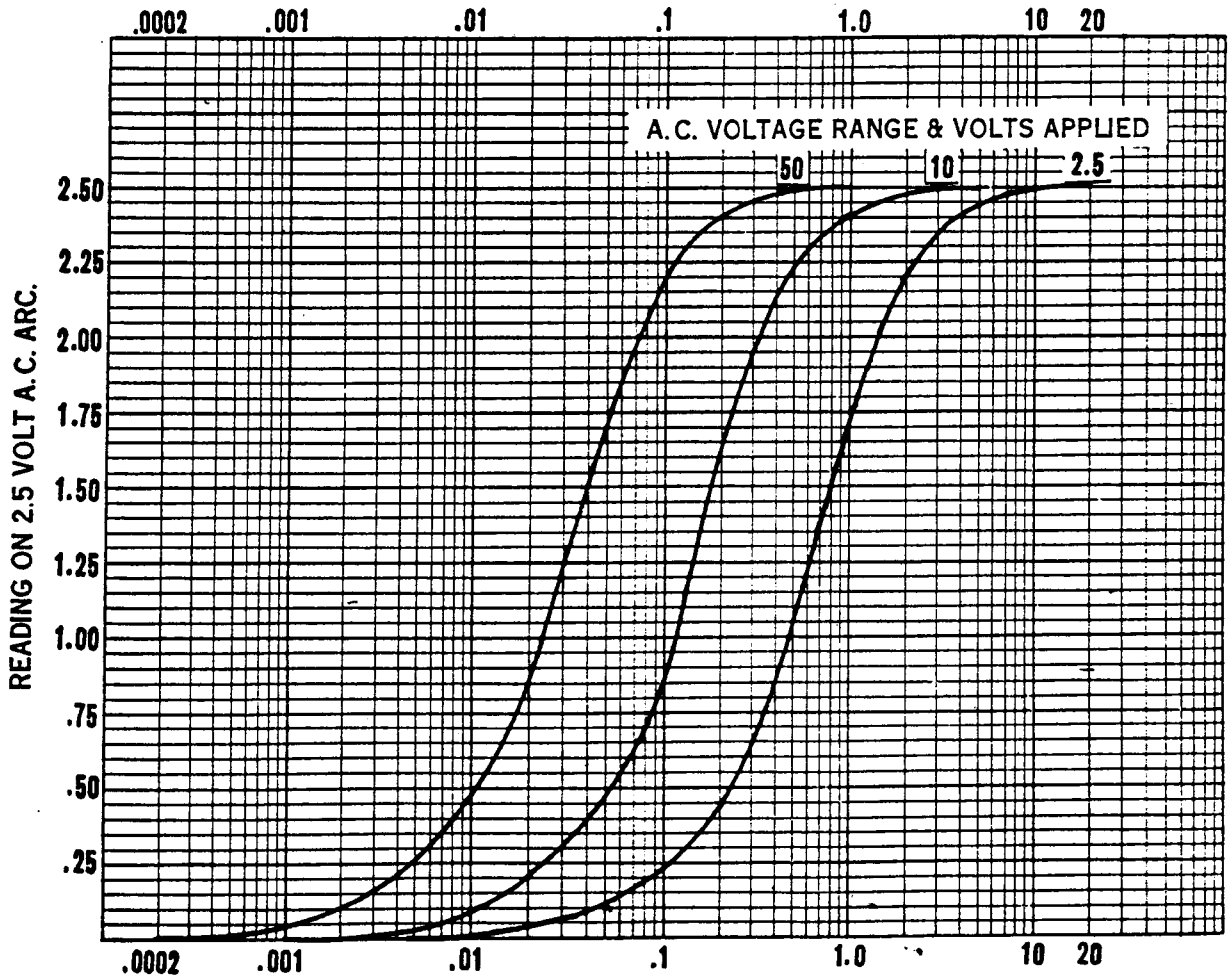

# 5,000 Volt D.C. Measurements at 20,000 Ohms Per Volt.

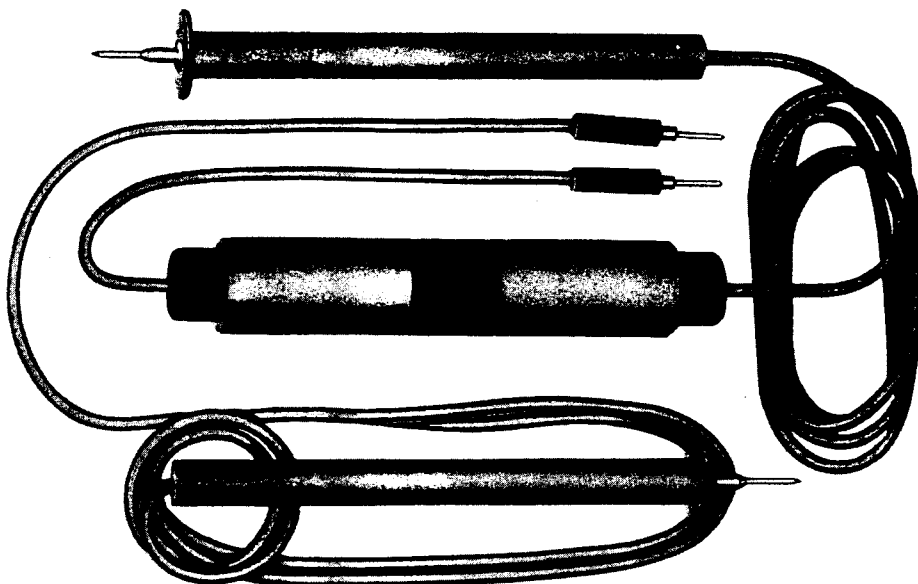

## Instructions For Weston Model 766 Type 1 Televerter Multiplier

This high voltage multiplier is used to extend the range of 20,000 ohm per volt analyzers to 5,000 volts. The Model 766 Televerter may be mounted with the spring clamp in the lead compartment. Using a #27 drill, a hole may be drilled from the outside of the case into the lead compartment near the center, and approximately 1" down from the panel mounting surface. A bolt, nut and lockwasher are supplied for this mounting. If desired, the Televerter may be operated loose in the compartment.

It is advisable to keep the analyzer at ground or chassis potential when measuring high voltages. Where the plus potential is grounded to chassis as on most Cathode Ray tube equipment, plug the 6" lead from the Televerter into the minus D.C. Volts jack. Connect the separate lead from the plus D.C. volts jack to chassis or low potential point, and the long lead from the Televerter to the high negative potential. Set Model 772 switch to 2.5 volts, with all other controls indexed for D.C. volts, 20,000 ohms per volt. Read

5,000 volts full scale on the 100 line D.C. arc. Six thousand volts can be read full scale by indexing volt switch to 1,000 volts.

If the negative of the circuit is at or near chassis potential, reverse the procedure connecting the 6" Televerter lead to the plus D.C. Volts jack; connect the separate lead from the minus D.C. Volts to the chassis or low potential point and the long Televerter lead to the high positive potential point. Set switches as outlined above and read 5,000 volts full scale.

The Televerter and leads are designed and manufactured to pass A.I.E.E. dielectric specifications. The unit is doubly sealed for protection against moisture and will maintain its accuracy under severe humid conditions.

CARE SHOULD BE EXERCISED IN TAKING HIGH POTENTIAL READINGS. USE ONE HAND AT A TIME.

Model 766 Type 2 for 10,000 Volts D. C. is also available.

SEC  
SOC

3  
4

# Tube Base Data Connections and Chart

*For Use With the Weston Methods  
of Selective Analysis*

---

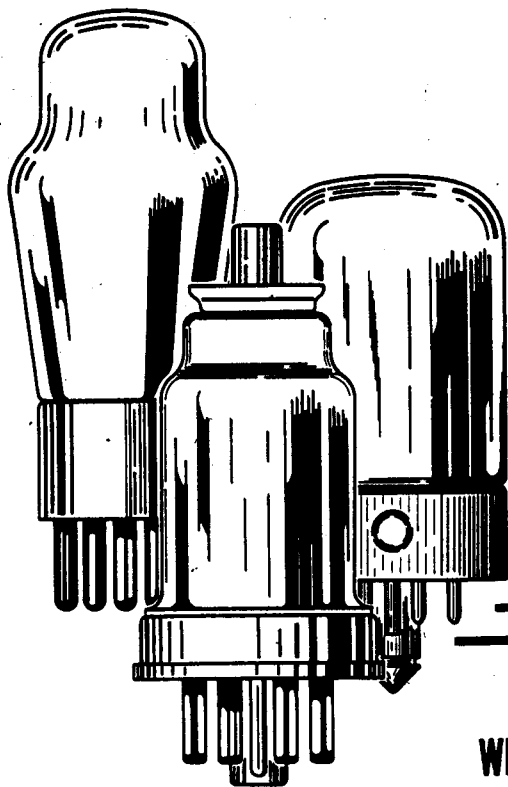

**WESTON ELECTRICAL INSTRUMENT CORP.**  
NEWARK, 5, NEW JERSEY, U. S. A.

# TUBE B LI DATA

For Use with the Weston *Models* of Selective Analysis

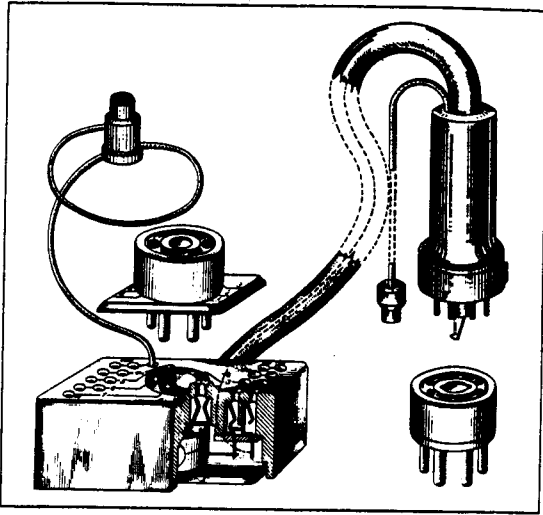

This socket selector unit is for the purpose of taking readings of current, voltage, resistance and other electrical measurements in a vacuum tube circuit. It may be used with any of the Weston analyzers or volt-ohmmeters, or other multi-range volt-ohm-milliammeters. The plug on the end of the cable, with its associated adapter may be inserted in the receiver tube socket, and the tube plugged into the socket selector block. This brings out through the cable all currents and voltages to a point where they may be measured on any volt-ohm-milliammeter. The charts in this booklet give the base connections for the various tube types. The numbering on each diagram for the various electrodes, corresponds with the engraved numbers on the socket selector block and skirted adapters.

**TO READ VOLTAGE**, plug the jumper leads into the outside jacks on the socket selector block. If plate voltage is required, and the base diagram shows the plate to be on pin #2, and the cathode on pin #7, then plug the jumper leads into the outside jack opposite the #2 and the #7 on the skirted adapter selected to fit the tube base. The open ends of the two jumper leads should be connected to the required voltmeter range.

**TO READ CURRENT** to any electrode, use the inside and outside jacks opposite the pin number on the skirted adapter. If plate current is required, and the base diagram shows the plate to be on pin #3, then plug the jumper leads into the adjacent jacks opposite the #3 on the skirted adapter. Inserting the pin in the inside

plug opens an internal switch connecting the milliammeter in series with the tube electrode.

**TO READ RESISTANCE** across any two terminals such as plate to cathode, use the outside jacks in the same manner as when reading voltage. Be sure that the receiver is turned off when taking resistance readings.

This unit was particularly designed for use with the various Weston analyzers and multi-range meters of both current and older designs. The pins on the bottom of the socket selector block are for mechanical mounting only, and do not make any electrical connection with the inside of the device.

## *Additional Instructions for Model 666 Type 1B*

The early design of the Model 666, the Type 1B, did not carry in the cable the connection for pin #1 on the octal adapter. A separate lead from pin #1 on the octal socket in the receiver should be connected to one of the two pin jacks marked GND in the upper right hand corner of the socket selector block. The skirted octal adapter has a short lead with a pin tip which should be connected into the other ground jack on the socket selector block. The skirted loctal adapter has a grid cap mounted on its side and the grid cap lead from the socket selector block should be connected to it. The loctal plug adapter has a short lead with a grid cap which should be placed on the grid stud mounted in the top of the plug handle.

## *Additional Instructions for Model 666 Type 1C*

The type 1C is equipped with an additional wire in the cable and will take care of all tubes including the octal, loctal and miniature series. No additional connection from the chassis of a receiver to the socket selector block is necessary. The skirted octal and loctal adapters for the type 1C have a pin tip lead which should be plugged into either one of the pin jacks marked "Pin Tip". In all other respects the type 1C is used exactly as explained in the first five paragraphs.

# TUBE BASE CONNECTIONS

## BOTTOM VIEW OF SOCKET OR BASE OF TUBE

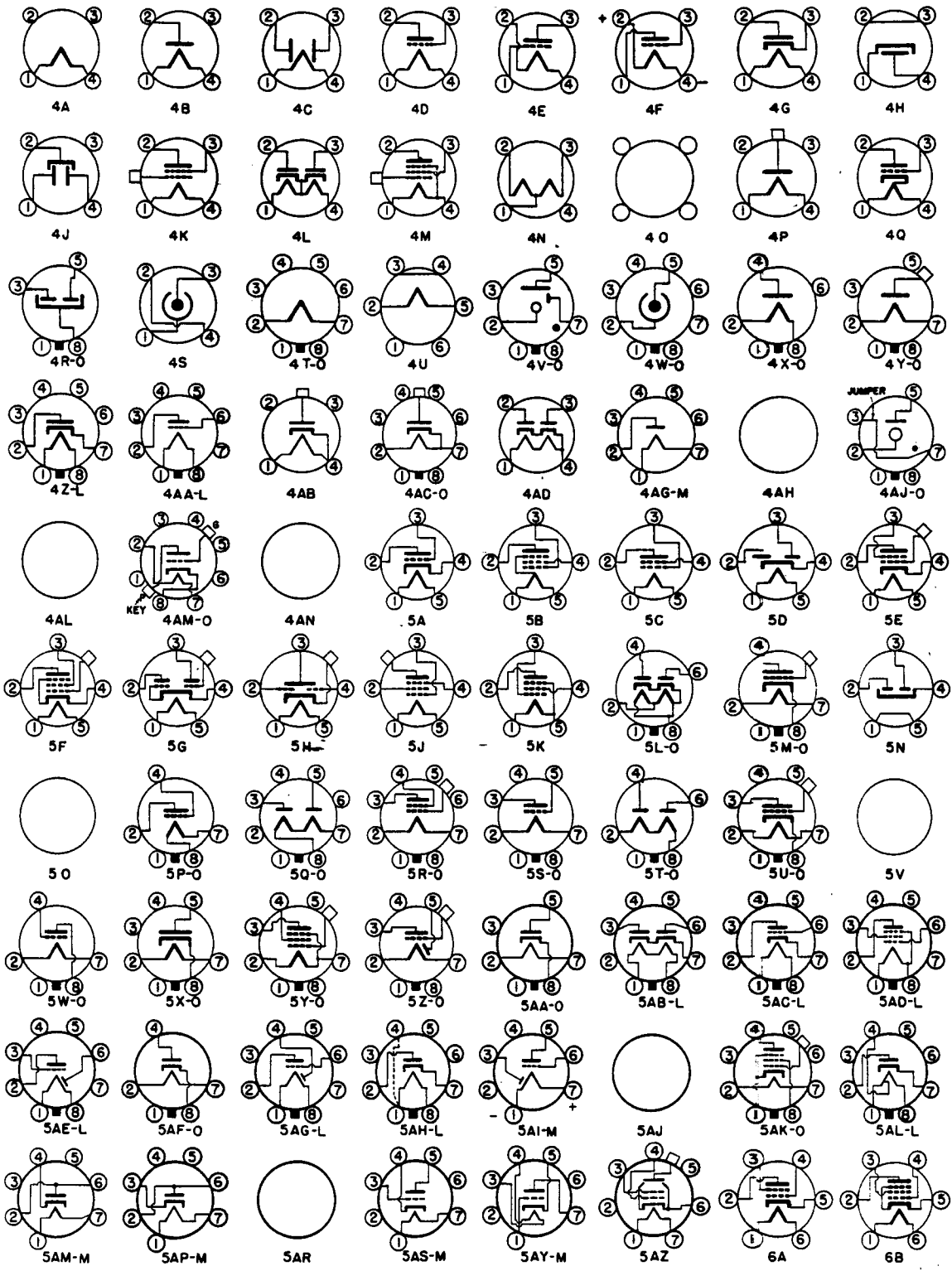

A letter O, L, M or A following the base diagram number indicates the following base type:

O — Octal  
L — Loctal

M — Miniature  
A — Acorn

# TUBE BASE CONNECTIONS

## BOTTOM VIEW OF SOCKET OR BASE OF TUBE

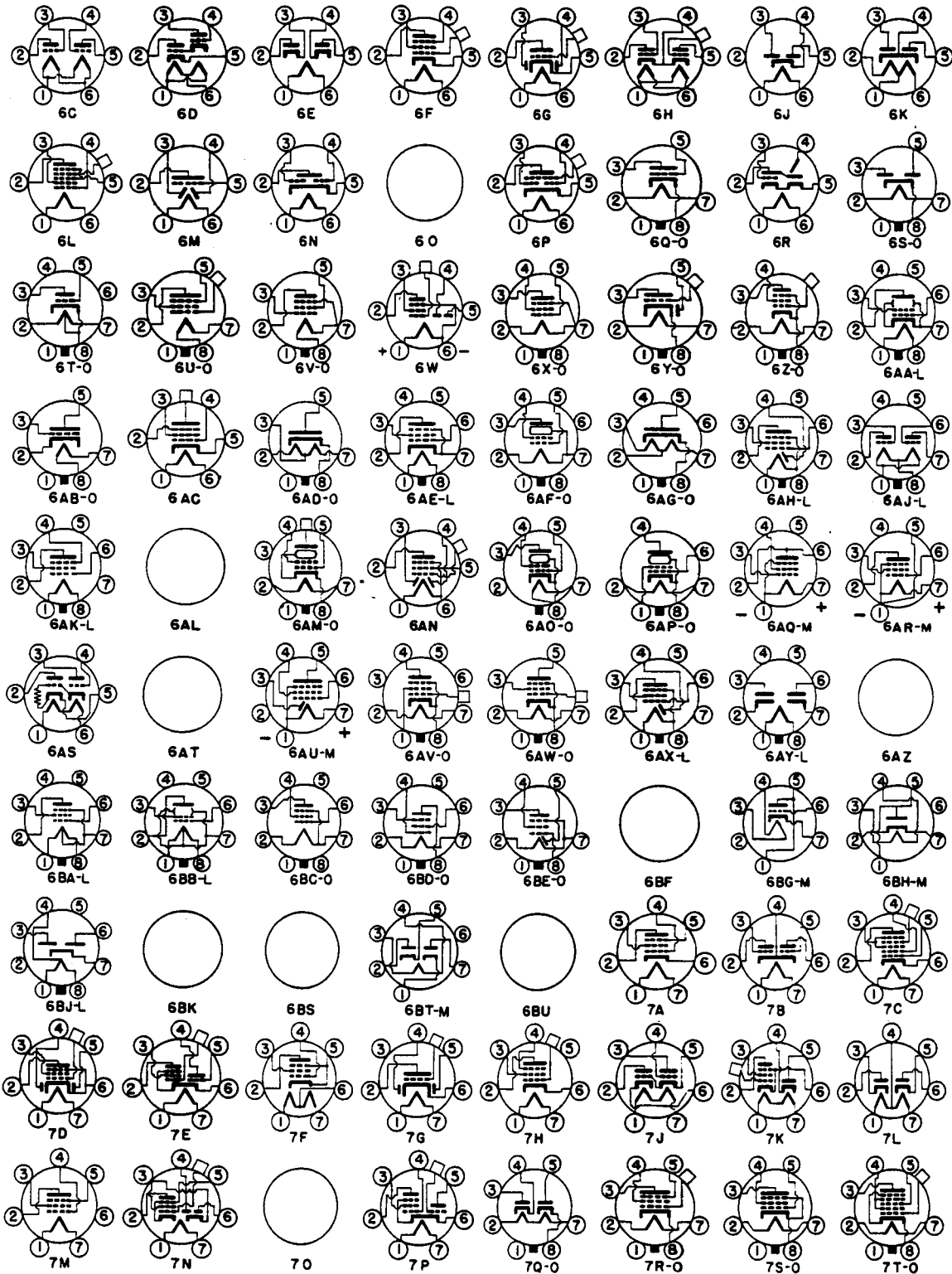

A letter O, L, M or A following the base diagram number indicates the following base type:

O — Octal  
 L — Loctal  
 M — Miniature  
 A — Acorn

# TUBE BASE CONNECTIONS

## BOTTOM VIEW OF SOCKET OR BASE OF TUBE

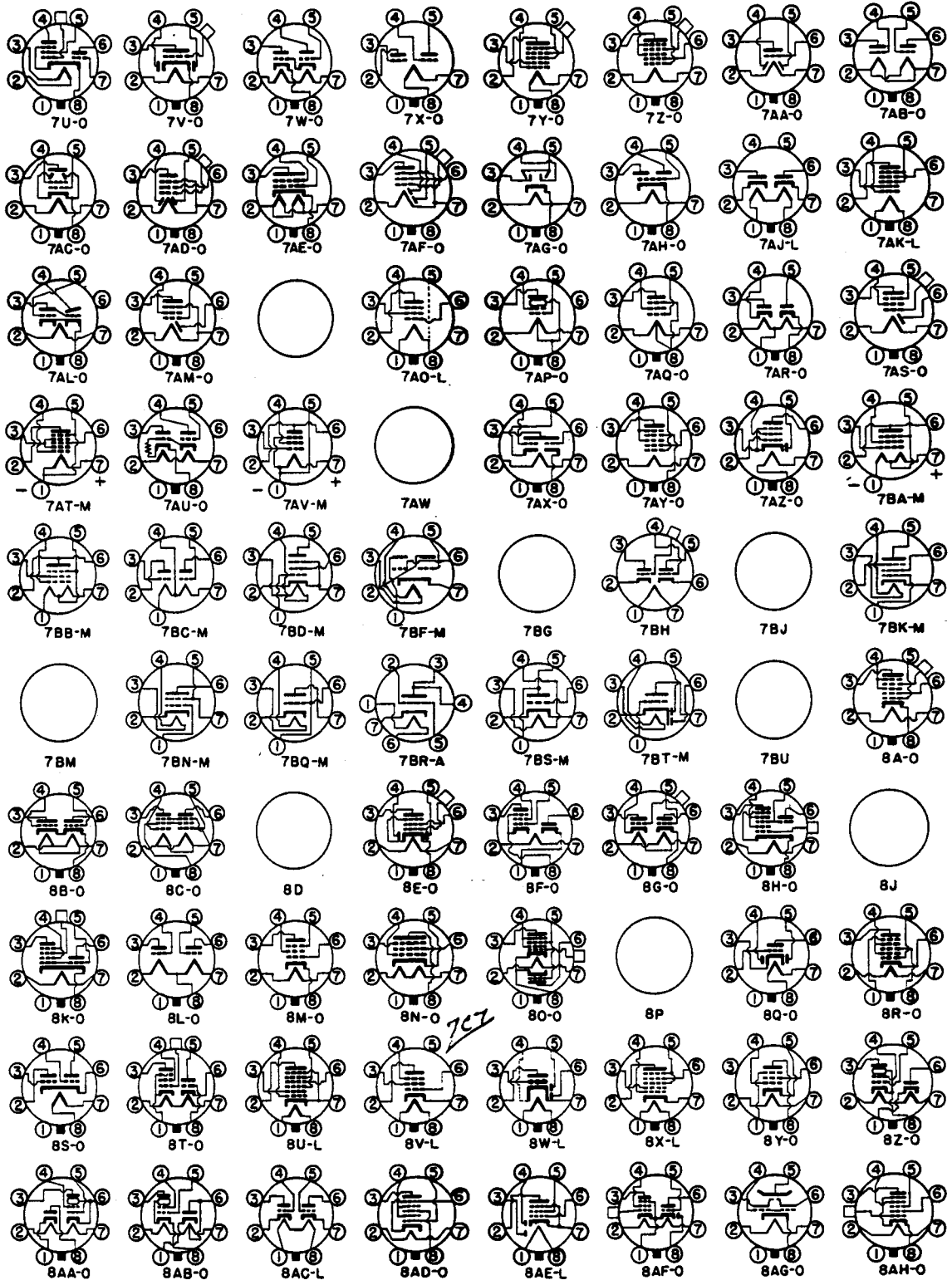

A letter O, L, M or A following the base diagram number indicates the following base type:

O — Octal  
L — Loctal

M — Miniature  
A — Acorn

# TUBE BASE CONNECTIONS

## BOTTOM VIEW OF SOCKET OR BASE OF TUBE

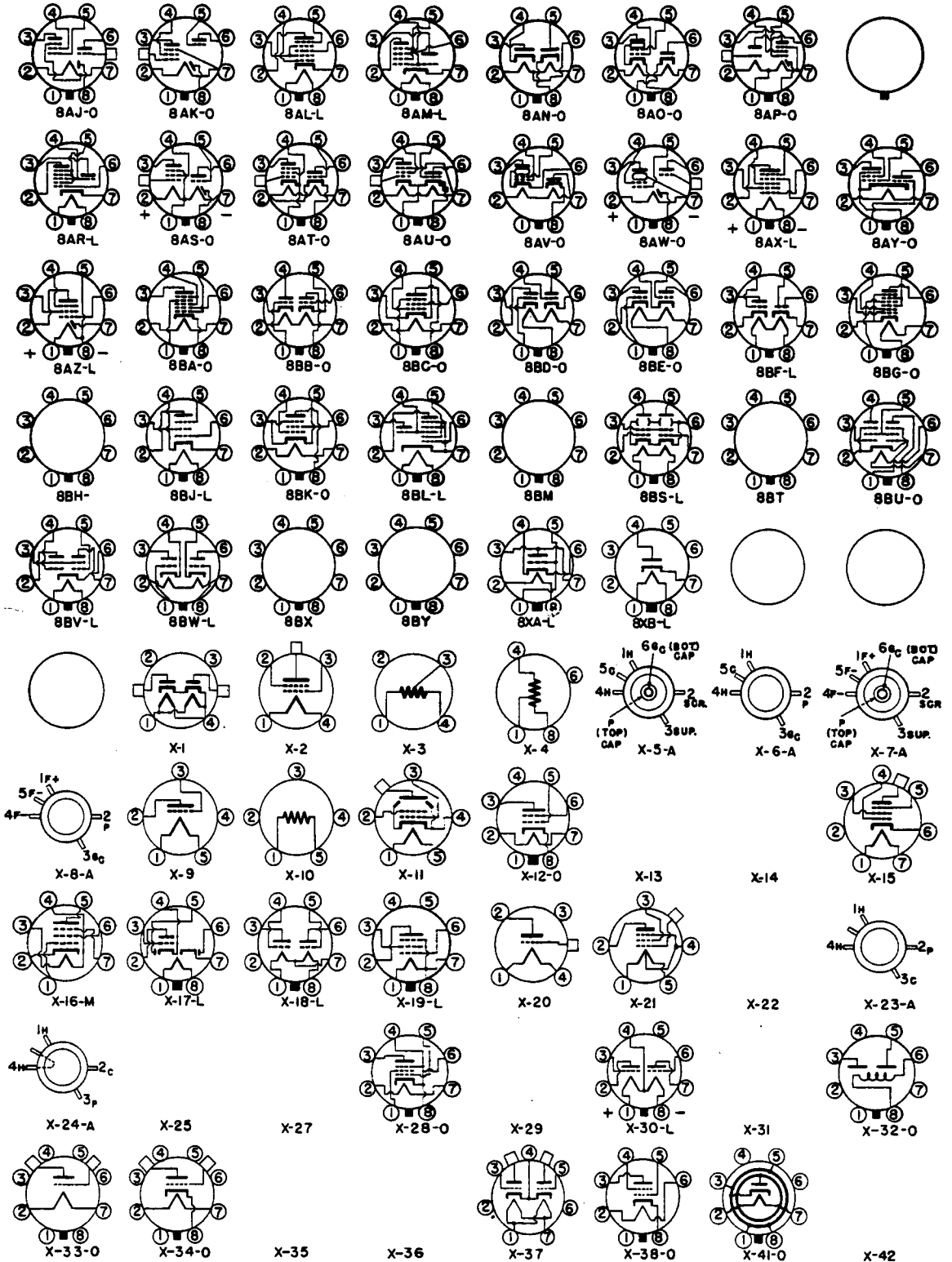

A letter O, L, M or A following the base diagram number indicates the following base type:

O — Octal  
 L — Loctal  
 M — Miniature  
 A — Acorn



# TUBE BASE LIST

Tube Type	Base	Tube Type	Base	Tube Type	Base	Tube Type	Base	Tube Type	Base
00	4D	1Q1	4T	6A7-S	7C	6L6	7AC	7K7	8BF
00A	4D	1Q5-GT	6AF	6A8	8A	6L7	7T	7L7	8V
0A3/VR75	4AJ	1R1-G	4T	6AB5	6R	6N5	6R	7N7	8AC
0A4-G	4V	1R4/1294	8XB	6AB6	7AU	6N6-G	7AU	7Q7	8AL
0B3/VR90	4AJ	1R5	7AT	6AB7/1853	8N	6N7	8B	7R7	8AE
0C3/VR105	4AJ	1S1-G	4T	6AC5-G	6Q	6P5-G	6Q	7S7	8BL
0D3/VR150	4AJ	1S4	7AV	6AC6-G	7W	6P7-G	7U	7T7	8V
0Z3	5N	1S5	6AU	6AC7/1852	8N	6Q5	6Q	7V7	8V
0Z4	4R	1SA6-GT	6BD	6AD5-G	6Q	6Q6-G	6Y	7W7	8BJ
01	4D	1SB6-GT	6BE	6AD6-G	7AG	6Q7	7V	7Y4	5AB
01A	4D	1T1-G	4T	6AD7-G	8AY	6R6-G	6AW	7Z4	5AB
01AA	4D	1T4	6AR	6AE5-GT	6Q	6R7	7V	8	4A
01B	4D	1T5-GT	6X	6AE6-G	7AH	6S6-GT	5AK	9	4A
1	4G	1-V	4G	6AE7-GT	7AX	6S7-G	7R	10	4D
1A1	4A	1V1	4A	6AF5-G	6Q	6SA7	8R	12A	4D
1A3	5AP	1Y1	4A	6AF6-G	7AG	6SA7-GT	8AD	12A5	7F
1A4-P	4M	1Z1	4A	6AF7	8AG	6SC7	8S	12A6	7AC
1A4-T	4K	2	4A	6AG5	7BD	6SD7-GT	8N	12A7	7K
1A5-G	6X	2A3	4D	6AG7	8Y	6SE7-GT	8N	12A8-GT	8A
1A6-GT	6L	2A3-H	4Q	6AH5-G	6AP	6SF5	6AB	12AH7-GT	8BE
1A6S	6L	2A4-G	5S	6AH7-GT	8BE	6SF7	7AZ	12B7	8V
1A7-G	7Z	2A5	6B	6AJ5	7BD	6SG7	8BK	12B8-GT	8T
1AB5	X-19	2A6	6G	6AJ7	8N	6SH7	8BK	12C8	8E
1B1	4A	2A7	7C	6AK5	7BD	6SJ7	8N	12E5-GT	6Q
1B4	4K	2B4	5A	6AK6	7BK	6SK7	8N	12F5-GT	5M
1B4-P	4M	2B6	7J	6AK7	8Y	6SL7-GT	8BD	12G7	7V
1B5/25S	6M	2B7	7D	6AL5	6BT	6SN7-GT	8BD	12H6	7Q
1B7-G	7Z	2C4	5AS	6AL6	6AM	6SQ7	8Q	12J5-GT	6Q
1C1	4A	2C21/1642	7BH	6A06	7BT	6SR7	8Q	12J7-GT	7R
1C5-G	6X	2C22	4AM	6AS6	X-16	6SS7	8N	12K7-GT	7R
1C6	6L	2C26	X-34	6B4-G	5S	6ST7	8Q	12K8	8K
1C7-G	7Z	2D21	7BN	6B5	6AS	6SU7-GTY	8BD	12L8-GT	8BU
1C21	4V	2E5	6R	6B6-G	7V	6T5	6R	12Q7-GT	7V
1D1	4A	2G5	6R	6B7	7D	6T7-G	7V	12SA7	8R
1D5-GP	5Y	2S/4S	5D	6B8	8E	6U5/6G5	6R	12SA7-GT	8AD
1D5-GT	5R	2V3-G	4Y	6C4	6BG	6U6-GT	7AC	12SC7	8S
1D7-G	7Z	2W3	4X	6C5	6Q	6U7-G	7R	12SF5	6AB
1D8-GT	8AJ	2X2/879	4AB	6C5-G	6Q	6V5-G	6AO	12SF7	7AZ
1E1	4A	2Y2	4AB	6C6	6F	6V6	7AC	12SG7	8BK
1E4-G	5S	2Y3	4C	6C7	7G	6V7-G	7V	12SH7	8BK
1E5-G	5R	2Y4	5D	6C8-G	8G	6W5-G	6S	12SJ7	8N
1E5-GP	5Y	2Z2/G-84	4B	6D4	5AY	6W6-GT	7AC	12SK7	8N
1E7-G	8C	3	4A	6D5	6Q	6W7-G	7R	12SL7-GT	8BD
1F1	4A	3A4	7BB	6D6	6F	6X5	6S	12SN7-GT	8BD
1F4	5K	3A5	7BC	6D7	7H	6Y3	4AC	12SQ7	8Q
1F5-G	6X	3A8-GT	8AS	6D8-G	8A	6Y5	6J	12SR7	8Q
1F6	6W	3B5-GT	7AP	6E5	6R	6Y6-G	7AC	12SW7-GT	8Q
1F7-G	7AD	3B7/1291	X-30	6E6	7B	6Y7-G	8B	12SX7-GT	8BD
1F7-GH	7AD	3B24	4P	6E7	7H	6Z3	4G	12SY7	8R
1F7-GV	7AD	3C5-GT	7AQ	6F4	7BR	6Z4	5D	12SY7-GT	8AD
1G1	4A	3D6/1299	6BB	6F5	5M	6Z5	6K	12X3	4AO
1G4-G	5S	3LE4	6BA	6F5-G	5M	6Z6	7Q	12Z3	4Q
1G5-G	6X	3LF4	6BB	6F6	7S	6Z7-G	8B	12Z5	6K
1G6-G	7AB	3Q4	7BA	6F7	7E	6ZY5-G	6S	14	5E
1H4-G	5S	3Q5-GT	7AP	6F7-S	7E	7	4A	14A4	5AC
1H5-G	5Z	3S4	7BA	6F8-G	8G	7A4	5AC	14A5	6AA
1H6-G	7AA	4	4A	6G5	6R	7A5	6AA	14A7	8V
1J1	4A	4A6-G	8L	6G6-G	7S	7A6	7AJ	14AF7/XXD	8AC
1J5-G	6X	4S	5D	6G7	7N	7A7-LM	8V	14B6	8W
1J6-G	7AB	5	4A	6G7S	7N	7A8	8U	14B8	8X
1K1	4A	5R4-GY	5T	6H4-GT	5AF	7B4	5AC	14C5	6AA
1L1	4T	5T4	5T	6H5	6R	7B5	6AE	14C7	8V
1L4	6AR	5U4-G	5T	6H6	7Q	7B6	8W	14E6	8W
1LA4	5AD	5V4-G	5L	6H7	7P	7B7	8V	14E7	8AE
1LA6	7AK	5W4	5T	6H7-S	7P	7B8	8X	14F7	8AC
1LB4	5AD	5X3	4C	6H8	8E	7C4/1203A	8XB	14H7	8V
1LB6	8AX	5X4-G	5Q	6J4	7BQ	7C5	6AA	14J7	8AR
1LC5	7AO	5Y3-GT/G	5T	6J5	6Q	7C6	8W	14N7	8AC
1LC6	7AK	5Y4-G	5Q	6J6	7BF	7C7	8V	14Q7	8AL
1LD5	6AX	5Z3	4C	6J7	7R	7E5/1201	8XA	14R7	8AE
1LE3	4AA	5Z4	5L	6J7-G	7R	7E6	8W	14S7	8BL
1LH4	5AG	6	4A	6J7-GT	7R	7E7	8AE	14W7	8BJ
1LN5	7AO	6A3	4D	6J8-G	8H	7F7	8AC	14Y4	5AB
1N1	4T	6A4/LA	5B	6K5-G	5U	7F8/1232	8BW	14Z3	4G
1N5-G	5Y	6A5-G	6T	6K6-G	7S	7G7	8V	15	5F
1N6-G	7AM	6A6	7B	6K7	7R	7G8/1206	8BV	17	5A
1P1	4T	6A7	7C	6K8	8K	7H7	8V	18	6B
1P5-G	5Y	6A7-M	8A	6L5-G	6Q	7J7	8AR	19	6C

# TUBE BASE LIST

Tube Type	Base	Tube Type	Base	Tube Type	Base	Tube Type	Base	Tube Type	Base
20.....	4D	47.....	5B	92.....	6N	985.....	5D	CK-1005.....	X-32
21A7.....	8AR	48.....	6A	95.....	6B	986.....	4C	D-1/2.....	4B
22.....	4K	49.....	5-C	96.....	4G	1003.....	4R	D-1.....	4C
24A.....	5E	49A2.....	X-4	98.....	5D	1005.....	X-32	DE.....	4D
24S.....	5E	49B2.....	X-4	112A.....	4D	1006.....	4C	E.....	4D
25.....	6M	50.....	4D	117L7-GT.....	8AO	1201.....	8XA	G.....	4D
25A6.....	7S	50A5.....	6AA	117M7-GT.....	8AO	1203.....	8XB	GA.....	5B
25A7-G.....	8F	50C6-G.....	7AC	117N7-GT.....	8AV	1204.....	X-28	G-2.....	5D
25AC5-GT.....	6Q	50L6-GT.....	7AC	117P7-GT.....	8AV	1206.....	8BV	G-2S.....	5D
25B5.....	6D	50Y6-GT.....	7Q	117Z4-GT.....	5AA	1221.....	6F	G-4.....	5D
25B6-G.....	7S	50Z6-G.....	7Q	117Z6-GT.....	7Q	1223.....	7R	G-4S.....	5D
25B8-GT.....	8T	50Z7-G.....	8AN	165R.....	4A	1231.....	8V	G-84.....	5D
25C6-G.....	7AC	51.....	5E	165R4.....	X-3	1232.....	8V	H.....	4D
25D8-GT.....	8AF	52.....	5C	165R8.....	X-3	1284.....	8V	HY-114B.....	X-33
25L6.....	7AC	53.....	7B	181.....	4D	1291.....	X-30	HY-615B.....	X-34
25N6-G.....	7W	55.....	6Q	182A.....	4D	1293.....	4AA	K-24.....	5E
25S.....	6M	56.....	5A	182B.....	4D	1294.....	8XB	K-27.....	5A
25X6-GT.....	7Q	56AS.....	5A	183/483.....	4D	1299.....	6BB	KR-1.....	4G
25Y4-GT.....	5AA	56S.....	5A	185R.....	4A	1602.....	4D	KR-2.....	4G
25Y5.....	6E	57.....	6F	185R4.....	X-3	1603.....	6F	KR-5.....	5B
25Z3.....	4G	57AS.....	6F	185R8.....	X-3	1609.....	5K	KR-20.....	6N
25Z4.....	5AA	57S.....	6F	210T.....	4D	1612.....	7T	KR-22.....	6N
25Z5.....	6E	58.....	6F	213.....	4C	1613.....	7S	KR-25.....	6B
25Z6.....	7Q	58AS.....	6F	213B.....	4C	1614.....	7AC	KR-28.....	5D
26.....	4D	58S.....	6F	216.....	4B	1620.....	7R	KR-31.....	4G
27.....	5A	59.....	7A	216B.....	4B	1621.....	7S	KR-98.....	5D
27HM.....	5A	59A.....	7A	257.....	5B	1622.....	7AC	KR-7184.....	X-38
27S.....	5A	59S.....	7A	264.....	4D	1625.....	5AZ	LA.....	5B
28D7.....	8BS	64.....	5E	291.....	5G	1626.....	6Q	P-361.....	5D
28Z5.....	6BJ	65.....	5E	293.....	5G	1629.....	7AL	PZ.....	5B
29.....	6N	67.....	5A	295.....	5G	1631.....	7AC	PZH.....	5B
30.....	4D	68.....	5E	482A.....	4D	1632.....	7AC	RA-1.....	4Q
31.....	4D	69.....	5E	482B.....	4D	1633.....	8BD	RE-1.....	4C
32.....	4K	70.....	6N	483.....	4D	1634.....	8S	RE-2.....	4B
32L7-GT.....	8Z	70A7-GT.....	8AB	484.....	5A	1635.....	8B	RK-19.....	X-1
33.....	5K	70L7-GT.....	8AA	485.....	5A	1642.....	7BH	RK-21.....	4AB
34.....	4M	71A.....	4D	486.....	X-9	1644.....	8BU	RK-22.....	X-1
35.....	5E	75.....	6G	559.....	X-41	1851.....	7R	RK-24.....	4D
35A5-LT.....	6AA	75M.....	7V	585.....	4D	1852.....	8N	RK-33.....	7BH
35L5-GT/G.....	7AC	75S.....	6G	586.....	4D	1853.....	8N	RK-34.....	X-37
35L6-GT.....	7AC	76.....	5A	801.....	4D	9001.....	7BD	RK-47.....	5J
35Y4.....	5AL	77.....	6F	803.....	5J	9002.....	7BS	RK-62.....	4D
35Z3-LT.....	4Z	77M.....	7R	804.....	5J	9003.....	7BD	SO-1.....	4Q
35Z4-GT.....	5AA	78.....	6F	807.....	X-11	9004.....	X-23	SO-2.....	4D
35Z5-GT.....	6AD	78S.....	6F	837.....	X-15	9005.....	X-24	V-99.....	4E
35Z6-G.....	7Q	79.....	6H	840.....	5J	9006.....	6BH	VR-50.....	4W
36.....	5E	80.....	4C	841.....	4D	A (5).....	5H	VR-75-30.....	4AJ
37.....	5A	81.....	4B	842.....	4D	A (6).....	6N	VR-90-30.....	4W
38.....	5F	82.....	4C	843.....	5A	A-22.....	4D	VR-105-30.....	4AJ
39/44.....	5F	82V.....	4L	864.....	4D	A-26.....	4D	VR-150-30.....	4AJ
40.....	4D	83.....	4C	865.....	X-2	A-28.....	4D	WE-215A.....	4D
40Z5.....	6AD	83V.....	4L	866-A/866.....	4P	A-30.....	4Q	WE-231D.....	4D
41.....	6B	84/6Z4.....	5D	874.....	4S	A-32.....	4Q	WE-257A.....	X-20
41M.....	7S	85.....	6G	878.....	4P	A-40.....	4Q	WE-300A.....	4D
42.....	6B	85AS.....	6G	879.....	4AB	A-48.....	4Q	WE-300B.....	4D
42A2.....	X-4	85L7.....	8AB	884.....	6Q	AC-22.....	5E	WE-306A.....	X-21
42B2.....	X-4	85M.....	7V	885.....	5A	AD.....	4G	WE-307A.....	5J
43.....	6B	85S.....	6G	950.....	5K	AF.....	4C	WE-350A.....	X-11
43-MG.....	7S	86M.....	6Q	951.....	4K	AG.....	4C	WE-713A.....	8BK
44.....	5F	87S.....	6F	954.....	X-5	AX.....	4Q	WE-717A.....	8BK
45.....	4D	88.....	4C	955.....	X-6	B.....	4E	X-99.....	4D
45Z3.....	5AM	88S.....	6F	956.....	X-5	BA.....	4J	XXB.....	X-18
45Z5-GT.....	6AD	89.....	6F	957.....	X-8	BH.....	4J	XXD.....	8AC
46.....	5C	89RS.....	7N	958.....	X-8	BR.....	4H	XXFM.....	X-17
46A1.....	X-10	90.....	6N	959.....	X-7	BX.....	4D	XXL.....	5AC
46B1.....	X-10	91.....	6N						

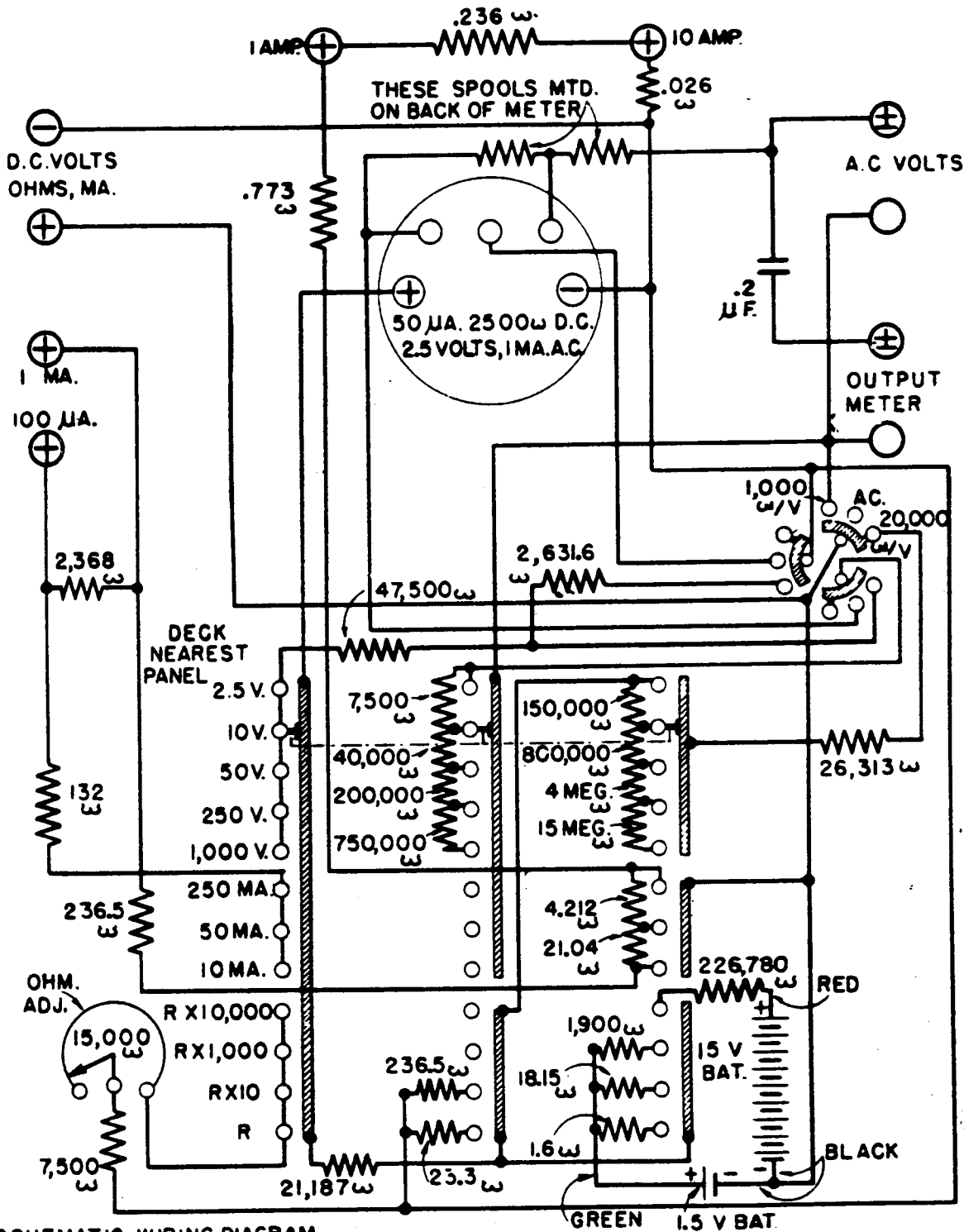

SCHEMATIC WIRING DIAGRAM  
 OF MODEL 772 TYPE 6  
 REAR VIEW OF PANFI

# Wiring Diagram for Model 772 Analyzer