

# BV-10

## MICROPIPETTE BEVELER

### OPERATION MANUAL

REV. 2.10 ( 20100630)



**SUTTER INSTRUMENT**

ONE DIGITAL DRIVE  
NOVATO, CA 94949

VOICE: 415-883-0128 WEB: [WWW.SUTTER.COM](http://WWW.SUTTER.COM)  
FAX: 415-883-0572 EMAIL: [INFO@SUTTER.COM](mailto:INFO@SUTTER.COM)

Copyright © 2010 Sutter Instrument Company. All Rights Reserved.

## DISCLAIMER

- The Model **BV-10** micropipette beveler is designed for the specific use of creating micropipettes and no other use is recommended.
- This instrument creates items that should only be used in a laboratory environment for use on animal tissues. It is not intended, nor should be used in human experimentation or applied to humans in any way. This is not a medical device.
- Do not open or attempt to repair the instrument without expressed and explicit instructions from Sutter Instrument Company. High voltages are present and could cause injury.
- Do not allow unauthorized and or untrained operatives to use this device.
- Any misuse will be the sole responsibility of the user/owner and Sutter Instruments assumes no implied or inferred liability for direct or consequential damages from this instrument if it is operated or used in any way other than for which it is designed.

## SAFETY WARNINGS

**Please read this manual carefully before operating the instrument.**

- **Do not disassemble the unit. Refer servicing to qualified personnel.**
- **Always use the grounded power supply cord set provided to connect the unit to a grounded outlet (3-prong). This is required to protect you from injury in the event that an electrical hazard develops.**

## PRECAUTIONS

**Failure to comply with any of the following precautions may damage this device.**

- **Operate the BV-10 using 100V - 240V AC., 50/60 Hz line voltage.**
- **The BV-10 is designed for operation in a laboratory environment (Pollution Degree I).**
- **The BV-10 is designed for connection to a standard laboratory power outlet (Overvoltage Category II).**
- **Operate only in a location where there is a free flow of fresh air on all sides. NEVER ALLOW THE FREE FLOW OF AIR TO BE RESTRICTED.**

*(This page intentionally blank.)*

## TABLE OF CONTENTS

<b>DISCLAIMER</b> .....	<b>iii</b>
<b>SAFETY WARNINGS</b> .....	<b>iii</b>
<b>PRECAUTIONS</b> .....	<b>iii</b>
<b>1. GENERAL INFORMATION</b> .....	<b>1</b>
1.1 Introduction.....	1
1.2 Models.....	2
1.3 Technical Support.....	2
1.4 Description and Function of Components.....	2
1.4.1 Motorbase.....	2
1.4.2 Manipulator.....	2
1.4.3 Pedestal/Grinding Assembly.....	3
1.4.4 BV-10 Meter (Optional).....	4
1.4.5 Optical Attachment (Optional).....	5
<b>2. INSTALLATION</b> .....	<b>7</b>
2.1 Description of Package Contents.....	7
2.2 <u>Set-Up and Assembly Instructions</u> .....	7
<b>3. OPERATING INSTRUCTIONS</b> .....	<b>11</b>
3.1 Grinding Procedure.....	11
3.1.1 General Information.....	11
3.1.2 Control of Beveling by Measuring Electrical Resistance.....	12
3.1.3 Control of Beveling by Monitoring Bubble Size.....	13
3.2 Using the Resistance Meter.....	14
3.2.1 Operation.....	14
3.2.2 Ohms Law – Theory of Operation.....	14
3.2.3 Accuracy.....	15
<b>4. MAINTENANCE</b> .....	<b>17</b>
4.1 Cleaning the Grinding Place.....	17
<b>5. TROUBLESHOOTING</b> .....	<b>19</b>
5.1 Grinding Plate Won't Turn.....	19
5.2 Jerky Plate.....	19
5.3 Beveling Takes a Long Time.....	19
5.4 No Beveling Occurs.....	19
5.5 Meter Does Not Work.....	19
5.6 Pipettes Break During Beveling.....	19
<b>Appendix A. Limited Warranty</b> .....	<b>21</b>
<b>Appendix B. Accessories</b> .....	<b>23</b>
Accessories.....	23
Replacement Parts.....	23
<b>Appendix C. Technical Specifications</b> .....	<b>25</b>
<b>INDEX</b> .....	<b>27</b>

**TABLE OF FIGURES**

Figure 1. Manipulator. .... 3  
Figure 2. Pedestal/Grinding Assembly..... 4  
Figure 3. BV-10 Meter..... 5  
Figure 4. BV-10 beveler component layout..... 7  
Figure 5. Pedestal/grinding plate assembly. .... 9  
Figure 6. Components of optical attachment. .... 10  
Figure 7. Top view of grinding plate..... 11

## 1. GENERAL INFORMATION

### 1.1 Introduction

The difficulty of penetrating a cell membrane or any other type of tissue with a micropipette increases with tip size. Beveling is a technique that significantly reduces the resistance to pipette penetration by forming an almost straight cutting edge on the end of a pipette. For intracellular recording, beveling facilitates penetrating and holding very small or difficult cells. Microinjection needles also benefit from beveling by promoting entry into cells with minimal damage and at the same time enhancing flow of material through the needle.

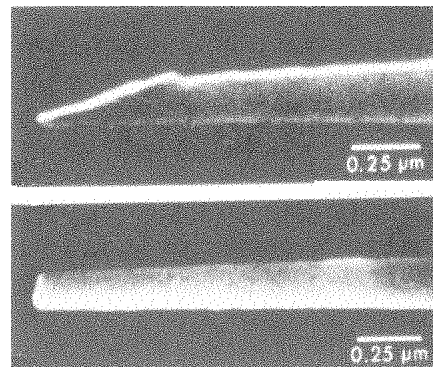

The BV-10 beveler design provides a flat, wobble free abrasive surface for beveling intracellular electrodes, microinjection needles, etc. The BV-10 is suitable for beveling micropipettes with tip diameters between 0.1 and 50.0 microns, depending on the grinding plate installed. The grinding plate rotates on a stationary, optically flat pedestal by virtue of a magnetic coupling with a rotating drive ring. Rotational speed is approximately 60 rpm. Pipette positioning relative to the grinding plate is controlled with the micromanipulator, which provides both course and fine position control and an adjustment for bevel angle.

For applications that involve micropipettes filled with an electrolyte, measuring the resistance of the pipette during beveling is a useful technique for monitoring the progress of beveling. The BV-10M resistance meter is designed for this purpose.

The relation between electrode resistance and tip diameter for a series of beveled electrodes is shown for measured tip diameters of 0.06 to 0.54 microns in the graph to the right. The form of this function is of interest because many applications require that either tip diameter or electrode resistance be minimized. The graph shows that when either tip diameter or electrode resistance has been reduced to a given low value, further decreases can be obtained only at the expense of a very marked and undesirable increase in the other variable.

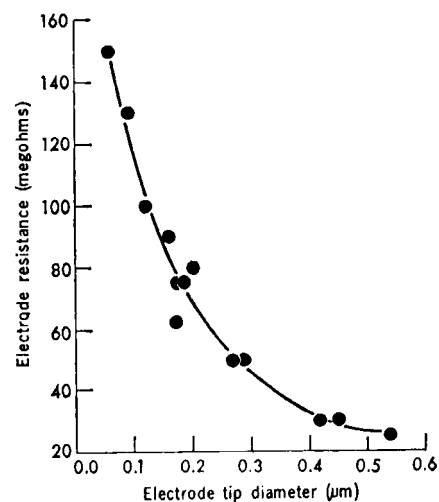

## 1.2 Models

The BV-10 Microelectrode Beveler is available in the following models:

<b>BV-10-B</b>	Micropipette beveler basic system <sup>1</sup>
<b>BV-10-C</b>	BV-10-B with electrode impedance meter.
<b>BV-10-D</b>	BV-10-B with 80X stereomicroscope.
<b>BV-10-E</b>	BV-10-B with impedance meter and 80X stereomicroscope.

## 1.3 Technical Support

Unlimited technical support is provided by Sutter Instrument Company at no charge to our customers. Our technical support staff is available between the hours of 8:00 AM and 5:00 PM (Pacific Standard Time) at (415) 883-0128. You may also E-mail your queries to [info@sutter.com](mailto:info@sutter.com).

## 1.4 Description and Function of Components

### 1.4.1 Motorbase

The motor base assembly consists of the base plate, DC drive motor and drive belt, motor housing, halogen lamp, meter receptacle and power cord.

### 1.4.2 Manipulator

The manipulator is used for advancing a pipette to the grinding surface. It consists of an **angle plate** used to clamp the pipette and adjust the bevel angle; a **coarse control** knob used to position the pipette just above the grinding plate surface; a **fine control** knob (micrometer) used to control the actual beveling of pipettes. The **sensitivity** of the fine control can be varied by moving the pointer near the back of the manipulator. It is factory pre-set to 1 (mid-point on the scale) for average beveling. Moving the pointer towards 0 will reduce the micrometer advance rate.

---

<sup>1</sup> Includes micromanipulator, reference wick, reference wick holder, pedestal oil, degreaser, manual, and two abrasive plates of your choice.



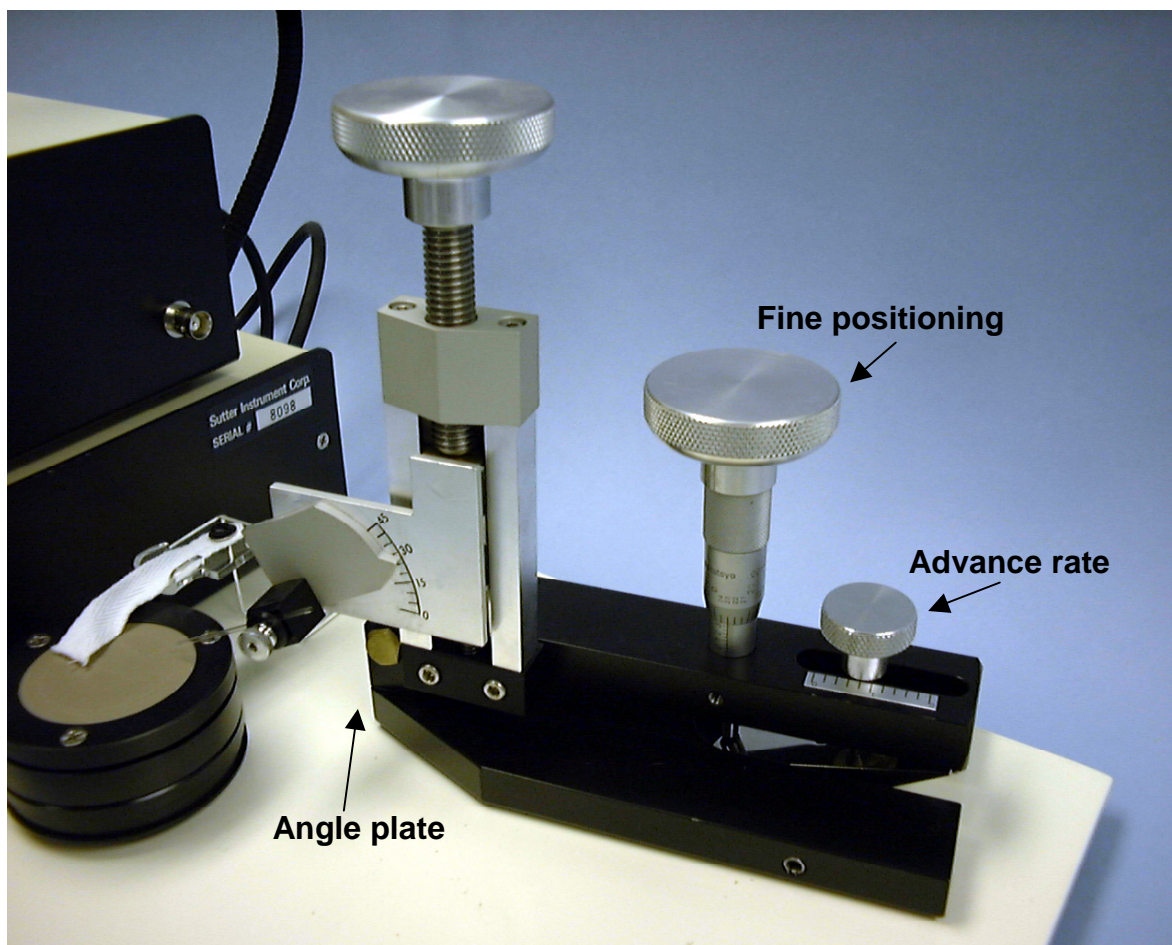

Figure 1. Manipulator.

#### 1.4.3 Pedestal/Grinding Assembly

The pedestal assembly includes a stationary pedestal with an optically flat quartz surface, a magnetic drive ring that rotates around the pedestal, and upper and lower retaining rings which hold the grinding plate. The grinding plate rotates wobble-free on the flat quartz surface by virtue of an oil film bearing and a magnetic coupling between the retaining ring assembly and the drive ring.

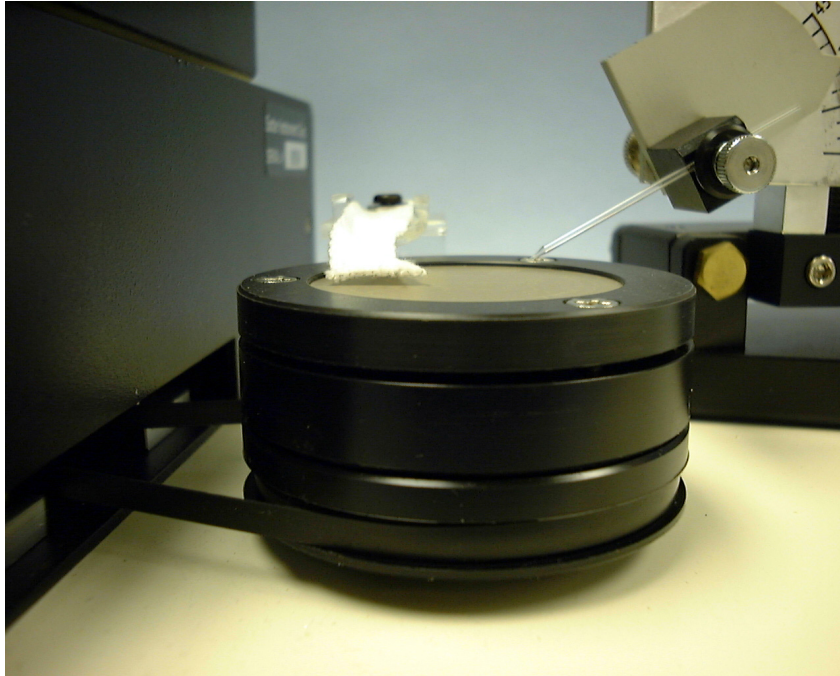

Figure 2. Pedestal/Grinding Assembly.

#### 1.4.4 BV-10 Meter (Optional)

The BV-10M is an electrode resistance meter designed to complement the BV-10 electrode beveler. Resistance is indicated by a precision analog meter, which allows the user to easily identify changes in microelectrode resistance while beveling.

**Each meter is calibrated using the active lead that is shipped with the meter. Use of another cable, even if it is from another BV-10M, may require recalibration to produce an accurate reading.**



Figure 3. BV-10 Meter.

#### 1.4.5 Optical Attachment (Optional)

To aid viewing the beveling process, an optical attachment is available. The unit consists of a 80x stereomicroscope and mounting hardware. For large diameter tips (>1 $\mu$ m) the attachment allows the user to bevel using an optically based beveling technique described in subsequent text.



## 2. INSTALLATION

### 2.1 Description of Package Contents

- Box 1:
1. Beveler motor base with motor housing, halogen lamp and pedestal assembly.
  2. BV-10M impedance meter (if ordered); resistance measuring leads.
  3. Optical attachment (if ordered).
  4. Grinding Plates (2) and retaining ring set.
  5. Pedestal oil; Degreaser.
  6. Operating Manual.
- Box 2  
(inside Box 1):
- Micromanipulator



Figure 4. BV-10 beveler component layout.

### 2.2 Set-Up and Assembly Instructions

- **Remove micromanipulator from Box 2.**

- **Remove the foam insert containing the meter (if ordered) and accessories from Box 1.**
- **Remove motor base assembly and place on table.**
- **Place micromanipulator on motor base, as shown in Figure 4.**
- **If meter is included with shipment**, place meter on top of motor unit and plug into the A.C. outlet on the back of the motor housing. Plug the BNC connector from the active lead (on manipulator) into the receptacle protruding from the side of the meter. Attach the small platinum wire to the end of the active lead using the connector provided. Plug the mini-banana plug from the reference lead (on wick assembly) into the reference connector on the back of the meter.
- **Assemble grinding plate system as described below. See Figure 5.**

Two grinding plates are supplied with the BV-10. The plates are made by embedding the abrasive particles on a film of plastic. With care, these plates can bevel thousands of pipettes. Unless otherwise specified, the plates supplied are a .05um alumina abrasive plate for pipette tips in the .05 um to .1 um, and a .3um alumina abrasive plate for beveling pipette tips in the .5um to 1um range. Diamond coated plates are available for beveling larger tips and can be ordered from Sutter Instrument Co.

1. Unscrew the three screws holding the upper retaining ring to the lower retaining ring.
2. Identify the abrasive surface on the grinding plate. The top abrasive surface has a speckled finish -- it is marked with a part number. Place grinding plate between the two retaining rings with abrasive surface facing the top retaining ring as per Figure 2. Secure in place by screwing upper retaining ring to lower retaining ring. Tighten screws down until you feel a slight resistance and then turn them another 1/8 turn.
3. Place ~1 to 2 drops of pedestal oil onto the optical flat surface of the pedestal.
4. Place grinding plate assembly onto pedestal. The magnets (embedded in the rotating base and the lower retaining ring) will attract each other and squeeze out the excess oil between the two glass surfaces to form a parallel oil bearing. After several hours, this oil will be forced out and the optical flat must be re-oiled. Indication of insufficient oil is a jerky movement of the abrasive plate or failure of the plate to turn. *Do not allow the beveler to be operated under these conditions, or damage to the optical flat surface may occur.*

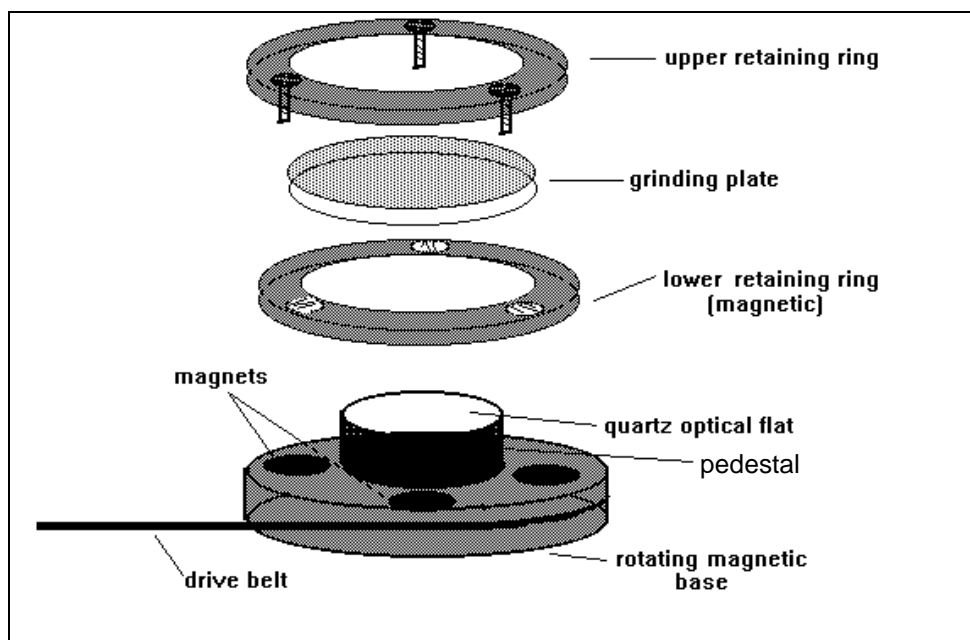

Figure 5. Pedestal/grinding plate assembly.

For cleaning instructions of the Grinding Plate, please refer to the Maintenance chapter.

➤ **Assemble optical attachment if supplied. — See Figure 5.**

1. Screw the vertical mounting post into the threaded hole in the BV-10 base plate. The Allen head bolt fits through the center of the mounting post and is used to screw the post onto the base plate.
2. Place the washer over the vertical mounting post such that it is resting on the base plate.
3. Place the black anodized mounting block onto the vertical mounting post. One of the thumbscrews is used to clamp the block to the post; the other thumbscrew is used to clamp the horizontal mounting bar to the block. The block should extend over the front edge of the BV-10 base plate.
4. Place the steel horizontal mounting bar through the horizontally oriented hole in the mounting block. The end of the bar with the threaded hole and flat face is directed to the left. The end of the bar with the setscrew is directed to the right. Orient the bar such that the flat face is facing up, and clamp in place with the thumbscrew.
5. Screw the chrome post onto the flat face of the horizontal bar with the Allen head screw provided. Remove the cap screw from the top of the chrome post. *Note: The chrome post/ horizontal bar may have been shipped as one assembly. If so, then just install the horizontal bar as in (4) with the chrome post oriented to the left of the mounting block.*
6. Place the microscope-focusing block onto the chrome post. If you have trouble pushing it onto the post, there is a retaining ring on the inside of the focusing block hole which will need to be rotated slightly such that the slit in the retaining ring is aligned with a small pin that protrudes from the retaining ring channel.
7. Once the scope is in place, install the cap screw onto the chrome post. Course focusing is performed by loosening the thumbscrew on the back of the focusing block

and adjusting the height of the scope relative to the beveler plate. Fine focusing is achieved by using the focusing block.

The position of the scope can be easily adjusted by loosening the thumbscrews on the mounting block and repositioning the scope, then tightening the thumbscrews. To swing the scope out of the way of the beveler plate, loosen the thumbscrew that clamps the mounting block to the vertical mounting post and rotate the scope counter clockwise relative to the vertical post. To adjust the angle of the scope relative to the beveler plate, hold the scope with one hand while loosening the thumbscrew that clamps the steel horizontal bar to the mounting block. Then rotate the scope to the appropriate angle and clamp the bar back in place with the thumbscrew.

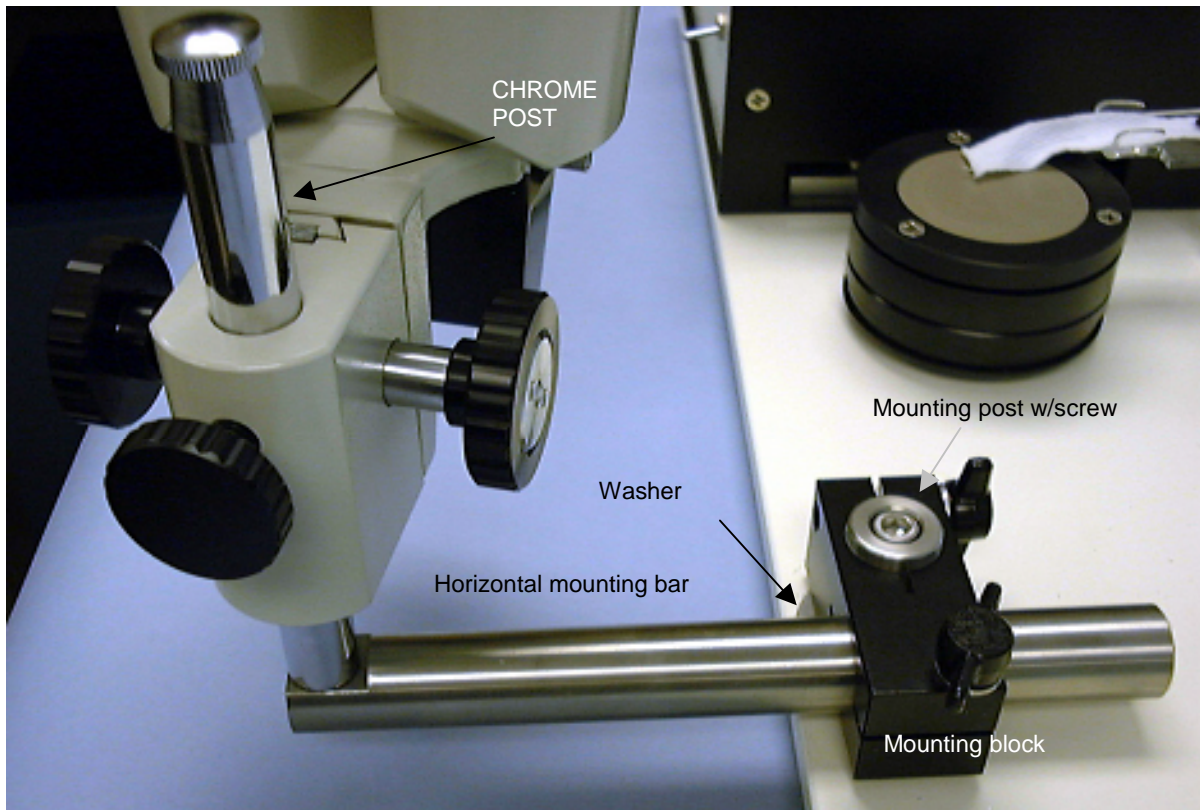

Figure 6. Components of optical attachment.

#### Optical attachment component list:

- 1 80X microscope
- 1 chrome microscope post with threaded cap screw
- 1 steel horizontal mounting bar
- 1 vertical mounting post with Allen head bolt
- 1 washer
- 1 black mounting block with 2 thumb screws

This completes the instructions for beveler assembly.



## 3. OPERATING INSTRUCTIONS

### 3.1 Grinding Procedure

#### 3.1.1 General Information

Place the micropipette or microelectrode you wish to bevel in the pipette clamp located on the manipulator. The clamp consists of a black nylon block with a V-groove cut in it, and a screw down nylon washer. The angle of the pipette can be adjusted by loosening the knurled knob on the backside of the angle plate and positioning the plate at the desired angle (typically 25 to 30 degrees). The manipulator should be placed such that the tip of the pipette can be lowered onto the beveling surface about two-thirds out from the center of rotation. Beveling on the outer edge or the center of the grinding plate should be avoided.

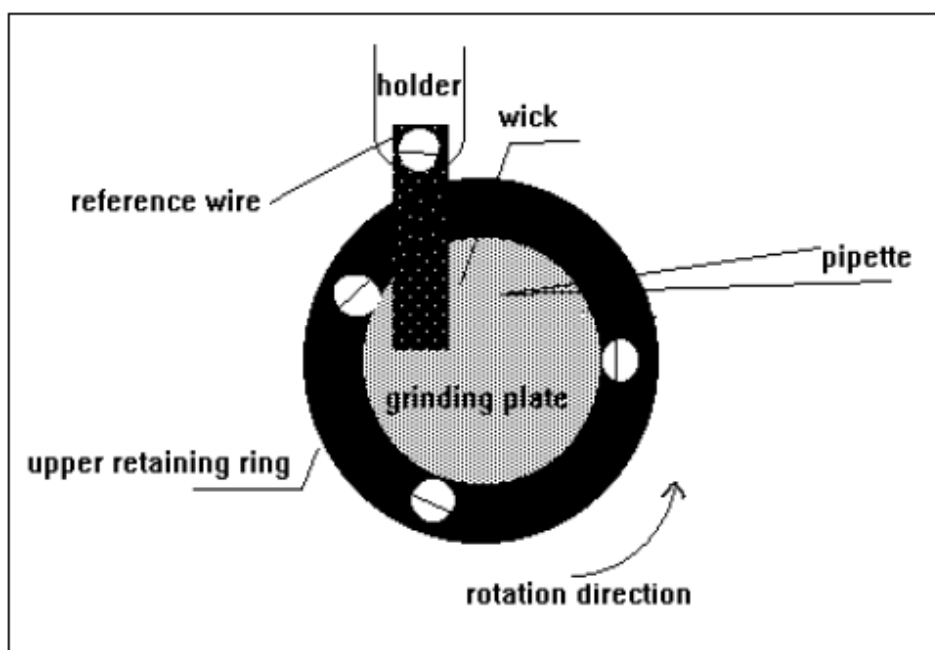

Figure 7. Top view of grinding plate.

Precision beveling a micropipette requires detecting when the tip contacts the abrasive surface and then monitoring the progress of beveling until a predetermined criteria is met. In cases where the tips are so fine that they cannot be viewed with a microscope, monitoring the micropipette resistance is very useful. The BV-10M meter was developed for this purpose. For applications requiring larger diameter tips (>1.0 micron), "bubble" beveling is a useful technique. Both techniques are described below.

Wet beveling is recommended for most applications. A wick assembly is included to keep an even distribution of fluid across the grinding plate surface. Adjust the plastic wick holder so the cotton wick is touching the surface of the grinding plate in the position shown in Figure 7. For resistance beveling the wick should be soaked with the saline solution given below. For bubble-beveling, distilled water, containing Photo-Flo (a 1% solution) is sufficient. The Photo-Flo is important for keeping the film of water as thin as possible and, by reducing surface tension, minimizing the tendency of the water to 'drag' the pipette tip.

Saline Solution for wick:

Per 100 ml water:

0.9 grams of sodium chloride (NaCl)

1.0 ml Kodak Photo-Flo (available at photo stores) to reduce surface tension.

### 3.1.2 Control of Beveling by Measuring Electrical Resistance

The BV-10M resistance meter is used for continuous monitoring of micropipette resistance during the beveling process. The meter is supplied with a **reference lead** that plugs into the back of the meter, and an **active lead** that plugs into a BNC receptacle on the side of the meter. To use the BV-10M meter, insert the active lead into the back of the microelectrode that has been filled with an electrolyte. The active lead is a small plug-in platinum wire located on the angle plate of the manipulator. The reference lead is located underneath a holding washer on the holder end of the wick.

With the wick in place on the grinding plate, turn on the motor and place a few drops of saline onto the wick. The wick must be saturated at the top, underneath the holding washer, so the saline will contact the reference wire. A 1-centimeter ring of saline will form across the grinding plate surface. It is of considerable advantage to have the saline layer on the plate as thin as possible, in order to reduce the time spent advancing the electrode through the saline down to the grinding surface.

The meter has four positions on its range switch: Standby, X0.1 for 0-10 Mohms, X1 for 0-100 Mohms, and X5 for 0-500 Mohms. Depending on the impedance of the unbeveled electrode, switch the meter to an appropriate measurement range. It is not necessary to switch to the standby position between beveling electrodes.

**Slowly advance the electrode towards the grinding surface while monitoring the meter. The electrode will first make contact with the saline ring and then with the grinding plate. As soon as the first change in resistance is noted, stop advancing the electrode. If the resistance remains steady, it means the electrode has only made contact with the saline, and therefore must be further advanced to the grinding plate. If the resistance continues to change, the electrode is in contact with the grinding surface and is being beveled. On contact with the grinding plate, the electrode resistance should begin to go down as the tip is beveled back. In general, a 5 to 10% change from the initial resistance reading gives the smallest possible tip and will produce a good bevel. Since this small change can take place in a few seconds, you must be ready to quickly back off the manipulator in order to lift the electrode from the grinding surface.**

It is uncommon for there to be minor increases of electrical resistance during beveling – these increases are probably the result of slight plugging of the tip by fine particles of glass making the tip abrasive. This problem can be minimized by reducing the angle of beveling. The danger here is that as the angle to the plate gets smaller, the bevel will become longer and the tip more fragile. Thus, a compromise must be reached, which in most cases is to grind at around a 25-degree angle and to accept the fact that some electrodes will go up in value.

### 3.1.3 Control of Beveling by Monitoring Bubble Size

Bubble beveling is a technique in which a gas (compressed air, nitrogen) is passed through the pipette to be beveled while the tip of the pipette is immersed in a thin film of water containing Photo-Flo on the rotating beveling surface. With the aid of a low power microscope, the bubble stream seen on the beveling surface is used as an indicator of the progress of grinding, and to help keep the tip of the pipette clear of ground-off glass and other debris.

A light source providing strong back-lighting of the grinding surface will enhance the visibility of the pipette and allow the user to quickly lower the tip toward the grinding surface. The microscope used should be of the low power dissecting type with long working distance. It is most convenient to have it mounted so that it may be swung over the grinding surface during beveling and moved away when changing pipettes, etc.

The gas source will most likely be a cylinder containing an appropriate gas and having a regulator capable of delivering good performance in the 5 - 50 psi range. It is also convenient to have a flow control valve in the line between the gas source and the pipette to allow for convenient shutoff of the gas flow. Under most circumstances, PE tubing or silicone tubing can simply be pushed onto the back end of the pipette; this type of connection will suffice up to about 50-60 psi.

Wet the wick with distilled water containing Photo-Flo until a ring of solution appears on the surface of the grinding plate.

**To bevel the pipette, first lower the tip of the pipette close to the grinding plate surface and swing the microscope into place. While monitoring the tip, lower it under fine control into the water on the surface. If the tip is large enough to emit the gas, one will see a continuous trail of bubbles from the tip. Now continue to lower the tip until the 'character' of the bubble stream changes; usually it appears that the bubble stream has disappeared, though it has probably broken up into a stream of very fine bubbles. Now raise the tip from the surface and the bubbles will reappear. The width of the stream will be an indication of how large a tip has been made.**

The size of the initial tip, pressure in the gas system and other factors will determine if one sees a bubble stream initially. If the tip is too small or the gas pressure too low, bubbles will not be emitted from the tip. However, do not raise the gas pressure too high. For tips of 1 micron or so, about 50 psi should be sufficient; too high a pressure will cause the tubing to pop off the back of the pipette. Also, remember that once the beveling is complete and the pipette is to be removed, there may still be pressure in the system. Either carefully remove the tubing from the back of the pipette or provide some pressure relief if necessary.

Beveling using this technique is mostly a matter of setting up the equipment and trying the procedure until one develops a touch for the equipment and sees the various 'bubble phenomena' that occur during the grinding process. Initially one will probably grind the tips too large until some skill is learned. If one is to grind large tips (>10 microns) it may help to touch the tip to the grinding surface two or three times to help clear debris from the beveled tip.

## 3.2 Using the Resistance Meter

It is not possible to anticipate all the situations in which the meter might be used by itself, so we will attempt only to give the user some general guidelines.

The meter is wired for operation at 110 volts, unless it has been modified for operation at 220 volts. The proper voltage for your unit should be indicated on the back. If you need to operate a 110-volt meter from a 220-volt source, you will need to supply a step down transformer. Make sure that the connections are correct, particularly the ground, and that the transformer can supply 0.1 amps at 110 volts. We cannot be responsible for incorrect use of such devices by the user.

When choosing a location for your meter, you should consider that the meter's accuracy can be affected by external noise sources. Large ungrounded conductive objects such as metal bench tops or active noise sources such as motors or line cords may cause inaccurate readings, particularly when measuring electrodes of high resistance. In addition, grounded objects very close to the electrode may cause a decrease in reading for high resistance. Pay particular attention to the method of mounting the electrode and the active lead. Use materials with high electrical resistance, such as virgin Teflon, to avoid shunting the active lead to ground.

### 3.2.1 Operation

There is no ON/OFF switch on the meter. This function is provided by the beveler unit when the two are used together. In normal use, the meter can be left on during the course of a day's work, but common sense dictates that the power should be disconnected when the unit is not in use or will be unattended. For stand-alone operation you may wish to use a switched outlet strip to provide an easy way to power-down the meter.

The meter should be left in the standby mode when not in use. This is particularly important if the meter is to be shipped, since this helps protect the meter movement from mechanical shocks. When you wish to make a reading, switch to the X5 range. If the reading is less than 100 Mohms, switch to the X0.1 range. This procedure will give the greatest resolution. When you wish to disconnect the electrode, we recommend that the range select switch be returned to the standby position.

### 3.2.2 Ohms Law – Theory of Operation

Ohm's law,  $V=IR$ , provides an obvious means for resistance measurement. If we force a known current,  $I$ , through the unknown resistance,  $R$ , we can then measure the voltage drop,  $V$ , across  $R$  and compute  $R$  as  $V/I$ . In practice, this is what the meter does. A controlled current is forced through the electrode under test and the resulting voltage drop across the electrode is measured. The current is in the form of a 12 Hz sine wave. This avoids the problems caused by passing DC current without causing inaccuracy due to stray capacitance.

The peak amplitude of the current is 0.5 nA on the X5 range, 1 nA on the X1 range and 10 nA on the X0.1 range. Thus, the peak-to-peak voltage drop across a test electrode of 100 megohms on the X1 range would be 100 mV. For the other ranges, a full-scale reading will also reflect a 100 mV peak-to-peak voltage across the test electrode. The meter provides circuits to scale filter and average this voltage signal so that it produces a steady full-scale deflection on the analog meter.

### 3.2.3 Accuracy

Each meter is calibrated for full-scale deflection at 500 megohms and 10 megohms using precision resistors and should be within  $\pm 1\%$ . Intermediate values are checked to assure that the meter reads within  $\pm 1$  minor division.

This level of absolute accuracy is more than enough for use in micropipette work since the micropipette is far from being an ideal resistor that obeys Ohm's Law. In practice, the current-voltage relationship of a micropipette is non-linear; doubling the current may produce much more than twice the voltage drop. Changing the sign of the current can dramatically change the magnitude of the voltage drop. As a result, there is no single number that uniquely defines the resistance of a pipette. Thus, two accurate instruments employing different measuring currents could produce completely different measured values of an electrode's resistance and both would be valid. It follows that an electrode resistance meter need only have absolute accuracy to within a few percent to accommodate most users. However, it is important to measure resistance with high resolution, particularly when screening electrodes or when beveling.



## 4. MAINTENANCE

### 4.1 Cleaning the Grinding Place

After each beveling session, the grinding plate should be removed and rinsed with distilled water. To remove the grinding plate, first remove the three screws holding the upper retaining ring to the lower retaining ring. Remove the upper retaining ring, and then slide the grinding plate off the pedestal. Do not attempt to lift the grinding plate straight up off the pedestal, as vacuum tension will prevent this. Wipe the oil off the bottom of the plate and the pedestal flat with a Kimwipe<sup>1</sup>. Rinse the plate with distilled water and blot dry with a Kimwipe.

It is necessary to have the abrasive surface cleaned of grease and oil, so that a thin layer of saline or water may be formed on the surface during beveling. If the grinding plate needs to be cleaned of oil and dirt, hold the plate on edge and spray the surface thoroughly with degreaser (Grease Relief, Texize Company). Allow excess degreaser to run off the edge of the plate. Rinse thoroughly in distilled water several times.

***CAUTION: Under no circumstances should the grinding plate be cleaned with any solvent except the degreaser recommended. Acetone or similar materials will immediately destroy the plate surface.***

---

<sup>1</sup> Kimwipes ® is a registered trademark of Kimberly-Clark Corporation.

*(This page intentionally left blank.)*



## 5. TROUBLESHOOTING

### 5.1 Grinding Plate Won't Turn

- ◆ Is unit plugged in?
- ◆ Is the power light on? If not, check to see if the fuse is blown.
- ◆ Is the drive belt mounted around the rotating ring?
- ◆ Is the drive belt slipping? If so, then the belt needs to be tightened, or possibly replaced. Call Sutter Instrument.

### 5.2 Jerky Plate

- ◆ Bearing may need re-oiling.
- ◆ Inspect pedestal and bottom of abrasive plate for scoring. If either surface is scored, call Sutter Instrument for technical support.

### 5.3 Beveling Takes a Long Time

- ◆ Abrasive rating of plate is too fine for desired tip size. Try a larger abrasive rating.

### 5.4 No Beveling Occurs

- ◆ Is the grinding plate mounted in retaining ring with abrasive surface up?

### 5.5 Meter Does Not Work

- ◆ Is meter plugged in to outlet on back of motor housing? If so, call Sutter.

### 5.6 Pipettes Break During Beveling

- ◆ If you are not able to bevel pipettes smoothly and/or pipettes seem to break or chip, the advancer should be adjusted for a slower advance rate per turn of the micrometer knob.

*(This page intentionally left blank.)*

## APPENDIX A. LIMITED WARRANTY

Sutter Instrument Company, a division of Sutter Instrument Corporation, limits the warranty on this instrument to repair or replacement of defective components for one year after the date of shipment, provided the instrument has been operated in accordance with the instructions outlined in the instruction manual.

Abuse, misuse or unauthorized repairs will void this warranty.

Limited warranty work is performed only at the factory, and the cost of shipment both ways is to be borne by the user.

This instrument creates items that should only be used in a laboratory environment for use on animal tissues. It is not intended, nor should be used in human experimentation or applied to humans in any way. This is not a medical device.

The limited warranty is as stated above and no implied or inferred liability for direct or consequential damages is intended.

*(This page intentionally left blank.)*

## APPENDIX B. ACCESSORIES

### Accessories

<b>BV-10M</b>	Electrode impedance meter with active and reference lead
<b>BV-10S</b>	80X stereo microscope
<b>104C</b>	Diamond abrasive plate - coarse (5.0 $\mu$ to 50 $\mu$ tip sizes)
<b>104D</b>	Diamond abrasive plate - fine (2.0 $\mu$ to 20 $\mu$ tip sizes)
<b>104E</b>	Diamond abrasive plate - very fine (0.7 $\mu$ to 2.0 $\mu$ tip sizes)
<b>104F</b>	Diamond abrasive plate - extra fine (0.2 $\mu$ to 1.0 $\mu$ tip sizes)
<b>007</b>	Degreaser (bottle)
<b>008</b>	Beveler pedestal oil
<b>220V-MOD</b>	Modification to 220 volts

### Replacement Parts

<b>101</b>	6-inch reference lead (body to meter)
<b>102</b>	2-inch active lead (platinum to pipette)
<b>003</b>	Reference wick
<b>003A</b>	Reference wick holder
<b>105</b>	Halogen bulb
<b>106</b>	Drive belt

*(This page intentionally left blank.)*

**APPENDIX C. TECHNICAL SPECIFICATIONS**

<b>Beveling Range:</b>	<b>0.1<math>\mu</math>m through 50<math>\mu</math>m finished electrodes, depending on abrasive plate used</b>
<b>Grinding Surface Variation:</b>	<b>Less than 1.0<math>\mu</math>m</b>
<b>Grinding Speed:</b>	<b>60 RPM</b>
<b>Beveling Angle Range:</b>	<b>5-90 degrees - adjustable</b>
<b>Micromanipulator:</b>	
<b>Course drive:</b>	<b>0.075in / dial revolution</b>
<b>Fine drive:</b>	<b>0.0004in / dial revolution</b>
<b>Dimensions:</b>	<b>19 x 9 x 8 in (48 x 22 x 20 cm)</b>
<b>Weight:</b>	<b>45 lbs (20 kg)</b>
<b>Electrical:</b>	<b>120 volts, 50/60-Hz power line (220-VAC optional, requiring special modification)</b>

*(This page intentionally left blank.)*



## INDEX

<b>B</b>	
BV-10 Beveler Set-Up and Assembly Instructions .....	8
BV-10 Meter (Optional) .....	4
<b>D</b>	
Description and Function of Components .....	2
Description of Package Contents .....	7
disclaimer .....	iii
<b>G</b>	
General Safety Information.....	iii
grinding plate	
cleaning.....	17
Grinding Plate Installation.....	8
grinding procedure	
control of beveling by measuring electrical	
resistance.....	12
control of beveling by monitoring bubble size	13
general information.....	11
Grinding Procedure.....	11
<b>I</b>	
Introduction .....	1
<b>L</b>	
Limited Warranty.....	21
<b>M</b>	
Manipulator .....	2
Motorbase.....	2
<b>N</b>	
notes	
user.....	28
<b>O</b>	
Optical Attachment (Optional) .....	5
<b>P</b>	
Pedestal/Grinding Assembly .....	3
precautions.....	iii
operation.....	iii
<b>R</b>	
Resistance Meter Stand Alone Use.....	14
resistance meter standalone use	
accuracy .....	15
ohms law – theory of operation .....	14
operation.....	14
<b>S</b>	
safety warnings .....	iii
<b>T</b>	
technical specifications.....	25
technical support.....	2
troubleshooting	
beveling takes a long time.....	19
grinding plate won't turn .....	19
jerky plate.....	19
meter does not work.....	19
no beveling occurs.....	19
pipettes break during beveling .....	19
Troubleshooting.....	19
<b>U</b>	
Unpacking and setting up.....	7

NOTES