

**Stemi DR, Stemi DV4
Stemi 2000**
Stereomicroscopes













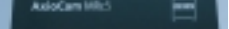
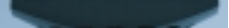

The Profile

**Conceived by Greenough,
Realized by Zeiss.**



Contents

	Stemi DR, Stemi DV4	4
	Stemi 2000	5
	Stands	6
	Mounting Brackets	7
	Stages	8
	Supplementary Lenses	10
	Eyepieces	11
	Operating Concepts	12
	Systems Overview	13
	Epi-Illuminators	18
	Transmitted-Light Illuminators	20
	Polarization	21
	Fluorescence	22
	Documentation	24
	Specification	26



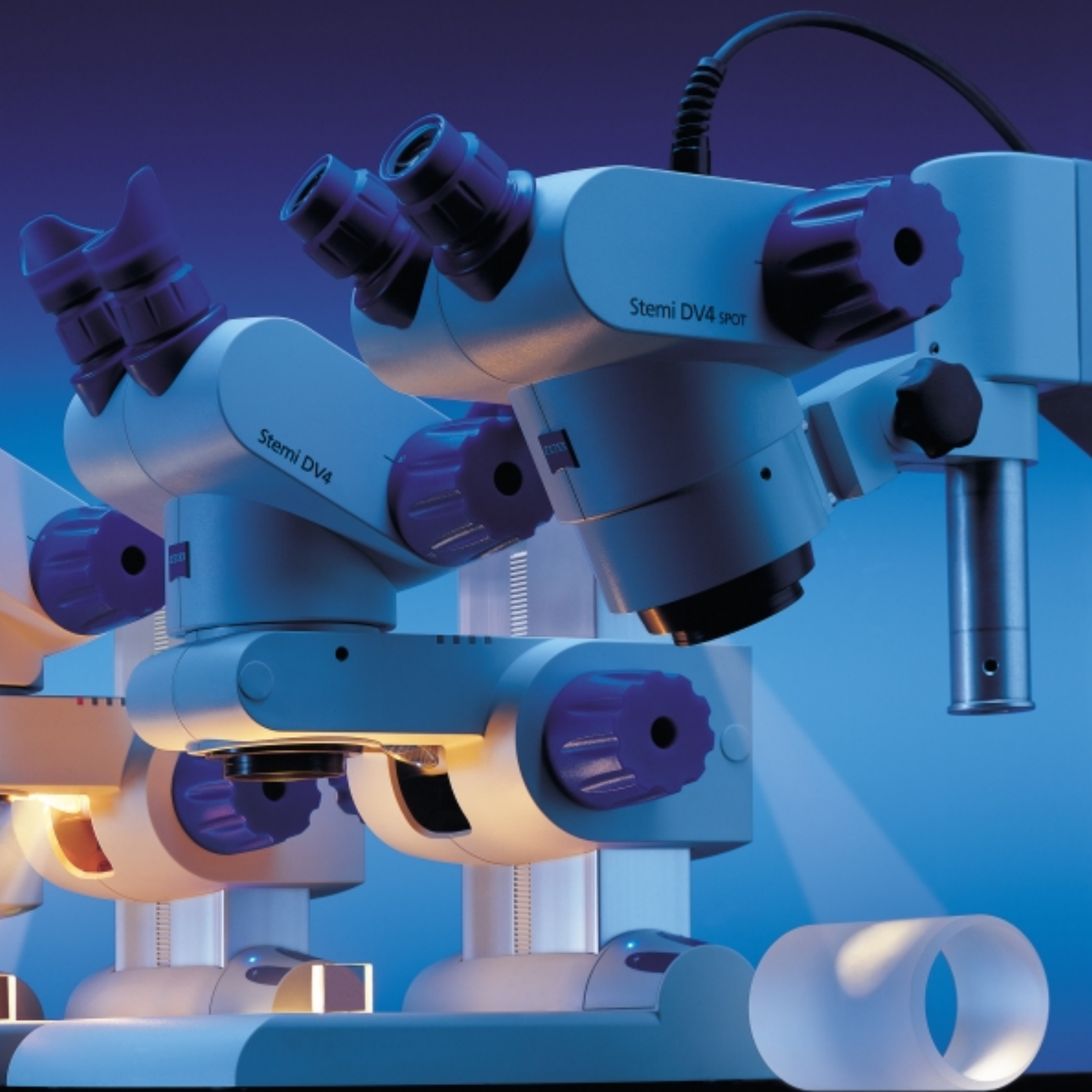



The Art of the Essential

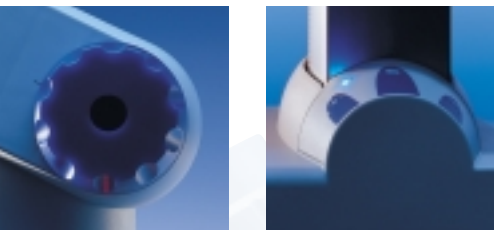

A bright and accurate optical image, straightforward operation, a compact, but attractive design, and all that at an acceptable price – this is perhaps the most concise description of a modern stereomicroscope.

This sounds very simple. Given the policy of Carl Zeiss to make no compromise in optics, though, it is far from simple. Yet Carl Zeiss has succeeded admirably. In collaboration with the Carl Zeiss innovation center, we created a number of advanced manufacturing processes which ensure the high Zeiss quality you expect while also permitting us to sell this product family at attractive prices.

Undisputedly, the Stemi DV4 with its brilliant images sets a new standard for stereomicroscopes in this performance class. Note, among other features, the novel electronic light control by pushbuttons.

And we trust you will admire the unconventional yet highly functional styling. All in all: a neat little work of art.

The microscope bodies:

Stemi DV4

- (Double-lens Vario, zoom factor 4)*
- Stereomicroscope with zoom (vario) magnification changer
 - Magnification range: 8x to 32x
 - Field-of-view number: 20
 - Free working distance: 92 mm

Stemi DV4 SPOT

- (Double-lens Vario, zoom factor 4)*
- Stereomicroscope with zoom (vario) magnification changer
 - Magnification range: 8x to 32x
 - Field-of-view number: 20
 - Free working distance: 92 mm
 - Built-in light SPOT with fiber-optic cable connecting to a cold-light source

Stemi DR1040

- (Double-lens Revolving nosepiece, fixed 10x and 40x magnifications)*
- Stereomicroscope with 2 selectable, fixed magnifications: 10x and 40x
 - Field-of-view number: 20
 - Free working distance: 92 mm

Stemi DR1663

- (Double-lens Revolving nosepiece, fixed 16x and 63x magnifications)*
- Stereomicroscope with 2 selectable, fixed magnifications: 16x and 63x
 - Field-of-view number: 20
 - Free working distance: 92 mm

(All data are given for the basic configurations without optical accessories)

Extra Excellence from Zeiss

Carl Zeiss Stemi 2000 stereomicroscopes definitely rank among the leading instruments of their performance class. Their deservedly fine reputation among the world's laboratories and industrial plants is mainly due to their unexcelled imaging quality in terms of contrast, depth of field and resolving power. The peerless standard 23 mm field of view lets you observe a specimen field sized up to 35 mm. The Stemi 2000 was the first to have a distinctly lower viewing angle of 35° – an essential ergonomic improvement in modular stereomicroscope setups of greater overall height.

An exchangeable dust glass protects the valuable zoom optics against dust and aggressive vapors.

As all Greenough microscopes, the Stemi 2000 models have the internationally common 76 mm mounting diameter.

Stemi 2000 – another proof of Zeiss excellence.



The microscope bodies:

Stemi 2000

- Stereomicroscope with factor 7.7 zoom magnification changer
- Switchable click stop
- Magnification range: 6.5x to 50x
- Field-of-view number: 23
- Free working distance: 92 mm

Stemi 2000 C

- Stereomicroscope with factor 7.7 zoom magnification changer
- Switchable click stop
- Magnification range: 6.5x to 50x
- Field-of-view number: 23
- Free working distance: 92 mm
- Camera port with 100/100% light selector switch

Stemi 2000 CS

- Stereomicroscope with factor 7.7 zoom magnification changer
- Switchable click stop
- Magnification range: 6.5x to 50x
- Field-of-view number: 23
- Free working distance: 92 mm
- Camera port with fixed 50/50% light distribution



The Solid Base of Quality Results

Flexible operations on a solid base: With a number of tried-and-approved stands for its stereomicroscopes, Carl Zeiss offers efficient solutions tailored to your specific requirements. Functional, variable and stable, these are stands you can depend on.

An inexpensive, but efficient accessory to the Model C stand: the darkfield transmitted light accessory.



Model P stand

With a sturdy, spring-mounted hinged arm, the Model P leaves lots of free space for positioning your stereomicroscope over the bench top. There is no problem in swiveling the instrument in and out as required.

Model C stand

This compact stand already incorporates the essential illuminating techniques – reflected, transmitted and mixed light. Select them by pressing a button, and control them separately. Optimum for teaching and simple routine work.

Cantilever-type or hinged-arm stands such as Model DA, Model D or Model G allow the observation of large specimens. Their rotating, swiveling and tilting facilities meet your flexibility requirements.

For footprints and column heights of all stereomicroscopes see page 27.

Model S stand

Economic and functional: the elementary stand.

Model N stand

Large, but low-weight base of sandwich design ensuring high stability.

Base plate 32 with column

Enormously stable. This sturdy base accommodates columns of 32 mm dia. and various lengths, and affords extra stability for extensive microscope setups. Ideal for observing large specimens.



The Link to Your Success

Four functions in one. The Stemi mounting bracket for the 32 mm dia. stand column combines all important functions:

- Supporting the microscope body at its 76 mm mounting diameter
- Focusing onto the specimen within a range of ± 20 mm
- Fitting to 32 mm dia. stand columns
- Accommodating optical fiber illuminators

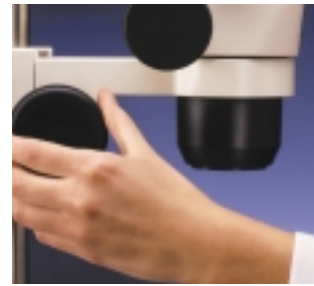

Surface finish and diameter of the control knobs ensure swift and sensitive focusing.

*Stemi mounting bracket with focusing knob for 32 mm column
Basic outfit for stereomicroscopy.
For fast, sensitive focusing –
from overview to detail.*



The combination of a non-focusing Stemi mounting bracket of 76 mm mounting dia. and a BMS adapter (Bonder Mount Socket 5/8") provides a tiltable connection with cantilever and hinged-arm stands.



Adapter for B&L mounting brackets
For fitting Zeiss stereomicroscopes to the barrel-shaped aperture of the brackets of earlier Bausch&Lomb stereomicroscopes.

Precise, Smooth Handling – Kind to Your Specimens

Stages not only facilitate observation but also help avoid damage to specimens. After placing the specimen on a stage, you can operate controls to shift and/or tilt your specimen without touching it again.



Jerk-free, specimen-preserving work with the sliding stage.

Sliding stage

For sensitive shifting and turning of specimens.
Stage diameter: 190 mm
Range of motion: ± 20 mm

Ball-and-socket stage

Can be tilted in any direction to allow observation of 3D objects sideways. Small specimens can be pricked to the exchangeable, adhesive soft pad inset.
Stage diameter: 158 mm.
Range of tilt: $\pm 30^\circ$.

Mechanical stage

Facilitates systematic scanning of specimens on slides or in Petri dishes with transmitted-light or epi-illumination. Can be fitted with optional specimen driver, glass plate, and/or various type M holder frames for specimen vessels.
Range of motion: 76 x 50 mm
Holder frames: Please inquire.

Rotating stage

For observations with reflected, transmitted and – especially – polarized light. Equipped with a vernier scale for object quantification and reproducible positioning. A specimen driver option is available for retrofitting.
Stage diameter: 115 mm
Range of rotation: 360°
Range of specimen slider motion: 75 x 25 mm.



24 Specimens at Your Fingertips

Fast, easy, safe: Retrofit your 32 mm column stand with the Model S Specimen Carousel, and click-stop any of 24 specimens to its precise position in the beam path. The carousel works with all illuminating techniques – reflected, transmitted or mixed light, brightfield or darkfield.



A special click stop mechanism exactly positions each specimen.

*Ideal and efficient for museums and exhibitions:
The Model C Specimen Carousel fitted to the compact Model C stand.*



The wells of the carousel accommodate commercial Petri dishes of 35 mm dia. Throughout the 24 places, the surface or detail of interest remains approximately in focus, requiring only slight correction.

*Place tall samples
in a Petri dish.*

Cover plate

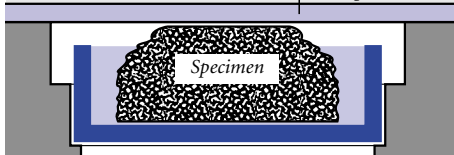

*Place samples of medium height
in the lid of the Petri dish.*

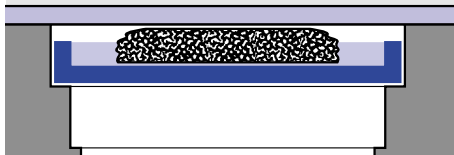

*Place flat samples
on top of the lid.*

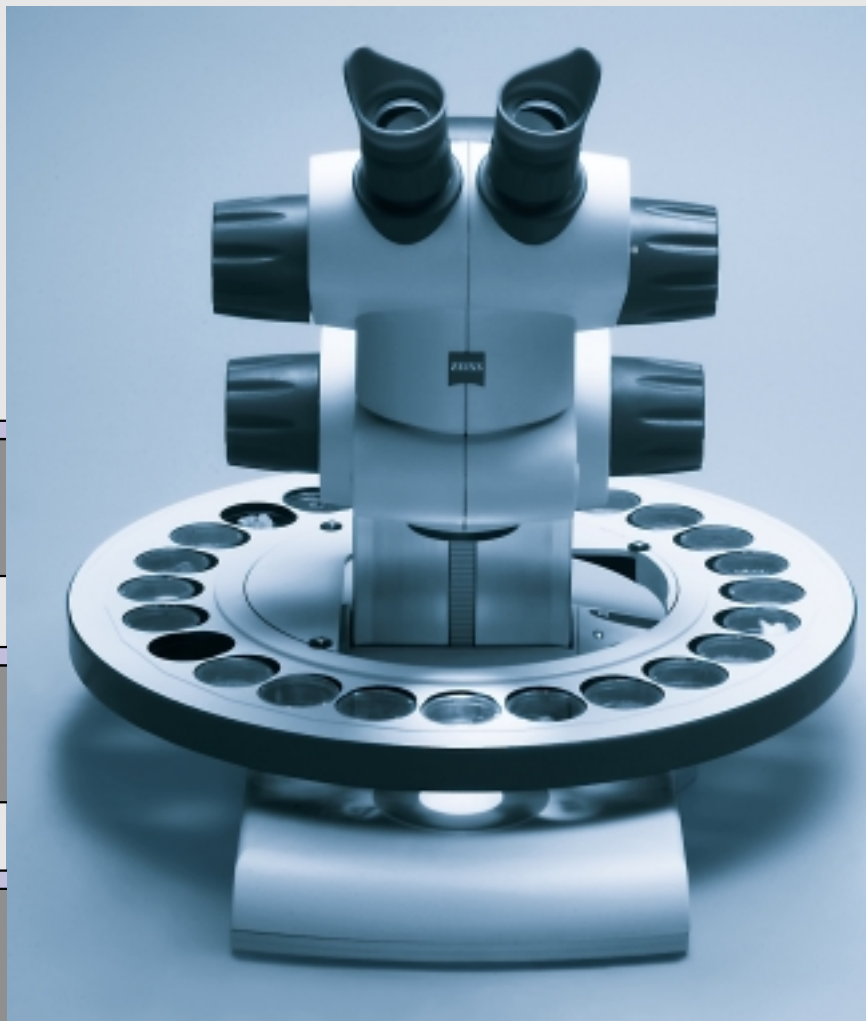
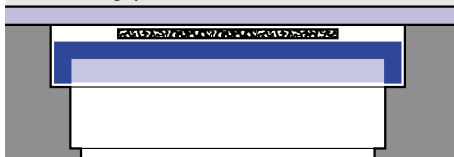

Extra Power

With supplementary lenses you can increase either the magnifying power or the free working distance of your stereomicroscope. Simply screw them to the objective front lens mount.



For extra-sensitive, vibration-free focusing, use the **supplementary 0.3x ... 0.5x zoom lens**. As an added advantage, it allows the viewing height to be varied within ± 70 mm. Specially suited as a companion to cantilever and hinged-arm stands.



Whereas supplementary lenses with power factors below 1 enlarge the object field and the working distance, ...

... those with power factors above 1 increase the stereomicroscope's magnification.

For working distances and object fields, see page 26.



Wide Fields

All eyepieces on Zeiss stereomicroscopes can be focused to allow the compensation of the observer's visual defects. Plug-in diameter: 30 mm.

And all eyepieces can accommodate micrometer disks.



Measuring, counting, comparing

Eyepiece micrometer disks are available with diameters of 26 and 21 mm.

They are calibrated with a stage micrometer.



Eyepieces W 10x/21 foc.* with eyecups.
Budget-priced wide-field eyepieces of high optical performance.
(Eyepiece micrometer disk dia.: 26 mm)

Eyepieces W-PL 10x/23 Br. foc.***
High-performance aspheric eyepieces with large, flattened 23 mm visual field
(Optional eyecups)
(Eyepiece micrometer disk dia.: 26 mm)

Eyepieces W-PL 16x/16 Br. foc.***
Eyepieces of high magnification with large 54° angular field
(Optional eyecups)
(Eyepiece micrometer disk dia.: 21 mm)

Eyepieces W 25x/10 foc.* with eyecups
For maximum magnifications
(Eyepiece micrometer disk dia.: 21 mm)

* focusing
** high eyepoint (for use with eyeglasses)

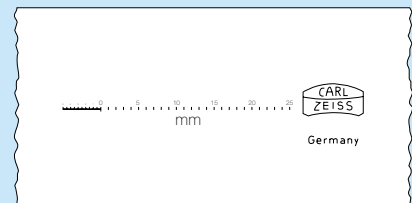
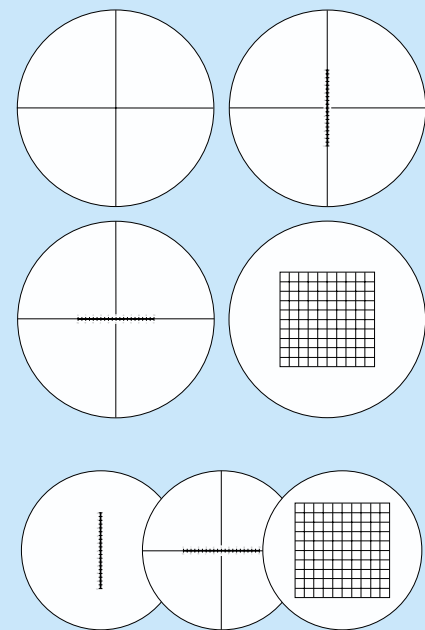

Left to right and top to bottom:

- Crosshairs, 26 mm dia.
- Crosshairs micrometer 10:100, 26 mm dia.
- Crosshairs micrometer 14:140, 26 mm dia.
- Net micrometer 12.5x12.5/5, 26 mm dia.
- Eyepiece micrometer 10:100, 21 mm dia.
- Crosshairs micrometer 10:100, 21 mm dia.
- Net micrometer 10x10/5; 10, 21 mm dia.
- Stage micrometer 25+50/10 mm

Stereomicroscopes Form True-to-Side, Erect 3D Images

The realistic, 3D images are especially effective with specimens having pronounced spatial structures.

The large object fields and long working distances are of particular advantage.

The total magnification limit of modern stereomicroscopes is about 250x.

Modern stereomicroscopes are built according to either of two design concepts:

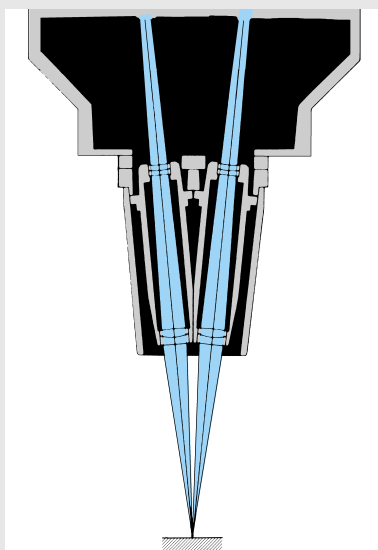

The Greenough design

Two identical objectives, arranged with their optical axes including the stereo angle, generate two separate images. Observed through separate eyepieces, they combine to form a 3D image.

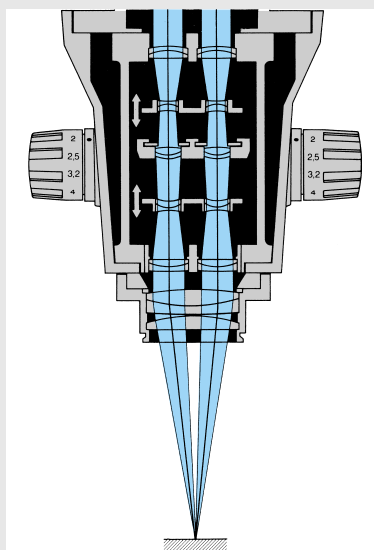

The Telescope design

Two microscope systems arranged in parallel share a common objective. The stereo angle is formed by the extra-axial pairs of rays.

The stereomicroscopes of the **Stemi DR**, **Stemi DV4** (Double lens) and **Stemi 2000** series conform to the Greenough concept.

The bodies of these stereomicroscopes are very compact. Even in their most basic configurations, the Carl Zeiss products excel by their outstanding imaging performance.

Systems Overview

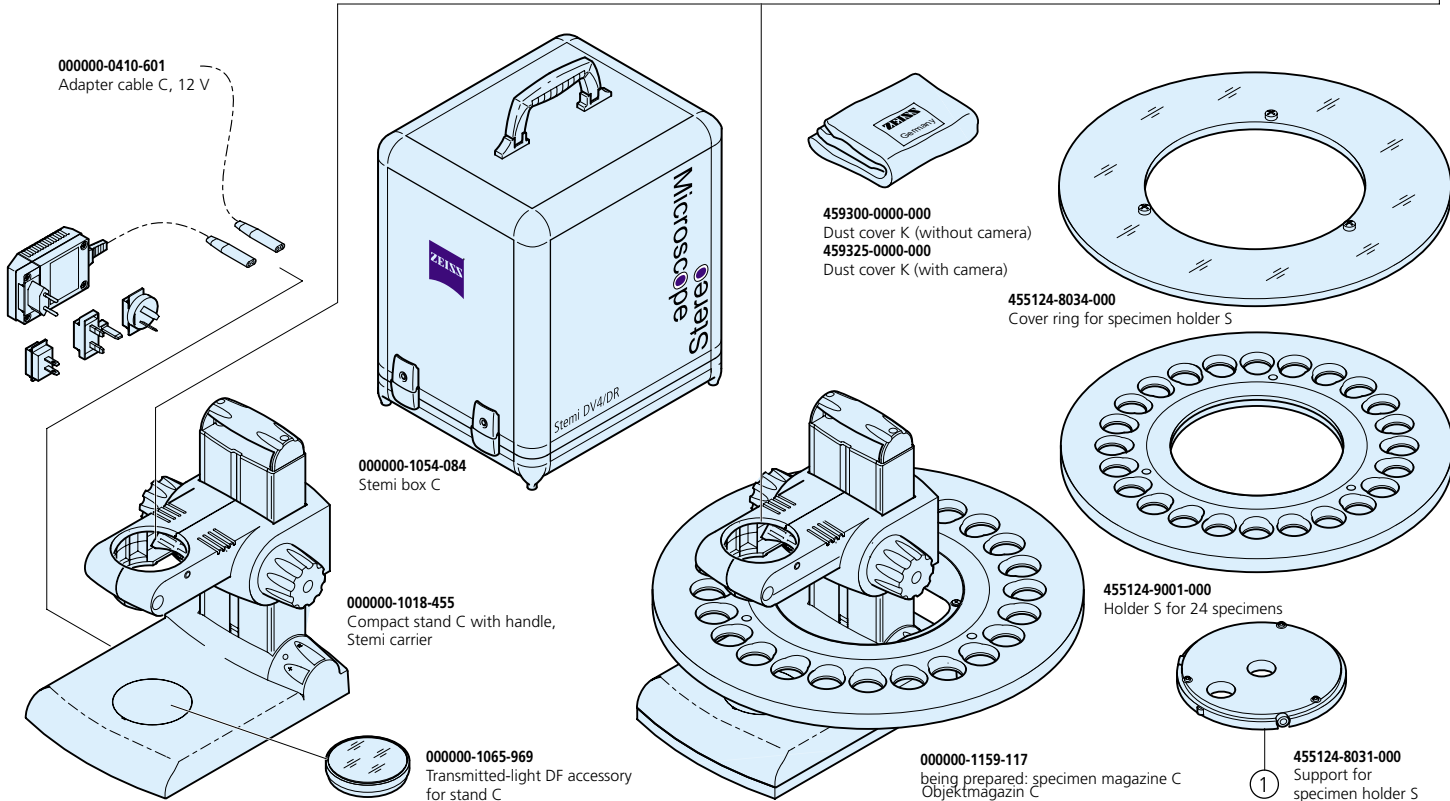
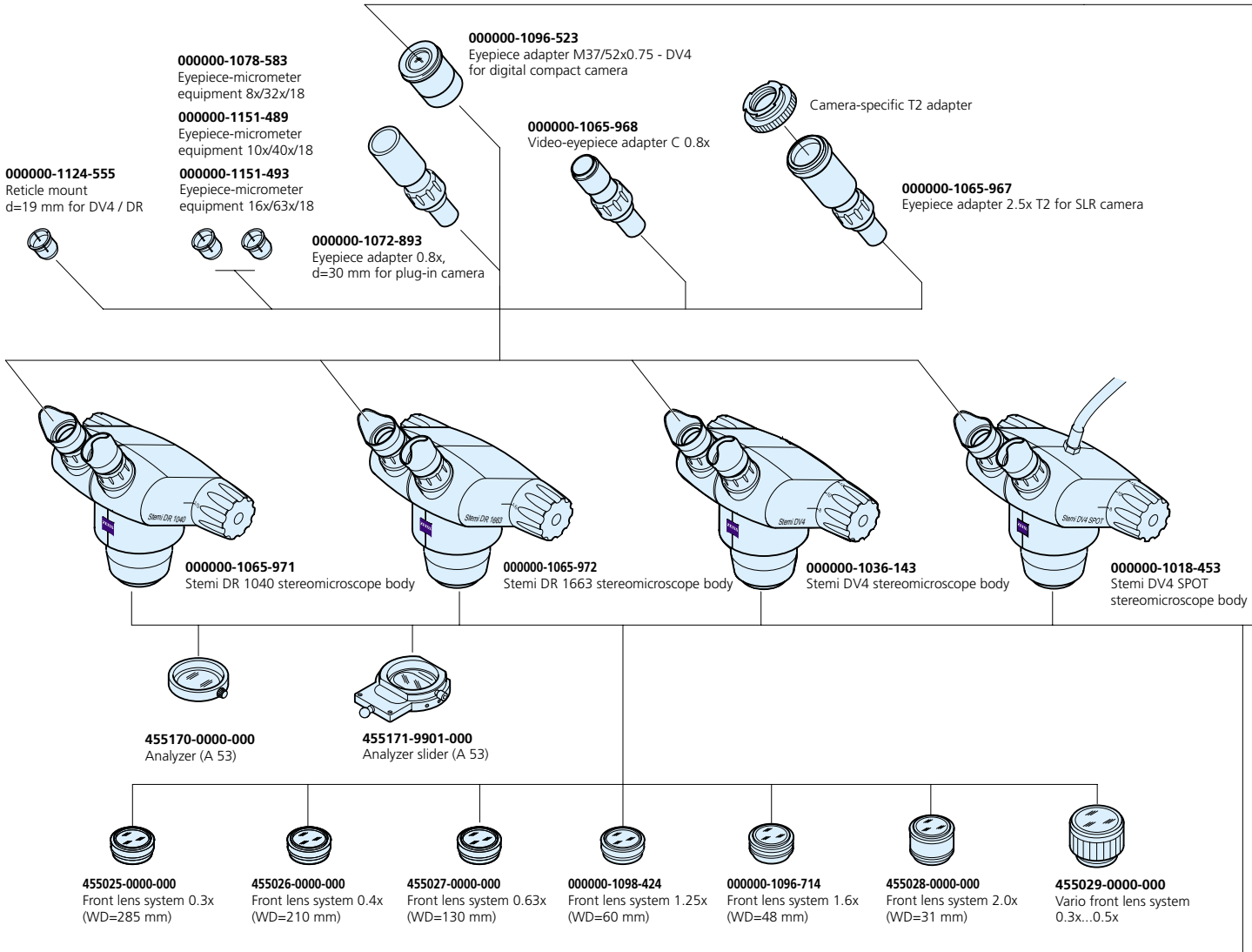

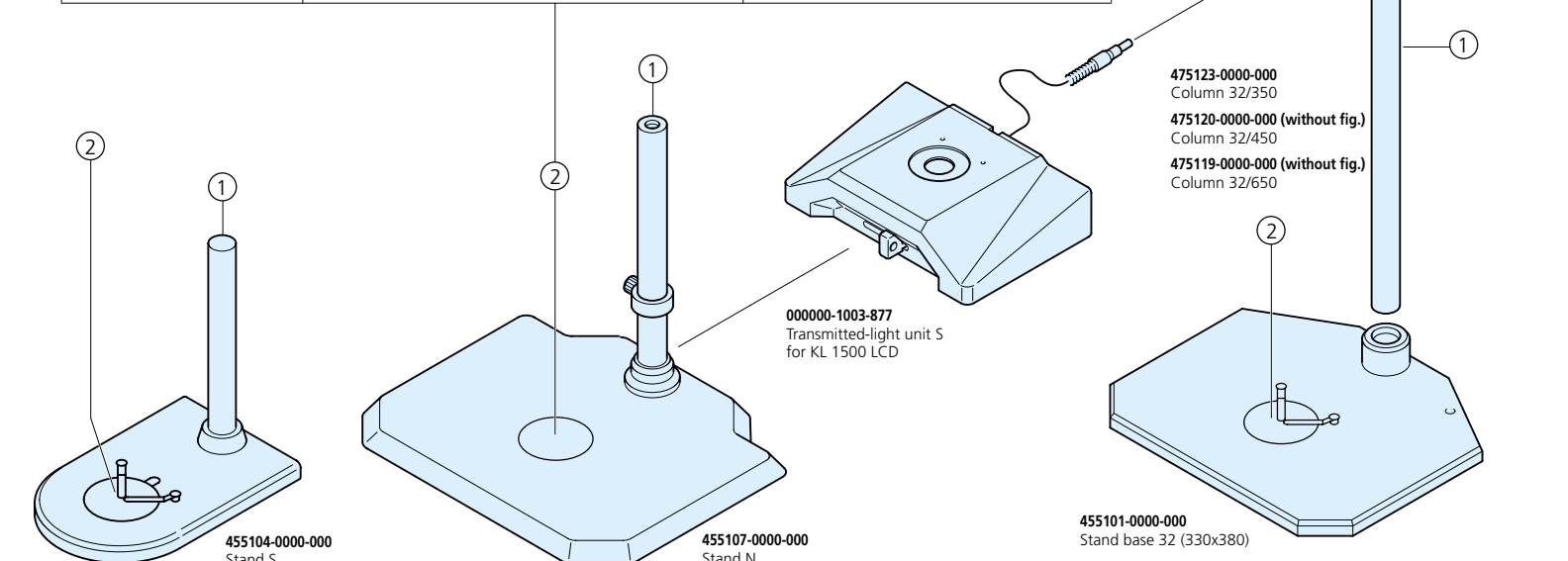
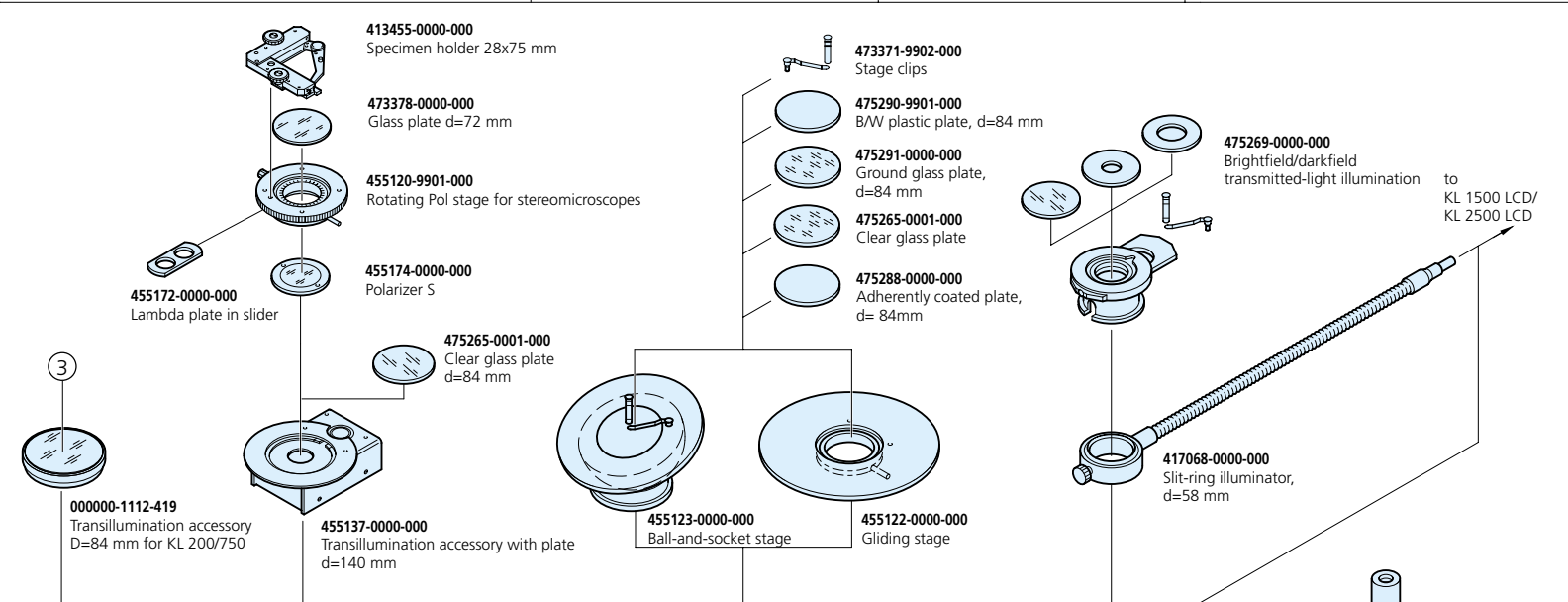
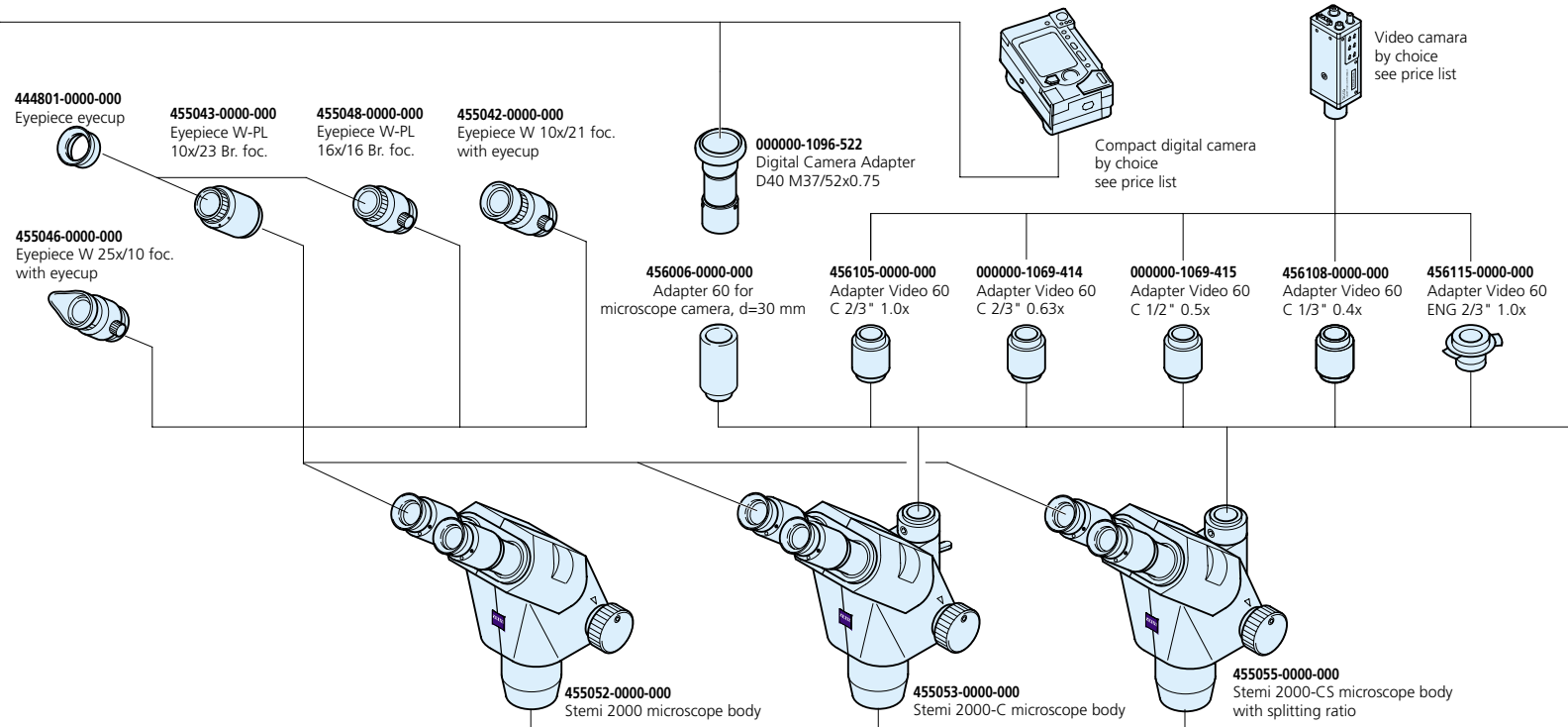



426131-0000-000
SLR Camera body
Canon EOS33 incl. cable release

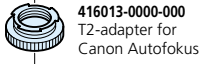

416013-0000-000
T2-adapter for
Canon Autofokus

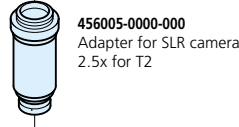

456005-0000-000
Adapter for SLR camera
2.5x for T2

Microscope camera MC 80 DX (without fig.)
Microscope camera MC 200 CHIP (without fig.)



456006-0000-000
Adapter 60 for
microscope camera,
d=30 mm

417059-9901-000
Focusing attachment
without filters

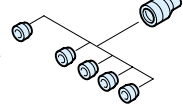

417065-0000-000
Polarization filter

417060-9901-000
Focusing attachment and filter set

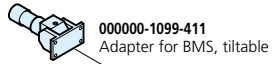

000000-1099-411
Adapter for BMS, tiltable



455096-0000-000
Stemi carrier without drive

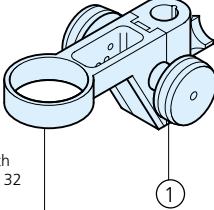

455094-0000-000
Stemi mount with
drive for column 32

455149-0000-000
Adapter for built-in illuminator

417085-9002-000
Light guide holder for Stemi mounts

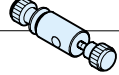

000000-1096-716 (without fig.)
Holding ring DV4/DR
for slit-ring illuminator
455184-0000-000
Holding ring d=58 mm
for 6-point ring illuminator

413458-9001-000
Specimen holder with
mounting frame and glass plate
(additional holding frames
available on request)

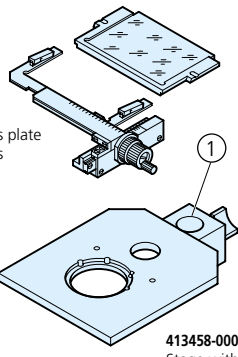

413458-0000-000
Stage with carrier 32

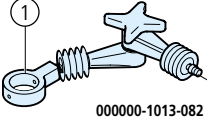

000000-1013-082
Articulated arm S

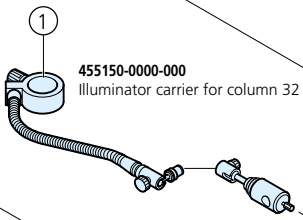

455150-0000-000
Illuminator carrier for column 32

455143-0000-000
Light guide holder for
illuminator carrier

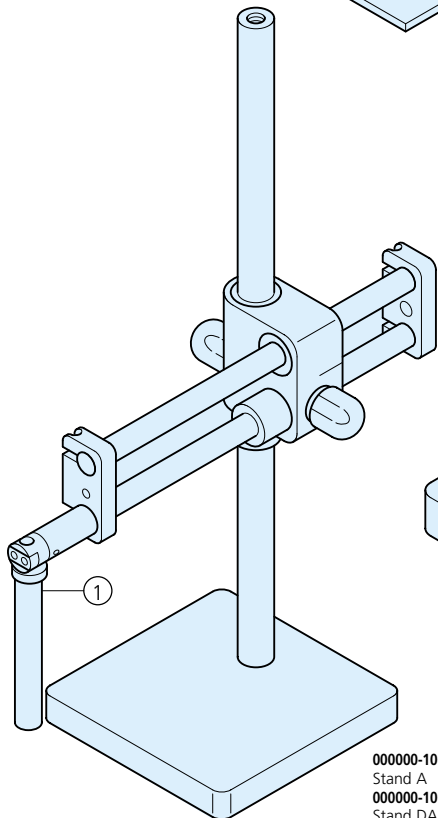

000000-1065-894 (without fig.)
Stand A
000000-1065-895
Stand DA

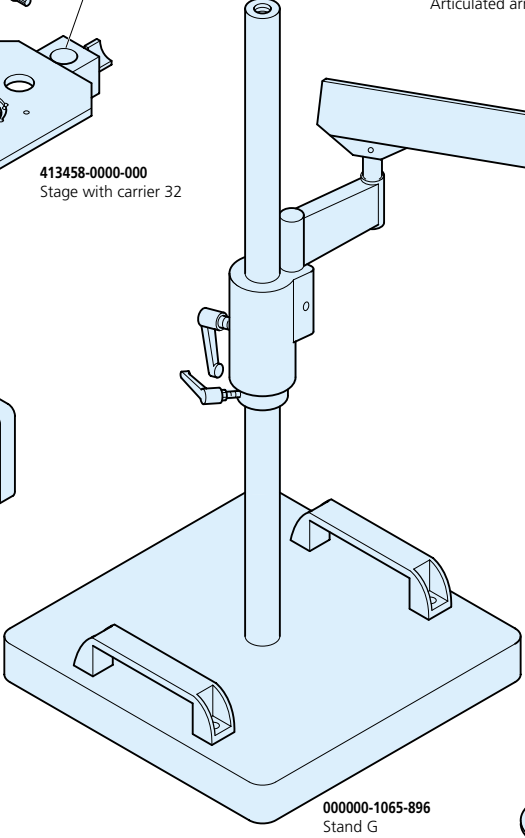

000000-1065-896
Stand G

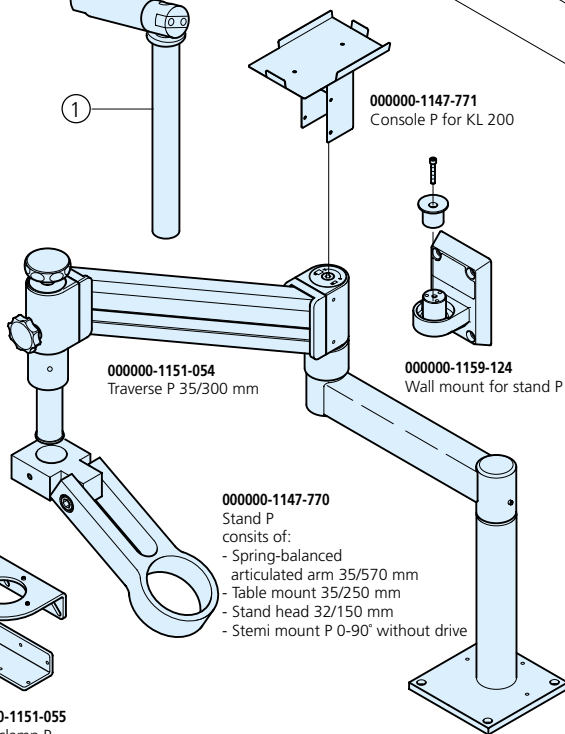

000000-1151-055
Table clamp P

000000-1151-054
Traverse P 35/300 mm

000000-1147-770
Stand P
consists of:
- Spring-balanced
articulated arm 35/570 mm
- Table mount 35/250 mm
- Stand head 32/150 mm
- Stemi mount P 0-90° without drive

000000-1147-771
Console P for KL 200

000000-1159-124
Wall mount for stand P

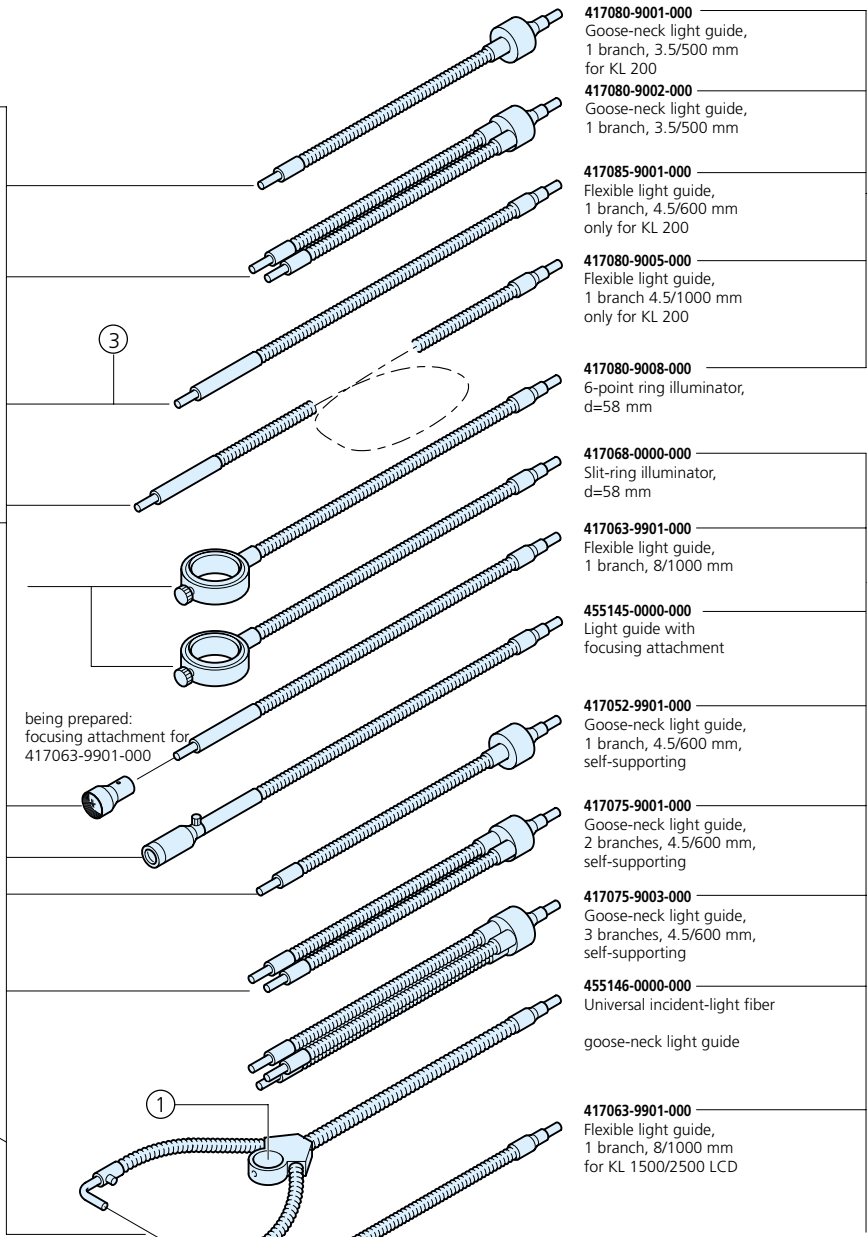

- 417080-9001-000**
Goose-neck light guide,
1 branch, 3.5/500 mm
for KL 200
- 417080-9002-000**
Goose-neck light guide,
1 branch, 3.5/500 mm
- 417085-9001-000**
Flexible light guide,
1 branch, 4.5/600 mm
only for KL 200
- 417080-9005-000**
Flexible light guide,
1 branch 4.5/1000 mm
only for KL 200
- 417080-9008-000**
6-point ring illuminator,
d=58 mm

- 417068-0000-000**
Slit-ring illuminator,
d=58 mm
- 417063-9901-000**
Flexible light guide,
1 branch, 8/1000 mm
- 455145-0000-000**
Light guide with
focusing attachment

- 417052-9901-000**
Goose-neck light guide,
1 branch, 4.5/600 mm,
self-supporting

- 417075-9001-000**
Goose-neck light guide,
2 branches, 4.5/600 mm,
self-supporting

- 417075-9003-000**
Goose-neck light guide,
3 branches, 4.5/600 mm,
self-supporting

- 455146-0000-000**
Universal incident-light fiber
goose-neck light guide

- 417063-9901-000**
Flexible light guide,
1 branch, 8/1000 mm
for KL 1500/2500 LCD

- 417090-9001-000**
Ring illuminator d=66 mm
for KL 2500 LCD

- 000000-1004-001**
Ring illuminator for
incident-light darkfield,
adjustable

- 000000-1063-307**
Line light S, l=50 mm

- 000000-1063-292**
Flexible light guide,
1 branch, 15/1000 mm
for KL 2500 LCD

- 417085-0000-000**
KL 200 cold-light source
(230 V)
- 417086-0000-000 (without fig.)**
KL 200 cold-light source
(120 V)

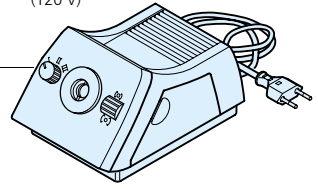

- 000000-1063-181**
Cold-light source
KL 1500 LCD (230 V)
- 000000-1063-182 (without fig.)**
Cold-light source
KL 1500 LCD (115 V)

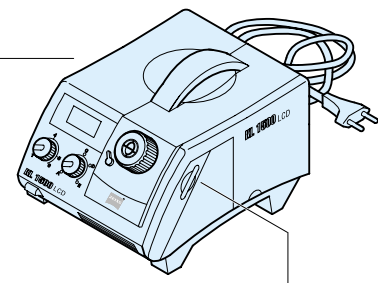

- 000000-1063-301**
Filter S, blue
- 000000-1063-302**
Filter S, red
- 000000-1063-303**
Filter S, green
- 000000-1063-304**
Filter S, yellow
- 000000-1063-306**
Conversion filter S

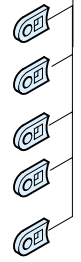

- 000000-1063-183**
Cold-light source
KL 2500 LCD (230V)

- 000000-1063-184 (without fig.)**
Cold-light source
KL 2500 LCD (115V)

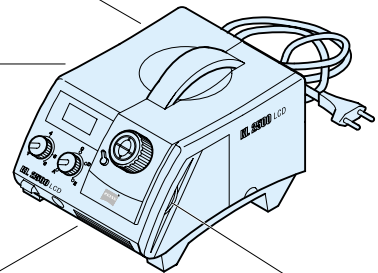

- 000000-1063-313**
Blue filter, d=28 mm
- 000000-1063-314**
Red filter, d=28 mm
- 000000-1063-315**
Green filter, d=28 mm
- 000000-1063-316**
Yellow filter, d=28 mm
- 000000-1063-317**
Conversion filter, d=28 mm

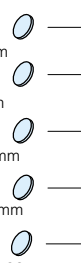

- 000000-1069-753**
Diffuser S for KL 1500 LCD

- 417075-9016-000**
AL-DF 2 adapter

- 417075-9015-000**
AL-DF 1 adapter

- 417090-9002-000**
focusing attachment for 000000-1063-292

000000-1063-183
Cold-light source
KL 2500 LCD (230 V)

000000-1063-181
Cold-light source
KL 1500 LCD (230 V)

000000-1063-184 (without fig.)
Cold-light source
KL 2500 LCD (115 V)

000000-1063-182 (without fig.)
Cold-light source
KL 1500 LCD (115 V)

417052-9901-000
Goose-neck light guide,
1 branch, 4.5/600 mm,
self-supporting

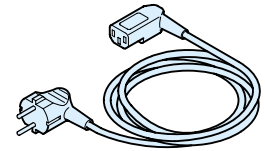

000000-1023-506
Illuminator LUMATEC
SUV-DC-P (HBO 200)

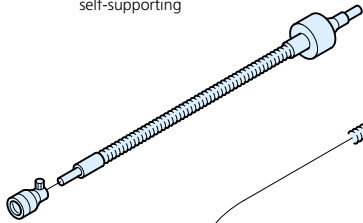

455145-0000-000
Light guide with
focusing attachment

417059-9901-000
Focusing attachment
without filters

455031-0000-000
Barrier filter adapter FL S
for Greenough systems



Barrier filter slider
from filter sets (see price list)



000000-1013-085
Empty slider for
one barrier filter d=45 mm



000000-1013-084
Empty slider for
two barrier filters d=25 mm

Stemi filter sets:

000000-1015-034
FL S filterset 02 UV

000000-1015-035
FL S filterset 05 GFP-violett

000000-1015-036
FL S Filterset 09 GFP plus

000000-1015-037
FL S filterset 13 GFP-blue

000000-1015-038
FL S filterset 15 green

000000-1017-341
FL S filterset 02 HT UV*

000000-1017-342
FL S filterset 05 HT GFP-violett*

000000-1017-343
FL S filterset 09 HT GFP plus*

* HT high-temperature-resistant filters
for LUMATEC HBO 200

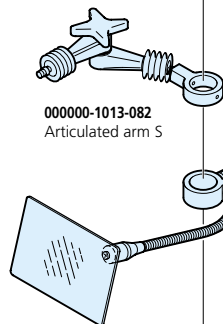

000000-1013-082
Articulated arm S

455177-0000-000
Antiglare screen FL S

①

455188-0000-000
Mount 32 for HBO lamps

000000-1083-459
Adapter for light guides 10/15/17

417088-0000-000
Focusing attachment for FL S

Exciter filter from filter sets

000000-1013-083
Empty mount for
excitation filter d=18 mm

000000-1012-895
Focusing attachment FL S 0.4

417087-0000-000
FL S liquid-core light guide,
8/1000 mm

447250-0000-000
Collector for light guide

Footswitch for
LUMATEC HBO 200

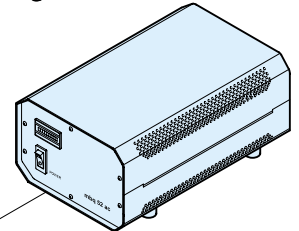
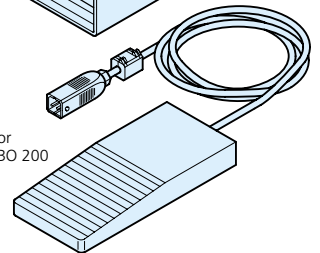

000000-1113-833
Transformer mbq 52 ac-z
for HBO 50 ac

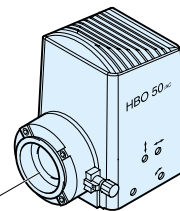

447220-0000-000
Lamp housing HBO 50
with socket

447270-0000-000
Lamp collector HBO 50/SF 25

381619-0000-000
HBO 50 super-pressure mercury lamp

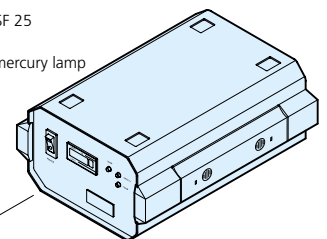

000000-1003-928
Power supply unit for N HBO 103

000000-1003-924
Power supply unit for N XBO 75

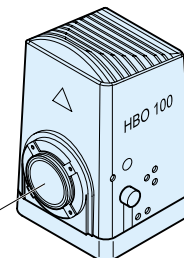

000000-1007-980
Illuminator N HBO 103

000000-1007-981
Illuminator N XBO 75

000000-1007-976
Collector N HBO 103/XBO 75 or

000000-1007-977
Quartz collector N HBO 103/XBO 75

380301-9350-000
Super-pressure mercury lamp
HBO 103 W/2
380053-9870-000
Xenon lamp XBO 75 W/2

Cold Light for Bright Views

Your stereomicroscope wants plenty of light in a small space. What it doesn't want is heat that could make the specimen change. That is why cold light is standard with Carl Zeiss stereomicroscopes.

**Universal Epi-Illuminator
with KL 1500 LCD cold light
source**

Two lamps at the end of goose-necks of enormous flexibility, easy to fit to the stand column. As the goosenecks come from behind, the specimen remains 100% accessible.



**Inside-Mounting Epi-Illuminator
with KL 200 cold light
source**

Built into the Stemi bracket, this spotlight illuminator does not interfere with specimen manipulation.



Ring Illuminators
*Ideal for shadowless,
homogeneous illumination.*



Select from three cold-light sources and a wide range of fiber-optic accessories to meet your requirements:

Schott KL 200 cold light source

This small, compact and inexpensive cold light source has an 8V/20W lamp with three switch-selectable brightness levels.

Schott KL 1500 LCD cold light source

The light source used most frequently. 12V/150W, with continuous electronic light control and a filter pocket.

Schott KL 2500 LCD cold light source

With its 12V/250W lamp, this is one of the most powerful cold light sources. Can be continuously dimmed, either electronically or mechanically (color temperature remains constant). With filter wheel and remote control box.



Simply rotate the ring lamp of the darkfield epi-illuminator to vary the contrast.

Darkfield Epi-Illuminator with KL 2500 LCD cold light source
Special ring illuminator that makes finest structures visible. It directs light onto the specimen at an angle of 60° rather than vertically. As a result, the objective captures only the light diffracted by the specimen structures; these appear bright against a dark ground. An adapter provides proper positioning of the ring light relative to the specimen.

Line Illuminator with KL 2500 LCD cold light source
Converts the round cross-section of the fiber-optic light conductor into a row of fibers. The emerging line of light, when incident at a grazing angle, covers the specimen with a luminous carpet. The shadows thus thrown make finest structures visible – e.g., those of a fingerprint.



Diffuse Illuminator with KL 1500 LCD cold light source
Involves the Model S Diffuser. High-contrast, almost reflection-free imaging of convex, glossy surfaces. Simply convincing.



The Pleasure of Seeing Through

To suit different requirements and budgets, Carl Zeiss provides a choice of three transmitted-light solutions for stereomicroscopes, ranging from highly affordable to extremely versatile.

Model S Transmitted-Light Illuminator
with KL 1500 LCD cold light source
Extremely versatile brightfield/dark-field illuminator. Optimum illumination matched to the specimen is achieved via a tiltable mirror unit with two reflectors which effect really bright, yet soft and even lighting. The unidirectional darkfield illumination facility provides not only good contrast but also a strong 3D effect.

Transillumination Light Box
with KL 200 cold light source
A specially low-priced solution for versatile brightfield transmitted-light illumination. It works in conjunction with one of the built-in illuminators available – simply direct the flexible fiber-optic conductor in the Stemi mounting bracket vertically down. The light is deflected onto the specimen from below via two mirrors.



Brightfield/Darkfield Transmitted-Light Illuminator
with KL 1500 LCD cold light source
Unstained transparent specimens are barely visible in a bright field. By simply switching to circular darkfield with this illuminator, you can easily detect the structures (defects, impurities) in or on such specimens in good contrast. This illuminator is used in conjunction with the annular slit illuminator.



For simple transmitted-light observations:
Brightfield transmitted-light accessory (84 mm dia.)
to Schott KL 200.



Polarization Brings It to Light

For polarizing microscopy, the transillumination light box or the universal transmitted-light illuminator can be supplemented with polarizing equipment including the rotating stage and an analyzer slider.



Polarizer S

The rotating stage (see page 8) has a recess to accommodate the Polarizer S and can be optionally equipped or retrofitted with a specimen driver and a compensator slider containing a 1st order red filter.

Analyzer slider

Analyzer S (no illustration)

Either of these fits over the 53 mm barrel of the stereomicroscope's front objective. The slider has the extra advantage of allowing quick change between plain brightfield and polarization.

Rotary polarizer for focusing attachment

To improve the illumination of glossy surfaces, a rotary polarizer can be screwed to the focusing attachment of an optical fiber cable illuminator. The analyzer S fitted to the objective then allows the elimination of disturbing reflections.



Retrofittable Fluorescence with Halogen ...

There is an increasing demand for a combination of fluorescent labeling with the large orthoscopic images of a Greenough stereomicroscope. Carl Zeiss has it. The external excitation source may either be a halogen or a super-pressure mercury vapor lamp.

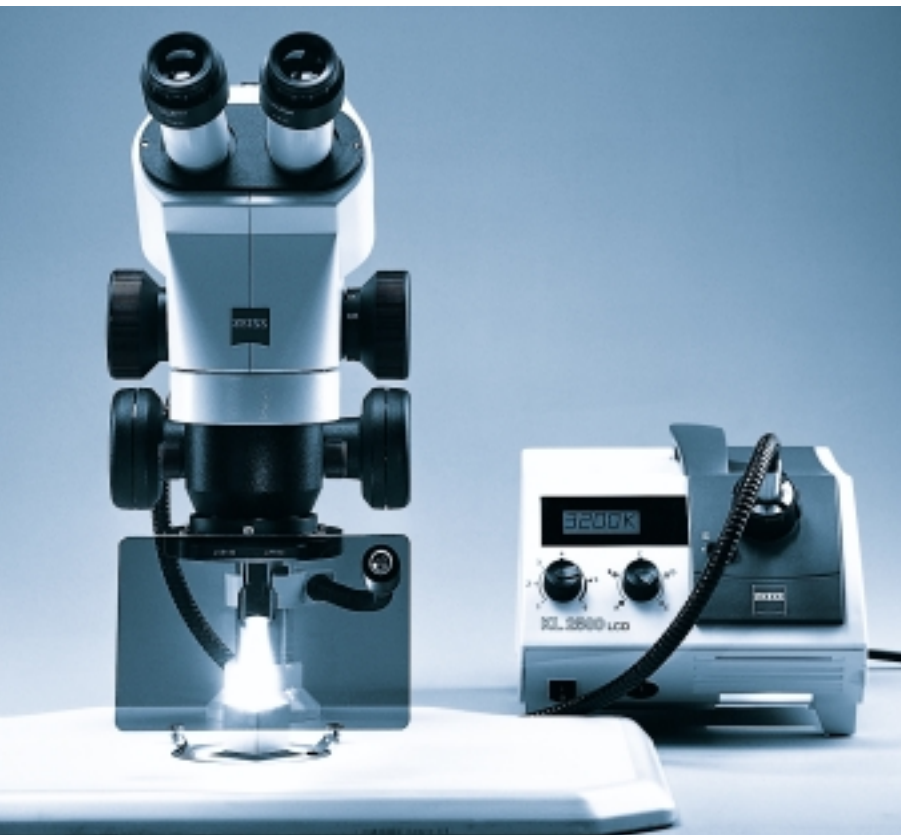

The greater active diameter of the fiber-optic cables for the KL 2500 LCD throws distinctly more light on the specimen.

Light sources

The Schott KL 2500 LCD cold light source with its 250W reflector lamp supplies many times the amount of light of other lamps known so far. It is excellent for simple applications with blue or green excitation.

Excitation

External excitation is by visible light conducted via fiber-optic cables. The 28 mm dia. excitation filters are located in the 5-place filter wheel of the source.



... or Super-Pressure Mercury Vapor Lamps



Easy change of emission filters.

Light sources

The ideal choice: Depending on your application and the energy required, choose from two super-pressure mercury vapor lamps, HBO 50 and HBO 100, which attach to the stand column, and the LUMATEC HBO 200, which provides extra power for critical fluorescence work. In either case, light is conducted to the specimen through a special liquid light conductor of improved transmittance.

Excitation filters

Excitation filters are screwed to the focusing attachment at the front end of the light conductor. The maximum illuminating aperture obtained with an FI S 0.4 focusing attachment is 0.4.



Emission filters

The emission filter collar FI S fits to the front lens of the stereomicroscope. It has a pocket accommodating the filter slider from the filter set used.

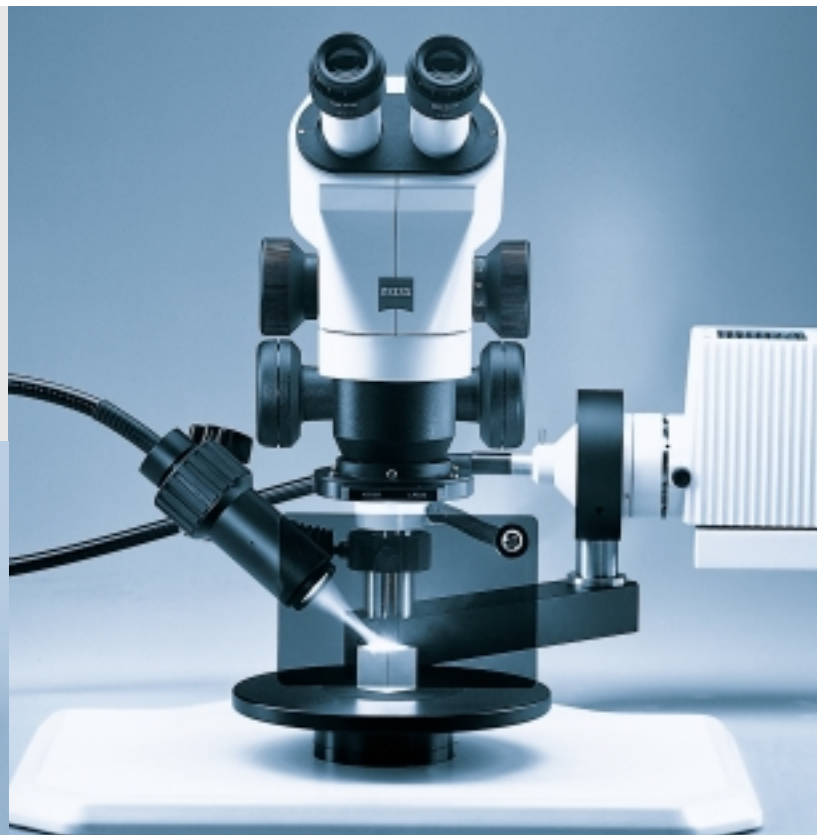

Filter sets

A filter set comprises a mounted excitation filter and a matching emission filter slider.

The following filter sets are available:

- FI S 02 (ultraviolet)
- FI S 05 (violet)
- FI S 09 (GFP plus)
- FI S 13 (blue)
- FI S 15 (green)

Special heat-resistant filter sets are available for use with the LUMATEC HBO 200:

- FI S 02 HT (ultraviolet)
- FI S 05 HT (violet)
- FI S 09 HT (GFP plus)

Holders for individual filters:

- Mount for one 18 mm dia. excitation filter
- Slider for one 45 mm dia. emission filter
- Slider for two 25 mm dia. emission filters

Do It Your Way

The choice is yours: Use your hobby SLR or one of those high-resolution camera systems specially designed for micrography. Carl Zeiss offers a wide range of camera adapters.

Photomicrography with your reflex camera

Whether you need pictures for your own archive or for publication, photography on 35mm film is the solution that costs you least, especially if you already own a 35mm SLR camera. Carl Zeiss can supply fast-mounting adapters for all quality cameras on the market.



Video camera adapters

The photo/video port of the Stemi 2000-C accommodates both single-chip and 3-chip CCD cameras. Whether bayonet or C-mount, it is no question that Carl Zeiss has the right adapter for each.





On-line PC processing of Stemi DV4 images.



Cameras attach to the Stemi DV4 and Stemi DR stereomicroscopes via one of the two eyepiece tubes.

Remove the eyepiece and replace it with an adapter, which ensures exact camera positioning relative to the microscope.

Digital camera adapter D40 M37/52x0.75 for connecting commercial digital still and video cameras.

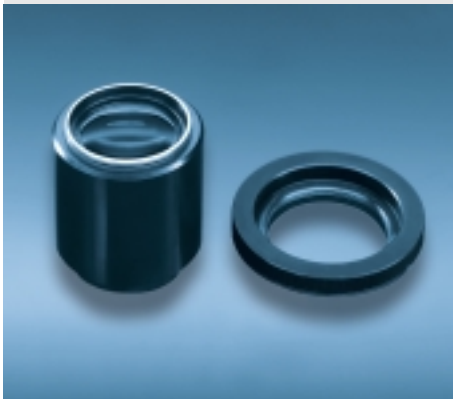

AxioCam MRc5

For top-grade documentation of your microscope images – pin-sharp and true to color. With its resolution of 2584 x 1952 pixels, the AxioCam MRc5 microscope camera outperforms a 3-chip CCD video camera in definition.

Simply follow the icons – operating the AxioCam MRc5 is child's play.

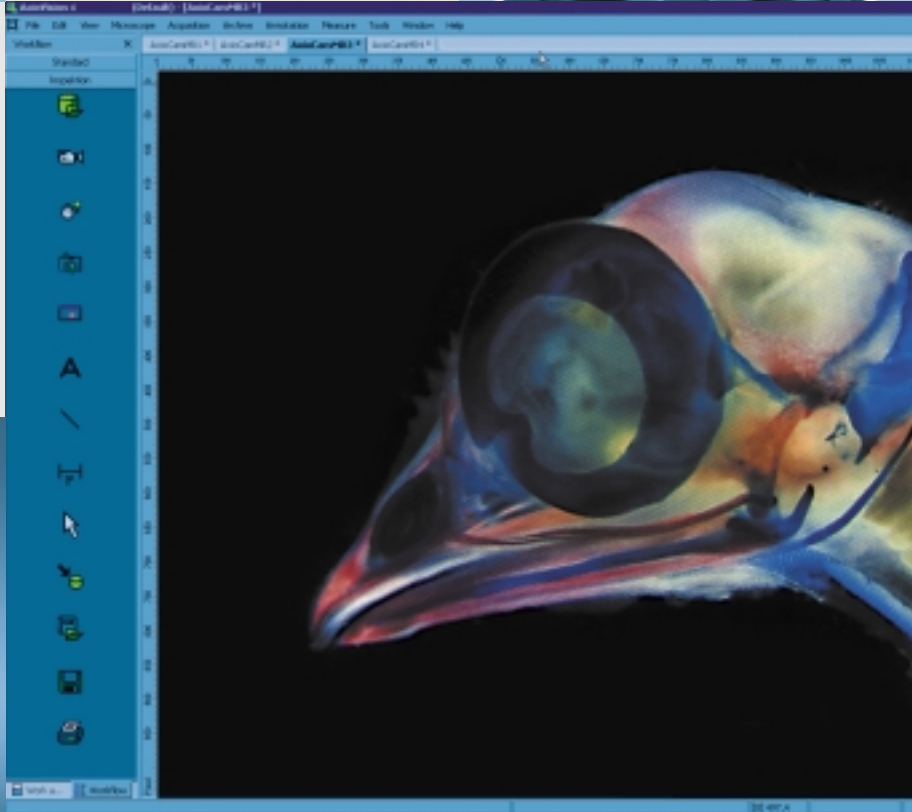

At a Glance

Stemi DR 1040

Eyepiece	W 10x/20 Br. foc.							
Supplementary lens	0.3x	0.4x	0.3x...0.5x	0.63x	none	1.25x	1.6x	2x
Free working distance	285 mm	210 mm	234...91 mm	130 mm	92 mm	60 mm	48 mm	31 mm
Magnifications	3.0x/12.0x	4.0x/16.0x	3.0x...5.0x / 12.0x...20.0	6.3x/25.2x	10.0x/40.0x	12.5x/50.0x	16.0x/64.0x	20.0x/80.0x
Object field (mm)	66.7/16.7	50.0/12.5	66.7...40.0 / 16.7...10.0	31.8/7.9	20.0/5.0	16.0/4.0	12.5/3.1	10.0/2.5

Stemi DR 1663

Eyepiece	W 10x/20 Br. foc.							
Supplementary lens	0.3x	0.4x	0.3x...0.5x	0.63x	none	1.25x	1.6x	2x
Free working distance	285 mm	210 mm	234...91 mm	130 mm	92 mm	60 mm	48 mm	31 mm
Magnifications	4.8x/18.9x	6.4x/25.2x	4.8x...8.0x / 18.9x...31.5	10.1x/39.7x	16.0x/63.0x	20.0x/78.8x	25.6x/100.8x	32.0x/126.0x
Object field (mm)	41.7/10.6	31.3/7.9	41.7...25.0 / 10.6...6.3	19.8/5.0	12.5/3.2	10.0/2.5	7.8/2.0	6.3/1.6

Stemi DV4 and Stemi DV4 spot

Eyepiece	W 10x/20 Br. foc.							
Supplementary lens	0.3x	0.4x	0.3x...0.5x	0.63x	none	1.25x	1.6x	2x
Free working distance	285 mm	210 mm	234...91 mm	130 mm	92 mm	60 mm	48 mm	31 mm
Magnifications	2.4x...9.6x	3.2x...12.8x	2.4x...16.0x	5.0x...20.2x	8.0x...32.0x	10.0x...40.0	12.8x...51.2	16.0x...64.0
Object field (mm)	83.3...20.8	62.5...15.6	83.3...12.5	40.0...9.9	25.0...6.3	20.0...5.0	15.6...3.9	12.5...3.1

Stemi 2000

Supplementary lens		Eyepiece					
Factor	Free working distance (mm)	WPL 10x/23 Br. foc.		WPL 16x/16 Br. foc.		W 25x/10 foc.	
		Magnifications	Object field (mm)	Magnifications	Object field (mm)	Magnifications	Object field (mm)
0.3x	285	1.95x ... 15.0x	118.0 ... 15.3	3.1x ... 24.0x	82.1 ... 10.7	4.9x ... 37.5x	51.3 ... 6.7
0.3x ... 0.5x	234 ... 91	1.95x ... 25.0x	118.0 ... 9.2	3.1x ... 40.0x	82.1 ... 6.4	4.9x ... 68.8x	51.3 ... 4.0
0.4x	210	2.6 x ... 20.0x	88.5 ... 11.5	4.2x ... 32.0x	61.5 ... 8.0	6.5x ... 50.0x	38.5 ... 5.0
0.63x	130	4.1 x ... 31.5x	56.2 ... 7.3	6.6x ... 50.4x	39.1 ... 5.1	10.2x ... 78.8x	24.4 ... 3.2
none	92	6.5 x ... 50.0x	35.4 ... 4.6	10.4x ... 80.0x	24.6 ... 3.2	16.3x ... 125.0x	15.4 ... 2.0
1.25x	60	8.1 x ... 62.5x	28.3 ... 3.7	13.0x ... 100.0x	19.7 ... 2.6	20.3x ... 156.3x	12.3 ... 1.6
1.6x	48	10.4x ... 80.0x	22.1 ... 2.9	16.6x ... 128.0x	15.4 ... 2.0	26.0x ... 200.0x	9.6 ... 1.3
2.0x	31	13.0x ... 100.0x	17.7 ... 2.3	20.8x ... 160.0x	12.3 ... 1.6	32.5x ... 250.0x	7.7 ... 1.0

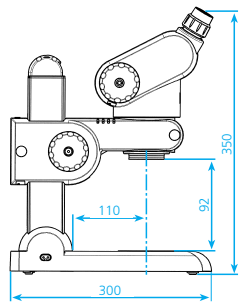
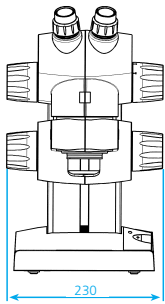

Stemi DV4
on Stand C
Weight: 5 kg

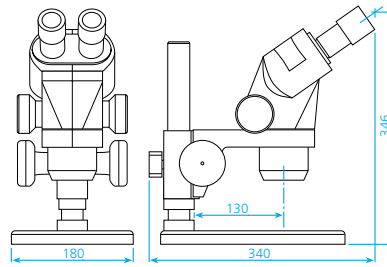

Stemi 2000
on Stand S
Weight: 4.2 kg

Microscope bodies	Stemi DR 1040 Stemi DR 1663 Stemi DV4 Stemi 2000 Interpupillary distance adjustable from 55 to 75 mm Interface: 76 mm (international)	Magnifications 10x and 40x (max.: 80x) 16x and 63x (max.: 126x) 8x to 32x (max.: 64x) 6.6x to 50x (max.: 250x)	Free working distance (FWD) 92 mm 92 mm 92 mm 92 mm
Eyepieces	Stemi DR, Stemi DV4 with fixed eyepiece Stemi 2000 with interchangeable eyepieces	W 10x/20 Br. foc. W 10x/21 foc. W-PI 10x/23 Br. foc.	W-PI 16x/16 Br. foc. W 25x/10 foc.
Supplementary lenses	0.3x FWD: 285 mm 0.4x FWD: 210 mm	0.3x ... 0.5x FWD: 234 ... 91 mm 0.63x FWD: 130 mm	1.25x FWD: 60 mm 1.6x FWD: 48 mm
Mounting brackets	Stemi brackets with focusing knob for 32 mm column; Stemi bracket w/o focusing knob; Stemi tiltable bracket 0 – 90°		
Stands	Model C Model S Model N Model P Model G Model A Model DA Base plate 32	Bench-top stand, footprint 210 x 300 mm, column height 290 mm Bench-top stand, footprint 180 x 240 mm, column height 260 mm Bench-top stand, footprint 440 x 360 mm, column height 350 mm Hinged-arm stand, max. outreach 880 mm Hinged-arm stand, footprint 360 x 360 mm, column height 600 mm, max. outreach 780 mm Column height 600 mm, max. outreach 460 mm Column height 600 mm, max. outreach 570 mm Bench-top stand, footprint 330 x 380 mm, column height options: 350 or 450 or 650 mm	
Stages	Sliding stage (dia. 190 mm) Rotating stage (dia. 115 mm)	Ball-and-socket stage (dia. 158 mm) Mechanical stage (78 x 50 mm)	24-place specimen carousel
Epi-illuminators	20W halogen 20W cold light 150W cold light 250W cold light	Integrated in Model C stand 2 models: fitting into Stemi mounting bracket, or attaching to stand column; 6-spot ring light or gooseneck 2 models: fitting into Stemi mounting bracket, or attaching to stand column; slit ring light (for bright- or darkfield) (adapter for use with cold light 250W available; gooseneck, diffuser S, or line light Attaching to stand column; slit ring light	
Transmitted-light illuminators	10W halogen 20W cold light 150W cold light	Integrated in Model C stand Transillumination light box accessory Transmitted-light mirror accessory Transmitted-light illuminator, model S Ring slit light for bright- and darkfield <small>(All fiber-optic components for 150 W cold light sources can be used for 250 W cold light via an adapter provided with the Schott KL 2500 LCD source.)</small>	
Fluorescence	250W cold light	External oblique excitation	HBO 50/100/200 External oblique excitation
Polarization	20/150/250W cold light with transmitted-light accessory		



**Carl Zeiss
Light Microscopy**

P.O.B. 40 41
37030 Göttingen
GERMANY
Phone: ++49 5 51 50 60 660
Telefax: ++49 5 51 50 60 464
E-Mail: micro@zeiss.de

www.zeiss.de/micro

Subject to change.