

Stereomicroscope SV8

Operating Instructions

G41-605

	Page
Stereomicroscope SV 8 for incident and transmitted light	4
1 Microscope assembly	5
2 Focusing the microscope image	5
3 Objectives, eyepieces, magnifications	6
Formulae	7
4 Stands LO and L	8
Mounting stereo body on stand L	8
5 Illuminators	9
Illuminator 10	9
Transmitted-light unit (47 52 65)	10
Polarization attachment for transmitted-light unit	10
Light guides for incident and transmitted light	11
4-point ring illuminator	11
Vertical illumination	12
Incident-light brightfield equipment	13
Illuminators on stemi illuminator carrier	14
Diffused-light box	15
6 Photomicrography	16
MC 63 camera system	16
MC 63 A camera body	17
35 mm camera with internal exposure meter	18
Automatic flash photography	18
Stereophotography	19
7 TV microscopy	19
8 Drawing with the stereomicroscope	20
9 Further stands	21
10 Specimen stages	22

Fig. 1: Stereomicroscope SV 8 with built-in illuminator 10 for incident light

- 1 Wide-angle eyepieces 10x/25 Br. ¹⁾ foc. with focusing eyelens. For table of eyepieces see page 6.
- 2 Eyepiece tubes, adjustable to user's pupil distance.
- 3 Binocular tube (47 50 89) ²⁾.
- 4 Locking screw for tube.
- 5 Knurled ring for double iris diaphragm to obtain optimum focal area.
- 6 Stereo body SV 8 (47 50 57).
- 7 Zoom magnification system 0.8x ... 6.4x.
- 8 Objective, interchangeable.
For magnifications and object fields see table page 6.
- 9 Stand L with built-in transformer 220 V (47 51 10-9904) ³⁾.
- 10 Stage plate, 84 mm dia. white one side, black the other.
- 11 On-off switch with brightness control.
- 12 Holding ring with clamp screw for stereo body (6).
- 13 Fine focusing control.
- 14 Clamping screw for stereo body (6).
- 15 Pinion box.
- 16 Lamp socket with 6 V 10 W halogen lamp.

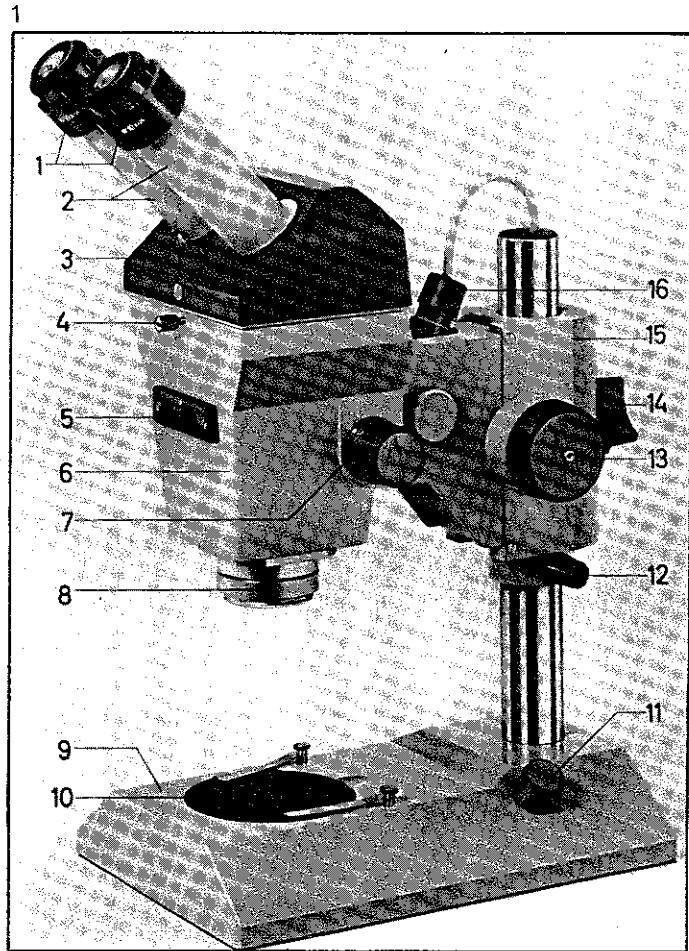
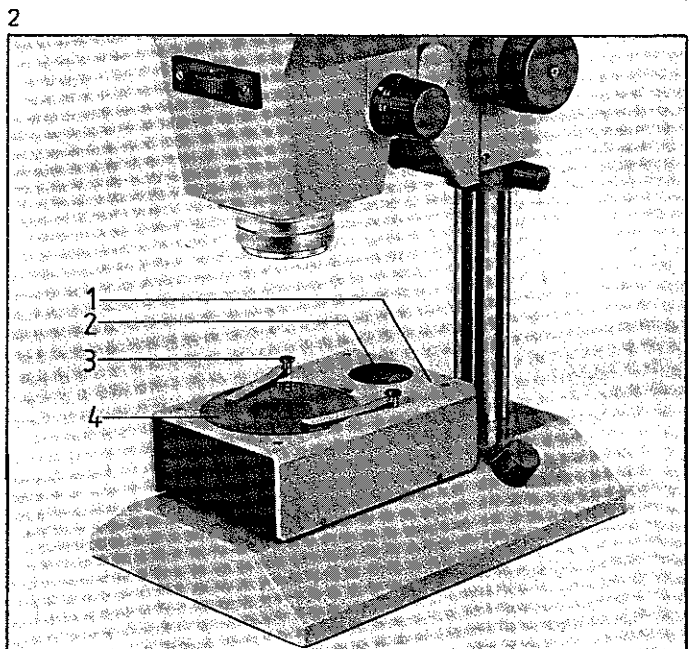

Fig. 2: Stereomicroscope SV 8 with illuminator 10 for incident light with attachment for transmitted light

- 1 Transmitted-light unit (47 52 65)
- 2 Light entrance aperture for transmitted light taking 32 mm dia. filters, see also Fig. 10.3.
- 3 Stage clips
- 4 84 mm dia. clear glass plate

- 1) Eyepieces for spectacle wearers
- 2) The six or ten digit figures in brackets are Catalog Nos. and in some cases engraved on the parts.
- 3) Stand L with built-in transformer 120 V, UL tested, (47 51 08-9903)



Place stand with 32 mm dia. column on a stable working surface. Fasten table clamp 32 (47 51 13) (Fig. 34) with 32 mm stand column to table top. Slip holding ring 1.12 (i.e. Fig. 1, No. 12) over the column and let it lie on the stand base. If using stand L, guide lamp socket (8.1) through the pinion box (1.15). Lower the stereo body SV 8 (1.6) on to the column, adjust to desired working distance and tighten with finger screw (1.14). The distance between objective mount and object with objective S 100 mm is about 88 mm. Lift holding ring (1.12) from base and tighten below pinion box to prevent from slipping. Place binocular tube (47 50 89) on the stereo body so that the dovetail ring (3.1) fits into the opening and guide pin (3.3) into the groove (3.2). Tighten screw (3.4). Check the tube for stability and tighten screw if necessary. Insert eyepieces into the tube.

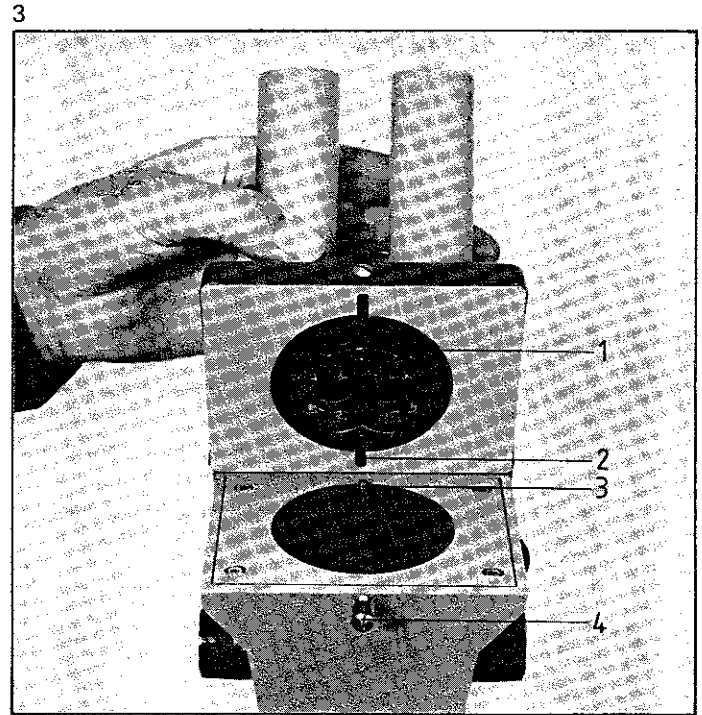

2 Focusing the microscope image

Insert 6 V 10 W halogen lamp into the socket and insert socket with lamp into illuminator 10 (see page 9). Connect transformer with line cable to power supply. Switch on lamp and select desired brightness. Look into binocular tube and adjust tubes so that both images coincide.

Set eyelens of both focusing eyepieces to about "0". First focus image with knob (1.13) at zoom magnification 6.4. Then switch to zoom magnification 0.8 and correct definition with both eyepiece lenses. Image definition of similar details will thus be maintained over the whole zoom range. Switch to desired magnification.

The motion of the focusing control is set to normal operation in the factory. It can be adjusted as desired with Allen key supplied (4.1). Clockwise turning of the key makes for tighter movement, anti-clockwise for slacker movement.

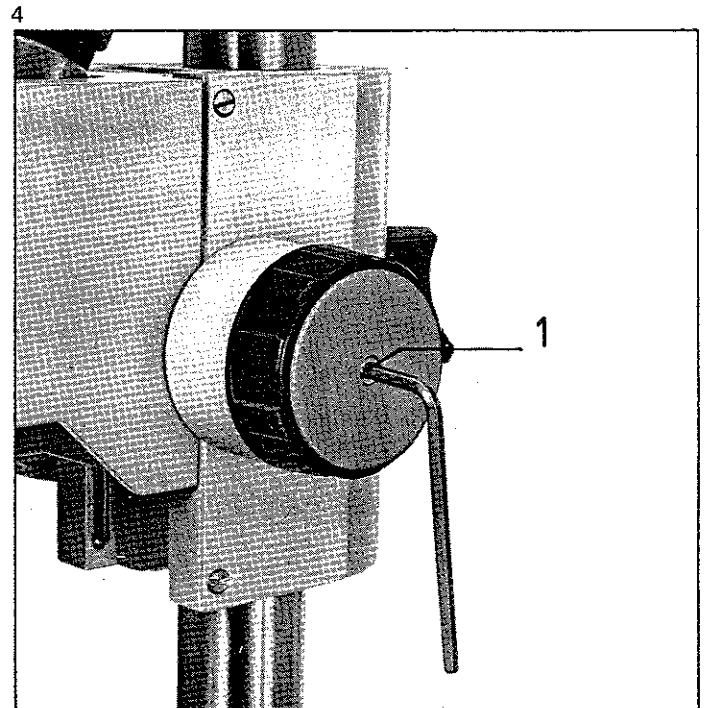

Objectives

There is a full range of objectives available for use with the stereomicroscope SV 8. It includes focal lengths ranging from 50 mm to 2000 mm and special purpose objectives for every possible application. The dual objective DS 100 (47 50 63) is designed on the Greenough principle. Producing outstanding chromatic quality, it is particularly recommended for colour micrography. It is also excellently suited for stereophotography (see page 19).

The flat field objective PLS 100 (47 50 62), producing a flat image to the edge of the field, is the ideal choice for quality control in the semi-conductor industry.

Stands L and LO have a column 260 mm long. As a result you can use your stereomicroscope SV 8 with objectives up to 150 mm focal length and objects up to 90 mm in height. For viewing larger objects and using longer focal length objectives, special stands with longer columns are available (see page 21).

Objectives

Focal length mm	Working distance ¹⁾ mm	Catalog No.
Objective S 50	30	30 57 01
Objective S 100	88	47 50 61 99 02
Flat field obj. PLS 100	104	47 50 62
Dual objective DS 100	87	47 50 63
Objective S 125	115	30 51 31
Objective S 150	143	30 57 02
Objective S 175	168	30 57 20
Objective S 200	193	30 51 32

Eyepieces

Magnification/ field of view number	Pupil height (mm)	Angular field	Catalog No.
Eyepiece 10x/20	12	44°	46 40 01 - 99 03
Eyepiece 10x/20 foc. ²⁾	12	44°	46 40 04 - 99 04
Wide-angle eyepiece 10x/25 Br. ³⁾	18	55°	46 40 02 - 99 01
Eyepiece 10x/25 Br. foc. ²⁾	18	55°	46 40 03
Wide-angle eyepiece 16x/16 Br. ³⁾	15	55°	46 42 02
Wide-angle eyepiece 25x/10.5 eyepiece 25x/10.5 foc. ²⁾	7.3 7.3	55° 55°	46 44 01 46 44 04 - 99 02

Magnifications, object fields

Zoom system setting	0.8	1.6	3.2	6.4
Numerical aperture	0.027	0.042	0.059	0.085
Eyepiece, magnification/ field of view number	Total magnification (M) and object field dia. (d) in mm with objective f = 100 mm			
10x/20 M	8	16	32	64
10x/20 foc d	25	12.5	6.3	3.1
W 10x/25 Br M	8	16	32	64
W 10x/25 Br foc d	31	16	7.8	3.9
W 16x/16 Br M	12.8	26	51	102
d	20	10	5	2.5
W 25x/10.5 M	20	40	80	160
W 25x/10.5 foc d	10	6.5	3.3	1.6

1) Free distance between objective mount and object.

2) Eyepiece with focusing eyelens for 26 mm dia. reticles

3) Eyepiece for spectacle wearers.

Magnification of stereomicroscope is:

$$M_{\text{microscope}} = F_{\text{zoom system}} \times M_{\text{eyepiece}} \times \frac{100 \text{ mm}}{f_{\text{objective}}}$$

Since the objective normally used is $f = 100 \text{ mm}$, a simpler formula applies:

$$M_{\text{microscope}} = F_{\text{zoom system}} \times M_{\text{eyepiece}}$$

The standard equipment includes the objective $f = 100 \text{ mm}$ and 10x eyepieces, so the zoom factor simply has to be multiplied by 10.

E.g. $M_{\text{microscope}} (32x) = F_{\text{zoom system}} (3.2) \times 10$

Scale of magnification on film is:

$$S_{\text{film}} = F_{\text{zoom system}} \times M_{\text{photo eyepiece}} \times \frac{100 \text{ mm}}{f_{\text{objective}}} \times F_{\text{camera}}$$

Standard equipment consists of objective $f = 100 \text{ mm}$, 10 x photo eyepiece and MC 63 camera system with M 35 camera, so the engraved zoom system factor is simply multiplied by 10 and by the camera factor 0.25⁴⁾.

E.g. $S_{\text{film}} (16:1) = F_{\text{zoom system}} (6.4) \times 10 \times 0.25$

Object field and field of view number

The field of view number gives the aperture diameter of the eyepiece. From it the diameter of the object field can be computed as follows.

$$\text{Object field dia in mm} = \frac{FVN_{\text{eyepiece}} \times f_{\text{objective}}}{F_{\text{zoom system}} \times 100 \text{ mm}}$$

Normally the objective $f = 100 \text{ mm}$ is combined with eyepieces W 10x/25 and the formula is simplified:

E.g. Object field dia. (20) mm = $\frac{FVN (25)}{F_{\text{zoom system}} (1.25)}$

- Where M = magnification
- S = scale
- F = factor
- f = focal length (of objective)
- FVN = field of view number
- W = wide angle

4) with large format = 0.8
 with 35 mm camera with objective f 50 mm = 0.2
 with 35 mm camera with objective f 125 mm = 0.5

Stand LO

Stand LO (43 51 05-9902) has a column (5.2) of 32 mm dia. and a length of 260 mm with holding ring (5.1). The stand base (5.5) contains a stage plate of 84 mm dia (5.3) which is white on one side and black on the other to heighten the contrast of the specimen background. It can be exchanged for the frosted glass plate (47 52 91).

The stage clips (5.4) serve to hold the slide.

Stand L

Stand L¹⁾ is similar to stand LO but the base contains a transformer 120 V or 230 V, 50 ... 60 Hz, 18 VA power consumption. Knob (1.11) is used to switch on and off and for brightness adjustment of illuminator 10 (46 72 53).

The built-in transformer is connected with earthed plug to the mains with cable (38 00 71-2810)²⁾.

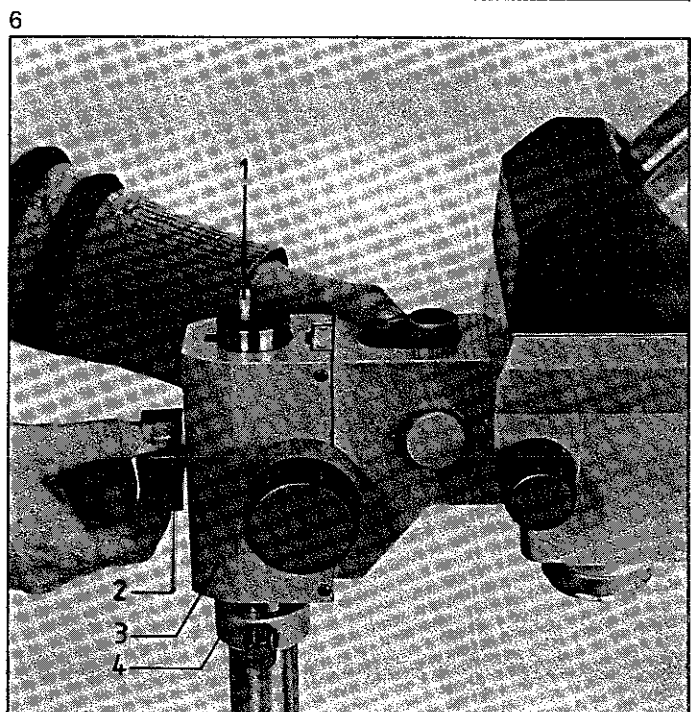
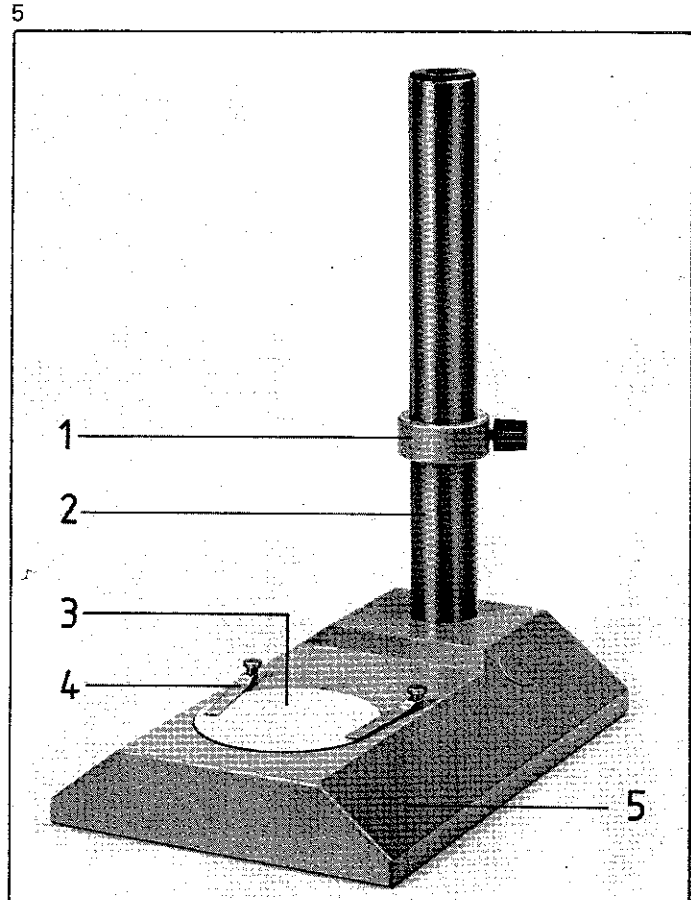
**Mounting stereo body on Stand L**

Guide the cable with lamp socket (6.1) sticking out of the stand column through the pinion box (6.3) and lower the stereomicroscope on to the column. Tighten with star knob (6.2) and secure against slipping with holding ring (6.4).

1) Stand L (47 51 08-9903) with transformer 120 V, UL, 50 ... 60 Hz
Stand L (47 51 10-9904) with transformer 220 V, 50 ... 60 Hz

2) Mains cable with American flat plug (38 00 74-0160)

Illuminator 10

To insert 6 V 10 W halogen lamp, grasp lamp socket with black knurled cuff (8.1), twist to the stop and pull out of illuminator 10. Hold 6 V 10 W halogen lamp (38 61 08) (7.2) with the protective cap supplied and insert into lamp socket (7.1). Remove any finger prints before switching on.

Insert socket and lamp (8.1) into lamp housing (8.3) so that the pin engages in the cutout.

With Stand L the socket is connected to the built-in transformer with a cable.

Switch on the lamp with knob (1.11) and adjust brightness.

With stand L0 or the stemi illuminator carrier (47 52 52) (Fig. 21), the illuminator 10 with 6 V 10 W halogen lamp (46 80 43) is powered by a step-transformer (39 25 64-9903) 110-127-220-240/3-4-5-6-7-8 V, 50 ... 60 Hz, 25 VA power consumption, or transformer (39 25 80) 240/5.5-6.5 V, 50 ... 60 Hz.

Switch on separate 6 V 10 W lamp via transformer and set desired brightness.

Note: Do not operate 6 V halogen lamp with excess voltage.

Installing illuminator 10 (46 72 53) in the stereomicroscope

The illuminator 10 is installed in the factory. The following operations are only necessary if it is supplied separately. Insert illuminator 10 (9.1) into the opening in the carrier from below. Align thread (9.2) of lamp housing with opening in the carrier, if necessary inserting first rotated by 90°. Holding the lamp housing from above, insert centering piece (9.3) with two spring washers into the hole.

Turn clamp screw only so far as to permit slight tilting of the lamp, from vertical position with accessory for transmitted light (47 52 65) to maximum tilt for incident light. Turn lamp socket (1.16) for optimum illumination of object.

7

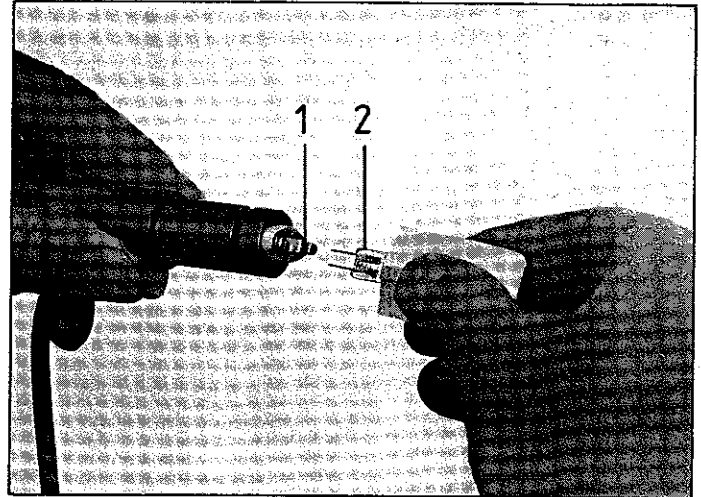

8

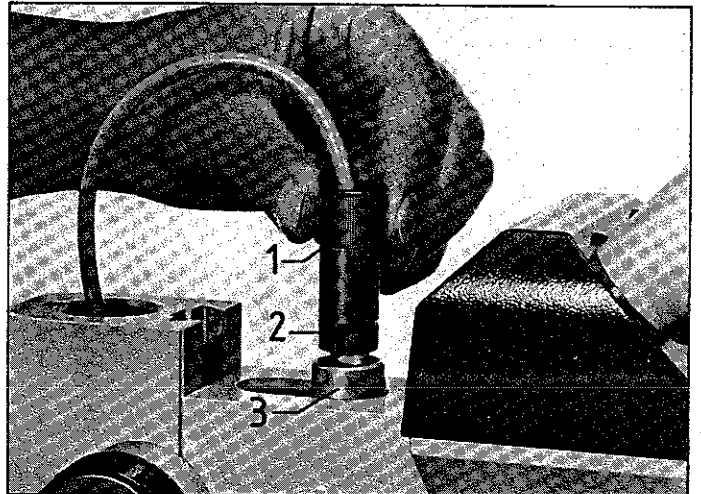

9

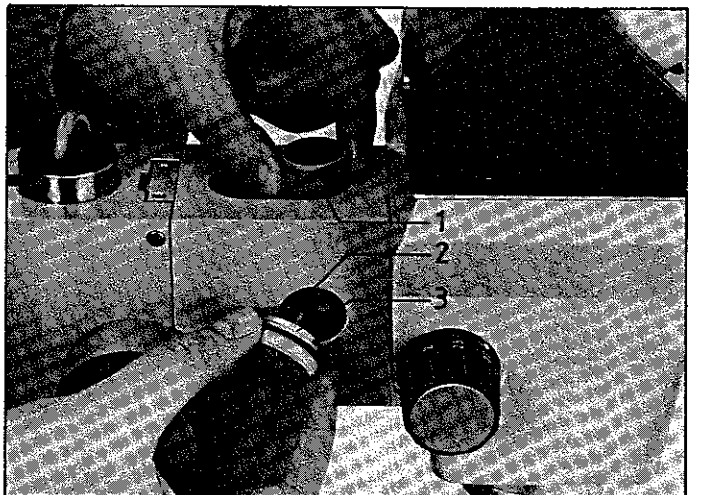

Transmitted light unit (47 52 65) (Fig. 10)

Place on the stand base with the two pins (10.4) in the holes provided. Set lamp socket (1.16) vertical to entrance aperture (10.3). Insert colour or grey filter 32 mm dia. on the glass blank.

0.8 accessory (43 52 13) (11.1)

This may be used on the transmitted-light unit (10.1) instead of the glass plate (10.2) if the zoom system (1.7) is at 0.8 and the field of view is to be illuminated to the edge.

Polarization attachment for transmitted-light unit

Place polarization attachment (47 52 28) (12.5) on the transmitted-light unit (47 52 65) (12.8) instead of the 84 mm dia. glass plate, fitting the wire loop into the cutout (12.9). Set illuminator 10 to vertical.

Switch polarizing filter on slide (12.7) into light path (click stop). One slide position is meant for a polarizer with λ -plate (47 36 80), which is inserted with correct orientation. For subsequent insertion of this combination plate, pull the slide (12.7) out of the polarization attachment. Remove the 4 screws (12.6) and then the holding plate. Insert λ -plate with polarizer so that the red point on the glass plate lies on the red point of the cover plate. Place cover plate on the slide and screw down. As specimen holder use the clear glass plate (12.4) on the polarizer attachment, not the frosted plate. Attach analyser (47 36 75) (12.2) in mount into dovetail ring of the objective and turn till the field background is as dark as possible. Then tighten clamp screw (12.1). Lay slide (12.3) on the rotatable glass plate and focus sharply. To determine the oscillation directions of a specimen, switch the λ -plate with polarizing filter into the light path.

10

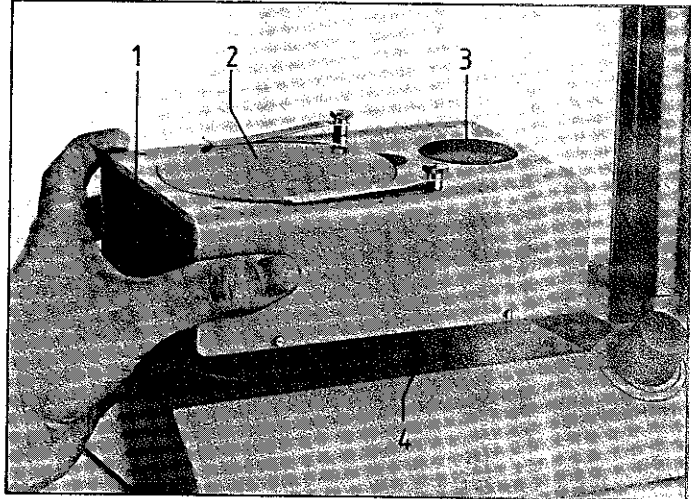

11

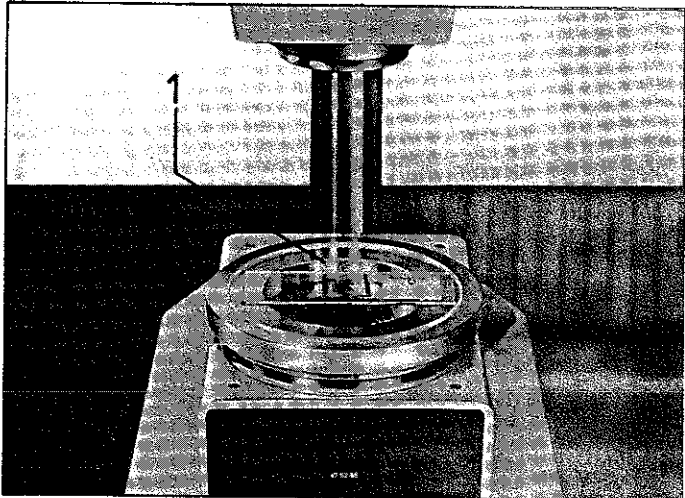

12

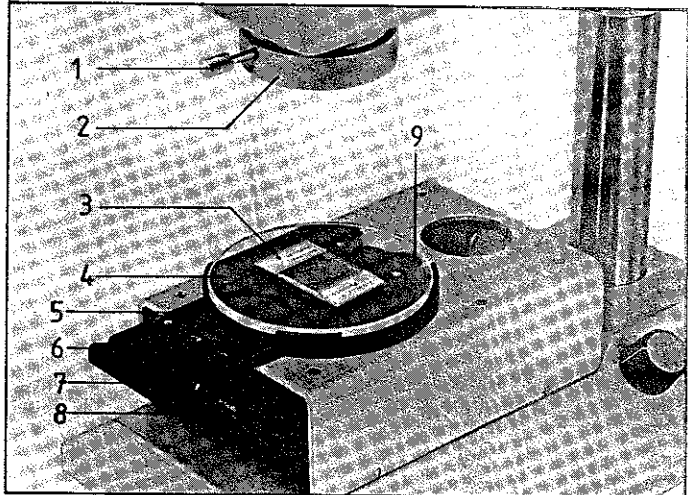

13

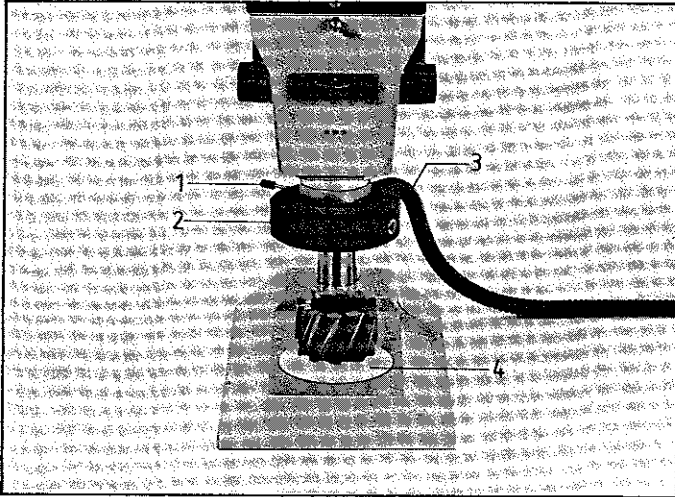

14

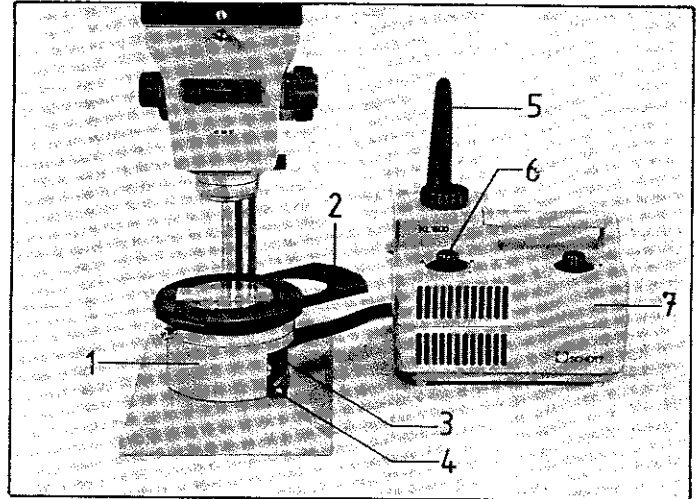

Light guide for incident and transmitted-light illumination

Equipment

4-point ring illuminator (41 70 61) with adapter ring (47 50 92-9901) (13.2) for incident light or for brightfield-darkfield illumination (14.1). Alternatively slit ring illuminator (41 70 68) with adapter (46 60 25) for incident light or brightfield-darkfield illumination (47 52 69-9902), Schott light source KL 1500 (14.7) 230 V (38 01 28-7580) or 115 V (38 01 28-7590), 50 ... 60 Hz with halogen lamp 15 V 150 W.

Colour temperature at rated voltage: ca. 3000 K.

At low voltage: ca. 2700 K.

Assembly and connection

For incident light darkfield attach the ring illuminator with adapter ring (13.2) to the dovetail ring¹⁾ of the objective and tighten with screw (13.1). Connect light guide (13.3) to the KL 1500 light source (see Schott operating instructions 7115). Select desired brightness with brightness control (14.6).

For transmitted light first attach brightfield-darkfield accessory (14.1) to stands L or L0, removing stage plate (13.4) from the stand base.

Lay stand on its side (Fig. 15).

Insert brightfield-darkfield attachment (15.1) in the opening.

Lay the bracket (15.2) from below on the edge of the opening and tighten with screw (15.3). Set stand upright again. Insert ring illuminator with holding ring

(16.2) in the brightfield-darkfield attachment (16.1) and tighten screw (14.4). The slide (14.2) has two positions, one for darkfield and the other with opal glass plate for brightfield.

15

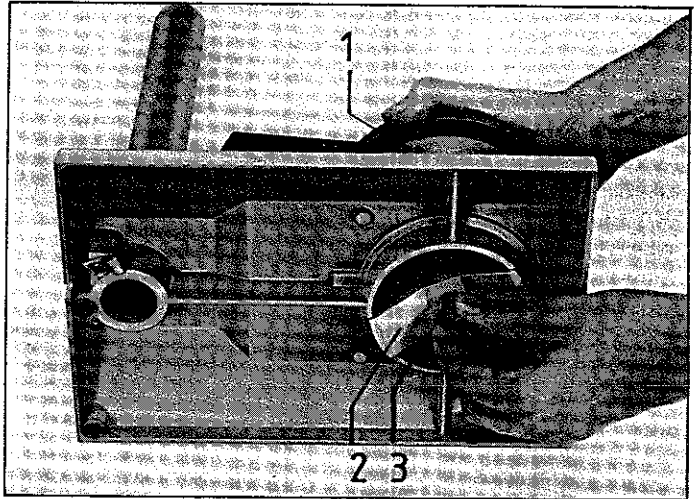

16

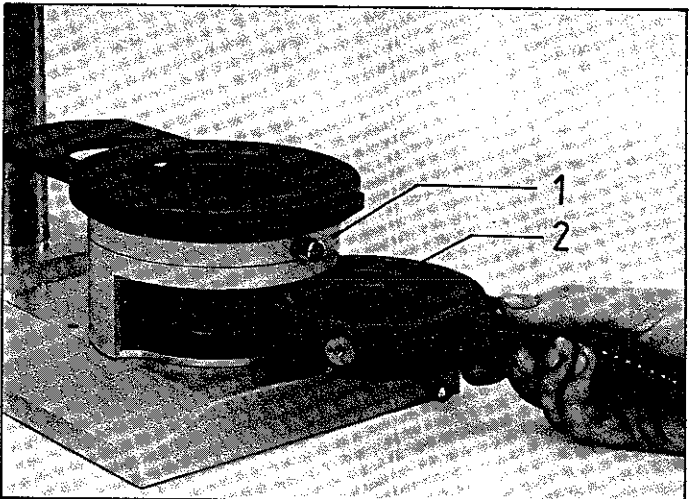

¹⁾ For objectives with focal lengths 125-200 mm the holder (47 50 64) is required.

Vertical illumination (Fig. 17)

The vertical illuminator (47 52 54) consists of a mirror which in its holder (17.1) is attached to the dovetail ring of the objective and lightly tightened. The KL 1500 light source (14.7) is used which illuminates the mirror via the light guide (17.5) (41 70 63-9901). Connect the shorter endpiece to the socket (17.3) of the vertical illuminator and the longer one to the KL 1500 and secure. Focus specimen sharply. Look into the tube at low magnification. Turn the mirror on the dovetail ring so that the field of view is free of vignetting. Tighten clamp screw (17.2).

Flexible light guides (Fig. 18)

With the self-supporting dual light guides (18.1) (41 70 58-9901) the specimen can be illuminated from two directions simultaneously.

The focusing lens (19.2) (41 70 60-9901) goes on the end of the light guide and filters can be screwed on to the lens. There is also a triple flexible light guide available (41 70 57-9901).

Eye cups (46 49 00) (18.5) prevent the entrance of sidelight when viewing without spectacles.

Flexible light guide on illuminator carrier (Fig. 19)

The flexible light guide (41 70 63-9901) (19.4) has a diameter of 8 mm and is 1000 mm long. It is attached to light source KL 1500 (18.2).

Assembly

Attach flexible illuminator carrier (47 52 52) (19.1) to 32 mm column. Attach adapter (47 52 53) (19.2) with three screws (19.3).

Insert flexible light guide (19.4) into adapter and light source and tighten.

Adjust position of light guide and set optimum illumination with focusing lens.

17

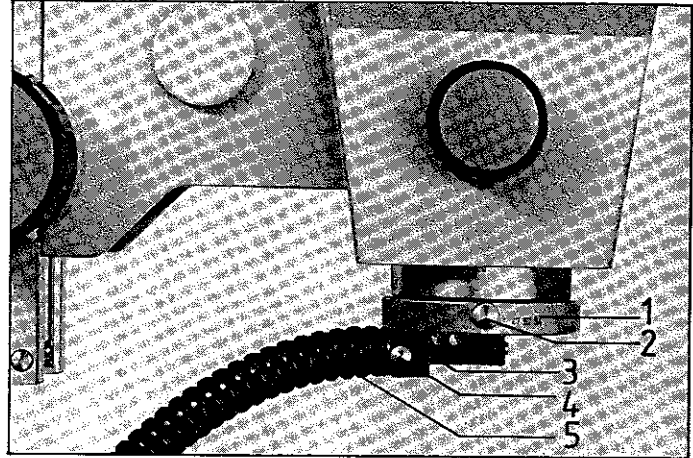

18

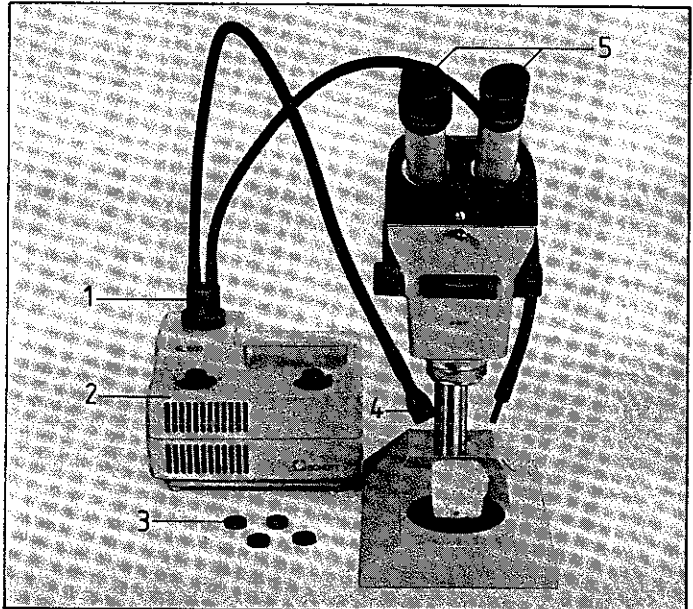

19

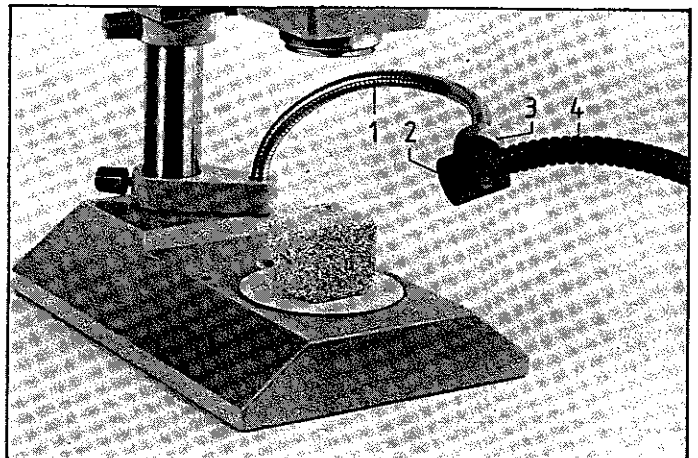

Incident-light brightfield equipment S (Fig. 20)

The incident-light brightfield unit S (47 52 58) (20.2) has a reflector which illuminates the object vertically through the objective. Light source is the KL 1500 (20.7) with double light guide (47 52 85) (20.6).

Built-in polarizers and analyzers eliminate disturbing reflections and ensure good image contrast even with weakly reflecting objects.

Assembly and connection

Remove objective S 100 mm (47 50 61-9902) with adapter ring S (47 50 70) from SV 8 and screw it into the incident-light brightfield unit (20.2).

Slot the flat field objective PLS 100 (47 50 62) (20.4) into the unit and secure with screw (20.3). The dual objective DS 100 (47 50 63) can also be attached. Attach the whole unit to the SV 8 stereo body and tighten with screw (20.1). Insert double light guide (20.6) into socket and tighten with screw (20.5). Connect the other end of the light guide to the KL 1500, switch on and adjust for desired brightness.

20

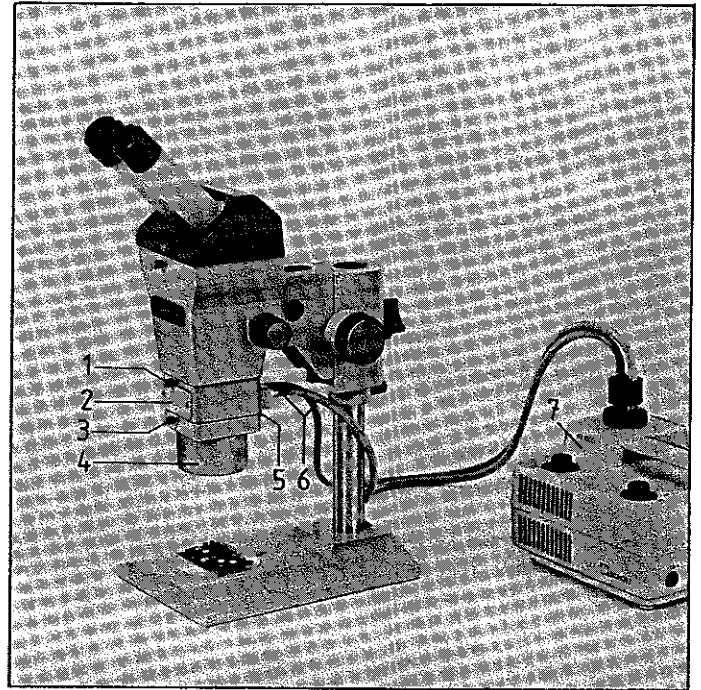

Illuminators on Stemi illuminator carrier (47 52 52) for stands with 32 mm dia. columns

Illuminator 10 S (46 72 54) (Fig. 21)

Insert lamp housing (21.2) of illuminator 10 S in holder (21.1) of illuminator carrier (21.4) and secure with three screws.

Slip carrier over the stand column and clamp in desired position with screw (21.3).

Insert 6 V 10 W halogen lamp (38 61 08) into socket (46 80 43) as shown in Fig. 7.

Connect to mains via transformer such as (38 25 64).

6 V 15 W epi-illuminator (Fig. 22)

To attach epi-illuminator screw adapter S (43 52 09) (22.1) to 6 V 15 W lamp housing with clear glass collector (46 72 55) (22.3). Insert grooved nut (22.2) in the holder of the flexible illuminator carrier (21.1) and secure with three screws.

Inserting 6 V 15 W filament lamp (Fig. 23)

Pick up 6 V 15 W filament lamp (38 00 18-1740) (23.1) with a soft cloth and insert in socket (46 80 10-9904) (23.3), matching the red dot to the red pin. Press in the lamp and turn clockwise to click stop. Slip black light shield (23.2) over the lamp. Connect lamp with cable to mains with a transformer, e.g. (39 25 64-9903). Before inserting lamp socket (22.5) in lamp housing, slacken ring (22.4) aligning its red dot with the red dot on the housing. If the field of view is not uniformly illuminated, slacken socket (22.5) with ring (22.4), adjust and rotate slightly in axial direction until uniform illumination is achieved and tighten up.

21

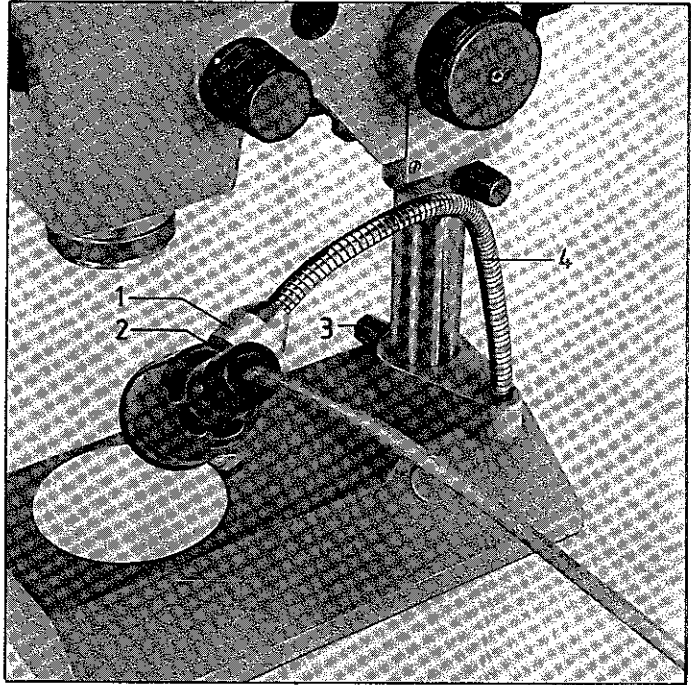

22

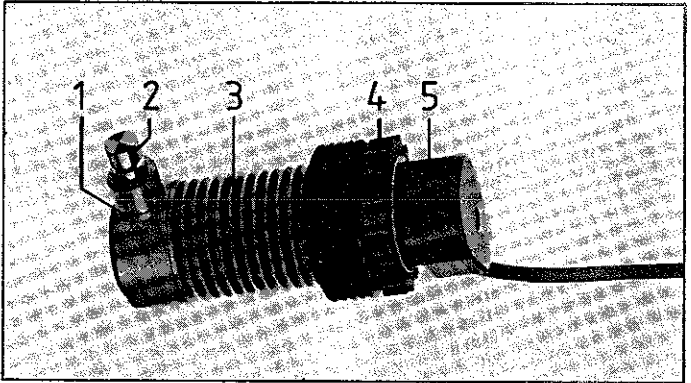

23

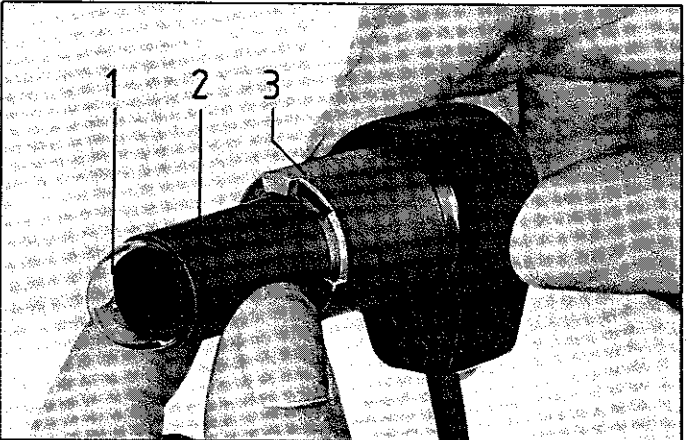

Diffuse illuminator S (46 60 21) (24.1)

With two fluorescent tubes type 33-TL 4 W (38 00 35-0230) and opal glass screen (24.2) to provide even illumination. Effective illumination area 40 x 115 mm. The illuminator is connected to mains with power supply unit supplied. It is switched on by pressing the white knob for a few seconds and switched off by pressing the red button. To exchange the fluorescent tubes, remove the opal glass screen, insert the new tube and turn till it clicks into place. Screw the cover on again to close.

For incident light the diffuse illuminator S with shaft (24.6) is fixed into clamp 12 with lamp mount S (47 51 36) (24.5) with three screws.

The clamp (24.5) is attached to the 12 mm dia. rod (47 25 65-0130) (24.4) of illuminator carrier 32 mm dia. (47 51 31) (24.3).

For transmitted light the diffuse illuminator with adapter (36.4) is inserted in a hole (36.2) in the stage attachment (36.1) and secured with clamp screw (36.3).

24

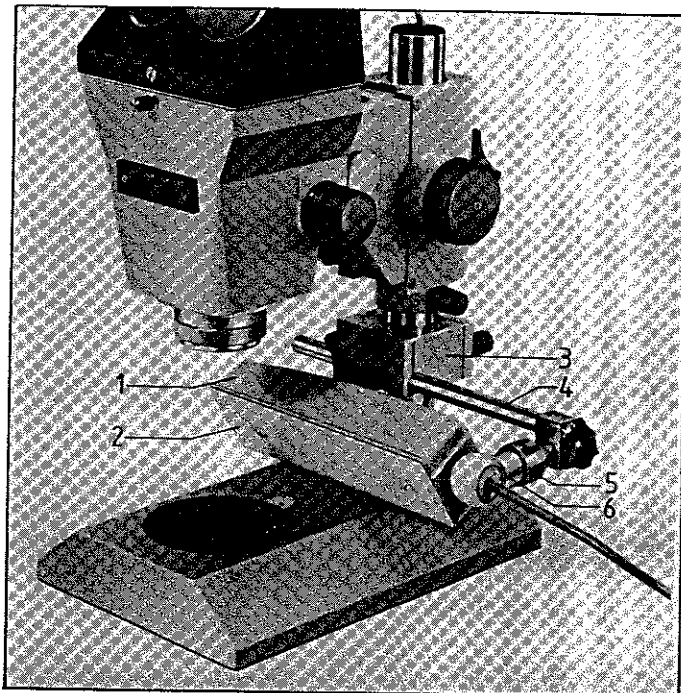

25

Diffused light box 2 x 8 W (41 52 57) (Fig. 25)

215 x 305 mm, with built-in power supply for 220 V, 50 ... 60 Hz. Connected to mains with fixed cable and switched on with switch (25.1).

The diffused light box is particularly recommended for transmitted light illumination of large area objects.

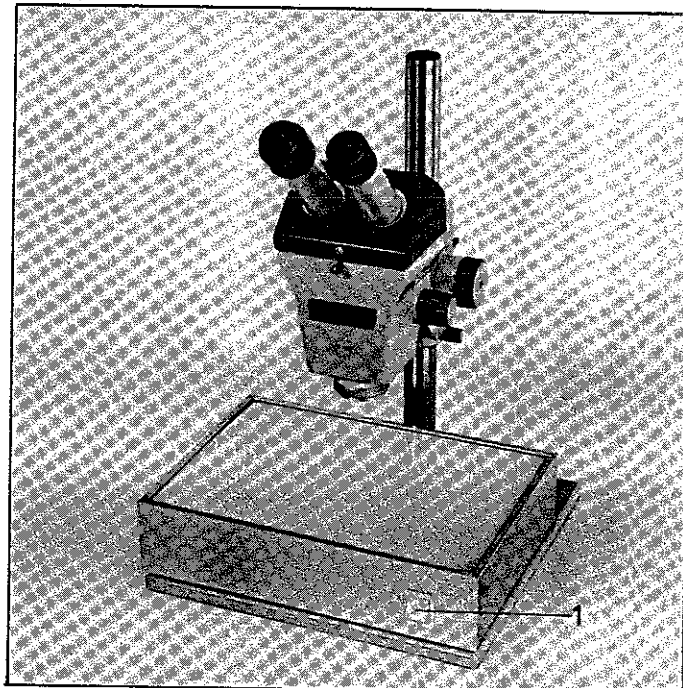
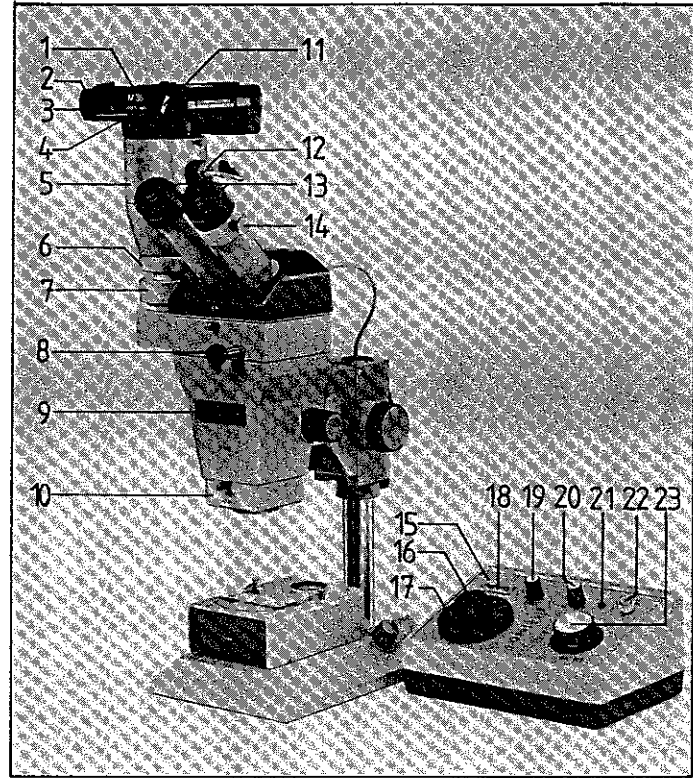

Fig. 26: MC 63 Camera system with motorized film transport on SV 8 stereomicroscope

- 1 M 35 camera body (47 60 72-9901) for 35 mm film with winder M (47 60 79-9901).
- 2 Transport lever (before inserting a film, press to stop).
- 3 Release knob for blind shots (film leader). Also depressed before manual film advance.
- 4 Light-shield slide, must be pulled out during exposure and film advance, otherwise the latter is blocked. Push in before changing camera.
- 5 Basic unit with shutter (47 60 12-9901).
- 6 Clamp ring for basic unit.
- 7 Phototube S (47 50 83) with a 10x eyepiece for photography. Mounted on the SV 8 stereo body like the binocular tube (Fig. 3).
- 8 With camera on the left:
 - a) knob pulled out¹⁾ – monocular viewing/photography
 - b) knob pushed in¹⁾ – binocular viewing
- 9 Knurled ring for double iris diaphragm for adjusting focal area.
- 10 Dual objective DS 100 (47 50 63).
- 11 Rewind knob, turns automatically during film advance.
- 12 Sensor ME (47 60 13-9901)
- 13 10x eyepiece with focusing eyelens for observation. Here inserted in the right tube, the eyepiece contains photo reticle with double crosslines (47 40 67) for delineating area photographed. Turn the eyepiece to align photo reticle with camera attachment, then secure eyepiece against slipping with clamp screw (14).
- 14 Eyepiece clamp screw (46 49 12).
- 15 Exposure control unit M (47 74 25-9903)
- 16 Film speed selector in 3-DIN graduations
- 17 Selector for DIN and ASA setting in 1 DIN graduations
- 18 Timing display. At 'Semi-Auto' timer knob (23) sends the pointer into the green area. Make fine adjustment if necessary with knob (20).
- 19 Knob for reciprocity compensation
- 20 Knob for fine adjustment of timing display
- 21 Pilot light lights up as long as the shutter is open
- 22 Exposure button – depress briefly

Position T for long-term exposure:
Turn button clockwise and depress.
To close shutter turn anti-clockwise.

26



- 23 Timer knob for 'Auto' and 'Semi-Auto' operation.

A photo stage plate (47 51 38), not visible in the picture, can be used to give a 5.5° tilt if photographing with a Greenough system. Inserted between glass plate and 84 mm dia. opening in the transmitted-light unit or between stage plate (1.10) and base, with marks aligned east-west, it permits alignment of the object perpendicular to one beam path of the stereomicroscope and thus a fully flattened image.

This photo stage plate can only be used with dual objective DS 100 (47 50 63).

The MC 63 camera attachment system for 35 mm and large format photography is described in detail in leaflet G 41-415-e.

¹⁾ If the phototube S is rotated on the stereo body SV 8 by 180° , the positions for observation/photography and binocular viewing are reversed.

Fig. 27: MC 63 A camera body for 35 mm format on stereomicroscope SV 8

The camera body MC 63 A is used with exposure control unit MA (27.1). All camera attachments in the MC 63 camera system can be combined with the MC 63 A.

- 1 Exposure control unit MA (47 74 20-9901)²⁾ 100-110-120-127-220-240 VA, 50 ... 60 Hz
- 2 On-off switch and pilot lamp
- 3 Film speed setting (DIN); inner for 35 mm film, outer for large format.
Exposure correction possible by adjusting film speed.
(Flash symbol: fixed time 1/60 sec)
- 4 Selector for intermediate values of (3). (25 DIN = 24 + 1; 14 DIN = 15 - 1)
- 5 Exposure button
- 6 Pilot lights –
Red: Too bright; subdue light with filter or lamp adjustment.
Yellow: Illumination within exposure range (max. exposure time ca. 1.5 min)
- 7 Test button: pilot lamp functions are operated without shutter opening.

If shutter is to be kept open for longer, turn knob (5) clockwise before exposure. Shutter will be closed by returning knob to original position.

The MC 63 A camera body is described in detail in Operating Instructions G 41-417.

27

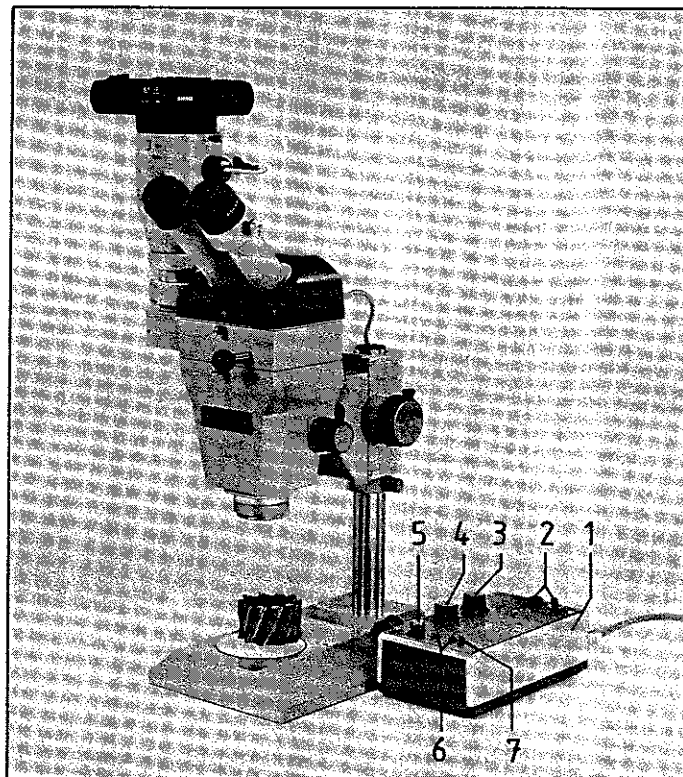

²⁾ Winder M (47 60 79) for motorized film advance can be used with camera body M 35, provided exposure control MA (47 74 20-9901) is available.

35 mm camera with internal exposure meter

Fig. 28: Contax RTS on stereomicroscope SV 8

- 1 Wide-angle eyepieces 10x/25 Br. foc. with focusing eyelens (46 40 03) for observation. Inserted here in the left-hand tube, the eyepiece contains the photo reticle with double crosslines (43 60 32) for delineating area photographed. Rotate eyepiece to align reticle with camera housing.
- 2 Eyepiece clamp ring (46 49 12)
With camera on right side —
- 3 a) Knob pushed in¹⁾: monocular viewing/photography
b) Knob pulled out¹⁾: binocular viewing
- 4 Contax RTS (41 61 65)
- 5 Planar 1.7/50 (41 61 70) (Filter screw thread M 55)
Diaphragm open, focused to ∞
- 6 Adapter (43 60 35)² with dovetail ring/screw thread M 55 x 0.75
- 7 Adapter ring (47 60 05)
- 8 Adapter ring clamp
- 9 Phototube S (47 50 83)
A wide-angle eyepiece 10x/25 Br. (46 40 02) is used in this tube for photography.

28

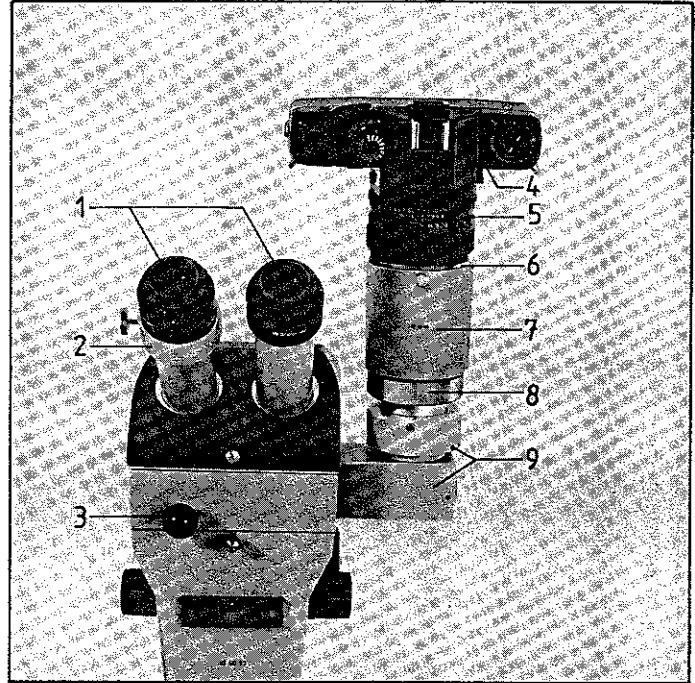
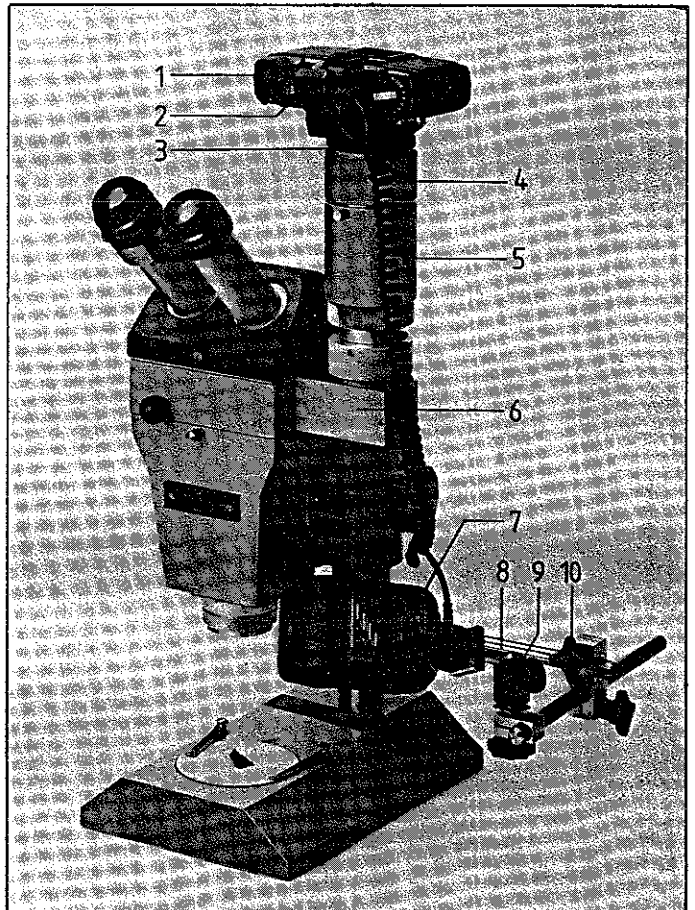

Fig. 29: Contax 139 single-lens reflex camera with automatic exposure and Contax flash unit TLA 20 for automatic flash photography on stereomicroscope SV 8

- 1 Contax 139 camera (41 61 75)
- 2 TLA cable connecting camera and flash unit
- 3 T2 adapter (47 60 89)³⁾
- 4 Objective f = 63 mm (47 60 29)
- 5 Adapter ring (47 60 05)
- 6 Phototube S (47 50 83), used with wide-angle eyepiece 10x/25 Br. (46 40 02) for photography
- 7 Flash unit TLA 20 or the more powerful TLA 30, available from photographic dealers.
- 8 Illuminator carrier (47 51 31) with clamp on stand column (hidden by flash unit)
- 9 Clamp with 1/4" thread and flash tilter (47 61 77) with flash unit attached
- 10 Cross-clamp with rod (47 61 76)

Contax TLA flash units and cameras are described in detail in their own user manuals.

29



1) If phototube S is rotated about the stereo body by 180°, the knob positions for observation/photography and binocular viewing are reversed.

2) Adapter (43 60 36) with dovetail ring/thread M 52 x 0.75
Adapter (43 60 37) with dovetail ring/thread M 49 x 0.75

3) T2 adapter (41 60 03) for MINOLTA
T2 adapter (41 60 04) for CANON
T2 adapter (41 60 09) for NIKON F
Other T2 adapters available

Stereophotography with the stereomicroscope SV 8

To obtain a three dimensional image of an object on film, two separate pictures have to be taken. Using camera (30.5) and adjusting phototube (30.10) two consecutive images are made, one in each beam path. The pair can then be viewed in the pocket stereoscope TS 4 (51 64 04).

Fig. 30: Stereomicroscope SV 8 equipped for stereo-photography

- 1 Wide-angle eyepiece 10x/25 Br. foc. (with focusing eyelens) and photo reticle MC (47 60 21)
- 2 Phototube here with eyepiece for survey
- 3 Phototube S (47 50 83)
- 4 Dual objective DS 100 (47 50 63)
- 5 Contax camera
- 6 T2 adapter (47 60 89)³⁾
- 7 Objective f = 63 mm (47 60 29)
- 8 Adapter ring (47 60 05)
- 9 Clamp 33/40 mm (43 40 46)
- 10 Sliding phototube (47 50 81) on phototube S.

30

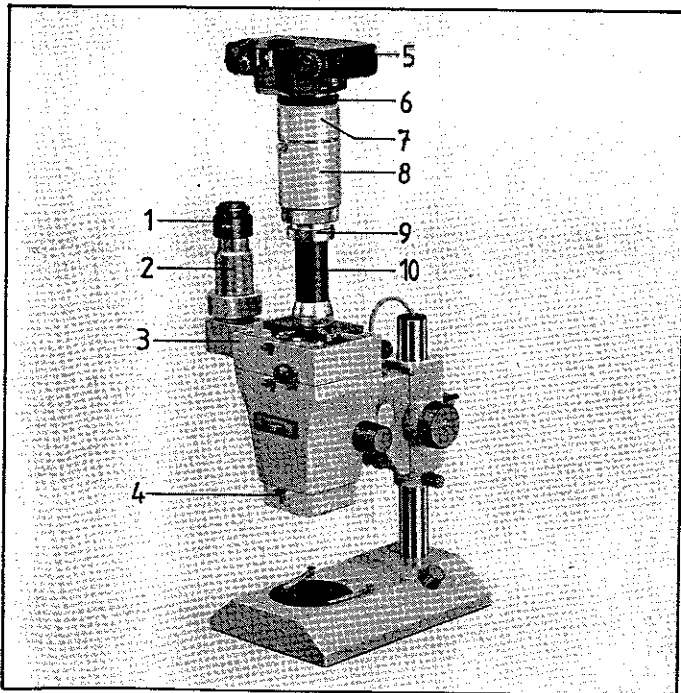

Mounting compact TV camera

Insert phototube S (47 50 83) (31.4) with TV mount (43 50 30) (31.3) between stereo body SV 8 and binocular tube and secure with screw. Screw adapter (47 79 21) (31.2) with standard C thread into TV camera (31.1). Set camera with adapter on to mount (31.3). Tighten screw. Focus specimen and look into binocular tube.

With camera to left side –

Knob (31.5)

- a) pulled out¹⁾: monocular viewing/TV microscopy
- b) pushed in¹⁾: binocular viewing

Connect TV camera to monitor and switch on. Focus specimen looking in binocular tube.

If supplied separately, the TV mount (43 50 30) (31.3) can be attached to phototube S (47 50 83) by our service technician or an experienced mechanic.

First loosen the three socket screws on the ring of the vertical phototube (28.9). Remove this phototube from phototube S and attach TV mount (31.3) with the three screws.

If another camera is to be attached to phototube S again, the TV mount (31.3) must be removed and the vertical phototube replaced and focused.

When focusing, ensure that the object is focused both in the eyepiece reticle and the film plane. (See leaflet G 41-415, page 23).

31

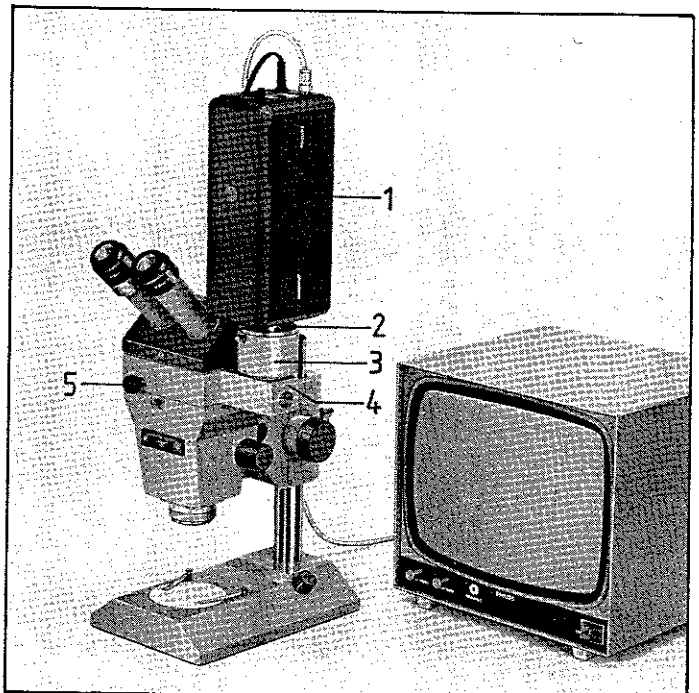

Attaching drawing apparatus

Attach drawing apparatus (47 46 22) (32.1) between stereo body SV 8 and binocular tube. The object image and the image of the drawing appear in the binocular tube.

Focusing equipment

Focus object sharply in stereomicroscope.

Reduce microscope illumination.

Set drawing paper (32.4) perpendicular to optical axis to avoid distortion of the microscope image. With slide (32.2) focus sharply on the drawing surface and the tip of the pencil.

Adjust illumination so that object and drawing paper are clearly seen. If necessary have a table lamp at the appropriate distance shining on the paper.

Adjust the size of the section to be drawn to drawing format with slide (32.3). The scale of the drawing can be changed continuously from 1 to 1.8 times. Read the factor from the left-hand edge of the slide.

Sketch the main contours of the object first.

32

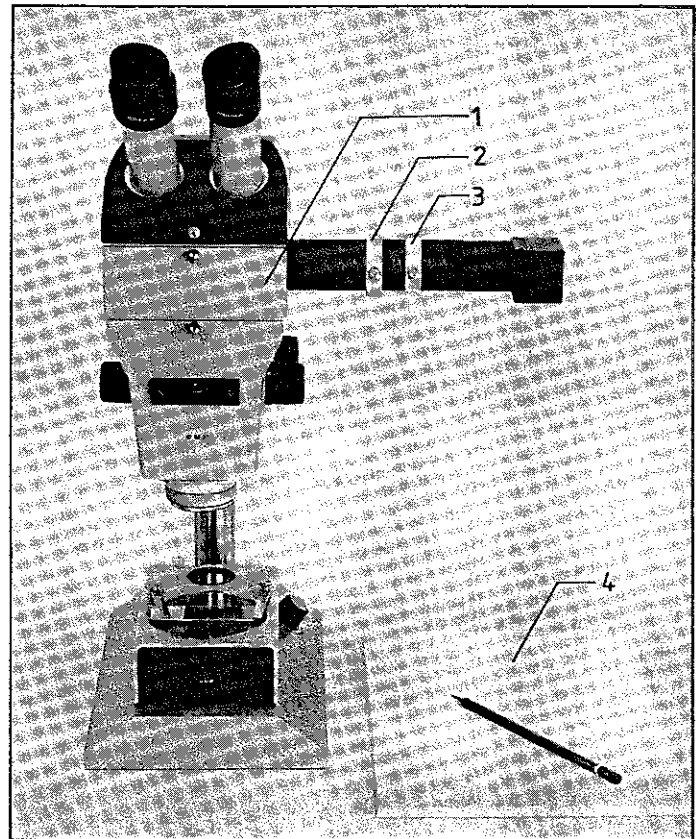

Fig. 32: Drawing apparatus (47 46 22) mounted on stereomicroscope SV 8.

Fig. 33: Stand system U with transmitted light and built-in transformers as base for stereomicroscope SV 8 with camera system MC 63 and Linhof double cassette 9 x 12 cm

- 1 Bridge U (47 51 26) connecting three columns to extremely sturdy base
- 2 Two columns 32 mm dia. for stability and for attachment of additional illuminators, e.g. 2 illuminators S with 6 V 10 W halogen lamp on semi illuminator carrier for incident light.
- 3 Stereo body SV 8 with pinion box.
- 4 32 mm dia. steel column. Columns of various lengths available permitting use of long focal length objective.
- 5 Illuminator 30 (46 72 30) with 12 V 30 W halogen lamp, focusing collector and concave mirror. Also attachable: illuminators 60 and 100 and lamp housing 15 (46 72 50) with dovetail ring (42 70 09) or illuminator 10 (46 72 53-9901) with holder (47 51 35).
- 6 Base plate U (47 51 03)
Dimensions: 260 mm wide x 325 mm deep. Two built-in transformers.
- 7 Two switches with independent brightness control functions.
- 8 Transmitted light for brightfield (47 52 73). Can be exchanged for transmitted light brightfield-darkfield (47 52 74) with 4-point ring illuminator (13.2) and KL 1500.

Stand with table clamp 32 (47 51 13)

Insert 32 mm dia. column into clamp hole (34.1) and secure with socket screw. Fix stand to the edge of a table with the turnscrew. Mount stereo body SV 8 on the column, lower on to holding ring and secure with locking screw. With table clamp 32 and parts of the stand system U a free-standing setup can be assembled which is stable, versatile and an ideal base for special stand setups.

Stand N (47 51 07-9901)

Consists of base 360 x 400 mm with exchangeable 84 mm dia. stage plate and clamp accepting 32 mm dia. column of any length from the U system.

33

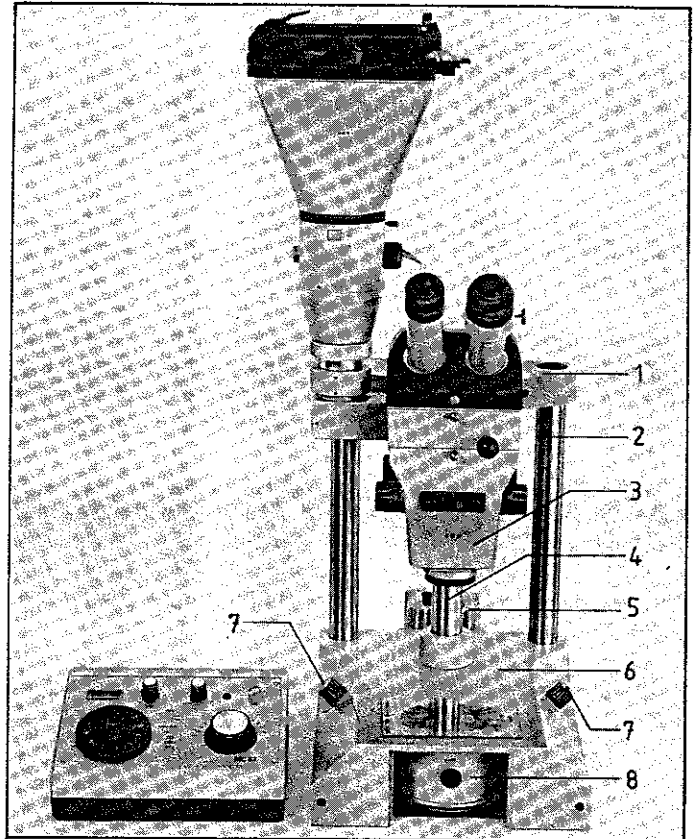

34

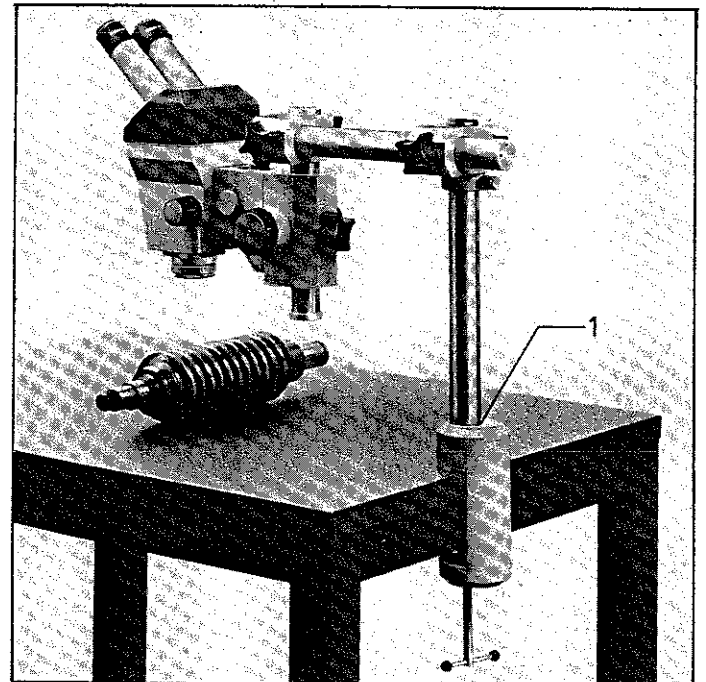

Stage with carrier 32 (47 52 38)

By loosening knob (35.2) and opening holding plate (35.1) the stage (35.4) can be swung to the side, permitting attachment or removal as desired. If a second holding ring (35.3) is attached beneath the stage, it can be turned to right or left by loosening the screw without losing height.

Specimen stages from the Standard range are used on the accessory stage (36.1) fixed from below with four screws in the holes provided (35.5).

The rotating and centering circular stage with centering piece (47 34 54) and clips is shown in Fig. 36 as an example. By moving the stage plate with the two pins (36.5) the specimen can be finely adjusted by hand. For detailed description see Operating Instructions G 41-111.

For transmitted light insert diffuse illuminator S (46 60 21) (36.6) with adapter (36.4) into the hole (36.2) and tighten with screw (36.3).

The Standard stage program includes coaxial stages with ranges of 25 x 75 mm, 50 x 75 mm, 4" x 4" (100 x 100 mm).

Also rotating and centering circular coaxial stages with a range of 50 x 75 mm..

35

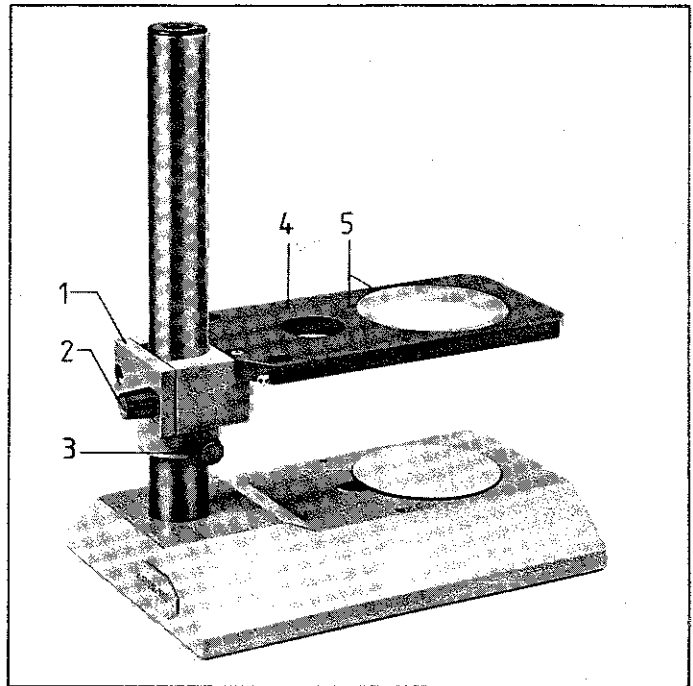

36

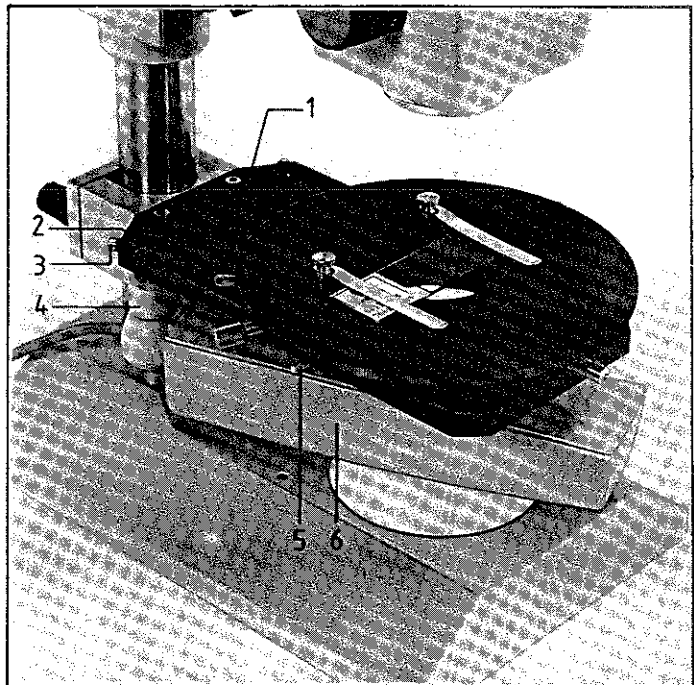

Ball and socket stage (47 52 25-9901) (Fig. 37.1)

This can be used instead of the 84 mm dia. stage plate (37.2) for incident light or instead of the glass plate (2.4) in the transmitted-light unit. The specimen can then be tilted in any direction.

37

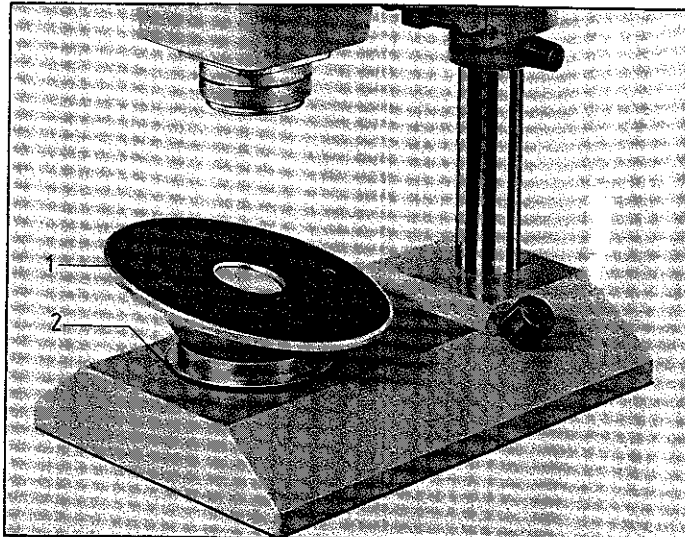

Tilting stage (47 52 26) with tweezers and probe (Fig. 38)

With this equipment small objects can be held fast, tilted in a suitable position for examination and clamped. Stops are provided for horizontal setting (0°) and 5.5° tilt for photography with the Greenough system using dual objective DS 100 mm. The specimen stage can be rotated horizontally by 360° . The 84 mm dia. stage opening takes the following inserts:

- slot-in plate with friction surface
- mount with spring clip for rotatable stage tweezers or probe; glass or plastic stage plate.

There are two holes for inserting the stage clips. The tilting stage can be used for examination in incident light or on the transmitted-light attachment (47 52 65) (2.2).

38

