



OpenGL Performer™
Programmer's Guide

Version 3.1

007-1680-090



CONTRIBUTORS

Written by George Eckel and Ken Jones

Illustrated by Chrystie Danzer and Chris Wengelski

Production by Karen Jacobson

Engineering contributions by Angus Dorbie, Paolo Farinelli, Tom Flynn, Yair Kurzion, Radomir Mech, Alexandre Naaman, Marcin Romaszewicz, Allan Schaffer, and Jenny Zhao

COPYRIGHT

© 1994, 2000–2003 Silicon Graphics, Inc. All rights reserved; provided portions may be copyright in third parties, as indicated elsewhere herein. No permission is granted to copy, distribute, or create derivative works from the contents of this electronic documentation in any manner, in whole or in part, without the prior written permission of Silicon Graphics, Inc.

LIMITED RIGHTS LEGEND

The electronic (software) version of this document was developed at private expense; if acquired under an agreement with the USA government or any contractor thereto, it is acquired as "commercial computer software" subject to the provisions of its applicable license agreement, as specified in (a) 48 CFR 12.212 of the FAR; or, if acquired for Department of Defense units, (b) 48 CFR 227-7202 of the DoD FAR Supplement; or sections succeeding thereto. Contractor/manufacturer is Silicon Graphics, Inc., 1600 Amphitheatre Pkwy 2E, Mountain View, CA 94043-1351.

TRADEMARKS AND ATTRIBUTIONS

Silicon Graphics, SGI, the SGI logo, IRIS, IRIX, ImageVision Library, Indigo, Indy, InfiniteReality, O2, Octane, Onyx, Onyx2, and OpenGL are registered trademarks and CASEVision, Crimson, Elan Graphics, IRIS Geometry Pipeline, IRIS GL, IRIS Graphics Library, IRIS InSight, IRIS Inventor, Indigo Elan, Indigo2, InfinitePerformance, InfiniteReality2, InfiniteReality4, Onyx4, OpenGL Multipipe, OpenGL Performer, OpenGL Shader, Performance Co-Pilot, REACT, RealityEngine, RealityEngine2, Showcase, UltimateVision, and VPro are trademarks of Silicon Graphics, Inc., in the United States and/or other countries worldwide.

AutoCAD is a registered trademark of Autodesk, Inc. CATIA is a registered trademark of DASSAULT SYSTEMES S.A. Designer's Workbench is a trademark of Centric Software, Inc. Lightscape is a trademark of Autodesk, Inc. Linux is a registered trademark of Linus Torvalds. Maya is a registered trademark and Wavefront is a trademark of Alias Systems, a division of Silicon Graphics Limited in the United States and/or other countries worldwide. Motif is a registered trademark and X Window System and OSF/Motif are trademarks of The Open Group. Purify is a registered trademark of Rational Software Corporation. Red Hat is a registered trademark of Red Hat, Inc. RPC is a trademark of ArchVision. VTune is a trademark of Intel Corporation. WindView is a trademark of Wind River Systems. Microsoft, Windows, and Windows NT are registered trademarks of Microsoft Corporation in the United States and other countries.

PATENT DISCLOSURE

Many of the techniques and methods disclosed in this Programmer's Guide are covered by patents held by Silicon Graphics including U.S. Patent Nos. 5,051,737; 5,369,739; 5,438,654; 5,394,170; 5,528,737; 5,528,738; 5,581,680; 5,471,572 and patent applications pending.

We encourage you to use these features in your OpenGL Performer application on SGI systems.

This functionality and OpenGL Performer are not available for re-implementation and distribution on other platforms without the explicit permission of Silicon Graphics.

New Features in This Guide

This revision of the guide documents OpenGL Performer 3.1, which has the following features:

- GPU programming on systems like Silicon Graphics Onyx4 UltimateVision visualization systems
- Curves and surfaces (higher-order primitives)
 - Parametric surfaces
 - Subdivision surfaces
- pfGeoArrays for efficient use of vertex arrays on systems like Silicon Graphics Onyx4 UltimateVision visualization systems
- New data sources
 - Maya exporter to OpenGL Performer
 - CATIA import to OpenGL Performer
- Miscellaneous
 - Small object culling
 - Linux: RedHat 8 support
 - Linux: RedHat 9 support
 - IRIX: Remove O32 support
 - Linux: Remove gcc2 support

Record of Revision

Version	Description
020	1994 Original publication.
060	November 2000 Updated for the 2.4 version of OpenGL Performer.
070	November 2001 Updated for the 2.5 version of OpenGL Performer.
080	December 2002 Updated for the 3.0 version of OpenGL Performer.
090	December 2003 Updated for the 3.1 version of OpenGL Performer.

Contents

Figures	xxix
Tables	xxxv
Examples	xxxix
About This Guide.	xliii
Why Use OpenGL Performer?	xliii
What You Should Know Before Reading This Guide	xliv
How to Use This Guide	xliv
What This Guide Contains	xliv
Sample Applications	xlvi
Conventions	xlvii
Internet and Hardcopy Reading for the OpenGL Performer Series	xlvii
Reader Comments	xlviii
1. OpenGL Performer Programming Interface	1
General Naming Conventions	1
Prefixes	1
Header Files	2
Naming in C and C++	2
Abbreviations	3
Macros, Tokens, and Enums	3
Class API	3
Object Creation	4
Set Routines	4
Get Routines	4
Action Routines	5
Enable and Disable of Modes	5
Mode, Attribute, or Value	6

Base Classes	6
Inheritance Graph	7
libpr and libpf Objects	10
User Data	10
pfDelete() and Reference Counting	11
Copying Objects with pfCopy()	15
Printing Objects with pfPrint()	15
Determining Object Type	17
2. Setting Up the Display Environment	19
Using Pipes	21
The Functional Stages of a Pipeline	21
Creating and Configuring a pfPipe	23
Example of pfPipe Use	25
Using Channels	26
Creating and Configuring a pfChannel	26
Setting Up a Scene	27
Setting Up a Viewport	27
Setting Up a Viewing Frustum	28
Setting Up a Viewpoint	30
Example of Channel Use	32
Controlling the Video Output	34
Using Multiple Channels	35
One Window per Pipe, Multiple Channels per Window	36
Using Channel Groups	40
Multiple Channels and Multiple Windows	43
Importing OpenGL Multipipe SDK (MPK) Configuration Files	44
3. Nodes and Node Types	49
Nodes	49
Attribute Inheritance	49
pfNode	51
pfGroup	53

Working with Nodes	56
Instancing	56
Bounding Volumes	59
Node Types.	61
pfScene Nodes.	61
pfSCS Nodes	62
pfDCS Nodes	62
pfFCS Nodes	63
pfDoubleSCS Nodes	64
pfDoubleDCS Nodes	64
pfDoubleFCS Nodes	67
pfSwitch Nodes	67
pfSequence Nodes	67
pfLOD Nodes	70
pfASD Nodes	70
pfLayer Nodes	70
pfGeode Nodes	71
pfText Nodes	73
pfBillboard Nodes	75
pfPartition Nodes	78
Sample Program	80
4. Database Traversal	85
Scene Graph Hierarchy	87
Database Traversals	87
State Inheritance	87
Database Organization	88
Application Traversal	88
Cull Traversal	90
Traversal Order	90
Visibility Culling	91
Organizing a Database for Efficient Culling	94
Sorting the Scene	97
Paths through the Scene Graph	100

Draw Traversal	100
Optimizing the Drawing of Sub-bins	101
Bin Draw Callbacks	101
Controlling and Customizing Traversals	102
pfChannel Traversal Modes	102
Cull Programs	103
pfNode Draw Mask	112
pfNode Cull and Draw Callbacks	113
Process Callbacks	116
Process Callbacks and Passthrough Data	118
Intersection Traversal	120
Testing Line Segment Intersections	120
Intersection Requests: pfSegSets	121
Intersection Return Data: pfHit Objects	121
Intersection Masks	122
Discriminator Callbacks	124
Line Segment Clipping	125
Traversing Special Nodes	125
Picking	126
Performance	126
Intersection Methods for Segments	127
5. Frame and Load Control	129
Frame Rate Management	129
Selecting the Frame Rate	130
Achieving the Frame Rate	130
Fixing the Frame Rate	131
Level-of-Detail Management	136
Level-of-Detail Models	136
Level-of-Detail States	140
Level-of-Detail Range Processing	141
Level-of-Detail Transition Blending	145
Run-Time User Control Over LOD Evaluation	146
Terrain Level-of-Detail	147

Maintaining Frame Rate Using Dynamic Video Resolution148
The Channel in DVR149
DVR Scaling150
Customizing DVR150
Understanding the Stress Filter151
Dynamic Load Management152
Successful Multiprocessing with OpenGL Performer155
Review of Rendering Stages155
Choosing a Multiprocessing Model.156
Asynchronous Database Processing163
Placing Multiple OpenGL Performer Processes on a Single CPU165
Rules for Invoking Functions While Multiprocessing166
Multiprocessing and Memory168
Shared Memory and pfInit()169
pfDataPools170
Passthrough Data170
CULL Process Optimizations.171
Cull Sidekick Processes173
Configuring CULL_SIDEKICK Processes174
CULL Sidekick Optimization Mask.174
CULL Sidekick Synchronization Policy175
CULL Sidekick User Functions176
Modifying Attributes of Cloned pfGeoSets178
Marking pfGeoSets for Optimization179
6. Creating Visual Effects181
Using pfEarthSky181
Atmospheric Effects182

Patchy Fog and Layered Fog	186
Creating Layered Fog	187
Creating Patchy Fog	187
Initializing a pfVolFog	188
Updating the View	191
Drawing a Scene with Fog	191
Deleting a pfVolFog	191
Specifying Fog Parameters	192
Advanced Features of Layered Fog and Patchy Fog	193
Performance Considerations and Limitations	196
Real-Time Shadows	198
Creating a pfShadow	199
Drawing a Scene with Shadows	201
Specifying Shadow Parameters	202
Assigning Data with Directions	202
Limitations of Real-Time Shadows	203
Image-Based Rendering	204
Creating a pfIBRnode	204
Creating a pfIBRnode Using a Proxy	205
Creating a pfIBRtexture	206
Parameters Controlling Drawing of a pfIBRnode	208
The Simplify Application	209
Creating Images of an Object with makeProxyImages	215
Creating Images of an Object with makeIBRimages	219
Limitations	220
7. Importing Databases	221
Overview of OpenGL Performer Database Creation and Conversion	221
libpfd - Utilities for Creating Efficient OpenGL Performer Run-Time Structures	222
pfdLoadFile - Loading Arbitrary Databases into OpenGL Performer	223
Database Loading Details.	225

Developing Custom Importers228
Structure and Interpretation of the Database File Format229
Scene Graph Creation Using Nodes as Defined in <code>libpf</code>229
Defining Geometry and Graphics State for <code>libpr</code>230
Creating an OpenGL Performer Database Converter using <code>libpfdu</code>230
Maximizing Database Loading and Paging Performance with PFB and PFI Formats240
<code>pfconv.</code>240
<code>pficonv</code>241
Supported Database Formats.241

Description of Supported Formats	244
AutoDesk 3DS Format	244
SGI BIN Format	244
Side Effects POLY Format	246
Brigham Young University BYU Format	248
Optimizer CSB Format	249
Virtual Cliptexture CT Loader	249
Designer’s Workbench DWB Format	249
AutoCAD DXF Format	250
MultiGen OpenFlight Format	252
McDonnell-Douglas GDS Format	254
SGI GFO Format	254
SGI IM Format	256
AAI/Graphicon IRTP Format	257
SGI Open Inventor Format	258
Lightscape Technologies LSA and LSB Formats	259
Medit Productions MEDIT Format	263
NFF Neutral File Format	263
Wavefront Technology OBJ Format	265
SGI PFB Format	267
SGI PFI Format.	268
SGI PHD Format	268
SGI PTU Format	270
ArchVision RPC Format	273
USNA Standard Graphics Format	275
SGI SGO Format	276
USNA Simple Polygon File Format	280
Sierpinski Sponge Loader.	280
Star Chart Format	281
3D Lithography STL Format	282
SuperViewer SV Format	283
Geometry Center Triangle Format	287
UNC Walkthrough Format	287

WRL Format287
Database Operators with Pseudo Loaders288
The Maya Database Exporter.290
Installation Requirements290
Exporting a Scene Using the Graphical Interface291
Exporting a Scene Using the Maya Embedded Language (MEL)296
Translation Details297
8. Geometry305
pfGeoSet (Geometry Set)305
Primitive Types307
pfGeoSet Draw Mode308
Primitive Connectivity310
Attributes312
Attribute Bindings314
Indexed Arrays315
pfGeoSet Operations317
pfGeoArray (Geometry Array)318
pfGeoArray Attributes319
pfGeoArray Attribute Types.321
pfGeoSet Primitive Types323
pfGeoArray Special Rendering Characteristics327
pfGeoArrays (Geometry) and pfGeoStates (Appearance)327
Drawing pfGeoArrays329
Intersecting with pfGeoArrays330
Clip Texture Emulation Support335
Quick Manipulation of Temporary pfGeoArrays336
Converting pfGeoSets to pfGeoArrays340
3D Text341
pfFont341
pfString343

9. Higher-Order Geometric Primitives	347
Features and Uses of Higher-Order Geometric Primitives	348
Reps and the Rendering Process	348
Trimmed NURBS	348
Objects Required by Reps	348
New Types Required for Reps	349
Classes for Scalar Functions	349
Matrix Class: pfRMatrix	351
Geometric Primitives: The Base Class pfRep and the Application repTest	352
Class Declaration for pfRep	354
Main Features of the Methods in pfRep	354
Planar Curves	354
Mathematical Description of a Planar Curve	355
Lines in the Plane	359
Circles in the Plane	360
Superquadric Curves: pfSuperQuadCurve2d	362
Hermite-Spline Curves in the Plane	365
NURBS Overview	366
NURBS Curves in the Plane	371
Piecewise Polynomial Curves: pfPieceWisePolyCurve2d	373
Discrete Curves in the Plane	374
Spatial Curves	377
Lines in Space	377
Circles in Space	378
Superquadrics in Space	378
Hermite Spline Curves in Space	379
NURBS Curves in Space	379
Curves on Surfaces: pfCompositeCurve3d	380
Discrete Curves in Space	381
Example of Using pfDisCurve3d and pfHsplineCurve3d	381

Parametric Surfaces381
Mathematical Description of a Parametric Surface382
Defining Edges of a Parametric Surface: Trim Loops and Curves383
Adjacency Information: pfEdge385
Base Class for Parametric Surfaces: pfParaSurface386
pfPlaneSurface390
pfSphereSurface392
pfCylinderSurface395
pfTorusSurface397
pfConeSurface399
Swept Surfaces401
pfFrenetSweptSurface405
Ruled Surfaces406
Coons Patches408
NURBS Surfaces410
Hermite-Spline Surfaces417
Meshes419
Mesh Faces422
Mesh Vertices423
Subdivision Surfaces426
Creating a Subdivision Surface427
Loop and Catmull-Clark Subdivisions430
Dynamic Modification of Vertices430
The libpfs subdiv Pseudo Loader430
Special Notes431
10. Creating and Maintaining Surface Topology433
Overview of Topology Tasks433
Summary of Scene Graph Topology: pfTopo434
Building Topology: Computing and Using Connectivity Information437
Reading and Writing Topology Information: Using Pseudo Loaders440
Class Declaration for pfTopo441
Main Features of the Methods in pfTopo442

	Collecting Connected Surfaces: pfSolid	443
	Class Declaration for pfSolid	443
	Main Features of the Methods in pfSolid	444
11.	Rendering Higher-Order Primitives: Tessellators	445
	Features of Tessellators	446
	Tessellators for Varying Levels of Detail	447
	Tessellators Act on a Whole Graph or Single Node	448
	Tessellators and Topology: Managing Cracks	448
	Base Class pfTessellateAction	449
	Retessellating a Scene Graph	449
	Class Declaration for pfTessellateAction	449
	Main Features of the Methods in pfTessellateAction	450
	Tessellating Parametric Surfaces	451
	pfTessParaSurfaceAction	451
	Sample From repTest: Tessellating and Rendering a Sphere	454
12.	Graphics State	457
	Immediate Mode	457
	Rendering Modes	459
	Rendering Values	464
	Enable / Disable	464
	Rendering Attributes	465
	Graphics Library Matrix Routines	483
	Sprite Transformations	484
	Display Lists	485
	State Management	486
	State Override	488
	pfGeoState	488
13.	Shaders	497
	Setting Up Shaded pfGeoSets	497
	Textures and Texture Coordinates	498
	OpenGL Shader and OpenGL Performer	499

14.	Using Scalable Graphics Hardware	.501
	Using OpenGL Performer with a DPLEX	.501
	Hyperpipe Concepts	.502
	Configuring Hyperpipes	.502
	Configuring pfPipeWindows and pfChannels	.509
	Programming with Hyperpipes	.513
	Using OpenGL Performer with an SGI Scalable Graphics Compositor	.514
	How the Compositor Functions	.515
	Using the pfCompositor Class	.516
	Load Balancing	.520
	Using OpenGL Performer with GPUs	.523
	The pfGProgram Class	.523
	The pfGProgramParms Class	.525
	The pfVertexProgram and pfFragmentProgram Classes	.526
15.	ClipTextures	.529
	Overview	.530
	Cliptexture Levels	.531
	Cliptexture Assumptions	.532
	Image Cache	.533
	Toroidal Loading	.536
	Updating the Clipcenter	.538
	Virtual Cliptextures on InfiniteReality Systems	.538
	Cliptexture Support Requirements	.540
	Special Features	.540
	How Cliptextures Interact with the Rest of the System	.541
	Cliptexture Support in OpenGL Performer	.542
	Cliptexture Manipulation	.544
	Cliptexture API	.545
	Preprocessing ClipTextures	.545
	Building a MIPmap	.546
	Formatting Image Data	.547
	Tiling an Image	.547

Cliptexture Configuration	548
Configuration Considerations	548
Load-Time Configuration.	549
Post-Load-Time Configuration	549
Configuration API	549
libppr Functionality	550
Configuration Utilities	553
Configuration Files	555
Post-Scene Graph Load Configuration	571
MPClipTextures	571
pfMPClipTexture Utilities	573
Using Cliptextures with Multiple Pipes.	576
Texture Memory and Hardware Support Checking	578
Manipulating Cliptextures	579
Cliptexture Load Control	579
Invalidating Cliptextures	584
Virtual ClipTextures	585
Custom Read Functions	591
Using Cliptextures	593
Cliptexture Insets	593
Estimating Cliptexture Memory Usage	597
Using Cliptextures in Multipipe Applications	601
Virtualizing Cliptextures	602
Customizing Load Control	603
Custom Read Functions	604
Cliptexture Sample Code	604
16. Windows	609
pfWindows	609
Creating a pfWindow	610
Configuring the Framebuffer of a pfWindow	613
pfWindows and GL Windows	615

Manipulating a pfWindow617
Alternate Framebuffer Configuration Windows618
Window Share Groups619
Synchronization of Buffer Swap for Multiple Windows620
Communicating with the Window System620
More pfWindow Examples621
17. pfPipeWindows and pfPipeVideoChannels625
Using pfPipeWindows625
Creating, Configuring and Opening pfPipeWindow625
pfPipeWindows in Action636
Controlling Video Displays638
Creating a pfPipeVideoChannel639
Multiple pfPipeVideoChannels in a pfPipeWindow640
Configuring a pfPipeVideoChannel640
Use pfPipeVideoChannels to Control Frame Rate641
18. Managing Nongraphic System Tasks643
Handling Queues643
Multiprocessing644
Queue Contents644
Adding or Retrieving Elements645
pfQueue Modes646
Running the Sort Process on a Different CPU649
High-Resolution Clocks650
Video Refresh Counter (Vclock)651
Memory Allocation651
Allocating Memory With pfMalloc()652
Shared Arenas653
Allocating Locks and Semaphores654
Datapools654
CycleBuffers655
Asynchronous I/O (IRIX only)658
Error Handling and Notification658
File Search Paths660

19.	Dynamic Data	663
	pfFlux	663
	Creating and Deleting a pfFlux	664
	Initializing the Buffers	665
	pfFlux Buffers	666
	Coordinating pfFlux and Connected pfEngines	669
	Synchronized Flux Evaluation	671
	Fluxed Geosets	674
	Fluxed Coordinate Systems	675
	Replacing pfCycleBuffer with pfFlux	677
	pfEngine	678
	Creating and Deleting Engines	678
	Setting Engine Types and Modes	679
	Setting Engine Sources and Destinations	686
	Setting Engine Masks	686
	Setting Engine Iterations	686
	Setting Engine Ranges	687
	Evaluating pfEngines	687
	Animating a Geometry	688
20.	Active Surface Definition	691
	Overview	691
	Using ASD	693
	LOD Reduction	693
	Hierarchical Structure	694
	ASD Solution Flow Chart	696
	A Very Simple ASD	697
	Morphing Vector	698
	A Very Complex ASD	699
	ASD Elements	699
	Vertices	700
	Evaluation Function	702

Data Structures703
Triangle Data Structure705
Attribute Data Array710
Vertex Data Structure711
Default Evaluation Function.712
pfASD Queries714
Aligning an Object to the Surface714
Adding a Query Array715
Using ASD for Multiple Channels716
Connecting Channels.716
Combining pfClipTexture and pfASD717
ASD Evaluation Function Timing717
Query Results718
Aligning a Geometry With a pfASD Surface Example718
Aligning Light Points Above a pfASD Surface Example720
Paging722
Interest Area722
Preprocessing for Paging.723
Multi-resolution Paging724
21. Light Points727
Uses of Light Points727
Creating a Light Point.728
Setting the Behavior of Light Points729
Intensity729
Directionality730
Emanation Shape730
Distance732
Attenuation through Fog.733
Size734
Fading735
Callbacks735
Multisample, Size, and Alpha738
Reducing CPU Processing Using Textures740

Preprocessing Light Points	741
Stage Configuration Callbacks	741
How the Light Point Process Works.	742
Calligraphic Light Points	743
Calligraphic Versus Raster Displays	744
LPB Hardware Configuration	746
Visibility Information	748
Required Steps For Using Calligraphic Lights	749
Accounting for Projector Differences	751
Callbacks	753
Frame to Frame Control	755
Significance.	756
Debunching	756
Defocussing Calligraphic Objects	757
Using pfCalligraphic Without pfChannel	757
Timing Issues	758
Light Point Process and Calligraphic	758
Debugging Calligraphic Lights on Non-Calligraphic Systems	758
Calligraphic Light Example	759
22. Math Routines	767
Vector Operations	767
Matrix Operations	769
Quaternion Operations	773
Matrix Stack Operations	775
Creating and Transforming Volumes	776
Defining a Volume	776
Creating Bounding Volumes	778
Transforming Bounding Volumes	779
Intersecting Volumes	780
Point-Volume Intersection Tests	780
Volume-Volume Intersection Tests	780

Creating and Working with Line Segments782
Intersecting with Volumes783
Intersecting with Planes and Triangles.784
Intersecting with pfGeoSets784
General Math Routine Example Program786
23. Statistics791
Interpreting Statistics Displays792
Status Line792
Stage Timing Graph793
Load and Stress796
CPU Statistics797
Rendering Statistics799
Fill Statistics800
Collecting and Accessing Statistics in Your Application800
Displaying Statistics Simply801
Enabling and Disabling Statistics for a Channel802
Statistics in libpr and libpf—pfStats Versus pfFrameStats802
Statistics Rules of Use803
Reducing the Cost of Statistics806
Statistics Output807
Customizing Displays809
Setting Update Rate809
The pfStats Data Structure809
Setting Statistics Class Enables and Modes810
24. Performance Tuning and Debugging811
Performance Tuning Overview811
How OpenGL Performer Helps Performance812
Draw Stage and Graphics Pipeline Optimizations812
Cull and Intersection Optimizations814
Application Optimizations815

Specific Guidelines for Optimizing Performance	816
Graphics Pipeline Tuning Tips	816
Process Pipeline Tuning Tips.	819
Database Concerns	823
Special Coding Tips	828
Performance Measurement Tools.	828
Using <code>pixie</code> , <code>prof</code> , and <code>gprof</code> to Measure Performance	829
Using <code>ogldebug</code> to Observe Graphics Calls	830
Guidelines for Debugging.	831
Shared Memory	831
Use the Simplest Process Model	831
Avoid Floating-Point Exceptions	832
When the Debugger Will Not Give You a Stack Trace	832
Tracing Members of OpenGL Performer Objects	833
Memory Corruption and Leaks	834
Purify	834
<code>libdmalloc</code> (IRIX only).	835
Notes on Tuning for RealityEngine Graphics	836
Multisampling	836
Transparency	837
Texturing	837
Other Tips	838
EventView—A Performance Analyzer	838
Viewing Events— <code>evanalyzer</code>	839
Controlling the Collection of OpenGL Performer Internal Events	840
Sample Use of EventView	840
Using EventView Tools	844
Understanding OpenGL Performer Internal Events	851
25. Building a Visual Simulation Application Using <code>libpfv</code>.	855
Overview	855
The Simplest <code>pfvViewer</code> Program	856
Adding Interaction to a <code>pfvViewer</code> Program	857
Reading XML Configuration Files	858

Module Scoping, Multiple Worlds and Multiple Views862
Extending a pfvViewer—Writing Custom Modules865
Extending a pfvViewer—Module Entry Points867
Picking, Selection, and Interaction868
More Sample Programs, Configuration Files, and Source Code871
26. Programming with C++873
Overview873
Class Taxonomy874
Public Structs874
libpr Classes874
libpf Classes875
pfType Class875
Programming Basics875
Header Files875
Creating and Deleting OpenGL Performer Objects879
Invoking Methods on OpenGL Performer Objects881
Passing Vectors and Matrices to Other Libraries881
Porting from C API to C++ API881
Typedefed Arrays Versus Structs882
Interface Between C and C++ API Code883
Subclassing pfObjects883
Initialization and Type Definition884
Defining Virtual Functions885
Accessing Parent Class Data Members886
Multiprocessing and Shared Memory886
Initializing Shared Memory886
Data Members and Shared Memory888
Multiprocessing and libpf Objects889
Performance Hints890
Constructor Overhead890
Math Operators890

Glossary.	891
Index.	913

Figures

Figure 1-1	Partial Inheritance Graph of OpenGL Performer Data Types	9
Figure 2-1	From Scene Graph to Visual Display.	20
Figure 2-2	Single Graphics Pipeline	22
Figure 2-3	Dual Graphics Pipeline	23
Figure 2-4	Symmetric Viewing Frustum	29
Figure 2-5	Heading, Pitch, and Roll Angles	31
Figure 2-6	Single-Channel and Multiple-Channel Display	37
Figure 2-7	The libpfmpk Import Operation	46
Figure 3-1	Nodes in the OpenGL Performer Hierarchy	50
Figure 3-2	Shared Instances	57
Figure 3-3	Cloned Instancing	58
Figure 3-4	A Scenario for Using Double-Precision Nodes	65
Figure 3-5	pfDoubleDCS Nodes in a Scene Graph	66
Figure 4-1	Culling to the Frustum.	92
Figure 4-2	Sample Database Objects and Bounding Volumes	94
Figure 4-3	How to Partition a Database for Maximum Efficiency	96
Figure 4-4	Intersection Methods	128
Figure 5-1	Frame Rate and Phase Control	132
Figure 5-2	Level-of-Detail Node Structure	137
Figure 5-3	Level-of-Detail Processing.	139
Figure 5-4	Real Size of Viewport Rendered Under Increasing Stress	149
Figure 5-5	Stress Processing	153
Figure 5-6	Multiprocessing Models	162
Figure 5-7	Loose Culling of pfGeosets	172
Figure 5-8	CULL_SIDEKICK Processing	174
Figure 6-1	Layered Atmosphere Model	183
Figure 6-2	Patchy Fog Versus Layered Fog	186

Figure 6-3	The Default Simplify Pane	210
Figure 6-4	The Simplify Pane for Simplifying an Object.	213
Figure 7-1	BIN-Format Data Objects	245
Figure 7-2	Soma Cube Puzzle in DWB Form	250
Figure 7-3	The Famous Teapot in DXF Form	251
Figure 7-4	Spacecraft Model in OpenFlight Format	253
Figure 7-5	GFO Database of Mies van der Rohe’s German Pavilion	255
Figure 7-6	Aircar Database in IRIS Inventor Format.	258
Figure 7-7	LSA-Format City Hall Database	261
Figure 7-8	LSB-Format Operating Room Database	262
Figure 7-9	SGI Office Building as OBJ Database	266
Figure 7-10	Plethora of Polyhedra in PHD Format	269
Figure 7-11	Terrain Database Generated by PTU Tools	271
Figure 7-12	Model in SGO Format	277
Figure 7-13	Sample STLA Database.	282
Figure 7-14	Early Automobile in SuperViewer SV Format	284
Figure 7-15	Maya Export Screen.	292
Figure 7-16	Maya Export Options	293
Figure 8-1	Primitives and Connectivity	311
Figure 8-2	pfGeoSet Structure	313
Figure 8-3	Indexing Arrays	316
Figure 8-4	Deciding Whether to Index Attributes	317
Figure 9-1	Class Hierarchy for Higher-Order Primitives	353
Figure 9-2	Parametric Curve: Parameter Interval (0,1).	356
Figure 9-3	Line in the Plane Parameterization	359
Figure 9-4	Circle in the Plane Parameterization	360
Figure 9-5	Superquadric Curve’s Dependence on the Parameter α	363
Figure 9-6	Hermite Spline Curve Parameterization	365
Figure 9-7	Discrete Curve Definition	374
Figure 9-8	Parametric Surface: Unit-Square Coordinate System	383
Figure 9-9	Trim Loops and Trimmed Surface: Both Trim Loops Made of Four Trim Curves	384
Figure 9-10	Plane Parameterization	390

Figure 9-11	Sphere Parameterization392
Figure 9-12	Cylinder Parameterization395
Figure 9-13	Torus Parameterization397
Figure 9-14	Cone Parameterization.399
Figure 9-15	Swept Surface: Moving Reference Frame and Effect of Profile Function402
Figure 9-16	Ruled Surface Parameterization407
Figure 9-17	Coons Patch Construction409
Figure 9-18	NURBS Surface Control Hull Parameterization413
Figure 9-19	Hermite Spline Surface With Derivatives Specified at Knot Points	.417
Figure 10-1	Topological Relations Maintained by Topology Classes435
Figure 10-2	Consistently Tessellated Adjacent Surfaces and Related Objects .	.436
Figure 11-1	Class Hierarchy for Tessellators446
Figure 11-2	Tessellations Varying With Changes in Control Parameter447
Figure 12-1	pfGeoState Structure493
Figure 12-2	Generating the Color of a Multitextured Pixel494
Figure 14-1	pfPipes Creating pfHyperpipes503
Figure 14-2	Multiple Hyperpipes504
Figure 14-3	Default Hyperpipe Mapping to Graphic Pipes505
Figure 14-4	Attaching Objects to the Master pfPipe510
Figure 14-5	Hardware Composition Schemes.516
Figure 14-6	Decomposition Modes for pfCompositor517
Figure 15-1	Cliptexture Components530
Figure 15-2	Image Cache Components.531
Figure 15-3	Mem Region Update534
Figure 15-4	Tex Region Update535
Figure 15-5	Cliptexture Cache Hierarchy536
Figure 15-6	Invalid Border537
Figure 15-7	Clipcenter Moving538
Figure 15-8	Virtual Cliptexture Concepts539
Figure 15-9	pfMPClipTexture Connections572
Figure 15-10	pfuClipCenterNode Connections.575
Figure 15-11	Master and Slave Cliptexture Resource Sharing576

Figure 15-12	Cliptexture Insets	594
Figure 15-13	Supersampled Inset Boundary.	596
Figure 15-14	Offset Slave Tex Regions	602
Figure 17-1	Directing Video Output	638
Figure 18-1	pfQueue Object	643
Figure 18-2	pfCycleBuffer and pfCycleMemory Overview	657
Figure 19-1	How pfFlux and Processes Use Frame Numbers	664
Figure 19-2	pfFlux Buffer Structure	667
Figure 19-3	Timing Diagram Showing the Use of Sync Groups	673
Figure 19-4	pfEngine Driving a pfFlux That Animates a pfFCS Node	675
Figure 20-1	Morphing Range Between LODs	695
Figure 20-2	Large Geometry	696
Figure 20-3	ASD Information Flow	697
Figure 20-4	A Very Simple pfASD	698
Figure 20-5	Reference Positions	701
Figure 20-6	Triangulated Image	701
Figure 20-7	LOD1 Replaced by LOD2	702
Figure 20-8	Data Structures	703
Figure 20-9	ASD Data Structures	704
Figure 20-10	Discontinuous, Neighboring LODs	707
Figure 20-11	Triangle Mesh	707
Figure 20-12	Using the tsid Field	708
Figure 20-13	Vertex and Reference Point Arrays, Counter-Clockwise Ordering	709
Figure 20-14	Vertex Neighborhoods	712
Figure 20-15	pfASD Evaluation Process	718
Figure 20-16	Example Setup for Geometry Alignment.	719
Figure 20-17	Aligning Light Points Above a pfASD Surface	720
Figure 20-18	Tiles at Different LODs	723
Figure 21-1	VASI Landing Light.	728
Figure 21-2	Attenuation Shape	731
Figure 21-3	Attenuation of Light	732
Figure 21-4	Lit Multisamples	739
Figure 21-5	Calligraphic Hardware Configuration	747

Figure 23-1	Stage Timing Statistics Display792
Figure 23-2	Conceptual Diagram of a Draw-Stage Timing Line794
Figure 23-3	Other Statistics Classes.798
Figure 24-1	The evanalyzer Main Display839
Figure 24-2	User Event myDrawCB844
Figure 24-3	Up-Close View of a Single Event848
Figure 24-4	evhist Sample Screen849
Figure 24-5	evgraph Sample Screen850

Tables

Table 1-1	Routines that Modify <code>libpr</code> Object Reference Counts	12
Table 2-1	Attributes in the Share Mask of a Channel Group	41
Table 3-1	OpenGL Performer Node Types	51
Table 3-2	<code>pfGroup</code> Functions	54
Table 3-3	<code>pfDCS</code> Transformations	63
Table 3-4	<code>pfFCS</code> Functions	63
Table 3-5	<code>pfSequence</code> Functions	67
Table 3-6	<code>pfLOD</code> Functions	70
Table 3-7	<code>pfLayer</code> Functions	71
Table 3-8	<code>pfGeode</code> Functions	72
Table 3-9	<code>pfText</code> Functions	73
Table 3-10	<code>pfBillboard</code> Functions	75
Table 3-11	<code>pfPartition</code> Functions	79
Table 4-1	Traversal Attributes for the Major Traversals	86
Table 4-2	Test Instructions	106
Table 4-3	Assign Instructions	106
Table 4-4	Jump Instructions	107
Table 4-5	Functions Available for User-Defined Cull Program Instructions	109
Table 4-6	Cull Callback Return Values	113
Table 4-7	Intersection-Query Token Names	121
Table 4-8	Database Classes and Corresponding Node Masks	123
Table 4-9	Representing Traversal Mask Values	124
Table 4-10	Possible Traversal Results	125
Table 5-1	Frame Control Functions	131
Table 5-2	LOD Transition Zones	145
Table 5-3	Multiprocessing Models	156
Table 5-4	Trigger Routines and Associated Processes	168

Table 6-1	pfEarthSky Functions	184
Table 6-2	pfEarthSky Attributes	184
Table 6-3	pfVolFog Functions	188
Table 6-4	pfVolFog Attributes	189
Table 6-5	pfVolFog Flags	190
Table 6-6	pfShadow Functions	200
Table 6-7	pfShadow Attributes	201
Table 6-8	Key Command-Line Options of makeProxyImages	215
Table 7-1	Database-Importer Source Directories	221
Table 7-2	libpfd Database Converter Functions	223
Table 7-3	Loader Name Composition	225
Table 7-4	libpfd Database Converter Management Functions	226
Table 7-5	pfdBuilder Modes and Attributes	239
Table 7-6	Supported Database Formats	242
Table 7-7	Geometric Definitions in LSA Files	259
Table 7-8	RPC Converter Values	273
Table 7-9	RPC Converter Attributes	275
Table 7-10	Object Tokens in the SGO Format	278
Table 7-11	Mesh Control Tokens in the SGO Format	279
Table 7-12	OpenGL Performer Pseudo Loaders	289
Table 7-13	Default Path for the Maya Export Plug-in	291
Table 7-14	Maya Export Options	294
Table 7-15	Maya Features Supported by the Exporter	297
Table 7-16	Maya Exporter Support for UV Mapping Methods	301
Table 7-17	Maya Exporter Support for Material Properties	302
Table 7-18	Maya Exporter Support for Texture Properties	303
Table 8-1	pfGeoSet Routines	306
Table 8-2	Geometry Primitives	307
Table 8-3	pfGeoSet PACKED_ATTR Formats	310
Table 8-4	Attribute Bindings	314
Table 8-5	Information Obtained from a pfHit	334
Table 8-6	pfFont Routines	341
Table 8-7	pfString Routines	344

Table 10-1	Topology Building Methods439
Table 10-2	Adding Topology and Tessellations to .iv and .csb Files440
Table 10-3	Reading and Writing .pfb Files: with and without Tessellations	.441
Table 12-1	pfGeoState Mode Tokens459
Table 12-2	pfTransparency Tokens461
Table 12-3	pfGeoState Value Tokens464
Table 12-4	Enable and Disable Tokens465
Table 12-5	Rendering Attribute Tokens466
Table 12-6	Texture Image Sources468
Table 12-7	Texture Load Modes472
Table 12-8	Texture Generation Modes477
Table 12-9	pfFog Tokens481
Table 12-10	pfHlightMode() Tokens482
Table 12-11	Matrix Manipulation Routines483
Table 12-12	pfSprite Rotation Modes485
Table 12-13	pfGeoState Routines491
Table 14-1	pfPipeWindow Functions That Do Not Propagate511
Table 14-2	Functions for Managing Compositors518
Table 14-3	Load Balancing Functions522
Table 15-1	Tiling Algorithms546
Table 15-2	Image Cache Configuration File Fields558
Table 15-3	Image Tile Filename Tokens562
Table 15-4	Cliptexture Configuration File Fields565
Table 15-5	Parameter Tokens568
Table 15-6	Image Tile Filename Tokens570
Table 16-1	pfWinType() Tokens611
Table 16-2	pfWinFBConfigAttrs() Tokens614
Table 16-3	Window System Types616
Table 16-4	pfWinMode() Tokens618
Table 17-1	pfPWinType Tokens628
Table 17-2	Processes From Which to Call Main pfPipeWindow Functions .	.633
Table 18-1	Thread Information646
Table 18-2	Default Input and Output Ranges649

Table 18-3	pfVclock Routines	651
Table 18-4	Memory Allocation Routines	652
Table 18-5	pfNotify Routines	659
Table 18-6	Error Notification Levels	659
Table 18-7	pfFilePath Routines	660
Table 19-1	pfEngine Types	678
Table 20-1	Fields in the Triangle Data Structure	705
Table 21-1	Raster Versus Calligraphic Displays	744
Table 22-1	Routines for 3-Vectors	768
Table 22-2	Routines for 4x4 Matrices	769
Table 22-3	Routines for Quaternions	774
Table 22-4	Matrix Stack Routines	775
Table 22-5	Routines to Create Bounding Volumes	778
Table 22-6	Routines to Extend Bounding Volumes	779
Table 22-7	Routines to Transform Bounding Volumes	779
Table 22-8	Testing Points for Inclusion in a Bounding Volume.	780
Table 22-9	Testing Volume Intersections	781
Table 22-10	Intersection Results	781
Table 22-11	Available Intersection Tests	785
Table 22-12	Discriminator Return Values	786
Table 26-1	Corresponding Routines in the C and C++ API	874
Table 26-2	Header Files for libpf Scene Graph Node Classes.	875
Table 26-3	Header Files for Other libpf Classes	876
Table 26-4	Header Files for libpr Graphics Classes	877
Table 26-5	Header Files for Other libpr Classes	878
Table 26-6	Data and Functions Provided by User Subclasses	884

Examples

Example 1-1	How to Use User Data	11
Example 1-2	Objects and Reference Counts	12
Example 1-3	Using <code>pfDelete()</code> with <code>libpr</code> Objects	13
Example 1-4	Using <code>pfDelete()</code> with <code>libpf</code> Objects	13
Example 1-5	Using <code>pfCopy()</code>	15
Example 1-6	General-Purpose Scene Graph Traverser	17
Example 2-1	<code>pfPipes</code> in Action	25
Example 2-2	Using <code>pfChannels</code>	32
Example 2-3	Multiple Channels, One Channel per Pipe	39
Example 2-4	Channel Sharing	42
Example 3-1	Making a Scene	53
Example 3-2	Hierarchy Construction Using Group Nodes	55
Example 3-3	Creating Cloned Instances.	59
Example 3-4	Automatically Updating a Bounding Volume	59
Example 3-5	Using <code>pfSwitch</code> and <code>pfSequence</code> Nodes	68
Example 3-6	Marking a Runway with a <code>pfLayer</code> Node	71
Example 3-7	Adding <code>pfGeoSets</code> to a <code>pfGeode</code>	72
Example 3-8	Adding <code>pfStrings</code> to a <code>pfText</code>	73
Example 3-9	Setting Up a <code>pfBillboard</code>	76
Example 3-10	Setting Up a <code>pfPartition</code>	79
Example 3-11	Inheritance Demonstration Program.	80
Example 4-1	Application Callback to Make a Pendulum	89
Example 4-2	<code>pfNode</code> Draw Callbacks	114
Example 4-3	Cull-Process Callbacks.	116
Example 4-4	Using Passthrough Data to Communicate with Callback Routines	119
Example 5-1	Frame Control Excerpt.	135
Example 5-2	Setting LOD Ranges	143

Example 5-3	Default Stress Function	154
Example 6-1	How to Configure a pfEarthSky	182
Example 6-2	Fog initialization Using pfVolFogAddPoint()	187
Example 6-3	Specifying Patchy Fog Boundaries Using pfVolFogAddNode()	187
Example 8-1	Loading Characters into a pfFont	342
Example 8-2	Setting Up and Drawing a pfString	343
Example 12-1	Using pfDecal() to a Draw Road with Stripes	463
Example 12-2	Pushing and Popping Graphics State	487
Example 12-3	Using pfOverride()	488
Example 12-4	Inheriting State	490
Example 14-1	Configuring a System with Three Hyperpipe Groups	505
Example 14-2	Mapping Hyperpipes to Graphic Pipes	506
Example 14-3	More Complete Example: Mapping Hyperpipes to Graphic Pipes	506
Example 14-4	Set FBConfigAttrs for Each pfPipeWindow	512
Example 14-5	Search the pfPipeWindow List of the pfPipe.	513
Example 15-1	Estimating System Memory Requirements	598
Example 16-1	Opening a pfWindow	610
Example 16-2	Using the Default Overlay Window	621
Example 16-3	Creating a Custom Overlay Window	622
Example 16-4	pfWindows and X Input	623
Example 17-1	Creating a pfPipeWindow	626
Example 17-2	pfPipeWindow With Alternate Configuration Windows for Statistics	630
Example 17-3	Custom Initialization of pfPipeWindow State	632
Example 17-4	Configuration of a pfPipeWindow Framebuffer.	635
Example 17-5	Opening and Closing a pfPipeWindow	636
Example 19-1	Fluxed pfGeoSet.	674
Example 19-2	Connecting Engines and Fluxes	688
Example 20-1	Aligning Light Points Above a pfASD Surface	720
Example 21-1	Raster Callback Skeleton	737
Example 21-2	Preprocessing a Display List - Light Point Process code	742
Example 21-3	Setting pfCalligraphic Parameters.	755
Example 21-4	Calligraphic Lights	759

Example 22-1	Matrix and Vector Math Examples772
Example 22-2	Quaternion Example774
Example 22-3	Quick Sphere Culling Against a Set of Half-Spaces782
Example 22-4	Intersecting a Segment With a Convex Polyhedron783
Example 22-5	Intersection Routines in Action786
Example 26-1	Valid Creation of Objects in C++880
Example 26-2	Invalid Creation of Objects in C++880
Example 26-3	Class Definition for a Subclass of pfDCS884
Example 26-4	Overloading the libpf Application Traversal885
Example 26-5	Changeable Static Data Member888

About This Guide

Welcome to the OpenGL Performer application development environment. OpenGL Performer provides a programming interface (with ANSI C and C++ bindings) for creating real-time graphics applications and offers high-performance, multiprocessed rendering in an easy-to-use 3D graphics toolkit. OpenGL Performer interfaces with the OpenGL graphics library; this library combined with the IRIX, Linux, or Microsoft Windows (Windows 2000, Windows NT, and Windows XP) operating system forms the foundation of a powerful suite of tools and features for creating real-time 3D graphics applications.

Why Use OpenGL Performer?

Use OpenGL Performer for building visual simulation applications and virtual reality environments; for rapid rendering in on-air broadcast and virtual-set applications; for assembly viewing in large, simulation-based design tasks; or to maximize the graphics performance of any application. Applications that require real-time visuals, free-running or fixed-frame-rate display, or high-performance rendering will benefit from using OpenGL Performer.

OpenGL Performer drastically reduces the work required to tune your application's performance. General optimizations include the use of highly tuned routines for all performance-critical operations and the reorganization of graphics data and operations for faster rendering. OpenGL Performer also handles SGI architecture-specific tuning issues for you by selecting the best rendering and multiprocessing modes at run time, based on the system configuration.

OpenGL Performer is an integral part of SGI visual simulation systems. It provides the interface to advanced features available exclusively with the SGI product line, such as the Silicon Graphics Onyx4 UltimateVision, InfiniteReality, Silicon Graphics Octane, Silicon Graphics O2, and VPro graphics subsystems. OpenGL Performer teamed with SGI graphics hardware provide a sophisticated image generation system in a powerful, flexible, and extensible software environment. OpenGL Performer is also tuned to

operate efficiently on a variety of graphics platforms; you do not need the hardware sophistication of InfiniteReality graphics to benefit from OpenGL Performer.

What You Should Know Before Reading This Guide

To use OpenGL Performer, you should be comfortable programming in ANSI C or C++. You should also have a fairly good grasp of graphics programming concepts. Terms such as “texture map” and “homogeneous coordinate” are not explained in this guide. It helps if you are familiar with the OpenGL library.

On the other hand, though you need to know a little about graphics, you do not have to be a seasoned C (or C++) programmer, a graphics hardware guru, or a graphics-library virtuoso to use OpenGL Performer. OpenGL Performer puts the engineering expertise behind SGI hardware and software at your fingertips, so you can minimize your application development time while maximizing the application’s performance and visual impact.

For a concise description of OpenGL Performer basics, see the *OpenGL Performer Getting Started Guide*.

How to Use This Guide

The best way to get started is to read the *OpenGL Performer Getting Started Guide*. If you like learning from sample code, turn to Chapter 1, “Getting Acquainted with OpenGL Performer,” which takes you on a tour of some demo programs. These programs let you see for yourself what OpenGL Performer does. Even if you are not developing a visual simulation application, you might want to look at the demos to see high-performance rendering in action. At the end of Chapter 2 in that guide, you will find suggestions pointing to possible next steps; alternatively, you can browse through the summary below to find a topic of interest.

What This Guide Contains

This guide is divided into the following chapters and appendixes:

- Chapter 1, “OpenGL Performer Programming Interface,” describes the fundamental ideas behind the OpenGL Performer programming interface.

- Chapter 2, “Setting Up the Display Environment,” describes how to set up rendering pipelines, windows, and channels (cameras).
- Chapter 3, “Nodes and Node Types,” describes the data structures used in OpenGL Performer’s memory-based, scene-definition databases.
- Chapter 4, “Database Traversal,” explains how to manipulate and examine a scene graph.
- Chapter 5, “Frame and Load Control,” explains how to control frame rate, synchronization, and dynamic load management. This chapter also discusses the load management techniques of multiprocessing and level-of-detail.
- Chapter 6, “Creating Visual Effects,” describes how to use environmental, atmospheric, lighting, and other visual effects to enhance the realism of your application.
- Chapter 7, “Importing Databases,” describes database formats and sample conversion utilities.
- Chapter 8, “Geometry,” discusses the classes used to create geometry in OpenGL Performer scenes.
- Chapter 9, “Higher-Order Geometric Primitives” describes higher-order primitives, including classes to define discrete curves and surfaces.
- Chapter 10, “Creating and Maintaining Surface Topology” describes the connectivity of parametric surfaces—that is, their topology.
- Chapter 11, “Rendering Higher-Order Primitives: Tessellators” describes how to control the tessellation of shapes.
- Chapter 12, “Graphics State,” describes the graphics state, which contains all of the fields that together define the appearance of geometry.
- Chapter 13, “Shaders,” describes the shader, a mechanism that allows complex rendering equations to be applied to OpenGL Performer objects.
- Chapter 14, “Using Scalable Graphics Hardware,” describes how to use OpenGL Performer in conjunction with an SGI Video Digital Multiplexer (DPLEX), an SGI Scalable Graphics Compositor, and graphics processing units (GPUs).
- Chapter 15, “ClipTextures,” describes how to work with large, high-resolution textures.
- Chapter 16, “Windows,” describes how to create, configure, manipulate, and communicate with a window in OpenGL Performer.

- Chapter 17, “pfPipeWindows and pfPipeVideoChannels,” describes the unified window and video channel control and management provided by pfPipeWindows and pfPipeVideoChannels.
- Chapter 18, “Managing Nongraphic System Tasks,” describes clocks, memory allocation, synchronous I/O, error handling and notification, and search paths.
- Chapter 19, “Dynamic Data,” describes how to connect pfFlux, pfFCS, and pfEngine nodes, which together can be used for animating geometries.
- Chapter 20, “Active Surface Definition,” describes the Active Surface Definition (ASD): a library that handles real-time surface meshing and morphing.
- Chapter 21, “Light Points,” describes the calligraphic lights, which are intensely bright lights.
- Chapter 22, “Math Routines,” details the comprehensive math support provided as part of OpenGL Performer.
- Chapter 23, “Statistics,” discusses the various kinds of statistics you can collect and display about the performance of your application.
- Chapter 24, “Performance Tuning and Debugging,” explains how to use performance measurement and debugging tools and provides hints for getting maximum performance.
- Chapter 25, “Building a Visual Simulation Application Using libpfv” describes a modular approach to building an application using a graphical viewer.
- Chapter 26, “Programming with C++,” discusses the differences between using the C and C++ programming interfaces.

Sample Applications

You can find the sample code for all of the sample OpenGL Performer applications installed under `/usr/share/Performer/src/pguide` on IRIX and Linux and under `%PFROOT%\Src\pguide` on Microsoft Windows.

Conventions

This guide uses the following typographical conventions:

- Bold** Used for function names, with parentheses appended to the name and also for the names of window menus and buttons. Also, bold lowercase letters represent vectors, and bold uppercase letters denote matrices.
- Italics* Indicates variables, book titles, and glossary items.
- `Fixed-width` Used for filenames, operating system command names, command-line option flags, code examples, and system output.
- Bold Fixed-width** Indicates user input, such as items that you type in from the keyboard.

Note that in some cases it is convenient to refer to a group of similarly named OpenGL Performer functions by a single name; in such cases an asterisk is used to indicate all the functions whose names start the same way. For instance, **pfNew*()** refers to all functions whose names begin with “pfNew”: **pfNewChan()**, **pfNewDCS()**, **pfNewESky()**, **pfNewGeode()**, and so on.

Internet and Hardcopy Reading for the OpenGL Performer Series

The OpenGL Performer series include the following manuals in printed and online formats:

- *OpenGL Performer Programmer’s Guide* (this book)
- *OpenGL Performer Getting Started Guide*

To read these online books, point your browser at the following:

- <http://docs.sgi.com>

For general information about OpenGL Performer, use the following URL:

- <http://www.sgi.com/software/performer>

The `info-performer` mailing list provides a forum for discussion of OpenGL Performer including technical and nontechnical issues. Subscription requests should be sent to `info-performer-request@sgi.com`. Much like the `comp.sys.sgi.*` newsgroups on the Internet, it is not an official support channel but is monitored by

several interested SGI employees familiar with the toolkit. The OpenGL Performer mailing list archives are at the following URL:

- <http://oss.sgi.com/projects/performer/mail/info-performer/>

Reader Comments

If you have comments about the technical accuracy, content, or organization of this document, please tell us. Be sure to include the title and document number of the manual with your comments. (Online, the document number is located in the front matter of the manual. In printed manuals, the document number can be found on the back cover.)

You can contact us in any of the following ways:

- Send e-mail to the following address:
`techpubs@sgi.com`
- Use the Feedback option on the Technical Publications Library World Wide Web page:
`http://docs.sgi.com`
- Contact your customer service representative and ask that an incident be filed in the SGI incident tracking system.
- Send mail to the following address:
Technical Publications
SGI
1600 Amphitheatre Pkwy., M/S 535
Mountain View, California 94043-1351

We value your comments and will respond to them promptly.

OpenGL Performer Programming Interface

This chapter describes the fundamental ideas behind the OpenGL Performer programming interface in the following sections:

- “General Naming Conventions” on page 1
- “Class API” on page 3
- “Base Classes” on page 6.

General Naming Conventions

The OpenGL Performer application programming interface (API) uses naming conventions to help you understand what a given command will do and even predict the appropriate names of routines for desired functionality. Following similar naming practices in the software that you develop will make it easier for you and others on your team to understand and debug your code.

The API is largely object-oriented; it contains classes of objects comprised of methods that do the following:

- Configure their parent objects.
- Apply associated operations, based on the current configuration of the object.

Both C and C++ bindings are provided for OpenGL Performer. In addition, naming conventions provide a consistent and predictable API and indicate the kind of operations performed by a given command.

Prefixes

The prefix of the command tells you in which library a C command or C++ class is found. All exposed OpenGL Performer base library C commands and C++ classes begin with ‘pf’. The utility libraries use an additional prefix letter, such as ‘pfu’ for the `libpfutil`

general utility library, 'pfi' for the libpfiui input handling library, and 'pfd' for the libpfd database utility library. libpr-level commands still have the 'pf' prefix as they are still in the main libpf library

Header Files

Each OpenGL Performer library contains a main header file in /usr/include/Performer on IRIX and Linux and in %PFROOT%\Include on Microsoft Windows that contains type and class definitions, the C API for that library, and global routines that are part of the C and C++ API. libpf is broken into two distinct pieces: the low-level rendering layer, libpr, and the application layer, libpf, and each has its own main header file: pr.h and pf.h. Since libpf is considered to include libpr, pf.h includes pr.h. C++ class header files are found under the following directories:

```
/usr/include/Performer/{pf, pr, ...} (IRIX and Linux)
%PFROOT%\Include\{pf, pr, ...} (Microsoft Windows)
```

Each class has its own C++ header file and that header must be included to use that class.

```
#include <Performer/pf.h>
#include <Performer/pf/pfGroup.h>
.....
pfGroup *group;
```

Naming in C and C++

All C++ class method names have an expanded C counterpart. Typically, the C routine (function) will include the class name in the routine, whereas the C++ method will not.

```
C: pfGetPipeScreen();
C++: pipe->getScreen();
```

For some very general routines on the most abstract classes, the class name is omitted. This is the case with the child API on pfNodes:

```
C: pfAddChild(node, child);
C++: node->addChild(child);
```

Command and type names are mixed case where the first letter of a new word in a name is capitalized. C++ method names always start with a lower case letter.

```
pfTexture *texture;  
texture->loadFile();
```

Abbreviations

Type names do not use abbreviations. The C API acting on that type will often use abbreviations for the type names, as will the associated tokens and enums.

In procedure names, a name will always be abbreviated or never, and the same abbreviation will always be used and will be in the `pfNew*` C command. For example: the `pfTexture` object uses 'Tex' in its API, such as **pfNewTex()**. If a type name has multiple words, the abbreviation will use the first letter of the first words and then the first syllable of the last word.

```
pfPipeWindow *pwin = pfNewPWin();  
pfPipeVideoChannel *pvchan = pfNewPVChan();  
pfTexLOD *tlod = pfNewTLOD();
```

Macros, Tokens, and Enums

Macros, tokens, and enums all use full upper-case. Token names associated with a class and methods of a class start with the abbreviated name for that class, such as `texture` to "tex" in `PFTEX_SHARPEN`.

Class API

The API of a given class, such as `pfTexture`, is comprised of the following:

- API to create an instance of the object
- API to set parameters on the object
- API to get those parameter settings
- API to perform actions on the configured object

Object Creation

Objects are always created with the following:

```
C: pfThing *thing = pfNewThing();  
C++: pfThing *thing = new pfThing;
```

libpf objects are automatically created out of the shared memory arena. libpr objects take as an argument an arena pointer which, if NULL, will cause allocation off the heap.

Set Routines

A set routine has the following form:

```
C: pfThingParam(thing, ... )  
C++: thing->setParam()
```

Note that there is no 'Set' in the name in the C version.

Set routines are usually very fast and are not order dependent. Work required to process the settings happens once when the object is first used after settings have changed. If particularly expensive options must be done, there will be a pfConfigThing routine or method to explicitly force this work that must be called before the object is to be used.

Get Routines

For every 'set' routine there is a matching 'get' routine to get back the value that was set.

```
C: pfGetThingParam(thing, ... )  
C++: thing->getParam()
```

If the set/get is for a single value, that value is usually the return value of the routine. If there are multiple values together, the 'get' routine will then take as arguments pointers to result variables.

Getting Current In-Use Values

Get routines return values that have been previously set by the user, or default values if no settings have been made. Sometimes a value other than the user-specified value is currently in use and that is the value that you would like to get. For these cases, there is a separate 'GetCur' routine to get the current in-use value.

```
C:   pfGetCurThingParam()
C++: thing->getcurParam()
```

These 'cur' routines may only be able to give reasonable values in the process which associated operations are happening. For example, to get the current texture (**pfGetCurTex()**), you need to be in the draw process since that is the only process that has a current texture.

Action Routines

An action routine has the following form:

```
C: pfVerbThing(), such as pfApplyTex()
C++: thing->verb(), such as tex->apply()
```

Action routines can have parameter scope and apply only to that parameter. These routines have the following form

```
C: pfVerbThingParam(), such as pfApplyTexMinLOD()
C++: thing->verbParam(), such as tex->applyMinLOD()
```

Apply and Draw Routines

The Apply and Draw action routines do graphics operations and must happen either in the draw process or in display list mode.

```
C: pfApplypfGState()
   pfDrawGSet()
C++: gstate->apply()
     gset->draw()
```

Enable and Disable of Modes

Features that can be enabled and disabled are done so with **pfEnable()** and **pfDisable()**, respectively.

pfGetEnable() takes PFEN_* tokens naming the graphics state operation to enable or disable. A **GetEnable()** is used to query enable status and will return 1 or 0 if the given mode is enabled or disabled, respectively.

```
ex: pfEnable(PFEN_TEXTURE), pfDisable(PFEN_TEXTURE),
     pfGetEnable(PFEN_TEXTURE);
```

Mode, Attribute, or Value

Classes instances are configured by having their internal fields set. These fields may be simple modes or complex attribute structures. Mode values are ints or tokens, attributes are typically pointers to objects, and values are floats.

```
pfGStateMode(gstate, PFSTATE_DECAL, PFDECAL_LAYER)
pfGStateAttr(gstate, PFSTATE_TEXTURE, texPtr)
pfGStateVal(gstate, PFSTATE_ALPHAREF, 0.5)
```

Base Classes

OpenGL Performer provides an object-oriented programming interface to most of its data structures. Only OpenGL Performer functions can change the values of elements of these data structures; for instance, you must call **pfMtlColor()** to set the color of a **pfMaterial** structure rather than modifying the structure directly.

For a more transparent type of memory, OpenGL Performer provides **pfMemory**. All object classes are derived from **pfMemory**. **pfMemory** instances must be explicitly allocated with the **new** operator and cannot be allocated statically, on the stack, or included directly in other object definitions. **pfMemory** is managed memory; it includes special fields, such as size, arena, and ref count, that are initialized by the **pfMemory new()** function.

Some very simple and unmanaged data types are not encapsulated for speed and easy access. Examples include **pfMatrix**, **pfSphere** and **pfVec3**. These data types are referred to as public structures and are inherited from **pfStruct**.

Unlike **pfMemory**, **pfStructs** can be handled as follows:

- Allocated statically
- Allocated on the stack
- Included directly in other structure and object definitions

pfStructs allocated off the stack or allocated statically are not in the shared memory arena and thus are not safe for multiprocessed use. Also, **pfStructs** allocated off the stack in a procedure do not exist after the procedure exits so they should not be given to persistent objects, such as a **pfVec3** array of vertices for a **pfGeoSet**.

In order to allow some functions to apply to multiple data types, OpenGL Performer uses the concept of class inheritance. Class inheritance takes advantage of the fact that different data types (classes) often share attributes. For example, a `pfGroup` is a node that can have children. A `pfDCS` (Dynamic Coordinate System) has the same basic structure as a `pfGroup`, but also defines a transformation to apply to its children—in other words, the `pfDCS` data type inherits the attributes of the `pfGroup` and adds new attributes of its own. This means that all functions that accept a `pfGroup*` argument will alternatively accept a `pfDCS*` argument.

For example, `pfAddChild()` takes a `pfGroup*` argument, but appends *child* to the list of children belonging to *dcs*:

```
pfDCS *dcs = pfNewDCS();
pfAddChild(dcs, child);
```

Because the C language does not directly express the notion of classes and inheritance, arguments to functions must be cast before being passed, as shown in this example:

```
pfAddChild((pfGroup*)dcs, (pfNode*)child);
```

In the example above, no such casting is required because OpenGL Performer provides macros that perform the casting when compiling with ANSI C, as shown in this example:

```
#define pfAddChild(g, c) pfAddChild((pfGroup*)g, (pfNode*)c)
```

Note: Using automatic casting eliminates type checking—the macros will cast anything to the desired type. If you make a mistake and pass an unintended data type to a casting macro, the results may be unexpected.

No such trickery is required when using the C++ API. Full type checking is always available at compile time.

Inheritance Graph

The relations between classes can be arranged in a directed acyclic inheritance graph in which each child inherits all of its parent's attributes, as illustrated in Figure 1-1. OpenGL Performer does not use multiple inheritance, so each class has only one parent in the graph.

Note: It is important to remember that an inheritance graph is different from a scene graph. The inheritance graph shows the inheritance of data elements and member functions among user-defined data types; the scene graph shows the relationship among instances of nodes in a hierarchical scene definition.

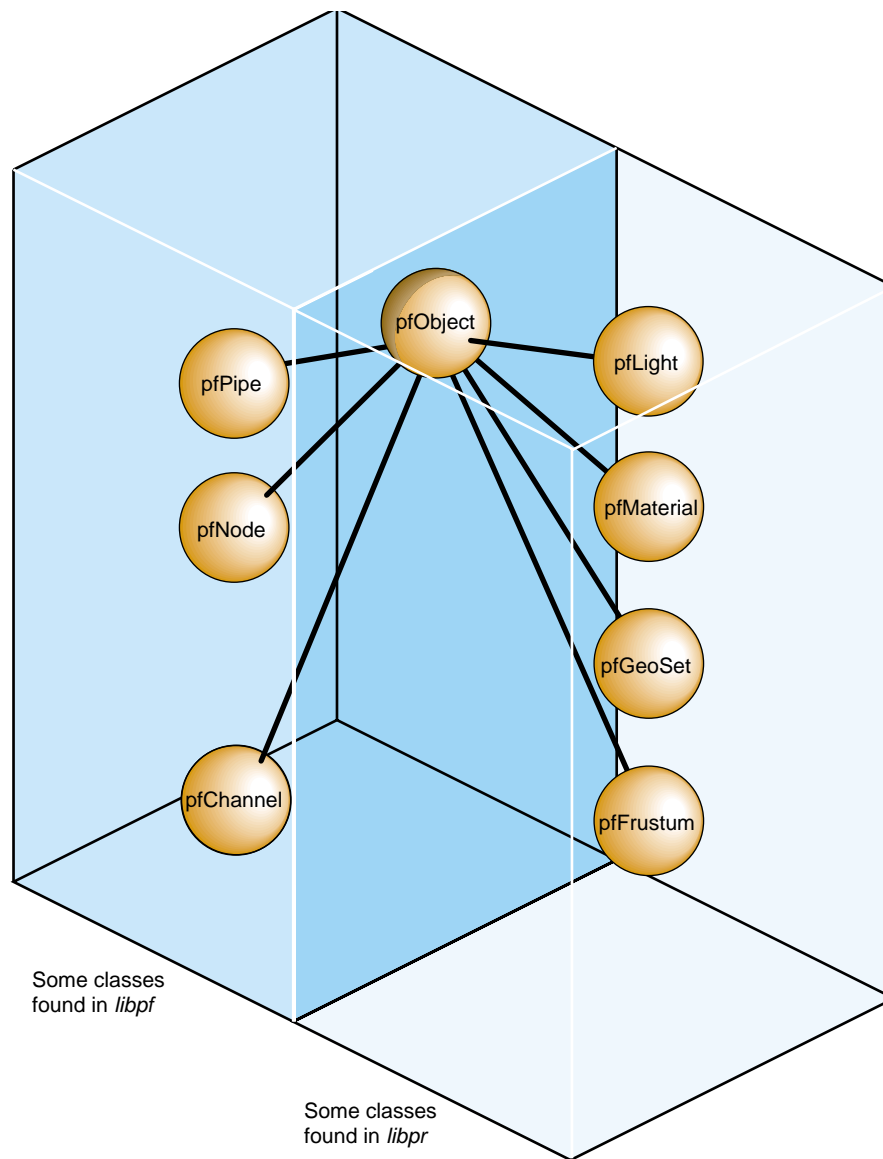

Figure 1-1 Partial Inheritance Graph of OpenGL Performer Data Types

OpenGL Performer objects are divided into two groups: those found in the `libpf` library and those found in the `libpr` library. These two groups of objects have some common attributes, but also differ in some respects.

While OpenGL Performer only uses single inheritance, some objects encapsulate others, hiding the encapsulated object but also providing a functional interface that mimics its original one. For example a `pfChannel` has a `pfFrustum`, a `pfFrameStats` has a `pfStats`, a `pfPipeWindow` has a `pfWindow`, and a `pfPipeVideoChannel` has a `pfVideoChannel`. In these cases, the first object in each pair provides functions corresponding to those of the second. For example, `pfFrustum` has a routine:

```
pfMakeSimpleFrust(frust, 45.0f);
```

`pfChannel` has a corresponding routine:

```
pfMakeSimpleChan(channel, 45.0f);
```

`libpr` and `libpf` Objects

All of the major classes in OpenGL Performer are derived from the `pfObject` class. This common, base class unifies the data types by providing common attributes and functions. `libpf` objects are further derived from `pfUpdatable`. The `pfUpdatable` abstract class provides support for automatic multibuffering for multiprocessing. `pfObjects` have no special support for multiprocessing and so all processes share the same copy of the `pfObject` in the shared arena. `libpr` objects allocated from the heap are only visible in the process in which they are created or in child processes created after the object. Changes made to such an object in one process are not visible in any other process.

Explicit multibuffering of `pfObjects` is available through the `pfFlux` class. In general, `libpr` provides lightweight and low-level modular pieces of functionality that are then enhanced by more powerful `libpf` objects.

User Data

The primary attribute defined by the `pfObject` class is the custom data a user gets to define on any `pfObject` called "user data." `pfUserDataSlot` attaches the user-supplied data pointer to user data. `pfUserData` attaches the user-supplied data pointer to user data slot. Example 1-1 shows how to use user data.

Example 1-1 How to Use User Data

```

typedef struct
{
    float coeffFriction;
    float density;
    float *dataPoints;
}
myMaterial;

myMaterial    *granite;

granite = (myMaterial *)pfMalloc(sizeof(myMaterial), NULL);
granite->coeffFriction = 0.5f;
granite->density = 3.0f;
granite->dataPoints = (float *)pfMalloc(sizeof(float)*8, NULL);
graniteMtl = pfNewMtl(NULL);

pfUserData(graniteMtl, granite);

```

pfDelete() and Reference Counting

Most kinds of data objects in OpenGL Performer can be placed in a hierarchical scene graph, using instancing when an object is referenced multiple times. Scene graphs can become quite complex, which can cause problems if you are not careful. Deleting objects can be a particularly dangerous operation, for example, if you delete an object that another object still references.

Reference counting provides a bookkeeping mechanism that makes object deletion safe: an object is never deleted if its reference count is greater than zero.

All `libpr` objects (such as `pfGeoState` and `pfMaterial`) have a reference count that specifies how many other objects refer to it. A reference is made whenever an object is attached to another using the OpenGL Performer routines shown in Table 1-1.

Table 1-1 Routines that Modify libpr Object Reference Counts

Routine	Action
pfGSetGState()	Attaches a pfGeoState to a pfGeoSet.
pfGStateAttr()	Attaches a state structure (such as a pfMaterial) to a pfGeoState.
pfGSetHlight()	Attaches a pfHighlight to a pfGeoSet.
pfTexDetail()	Attaches a detail pfTexture to a base pfTexture.
pfGSetAttr()	Attaches attribute and index arrays to a pfGeoSet.
pfTexImage()	Attaches an image array to a pfTexture.
pfAddGSet(), pfReplaceGSet(), pfInsertGSet()	Modify pfGeoSet/pfGeode association.

When object A is attached to object B, the reference count of A is incremented. Additionally, if A replaces a previously referenced object C, then the reference count of C is decremented. Example 1-2 demonstrates how reference counts are incremented and decremented.

Example 1-2 Objects and Reference Counts

```
pfGeoState *gstateA, *gstateC;
pfGeoSet *gsetB;

/* Attach gstateC to gsetB. Reference count of gstateC
 * is incremented. */
pfGSetGState(gsetB, gstateC);

/* Attach gstateA to gsetB, replacing gstateC. Reference
 * count of gstateC is decremented and that of gstateA
 * is incremented. */
pfGSetGState(gsetB, gstateA);
```

This automatic reference counting done by OpenGL Performer routines is usually all you will ever need. However, the routines **pfRef()**, **pfUnref()**, and **pfGetRef()** allow you to increment, decrement, and retrieve the reference count of a libpr object should you wish to do so. These routines also work with objects allocated by **pfMalloc()**.

An object whose reference count is equal to 0 can be deleted with **pfDelete()**. **pfDelete()** works for all `libpr` objects and all `pfNodes` but not for other `libpf` objects like `pfPipe` and `pfChannel`. **pfDelete()** first checks the reference count of an object. If the reference count is nonpositive, **pfDelete()** decrements the reference count of all objects that the current object references, then it deletes the current object. **pfDelete()** does not stop here but continues down all reference chains, deleting objects until it finds one whose count is greater than zero. Once all reference chains have been explored, `pfDelete` returns a boolean indicating whether it successfully deleted the first object or not. Example 1-3 illustrates the use of **pfDelete()** with `libpr`.

Example 1-3 Using **pfDelete()** with `libpr` Objects

```

pfGeoState *gstate0, *gstate1;
pfMaterial *mtl;
pfGeoSet *gset;

gstate0 = pfNewGState(arena); /* initial ref count is 0 */
gset = pfNewGSet(arena); /* initial ref count is 0 */
mtl = pfNewMtl(arena); /* initial ref count is 0 */

/* Attach mtl to gstate0. Reference count of mtl is
 * incremented. */
pfGStateAttr(gstate0, PFSTATE_FRONTMTL, mtl);

/* Attach mtl to gstate1. Reference count of mtl is
 * incremented. */
pfGStateAttr(gstate1, PFSTATE_FRONTMTL, mtl);

/* Attach gstate0 to gset. Reference count of gstate0 is
 * incremented. */
pfGSetGState(gset, gstate0);

/* This deletes gset, gstate0, but not mtl since gstate1 is
 * still referencing it. */
pfDelete(gset);

```

Example 1-4 illustrates the use of **pfDelete()** with `libpf`.

Example 1-4 Using **pfDelete()** with `libpf` Objects

```

pfGroup *group;
pfGeode *geode;
pfGeoSet *gset;

group = pfNewGroup(); /* initial parent count is 0 */

```

```
geode = pfNewGeode(); /* initial parent count is 0 */
gset = pfNewGSet(arena); /* initial ref count is 0 */

/* Attach geode to group. Parent count of geode is
 * incremented. */
pfAddChild(group, geode);

/* Attach gset to geode. Reference count of gset is
 * incremented. */
pfAddGSet(geode, gset);

/* This has no effect since the parent count of geode is 1.*/
pfDelete(geode);

/* This deletes group, geode, and gset */
pfDelete(group);
```

Some notes about reference counting and **pfDelete()**:

- All reference count modifications are locked so that they guarantee mutual exclusion when multiprocessing.
- Objects added to a `pfDispList` do not have their counts incremented due to performance considerations.
- In the multiprocessing environment of `libpf`, the successful deletion of a `pfNode` does not have immediate effect but is delayed one or more frames until all processes in all processing pipelines are through with the node. This accounts for the fact that `pfDispLists` do not reference-count their objects.
- **pfUnrefDelete(obj)** is shorthand for the following:

```
if(pfUnref(obj) ==0)
    pfDelete(obj);
```

This is true when `pfUnrefGetRef` is atomic.

- Objects whose count reaches zero are not automatically deleted by OpenGL Performer. You must specifically request that an object be deleted with **pfDelete()** or **pfUnrefDelete()**.

Copying Objects with pfCopy()

pfCopy() is currently implemented for `libpr` (and **pfMalloc()**) objects only. Object references are copied and reference counts are modified appropriately, as illustrated in Example 1-5.

Example 1-5 Using pfCopy()

```
pfGeoState *gstate0, *gstate1;
pfMaterial *mtlA, *mtlB;

gstate0 = pfNewGState(arena);
gstate1 = pfNewGState(arena);
mtlA = pfNewMtl(arena); /* initial ref count is 0 */
mtlB = pfNewMtl(arena); /* initial ref count is 0 */

/* Attach mtlA to gstate0. Reference count of mtlA is
 * incremented. */
pfGStateAttr(gstate0, PFSTATE_FRONTMTL, mtlA);

/* Attach mtlB to gstate1. Reference count of mtlB is
 * incremented. */
pfGStateAttr(gstate1, PFSTATE_FRONTMTL, mtlB);

/* gstate1 = gstate0. The reference counts of mtlA and mtlB
 * are 2 and 0 respectively. Note that mtlB is NOT deleted
 * even though its reference count is 0. */
pfCopy(gstate1, gstate0);
```

pfMalloc and the related routines provide a consistent method to allocate memory, either from the user's heap (using the C-library **malloc()** function) or from a shared memory arena.

Printing Objects with pfPrint()

pfPrint() can print many different kinds of objects to a file; for example, you can print nodes and geosets. To do so, you specify in the argument of the function the object to print, the level of verbosity, and the destination file. An additional argument, *which*, specifies different data according to the type of object being printed.

The different levels of verbosity include the following:

- `PFPRINT_VB_OFF`—no printing

- PFPRINT_VB_ON—minimal printing (default)
- PFPRINT_VB_NOTICE—minimal printing (default)
- PFPRINT_VB_INFO—considerable printing
- PFPRINT_VB_DEBUG—exhaustive printing

If the object to print is a type of `pfNode`, *which* specifies whether the print traversal should only traverse the current node (PFTRAV_SELF) or the entire scene graph where the node specified in the argument is the root node (PFTRAV_SELF | PFTRAV_DESCEND). For example, to print an entire scene graph, in which *scene* is the root node, to the file, *fp*, with default verbosity, use the following line of code:

```
file = fopen ("scene.out", "w");
pfPrint(scene, PFTRAV_SELF | PFTRAV_DESCEND, PFPRINT_VB_ON, fp);
fclose(file);
```

If the object to print is a `pfFrameStats`, *which* should specify a bitmask of the frame statistics classes that you want printed. The values for the bitmask include the following:

- PFSTATS_ON enables the specified classes.
- PFSTATS_OFF disables the specified classes.
- PFSTATS_DEFAULT sets the specified classes to their default values.
- PFSTATS_SET sets the class enable mask to `enmask`.

For example, to print select classes of a `pfFrameStats` structure, *stats*, to `stderr`, use the following line of code:

```
pfPrint(stats, PFSTATS_ENGFx | PFFSTATS_ENDB |
PFFSTATS_ENCULL, PFSTATS_ON, NULL);
```

If the object to print is a `pfGeoSet`, *which* is ignored and information about that `pfGeoSet` is printed according to the verbosity indicator. The output contains the types, names, and bounding volumes of the nodes and `pfGeoSets` in the hierarchy. For example, to print the contents of a `pfGeoSet`, *gset*, to `stderr`, use the following line of code:

```
pfPrint(gset, NULL, PFPRINT_VB_DEBUG, NULL);
```

Note: When the last argument, *file*, is set to `NULL`, the object is printed to `stderr`.

Determining Object Type

Sometimes you have a pointer to a `pfObject` but you do not know what it really is—is it a `pfGeoSet`, a `pfChannel`, or something else? `pfGetType()` returns a `pfType` which specifies the type of a `pfObject`. This `pfType` can be used to determine the class ancestry of the object. Another set of routines, one for each class, returns the `pfType` corresponding to that class, for example, `pfGetGroupClassType()` returns the `pfType` corresponding to `pfGroup`.

`pfIsOfType()` tells whether an object is derived from a specified type, as opposed to being the exact type.

With these functions you can test for class type as shown in Example 1-6.

Example 1-6 General-Purpose Scene Graph Traverser

```
void
travGraph(pfNode *node)
{
    if (pfIsOfType(node, pfGetDCSClassType()))
        doSomethingTransforming(node);

    /* If 'node' is derived from pfGroup then recursively
     * traverse its children */
    if (pfIsOfType(node, pfGetGroupClassType()))
        for (i = 0; i < pfGetNumChildren(node); i++)
            travGraph(pfGetChild(node, i));
}
```

Because OpenGL Performer allows subclassing of built-in types, when decisions are made based on the type of an object, it is usually better to use `pfIsOfType()` to test the type of an object rather than to test for the strict equality of the `pfTypes`. Otherwise, the code will not have reasonable default behavior with file loaders or applications that use subclassing.

The `pfType` returned from `pfGetType()` is useful for programs but it is not in a readable form for you. Calling `pfGetTypeFullName()` on a `pfType` returns a null-terminated ASCII string that identifies an object's type. For a `pfDCS`, for example, `pfGetTypeFullName()` returns the string "pfDCS." The type returned by `pfGetType()` can then be compared to a class type using `pfIsOfType()`. Class types can be returned by methods such as `pfGetGroupClassType()`.

Setting Up the Display Environment

You can use the library `libpf` or `libpfv` as your base to build your application. For the most part, this chapter (and guide) shows how to do so with `libpf`. For a more modular approach using a graphical viewer, see Chapter 25, “Building a Visual Simulation Application Using `libpfv`”.

The library `libpf` is a visual-database processing and rendering system. The visual database has at its root a `pfScene` (as described in Chapter 3 and Chapter 4). The chain of events necessary to proceed from the scene graph to the display includes the following:

1. A `pfScene` is viewed by a `pfChannel`.
2. The `pfChannel` view of the `pfScene` is rendered by a `pfPipe` into a framebuffer.
3. A `pfPipeWindow` manages the framebuffer.
4. The images in the framebuffer are transmitted to a display system that is managed by a `pfPipeVideoChannel`.

Figure 2-1 shows this chain of events.

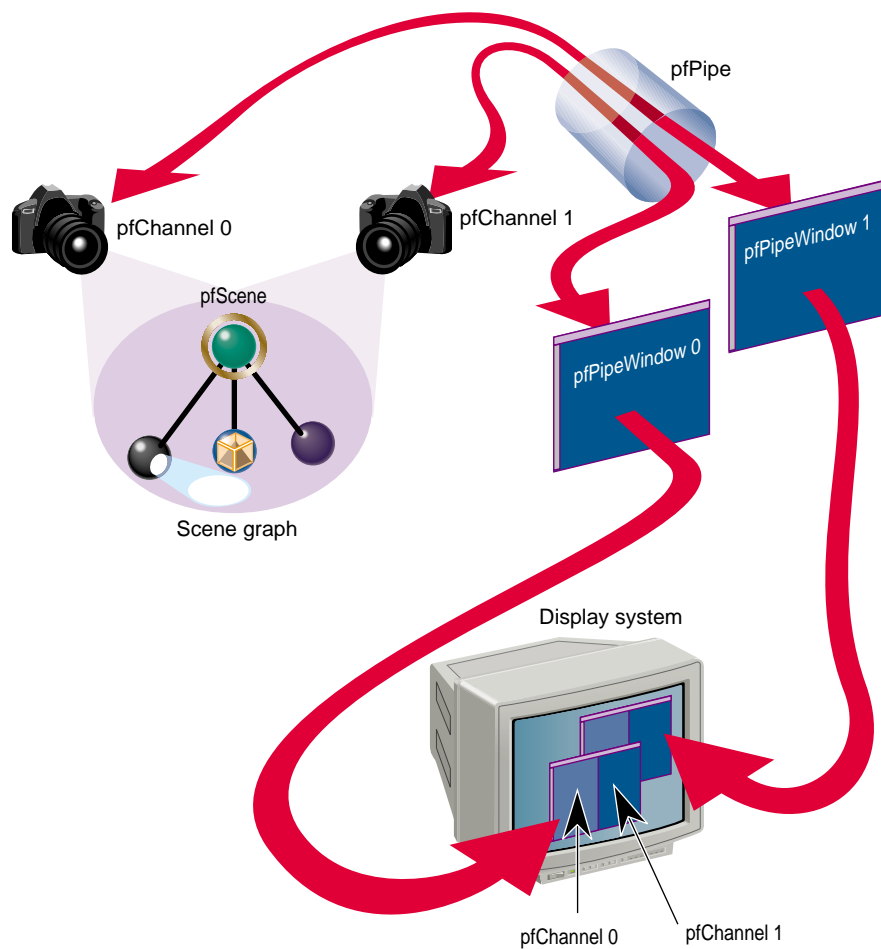

Figure 2-1 From Scene Graph to Visual Display

The following sections describe how to implement this chain of events using pfPipes, pfPipeWindows, and pfChannels directly or through the use of a configuration file:

- “Using Pipes” on page 21
- “Using Channels” on page 26
- “Controlling the Video Output” on page 34
- “Using Multiple Channels” on page 35

- “Using Channel Groups” on page 40
- “Importing OpenGL Multipipe SDK (MPK) Configuration Files” on page 44

Using Pipes

This section describes *rendering pipelines* (pfPipes) and their implementation in OpenGL Performer. Each rendering pipeline draws into one or more windows (pfPipeWindows) associated with a single geometry pipeline. A minimum of one rendering pipeline is required, although it is possible to have more than one.

The Functional Stages of a Pipeline

This rendering pipeline comprises three primary functional stages:

APP	Simulation processing, which includes reading input from control devices, simulating the vehicle dynamics of moving models, updating the visual database, and interacting with other networked simulation stations.
CULL	Traverses the visual database and determines which portions of it are potentially visible (a procedure known as <i>culling</i>), selects a level of detail (LOD) for each model, sorts objects and optimizes state management, and generates a display list of objects to be rendered.
DRAW	Traverses the display list and issues graphics library commands to a Geometry Pipeline in order to create an image for subsequent display.

Figure 2-2 shows the process flow for a single-pipe system. The application constructs and modifies the scene definition (a pfScene) associated with a channel. The traversal process associated with that channel’s pfPipe then traverses the scene graph, building an OpenGL Performer `libpr` display list. As shown in the figure, this display list is used as input to the draw process that performs the actual graphics library actions required to draw the image.

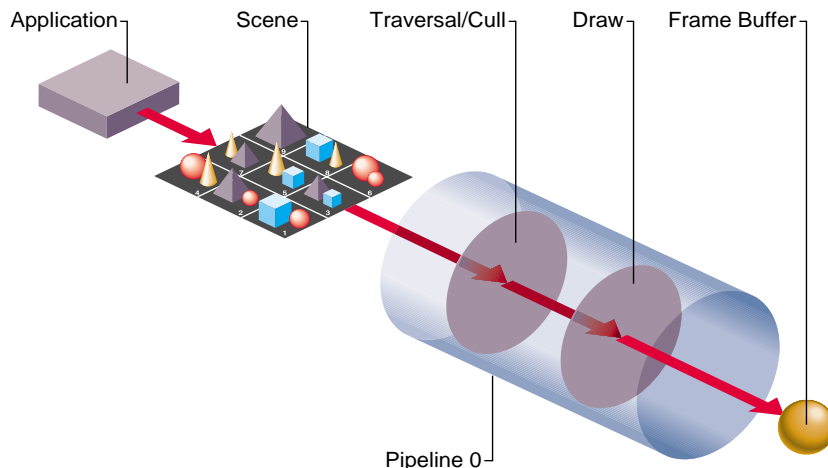

Figure 2-2 Single Graphics Pipeline

OpenGL Performer also provides additional processes for application processing tasks, such as database loading and intersection traversals, but these processes are optional and are asynchronous to the software rendering pipeline(s).

An OpenGL Performer application renders images using one or more pfPipes. Each pfPipe represents an independent software-rendering pipeline. Most IRIS systems contain only one Geometry Pipeline; so, a single pfPipe is usually appropriate. This single pipeline is often associated with a window that occupies the entire display surface.

Alternative configurations include Onyx3 systems with InfiniteReality3 graphics (allowing up to 16 Geometry Pipelines). Applications can render into multiple windows, each of which is connected to a single Geometry Pipeline through a pfPipe rendering pipeline.

Figure 2-3 shows the process flow for a dual-pipe system. Notice both the differences and similarities between these two figures. Each pipeline (pfPipe) is independent in multiple-pipe configurations; the traversal and draw tasks are separate, as are the `libpr` display lists that link them. In contrast, these pfPipes are controlled by the same application process, and in many situations access the same shared scene definition.

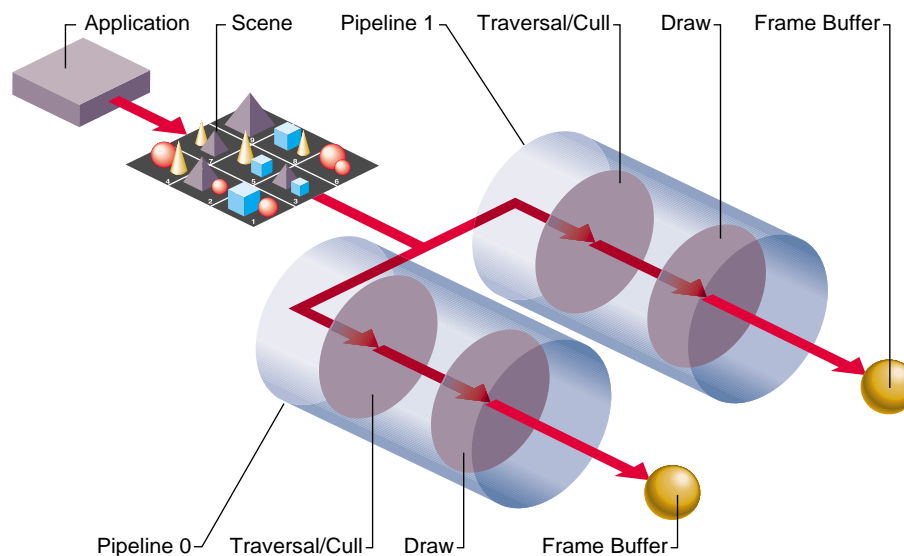

Figure 2-3 Dual Graphics Pipeline

Each of these stages can be combined into a single process or split into multiple processes (`pfMultiprocess`) for enhanced performance on multiple CPU systems. Multiprocessing and multiple pipes are advanced topics that are discussed in “Successful Multiprocessing with OpenGL Performer” in Chapter 5.

Creating and Configuring a `pfPipe`

`pfPipes` and their associated processes are created when you call `pfConfig()`. They exist for the duration of the application. After `pfConfig()`, the application can get handles to the created `pfPipes` using `pfGetPipe()`. The argument to `pfGetPipe()` indicates which `pfPipe` to return and is an integer between 0 and `numPipes-1`, inclusive. The `pfPipe` handle is then used for further configuration of the `pfPipe`.

`pfMultiPipe()` specifies the number of `pfPipes` desired; the default is one. `pfMultiprocess()` specifies the multiprocessing mode used by all `pfPipes`. These two routines are discussed further in “Successful Multiprocessing with OpenGL Performer” in Chapter 5.

A key part of pfPipe initialization is the determination of the graphics hardware pipeline (or screen) and the creation of a window on that screen. The screen of a pfPipe can be set explicitly using **pfPipeScreen()**. Under single pipe operation, pfPipes can also inherit the screen of their first opened window. Under multipipe operation, the screen of all pfPipes must be determined before the pipes are configured by **pfConfigStage()** or the first call to **pfFrame()**. There may be other operations that require preset knowledge of the screen even under single pipes, such as custom configuration of video channels, discussed in “Creating and Configuring a pfChannel” on page 26.

Once the screen of a pfPipe has been set, it cannot be changed. All windows of a given pfPipe must be opened on the same screen. A graphics window is associated with a pfPipe through the pfPipeWindow mechanism. If you do not create a pfPipeWindow, OpenGL Performer will automatically create and open a full screen window with a default configuration for your pfPipe.

Once you create and initialize a pfPipe, you can query information about its configuration parameters. **pfGetPipeScreen()** returns the index number of the hardware pipeline for the pfPipe, starting from zero. On single-pipe systems the return value will be zero. If no screen has been set, the return value will be (-1). **pfGetPipeSize()** returns the full screen size, in pixels, of the rendering area associated with a pfPipe.

You may have application states associated with pfPipe stages and processes that need special initialization. For this purpose, you may provide a stage configuration callback for each pfPipe stage using **pfStageConfigFunc(pipe, stageMask, configFunc)** and specify the pfPipe, the stage bitmask (including one or more of PFPROC_APP, PFPROC_CULL, and PFPROC_DRAW), and your stage configuration callback routine. At any time, you may call the function **pfConfigStage()** from the application process to trigger the execution of your stage configuration callback in the process associated with that pfPipe’s stage. The stage configuration callback will be invoked at the start of that stage within the current frame (the current frame in the application process, and subsequent frames through the cull and draw phases of the software rendering pipeline). Use a **pfStageConfigFunc()** callback function to configure OpenGL Performer processes not associated with pfPipes, such as the database process, PFPROC_DBASE, and the intersection process, PFPROC_ISECT. A common process initialization task for real-time applications is the selection and/or specification of a CPU on which to run.

Example of pfPipe Use

The sample source code shipped with OpenGL Performer includes several simple examples of pfPipe use in both C and C++. Specifically, look at the following examples under the C and C++ directories in `/usr/share/Performer/src/pguide/libpf` for IRIX and Linux and in `%PFROOT%\Src\pguide\libpfc` for Microsoft Windows, such as `hello.c`, `simple.c`, and `multipipe.c`.

Example 2-1 illustrates the basics of using pipes. The code in this example is adapted from OpenGL Performer sample programs.

Example 2-1 pfPipes in Action

```
main()
{
    int i;

    /* Initialize OpenGL Performer */
    pfInit();
    /* Set number of pfPipes desired -- THIS MUST BE DONE
     * BEFORE CALLING pfConfig().
     */
    pfMultipipe(NumPipes);
    /* set multiprocessing mode */
    pfMultiprocess(PFMP_DEFAULT);
    ...
    /* Configure OpenGL Performer and fork extra processes if
     * configured for multiprocessing.
     */
    pfConfig();
    ...

    /* Optional custom mapping of pipes to screens.
     * This is actually the reverse as the default.
     */
    for (i=0; i < NumPipes; i++)
        pfPipeScreen(pfGetPipe(i), NumPipes-(i+1));
    {
        /* set up optional DRAW pipe stage config callback */
        pfStageConfigFunc(-1 /* selects all pipes */,
            PFPROC_DRAW /* stage bitmask */,
            ConfigPipeDraw /* config callback */);
        /* Config func should be done next pfFrame */
        pfConfigStage(i, PFPROC_DRAW);
    }
}
```

```
    }
    InitChannels();
    ...
    /* trigger the configuration and opening of pfPipes
     * and pfWindows
     */
    pfFrame();

    /* Application's simulation loop */
    while(!SimDone())
    {
        ...
    }
}

/* CALLBACK FUNCTIONS FOR PIPE STAGE INITIALIZATION */
void
ConfigPipeDraw(int pipe, uint stage)
{
    /* Application state for the draw process can be initialized
     * here. This is also a good place to do real-time
     * configuration for the drawing process, if there is one.
     * There is no graphics state or pfState at this point so no
     * rendering calls or pfApply*() calls can be made.
     */
    pfPipe *p = pfGetPipe(pipe);
    pfNotify(PFNFY_INFO, PFNFY_PRINT,
            "Initializing stage 0x%x of pipe %d", stage, pipe);
}
```

Using Channels

This section describes how to use pfChannels. A pfChannel is a view of a scene. A pfChannel is a required element for an OpenGL Performer application because it establishes the visual frame of reference for what is rendered in the drawing process.

Creating and Configuring a pfChannel

When you create a new pfChannel, it is attached to a pfPipe for the duration of the application. The pfPipe renders the pfScene viewed by the pfChannel into a

pfPipeWindow that is managed by that pipe. Use **pfNewChan()** to create a new pfChannel and assign it to a pfPipe. pfChannels are automatically assigned to the first pfPipeWindow of the pfPipe. In the sample program, the following statement creates a new channel and assigns it to pipe *p*.

```
chan = pfNewChan(p);
```

The pfChannel is automatically placed in the first pfPipeWindow of the pfPipe. A pfPipeWindow is created automatically if one is not explicitly created with **pfNewPWin()**.

The simplest configuration uses one pipe, one channel, and one window. You can use multiple channels in a single pfPipeWindow on a pfPipe, thereby allowing channels to share hardware resources. Using multiple channels is an advanced topic that is discussed in the section of this chapter on “Using Multiple Channels.” For now, focus your attention on understanding the concepts of setting up and using a single channel.

The primary function of a pfChannel is to define the view of a scene. A view is fully characterized by a *viewport*, a *viewing frustum*, and a *viewpoint*. The following sections describe how to set up the scene and view for a pfChannel.

Setting Up a Scene

A pfChannel draws the pfScene set by **pfChanScene()**. A channel can draw only one scene per frame but can change scenes from frame to frame. Other pfChannel attributes such as LOD modifications, described in “pfLOD Nodes” in Chapter 3, affect the scene.

A pfChannel also renders an environmental model known as pfEarthSky. A pfEarthSky defines the method for clearing the channel viewport before rendering the pfScene and also provides environmental effects, including ground and sky geometry and fog and haze. A pfEarthSky is attached to a pfChannel by **pfChanESky()**.

Setting Up a Viewport

A pfChannel is rendered by a pfPipe into its pfPipeWindow. The screen area that displays a pfChannel’s view is determined by the origin and size of the window and the channel viewport specified by pfChanViewport. The channel viewport is relative to the lower left corner of the window and ranges from 0 to 1. By default, a pfChannel viewport covers the entire window.

Suppose that you want to establish a viewport that is one-quarter of the size of the window, located in the lower left corner of the window. Use **pfChanViewport**(*chan*, 0.0, 0.25, 0.0, 0.25) to set up the one-quarter window viewport for the channel *chan*.

You can then set up other channels to render to the other three-quarters of the window. For example, you can use four channels to create a four-way view for an architectural or CAD application. See “Using Multiple Channels” on page 35 to learn more about multiple channels.

Setting Up a Viewing Frustum

A viewing frustum is a truncated pyramid that defines a viewing volume. Everything outside this volume is clipped, while everything inside is projected onto the viewing plane for display. A frustum is defined by the following:

- field-of-view (FOV) in the horizontal and vertical dimensions
- near and far *clipping planes*

A viewing frustum is created by the intersections of the near and far clipping planes with the top, bottom, left, and right sides of the infinite viewing volume formed by the FOV and aspect ratio settings. The aspect ratio is the ratio of the vertical and horizontal dimensions of the FOV.

Figure 2-4 shows the parameters that define a symmetric viewing frustum. To establish asymmetric frusta refer to the `pfChannel (3pf)` or `pfFrustum (3pf)` man pages for further details.

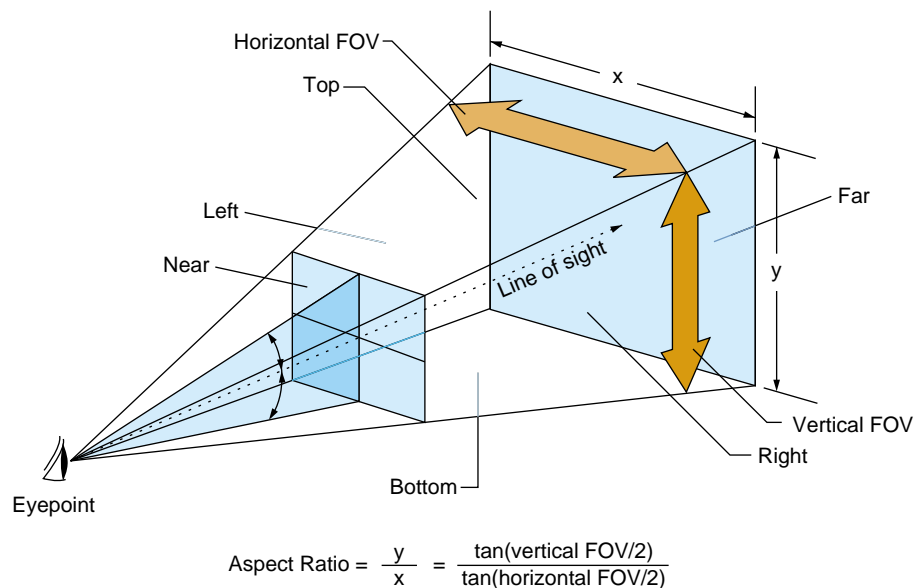

Figure 2-4 Symmetric Viewing Frustum

The viewing frustum is called symmetric when the vertical half-angles are equal and the horizontal half-angles are equal.

Field-of-View

The FOV is the angular width of view. Use `pfChanFOV(chan, horiz, vert)` to set up viewing angles in OpenGL Performer. The quantities *horiz* and *vert* are the total horizontal and vertical fields of view in degrees; usually you specify one and let OpenGL Performer compute the other. If you are specifying one angle, pass any amount less than or equal to zero, or greater than or equal to 180, as the other angle. OpenGL Performer automatically computes the unspecified FOV angle to fit the pfChannel viewport using the aspect-ratio preserving relationship

$$\tan(\text{vert}/2) / \tan(\text{horiz}/2) = \text{aspect ratio}$$

That is, the ratio of the tangents of the vertical and horizontal half-angles is equal to the aspect ratio. For example, if *horiz* is 45 degrees and the channel viewport is twice as wide as it is high (so the aspect ratio is 0.5), then the vertical field-of-view angle, *vert*, is

computed to be 23.4018 degrees. If both angles are unspecified, **pfChanFOV()** assumes a default value of 45 degrees for *horiz* and computes the value of *vert* as described.

Clipping Planes

Clipping planes define the near and far boundaries of the viewing volume. These distances describe the extent of the visual range in the view, because geometry outside these boundaries is *clipped*, meaning that it is not drawn.

Use **pfChanNearFar(*chan, near, far*)** to specify the distance along the line of sight from the viewpoint to the *near* and *far* planes that bound the viewing volume. These clipping planes are perpendicular to the line of sight. For the best visual acuity, choose these distances so that *near* is as far away as possible from the viewpoint and *far* is as close as possible to the viewpoint. Minimizing the range between *near* and *far* provides more resolution for distance comparisons and fog computations.

Setting Up a Viewpoint

A viewpoint describes the position and orientation of the viewer. It is the origin of the viewing location, the direction of the line of sight from the viewer to the scene being viewed, and an up direction. The default viewpoint is at the origin (0, 0, 0) looking along the +Y axis, with +Z up and +X to the right.

Use **pfChanView(*chan, point, dir*)** to define the viewpoint for the pfChannel identified by *chan*. Specify the view origin for *point* in *x, y, z* world coordinates. Specify the view direction for *dir* in degrees by giving the degree measures of the three *Euler angles*: *heading, pitch, and roll*.

Heading is a rotation about the Z axis, pitch is a rotation about the X axis, and roll is a rotation about the Y axis. The value of *dir* is the product of the rotations $ROT_y(roll) * ROT_x(pitch) * ROT_z(heading)$, where $ROTA(angle)$ is a rotation matrix about axis *A* of *angle* degrees.

Angles have not only a degree value, but also a *sense*, + or -, indicating whether the direction of rotation is clockwise or counterclockwise. Because different systems follow different conventions, it is very important to understand the sense of the Euler angles as they are defined by OpenGL Performer. OpenGL Performer follows the *right-hand rule*. According to the right-hand rule, counterclockwise rotations are positive. This means that a rotation about the X axis by +90 degrees shifts the +Y axis to the +Z axis, a rotation

about the Y axis by +90 degrees shifts the +Z axis to the +X axis, and a rotation about the Z axis by +90 degrees shifts the +X axis to the +Y axis.

Figure 2-5 shows a toy plane (somewhat reminiscent of the Ryan S-T) at the origin of a coordinate system with the angles of rotation labeled for heading, pitch, and roll. The arrows show the direction of positive rotation for each angle.

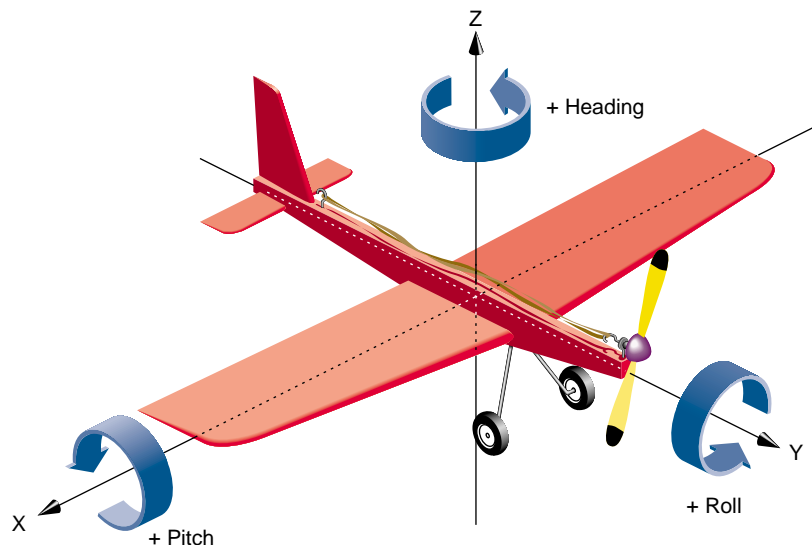

Figure 2-5 Heading, Pitch, and Roll Angles

A roll motion tips the wings from side to side. A pitch motion tips the nose up or down. Changing the heading, a yaw motion steers the plane. Accurate readings of these angles are critical information for a pilot during a flight, and a thorough understanding of how the angles function together is required for creation of an accurate flight simulation visual with OpenGL Performer. The same is also true of marine and other vehicle simulations.

Alternatively, you can use `pfChanViewMat(chan, mat)` to specify a 4x4 homogeneous matrix *mat* that defines the view coordinate system for channel *chan*. The upper left 3x3 submatrix defines the coordinate system axes, and the bottom row vector defines the origin of the coordinate system. The matrix must be orthonormal, or the results will be undefined. You can construct matrices using tools in the `libpr` library.

The origin and heading, pitch, and roll angles, or the view matrix, create a complete view specification. The view specification can locate the eyepoint frame-of-reference origin at any point in world coordinates. The *gaze vector*, the eye's +Y axis, can point in any direction. The *up vector*, the eye's +Z axis, can point in any direction perpendicular to the gaze vector.

You can query the system for the view and eyepoint-direction values with **pfGetChanView()**, or obtain the view matrix directly with **pfGetChanViewMat()**.

The view direction can be modified by one or more offsets, relative to the eyepoint frame-of-reference. View offsets are useful in situations where several channels render the same scene into adjacent displays for a wider field-of-view or higher resolution. Offsets are also used for multiple viewer perspectives, such as pilot and copilot views.

Use **pfChanViewOffsets(*chan, xyz, hpr*)** to specify additional translation and rotation offsets for the viewpoint and direction; *xyz* specifies a translation vector and *hpr* specifies a heading/pitch/roll rotation vector. Viewing offsets are automatically added each frame to the view direction specified by **pfChanView()** or **pfChanViewMat()**.

For example, to create three different perspectives of the same scene as displayed by three windows in an airplane cockpit, use azimuth offsets of 45, 0, and -45 for left, middle, and right views. To create vertical view groups such as might be seen through the windscreen of a helicopter, use both azimuth and elevation offsets. Once the view offsets have been set up, you need only set the view once per frame. View offsets are applied after the eyepoint position and gaze direction have been established. As with the other angles, be aware that the conventions for measuring azimuth and elevation angles vary between graphics systems; so, you should verify that the sense of the angles is correct.

Example of Channel Use

Example 2-2 shows how to use various pfChannel-related functions. The code is derived from OpenGL Performer sample programs.

Example 2-2 Using pfChannels

```
main()
{
    pfInit();
    ...
    pfConfig();
}
```



```

...
InitScene();
InitPipe();
InitChannel();

/* Application main loop */
while(!SimDone())
{
    ...
}
}

void InitChannel(void)
{
    pfChannel *chan;
    chan = pfNewChan(pfGetPipe(0));

    /* Set the callback routines for the pfChannel */
    pfChanTravFunc(chan, PFTRAV_CULL, CullFunc);
    pfChanTravFunc(chan, PFTRAV_DRAW, DrawFunc);

    /* Attach the visual database to the channel */
    pfChanScene(chan, ViewState->scene);

    /* Attach the EarthSky model to the channel */
    pfChanESky(chan, ViewState->eSky);

    /* Initialize the near and far clipping planes */
    pfChanNearFar(chan, ViewState->near, ViewState->far);

    /* Vertical FOV is matched to window aspect ratio. */
    pfChanFOV(chan, 45.0f/NumChans, -1.0f);

    /* Initialize the viewing position and direction */
    pfChanView(chan, ViewState->initView.xyz,
               ViewState->initView.hpr);
}

/* CULL PROCESS CALLBACK FOR CHANNEL*/
/* The cull function callback. Any work that needs to be
 * done in the cull process should happen in this function.
 */
void
CullFunc(pfChannel * chan, void *data)
{

```

```
static long first = 1;

if (first)
{
    if ((pfGetMultiprocess() & PFMP_FORK_CULL) &&
        (ViewState->procLock & PFMP_FORK_CULL))
        pfuLockDownCull(pfGetChanPipe(chan));
    first = 0;
}
PreCull(chan, data);

pfCull();          /* Cull to the viewing frustum */

PostCull(chan, data);
}

/* DRAW PROCESS CALLBACK FOR CHANNEL*/
/* The draw function callback. Any graphics functionality
 * outside OpenGL Performer must be done here.
 */
void
DrawFunc(pfChannel *chan, void *data)
{
    PreDraw(chan, data);    /* Clear the viewport, etc. */

    pfDraw();              /* Render the frame */

    /* draw HUD, or whatever else needs
     * to be done post-draw.
     */
    PostDraw(chan, data);
}
```

Controlling the Video Output

Note: This is an advanced topic.

You use `pfPipeVideoChannel` to query and control the configuration of a hardware video channel. The methods allow you to, for example, query or specify the origin and size of the video output and scale the display.

By default, all `pfVideoChannels` on a `pfPipe` use the first entire video channel on the screen selected by the `pfPipe`. Each `pfPipeWindow` initially has a default `pfPipeVideoChannel` already assigned to it. When `pfChannels` are added to `pfPipeWindows`, they will be using, by default, this first `pfPipeVideoChannel`. You can get a `pfPipeVideoChannel` of a `pfPipeWindow` with **`pfGetPWinPVChan()`** and specifying the index of the `pfPipeVideoChannel` on the `pfPipeWindow`; the initial default one will be at index 0. You can then reconfigure this `pfPipeVideoChannel` to select a different video channel or change the attributes of the selected video channel. You can create a `pfPipeVideoChannel` with **`pfNewPVChan()`**. To use this for a given `pfChannel`, you must add it to a `pfPipeWindow` that will cover the screen area of the desired video channel. When a `pfPipeVideoChannel` is added to a `pfPipeWindow` with **`pfAddPWinPVChan()`**, the index into the `pfPipeWindow` list of video channels is returned and by default the `pfPipeVideoChannel` will get the next active hardware video channel after the previous `pfPipeVideoChannel` on that `pfPipeWindow`. You can explicitly select the hardware video channel with **`pfPVChanId()`**. The `pfChannel` will then reference this `pfPipeVideoChannel` through the index that you got back from **`pfAddPWinPVChan()`** and assign to the `pfChannel` with **`pfChanPWinPVChanIndex()`**.

```
pvc = pfNewPVChan(p);
pvcIndex = pfAddPWinPVChan(pw, pvc);
pfChanPWinPVChanIndex(chan, pvcIndex);
```

Note that the screen of the `pfPipe` must be known to fully specify the desired video channel. Queries on the `pfPipeVideoChannel` will return values indicating unknown configuration until the screen is known. The screen can be determined by OpenGL Performer when the window is opened in the DRAW process but you can also explicitly set the screen of the `pfPipe` with **`pfPipeScreen()`**.

You can also get to the hardware video channel structure, **`pfVideoChannelInfo()`**, for more configuration options, such as reading gamma data or even a specific video format. For more information on `pfPipeWindows` and `pfPipeVideoChannels`, see Chapter 17, “`pfPipeWindows` and `pfPipeVideoChannels`.”

Using Multiple Channels

Each rendering pipeline can render multiple channels with multiple `pfPipeVideoChannels` to a single `pfPipeWindows`. Multiple `pfPipeWindows` can also be used but at the cost of some additional processing overhead. The `pfChannel` is assigned to the proper `pfPipeWindow` and selects its `pfPipeVideoChannel` from that

`pfPipeWindow`. The `pfChannel` must also have a viewport, set with `pfChanViewport()`, that covers the proper window area to match that of the desired `pfPipeVideoChannel`.

Each channel represents an independent viewpoint into either a shared or an independent visual database. Different types of applications can have vastly different pipeline-window-channel configurations. This section describes two extremes: visual simulation applications, where there is typically one window per pipeline, and highly interactive uses that require dynamic window and channel configuration.

One Window per Pipe, Multiple Channels per Window

Often there is a single channel associated with each pipeline, as shown in the top half of Figure 2-6. This section describes two important uses for multiple-channel support—multiple pipelines per system and multiple windows per pipeline—the second of which is illustrated in the bottom half of Figure 2-6.

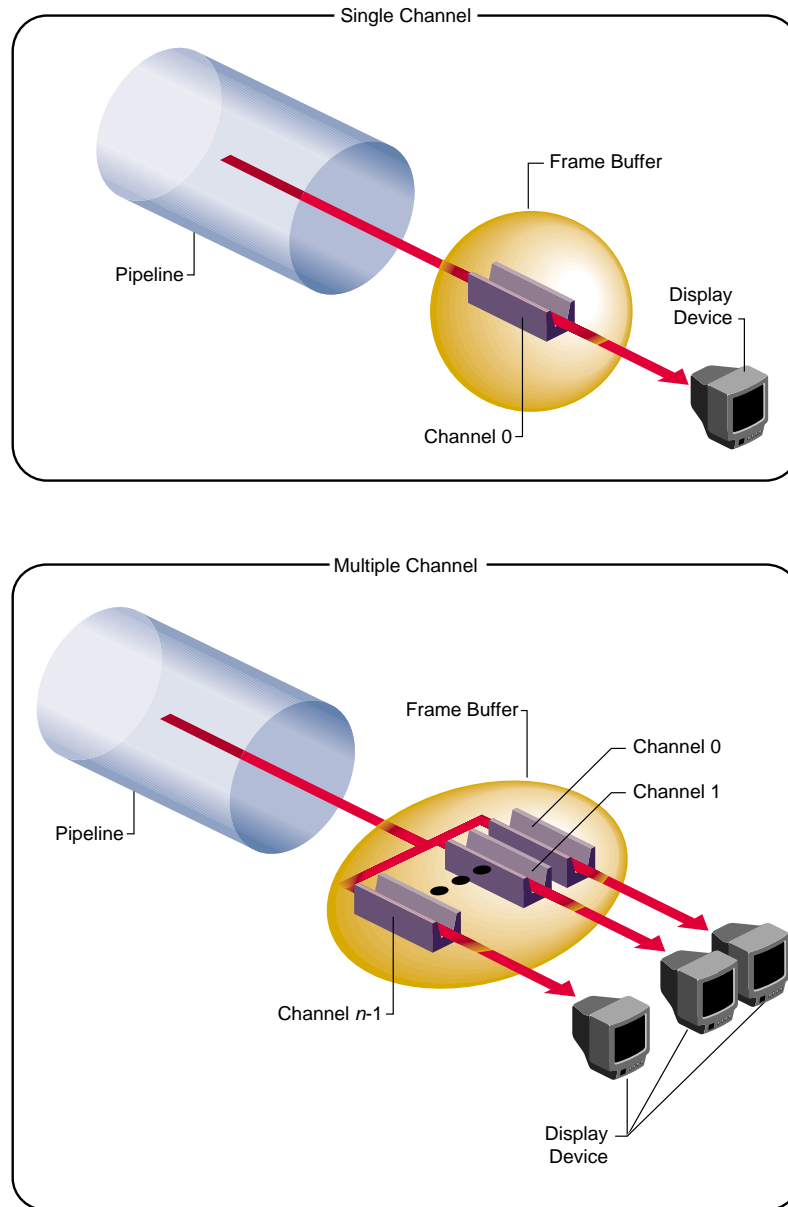

Figure 2-6 Single-Channel and Multiple-Channel Display

One situation that requires multiple channels occurs when inset views must appear within an image. A simple example of this application is a driving simulator in which the screen image represents the view out the windshield. If a rear-view mirror is to be drawn, it must overlay the main forward view to provide a separate view of the same database within the borders of the simulated mirror's frame.

Channels are rendered in the order that they are assigned to a `pfPipeWindow` on their parent `pfPipe`. Channels, upon creation, are assigned to the end of the channel list of the first window of their `pfPipe`. In the driving simulator example, creating pipes and channels with the following structure creates two channels on a single shared pipeline:

```
pipeline = pfGetPipe(0);
frontView = pfNewChan(pipeline);
rearView = pfNewChan(pipeline);
```

In this case, OpenGL Performer's actual drawing order becomes the following:

1. Clear *frontView*.
2. Draw *frontView*.
3. Clear *rearView*.
4. Draw *rearView*.

This default ordering results in the rear-view mirror image always overlaying the front-view image, as desired. You can control and reorder the drawing of channels within a `pfPipeWindow` with the `pfInsertChan(pwin, where, chan)` and `pfMoveChan(pwin, where, chan)` routines. More details about multiple channels and multiple window are discussed in the next section.

When the host has multiple Geometry Pipelines, as supported on Onyx RealityEngine2 and InfiniteReality systems, you can create a `pfPipe` and `pfChannel` pair for each hardware pipeline. The following code fragment illustrates a two-channel, two-pipeline configuration:

```
leftPipe = pfGetPipe(0);
leftView = pfNewChan(leftPipe);
rightPipe = pfGetPipe(1);
rightView = pfNewChan(rightPipe);
```

This configuration forms the basis for a high-performance stereo display system, since there is a hardware pipeline dedicated to each eye and rendering occurs in parallel.

The two-channel stereo-view application described in this example and the inset-view application described in the previous example can be combined to provide stereo views for a driving simulator with an inset rear-view mirror. The correct management of each eye's viewpoint and the mirror reflection helps provide a convincing sense of physical presence within the vehicle.

The third and most common multiple-channel situation involves support for multiple video outputs per pipeline. To do this, first associate each pipeline with a set of nonoverlapping channels, one for each desired view. Next, use one of the following video-splitting methods:

- Use the multi-channel hardware options, available from SGI, for systems such as the 8-channel Display Generator (DG) for InfiniteReality graphics, where you can create up to eight independent video outputs from a single Graphics Pipeline, with each video output corresponding to one of the tiled channels. The Octane video option supports four video outputs and the RealityEngine2 MultiChannel Option supports six video channels per Graphics Pipeline.
- Connect multiple video monitors in series to a single pipeline's video output. Because each monitor receives the same display image, a masking *bezel* is used to obscure all but the relevant portion of each display surface.

The three multiple-channel concepts described here can be used in combination. For example, use of three InfiniteReality pipelines, each equipped with the 8-channel DG, allows creation of up to 24 independent video displays. The channel-tiling method can also be used for some or all of these displays.

Example 2-3 shows how to use multiple channels on separate pipes.

Example 2-3 Multiple Channels, One Channel per Pipe

```
pfChannel *Chan[MAX_CHANS];

void InitChannel(int NumChans)
{
    /* Initialize each channel on a separate pipe */
    for (i=0; i< NumChans; i++)
        Chan[i] = pfNewChan(pfGetPipe(i));

    ...

    /* Make channel n/2 the master channel (can be any
     * channel).
     */
}
```

```
ViewState->masterChan = Chan[NumChans/2];

{
    long share;

    /* Get the default channel-sharing mask */
    share = pfGetChanShare(ViewState->masterChan);

    /* Add in the viewport share bit */
    share |= PFCHAN_VIEWPORT;

    if (GangDraw)
    {
        /* add GangDraw to channel share mask */
        share |= PFCHAN_SWAPBUFFERS_HW;
    }
    pfChanShare(ViewState->masterChan, share);
}

/* Attach channels */
for (i=0; i< NumChans; i++)
    if (Chan[i] != ViewState->masterChan)
        pfAttachChan(ViewState->masterChan, Chan[i]);

...
/* Continue with channel initialization */
}
```

Using Channel Groups

In many multiple-channel situations, including the examples described in the previous section, it is useful for channels to share certain attributes. For the three-channel cockpit scenario, each `pfChannel` shares the same eyepoint while the left and right views are offset using `pfChanViewOffsets()`. OpenGL Performer supports the notion of *channel groups*, which facilitate attribute sharing between channels.

`pfChannels` can be gathered into channel groups that share like attributes. A channel group is created by attaching one `pfChannel` to another, or to an existing channel group. Use `pfAttachChan()` to create a channel group from two channels or to add a channel to an existing channel group. Use `pfDetachChan()` to remove a `pfChannel` from a channel group.

A *channel share mask* defines shared attributes for a channel group. The attribute tokens listed in Table 2-1 are bitwise OR-ed to create the share mask.

Table 2-1 Attributes in the Share Mask of a Channel Group

Token	Shared Attributes
PFCHAN_FOV	Horizontal and vertical fields of view
PFCHAN_VIEW	View position and orientation
PFCHAN_VIEW_OFFSETS	(x, y, z) and <i>(heading, pitch, roll)</i> offsets of the view direction
PFCHAN_NEARFAR	Near and far clipping planes
PFCHAN_SCENE	All channels display the same scene.
PFCHAN_EARTHSKY	All channels display the same earth/sky model.
PFCHAN_STRESS	All channels use the same stress filter.
PFCHAN_LOD	All channels use the same LOD modifiers.
PFCHAN_SWAPBUFFERS	All channels swap buffers at the same time.
PFCHAN_SWAPBUFFERS_HW	Synchronize swap buffers for channels on different graphics pipelines.

Use **pfChanShare()** to set the share mask for a channel group. By default, channels share all attributes except PFCHAN_VIEW_OFFSETS. When you add a pfChannel to a channel group, it inherits the share mask of that group.

A change to any shared attribute is applied to all channels in a group. For example, if you change the viewpoint of a pfChannel that shares PFCHAN_VIEW with its group, all other pfChannels in the group will acquire the same viewpoint.

Two attributes are particularly important to share in adjacent-display multiple-channel simulations: PFCHAN_SWAPBUFFERS and PFCHAN_LOD. PFCHAN_LOD ensures that geometry that straddles displays is drawn the same way in each channel. In this case, all channels will use the same LOD modifier when rendering their scenes so that LOD behavior is consistent across channels. PFCHAN_SWAPBUFFERS ensures that channels refresh the display with a new frame at the same time. pfChannels in different pfPipes that share PFCHAN_SWAPBUFFERS_HW will frame-lock the graphics pipelines together.

Example 2-4 illustrates the use of multiple channels and channel sharing.

Example 2-4 Channel Sharing

```
pfChannel *Chan[MAX_CHANS];

main()
{
    pfInit();
    ...
    /* Set number of pfPipes desired. THIS MUST BE DONE
     * BEFORE CALLING pfConfig().
     */
    pfMultipipe(NumPipes);
    ...
    pfConfig();
    ...
    InitScene();

    InitChannels();

    pfFrame();

    /* Application main loop */
    while(!SimDone())
    {
        ...
    }
}

void InitChannel(int NumChans)
{
    /* Initialize all channels on pipe 0 */
    for (i=0; i< NumChans; i++)
        Chan[i] = pfNewChan(pfGetPipe(0));

    ...

    /* Make channel n/2 the master channel (can be any
     * channel).
     */
    ViewState->masterChan = Chan[NumChans/2];

    ...
}
```

```

/* Attach all Channels as slaves to the master channel */
for (i=0; i< NumChans; i++)
    if (Chan[i] != ViewState->masterChan)
        pfAttachChan(ViewState->masterChan, Chan[i]);

pfSetVec3(xyz, 0.0f, 0.0f, 0.0f);
/* Set each channel's viewing offset. In this case use
 * many channels to create one multichannel contiguous
 * frustum with a 45° field of view.
 */
for (i=0; i < NumChans; i++)
{
    float fov = 45.0f/NumChans;

    pfSetVec3(hpr, (((NumChans - 1) * 0.5f) - i) * fov,
              0.0f, 0.0f);
    pfChanViewOffsets(Chan[i], xyz, hpr);
}

...

/* Now, just configure the master channel and all of the
 * other channels will share those attributes.
 */

chan = ViewState->masterChan;
pfChanTravFunc(chan, PFTRAV_CULL, CullFunc);
pfChanTravFunc(chan, PFTRAV_DRAW, DrawFunc);
pfChanScene(chan, ViewState->scene);
pfChanESky(chan, ViewState->eSky);
pfChanNearFar(chan, ViewState->near, ViewState->far);
pfChanFOV(chan, 45.0f/NumChans, -1.0f);
pfChanView(chan, ViewState->initView.xyz,
           ViewState->initView.hpr);

...
}

```

Multiple Channels and Multiple Windows

For some interactive applications, you may want to be able to dynamically control the configuration of channels and windows. OpenGL Performer allows you to dynamically create, open, and close windows. You can also move channels among the windows of the shared parent `pfPipe`, and reorder channels within a `pfPipeWindow`. Channels can be

appended to the end of a `pfPipeWindow` channel list with **`pfAddChan()`** and removed with **`pfRemoveChan()`**. A channel can only be attached to one `pfPipeWindow` — no instantiating of `pfChannels` is allowed. When a `pfChannel` is put on a `pfPipeWindow`, it is automatically deleted from its previous `pfPipeWindow`. A channel that is not assigned to a `pfPipeWindow` is not drawn (though it may still be culled).

You can control and reorder the drawing of channels within a `pfPipeWindow` with the **`pfInsertChan(pwin, where, chan)`** and **`pfMoveChan(pwin, where, chan)`** routines. Both of these routines do a type of insertion: **`pfInsertChan()`** will add *chan* to the *pwin* channel list in front of the channel in the list at location *where*. **`pfMoveChan()`** will delete *chan* from its old location and move it to *where* in the *pwin* channel list.

On IRIX systems, if you have `pfChannels` in different `pfPipeWindows` or `pfPipes` that are supposed to combine to form a continuous scene, you will want to ensure that both the vertical retrace and double buffering of these windows is synchronized. This is required for both reasonable performance and visual quality. Use the `genlock(7)` system video feature to ensure that the vertical retraces of different graphics pipelines are synchronized. To synchronize double buffering, you want to either specify `PFCHAN_SWAPBUFFERS_HW` in the share mask of the `pfChannels` and put the `pfChannels` in a share group, or else create a `pfPipeWindow` swap group, discussed in Chapter 17, “`pfPipeWindows` and `pfPipeVideoChannels`.”

Importing OpenGL Multipipe SDK (MPK) Configuration Files

OpenGL Multipipe SDK (MPK) is a software package for managing a multipipe rendering environment. MPK uses a configuration file to describe the layout and hierarchy of pipes, windows, and channels used by an application. The manual *SGI OpenGL Multipipe SDK User's Guide* describes the format of the configuration file.

An OpenGL Performer application can import MPK configuration files and skip the explicit generation of pipes, windows, and channels. The library `libpfmpk` contains functions for importing and configuring pipes, windows, and channels from an MPK configuration file. The functions in `libpfmpk` store the display configuration information in a `pfvDisplayMngr` class for easy access by the application. The `pfvDisplayMngr` class is part of the `pfViewer` implementation, which is described in Chapter 25, “Building a Visual Simulation Application Using `libpfv`”.

The **`pfMPKImportFile()`** function takes an MPK configuration filename and generates OpenGL Performer objects (`pfPipes`, `pfPipeWindows`, and `pfChannels`) accordingly. The

function **pfMPKImportConfig()** is very similar. Instead of accepting a filename, it accepts an MPK configuration class **MPKConfig**. The result of both these functions is two-fold:

- OpenGL Performer is configured with pipes, windows, and channels as specified in the MPK configuration file.
- The **pfvDisplayMngr** class contains a description of the configured display topology (what pipe has what windows and what channels). It also contains pointers to all the newly generated OpenGL Performer classes (**pfPipe**, **pfPipeWindow**, and **pfChannel**).

The following is a code sample section for using the **pfMPKImportFile()** function:

```
// Initialize Performer
pfInit();

// Initialize the MultipipeSDK import library.
// No need to initialize MPK directly.
pfmpkInit();

// Import a MultipipeSDK file. This function calls pfConfig
// so we don't have to.
pfMPKImportFile(config_filename);

// Load a model file for display.
pfNode *root = pfdLoadFile(model_filename);

// Attach loaded file to a new pfScene
pfScene *scene = new pfScene;
scene->addChild(root);

// Create a pfLightSource and attach it to scene
scene->addChild(new pfLightSource);

// Get access to the results of the MultipipeSDK import.
// pfvDisplayMngr contains pointers to all the
// pipes/windows/channels that the MultipipeSDK file specified.
pfvDisplayMngr *dm = pfvDisplayMngr::getMngr();

// All configured channels share the scene graph so we only
// have to assign one channel.
pfChannel *chan = dm -> getChan(0) -> getHandle();
chan->setScene(scene);
```

Note: Since the `pfvDisplayMgr` class has no C API, you can only use `libpfmpk` from C++ programs.

Figure 2-1 contains a diagram of the various objects participating in any `libpfmpk` import operation.

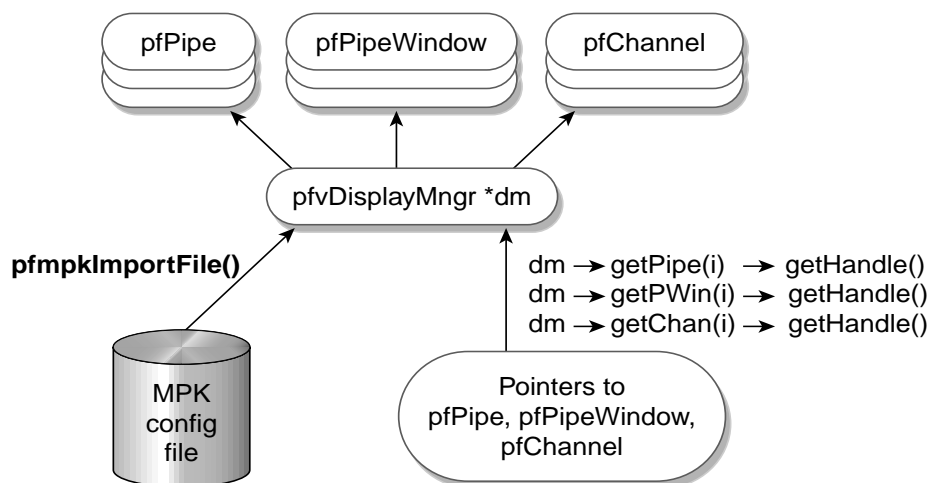

Figure 2-7 The `libpfmpk` Import Operation

Both functions `pfMPKImportFile()` and `pfMPKImportConfig()` encapsulate the entire OpenGL Performer configuration stage including the call to function `pfConfig()`. This may be too inflexible for some applications. An additional set of functions in `libpfmpk` provides lower-level access.

The following code sample shows the internal structure of function `pfMPKImportConfig()`. All calls that `pfMPKImportConfig()` makes are publicly accessible and an application can call them directly:

```
void pfMPKImportConfig(MPKConfig *cfg)
{
    pfvDisplayMgr      *dm = pfvDisplayMgr::getMgr();
    pfMPKImportInfo    info;

    // Prepare temporary storage for pipe information.
    info . numPipes = mpkConfigNPipes(cfg);
```

```

info . pipeInfo = (pfMPKImportPipeInfo *)
malloc (info.numPipes * sizeof (pfMPKImportPipeInfo));

// Translate contents of MPKConfig into pfvDisplayMngr terms.
pfMPKPreConfig(cfg, &info);

// Let pfvDisplayMngr run all its pre-pfConfig processing.
dm -> preConfig();

// Performer configuration: After this point, we can start
// creating Performer windows and channels.
pfConfig();

// Inquire pipe sizes, and configure all pfvDisplayMngr
// objects that depend on them.
pfMPKPostConfig(cfg, &info);

// Ask pfDisplayMngr to create all the windows/channels.
dm -> postConfig();

// Invoke any pfPipe/pfPipeWindow/pfChannel calls that
// pfDisplayMngr doesn't encapsulate.

pfMPKPostDMConfig(cfg, &info);
}

```

For completeness, the following is the source code for **pfMPKImportFile()**:

```

void pfMPKImportFile(char *filename)
{
// Ask MPK to load the configuration file and pass to
// pfMPKImportConfig
pfMPKImportConfig(mpkConfigLoad(filename));
}

```

The function **pfMPKPreConfig()** traverses the MPKConfig class and creates its pfvDisplayMngr equivalent. The function **pfMPKPostConfig()** patches the previous pfvDisplayMngr configuration using pipe size information. This information becomes available only after the call to **pfConfig()**; hence, patching cannot happen in **pfMPKPreConfig()**.

The function **pfMPKPostDMConfig()** traverses the pfvDisplayMngr hierarchy one last time. This time pfvDisplayMngr already contains valid pointers to the OpenGL Performer classes it creates. The function **pfMPKPostDMConfig()** makes

OpenGL Performer calls on the `pfPipe`, `pfPipeWindow`, and `pfChannel` pointers. Since `pfvDisplayMngr` does not encapsulate all configuration details, **`pfMPKPostDMConfig()`** makes these configuration calls directly on the new OpenGL Performer classes.

Nodes and Node Types

A scene graph holds the data that defines a virtual world. The scene graph includes low-level descriptions of object geometry and their appearance, as well as higher-level, spatial information, such as specifying the positions, animations, and transformations of objects, as well as additional application-specific data.

Scene graph data is encapsulated in many different types of nodes. One node might contain the geometric data of an object; another node might contain the transformation for that object to orient and position it in the virtual world. The nodes are associated in a hierarchy that is an adirected, acyclic graph. OpenGL Performer and your application can act on the scene graph to perform various complex operations efficiently, such as database intersection and rendering scenes.

This chapter focuses on the data types themselves rather than instances of those types. Chapter 4, “Database Traversal,” discusses traversing sample scene graphs in terms of actual objects rather than abstract data types.

Nodes

A scene is represented by a graph of nodes. A node is a subclass of `pfNode`. Only nodes can be in scene graphs and have child nodes. In general, nodes either contain descriptive information about scene graph geometry, or they create groups and hierarchies of nodes. Many classes, such as `pfEngine` and `pfFlux`, that are not nodes can interact with nodes.

Attribute Inheritance

The basic element of a scene hierarchy is the node. While OpenGL Performer supplies many specific types of nodes, it also uses a concept called *class inheritance*, which allows different node types to share attributes. An attribute is a descriptive element of geometry or its appearance.

pfNode

OpenGL Performer's node hierarchy begins with the pfNode class, as shown in Figure 3-1.

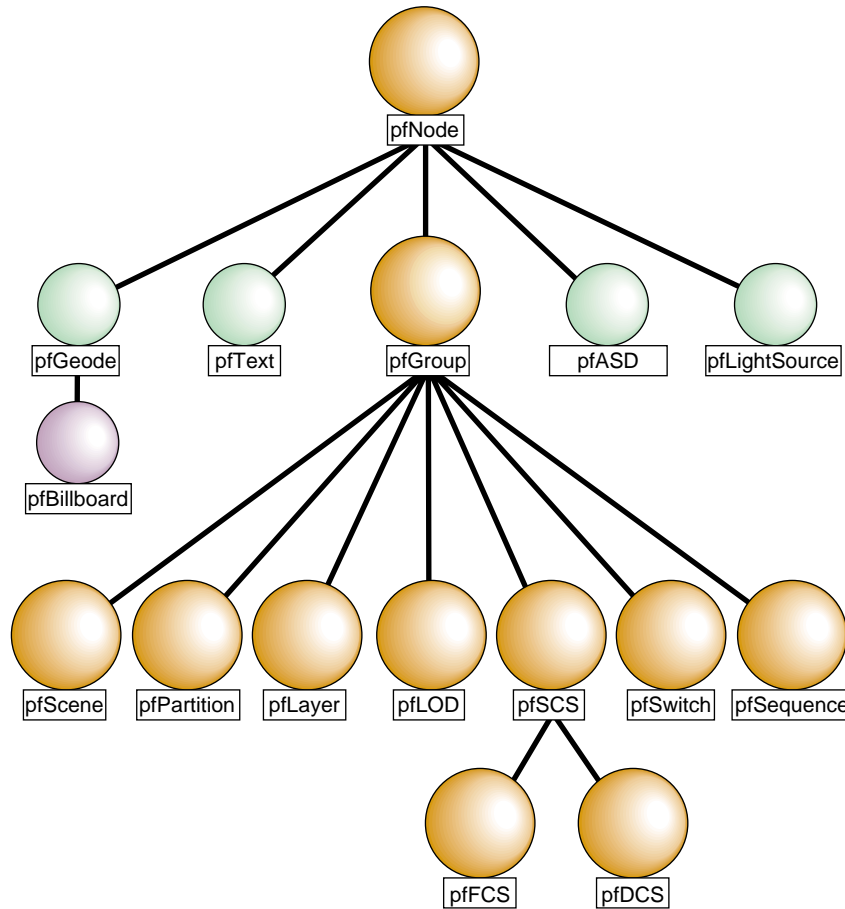

Figure 3-1 Nodes in the OpenGL Performer Hierarchy

All node types are derived from pfNode; they inherit pfNode's attributes and the libpf routines for setting and getting attributes. In general, a node type inherits the attributes and routines of all its parent nodes in the type hierarchy.

Table 3-1 lists the basic node class and gives a simple description for each node type.

Table 3-1 OpenGL Performer Node Types

Node Type	Node Class	Description
pfNode	Abstract	Basic node type.
pfGroup	Branch	Groups zero or more children..
pfScene	Root	Parent of the visual database.
pfSCS	Branch	Static coordinate system.
pfDCS	Branch	Dynamic coordinate system.
pfFCS	Branch	Flux coordinate system.
pfDoubleSCS	Branch	Double-precision static coordinate system.
pfDoubleDCS	Branch	Double-precision dynamic coordinate system.
pfDoubleFCS	Branch	Double-precision flux coordinate system.
pfSwitch	Branch	Selects among multiple children.
pfSequence	Branch	Sequences through its children.
pfLOD	Branch	Level-of-detail node.
pfLayer	Branch	Renders coplanar geometry.
pfLightSource	Leaf	Contains specifications for a light source.
pfGeode	Leaf	Contains geometric specifications.
pfBillboard	Leaf	Rotates geometry to face the eyepoint.
pfPartition	Branch	Partitions geometry for efficient intersections.
pfText	Leaf	Renders 2D and 3D text.
pfASD	Leaf	Controls transition between LOD levels.

pfNode

As shown in Figure 3-1, all `libpf` nodes are arranged in a type hierarchy, which defines the inheritance of functionality. A `pfNode` is an abstract class, meaning that a `pfNode` can

never be explicitly created by an application, and all other nodes inherit the functionality of `pfNode`. Its purpose is to provide a root to the type hierarchy and to define the attributes that are common to all node types.

pfNode Attributes

The following `pfNode` attributes are inherited by all other `libpf` node types:

- Node name
- Parent list
- Bounding geometry
- Intersection and traversal masks
- Callback functions and data
- User data

Bounding geometry, intersection masks, user data, and callbacks are advanced topics that are discussed in Chapter 4, “Database Traversal.”

The routines that set, get, and otherwise manipulate these attributes can be used by all `libpf` node types, as indicated by the keyword ‘Node’ in the routine names. Nodes used as arguments to `pfNode` routines must be cast to `pfNode*` to match parameter prototypes, as shown in this example:

```
pfNodeName((pfNode*) dcs, "rotor_rotation");
```

However, you usually do not need to do this casting explicitly. When you use the C API and compile with the `-ansi` flag (which is the usual way to compile OpenGL Performer applications), `libpf` provides macro wrappers around `pfNode` routines that automatically perform argument casting for you. When you use the C++ API, such type casting is not necessary.

pfNode Operations

In addition to sharing attributes, certain basic operations are provided for all node types. They include the following:

New	Create and return a handle to a new node.
Get	Get node attributes.
Set	Set node attributes.

Find	Find a node based on its name.
Print	Print node data.
Copy	Copy node data.
Delete	Delete a node.

The Set operation is implied in the node attribute name. The names of the attribute-getting functions contain the string "Get."

An Example of Scene Creation

Example 3-1 illustrates the creation of a scene that includes two different kinds of pfNodes. (For information about pfScene nodes, see "pfScene Nodes" on page 61; for information about pfDCS nodes, see "pfDCS Nodes" on page 62.)

Example 3-1 Making a Scene

```

pfScene *scene;
pfDCS *dcs1, *dcs2;

scene = pfNewScene();          /* Create a new scene node */
dcs1 = pfNewDCS();            /* Create a new DCS node */
dcs2 = pfNewDCS();            /* Create a new DCS node */
pfCopy(dcs2, dcs1);           /* Copy all node attributes */
                               /*      from dcs1 to dcs2 */
pfNodeName(scene, "Scene_Graph_Root"); /* Name scene node */
pfNodeName(dcs1, "DCS_1");     /* Name dcs1 */
pfNodeName(dcs2, "DCS_2");     /* Name dcs2 */
...
/* Use a pfGet*() routine to determine node name */
printf("Name of first DCS node is %s.", pfGetNodeName(dcs1));
...
/* Recursively free this node if it's no longer referenced */
pfDelete(scene);
...

```

pfGroup

In addition to inheriting the pfNode attributes described in the "pfNode" section of this chapter, a pfGroup also maintains a list of zero or more child nodes that are accessed and

manipulated using group operators. Children of a pfGroup can be either branch or leaf nodes. Traversals process the children of a pfGroup in left-to-right order.

Table 3-2 lists the pfGroup functions, with a description and a visual interpretation of each.

Table 3-2 pfGroup Functions

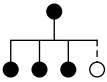
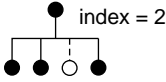
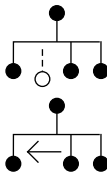
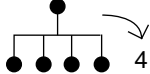
Function Name	Description	Diagram
pfAddChild (<i>group, child</i>)	Appends <i>child</i> to the list for <i>group</i> .	
pfInsertChild (<i>group, index, child</i>)	Inserts <i>child</i> before the child whose place in the list is <i>index</i> .	
pfRemoveChild (<i>group, child</i>)	Detaches <i>child</i> from the list and shifts the list to fill the vacant spot. Returns 1 if <i>child</i> was removed. Returns 0 if <i>child</i> was not found in the list. Note that the “removed” node is only detached, not deleted.	
pfGetNumChildren (<i>group</i>)	Returns the number of children in <i>group</i> .	

The pfGroup nodes can organize a database hierarchy either logically or spatially. For example, if your database contains a model of a town, a logical organization might be to group all house models under a single pfGroup. However, this kind of organization is less efficient than a spatial organization, which arranges geometry by location. A spatial organization improves culling and intersection performance; in the example of the town, spatial organization would consist of grouping houses with their local terrain geometry instead of with each other. Chapter 4 describes how to spatially organize your database for best performance.

The code fragment in Example 3-2 illustrates building a hierarchy using pfGroup nodes.

Example 3-2 Hierarchy Construction Using Group Nodes

```

scene = pfNewScene();

/* The following loop constructs a sample hierarchy by
 * adding children to several different types of group
 * nodes. Notice that in this case the terrain was broken
 * up spatially into a 4x4 grid, and a switch node is used
 * to cause only one vehicle per terrain node to be
 * traversed.
 */

for(j = 0; j < 4; j++)
    for(i = 0; i < 4; i++)
    {
        pfGroup *spatial_terrain_block = pfNewGroup();
        pfSCS *house_offset = pfNewSCS();
        pfSCS *terrain_block_offset = pfNewSCS();
        pfDCS *car_position = pfNewDCS();
        pfDCS *tank_position = pfNewDCS();
        pfDCS *heli_position = pfNewDCS();
        pfSwitch *current_vehicle_type;
        pfGeode *heli, *car, *tank;

        pfAddChild(scene, spatial_terrain_block);
        pfAddChild(spatial_terrain_block,
                    terrain_block_offset);
        pfAddChild(spatial_terrain_block, house_offset);
        pfAddChild(spatial_terrain_block,
                    current_vehicle_type);
        pfAddChild(current_vehicle_type, car_position);
        pfAddChild(current_vehicle_type, tank_position);
        pfAddChild(current_vehicle_type, heli_position);
        pfAddChild(car_position, car);
        pfAddChild(tank_position, tank);
        pfAddChild(heli_position, heli);
    }

...

/* The following shows how one might use OpenGL Performer to
 * manipulate the scene graph at run time by adding and
 * removing children from branch nodes in the scene graph.

```

```
*/  
for(j = 0; j < 4; j++)  
    for(i = 0; i < 4; i++)  
        {  
            pfGroup *this_terrain;  
            this_terrain = pfGetChild(scene, j*4 + i);  
            if (pfGetNumChildren(this_terrain) > 2)  
                this_tank = pfGetChild(this_terrain, 2);  
            if (is_tank_disable(this_tank))  
                {  
                    pfRemoveChild(this_terrain, this_tank);  
                    pfAddChild(disabled_tanks, this_tank);  
                }  
        }  
...
```

Working with Nodes

This section describes the basic concepts involved in working with nodes. It explains how *shared instancing* can be used to create multiple copies of an object, and how changes made to a parent node propagate down to its children. A sample program that illustrates these concepts is presented at the end of the chapter.

Instancing

A scene graph is typically constructed at application initialization time by creating and adding new nodes to the graph. If a node is added to two or more parents it is termed *instanced* and is shared by all its parents. Instancing is a powerful mechanism that saves memory and makes modeling easier. `libpf` supports two kinds of instancing, shared instancing and cloned instancing, which are described in the following sections.

Shared Instancing

Shared instancing is the result of simply adding a node to multiple parents. If an instanced node has children, then the entire subgraph rooted by the node is considered to be instanced. Each parent shares the node; thus, modifications to the instanced node or its subgraph are experienced by all parents. Shared instances can be nested—that is, an instance can itself instance other nodes.

In the following sample code, group0 and group1 share a node:

```
pfAddChild(group0, node);
pfAddChild(group1, node);
```

Figure 3-2 shows the structure created by this code. Before the instancing operation, the two groups and the node to be shared all exist independently, as shown in the left portion of the figure. After the two function calls shown above, the two groups both reference the same shared hierarchy. (If the original groups referenced other nodes, those nodes would remain unchanged.) Note that each of the group nodes considers the shared hierarchy to be its own child.

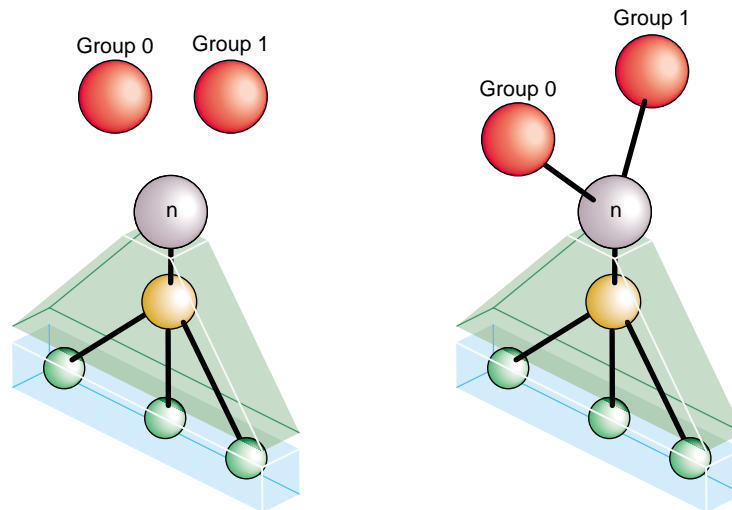

Figure 3-2 Shared Instances

Cloned Instancing

In many situations shared instancing is not desirable. Consider a subgraph that represents a model of an airplane with articulations for ailerons, elevator, rudder, and landing gear. Shared instances of the model result in multiple planes that share the same articulations. Consequently, it is impossible for one plane to be flying with its landing gear retracted while another is on a runway with its landing gear down.

Cloned instancing provides the solution to this problem by *cloning*—creating new copies of variable nodes in the subgraph. Leaf nodes containing geometry are not cloned and

are shared to save memory. Cloning the airplane model generates new articulation nodes, which can be modified independently of any other cloned instance. The cloning operation, `pfClone()`, is actually a traversal and is described in detail in Chapter 4.

Figure 3-3 shows the result of cloned instancing. As in the previous figure, the left half of the drawing represents the situation before the operation, and the right half shows the result of the operation.

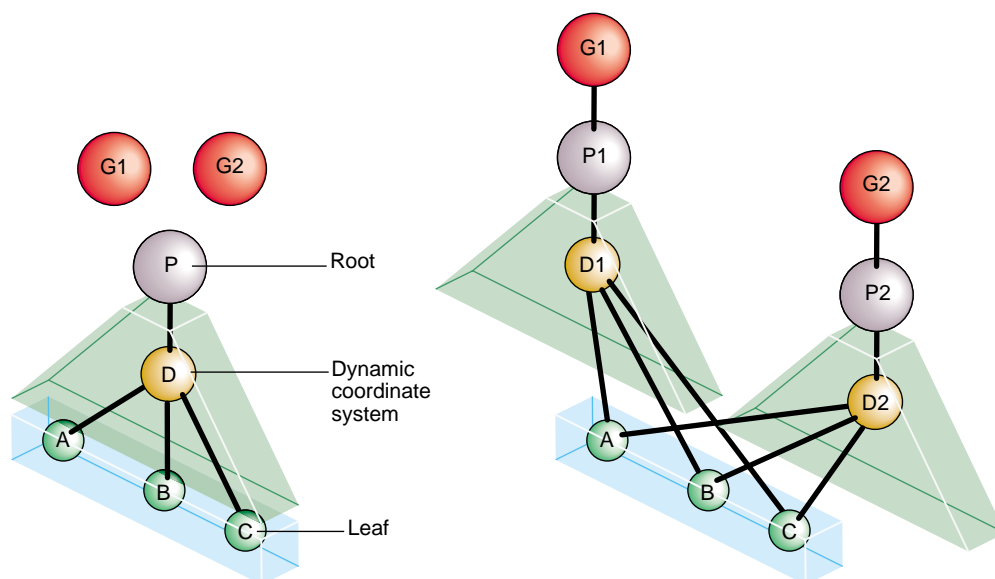

Figure 3-3 Cloned Instancing

The cloned instancing operation constructs new copies of each internal node of the shared hierarchy, but uses the same shared instance of all the leaf nodes. In use, this is an important distinction, because the number of internal nodes may be relatively few, while the number and content of geometry-containing leaf nodes is often quite extensive.

Nodes G1 and G2 in Figure 3-3 are the groups that form the root nodes after the *cloned instancing* operation is complete. Node P is the parent or root node of the instanced object, and D is a dynamic coordinate system contained within it. Nodes A, B, and C are the leaf geometry nodes; they are shared rather than copied.

The code in Example 3-3 shows how to create cloned instances.

Example 3-3 Creating Cloned Instances

```

pfGroup *g1, *g2, *p;
pfDCS *d;
pfGeode *a, *b, *c;

...
/* Create initial instance of scene hierarchy of p under
 * group g1: add a DCS to p, then add three pfGeode nodes
 * under the DCS.
 */
pfAddChild(g1,p);
pfAddChild(p,d);
pfAddChild(d,a);
pfAddChild(d,b);
pfAddChild(d,c);

...
/* Create cloned instance version of p under g2 */
pfAddChild(g2, pfClone(p,0));
/* Notice that pfGeodes are cloned by instancing rather than
 * copying. Also notice that the second argument to
 * pfClone() is 0; that argument is currently required by
 * OpenGL Performer to be zero.
 */
...

```

Bounding Volumes

The `libpf` library uses bounding volumes for culling and to improve intersection performance. `libpf` computes bounding volumes for all nodes in a database hierarchy unless the bound is explicitly set by the application. The bounding volume of a branch node encompasses the spatial extent of all its children. `libpf` automatically recomputes bounds when children are modified.

By default, bounding volumes are *dynamic*; that is, `libpf` automatically recomputes them when children are modified. For instance, in Example 3-4 when the DCS is rotated, nothing more needs to be done to update the bounding volume for `g1`.

Example 3-4 Automatically Updating a Bounding Volume

```

pfAddChild(g1,dcs);
pfAddChild(dcs, helicopter);

```

```
...  
pfDCSRot(dcs, heading+10.0f, pitch,roll);  
...  
pfDCSRot(dcs, heading, pitch - 5.0f, roll + 2.0f);
```

In some cases, you may not want bounding volumes to be recomputed automatically. For example, in a merry-go-round with horses moving up and down, you know that the horses stay within a certain volume. Using **pfNodeBSphere()**, you can specify a bounding sphere within which the horse always remains and tell OpenGL Performer that the bounding volume is “static”—not to be updated no matter what happens to the node’s children. You can always force an update by setting the bounding volume to NULL with **pfNodeBSphere()**, as follows:

```
pfNodeBSphere(node, NULL, NULL, PFBOUND_STATIC);
```

At the lowest level, within **pfGeoSets**, bounding volumes are maintained as axially-aligned boxes. When you add a **pfGeoSet** to a **pfGeode** or directly invoke **pfGetGSetBBox()** on the **pfGeoSet**, a bounding box is created for the **pfGeoSet**. Neither the bounding box of the **pfGeoSet** nor the bounding volume of the **pfGeode** is updated if the geometry changes inside the **pfGeoSet**. You can force an update by setting the **pfGeoSet** bounding box and then the **pfGeode** bounding volume to a NULL bounding box, as follows:

- Recompute the **pfGeoSet** bounding box from the internal geometry:

```
pfGSetBBox(gset, NULL);
```
- Recompute the **pfGeode** bounding volume from the bounding boxes of its **pfGeoSets**:

```
pfNodeBSphere(geode, NULL, PFBOUND_DYNAMIC);
```

Node Types

This section describes the node types and the functions for working with each node type.

pfScene Nodes

A pfScene is a root node that is the parent of a visual database. Use **pfNewScene()** to create a new scene node. Before the scene can be drawn, you must call **pfChanScene(*channel*, *scene*)** to attach it to a pfChannel.

Any nodes that are within the graph that is parented by a pfScene are culled and drawn once the pfScene is attached to a pfChannel. Because pfScene is a group, it uses pfGroup routines; however, a pfScene cannot be the child of any other node. The following statement adds a pfGroup to a scene:

```
pfAddChild(scene, root);
```

In the simplest case, the pfScene is the only node you need to add. Once you have a pfPipe, pfChannel, and pfScene, you have all the necessary elements for generating graphics using OpenGL Performer.

pfScene Default Rendering State

The pfScene nodes may specify a global pfGeoState that all other pfGeoStates in nodes below the pfScene will inherit from. Specification of this scene pfGeoState is done via the function **pfSceneGState()**. This functionality allows for the subtle optimization of pushing the most frequently used pfGeoState attributes for a particular scene graph into a global state and having the individual states inherit these attributes rather than specify them. This can save OpenGL Performer work during culling (by having to ‘unwrap’ fewer pfGeoStates) and thus possibly increase frame rate.

There are several database utility functions in `libpfdu` designed to help with this optimization. **pfdMakeSceneGState()** returns an ‘optimal’ pfGeoState based on a list of pfGeoStates. **pfdOptimizeGStateList()** takes an existing global pfGeoState, a new global pfGeoState, and a list of pfGeoStates that should be optimized and cause all attributes of pfGeoStates in the list of pfGeoStates to be inherited if they are the same as the attribute in the new global pfGeoState. Lastly, **pfdMakeSharedScene()** causes this optimization to happen for all of the pfGeoStates under the pfScene that was passed into the function. For more information on pfGeoStates see Chapter 8, “Geometry,” which discusses `libpr` in more detail. For more information on the creation and optimization of

databases, see Chapter 7, “Importing Databases,” which discusses building database converters and `libpfdu`.

pfSCS Nodes

A pfSCS is a branch node that represents a static coordinate system. A pfSCS node contains a fixed modeling transformation matrix that cannot be changed once it is created. pfSCS nodes are useful for positioning models within a database. For example, a house that is modeled at the origin should be placed in the world with a pfSCS because houses rarely move during program execution.

Use `pfNewSCS(matrix)` to create a new pfSCS using the transformation defined by *matrix*. To find out what matrix was used to create a given pfSCS, call `pfGetSCSMat()`.

For best graphics performance, matrices passed to pfSCS nodes (and the pfDCS node type described in the next section) should be orthonormal (translations, rotations, and uniform scales). Nonuniform scaling requires renormalization of normals in the graphics pipe. Projections and other non-affine transformations are not supported.

While pfSCS nodes are useful in modeling, using too many of them can reduce culling, rendering, and intersection performance. For this reason, `libpf` provides the `pfFlatten()` traversal. `pfFlatten()` will traverse a scene graph and apply static transformations directly to geometry to eliminate the overhead associated with managing the transformations. `pfFlatten()` is described in detail in Chapter 4, “Database Traversal.”

pfDCS Nodes

A pfDCS is a branch node that represents a dynamic coordinate system. Use a pfDCS when you want to apply an initial transformation to a node and also change the transformation during the application. Use a pfDCS to articulate moving parts and to show object motion.

Use `pfNewDCS()` to create a new pfDCS. The initial transformation of a pfDCS is the *identity matrix*. Subsequent transformations are set by specifying a new transformation matrix, or by replacing the rotation, scale, or translation in the current transformation matrix. The pfDCS transforms each child $C(i)$ to $C(i)*Scale*Rotation*Translation$.

Table 3-3 lists functions for manipulating a pfDCS, including rotating, scaling, and translating the children of the pfDCS.

Table 3-3 pfDCS Transformations

Function Name	Description
pfNewDCS()	Create a new pfDCS node.
pfDCSTrans()	Set the translation coordinates to x, y, z .
pfDCSRot()	Set the rotation transformation to h, p, r .
pfDCSCoord()	Rotate and translate by <i>coord</i> .
pfDCSScale()	Scale by a uniform scale factor.
pfDCSMat()	Use a matrix for transformations.
pfGetDCSMat()	Retrieve the current matrix for a given pfDCS.

pfFCS Nodes

A pfFCS is a branch node that represents a flux coordinate system. The transformation matrix of a pfFCS is contained in the pfFlux which is linked to it. This linkage allows a pfEngine to animate the matrix of a pfFCS. The linkage also allows multiple pfFCSs to share the same transformation.

Use **pfNewFCS(*flux*)** to create a new pfFCS linked to *flux*.

Table 3-4 lists functions for manipulating a pfFCS. pfFCS, pfFlux, and pfEngine are fully described in Chapter 19, “Dynamic Data.”

Table 3-4 pfFCS Functions

Function	Description
pfNewFCS()	Create a new pfFCS node.
pfFCSFlux()	Link a flux to a given pfFCS.
pfGetFCSFlux()	Get a pointer to the flux linked to a given pfFCS.

Table 3-4 pfFCS Functions (continued)

Function	Description
<code>pfGetFCSMat()</code>	Retrieve the current matrix for a given pfFCS.
<code>pfGetFCSMatPtr()</code>	Get a pointer to the current matrix for a given pfFCS.

pfDoubleSCS Nodes

The pfDoubleSCS nodes are double-precision versions of pfSCS nodes. Instead of storing a pfMatrix, they store a pfMatrix4d, a 4x4 matrix of double-precision numbers.

See the section “pfDoubleDCS Nodes” for a discussion on using double-precision matrix nodes.

pfDoubleDCS Nodes

pfDoubleDCS nodes are double-precision versions of pfDCS nodes. Instead of a pfMatrix, they maintain a pfMatrix4d, a 4x4 matrix of double-precision numbers.

Double-precision nodes are useful for modeling and rendering objects very far from the origin of the database. The following example demonstrates how double-precision nodes help. Consider a model of the entire Earth and visualize a model of a car moving on the surface of the Earth. Placing the origin of the Earth model in the center of the Earth makes the car object on the surface of the Earth very far from the origin. In Figure 3-4, the distance from the center of the Earth to the car or to the camera is larger than D , and the distance from the viewer to the car is d . D is very large; therefore, single-precision floating point numbers cannot express small changes in the car position. The motion of the car will be shaky and unsmooth.

One potential solution for the shaky car motion is to use double-precision matrices in OpenGL. Unfortunately, the underlying hardware implementation does not support double-precision values. All values are converted to single-precision floating point numbers and OpenGL Performer cannot eliminate the shaky motion.

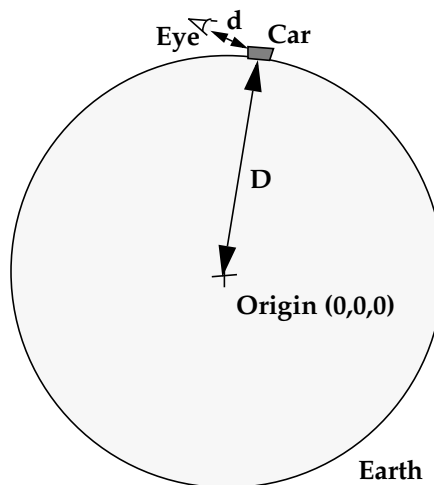

Figure 3-4 A Scenario for Using Double-Precision Nodes

In order to solve the shaky motion problem, we observe the following: we usually want to see small translations of an object when the camera is fairly close to that object. If we look at the car from 200 miles away, we do not care to see a 10-inch translation in its position. Therefore, if we could dynamically drag the origin with the camera, then any object will be close enough to the origin when the camera is near it, which is exactly when we want to see its motion smoothly.

Double-precision matrix nodes (`pfDoubleSCS`, `pfDoubleDCS`, and `pfDoubleFCS`) allow modeling with a dynamic origin. We start by setting the `pfChannel` viewing matrix to the identity matrix. This puts the channel eyepoint in the origin. We create a scene graph as in Figure 3-5. Each `pfGeode` represents a tile of the Earth surface. We model each tile with a local origin somewhere within the tile.

Each of the `pfDoubleDCS` nodes above the `pfGeode` nodes contains a transformation that sends the node under it to its correct position around the globe. We set the transformation in the `pfDoubleDCS` node marked `EYE` to the inverse of the matrix taking an object to the true camera position. This transforms all nodes under `EYE` to a coordinate system with the eyepoint in the origin.

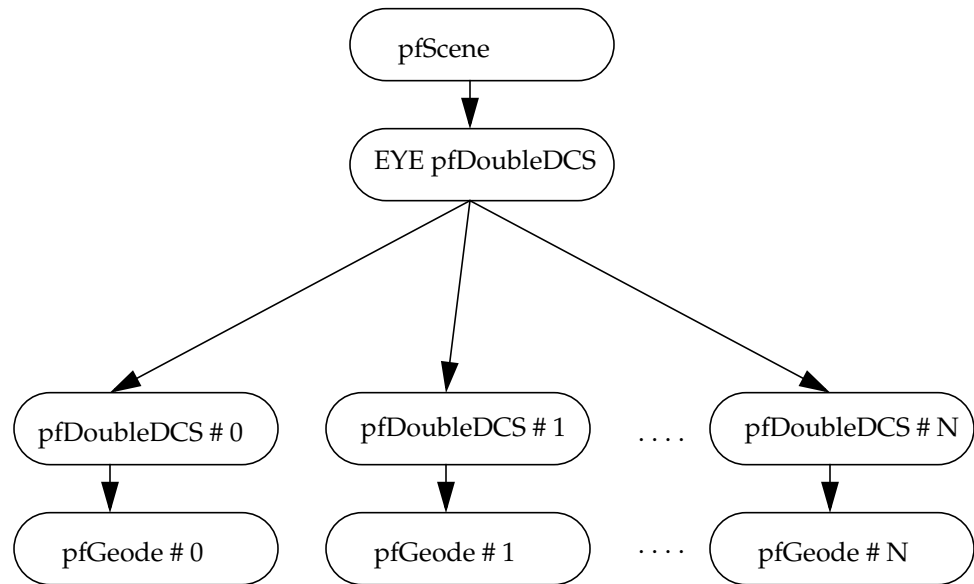

Figure 3-5 pfDoubleDCS Nodes in a Scene Graph

In more practical terms, we set the channel camera position to the origin with the following call:

```
pfChanViewMat(chan, pfIdentMat);
```

The following code fragment loads the EYE pfDoubleDCS node with the correct matrix. We call the function with EYE as the first parameter and the camera position in the second parameter:

```
void
loadViewingMatrixOnDoubleDCS (pfDoubleDCS *ddcs, pfCoordd *coord)
{
    pfMatrix4d          mat, invMat;

    pfMakeCoorddMat4d (mat, coord);
    pfInvertOrthoNMat4d (invMat, mat);
    pfDoubleDCSMat (ddcs, invMat);
}
```

pfDoubleFCS Nodes

A pfDoubleFCS node is similar to a pfFCS node. Instead of a single-precision matrix, it maintains a pfFlux with a double-precision matrix. See “pfDoubleDCS Nodes” for information on using pfDoubleFCS nodes.

pfSwitch Nodes

A pfSwitch is a branch node that selects one, all, or none of its children. Use **pfNewSwitch()** to return a handle to a new pfSwitch. To select all the children, use the PFSWITCH_ON argument to **pfSwitchVal()**. Deselect all the children (turning the switch off) using PFSWITCH_OFF. To select a single child, give the index of the child from the child list. To find out the current value of a given switch, call **pfGetSwitchVal()**. Example 3-5 (in the “pfSequence Nodes” section) illustrates a use of pfSwitch nodes to control pfSequence nodes.

pfSequence Nodes

A pfSequence is a pfGroup that sequences through a range of its children, drawing each child for a specified duration. Each child in a sequence can be thought of as a frame in an animation. A sequence can consist of any number of children, and each child has its own duration. You can control whether an entire sequence repeats from start to end, repeats from end to start, or terminates.

Use **pfNewSeq()** to create and return a handle to a new pfSequence. Once the pfSequence has been created, use the group function **pfAddChild()** to add the children that you want to animate.

Table 3-5 describes the functions for working with pfSequences.

Table 3-5 pfSequence Functions

Function	Description
pfNewSeq()	Create a new pfSequence node.
pfSeqTime()	Set the length of time to display a frame.
pfGetSeqTime()	Find out the time allotted for a given frame.

Table 3-5 pfSequence Functions (continued)

Function	Description
<code>pfSeqInterval()</code>	Set the range of frames and sequence type.
<code>pfGetSeqInterval()</code>	Find out interval parameters.
<code>pfSeqDuration()</code>	Control the speed and number of repetitions of the entire sequence.
<code>pfGetSeqDuration()</code>	Retrieve speed and repetition information for the sequence.
<code>pfSeqMode()</code>	Start, stop, pause, and resume the sequence.
<code>pfGetSeqMode()</code>	Find out the sequence's current mode.
<code>pfGetSeqFrame()</code>	Get the current frame.

Example 3-5 demonstrates a possible use of both switches and sequences. First, sequences are set up to contain animation sequences for explosions, fire, and smoke; then a switch is used to control which sequences are currently active.

Example 3-5 Using pfSwitch and pfSequence Nodes

```

pfSwitch *s;
pfSequence *explosion1_seq, *explosion2_seq, *fire_seq,
           *smoke_seq;

...
s = pfNewSwitch();
explosion1_seq = pfNewSeq();
explosion2_seq = pfNewSeq();
fire_seq = pfNewSeq();
smoke_seq = pfNewSeq();

pfAddChild(s, explosion1_seq);
pfAddChild(s, explosion2_seq);
pfAddChild(s, fire_seq);
pfAddChild(s, smoke_seq);
pfSwitchVal(s, PFSWITCH_OFF);
...
if (direct_hit)
{
    pfSwitchVal(s, PFSWITCH_ON); /* Select all sequences */

    /* Set first explosion sequence to go double normal
       * speed and repeat 3 times. */

```

```
    pfSeqMode(explosion1_seq, PFSEQ_START);
    pfSeqDuration(explosion1_seq, 2.0f, 3);

    /* Set second explosion sequence to display first child
     * of sequence for 2 seconds before continuing. */
    pfSeqMode(explosion2_seq, PFSEQ_START);
    pfSeqTime(explosion2, 0.0f, 2.0f);

    /* Set fire to wait on first frame of sequence until .3
     * seconds after second explosion. */
    pfSeqMode(fire_seq, PFSEQ_START);
    pfSeqTime(fire_seq, 0.0f, 2.3f);

    /* Set smoke to wait until .1 seconds after fire. */
    pfSeqMode(smoke_seq, PFSEQ_START);
    pfSeqTime(smoke_seq, 0.0f, 2.4f);
}
else if (explosion && (expl_type == 0))
{
    pfSeqMode(explosion1_seq, PFSEQ_START);
    pfSwitchVal(s, 0);
}
else if (explosion && (expl_type == 1))
{
    pfSeqMode(explosion2_seq, PFSEQ_START);
    pfSwitchVal(s, 1);
}
else if (fire_is_burning)
{
    pfSeqMode(fire_seq, PFSEQ_START);
    pfSwitchVal(s, 2);
}
else if (smoking)
{
    pfSeqMode(smoke_seq, PFSEQ_START);
    pfSwitchVal(s, 3);
}
else
    pfSwitchVal(s, PFSWITCH_OFF);
...
```

pfLOD Nodes

A pfLOD is a level-of-detail node. Level-of-detail switching is an advanced concept that is discussed in Chapter 5, “Frame and Load Control.” A level-of-detail node specifies how its children are to be displayed, based on the visual range from the channel’s viewpoint. Each child has a defined range, and the entire pfLOD has a defined center.

Table 3-6 describes the functions for working with pfLODs.

Table 3-6 pfLOD Functions

Function	Description
pfNewLOD()	Create a level of detail node.
pfLODRange()	Set a range at which to use a specified child node.
pfGetLODRange()	Find out the range for a given node.
pfLODCenter()	Set the pfLOD center.
pfGetLODCenter()	Retrieve the pfLOD center.
pfLODTransition()	Set the width of a specified transition.
pfGetLODTransition()	Get the width of a specified transition.

pfASD Nodes

The pfASD nodes handle dynamic generation and morphing of the visible part of a surface based on multiple LODs. pfASD nodes allow for the smooth LOD transition of large and complex surfaces, such as large area terrain. For information on pfASD nodes, see Chapter 20, “Active Surface Definition.”

pfLayer Nodes

A pfLayer is a leaf node that resolves the visual priority of coplanar geometry. A pfLayer allows the application to define a set of *base geometry* and a set of *layer geometry* (sometimes called *decal geometry*). The base geometry and the decal geometry should be coplanar, and the decal geometry must lie within the extent of the base polygons.

Table 3-7 describes the functions for working with `pfLayers`.

Table 3-7 `pfLayer` Functions

Function	Description
<code>pfNewLayer()</code>	Create a <code>pfLayer</code> node.
<code>pfLayerMode()</code>	Specify a hardware mode to use in drawing decals.
<code>pfGetLayerMode()</code>	Get the current mode.
<code>pfLayerBase()</code>	Specify the child containing base geometry.
<code>pfGetLayerBase()</code>	Find out which child contains base geometry.
<code>pfLayerDecal()</code>	Specify the child containing decal geometry.
<code>pfGetLayerDecal()</code>	Find out which child contains decal geometry.

The `pfLayer` nodes can be used to overlay any sort of markings on a given polygon and are important to avoid *flimmering*. Example 3-6 demonstrates how to display runway markings as a decal above a coplanar runway. This example uses the performance mode `PFDECAL_BASE_FAST` for layering; as described in the `pfLayer` and `pfDecal` man pages, other available modes are `PFDECAL_BASE_HIGH_QUALITY`, `PFDECAL_BASE_DISPLACE`, and `PFDECAL_BASE_STENCIL`.

Example 3-6 Marking a Runway with a `pfLayer` Node

```
pfLayer *layer;
pfGeode *runway, *runway_markings;

...
/* avoid flimmering of runway and runway_markings */
layer = pfNewLayer();
pfLayerBase(layer, runway);
pfLayerDecal(layer, runway_markings);
pfLayerMode(layer, PFDECAL_BASE_FAST);
```

pfGeode Nodes

The `pfGeode` node is short for geometry node and is the primary node for defining geometry in `libpf`. A `pfGeode` contains a list of geometry structures called `pfGeoSets`, which are part of the OpenGL Performer `libpr` library. `pfGeoSets` encapsulate graphics

state and geometry and are described in the section, “pfGeoSet (Geometry Set)” in Chapter 8. It is important to understand that pfGeoSets are not nodes but are simply elements of a pfGeode.

Table 3-8 describes the functions for working with pfGeodes.

Table 3-8 pfGeode Functions

Function	Description
pfNewGeode()	Create a pfGeode.
pfAddGSet()	Add a pfGeoSet.
pfRemoveGSet()	Remove a pfGeoSet.
pfInsertGSet()	Insert a pfGeoSet.
pfReplaceGSet()	Replace a pfGeoSet.
pfGetGSet()	Supply a pointer to the specified pfGeoSet.
pfGetNumGSets()	Determine how many pfGeoSets are in the given pfGeode.

Example 3-7 shows how to attach several pfGeoSets to a pfGeode.

Example 3-7 Adding pfGeoSets to a pfGeode

```
pfGeode *carl;
pfGeoSet *muffler, *frame, *windows, *seats, *tires;

muffler = read_in_muffler_geometry();
frame = read_in_frame_geometry();
seats = read_in_seat_geometry();
tires = read_in_tire_geometry();

pfAddGSet(carl, muffler);
pfAddGSet(carl, frame);
pfAddGSet(carl, seats);
pfAddGSet(carl, tires);
...
```

pfText Nodes

A `pfText` node is a `libpf` leaf node that contains a set of `libpr` `pfStrings` that should be rendered based on the `libpf` cull and draw traversals. In this sense, a `pfText` is similar to a `pfGeode` except that it renders 3D text through the `libpr` `pfString` and `pfFont` mechanisms rather than rendering standard 3D geometry via `libpr` `pfGeoSet` and `pfGeoState` functionality. `pfText` nodes are useful for displaying 3D text and other collections of geometry from a fixed index list. Table 3-9 lists the major `pfText` functions.

Table 3-9 `pfText` Functions

Function	Description
<code>pfNewText()</code>	Create a <code>pfText</code> .
<code>pfAddString()</code>	Add a <code>pfString</code> .
<code>pfRemoveString()</code>	Remove a <code>pfString</code> .
<code>pfInsertString()</code>	Insert a <code>pfString</code> .
<code>pfReplaceString()</code>	Replace a <code>pfString</code> .
<code>pfGetString()</code>	Supply a pointer to the specified <code>pfString</code> .
<code>pfGetNumStrings()</code>	Determine how many <code>pfStrings</code> are in the given <code>pfText</code> .

Using the `pfText` facility is easy. Example 3-8 shows how a `pfFont` is defined, how `pfStrings` are created that reference that font, and then how those `pfStrings` are added to a `pfText` node for display. See the description of `pfStrings` and `pfFonts` in Chapter 8, “Geometry,” for information on setting up individual strings to input into a `pfText` node.

Example 3-8 Adding `pfStrings` to a `pfText`

```
int nStrings,i;
char tmpBuf[8192];
char fontName[128];
pfFont *fnt = NULL;
/* Create a new text node
pfText *txt = pfNewText();

/* Read in font using libpfdu utility function */
scanf("%s",fontName);
fnt = pfdLoadFont("type1",fontName,PFDFONT_EXTRUDED);
```

```
/* Cant render pfText or libpr pfString without a pfFont */
if (fnt == NULL)
    pfNotify(PFNFY_WARN,PFNFY_PRINT,
            "No Such Font - %s\n",fontName);

/* Read nStrings text strings from standard input and */
/* Attach them to a pfText */
scanf("%d",&nStrings);
for(i=0;i<nStrings;i++)
{
    char c;
    int j=0;
    int done = 0;
    pfString *curStr = NULL;

    while(done < 2) /* READ STRING - END on '||' */
    {
        c = getchar();
        if (c == '|')
            done++;
        else
            done = 0;
        tmpBuf[j++] = c;
    }
    tmpBuf[PF_MAX2(j-2,0)] = '\0';

/* Create new libpr pfString structure to attach to pfText */
    curStr = pfNewString(pfGetSharedArena());

/* Set the font for the libpr pfString */
    pfStringFont(curStr, fnt);

/* Assign the char string to the pfString */
    pfStringString(curStr, tmpBuf);

/* Add this libpr pfString to the pfText node */
/* Like adding a libpr pfGeoSet to a pfGeode */
    pfAddString(txt, curStr);
}
pfAddChild(SceneGroup, txt);
```

pfBillboard Nodes

A pfBillboard is a pfGeode that rotates its children's geometry to follow the view direction or the eyepoint. Billboards are useful for portraying complex objects that are roughly symmetrical in one or more axes. The billboard rotates to always present the same image to the viewer using far fewer polygons than a solid model uses. In this way, billboards reduce both transformation and pixel fill demands on the graphics subsystem at the expense of some additional host processing. A classic example is a textured billboard of a single quadrilateral representing a tree.

Because a pfBillboard is also a pfGeode, you can pass a pfBillboard argument to any pfGeode routine. To add geometry, call **pfAddGSet()** (see "pfGeode Nodes" on page 71). Each pfGeoSet in the pfBillboard is treated as a separate piece of billboard geometry; each one turns so that it always faces the eyepoint.

The pfBillboards can be either constrained to rotate about an axis, as is done for a tree or a lamp post, or constrained only by a point, as when simulating a cloud or a puff of smoke. Specify the rotation mode by calling **pfBboardMode()**; specify the rotational axis by calling **pfBboardAxis()**. Since rotating the geometry to the eyepoint does not fully constrain the orientation of a point-rotating billboard, modes are available to use the additional degree of freedom to align the billboard in eye space or world space. Usually the normals of billboards are specified to be parallel to the rotational axis to avoid lighting anomalies.

The **pfFlatten()** function is highly recommended for billboards. If a billboard lies beneath a pfSCS or pfDCS, an additional transformation is done for each billboard. This can have a substantial performance impact on the cull process, where billboards are transformed.

Table 3-10 describes the functions for working with pfBillboards.

Table 3-10 pfBillboard Functions

Function	Description
pfNewBboard()	Create a pfBillboard node.
pfBboardPos()	Set a billboard's position.
pfGetBboardPos()	Find out a billboard's position.
pfBboardAxis()	Specify the rotation or alignment axis.
pfGetBboardAxis()	Find out the rotation or alignment axis.

Table 3-10 pfBillboard Functions (continued)

Function	Description
<code>pfBboardMode()</code>	Specify a billboard's rotation type.
<code>pfGetBboardMode()</code>	Find out a billboard's rotation type.

Example 3-9 demonstrates the construction of a pfBillboard node. The code can be found in `/usr/share/Performer/src/pguide/libpf/C/billboard.c` for IRIX and Linux and in `%PFROOT%\Src\pguide\libpf\C\billboard.c` for Microsoft Windows.

Example 3-9 Setting Up a pfBillboard

```
static pfVec2 BBTexCoords[] = {{0.0f, 0.0f},
                               {1.0f, 0.0f},
                               {1.0f, 1.0f},
                               {0.0f, 1.0f}};

static pfVec3 BBVertCoords[4] = /* XZ plane for pt bboards */
    {{-0.5f, 0.0f, 0.0f},
     { 0.5f, 0.0f, 0.0f},
     { 0.5f, 0.0f, 1.0f},
     {-0.5f, 0.0f, 1.0f}};

static pfVec3 BBAxes[4] = {{1.0f, 0.0f, 0.0f}, /* X */
                          {0.0f, 1.0f, 0.0f}, /* Y */
                          {0.0f, 0.0f, 1.0f}, /* Z */
                          {0.0f, 0.0f, 1.0f}}; /*world Zup*/

static int BBPrimLens[] = { 4 };

static pfVec4 BBColors[] = {{1.0, 1.0, 1.0, 1.0}};

/* Convert static data to pfMalloc'ed data */
static void*
memdup(void *mem, size_t bytes, void *arena)
{
    void *data = pfMalloc(bytes, arena);
    memcpy(data, mem, bytes);
    return data;
}
```

```

/* For pedagogical use only. Reasonable performance
 * requires more then one pfGeoSet per pfBillboard.
 */

pfBillboard*
MakeABill(pfVec3 pos, pfGeoState *gst, long bbType)
{
    pfGeoSet *gset;
    pfGeoState *gstate;
    pfBillboard *bill;
    void *arena = pfGetSharedArena();

    gset = pfNewGSet(arena);
    gstate = pfNewGState(arena);

    pfGStateMode(gstate, PFSTATE_ENLIGHTING, PF_OFF);
    pfGStateMode(gstate, PFSTATE_ENTEXTURE, PF_ON);
    /*... Create/load texture map for billboard... */
    pfGStateAttr(gstate, PFSTATE_TEXTURE, texture);
    pfGSetGState(gset, gstate);

    pfGSetAttr(gset, PFGS_COORD3, PFGS_PER_VERTEX,
               memdup(BBVertCoords, sizeof(BBVertCoords), arena),
               NULL);
    pfGSetAttr(gset, PFGS_TEXCOORD2, PFGS_PER_VERTEX,
               memdup(BBTexCoords, sizeof(BBTexCoords), arena),
               NULL);

    pfGSetAttr(gset, PFGS_COLOR4, PFGS_OVERALL,
               memdup(BBColors, sizeof(BBColors), arena),
               NULL);

    pfGSetPrimLengths(gset,
                      (int*)memdup(BBPrimLens, sizeof(BBPrimLens), arena));
    pfGSetPrimType(gset, PFGS_QUADS);
    pfGSetNumPrims(gset, 1);
    pfGSetGState(gset, gst);

    bill = pfNewBboard();
    switch (bbType)
    {
    case PF_X: /* axial rotate */
    case PF_Y:
    case PF_Z:
        pfBboardAxis(bill, BBAxes[bbType]);
    }
}

```

```
        pfBboardMode(bill, PFBB_ROT, PFBB_AXIAL_ROT);
        break;
    case 3: /* point rotate */
        pfBboardAxis(bill, BBAxes[bbType]);
        pfBboardMode(bill, PFBB_ROT, PFBB_POINT_ROT_WORLD);
        break;
    }
    pfAddGSet(bill, gset);
    pfBboardPos(bill, 0, pos);

    return bill;
}
```

pfPartition Nodes

A pfPartition is a pfGroup that organizes the scene graphs of its children into a static data structure that can be more efficient for intersections. Currently, partitions are only useful for data that lies more or less on an XY plane, such as terrain. Therefore, a pfPartition would be inappropriate for a skyscraper model.

Partition construction comes in two phases. After a piece of the scene graph has been placed under the pfPartition, **pfBuildPart()** examines the spatial arrangement of geometry beneath the pfPartition and determines an appropriate origin and spacing for the grid. Because the search is exhaustive, this examination can be time-consuming the first time through. Once a good partitioning is determined, the search space can be restricted for future database loads using the partition attributes.

The second phase is invoked by **pfUpdatePart()**, which distributes the pfGeoSets under the pfPartition into cells in the spatial partition created by **pfBuildPart()**. **pfUpdatePart()** needs to be called if any geometry under the pfPartition node changes.

During intersection traversal, the segments in a pfSegSet (see “Intersection Requests: pfSegSets” in Chapter 4) are scan-converted onto the grid, yielding faster access to those pfGeoSets that potentially intersect the segment. A pfPartition can be made to function as a normal pfGroup during intersection traversal by ORing PFTRAV_IS_NO_PART into the intersection traversal mode in the pfSegSet.

Table 3-11 describes the functions for working with pfPartitions.

Table 3-11 pfPartition Functions

Function	Description
pfNewPart()	Create a pfPartition.
pfPartVal()	Set the desired pfPartition value.
pfGetPartVal()	Find out the attributes of the specified value.
pfPartAttr()	Set the desired pfPartition attribute.
pfGetPartAttr()	Find out the attributes of specified the attribute.
pfBuildPart()	Construct a spatial partitioning based on the attributes.
pfUpdatePart()	Traverse the partition's children and incorporate changes.
pfGetPartType()	Determine what kind of partition is being used.

Example 3-10 demonstrates setting up and using a pfPartition node.

Example 3-10 Setting Up a pfPartition

```

pfGroup *terrain;
pfPartition *partition;
pfScene *scene;

...

terrain = read_in_grid_aligned_terrain();

...

/* create a default partitioning of a terrain grid */
partition = pfNewPart();
pfAddChild(scene, partition);
pfAddChild(partition, terrain);
pfBuildPart(partition);

...

/* use the partitions to perform efficient intersections
 * of sets of segments with the terrain */
for(i = 0; i < numVehicles; i++)

```

```
        pfNodeIsectSegs(partition, vehicle_segment_set[i],
                        hit_struct);
    ...
```

Sample Program

The sample program shown in Example 3-11 demonstrates scene graph construction, shared instancing, and transformation inheritance. The program uses OpenGL Performer objects and functions that are described fully in later chapters.

This program reads the names of two objects from the command line, although defaults are supplied if file names are not given. These files are loaded and a second instance of each object is created. In each case, this instance is made to orbit the original object, and the second pair are also placed in orbit around the first. This program is `inherit.c` and is part of the suite of *OpenGL Performer Programmer's Guide* example programs.

Example 3-11 Inheritance Demonstration Program

```
/*
 * inherit.c - transform inheritance example
 */

#include <math.h>
#include <Performer/pf.h>
#include <Performer/pfdu.h>

int
main(int argc, char *argv[])
{
    pfPipe *pipe;
    pfPipeWindow *pw;
    pfScene *scene;
    pfChannel *chan;
    pfCoord view;
    float z, s, c;
    pfNode *model1, *model2;
    pfDCS *node1, *node2;
    pfDCS *dcs1, *dcs2, *dcs3, *dcs4;
    pfSphere sphere;
    char *file1, *file2;

    /* choose default objects of none specified */
```



```
file1 = (argc > 1) ? argv[1] : "blob.nff";
file2 = (argc > 1) ? argv[1] : "torus.nff";

/* Initialize Performer */
pfInit();

pfFilePathv(
    ".",
    "./data",
    "../data",
    "../../data",
    "../../../data",
    "../../../../data",
    "/usr/share/Performer/data",
    NULL);

/* Single thread for simplicity */
pfMultiprocess(PFMP_DEFAULT);

/* Load all loader DSO's before pfConfig() forks */
pfdInitConverter(file1);
pfdInitConverter(file2);

/* Configure */
pfConfig();

/* Load the files */
if ((modell = pfdLoadFile(file1)) == NULL)
{
    pfExit();
    exit(-1);
}
if ((model2 = pfdLoadFile(file2)) == NULL)
{
    pfExit();
    exit(-1);
}

/* scale models to unit size */
node1 = pfNewDCS();
pfAddChild(node1, modell);
pfGetNodeBSphere(modell, &sphere);
if (sphere.radius > 0.0f)
    pfDCSScale(node1, 1.0f/sphere.radius);
```

```
node2 = pfNewDCS();
pfAddChild(node2, model2);
pfGetNodeBSphere(model2, &sphere);
if (sphere.radius > 0.0f)
    pfDCSScale(node2, 1.0f/sphere.radius);

/* Create the hierarchy */
dcs4 = pfNewDCS();
pfAddChild(dcs4, node1);
pfDCSScale(dcs4, 0.5f);

dcs3 = pfNewDCS();
pfAddChild(dcs3, node1);
pfAddChild(dcs3, dcs4);

dcs1 = pfNewDCS();
pfAddChild(dcs1, node2);

dcs2 = pfNewDCS();
pfAddChild(dcs2, node2);
pfDCSScale(dcs2, 0.5f);
pfAddChild(dcs1, dcs2);

scene = pfNewScene();
pfAddChild(scene, dcs1);
pfAddChild(scene, dcs3);
pfAddChild(scene, pfNewLSource());

/* Configure and open GL window */
pipe = pfGetPipe(0);
pw = pfNewPWin(pipe);
pfPWinType(pw, PFPWIN_TYPE_X);
pfPWinName(pw, "OpenGL Performer");
pfPWinOriginSize(pw, 0, 0, 500, 500);
pfOpenPWin(pw);

chan = pfNewChan(pipe);
pfChanScene(chan, scene);

pfSetVec3(view.xyz, 0.0f, 0.0f, 15.0f);
pfSetVec3(view.hpr, 0.0f, -90.0f, 0.0f);
pfChanView(chan, view.xyz, view.hpr);

/* Loop through various transformations of the DCS's */
for (z = 0.0f; z < 1084; z += 4.0f)
```

```
{
    pfDCSRot(dcs1,
        (z < 360) ? (int) z % 360 : 0.0f,
        (z > 360 && z < 720) ? (int) z % 360 : 0.0f,
        (z > 720) ? (int) z % 360 : 0.0f);

    pfSinCos(z, &s, &c);
    pfDCSTrans(dcs2, 1.0f * c, 1.0f * s, 0.0f);

    pfDCSRot(dcs3, z, 0, 0);
    pfDCSTrans(dcs3, 4.0f * c, 4.0f * s, 4.0f * s);
    pfDCSRot(dcs4, 0, 0, z);
    pfDCSTrans(dcs4, 1.0f * c, 1.0f * s, 0.0f);

    pfFrame();
}

/* show objects static for three seconds */
sleep(3);

pfExit();
exit(0);
}
```

Database Traversal

Chapter 3, “Nodes and Node Types,” described the node types used by `libpf`. This chapter describes the operations that can be performed on the run-time database defined by a scene graph. These operations typically work with part or all of a scene graph and are known as *traversals* because they traverse the database hierarchy. OpenGL Performer supports four major kinds of database traversals:

- Application
- Cull
- Draw
- Intersection

The application traversal updates the active elements in the scene graph for the next frame. This includes processing active nodes and invoking user-supplied callbacks for animations or other embedded behaviors.

Visual processing consists of two basic traversals: culling and drawing. The cull traversal selects the visible portions of the database and puts them into a display list. The draw traversal then runs through that display list and sends rendering commands to the Geometry Pipeline. Once you have set up all the necessary elements, culling and drawing are automatic, although you can customize each traversal for special purposes.

The intersection traversal computes the intersection of one or more line segments with the database. The intersection traversal is user-directed. Intersections are used to determine the following:

- Height above terrain
- Line-of-sight visibility
- Collisions with database objects

Like other traversals, intersection traversals can be directed by the application through identification masks and function callbacks. Table 4-1 lists the routines and data types

relevant to each of the major traversals; more information about the listed traversal attributes can be found later in this chapter and in the appropriate man pages.

Table 4-1 Traversal Attributes for the Major Traversals

Traversal Attribute	Application PFTRAV_APP	Cull PFTRAV_CULL	Draw PFTRAV_DRAW	Intersection PFTRAV_ISECT
Controllers	pfChannel	pfChannel	pfChannel	pfSegSet
Global Activation	pfFrame() pfSync() pfAppFrame()	pfFrame()	pfFrame()	pfFrame() pfNodeIsect- Segs(), pfChan- NodeIsectSegs()
Global Callbacks	pfChanTrav- Func()	pfChanTrav- Func()	pfChanTrav- Func()	pfIsectFunc()
Activation within Callback	pfApp()	pfCull()	pfDraw()	pfFrame() pfNodeIsect- Segs(), pfChan- NodeIsectSegs()
Path Activation	N/A	pfCullPath()	N/A	N/A
Modes	pfChanTrav- Mode()	pfChanTrav- Mode()	pfChanTrav- Mode()	pfSegSet (also discriminator callback)
Node Callbacks	pfNodeTrav- Funcs()	pfNodeTrav- Funcs()	pfNodeTrav- Funcs()	pfNodeTrav- Funcs()
Traverser Masks	pfChanTrav- Mask()	pfChanTrav- Mask()	pfChanTrav- Mask()	pfSegSet mask
Traversee Masks	pfNodeTrav- Mask()	pfNodeTrav- Mask()	pfNodeTrav- Mask()	pfNodeTrav- Mask() pfGSetIsect- Mask()

Scene Graph Hierarchy

A visual database, also known as a *scene*, contains state information and geometry. A scene is organized into a hierarchical structure known as a *graph*. The graph is composed of connected database units called nodes. Nodes that are attached below other nodes in the tree are called *children*. Children belong to their *parent* node. Nodes with the same parent are called *siblings*.

Database Traversals

The scene hierarchy supplies definitions of how items in the database relate to one another. It contains information about the logical and spatial organization of the database. The scene hierarchy is processed by visiting the nodes in depth-first order and operating on them. The process of visiting, or touching, the nodes is called *traversing* the hierarchy. The tree is traversed from top to bottom and from left to right. OpenGL Performer implements several types of database traversals, including application, clone, cull, delete, draw, flatten, and intersect. These traversals are described in more detail later in this chapter.

The principal traversals (application, cull, draw and intersect) all use a similar traversal mechanism that employs traversal masks and callbacks to control the traversal. When a node is visited during the traversal, processing is performed in the following order:

1. Prune the node based on the bitwise AND of the traversal masks of the node and the pfChannel (or pfSegSet). If pruned, traversal continues with the node's siblings.
2. Invoke the node's pre-traversal callback, if any, and either prune, continue, or terminate the traversal, depending on the callback's return value.
3. Traverse, beginning again at step 1, the node's children or geometry (pfGeoSets). If the node is a pfSwitch, a pfSequence, or a pfLOD, the state of the node affects which children are traversed.
4. Invoke the node's post-traversal callback, if any.

State Inheritance

In addition to imposing a logical and spatial ordering of the database, the hierarchy also defines how state is inherited between parent and child nodes during scene graph traversals. For example, a parent node that represents a transformation causes the

subsequent transformation of each of its children when it and they are traversed. In other words, the children inherit *state*, which includes the current coordinate transformation, from their parent node during database traversal.

A *transformation* is a 4x4 homogeneous matrix that defines a 3D transformation of geometry, which typically consist of scaling, rotation, and translation. The node types `pfSCS` and `pfDCS` both represent transformations. Transformations are inherited through the scene graph with each new transformation being concatenated onto the ones above it in the scene graph. This allows chained articulations and complex modeling hierarchies.

The effects of state are propagated downward only, not from left to right nor upward. This means that only parents can affect their children—siblings have no effect on each other nor on their parents. This behavior results in an easy-to-understand hierarchy that is well suited for high-performance traversals.

Graphics states such as textures and materials are not inherited by way of the scene graph but are encapsulated in leaf geometry nodes called `pfGeode` nodes, which are described in the section “Node Types” in Chapter 3.

Database Organization

OpenGL Performer uses the spatial organization of the database to increase the performance of certain operations such as drawing and intersections. It is therefore recommended that you consider the spatial arrangement of your database. What you might think of as a logical arrangement of items in the database may not match the spatial arrangement of those items in the visual environment, which can reduce OpenGL Performer’s ability to optimize operations on the database. See “Organizing a Database for Efficient Culling” on page 94 for more information about spatial organization in a visual database and the efficiency of database operations.

Application Traversal

The application traversal is the first traversal that occurs during the processing of the scene graph in preparation for rendering a frame. It is initiated by calling `pfAppFrame()`. If `pfAppFrame()` is not explicitly called, the traversal is automatically invoked by `pfSync()` or `pfFrame()`. An application traversal can be invoked for each channel, but usually channels share the same application traversal (see `pfChanShare()`).

The application traversal updates dynamic elements in the scene graph, such as geometric morphing. The application traversal is also often used for implementing animations or other custom processing when it is desirable to have those behaviors embedded in the scene graph and invoked by OpenGL Performer rather than requiring application code to invoke them every frame.

The traversal proceeds as described in “Database Traversals.” The selection of which children to traverse is also affected by the application traversal mode of the channel, in particular the choice of all, none, or one of the children of pfLOD, pfSequence and pfSwitch nodes is possible. By default, the traversal obeys the current selection dictated by these nodes.

The following example (this loader reads both Open Inventor and VRML files) shows a simple callback changing the transformation on a pfDCS every frame.

Example 4-1 Application Callback to Make a Pendulum

```
int
AttachPendulum(pfDCS *dcs, PendulumData *pd)
{
    pfNodeTravFuncs(dcs, PFTRAV_APP, PendulumFunc, NULL);
    pfNodeTravData(dcs, PFTRAV_APP, pd);
}

int
PendulumFunc(pfTraverser *trav, void *userData)
{
    PendulumData *pd = (PendulumData*)userData;
    pfDCS *dcs = (pfDCS*)pfGetTravNode(trav);

    if (pd->on)
    {
        pfMatrix mat;
        double now = pfGetFrameTimeStamp();
        float frac, dummy;

        pd->lastAngle += (now - pd->lastTime)*360.0f*pd->frequency;
        if (pd->lastAngle > 360.0f)
            pd->lastAngle -= 360.0f;

        // using sinusoidally generated angle
        pfSinCos(pd->lastAngle, &frac, &dummy);
        frac = 0.5f + 0.5f * frac;
        frac = (1.0f - frac)*pd->angle0 + frac*pd->angle1;
```

```
    pfMakeRotMat(mat,
        frac, pd->axis[0], pd->axis[1], pd->axis[2]);
    pfDCSMat(dcs, mat);
    pd->lastTime = now;
}

return PFTRAV_CONT;
}
```

Cull Traversal

The cull traversal occurs in the cull phase of the `libpf` rendering pipeline and is initiated by calling `pfFrame()`. A cull traversal is performed for each `pfChannel` and determines the portion of the scene to be rendered. The traversal processes the subgraphs of the scene that are both visible and selected by nodes in the scene graph that control traversal (that is, `pfLOD`, `pfSequence`, `pfSwitch`). The visibility culling itself is performed by testing bounding volumes in the scene graph against the channel's viewing frustum.

For customizing the cull traversal, `libpf` provides traversal masks and function callbacks for each node in the database, as well as a function callback in which the application can do its own culling of custom data structures.

Traversal Order

The cull is a depth-first, left-to-right traversal of the database hierarchy beginning at a `pfScene`, which is the hierarchy's root node. For each node, a series of tests is made to determine whether the traversal should *prune* the node—that is, eliminate it from further consideration—or continue on to that node's children. The cull traversal processing is much as described earlier; in particular, the draw traversal masks are compared and the node is checked for visibility before the traversal continues on to the node's children. Processing proceeds in the following order:

1. Prune the node, based on the channel's draw traversal mask and the node's draw mask.
2. Invoke the node's pre-cull callback and either prune, continue, or terminate the traversal, depending on callback's return value.
3. Prune the node if its bounding volume is completely outside the viewing frustum.

4. Traverse, beginning again at step 1, the node's children or geometry (pfGeoSets) if the node is completely or partially in the viewing frustum. If the node is a pfSwitch, a pfSequence, or a pfLOD, the state of the node affects which children are traversed.
5. Invoke the node's post-cull callback.

The following sections discuss these steps in more detail.

Visibility Culling

Culling determines whether a node is within a pfChannel's viewing frustum for the current frame. Nodes that are not visible are pruned—omitted from the list of objects to be drawn—so that the Geometry Pipeline does not waste time processing primitives that couldn't possibly appear in the final image.

Hierarchical Bounding Volumes

Testing a node for visibility compares the *bounding volume* of each object in the scene against a viewing frustum that is bounded by the near and far clip planes and the four sides of the viewing pyramid. Both nodes (see Chapter 3, “Nodes and Node Types”) and pfGeoSets (see Chapter 8, “Geometry”) have bounding volumes that surround the geometry that they contain. Bounding volumes are simple geometric shapes whose centers and edges are easy to locate. Bounding volumes are organized hierarchically so that the bounding volume of a parent encloses the bounding volumes of all its children. You can specify bounding volumes or let OpenGL Performer generate them for you (see “Bounding Volumes” in Chapter 3).

Figure 4-1 shows a frustum and three objects surrounded by bounding boxes. Two of the objects are outside the frustum; one is within it. One of the objects outside the frustum has a bounding box whose edges intersect the frustum, as shown by the shaded area. The visibility test for this object returns TRUE, because its bounding box does intersect the view frustum even though the object itself does not.

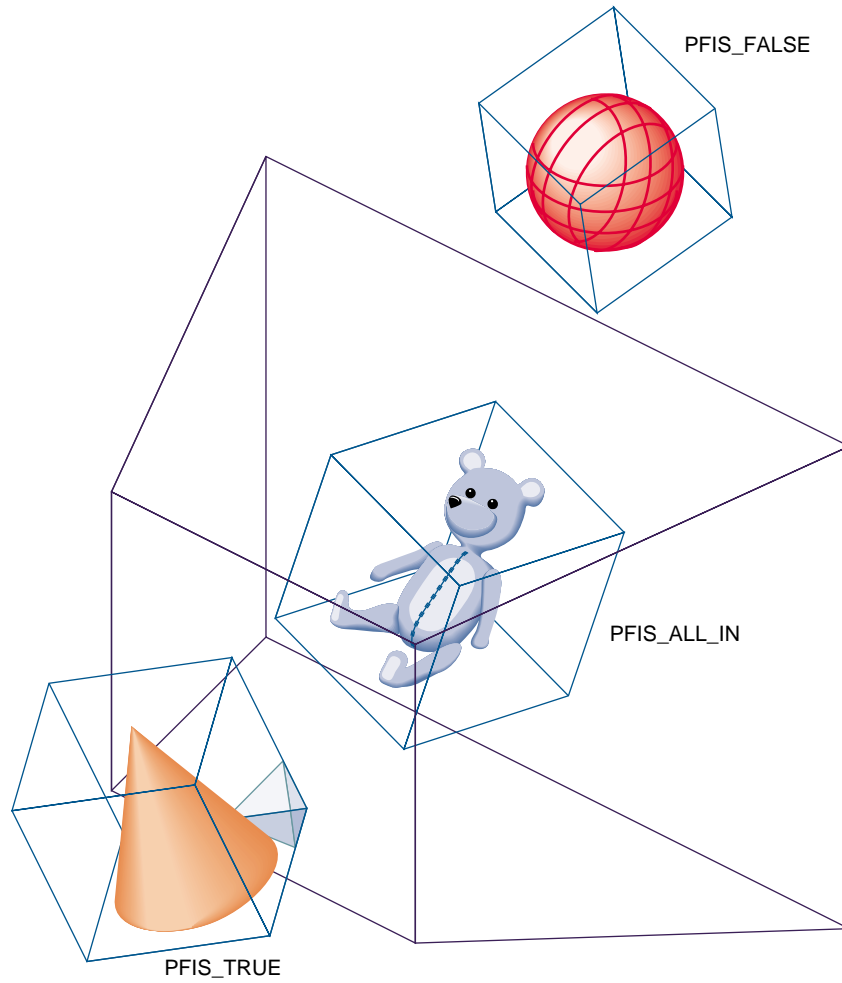

Figure 4-1 Culling to the Frustum

Visibility Testing

The cull traversal begins at the root node of a channel's scene graph (the `pfScene` node) and continues downward, directed by the results of the cull test at each node. At each node the cull test determines the relationship of the node's bounding volume to the viewing frustum. Possible results are that the bounding volume is entirely outside, is entirely within, is partially within, or completely contains the viewing frustum.

If the intersection test indicates that the bounding volume is entirely outside the frustum, the traversal prunes that node—that is, it does not consider the children of that node and continues with the node's next sibling.

If the intersection test indicates that the bounding volume is entirely inside the frustum, the node's children are not cull-tested because the hierarchical nature of bounding volumes implies that the children must also be entirely within the frustum.

If the intersection test indicates that the bounding volume is partially within the frustum, or that the bounding volume completely contains the frustum, the testing process continues with the children of that node. Because a bounding volume is larger than the object it surrounds, it is possible for a bounding volume to be partially within a frustum even when none of its enclosed geometry is visible.

By default, OpenGL Performer tests bounding volumes all the way down to the `pfGeoSet` level (see Chapter 8, "Geometry") to provide fine-grained culling. However, if your application is spending too much time culling, you can stop culling at the `pfGeode` level by calling `pfChanTravMode()`. Then if part of a `pfGeode` is potentially visible, all geometry in that `pfGeode` is drawn without cull-testing it first.

Visibility Culling Example

Figure 4-2 portrays a simple database that contains a toy block, train, and car. The block is outside the frustum, the bounding volume of the car is partially inside the frustum, and the train is completely inside the frustum.

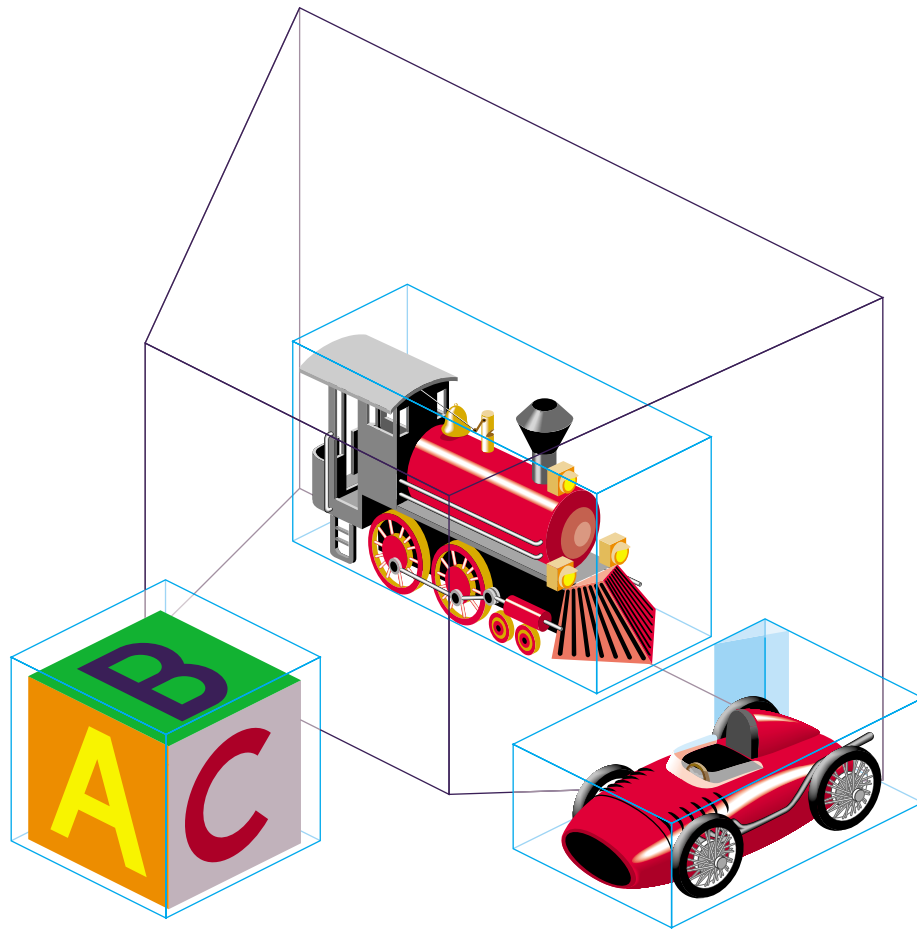

Figure 4-2 Sample Database Objects and Bounding Volumes

Organizing a Database for Efficient Culling

Efficient culling depends on having a database whose hierarchy is organized spatially. A good technique is to partition the database into regions, called *tiles*. Tiling is also required for *database paging*. Instead of culling the entire database, only the tiles that are within the view frustum need to be traversed.

The worst case for the cull traversal performance is to have a very flat hierarchy—that is, a pfScene with all the pfGeodes directly under it and many pfGeoSets in each pfGeode—or a hierarchy that is organized by object type (for example, having all trees in the database grouped under one pine tree node, rather than arranged spatially).

Figure 4-3 shows a sample database represented by cubes, cones, pyramids, and spheres. Organizing this database spatially, rather than by object type, promotes efficient culling. This type of spatial organization is the most effective control you have over efficient traversal.

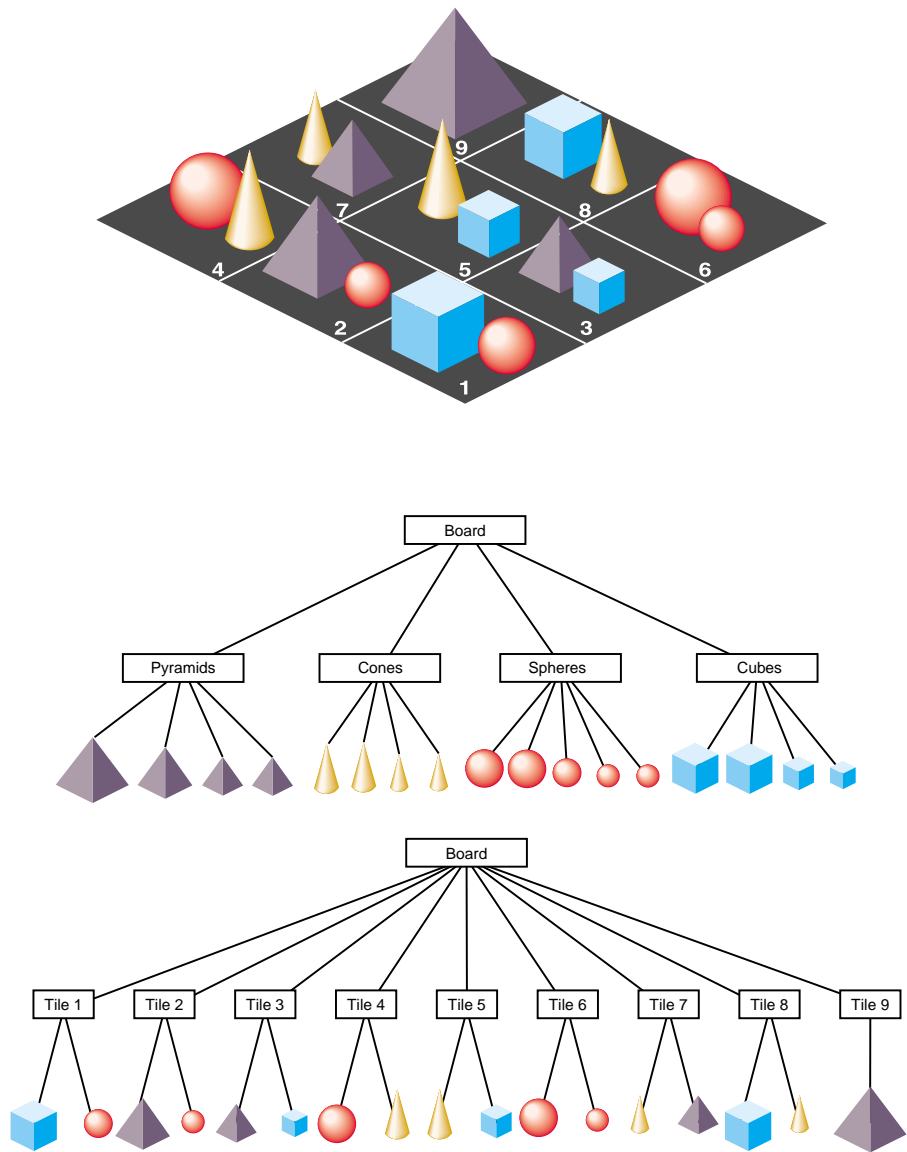

Figure 4-3 How to Partition a Database for Maximum Efficiency

When modeling a database, you should consider other trade-offs as well. Small amounts of geometry in each culling unit, whether pfGeode or pfGeoSet, provide better culling resolution and result in sending less nonvisible geometry to the pipeline. Small pieces also improve the performance of line-segment intersection inquiries (see “Database Concerns” in Chapter 24). However, using many small pieces of geometry can increase the traversal time and can also reduce drawing performance. The optimal amount of geometry to place in each pfGeoSet depends on the application, database, system CPU, and graphics hardware.

Custom Visibility Culling

Existence within the frustum is not the only criterion that determines an object’s visibility. The item may be too distant to be seen from the viewpoint, or it may be obscured by other objects between it and the viewer, such as a wall or a hill. Atmospheric conditions can also affect object visibility. An object that is normally visible at a certain distance may not be visible at that same distance in dense fog.

Implementing more sophisticated culling requires knowledge of visibility conditions and control over the cull traversal. The cull traversal can be controlled through traversal masks, which are described in the section titled “Controlling and Customizing Traversals” on page 102.

Knowing whether an object is visible requires either prior information about the spatial organization of a database, such as cell-to-cell visibilities, or run-time testing such as computing line-of-sight visibility (LOS). You can compute simple LOS visibility by intersecting line segments that start at the eyepoint with the database. See the “Intersection Traversal” on page 120.

Sorting the Scene

During the cull traversal, a pfChannel can rearrange the order in which pfGeoSets are rendered for improved performance and image quality. It does this by *binning* and *sorting*. Binning is the act of placing pfGeoSets into specific *bins*, which are rendered in a specific order. OpenGL Performer provides two default bins: one for opaque geometry and one for blended, transparent geometry. The opaque bin is drawn before the transparent bin so transparent surfaces are properly blended with the background scene. Applications are free to add new bins and specify arbitrary bin orderings.

Bins are often used to group geometry with certain desired characteristics. Sometimes it may be desirable for a pfGeoSet to be in several bins. For this purpose you can create a

sub-bin of two existing bins using the function **pfChanFindSubBin**(*bin1,bin2,int*). The parameters are the two parent bins and an integer value indicating whether the sub-bin should be created if it does not exist. The function returns a value of -1 if the bin does not exist (and it was not supposed to be created) or if any of the parent bins do not exist. If you need to create a sub-bin of more than two bins, call this function several times. For example, to create a sub-bin of bin 5, 6, and 7, you call **pfChanFindSubBin()** with parameters 5 and 6. Let us assume that sub-bin of bin 5 and 6 is bin 8. Then you call **pfChanFindSubBin()** again with parameters 8 and 7 to obtain a sub-bin of bins 5, 6, and 7. It does not matter in what order you call it because all sub-bins are directly linked to their parent root bins (and vice versa); there is no tree hierarchy. See the section “Cull Programs” on page 103 for an example of using sub-bins.

The function **pfChanFindBinParent**(*bin,int*) returns the first parent of bin *bin* that is bigger than the value specified as the second parameter. Thus, by calling this method several times (until it returns -1), you can determine all parents of a bin.

Sorting is done on a per-bin basis. **pfGeoSets** within a given bin are sorted by a specific criterion. Two useful criteria provided by OpenGL Performer are sorting by graphics state and sorting by range. When sorting by state, **pfGeoSets** are sorted first by their **pfGeoState**, then by an application-specified hierarchy of state modes, values, and attributes which are identified by **PFSTATE_*** tokens and are described in Chapter 12, “Graphics State”. State sorting can offer a huge performance advantage since it greatly reduces the number of mode changes carried out by the Geometry Pipeline. State sorting is the default sorting configuration for the opaque bin. If a bin has sub-bins, **pfGeoSets** are ordered in each sub-bin separately, as are **pfGeoSets** that do not belong to any sub-bin of the bin.

Range sorting is required for proper rendering of blended, transparent surfaces, which must be rendered in back-to-front order so that each surface is properly blended with the current background color. Front-to-back sorting is also supported. The default sorting for the transparent bin is back-to-front sorting. Note that the sorting granularity is per-**pfGeoSet**, not per-triangle so transparency sorting is not perfect.

In case of the transparent bin, the order in which **pfGeoSets** are drawn (back-to-front) is important to avoid visible artifacts. Sub-bins, even if their **pfGeoSets** were ordered back-to-front, may break that order. For this purpose, you can mark selected bins as non-exclusive. If a **pfGeoSet** belongs to a sub-bin of a non-exclusive bin, it is added both to the sub-bin and directly to the list of **pfGeoSets** of the non-exclusive bin. Thus, when **pfGeoSets** of a non-exclusive bin are sorted, they are all in one list. Any root bin can be marked non-exclusive by setting flag **PFBIN_NONEXCLUSIVE_BIN** using the function **pfChanBinFlags()**. The transparent bin is by default non-exclusive.

The pfChannel bins are given a rendering order and a sorting configuration with **pfChanBinOrder()** and **pfChanBinSort()**, respectively. A sub-bin inherits sorting configuration from a parent with the highest sort priority, set by **pfChanBinSortPriority()**. Sorting configuration of sub-bins cannot be changed using **pfChanBinOrder()**.

A bin's order is simply an integer identifying its place in the list of bins. An order less than 0 or PFSORT_NO_ORDER means that pfGeoSets that fall into the bin are drawn immediately without any ordering or sorting. Multiple bins may have the same order but the rendering precedence among these bins is undefined. The rendering order of sub-bins is determined by the child-order mask of their parents. This mask can be set by **pfChanBinChildOrderMask()**. When a sub-bin is created, the mask of all its parents is combined (using a binary OR) and set as a rendering order of the sub-bin.

A bin's sorting configuration is given as a token identifying the major sorting criterion and then an optional list of tokens, terminated with the PFSORT_END token, that defines a state sorting hierarchy. The following tokens control the sort:

PFSORT_BY_STATE

pfGeoSets are sorted first by pfGeoState then by the state elements found between the PFSORT_STATE_BGN and PFSORT_STATE_END tokens, for example.

PFSORT_FRONT_TO_BACK

pfGeoSets are sorted by nearest to farthest range from the eyepoint. Range is computed from eyepoint to the center of the pfGeoSet's bounding volume.

PFSORT_BACK_TO_FRONT

pfGeoSets are sorted by farthest to nearest range from the eyepoint. Range is computed from eyepoint to the center of the pfGeoSet's bounding volume.

PFSORT_QUICK

A special, low-cost sorting technique. pfGeoSets must fall into a bin whose order is 0 in which case they will be sorted by pfGeoState and drawn immediately. This is the default sorting mode for the PFSORT_OPAQUE_BIN bin.

For example, the following specification will sort the opaque bin by pfGeoState, then by pfTexture, then by pfMaterial:

```
static int sort[] = {PFSORT_STATE_BGN,  
                    PFSTATE_TEXTURE, PFSTATE_FRONTMTL,  
                    PFSORT_STATE_END, PFSORT_END};  
pfChanBinSort(chan, PFSORT_OPAQUE_BIN, PFSORT_BY_STATE,  
              sort);
```

A `pfGeoSet`'s draw bin may be set directly by the application with `pfGSetDrawBin()`. Otherwise, OpenGL Performer automatically determines if the `pfGeoSet` belongs in the default opaque or transparent bins. Based on the position of a `pfGeoSet` in the scene, cull programs, if they are enabled, can determine the draw bin of the `pfGeoSet`. See section "Cull Programs" on page 103 for more details.

Paths through the Scene Graph

You can define a chain, or *path*, of nodes in a scene graph using the `pfPath` data structure. (Note that a `pfPath` has nothing to do with filesystem paths as specified with the `PFPATH` environment variable or with specifying a path for a user to travel through a scene.) Once you have specified a `pfPath` with a call to `pfNewPath()`, you can traverse and cull that path as a subset of the entire scene graph using `pfCullPath()`. The function `pfCullPath()` must only be called from the cull callback function set by `pfChanTravFunc()`—see "Process Callbacks" on page 116 for details. For more information about the `pfPath` structure, see the `pfPath(3pf)` and `pfList(3pf)` man pages.

When OpenGL Performer looks for intersections, it can return a `pfPath` to the node containing the intersection. This feature is particularly useful when you are using instancing, in which case you cannot use `pfGetParent()` to find out where in the scene graph the given node is. Finding out the `pfPath` to a given node is also useful in implementing picking.

Draw Traversal

For each bin the cull traversal generates a `libpr` display list of geometry and state commands (see "Display Lists" in Chapter 12), which describes the bin's geometry that is visible from a `pfChannel`. The draw traversal parses all root bins (bins without a parent bin) in the order given by their rendering order value. For each root bin, it simply traverses the display list and sends commands to the Geometry Pipeline to generate the image. If a bin has sub-bins, objects that are not in any sub-bin of the bin are rendered

first and are followed by objects of each sub-bin. The order in which sub-bins of the bin are drawn is determined by their rendering order value.

Optimizing the Drawing of Sub-bins

To avoid drawing sub-bins multiple times (for each of its parents), set the flag `PFBIN_DONT_DRAW_BY_DEFAULT` for those root bins that share sub-bins with the default opaque or transparent bin. The bin flags can be set using the function `pfChanBinFlags()`.

Individual bins, including sub-bins, may be rendered with the function `pfDrawBin()` called from the draw callback of `pfChannel` (see `pfChanTravFunc()`). The bin `-1` is a special `pfDrawBin()` argument that lets you render the default scene display list, which contains all the objects that did not fall in any defined bin. Note that this default scene display list exists only in `PFMP_CULL_DL_DRAW` multiprocessing mode. In the case of drawing a sub-bin, all sub-bins that have the same parents as a given sub-bin will be drawn. For example, consider root bins 5, 6, and 7 and sub-bins 8 (child of 5 and 6) and 9 (child of 5, 6, and 7). When `pfDrawBin()` is called with bin 8, bin 9 will be rendered as well.

Traversing a `pfDispList` is much faster than traversing the database hierarchy because the `pfDispList` *flattens* the hierarchy into a simple, efficient structure. In this way, the cull traversal removes much of the processing burden from the draw traversal; throughput greatly increases when both traversals are running in parallel.

Bin Draw Callbacks

Root bins can have draw callbacks associated with them. Draw callbacks are set by calling function `pfChanBinCallback()`. The parameters are the bin number, the type of a callback (`PFBIN_CALLBACK_PRE_DRAW` or `PFBIN_CALLBACK_POST_DRAW`), and the callback itself. The callback is a function that has only one parameter, a void pointer that points to the user data. Each bin has one user-data pointer, shared between pre-draw and post-draw callbacks. This pointer can be set using function `pfChanBinUserData()`.

If the callbacks are costly, it makes sense to group sub-bins of a bin with costly callbacks together. To achieve this, ensure that you set a high child-order mask for the bin (see the section “Sorting the Scene” on page 97).

Controlling and Customizing Traversals

The result of the cull traversal is a display list of geometry to be rendered by the draw traversal. What gets placed in the display list is determined by both visibility and by other user-specified modes and tests.

pfChannel Traversal Modes

The PFTRAV_CULL argument to **pfChanTravMode()** modifies the culling traversal. The cull mode is a bitmask that specifies the modes to enable; it is formed by the logical OR of one or more of these tokens:

- PFCULL_VIEW
- PFCULL_GSET
- PFCULL_SORT
- PFCULL_IGNORE_LSOURCES
- PFCULL_PROGRAM

Culling to the view frustum is enabled by the PFCULL_VIEW token. Culling to the pfGeoSet-level is enabled by the PFCULL_GSET token and can produce a tighter cull that improves rendering performance at the expense of culling time.

PFCULL_SORT causes the cull to sort geometry by state—for example, by texture or by material, in order to optimize rendering performance. It also causes transparent geometry to be drawn after opaque geometry for proper transparency effects.

By default, the enabled culling modes are PFCULL_VIEW | PFCULL_GSET | PFCULL_SORT. It is recommended that these modes be enabled unless the cull traversal becomes a significant bottleneck in the processing pipeline. In this case, try disabling PFCULL_GSET first, then PFCULL_SORT.

Normally, a pfChannel's cull traversal pre-traverses the scene, following all paths from the scene to all pfLightSources in the scene so that light sources can be set up before the normal scene traversal. If you want to disable this pre-traversal, set the PFCULL_IGNORE_LSOURCES cull-enable bit but your pfLightSources will not illuminate the scene.

When the PFCULL_PROGRAM token is set, a cull program attached to the channel is executed for each pfGeoSet during the cull traversal. See the following section “Cull Programs” for more details.

The PFTRAV_DRAW argument to **pfChanTravMode()** modifies the draw traversal. A mode of PFDRAW_ON is the default and will cause the pfChannel to be rendered. A mode of PFDRAW_OFF indicates that the pfChannel should not be drawn and essentially turns off the pfChannel.

Cull Programs

This section uses the following topics to describe cull programs:

- “The pfCullProgram Class” on page 103
- “Polytopes” on page 104
- “Predefined Cull Program Instructions” on page 105
- “User-Defined Cull Program Instructions” on page 109
- “Cull Traversal” on page 110
- “Occlusion Culling Using Cull Programs” on page 110
- “Small-Feature Culling Using Cull Programs” on page 112

The pfCullProgram Class

A pfCullProgram is a class that is used to set up a cull program, a sequence of instructions that are executed for each scene graph node and each pfGeoSet during the cull traversal. There can be two separate cull programs, one for scene graph nodes and one for pfGeoSets. The node cull program uses a set of polytopes. Based on the position of the node with respect to each polytope (inside, outside, intersects), it can determine whether the node is culled out (good for occlusion culling) or whether all pfGeoSets under this node are assigned to a specific bin. The pfGeoSet cull program also uses a set of polytopes and assigns each pfGeoSet to a different bin based on the position of the pfGeoSet with respect to each polytope or it culls out the pfGeoSet. The best use of cull programs is for occlusion culling (see section “Occlusion Culling Using Cull Programs” on page 110) or in multipass rendering when in some passes only parts of the scene have to be rendered. Being able to assign these parts to a bin can reduce the rendering time.

There is always a default cull program present on a `pfChannel`. To access it, you can call **`pfGetChanCullProgram()`**. Then you can set the program's instructions and the polytopes and can enable the cull program by setting token `PFCULL_PROGRAM` using the function **`pfChanTravMode()`**. See the previous section “`pfChannel` Traversal Modes” for more details.

The following code sequence illustrates the use of a cull program:

```
pfCullProgram *cullPgm = pfGetChanCullProgram(channel);

pfCullProgramResetPgm(cullPgm, PFCULLPG_GEOSET_PROGRAM);
pfCullProgramAddPgmOpcode(cullPgm, opcode1, data1);
...
pfCullProgramAddPgmOpcode(cullPgm, opcodeN, dataN);

pfCullProgramResetPgm(cullPgm, PFCULLPG_NODE_PROGRAM);
pfCullProgramAddPgmOpcode(cullPgm, opcode1, data1);
...
pfCullProgramAddPgmOpcode(cullPgm, opcodeM, dataM);

pfCullProgramNumPolytopes(cullPgm, 2);
pfCullProgramPolytope(cullPgm, ptope1);
pfCullProgramPolytope(cullPgm, ptope2);
```

You can define both a node and a `pfGeoSet` cull program at once by setting the token in **`pfCullProgramResetPgm()`** to `PFCULLPG_GEOSET_PROGRAM | PFCULLPG_NODE_PROGRAM`.

Polytopes

Cull program polytopes are standard `pfPolytopes`. They can be used to define various areas: the area could be some subset of a view frustum in which the geometry is drawn using special attributes, it could be a bounding box around some area of interest, and so on.

To initialize cull program polytopes, you set the number of polytopes that are used by the cull programs using **`pfCullProgramNumPolytopes()`**. Then create a new `pfPolytope` in the shared arena and set it using **`pfCullProgramPolytope()`**. The polytopes are indexed from 0. Polytopes are shared between the node and the `pfGeoSet` cull program even if the programs are different.

To modify a polytope of a certain index during the simulation, you get a pointer to the polytope using **pfGetCullProgramPolytope()**, modify it, and then call **pfCullProgramPolytope()**.

Predefined Cull Program Instructions

A cull program is a set of instructions that operate on bins and predefined polytopes. You define instructions one-by-one in the order of their desired execution. First, you use the function **pfCullProgramResetPgm()** to reset the default program, which consists of a return instruction only. Then you specify each instruction by its opcode (predefined instruction specified with the function **pfCullProgramAddPgmOpcode()**) or directly by specifying a user-defined instruction using **pfCullProgramAddPgmInstruction()**. For the details of user-defined instructions, see the later section “User-Defined Cull Program Instructions” on page 109. Each instruction has an associated integer value that is used as a parameter for the instruction.

The cull program starts with the bin that is associated with the **pfGeoSet**. As the cull program executes, it modifies the **pfGeoSet**. The output is a new bin assignment.

The following categories of predefined instructions are available:

- Test instructions
- Assign instructions
- Add-bin instructions
- Jump instructions
- Return instruction

Test Instructions

Table 4-2 describes the test instructions.

Table 4-2 Test Instructions

Instruction	Description
PFCULLPG_TEST_POLYTOPE <i>n</i>	Tests the bounding box of the pfGeoSet or the bounding sphere of the node against the polytope with index <i>n</i> . The result is one of PFIS_FALSE (all out), PFIS_MAYBE (possible intersection), or PFIS_MAYBE PFIS_TRUE (all in).
PFCULLPG_TEST_IS_SUBBIN_OF <i>b</i>	Tests whether the bin that has been determined up to this point is a sub-bin of bin <i>b</i> . The result is 1 or 0. Note that bin <i>b</i> is considered a sub-bin of itself.
PFCULLPG_TEST_IS_TRANSPARENT	Tests whether the pfGeoSet is transparent. The parameter is ignored. The result is 1 or 0.
PFCULLPG_TEST_IS_LIGHT_POINT	Tests whether the pfGeoSet belongs to a light point bin. The parameter is ignored. The result is 1 or 0.

Assign Instructions

Table 4-3 describes the assign instructions.

Table 4-3 Assign Instructions

Instruction	Description
PFCULLPG_ASSIGN_BIN_MAYBE <i>b</i>	Assigns bin <i>b</i> to the pfGeoSet if the result of the last polytope test was PFIS_MAYBE.
PFCULLPG_ASSIGN_BIN_TRUE <i>b</i>	Assigns bin <i>b</i> to the pfGeoSet if the result of the last binary test was 1.
PFCULLPG_ASSIGN_BIN_ALL_IN <i>b</i>	Assigns bin <i>b</i> to the pfGeoSet if the result of the last polytope test was PFIS_MAYBE PFIS_TRUE.
PFCULLPG_ASSIGN_BIN_ALL_OUT <i>b</i>	Assigns bin <i>b</i> to the pfGeoSet if the result of the last polytope test was PFIS_FALSE.

Table 4-3 Assign Instructions (continued)

Instruction	Description
PFCULLPG_ASSIGN_BIN_FALSE <i>b</i>	Assigns bin <i>b</i> to the pfGeoSet if the result of the last binary test was 0.
PFCULLPG_ASSIGN_BIN <i>b</i>	Assigns bin <i>b</i> to the pfGeoSet.

Add-Bin Instructions

For each PFCULLPG_ASSIGN* instruction, there is an equivalent PFCULLPG_ADD_BIN* instruction, in which the pfGeoSet is assigned a sub-bin of bin *b* and the existing bin. If the existing bin is -1 , the instruction operates as an assign instruction. If the sub-bin does not exist, it is dynamically created.

The following are the add-bin instructions:

- PFCULLPG_ADD_BIN_MAYBE *b*
- PFCULLPG_ADD_BIN_TRUE *b*
- PFCULLPG_ADD_BIN_ALL_IN *b*
- PFCULLPG_ADD_BIN_ALL_OUT *b*
- PFCULLPG_ADD_BIN_FALSE *b*
- PFCULLPG_ADD_BIN *b*

Jump Instructions

Table 4-4 describes the jump instructions.

Table 4-4 Jump Instructions

Instruction	Description
PFCULLPG_JUMP_MAYBE <i>c</i>	Skips next <i>c</i> instructions if the result of the last polytope test was PFIS_MAYBE. If <i>c</i> is negative, go back $ c -1$ instructions.
PFCULLPG_JUMP_TRUE <i>c</i>	Skips next <i>c</i> instructions if the result of the last binary test was 1.
PFCULLPG_JUMP_ALL_IN <i>c</i>	Skips next <i>c</i> instructions if the result of the last polytope test was PFIS_MAYBE PFIS_TRUE.

Table 4-4 Jump Instructions (**continued**)

Instruction	Description
PFCULLPG_JUMP_ALL_OUT <i>c</i>	Skips next <i>c</i> instructions if the result of the last polytope test was PFI_FALSE.
PFCULLPG_JUMP_FALSE <i>c</i>	Skips next <i>c</i> instructions if the result of the last polytope test was 0.
PFCULLPG_JUMP <i>c</i>	Skips next <i>c</i> instructions.

Return Instruction

Each cull program must be terminated by a return instruction. You specify the return instruction with PFCULLPG_RETURN flags. The PFCULLPG_RETURN parameter is a combination of the following binary flags:

- PFCULLPG_CULL
- PFCULLPG_CULL_ON_ALL_IN
- PFCULLPG_CULL_ON_ALL_OUT
- PFCULLPG_DONT_TEST_TRANSPARENCY
- PFCULLPG_TEST_LPOINTS
- PFCULLPG_DONT_TEST_LPOINTS

The first three flags determine whether the node or the pfGeoSet is culled out, optionally based on the result of the last polytope test. In that case, any bin assignment made by the cull program is ignored.

The last three flags control whether an additional test for the pfGeoSet being transparent or being a light point is performed. These flags affect only the pfGeoset cull program. If the pfGeoSet is transparent or is a light point, the pfGeoSet is assigned the bin resulting from the cull program and either a sub-bin of the transparent bin or the light point bin.

If initially the pfGeoSet has no bin assigned to it, both the transparency and light point tests are performed (to follow the operation of a regular cull traversal). If those tests are not needed, you can use the two DONT_TEST flags. If the pfGeoSet has initially assigned a bin, the tests are not performed unless the binary flags specify so.

If you need to perform any of these two tests earlier—for example, to differentiate bin assignment based on transparency—you can use the instructions `PFCULLPG_TEST_IS_TRANSPARENT` and `PFCULLPG_TEST_IS_LIGHT_POINT`.

User-Defined Cull Program Instructions

You may provide your own cull program instructions. Each instruction must be a function that takes two parameters: a pointer to `pfCullProgram` and an integer value (the instruction parameter). The instruction has to return a value by which the instruction counter is increased. This value is 1 for all instructions, except jump instructions. Actually, it is possible to write whole cull programs as a single, user-defined instruction.

There are two variables that a user-defined instruction can access during the execution of a cull program and there are several useful methods they may use. The following are the two variables:

- `currentResult` Result of the last polytope test or a binary test
- `bbox` Bounding box for the `pfGeoSet`

Table 4-5 describes the four functions that can be used in instructions.

Table 4-5 Functions Available for User-Defined Cull Program Instructions

Function	Description
<code>pfCullProgramTestPolytope(pgm,n)</code>	Tests polytope <i>n</i> using <code>bbox</code> , the bounding box of the <code>pfGeoSet</code> or the bounding sphere of the node. Use this function rather than doing the test directly because the result is often already known by testing the nodes above the current <code>pfGeoSet</code> or the current node and the test can be avoided.
<code>pfCullProgramAddBinParent(pgm,b)</code>	Adds a new parent <i>b</i> , which could also be a sub-bin. The cull program keeps the list of parents that identify the current bin (to avoid creating many sub-bins that may not be needed). This function adds a new parent <i>b</i> , which can be a sub-bin also.
<code>pfCullProgramIsSubbinOf(pgm,b)</code>	Tests whether the current bin is a sub-bin of bin <i>b</i> .
<code>pfCullProgramResetBinParents(pgm)</code>	Resets the list of parents of the current bin.

For example, the predefined instruction `PFCULLPG_ASSIGN_BIN_MAYBE` can be implemented as shown in the following code:

```
int MyAssignBinMaybe(pfCullProgram *pgm, int data)
{
    if(pgm->currentResult & PFIS_MAYBE)
    {
        pfCullProgramResetBinParents(pgm);
        pfCullProgramAddBinParent(pgm, data);
    }
    return 1;
}
```

Cull Traversal

To reduce the amount of testing performed for each `pfGeoSet`, each node of the tree is tested against all cull program polytopes when cull programs are enabled. If the test is conclusive—that is, the bounding sphere of the node is inside or outside of a polytope—children of the node are not tested against the given polytope. Use the node cull program to determine culling and use the `pfGeoSet` cull program to assign bins at the `pfGeoSet` level.

If culling to the view frustum is enabled (token `PFCULL_VIEW` set by `pfChanTravMode()`), it is done before the cull program is executed. In this case, nodes and `pfGeoSets` that are not intersecting the view frustum are culled out and the cull program is not executed for them.

Sample code illustrating the use of cull programs can be found in the following files in the directory `/usr/share/Performer/src/pguide/libpf/C++` on IRIX and Linux and in `%PFROOT%\Src\pguide\libpf\C++` on Microsoft Windows:

- `cullPgmSimple`
- `cullPgmMultipass`

Occlusion Culling Using Cull Programs

In order to use cull programs for occlusion culling you must choose the occluders in the scene—for example, walls in a room or the walls of the nearest buildings in a city. Then you must create a polytope around each occluder. If the occluder is a rectangle, the polytope must have one face for the rectangle and four faces for the edges, four planes each defined by the edge and the eye. You must update the polytope or polytopes every time the eye or the occluder moves.

For an example of occlusion culling, see the following program:

```
/usr/share/Performer/src/pguide/libpf/C++/occlusionCull.C
(IRIX and Linux)
%PFROOT%\Src\pguide\libpf\C++\occlusionCull.cxx
(Microsoft Windows)
```

The sample program also includes a function that creates a polytope for a polygon defined by four vertices.

At present the polytopes must be convex. Consequently, in the case that two occluders are touching but their common shape is concave, they must be defined as two polytopes. In this case, the geometry that is occluded by both occluders and that spans their common boundary is not culled out. To avoid this problem, you can define a convex polytope that contains both shapes (a convex hull) and then define convex cut areas that are not part of the occluders. In this way, you can also add holes in occluders. As long as you start with a convex polytope, you can subtract as many convex polytopes as you need.

The following code sequence illustrates the use of a convex hull and cut-out areas:

```
PFCULLPG_TEST_POLYTOPE, 0 // convex hull
PFCULLPG_JUMP_ALL_IN, 1
PFCULLPG_RETURN, 0 // no cull

PFCULLPG_TEST_POLYTOPE, 1 // first cutout area
PFCULLPG_JUMP_ALL_OUT, 1
PFCULLPG_RETURN, 0 // no cull

...

PFCULLPG_TEST_POLYTOPE, N // n-th cutout area
PFCULLPG_JUMP_ALL_OUT, 1
PFCULLPG_RETURN, 0 // no cull

PFCULLPG_RETURN, PFCULLPG_CULL
```

For a complete example, see the following program:

```
/usr/share/Performer/src/pguide/libpf/C++/occlusionCullConcave.C
(IRIX and Linux)
%PFROOT%\Src\pguide\libpf\C++\occlusionCullConcave.cxx
(Microsoft Windows)
```

Small-Feature Culling Using Cull Programs

In small-feature culling, geometry that is smaller (in screen space) than a given number of pixels is culled. Since cull programs have access to bounding spheres of nodes and bounding boxes of geosets, the cull programs can be used for small-feature culling.

A cull program that performs small-feature culling looks like the following:

```
PFCULLPG_TEST_SMALLER_THAN, 1.5 // smaller than 1.5 pixels
PFCULLPG_RETURN, PFCULLPG_CULL_ON_TRUE
```

You must specify this program both for nodes and geosets. You can find an example of small-feature culling in the following file:

```
/usr/share/Performer/src/pguide/libpf/C++/cullSmallFeature.C
(IRIX and Linux)
%PFROOT%\Src\pguide\libpf\C++\cullSmallFeature.C
(Microsoft Windows)
```

This feature can be also accessed in Perfly from the **FOV** pane.

pfNode Draw Mask

Each node in the database hierarchy can be assigned a mask that dictates whether the node is added to the display list and thereby whether it is drawn. This mask is called the *draw mask* (even though it is evaluated in the cull traversal) because it tells the cull process whether the node is drawable or not.

The draw mask of a node is set with **pfNodeTravMask()**. The channel also has a draw mask, which you set with **pfChanTravMask()**. By default, the masks are all 1's or 0xffffffff.

Before testing a node for visibility, the cull traversal ANDs the two masks together. If the result is zero, the cull prunes the node. If the result is nonzero, the cull proceeds normally. Mask testing occurs before all visibility testing and function callbacks.

Masks allow you to draw different subgraphs of the scene on different channels, to turn portions of the scene graph on and off, or to ignore hidden portions of the scene graph while drawing but make them active during intersection testing.

pfNode Cull and Draw Callbacks

One of the primary mechanisms for extending OpenGL Performer is through the use of function callbacks, which can be specified on a per-node basis. OpenGL Performer allows separate cull and draw callbacks, which are invoked both before and after node processing. Node callbacks are set with **pfNodeTravFuncs()**.

Cull callbacks can direct the cull traversal, while draw callbacks are added to the display list and later executed in the draw traversal for custom rendering. There are pre-cull and pre-draw callbacks, invoked before a node is processed, and post-cull and post-draw callbacks, invoked after the node is processed.

The cull callbacks return a value indicating how the cull traversal should proceed, as shown in Table 4-6.

Table 4-6 Cull Callback Return Values

Value	Action
PFTRAV_CONT	Continue and traverse the children of this node.
PFTRAV_PRUNE	Skip the subgraph rooted at this node and continue.
PFTRAV_TERM	Terminate the entire traversal.

Callbacks are processed by the cull traversal in the following order:

1. If a pre-cull callback is defined, then call the pre-cull callback to get a cull result and find out whether traversal should continue. Possible return values are listed in Table 4-6.
2. If the pre-cull callback returns PFTRAV_PRUNE, the traversal returns to the parent and continues with the node's siblings, if any. If the callback returns PFTRAV_TERM, the traversal terminates immediately. Otherwise, cull processing continues.
3. If the pre-cull callback does not set the cull result using **pfCullResult()**, and view-frustum culling is enabled, then perform the standard node-within-frustum test and set the cull result accordingly.
4. If the cull result is PFIS_FALSE, skip the traversal of children. The post-cull callback is invoked and traversal returns so that the parent node can traverse any siblings.

5. If a pre-draw callback is defined, then place a `libpr` display-list packet in the display list so that the node's pre-draw callback will be called by the draw process. If running a combined CULLDRAW traversal, invoke the pre-draw callback directly instead.
6. Process the node, continuing the cull traversal with each of the node's children or adding the node's geometry to a display list (for `pfGeodes`). If the cull result was `PFIS_ALL_IN`, view-frustum culling is disabled during the traversal of the children.
7. If a post-draw callback is defined, then place a `libpr` display-list packet in the display list so that the node's post-draw callback will be called by the draw process. If running a combined CULLDRAW traversal, invoke the post-draw callback directly instead.
8. If a post-cull callback is defined, then call the post-cull callback.

Draw callbacks are commonly used to place tags or change state while a subgraph is rendered. Note that if the pre-draw callback is called, the post-draw callback is guaranteed to be invoked. This way the callback can restore any state modified by the pre-draw callback. This is useful for state changes such as `pfPushMatrix()` and `pfPopMatrix()`, as shown in the environment-mapping code that is part of Example 4-2.

For doing customized culling, the pre-cull callback can determine whether a `PFIS_ALL_IN` has already turned off view-frustum culling using `pfGetParentCullResult()`, in which case it may not wish to do its own cull testing. It can also find out the result of the standard cull test by calling `pfGetCullResult()`.

Cull callbacks can also be used to render geometry (`pfGeoSets`) or change graphics state. Any `libpr` drawing commands are captured in a display list and are later executed during the draw traversal (see "Display Lists" in Chapter 12). However, direct graphics library calls can be made safely only in draw function callbacks, because only the draw process of multiprocess OpenGL Performer configurations is known to be associated with a window.

Example 4-2 shows some sample node callbacks.

Example 4-2 `pfNode` Draw Callbacks

```
void
LoadScene(char *filename)
{
    pfScene *scene = pfNewScene();
    pfGroup *root = pfNewGroup();
    pfGroup *reflectiveGeodes = NULL;
```

```

root = pfdLoadFile(filename);
...
reflectiveGeodes =
    ReturnListOfGeodesWithReflectiveMaterials(root);

/* Use a node callback in the Draw process to turn on
 * and off graphics library environment mapping before
 * and after drawing all of the pfGeodes that have
 * pfGeoStates with reflective materials.
 */
pfNodeTravFuncs(reflectiveGeodes, PFTRAV_DRAW,
    pfdPreDrawReflMap, pfdPostDrawReflMap);
}

/* This callback turns on graphics library environment
 * mapping. Because it changes graphics state it must be a
 * Draw process node callback. */
/*ARGSUSED*/
int
pfdPreDrawReflMap(pfTraverser *trav, void *data)
{
    glTexGenf(GL_S, GL_TEXTURE_GEN_MODE, GL_SPHERE_MAP);
    glTexGenf(GL_T, GL_TEXTURE_GEN_MODE, GL_SPHERE_MAP);
    glEnable(GL_TEXTURE_GEN_S);
    glEnable(GL_TEXTURE_GEN_T);
    return NULL;
}

/* This callback turns off graphics library environment
 * mapping. Because it also changes graphics state it also
 * must be a Draw process node callback. Also notice that
 * it is important to return the graphics library's state to
 * the state at which it was in before the preNode callback
 * was even made.
 */
/*ARGSUSED*/
int
pfdPostDrawReflMap(pfTraverser *trav, void *data)
{
    glDisable(GL_TEXTURE_GEN_S);
    glDisable(GL_TEXTURE_GEN_T);
    return NULL;
}

```

Process Callbacks

The `libpf` library processes a visual database with a software-rendering pipeline composed of application, cull, and draw stages. The system of *process callbacks* allows you to insert your own custom culling and drawing functions into the rendering pipeline. Furthermore, these callbacks are invoked by the proper process when your OpenGL Performer application is configured for multiprocessing.

By default, OpenGL Performer culls and draws all active `pfChannels` when `pfFrame()` is called. However, you can specify cull and draw function callbacks so that `pfFrame()` will cause OpenGL Performer to call your custom functions instead. These functions have the option of using the default OpenGL Performer processing in addition to their own custom processing.

When multiprocessing is used, the rendering pipeline works on multiple frames at once. For example, when the draw process is rendering frame n , the cull process is working on frame $n+1$, and the application process is working on frame $n+2$. This situation requires careful management of data so that data generated by the application is propagated to the cull process and then to the draw process at the right time. OpenGL Performer manages data that is passed to the process callbacks to ensure that the data is frame-coherent and is not corrupted.

Example 4-3 illustrates the use of a cull-process callback.

Example 4-3 Cull-Process Callbacks

```
InitChannels()
{
    ...
    /* create and configure all channels*/
    ...
    /* define callbacks for cull and draw processes */
    pfChanTravFunc(chan, PFTRAV_CULL, CullFunc);
    pfChanTravFunc(chan, PFTRAV_DRAW, DrawFunc);
    ...
}

/* The Cull callback. Any work that needs to be done in the
 * Cull process should happen in this function.
 */
void
CullFunc(pfChannel * chan, void *data)
{
```

```
static long first = 1;

/* Lock down whatever processor the cull is using when
 * the cull callback is first called.
 */
if (first)
{
    if ((pfGetMultiprocess() & PFMP_FORK_CULL) &&
        (ViewState->procLock & PFMP_FORK_CULL))
        pfuLockDownCull(pfGetChanPipe(chan));
    first = 0;
}

/* User-defined pre-cull processing. Application-
 * specific cull knowledge might be used to provide
 * things like line-of-sight culling.
 */
PreCull(chan, data);

/* standard Performer culling to the viewing frustum */
pfCull();

/* User-defined post-cull processing; this routine might
 * be used to do things like record cull state from this
 * cull to be used in future culls.
 */
PostCull(chan, data);
}

/* The draw function callback.
 * Any graphics library functionality outside
 * OpenGL Performer must be done here.
 */
void
DrawFunc(pfChannel *chan, void *data)
{
    /* pre-Draw tasks like clearing the viewport */
    PreDraw(chan, data);

    pfDraw();          /* render the frame */

    /* draw HUD and so on */
    PostDraw(chan, data);
}
```

Process Callbacks and Passthrough Data

Cull and draw callbacks are specified on a per-pfChannel basis using the functions **pfChanTravFunc()** with PFTRAV_CULL and PFTRAV_DRAW, respectively. **pfAllocChanData()** allocates *passthrough data*, data which is passed down the rendering pipeline to the callbacks.

In the cull phase of the rendering pipeline, OpenGL Performer invokes the cull callback with a pointer to the pfChannel that is being culled and a pointer to the pfChannel's passthrough data buffer. The cull callback may modify data in the buffer. The potentially modified buffer is then copied and passed to the user's draw callback.

Default OpenGL Performer processing is triggered by **pfCull()** and **pfDraw()**. By default, **pfFrame()** calls **pfCull()** first, then calls **pfDraw()**. If process callbacks are defined, however, **pfCull()** and **pfDraw()** are not invoked automatically and must be called by the callbacks to use OpenGL Performer's default processing. **pfCull()** should be called only in the cull callback; it causes OpenGL Performer to cull the current channel and to generate a display list suitable for rendering.

Channels culled by **pfCull()** may be drawn in the draw callback by **pfDraw()**. It is valid for the draw callback to call **pfDraw()** more than once. Multipass renderings performed with multiple calls to **pfDraw()** are typical when you use accumulation buffer techniques.

When the draw callback is invoked, the window will have already been properly configured for drawing the pfChannel. Specifically, the viewport, perspective, and viewing matrices are set to their correct values. User modifications of these values are not reset by **pfDraw()**. If a draw callback is specified, OpenGL Performer does not automatically clear the viewport; it leaves that responsibility to the application. **pfClearChan()** can be called from the draw callback to clear the channel viewport. If *chan* has a **pfEarthSky()**, then the **pfEarthSky()** is drawn. Otherwise, the viewport is cleared to black and the z-buffer is cleared to its maximum value.

You should call **pfPassChanData()** to indicate that user data should be passed through the rendering pipeline, which propagates the data downstream to cull and draw callbacks. The next call to **pfFrame()** copies the channel buffer into internal buffers, so that the application is then free to modify data in the buffer without fear of corruption. The **pfPassChanData()** function should be called only when necessary, since calling it imposes some buffer-copying overhead. In addition, passthrough data should be as small as possible to reduce the time spent copying data.

The code fragment in Example 4-4 is an example of cull and draw callbacks and the passthrough data that is used to communicate with them.

Example 4-4 Using Passthrough Data to Communicate with Callback Routines

```
typedef struct
{
    long val;
} PassData;

void cullFunc(pfChannel *chan, void *data);
void drawFunc(pfChannel *chan, void *data);

int main()
{
    PassData *pd;

    /* allocate passthrough data */
    pd = (PassData*)pfAllocChanData(chan, sizeof(PassData));

    /* initialize channel callbacks */
    pfChanTravFunc(chan, PFTRAV_CULL, cullFunc);
    pfChanTravFunc(chan, PFTRAV_DRAW, drawFunc);

    /* main simulation loop */
    while (1)
    {
        pfSync();
        pd->val = 0;
        pfPassChanData(chan);
        pfFrame();
    }
}

void
cullFunc(pfChannel *chan, void *data)
{
    PassData *pd = (PassData*)data;

    pd->val++;
    pfCull();
}

void
drawFunc(pfChannel *chan, void *data)
```

```
{
    PassData    *pd = (PassData*)data;
    fprintf(stderr, "%ld\n", pd->val);
    pfClearChan(chan);
    pfDraw();
}
```

This example would, regardless of the multiprocessing mode, have the values 0, 1, and 1 for *pd->val* at the points where **pfFrame()**, **pfCull()**, and **pfDraw()** are called. In this way, control data can be sent down the pipeline from the application, through the cull, and on to the draw process with frame synchronization without regard to the active multiprocessing mode.

When configured as a process separate from the draw, the cull callback should not attempt to send graphics commands to an OpenGL Performer window because only the draw process is attached to the window. Callbacks should not modify the OpenGL Performer database, but they can use **pfGet()** routines to inquire about database information. The draw callback should not call **glXSwapBuffers()** because OpenGL Performer must control buffer swapping in order to manage the necessary frame and channel synchronization. However, if you need special control over buffer swapping, use **pfPipeSwapFunc()** to register a function as the given pipe's buffer-swapping function. Once your function is registered, it will be called instead of **glXSwapBuffers()**.

Intersection Traversal

You can make spatial inquiries in OpenGL Performer by testing the intersection of line segments with geometry in the database. For example, a single line segment pointing straight down from the eyepoint can determine your height above terrain, four such segments can simulate the four tires of a car, and segments swept out by points on a moving object can determine collisions with other objects.

Testing Line Segment Intersections

The testing of each line segment or group of spatially grouped segments requires a traversal of part or all of a scene graph. You make these inquiries using **pfNodeIsectSegs()**, which intersects the specified group of segments with the subgraph rooted at the specified node. **pfChanNodeIsectSegs()** functions similarly, but includes a channel so that the traversal can make decisions based on the level-of-detail specified by pfLOD nodes.

Intersection Requests: pfSegSets

A `pfSegSet` is a structure that embodies an intersection request.

```
typedef struct _pfSegSet
{
    long    mode;
    void*   userData;
    pfSeg   segs[PFIS_MAX_SEGS];
    ulong   activeMask;
    ulong   isectMask;
    void*   bound;
    long    (*discFunc)(pfHit*);
} pfSegSet;
```

The `segs` field is an array of line segments making up the query. You tell **pfNodeIsectSegs()** which segments to test with by setting the corresponding bit in the `activeMask` field. If your `pfSegSet` contains many closely-grouped line segments, you can specify a bounding volume using the data structure's `bound` field. **pfNodeIsectSegs()** can use that bounding volume to more quickly test the request against bounding volumes in the scene graph. The `userData` field is a pointer with which you can point to other information about the request that you might access in a callback. The other fields are described in the following sections. The `pfSegSet` is not modified during the traversal.

Intersection Return Data: pfHit Objects

Intersection information is returned in `pfHit` objects. These can be queried using **pfQueryHit()** and **pfMQueryHit()**. Table 4-7 lists the items that can be queried from a `pfHit` object.

Table 4-7 Intersection-Query Token Names

Query Token	Description
PFQHIT_FLAGS	Status and validity information
PFQHIT_SEGNUM	Index of the segment in a <code>pfSegSet</code> request
PFQHIT_SEG	Line segment as currently clipped
PFQHIT_POINT	Intersection point in object coordinates
PFQHIT_NORM	Geometric normal of an intersected triangle

Table 4-7 (continued) Intersection-Query Token Names

Query Token	Description
PFQHIT_VERTS	Vertices of an intersected triangle
PFQHIT_TRI	Index of an intersected triangle
PFQHIT_PRIM	Index of an intersected primitive in pfGeoSet
PFQHIT_GSET	pfGeoSet of an intersection
PFQHIT_NODE	pfGeode of an intersection
PFQHIT_NAME	Name of pfGeode
PFQHIT_XFORM	Current transformation matrix
PFQHIT_PATH	Path in scene graph of intersection

The PFQHIT_FLAGS field is bit vector with bits that indicate whether an intersection occurred and whether the point, normal, primitive and transformation information is valid. For some types of intersections only some of the information has meaning; for instance, for a pfSegSet bounding volume intersecting a pfNode bounding sphere, the point information may not be valid.

Queries can be performed singly by calling **pfQueryHit()** with a single query token, or several at a time by using **pfMQueryHit()** with an array of tokens. In the latter case, the return information is placed in the specified order into a return array.

Intersection Masks

Before using **pfNodeIsectSegs()** to intersect the geometry in the scene graph, you must set intersection masks for the nodes in the scene graph and correspondingly in your search request.

Setting the Intersection Mask

The **pfNodeTravMask()** function sets the intersection masks in a subgraph of the scene down through GeoSets. For example:

```
pfNodeTravMask(root, PFTRAV_ISECT, 0x01,
               PFTRAV_SELF | PFTRAV_DESCEND, PF_SET)
```

This function sets the intersection mask of all nodes and GeoSets in the scene graph to 0x01. A subsequent intersection request would then use 0x01 as the mask in **pfNodeIsectSegs()**. A description of how to use this mask follows.

Specifying Different Classes of Geometry

Databases can contain different classes of objects, and only some of those may be relevant for a particular intersection request. For example, the wheels on a truck follow the ground, even through a small pond; therefore, you only want to test for intersection with the ground and not with the water. For a boat, on the other hand, intersections with both water and the lake bottom have significance.

To accommodate distinctions between classes of objects, each node and GeoSet in a scene graph has an intersection mask. This mask allows traversals, such as intersections, to either consider or ignore geometry by class.

For example, you could use four classes of geometry to control tests for collision detection of a moving ship, collision detection for a falling bowling ball, and line-of-sight visibility. Table 4-8 matches database classes with the **pfNodeTravMask()** and **pfGeoSetIsectMask()** values used to support the traversal tests listed above.

Table 4-8 Database Classes and Corresponding Node Masks

Database Class	Node Mask
Water	0x01
Ground	0x02
Pier	0x04
Clouds	0x08

Once the mask values at nodes in the database have been set, intersection traversals can be directed by them. For example, the line segments for ship collision detection should be sensitive to the water, ground, and pier, while those for a bowling ball would ignore intersections with water and the clouds, testing only against the ground and pier. Line-of-sight ranging should be sensitive to all the geometry in the scene. Table 4-9 lists

the traversal mask values and mask representations that would achieve the proper intersection tests.

Table 4-9 Representing Traversal Mask Values

Intersection Class	Mask Value	Mask Representation
Ship	0x07	(Water Ground Pier)
Bowling ball	0x06	(Ground Pier)
Line-of-sight ranging	0x0f	(Water Ground Pier Clouds)

The intersection traversal prunes a node as soon as it gets a zero result from doing a bitwise AND of the node intersection mask and the traversal mask specified by the `pfSegSet's` `isectMask` field. Thus, all nodes in the scene graph should normally be set to be the bitwise OR of the masks of their children. After setting the class-specific masks for different subgraphs of the scene, this can be accomplished by calling this function:

```
pfNodeTravMask(root, PFSET_OR, PFTRAV_SET_FROM_CHILD, 0x0);
```

This function sets each node's mask by ORing 0x0 with the current mask and the masks of the node's children.

Note that this traversal, like that used to update node bounding volumes, is unusual in that it propagates information up the graph from leaf nodes to root.

Discriminator Callbacks

If you need to make a more sophisticated discrimination than node masks allow about when an intersection is valid, OpenGL Performer can issue a callback on each successful intersection and let you decide whether the intersection is valid in the current context.

If a callback is specified in `pfNodeIsectSegs()`, then at each level where an intersection occurs—for example, with bounding volumes of `libpfp` `pfGeodes` (mode `PFTRAV_IS_GEODE`), `libpvr` `GeoSets` (mode `PFTRAV_IS_GSET`), or individual geometric primitives (mode `PFTRAV_IS_PRIM`)—OpenGL Performer invokes the callback, giving it information about the candidate intersection. The value you return from the callback determines whether the intersection should be ignored and how the intersection traversal should proceed.

If the return value includes the bit `PFTRAV_IS_IGNORE`, the intersection is ignored. The intersection traversal itself can also be influenced by the callback. The traversal is subject to three possible fates, as detailed in Table 4-10.

Table 4-10 Possible Traversal Results

Set Bits	Meaning
<code>PFTRAV_CONT</code>	Continue the traversal inside this subgraph or GeoSet.
<code>PFTRAV_PRUNE</code>	Continue the traversal but skip the rest of this subgraph or GeoSet.
<code>PFTRAV_TERM</code>	Terminate the traversal here.

Line Segment Clipping

Usually, the intersection point of most interest is the one that is nearest to the beginning of the segment. By default, after each successful intersection, the end of the segment is clipped so that the segment now ends at the intersection point. Upon the final return from the traversal, it contains the closest intersection point.

However, if you want to examine all intersections along a segment you can use a discriminator callback to tell OpenGL Performer not to clip segments—simply leave out the `PFTRAV_IS_CLIP_END` bit in the return value. If you want the farthest intersection point, you can use `PFTRAV_IS_CLIP_START` so that after each intersection the new segment starts at the intersection point and extends outward.

Traversing Special Nodes

Level-of-detail nodes are intersected against the model for range zero, which is typically the highest level-of-detail (LOD). If you want to select a different model, you can turn off the intersection mask for the LOD node and place a switch node in parallel (having the same parent and children as the LOD) and set it to the desired model.

Sequences and switches intersect using the currently active child or children. Billboards are not intersected, since no eyepoint is defined for intersection traversals.

Picking

The **pfChanPick()** function provides a simple interface for intersection testing by enabling the user to move a mouse to select one or more geometries. The method uses **pfNodeIsectSegs()** and uses the high bit, `PFIS_PICK_MASK`, of the intersection mask in the scene graph. Setting up picking with **pfNodePickSetup()** sets this bit in the intersection mask throughout the specified subgraph but does not enable caching inside `pfGeoSets`. See “Performance” on page 126.

The **pfChanPick()** function has an extra feature: it can either return the closest intersection (`PFPK_M_NEAREST`) or return all `pfHits` along the picking ray (`PFPK_M_ALL`).

Performance

The intersection traversal uses the hierarchical bounding volumes in the scene graph to allow culling of the database and then processes candidate `GeoSets` by testing against their internal geometry. For this reason, the hierarchy should reflect the spatial organization of the database. High-performance culling has similar requirements (see Chapter 24, “Performance Tuning and Debugging”).

Performance Trade-offs

OpenGL Performer currently retains no information about spatial organization of data within `GeoSets`; so, each triangle in the `GeoSet` must be tested. Although large `GeoSets` are good for rendering performance in the absence of culling, spatially localized `GeoSets` are best for culling (since a `GeoSet` is the smallest culling unit), and spatially localized `GeoSets` with few primitives are best for intersections.

Front Face/Back Face

One way to speed up intersection testing is to turn on `PFTRAV_IS_CULL_BACK`. When this flag is enabled, only front-facing geometry is tested.

Enabling Caching

Precomputing information about normals and projections speeds up intersections inside `GeoSets`. For the best performance, you should enable caching in `GeoSets` when you set the intersection masks with **pfNodeTravMask()**.

If the geometry within a GeoSet is dynamic, such as waves on a lake, caching can cause incorrect results. However, for geometry that changes only rarely, you can use **pfGeoSetIsectMask()** to recompute the cache as needed.

Intersection Methods for Segments

Normally, when intersecting down to the primitive level each line segment is separately tested against each bounding volume in the scene graph, and after passing those tests is intersected against the pfGeoSet bounding box. Segments that intersect the bounding box are eventually tested against actual geometry.

When a pfSegSet has a spatially localized group of at least several line segments, you can speed up the traversal by providing a bounding volume. You can use **pfCylAroundSegs()** to create a bounding cylinder for the segments, place a pointer to the resulting cylinder in the pfSegSet's *bound* field, then OR the PFTRAV_IS_BCYL bit into the pfSegSet's *mode* field.

If only a rough volume-volume intersection is required, you can specify a bounding cylinder in the pfSegSet without any line segments at all and request discriminator callbacks at the PFTRAV_IS_NODE or PFTRAV_IS_GSET level.

Figure 4-4 illustrates some aspects of this process. The portion of the figure labeled A represents a single segment; B is a collection of nonparallel segments, not suitable for tightly bounding with a cylinder; and C shows parallel segments surrounded by a bounding cylinder. In the bottom portion of the figure, the bounding cylinder around the segments intersects the bounding box around the object; each segment in the cylinder, thus, must be tested individually to see if any of them intersect.

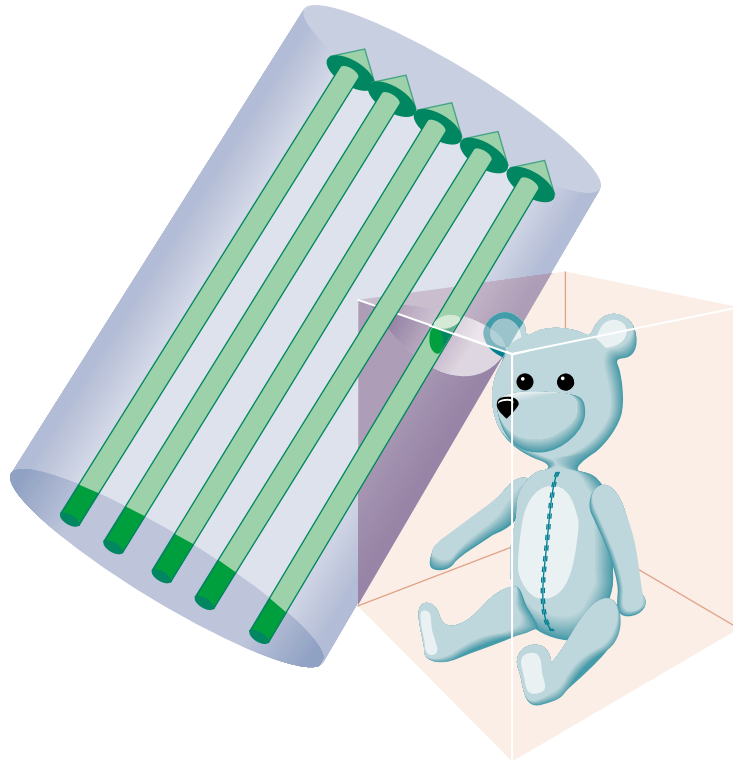

Figure 4-4 Intersection Methods

Frame and Load Control

This chapter describes how to manage the display operations of a visual simulation application to maintain the desired frame rate and visual performance level. In addition this chapter covers advanced topics including multiprocessing and shared memory management.

Frame Rate Management

A *frame* is the period of time in which all processing must be completed before updating the display with a new image, for example, a frame rate of 60 Hz means the display is updated 60 times per second and the time extent of a frame is 16.7 milliseconds. The ability to fit all processing within a frame depends on several variables, some of which are the following:

- The number of pixels being filled
- The number of transformations and modal changes being made
- The amount of processing required to create a display list for a single frame
- The quantity of information being sent to the graphics subsystem

Through intelligent management of SGI CPU and graphics hardware, OpenGL Performer minimizes the above variables in order to achieve the desired frame rate. However, in some cases, peak frame rate is less important than a *fixed frame rate*. Fixed frame rate means that the display is updated at a consistent, unvarying rate. While a simple step toward achieving a fixed frame rate is to reduce the maximum frame rate to an easily achievable level, we shall explore other (less Draconian) mechanisms in this chapter that do not adversely impact frame rates.

As discussed in the following sections, OpenGL Performer lets you select the frame rate and has built-in functionality to maintain that frame rate and control overload situations when the draw time exceeds or grows uncomfortably close to a frame time. While these methods can be effective, they do require some cooperation from the run-time database.

In particular, databases should be modeled with levels-of-detail and be spatially arranged.

Selecting the Frame Rate

OpenGL Performer is designed to run at the fixed frame rate as specified by `pfFrameRate()`. Selecting a fixed frame rate does not in itself guarantee that each frame can be completed within the desired time. It is possible that some frames might require more computation time than is allotted by the frame rate. By taking too long, these frames cause *dropped* or *skipped* frames. A situation in which frames are dropped is called an *overload* or *overrun* situation. A system that is close to dropping frames is said to be in *stress*.

Achieving the Frame Rate

The first step towards achieving a frame rate is to make sure that the scene can be processed in less than a frame's time—hopefully **much** less than a frame's time. Although minimizing the processing time of a frame is a huge effort, rife with tricks and black magic, certain techniques stand out as OpenGL Performer's main weapons against slothful performance:

- **Multiprocessing.** The use of multiple processes on multi-CPU systems can drastically increase throughput.
- **View culling.** By trivially rejecting portions of the database outside the viewing volume, performance can be increased by orders of magnitude.
- **State sorting.** Many graphics pipelines are sensitive to graphics mode changes. Sorting a scene by graphics state greatly reduces mode changes, increasing the efficiency of the hardware.
- **Level-of-detail.** Objects that are far away project to a relatively small area of the display so fewer polygons can be used to render the object without substantial loss of image quality. The overall result is fewer polygons to draw and improved performance.

Multiprocessing and level-of-detail is discussed in this chapter while view culling and state sorting are discussed in Chapter 4, "Database Traversal." More information on sorting in the context of performance tuning can be found in Chapter 24, "Performance Tuning and Debugging."

Fixing the Frame Rate

Frame intervals are fixed periods of time but frame processing is variable in nature. Because things change in a scene, such as when objects come into the field of view, frame processing cannot be fixed. In order to maintain a fixed frame rate, the average frame processing time must be less than the frame time so that fluctuations do not exceed the selected frame rate. Alternately, the scene complexity can be automatically reduced or increased so that the frame rate stays within a user-defined “sweet spot.” This mechanism requires that the scene be modeled with levels of detail (pfLOD nodes).

OpenGL Performer calculates the system *load* for each frame. Load is calculated as the percentage of the frame period it took to process the frame. Then if the default OpenGL Performer fixed frame rate mechanisms are enabled, load is used to calculate system *stress*, which is in turn used to adjust the level of detail (LOD) of visible models. LOD management is OpenGL Performer’s primary method of managing system load.

Table 5-1 shows the OpenGL Performer functions for controlling frame processing.

Table 5-1 Frame Control Functions

Function	Description
pfFrameRate()	Set the desired frame rate.
pfSync()	Synchronize processing to frame boundaries.
pfFrame()	Initiate frame processing.
pfPhase()	Control frame boundaries.
pfChanStressFilter()	Control how stress is applied to LOD ranges.
pfChanStress()	Manually control the stress value.
pfGetChanLoad()	Determine the current system load.
pfChanLODAttr()	Control how LOD is performed, including global LOD adjustment and blending (fade).

Figure 5-1 shows a frame-timing diagram that illustrates what occurs when frame computations are not completed within the required interval. The solid vertical lines in Figure 5-1 represent frame-display intervals. The dashed vertical lines represent video refresh intervals.

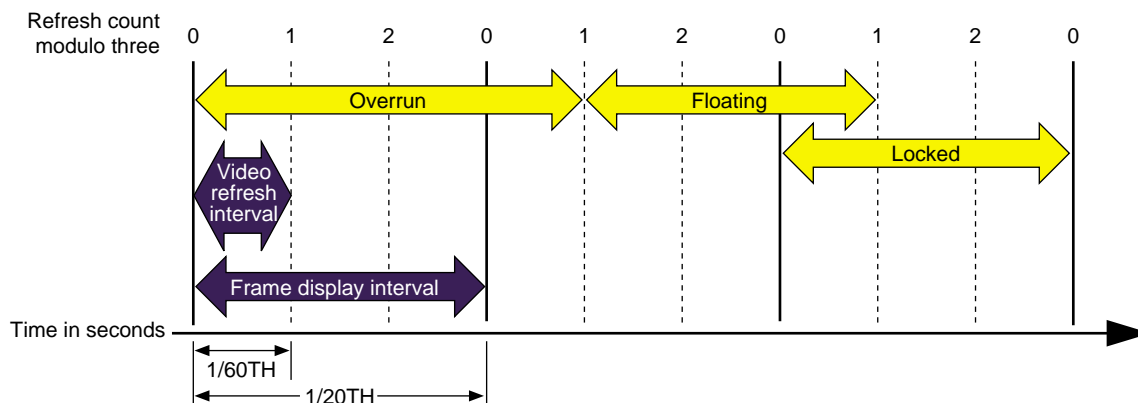

Figure 5-1 Frame Rate and Phase Control

In this example, the video scan rate is 60 Hz and the frame rate is 20 Hz. With the video hardware running at 60 Hz, each of the 20 Hz frames should be scanned to the video display three times, and the system should wait for every third vertical retrace signal before displaying the next image. The numbers across the top of the figure represent the refresh count modulo three. New images are displayed on refreshes whose count modulo three is zero, as shown by the solid lines.

In the first frame of this example, the new image is not yet completed when the third vertical retrace signal occurs; therefore, the same image must be displayed again during the next interval. This situation is known as frame *overrun*, because the frame computation time extends past a refresh boundary.

Frame Synchronization

Because of the overrun, the frame and refresh interval timing is no longer synchronized; it is out of phase. A decision must be made either to display the same image for the remaining two intervals, or to switch to the next image even though the refresh is not aligned on a frame boundary. The frame-rate control mode, discussed in the next section, determines which choice is selected.

Knowing that the situation illustrated in Figure 5-1 is a possibility, you can specify a frame control mode to indicate what you would like the system to do when a frame overrun occurs.

To specify a method of frame-rate control, call **pfPhase()**. There are the following choices:

- Free run without phase control (PFPHASE_FREE_RUN) tells the application to run as fast as possible—to display each new frame as soon as it is ready, without attempting to maintain a constant frame rate.
- Free run without phase control but with a limit on the maximum frame rate (PFPHASE_LIMIT) tells the application to run no faster than the rate specified by **pfFrameRate()**.
- Fixed frame rate with floating phase (PFPHASE_FLOAT) allows the drawing process to display a new frame (using **glXSwapBuffers()** at any time, regardless of frame boundaries).
- Fixed frame rate with locked phase (PFPHASE_LOCK) requires the draw process to wait for a frame boundary before displaying a new frame.
- The draw by default will wait for a new cull result to execute its stage functions. This behavior can be changed by including the token PFPHASE_SPIN_DRAW with the desired mode token from the above choices. This will allow the draw to run every frame, redrawing the previous cull result. This can allow you to make changes of your own in draw callback functions. Objects such as viewing frustum, pfLODs, pfDCSs, and anything else normally processed by the cull or application processes will not be updated until the next full cull result is available.

Free-Running Frame-Rate Control

The simplest form of frame-rate control, called *free-running*, is to have no control at all. This uncontrolled mode draws frames as quickly as the hardware is able to process them. In free-running mode, the frame rate may be 60 Hz in the areas of low database complexity, but could drop to a slower rate in views that place greater demand on the system. Use **pfPhase(PFPHASE_FREE_RUN)** to specify a free-running frame rate.

In applications in which real-time graphics provide the majority of visual cues to an observer, the variable frame rates produced by the free-running mode may be undesirable. The variable lag in image update associated with variable frame rate can lead to motion sickness for the simulation participants, especially in motion platform-based trainers or ingressive head-mounted displays. For these and other reasons it is usually preferable to maintain a steady, consistent frame-update rate.

Fixed Frame-Rate Control

Assume that the overrun frame in Figure 5-1 completes processing during the next refresh period, as shown. After the overrun frame, the simulation is still running at the chosen 20-Hz rate and is updating at every third vertical retrace. If a new image is displayed at the next refresh, its start time lags by 1/60th of a second, and therefore it is out of phase by that much.

Subsequent images are displayed when the refresh count modulo three is one. As the simulation continues and additional extended frames occur, the phase continues to drift. This mode of operation is called *floating phase*, as shown by the frame in Figure 5-1 labeled "Floating." Use `pfPhase(PFPHASE_FLOAT)` to select floating-phase frame control.

The alternative to displaying a new image out of phase is to display the old image for the remainder of the current update period, then change to the new image at the normal time. This *locked phase* extends each frame overrun to an integral multiple of the selected frame time, making the overrun more evident but also maintaining phase throughout the simulation. This timing is shown by the frame in Figure 5-1 labeled **Locked**. Although this mode is the most restrictive, it is also the most desirable in many cases. Use `pfPhase(PFPHASE_LOCK)` to select phase-locked frame control.

For example, a 20-Hz phase-locked frame rate is selected by specifying the following:

```
pfPhase(PFPHASE_LOCK);  
pfFrameRate(20.0f);
```

These specifications prevent the system from switching to a newly computed image until a display period of 1/20th second has passed from the time the previous image was displayed. The frame rate remains fixed even when the Geometry Pipeline finishes its work in less time. Fixed frame-rate display, therefore, involves setting the desired frame rate and selecting one of the two fixed-frame-rate control modes.

Frame Skipping

When multiple frame times elapse during the rendering of a single frame, the system must choose which frame to draw next. If the per-frame display lists are processed in strict succession even after a frame overrun, the visual image slowly recedes in time and the positional correlation between display and simulation is lost. To avoid this problem, only the most recent frame definition received by the draw process is sent to the

Geometry Pipeline, and all intervening frame definitions are abandoned. This is known as *dropping* or *skipping* frames and is performed in both of the fixed frame-rate modes.

Because the effects of variable frame rates, phase variance, and frame dropping are distracting, you should choose a frame rate with care. Steady frame rates are achieved when the frame time allows the worst-case view to be computed without overload. The structure of the visual database, particularly in terms of uniform “complexity density,” can be important in maximizing the system frame rate. See “Organizing a Database for Efficient Culling” in Chapter 4 and Figure 4-3 for examples of the importance of database structure.

Maintaining a fixed frame rate involves managing future system load by adjusting graphics display actions to compensate for varying past and present loads. The theory behind load management and suggested methods for dealing with variable load situations are discussed in the “Level-of-Detail Management” on page 136 of this chapter.

Sample Code

Example 5-1 demonstrates a common approach to frame control. The code is based on part of the `main.c` source file used in the *perfly* sample application.

Example 5-1 Frame Control Excerpt

```
/* Set the desired frame rate. */
pfFrameRate(ViewState->frameRate);

/* Set the MP synchronization phase. */
pfPhase(ViewState->phase);

/* Application main loop */
while (!SimDone())
{
    /* Sleep until next frame */
    pfSync();

    /* Should do all latency-critical processing between
     * pfSync() and pfFrame(). Such processing usually
     * involves changing the viewing position.
     */
    PreFrame();

    /* Trigger cull and draw processing for this frame. */
```

```
    pfFrame();  
  
    /* Perform non-latency-critical simulation updates. */  
    PostFrame();  
}
```

Level-of-Detail Management

All graphics systems have finite capabilities that affect the number of geometric primitives that can be displayed per frame at a specified frame rate. Because of these limitations, maximizing visual cues while minimizing the polygon count in a database is often an important aspect of database development. Level-of-detail (LOD) processing is one of the most beneficial tools available for managing database complexity for the purpose of improving display performance.

The basic premise of LOD processing is that objects that are barely visible, either because they are located a great distance from the eyepoint or because atmospheric conditions reduce visibility, do not need to be rendered in great detail in order to be recognizable. This is in stark contrast to mandating that all polygons be rendered regardless of their contribution to the visual scene. Both atmospheric effects and the visual effect of perspective decrease the importance of details as range from the eyepoint increases. The predominant visual effect of distance is the perspective foreshortening of objects, which makes them appear to shrink in size as they recede into the distance.

To save rendering time, objects that are visually less important in a frame can be rendered with less detail. The LOD approach to optimizing the display of complex objects is to construct a number of progressively simpler versions of an object and to select one of them for display as a function of range.

This requires you to create multiple models of an object with varying levels of detail. You also must supply a rule to determine how much detail is appropriate for a given distance to the eyepoint. The sections that follow describe how to create multiple LOD models and how to control when the changeover to a different LOD occurs.

Level-of-Detail Models

Most objects comprise smaller objects that become visually insignificant at ranges where the conglomerate object itself is still quite prominent. For example, a complex model of

an automobile might have door handles, side- and rear-view mirrors, license plates, and other small details.

A short distance away, these features may no longer be visible, even though the car itself is still a visually significant element of the scene. It is important to realize that as a group, these small features may contain as many polygons as the larger car itself, and thus have a detrimental effect on rendering speed.

You can construct two LOD models simply by providing one model that contains all of the detailed features and another model that contains only the car body itself and none of the detailed features. A more sophisticated scheme uses multiple LOD models that are grouped under an LOD node.

Figure 5-2 shows an LOD node with multiple children numbered 1 through n . In this case, the model named LOD 1 is the most detailed model and models LOD 2 through LOD n represent progressively coarser models. Each of these LOD models might contain children that also have LOD components. Associated with the LOD node is a list of ranges that define the distance at which each model is appropriate to display. There is no limit to the number of levels of detail that can be used.

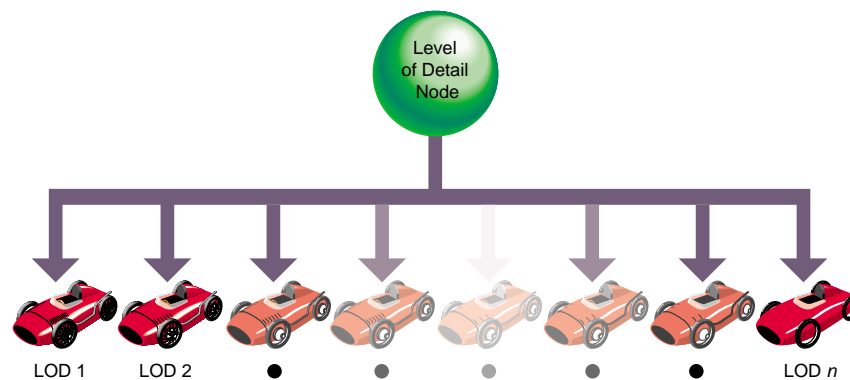

Figure 5-2 Level-of-Detail Node Structure

The object can be transformed as needed. During the culling phase of frame processing, the distance from the eyepoint to the object is computed and used (with other factors) to select which LOD model to display.

The OpenGL Performer pfLOD node contains a value known as the center of LOD processing. The LOD center point is an x, y, z location that defines the point used in conjunction with the eyepoint for LOD range-switching calculations, as described in the section “Level-of-Detail Range Processing” on page 141 of this chapter.

Figure 5-3 shows an example in which multiple LOD models grouped under a parent LOD node are used to represent a toy race car.

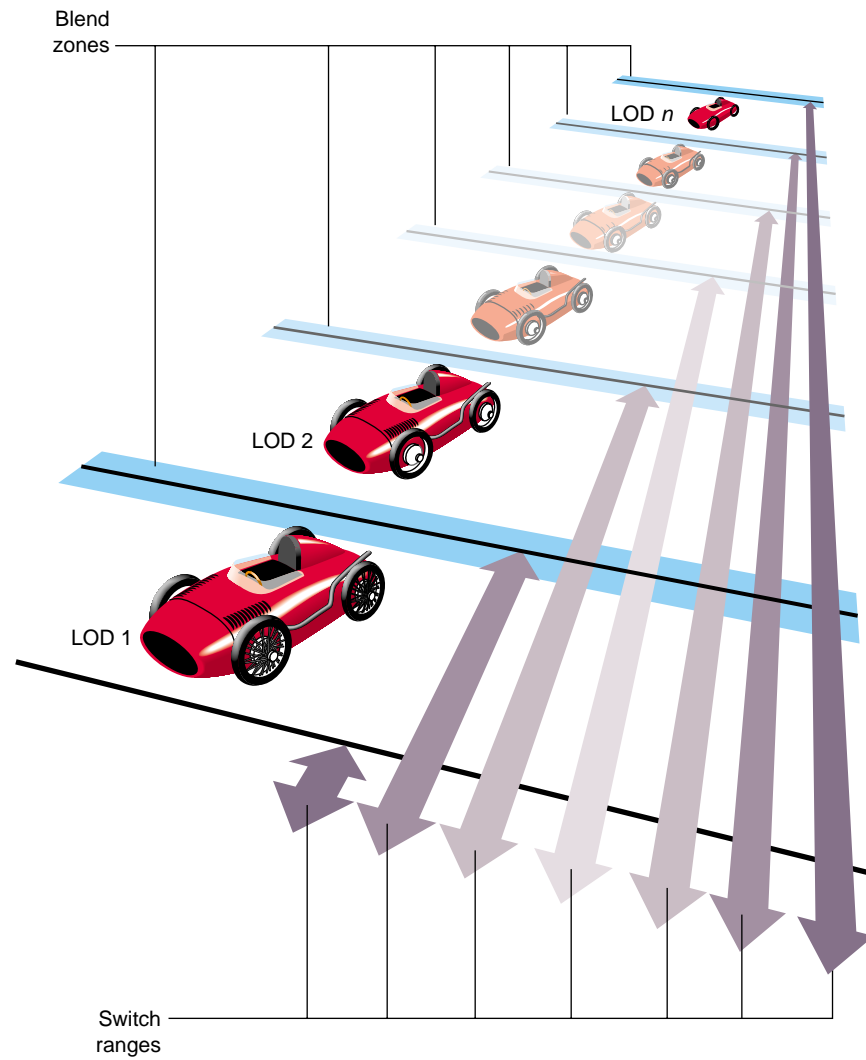

Figure 5-3 Level-of-Detail Processing

Figure 5-3 demonstrates that each car in a row of identical cars placed at increasing range from the eyepoint is drawn using a different child of the tree's LOD node.

The double-ended arrows indicate a switch range for each level of detail. When the car is closer to the eyepoint than the first range, nothing is drawn. When the car is between the first and second ranges, LOD 1 is drawn. When the car is between the second and third ranges, LOD 2 is drawn.

This range bracketing continues until the final range is passed, at which point nothing is drawn. The pfLOD node's switch range list contains one more entry than the number of child nodes to allow for this range bracketing.

OpenGL Performer provides the ability to specify a blend zone for each switch between LOD models. These blend zones will be discussed in more detail in "Level-of-Detail Transition Blending" on page 145.

Level-of-Detail States

In addition to standard LOD nodes, OpenGL Performer also supports LOD state—the pfLODState. A pfLODState is in essence a way of creating classes or priorities among LODs. A pfLODState contains eight parameters used to modify four different ways in which OpenGL Performer calculates LOD switch ranges and LOD transition distances. LOD states contain the following parameters:

- Scale for LODs switch ranges
- Offset for LODs switch ranges
- Scale for the effect of Stress of switch ranges
- Offset for the effect of Stress on switch ranges
- Scale for the transition distances per LOD switch
- Offset for the transition distances per LOD switch
- Scale for the effect of stress on transition distances
- Offset for the effect of stress on transition distances

These LOD states can then be attached to either single or multiple LOD nodes such that the LOD behavior of groups or classes of objects can be different and be easily modified. The man pages for **pfLODL0DState()** and **pfLODL0DStateIndex()** contain detailed information on how to attach pfLODStates.

LOD states are useful because in a particular scene there often exists an object of focus such as a sign, a target, or some other object of particular visual significance that needs to be treated specially with regard to visual importance and thus LOD behavior. It stands to reason that this particular object (or small group of objects) should be at the highest detail possible despite being farther away than other elements in the scene which might not be as visually significant. In fact, it might be feasible to diminish the detail of less important objects (like rocks and trees) in favor of the other more important objects (despite these objects being more distant). In this case one would create two LOD states. The first would be for the important objects and could disable the effect of stress on these nodes as well as scale the switch ranges such that the object(s) would maintain more detail for further ranges. The second LOD state would be used to make the objects of less importance be more responsive to system stress and possibly scale their switch ranges such that they would show even less detail than normal. In this way, LOD states allow biasing among different LODs to maintain desirable rendering speeds while maintaining the visual integrity of various objects depending on their subjective importance (rather than solely on their current visual significance).

In some multichannel applications, LOD states are used to control the action of LODs in different viewing channels that have different visual significance criteria—for instance one channel might be a normal channel while a second might represent an infrared display. Rather than simple use of LOD states, it is also possible to specify a list of LOD states to a channel and use indexes from this list for particular LODs (with **pfChanLODStateList()** and **pfLODLODStateIndex()**). In this way, in the normal channel a car's geometry might be particularly important while in the infrared channel, the hot exhaust of the same car might be much more important to observe. This type of channel-dependent LOD can be set up by using two distinct and different LOD states for the same index in the lists of LOD states specified for unique channels.

Note that because OpenGL Performer performs LOD calculations in a range squared space as much as possible for efficiency reasons, LOD computation becomes more costly when LOD states contain scales that are not equal to 1.0 or offsets not equal to 0.0 for transitions or switch ranges—these offsets force OpenGL Performer to perform otherwise avoidable square root calculations in order to correctly calculate the effects of scale and offset on the LOD.

Level-of-Detail Range Processing

The LOD switch ranges present in LOD nodes are processed before being used to make the level of detail selection. The goal of range setting is to switch LODs as objects reach certain levels of perceptibility. The size of a channel in pixels, the field of view used in

viewing, and the distance from the observer to the display surface all affect object perceptibility.

OpenGL Performer uses a channel size of 1024x1024 pixels and a 45-degree field of view as the basis for calculating LOD switching ranges. The screen space size of a channel and the current field of view are used to compute an LOD scale factor that is updated whenever the channel size or the field of view changes.

There is an additional global LOD scale factor that can be used to adjust switch ranges based on the relationship between the observer and the display surface. The default global scale factor is 1.

Note that LOD switch ranges are also affected by LOD states that have been attached to either a particular LOD or to a channel that contains the LOD. These LOD states provide the mechanism to apply both a scale and an offset for an LODs switch ranges and to the effect of system stress on those switch ranges. See “Level-of-Detail States” on page 140 for more information on pfLODStates.

Ultimately, an LOD’s switch range without regard to system stress can be computed as follows:

```
switch_range[i] =
    (range[i] *
     LODStateRangeScale *
     ChannelLODStateRangeScale +
     LODStateRangeOffset +
     ChannelLODStateRangeOffset) *
    ChannelLODScale *
    ChannelSizeAndFOVFactor;
```

If OpenGL Performer channel stress processing is active, the computed range is modified as follows:

```
switch_range[i] *=
    (ChannelLODStress *
     LODStateRangeStressScale *
     ChannelLODStateRangeStressScale +
     LODStateRangeStressOffset +
     ChannelLODStateRangeStressOffset);
```

Example 5-2 illustrates how to set LOD ranges.

Example 5-2 Setting LOD Ranges

```

/* setLODRanges() -- sets the ranges for the LOD node. The
 * ranges from 0 to NumLODs are equally spaced between min
 * and max. The last range, which determines how far you
 * can get from the object and still see it, is set to
 * visMax.
 */
void
setLODRanges(pfLOD *lod, float min, float max, float visMax)
{
    int i;
    float range, rangeInc;

    rangeInc = (max - min)/(ViewState->shellLOD + 1);
    for (range = min, i = 0; i < ViewState->shellLOD; i++)
    {
        ViewState->range[i] = range;
        pfLODRange(lod, i, range);
        range += rangeInc;
    }
    ViewState->range[i] = visMax;
    pfLODRange(lod, i, visMax);
}

/* generateShellLODs() -- creates shell LOD nodes according
 * to the parameters specified in the shared data structure.
 */
void
generateShellLODs(void)
{
    int i;
    pfGroup *grp;
    pfVec4 clr;
    long numLOD = ViewState->shellLOD;
    long numPnts = ViewState->shellPnts;
    long numPcs = ViewState->shellPcs;

    for (i = 1; i <= numLOD; i++)
    {
        if (ViewState->shellColor == SHELL_COLOR_SING)
            pfSetVec4(clr, 0.9f, 0.1f, 0.1f, 1.0f);
        else
            /* set the color. highest level = RED;
             * middle LOD = GREEN; lowest LOD = BLUE

```

```
    */
    pfSetVec4(clr,
              (i <= (long)floor((double)(numLOD/2.0f)))?
              (-2.0f/numLOD) * i + 1.0f + 2.0f/numLOD:
              0.0f,
              (i <= (long)floor((double)(numLOD/2)))?
              (2.0f/numLOD) * (i - 1):
              (-2.0f/numLOD) * i + 2.0f,
              (i <= (long)floor((double)(numLOD/2)))?
              0.0f:
              (2.0f/numLOD) * i - 1.0f,
              1.0f);

    /* build a shell GeoSet */
    grp = createShell(numPcs, numPnts,
                    ViewState->shellSweep, &clr,
                    ViewState->shellDraw);
    normalizeNode((pfNode *)grp);

    /* add geode as another level of detail node */
    pfAddChild(ViewState->LOD, grp);

    /* simplify the geometry, but don't have less than
     * 4 points per circle or less than 3 pieces */
    numPnts = (numPnts > 7) ? numPnts-4 : 4;
    numPcs = (numPcs > 6) ? numPcs-4 : 3;
}
}
...
ViewState->LOD = pfNewLOD();

generateShellLODs();

/* get the LOD's extents */
pfGetNodeBSphere(ViewState->LOD, &(ViewState->bSphere));
pfLODCenter(ViewState->LOD, ViewState->bSphere.center);
/* set ranges for LODs; there should be (num LODs + 1)
 * range entries */
setLODRanges(ViewState->LOD, ViewState->minRange,
             ViewState->maxRange, ViewState->max);
```

Level-of-Detail Transition Blending

An undesirable effect called *popping* occurs when the sudden transition from one LOD to the next LOD is visually noticeable. This distracting image artifact can be ameliorated with a slight modification to the normal LOD-switching process.

In this modified method, a transition per LOD switch is established rather than making a sudden substitution of models at the indicated switch range. These transitions specify distances over which to blend between the previous and next LOD. These zones are considered to be centered at the specified LOD switch distance, as shown by the horizontal shaded bars of Figure 5-3. Note that OpenGL Performer limits the transition distances to be equal to the shortest distance between the switch range and the two neighboring switch ranges. For more information, see the **pfLODTransition()** man page.

As the range from eyepoint to LOD center-point transitions the blend zone, each of the neighboring LOD levels is drawn by using transparency-to-composite samples taken from the present LOD model with samples taken from the next LOD model. For example, at the near, center, and far points of the transition blend zone between LOD 1 and LOD 2, samples from both LOD 1 and LOD 2 are composited until the end of the transition zone is reached, where all the samples are obtained from LOD 2.

Table 5-2 lists the transparency factors used for transitioning from one LOD range to another LOD range.

Table 5-2 LOD Transition Zones

Distance	LOD 1	LOD 2
Near edge of blend zone	100% opaque	0% opaque
Center of blend zone	50% opaque	50% opaque
Far edge of blend zone	0% opaque	100% opaque

LOD transitions are made smoother and much less noticeable by applying a blending technique rather than making a sudden transition. Blending allows LOD transitions to look good at ranges closer to the eye than LOD popping allows. Decreasing switch ranges in this way improves the ability of LOD processing to maximize the visual impact of each polygon in the scene without creating distracting visual artifacts.

The benefits of smooth LOD transition have an associated cost. The expense lies in the fact that when an object is within a blend zone, two versions of that object are drawn. This

causes blended LOD transitions to increase the scene polygon complexity during the time of transition. For this reason, the blend zone is best kept to the shortest distance that avoids distracting LOD-popping artifacts. Currently, fade level of detail is supported only on RealityEngine and InfiniteReality graphics systems.

Note that the actual 'blend' or 'fade' distance used by OpenGL Performer can also be adjusted by the LOD priority structures called pLODStates. pLODStates hold an offset and scale for the size of transition zones as well as an offset and scale for how system stress can affect the size of the transition zones. See "Level-of-Detail States" on page 140 for more information on pLODStates.

Note also, that there exists a global LOD transition scale on a per channel basis that can affect all transition distances uniformly.

Thus for an LOD with 5 switch ranges R0, R1, R2, R3, R4 to switch between four models (M0, M1, M2, M3), there are 5 transition zones T0 (fade in M0), T1 (blend between M0 and M1), T2 (blend between M1 and M2), T3 (blend between M2 and M3), T4 (fade out M3). The actual fade distances (without regard to channel stress) are as follows:

```
fadeDistance[i] =
    (transition[i] *
     LODStateTransitionScale *
     ChannelLODStateTransitionScale +
     LODStateTransitionOffset +
     ChannelLODStateTransitionOffset) *
    ChannelLODFadeScale;
```

If OpenGL Performer management of channel stress is turned on then the above fade distance is modified as follows:

```
fadeDistance[i] /=
    (ChannelStress *
     LODStateTransitionStressScale *
     ChannelLODStateTransitionStressScale +
     LODStateTransitionStressOffset +
     ChannelLODStateTransitionStressOffset);
```

Run-Time User Control Over LOD Evaluation

A pLOD node provides one last resort for applications that have complex level-of-detail calculations. For example, an application might wish to limit the speed at which different LODs of an object switch. When switching depends on the range from the camera, a very

fast-moving camera may result in rapid changes of LODs. The application may require an artificial filter to take the simple range-based evaluation and ease it into the display over time.

An application may take over the LOD evaluation function using the API **pfLODUserEvalFunc()** on **pfLOD**. The user-supplied function must return a floating point number. Similar to the result of **pfEvaluateLOD()**, this number picks either a single child or a blend of two children of the **pfLOD** node.

Note that the performance of the cull process may decrease if the user function is too slow to execute.

Terrain Level-of-Detail

In creating LOD models and transitions for objects, it is often safe to assume that the **entire** model should transition at the same time. It is quite reasonable to make features of an automobile such as door handles disappear from the scene at the same time even when the passenger door is slightly closer than the driver's door. It is much less clear that this approach would work for very large objects such as an aircraft carrier or a space station, and it is clearly not acceptable for objects that span a large extent, such as a terrain surface.

Active Surface Definition (ASD)

Attempts to handle large-extent objects with discrete LOD tools focus on breaking the big object into myriad small objects and treating each small object independently. This works in some cases but often fails at the junction between two or more independent objects where cracks or seams exist when different detail levels apply to the objects. Some terrain processing systems have attempted to provide a hierarchy of crack-filling geometry that is enabled based on the LOD selections of two neighboring terrain patches. This "digital grout" becomes untenable when more than a few patches share a common vertex.

You can always make the transitions between LODs smooth by using active surface definition. ASD treats the entire terrain as a single connected surface rather than multiple patches that are loaded into memory as necessary. The surface is modeled with several hierarchical LOD meshes in data structures that allow for the rapid evaluation of smooth LOD transitions, load management on the evaluation itself, and efficient generation of a meshed terrain surface of the visible triangles for the current frame. For more information, refer to the Chapter 20, "Active Surface Definition."

Arbitrary Morphing

Terrain level of detail using an interpolative active surface definition is a restricted form of the more general notion of object morphing. Morphing of models such as the car in a previous example can simply involve scaling a small detail to a single point and then removing it from the scene. Morphing is possible even when the topologies of neighboring pairs do not match. Both models and terrain can have vertex, normal, color, and appearance information interpolated between two or more representations. The advantages of this approach include: reduced graphics complexity since blending is not used, constant intersection truth for collision and similar tasks, and monotonic database complexity that makes system load management much simpler. Such evaluation might make use of the compute process and `pfFlux` objects to hold the vertex data and to modify the scene graph control to chose the proper form of the object. `pfSwitch` nodes can take a `pfFlux` for holding its value; see the `pfSwitchValFlux()` man page. `pfLOD` nodes can take a flux for controlling range with `pfLODRangeFlux()`. See the `pfLOD` and `pfEngine` man pages for more information on morphing.

Maintaining Frame Rate Using Dynamic Video Resolution

When frame rate is not maintained, some frames display longer than others. If, for example, when the frame rate is 30 frames per second, a frame takes longer than 1/30th of a second to fill the frame buffer, the frame is not displayed. Consequently, the current frame is displayed for two instead of one 1/30ths of a second. The result of inconsistent frame rates is jerky motion within the scene.

Note: You have some control over what happens when a frame rate is missed. You can choose, for example, to begin the next frame in the next 1/60th of a second, or wait for the start of the next 1/30th second. For more information about handling frame drawing overruns, see `pfPhase` in “Free-Running Frame-Rate Control” on page 133.

The key to maintaining frame rate is limiting the amount of information to be rendered. OpenGL Performer can take care of this problem automatically for you on InfiniteReality systems when you use the `PPPVC_DVR_AUTO` token with `pfPVChanDVRMode()`.

In `PPPVC_DVR_AUTO` mode, OpenGL Performer checks every rendered frame to see if it took too long to render. If it did, OpenGL Performer reduces the size of the image, and correspondingly, the number of pixels in it. Afterwards, the video hardware enlarges the

images to the same size as the pfChannel; in this way, the image is the correct size, but it contains a reduced number of pixels, as suggested in Figure 5-4.

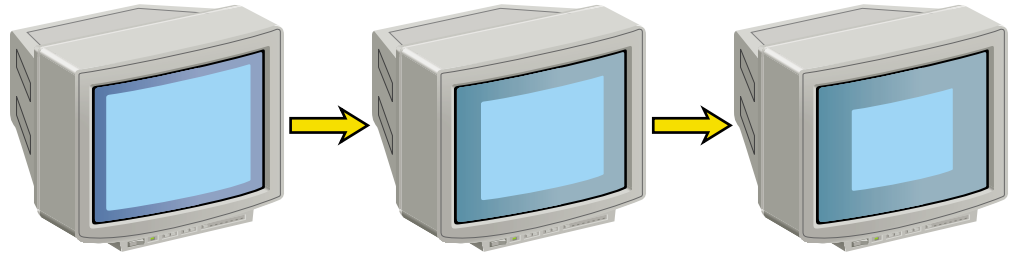

Figure 5-4 Real Size of Viewport Rendered Under Increasing Stress

Although the viewport is reduced as stress increases, the viewer never sees the image grow smaller because bipolar filtering is used to enlarge the image to the size of the channel.

The Channel in DVR

When using Dynamic Video Resolution (DVR), the origin and size of a channel are dynamic. For example, a viewport whose lower-left corner is at the center of a pfPipe (with coordinates 0.5, 0.5) would be changed to an origin of (0.25, 0.25) with respect to the full pfPipe window if the DVR settings were scaled by a factors of 0.5 in both X and Y dimensions.

If you are doing additional rendering into a pfChannel, you may need to know the size and the actual rendered area of the pfChannel. Use **pfGetChanOutputOrigin()** and **pfGetChanOutputSize()** to get the actual rendered origin and size, respectively, of a pfChannel. **pfGetChanOrigin()** and **pfGetChanSize()** give the displayed origin and size of the pfChannel and these functions should be used for mapping mouse positions or other window-relative nonrendering positions to the pfChannel area.

Additionally, if DVR alters the rendered size of a pfChannel, a corresponding change should be made to the width of points and lines. For example, when a channel is scaled in size by one half, lines and points must be drawn half as wide as well so that when the final image is enlarged, in this case by a factor of two, the lines and points scale correctly. **pfChanPixScale()** sets the pixel scale factor. **pfGetChanPixScale()** returns this value for a channel. pfChannels set this pixel scale automatically.

DVR Scaling

DVR scales linearly in response to the most common cause of draw overload: filling the polygons. For example, if the DRAW stage process is overran by 50%, to get back in under the frame time, the new scene must draw 30% fewer pixels. We can do this with DVR by rendering to a smaller viewport and letting the video hardware rescale the image to the correct display size.

If **pfPVChanMode()** is set to `PPFVC_DVR_AUTO`, OpenGL Performer automatically scales each of the `pfChannels`. `pfChannels` automatically scale themselves according to the scale set on the `pfPipeVideoChannel` they are using.

If the **pfPVChanMode()** is `PPFVC_DVR_MANUAL`, you control scaling according to your own policy by setting the scale and size of the `pfPipeVideoChannel` in the application process between **pfSync()** and **pfFrame()**, as shown in this example:

Total pixels drawn last frame = ChanOutX * ChanOutY * Depth Complexity

To make the total pixels drawn 30% less, do the following:

```
NewChanOutX = NewChanOutY = .7 * (Chan OutX * ChanOut.)
New ChanOut X = sqrt (.7) * ChanOutX
New ChanOut Y = sqrt (.7) * ChanOut Y
NewChanOut = sqrt (.7) * ChanOut
```

Customizing DVR

Your application has full control over DVR behavior. You can either configure the automatic mode or implement your own response control.

Automatic resizing can cause problems when an image has so much information in it the viewport is reduced too drastically, perhaps to only a few hundred pixels, so that when the image is enlarged, the image resolution is unacceptably blurry. To remedy this problem, `pfPipeVideoChannel` includes the following methods to limit the reduction of a video channel:

pfPVChanMaxDecScale()

Sets the maximum X and Y decrement scaling that can happen in a single step of automatic dynamic video resizing. A scale value of (-1), the default, removes the upper bound on decremental scales.

pfPVChanMaxIncScale()

Sets the maximum X and Y increment scaling that can happen in a single step of automatic dynamic video resizing. A scale value of (-1), the default, removes the upper bound on incremental scales.

pfPVChanMinDecScale()

Sets the minimum X and Y decrement scaling that can happen in a single step of automatic dynamic video resizing. The default value is 0.0.

pfPVChanMinIncScale()

Sets the minimum X and Y increment scaling that can happen in a single step of automatic dynamic video resizing. The default value is 0.0.

pfPVChanStress()

Sets the stress of the pfPipeVideoChannel for the current frame. This call should be made in the application process after **pfSync()** and before **pfFrame()** to affect the next immediate draw process frame.

pfPVChanStressFilter()

Sets the parameters for computing stress if it is not explicitly set for the current frame by **pfPVChanStress()**.

Each of these methods have corresponding Get methods that return the values set by these methods.

To resize the video channel manually, use pfPipeVideoChannel sizing methods, such as **pfPVChanOutputSize()**, **pfPVChanAreaScale()**, and **pfPVChanScale()**.

The pfPipeVideoChannel associated with a channel is returned by **pfGetChanPVChan()**. If there is more than one pfPipeVideoChannel associated with a pfPipeWindow, each one is identified by an index number. In the case of multiple pfPipeVideoChannels, the pfPipeVideoChannel index is set using **pfChanPWinPVChanIndex()** and returned by **pfGetChanPWinPVChanIndex()**.

Understanding the Stress Filter

The **pfPVChanStressFilter()** function sets the parameters for computing stress for a pfPipeVideoChannel when the stress is not explicitly set for the current frame by **pfPVChanStress()**, as shown in the following example:

```
void pfPipeVideoChannel::setStressFilter(float *frameFrac,
    float *lowLoad, float *highLoad, float *pipeLoadScale,
    float *stressScale, float *maxStress);
```

The *frameFrac* argument is the fraction of a frame that `pfPipeVideoChannel` is expected to take to render the frame; for example, if the rendering time is equal to the period of the frame rate, *frameFrac* is 1.

If there is only one `pfPipeVideoChannel`, it is best if *frameFrac* is 1. If there are more than one `pfPipeVideoChannels` on the `pfPipe`, by default *frameFrac* is divided among the `pfPipeVideoChannels`. You can set *frameFrac* explicitly for each `pfPipeVideoChannel` such that a channel rendering visually complex scenes is allocated more time than a channel rendering simple scenes.

The **`pfGetPFChanStressFilter()`** function returns the stress filter parameters for `pfPipeVideoChannel`. If *stressScale* is nonzero, stress is computed for the `pfPipeVideoChannel` every frame. The parameters *low* and *high* define a hysteresis band for system load. When the load is above *lowLoad* and below *highLoad*, stress is held constant. When the load falls outside of the *lowLoad* and *highLoad* parameters, OpenGL Performer reduces or increases stress respectively by dynamically resizing the output area of the `pfPipeVideoChannel` until the load stabilizes between *lowLoad* and *highLoad*.

If *pipeStressScale* is nonzero, the load of the `pfPipe` of the `pfPipeVideoChannel` are considered in computing the stress. The parameter *maxStress* is the clamping value above which the stress value cannot go. For more information about the stress filter, see the man page for `pfPipeVideoChannel`.

Dynamic Load Management

Because the effects of variable image update rates can be objectionable, many simulation applications are designed to operate at a fixed frame rate. One approach to selecting this fixed frame rate is to select an update rate constrained by the most complex portion of the visual database. Although this conservative approach may be acceptable in some cases, OpenGL Performer supports a more sophisticated approach using dynamic LOD scaling.

Using multiple LOD models throughout a database provides the traversal system with a parameter that can be used to control the polygonal complexity of models in the scene. The complexity of database objects can be reduced or increased by adjusting a global LOD range multiplier that determines which LOD level is drawn.

Using this facility, a closed-loop control system can be constructed that adjusts the LOD-switching criteria based on the system load, also called *stress*, in order to maintain a selected frame rate.

Figure 5-5 illustrates a stress-processing control system.

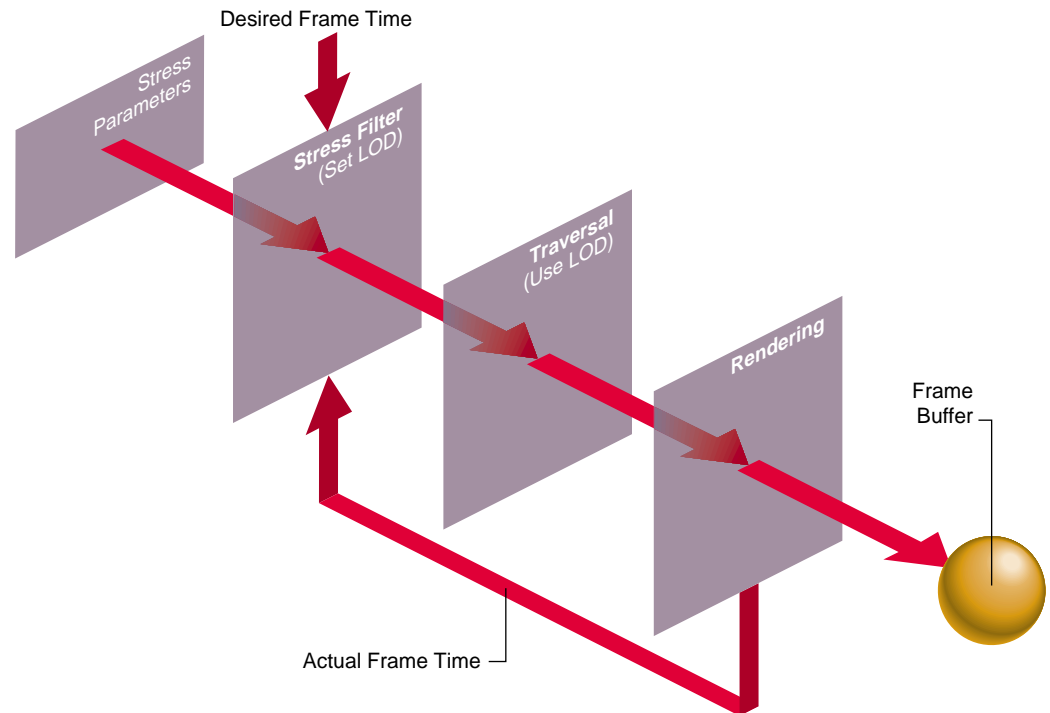

Figure 5-5 Stress Processing

In Figure 5-5, the desired and actual frame times are compared by the stress filter. Based on the user-supplied stress parameters, the stress filter adjusts the global LOD scale factor by increasing it when the system is overloaded and decreasing it when the system is underloaded. In this way, the system load is monitored and adjusted before each frame is generated.

The degree of stability for the closed-loop control system is an important issue. The ideal situation is to have a *critically damped* control system—that is, one in which just the right amount of control is supplied to maintain the frame rate without introducing undesirable effects. The effects of overdamped and underdamped systems are visually

distracting. An underdamped system oscillates, causing the system to continuously alternate between two different LOD models without reaching equilibrium. Overdamped systems may fail to react within the time required to maintain the desired frame rate. In practice, though, dynamic load management works well, and simple stress functions can handle the slowly changing loads presented by many databases.

The default stress function is controlled with user-selectable parameters. These parameters are set using the **pfChanStressFilter()** function.

The default stress function is implemented by the code fragment in Example 5-3.

Example 5-3 Default Stress Function

```
/* current load */
curLoad = drawTime * frameRate / frameFrac;

/* integrated over time */
if (curLoad < lowLoad)
    stressLevel -= stressParam * stressLevel;
else
if (curLoad > highLoad)
    stressLevel += stressParam * stressLevel;

/* limited to desired range */
if (stressLevel < 1.0)
    stressLevel = 1.0;
else
if (stressLevel > maxStress)
    stressLevel = maxStress;
```

The parameters *lowLoad* and *highLoad* define a comfort zone for the control system. The first if-test in the code fragment demonstrates that this comfort zone acts as a dead band. Instantaneous system load within the bounds of the dead band does not result in a change in the system stress level. If the size of the comfort zone is too small, oscillatory distress is the probable result. It is often necessary to keep the *highLoad* level below the 100% point so that blended LOD transitions do not drive the system into overload situations.

For those applications in which the default stress function is either inappropriate or insufficient, you can compute the system stress yourself and then set the stress load factor. Your filter function can access the same system measures that the default stress function uses, but it is also free to keep historical data and perform any feedback-transfer processing that application-specific dynamic load management may require.

The primary limitation of the default stress function is that it has a reactive rather than predictive nature. One of the major advantages of user-written stress filters is their ability to predict future stress levels before increased or decreased load situations reach the pipeline. Often the simulation application knows, for example, when a large number of moving models will soon enter the viewing frustum. If their presence is anticipated, then stress can be artificially increased so that no sudden LOD changes are required as they actually enter the field of view.

Successful Multiprocessing with OpenGL Performer

Note: This is an advanced topic.

This section does not apply to Microsoft Windows. OpenGL Performer 3.0 for Microsoft Windows does not support more than a single processor.

This section describes an advanced topic that applies only to systems with more than one CPU. If you do not have a multiple-CPU system, you may want to skip this section.

OpenGL Performer uses multiprocessing to increase throughput for both rendering and intersection detection. Multiprocessing can also be used for tasks that run asynchronously from the main application like database management. Although OpenGL Performer hides much of the complexity involved, you need to know something about how multiprocessing works in order to use multiple processors well.

Review of Rendering Stages

The OpenGL Performer application renders images using one or more pfPipes as independent software-rendering pipelines. The flow through the rendering pipeline can be modeled using these functional *stages*:

- | | |
|--------------|--|
| Intersection | Test for intersections between segments and geometry to simulate collision detection or line-of-sight for example. |
| Application | Do requisite processing for the visual simulation application, including reading input from control devices, simulating the vehicle dynamics of moving models, updating the visual database, and interacting with other networked simulation stations. |

Cull	Traverse the visual database and determine which portions of it are potentially visible, perform a level-of-detail selection for models with multiple representations, and a build sorted, optimized display list for the draw stage.
Draw	Issue graphics library commands to a Geometry Pipeline in order to create an image for subsequent display.

You can partition these stages into separate parallel processes in order to distribute the work among multiple CPUs. Depending on your system type and configuration, you can use any of several available multiprocessing models.

Choosing a Multiprocessing Model

Use `pfMultiprocess()` to specify which functional stages, if any, should be forked into separate processes. The multiprocessing mode is actually a bitmask where each bit indicates that a particular stage should be configured as a separate process. For example, the bit `PFMP_FORK_DRAW` means the draw stage should be split into its own process. Table 5-3 lists some convenient tokens that represent common multiprocessing modes.

Table 5-3 Multiprocessing Models

Model Name	Description
<code>PFMP_APPCULLDRAW</code>	Combine the application, cull, and draw stages into a single process. In this model, all of the stages execute within a single frame period. This is the minimum-latency mode of operation.
<code>PFMP_APP_CULLDRAW</code> or <code>PFMP_FORK_APP</code>	Combine the cull and draw stages in a process that is separate from the application process. This model provides a full frame period for the application process, while culling and drawing share this same interval. This mode is appropriate when the host's simulation tasks are extensive but graphic demands are light, as might be the case when complex vehicle dynamics are performed but only a simple dashboard gauge is drawn to indicate the results.

Table 5-3 Multiprocessing Models (**continued**)

Model Name	Description
PFMP_APPCULL_DRAW or PFMP_FORK_DRAW	Combine the application and cull stages in a process that is separate from the draw process. This mode is appropriate for many simulation applications when application and culling demands are light. It allocates a full CPU for drawing and has the application and cull stages share a frame period. Like the PFMP_APP_CULLDRAW mode, this mode has a single frame period of pre-draw latency.
PFMP_APP_CULL_DRAW or PFMP_FORK_CULL PFMP_FORK_DRAW	Perform the application, cull, and draw stages as separate processes. This is the full maximum-throughput multiprocessing mode of OpenGL Performer operation. In this mode, each pipeline stage is allotted a full frame period for its processing. Two frame periods of latency exist when using this high degree of parallelism.

You can also use the **pfMultiprocess()** function to specify the method of communication between the cull and draw stages, using the bitmasks PFMP_CULLoDRAW and PFMP_CULL_DL_DRAW.

Cull-Overlap-Draw Mode

Setting PFMP_CULLoDRAW specifies that the cull and draw processes for a given frame should overlap—that is, that they should run concurrently. For this to work, the cull and draw stages must be separate processes (PFMP_FORK_DRAW must be true). In this mode the two stages communicate in the classic producer-consumer model, by way of a pfDispList that is configured as a ring (FIFO) buffer; the cull process puts commands on the ring while the draw process simultaneously consumes these commands.

The main benefit of using PFMP_CULLoDRAW is reduced latency, since the number of pipeline stages is reduced by one and the resulting latency is reduced by an entire frame time. The main drawback is that the draw process must wait for the cull process to begin filling the ring buffer.

Forcing Display List Generation

When the cull and draw stages are in separate processes, they communicate through a pfDispList; the cull process generates the display list, and the draw process traverses and renders it. (The display list is configured as a ring buffer when using PFMP_CULLoDRAW mode, as described in the “Cull-Overlap-Draw Mode” section).

However, when the cull and draw stages are in the same process (as occurs with the PFMP_APPCULLDRAW or PFMP_APP_CULLDRAW multiprocessing models) a display list is not required and by default one will not be used. Leaving out the pfDispList eliminates overhead. When no display list is used, the cull trigger function **pfCull()** has no effect; the cull traversal takes place when the draw trigger function **pfDraw()** is invoked.

In some cases you may want an intermediate pfDispList between the cull and draw stages even though those stages are in the same process. The most common situation that calls for such a setup is multipass rendering when you want to cull only once but render multiple times. With PFMP_CULL_DL_DRAW enabled, **pfCull()** generates a pfDispList that can be rendered multiple times by multiple calls to **pfDraw()**.

Intersection Pipeline

The *intersection pipeline* is a two-stage pipeline consisting of the application and the intersection stages. The intersection stage may be configured as a separate process by setting the PFMP_FORK_ISECT bit in the bitmask given to **pfMultiprocess()**. When configured as such, the intersection process is triggered for the current frame when the application process calls **pfFrame()**. Then in the special intersection callback set with **pfIsectFunc()**, you can invoke any number of intersection requests with **pfNodeIsectSegs()**. To support this operation, the intersection process keeps a copy of the scene graph pfNodes.

The intersection process is asynchronous so that if it does not finish within a frame time it does not slow down the rendering pipeline(s).

Compute Process

The *compute process* is an asynchronous process provided for doing extensive asynchronous computation. The compute stage is done as part of **pfFrame()** in the application process unless it is configured to run as separate process by setting the PFMP_FORK_COMPUTE bit in the **pfMultiprocess()** bitmask. The compute process is asynchronous so that if it does not finish within a frame time, it will not slow down the rendering pipeline. The compute process is intended to work with pfFlux objects by placing the results of asynchronous computation in pfFluxes. pfFlux will automatically manage the needed multibuffering and frame consistency requirements for the data. See Chapter 19, “Dynamic Data,” for more information on pfFlux. Some OpenGL Performer objects, such as pfASD, do their computation in the compute stage so **pfCompute()** must

be called from any compute user callback if one has been specified with **pfComputeFunc()**.

Multiple Rendering Pipelines

By default, OpenGL Performer uses a single pfPipe, which in turn draws one or more pfChannels into one or more pfPipeWindows. If you want to use multiple rendering pipelines, as on two- or three-Geometry Pipeline Onyx RealityEngine2 and InfiniteReality systems, use **pfMultipipe()** to specify the number of pfPipes required. When using multiple pipelines, the PFMP_APPCULLDRAW and PFMP_APPCULL_DRAW modes are not supported and OpenGL Performer defaults to the PFMP_APP_CULL_DRAW multiprocessing configuration. Regardless of the number of pfPipes, there is always a single application process that triggers the rendering of all pipes with **pfFrame()**.

Multithreading

For additional multiprocessing and attendant increased throughput, the CULL stage of the rendering pipeline may be *multithreaded*. Multithreading means that a single pipeline stage is split into multiple processes, or threads which concurrently work on the same frame. Use **pfMultithread()** to allocate a number of threads for the cull stage of a particular rendering pipeline.

Cull multithreading takes place on a per-pfChannel basis; that is, each thread does all the culling work for a given pfChannel. Thus, an application with only a single channel will not benefit from multithreading the cull. An application with multiple, equally complex channels will benefit most by allocating a number of cull threads equal to the number of channels. However, it is valid to allocate fewer cull threads if you do not have enough CPUs—in this case the threads are assigned to channels on a need basis.

CULL Sidekick Processes

The OpenGL Performer CULL process traverses a scene graph and culls out any invisible geometry. Its result is a list of visible pfGeoSets. The OpenGL Performer CULL process does not break pfGeoSets into their visible and invisible parts. This means that a pfGeoSet whose bounding box intersects the viewing frustum will be sent to the graphics pipe even if only one triangle in this pfGeoSet is visible.

One way to overcome this problem is to allocate extra processes for cleaning up the pfGeoSet lists that the CULL processes produce. These extra processes are called CULL

sidekicks. By default, a CULL sidekick process checks all the primitives in all pfGeoSets on the CULL output. It replaces original pfGeoSets with temporary pfGeoSets and populates the temporary pfGeoSets with the visible parts of the original pfGeoSets. By default, CULL sidekick processes test each primitive twice for the following:

- For frustum visibility
A primitive outside the viewing frustum will be omitted from the temporary pfGeoSet.
- For backface culling
A primitive facing away from the viewer will be omitted from the temporary pfGeoSet. This test is skipped when a pfGeoSet is drawn without backface testing.

Each CULL process can have multiple CULL_SIDEKICK processes. You can use the **pfMultithread()** call to specify the number of CULL_SIDEKICK processes for each CULL process. The collection of CULL_SIDEKICK processes configured for each CULL process traverse the pfGeoSet list that the CULL process produces in a round-robin manner. The more CULL_SIDEKICK processes (each assigned to a separate CPU), the faster they process the pfGeoSet list that the CULL process produces. For more information about CULL_SIDEKICK processes in the context of CULL optimizations, see section “Cull Sidekick Processes” on page 173.

Order of Calls

The multiprocessing model set by **pfMultiprocess()** is used for each of the rendering pipelines. In programs that configures the application stage as a separate process, all OpenGL Performer calls must be made from the process that calls **pfConfig()** or the results are undefined. Both **pfMultiprocess()**, **pfMultithread()**, and **pfMultipipe()** must be called after **pfInit()** but before **pfConfig()**. **pfConfig()** configures OpenGL Performer according to the required number of pipelines and the desired multiprocessing and multithreading modes, forks the appropriate number of processes, and then returns control to the application. **pfConfig()** should be called only once during each OpenGL Performer application.

Comparative Structure of Models

Figure 5-6 shows timing diagrams for each of the process models. The vertical lines are frame boundaries. Five frames of the simulation are shown to allow the system to reach steady-state operation. Only one of these models can be selected at a time, but they are shown together so that you can compare their structures.

Boxes represent the functional stages and are labeled as follows:

A_n Application process for the n th frame

C_n Cull process for the n th frame

D_n Draw process for the n th frame

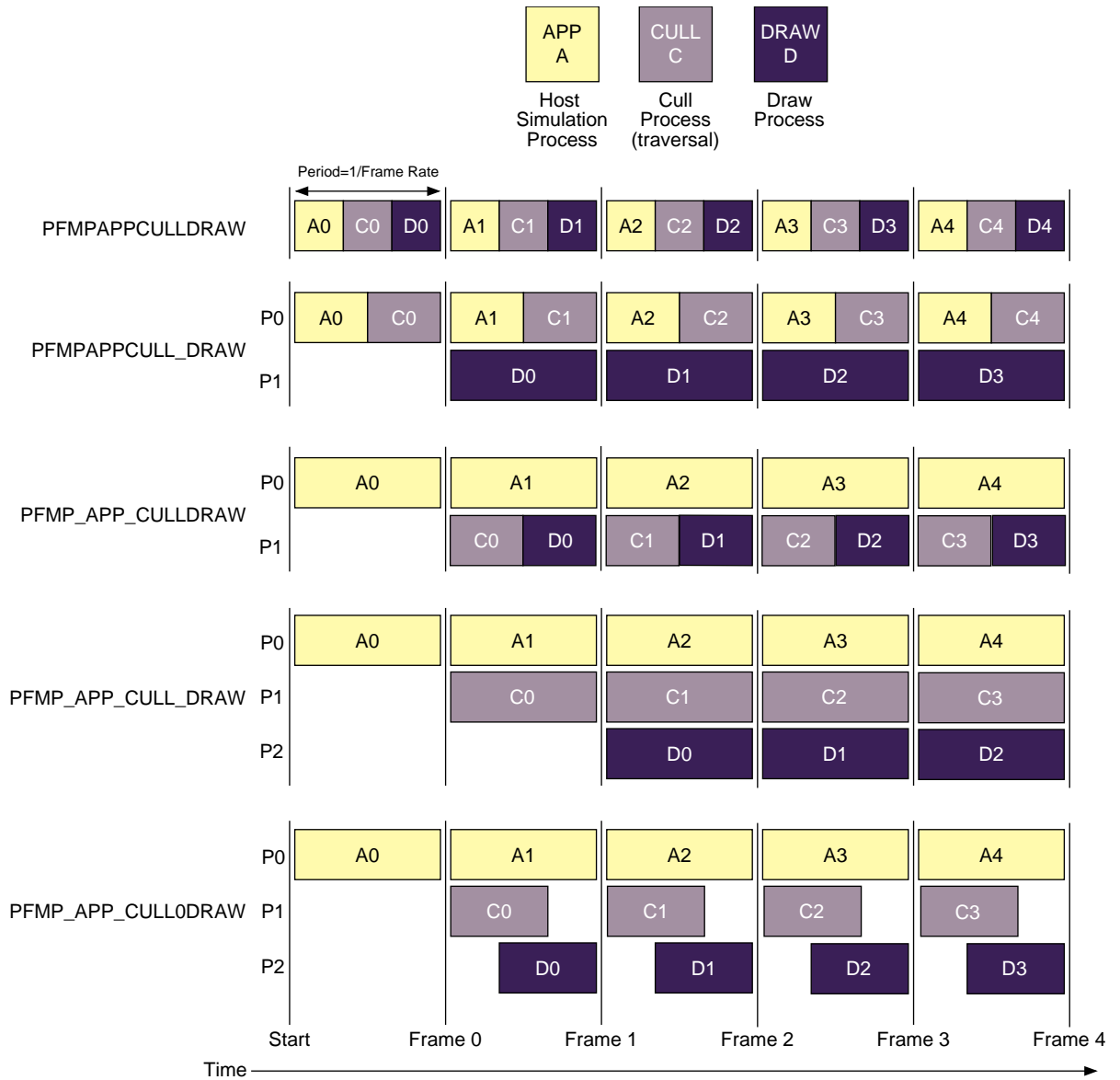

Figure 5-6 Multiprocessing Models

Notice that when a stage is split into its own process, the amount of time available for all stages increases. For example, in the case where the application, cull, and draw stages are three separate processes, it is possible for total system performance to be tripled over the single process configuration.

Asynchronous Database Processing

Many databases are too large to fit into main memory. A common solution to this problem is called *database paging* where the database is divided into manageable chunks on disk and loaded into main memory when needed. Usually chunks are paged in just before they come into view and are deleted from the scene when they are comfortably out of viewing range.

All this paging from disk and deleting from main memory takes a lot of time and is certainly not amenable to maintaining a fixed frame rate. The solution supported by OpenGL Performer is *asynchronous database paging* in which a process, completely separate from the main processing pipeline(s), handles all disk I/O and memory allocations and deletions. To facilitate asynchronous database paging, OpenGL Performer provides the `pfBuffer` structure and the DBASE process.

DBASE Process

The database (or DBASE) process is forked by `pfConfig()` if the `PFMP_FORK_DBASE` bit was set in the mode given to `pfMultiprocess()`. The database process is triggered when the application process calls `pfFrame()` and invokes the user-defined callback set with `pfDBaseFunc()`. The database process is totally asynchronous. If it exceeds a frame time it does not slow down any rendering or intersection pipelines.

The DBASE process is intended for asynchronous database management when used with a `pfBuffer`.

pfBuffer

A `pfBuffer` is a logical buffer that isolates database changes to a single process to avoid memory collisions on data from multiple processes. In typical use, a `pfBuffer` is created with `pfNewBuffer()`, made current with `pfSelectBuffer()`, and merged with the main OpenGL Performer buffer with `pfMergeBuffer()`. While the DBASE process is intended for `pfBuffer` use, other processes forked by the application may also use different `pfBuffers` in parallel for multithreaded database management. By ensuring that only a

single process uses a given `pfBuffer` at a given time and following a few scoping rules discussed in the following paragraphs, the application can safely and efficiently implement asynchronous database paging

A `pfNode` is said to have *buffer scope* or be “in” a particular `pfBuffer`. This is an important concept because it affects what you can do with a given node. A newly created node is automatically “in” the currently active `pfBuffer` until that `pfBuffer` is merged using **`pfMergeBuffer()`**. At that instant, the `pfNode` is moved into the main OpenGL Performer buffer, otherwise known as the *application buffer*.

A rule in `pfBuffer` management is that a process may only access nodes that are in its current `pfBuffer`. As a result, a database process may not directly add a newly created subgraph of nodes to the main scene graph because all nodes in the main scene graph have application buffer scope only—they are isolated from the database `pfBuffer`. This may seem inconvenient at first but it eliminates catastrophic errors. For example, the application process traverses a group at the same time you add a child; this changes its child list and causes the traversal to chase a bad pointer.

Remedies to the inconveniences stated above are the **`pfBufferAddChild()`**, **`pfBufferRemoveChild()`**, and **`pfBufferClone()`** functions. The first two functions are identical to their non-buffer counterparts **`pfAddChild()`** and **`pfRemoveChild()`** except the buffer versions do not happen immediately. Other functions, **`pfBufferAdd()`**, **`pfBufferInsert()`**, **`pfBufferReplace()`**, and **`pfBufferRemove()`**, perform the buffer-oriented delayed-action versions of the corresponding non-buffer `pfList` functions. In all cases the add, insert, replace, or removal request is placed on a list in the current `pfBuffer` and is processed later at **`pfMergeBuffer()`** time.

The **`pfBufferClone()`** function supports the notion of maintaining a library of common objects like trees or houses in a special library `pfBuffer`. The main database process then clones objects from the library `pfBuffer` into the database `pfBuffer`, possibly using the **`pfFlatten()`** function for improved rendering performance. **`pfBufferClone()`** is identical to **`pfClone()`** except the buffer version requires that the source `pfBuffer` be specified and that all cloned nodes have scope in the source `pfBuffer`.

`pfAsyncDelete`

We have discussed how to create subgraphs for database paging: create and select a current `pfBuffer`, create nodes and build the subgraph, call **`pfBufferAddChild()`** and finally **`pfMergeBuffer()`** to incorporate the subgraph into the application’s scene. This section describes how to use the function **`pfAsyncDelete()`** to free the memory of old, unwanted subgraphs.

The **pfDelete()** function is the normal mechanism for deleting objects and freeing their associated memory. However, the function **pfDelete()** can be a very expensive since it must traverse, unreference, and register a deletion request for every OpenGL Performer object it encounters which has a 0 reference count. The function **pfAsyncDelete()** used in conjunction with a forked DBASE process moves the burden of deletion to the asynchronous database process so that all rendering and intersection pipelines are not adversely affected.

The **pfAsyncDelete()** function may be called from any process and places an asynchronous deletion request on a global list that is processed later by the DBASE stage when its trigger function **pfDBase()** is called. A major difference from **pfDelete()** is that **pfAsyncDelete()** does not immediately check the reference count of the object to be deleted and, so, does not return a value indicating whether the deletion was successful. At this time there is no way of querying the result of a **pfAsyncDelete()** request so care should be taken that the object to be deleted has no reference counts or memory leaks will result.

Placing Multiple OpenGL Performer Processes on a Single CPU

When placing multiple OpenGL Performer processes on the same CPU, some combinations of processes and priorities may have an effect on the APP process timing even if the APP process runs on its own separate CPU. This happens because the APP process often waits on other processes for completion of various tasks. If these other processes share a CPU with high-priority processes, they may take a long time to finish their task and release the APP process.

An application can request that OpenGL Performer upgrade the priority of processes when the APP process waits on them by calling **pfProcessPriorityUpgrade()**. The APP process upgrades the other process' priority before it starts waiting for it, and the other process resumes its previous priority as soon as it releases the APP process. In this way, the original settings of priorities is maintained, except when the APP process waits for another process. OpenGL Performer uses the priority 87 as the default priority for upgrading processes. This priority is the default because it is close to the highest priority that any application-level process should ever have (89). The application may change this priority by using **pfProcessHighestPriority()**.

The priority-upgrade mode is turned off by default. An OpenGL Performer application that does not try to place multiple processes on the same processor or a non-realtime application does not have to set this flag.

Rules for Invoking Functions While Multiprocessing

There are some restrictions on which functions can be called from an OpenGL Performer process while multiple processes are running. Some specialized processes (such as the process handling the draw stage) can call only a few specific OpenGL Performer functions and cannot call any other kinds of functions. This section lists general and specific rules concerning function invocation in the various OpenGL Performer and user processes.

In this section, the phrase “the draw process” refers to whichever process is handling the draw stage, regardless of whether that process is also handling other stages. Similarly, “the cull process” and “the application process” refer to the processes handling the cull and application stages, respectively.

This is a general list of the kinds of routines you can call from each process:

application	Configuration routines, creation and deletion routines, set and get routines, and trigger routines such as pfAppFrame() , pfSync() , and pfFrame()
database	Creation and deletion routines, set and get routines, pfDBase() , and pfMergeBuffer()
cull	pfCull() , pfCullPath() , OpenGL Performer graphics routines
draw	pfClearChan() , pfDraw() , pfDrawChanStats() , OpenGL Performer graphics routines, and graphics library routines

More specific elaborations:

- You should call configuration routines only from the application process, and only after **pfInit()** and before **pfConfig()**. **pfInit()** must be the first OpenGL Performer call, except for those routines that configure shared memory (see “Memory Allocation” in Chapter 18). Configuration routines do not take effect until **pfConfig()** is called. These are the configuration routines:
 - **pfMultipipe()**
 - **pfMultiprocess()**
 - **pfMultithread()**
 - **pfHyperpipe()**

- You should call creation routines, such as **pfNewChan()**, **pfNewScene()**, and **pfAllocIsectData()**, only in the application process after calling **pfConfig()** or in a process that has an active **pfBuffer**. There is no restriction on creating **libpr** objects like **pfGeoSets** and **pfTextures**.
- The **pfDelete()** function should only be called from the application or database processes while **pfAsyncDelete()** may be called from any process.
- Read-only routines—that is, the **pfGet*()** functions—can be called from any OpenGL Performer process. However, if a forked draw process queries a **pfNode**, the data returned will not be frame-accurate. (See “Multiprocessing and Memory” on page 168.)
- Write routines—functions that set parameters—should be called only from the application process or a process with an active **pfBuffer**. It is possible to call a write routine from the cull process, but it is not recommended since any modifications to the database will not be visible to the application process if it is separate from the cull (as when using **PFMP_APP_CULLDRAW** or **PFMP_APP_CULL_DRAW**). However, for transient modifications like custom level-of-detail switching, it is reasonable for the cull process to modify the database. The draw process should never modify any **pfNode**.
- OpenGL Performer graphics routines should be called only from the cull or draw processes. These routines may modify the hardware graphics state. They are the routines that can be captured by an open **pfDispList**. (See “Display Lists” in Chapter 12.) If invoked in the cull process, these routines are captured by an internal **pfDispList** and later invoked in the draw process; but if they are invoked in the draw process, they immediately affect the current window. These graphics routines can be roughly partitioned into those that do the following:
 - Apply a graphics entity: **pfApplyMtl()**, **pfApplyTex()**, and **pfLightOn()**.
 - Enable or disable a graphics mode: **pfEnable()** and **pfDisable()**.
 - Set or a modify graphics state: **pfTransparency()**, **pfPushState()**, and **pfMultMatrix()**.
 - Draw geometry or modify the screen: **pfDrawGSet()**, **pfDrawString()**, and **pfClear()**.
- Graphics library routines should be called only from the draw process. Since there is no open display list to capture these commands, an open window is required to accept them.

- “Trigger” routines should be called only from the appropriate processes (see Table 5-4).

Table 5-4 Trigger Routines and Associated Processes

Trigger Routine	Process/Context
pfAppFrame() pfSync() pfFrame()	APP/main loop
pfPassChanData() pfPassIsectData()	APP/main loop
pfApp()	APP/channel APP callback
pfCull() pfCullPath()	CULL/channel CULL callback
pfDraw() pfDrawBin()	DRAW/channel DRAW callback
pfNodeIsectSegs() pfChanNodeIsectSegs()	ISECT/callback or APP/main loop
pfDBase()	DBASE/callback

- User-spawned processes created with **sproc()** can trigger parallel intersection traversals through multiple calls to **pfNodeIsectSegs()** and **pfChanNodeIsectSegs()**.
- Functions **pfApp()**, **pfCull()**, **pfDraw()**, and **pfDBase()** are only called from within the corresponding callback specified by **pfChanTravFunc()** or **pfDBaseFunc()**.

Multiprocessing and Memory

In OpenGL Performer, as is often true of multiprocessing systems, memory management is the most difficult aspect of multiprocessing. Most data management problems in an OpenGL Performer application can be partitioned into three categories:

- Memory visibility. OpenGL Performer uses **fork()**, which—unlike **sproc()**—generates processes that do not share the same address space. The processes also cannot share global variables that are modified after the **fork()** call. After calling **fork()**, processes must communicate through explicit shared memory.

- Memory exclusion. If multiple processes read or write the same chunk of data at the same time, consequences can be dire. For example, one process might read the data while in an inconsistent state and end up dumping core while dereferencing a NULL pointer.
- Memory synchronization. OpenGL Performer is configured as a pipeline where different processes are working on different frames at the same time. This pipelined nature is illustrated in Figure 5-6 on page 162, which shows that, for instance, in the PFMP_APP_CULL_DRAW configuration the application process is working on frame n while the draw process is working on frame $n-2$. If, in this case, if we have only a single memory location representing the viewpoint, then it is possible for the application to set the viewpoint to that of frame n and the draw process to incorrectly use that same viewpoint for frame $n-2$. Properly synchronized data is called *frame accurate*.

Fortunately, OpenGL Performer transparently solves all of the problems just described for most OpenGL Performer data structures and also provides powerful tools and mechanisms that the application can use to manage its own memory.

Shared Memory and `pfInit()`

The `pfInit()` function creates a shared memory arena that is shared by all processes spawned by OpenGL Performer and all user processes that are spawned from any OpenGL Performer process. A handle to this arena is returned by `pfGetSharedArena()` and should be used as the arena argument to routines that create data that must be visible to all processes. Routines that accept an arena argument are the `pfNew*()` routines found in the `libpr` library and the OpenGL Performer memory allocator, `pfMalloc()`. In practice, it is usually safest to create `libpr` objects like `pfGeoSets` and `pfMaterials` in shared memory. `libpf` objects like `pfNodes` are always created in shared memory.

Allocating shared memory does not by itself solve the memory visibility problem discussed above. You must also make sure that the pointer that references the memory is visible to all processes. OpenGL Performer objects, once incorporated into the database through routines like `pfAddGSet()`, `pfAddChild()`, and `pfChanScene()`, automatically ensure that the object pointers are visible to all OpenGL Performer processes.

However, pointers to application data must be explicitly shared. A common way of doing this is to allocate the shared memory after `pfInit()` but before `pfConfig()` and to reference the memory with a global pointer. Since the pointer is set before `pfConfig()` forks any processes, these processes will all share the pointer's value and can thereby

access the same shared memory region. However, if this pointer value changes in a process, its value will not change in any other process, since forked processes do not share the same address space.

Even with data visible to all processes, data exclusion is still a problem. The usual solution is to use hardware spin locks so that a process can lock the data segment while reading or writing data. If all processes must acquire the lock before accessing the data, then a process is guaranteed that no other processes will be accessing the data at the same time. All processes must adhere to this locking protocol, however, or exclusion is not guaranteed.

In addition to a shared memory arena, **pfInit()** creates a semaphore arena whose handle is returned by **pfGetSemaArena()**. Locks can be allocated from this semaphore arena by **usnewlock()** and can be set and unset by **ussetlock()** and **usunsetlock()**, respectively.

pfDataPools

The **pfDataPools**—named shared memory arenas with named allocation blocks—provide a complete solution to the memory visibility and memory exclusion problems, thereby obviating the need to set global pointers between **pfInit()** and **pfConfig()**. For more information about **pfDataPools**, see the **pfDataPools** man page.

Passthrough Data

The techniques discussed thus far do not solve the memory synchronization problem. OpenGL Performer's **libpf** library provides a solution in the form of *passthrough data*. When using pipelined multiprocessing, data must be passed through the processing pipeline so that data modifications reach the appropriate pipeline stage at the appropriate time.

Passthrough data is implemented by allocating a data buffer for each stage in the processing pipeline. Then, at well-defined points in time, the passthrough data is copied from its buffer into the next buffer along the pipeline. This copying guarantees memory exclusion, but you should minimize the amount of passthrough data to reduce the time spent copying.

Allocate a passthrough data buffer for the rendering pipeline using **pfAllocChanData()**; for data to be passed down the intersection pipeline, call **pfAllocIsectData()**. Data returned from **pfAllocChanData()** is passed to the channel cull and draw callbacks that

are set by **pfChanTravFunc()**. Data returned from **pfAllocIsectData()** is passed to the intersection callback specified by **pfIsectFunc()**.

Passthrough data is not automatically passed through the processing pipeline. You must first call **pfPassChanData()** or **pfPassIsectData()** to indicate that the data should be copied downstream. This requirement allows you to copy only when necessary—if your data has not changed in a given frame, simply do not call a **pfPass*()** routine, and you will avoid the copy overhead. When you do call a **pfPass*()** routine, the data is not immediately copied but is delayed until the next call to **pfFrame()**. The data is then copied into internal OpenGL Performer memory and you are free to modify your passthrough data segment for the next frame.

Modifications to all `libpf` objects—such as `pfNodes` and `pfChannels`—are automatically passed through the processing pipeline, so frame-accurate behavior is guaranteed for these objects. However, in order to save substantial amounts of memory, `libpr` objects such as `pfGeoSets` and `pfGeoStates` do not have frame-accurate behavior; modifications to such objects are immediately visible to all processes. If you want frame-accurate modifications to `libpr` objects you must use the passthrough data mechanism, use a frame-accurate `pfSwitch` to select among multiple copies of the objects you want to change, or use the `pfCycleBuffer` memory type.

CULL Process Optimizations

The OpenGL Performer CULL process traverses a scene graph and culls out invisible geometry. Its result is a list (`pfDispList`) of visible `pfGeoSets`. The OpenGL Performer CULL process treats `pfGeoSets` as rendering atoms: It does not break them into their visible and invisible parts. If the bounding box of a `pfGeoSet` intersects the viewing frustum, OpenGL Performer draws the entire `pfGeoSet` even if only one of its triangles is visible. Figure 5-7 demonstrates this problem using a triangle strip.

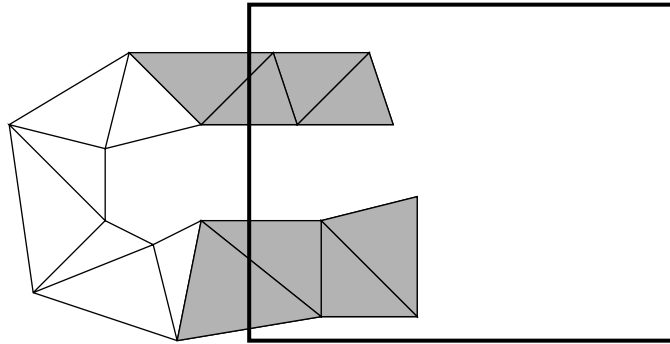

Figure 5-7 Loose Culling of pfGeosets

The figure shows a triangle strip starting inside the viewing frustum, leaving the viewing frustum, and then returning into the viewing frustum. Only the shaded triangles of the strip are visible, but OpenGL Performer renders the entire strip. In this figure, OpenGL Performer sends five superfluous vertices to the graphics pipe.

This problem is important in applications with one of the following bottlenecks:

- Geometry processing
Applications that render large numbers of relatively small triangles—for example, CAD visualization or detailed terrain visualization.
- Host-Pipe interface bandwidth
Applications that saturate the interface between the host CPU and the graphics pipe either by rendering too many triangles or by downloading too many texture maps each frame.

This problem is not important in raster-limited applications that render very large triangles (in screen space). These application saturate the raster portion of the graphics pipe but leave the geometry portion idle. Therefore, speeding up the geometry portion of the graphic pipe does not speed up the overall application frame rate.

Cull Sidekick Processes

You can overcome the loose-culling problem by allocating extra processes for cleaning up the pfGeoSet lists that the CULL processes produce. These extra processes are called CULL sidekicks. By default, a CULL sidekick process checks all the primitives in all pfGeoSets on the CULL output. It replaces original pfGeoSets with temporary pfGeoSets and populates the temporary pfGeoSets with the visible parts of the original pfGeoSets. By default, CULL sidekick processes test each primitive twice for the following:

- For frustum visibility

A primitive outside the viewing frustum will be omitted from the temporary pfGeoSet.

- For backface culling

A primitive facing away from the viewer will be omitted from the temporary pfGeoSet. This test is especially powerful when rendering enclosed objects (for example—vehicles, houses, or machine parts) because about half of the triangles in such models face away from the viewer. This test is skipped when a pfGeoSet is drawn without backface testing.

CULL sidekick processes run side-by-side with their CULL process. They do not interact with the CULL process during its frame, but they merely patch the visible pfGeoSet list as the CULL process populates it. This means that configuring CULL sidekick processes does not add any latency to the application.

Figure 5-8 shows how CULL_SIDEKICK optimizes visible pfGeoSet lists while CULL is writing them. The figure shows three CULL_SIDEKICK processes working on the visible pfGeoSet list that a CULL process produces. Visible pfGeoSet#1 is replaced by Temporary pfGeoSet#1. Visible pfGeoSet#2 contains no visible primitives and is skipped entirely.

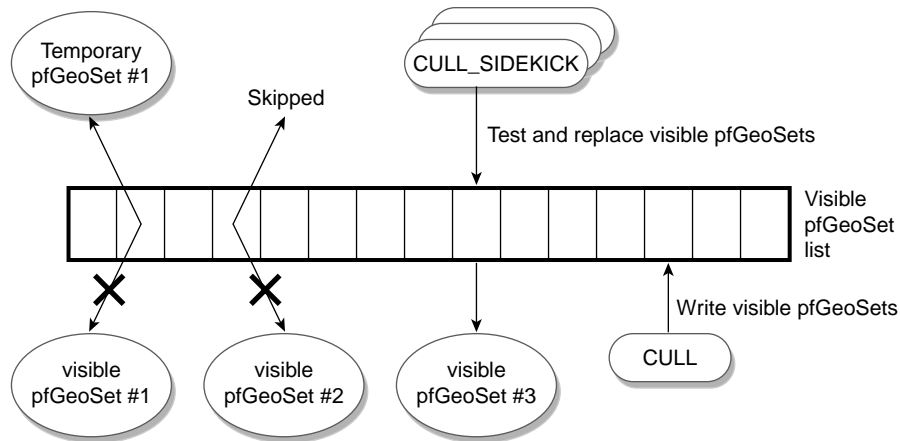

Figure 5-8 CULL_SIDEKICK Processing

Configuring CULL_SIDEKICK Processes

Each CULL process can have multiple CULL_SIDEKICK processes. You can use the **pfMultithread()** call to specify the number of CULL_SIDEKICK processes for each CULL process. The collection of CULL_SIDEKICK processes configured for each CULL process traverses in a round-robin manner the pfGeoSet list that the CULL process produces. The more CULL_SIDEKICK processes (each assigned to a separate CPU), the faster they process the pfGeoSet list that the CULL process produces.

CULL Sidekick Optimization Mask

Using the function **pfMultithreadParami()** and the parameter **PFSK_OPTIMIZATION**, an application can specify a bit-wise OR of the constants **PFSK_BACKFACE_CULL** and **PFSK_FRUSTUM_CULL**. Specifying the **PFSK_BACKFACE_CULL** flag instructs CULL_SIDEKICK to run a backface test on each primitive and to remove backfacing primitives. This mode is aware of the pfGeoState setting for each pfGeoSet and correctly ignores pfGeoSets that do not require this test. Specifying the **PFSK_FRUSTUM_CULL** flag instructs CULL_SIDEKICK to run a frustum test on each primitive and to remove primitives outside the viewing frustum. Both of these tests break triangle strips, line strips, and triangle fans if portions of these are invisible.

Note: It is safe to change the CULL_SIDEKICK optimization mask on the fly.

CULL Sidekick Synchronization Policy

Since traversing the visible pfGeoSet list that CULL produces may take longer than a single frame, you can specify a policy for the behavior of CULL_SIDEKICK processes.

Using the function **pfMultithreadParami()** and the parameter PFSK_POLICY, you can specify one of three options:

- PFSK_CULL_DONE

All CULL_SIDEKICK processes stop processing pfGeoSet lists as soon as their CULL process finishes its frame. This means that the CULL_SIDEKICK process is likely to skip the optimization of many pfGeoSets on the visible pfGeoSet list.

- PFSK_CULL_FRAME_DONE

All CULL_SIDEKICK processes continue processing until the end of the expected CULL frame time. If the CULL process finishes its frame early in the PFSK_CULL_DONE mode, the CULL_SIDEKICK processes cannot use the remainder of the time to complete their own processing. The PFSK_CULL_FRAME_DONE mode allows the CULL_SIDEKICK processes to use all of the available frame time for processing. Use the parameter PFSK_SAFETY_MARGIN to specify a floating number of seconds. This sets a margin before the end of the frame where CULL_SIDEKICK stops processing. This is a safety measure. If CULL_SIDEKICK does not complete early enough, it can make CULL miss its frame. The default value is 1.0 millisecond. The more sensitive to frame drops your application is, the larger this margin should be.

- PFSK_CULL_SIDEKICK_DONE

All CULL_SIDEKICK processes finish processing all the visible pfGeoSet lists that the CULL process produces. If this takes longer than the desired CULL frame rate, the CULL process waits for its CULL_SIDEKICK helpers and may miss a frame.

Note: It is safe to change the CULL_SIDEKICK synchronization policy on the fly.

CULL Sidekick User Functions

Use the function **pfMultithreadParami0** with parameters `PFSK_USER_FUNC` and `PFSK_USER_FUNC_DATA` to register a callback function for the `CULL_SIDEKICK` `pfGeoSet` optimization. When specified, a `CULL_SIDEKICK` calls the callback function instead of running the default optimization. The `CULL_SIDEKICK` provides the callback function with a target `pfGeoSet`. The callback function can clone the target `pfGeoSet`, modify the cloned `pfGeoSet`, and return it as a replacement for the target `pfGeoSet`.

The callback function should return a `pfGeoSet` pointer. It can return one of the following values:

- The original `pfGeoSet` pointer
`CULL_SIDEKICK` does not optimize this `pfGeoSet` and leaves it on the visible `pfGeoSet` list.
- A new `pfGeoSet` pointer
`CULL_SIDEKICK` replaces the `pfGeoSet` in the visible `pfGeoSet` list with the returned value.
- A `NULL` pointer
`CULL_SIDEKICK` removes this `pfGeoSet` from the visible `pfGeoSet` list.

The callback function receives as a parameter a pointer to a `pfDispListOptimizer` class. The callback function can use this pointer in order to do the following:

- Retrieve the projection/modelview matrix that will be loaded when this `pfGeoSet` is rendered.
- Allocate temporary `pfGeoSets`.
- Allocate temporary memory buffers.
- Clone a `pfGeoSet` onto a temporary `pfGeoSet`.
- Invoke the default optimization on a `pfGeoSet`.
- Get a pointer to the `pfChannel` in which this `pfGeoSet` was found visible.
- Get the number of `CULL_SIDEKICK` processes working for the `CULL` process and get the index of the calling `CULL_SIDEKICK` process.
- Get the optimization mask of this `CULL_SIDEKICK` process.

The following is a sample callback function. This function clones the incoming pfGeoSet, jitters all its coordinates by a random amount, and replaces all its colors by random colors:

```

pfGeoSet *
userFunction(pfGeoSet *gset, pfDispListOptimizer *op, void *userData)
{
    pfGeoSet    *new_gset;
    ushort      *ilist;
    int          *len;
    float        *c;
    float        *v;
    int          numVerts, numPrims, numColors;
    int          i;

    /* Modify geosets with line-strip/tri-strip primitives only. */
    /* When not modifying a pfGeoSet, return its original pointer. */
    if ((pfGetGSetPrimType(gset) != PFGS_LINESTRIPS) &&
        (pfGetGSetPrimType(gset) != PFGS_TRISTRIPS))
        return (gset);

    /* Clone geoset. We can modify the cloned geoset because it */
    /* is temporary for this CULL process for this frame. */
    new_gset = pfDLOptimizerCloneGSet(op, gset,
        PFSK_COORD3 | PFSK_NORMAL3 |
        PFSK_TEXCOORD2 | PFSK_ATTR_LENGTHS);

    /* Get pointers to cloned geoset attributes */
    pfGetGSetAttrLists(new_gset, PFGS_COLOR4, &c, &ilist);
    if (ilist) return gset; /* ignore indexed gsets */
    pfGetGSetAttrLists(new_gset, PFGS_COORD3, &v, &ilist);
    if (ilist) return gset; /* ignore indexed gsets */
    len = pfGetGSetPrimLengths(new_gset);
    numPrims = pfGetGSetNumPrims(new_gset);

    /* Count how many vertex entries in the COORD3 attribute. */
    numVerts = 0;
    for (i = 0 ; i < numPrims ; i ++ )
        numVerts += len[i];

    /* Count how many color entries in the COLOR4 attribute. */
    switch (pfGetGSetAttrBind(gset, PFGS_COLOR4))
    {
        case PFGS_PER_VERTEX:
            numColors = numVerts;
    }
}

```

```
        break;
    case PFGS_PER_PRIM:
        numColors = numPrims;
        break;
    case PFGS_OVERALL:
        numColors = 1;
        break;
    case PFGS_OFF:
        numColors = 0;
        break;
}
/* Pick a random color for each color entry in the cloned */
/* color attribute array. */
for (i = 0 ; i < numColors ; i ++ )
{
    *(c++) = getRand(); *(c++) = getRand(); *(c++) = getRand();
    *(c++) = 1.0;
}
/* Pick a random perturbation for each coordinate */
for (i = 0 ; i < numVerts ; i ++ )
{
    *(v++) += vertex_jitter_amount * getRand();
    *(v++) += vertex_jitter_amount * getRand();
    *(v++) += vertex_jitter_amount * getRand();
}
/* Send new gset for default frustum/backface culling. */
return pfDLOptimizerOptimize(op, new_gset);
}
```

Modifying Attributes of Cloned pfGeoSets

When cloning a pfGeoSet from within a CULL_SIDEKICK callback function, you may wish to modify the pointers to the attribute arrays of the cloned pfGeoSet. Cloned pfGeoSets are temporary and do not require reference counting. Use the following quick methods on the pfGeoSet in order to manipulate its attributes:

- **pfQuickCopyGSet()**
Copies the contents of one pfGeoSet onto another with no reference count considerations.
- **pfGSetQuickAttr()**
Sets an attribute of a pfGeoSet.

- **pfGSetQuickMultiAttr()**
Sets a multi-value attribute of a pfGeoSet (for example, multitexture)
- **pfGSetQuickPrimLengths()**
Sets the primitive length array of a pfGeoSet.
- **pfQuickResetGSet()**
Sets all attribute arrays to NULL. No reference counting.

Note: If you wish to replace the attribute binding of cloned pfGeoSet attributes, you must use the standard pfGeoSet API (as opposed to the quick API). Changing anything other than the pointers to attribute arrays requires internal pfGeoSet state changes and, therefore, cannot happen through the quick API.

Marking pfGeoSets for Optimization

Use the function **pfGSetOptimize()** to mark any single pfGeoSet for optimization by the CULL_SIDEKICK process. By default, all pfGeoSets under a pfGeode node undergo optimization. All pfGeoSetCBs are not optimized by default but can be optimized using this function. No pfGeoSet under a pfBillboard node is ever optimized (regardless of the optimization flag setting).

Creating Visual Effects

This chapter describes how to use environmental, atmospheric, lighting, and other visual effects to enhance the realism of your application. The following sections appear:

- “Using pfEarthSky” on page 181
- “Atmospheric Effects” on page 182
- “Patchy Fog and Layered Fog” on page 186
- “Real-Time Shadows” on page 198
- “Image-Based Rendering” on page 204

Using pfEarthSky

A pfEarthSky is a special set of functions that clears a pfChannel’s viewport efficiently and implements various atmospheric effects. A pfEarthSky is attached to a pfChannel with **pfChanESky()**. Several pfEarthSky definitions can be created, but only one can be in effect for any given channel at a time.

A pfEarthSky can be used to draw a sky and horizon, to draw sky, horizon, and ground, or just to clear the entire screen to a specific color and depth. The colors of the sky, horizon, and ground can be changed in real time to simulate a specific time of day. At the horizon boundary, the ground and sky share a common color, so that there is a smooth transition from sky to horizon color. The width of the horizon band can be defined in degrees.

A pfChannel’s earth-sky model is automatically drawn by OpenGL Performer before the scene is drawn unless the pfChannel has a draw callback set with **pfChanTravFunc()**. In this case it is the application’s responsibility to clear the viewport. Within the callback **pfClearChan()** draws the channel’s pfEarthSky.

Example 6-1 shows how to set up a `pfEarthSky()`.

Example 6-1 How to Configure a `pfEarthSky`

```
pfEarthSky *esky;  
pfChannel *chan;  
  
sky = pfNewESky();  
pfESkyMode(esky, PFES_BUFFER_CLEAR, PFES_SKY_GRND);  
pfESkyAttr(esky, PFES_GRND_HT, -1.0f);  
pfESkyColor(esky, PFES_GRND_FAR, 0.3f, 0.1f, 0.0f, 1.0f);  
pfESkyColor(esky, PFES_GRND_NEAR, 0.5f, 0.3f, 0.1f, 1.0f);  
pfChanESky(chan, esky);
```

Atmospheric Effects

The complexities of atmospheric effects on visibility are approximated within OpenGL Performer using a multiple-layer sky model, set up as part of the `pfEarthSky` function. In this design, individual layers are used to represent the effects of ground fog, clear sky, and clouds. Figure 6-1 shows the identity and arrangement of these layers.

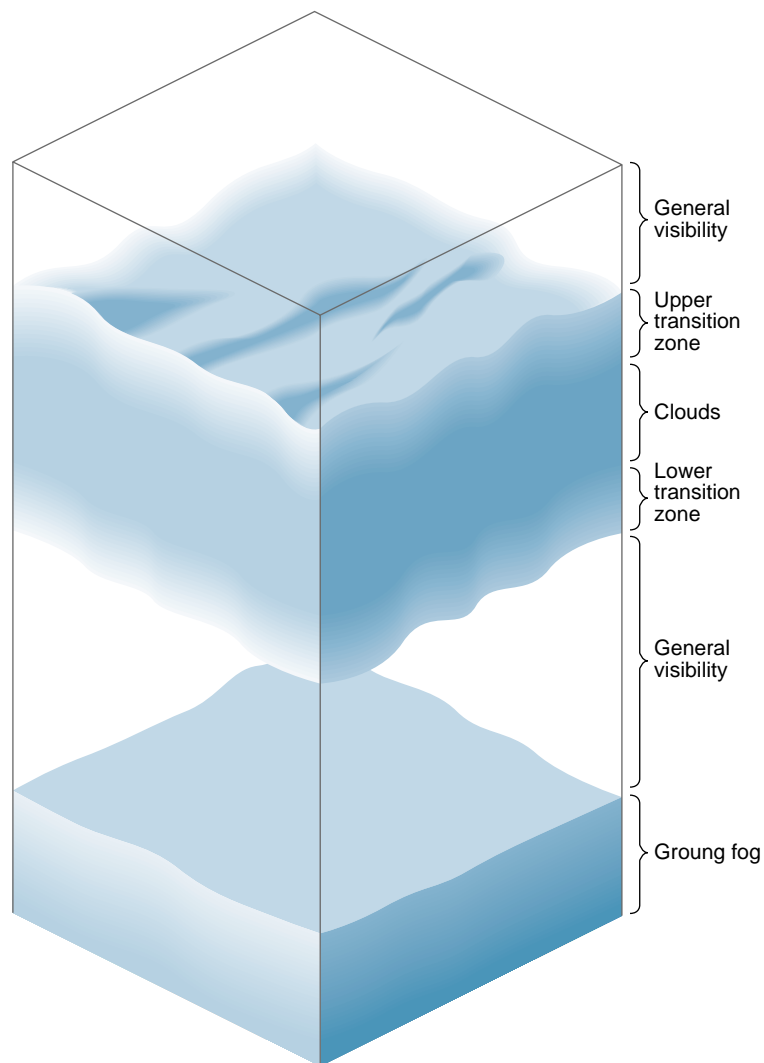

Figure 6-1 Layered Atmosphere Model

The lowest layer consists of ground fog, extending from the ground up to a user-selected altitude. The fog thins out with increasing altitude, disappearing entirely at the bottom of the general visibility layer. This layer extends from the top of the ground fog layer to the bottom of the cloud layer's lower transition zone, if such a zone exists. The transition

zone provides a smooth transition between general visibility and the cloud layer. (If there is no cloud layer, then general visibility extends upward forever.) The cloud layer is defined as an opaque region of near-zero visibility; you can set its upper and lower boundaries. You can also place another transition zone above the cloud layer to make the clouds gradually thin out into clear air.

Set up the atmospheric simulation with the commands listed in Table 6-1

Table 6-1 pfEarthSky Functions

Function	Action
pfNewESky()	Create a pfEarthSky.
pfESkyMode()	Set the render mode.
pfESkyAttr()	Set the attributes of the earth and sky models.
pfESkyColor()	Set the colors for earth and sky and clear.
pfESkyFog()	Set the fog functions.

You can set any pfEarthSky attribute, mode, or color in real time. Selecting the active pfFog definition can also be done in real time. However, changing the parameters of a pfFog once they are set is not advised when in multiprocessing mode.

The default characteristics of a pfEarthSky are listed in Table 6-2.

Table 6-2 pfEarthSky Attributes

Attribute	Default
Clear method	PFES_FAST (full screen clear)
Clear color	0.0 0.0 0.0
Sky top color	0.0 0.0 0.44
Sky bottom color	0.0 0.4 0.7
Ground near color	0.5 0.3 0.0
Ground far color	0.4 0.2 0.0
Horizon color	0.8 0.8 1.0

Table 6-2 pfEarthSky Attributes **(continued)**

Attribute	Default
Ground fog	NULL (no fog)
General visibility	NULL (no fog)
Cloud top	20000.0
Cloud bottom	20000.0
Cloud bottom color	0.8 0.8 0.8
Cloud top color	0.8 0.8 0.8
Transition zone bottom	15000.0
Transition zone top	25000.0
Ground height	0
Horizon angle	10 degrees

By default, an earth-sky model is not drawn. Instead, the channel is simply cleared to black and the Z-buffer is set to its maximum value. This default action also disables all other atmospheric attributes. To enable atmospheric effects, select PFES_SKY, PFES_SKY_GRND, or PFES_SKY_CLEAR when turning on the earth-sky model.

Clouds are disabled when the cloud top is less than or equal to the cloud bottom. Cloud transition zones are disabled when clouds are disabled.

Fog is enabled when either the general or ground fog is set to a valid pfFog. If ground fog is not enabled, no ground fog layer will be present and fog will be used to support general visibility. Setting a fog attribute to NULL disables it. See “Atmospheric Effects” on page 182 for further information on fog parameters and operation.

The earth-sky model is an attribute of the channel and thus accesses information about the viewer’s position, current field of view, and other pertinent information directly from pfChannel. To set the pfEarthSky in a channel, use **pfChanESky()**.

Patchy Fog and Layered Fog

A `pfVolFog` is a class that uses a multi-pass algorithm to draw the scene with a fog that has different densities at different locations. It extends the basic layered fog provided by `pfEarthSky` and introduces a new type of fog: a patchy fog. A patchy fog has a constant density in a given area. The boundaries of this area can be defined by an arbitrary three-dimensional object or by a set of objects.

A layered fog changes only with elevation; its density and color is uniform at a given height. It is defined by a set of elevation points, each specifying a fog density and, optionally, also a fog color at the point's elevation. The density and the color between two neighboring points is linearly interpolated.

Figure 6-2 illustrates the basic difference between patchy fog and layered fog.

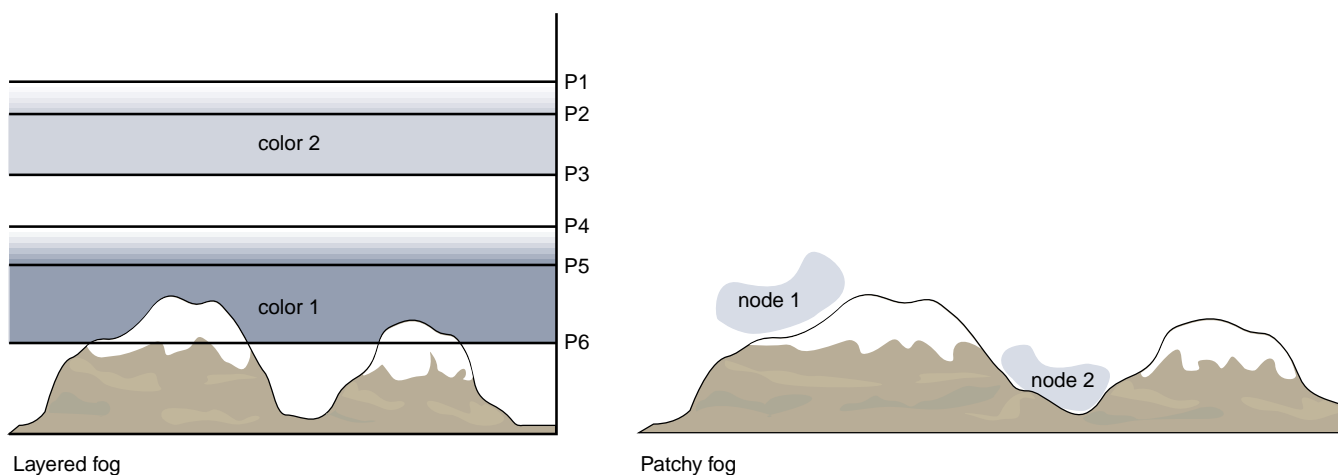

Figure 6-2 Patchy Fog Versus Layered Fog

Compared to a layered fog in `pfEarthSky`, a layered fog in `pfVolFog` has distinct advantages:

- It can be specified by an arbitrary number of elevation points.
- Each elevation point can have a different color associated with it.
- A layered fog in `pfVolFog` is not dependent on an `InfiniteReality`-specific texgen. It can also be drawn using only 2D textures to simulate the 3D texture. Thus, a layered fog in `pfVolFog` can virtually be used on any machine.

Creating Layered Fog

A `pfVolFog` is not part of the scene graph; it is created separately by the application process. Once created, elevation points of a layered fog can be specified by calling `pfVolFogAddPoint()` or `pfVolFogAddColoredPoint()` repeatedly. The fog initialization is completed by calling `pfApplyVolFog()`.

Example 6-2 Fog initialization Using `pfVolFogAddPoint()`

```
pfVolFog *lfog;
lfog = pfNewVolFog(arena);
pfVolFogAddPoint(lfog, elev1, density1);
pfVolFogAddPoint(lfog, elev2, density2);
pfVolFogAddPoint(lfog, elev2, density2);

pfApplyVolFog(lfog);
```

Creating Patchy Fog

The boundary of a patchy fog is specified by `pfVolFogAddNode(pfog,node)`, where *node* contains the surfaces enclosing the foggy areas. It is possible to define several disjoint areas in the same tree or by adding several different nodes. Note that each area has to be completely enclosed, and the vertices of the surfaces have to be ordered so that the front face of each surface faces outside the foggy area. The node has to be part of the scene graph for the rendering to work properly.

Example 6-3 Specifying Patchy Fog Boundaries Using `pfVolFogAddNode()`

```
pfVolFog *pfog;
pfNode *fogNode;
pfog = pfNewVolFog(arena);
fogNode = pfdLoadFile(filename);
pfVolFogAddNode(pfog, fogNode);
pfAddChild(scene, fogNode);
pfApplyVolFog(pfog);
```

Patchy and layered fog can be combined but only if layered fog has a uniform color; that is, it is specified using `pfVolFogAddPoint()` only.

Initializing a pfVolFog

The function **pfApplyVolFog()** initializes a pfVolFog. If at least two elevation points were defined, it initializes data structures necessary for rendering of a layered fog, including a 3D texture. Any control points defined afterward are ignored. If a node containing patchy fog boundaries has been added prior to calling **pfApplyVolFog()**, a patchy fog is initialized. Since function **pfVolFogAddNode()** only marks the parts of the scene graph that specifies the texture, it is possible to add additional patchy fog nodes, even after **pfApplyVolFog()** has been called.

Table 6-3 summarizes routines for initialization and drawing of a pfVolFog.

Table 6-3 pfVolFog Functions

Function	Action
pfNewVolFog()	Create a pfVolFog.
pfVolFogAddChannel()	Add a channel on which pfVolFog is used.
pfVolFogAddPoint()	Add a point specifying fog density at a certain elevation.
pfVolFogAddColoredPoint()	Add a point specifying fog density and color at a certain elevation.
pfVolFogAddNode()	Add a node defining the boundary of a patchy fog.
pfVolFogSetColor()	Set color of a layered fog or patchy fog.
pfVolFogSetDensity()	Set density of a patchy fog.
pfVolFogSetFlags()	Set binary flags.
pfVolFogSetVal()	Set a single attribute.
pfVolFogSetAttr()	Set an array of attributes.
pfApplyVolFog()	Initialize data structures necessary for rendering fog.
pfVolFogAddChannel()	Add a channel on which pfVolFog is used.
pfVolFogUpdateView()	Update the current view for all stored channels.
pfDrawVolFog()	Draw the scene with fog.
pfGetVolFogTexture()	Return the texture used by layered fog.

The attributes of a pfVolFog are listed in Table 6-4.

Table 6-4 pfVolFog Attributes

Attribute	Identifier	Default
General		
Color	PFVFOG_COLOR	0.9, 0.9, 1
Density	PFVFOG_DENSITY	1.0
Density bias	PFVFOG_DENSITY_BIAS	0
Maximum distance	PFVFOG_MAX_DISTANCE	2000
Mode	PFVFOG_MODE	PFVFOG_LINEAR
Layered fog		
Layered fog mode	PFVFOG_LAYERED_MODE	PFVFOG_LINEAR
Texture size	PFVFOG_3D_TEX_SIZE	64 x 64 x 64
Patchy fog		
Resolution	PFVFOG_RESOLUTION	0.2
Patchy fog mode	PFVFOG_PATCHY_MODE	PFVFOG_LINEAR
Texture bottom	PFVFOG_PATCHY_TEXTURE_BOTTOM	0.3
Texture top	PFVFOG_PATCHY_TEXTURE_TOP	0.1.5
Layered patchy fog		
Rotation matrix	PFVFOG_ROTATE_NODE	Identity
Light shafts		
Attenuation scale	PFVFOG_LIGHT_SHAFT_ATTEN_SCALE	0.04
Attenuation shift	PFVFOG_LIGHT_SHAFT_ATTEN_TRANSLATE	6
Darken factor	PFVFOG_LIGHT_SHAFT_DARKEN_FACTOR	0.3

The flags of a pfVolFog are listed in Table 6-5.

Table 6-5 pfVolFog Flags

Flag	Identifier	Default
General		
Close surfaces	PFVFOG_FLAG_CLOSE_SURFACES	1
Use 2D texture	PFVFOG_FLAG_FORCE_2D_TEXTURE	0
Force patchy fog passes	PFVFOG_FLAG_FORCE_PATCHY_PASS	0
Layered fog		
Self-shadowing	PFVFOG_FLAG_SELF_SHADOWING	0
Darken objects	PFVFOG_FLAG_DARKEN_OBJECTS	0
Filter color	PFVFOG_FLAG_FOG_FILTER	0
Patchy fog		
Faster patchy fog	PFVFOG_FLAG_FASTER_PATCHY_FOG	0
No object in fog	PFVFOG_FLAG_NO_OBJECT_IN_FOG	0
1D texture on surface	PFVFOG_FLAG_PATCHY_FOG_1DTEXTURE	0
Separate node bins	PFVFOG_FLAG_SEPARATE_NODE_BINS	0
Screen-bounding rectangle	PFVFOG_FLAG_SCREEN_BOUNDING_RECT	1
Draw nodes separately	PFVFOG_FLAG_DRAW_NODES_SEPARATELY	0
User-defined texture	PFVFOG_FLAG_USER_PATCHY_FOG_TEXTURE	0
Use cull programs	PFVFOG_FLAG_USE_CULL_PROGRAM	0
Layered patchy fog		
Use layered patchy fog	PFVFOG_FLAG_LAYERED_PATCHY_FOG	0
Light shafts		
Light shaft	PFVFOG_FLAG_LIGHT_SHAFT	0

Updating the View

A `pfVolFog` needs information about the current eye position and view direction. Since this information is not directly accessible in a draw process, it is necessary to call `pfVolFogAddChannel()` for each channel at the beginning of the application. Whenever the view changes, the application process has to call `pfVolFogUpdateView()`. See programs in `/usr/share/Performer/src/sample/apps/C/fogfly` or `/usr/share/Performer/src/sample/apps/C++/volfog` on IRIX and Linux or `%PFROOT%\Src\sample\apps\C\fogfly` or `%PFROOT%\Src\sample\apps\C++\volfog` on Microsoft Windows for an example. If you do not update the view, the fog will not be rendered.

If the application changes the position of the patchy fog boundaries (for example, by inserting a `pfSCS`, `pfDCS`, or `pfFCS` node above the fog node) or the orientation of the whole scene with respect to the up vector (for example, the use of a trackball in `Perfly`), the fog may not be drawn correctly.

Drawing a Scene with Fog

To draw the scene with a fog, the draw process has to call `pfDrawVolFog()` instead of `pfDraw()`. This function takes care of drawing the whole scene graph with the specified fog. Expect the draw time to increase because the scene is drawn twice (three times if both patchy and layered fog are specified). In case of a patchy fog there may also be several full-screen polygons being drawn. You can easily disable the fog by not calling `pfDrawVolFog()`.

Since boundaries of patchy fog are in the scene graph, do not use `pfDraw()` to draw the scene without fog; instead, use `pfDrawBin()` with `PFSORT_DEFAULT_BIN`, `PFSORT_OPAQUE_BIN`, and `PFSORT_TRANSP_BIN`.

A patchy fog needs as deep a color buffer as possible (optimally 12 bits per color component) and a stencil buffer. Use at least a 4-bit stencil buffer (1-bit is sufficient only for very simple fog objects). It may be necessary to modify your application so that it asks for such a visual.

Deleting a pfVolFog

A `pfVolFog` can be deleted using `pfDelete()`. In case of a layered fog it is necessary to delete the texture handle in a draw process. The texture is returned by

pfGetVolFogTexture(). See the example in `/usr/share/Performer/src/sample/apps/C/fogfly` on IRIX and Linux and in `%PFROOT%\Src\sample\apps\C\fogfly` on Microsoft Windows.

Specifying Fog Parameters

This section describes how to manage the various parameters for both layered and patchy fog.

Layered Fog

As mentioned earlier, a layered fog of a uniform color is specified by function **pfVolFogAddPoint()**, which sets the fog density at a given elevation. The density is scaled so that if the fog has a density of 1, the nearest object inside the fog that has full fog color is at a distance equal to 1/10 of the diagonal of the scene bounding box. The layered fog color is set by function **pfVolFogSetColor()** or by calling **pfVolFogSetAttr()** with parameter `PFVFOG_COLOR` and a pointer to an array of three floats.

A layered fog of nonuniform color is specified by function **pfVolFogAddColoredPoint()**, which sets the fog density and the fog color at a given elevation. The color set by **pfVolFogSetColor()** is then ignored.

The layered fog mode is set by function **pfVolFogSetVal()** with parameter `PFVFOG_LAYERED_MODE` and one of `PFVFOG_LINEAR`, `PFVFOG_EXP`, or `PFVFOG_EXP2`.

It is also possible to set the mode both for a layered and patchy fog at once by using parameter `PFVFOG_MODE`. The default mode is `PFVFOG_LINEAR`. The function of the mode parameter is equivalent to the function of the fog mode parameter of the OpenGL function **glFog()**.

The size of a 3D texture used by a layered fog can be modified by calling **pfVolFogSetAttr()** with parameter `PFVFOG_3D_TEX_SIZE` and an array of three integer values. The default texture size is 64x64x64, but reasonable results can be achieved with even smaller sizes. The sizes are automatically rounded up to the closest power of 2. The second value should be equal to or greater than the third value. If 3D textures are not supported, a set of 2D textures is used instead of a 3D texture (the number of 2D textures is equal to the third dimension of the 3D texture). Every time the r coordinate changes more than 0.1, a new texture is computed by interpolating between two neighboring

slices, and the texture is reloaded. The use of 2D textures can be forced by calling: **pfVolFogSetFlags()** with flag `PFVFOG_FLAG_FORCE_2D_TEXTURE` set to 1.

Note: Once a layered fog is initialized by calling the **pfApplyVolFog()**, changing any of the parameters described here will not affect rendering of the layered fog.

Patchy Fog

The density of a patchy fog is controlled by function **pfVolFogSetDensity()** or by using **pfVolFogSetVal()** with parameter `PFVFOG_FOG_DENSITY`. As in the case of a layered fog, the density of a patchy fog is scaled by 1/10 of the diagonal of the scene bounding box.

You can specify an additional density value that is added to every pixel inside or behind a patchy fog boundary using the function **pfVolFogSetVal()** with parameter `PFVFOG_FOG_DENSITY_BIAS`. This value makes a patchy fog appear denser but it may create unrealistically sharp boundaries.

The patchy fog color is set by function **pfVolFogSetColor()** or by calling **pfVolFogSetAttr()** with parameter `PFVFOG_COLOR` and a pointer to an array of three floats. If the `blend_color` extension is not available, patchy fog will be white.

The patchy fog mode is set by function **pfVolFogSetVal()** with parameter `PFVFOG_PATCHY_MODE` and one of `PFVFOG_LINEAR`, `PFVFOG_EXP`, or `PFVFOG_EXP2`.

It is also possible to set the mode both for a patchy and layered fog at once by using parameter `PFVFOG_MODE`. The default mode is `PFVFOG_LINEAR`.

Note: The parameters of a patchy fog can be modified at any time and they will affect the rendering of the subsequent frame.

Advanced Features of Layered Fog and Patchy Fog

This section describes the following topics:

- “Enabling Self-Shadowing of a Layered Fog and Scene Darkening”

- “Animating Patchy Fog”
- “Selecting a Different Type of Patchy Fog Algorithm”
- “Simulating Self-Shadowing in Patchy Fog”
- “Layered Patchy Fog”
- “Light Shafts”

The example in `/usr/share/Performer/src/sample/C++/volfog` on IRIX and Linux and in `%PFROOT%\Src\sample\C++\volfog` on Microsoft Windows illustrates the use of all these advanced features.

Enabling Self-Shadowing of a Layered Fog and Scene Darkening

A layered fog can be self-shadowed—that is, the lower parts of a dense fog appear darker. Self-shadowing is enabled by setting the flag `PFVFOG_FLAG_SELF_SHADOWING` to 1. The fog mode should be set to `PFVFOG_EXP`.

When the fog has different colors at different elevations and the flag `PFVFOG_FLAG_FOG_FILTER` is set to 1, a secondary scattering is approximated. In this case, the color of a higher layer may affect the color of a lower layer.

If the flag `PFVFOG_FLAG_DARKEN_OBJECTS` is set, even the objects below a dense fog become darker. The light is assumed to come from the top.

Animating Patchy Fog

A patchy fog can be animated by modifying the geometry of the fog nodes. When changing the content of geosets specifying the fog boundary, make sure that the geosets are fluxed and that the bounding box of each geoset is updated. In addition, function `pfVolFogAddNode()` has to be called every time the fog bounding box changes.

Selecting a Different Type of Patchy Fog Algorithm

It is possible to use a different algorithm for rendering patchy fog that can handle semi-transparent surfaces better. To use this algorithm, set the flag `PFVFOG_FASTER_PATCHY_FOG` to 1. Some advanced features of patchy fog described in the following subsections are supported only in one of the two algorithms. In such cases, this limitation is noted.

Simulating Self-Shadowing in Patchy Fog

If the flag `PFVFOG_FASTER_PATCHY_FOG` is set to 1, the algorithm also allows the color of the patchy fog boundary to be modified using a texture. Either a built-in 1D texture expressing the attenuation between two elevations is used or you can provide a 1D or a 3D texture for each volume object. This can be used to simulate self-shadowing of dense gases, such as clouds.

The built-in 1D texture is enabled by setting the flag `PFVFOG_FLAG_PATCHY_FOG_1DTEXTURE`. The texture is mapped to the range of elevations between the bottom and top of the fog bounding box. The texture value at the bottom (default of 0.3) can be modified by calling `pfVolFogSetVal()` with parameter `PFVFOG_PATCHY_TEXTURE_BOTTOM` and the value at the top (default of 1.5) using parameter `PFVFOG_PATCHY_TEXTURE_TOP`.

To use a different scale for objects of different sizes, you must specify the fog objects separately. When the flag `PFVFOG_FLAG_SEPARATE_NODE_BINS` is set, all calls to `pfVolFogAddNode()` define fog nodes that are drawn separately, and the predefined texture is scaled according to the bounding box of each node.

If both the flag `PFVFOG_FLAG_PATCHY_FOG_1DTEXTURE` and the flag `PFVFOG_FLAG_USER_PATCHY_FOG_TEXTURE` are set, textures associated with the fog nodes are used to modify the surface color of a patchy fog.

To avoid artifacts on overlapping colored patchy fog objects the flag `PFVFOG_FLAG_DRAW_NODES_SEPARATELY` forces the algorithm to be applied to each node separately in the back-to-front order with respect to the viewpoint. Currently, this mode does not work well when scene objects intersect fog objects.

Layered Patchy Fog

If the flag `PFVFOG_FLAG_LAYERED_PATCHY_FOG` is set, the layered fog is used to define the density of a patchy fog. The layered fog is then present only in areas enclosed by the patchy fog boundaries. Since layered fog is computed for the whole scene, it is important to set fog parameter `PFVFOG_MAX_DISTANCE` to a value that corresponds to the size of the patchy fog area (for example, a diameter of its bounding sphere). Use function `pfVolFogSetVal()` to modify the maximum distance parameter.

Layered patchy fog nodes can be moved and rotated by specifying a matrix for each fog node, identified by its index (the order in which nodes were specified). The function `pfVolFogSetAttr()` with three parameters specified can be used for this purpose. The first

parameter is `PFVFOG_ROTATE_NODE`, the second parameter specifies the node index, and the last one is a pointer to a `pfMatrix`.

Light Shafts

Light shafts are a special application of a layered patchy fog. The fog boundary specifies a cone of light with decreasing intensity (density) along the cone axis. Additional rendering passes darken the objects outside the cone of light and lighten the objects inside the light shaft based on their distance from the light. To enable these additional passes, set flag `PFVFOG_FLAG_LIGHT_SHAFT` to 1. To ensure that these passes are applied even if the light shaft is not in the field of view, you must also set flag `PFVFOG_FLAG_FORCE_PATCHY_PASS` to 1.

To control the additional passes, the parameter `PFVFOG_LIGHT_SHAFT_DARKEN_FACTOR` (set using `pfVolFogSetAttr()`) can change the factor by which all objects outside the light shaft are darkened. The default value is 0.3.

Parameters `PFVFOG_LIGHT_SHAFT_ATTEN_SCALE` and `PFVFOG_LIGHT_SHAFT_ATTEN_TRANSLATE` set the translate and scaling of a built-in, one-dimensional texture that is used to reduce the color of objects lit by the light. Set the translate to a small value—for example, 10 to 20% of the shaft length—and the scale to the inverse of the shaft length.

Performance Considerations and Limitations

The quality and speed of patchy fog rendering can be controlled by calling `pfVolFogSetVal()` with the parameter `PFVFOG_RESOLUTION`. The resolution is a value between 0 and 1. Higher values will reduce banding and speed up the drawing. On the other hand, high values may cause corruption in areas of many overlapping fog surfaces. The default value is 0.2, but you may use values higher than that if your fog boundaries do not overlap much.

The following are other performance considerations:

- The multipass algorithms used for rendering layered and patchy fog may produce incorrect results if the scene graph contains polygons that have equal depth values. To avoid such problems, a stencil buffer is used during rendering of the second pass. You can disable this function by setting the flag `PFVFOG_FLAG_CLOSE_SURFACES` to 0.

- By default, the multipass algorithm is applied only when boundaries of a patchy fog are visible. This may cause undesirable changes of semi-transparent edges of scene objects when fog objects move into or away from the view. To force the use of the multipass algorithm, set the flag `PFVFOG_FLAG_FORCE_PATCHY_PASS` to 1.
- Cull programs (see “Cull Programs” in Chapter 4) can speed up rendering of patchy fog because in some draw passes only the part of the scene intersecting the fog boundary is rendered. To enable cull programs, set the flag `PFVFOG_FLAG_USE_CULL_PROGRAM` to 1.
- A layered fog is faster to render than a patchy fog; use a layered fog instead of a patchy fog whenever possible. Rendering of both types of fog together is even slower; so, you may try to define only one type.
- Changing the fog mode does not affect the rendering speed in the case of a layered fog but rendering of a patchy fog is slower for fog modes `PFVFOG_EXP` and `PFVFOG_EXP2`. If you prefer using non-linear modes, try to use them only for layered fog and not for patchy fog.
- You can speed up drawing of a patchy fog by reducing the size of the fog boundaries. In case of several disjoint fog areas, the size of a bounding box containing all boundaries will affect the draw time and quality. Try to avoid defining a patchy fog in two opposite parts of your scene. Try also to increase the value of resolution (if there are not too many overlapping fog boundaries) or reduce the patchy fog density.
- If there is a lot of banding visible in the fog, try to choose a visual with as many bits per color component as possible. Keep in mind that a patchy fog needs a stencil buffer. You can also try to apply all techniques mentioned in the previous item—reducing the size of patchy fog boundaries, increasing resolution, or decreasing density.
- If a patchy fog looks incorrect (the fog appears outside the specified boundaries) make sure that the vertices of the fog boundaries are specified in the correct order so that front faces always face outside the foggy area.
- If you see a darker band in a layered fog at eye level, make sure the texture size is set so that the second value is equal to or greater than the third value.
- Since light shafts are using a combination of layered and patchy fog and the density is decreasing to 0 at the end of the light cone, the quality of results is very sensitive to the depth of color buffers. 12-bit visuals are required and the light shaft should not be too large. Also, ensure that `PFVFOG_MAX_DISTANCE` is set as small as possible.

OpenGL Performer has the following limitations in regards to fog management:

Layered fog

- The values of a layered fog are determined at each vertex and interpolated across a polygon. Consequently, an object located on top of a large ground polygon may be fogged a bit more or less than the part of the polygon just under the object.
- A layered fog works fast with a 3D texture. Reloading of 2D textures during the animation can be slow.

Patchy fog

- The method does not work well for semitransparent surfaces. If your scene contains objects that are semitransparent or that have semitransparent edges, (for example, tree billboards or mountains in Performer Town), these objects or edges may be cut or may be fogged more than the neighboring pixels. Even if a semitransparent edge of a billboard is outside the fog, it will not be smooth.
- A layered patchy fog is extremely sensitive to the size of the fog area and the density of the layered fog. Specifically, the fog values accumulated along an arbitrary line crossing the bounding box of the fog area should not reach 1.
- A patchy fog needs a stencil buffer and the deepest color buffers possible. The rendering quality on a visual with less than 12 bits per color component is low unless the fogged area is very small compared to the size of the whole scene.
- If the `blend_color` extension is not available, the patchy fog color will be white.

Real-Time Shadows

You can create real-time shadows using the class `pfShadow`. You specify a set of light sources and a set of objects that cast shadows on all other objects in the scene. The class manages the drawing and renders shadows for each combination of a shadow caster and a light source. Shadows are rendered by projecting the objects as seen from the light source into a texture and projecting the texture onto a scene. To avoid computing the texture for each frame, a set of textures is precomputed at the first frame, then for each frame the best representative is chosen and warped to approximate the correct shadow.

The following sections further describe real-time shadows:

- “Creating a `pfShadow`”
- “Drawing a Scene with Shadows”

- “Specifying Shadow Parameters”
- “Assigning Data with Directions”
- “Limitations of Real-Time Shadows”

Creating a pfShadow

A pfShadow is not part of the scene graph; it is created separately by the application process. Once the pfShadow is created, you can specify the number of shadow casters by calling function **pfShadowNumCasters()** and then set each caster using the function **pfShadowShadowCasters()**. Each shadow caster is specified by a scene graph node and a matrix that contains the transformation of the node with respect to the scene graph root. Shadow casters are indexed from 0 to the number of casters minus 1.

Similarly, the number of light sources is set by function **pfShadowNumSources()**. A light source is defined by its position or direction, set by **pfShadowSourcePos()** or **pfShadowLight()**.

A pfShadow needs information about the current eye position and view direction. Since this information is not directly accessible in a draw process, it is necessary to call **pfShadowAddChannel()** for each channel at the beginning of the application. Whenever the view changes, the application process has to call **pfShadowUpdateView()**. Even if the view does not change, this function must be called at least once in single-process mode or as many times as the number of buffers in a pfFlux in multiprocess mode. Without updating the view, the shadow is not rendered correctly.

The class initialization is completed by calling the function **pfShadowApply()** as shown in the following creation example:

```
pfShadow *shd = pfNewShadow();

pfShadowNumCasters(shd, 2);
pfShadowShadowCaster(shd, 0, node1, matrix1);
pfShadowShadowCaster(shd, 1, node2, matrix2);

pfShadowNumSources(shd, 1);
pfShadowSourcePos(shd, 0, x1, y1, z1, w1);

pfShadowAddChannel(channel);

pfShadowApply(shd);
```

Table 6-6 summarizes the functions for the initialization and drawing of a `pfShadow`.

Table 6-6 `pfShadow` Functions

Function	Action
<code>pfNewShadow()</code>	Create a <code>pfShadow</code> .
<code>pfShadowNumCasters()</code>	Set number of shadow casters.
<code>pfShadowShadowCaster()</code>	Set a shadow caster and its rotation matrix.
<code>pfShadowAdjustCasterCenter()</code>	Specify the translation of caster's center.
<code>pfShadowNumSources()</code>	Set number of light sources.
<code>pfShadowSourcePos()</code>	Specify light source position.
<code>pfShadowLight()</code>	Specify light source.
<code>pfShadowAmbientFactor()</code>	Set ambient factor.
<code>pfShadowShadowTexture()</code>	Set a user-defined shadow texture for a given caster and light source.
<code>pfShadowTextureBlendFunc()</code>	Set a function used when blending closest shadows.
<code>pfShadowAddChannel()</code>	Add a channel on which <code>pfShadow</code> is used.
<code>pfShadowUpdateView()</code>	Update the current view for all stored channels.
<code>pfShadowUpdateCaster()</code>	Update rotation matrix of a caster.
<code>pfShadowFlags()</code>	Set binary flags.
<code>pfShadowVal()</code>	Set a single attribute.
<code>pfGetShadowDirData()</code>	Get a <code>pfDirData</code> associated with the <code>pfShadow</code> .
<code>pfShadowApply()</code>	Initialize a <code>pfShadow</code> .
<code>pfShadowDraw()</code>	Draw the scene and shadows.

The attributes of a `pfShadow` are listed in Table 6-7.

Table 6-7 `pfShadow` Attributes

Attribute	Identifier	Default
Size of shadow texture	PFSHD_PARAM_TEXTURE_SIZE	512 x 512
Number of shadow textures	PFSHD_PARAM_NUM_TEXTURES	1

There is only one `pfShadow` flag, `PFSHD_BLEND_TEXTURES`. This blend-textures flag has a default of 0.

Drawing a Scene with Shadows

To draw a scene with real-time shadows, the draw process has to call the draw function provided by the `pfShadow` class: **`pfShadowDraw()`**. Before the first frame is rendered, all required shadow textures are precomputed. A warning is printed if the window size is smaller than the texture dimensions. Ensure that the window is not obscured; otherwise, the textures will not be correct.

By default, only the closest shadow texture is selected for any direction and it is skewed so that it approximates the correct shadow. Optionally, the flag `PFSHD_BLEND_TEXTURES` can be set using the function **`pfShadowFlags()`**. In this case, the two closest textures are selected and blended together, resulting in smoother transitions. Also, instead of a linear blend between the textures, you can define a blend function, mapping values 0–1 to the interval 0–1. The blend function can be set using the function **`pfShadowTextureBlendFunc()`**.

Every time the caster changes its position or orientation with respect to the light source, it is necessary to update its matrix using **`pfShadowUpdateCaster()`** (the caster is identified by its index). When the caster's matrix changes, the shadow of the caster changes as well. In this case, the set of precomputed shadow textures is searched to find the one or two closest representatives.

Specifying Shadow Parameters

The shadow texture is used to darken the scene pixels when the texture `texel` is set to 1. The amount by which the scene pixel is darkened can be set by the function **`pfShadowAmbientFactor()`**. The default value is 0.6.

As the caster is projected into a shadow texture, the center of the projection corresponds with the center of the bounding box of the caster's node. When the shadow texture is skewed to approximate shadows from a slightly different direction, it is best if the center of the projection corresponds with the center of the object. The bounding box center may not coincide with the center of the object (in the case of some long protruding parts) and you can use the function **`pfShadowAdjustCasterCenter()`** to shift the bounding box center toward the center of the object.

For each combination of a shadow caster and a light source, it is possible to specify the number of shadow textures used, their sizes, and a set of directions for which the textures are precomputed. The number of textures and their sizes can be set by the function **`pfShadowVal()`**, where the first parameter is `PFSHD_PARAM_TEXTURE_SIZE` or `PFSHD_PARAM_NUM_TEXTURES`.

The set of directions can be controlled by using the function **`pfGetShadowDirData()`** to get the pointer to the corresponding `pfDirData`, a class that stores data associated with a set of directions. Then you can either select the default mode or specify the directions directly. See following section “Assigning Data with Directions” for more details. By default, there is one texture of size 512 x 512 and the direction corresponds to the light direction (or a vector from a point light source to the object's center). If there are more textures, the original light direction is rotated around a horizontal direction, assuming that the object will primarily keep its horizontal position (for example, a helicopter or a plane).

A sample implementation of shadows is in the file `perf/samples/pguide/libpf/C++/shadowsNew`.

Assigning Data with Directions

The `pfDirData` class is used to store directional data—that is, data that depend on direction. A `pfDirData` stores an array of directions and an array of `(void *)` pointers representing the data associated with each direction.

The directions and data can be set using the function **pfDirDataData()**. Optionally, you can set only the directions using the function **pfDirDataDirections()** in the case that the associated data are defined later or generated internally by another OpenGL Performer class (such as **pfShadow**).

You can also generate directions automatically using the function **pfDirDataGenerateDirections()**. The first parameter defines one of the default sets of directions and the second parameter is used to specify additional values. At present only type **PFDD_2D_ROTATE_AROUND_UP** is supported, in which case the second parameter points to a 3D vector that is rotated around the up vector, creating a number of directions.

The data can be queried using the **pfDirDataFindData()** or **pfDirDataFindData2()** function. In the first case, the function finds the closest direction to the direction specified as the first parameter, copies it to the second parameter, and returns the pointer to the data associated with it. The input direction has to be normalized. The second function finds the two closest directions to the specified direction. It copies the two directions to the second parameter (which should point to an array of two vectors). The two pointers to the data associated with the two directions are copied to the array of two (**void ***) pointers specified as the third parameter. In addition, two weights associated with each direction are copied to the array of two floats. These weights are determined based on the distance of the end point of the input direction and each of the two closest directions.

Limitations of Real-Time Shadows

The following are limitations of real-time shadows in OpenGL Performer:

- When projecting a caster into a shadow texture, **pfSwitch** children are selected according to switch value. In the case of **pfLOD**, the finest level is chosen. Also, **pfSequences** are ignored—which can be useful in the case of helicopter rotors, for example.
- The **pfShadow** class uses cull programs to cull out geometry that is not affected by the shadow to make the multipass drawing more efficient. At present, though, the cull program used by the **pfShadow** class overwrites any other cull program you specify.

Note: Ensure that you do not overwrite **TravMode** in your application by setting it to **PFCULL_ALL**. The mode is set by **pfShadow** when **pfShadowApply()** is called.

- When projecting a caster into a shadow texture, `pfSwitch` and `pfLOD` may not be handled properly. Also, `pfSequences` are ignored—which can be useful in case of helicopter rotors, for example.

Image-Based Rendering

The image-based rendering approach is used for very complex objects. Such an object is represented by a set of images taken from many directions around it. When the object is rendered for each view direction, several closest views are blended together.

In OpenGL Performer, you can use the `pfIBRnode` class to represent complex objects. Unlike a `pfBillboard`, a parent class of `pfIBRnode`, the texture on `pfGeoSets` of a `pfIBRnode` is not static, but it changes based on the view direction for each `pfGeoSet`.

The following sections further describe image-based rendering:

- “Creating a `pfIBRnode`” on page 204
- “Creating a `pfIBRnode` Using a Proxy” on page 205
- “Creating a `pfIBRtexture`” on page 206
- “Parameters Controlling Drawing of a `pfIBRnode`” on page 208
- “The Simplify Application” on page 209
- “Creating Images of an Object with `makeProxyImages`” on page 215
- “Creating Images of an Object with `makeIBRimages`” on page 219
- “Limitations” on page 220

Creating a `pfIBRnode`

A `pfIBRnode` is a child class of `pfBillboard`. You create a `pfIBRnode` in a fashion similar to that of a `pfBillboard`. Compared to a `pfBillboard`, a `pfIBRnode` has two additional parameters: a `pfIBRtexture` and an array of angles defining the initial rotation of the objects.

Each `pfIBRnode` has associated with it a single `pfIBRtexture`, which stores a set of images of the complex object as viewed from different directions. Each `pfGeoSet` is then rendered

with a texture representing the view of the object from the given direction. A `pfIBRtexture` is specified using the function `pfIBRnodeIBRtexture()`.

Using the function `pfIBRnodeAngles()`, you control the initial orientation of the complex object by specifying the rotation from the horizontal and vertical planes for each `pfGeoSet`. These angles are very useful in case of trees, for example, because you can use a different vertical angle for each instance of the tree. The trees then appear different, although they all use the same `pfIBRtexture`. The first value is ignored in the case that only one ring of views around the object is used.

You must set up a `pfIBRnode` so that the `pfIBRtexture` applied to it can modify properly the image at each frame. You do so in the following manner:

1. Set the texture of the `pfGeoState` associated with each `pfGeoSet` of the `pfIBRnode` to the texture returned by the function `pfGetIBRtextureDefaultTexture()`.
2. If the `pfIBRtexture` has the flag `PFIBR_USE_REG_COMBINERS` set, enable multitexturing and specify texture coordinates for additional texture units.
3. If the `pfIBRtexture` has the flag `PFIBR_3D_VIEWS` enabled, set the billboard rotation (`PFBB_ROT`) to `PFBB_AXIAL_ROT`.

On IRIX and Linux, see the example in the following file:

```
/usr/share/Performer/src/sample/pguide/C++/IBRnode.C
```

On Microsoft Windows, see the example in the following file:

```
%PFROOT%\Src\sample\pguide\C++\IBRnode.C
```

Creating a `pfIBRnode` Using a Proxy

By default, it is assumed that the `geosets` of the `pfIBRnode` specify rectangles that are always facing the viewer (like billboards). This approach is very fast but it requires a large number of views to limit the artifacts due to the differences between the neighboring views.

To reduce the number of views required to obtain a reasonable image of the complex object from any direction, we can use a shape that approximates the surface of the complex object instead of a billboard. This shape is called a proxy. The closer the proxy is to the original surface, the fewer views of the objects are required. Optimally, you create a proxy that contains a relatively small number of primitives and that is very close

to the original surface. The proxy can be created using the new tool `Simply`. See section “The Simplify Application” on page 209 for the details.

Compared to default mapping of views on a billboard there are only minor changes. Instead of a billboard, the node's geosets contain the proxy geometry. The `pfIBRtexture` associated with the node has the flag `PFIBR_USE_PROXY` set. There is an array of texture coordinates indexed by the view index and the geoset index. These texture coordinates can be defined and queried by `pfIBRnodeProxyTexCoords()` and `pfGetIBRnodeProxyTexCoords()`. Note that it is more efficient to store the proxy in one geoset.

Optionally, it is possible to specify different geosets for each view (if the `PFIBR_NEAREST` flag is set in the `pfIBRtexture` assigned to the `pfIBRnode`) or for each group of views if the views are blended. In this case, you must set the flag `PFIBRN_VARY_PROXY_GEOSETS` using `pfIBRnodeFlags()`. This can be useful for removing the invisible parts of the proxy (invisible from the range of views in the group) or for sorting the proxy triangles to avoid artifacts when edges of the proxy textures are transparent. The array of texture coordinates is then organized as follows:

- The first index is the view index or the group index (if the views are blended).
- The second index is the geoset index multiplied by the number of views in a group (1 for the nearest view).
- The coordinates are grouped by geosets.

Thus, there are texture coordinates for the geoset 0 for all views in the group, then for geoset 1, and so on.

The geosets are organized as follows: if the proxy has n geosets and there are v views or groups of views, the `pfIBRnode` has $n*v$ geosets, and each group of n geosets belongs to one view.

To create views of a complex object from various directions and to compute the texture coordinates of its proxy, you can use the `makeProxyImages` tool described in section “Creating Images of an Object with `makeProxyImages`” on page 215.

Creating a `pfIBRtexture`

A `pfIBRtexture` stores a set of images of a complex object as viewed from different directions. The directions are specified using `pfIBRtextureIBRdirections()`. Internally,

`pfIBRtexture` uses `pfDirData` to store the views. A `pfDirData` determines the type of view distribution. It could be a set of views around the object with all views perpendicular to the vertical axis, or the views can be from a set of rings and each ring contains an array of evenly spaced views that have the same angle from the horizontal plane. Otherwise, the views are assumed to be uniformly or randomly distributed around the sphere of directions. You must specify the directions before the images are set.

Once you specify the directions, you set the images using `pfIBRtextureIBRtextures()`. The parameters are an array of pointers to the textures containing the views and the number of the textures in this array.

If views are organized in rings, you can load the images directly from a set of files using `pfIBRtextureLoadIBRtexture()` without the need to specify the directions first. The parameter `format` specifies the path where the images are stored as well as how they are indexed—for example, `images/view%03d.rgb`. The other two parameters specify the number of images and the increment between two loaded images. The increment specification is useful when the texture memory is limited; for instance, specifying `step=2` causes every second image to be skipped. Optionally, you can specify the views using the function `pfIBRtextureIBRtextures()`. The parameters are an array of pointers to the textures containing the views and the number of the textures in this array.

If the views are organized in rings, the textures, by default, represent views around the object, all perpendicular to the vertical axis. In this case, specified textures form a single ring of views that are evenly spaced. If the flag `PFIBR_3D_VIEWS` is specified by the function `pfIBRtextureFlags()`, the textures form a set of rings. Each ring contains an array of evenly spaced views that have the same angle from the horizontal plane.

If the flag `PFIBR_3D_VIEWS` is not set, both functions `pfIBRtextureLoadIBRtexture()` and `pfIBRtextureIBRtextures()` will set one ring with the specified number of textures and a horizontal angle of 0. If the flag `PFIBR_3D_VIEWS` is set, the class checks whether a file `info` is present in the image directory. If it is, the information about rings is loaded from that file. The file contains two values on each line: the horizontal angle and the number of textures at each ring. If the file is not present in the image directory, you must specify the rings before the images are loaded by calling the functions `pfIBRtextureNumRings()` and `pfIBRtextureRing()`. Rings are indexed from 0 and should be ordered by the horizontal angle, with the lowest angle at index 0. Each ring can have a different number of textures associated with it.

When 3D views are used, the image files read by function `pfIBRtextureLoadIBRtexture()` should be indexed by the ring index and the index of the

image in a given ring. Specify the format string in the manner shown in the following example:

```
images/view%02d_%03d.rgb
```

If you specify the textures using the function **pfIBRtextureIBRtextures()**, the texture pointers are all stored in a single array, starting with textures of the first ring, followed by textures of the second ring, and so on.

It is assumed that the views in each ring are uniformly spaced and they are ordered clockwise with respect to the vertical axis. If the views are ordered in the opposite direction, use the function **pfIBRtextureDirection()** to set the direction to `-1`.

When using `pfIBRnodes` and `pfIBRtextures` in `Perfly`, you need an alpha buffer. If the `pfIBRnode` is rendered as an opaque rectangle, try the command-line parameter `-9`, in which case `Perfly` requests a visual with an alpha buffer.

For more details about associating a `pfIBRtexture` with a `pfIBRnode`, see the `pfIBRnode` man page and the following program:

```
/usr/share/Performer/src/sample/pguide/C++/IBRnode (IRIX and Linux)  
%PFROOT%\Src\sample\pguide\C++\IBRnode (Microsoft Windows)
```

Parameters Controlling Drawing of a `pfIBRnode`

At present, the `pfIBRtexture` class is used only by the `pfIBRnode` class. The `pfIBRtexture` class provides a draw function for `pfGeoSets` that belong to the `pfIBRnode`, but the draw process is transparent to you. You can control the drawing by setting flags using the function **pfIBRtextureFlags()**. If the flag `PFIBR_NEAREST` is set, the closest view from the closest ring is selected and applied as a texture of the `pfGeoSet`. This approach is fast on all platforms, but it results in visible jumps when the texture is changed. Thus, by default, the flag `PFIBR_NEAREST` is not set and the two or, in case of 3D views, four closest views are blended together. If the graphics hardware supports register combiners, flags `PFIBR_USE_REG_COMBINERS` and `PFIBR_USE_2D_TEXTURES` are automatically set by the class constructor and blending of textures can be done in one pass.

The flag `PFIBR_USE_PROXY` is used when the views are mapped on an approximation of the complex object (a proxy) and a different draw function is applied. You can read more about proxies in section “Creating a `pfIBRnode` Using a Proxy” on page 205.

By default on IRIX, the flag `PFIBR_USE_2D_TEXTURES` is not set and a 3D texture is used for fast blending between the two closest views. To avoid flickering when the object is viewed from a distance, additional 3D textures are used to store additional mipmap levels. This feature is available on machines with multisampling only (InfiniteReality systems). To disable the mipmapping, set flag `PFIBR_MIPMAP_3DTEXTURES` to zero. In case of several rings, the nearest ring is selected and the views inside this ring are blended using the 3D texture. 3D texture is not compatible with other distributions of the views. Hence, in this case, ensure that you set flag `PFIBR_USE_2D_TEXTURES`.

The Simplify Application

The Simplify application is an interactive tool that is used to simplify a complex object. It has the following two main functions:

- Create a regular simplification of an object
- Create a proxy of an object

In a regular simplification of an object, the resulting geometry does not cross the inner and outer boundaries of the original object. The distance of these boundaries from the original object controls the coarseness of the resulting geometry. All vertex parameters, such as the normal or texture coordinates, are preserved. A simplified version of the object can be used to create a pfLOD node (see section “pfLOD Nodes” on page 70).

A proxy is a simplified version of the object where the original object is fully inside the proxy. This property is important because the proxy is used in image-based rendering where the images of a complex object from various directions are projected onto the proxy. In this way, it is possible to render a very complex object using a simplified version (a proxy) and store the surface detail, including the associated lighting, in multiple textures. See section “Creating Images of an Object with `makeProxyImages`” on page 215 for the process of making the textures that are projected on the proxy.

The Simplify Graphical User Interface (GUI)

The Simplify application is based on the `Perfly` application and they share many command-line parameters and key commands (see the man page for `perfly`). The syntax for the command-line invocation is as follows:

```
simplify [ perfly-options ] infile outfile [ simplification-options ]
```

You can get the list of the simplification options by running `simplify` with no option or with only the option `-h`.

When you start the Simplify application, the menu is similar to that of Perfly. There is an additional pane of buttons and sliders, called the Simplify pane, which can be enabled and disabled using the **Simplify pane** button. Figure 6-3 shows the Simplify pane, which is enabled by default. Most of the buttons and sliders on the Simplify pane have command-line equivalents.



Figure 6-3 The Default Simplify Pane

Making a Proxy of an Object

Computing a proxy with Simplify requires two basic decisions:

- Where to position the initial proxy and an outer boundary for the original object
- What algorithm to use for creating the initial proxy and the outer boundary

Since these decisions may be difficult to make in an analytical fashion initially, the Simplify GUI allows you to make some guesses and refine them in an iterative fashion. The following procedure for making a proxy assumes that you have invoked the Simplify application using the default simplification options.

1. Ensure that the **Simplify into proxy** button is selected (the default).
2. Specify the initial distance of the proxy from the object and an outer boundary.

Use the sliders **Initial distance** and **Outer boundary** to do this. Distances are specified as a percentage of the object diameter (more precisely, the diameter of the object's bounding sphere). Initially, you might want to use the defaults, 2% for **Initial distance** and 5% for **Outer boundary**.

3. Select the algorithm for creating the initial proxy.

Simplify provides two algorithms: the marching cubes algorithm and the deplace-along-normals algorithm. The first button on the Simplify pane is the **Do marching cubes** button, which is selected by default. If the **Do marching cubes** button is not selected, Simplify uses the deplace-along-normals algorithm.

The marching cubes algorithm creates an isosurface at a certain distance (slider **Iso distance**) from the original object. The isosurface is later moved to the distance of the outer boundary (slider **Outer boundary**) and a copy of the isosurface is moved to the distance of the initial proxy (slider **Initial distance**).

The marching cubes algorithm has the following additional controls:

- **Grid Size X** slider
- **Grid Size Y** slider
- **Grid Size Z** slider
- **Iso distance** slider

With these controls, you can set the grid size at each axis and the distance of the isosurface from the object (using the slider **Iso distance**). The finer the grid, the longer the algorithm takes and the more complex the initial proxy. On the other hand, if the grid is too coarse, many details may be missed.

In general, the algorithm does not work very well if the desired isosurface distance is too small compared to the size of a grid voxel. For this reason, it is possible to specify the isosurface distance separately from the outer boundary distance and the initial proxy distance. Often it is possible to specify the isosurface distance large enough so that the isosurface does not miss any part of the object and then move it closer as needed. It is also possible to preview the isosurface by clicking the button **Get isosurface** while the button **Show boundary** is selected.

If you select the deplace-along-normals algorithm, the outer boundary and the initial proxy are created by displacing the original surface along its normals. This approach works better in the case where distances are very small. Unfortunately, some areas of the object may not be simplified. For example, if two parts of the object are touching, displacing along the normals will create a self-intersecting boundary that will not allow any room for simplification in the area of intersection.

With the deplace-along-normals algorithm, the grid is used to accelerate the intersection test of the simplified proxy with the boundary surfaces. Thus, do not reduce the grid resolution too much.

4. Click the **Run simplify proxy** button to start the simplification.

The simplification algorithm starts by moving the isosurface or the original surface to create the outer boundary and the initial proxy. The initial proxy is simplified by removing vertices and edges as long as the surface is within the surfaces defined by the object and the outer boundary. At the end, the vertices of the proxy are moved as close to the original object as possible.

After completing the computation, the proxy is saved in the file specified on the command line.

The simplification algorithm can be stopped or paused by clicking the **Stop simplify** or **Pause** button, respectively. When the algorithm is paused, it is possible to save the current proxy by clicking the **Save mesh** button. The file name contains the index of the current step so that several meshes can be output during the simplification.

Simplifying an Object

The procedure for a regular simplification is very similar to the procedure for making a proxy, as described in the preceding section. In contrast to making a proxy, however, Simplify uses two boundary surfaces, an outer boundary (set by the slider **Outer boundary**) and an inner boundary (set by the slider **Inner boundary**) to create a regular simplification.

To simplify an object requires two basic decisions:

- Where to place an outer boundary and inner boundary
- What algorithm to use for creating the boundaries

The following procedure for making a proxy assumes that you have invoked the Simplify application using the default simplification options.

1. Ensure that the **Simplify into proxy** button is **not** selected.

This is not the default. Figure 6-4 shows the resulting Simplify pane.



Figure 6-4 The Simplify Pane for Simplifying an Object

2. Specify inner and outer boundaries.

Use the sliders **Inner boundary** and **Outer boundary** to do this. Distances are specified as a percentage of the object diameter (more precisely, the diameter of the object's bounding sphere). Initially, you might want to use the defaults, 2.5% for **Inner boundary** and 5% for **Outer boundary**.

3. Select the algorithm for creating the boundaries.

Simplify provides two algorithms: the marching cubes algorithm and the deplace-along-normals algorithm. The first button on the Simplify pane is the **Do marching cubes** button, which is selected by default. If the **Do marching cubes** button is not selected, Simplify uses the deplace-along-normals algorithm. See the preceding section for a description of the algorithms.

If you select the marching cubes algorithm, the distance of both boundaries from the original surface is the same (in absolute value) and it is controlled by the slider **Iso distance**. As in the case of making a proxy, the isosurface can be previewed by clicking the **Get isosurface** button.

If you select the deplace-along-normals algorithm, the boundaries are created by moving the original surface along its normals to distances specified by the sliders **Outer boundary** and **Inner boundary**. Note that the distance for the inner boundary is specified as a negative number.

4. Click the **Run simplify** button to start the simplification.

The computation can be paused or stopped by clicking the **Pause** or **Stop simplify** button, respectively. When the algorithm is paused, it is possible to save the intermediate result by clicking the **Save mesh** button or to toggle the visibility of the boundary by clicking the **Show boundary** button. After the simplification is finished you can display the original object by clicking the **Restore object** button. You can restart the algorithm without restoring the original object.

As you may realize, this procedure could be used to create an object proxy if you select the displace-along-normals algorithm and the inner boundary is set to zero. The result may be different, though, because the algorithm is trying to preserve seams between pfGeoSets with different pfGeoStates; the seam preservation is not necessary for the proxy.

Creating Images of an Object with `makeProxyImages`

You can use the program `makeProxyImages` to create images (views) of the specified object from a set of directions. Since the images are being projected on a proxy, a simplification of the original object, additional processing may be required to add views of parts of the proxy that are partially or fully obstructed by other parts. These additional texture pieces are important because as the proxy is rotated away from the view at which the texture was computed, some parts of the proxy that were not directly visible from the view may become visible. Thus, each image consists of the view of the object and a collection of texture pieces for obstructed parts of the proxy.

It is necessary to store texture coordinates for each proxy triangle so that the texture pieces are correctly mapped. Consequently, the program `makeProxyImages` outputs not only textures storing the views but also a `pFIBRnode` that contains the texture coordinates and the proxy geometry. You can create the proxy of an object using the program `Simplify`.

Command-Line Options for `makeProxyImages`

The input to the `makeProxyImages` program is the file containing the original complex object. Table 6-8 and the following sections describe other key, command-line options:

- “Packing Additional Textures Pieces” on page 216
- “Fine Tuning Texture Rendering” on page 217
- “Potential Problems” on page 218

Table 6-8 Key Command-Line Options of `makeProxyImages`

Command Option	Description
<code>-pf</code>	Specifies the file containing the proxy.
<code>-f</code>	Specifies the files where the images are stored. A view number and the extension <code>rgb</code> is added automatically.
<code>-pfb</code>	Specifies the file where the resulting <code>pFIBRnode</code> is stored.
<code>-w</code>	Specifies the size of the texture (<code>-w xsize ysize</code>). It is important to specify the size.
<code>-o</code>	Specifies the oversampling factor. Specify this option when the hardware does not support antialiasing.

Table 6-8 Key Command-Line Options of `makeProxyImages` (continued)

Command Option	Description
<code>-rv</code>	Specifies the text file with ring information to determine the view directions. Each line of the ring file contains two values: the angle from the horizontal plane and how many views are created for that angle.
<code>-n</code>	Specifies that only views around the object are used.
<code>-nv</code>	Specifies that uniformly distributed 3D views are used.
<code>-sk</code>	Enables skipping a certain number of views in each ring.
<code>-s</code>	Scales up the object. By default, the program uses orthographic projection. The center of the projection is the center of the bounding sphere around the object and the object is scaled so that the bounding sphere fits the window. If the bounding sphere is too large you may try to upscale the object using the <code>-s</code> option to make better use of the texture. You can use perspective projection by defining the distance of the camera from the center of the bounding sphere. Unless there are reasons for doing otherwise, use the orthographic projection.
<code>-l</code>	Specifies non-default lighting. In image-based rendering the lighting is captured in the textures. Thus, it is important you specify the lights in the same way as in your scene. By default, the default Perfly lighting is selected. You can specify your own lights using the <code>-l</code> option: <pre><code>-l <i>posx posy posz posw r g b</i></code></pre> <p>You can use multiple <code>-l</code> specifications to define multiple lights.</p>

To obtain the full set of options, run the program `makeProxyImages` without any parameters.

Packing Additional Textures Pieces

By default, the program `makeProxyImages` renders only the view of the object without the extra texture pieces for obstructed triangles of the proxy. To enable this feature you have to add the option `-ev`. The process has two steps. First, the number and size of texture pieces is determined and a packing algorithm determines their position around the primary view. Second, for each view the texture pieces are rendered in place.

The packing algorithm operates on the pixel level and there are several options that affect its speed and the quality of the results. To speed up the packing algorithm, you can downsample the textures before packing using the option `-evd`. The drawback is that there may be more wasted space between texture pieces. You can also reduce the number of neighboring pixels the texture packing algorithm checks when finding the optimal place for texture pieces by using the option `-evp`. In general, the texture pieces are not aligned with their neighboring pieces. Thus, when the view texture is mipmapped, the gaps between the textures may become visible. For this purpose, you can add the option `-evmp` to set the number of mipmapping levels that will not have cracks. Each edge of the texture piece that is not a silhouette edge is extended to contain more pixels from neighboring triangles. Setting the value too high may cause the packing algorithm to fail.

If the packing algorithm fails to place the texture pieces around the primary view, the object is scaled down a little (for the given view) and the algorithm is restarted. This process repeats until all the texture pieces fit.

Similarly, as obstructed triangles may come into full view, backfacing triangles may become visible as the proxy is rotated away from the view. Thus, it is possible to add texture pieces for backfacing triangles into the view texture using the option `-bf`. Not all backfacing triangles are added but only those that may be visible from neighboring views. Since additional texture pieces that are used for backfacing triangles of the proxy can be found in neighboring views, it is advantageous to combine several views into a single texture. This reduces the number of texture pieces packed into a texture for one view. You can use the option `-tm` to control this. Do not exceed 2Kx2K when combining several views into one texture.

Fine Tuning Texture Rendering

When rendering additional texture pieces, you can control how far before and after the proxy triangle the clip planes are being set. This option affects triangles around the silhouette of the object. This is view-dependent: for each view, there are different triangles that contain the silhouette of the object. Since the proxy fully contains the original object, parts of the silhouette triangles may be transparent. This may cause visible cracks when the object is rotated. Moving the clip planes reduces some of the cracks.

If you move the plane that is behind the triangle farther away (using option `-evlb`), some of the geometry that is behind the silhouette is included in the texture. When you move the front clip plane closer to the cameras (using option `-evlf`), some of the geometry that is in front of the silhouette is included in the texture.

Because some proxy triangles may have a texture with transparent edges, it may be desirable to sort the proxy triangles. Because the proxy can be viewed from any direction, it is necessary to determine how the triangles are sorted. If the proxy is rendered with only the nearest views selected, the triangles are ordered for each view differently. You must set that mode using the option `-nr`. By default, three or four of the nearest views are blended together. In that case, the proxy triangles are sorted for each group of views. Sometimes it may be possible to see changes in transparency as the view moves from one group of views to another. If this becomes too obvious, you can disable the sorting using the option `-evns`.

Potential Problems

Generally, you can drastically reduce problems if you place the proxy very close to the original object (especially around visible sharp edges) or if you increase the number of views. The following are some potential problems you might encounter:

- The images are missing an alpha channel.

If your machine does not support a single-buffered visual with at least 8 bits per red, green, blue, and alpha component, the images may be missing an alpha channel. Note the number of alpha bits printed at the beginning of the `makeProxyImages` output. On some SGI systems with multisampling, you may try to use the option `-nms` to request a visual without multisampling to improve the probability of getting a visual with an alpha channel.

- Your textures are not antialiased.

Do not forget to oversample the textures on machines with no antialiasing (using option `-o`).

- The processing time is very long.

The process may take a very long time if the proxy is very fine and many texture pieces have to be added to each view. Since the rendering is done into a window, ensure that you do not overlap the window during the process or that the screen saver does not start. If some of the textures are corrupt, you may restart the program with the same parameters and add the option `-sfr`, which skips the rendering of the specified number of textures. It is also a good idea to increase shared arena size (use environment variable `PFSHAREDSIZE`) to avoid memory overflow when the `pfIBRnode` is saved at the end.

- Texture pieces intersect the image of the object.

Inspecting the view textures, you may notice that sometimes the additional texture pieces may intersect the image of the object. This is fine because those triangles that are overlapped are assigned one of the additional texture pieces packed around the object.

Creating Images of an Object with `makeIBRimages`

You can use the program `makeIBRimages` from the directory `/usr/share/Performer/src/conv/` on IRIX and Linux and `%PFROOT%\Src\conv` on Microsoft Windows to create images (views) of a specified object from a set of directions. The input is a file that can be read by OpenGL Performer and the output is a set of images of that object that can be directly used as an input for a `pfIBRtexture`. The images are stored in a directory specified using the option `-f`.

If a text file `info` is present in the output directory, a set of 3D views is rendered. The file has the same syntax as described in section “Creating a `pfIBRtexture`” on page 206. Each line of the file `info` contains two values: the angle from the horizontal plane and how many views are created for that angle. The images are then indexed by two integer values that are appended to the name specified by the option `-f`. The first value is the ring index of the views and the second one indexes the views within the ring.

If the file `info` is not present, a set of N views (set by the option `-n`) is computed around the object using the horizontal angle of 0. In this case, only one index is appended to the image name.

If you specify the option `-pfb`, the program outputs a `pfb` file in the specified directory. The file contains a single `pfIBRnode` that uses the created images.

Note:

Before loading `perfly`, ensure that `PFPATH` is set to the directory that contains the images.

If your machine does not support a single-buffered visual with at least 8 bits per red, green, blue, and alpha component, the images may be missing the alpha channel. Note the number of alpha bits printed when `makeIBRimages` begins.

When using `pfIBRnodes` and `pfIBRtextures` in `perfly`, you also need an alpha buffer. If the `pfIBRnode` is rendered as a full rectangle, try the command-line parameter `-9`, in which case `perfly` requests a visual with alpha.

To obtain the full set of command-line options, run the program `makeIBRimages` without any parameters.

Limitations

The following are current limitations of image-based rendering in OpenGL Performer:

- A `pfIBRtexture` applied to a `pfIBRnode` is not properly rotated when the `pfIBRnode` is viewed from the top. This may result in visible rotation of the texture with respect to the ground.
- When the flag `PFIBR_3D_VIEWS` is set in a `pfIBRtexture`, do not use 3D textures. This mode is not implemented.

Importing Databases

Once you have learned how to create visual simulation applications with OpenGL Performer, your next task is to import visual databases into those applications. OpenGL Performer provides import and export functions for numerous popular database formats to ease this effort.

This chapter describes the following:

- The steps involved in creating custom loaders for other data formats
- Pre-existing file loading utilities
- Several utility functions in the OpenGL Performer database utility library that can make the process of database conversion easier for you
- Supported database formats
- The Maya database exporter

Overview of OpenGL Performer Database Creation and Conversion

Source code is provided for most of the tools discussed in this chapter. In most cases the loaders are short, easy to understand, and easy to modify.

Table 7-1 lists the subdirectories of `/usr/share/Performer/src/lib` on IRIX and Linux and `%PFROOT%\Src\lib` on Microsoft Windows where you can find the source code for the database processing tools.

Table 7-1 Database-Importer Source Directories

Directory Name	Directory Contents
<code>libpfdu</code>	General database processing tools and utilities.

Table 7-1 Database-Importer Source Directories (**continued**)

Directory Name	Directory Contents
<code>libpfdb</code>	Load, convert, and store specific database formats..
<code>libpftutil</code>	Additional utility functions.

Before you can import a database, you must create it. Some simulation applications create data procedurally; for examples of this approach, see the “SGI PHD Format” on page 268 or the “Sierpinski Sponge Loader” on page 280” sections of this chapter.

In most cases, however, you must create visual databases manually. Several software packages are available to help with this task, and most such systems facilitate geometric modeling, texture creation, and interactive specification of colors and material properties. Some advanced systems support level-of-detail specification, animation sequences, motion planning for jointed objects, automated roadway and terrain generation, and other specialized functions.

`libpftdu` - Utilities for Creating Efficient OpenGL Performer Run-Time Structures

There are several layers of support in OpenGL Performer for loading 3D models and 3D environments into OpenGL Performer run-time scene graphs. OpenGL Performer contains the `libpftdu` library devoted to the import of data into (and export of data from) OpenGL Performer run-time structures. Note that two database exporters have already been written for the Medit and DWB database formats.

At the top level of the API, OpenGL Performer provides a standard set of functions to read in files and convert databases of unknown type. This functionality is centered around the notion of a database converter. A database converter is an abstract entity that knows how to perform some or all of a set of database format conversion functions with a particular database format. Moreover, converters must follow certain API guidelines for standard functionality such that they can be easily integrated into OpenGL Performer in a run-time environment without OpenGL Performer needing any prior knowledge of a particular converter’s existence. This run-time integration is done through the use of dynamic shared object (DSO) libraries on IRIX and Linux. On Microsoft Windows this is accomplished using Dynamic-link Libraries (DLL).

pfdLoadFile - Loading Arbitrary Databases into OpenGL Performer

Table 7-2 describes the general routines for 3D databases provided by libpfd.

Table 7-2 libpfd Database Converter Functions

Function Name	Description
pfdInitConverter()	Initialize the library and its classes for the desired format.
pfdLoadFile()	Load a database file into an OpenGL Performer scene graph.
pfdStoreFile()	Store a run-time scene graph into a database file.
pfdConvertFrom()	Convert an external run-time format into an OpenGL Performer scene graph.
pfdConvertTo()	Convert an OpenGL Performer scene graph into an external run-time format.

The database loader utility library, libpfd, provides a convenient function, named **pfdLoadFile()**, that imports database files stored in any of the supported formats listed in Table 7-6 on page 242.

Loading database files with **pfdLoadFile()** is easy. The function prototype is

```
pfdNode *pfdLoadFile(char *fileName);
```

pfdLoadFile() tests the filename-extension portion of *fileName* (the substring starting at the last period in *fileName*, if any) for one of the format-name codes listed in Table 7-6 on page 242, then calls the appropriate importer.

The file-format selection process is implemented using dynamic loading of DSOs, dynamic shared objects, for IRIX and Linux and DLLs, dynamic link libraries, for Microsoft Windows. This process allows new loaders that are developed as database formats change to be used with OpenGL Performer-based applications without requiring recompilation of the OpenGL Performer application.

Note: Subsequent general references in this manual to DSOs also pertain to DLLs unless otherwise noted.

If at all possible, **pfdInitConverter()** should be called before **pfConfig()** for the potential formats that may be loaded. This will preload the DSO and allow it to initialize any of its own data structures and classes. This is required if the loader DSO extends

OpenGL Performer classes or uses any node traversal callbacks so that if multiprocessing these data elements will all have been precreated and be valid in all potential processes. **pfdInitConverter()** automatically calls **pfdLoadNeededDSOs_EXT()** to preload additional DSOs needed by the loader if the given loader has defined that routine. These routines take a filename so that the loader has the option to search through the file for possible DSO references in the file.

Loading Process Internals

The details of the loading process internal to **pfdLoadFile()** include the following:

1. Searching for the named file using the current OpenGL Performer file path.
2. Extraction of the file-type extension.
3. Translation of the extension using a registered alias facility, formation of the DSO or DLL name.
4. Formation of a loader function name.
5. Finding that function within the DSO using either **dlsym()** on IRIX and Linux or **GetProcAddress()** on Microsoft Windows.
6. Searching first the current executable and loaded DSOs for the proper load function and then searching through a list of user-defined and standard directories for that DSO. Dynamic loading of the indicated DSO using **dlopen()** on IRIX and Linux and using **LoadLibrary()** on Microsoft Windows.
7. Invocation of the loader function.

Loader Name

The loader function name is constructed from two components:

- A prefix always consisting of `pfdLoadFile_`.
- Loader suffix, which is the file extension string.

Note: The loader function `pfdLoadFile_` must be exported using `_declspec(dllexport)` on Microsoft Windows only.

Examples of several complete loader function names are shown in Table 7-3.

Table 7-3 Loader Name Composition

File Extension	Loader Function Name
dwb	pfdLoadFile_dwb()
flt	pfdLoadFile_flt()
medit	pfdLoadFile_medit()
obj	pfdLoadFile_obj()
pfb	pfdLoadFile_pfb()

Shell Environment Variables

Several shell environment variables are used in the loader location process. These are `PFLD_LIBRARY{N32,64}_PATH`, `LD_LIBRARY{N32,64}_PATH`, and `PFHOME`. Confusion about loader locations can be resolved by consulting the sources mentioned earlier in this chapter to understand the use of these directory lists and reading the following section, “Database Loading Details” on page 225. When the `pfNotifyLevel` is set to the value for `PFNFY_DEBUG` (5) or greater, the DSO and loader function names are printed as databases are loaded, as is the name of each directory that is searched for the DSO.

The OpenGL Performer sample programs, including `perfly`, use **pfdLoadFile()** for database importing. This allows them to simultaneously load and display databases in many disparate formats. As you develop your own database loaders, follow the source code examples in any of the `libpfd` loaders. Then you will be able to load your data into any OpenGL Performer application. You will not need to rebuild `perfly` or other applications to view your databases.

Database Loading Details

Details about the database loading process are described further in this section, the `pfdLoadFile` man page, and the source code which is in `/usr/share/Performer/src/lib/libpfd/pfdLoadFile.c` on IRIX and Linux and in `%PFROOT%\Src\lib\libpfd\pfdLoadFile.c` on Microsoft Windows.

The routines **pdfInitConverter()**, **pdfLoadFile()**, **pdfStoreFile()**, **pdfConvertFrom()**, and **pdfConvertTo()** exist only as a level of indirection to allow you to manipulate all databases regardless of format through a central API. They are in fact merely a mechanism for creating an open environment for data sharing among the multitudes of three-dimensional database formats. Each of these routines determines, using file-type extensions, which database converter to load as a run-time DSO. The routine then calls the appropriate functionality from that converter's DSO. All converters must provide API that is exactly the same as the corresponding `libpdfdu` API with `_EXT` added to the routine names (for example, for `.medit` files, the suffix is `_medit`). Note that multiple physical extensions can be mapped to one converter extension with calls to **pdfAddExtAlias()**. Several aliases are predefined upon initialization of `libpdfdu`.

It is also important to note that because each of these converters is a unique entity that they each may have state that is important to their proper function. Moreover, their database formats may allow for multiple OpenGL Performer interpretations; so, there exist APIs, shown in Table 7-4, not only to initialize and exit database converters, but also to set and get modes, attributes, and values that might affect the converter's methodology.

Table 7-4 `libpdfdu` Database Converter Management Functions

Function Name	Description
pdfInitConverter()	Initialize a database conversion DSO.
pdfExitConverter()	Exit a database conversion DSO.
pdfConverterMode()	Specify a mode for a specific conversion DSO.
pdfGetConverterMode()	Get a mode setting from a specific conversion DSO.
pdfConverterAttr()	Specify an attribute for a conversion DSO.
pdfGetConverterAttr()	Get an attribute setting from a conversion DSO.
pdfConverterVal()	Specify a value for a conversion DSO.
pdfGetConverterVal()	Get a value setting from a conversion DSO.

Once again each converter provides the equivalent routines with `_EXT` added to the function name.

For example, the converter for the Open Inventor format would define the function **pdfInitConverter_iv()** if it needed to be initialized before it was used. Likewise, it would

define the function **pfdLoadFile_iv()** to read an Open Inventor “.iv” file into an OpenGL Performer scene graph.

Note: Because each converter is an individual entity (DSO) and deals with a particular type of database, it may be the case that a converter will **not** provide all of the functionality listed above, but rather only a subset. For instance, most converters that come with OpenGL Performer only implement their version of **pfdLoadFile** but not **pfdStoreFile**, **pfdConvertFrom**, or **pfdConvertTo**. However, users are free to add this functionality to the converters using compliant APIs and OpenGL Performer’s `libpfd` will immediately recognize this functionality. Also, `libpfd` traps access to nonexistent converter functionality and returns gracefully to the calling code while notifying the user that the functionality could not be found.

Finding and initializing a Converter

When one of the general database converter functions is called, it in turn calls the corresponding routine provided by the converter, passing on the arguments it was given.

But the first time a converter is called, a search occurs to identify the converter and the functions it provides. This is accomplished as follows.

- Parse the extension—what appears after the final “.” in the filename. This is referred to as EXT in the following bulleted items.
- Check to see if any alias was created for the EXT extension with **pfdAddExtAlias()**. If a translation is defined, EXT is replaced with that extension.
- Check the current executable to see if the symbol `pfdLoadFile_EXT` is already defined, that is. if the loader was statically linked into the executable or a DSO was previously loaded by some other mechanism. If not, the search continues.

For IRIX and Linux:

- Generate a DSO library name to search for using the extension prototype “`libpfdEXT_{-g,}.so`”. This means the following strings will be constructed:

`libpfdEXT_.so` for the optimized OpenGL loader

`libpfdEXT_-g.so` for the debug OpenGL loader

- Look for the DSO in several places, including the following:

·
`$PFLD_LIBRARY_PATH`

```
$LD_LIBRARY_PATH
$PFHOME/usr/lib{,32,64}/libpfd
$PFHOME/usr/share/Performer/lib/libpfd
```

- Open the DSO using **dlopen()**.

For Microsoft Windows:

- Generate a DLL library name to search for using the extension prototype “libpfdEXT_{-g,.so}”. This means the following strings will be constructed:

libpfdEXT_.so for the optimized OpenGL loader

libpfdEXT_-g.so for the debug OpenGL loader

- Look for the DLL in several places, including the following:

```
.
$PF_LD_LIBRARY_PATH
$LD_LIBRARY_PATH
$PFHOME/Lib/libpfd
$PFHOME/Lib/Debug/libpfd
```

- Open the DLL using **LoadLibrary()**.
- Once the object has been found, processing continues.
 - Query all libpfd converter functionality from the symbol table of the DSO using **dlsym()** on IRIX and Linux and of the DLL using **GetProcAddress()** on Microsoft Windows with function names generated by appending **_EXT** to the name of the corresponding pfd routine name. This symbol dictionary is retained for future use.
 - Invoke the converter’s initialization function, **pfdInitConverter_EXT()**, if it exists.
 - Invoke **pfdLoadNeededDSOs_EXT()** if it exists. This routine can then recursively call **pfdInitConverter_EXT()**, as needed.

Developing Custom Importers

Having fully described how database converters can be integrated into OpenGL Performer and the types of functionality they provide, the next undertaking is actually implementing a converter from scratch. OpenGL Performer makes a great effort at allowing the quick and easy development of effective and efficient database converters.

While creating a new file loader for OpenGL Performer is not inherently difficult, it does require a solid understanding of the following issues:

- The structure and interpretation of the data file to be read
- The scene graph concepts and nodes of `libpf`
- The geometry and attribute definition objects of `libpr`

Structure and Interpretation of the Database File Format

In order to effectively convert a database into an OpenGL Performer scene graph, it is important to have a substantial understanding of several concepts related to the original database format:

- The parsing of the file based on the database format
- The data types represented in the format and their OpenGL Performer correspondence
- The scene graph structure of the file (if any)
- The method of graphics state definition and inheritance defined in the format

Before trying to convert sophisticated 3D database formats into OpenGL Performer it is important to have a thorough grasp of how every structure in the format needs to affect how OpenGL Performer performs its run-time management of a scene graph. However, although it requires a great deal of understanding to convert complex behaviors of external formats into OpenGL Performer, it is still very straight forward to migrate basic structure, geometry, and graphics state into efficient OpenGL Performer run-time structures using the functionality provided in the OpenGL Performer database builder, `pfdBuilder`.

Scene Graph Creation Using Nodes as Defined in `libpf`

Creating an OpenGL Performer scene graph requires a definite knowledge of the following OpenGL Performer `libpf` node types: `pfScene`, `pfGroup`, and `pfGeode`.

These nodes can be used to define a minimally functional OpenGL Performer scene graph. See “Nodes” in Chapter 3 for more details on `libpf` and OpenGL Performer scene graphs and node types.

Defining Geometry and Graphics State for `libpr`

In order to input geometry and graphics into OpenGL Performer, it is important to have an understanding of how OpenGL Performer's low-level rendering objects work in `libpr`, OpenGL Performer's performance rendering library. The main `libpr` rendering primitives are a `pfGeoSet` and a `pfGeoState`. A `pfGeoSet` is a collection of like geometric primitives that can all be rendered in exactly the same way in one large continuous chunk. A `pfGeoState` is a complete definition of graphics mode settings for the rendering hardware and software. It contains many attributes such as texture and material. Given a `pfGeoSet` and a corresponding `pfGeoState`, `libpr` can completely and efficiently render all of the geometry in the `pfGeoSet`. For a more detailed description of `pfGeoSets` and `pfGeoStates`, see "pfGeoSets and pfGeoStates" in Chapter 12, which goes into detail on all `libpr` primitives and how OpenGL Performer will use them.

However, realizing that OpenGL Performer's structuring of geometry and graphics state is optimized for rendering speed and not for modeling ease or general conceptual partitioning, OpenGL Performer now contains a new mechanism for translating external graphics state and geometry into efficient `libpr` structures. This new mechanism is the `pfdBuilder` that exists in `libpfdu`.

The `pfdBuilder` allows the immediate mode input of graphics state and primitives through very simple and exposed data structures. After having received all of the relevant information, the `pfdBuilder` builds efficient and somewhat optimized `libpr` data structures and returns a low-level `libpf` node that can be attached to an OpenGL Performer scene graph. The `pfdBuilder` is the recommended method of importing data from non-OpenGL Performer-based formats into OpenGL Performer.

Creating an OpenGL Performer Database Converter using `libpfdu`

Creating a new format converter is very simple process. More than thirty database loaders are shipped with OpenGL Performer in source code form to serve as practical examples of this process. The loaders read formats that range from trivial to complex and should serve as an instructive starting point for those developing loaders for other formats. These loaders can be found in the directory `/usr/share/Performer/src/lib/libpfdp/libpf*` on IRIX and Linux and in `%PFROOT%\Src\lib\libpfdp\libpf*` on Microsoft Windows.

This section describes the `libpfdu` framework for creating a 3D database format converter. Consider writing a converter for a simple ASCII format that is called the Imaginary Immediate Mode format with the file type extension `.iim`. This format is

much like the more elaborate `.im` format loader used at SGI for the purposes of testing basic OpenGL Performer functionality.

The first thing to do is set up the routine that `pfLoadFile()` will call when it attempts to load a file with the extension `.iim`.

```

#ifdef WIN32
#define PFDB_DLLEXPOT __declspec(dllexport)
#else
#define PFDB_DLLEXPOT /* no-op */
#endif

extern PFDB_DLLEXPOT pfNode *pfLoadFile_iim(char *fileName)
{
}

```

This function needs to perform several basic actions:

1. Find and open the given file.
2. Reset the `libpfdu` `pfBuilder` for input of new geometry and state.
3. Set up any `pfBuilder` modes that the converter needs enabled.
4. Set up local data structures that can be used to communicate geometry and graphics state with the `pfBuilder`.
5. Set up a `libpf` `pfGroup` which can hold all of the logical partitions of geometry in the file (or hold a subordinate collection of nodes as a general scene graph if the format supports it).
6. Optionally set up a default state to use for geometry with unspecified graphics state.
7. Parse the file, which entails the following:
 - Filling in the local geometry and graphics state data structures
 - Passing them to the `pfBuilder` as inputted from the file
 - Asking the `pfBuilder` to build the data structures into OpenGL Performer data structures when a logical partition of the file has ended
 - Attaching the OpenGL Performer node returned by the build to the higher-level group which will hold the entire OpenGL Performer representation of this file. Note that this step becomes more complex if the format supports the notion of hierarchy only in that the appropriate `libpf` nodes must be created and attached to each other using `pfAddChild()` to build the hierarchy. In this case

requests are made for the builder to build after inputting all of the geometry and state found in a particular leaf node in the database.

8. Delete local data structures used to input geometry and graphics state.
9. Close the file.
10. Perform any optional optimization of the OpenGL Performer scene graph. Optimizations might include calls to **pfdFreezeTransforms()**, **pfFlatten()** or **pfCleanTree()**.
11. Return the **pfGroup** containing the entire OpenGL Performer representation of the database file.

Steps 1-8 expand the function outline to the following:

```
extern PFDB_DLLEXPORT pfNode *pfdLoadFile_iim(char *fileName)
{
    FILE* iimFile;
    pfdGeom* polygon;
    pfGroup* root;

    /* Performer has utility for finding and opening file */
    if ((iimFile = pfdOpenFile(fileName)) == NULL)
        return NULL;

    /* Clear builder from previous converter invocations */
    pfdResetBldrGeometry();
    pfdResetBldrState();

    /* Call pfdBldrMode for any needed modes here */

    /* Create polygon structure */
    /* holds one N-sided polygon where N is < 300 */
    polygon = pfdNewGeom(300);

    /* Create pfGroup to hold entire database */
    /* loaded from this file */
    root = pfNewGroup();

    /* Specify state for geometry with no graphics state */
    /* As well as default enables, etc. This routine */
    /* should invoke pfdCaptureDefaultBldrState()*/
    SetupDefaultGraphicsStateIfThereIsOne();

    /* Do all the real work in parsing the file and */
```



```

/* converting into Performer */
ParseIIMFile(iimFile, root, polygon);

/* Delete local polygon struct */
pfdDelGeom(polygon);

/* Close File */
fclose(iimFile);

/* Optimize OpenGL Performer scene graph */
/* via use of pfFlatten, pfdCleanTree, etc. */
OptimizeGraph(root);

return (pfNode*)root;
}

```

At the heart of the file loader lies the **ParseIIMFile()** function. The specifics of parsing a file are completely dependent on the format; so, the parsing will be left as an exercise to you. However, the following code fragments should show a framework for what goes into integrating the parser with the pfdBuilder framework for geometry and graphics state data conversion. Note that several possible graphics state inheritance models might be used in external formats and that the pfdBuilder is designed to support all of them:

- The default pfdBuilder state inheritance is that of immediate mode graphics state. Immediate mode state is specified through calls to **pfdBldrStateMode()**, **pfdBldrStateAttr()**, and **pfdBldrStateVal()**.
- There also exists a pfdBuilder state stack for hierarchical state application to geometry. This is accomplished through the use of **pfdPushBldrState()** and **pfdPopBldrState()** in conjunction with the normal use of the immediate mode pfdBuilder state API.
- Lastly, there is a pfdBuilder named state list that can be used to define a number of "named materials" or "named state definitions" that can then be recalled in one API called (for instance, you might define a "brick" state with a red material and a brick texture. Later you might just want to say "brick" is the current state and then input the walls of several buildings). This type of state naming is accomplished by fully specifying the state to be named using the immediate mode API and then calling **pfdSaveBldrState()**. This state can then be recalled using **pfdLoadBldrState()**.

```

ParseIIMFile(FILE *iimFile, pfGroup *root, pfdGeom *poly)
{
    while((op = GetNextOp(iimFile)) != NULL)
    {
        switch(op)

```

```
{
case GEOMETRY_POLYGON:
    polygon->numVerts = GetNumVerts(iimFile);

    /* Determine if polygon has Texture Coords */
    if (pfdGetBldrStateMode(PFSTATE_ENTEXTURE)==PF_ON)
        polygon->tbind = PFGS_PER_VERTEX;
    else
        polygon->tbind = PFGS_OFF;

    /* Determine if Polygon has normals */
    if (AreThereNormalsPerVertex() == TRUE)
        polygon->nbind = PFGS_PER_VERTEX;
    else if
        (pfdGetBldrStateMode(PFSTATE_ENLIGHTING)==PF_ON)
        polygon->nbind = PFGS_PER_PRIM;
    else
        polygon->nbind = PFGS_OFF;

    /* Determine if Polygon has colors */
    if (AreThereColorsPerVertex() == TRUE)
        polygon->cbind = PFGS_PER_VERTEX;
    else if (AreThereColorsPerPrim() == TRUE)
        polygon->cbind = PFGS_PER_PRIM;
    else
        polygon->cbind = PFGS_OFF;
    for(i=0;i<polygon->numVerts;i++)
    {
        /* Read ith Vertex into local data structure */
        polygon->coords[i][0] = GetNextVertexFloat();
        polygon->coords[i][1] = GetNextVertexFloat();
        polygon->coords[i][2] = GetNextVertexFloat();

        /* Read texture coord for ith vertex if any */
        if (polygon->tbind == PFGS_PER_VERTEX)
        {
            polygon->texCoords[i][0] = GetNextTexFloat();
            polygon->texCoords[i][1] = GetNextTexFloat();
        }

        /* Read normal for ith Vertex if normals bound*/
        if (polygon->nbind == PFGS_PER_VERTEX)
        {
            polygon->norms[i][0] = GetNextNormFloat();
            polygon->norms[i][1] = GetNextNormFloat();
        }
    }
}
```

```

    polygon->norms[i][2] = GetNextNormFloat();
}
/* Read only one normal per prim if necessary */
else if ((polygon->nbind == PFGS_PER_PRIM) &&
        (i == 0))
{
    polygon->norms[0][0] = GetNextNormFloat();
    polygon->norms[0][1] = GetNextNormFloat();
    polygon->norms[0][2] = GetNextNormFloat();
}

/* Get Color for the ith Vertex if color bound*/
if (polygon->cbind == PFGS_PER_VERTEX)
{
    polygon->colors[i][0] =
        GetNextColorFloat();
    polygon->colors[i][1] =
        GetNextColorFloat();
    polygon->colors[i][2] =
        GetNextColorFloat();
}
/* Get one color per prim if necessary */
else if ((polygon->cbind == PFGS_PER_PRIM) &&
        (i == 0))
{
    polygon->colors[0][0] =
        GetNextColorFloat();
    polygon->colors[0][1] =
        GetNextColorFloat();
    polygon->colors[0][2] =
        GetNextColorFloat();
}
}
/* Add this polygon to pfdBuilder */
/* Because it is a single poly, 1 */
/* is specified here */
pfdAddBldrGeom(1);
break;
case GRAPHICS_STATE_TEXTURE:
{
    char *texName;
    pfTexture *tex;
    texName = ReadTextureName(iimFile);
    if (texName != NULL)
    {

```

```
        /* Get prototype tex from pfdBuilder*/
        tex =
            pfdGetTemplateObject(pfGetTexClassType());

        /* This clears that object to default */
        pfdResetObject(tex);

        /* If just the name of a pfTexture is */
        /* set, pfdBuilder will auto find & Load */
        /* the texture*/
        pfTexName(tex, texName);

        /* This is the current pfdBuilder */
        /* texture and texturing is on */
        pfdBldrStateAttr(PFSTATE_TEXTURE, tex);
        pfdBldrStateMode(PFSTATE_ENTEXTURE, PF_ON);
    }
    else
    {
        /* No texture means disable texturing */
        /* And set current texture to NULL */
        pfdBldrStateMode(PFSTATE_ENTEXTURE, PF_OFF);
        pfdBldrStateAttr(PFSTATE_TEXTURE, NULL);
    }
}
break;
case GRAPHICS_STATE_MATERIAL:
{
    pfMaterial *mtl;
    mtl = pfdGetTemplateObject(pfGetMtlClassType());
    pfdResetObject(mtl);
    pfMtlColor(mtl, PFMTL_AMBIENT,
        GetAmRed(), GetAmGreen(), GetAmBlue());
    pfMtlColor(mtl, PFMTL_DIFFUSE,
        GetDfRed(), GetDfGreen(), GetDfBlue());
    pfMtlColor(mtl, PFMTL_SPECULAR,
        GetSpRed(), GetSpGreen(), GetSpBlue());
    pfMtlShininess(mtl, GetMtlShininess());
    pfMtlAlpha(mtl, GetMtlAlpha());
    pfdBldrStateAttr(PFSTATE_FRONTMTL, mtl);
    pfdBldrStateAttr(PFSTATE_BACKMTL, mtl);
}
break;
case GRAPHICS_STATE_STORE:
    pfdSaveBldrState(GetStateName());
```

```

        break;
    case GRAPHICS_STATE_LOAD:
        pfdLoadBldrState(GetStateName());
        break;
    case GRAPHICS_STATE_PUSH:
        pfdPushBldrState();
        break;
    case GRAPHICS_STATE_POP:
        pfdPopBldrState();
        break;
    case GRAPHICS_STATE_RESET:
        pfdResetBldrState();
        break;
    case GRAPHICS_STATE_CAPTURE_DEFAULT:
        pfdCaptureDefaultBldrState();
        break;
    case BEGIN_LEAF_NODE:
        /* Not really necessary because it is */
        /* destroyed on build*/
        pfdResetBldrGeometry();
        break;
    case END_LEAF_NODE:
        {
            pfNode *nd = pfdBuild();
            if (nd != NULL)
                pfAddChild(root,nd);
        }
        break;
    }
}
}

```

One of the fundamental structures involved in the above routine outline is the `pfGeom` structure which you fill in with information about a single primitive, or a single strip of primitives. The `pfGeom` structure is essential in communicating with the `pfBuilder` and is defined as follows:

```

typedef struct _pfGeom
{
    int         flags;
    int         nbind, cbind, tbind[PF_MAX_TEXTURES];

    int         numVerts;
    short       primtype;
    float       pixelsize;
}

```

```
/* Non-indexed attributes - do not set if poly is indexed */
pfVec3      *coords;
pfVec3      *norms;
pfVec4      *colors;
pfVec2      *texCoords[PF_MAX_TEXTURES];

/* Indexed attributes - do not set if poly is non-indexed */
pfVec3      *coordList;
pfVec3      *normList;
pfVec4      *colorList;
pfVec2      *texCoordList[PF_MAX_TEXTURES];

/* Index lists - do not set if poly is non-indexed */
ushort      *icoords;
ushort      *inorms;
ushort      *icolors;
ushort      *itexCoords[PF_MAX_TEXTURES];

int          numTextures;

struct _pfdGeom      *next;
} pfdGeom;
```

See the `pfdGeoBuilder(3pf)` man pages for more information on using this structure along with its sister structure, the `pfdPrim`.

The above should provide a well-defined framework for creating a database converter that can be used with any OpenGL Performer applications using the `pfdLoadFile()` functionality.

However, it is also important to note that there are a multitude of `pfdBuilder` modes and attributes that can be used to affect some of the basic methods that the builder actually uses:

Table 7-5 pfdBuilder Modes and Attributes

Function Name	Token Description
pfd{Get}BlDrMode()	PFDBLDR_MESH_ENABLE
	PFDBLDR_MESH_SHOW_TSTRIPS
	PFDBLDR_MESH_INDEXED
	PFDBLDR_MESH_MAX_TRIS
	PFDBLDR_MESH_RETESSELLATE
	PFDBLDR_MESH_LOCAL_LIGHTING
	PFDBLDR_AUTO_COLORS
	PFDBLDR_AUTO_NORMALS
	PFDBLDR_AUTO_ORIENT
	PFDBLDR_AUTO_ENABLES
	PFDBLDR_AUTO_CMODE
	PFDBLDR_AUTO_DISABLE_TCOORDS_BY_STATE
	PFDBLDR_AUTO_DISABLE_NCOORDS_BY_STATE
	PFDBLDR_AUTO_LIGHTING_STATE_BY_NCOORDS
	PFDBLDR_AUTO_LIGHTING_STATE_BY_MATERIALS
	PFDBLDR_AUTO_TEXTURE_STATE_BY_TEXTURES
	PFDBLDR_AUTO_TEXTURE_STATE_BY_TCOORDS
	PFDBLDR_BREAKUP
	PFDBLDR_BREAKUP_SIZE
	PFDBLDR_BREAKUP_BRANCH
	PFDBLDR_BREAKUP_STRIP_LENGTH
	PFDBLDR_SHARE_MASK
PFDBLDR_ATTACH_NODE_NAMES	

Table 7-5 pfdBuilder Modes and Attributes (continued)

Function Name	Token Description
	PFDBLDR_DESTROY_DATA_UPON_BUILD
	PFDBLDR_PF12_STATE_COMPATIBLE
	PFDBLDR_BUILD_LIMIT
	PFDBLDR_GEN_OPENGL_CLAMPED_TEXTURE_COORDS
	PFDBLDR_OPTIMIZE_COUNTS_NULL_ATTRS
pfd{Get}BldrAttr()	PFDBLDR_NODE_NAME_COMPARE
	PFDBLDR_STATE_NAME_COMPARE

Because the pfdBuilder is released as source code, it is easy to add further functionality and more modes and attributes to even further customize this central functionality.

In fact, because the pfdBuilder acts as a “data funnel” in converting data into OpenGL Performer run-time structures, it is easy to control the behavior of many standard conversion tasks through merely globally setting builder modes which will subsequently affect all converters that use the pfdBuilder to process their data.

Maximizing Database Loading and Paging Performance with PFB and PFI Formats

“Description of Supported Formats” on page 244 describes all of the file formats supported by OpenGL Performer. Although you can use files in these formats directly, you can dramatically reduce database loading time by preconverting databases into the PFB format and images into the PFI format.

To convert to the PFB file format or the PFI image format, use the `pfconv` and `pficonv` utilities.

`pfconv`

The `pfconv` utility converts from any format for which a `pfdLoadFile...()` function exists into any format for which a `pfdStoreFile...()` exists. The most common format to convert

to is the PFB format. For example, to convert `cow.obj` into the PFB format, use the following command:

```
% pfconv cow.obj cow.pfb
```

By default, `pfconv` optimizes the scene graph when doing the conversion. The optimizations are controlled with the `-o` and `-O` command line options. Builder options are controlled with the `-b` and `-B` command line options. Converter modes are controlled with the `-m` and `-M` command line options. Refer to the help page for more specific information about the command line options by entering:

```
% pfconv -h
```

Example Conversion

When converting to the PFB format, texture files can be converted to the PFI format using the following command line options:

```
% pfconv -M pfb, 5, 1
```

5 means `PFPFB_SAVE_TEXTURE_PFI`.

1 means convert `.rgb` texture images to `.pfi`.

`pficonv`

The `pficonv` utility converts from IRIS libimage format to PFI format image files. For example, to convert `cafe.rgb` into the PFI format, use the following command:

```
% pficonv cafe.rgb cafe.pfi
```

MIPmaps can be automatically generated and stored in the resulting PFI files by adding `-m` to the command line.

Supported Database Formats

Vendors of several leading database construction and processing tools have provided database-loading software for you to use with OpenGL Performer. This section describes these loaders, the loaders developed by the OpenGL Performer engineering team and

several loaders developed in the OpenGL Performer user community for other database formats.

Importing your databases is simple if they are in formats for which OpenGL Performer database loaders have already been written. Each of the loaders listed in Table 7-6 is included with OpenGL Performer. If you want to import or export databases in any of these formats, refer to the appropriate section of this chapter for specific details about the individual loaders.

Table 7-6 Supported Database Formats

Name	Description
3ds	AutoDesk 3DStudio binary data
bin	SGI format used by <code>powerflip</code>
bpoly	Side Effects Software PRISMS binary data
byu	Brigham Young University CAD/FEA data
csb	OpenGL Optimizer Format
ct	Cliptexture config file loader - auto-generates viewing geometry
dwb	Coryphaeus Software Designer's Workbench data
dxg	AutoDesk AutoCAD ASCII format
flt11	MultiGen public domain Flight v11 format
flt	MultiGen OpenFlight format provided by MultiGen
gds	McDonnell-Douglas GDS things data
gfo	Old SGI radiosity data format
im	Simple OpenGL Performer data format
irtp	AAI/Graphicon Interactive Real-Time PHIGS
iv	SGI Open Inventor format (VRML 1.0 superset)
lsa	Lightscape Technologies ASCII radiosity data
lsb	Lightscape Technologies binary radiosity data

Table 7-6 Supported Database Formats **(continued)**

Name	Description
medit	Medit Productions medit modeling data
nff	Eric Haines' ray tracing test data
pfb	OpenGL Performer fast binary format
obj	Wavefront Technologies data format
pegg	Radiosity research data format
phd	SGI polyhedron data format
poly	Side Effects Software PRISMS ASCII data
ptu	Simple OpenGL Performer terrain data format
rpc	ArchVision rich photorealistic content
sgf	US Naval Academy standard graphics format
sgo	Paul Haeberli's graphics data format
spf	US Naval Academy simple polygon format
sponge	Sierpinski sponge 3D fractal generator
star	Astronomical data from Yale University star chart
stla	3D Structures ASCII stereolithography data
stlb	3D Structures binary stereolithography data
stm	Michael Garland's terrain data format
sv	John Kichury's i3dm modeler format
tri	University of Minnesota Geometry Center data
unc	University of North Carolina walkthrough data
wrl	OpenWorlds VMRL 2.0 provided by DRaW Computing

Description of Supported Formats

This section describes the different database file formats that OpenGL Performer supports.

AutoDesk 3DS Format

The AutoDesk 3DS format is used by the 3DStudio program and by a number of 3D file-interchange tools. The OpenGL Performer loader for 3DS files is located in the directory `/usr/share/Performer/src/lib/libpfdp/libpf3ds` on IRIX and Linux and in `%PFROOT%\Src\lib\libpfdp\libpf3ds` on Microsoft Windows. This loader uses an auxiliary library, `3dsftk.a`, to parse and interpret the 3ds file.

`pfdLoadFile()` uses the function `pfdLoadFile_3ds()` to import data from 3DStudio files into OpenGL Performer run-time data structures.

SGI BIN Format

The SGI BIN format is supported by both Showcase and the `powerflip` demonstration program. BIN files are in a simple format that specifies only independent quadrilaterals.

The image in Figure 7-1 shows several of the BIN-format objects provided in the OpenGL Performer sample data directory.

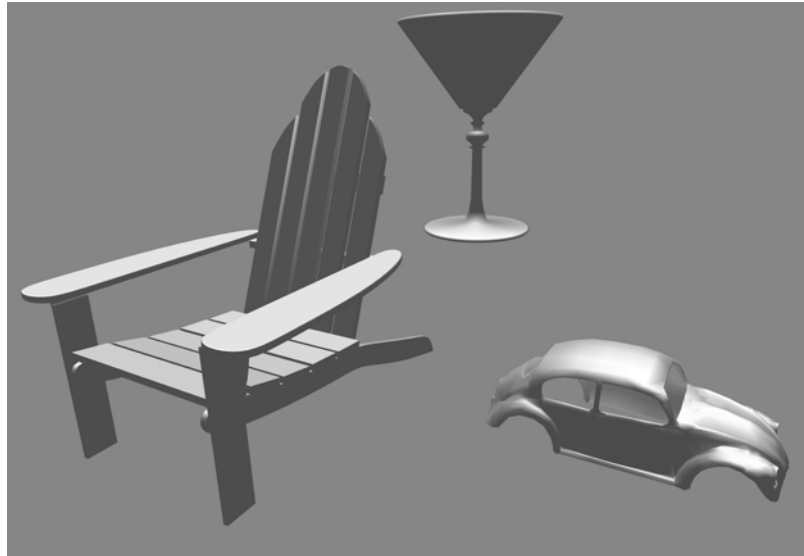

Figure 7-1 BIN-Format Data Objects

The source code for the BIN-format importer **pfLoadFile_bin()** is provided in the file `pfbin.c`. This code shows how easy it can be to implement an importer. Since **pfLoadFile_bin()** is based on the **pfBuilder()** utility function, it will build efficient triangle-strip `pfGeoSets` from the quadrilaterals of a given BIN file. The BIN format has the following structure:

1. A 4-byte magic number, `0x5432`, which identifies the file as a BIN file.
2. A 4-byte number that contains the number of vertices, which is four times the number of quadrilaterals.
3. Four bytes of zero.
4. A list of polygon data for each vertex in the object. The data consists of three floating-point words of information about normals followed by three floating-point words of vertex information.

The BIN format uses these data structures:

```
typedef struct
{
    float normal[3];
    float coordinate[3];
```

```
    } Vertex;  
  
typedef struct  
{  
    long magic;  
    long vertices;  
    long zero;  
    Vertex vertex[1];  
} BinFile;
```

pdfLoadFile() uses the function **pdfLoadFile_bin()** to import data from BIN format files into OpenGL Performer run-time data structures:

The **pdfLoadFile_bin()** function composes a random color for each file it reads. The chosen color has red, green, and blue components uniformly distributed within the range 0.2 to 0.7 and is fully opaque.

Side Effects POLY Format

The Side Effects software PRISMS database modeler format supports both ASCII and binary forms of the POLY format. The OpenGL Performer loader for ASCII “.poly” files is located in the directory

/usr/share/Performer/src/lib/libpfdB/libpfpoly for IRIX and Linux and in %PFROOT%\Src\lib\libpfdB\libpfpoly for Microsoft Windows. The binary format “.bpoly” loader is located in the directory

/usr/share/Performer/src/lib/libpfdB/libpfbpoly for IRIX and Linux and in %PFROOT%\Src\lib\libpfdB\libpfbpoly for Microsoft Windows. These formats are equivalent in content and differ only in representation.

The POLY format is an easy to understand ASCII data representation with the following structure:

1. A text line containing the keyword “POINTS”
2. One text line for each vertex in the file. Each line begins with a vertex number, followed by a colon, followed by the X, Y, and Z axis coordinates of the vertex, optional additional information, and a new-line character. The optional information includes color specification in the form “c(R,G,B,A)”, a normal vector of the form “n(NX,NY,NZ)”, or a texture coordinate in the form “uv(S,T)” where each of the values shown are floating point numbers.
3. A text line containing the keyword “POLYS”

4. One text line for each polygon in the file. Each line begins with a polygon number, followed by a colon, followed by a series of vertex indices, optional additional information, an optional "<" character, and a new-line. The optional information includes color specification in the form "c(R,G,B,A)", a normal vector of the form "n(NX,NY,NZ)", or a texture coordinate in the form "uv(S,T)" where the values in parentheses are floating point numbers.

Here is a sample POLY format file for a cube with colors, texture coordinates, and normals specified at each vertex:

```
POINTS
1: -0.5 -0.5 -0.5 c(0, 0, 0, 1) uv(0, 0) n(0, -1, 0)
2: -0.5 -0.5 0.5 c(0, 0, 1, 1) uv(0, 0) n(0, -1, 0)
3: 0.5 -0.5 0.5 c(1, 0, 1, 1) uv(1, 0) n(0, -1, 0)
4: 0.5 -0.5 -0.5 c(1, 0, 0, 1) uv(1, 0) n(0, -1, 0)
5: -0.5 -0.5 0.5 c(0, 0, 1, 1) uv(0, 0) n(0, 0, 1)
6: -0.5 0.5 0.5 c(0, 1, 1, 1) uv(0, 1) n(0, 0, 1)
7: 0.5 0.5 0.5 c(1, 1, 1, 1) uv(1, 1) n(0, 0, 1)
8: 0.5 -0.5 0.5 c(1, 0, 1, 1) uv(1, 0) n(0, 0, 1)
9: -0.5 0.5 0.5 c(0, 1, 1, 1) uv(0, 1) n(0, 1, 0)
10: -0.5 0.5 -0.5 c(0, 1, 0, 1) uv(0, 1) n(0, 1, 0)
11: 0.5 0.5 -0.5 c(1, 1, 0, 1) uv(1, 1) n(0, 1, 0)
12: 0.5 0.5 0.5 c(1, 1, 1, 1) uv(1, 1) n(0, 1, 0)
13: -0.5 -0.5 -0.5 c(0, 0, 0, 1) uv(0, 0) n(0, 0, -1)
14: 0.5 -0.5 -0.5 c(1, 0, 0, 1) uv(1, 0) n(0, 0, -1)
15: 0.5 0.5 -0.5 c(1, 1, 0, 1) uv(1, 1) n(0, 0, -1)
16: -0.5 0.5 -0.5 c(0, 1, 0, 1) uv(0, 1) n(0, 0, -1)
17: -0.5 -0.5 -0.5 c(0, 0, 0, 1) uv(0, 0) n(-1, 0, 0)
18: -0.5 0.5 -0.5 c(0, 1, 0, 1) uv(0, 1) n(-1, 0, 0)
19: -0.5 0.5 0.5 c(0, 1, 1, 1) uv(0, 1) n(-1, 0, 0)
20: -0.5 -0.5 0.5 c(0, 0, 1, 1) uv(0, 0) n(-1, 0, 0)
21: 0.5 0.5 0.5 c(1, 1, 1, 1) uv(1, 1) n(1, 0, 0)
22: 0.5 0.5 -0.5 c(1, 1, 0, 1) uv(1, 1) n(1, 0, 0)
23: 0.5 -0.5 -0.5 c(1, 0, 0, 1) uv(1, 0) n(1, 0, 0)
24: 0.5 -0.5 0.5 c(1, 0, 1, 1) uv(1, 0) n(1, 0, 0)
POLYS
1: 1 2 3 4 <
2: 5 6 7 8 <
3: 9 10 11 12 <
4: 13 14 15 16 <
5: 17 18 19 20 <
6: 21 22 23 24 <
```

pfdLoadFile() uses the functions **pfdLoadFile_poly()** and **pfdLoadFile_bpoly()** to import data from “.poly” and “.bpoly” format files into OpenGL Performer run-time data structures.

Brigham Young University BYU Format

The Brigham Young University “.byu” format is used as an interchange format by some finite element analysis packages. The OpenGL Performer loader for “.byu” files is located in the directory /usr/share/Performer/src/lib/libpfd/libpfdbyu for IRIX and Linux and in %PFROOT%\Src\lib\libpfd\libpfdbyu for Microsoft Windows.

The format of a BYU file consists of four parts as defined below:

1. A text line containing four counts: the number of `parts`, the number of `vertices`, the number of `polygons`, and the number of `elements` in the connectivity array.
2. The part definition list, containing the starting polygon number and ending polygon number (one pair per line) for `parts` lines.
3. The vertex list, which has the X, Y, Z coordinates of each vertex in the database packed two per line. This means that vertices 1 and 2 are on the first line, 3 and 4 are on the second, and so on for $(\text{vertices} + 1)/2$ lines of text in the file.
4. The connectivity array, with an entry for each polygon. These entries may span multiple lines in the input file and each consists of three or more vertex indices with the last negated as an end of list flag. For example, if the first polygon were a quad, the connectivity array might start with “1 2 3 -4” to define a polygon that connects the first four vertices in order.

The following BYU format file defines two adjoining quads:

```
2 6 2 0
1 1
2 2
0 0 0 10 0 0
10 10 0 0 10 0
10 10 10 0 10 10
1 2 3 -4
4 3 5 -6
```

pfdLoadFile() uses the function **pfdLoadFile_byu()** to import data from “.byu” format files into OpenGL Performer run-time data structures.

Optimizer CSB Format

OpenGL Performer can load native OpenGL Optimizer format files using this loader. OpenGL Optimizer can also load OpenGL Performer's PFB native format files, providing full database interoperability. This allows you to use OpenGL Optimizer database simplification and optimization tools on OpenGL Performer databases.

Virtual Cliptexture CT Loader

The OpenGL Performer CT loader allows you to create and configure cliptextures and virtual cliptextures, complete with a scene graph containing simple geometry and callbacks. See the Cliptexture chapter for more details.

Designer's Workbench DWB Format

The binary DWB format is used for input and output by the Designer's Workbench, EasyT, and EasyScene database modeling tools produced by Coryphaeus Software. DWB is an advanced database format that directly represents many of OpenGL Performer's attribute and hierarchical scene graph concepts.

An importer for this format, named `pfdLoadFile_dwb()`, has been provided by Coryphaeus Software for your use. The loader code and its associated documentation are in the directory `/usr/share/Performer/src/lib/libpfdb/libpfdwb` for IRIX and Linux and in `%PFROOT%\Src\lib\libpfdb\libpfdwb` for Microsoft Windows. The image in Figure 7-2 shows a model of the Soma Cube puzzle invented by Piet Hein. The model was created using Designer's Workbench. Each of the pieces is stored as an individual DWB-format file. Do you see how to form the 3 x 3 cube at the lower left from the seven individual pieces?

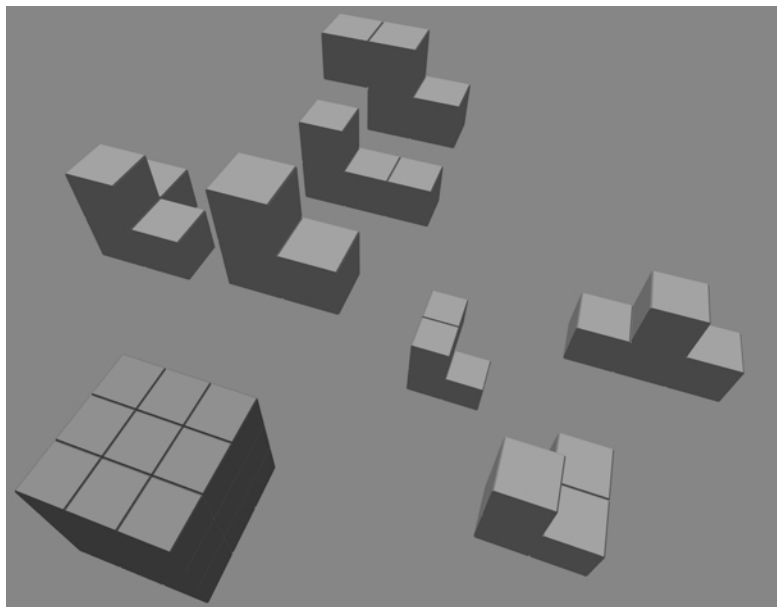

Figure 7-2 Soma Cube Puzzle in DWB Form

pdfLoadFile() uses the function **pdfLoadFile_dwb()** to load Designer's Workbench files into OpenGL Performer run-time data structures.

AutoCAD DXF Format

The DXF format originated with Autodesk's AutoCAD database modeling system. The version recognized by the **pdfLoadFile_dxf()** database importer is a subset of ASCII Drawing Interchange Format (DXF) Release 12. The binary version of the DXF format, also known as DXB, is not supported. Source code for the importer is in the file `/usr/share/Performer/src/lib/libpfdw/libpfdxf/pfdxf.c` for IRIX and Linux and in `%PFROOT%\Src\lib\libpfdw\libpfdxf\pfdxf.c` for Microsoft Windows. **pdfLoadFile_dxf()** was derived from the DXF-to-DKB data file converter developed and placed in the public domain by Aaron A. Collins.

The image in Figure 7-3 shows a DXF model of the famous Utah teapot. This model was loaded from DXF format using the **pdfLoadFile_dxf()** database importer.



Figure 7-3 The Famous Teapot in DXF Form

The DXF format has an unusual though well-documented structure. The general organization of a DXF file is the following:

1. HEADER section with general information about the file
2. TABLES section to provide definitions for named items, including:
 - LTYPE, the line-type table
 - LAYER, the layer table
 - STYLE, the text-style table
 - VIEW, the view table
 - UCS, the user coordinate-system table
 - VPORT, the viewport configuration table
 - DIMSTYLE, the dimension style table
 - APPID, the application identification table

3. BLOCKS section containing block definition entities
4. ENTITIES section containing entities and block references
5. END-OF-FILE

Within each section are groups of values, where each value is defined by a two-line pair of tokens. The first token is a numeric code indicating how to interpret the information on the next line. For example, the sequence

```
10
1.000
20
5.000
30
3.000
```

defines a “start point” at the XYZ location (1, 5, 3). The codes 10, 20, and 30 indicate, respectively, that the primary X, Y, and Z values follow. All data values are retained in a set of numbered registers (10, 20, and 30 in this example), which allows values to be reused. This simple state-machine type of run-length coding makes DXF files space-efficient at the cost of making them harder to interpret.

pdfLoadFile() uses the function **pdfLoadFile_dxf()** to load DXF format files into OpenGL Performer run-time data structures.

Several widely available technical books provide full details of this format if you need more information. Chief among these are *AutoCAD Programming, 2nd Edition*, by Dennis N. Jump, Windcrest Books, 1991, and *AutoCAD: The Complete Reference, Second Edition*, by Nelson Johnson, Osborne McGraw-Hill, 1991.

MultiGen OpenFlight Format

The OpenFlight format is a binary format used for input and output by the MultiGen and ModelGen database modeling tools produced by MultiGen. It is a comprehensive format that can represent nearly all of OpenGL Performer’s advanced concepts, including object hierarchy, instancing, level-of-detail selection, light-point specification, texture mapping, and material property specification.

MultiGen has provided an OpenFlight-format importer, **pdfLoadFile_flt()**, for your use. The loaders and associated documentation are in the directories `/usr/share/Performer/src/lib/libpfdb/libpfflt11` and `libpfflt` for

IRIX and Linux and in %PFROOT%\Src\lib\libpfdb\libpfflt11 and libpfflt for Microsoft Windows. Refer to the Readme files in these directories for important information about the loaders and for help in contacting MultiGen for information about **pfdLoadFile_flt()** or the OpenFlight format.

The image in Figure 7-4 shows a model of a spacecraft created by Viewpoint Animation Engineering using MultiGen. This OpenFlight format model was loaded into OpenGL Performer using **pfdLoadFile_flt()**.

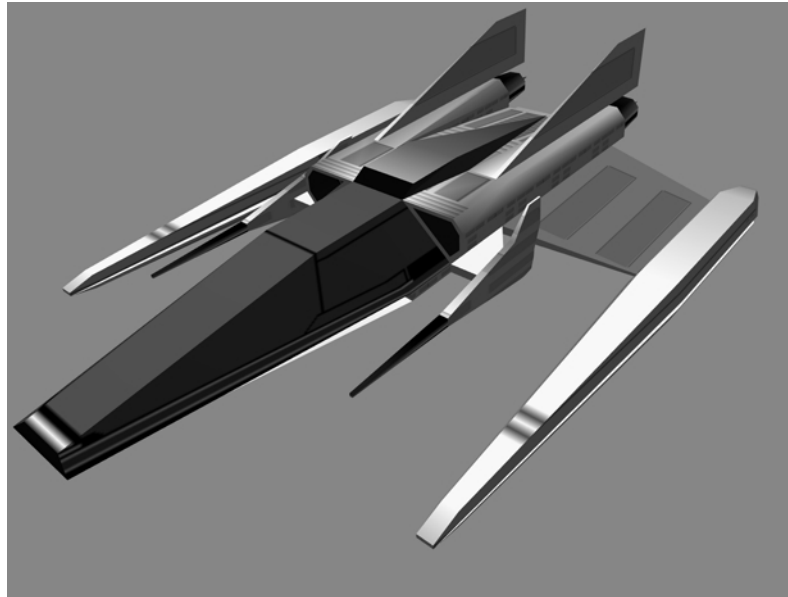

Figure 7-4 Spacecraft Model in OpenFlight Format

pfdLoadFile() uses the function **pfdLoadFile_flt()** to load OpenFlight format files into OpenGL Performer run-time data structures.

Files in the OpenFlight format are structured as a linear sequence of records. The first few bytes of each record are a header containing an op-code, the length of the record, and possibly an ASCII name for the record. The first record in the file is a special “database header” record whose op-code, stored as a 2-byte short integer, has the value 1. This op-code header can be used to identify OpenFlight-format files. By convention, these files have a “.flt” filename extension.

pfdLoadFile_flt() makes use of several environment variables when locating data and texture files. These variables and several additional functions, including **pfdConverterMode_flt()**, **pfdGetConverterMode_flt()**, and **pfdConverterAttr_flt()** assist in OpenFlight file processing.

McDonnell-Douglas GDS Format

The “.gds” format (also known as the “Things” format) is used in at least one CAD system, and a minimal loader for this format has been developed for OpenGL Performer users. The OpenGL Performer loader for “.gds” files is located in the directory `/usr/share/Performer/src/lib/libpfd/libpfgds` for IRIX and Linux and in `%PFROOT%\Src\lib\libpfd\libpfgds` for Microsoft Windows.

The GDS format subset accepted by the **pfdLoadFile_gds()** function is easy to describe. It consists of the following five sequential sections in an ASCII file:

1. The number of `vertices`, which is given following a “YIN” tag
2. The vertices, with one X, Y, Z triple per line for `vertices` lines
3. The number zero on a line by itself
4. The number of `polygons` on a line by itself
5. A series of polygon definitions, each of which is represented on two or more lines. The first line contains the number one and the name of a material to use for the polygon. The next line or lines contain the indices for the polygons vertices. The first number on the first line is the number of `vertices`. This is followed by that number of vertex indices on that and possibly subsequent lines.

pfdLoadFile() uses the function **pfdLoadFile_gds()** to load “.gds” format files into IRIS Performer.

SGI GFO Format

The GFO format is the simple ASCII format of the `barcelona` database that is provided in the OpenGL Performer sample database directory. This database represents the famous German Pavilion at the Barcelona Exhibition of 1929, which was designed by Ludwig Mies van der Rohe and is shown in Figure 7-5.

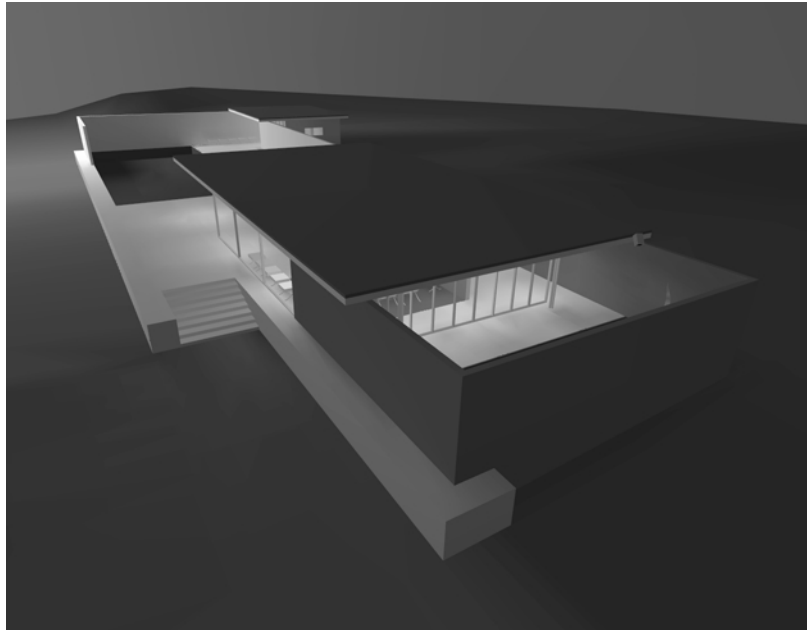

Figure 7-5 GFO Database of Mies van der Rohe's German Pavilion

The source code for the GFO-format loader is provided in the file `/usr/share/Performer/src/lib/libpfdb/libpfgfo/pfgfo.c` for IRIX and Linux and in `%PFROOT%\Src\lib\libpfdb\libpfgfo\pfgfo.c` for Microsoft Windows.

pfdLoadFile() uses the function **pfdLoadFile_gfo()** to load GFO format files into OpenGL Performer run-time data-structures.

When working with GFO files, remember that hardware lighting is not used since all illumination effects have already been accounted for with the ambient color at each vertex.

The GFO format defines polygons with a color at every vertex. It is the output format of an early radiosity system. Files in this format have a simple ASCII structure, as indicated by the following abbreviated GFO file:

```
scope {
v3f {42.9632 8.7500 0.9374}
cpack {0x8785a9}
v3f {42.9632 8.0000 0.9374}
cpack {0x8785a9}
...
v3f {-1.0000 -6.5858 10.0000}
cpack {0xffffffff}
polygon {cpack[0] v3f[0] cpack[1] v3f[1] cpack[2] v3f[2] cpack[3] v3f[3] }
polygon {cpack[4] v3f[4] cpack[5] v3f[5] cpack[6] v3f[6] cpack[7] v3f[7] }
...
polygon {cpack[7330] v3f[7330] cpack[7331] v3f[7331] cpack[7332] v3f[7332]
cpack[7333] v3f[7333] }
instance {
polygon[0]
polygon[1]
...
polygon[2675]
}
}
```

This example is taken from the file `barcelona-1.gfo`, one of only two known databases in the GFO format. The importer uses functions from the `libpfd` library (such as those from the `pfdBuilder`) to generate efficient shared triangle strips. This increases the speed with which GFO databases can be drawn and reduces the size and complexity of the loader, since the builder's functions hide the details of the `pfGeoSet` construction process.

SGI IM Format

The ".im" format is a simple format developed for test purposes by the OpenGL Performer engineering team. As new features are added to OpenGL Performer, the ".im" loader is extended to allow experimentation and testing. A recent example of this is support for `pfText`, `pfString`, and `pfFont` objects which can be seen by running `Perfly` on the sample data file `fontsample.im`. The OpenGL Performer ".im" loader is in the directory `/usr/share/Performer/src/lib/libpfdb/libpfim` for IRIX and Linux and in `%PFROOT%\Src\lib\libpfdb\libpfim` for Microsoft Windows.

Here is an example IM format file that creates an extruded 3D text string. Copy this to a file ending in the extension ".im" and load it into `Perfly`. For a complete example of how text is handled in OpenGL Performer, use `Perfly` to examine the file

`/usr/share/Performer/data/fontsample2.im` on IRIX and Linux and in `%PFROOT%\Data\fontsample2.im` on Microsoft Windows.

```
breakup 0 0.0 0 0
new root top
end_root

new font mistr-extruded Mistr 3
end_font

new str_text textnode mistr-extruded 1
Hello World| |
end_text

attach top textnode
```

pfLoadFile() uses the function **pfLoadFile_im()** to load “.im” format files into OpenGL Performer run-time data structures:

pfLoadFile_im() searches the current OpenGL Performer file path for the named file and returns a pointer to the pfNode parenting the imported scene graph, or NULL if the file is not readable or does not contain a valid database.

AAI/Graphicon IRTP Format

The AAI/Graphicon “.irtp” format is used by the TopGen database modeling system and by the Graphicon-2000 image generator. The name IRTP is an acronym for Interactive Real-Time PHIGS. The OpenGL Performer “.irtp” loader is in the directory `/usr/share/Performer/src/lib/libpfdb/libpfirtp` for IRIX and Linux and in `%PFROOT%\Src\lib\libpfdb\libpfirtp` for Microsoft Windows. Though loader does not support the more arcane IRTP features, such as binary separating planes or a global matrix table, it has served as a basis for porting applications to OpenGL Performer and the RealityEngine.

pfLoadFile() uses the function **pfLoadFile_irtp()** to load IRTP format files into OpenGL Performer run-time data structures.

SGI Open Inventor Format

The Open Inventor object-oriented 3D-graphics toolkit defines a persistent data format that is also a superset of the VRML networked graphics data format. The image in Figure 7-6 shows a sample Open Inventor data file.

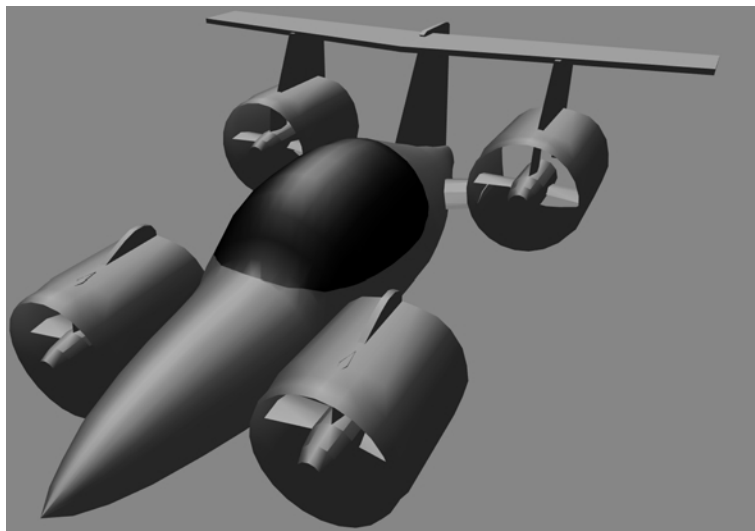

Figure 7-6 Aircar Database in IRIS Inventor Format

The model in Figure 7-6 represents one design for the perennial “personal aircar of the future” concept. It was created, using Imagine, by Mike Halvorson of Impulse, and was modeled after the Moller 400 as described in *Popular Mechanics*.

The Open Inventor data-file loader provided with OpenGL Performer reads both binary and ASCII format Open Inventor data files. Open Inventor scene graph description files in both formats have the suffix “.iv” appended to their file names.

Here is a simple Open Inventor file that defines a cone:

```
#Inventor V2.1 ascii

Separator {
  Cone {
  }
}
```

The source code for the Open Inventor format importer is provided in the `libpfd`/`libpfiv` source directory.

`pfdLoadFile()` uses the function `pfdLoadFile_iv()` to load Open Inventor format files into OpenGL Performer run-time data-structures. OpenGL Performer also comes with an Inventor loader that works with Open Inventor 2.0, if Open Inventor 2.1 is not installed.

Lightscape Technologies LSA and LSB Formats

The Lightscape Visualization system is a product of Lightscape Technologies, Inc., and is designed to compute accurate simulations of global illumination within complex 3D environments. The output files created with Lightscape Visualization can be read into OpenGL Performer for real-time visual exploration.

Lightscape Technologies provides importers for two of their database formats, the simple ASCII LSA format and the comprehensive binary LSB format. These loaders are in the files `pflsa.c` and `pflsb.c` in the directories `/usr/share/Performer/src/lib/libpfd/libpflsa` and `libpflsb` for IRIX and Linux and in `%PFROOT%\Src\lib\libpfd\libpflsa` and `libpflsb` for Microsoft Windows. Files in the LSA format are in ASCII and have the following components:

1. A 4x4 view matrix representing a default transformation
2. Counts of the number of independent triangles, independent quadrilaterals, triangle meshes, and quadrilateral meshes in the file
3. Geometric data definitions

There are four types of geometric definitions in LSA files. The formats of these definitions are as shown in Table 7-7.

Table 7-7 Geometric Definitions in LSA Files

Geometric Type	Format
Triangle	t X1 Y1 Z1 C1 X2 Y2 Z2 C2 X3 Y3 Z3 C3
Triangle mesh	tm n X1 Y1 Z1 C1 X2 Y2 Z2 C2 ...

Table 7-7 Geometric Definitions in LSA Files (**continued**)

Geometric Type	Format
Quadrilateral	q X1 Y1 Z1 C1 X2 Y2 Z2 C2 X3 Y3 Z3 C3 X4 Y4 Z4 C4
Quadrilateral mesh	qm n X1 Y1 Z1 C1 X2 Y2 Z2 C2 ...

The Cn values in Table 7-7 refer to colors in the format accepted by the OpenGL function `glColor()`; these colors should be provided in decimal form. The X, Y, and Z values are vertex coordinates. Polygon vertex ordering in LSA files is consistently counterclockwise, and polygon normals are not specified. The first few lines of the LSA sample file `chamber.0.lsa` provide an example of the format:

```

0.486911 0.03228900 0.979046 0.9596590
-1.665110 0.00944197 0.286293 0.2806240
0.000000 1.92730000 -0.017805 -0.0174524
0.240398 -5.54670000 13.021200 13.4945000

1782 4751 0 0

t 4.35 -7.3677 2.57 6188666 6.5 -9.3 2.57 5663353 4.35 -9.3 2.57 5728890
t 6.5 -9.3 2.57 5663353 4.35 -7.3677 2.57 6188666 6.5 -8.2463 2.57 6057596

```

The count line indicates that the file contains 1782 independent triangles and 4751 independent quadrilaterals, which together represent 11,284 triangles. The image in Figure 7-7 shows this database, the New Jerusalem City Hall. This was produced by A.J. Diamond of Donald Schmitt and Company, Toronto, Canada, using the Lightscape Visualization system.



Figure 7-7 LSA-Format City Hall Database

pfdLoadFile() uses the function **pfdLoadFile_lsa()** to load LSA format files into OpenGL Performer run-time data structures.

Files in the LSB binary format have a very different structure from LSA files. Representing not just polygon data, they contain much of the structural information present in the “.ls” files used by the Lightscape Visualization system, including material, layer, and texture definitions as well as a hierarchical mesh definition for geometry. This information is structured as a series of data sections, which include the following:

- The signature, a text string that identifies the file
- The header, which contains global file information
- The material table, defining material properties
- The layer table, defining grouping and association
- The texture table, referencing texture images
- Geometry in the form of clusters

The format of the geometric clusters is somewhat complicated. A cluster is a group of coplanar surfaces called patches that share a common material, layer, and normal. Each patch shares at least one edge with another patch in the cluster. Each patch defines either a convex quadrilateral or a triangle, and patches represent quad-trees called nodes. Each node points to its corner vertices and its children. The leaf nodes point to their corner vertices and the child pointers can optionally point to the vertices that split an edge of the node. Only the locations of vertices that are corners of the patches are stored in the file; other vertices are created by subdividing nodes of the quad-tree as the LSB file is loaded. The color information for each vertex is unique and is specified in the file.

The image in Figure 7-8 shows an LSB-format database developed during the design of a hospital operating room. This database was produced by the DeWolff Partnership of Rochester, New York, using the Lightscape Visualization system.

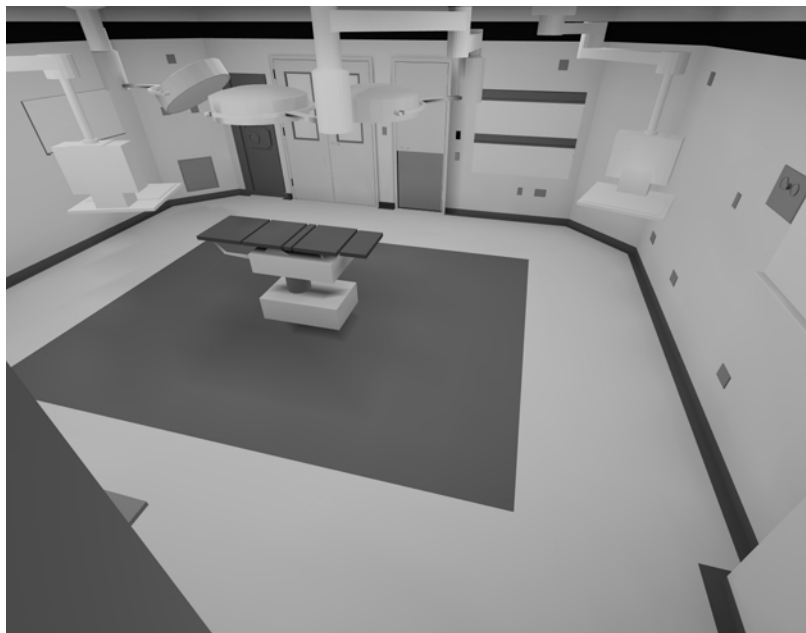

Figure 7-8 LSB-Format Operating Room Database

pfLoadFile() uses the function **pfLoadFile_lsb()** to load LSB format files into OpenGL Performer run-time data structures.

When working with Lightscape Technologies files, remember that hardware lighting is not needed because all illumination effects have already been accounted for with the ambient color at each vertex.

Medit Productions MEDIT Format

The “.medit” format is used by the Medit database modeling system produced by Medit Productions. The OpenGL Performer “.medit” loader is in the directory /usr/share/Performer/src/lib/libpfdp/libpfdmedit for IRIX and Linux and in %PFROOT%\Src\lib\libpfdp\libpfdmedit for Microsoft Windows.

pfdLoadFile() uses the function **pfdLoadFile_medit()** to load MEDIT format files into OpenGL Performer run-time data structures.

NFF Neutral File Format

The “.nff” format was developed by Eric Haines as a way to provide standard procedural databases for evaluating ray tracing software. OpenGL Performer includes an extended NFF loader with superquadric torus support, a named `build` keyword, and numerous small bug fixes. The “.nff” loader is located in the directory /usr/share/Performer/src/lib/libpfdp/libpfnff for IRIX and Linux and in %PFROOT%\Src\lib\libpfdp\libpfnff for Microsoft Windows.

The file /usr/share/Performer/data/sampler.nff on IRIX and Linux and %PFROOT%\Data\sampler.nff on Microsoft Windows uses each of the NFF data types. It is an excellent way to explore the “Show Tree”, “Draw Style”, and “Highlight Mode” features of Perfly. It is included here:

```
#-- torus
f .75 .00 .25 .6 .8 20 0
t 5 5 0 0 0 1 2 1
build torus

#-- cylinder
f .00 .75 .25 .6 .8 20 0
c
15 5 -3 2
15 5 3 2
#-- put a disc on the top and bottom of the cylinder
d 15 5 -3 0 0 -1 0 2
```

```
d 15 5 3 0 0 1 0 2
build cylinder

#-- cone
f .00 .25 .75 .6 .8 20 0
c
25 5 -3 3
25 5 3 0
#-- put a disc on the bottom of the cone
d 25 5 -3 0 0 -1 0 3
build cone

#-- sphere
f .75 .00 .75 .6 .8 20 0
s 5 15 0 3
build sphere

#-- hexahedron
f .25 .25 .50 .6 .8 20 0
h 13 13 -2 17 17 2
build hexahedron

#-- superquadric sphere
f .80 .10 .30 .6 .8 20 0
ss 25 15 0 2 2 2 .1 .4
build superquadric_sphere

#-- disc (washer shape)
f .20 .20 .90 .6 .8 20 0
d 5 25 0 0 0 1 1 2.5
build disc

#-- grid (height field)
f .80 .80 .10 .6 .8 20 0
g 4 4 12 18 22 28 0 4
0 0 0 0
0 1 0 0
0 0 -1 0
0 0 0 0
build grid

#-- superquadric torid
f .40 .20 .60 .6 .8 20 0
st 25 25 0 0.5 0.5 0.5 .33 .33 3
build superquadric_torid
```



```
#-- polygon with no normals
f .20 .20 .20 .6 .8 20 0
p 4
-5 -5 -10
35 -5 -10
35 35 -10
-5 35 -10
build polygon
```

pfdLoadFile() uses the function **pfdLoadFile_nff()** to load NFF format files into OpenGL Performer run-time data structures.

Wavefront Technology OBJ Format

The OBJ format is an ASCII data representation read and written by the Wavefront Technology `Model` program. A number of database models in this format have been placed in the public domain, making this a useful format to have available. OpenGL Performer provides the function **pfdLoadFile_obj()** to import OBJ files. The source code for **pfdLoadFile_obj()** is in the file `pfobj.c` in the loader source directory `/usr/share/Performer/src/lib/libpfd/libpfobj` for IRIX and Linux and in `%PFROOT%\Src\lib\libpfd\libpfobj` for Microsoft Windows.

The OBJ-format database shown in Figure 7-9 models an office building that is part of the SGI corporate campus in Mountain View, California.

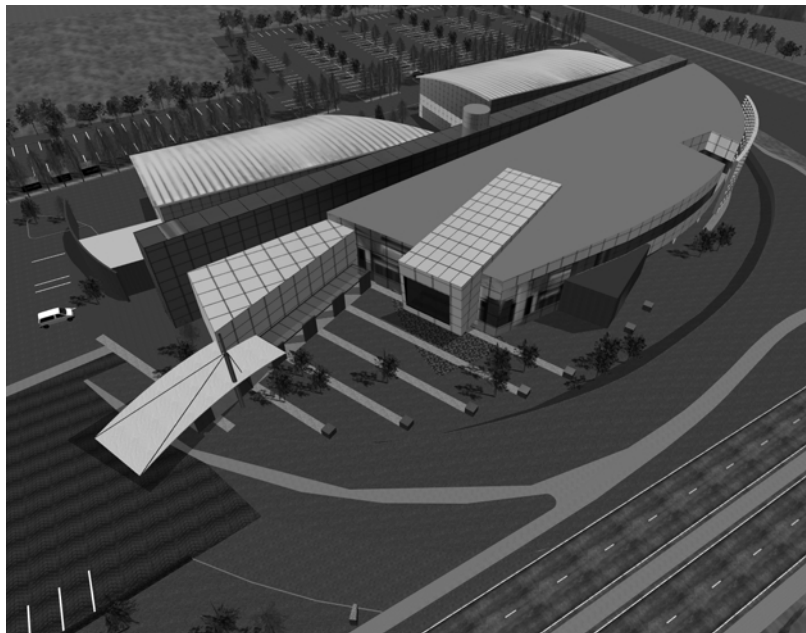

Figure 7-9 SGI Office Building as OBJ Database

Files in the OBJ format have a flexible all-ASCII structure, with simple keywords to direct the parsing of the data. This format is best illustrated with a short example that defines a texture-mapped square:

```
#-- 'v' defines a vertex; here are four vertices
v -5.000000  5.000000  0.000000
v -5.000000 -5.000000  0.000000
v  5.000000 -5.000000  0.000000
v  5.000000  5.000000  0.000000

#-- 'vt' defines a vertex texture coordinate; four are given
vt 0.000000  1.000000  0.000000
vt 0.000000  0.000000  0.000000
vt 1.000000  0.000000  0.000000
vt 1.000000  1.000000  0.000000

#-- 'usemtl' means select the material definition defined
#-- by the name MaterialName
usemtl MaterialName
```

```
#-- 'usemap' means select the texturing definition defined
#-- by the name TextureName
usemap TextureName

#-- 'f' defines a face. This face has four vertices ordered
#-- counterclockwise from the upper left in both geometric
#-- and texture coordinates. Each pair of numbers separated
#-- by a slash indicates vertex and texture indices,
#-- respectively, for a polygon vertex.
f 1/1 2/2 3/3 4/4
```

pfLoadFile() uses the function **pfLoadFile_obj()** to load Wavefront OBJ files into OpenGL Performer run-time data structures.

SGI PFB Format

Note: The PFB format is undocumented and is subject to change.

Although OpenGL Performer has no true native database format, the PFB format is designed to exactly replicate the OpenGL Performer scene graph; this design increases loading speed. A file in the PFB format has the following advantages:

- PFB files often load in one tenth (or less) of the time it takes an equivalent file in another format to load.
- PFB files are often half the size of equivalent files in another format.

You can think of the PFB format as being a cache. You can convert your files into PFB for fast and efficient loading or paging, but you should always keep your original files in case you wish to modify them.

Converting to the PFB Format

You can convert files into the PFB format in one of the following ways:

- Use the function **pfStoreFile_pfb()** in `libpfpfb`.
- Use `pfconv`.

SGI PFI Format

The PFI image file format is designed for fast loading of images into `pfTextures`. `pfLoadTexFile()` can load PFI files as the image of a `pfTexture`. Since the format of the image in a PFI file matches that of a `pfTexture`, data is not reformatted at load time. Eliminating the reformatting often cuts the load time of textures to half of the load time of the same image in the IRIS RGB image format.

PFI files can contain the mipmaps of the image. This feature saves significant time in the OpenGL Performer DRAW process since it does not have to generate the mipmaps.

Creating PFI Files

PFI files are created in the following ways:

- `pfSaveTexFile()` creates a PFI file from a `pfTexture`.
- The `pfImage` methods in `libpfdu` create PFI files.
- `pficonv` converts IRIS RGB image files into PFI files.
- `pfconv` converts all referenced image files into PFI files when the setting `PF_PFB_SAVE_TEXTURE_PFI` mode is `PF_ON`. The command line options to do this with `pfconv` is `-Mpfb, 5`.

SGI PHD Format

The PHD format was created to describe the geometric polyhedron definitions derived mathematically by Andrew Hume and by the `Kaleido` program of Zvi Har'El. This format describes only the geometric shape of polyhedra; it provides no specification for color, texture, or appearance attributes such as specularity.

The OpenGL Performer sample data directories contain numerous polyhedra in the PHD format. The image in Figure 7-10 shows many of the polyhedron definitions laboriously computed by Andrew Hume.

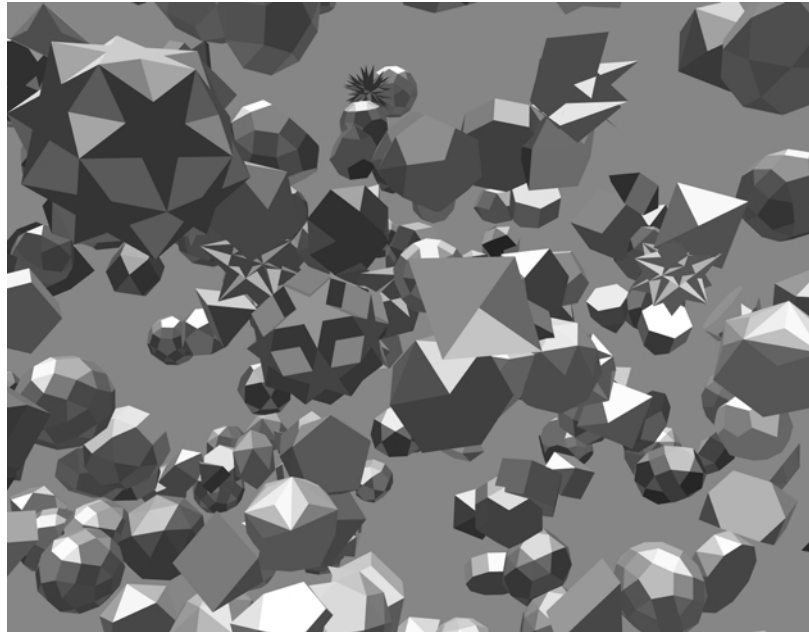

Figure 7-10 Plethora of Polyhedra in PHD Format

The source code for the PHD-format importer is in the file `/usr/share/Performer/src/lib/libpfdp/libpfpoly/pfpd.c` on IRIX and Linux and in `%PFROOT%\Src\lib\libpfdp\libpfpoly\pfdhd.c` on Microsoft Windows.

PHD format files have a line-structured ASCII form; an initial keyword defines the contents of each line of data. The file format consists of a filename definition (introduced by the keyword `file`) followed by one or more object definitions.

Object definitions are bracketed by the keywords `object.begin` and `object.end` and contain one or more polygon definitions. Objects can have a name in quotes following the `object.begin` keyword; such a name is used by the loader for the name of the corresponding OpenGL Performer node.

Polygon definitions are bracketed by the keywords `polygon.begin` and `polygon.end` and contain three or more vertex definitions.

Vertex definitions are introduced by the `vertex` keyword and define the X, Y, and Z coordinates of a single vertex.

The following is a PHD-format definition of a unit-radius tetrahedron centered at the origin of the coordinate axes. It is derived from the database developed by Andrew Hume but has since been translated, scaled, and reformatted.

```
file 000.phd
object.begin "tetrahedron"
polygon.begin
vertex -0.090722 -0.366647 0.925925
vertex 0.544331 -0.628540 -0.555555
vertex 0.453608 0.890430 0.037037
polygon.end
polygon.begin
vertex -0.907218 0.104757 -0.407407
vertex -0.090722 -0.366647 0.925925
vertex 0.453608 0.890430 0.037037
polygon.end
polygon.begin
vertex -0.090722 -0.366647 0.925925
vertex -0.907218 0.104757 -0.407407
vertex 0.544331 -0.628540 -0.555555
polygon.end
polygon.begin
vertex 0.453608 0.890430 0.037037
vertex 0.544331 -0.628540 -0.555555
vertex -0.907218 0.104757 -0.407407
polygon.end
object.end
```

`pfdLoadFile()` uses the function **`pfdLoadFile_phd()`** to load PHD format files into OpenGL Performer run-time data structures.

The **`pfdLoadFile_phd()`** function composes a color with red, green, and blue components uniformly distributed within the range 0.2 to 0.7 that is consistent for each polygon with the same number of vertices within a single polyhedron.

SGI PTU Format

The PTU format is named for the *OpenGL Performer Terrain Utilities*, of which the **`pfdLoadFile_ptu()`** function is the sole example at the present time. This function accepts

as input the name of a control file (the file with the ".ptu" filename extension) that defines the desired terrain parameters and references additional data files.

The database shown in Figure 7-11 represents a portion of the Yellowstone National Park. This terrain database was generated completely by the OpenGL Performer Terrain Utility data generator from digital terrain elevation data and satellite photographic images. Image manipulation is performed using the SGI ImageVision Library functions.

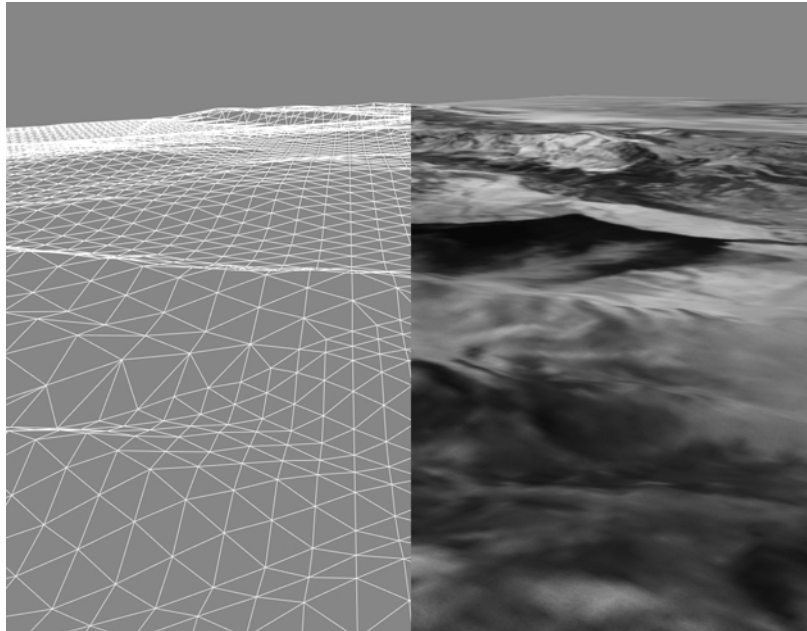

Figure 7-11 Terrain Database Generated by PTU Tools

The PTU control file has a fixed format that does not use keywords. The contents of this file are simply ASCII values representing the following data items:

1. The name to be assigned to the top-level pfNode built by **pfLoadFile_ptu()**.
2. The number of desired levels-of-detail (LOD) for the resulting terrain surface. The **pfLoadFile_ptu()** function will construct this many versions of the terrain, each representing the whole surface but with exponentially fewer numbers of polygons in each version.

3. The number of highest-LOD tiles that will tessellate the entire terrain surface in the X and Y axis directions.
4. Two numeric values that define the mapping of texture image pixels to world-coordinate terrain geometry. These values are the number of meters per *texel* (texture pixel) of filtered grid post data in the X and Y axis dimensions.
5. The name of an image file that represents terrain height at regularly spaced sample points in the form of a monochrome image whose brightness at each pixel indicates the height at that sample point. Additional arguments are the number of samples in the input image in the X and Y directions, as well as the desired number of samples in these directions. The **pfdLoadFile_ptu()** function resamples the grid posts from the original to the desired resolution by filtering the height image using SGI ImageVision Library functions.
6. The name of an image file that represents the terrain texture image at regularly spaced sample points. Subsequent arguments are the number of samples in the image in the X and Y directions as well as the desired number of samples in these directions. This image will be applied to the terrain geometry. The scale values provided in the PTU file allow the terrain grid and texture image to be adjusted to create an orthographic alignment.
7. An optional second texture-image filename that serves as a detail texture when the terrain is viewed on RealityEngine systems. This texture is used in addition to the base texture image.
8. An optional detail-texture spline-table definition. The blending of the primary texture image and the secondary detail texture is controlled by a blend table defined by this spline function. The spline table is optional even when a detail texture is specified. Detail texture and its associated blend functions are applicable only on RealityEngine systems.

The source code for the PTU-format importer is provided in the file `/usr/share/Performer/src/lib/libpfdb/libpfptu/pfptu.c` on IRIX and Linux and in `%PFROOT%\Src\lib\libpfdb\libpfptu\pfptu.c` on Microsoft Windows.

pfdLoadFile() uses the function **pfdLoadFile_ptu()** to load PTU format files into OpenGL Performer run-time data structures.

ArchVision RPC Format

ArchVision provides the rich photorealistic content (RPC) loader. The RPC loader loads in images from an ArchVision RPC file. The images represent views of an object from a set of directions around the object. If you provide an existing `pfIBRnode`, the images are loaded into a `pfIBRtexture` of the node. Otherwise, the function creates a new `pfIBRnode` with a single `pfGeoSet` and a `pfIBRtexture` containing the images. In the case of new content with meshes, the `pfGeoSet` contains the mesh, which becomes the proxy in the `pfIBRnode`.

The following functions allow you to access and alter the modes, values, and attributes of the RPC loader:

- `pfdConverterMode_rpc()`, `pfdGetConverterMode_rpc()`
- `pfdConverterVal_rpc()`, `pfdGetConverterVal_rpc()`
- `pfdConverterAttr_rpc()`, `pfdGetConverterAttr_rpc()`

You control the RPC converter modes with the token `PFRPC_USE_USER_IBRNODE`. By default, the loader creates a `pfIBRnode` with a single `pfGeoSet` and a `pfIBRtexture` that contains the loaded images. If this mode is set to `PF_ON` and you supply a `pfIBRnode` using `pfdConverterAttr_rpc()`, the images are loaded into the `pfIBRtexture` of that node.

Table 7-8 describes the RPC converter values.

Table 7-8 RPC Converter Values

Converter Value	Description
<code>PFRPC_SKIP_TEXTURES</code>	Skips every <i>n</i> images. ArchVision RPC files often contain hundreds of images. A <code>pfIBRtexture</code> containing so many images would be too large. The default is set to 2. If you want to use all images in the file, set it to 0.
<code>PFRPC_CROP_LEFT</code>	Crops the loaded images by the specified number of pixels on the left.
<code>PFRPC_CROP_RIGHT</code>	Crops the loaded images by the specified number of pixels on the right. Note that the resulting image width should be a power of 2.
<code>PFRPC_CROP_TOP</code>	Crops the loaded images by the specified number of pixels on the top.

Table 7-8 RPC Converter Values **(continued)**

Converter Value	Description
PFRPC_CROP_BOTTOM	Crops the loaded images by the specified number of pixels on the bottom. Note that the resulting image height should be a power of 2.
PFRPC_SCALE_WIDTH	Scales the billboard width in the case of a pfIBRnode without a proxy.
PFRPC_SCALE_HEIGHT	Scales the billboard height in the case of a pfIBRnode without a proxy.
PFRPC_NEAREST	Sets flag PFIBR_NEAREST on the pfIBRnode created by the loader.
PFRPC_USE_NEAREST_RING	In the case of content with a proxy and having more than one ring of views, forces the mode in which views are selected from the nearest ring rather than having the views blended between the two nearest rings.
PFRPC_COMBINED_TEXTURE_SIZE	Combines textures into a square texture of the specified size (should be a power of 2). By default, if the texture size is not a power of 2, textures are combined into a texture of size 2048x2048. If the texture size is power of 2, textures are not combined into a bigger texture unless the value PFRPC_COMBINED_TEXTURE_SIZE is explicitly specified. You can also set it to 0 to disable combining.

Table 7-9 describes the converter attributes.

Table 7-9 RPC Converter Attributes

Converter Attribute	Description
PFRPC_USER_IBRNODE	Specifies a pfiBRnode. The images from the RPC file are loaded into the pfiBRtexture of the node.
PFRPC_RING_FILE	Specifies the path to ring files that define the rings of views where proxies are used. There is one file for each component of the input RPC file, indexed by extension .0, .1, .2, and so on. Each line of the ring file contains the angle of the ring from the horizon and the number of views in that ring. If no ring file is specified, each component has only one ring of 16 views at horizontal angle 0. You can use an environment variable of the same name to set this attribute.
PFRPC_SKIP_TEXTURES PFRPC_SCALE_WIDTH PFRPC_FLIP_TEXTURES PFRPC_NEAREST PFRPC_USE_NEAREST_RING PFRPC_COMBINED_TEXTURE_SIZE	See Table 7-8 for the descriptions of these attributes. You can use an environment variable of the same name to set this attribute. Setting attribute values through the use of environment variables allows you to affect the loading of the files without the necessity of changing your application.

Note: The loader is using a relatively slow, third-party routine for decompressing images. For a faster load time, you may want to convert your RPC files into PFB files using `pfconv`.

Two sample RPC files can be found in directory `/usr/share/Performer/data/ibr/rpc` for IRIX and Linux and in `%PFROOT%\Data\ibr\rpc` for Microsoft Windows. You can download other files from the ArchVision webpage at www.archvision.com.

USNA Standard Graphics Format

The SGF format is used at the United States Naval Academy as a standard graphics format for geometric data. The loader was developed based on the description of the

standard graphics format as described by David F. Rogers and J. Alan Adams in the book *Mathematical Elements for Computer Graphics*. The OpenGL Performer “.sgf” format loader is located in the directory `/usr/share/Performer/src/lib/libpfdlibpfsfgf` for IRIX and Linux and in `%PFROOT%\Src\lib\libpfdlibpfsfgf` for Microsoft Windows

Here is the vector definition for four stacked squares in SGF form:

```
0, 0, 0
1, 0, 0
1, 1, 0
0, 1, 0
0, 0, 0
1.0e37, 1.0e37, 1.0e37
0, 0, 1
1, 0, 1
1, 1, 1
0, 1, 1
0, 0, 1
1.0e37, 1.0e37, 1.0e37
0, 0, 2
1, 0, 2
1, 1, 2
0, 1, 2
0, 0, 2
1.0e37, 1.0e37, 1.0e37
0, 0, 3
1, 0, 3
1, 1, 3
0, 1, 3
0, 0, 3
1.0e37, 1.0e37, 1.0e37
```

pfdLoadFile() uses the function **pfdLoadFile_sgf()** to load SGF format files into OpenGL Performer run-time data-structures.

SGI SGO Format

The SGI Object format is used by several utility programs and was one of the first database formats supported by OpenGL Performer. The image in Figure 7-12 shows a model generated by Paul Haeberli and loaded into Perfly by the **pfdLoadFile_sgo()** database importer.



Figure 7-12 Model in SGO Format

Objects in the SGO format have per-vertex color specification and multiple data formats. Objects contained in SGO files are constructed from three data types:

- Lists of quadrilaterals
- Lists of triangles
- Triangle meshes

Objects of different types can be included as data within one SGO file.

The SGO format has the following structure:

1. A magic number, 0x5424, which identifies the file as an SGO file.
2. A set of data for each object. Each object definition begins with an identifying token, followed by geometric data. There can be multiple object definitions in a single file. An end-of-data token terminates the file.

The layout of an SGO file is the following:

```
<SGO-file magic number>
<data-type token for object #1>
<data for object #1>
<data-type token for object #2>
<data for object #2>
...
<data-type token for object #n>
<data for object #n>
<end-of-data token>
```

Each of the identifying tokens is 4 bytes long. Table 7-10 lists the symbol, value, and meaning for each token.

Table 7-10 Object Tokens in the SGO Format

Symbol	Value	Meaning
OBJ_QUADLIST	1	Independent quadrilaterals
OBJ_TRILIST	2	Independent triangles
OBJ_TRIMESH	3	Triangle mesh
OBJ_END	4	End-of-data token

The next word following any of the three object types is the number of 4-byte words of data for that object. The format of this data varies depending on the object type.

For quadrilateral list (OBJ_QUADLIST) and triangle list (OBJ_TRILIST) objects, there are nine words of floating-point data for each vertex, as follows:

1. Three words that specify the components of the normal vector at the vertex
2. Three words that specify the red, green, and blue color components, scaled to the range 0.0 to 1.0
3. Three words that specify the X, Y, and Z coordinates of the vertex itself

In quadrilateral lists, vertices are in groups of four; so, there are $4 \times 9 = 36$ words of data for each quadrilateral. In triangle lists, vertices are in groups of three, for $3 \times 9 = 27$ words per triangle.

The triangle mesh, OBJ_TRIMESH, is the most complicated of the three object data types. Triangle mesh data consists of a set of vertices followed by a set of mesh-control commands. Triangle mesh data has the following format:

1. A long word that contains the number of words in the complete triangle mesh data packet
2. A long word that contains the number of floating-point words required by the vertex data, at nine words per vertex
3. The data for each vertex, consisting of nine floating-point words representing normal, color, and coordinate data
4. A list of triangle mesh controls

The triangle mesh controls, each of which is one word in length, are listed in Table 7-11.

Table 7-11 Mesh Control Tokens in the SGO Format

Symbol	Value	Meaning
OP_BGNTMESH	1	Begin a triangle strip.
OP_SWAPTMESH	2	Exchange old vertices.
OP_ENDBGNTMESH	3	End then begin a strip.
OP_ENDTMESH	4	Terminate triangle mesh.

The triangle-mesh controls are interpreted sequentially. The first control must always be OP_BGNTMESH, which initiates the mesh-decoding logic. After each mesh control is a word (of type long integer) that indicates how many vertex indices follow. The vertex indices are in byte offsets, so to access vertex n , you must use the byte offset $n \times 9 \times 4$.

pfdLoadFile() uses the function **pfdLoadFile_sgo()** to load SGO format files into OpenGL Performer run-time data structures.

You can find the source code for the SGO-format importer in the file `pfsgo.c`. This importer does not attempt to decode any triangle meshes present in input files; instead, it terminates the file conversion process as soon as an OBJ_TRIMESH data-type token is encountered. If you use SGO-format files containing triangle meshes you will need to extend the conversion support to include the triangle mesh data type.

USNA Simple Polygon File Format

The “.spf” format is used at the United States Naval Academy as a simple polygon file format for geometric data. The loader was developed based on the description in the book *Mathematical Elements for Computer Graphics*. The OpenGL Performer “.spf” loader is in the directory `/usr/share/Performer/src/lib/libpfdlib/pfdlib/spf` on IRIX and Linux and in `%PFROOT%\Src\lib\libpfdlib\pfdlib/spf` on Microsoft Windows.

The following “.spf” format file is defined in that book.

```
polygon with a hole
14,2
4,4
4,26
20,26
28,18
28,4
21,4
21,8
10,8
10,4
10,12
10,20
17,20
21,16
21,12
9,1,2,3,4,5,6,7,8,9
5,10,11,12,13,14
```

If you look at this file in Perfly, you will see that the hole is not cut out of the letter “A” as might be desired. Such computational geometry computations are not considered the province of simple database loaders.

pfdLoadFile() uses the function **pfdLoadFile_spf()** to load SPF format files into OpenGL Performer run-time data structures.

Sierpinski Sponge Loader

The Sierpinski Sponge (also known as Menger Sponge) loader is not based on a data format but rather is a procedural data generator. The loader interprets the portion of the user-provided filename before the period and extension as an integer which specifies the number of recursive subdivisions desired in data generation. For example, providing the

pseudo filename "3.sponge" to Perfly will result in the Sponge loader being invoked and generating a sponge object using three levels of recursion, resulting in a 35712 polygon database object. The OpenGL Performer ".sponge" loader can be found in the directory /usr/share/Performer/src/lib/libpfdB/libpfsponge on IRIX and Linux and in %PFROOT%\Src\lib\libpfdB\libpfsponge on Microsoft Windows.

pfLoadFile() uses the function **pfLoadFile_sponge()** to load Sponge format files into OpenGL Performer run-time data structures.

Star Chart Format

The ".star" format is a distillation of astronomical data from the Yale Compact Star Chart (YCSC). The sample data file /usr/share/Performer/data/3010.star for IRIX and Linux and %PFROOT%\Data\3010.star for Microsoft Windows contains data from the YCSC that has been reduced to a list of the 3010 brightest stars as seen from Earth and positioned as 3010 points of light on a unit-radius sphere. The OpenGL Performer ".star" loader can read this data and is provided as a convenience for making dusk, dawn, and night-time scenes. The loader is in the directory /usr/share/Performer/src/lib/libpfdB/libpfstar on IRIX and Linux and in %PFROOT%\Src\lib\libpfdB\libpfstar on Microsoft Windows.

Data in a ".star" file is simply a series of ASCII lines with the "s" (for star) keyword followed by X, Y, and Z coordinates, brightness, and an optional name. Here are the 10 brightest stars (excluding Sol) in the ".star" format:

```
s -0.18746032  0.93921369 -0.28763914  1.00  Sirius
s -0.06323564  0.60291260 -0.79529721  1.00  Canopus
s -0.78377002 -0.52700269  0.32859191  1.00  Arcturus
s  0.18718566  0.73014212  0.65715599  1.00  Capella
s  0.12507832 -0.76942003  0.62637711  0.99  Vega
s  0.13051330  0.68228769  0.71933979  0.99  Capella
s  0.19507207  0.97036278 -0.14262892  0.98  Rigel
s -0.37387931 -0.31261155 -0.87320572  0.94  Rigil Kentaurus
s -0.41809806  0.90381104  0.09121194  0.94  Procyon
s  0.49255905  0.22369388 -0.84103900  0.92  Achernar
```

pfLoadFile() uses the function **pfLoadFile_star()** to load Star format files into OpenGL Performer run-time data structures.

3D Lithography STL Format

The STL format is used to define 3D solids to be imaged by 3D lithography systems. STL defines objects as collections of triangular facets, each with an associated face normal. The ASCII version of this format is known as STLA and has a very simple structure.

The image in Figure 7-13 shows a typical STLA mechanical CAD database. This model is defined in the `bendix.stla` sample data file.

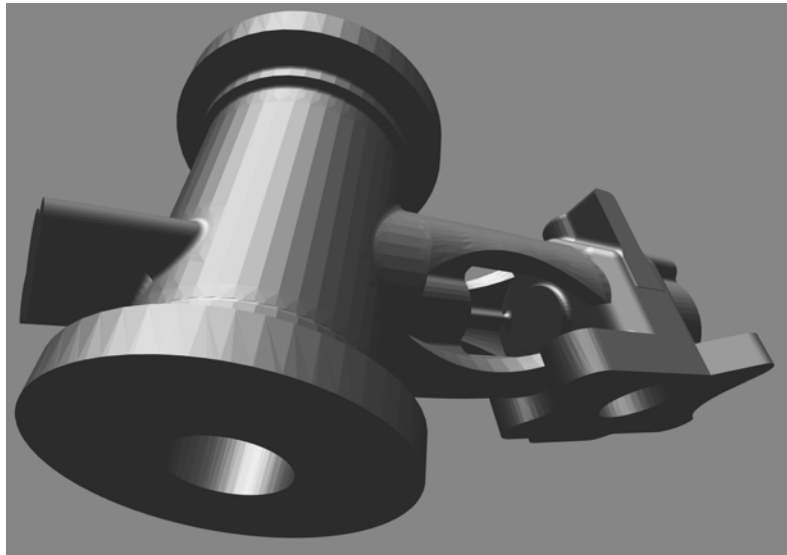

Figure 7-13 Sample STLA Database

The source code for the STLA-format loader is in the files `/usr/share/Performer/src/lib/libpfdp/libpfstla/pfstla.c` on IRIX and Linux and in `%PFROOT%\Src\lib\libpfdp\libpfstla\pfstla.c` on Microsoft Windows.

STLA-format files have a line-structured ASCII form; an initial keyword defines the contents of each line of data. An STLA file consists of one or more facet definitions, each of which contains the following:

1. The facet normal, indicated with the `facet normal` keyword
2. The facet vertices, bracketed by `outer loop` and `endloop` keywords

3. The endloop keyword

Here is an excerpt from `nut.stla`, one of the STLA files provided in the OpenGL Performer sample data directories. These are the first two polygons of a 524-triangle hex-nut object:

```
facet normal 0 -1 0
  outer loop
    vertex 0.180666 -7.62 2.70757
    vertex -4.78652 -7.62 1.76185
    vertex -4.436 -7.62 0
  endloop
endfacet
facet normal -0.381579 -0.921214 -0.075915
  outer loop
    vertex -4.48833 -7.59833 0
    vertex -4.436 -7.62 0
    vertex -4.78652 -7.62 1.76185
  endloop
endfacet
```

Use this function to import data from STLA-format files into OpenGL Performer run-time data structures:

```
pfNode *pfdLoadFile_stla(char *fileName);
```

pfdLoadFile_stla() searches the current OpenGL Performer file path for the file named by the *fileName* argument and returns a pointer to the pfNode that parents the imported scene graph, or NULL if the file is not readable or does not contain recognizable STLA format data.

SuperViewer SV Format

The SuperViewer (SV) format is one of the several database formats that the I3DM database modeling tool can read and write. The I3DM modeler was developed by John Kichury of SGI and is provided with OpenGL Performer. The source code for the SV format importer is in the file `pfsv.c`.

The passenger vehicle database shown in Figure 7-14 was modeled using I3DM and is stored in the SV database format.



Figure 7-14 Early Automobile in SuperViewer SV Format

Within SV files, object geometry and attributes are described between text lines that contain the keywords `model` and `endmodel`. For example:

```
model wing
    geometry and attributes
endmodel
```

Any number of models can appear within a SuperViewer file. The geometry and attribute data mentioned above each consist of one of the following types:

- 3D Polygon with vertex normals and optional texture coordinates:

```
poly3dn <num_vertices> [textured]
x1 y1 z1 nx1 ny1 nz1 [s1 t1]
x2 y2 z2 nx2 ny2 nz2 [s2 t2]
...
```

where the coordinates and normals are defined as follows:

- $X_n Y_n Z_n$ are the n th vertex coordinates
- $N_{xn} N_{yn} N_{zn}$ are the n th vertex normals

- $S_n T_n$ are the n th texture coordinates
- 3D Triangle mesh with vertex normals and optional texture coordinates

```
tmeshn <num_vertices> [textured]
x1 y1 z1 nx1 ny1 nz1 [s1 t1]
x2 y2 z2 nx2 ny2 nz2 [s2 t2]
...
```

where the coordinates and normals are defined as follows:

 - $X_n Y_n Z_n$ are the n th vertex coordinates
 - $N_{xn} N_{yn} N_{zn}$ are the n th vertex normals
 - $S_n T_n$ are the n th texture coordinates
- Material definition. If the material directive exists before a model definition, it is taken as a new material specification. Its format is the following:

```
material n Ar Ag Ab Dr Dg Db Sr Sg Sb Shine Er Eg Eb
```

where the variables represent the following:

 - n is an integer specifying a material number
 - $Ar Ag Ab$ is the ambient color.
 - $Dr Dg Db$ is the diffuse color.
 - $Sr Sg Sb$ is the specular color.
 - *Shine* is the material shininess.
 - $Er Eg Eb$ is the emissive color.

If the material directive exists within a model description, the format is the following:

```
material n
```

where n is an integer specifying which material (as defined by the material description above) is to be assigned to subsequent data.
- Texture definition. If the texture directive exists before a model definition it is taken as a new texture specification. Its format is the following:

```
texture n TextureFileName
```

If the texture directive exists within a model description, the format is the following:

```
texture n
```

where n is an integer specifying which texture (as defined by the texture description above) is to be assigned to subsequent data.

- Backface polygon display mode. The backface directive is specified within model definitions to control backface polygon culling:

```
backface mode
```

where a *mode* of “on” allows the display of backfacing polygons and a *mode* of “off” suppresses their display.

In actual use the SV format is somewhat self-documenting. Here is part of the SV file `apple.sv` from the directory `/usr/share/Performer/data` on IRIX and Linux and in `%PFROOT%\Data` on Microsoft Windows:

```
material 20 0.0 0.0 0 0.400000 0.000000 0 0.333333 0.000000 0.0 10.0000 0 0 0
material 42 0.2 0.2 0 0.666667 0.666667 0 0.800000 0.800000 0.8 94.1606 0 0 0
material 44 0.0 0.2 0 0.000000 0.200000 0 0.000000 0.266667 0.0 5.0000 0 0 0
```

```
texture 4 prchmnt.rgb
texture 6 wood.rgb
```

```
model LEAF
material 44
texture 4
backface on
poly3dn 4 textured
  1.35265 1.35761 13.8338 0.0686595 -0.234553 -0.969676 0 1
  0.88243 0.96366 14.0329 0.0502096 -0.376701 -0.924973 0 0.75
-4.44467 1.24026 13.5669 0.0363863 -0.337291 -0.940697 0.0909091 0.75
-2.37938 2.17479 13.3626 0.0363863 -0.337291 -0.940697 0.0909091 1
poly3dn 4 textured
-2.37938 2.17479 13.3626 0.0363863 -0.337291 -0.940697 0.0909091 1
-4.44467 1.24026 13.5669 0.0363863 -0.337291 -0.940697 0.0909091 0.75
-9.23775 2.34664 13.1475 0.0344832 -0.284369 -0.958095 0.181818 0.75
-6.69592 3.94535 12.6716 0.0344832 -0.284369 -0.958095 0.181818 1
```

This excerpt specifies material properties and references texture images stored in the files `prchmnt.rgb` and `wood.rgb`, and then defines two polygons.

pdfLoadFile() uses the function **pdfLoadFile_sv()** to load SuperViewer files into OpenGL Performer run-time data structures.

Geometry Center Triangle Format

The “.tri” format is used at the University of Minnesota’s Geometry Center as a simple geometric data representation. The loader was developed by inspection of a few sample files. The OpenGL Performer “.tri” loader is in the directory `/usr/share/Performer/src/lib/libpfdb/libpftri` on IRIX and Linux and in `%PFROOT%\Src\lib\libpfdb\libpftri` on Microsoft Windows.

These files have a very simple format: a line per vertex with position and normal given on each line as 6 ASCII numeric values. The file is simply a series of these triangle definitions. Here are the first two triangles from the data file `/usr/share/Performer/data/mobrect.tri` on IRIX and Linux and in `%PFROOT%\Data\mobrect.tri` on Microsoft Windows:

```
1.788180  1.000870  0.135214  0.076169  -0.085488  0.993423
1.574000  0.925908  0.146652  0.089015  -0.086072  0.992304
1.793360  0.634711  0.099409  0.076402  -0.111845  0.990784
0.836848  -0.595230  0.197960  0.156677   0.044503  0.986647
0.709638  -0.345676  0.210010  0.157642   0.021968  0.987252
0.581200  -0.535321  0.234807  0.145068   0.030985  0.988936
```

pfdLoadFile() uses the function **pfdLoadFile_tri()** to load “.tri” format files into OpenGL Performer run-time data structures.

UNC Walkthrough Format

The “.unc” format was once used at the *University of North Carolina* as a format for geometric data in an architectural walkthrough application. The loader was developed based on inspection of a few sample files. The OpenGL Performer “.unc” loader is in the directory `/usr/share/Performer/src/lib/libpfdb/libpfunc` for IRIX and Linux and in `%PFROOT%\Src\lib\libpfdb\libpfunc` for Microsoft Windows.

pfdLoadFile() uses the function **pfdLoadFile_unc()** to load UNC format files into OpenGL Performer run-time data structures.

WRL Format

The VRML 2.0 format for OpenGL Performer, `wrl`, is made by DRaW Computing Associates. It accepts geometry and texture only. Basic geometry nodes like Sphere, Cone, Cylinder, Box and related nodes like Shape, Material, Appearance,

TextureTransform, ImageTexture, and ElevationGrid are supported. Also, complex geometries can be obtained using the IndexedFaceSet node. You can do geometric manipulations to nodes using Group nodes and Transform nodes. You can also make very complex structures using PROTOs, where you group many geometry nodes.

Database Operators with Pseudo Loaders

The OpenGL Performer dynamic database loading mechanism provides additional DSOs that operate on the resulting scene graph from a file or set of files after the file(s) are loaded. This mechanism, called “pseudo loaders,” enables the desired operator DSO to be specified as additional suffixes to the filename. The DSO matching the last suffix is loaded first and provided the entire filename. That pseudo loader then can parse the arbitrary filename and invoke the next operator or loader and then operate on the results. This process allows additional arguments to be buried in the specified filename for the pseudo loader to detect and parse.

One set of pseudo loaders included with OpenGL Performer are the `rot`, `trans`, and `scale` loaders. These loaders take `hpr` and `xyz` arguments in addition to their `Filename` and can be invoked from any program using `pfLoadFile()`, as shown in this example:

```
% perfly cow.obj.-90,90,0.rot
```

-90, 90, and 0 are the *h*, *p*, and *r* values, respectively.

If you are using a shell with argument expansion, such as `csh`, you can create interesting cow art. Try out the following example:

```
% perfly cow.obj.{0,1},0,0.trans cow.obj.{0,1,2,3,4},0,-5.trans
```

Specifying a base filename is only needed if the specified pseudo loader expects a file to process. Loaders can generate their scene graphics procedurally based on simple parameters specified in the command string.

The pseudo loaders in the OpenGL Performer distribution are described in Table 7-12.

Table 7-12 OpenGL Performer Pseudo Loaders

Pseudo Loaders	Description
<code>libpfrot</code>	Add pfSCS at root to rotate scene graph by specified h,p,r .
<code>libpftrans</code>	Add pfSCS at root to translate scene graph by specified x,y,z .
<code>libpfscale</code>	Add pfSCS at root to scale scene graph by specified x,y,z .
<code>libpfclosest</code>	Adds run-time application callback to highlight closest point each frame.
<code>libpfcliptile</code>	Adds callback to compute for the specified <i>tilename</i> , <i>minS</i> , <i>minT</i> , <i>maxS</i> , and <i>maxT</i> , the proper virtual cliptexture viewing parameters.
<code>libpfsphere</code>	Generates a sphere database with morphing LOD starting from an n-gon for specified <i>n</i> , power of 2.
<code>libpfvct</code>	Convert normal cliptexture .ct file to virtual cliptexture.
<code>libpfsubdiv</code>	Subdivide an arbitrary file using Loop or Catmull-Clark subdivision.
<code>libpfgeoa</code>	Convert geometry from pfGeoSets to pfGeoArrays.
<code>libpfbreakup</code>	Create an artificial hierarchy from unstructured input.

Pseudo loaders should define `pfLoadNeededDSOs_EXT()` for the following:

- Preinitializing DSOs
- Loading other special files
- Performing additional initialization, such as class initialization, that should happen before `pfConfig()`

The `libpfbreakup` pseudo loader, which creates an artificial hierarchy from unstructured input, uses the `pfBreakup()` function, whose syntax follows:

```
pfNode * pfBreakup(pfGeode *geode, float geodeSize, int stripLength, int geodeChild);
```

The function accepts a pfGeode that contains pfGeoSets of type `PFGS_TRISTRIPS` and builds a new scene graph with the same geometric content but with a spatial subdivision structure designed for efficient processing. The function returns the root of the new scene graph (a pfGroup) or, if the subdivision was not done, a copy of the original pfGeode.

The first triangle strips of all `pfGeoSets` in `geode` are split into strips no longer than `stripLength`. If the `pfGeoSets` do not contain triangle strips, they are left untouched and `geode` is subdivided based on the geometrical centers of the split `pfGeoSets` using an octree. The degree of recursive partitioning desired is specified in the function arguments. The resulting scene graph is a `pfGroup` that contains more `pfGroups`, recursively. The recursion stops if the resulting `pfGeode` is smaller than `geodeSize` (`geodeSize` is the maximum size of the leaf octants in world coordinates) or the number of its `pfGeoSets` is smaller than `geodeChild`.

Note: The input `pfGeode` is not deleted.

See also “The `libpfs subdiv Pseudo Loader`” on page 431.

The Maya Database Exporter

OpenGL Performer provides the `PFBexport` plug-in for Maya. This Maya exporter converts a Maya scene into OpenGL Performer data structures and saves them in an OpenGL Performer binary (`.pfb`) or ASCII (`.pfa`) file. These output files can be displayed with the OpenGL Performer viewer or imported into an OpenGL Performer application. The exporter produces a log file that describes the Maya objects converted and flags any errors or unsupported features.

This section describes the following topics:

- “Installation Requirements”
- “Exporting a Scene Using the Graphical Interface”
- “Exporting a Scene Using the Maya Embedded Language (MEL)”
- “Translation Details”

Installation Requirements

The Maya exporter should be installed for you automatically as part of the OpenGL Performer installation process. You must have a licensed copy of Maya 4.5 or later installed on every machine that runs the exporter because it is a Maya plug-in and can only run within the Maya environment. This differs from previous OpenGL Performer

file loaders that run within the OpenGL Performer environment. The Maya exporter is available for both IRIX and Windows, but not for Linux.

The `.pfa` and `.pfb` files produced by the Maya exporter can be viewed on any machine with OpenGL Performer 3.1 or later installed. These files are not compatible with previous versions of OpenGL Performer. Maya has capabilities like subdivision surfaces and non-uniform rational B-splines (NURBS) that require the OpenGL Performer 3.1 or later run-time environment. The exporter can optimize geometry to take advantage of the new OpenGL extensions available on Onyx 4 systems. These extensions also need OpenGL Performer 3.1 or later support.

If you launch Maya and it cannot find the plug-in, you can troubleshoot by checking the `MAYA_PLUG_IN_PATH` and `MAYA_SCRIPT_PATH` environment variables. Both variables should be defined at installation to reference the OpenGL Performer directory containing the Maya extensions.

Table 7-13 shows the default path for IRIX and Microsoft Windows.

Table 7-13 Default Path for the Maya Export Plug-in

Platform	Default Path
IRIX	<code>/usr/share/OpenGL Performer/bin</code>
Microsoft Windows	<code>c:/SGI/OpenGL Performer/Bin</code>

Exporting a Scene Using the Graphical Interface

Any Maya scene can be exported to OpenGL Performer format. Unsupported features will be flagged in the export log file and may result in objects missing from the scene when viewed with OpenGL Performer. To run the plug-in from the Maya graphical user interface, use the Export All or Export Selection items from the File menu. As shown in Figure 7-15, you should be able to select `PFBexport` as one of the file types. The only supported extensions are `.pfb` and `.pfa`.

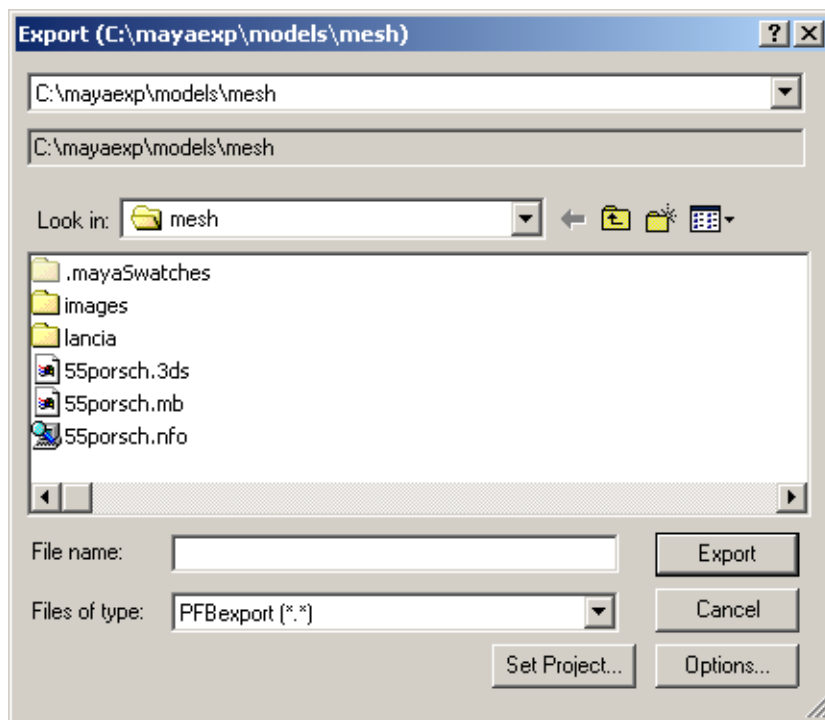

Figure 7-15 Maya Export Screen

There are a number of parameters that control how Maya content is translated to OpenGL Performer format. You can produce exported files that take advantage of OpenGL extensions for multitexturing and vertex buffer objects but you must be running Maya on a platform which has these features. In general, OpenGL Performer .pfa and .pfb files are cross-platform and can be successfully imported on machines that are less-capable than where they originated with some loss of fidelity. For example, displaying a multitextured object on an Octane will drop all textures but the first.

As shown in Figure 7-16, you can optimize for earlier versions of SGI hardware by choosing Optimize for OpenGL 1.0. If you have have an Onyx 4 system, do not check this option or you will not get the best graphics performance. If your graphics hardware does not have multitexturing capabilities, do check this option.

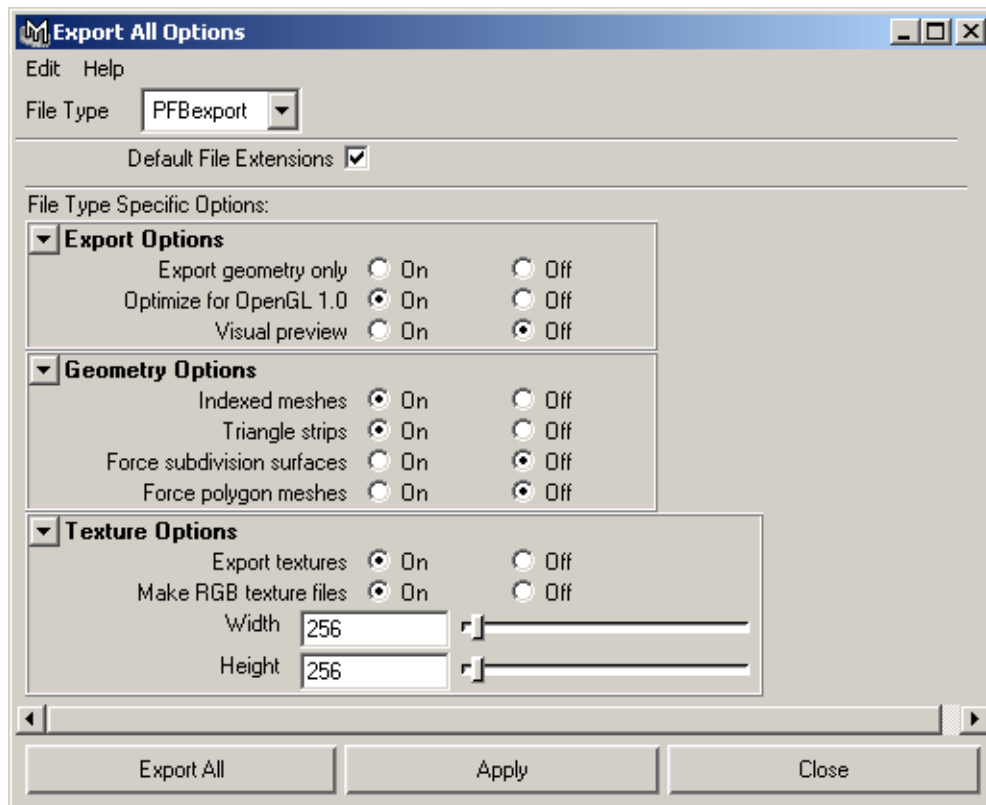

Figure 7-16 Maya Export Options

Table 7-14 describes the export options.

Table 7-14 Maya Export Options

Category	Option	Description
Export Options	Export geometry only	If checked, only geometry will be included in the are also exported. This can result in poor performance from using too many light sources.
	Optimize for OpenGL 1.0	If checked, the exporter optimizes for earlier versions of SGI hardware without multitexturing capabilities. Do not check this option for an Onyx4 system.
	Visual preview	If checked, you get a visual preview.
Geometry Options	Indexed meshes	If checked, polygon mesh geometry will be exported as indexed, allowing vertices to be shared. Non-indexed meshes are faster on OpenGL 1.0.
	Triangle strips	If checked, the exporter will convert polygon meshes to triangle lists or triangle strips if possible. This option is faster on all platforms but should not be checked if you are producing subdivision surfaces (see the option Force subdivision surfaces). If not checked, the Maya polygonal structure is preserved in the OpenGL Performer geometry. (Triangle stripping is not performed on indexed meshes.)
	Force subdivision surfaces	If checked, the exporter will convert polygon meshes to subdivision surfaces in the OpenGL Performer file. This works best with low-count polygon meshes. Using complex meshes can exhaust memory or produce large models that are slow to display.

Table 7-14 Maya Export Options (**continued**)

Category	Option	Description
	Force polygon meshes	If checked, the exporter will convert subdivision surfaces and NURBS models to polygon meshes. The format of the output meshes is controlled by the mesh export options (see category Export geometry). If not checked, subdivision surfaces and NURBS from Maya are preserved in OpenGL Performer.
Texture Options	Export textures	If checked, texturing and UV mapping is enabled. Objects that are textured in Maya will be output as textured in the OpenGL Performer file. If you uncheck this box, the exporter ignores all Maya texturing and produces OpenGL Performer geometry with materials only.
	Make RGB texture files	If checked, all textures encountered in Maya are converted to RGB format as part of the export process. The Width and Height sliders control the size of the RGB texture images. This option should be checked if you are using procedural textures in your Maya scene or if you plan to use IRIX to display your OpenGL Performer files.

Exporting a Scene Using the Maya Embedded Language (MEL)

If you are familiar with MEL, the Maya scripting language, you can invoke the OpenGL Performer export plug-in from within a script. This allows you to do batch translation of Maya files to OpenGL Performer. The following sample MEL script converts all of the Maya binary (.mb) files in a given directory to OpenGL Performer binary (.pfb) format:

```
global proc int ExportAsPFB(string $indir, string $opts)
{
    string $infile;
    string $outfile;
    string $files[];
    string $s;
    int $succeed = 1;

    if ($opts == "")
        $opts = "textures=1;width=256;height=256;indexed=1;tristrip=1;"
            "gll=1;preview=0;";
    if ($indir == "")
        $indir = "./";
    setProject $indir;
    $files=`getFileList -folder $indir -filespec "*.mb"`;

    for ($infile in $files)
    {
        $outfile = $indir + substring($infile, 1, size($infile) - 3) +
            ".pfb";
        $infile = $indir + $infile;
        file -open -force $infile;
        $s = `file -exportAll -type "PFBexport" -options $opts -force
            $outfile`;
        $succeed = `file -query -exists $s`;
        if (!$succeed)
            $s = "ERROR: failed to export " + $outfile + "\n";
        else
            $s = "exported " + $s + "\n";
        print $s;
    }
    return $succeed;
}
```

Translation Details

This section describes the translation of Maya scenes to OpenGL Performer using the following topics:

- “Supported Maya Features”
- “Hierarchy”
- “Geometry”
- “Shaders”

Supported Maya Features

Maya has many capabilities that cannot be represented in OpenGL Performer, particularly in the area of shaders. Some of these features are simply ignored while others may suffer quality loss. OpenGL Performer uses the OpenGL graphics pipeline, which only allows light sources to illuminate objects directly. Light reflected from objects does not illuminate other objects in the scene as it does with Maya. Consequently, high-quality shading effects are often lost in the conversion.

Table 7-15 lists the Maya features that are supported by the exporter (column 1) and those that are not supported (column 2).

Table 7-15 Maya Features Supported by the Exporter

Supported Maya Features	Unsupported Maya Features
Polygonal meshes	Layered shaders
Subdivision surfaces	Ramp shaders
NURBS	Shading maps
Multitexturing	Anisotropic materials
Lambert, Blinn and Phong materials	Volumetric materials
Layered textures	Translucence
Procedural textures	Displacement mapping
Filtering, mipmapping	Quadratic, quartic, and Gaussian filtering

Table 7-15 Maya Features Supported by the Exporter (**continued**)

Supported Maya Features	Unsupported Maya Features
Reflection mapping	3D or cube map textures
Cameras	Animation and skinning
Ambient, point, directional, and spot light sources	Area and volume light sources
Node instancing	Ray tracing
Shadow mapping	Custom shaders and mental ray
Bump mapping	Glow, fog, and motion blur
Vertex colors	Dynamics and fluids
Per-object light list	Switches, expressions, and scripting

Hierarchy

The exporter attempts to preserve the structure of the Maya scene graph as much as possible in the OpenGL Performer output. Nodes that are instanced in Maya are also shared in the OpenGL Performer hierarchy.

Maya and OpenGL Performer use different internal coordinate systems. This is not a issue when importing a Maya scene into an OpenGL Performer application if you use the whole scene because the root transformation corrects for the coordinate system differences. However, if you take part of a scene from a `.pfb` file exported from Maya and use it within another OpenGL Performer scene, the Maya objects may be oriented incorrectly.

The following subsections describe translation details surrounding the scene graph hierarchy:

- Naming
- Cameras
- Light Sources
- Sprites and Billboards

Naming

Node names are preserved so that Maya objects can be found by name in an OpenGL Performer application. The name of an OpenGL Performer scene graph node is composed of the file base name and the Maya object name. This is to permit multiple Maya files to be imported without naming conflicts. For example, the Maya object `pCubeShape` exported to file `/usr/people/nola/myscene.pfb` would be called `myscene.pCubeShape` in the OpenGL Performer scene graph.

Cameras

Maya cameras are kept in the scene graph and any camera node may be used to view the scene. In OpenGL Performer, the camera functionality is provided by the channel, which is the root of the scene hierarchy. Maya cameras are exported as OpenGL Performer DCS (dynamic coordinate system) nodes and keep their relative position within the hierarchy so that they are accessible in OpenGL Performer applications. The root of the exported scene graph includes the appropriate viewing transformation to display the scene from the viewpoint of the current Maya viewport camera. The Maya background color associated with the camera is not preserved in the OpenGL Performer scene.

Light Sources

OpenGL Performer has equivalents for ambient, directional, point, and spot light sources because they are supported by the OpenGL pipeline. Area and volume lights are ignored by the exporter. The exporter honors Maya per-object lighting. If you specify that only certain lights should affect an object in Maya, this light list is associated with the OpenGL Performer object. Because adding a light source in a real-time system can be computationally costly, it is a good idea to use as few lights as possible when exporting to OpenGL Performer.

Sprites and Billboards

A Maya *sprite* is an animated particle type that maps an image sequence onto a flat rectangle. Sprites always face the camera and maintain their size when moved in the Z direction. The sprite texture can be a single image or a sequence of images (texture animation). Sprites are supported by the exporter.

Maya does not have an equivalent to the OpenGL Performer billboard that makes arbitrary geometry face the camera at run time. Billboards are exported as DCS nodes.

Geometry

Maya has three ways to construct and represent geometry:

- Indexed triangle meshes
- Subdivision surfaces
- NURBS

OpenGL Performer supports all three of these surface description methods directly. So, Maya geometry can be displayed without a loss of fidelity.

The following subsections further describe geometry translation:

- Polygonal Meshes
- Subdivision Surfaces
- UV Mapping

Polygonal Meshes

Polygonal meshes in Maya are indexed and share vertex, normal, and texture coordinate data whenever possible. In Maya, different faces in the mesh can use different shaders. Therefore, a single mesh can be associated with multiple appearances. In this case, one mesh in Maya can produce several OpenGL Performer meshes, one for each appearance. This is true of surfaces as well.

There are several ways to export Maya meshes to OpenGL Performer depending on how you plan to use the geometry and the platform. Static geometry that is not modified at run time can be highly optimized to display quickly. Meshes that will be dynamically modified preserve the original Maya structure to make vertex manipulation at run time easier and more efficient.

All exported meshes have locations and either normals or vertex colors depending on how they were constructed in Maya. Texture coordinate sets are only included if texture output is enabled and the mesh is textured. Per-vertex colors are not supported by the exporter and will be ignored.

Subdivision Surfaces

Both Maya and OpenGL Performer subdivision surfaces use the Catmull-Clark algorithm. Therefore, run-time tessellation should produce results similar to Maya.

OpenGL Performer subdivision surfaces allow multiple materials on a single mesh and will preserve connectivity.

Although Maya NURBS shapes can use multiple shaders, the OpenGL Performer NURBS geode only supports one material. The exporter does not support the use of multiple shaders across a NURBS surface.

You can export a surface as a polygonal mesh and the exporter will use Maya to tessellate the surface.

UV Mapping

The UV mapping process transforms or generates texture coordinates for a mesh. Static UV mapping is applied to the Maya texture coordinates at export time. Environment mapping dynamically generates texture coordinates at run time based on the location of the viewer. Texture coordinate animation is not supported by the exporter.

Table 7-16 describes how the exporter supports the various UV mapping methods.

Table 7-16 Maya Exporter Support for UV Mapping Methods

UV Map Method	Exporter Support
place2dTexture	2D translation, scaling and rotation of the texture coordinates done at export time.
envSphere	Spherical environment mapping. Texture coordinates are generated by OpenGL Performer at run time.
envCube	Cubic environment mapping. Texture coordinates are generated by OpenGL Performer at run time.
Place3dTexture	3D matrix applied to texture coordinates at run time.
envSky	Ignored.
envChrome	Ignored.
envBall	Ignored.

Shaders

The following subsections describe how the exporter supports Maya shaders:

- Materials
- Textures
- Texture Effects
- Procedural Textures
- Layered Textures

Materials

Lambert, Blinn, and Phong materials are supported by the exporter but not all of the material properties are honored, as shown in Table 7-17.

Table 7-17 Maya Exporter Support for Material Properties

Material Property	Exporter Support
Color	Becomes diffuse material color.
Transparency	Becomes material transparency. You cannot specify a map here to be used as an alpha channel. The texture alpha channel must be included in the texture file.
Ambient color	Becomes ambient material color. If a texture map is used here, it is added to the overall color and light sources do not affect it.
Incandescence	Becomes emissive material color. If a texture map is used here, it is added to the overall color.
Diffuse	Is used as a multiplier for diffuse material color.
Translucence	Ignored.
Glow intensity	Ignored.
Hide source	Ignored.
Matte opacity	Ignored.
Ray trace options	Ignored.

Textures

All textures used with OpenGL Performer must come from bitmap files. Because OpenGL Performer does not support all texture formats on every platform, use the `.rgb` format for textures if you plan to use your exported files on multiple platforms.

OpenGL Performer multitexturing support is hardware-based and varies across platforms. On some older IRIX systems, multitexturing is not supported. Newer hardware can have two or four texture units. The Maya exporter supports a maximum of eight textures per object. It is possible to produce `.pfb` files that will not look the same on all platforms. If you use more than eight textures on a single mesh, the exporter will ignore the extra textures and produce an error message in the log file.

Texture Effects

Maya allows you to correctly color your textures by adding and/or multiplying the texture by a color before applying it (using the `color gain` and `color offset` attributes). You can also invert or filter the texels. These texture effects are only preserved if you convert your textures to RGB. The exporter captures the texture after these computations have been performed.

Table 7-18 describes how the exporter supports the various the Maya texture properties.

Table 7-18 Maya Exporter Support for Texture Properties

Texture Property	Exporter Support
Image name	Name of bitmap file containing texture data.
Color gain	Ignored unless the Make RGB option is enabled.
Color offset	Ignored unless the Make RGB option is enabled.
Invert	Ignored the unless Make RGB option is enabled.
Wrap	Becomes texture wrap mode.
Filter	Only <code>mipmap</code> and <code>box</code> filters may be used.
Hardware cycling	If animation export is enabled, a texture animation is produced. Otherwise, it is ignored.

Table 7-18 Maya Exporter Support for Texture Properties (continued)

Texture Property	Exporter Support
Filter offset	Ignored.
Blend	Ignored.
Alpha gain	Ignored.
Alpha offset	Ignored.
Alpha is luminance	Ignored.
Default color	Ignored.
Color remap	Ignored.

Procedural Textures

Maya has a rich library of procedural textures that can dynamically create texel patterns without requiring bitmap files. When the exporter encounters a procedural texture, it produces a reference to a bitmap file containing a snapshot of the procedural texture from Maya. If the **Make RGB** option is enabled, the exporter creates a separate RGB bitmap file for every texture used in the scene. This step only needs to be done when you add new textures or change the construction options on an existing procedural texture. The name of the RGB file is constructed by using the name of the Maya texture object with a `.rgb` suffix. Consequently, if you export multiple files that use the same object names, the exporter will use the same filename for multiple textures. Consequently, the same filenames could cause problems if the textures are not the same.

Procedural textures are emulated in OpenGL Performer using 2D UV coordinates and the texture matrix. It is not always possible to get the same results as Maya, particularly with 3D textures. The exporter uses the first UV set on the mesh to map the snapshot of the procedural texture. By manipulating these UVs, you can often improve the real-time appearance of procedural textures.

Layered Textures

Layered textures in Maya allow the artist to blend several different textures together to produce an output color. The exporter supports layered textures but OpenGL Performer cannot implement all of the blend modes. Only the `None`, `Over`, `In`, `Add` and `Multiply` blend modes are honored. All other modes default to `Multiply`.

Geometry

All `libpr` geometry is defined by modular units of primitives that employ a flexible specification method. The following two classes allow you to group these basic primitives:

- “`pfGeoSet` (Geometry Set)” on page 305
- “`pfGeoArray` (Geometry Array)” on page 319

This chapter describes these two classes. In addition, the last section, “3D Text” on page 342, describes how you can render 3D characters.

`pfGeoSet` (Geometry Set)

A `pfGeoSet` is a collection of geometry that shares certain characteristics. All items in a `pfGeoSet` must be of the same primitive type (whether they are points, lines, or triangles) and share the same set of attribute bindings (you cannot specify colors-per-vertex for some items and colors-per-primitive for others in the same `pfGeoSet`). A `pfGeoSet` forms primitives out of lists of attributes that may be either indexed or nonindexed. An indexed `pfGeoSet` uses a list of unsigned short integers to index an attribute list. (See “Attributes” on page 313 for information about attributes and bindings.)

Indexing provides a more general mechanism for specifying geometry than hard-wired attribute lists and also has the potential for substantial memory savings as a result of shared attributes. Nonindexed `pfGeoSets` are sometimes easier to construct, usually a bit faster to render, and may save memory (since no extra space is needed for index lists) in situations where vertex sharing is not possible. A `pfGeoSet` must be either completely indexed or completely nonindexed; it is not valid to have some attributes indexed and others nonindexed.

Note: `libpf` applications can include `pfGeoSets` in the scene graph with the `pfGeode` (Geometry Node).

Table 8-1 lists a subset of the routines that manipulate pfGeoSets.

Table 8-1 pfGeoSet Routines

Routine	Description
pfNewGSet()	Create a new pfGeoSet.
pfDelete()	Delete a pfGeoSet.
pfCopy()	Copy a pfGeoSet.
pfGSetGState()	Specify the pfGeoState to be used.
pfGSetGStateIndex()	Specify the pfGeoState index to be used.
pfGSetNumPrims()	Specify the number of primitive items.
pfGSetPrimType()	Specify the type of primitive.
pfGSetPrimLengths()	Set the lengths array for strip primitives.
pfGetGSetPrimLength()	Get the length for the specified strip primitive.
pfGSetAttr()	Set the attribute bindings.
pfGSetMultiAttr()	Set multi-value attributes (for example, multi-texture coordinates).
pfGSetDrawMode()	Specify draw mode (for example, flat shading or wireframe).
pfGSetLineWidth()	Set the line width for line primitives.
pfGSetPntSize()	Set the point size for point primitives.
pfGSetHlight()	Specify highlighting type for drawing.
pfDrawGSet()	Draw a pfGeoSet.
pfGSetBBox()	Specify a bounding box for the geometry.
pfGSetIsectMask()	Specify an intersection mask for pfGSetIsectSegs() .
pfGSetIsectSegs()	Intersect line segments with pfGeoSet geometry.
pfQueryGSet()	Determine the number of triangles or vertices.
pfPrint()	Print the pfGeoSet contents.

Primitive Types

All primitives within a given pfGeoSet must be of the same type. To set the type of all primitives in a pfGeoSet named *gset*, call **pfGSetPrimType(*gset*, *type*)**. Table 8-2 lists the primitive type tokens, the primitive types that they represent, and the number of vertices in a coordinate list for that type of primitive.

Table 8-2 Geometry Primitives

Token	Primitive Type	Number of Vertices
PFGS_POINTS	Points	<i>numPrims</i>
PFGS_LINES	Independent line segments	2 * <i>numPrims</i>
PFGS_LINESTRIPS	Strips of connected lines	Sum of <i>lengths</i> array
PFGS_FLAT_LINESTRIPS	Strips of flat-shaded lines	Sum of <i>lengths</i> array
PFGS_TRIS	Independent triangles	3 * <i>numPrims</i>
PFGS_TRISTRIPS	Strips of connected triangles	Sum of <i>lengths</i> array
PFGS_FLAT_TRISTRIPS	Strips of flat-shaded triangles	Sum of <i>lengths</i> array
PFGS_TRIFANS	Fan of connected triangles	Sum of <i>lengths</i> array
PFGS_FLAT_TRIFANS	Fan of flat-shaded triangles	Sum of <i>lengths</i> array
PFGS_QUADS	Independent quadrilaterals	4 * <i>numPrims</i>
PFGS_POLYS	Independent polygons	Sum of <i>lengths</i> array

The parameters in the last column denote the following:

- numPrims* The number of primitive items in the pfGeoSet, as set by **pfGSetNumPrims()**.
- lengths* The array of strip lengths in the pfGeoSet, as set by **pfGSetPrimLengths()** (note that length is measured here in terms of number of vertices).

Connected primitive types (line strips, triangle strips, and polygons) require a separate array that specifies the number of vertices in each primitive. Length is defined as the number of vertices in a strip for STRIP primitives and is the number of vertices in a polygon for the POLYS primitive type. The number of line segments in a line strip is

$numVerts - 1$, while the number of triangles in a triangle strip and polygon is $numVerts - 2$. Use `pfGSetPrimLengths()` to set the length array for strip primitives.

The number of primitives in a `pfGeoSet` is specified by `pfGSetNumPrims(gset, num)`. For strip and polygon primitives, num is the number of strips or polygons in `gset`.

pfGeoSet Draw Mode

In addition to the primitive type, `pfGSetDrawMode()` further defines how a primitive is drawn. Triangles, triangle strips, quadrilaterals, and polygons can be specified as either filled or as wireframe, where only the outline of the primitive is drawn. Use the `PFGS_WIREFRAME` argument to enable or disable wireframe mode. Another argument, `PFGS_FLATSHADE`, specifies that primitives should be shaded. If flat shading is enabled, each primitive or element in a strip is shaded with a single color.

PFGS_COMPILE_GL

At the next draw for each `pfState`, compile `gset`'s geometry into a GL *display list* and subsequently render the display list.

PFGS_DRAW_GLOBJ

Select the rendering of an already created display list but do not force a recompile.

PFGS_PACKED_ATTRS

Use the `gset`'s packed attribute arrays, set with the `PFGS_PACKED_ATTRS` to `pfGSetAttr`, to render geometry with GL vertex arrays.

The `pfGeoSets` are normally processed in immediate mode, which means that `pfDrawGSet()` sends attributes from the user-supplied attribute arrays to the Graphics Pipeline for rendering. However, this kind of processing is subject to some overhead, particularly if the `pfGeoSet` contains few primitives. In some cases it may help to use GL display lists (this is different from the `LIBPR` display list type `pfDispList`) or *compiled mode*. In compiled mode, `pfGeoSet` attributes are copied from the attribute lists into a special data structure called a display list during a compilation stage. This data structure is highly optimized for efficient transfer to the graphics hardware. However, compiled mode has some major disadvantages:

- Compilation is usually costly.
- A GL display list must be recompiled whenever its `pfGeoSet`'s attributes change.
- The GL display list uses a significant amount of extra host memory.

In general, immediate mode will offer excellent performance with minimal memory usage and no restrictions on attribute volatility, which is a key aspect in many advanced applications. Despite this, experimentation may show databases or machines where compiled mode offers a performance benefit.

To enable or disable compiled mode, call **pfGSetDrawMode()** with the `PFGS_COMPILE_GL` token. When enabled, compilation is delayed until the next time the `pfGeoSet` is drawn with **pfDrawGSet()**. Subsequent calls to **pfDrawGSet()** will then send the compiled `pfGeoSet` to the graphics hardware.

To select a display list to render, without recompiling it, use **pfGSetDrawMode()** with the token `PFGS_DRAW_GLOBJ`.

Packed Attributes

Packed attributes is an optimized way of sending formatted data to the graphics pipeline under OpenGL that does not incur the same memory overhead or recompilation burden as GL display lists. To render geometry with packed attributes, use the **pfGSetDrawMode(PFGS_PACKED_ATTRS)** method when using OpenGL. This `pfGSetAttr` list includes the currently bound `PER_VERTEX` vertex attribute data packed into a single nonindexed array. When specifying a packed attribute array, the optional vertex attributes, colors, normals, and texture coordinates, can be `NULL`. This array, like the other attribute arrays, is then shared between OpenGL Performer, the GL, and accessible by the user. Optionally, you can put your vertex coordinates in this packed array but in this case the vertices must be duplicated in the normal coordinate array because vertex coordinate data is used internally for other nondrawing operations such as intersections and computation of bounding geometry. Packed attribute arrays also allow OpenGL Performer to extend the vertex attribute types accepted by `pfGeoSets`. There are several base formats that expect all currently bound attributes of specified data type (unsigned byte, short, or float) to be in the attribute array. Attributes specified by the format but not bound to vertices are assumed to not be present and the present data is packed with the data for each vertex starting on a 32-bit word-aligned boundary. Then, there are several derived formats that let you put some attribute data in the packed array while leaving the rest in the normal individual coordinate attribute arrays. Table 8-3 shows the different base formats supported.

Table 8-3 pfGeoSet PACKED_ATTR Formats

Format	Description
PFGS_PA_C4UBN3ST2FV3F	Accepts all currently bound coordinate attributes; colors are unsigned bytes; normals are shorts. Vertices are duplicated in the packed attribute array.
PFGS_PA_C4UBN3ST2F	Vertices are in the normal coordinate array.
PFGS_PA_C4UBT2F	Normals and vertices are in the normal coordinate array.
PFGS_PA_C4UBN3ST2SV3F	All bound coordinate attributes are in the packed attribute array. Colors are unsigned bytes, normals are shorts, and texture coordinates are unsigned shorts.
PFGS_PA_C4UBN3ST3FV3F	Texture coordinates are 3D floats.
PFGS_PA_C4UBN3ST3SV3F	Texture coordinates are 2D shorts.

To create packed attributes, you can use the utility **pfuTravCreatePackedAttrs()**, which traverses a scene graph to create packed attributes for pfGeoSets and, optionally, pfDelete redundant attribute arrays. This utility packs the pfGeoSet attributes using **pfuFillGSetPackedAttrs()**. Examples of packed attribute usage can be seen in `/usr/share/Performer/src/pguide/libpr/C/packedattrs.c` and `/usr/share/Performer/src/sample/C/perfly.c` and `/usr/share/Performer/src/sample/C++/perfly.C` for IRIX and Linux and in `%PFROOT%\Src\pguide\libpr\C\packedattrs.c`, `%PFROOT%\Src\sample\C\perfly.c`, and `%PFROOT%\Src\sample\C++\perfly.C` for Microsoft Windows.

Primitive Connectivity

A pfGeoSet requires a coordinate array that specifies the world coordinate positions of primitive vertices. This array is either indexed or not, depending on whether a coordinate index list is supplied. If the index list is supplied, it is used to index the coordinate array; if not, the coordinate array is interpreted in a sequential order.

A pfGeoSet's primitive type dictates the connectivity from vertex to vertex to define geometry. Figure 8-1 shows a coordinate array consisting of four coordinates, A, B, C, and D, and the geometry resulting from different primitive types. This example uses index lists that index the coordinate array.

Note: Flat-shaded line strip and flat-shaded triangle strip primitives have the vertices listed in the same order as for the smooth-shaded varieties.

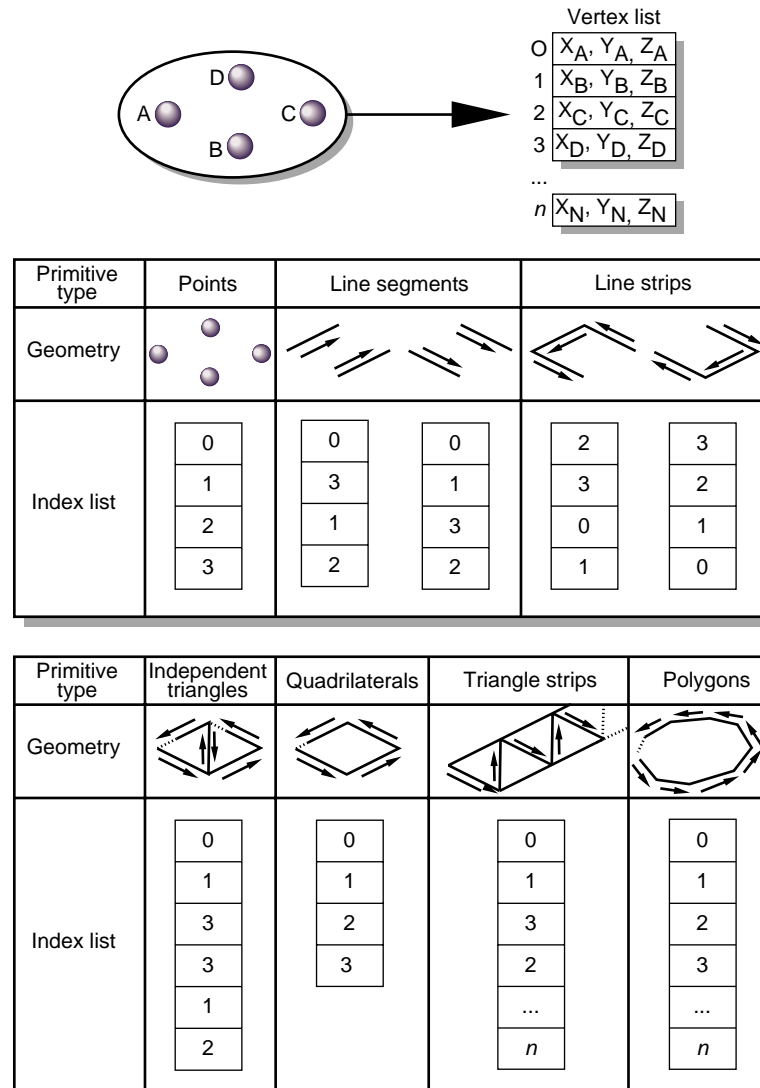

Figure 8-1 Primitives and Connectivity

Attributes

The definition of a primitive is not complete without attributes. In addition to a primitive type and count, a `pfGeoSet` references four attribute arrays (see Figure 8-2):

- Colors (red, green, blue, alpha)
- Normals (N_x , N_y , N_z)
- Texture coordinates (S, T)—multiple arrays for multitexture.
- Vertex coordinates (X, Y, Z)

(A `pfGeoState` is also associated with each `pfGeoSet`; see Chapter 12, “Graphics State” for details.) The four components listed above can be specified with `pfGSetAttr()`. Multivalued attributes (texture coordinates) can be specified using `pfGSetMultiAttr()` or `pfGSetAttr()`. Using zero as the index parameter for `pfGSetMultiAttr()` is equivalent to calling `pfGSetAttr()`. Attributes may be set in two ways: by indexed specification—using a pointer to an array of components and a pointer to an array of indices; or by direct specification—providing a NULL pointer for the indices, which indicates that the indices are sequential from the initial value of zero. The choice of indexed or direct components applies to an entire `pfGeoSet`; that is, all of the supplied components within one `pfGeoSet` must use the same method. However, you can emulate partially indexed `pfGeoSets` by using indexed specification and making each nonindexed attribute’s index list be a singly shared “identity mapping” index array whose elements are 0, 1, 2, 3, ..., N-1, where N is the largest number of attributes in any referencing `pfGeoSet`. (You can share the same array for all such emulated `pfGeoSets`.) The direct method avoids one level of indirection and may have a performance advantage compared with indexed specification for some combinations of CPUs and graphics subsystems.

Note: Use `pfMalloc()` to allocate your arrays of attribute data. This allows OpenGL Performer to reference-count the arrays and delete them when appropriate. It also allows you to easily put your attribute data into shared memory for multiprocessing by specifying an arena such as `pfGetSharedArena()` to `pfMalloc()`. While perhaps convenient, it is very dangerous to specify pointers to static data for `pfGeoSet` attributes. Early versions of OpenGL Performer permitted this but it is strongly discouraged and may have undefined and unfortunate consequences.

Attribute arrays can be created through `pfFlux` to support the multiprocessed generation of the vertex data for a dynamic object, such as ocean waves, or morphing geometry. `pfFlux` will automatically keep separate copies of data for separate processes so that one

process can generate data while another draws it. The pfFluxed buffer can be handed directly to **pfGSetAttr()** or **pfGSetMultiAttr()**. In fact, the entire pfGeoSet can be contained in a pfFlux. Index lists cannot be pfFluxed. See Chapter 19, “Dynamic Data,” for more information on pfFlux.

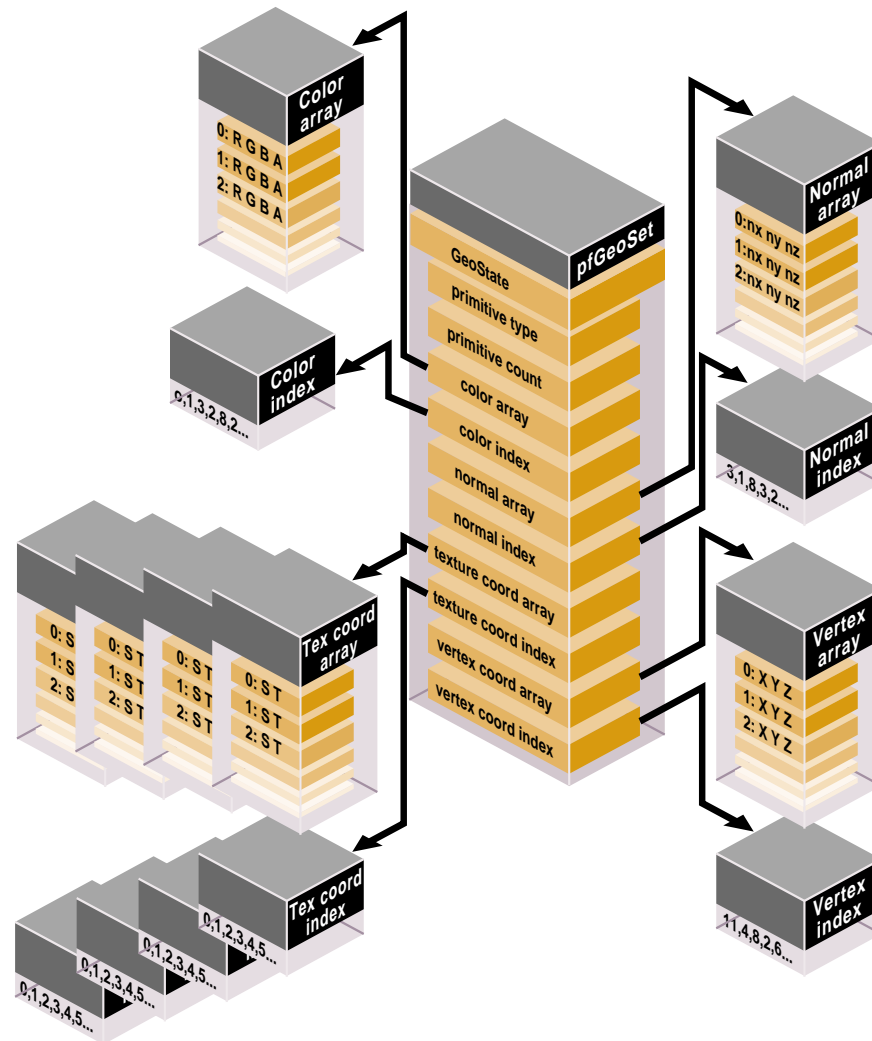

Figure 8-2 pfGeoSet Structure

Note: When using multiple texture-coordinate arrays, `pfGeoSet` recognizes texture-coordinate arrays starting at the first array (index of 0) and ending immediately before the first index with a NULL array. In other words, specifying texture-coordinate arrays using `pfGSetMultiAttr()` for indices 0, 1, and 3 is equivalent to specifying texture-coordinate arrays for only indices 0 and 1. When using `pfTexGen` to automatically generate texture coordinates for some texture units, the application should not interleave texture units with texture coordinates and texture units with `pfTexGen`. Texture units with texture coordinates should come before texture units with `pfTexGen`. This is an implementation limitation and may be removed in future releases.

Attribute Bindings

Attribute bindings specify where in the definition of a primitive an attribute has effect. You can leave a given attribute unspecified; otherwise, its binding location is one of the following:

- Overall (one value for the entire `pfGeoSet`)
- Per primitive
- Per vertex

Only certain binding types are supported for some attribute types.

Table 8-4 shows the attribute bindings that are valid for each type of attribute.

Table 8-4 Attribute Bindings

Binding Token	Color	Normal	Texture Coordinate	Coordinate
PFGS_OVERALL	Yes	Yes	No	No
PFGS_PER_PRIM	Yes	Yes	No	No
PFGS_PER_VERTEX	Yes	Yes	Yes	Yes
PFGS_OFF	Yes	Yes	Yes	No

Attribute lists, index lists, and binding types are all set by `pfGSetAttr()`.

For FLAT primitives (PFGS_FLAT_TRISTRIPS, PFGS_FLAT_TRIFANS, PFGS_FLAT_LINESTRIPS), the PFGS_PER_VERTEX binding for normals and colors has slightly different meaning. In these cases, per-vertex colors and normals should not be specified for the first vertex in each line strip or for the first two vertices in each triangle strip since FLAT primitives use the last vertex of each line segment or triangle to compute shading.

Indexed Arrays

A cube has six sides; together those sides have 24 vertices. In a vertex array, you could specify the primitives in the cube using 24 vertices. However, most of those vertices overlap. If more than one primitive can refer to the same vertex, the number of vertices can be streamlined to 8. The way to get more than one primitive to refer to the same vertex is to use an index; three vertices of three primitives use the same index which points to the same vertex information. Adding the index array adds an extra step in the determination of the attribute, as shown in Figure 8-3.

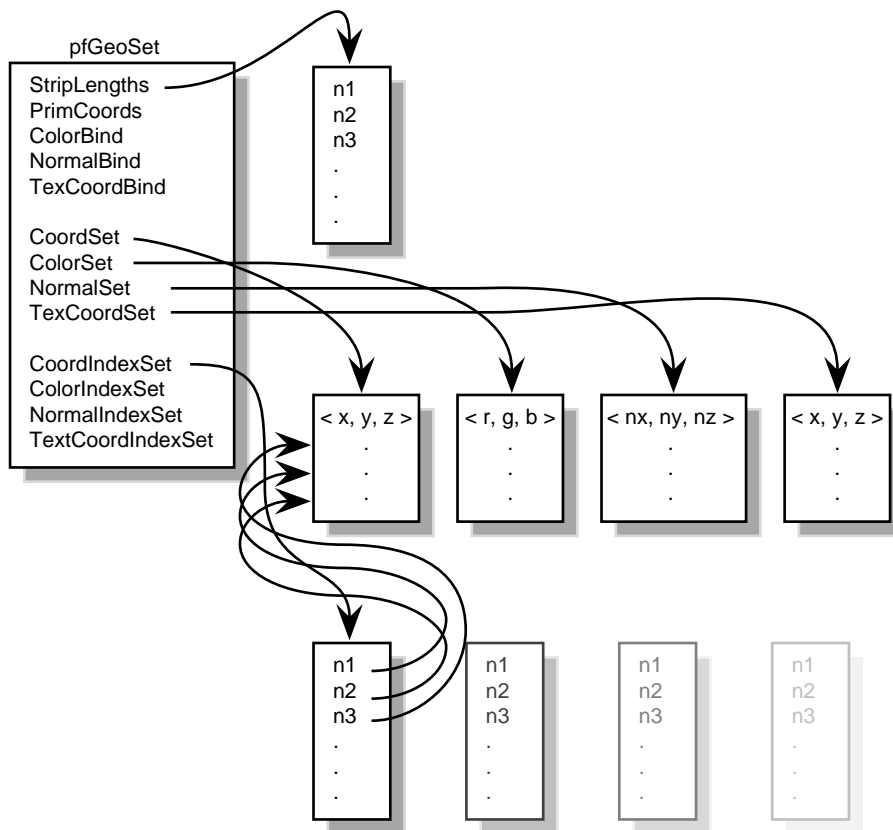

Figure 8-3 Indexing Arrays

Indexing can save system memory, but rendering performance is often lost.

When to Index Attributes

The choice of using indexed or sequential attributes applies to all of the primitives in a `pfGeoSet`; that is, all of the primitives within one `pfGeoSet` must be referenced sequentially or by index; you cannot mix the two.

The governing principle for whether to index attributes is how many vertices in a geometry are shared. Consider the following two examples in Figure 8-4, where each dot marks a vertex.

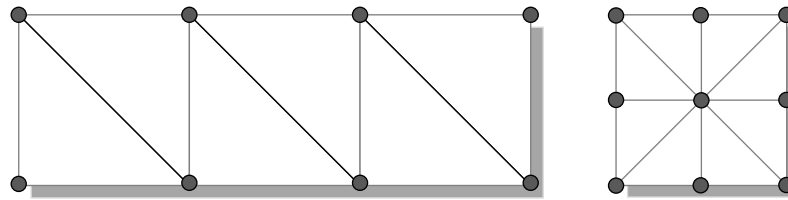

Figure 8-4 Deciding Whether to Index Attributes

In the triangle strip, each vertex is shared by two adjoining triangles. In the square, the same vertex is shared by eight triangles. Consider the task that is required to move these vertices when, for example, morphing the object. If the vertices were not indexed, in the square, the application would have to look up and alter eight triangles to change one vertex.

In the case of the square, it is much more efficient to index the attributes. On the other hand, if the attributes in the triangle strip were indexed, since each vertex is shared by only two triangles, the index look-up time would exceed the time it would take to simply update the vertices sequentially. In the case of the triangle strip, rendering is improved by handling the attributes sequentially.

The deciding factor governing whether to index attributes relates to the number of primitives that share the same attribute: if attributes are shared by many primitives, the attributes should be indexed; if attributes are not shared by many primitives, the attributes should be handled sequentially.

pfGeoSet Operations

There are many operations you can perform on pfGeoSets. **pfDrawGSet()** “draws” the indicated pfGeoSet by sending commands and data to the Geometry Pipeline, unless OpenGL Performer’s display-list mode is in effect. In display-list mode, rather than sending the data to the pipeline, the current pfDispList “captures” the **pfDrawGSet()** command. The given pfGeoSet is then drawn along with the rest of the pfDispList with the **pfDrawDList()** command.

When the PFGS_COMPILE_GL mode of a pfGeoSet is not active (**pfGSetDrawMode()**), **pfDrawGSet()** uses rendering loops tuned for each primitive type and attribute binding combination to reduce CPU overhead in transferring the geometry data to the hardware pipeline. Otherwise, **pfDrawGSet()** sends a special, compiled data structure.

Table 8-1 on page 306 lists other operations that you can perform on `pfGeoSets`. `pfCopy()` does a shallow copy, copying the source `pfGeoSet`'s attribute arrays by reference and incrementing their reference counts. `pfDelete()` frees the memory of a `pfGeoSet` and its attribute arrays (if those arrays were allocated with `pfMalloc()` and provided their reference counts reach zero). `pfPrint()` is strictly a debugging utility and will print a `pfGeoSet`'s contents to a specified destination. `pfGSetIsectSegs()` allows intersection testing of line segments against the geometry in a `pfGeoSet`; see "Intersecting with `pfGeoSets`" in Chapter 22 for more information on that function.

pfGeoArray (Geometry Array)

The `pfGeoArray` is a new OpenGL Performer data structure aimed at replacing the class `pfGeoSet`. Conceptually, `pfGeoArrays` are very similar to `pfGeoSets`, but they allow you to define new sets of attributes in addition to the standard vertex coordinates, normals, texture coordinates, and colors. These attributes can be used by vertex or fragment programs applied to the primitives (see "Using OpenGL Performer with GPUs" on page 523). Also, `pfGeoArrays` are rendered using vertex arrays and vertex objects, making the rendering much more efficient. `pfGeoArrays` can be up to 10 times faster than `pfGeoSets` on Onyx4 systems.

Each `pfGeoArray` is a collection of geometry with one primitive type, such as points, lines, or triangles. Vertex coordinates, normals, colors, texture coordinates, and user-defined attributes are used to specify the primitives. There are two ways to specify the attributes. First, each attribute is specified per vertex, there is no concept of an attribute per primitive or an overall attribute. Second, you can use a single list of unsigned integers to index all attributes of a `pfGeoArray`.

Indexing provides a more general mechanism for specifying geometry than hardwired attribute lists and, in many cases, provides substantial memory savings due to shared attributes. Nonindexed `pfGeoArrays` are sometimes easier to construct and may exhibit better caching behavior. Indexing is often a desirable approach especially when your primitives are sharing many attributes (such as having the same normal for each face). Also, if you have a primitive with many triangle strips, it is better to create a single `pfGeoArray` containing indexed triangles than to have a set of short `pfGeoArrays`, each containing one triangle strip.

The function `pfNewGArray()` creates and returns a handle to a `pfGeoArray`. The parameter `arena` specifies a `malloc()` arena out of which the `pfGeoArray` is allocated or `NULL` for allocation off the process heap. `pfGeoArrays` can be deleted with `pfDelete()`.

The call **new(arena)** allocates a pfGeoArray from the specified memory arena, or from the process heap if *arena* is NULL. The **new()** call allocates a pfGeoArray from the default memory arena (see the man page for pfGetSharedArena). Like other pfObjects, pfGeoArrays cannot be automatically created statically on the stack or in arrays. Delete pfGeoArrays with **pfDelete()** rather than with the delete operator.

pfGeoArray Attributes

The function **pfGArrayAddAttr()** adds a new attribute to the list of attributes of a pfGeoArray. This list is initially empty. An attribute is specified by its attribute type and the following parameters:

size	Specifies the number of coordinates per vertex; It must be 2, 3, or 4.
type	Specifies the type of each component in the attribute data. It is one of GL_DOUBLE, GL_FLOAT, GL_INT, GL_UNSIGNED_INT, GL_UNSIGNED_SHORT, GL_SHORT, GL_UNSIGNED_BYTE, and GL_BYTE.
stride	Specifies the byte offset between consecutive vertex data. It is usually 0.
pointer	Specifies a pointer to the attribute data.

According to the attribute type, pfGeoArray attributes may include vertex coordinates, color specification, normal vector, texture coordinates, or a user-defined generic attribute. See the following section “pfGeoArray Attribute Types” on page 322.

You can modify the size, the data type, the stride, and the data pointer for any existing attribute using the following functions:

- **pfGArrayAttrSize()**
- **pfGArrayAttrType()**
- **pfGArrayAttrStride()**
- **pfGArrayAttrPtr()**

You can also remove an attribute using the function **pfGArrayRemoveAttr()**. In all these functions, the attribute is identified by its attribute type and an index identifying which attribute of the given attribute type to use. Any attribute type can be used multiple times in a single pfGeoArray, but this is rarely a case.

Multitexturing is supported by adding a texture stage index to the attribute type specifying the texture. To do so, use the function **pfGArrayAddTextureAttrType()**. Similarly, the generic parameters, specified by **pfGArrayAddGenericAttrType()** can be indexed.

Note that since the **pfGeoArray** attributes are rendered in the order they were added, it is possible to interleave the attributes with your own callbacks. To do so, create a special "callback" type with a function mask 0 (no callback data) or a function mask 0x1 (callback data is used).

It is possible to index the attributes, although (in contrast to **pfGeoSets**), a single index list is used for all attributes. The optional attribute index list is a list of unsigned short integers. The index list is specified using the function **pfGArrayIndexArray()**.

If attribute and index lists are allocated from the **pfMalloc** routines, **pfGArrayAddAttr()** and **pfGArrayAttrPtr()** will correctly update the reference counts of the lists. Specifically, they will decrement the reference counts of the old lists and increment the reference counts of the new lists. It will not free any lists whose reference counts reach 0. When a **pfGeoArray** is deleted with **pfDelete()**, all **pfMalloc**'ed lists will have their reference counts decremented by one and will be freed if their count reaches 0.

When **pfGeoArrays** are copied with **pfCopy()**, all **pfMalloc**'ed lists of the source **pfGeoArray** will have their reference counts incremented by one and those **pfMalloc**'ed lists of the destination **pfGeoArray** will have their reference counts decremented by one. The function **pfCopy()** copies lists only by reference (only the pointer is copied) and will not free any lists whose reference counts reach 0.

Attribute data may be any of the following types of memory:

- Data allocated with **pfMalloc**
This is the usual and recommended memory type for **pfGeoArray** index and attribute arrays.
- Static, **malloc()**, **amalloc()**, **usmallloc()**, and similar data (non-**pfMalloc**'ed data)
This type of memory is not generally recommended since it does not support reference counting or other features provided by **pfMalloc**. In particular, do not use static data because it may result in segmentation violations.
- **pfFlux** memory

In a pipelined, multiprocessing environment, a pfFlux provides multiple data buffers, which allow frame-accurate data modifications to pfGeoArray attribute arrays like coordinates (facial animation) and texture coordinates (ocean waves, surf). The functions **pfGArrayAddAttr()** and **pfGArrayAttrPtr()** will accept a pfFlux* or pfFluxMemory* for the attribute list (index lists do not support pfFlux) and the pfGeoArray will select the appropriate buffer when rendered or intersected. See the man page for pfFlux for more details.

Since pfGeoArrays are cached using vertex array objects, if you want to animate some attributes, you need to either disable caching using the function **pfGArrayAllowCache()** or call the function **pfGArrayUpdateData()** each time you change any of the attribute data.

- pfCycleBuffer and pfCycleMemory

Note that pfCycleBuffer has been obsoleted by pfFlux. See the man page for pfCycleBuffer for more details.

Performer allows mixing pfMalloc'ed, pfFlux, and pfCycleBuffer attributes on a single pfGeoArray.

pfGeoArray Attribute Types

When a new pfGeoArray is created it has no default attribute. When adding a new attribute, you must specify the type of the attribute— that is, whether it specifies one of the following:

- Vertex coordinates
- A normal vector
- color
- Texture coordinates
- Generic user-defined attributes

Attribute types are identified by their name (a string). By default, the following four basic types are defined:

"vertex"	Specifies vertex coordinates. The set function is glVertexPointer() , the OpenGL name is <code>GL_VERTEX_ARRAY</code> , and the mask is <code>0x0f</code> .
"normal"	Specifies normals. The set function is glNormalPointer() , the OpenGL name is <code>GL_NORMAL_ARRAY</code> , and the mask is <code>0x07</code> .
"color"	Specifies colors. The set function is glColorPointer() , the OpenGL name is <code>GL_COLOR_ARRAY</code> , and the mask is <code>0x0f</code> .
"texture coord"	Specifies texture coordinates. The set function is glTexCoordPointer() , the OpenGL name is <code>GL_TEXTURE_COORD_ARRAY</code> , and the mask is <code>0x0f</code> .

These default attribute types and any other types you add are shared among all `pfGeoArray` classes.

A new attribute type can be added using the function **pfGArrayAddAttrType()**. The parameter `func` is the function used to set the attribute, the parameter `ecs` is the OpenGL name of the attribute, and the parameter `mask` is a mask specifying what parameters are sent to the function `func`. The function `func` can have up to four parameters: `size`, `type`, `stride`, and `pointer` (see the previous section for an explanation of these parameters). The parameter `mask` determines which parameters need to be sent. For example, the function **glNormalPointer()** does not take `size` as a parameter. Therefore, the corresponding mask would be `0x07`. A special mask of `0x10` is used for the function **glVertexAttribPointerARB()**, which takes six parameters: `index`, `size`, `type`, `normalized`, `stride`, and `data`.

For convenience, you can also use the following functions to define the attribute types:

pfGArrayAddVertexAttrType() Defines the vertex coordinates attribute type.

pfGArrayAddNormalAttrType() Defines the normals attribute type.

pfGArrayAddColorAttrType() Defines the colors attribute type.

pfGArrayAddTextureAttrType() Defines the texture coordinates attribute type.

pfGArrayAddGenericAttrType() Defines a generic attribute type.

In case of textures, you can specify the texture stage `0,1,...`. Generic attributes use the set function **glVertexAttribPointerARB()** and mask `0x10`.

pfGeoSet Primitive Types

A primitive is a single point, line segment, line strip, triangle, triangle strip, quad, or polygon depending on the primitive type. The primitive type dictates how the coordinate and coordinate index lists are interpreted to form geometry.

Specifying Primitive Types

The function **pfGSetPrimType()** specifies the type of primitives found in a pfGeoArray. The type is one of the following symbolic tokens:

- PFGS_POINTS
- PFGS_LINES
- PFGS_LINESTRIPS
- PFGS_TRIS
- PFGS_QUADS
- PFGS_TRISTRIPS
- PFGS_TRIFANS
- PFGS_POLYS

See the following subsection describes the primitive types. The function **pfGetGSetPrimType()** returns the primitive type of the pfGeoArray. The functions **pfGSetNumPrims()** and **pfGetGSetNumPrims()** set and get the number of primitives in the pfGeoArray, respectively.

Primitive Type Descriptions

A single line strip, triangle strip, or polygon is considered to be a primitive. Therefore, a pfGeoArray may contain multiple strips of differing lengths or multiple polygons with differing number of sides. Therefore, for strip primitives and PFGS_POLYS, a separate array is necessary to specify the number of vertices in each strip or polygon. This array is set by **pfGSetPrimLengths()**. The parameter lengths is an array of vertex counts where the array index is defined as follows:

```
lengths[0] = number of vertices in strip/polygon 0
lengths[1] = number of vertices in strip/polygon 1
.
.
```

`lengths[n-1]` = number of vertices in strip/polygon $n-1$

The value n is the number of primitives set by `pfGSetNumPrims()`. The negative of the proper length may be specified for an individual length of a strip primitive in the `lengths` array to indicate that this `pfGeoArray` attribute should be "hidden" from drawing.

You can use the following functions to manage the length of the strip:

pfGetGSetPrimLengths()	Returns a pointer to the <code>lengths</code> array of <code>geoa</code> , the <code>pfGeoArray</code> .
pfHideGSetStripPrim()	Forces the length of the i th primitive of a stripped <code>pfGeoArray</code> to be the negative of its proper length.
pfUnhideGSetStripPrim()	Sets the primitive length to be the positive value.
pfisGSetStripPrimHidden()	Returns 1 if the i th primitive of the <code>pfGeoArray</code> is negative and 0, otherwise.
pfGetGSetPrimLength()	Always returns a positive length for the i th primitive of the <code>pfGeoArray</code> and can be used wherever the <code>lengths</code> of <code>pfGeoArrays</code> of an unknown source must be inspected to protect against negative values in the <code>lengths</code> array.

In case of line strips, triangle strips, and polygons, use only one primitive in the `pfGeoArray`. It is possible to define more than one strip or polygon but then, internally, one vertex array is used for each strip or polygon, often reducing the performance. It is better to split the strips and polygon into triangles and render it as a set of indexed triangles.

Assume the the following:

- The index list is an array V indexed by i .
- `num` is the number of primitives.
- `lengths` is the array of strip or polygon lengths.
- N_V the size of the coordinate index list.

Given these assumptions, the primitive type interprets V in the following ways:

Primitive Type	Array Interpretation
PFGS_POINTS	The pfGeoArray is a set of num points. Each $V[i]$ is a point where $i = 0, 1, 2, \dots, \text{num}-1$. $Nv = \text{num}$.
PFGS_LINES	The pfGeoArray is a set of num disconnected line segments. Each line segment is drawn from $V[i]$ to $V[i+1]$ where $i = 0, 2, \dots, 2*(\text{num}-1)$. $Nv = 2 * \text{num}$.
PFGS_LINESTRIPS	The pfGeoArray is a collection of num vertex arrays, each containing one line strip (also known as a polyline). $\text{Linestrip}[i]$ is drawn between $V[p+j]$, $j = 0, 1, \dots, \text{lengths}[i]-1$ where p is sum of all $\text{lengths}[k]$, $0 \leq k < i$. $Nv = \text{sum of all lengths}[k]$ where $k = 0, 1, \dots, \text{num}-1$. Note that all $\text{lengths}[i]$ values should be greater than or equal to 2.
PFGS_TRIS	The pfGeoArray is a set of num independent triangles. Each triangle is $V[i], V[i+1], V[i+2]$ where $i = 0, 3, 6, \dots, 3*(\text{num}-1)$. $Nv = 3 * \text{num}$.
PFGS_QUADS	The pfGeoArray is a set of num independent quads. Each quad is $V[i], V[i+1], V[i+2], V[i+3]$ where $i = 0, 4, 8, \dots, 4*(\text{num}-1)$. $Nv = 4 * \text{num}$.
PFGS_TRISTRIPS	The pfGeoArray is a collection of num vertex arrays, each containing one triangle strip. $\text{Tristrip}[i]$ is drawn between $V[p+j]$, $j = 0, 1, \dots, \text{lengths}[i]-1$, where p is sum of all $\text{lengths}[k]$ where $0 \leq k < i$. $Nv = \text{sum of all lengths}[k]$ where $k = 0, 1, \dots, \text{num}-1$. Note that all $\text{lengths}[i]$ values should be greater than or equal to 3.
PFGS_TRIFANS	The pfGeoArray is a collection of num vertex arrays, each containing one triangle fan. Each $\text{trifan}[i]$ is a set of $\text{lengths}[i]$ triangles. The fan starts with the center vertex $V[0]$, with the remaining $\text{lengths}[i]-1$ vertices specifying the outside points.
PFGS_POLYS	The pfGeoArray is a collection of num vertex arrays, each containing one polygon. $\text{Polygon}[i]$ is the convex hull of the vertices $V[p+j]$ where $j = 0, 1, \dots, \text{lengths}[i]-1$ where p is sum of all $\text{lengths}[k]$ where $0 \leq k < i$. $Nv = \text{sum of all lengths}[k]$ where $k = 0, 1, \dots, \text{num}-1$. Note that all $\text{lengths}[i]$ should be greater or equal to 3.

The primitive types `PFGS_TRIS`, `PFGS_QUADS`, `PFGS_TRISTRIPS`, and `PFGS_POLYS` are rendered as filled polygons but will be rendered in wireframe according to the following rules:

Always render in wireframe mode if `PFEN_WIREFRAME` mode is enabled through **`pfGSetDrawMode()`**.

Use the wireframe mode set by the attached `pfGeoState`, if any, as described in the following section “`pfGeoArrays (Geometry) and pfGeoStates (Appearance)`” on page 328.

Use the wireframe mode set by **`pfEnable()`** or **`pfDisable()`** with the `PFEN_WIREFRAME` argument.

The following example creates a nonindexed tristrip `pfGeoArray`.

```
/* Set up a non-indexed, TRISTRIP pfGeoArray */

/* get the default attribute types */
vattr = pfGArrayQueryAttrType("vertex");
cattr = pfGArrayQueryAttrType("color");

garray = pfNewGArray(NULL);
pfGSetPrimType(garray, PFGS_TRISTRIPS);
pfGSetNumPrims(garray, 1);
lengths[0] = 4;
pfGSetPrimLengths(gset, lengths);

coords = (pfVec3*) pfMalloc(sizeof(pfVec3) * 4, NULL);
colors = (pfVec4*) pfMalloc(sizeof(pfVec4) * 4, NULL);

pfGArrayAddAttr(garray, vattr, 3, GL_FLOAT, 0, coords);
pfGArrayAddAttr(garray, cattr, 4, GL_FLOAT, 0, colors);
```

pfGeoArray Special Rendering Characteristics

The functions **pfGSetPntSize()** and **pfGSetLineWidth()** set the point size and line width, respectively, of the pfGeoArray. Point size has effect only when the primitive type is `PFGS_POINTS` and line width is used only for primitive types `PFGS_LINES` and `PFGS_LINESTRIPS` and for all primitives drawn in wireframe mode. A pfGeoArray sets the point size and line width immediately before rendering only if the size or width is greater than zero. Otherwise, it will inherit size or width through the graphics library.

The functions **pfGetGSetPntSize()** and **pfGetGSetLineWidth()** return the point size and line width of the `garray`, respectively.

For pfGeoArrays, there is no function equivalent to **pfGSetDrawMode()** for pfGeosets. Since pfGeoArrays are directly using vertex arrays and vertex objects, the rendering into display lists is not relevant anyway.

pfGeoArrays (Geometry) and pfGeoStates (Appearance)

A pfGeoState is an encapsulation of `libpr` graphics modes and attributes (see Chapter 12, “Graphics State”). For example, a pfGeoState representing a glass surface may reference a shiny pfMaterial and enable transparency. A pfGeoState does not inherit state from other pfGeoStates. Consequently, when attached to a pfGeoArray using **pfGSetGState()**, the pfGeoArray will always be rendered with the state encapsulated by `gstate`, regardless of the order in which pfGeoArray/pfGeoState pairs are rendered. This behavior greatly eases the burden of managing graphics state in the graphics library. A pfGeoArray may directly reference or indirectly index a pfGeoState through a global table.

The function **pfGSetGState()** “attaches” `gstate` to the pfGeoArray so that the pfGeoArray may be drawn with a certain graphics state. When drawn, a pfGeoArray will apply its pfGeoState (if it has one) with **pfApplyGState()** and the graphics library will be initialized to the proper state for drawing the pfGeoArray. A `gstate` value of `NULL` will remove any previous pfGeoState and cause the pfGeoArray to inherit whatever graphics state is around at the time of rendering.

The function **pfGSetGStateIndex()** allows a pfGeoArray to index its pfGeoState. Indexing is useful for efficiently managing a single database with multiple appearances—for example, a normal compared to an infrared view of a scene would utilize two pfGeoState tables, each referencing a different set of pfGeoStates.

Indexed `pfGeoStates` use a global table of `pfGeoState*` specified by **`pfApplyGStateTable()`**. When indexing a `pfGeoState` during the rendering of a `pfGeoArray`, **`pfApplyGState()`** is called with the `indexth` entry of this table if the index can be properly resolved. Otherwise, no `pfGeoState` is applied. The function **`pfGetGSetGStateIndex()`** returns the `pfGeoState` index of the `pfGeoArray` or `-1` if the `pfGeoArray` directly references its `pfGeoState`.

The function **`pfGSetGState()`** increments the reference count of the new `pfGeoState` by one and decrements the reference count of the previous `pfGeoState` by one but does not delete the previous `pfGeoState` if its reference count reaches zero. The function **`pfGSetGStateIndex()`** does not affect `pfGeoState` reference counts.

Note: Any `pfGeoArray` without an associated `pfGeoState` will **not** be rendered with the global, default state but will be drawn with the current state. To inherit the global state, a `pfGeoState` that inherits all state elements should be attached to the `pfGeoArray`. For economy (space and rendering time), `pfGeoArrays` should share like `pfGeoStates`. For more details, see the man page for `pfGeoState`.

The function **`pfGetGSetGState()`** returns the `pfGeoState` associated with the `pfGeoArray` or `NULL` if there is none. If the `pfGeoArray` indexes its `pfGeoState`, **`pfGetGSetGState()`** will look up the `pfGeoState` index in the global `pfGeoState` table and return the result or `NULL` if it cannot resolve the reference.

The function **`pfGSetDecalPlane()`** sets `plane` to be the reference plane used for the the `pfGeoArray` when the current decal mode has `PFDECAL_PLANE` selected. Setting a decal plane on a `pfGeoArray` (as opposed to a `pfGeoState`) may add a small amount of overhead to the drawing of the `pfGeoArray` that may be visible for small `pfGeoArrays`. However, this may be preferable to breaking up `pfGeoStates` for handling many different reference planes. Reference planes are only supported under OpenGL operation and require the `reference_plane` SGI extension to OpenGL. The `PFQFTR_DECAL_PLANE` to `pfQueryFeature` can be used for run-time queries for the support of decal reference planes. See the man page for `pfDecal` for more information.

The function **`pfGSetHighlight()`** sets `highlight` to be the highlighting structure used for the `pfGeoArray`. When this flag is not `PFHL_OFF`, this `pfGeoArray` will be drawn as highlighted unless highlighting has been overridden as off with `pfOverride`. See the man page for `pfHighlight` for information on creating and configuring a highlighting state structure. The function **`pfGetGSetHighlight()`** returns the current `pfGeoSet` highlight definition.

The function **pfDrawHlitedGSet()** is a convenience routine for drawing only the highlighting stage of *gset*, the *pfGeoSet*, according to the currently active highlighting structure. *pfGeoArrays* do not support the highlight mode with highlighted normals.

Drawing pfGeoArrays

The behavior of **pfDrawGSet()** is affected by the presence of a display list. If a *pfDispList* has been opened by **pfOpenDList()**, **pfDrawGSet()** will not have immediate effect but will be captured by the *pfDispList* and will only have effect when that *pfDispList* is later drawn with **pfDrawDList()**.

If *garray* has an attached *pfGeoState*, then **pfDrawGSet()** first calls **pfApplyGState()** before rendering the *pfGeoArray* geometry, as shown in following examples. Note that the *pfGeoArray* inherits the draw function from the parent *pfGeoSet* class.

Example 1:

```
/* Make sure 'garray' has not attached pfGeoState */
pfGSetGState(garray, NULL);

/* Apply graphics state encapsulated by 'gstate' */
pfApplyGState(gstate);

/* Draw 'garray' with graphics state encapsulated by 'gstate' */
pfDrawGSet(garray);
```

Example 2:

```
/* Attach 'gstate' to 'garray' */
pfGSetGState(garray, gstate);

/* Draw 'garray' with graphics state encapsulated by 'gstate' */
pfDrawGSet(garray);
```

Example 3:

```
/* Use indexed pfGeoState */
pfGSetGStateIndex(garray, 2);

/* Set up and apply pfGeoState table */
pfSet(list, 2, gstate);
pfApplyGStateTable(list);
```

```
/* Draw 'garray' with graphics state encapsulated by 'gstate' */  
pfDrawGSet(garray);
```

Examples 1, 2, and 3 are equivalent methods for drawing the same thing. Example 2 is recommended though since the `pfGeoState` and `pfGeoArray` pair can be set up at database initialization time.

The function **pfGSetDrawBin()** sets the `pfGeoArray`'s draw bin identifier to `bin`. The parameter `bin` identifies a drawing bin to which the `pfGeoArray` belongs and is used for controlling the rendering order of a database. The `pfGeoArray` draw bin is currently used only by `libpf` applications (see the description of **pfChanBinOrder()** in section “Sorting the Scene” on page 97) and is ignored by `libpr`-only applications. The default `pfGeoArray` draw bin identifier is `-1`. The function **pfGetGSetDrawBin()** returns the draw bin identifier of `garray`.

The function **pfGSetDrawOrder()** sets the `pfGeoArray`'s order in the bin if the bin sort order is `PFSORT_DRAW_ORDER`. It is necessary to set the draw order of each `pfGeoArray` that contains calligraphic light points (see the man pages for `pfCalligraphic`). Do not set the draw bin for those `pfGeoArrays`, as they will automatically go in the light point display list if a `LPoint` process has been started.

Intersecting with `pfGeoArrays`

The function **pfGSetIsectMask()** enables intersections and sets the intersection mask for the `pfGeoArray`. The parameter `mask` is a 32-bit mask used to determine whether a particular `pfGeoArray` should be examined during a particular intersection request. A non-zero bit-wise AND of the `pfGeoArray`'s mask with the mask of the intersection request **pfGSetIsectSegs()** indicates that the `pfGeoArray` should be tested. The default mask is all one—that is, `0xffffffff`. The function **pfGetGSetIsectMask()** returns the intersection mask of the specified `pfGeoArray`.

Intersections for geometry whose vertex coordinates do not change are more efficient when information is cached for each `pfGeoArray` subjected for intersection. When setting the mask or changing caching, `PFTRAV_SELF` should always be part of `setMode`. If you OR `PFTRAV_IS_CACHE` into `setMode`, it causes the creation or update of the cache. Because creating the cache requires a moderate amount of computation, it is best done at setup time.

For objects whose geometry changes only occasionally, additional calls to **pfGSetIsectMask()** with `PFTRAV_IS_CACHE` ORed into `setMode` will recompute the

cached information. Alternately, if you OR `PFTRAV_IS_UNCACHE` into `setMode`, it will disable caching.

The `bitOp` argument is one of `PF_AND`, `PF_OR`, or `PF_SET` and indicates, respectively, whether the new mask is derived from an AND operation with the old mask, an OR operation with the old mask, or whether it is simply set.

The function **pfGSetBBox()** sets the bounding volume of the `pfGeoArray`. Each `pfGeoArray` has an associated bounding volume used for culling and intersection testing and a bounding mode, either static or dynamic. By definition, the bounding volume of a node encloses all the geometry parented by node. This means that the node and all its children fit within the node's bounding volume.

The mode argument to **pfGSetBBox()** specifies whether or not the bounding volume for node should be recomputed when an attribute of the `pfGeoArray` is changed. If the mode is `PFBOUND_STATIC`, OpenGL Performer will not modify the bound once it is set or computed. If the mode is `PFBOUND_DYNAMIC`, OpenGL Performer will recompute the bound if the number of primitives, the primitive lengths array, or the vertex coordinate arrays are changed. Note that OpenGL Performer does not know if the contents of these arrays changes, only when the pointer itself is set. Recomputation of the bounding box can be forced by calling **pfGSetBBox()** with a `bbox` that is `NULL`. Also note that a `pfGeoArray` cannot update the parent `pfGeode` with this new bounding volume information. As a result, a `pfGeoArray` will not propagate new bounding information up the tree. Call **pfNodeBSphere()** on the parent `pfGeode` to recompute the bounding volume.

The function **pfGetGSetBBox()** copies the bounding box of the `pfGeoArray` into `bbox` and returns the current bounding mode.

The functions **pfGSetBBoxFlux()** and **pfGetGSetBBoxFlux()** set and get a `pfFlux` that can be used to contain the bounding box of a `pfGeoArray`.

The function **pfGSetIsectSegs()** tests for intersections among the `pfGeoArray` and the group of line segments specified in `segSet`. The resulting intersections (if any) are returned in `hits`. The return value of **pfGSetIsectSegs()** is the number of segments that intersected the `pfGeoArray`.

You must supply an empty array `hits` through which results are returned. The array must have an entry for each segment in `segSet`. Upon return, `hits[i][0]` is a `pfHit*` that gives the intersection result for the i^{th} segment in `segSet`. The `pfHit` objects come from an internally maintained pool and are reused on subsequent requests. Hence, the

contents are only valid until the next invocation of **pfGSetIsectSegs()** in the current process. They should not be freed by the application.

The argument *segSet* is a **pfSegSet** public structure specifying the intersection request. In the structure, *segs* is an array of line segments to be intersected against the **pfGeoArray**. The argument *activeMask* is a bit vector specifying which segments in the **pfSegSet** are to be active for the current request. If the *i*th bit is set to 1, it indicates the corresponding segment in the *segs* array is active.

The bit vector *mode* specifies the behavior of the intersection process and is a bit-wise OR of the following:

PFTRAV_IS_PRIM	Intersect with primitives (quads or triangles).
PFTRAV_IS_GSET	Intersect with pfGeoArray bounding boxes.
PFTRAV_IS_NORM	Return a normal in the pfHit structure.
PFTRAV_IS_CULL_BACK	Ignore backfacing polygons.
PFTRAV_IS_CULL_FRONT	Ignore front-facing polygons.

The bit fields **PFTRAV_IS_PRIM** and **PFTRAV_IS_GSET** indicate the level at which intersections should be evaluated and discriminator callbacks, if any, invoked. Note that if neither of these level selectors are specified, no intersection testing is done at all. In the **pfSegSet**, *isectMask* is another bit vector. It is bit-wise ANDed with the intersection mask of the **pfGeoArray**. If the result is zero, no intersection testing is done.

The *bound* field in a **pfSegSet** is an optional user-specified bounding volume around the set of segments. The only supported volume is a cylinder. To use a bounding cylinder, bit-wise OR **PFTRAV_IS_BCYL** into the *mode* field of the **pfSegSet** and assign the pointer to the bounding volume to the *bound* field. The function **pfCylAroundSegs()** will construct a cylinder around the segments.

When a bounding volume is supplied, the bounding volume is tested against the **pfGeoArray** bounding box before examining the individual segments. The largest improvement is for groups of at least several segments which are closely grouped segments. Placing a bounding cylinder around small groups or widely dispersed segments can decrease performance.

The *userData* pointer allows an application to associate other data with the **pfSegSet**. Upon its return in discriminator callbacks, the **pfSegSet**'s *userData* pointer can be

obtained from the returned pfHit with **pfGetUserData()**, the virtual function **pfObject::getUserData()**.

The field `discFunc` is a user-supplied callback function which provides a more powerful means for controlling intersections than the simple mask test. The function acts as a discriminating function which examines information about candidate intersections and judges their validity. When a candidate intersection occurs, the `discFunc` callback is invoked with a pfHit structure containing information about the intersection.

The callback may then return a value that indicates whether and how the intersection should continue. This value is composed of the following major action specifications with additional modifiers bit-wise ORed as explained in the following list:

PFTRAV_CONT	Indicates that the process should continue traversing the primitive list.
PFTRAV_PRUNE	Stops further testing of the line segment against the current pfGeoArray.
PFTRAV_TERM	Stops further testing of the line segment completely.

To have PFTRAV_TERM or PFTRAV_PRUNE apply to all segments, PFTRAV_IS_ALL_SEGS can be ORed into the discriminator return value. This causes the entire traversal to be terminated or pruned.

The callback may OR into the status return value any of the following:

PFTRAV_IS_IGNORE	Indicates that the current intersection should be ignored. Otherwise, the intersection is taken as valid.
PFTRAV_IS_CLIP_START	Indicates that for pruned and continued traversals that, before proceeding, the segment should be clipped to start at the current intersection point.
PFTRAV_IS_CLIP_END	Indicates that for pruned and continued traversals that, before proceeding, the segment should be clipped to end at the current intersection point.

If the field `discFunc` is NULL, the behavior is the same as if the discriminator returned (PFTRAV_CONT | PFTRAV_IS_CLIP_END) so that the intersection nearest the start of the segment will be returned.

A `pfHit` object also conveys information, if any, to the discriminator callback. Table 8-5 lists the information which can be obtained from a `pfHit`.

Table 8-5 Information Obtained from a `pfHit`

Query	Type	Contents
<code>PFQHIT_FLAGS</code>	<code>int</code>	Status flags
<code>PFQHIT_SEGNUM</code>	<code>int</code>	Index of segment in <code>pfSegSet</code>
<code>PFQHIT_SEG</code>	<code>pfSeg</code>	Segment, as clipped
<code>PFQHIT_POINT</code>	<code>pfVec3</code>	Intersection point
<code>PFQHIT_NORM</code>	<code>pfVec3</code>	Normal at intersection point
<code>PFQHIT_VERTS</code>	<code>pfVec3[3]</code>	Vertices of intersected triangle
<code>PFQHIT_TRI</code>	<code>int</code>	Index of triangle in <code>pfGeoArray</code> primitive
<code>PFQHIT_PRIM</code>	<code>int</code>	Index of primitive in <code>pfGeoArray</code>
<code>PFQHIT_GSET</code>	<code>pfGeoArray *</code>	Pointer to intersected <code>pfGeoArray</code>
<code>PFQHIT_NODE</code>	<code>pfNode *</code>	Pointer to <code>pfGeode</code>
<code>PFQHIT_NAME</code>	<code>char *</code>	Name of <code>pfGeode</code>
<code>PFQHIT_XFORM</code>	<code>pfMatrix</code>	Transformation matrix
<code>PFQHIT_PATH</code>	<code>pfPath *</code>	Path within scene graph

The function `pfQueryGSet()` is a convenience routine for determining the values of implicit `pfGeoArray` parameters. The `which` argument is a token which selects the parameter from the set `PFQGSET_NUM_TRIS` and `PFQGSET_NUM_VERTS`. The result is written to the address indicated by `dst`. The number of bytes written to `dst` is returned as the value of `pfQueryGSet()`. The function `pfMQueryGSet()` is similar but copies a series of items sequentially into the buffer specified by `dst`. The items and their order are defined by a NULL-terminated array of query tokens pointed to by `which`. For both functions, the return value is the number of bytes written to the destination buffer.

The function **pfGetGSetClassType()** returns the `pfType*` for the `pfGeoArray` class. The `pfType*` returned by **pfGetGSetClassType()** is the same as the `pfType*` returned by invoking **pfGetType()**, the virtual function **getType()**, on any instance of the `pfGeoArray` class. Because OpenGL Performer allows subclassing of built-in types, when decisions are made based on the type of an object, it is usually better to use **pfIsOfType()**, the member function **isOfType()**, to test if an object is of a type derived from OpenGL Performer type rather than to test for strict equality of the types.

Clip Texture Emulation Support

The function **pfGSetUpdateCteRefs()** determines whether a `pfGeoArray` is to be rendered with an emulated clip texture by looking at the texture `attr` of the `pfGeoState` associated with the `pfGeoArray`. If so, texture coordinate bounds are computed and stored. If not, then any previously allocated texture bounds data is freed. This should be called after changing the texture `attr` (or the texture enable flag) on a `pfGeoState` that has already been assigned to a `pfGeoArray`. Note that **pfGSetGState()** automatically calls **pfGSetUpdateCteRefs()**.

The function **pfGSetCalcTexBBox()** forces the recomputation of a `pfGeoArray`'s texture coordinate bounds, used for clip texture emulation. This should be called after changing texture coordinate values for a `pfGeoArray` if this is to be rendered with an emulated clip texture. Note that this has no effect on `pfGeoArrays` that have not been identified as using an emulated clip texture by a previous call to **pfGSetUpdateCteRefs()**. Note also that **pfGSetUpdateCteRefs()** automatically calls **pfGSetCalcTexBBox()**.

The functions **pfGSetTexBBox_i(uint,uint,uint,uint)** and **pfGSetTexBBox_f(float,float,float,float)** allow you to explicitly set texture coordinate bounds for a `pfGeoArray`. Texture coordinate bounds may be set as four floats, indicating minimum and maximum texture coordinate values for `s` and `t`, or as four integers, as follows for a clip texture with virtual size `V`, and texture coordinate bounding box of `minS, maxS, minT, maxT`:

```
centerS = V*(minS+maxS)/2;
centerT = V*(minT+maxT)/2;
halfwidth = V*(maxS-minS)/2;
halfheight = V*(maxT-minT)/2;
```

Note that this has no effect on `pfGeoArrays` that have not been identified as using an emulated clip texture by a previous call to **pfGSetUpdateCteRefs()**. Note also that `pfGeoArray`'s texture coordinate bounds are internally stored in the integer representation. Therefore, using the integer method is faster.

The functions `pfGSetTexBBox_i(uint*,uint*,uint*,uint*)` and `pfGSetTexBBox_f(float*,float*,float*,float*)` may be used to retrieve the texture coordinate bounds for a `pfGeoArray` that has been identified as using an emulated clip texture by a previous call to `pfGSetUpdateCteRefs()`. Note that both functions return `FALSE` if `pfGeoArray` has not been identified as using an emulated clip texture or `TRUE`, otherwise.

Quick Manipulation of Temporary `pfGeoArrays`

For more information about temporary `pfGeoArrays` and about using the "quick methods/functions", see the man page for `pfDispListOptimizer`.

The function `pfGSetOptimize()` controls whether a `pfGeoArray` is optimized by a `pfDispListOptimizer` (from within a `CULL_SIDEKICK` process). If `_state` is 0, a `pfDispListOptimizer` skips this `pfGeoArray` entirely. The function `pfGetGSetOptimize()` returns the current optimization state of a `pfGeoArray`. The default optimization state of a `pfGeoArray` is 1.

The following example shows one way to create a `pfGeoArray` defining a hexahedron (cube).

```
static pfVec3 coords[] =
{
    {-1.0, -1.0,  1.0}, /* front */
    { 1.0, -1.0,  1.0},
    { 1.0,  1.0,  1.0},
    {-1.0,  1.0,  1.0},

    {-1.0, -1.0,  1.0}, /* left */
    {-1.0,  1.0,  1.0},
    {-1.0,  1.0, -1.0},
    {-1.0, -1.0, -1.0},

    {-1.0, -1.0, -1.0}, /* back */
    {-1.0,  1.0, -1.0},
    { 1.0,  1.0, -1.0},
    { 1.0, -1.0, -1.0},

    { 1.0, -1.0,  1.0}, /* right */
    { 1.0, -1.0, -1.0},
    { 1.0,  1.0, -1.0},
    { 1.0,  1.0,  1.0},
}
```



```
        {-1.0, 1.0, 1.0}, /* top */
        { 1.0, 1.0, 1.0},
        { 1.0, 1.0, -1.0},
        {-1.0, 1.0, -1.0},

        {-1.0, -1.0, 1.0}, /* bottom */
        {-1.0, -1.0, -1.0},
        { 1.0, -1.0, -1.0},
        { 1.0, -1.0, 1.0}
};

static pfVec3 norms[] =
{
    { 0.0, 0.0, 1.0},
    { 0.0, 0.0, 1.0},
    { 0.0, 0.0, 1.0},
    { 0.0, 0.0, 1.0},

    {-1.0, 0.0, 0.0},
    {-1.0, 0.0, 0.0},
    {-1.0, 0.0, 0.0},
    {-1.0, 0.0, 0.0},

    { 0.0, 0.0, -1.0},
    { 0.0, 0.0, -1.0},
    { 0.0, 0.0, -1.0},
    { 0.0, 0.0, -1.0},

    { 1.0, 0.0, 0.0},
    { 1.0, 0.0, 0.0},
    { 1.0, 0.0, 0.0},
    { 1.0, 0.0, 0.0},

    { 0.0, 1.0, 0.0},
    { 0.0, 1.0, 0.0},
    { 0.0, 1.0, 0.0},
    { 0.0, 1.0, 0.0},

    { 0.0, -1.0, 0.0},
    { 0.0, -1.0, 0.0},
    { 0.0, -1.0, 0.0},
    { 0.0, -1.0, 0.0}
};

/* Convert static data to pfMalloc'ed data */
```

```
static void*
memdup(void *mem, size_t bytes, void *arena)
{
    void *data = pfMalloc(bytes, arena);
    memcpy(data, mem, bytes);
    return data;
}

/* Set up a PFGS_QUADS pfGeoArray */
vattrib = pfGArrayQueryAttrType("vertex");
nattrib = pfGArrayQueryAttrType("normal");

garray = pfNewGArray(NULL);
pfGSetPrimType(garray, PFGS_QUADS);
pfGSetNumPrims(garray, 6);

pfGArrayAddAttr(garray, vattrib, 3, GL_FLOAT, 0,
memdup(coords, sizeof(coords), NULL));
pfGArrayAddAttr(garray, nattrib, 3, GL_FLOAT, 0,
memdup(norms, sizeof(norms), NULL));

static pfVec3 coords[] =
{
    {-1.0, -1.0, 1.0}, /* front */
    { 1.0, -1.0, 1.0},
    { 1.0, 1.0, 1.0},
    {-1.0, 1.0, 1.0},

    {-1.0, -1.0, 1.0}, /* left */
    {-1.0, 1.0, 1.0},
    {-1.0, 1.0, -1.0},
    {-1.0, -1.0, -1.0},

    {-1.0, -1.0, -1.0}, /* back */
    {-1.0, 1.0, -1.0},
    { 1.0, 1.0, -1.0},
    { 1.0, -1.0, -1.0},

    { 1.0, -1.0, 1.0}, /* right */
    { 1.0, -1.0, -1.0},
    { 1.0, 1.0, -1.0},
    { 1.0, 1.0, 1.0},

    {-1.0, 1.0, 1.0}, /* top */
    { 1.0, 1.0, 1.0},
```

```
        { 1.0,  1.0, -1.0},
        {-1.0,  1.0, -1.0},

        {-1.0, -1.0,  1.0}, /* bottom */
        {-1.0, -1.0, -1.0},
        { 1.0, -1.0, -1.0},
        { 1.0, -1.0,  1.0}
    };

    static pfVec3 norms[] =
    {
        { 0.0,  0.0,  1.0},
        { 0.0,  0.0,  1.0},
        { 0.0,  0.0,  1.0},
        { 0.0,  0.0,  1.0},

        {-1.0,  0.0,  0.0},
        {-1.0,  0.0,  0.0},
        {-1.0,  0.0,  0.0},
        {-1.0,  0.0,  0.0},

        { 0.0,  0.0, -1.0},
        { 0.0,  0.0, -1.0},
        { 0.0,  0.0, -1.0},
        { 0.0,  0.0, -1.0},

        { 1.0,  0.0,  0.0},
        { 1.0,  0.0,  0.0},
        { 1.0,  0.0,  0.0},
        { 1.0,  0.0,  0.0},

        { 0.0,  1.0,  0.0},
        { 0.0,  1.0,  0.0},
        { 0.0,  1.0,  0.0},
        { 0.0,  1.0,  0.0},

        { 0.0, -1.0,  0.0},
        { 0.0, -1.0,  0.0},
        { 0.0, -1.0,  0.0},
        { 0.0, -1.0,  0.0}
    };

    // Convert static data to pfMalloc'ed data
    static void*
    memdup(void *mem, size_t bytes, void *arena)
```

```
{
    void *data = pfMalloc(bytes, arena);
    memcpy(data, mem, bytes);
    return data;
}

/* Set up a PFGS_QUADS pfGeoArray */
vattrib = pfGeoArray::queryAttrType("vertex");
nattrib = pfGeoArray::queryAttrType("normal");

garray = new pfGeoArray;
garray->setPrimType(PFGS_QUADS);
garray->setNumPrims(6);

garray->addAttr(vattrib, 3, GL_FLOAT, 0,
memdup(coords, sizeof(coords), NULL));
garray->addAttr(nattrib, 3, GL_FLOAT, 0,
memdup(norms, sizeof(norms), NULL));
```

With `pfGeoArrays`, unlike with `pfGeoSets`, you cannot index vertex coordinates and normals separately. This results in bigger memory requirements. The extra storage is worth the reduced rendering times, though.

Other examples of creating `pfGeoArrays` can be found in following files:

(IRIX and Linux)

```
/usr/share/Performer/src/pguide/libpfdu/pfdConvertToGeoArrays.C
/usr/share/Performer/src/pguide/libpr/C++/geoArray.C
```

(Microsoft Windows)

```
%PFROOT%\Src\pguide\libpfdu\pfdConvertToGeoArrays.cxx
%PFROOT%\Src\pguide\libpr\C++\geoArray.cxx
```

Converting `pfGeoSets` to `pfGeoArrays`

Since using `pfGeoArrays` can be much faster on some platforms, such as Onyx4 systems, you can convert your geometry from `pfGeoSets` to `pfGeoArrays` using two functions: **`pfdConvertGeoSetToGeoArray()`** and **`pfdConvertNodeGeoSetsToGeoArrays()`**. The first function converts an individual `pfGeoSet` into a `pfGeoArray`. The second function traverses a `pfNode` and replaces all its `pfGeoSets` with `pfGeoArrays`.

Also, it is possible to use the pseudo loader `libpfgeoa` to convert the geometry from `pfGeoSets` to `pfGeoArrays` during loading. The pseudo loader is used as follows:

```
perfly file.ext.geoa
```

3D Text

In addition to the `pfGeoSet` and `pfGeoArray`, `libpr` offers two other primitives which together are useful for rendering a specific type of geometry—3D characters. See Chapter 3, “Nodes and Node Types” and the description for `pfText` nodes for an example of how to set up the 3D text within the context of `libpf`.

pfFont

The basic primitive supporting text rendering is the `libpr` `pfFont` primitive. A `pfFont` is essentially a collection of `pfGeoSets` in which each `pfGeoSet` represents one character of a particular font. `pfFont` also contain metric data, such as a per-character *spacing*, the 3D escapement offset used to increment a text ‘cursor’ after the character has been drawn. Thus, `pfFont` maintains all of the information that is necessary to draw any and all valid characters of a font. However, note that `pfFont`s are passive and have little functionality on their own; for example, you cannot draw a `pfFont`—it simply provides the character set for the next higher-level text data object, the `pfString`.

Table 8-6 lists some routines that are used with a `pfFont`.

Table 8-6 `pfFont` Routines

Routine	Description
<code>pfNewFont()</code>	Create a new <code>pfFont</code> .
<code>pfDelete()</code>	Delete a <code>pfFont</code> .
<code>pfFontCharGSet()</code>	Set the <code>pfGeoSet</code> to be used for a specific character of this <code>pfFont</code> .
<code>pfFontCharSpacing()</code>	Set the 3D spacing to be used to update a text cursor after this character has been rendered.

Table 8-6 **pfFont Routines (continued)**

Routine	Description
pfFontMode()	Specify a particular mode for this pfFont. Valid modes: PFFONT_CHAR_SPACING—Specify whether to use fixed or variable spacings for all characters of a pfFont. Possible values are PFFONT_CHAR_SPACING_FIXED and PFFONT_CHAR_SPACING_VARIABLE, the latter being the default. PFFONT_NUM_CHARS—Specify how many characters are in this font. PFFONT_RETURN_CHAR—Specify the index of the character that is considered a ‘return’ character and thus relevant to line justification.
pfFontAttr()	Specify a particular attribute of this pfFont. Valid attributes: PFFONT_NAME—Name of this font. PFFONT_GSTATE—pfGeoState to be used when rendering this font. PFFONT_BBOX—Bounding box that bounds each individual character. PFFONT_SPACING—Set the overall character spacing if this is a fixed width font (also the spacing used if one has not been set for a particular character).

Example 8-1 Loading Characters into a pfFont

```

/* Setting up a pfFont */
pfFont *ReadFont(void)
{
    pfFont *fnt = pfNewFont(pfGetSharedArena());
    for(i=0;i<numCharacters;i++)
    {
        pfGeoSet* gset = getCharGSet(i);
        pfVec3* spacing = getCharSpacing(i);

        pfFontCharGSet(fnt, i, gset);
        pfFontCharSpacing(fnt, i, spacing);
    }
}

```

pfString

Simple rendering of 3D text can be done using a pfString. A pfString is an array of font indices stored as 8-bit bytes, 16-bit shorts, or 32-bit integers. Each element of the array contains an index to a particular character of a pfFont structure. A pfString can not be drawn until it has been associated with a pfFont object with a call to **pfStringFont()**. To render a pfString once it references a pfFont, call the function **pfDrawString()**.

The pfString class supports the notion of ‘flattening’ to trade off memory for faster processing time. This causes individual, noninstanced geometry to be used for each character, eliminating the cost of translating the text cursor between each character when drawing the pfString.

Example 8-2 illustrates how to set up and draw a pfString.

Example 8-2 Setting Up and Drawing a pfString

```

/* Create a string a rotate it for 2.5 seconds */
void
LoadAndDrawString(const char *text)
{
    pfFont *myfont = ReadMyFont();
    pfString *str = pfNewString(NULL);
    pfMatrix mat;
    float start,t;

    /* Use myfont as the 3-d font for this string */
    pfStringFont(str, fnt);

    /* Center String */
    pfStringMode(str, PFSTR_JUSTIFY, PFSTR_MIDDLE);

    /* Color String is Red */
    pfStringColor(str, 1.0f, 0.0f, 0.0f, 1.0f);

    /* Set the text of the string */
    pfStringString(str, text);

    /* Obtain a transform matrix to place this string */
    GetTheMatrixToPlaceTheString(mat);
    pfStringMat(str, &mat);

    /* optimize for draw time by flattening the transforms */
    pfFlattenString(str);

```

```
/* Twirl text for 2.5 seconds */
start = pfGetTime();
do
{
    pfVec4 clr;
    pfSetVec4(clr, 0.0f, 0.0f, 0.0f, 1.0f);

    /* Clear the screen to black */
    pfClear(PFCL_COLOR|PFCL_DEPTH, clr);

    t = (pfGetTime() - start)/2.5f;
    t = PF_MIN2(t, 1.0f);

    pfMakeRotMat(mat, t * 315.0f, 1.0f, 0.0f, 0.0f);
    pfPostRotMat(mat, mat, t * 720.0f, 0.0f, 1.0f, 0.0f);

    t *= t;
    pfPostTransMat(mat, mat, 0.0f,
        150.0f * t + (1.0f - t) * 800.0f, 0.0f);

    pfPushMatrix();
    pfMultMatrix(mat);

    /* DRAW THE INPUT STRING */
    pfDrawString(str);

    pfPopMatrix();

    pfSwapWinBuffers(pfGetCurWin());
} while(t < 2.5f);
}
```

Table 8-7 lists the key routines used to manage pfStrings.

Table 8-7 pfString Routines

Routine	Description
pfNewString()	Create a new pfString.
pfDelete()	Delete a pfString.
pfStringFont()	Set the pfFont to use when drawing this pfString.

Table 8-7 pfString Routines (continued)

Routine	Description
pfStringString()	Set the character array that this pfString will represent or render.
pfDrawString()	Draw this pfString.
pfFlattenString()	Flatten all positional translations and the current specification matrix into individual pfGeoSets so that more memory is used, but no matrix transforms or translates have to be done between each character of the pfString.
pfStringColor()	Set the color of the pfString.
pfStringMode()	Specify a particular mode for this pfString. Valid modes: PFSTR_JUSTIFY — Sets the line justification and has the following possible values: PFSTR_FIRST or PFSTR_LEFT, PFSTR_MIDDLE or PFSTR_CENTER, and PFSTR_LAST or PFSTR_RIGHT. PFSTR_CHAR_SIZE — Sets the number of bytes per character in the input string and has the following possible values: PFSTR_CHAR, PFSTR_SHORT, PFSTR_INT.
pfStringMat()	Specify a transform matrix that affects the entire character string when the pfString is drawn.
pfStringSpacingScale()	Specify a scale factor for the escapement translations that happen after each character is drawn. This routine is useful for changing the spacing between characters and even between lines.

Higher-Order Geometric Primitives

OpenGL Performer also supports a large set of higher-order primitives that you can include in a scene graph. These higher-order primitives extend the simpler geometric primitives that can be specified using `pfGeodes`. “Higher-order” means objects other than sets of triangles, and typically implies an object that is defined mathematically.

Designs produced by CAD systems are defined by mathematically defined surface representations. By providing direct support for them, OpenGL Performer expands possible applications from simple walkthrough ability to direct interaction with the design data base.

OpenGL Performer also provides classes to define discrete curves and discrete surfaces.

The objects are discussed in the following sections:

- “Features and Uses of Higher-Order Geometric Primitives” on page 348
- “Objects Required by Reps” on page 348
- “Geometric Primitives: The Base Class `pfRep` and the Application `repTest`” on page 352
- “Planar Curves” on page 354
- “Spatial Curves” on page 377
- “Parametric Surfaces” on page 381
- “Meshes” on page 420
- “Subdivision Surfaces” on page 427

Features and Uses of Higher-Order Geometric Primitives

Higher-order geometric primitives, called *representations* or simply *reps*, facilitate the design process by providing a library of useful curves and surfaces that ease interactive flexibility, accelerate scene-graph transformations, and reduce the memory footprint of the scene graph. Reps yield these advantages by using parameters to describe objects. Instead of a collection of vertices, which must be manipulated independently to change a surface, reps define surfaces in terms of a relatively small set of control parameters; they are more like pure mathematical objects.

Reps and the Rendering Process

OpenGL Performer allows you to interact with an abstract object (a representation or rep) and treat rendering as a separate operation. A simple example of a rep is a sphere, defined by a radius and a center. After defining a sphere, you can implement how it is rendered in several ways: by tessellating, by a sphere-specific draw routine, or conceivably by hardware. Member functions of geometric-primitive classes allow you to implement the most appropriate way of rendering. The fundamental rendering step of tessellating a representation is discussed in Chapter 11, “Rendering Higher-Order Primitives: Tessellators”.

Trimmed NURBS

NURBS curves and surfaces are included in the set of OpenGL Performer reps. OpenGL also has these, but OpenGL Performer NURBS have two advantages:

- You can maintain topology, so cracks do not appear at the boundaries of adjacent tessellations when they are drawn.
- You have better control over tessellation.

See Chapter 10, “Creating and Maintaining Surface Topology”.

Objects Required by Reps

To use reps effectively, you have to understand the OpenGL Performer representations of geometric points and the transformation matrices that are used by the methods of the rep classes.

New Types Required for Reprs

The classes `pfRVec2`, `pfRVec3`, and `pfRVec4` define two-, three-, and four-dimensional vectors, and include common operations of vector algebra such as addition, scalar multiplication, cross products, and so on. See the header file `Performer/pr/pfLinMath.h` for a list of operations defined for each vector.

The classes `pfRVec2`, `pfRVec3`, `pfRVec4` and `pfRMatrix` are composed of either single- or double-precision values based on the `PF_REAL_IS_DOUBLE` `#define`. Currently, `PF_REAL_IS_DOUBLE` is set to 0. Hence, all `pfRVecs` as well as `pfRMatrix` and the `pfReal` type are defined as single-precision elements. It is important to use these new types (which are essentially `#define` statements) so that you may change to double- or arbitrary-precision versions of these elements when this functionality is enabled in OpenGL Performer.

One more type, `pfBool`, has also been added to the repertoire of types for OpenGL Performer and it always maps to the value of a 32-bit integer, regardless of the value of the `PF_REAL_IS_DOUBLE` `#define`, which can be found in `Performer/pf.h`.

In addition, `pfLoop` has been defined as a 32-bit integer and can take on one of the following values:

- `PFLOOP_OPEN`
- `PFLOOP_CLOSED`
- `PFLOOP_PERIODIC`
- `PFLOOP_UNRESOLVED`

Classes for Scalar Functions

The `pfScalar` class is the base class for defining scalar functions; it allows you to conveniently read and write functions. The class provides a virtual evaluation method.

Class Declaration for pfScalar

The class has the following main methods:

```
class pfScalar : public pfObject
{ public:
  // Creating and destroying
  pfScalar();
  virtual ~pfScalar();
  virtual pfReal eval(pfReal u) = 0;
};
```

The class pfCompositeScalar allows you to define the functional composition of two pfScalars.

Class Declaration for pfCompositeScalar

The class has the following main methods:

```
class pfCompositeScalar : public pfScalar
{ public:
  // Creating and destroying
  pfCompositeScalar( );
  pfCompositeScalar(pfScalar *outFun, pfScalar *inFun);
  virtual ~pfCompositeScalar();

  // Accessor functions
  pfScalar *getOutF()
  pfScalar *getInF()
  void      setOutF(pfScalar *outF);
  void      setInF (pfScalar *inF);

  pfReal eval(pfReal t);
```

Main Features of the Methods in pfCompositeScalar

eval() Returns the value of **outF(inF(t))**.

Trigonometric Functions

OpenGL Performer provides classes for two trigonometric functions, pfCosScalar and pfSinScalar. The class declarations are similar to that of pfScalar.

Polynomials

Polynomials of arbitrary degree are defined by the class pfPolyScalar.

Class Declaration for pfPolyScalar

The class has the following main methods:

```
class pfPolyScalar : public pfScalar
{
public:
    // Creating and destroying
    pfPolyScalar( void );
    pfPolyScalar( int degree, pfReal* coef);
    virtual ~pfPolyScalar();
    // Accessor functions
    void set( int degree, pfReal* coef);
    int getDegree()
    pfReal getCoef( int i)
    // Evaluators
    pfReal eval(pfReal u);
};
```

Matrix Class: pfRMatrix

Each geometric primitive is defined with respect to its own coordinate system. The elementary definition of an object gives a particular orientation and location with respect to the origin. This reference frame can, in turn, be manipulated by a pfDCS to place it in a scene or manipulate it.

The base class for higher-order primitives has methods that allow you to locate and orient a primitive with respect to its own reference frame. These methods make insertion of pfDCS nodes whenever you want to define the location or orientation of an object or to change the shape of an object unnecessary.

The location is defined by an pfRVec2 or pfRVec3, and the orientation is controlled by a 3×3 matrix, held in the class pfRMatrix. If the matrix is not a rotation matrix, you can change the shape of an object, for example, you can distort a sphere into an ellipsoid.

Geometric Primitives: The Base Class pfRep and the Application repTest

pfRep is the base class for higher-order geometric primitives that are stored in an OpenGL Performer scene graph. A pfRep is derived from a pfGeode and is therefore always a leaf node. Figure 9-1 shows the hierarchy of classes derived from pfRep.

The following sections discuss the subclasses of pfRep:

- “Planar Curves” on page 354
- “Spatial Curves” on page 377
- “Parametric Surfaces” on page 381
- “Meshes” on page 420
- “Subdivision Surfaces” on page 427

To experiment with pfReps, you can use and modify the application repTest in `/usr/share/Performer/src/pguide/libpf/C++/repTest.C` on IRIX and Linux and in `%PFROOT%\Src\pguide\libpf\C++\repTest.cxx` on Microsoft Windows. This code provides sample instances of several geometric representations, as well as the tessellation and OpenGL Performer calls that render the objects. Sample code from repTest is included with discussions of several of the classes derived from pfRep.

pfRep has methods to orient the object in space, so you do not have to place a pfDCS node above each pfRep to move it from its default position.

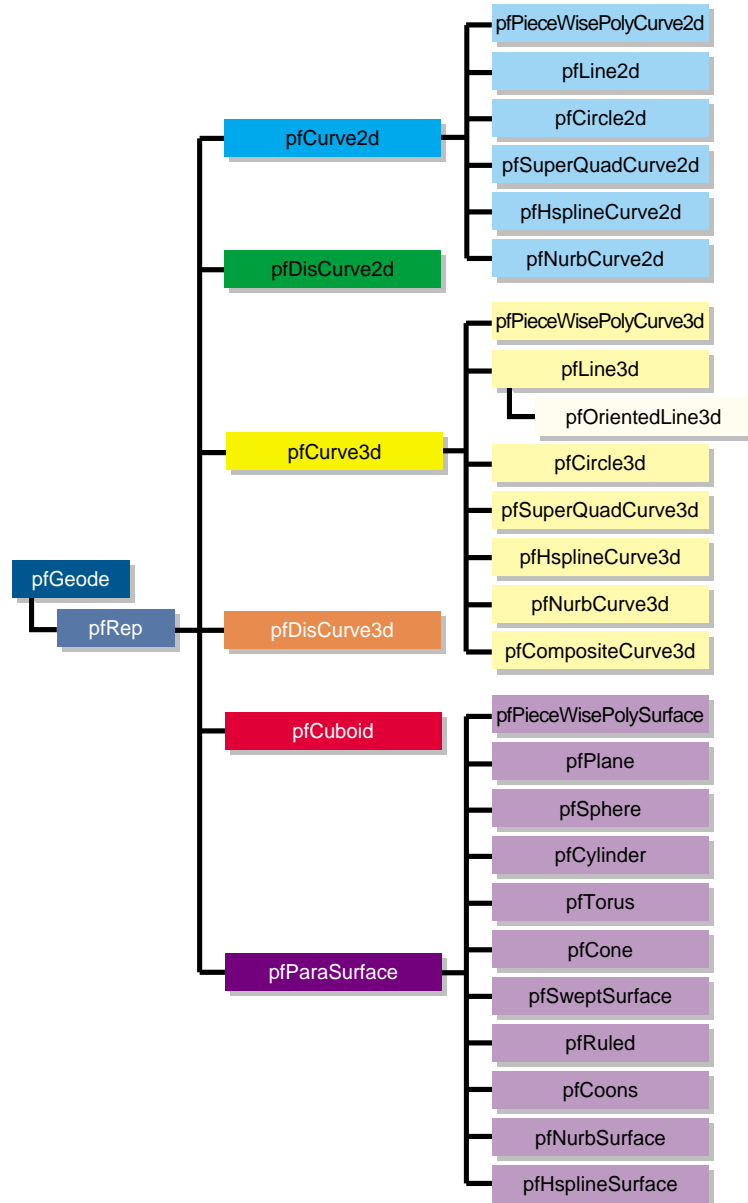

Figure 9-1 Class Hierarchy for Higher-Order Primitives

Class Declaration for pfRep

The class has the following main methods:

```
class pfRep : public pfGeode
{
public:
  pfRep( );
  virtual ~pfRep( );

  // Accessor functions
  void setOrigin( const pfRVec3& org );
  void setOrient( const pfRMatrix& mat );

  void getOrigin(pfRMatrix& mat );
  void getOrient(pfRVec3& org );
};
```

Main Features of the Methods in pfRep

- setOrient()** Sets the orientation of the representation with respect to the origin using matrix multiplication.
- setOrigin()** Sets the location of the representation with respect to the origin. For example, supplying the vector (1,0,0) shifts the location of the object 1 unit in the direction of the positive X axis.

pfRep's subclasses typically include evaluator methods to determine coordinates of points, tangents, and normals. If you do not want the values corresponding to the default position, do not call these methods before you use **setOrient()** and **setOrigin()** to locate an pfRep. Thus, for example, when defining points on a circle, first set the center and the radius, then call **setOrient()** to set the orientation, and then evaluate points.

Planar Curves

A parametric curve in the plane can be thought of as the result of taking a piece of the real number line, twisting it, stretching it, maybe gluing the ends together, and laying it down on the plane. The base class for parametric curves that lie in the XY plane is the class pfCurve2d.

An important use of `pfCurve2d` is to specify trim curves, which define boundaries for surfaces. Surfaces are parameterized by part of a plane, which in OpenGL Performer is referred to as the *uv plane*. When an `pfCurve2d` is used to define a trim curve, it is treated as a curve in the UV plane. This topic is discussed further in the section “Parametric Surfaces” on page 381.

Another important use of `pfCurve2d` is for specifying cross sections for swept surfaces. See “Swept Surfaces” on page 401.

OpenGL Performer also provides a class to create discrete curves, `pfDisCurve2d`.

The following sections discuss planar curve classes, most of which are derived from `pfCurve2d`:

- “Mathematical Description of a Planar Curve” on page 355
- “Lines in the Plane” on page 359
- “Circles in the Plane” on page 360
- “Superquadric Curves: `pfSuperQuadCurve2d`” on page 362
- “Hermite-Spline Curves in the Plane” on page 365
- “NURBS Overview” on page 366
- “NURBS Curves in the Plane” on page 371
- “Piecewise Polynomial Curves: `pfPieceWisePolyCurve2d`” on page 373
- “Discrete Curves in the Plane” on page 374

Mathematical Description of a Planar Curve

Planar curves consist of sets of points, described by two-dimensional vectors, `pfRVec2s`. They are parameterized by the `pfReal` variable t ; as t varies, a point “moves” along the curve. t can be thought of as the amount of time that has passed as a point moves along the curve. Or, t can measure the distance traveled.

More precisely, each component of a point on the curve is a function of t , which lies in the *parameter interval* (t_0, t_1) on the real line. Points on the curve are described by a pair of functions of t : $(x(t), y(t))$.

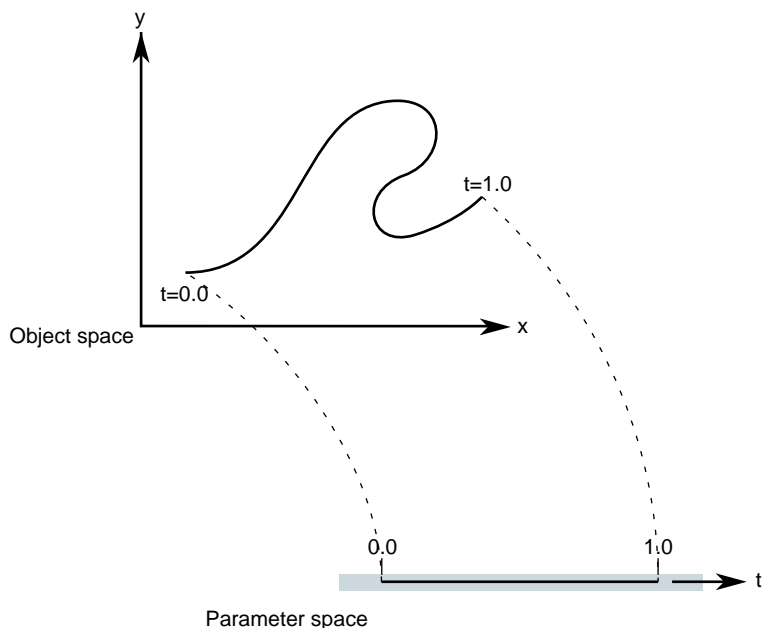

Figure 9-2 Parametric Curve: Parameter Interval (0,1).

Classes derived from `pfCurve2d` inherit a set of *evaluator functions* which, for a given value of t , evaluate a point on the curve, the tangent and normal vectors at the point, and the curvature. Naturally, the base-class evaluator that locates points on the curve is a pure virtual function.

To evaluate tangent and normal vectors at a point, `pfCurve2d` provides virtual functions that, by default, use finite-central-difference calculations. To compute the tangent to the curve at $\mathbf{p}[t]$, a point on the curve, the tangent evaluator function takes the vector connecting two “nearby” points on the curve, $\mathbf{p}[t+\Delta t] - \mathbf{p}[t-\Delta t]$ where Δt is “small,” and divides by $2\Delta t$. Similarly, a finite-central-difference calculation of the normal vector uses the difference between two nearby tangent vectors: $\mathbf{n}[t] = (\mathbf{t}[t+\Delta t] - \mathbf{t}[t-\Delta t])/2\Delta t$.

Class Declaration for pfCurve2d

The class has the following main methods:

```

class pfCurve2d : public pfRep
{
public:
// Creating and destroying
pfCurve2d( );
pfCurve2d( pfReal beginT, pfReal endT );

virtual ~pfCurve2d();

// Accessor functions
void setBeginT( const pfReal beginT );
void setEndT( const pfReal endT );

pfReal getBeginT();
pfReal getEndT();

pfRVec2 getBeginPt();
pfRVec2 getEndPt();

pfRVec2 getBeginTan();
pfRVec2 getEndTan();

void setClosed( const pfLoop loopVal );
pfLoop getClosed();

void setClosedTol( const pfReal tol );
pfReal getClosedTol() const;

// Evaluators
virtual void evalPt( pfReal t, pfRVec2 &pnt ) = 0;
virtual void evalTan( pfReal t, pfRVec2 &tan );
virtual void evalNorm( pfReal t, pfRVec2 &norm );
virtual void evalCurv( pfReal t, pfReal *curv );
virtual void eval( pfReal t, pfRVec2 &pnt,
                  pfRVec2 &tan,
                  pfReal *curv,
                  pfRVec2 &norm );
};

```

Main Features of the Methods in pfCurve2d**pfCurve2d(beginT, endT)**

Creates an instance of **pfCurve2d()**. If you do not specify any arguments, then the parametric range of the curve is [0.0,1.0].

eval()

For a given t , returns the position, tangent, curvature, and normal vectors.

evalPt()

Is a pure virtual function to evaluate position on the curve.

evalTan(), evalCurv(), and evalNorm()

Evaluate the curve's tangent, curvature, and normal vectors, respectively. The default methods approximate the computation using central differences taken about a small Δt , given by $(endT - beginT) * functionTol$. *functionTol* is a static data element specified in the file *pfRep.h*.

setBeginT() and setEndT(), getBeginPt() and getEndPt()

Set and get the parameter range for the curve. Whenever you set one of these values, the endpoint of the curve changes. Therefore, each of these methods also recomputes the endpoint, which is cached because it is frequently used. Also, the methods recompute the Δt used to approximate derivatives.

Note that all planar curve classes derived from **pfCurve2d** reuse **setBeginT()** and **setEndT()** to define the extents of their curves.

setClosed() and getClosed()

Set and get whether a curve is closed.

A closed curve is one for which the endpoints match. OpenGL Performer determines automatically whether curves are closed, but you can override this with **setClosed()**.

setClosedTol() and getClosedTol()

Set and get the mismatch between endpoints that is allowed when calculating whether curves are closed.

To specify the origin used to locate an **pfCurve2d**, use the first two components set by the inherited method **pfRep::setOrigin()**.

Lines in the Plane

Parametric lines in the plane are defined by beginning and ending points. The parameterization is such that as t varies from t_1 to t_2 , a point on the line “moves,” at a uniform rate, from the beginning to the ending point.

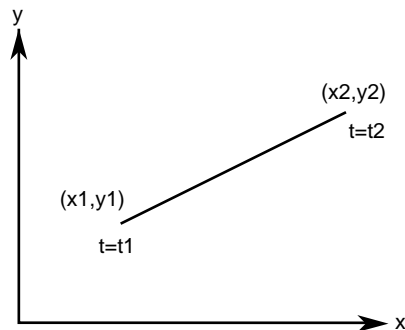

Figure 9-3 Line in the Plane Parameterization

Class Declaration for pfLine2d

The class has the following main methods:

```
class pfLine2d : public pfCurve2d
{
public:
// Creating and destroying
pfLine2d();
pfLine2d( pfReal x1, pfReal y1, pfReal t1,
          pfReal x2, pfReal y2, pfReal t2 );
virtual ~pfLine2d();

// Accessor functions
void setPoint1( pfReal x1, pfReal y1, pfReal t1 ) ;
void setPoint2( pfReal x2, pfReal y2, pfReal t2 ) ;
void getPoint1( pfReal *x1, pfReal *y1, pfReal *t1 ) const;
void getPoint2( pfReal *x2, pfReal *y2, pfReal *t2 ) const;
// Evaluators
void evalPt( pfReal t, pfRVec2 &pnt );
};
```

Main Features of Methods in pfLine2d

- pfLine2d()** Creates a parametric line with end points $(0,0)$ and $(1,0)$, and parameter interval $(0,1)$.
- pfLine2d($x1, y1, t1, x2, y2, t2$)** Creates a parametric line starting at the point $(x1, y1)$ and ending at $(x2, y2)$. The line is parameterized so that $t = t1$ corresponds to $(x1, y1)$ and $t = t2$ corresponds to $(x2, y2)$.
- evalPt()** Is the only evaluator function defined for this object. The tangent vector is $(x2-x1, y2-y1)$ and the curvature is zero.
- setPoint*()** and **getPoint*()** Set and get the end points of the line.

Circles in the Plane

Use the class pfCircle2d to define a parametric circle in the plane. The parameterization is such that t is the angular displacement, in radians, in a counterclockwise direction from the X axis. Figure 9-4 illustrates the parameterization of the circle.

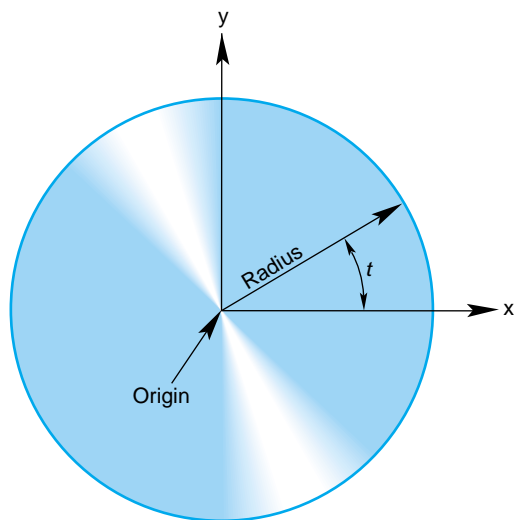

Figure 9-4 Circle in the Plane Parameterization

Class Declaration for pfCircle2d

The class has the following main methods:

```
class pfCircle2d : public pfCurve2d
{
public:
    // Creating amd destroying
    pfCircle2d();
    pfCircle2d( pfReal rad, pfRVec2 *org );
    virtual ~pfCircle2d();
    // Accessor functions
    void setRadius( pfReal rad ) ;
    pfReal getRadius() const;
    // Evaluator
    void evalPt( pfReal t, pfRVec2 &pnt );
    void evalTan( pfReal t, pfRVec2 &tan );
    void evalCurv( pfReal t, pfReal *curv );
    void evalNorm( pfReal t, pfRVec2 &norm );
    void eval( pfReal t,
              pfRVec2 &pnt,
              pfRVec2 &tan,
              pfReal *curv,
              pfRVec2& norm );
};
```

Main Features of the Methods in pfCircle2d

pfCircle2d inherits methods to set the range of parameter values from pfCurve2d.

pfCircle2d(*rad*, *org*)

Creates an instance of a two-dimensional circle with radius *rad* centered at *org*. The default circle has unit radius and origin (0,0). To change the default position, use the methods **setOrigin()** and **setOrient()** inherited from **pfRep**.

setRadius() and getRadius()

Set and get the circle's radius.

pfCircle2d provides exact calculations for the evaluator functions inherited from pfCurve2d.

Superquadric Curves: pfSuperQuadCurve2d

The class pfSuperQuadCurve2d provides methods to define a generalization of a circle that, when used for constructing a swept surface, is convenient for generating rounded, nearly square surfaces, or surfaces with sharp cusps (see “Swept Surfaces” on page 401). Two examples of superquadrics appear in repTest.

The position along the curve is specified by an angle from the x axis, in the same as for an pfCircle2d. The shape of the curve is controlled by a second parameter.

A superquadric is the set of points (x,y) given by the following equation that clearly expresses the relationship to the equation of a circle:

$$(x^2)^{1/\alpha} + (y^2)^{1/\alpha} = (r^2)^{1/\alpha}$$

The above equation can be written in a parametric form:

$$x(t) = r|\cos[t]|^\alpha \text{sign}[\cos[t]]$$

$$y(t) = r|\sin[t]|^\alpha \text{sign}[\sin[t]]$$

The family of curves generated by these equations as the quantity α varies can be described as follows (see Figure 9-5).

Four points are always on the curve for any value of α : $(\pm r, 0)$ and $(0, \pm r)$.

- If α is 1, the curve is a circle of radius r .
- As α approaches zero, the circle expands to fill a square of side $2r$ as if you were inflating a balloon in a box.
- As α approaches infinity, the circle contracts towards the two diameters along the x and y axes, approaching two orthogonal lines as if you deflated a balloon with two rigid orthogonal sticks inside it.

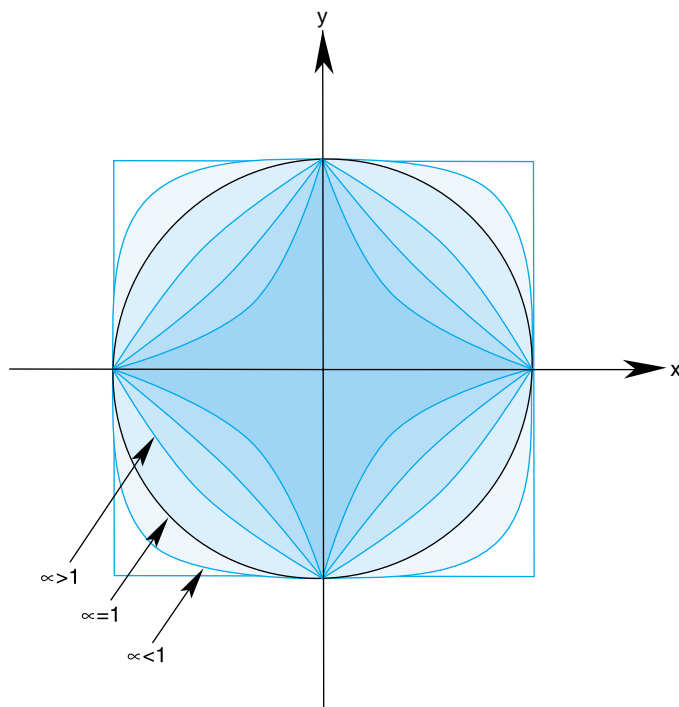

Figure 9-5 Superquadric Curve's Dependence on the Parameter α .

Class Declaration for `pfSuperQuadCurve2d`

The class has the following main methods:

```
class pfSuperQuadCurve2d : public pfCurve2d
{
public:
    // Creating and destroying
    pfSuperQuadCurve2d();
    pfSuperQuadCurve2d( pfReal radius,
                        pfRVec2 *origin,
                        pfReal exponent );
    virtual ~pfSuperQuadCurve2d();

    // Accessor functions
    void setRadius( pfReal _radius );
```

```
pfReal getRadius() const;

void  setExponent( pfReal _exponent );
pfReal getExponent() const;

// Evaluator
void evalPt( pfReal t, pfRVec2 &pnt );
};
```

Main Features of the Methods in pfSuperQuadCurve2d

The accessor functions allow you to control the radius r and exponent α of the curve. To change the default position, use the methods **setOrigin()** and **setOrient()** inherited from pfRep.

Hermite-Spline Curves in the Plane

A *spline* is a mathematical technique for generating a single geometric object from pieces. An advantage of breaking a curve into pieces is greater flexibility when you have many points controlling the shape: changes to one piece of the curve do not have significant effects on remote pieces. To define a spline curve for a range of values for the parameter t , say from 0 to 3, you “tie” together pieces of curves defined over intervals of values for t . For example, you might assign curve pieces to the three intervals 0 to 1, 1 to 2, and 2 to 3. The four points in the set of parameters, 0, 1, 2, and 3, define the endpoints of the intervals and are called *knots*.

A *Hermite-spline* curve is a curve whose segments are cubic polynomials of the parameter t , where the coefficients of the polynomials are determined by the position and tangent to the curve at each knot point. Thus the curve passes through each of a set of specified points with a specified tangent vector. The set of knot points must be increasing values of the parameter t .

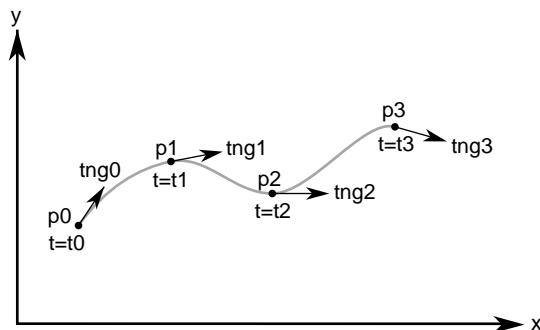

Figure 9-6 Hermite Spline Curve Parameterization

Class Declaration for pfHsplineCurve2d

The class for creating Hermite spline curves is `pfHsplineCurve2d`. The class has the following main methods:

```
class pfHsplineCurve2d : public pfCurve2d
{
public:
// Creating and destroying
pfHsplineCurve2d();
virtual ~pfHsplineCurve2d();
```

```
// Accessor functions
void setPoint( int i, const pfRVec2 &p );
void setTangent( int i, const pfRVec2 &tng );
void setKnot( int i, pfReal t );

int getKnotCount() const;
pfRVec2* getPoint( int i );
pfRVec2* getTangent( int i );
pfReal getKnot( int i );

// Evaluator
virtual void evalPt( pfReal t, pfRVec2 &pnt );
};
```

NURBS Overview

The acronym NURBS stands for “nonuniform rational B-splines.” NURBS define a set of curves and surfaces that generalizes Bezier curves. Both NURBS curves and Bezier curves are “smooth” curves that are well suited for CAD design work. They are essentially determined by a set of points that controls the shape of the curves, although the points do not lie on the curves.

Because NURBS properties are not widely known, a discussion of their features precedes details of how to create instances of them. The discussion is necessarily brief and is intended to provide the minimum amount of information needed to start using OpenGL Performer NURBS classes.

This general discussion of NURBS is presented in the following sections:

- “OpenGL Performer NURBS Classes” on page 367
- “NURBS Elements That Determine the Control Parameters” on page 367
- “Knot Points” on page 368
- “Control Hull” on page 368
- “Features of NURBS and Bezier Curves” on page 369
- “Weights for Control Points” on page 368

OpenGL Performer NURBS Classes

The OpenGL Performer classes allow you to treat a NURBS object as a black box that takes a set of control parameters and generates a geometric shape. A NURBS object's essential properties are rather straightforward, although the underlying mathematics are complex. Unlike lines and circles, NURBS can represent a large set of distinct complex shapes. Because of this flexibility, developing a NURBS object is often best done interactively. For example, you could allow a user to design a curve using an interface in which control parameters are changed by clicking and dragging and by using sliders.

There are three classes:

- The `pfNurbCurve2d` class generates curves in the plane, the simplest NURBS object provided by OpenGL Performer.
- The `pfNurbCurve3d` class generates NURBS curves in three-dimensional space.
- The `pfNurbSurface` class generates NURBS surfaces, which extend the ideas underlying NURBS curves to two-dimensional objects. The principles for controlling the shapes of these objects are all essentially the same.

NURBS Elements That Determine the Control Parameters

This section provides some theoretical background information on NURBS elements. If you already understand NURBS, continue with "NURBS Curves in the Plane" on page 371)

NURBS are defined by the following elements, discussed in this chapter:

- Nonuniform knot points (see "Knot Points" on page 368)
- A control hull consisting of control points (see "Control Hull" on page 368)
- Weighting parameters for control points (see "Weights for Control Points" on page 368)

Knot Points

The knot points determine how and where the pieces of the NURBS object are joined. The knots are nondecreasing— but not necessarily uniformly spaced or distinct—values of the parameter t for the curve. The sequence of knots need not have uniform spacing in the parameter interval. In fact, the mathematics of NURBS make it possible and, perhaps, necessary to repeat knot values; that is, knots can appear with a certain *multiplicity*. The number of knot points is determined by counting all the knot points, including all multiplicities.

For example, although the sequence $(0,0,0,0,1,1,1,1)$ has only two distinct knot points, the number of knot points is eight. (This example it is the set of knot points for a cubic Bezier curve defined on the interval 0 to 1). How to determine the order of a NURBS curve is discussed in “Features of NURBS and Bezier Curves” on page 369.

Control Hull

The control hull is the set of all points that determine the basic shape of NURBS object. The effect of the control hull is determined by a “B-spline.”

A B-spline is a basis spline; a set of special curves associated with a given knot sequence from which you can generate all other spline curves having the same knot sequence and control hull. For each interval described by the knot sequence, the corresponding piece of a B-spline curve is a Bezier curve.

B-spline curves are like Bezier curves in that they are defined by an algorithm that acts on a sequence of control points, the *control hull*, which lie in the plane or in three-dimensional space.

Weights for Control Points

The third set of control parameters for a NURBS curve is the set of weights associated with the control points.

A *rational* B-spline consists of curves that have a weight associated with each control point. The individual pieces of a NURBS curve usually are not Bezier curves but rational Bezier curves. The values of the weights have no absolute meaning; they control how “hard” an individual control point pulls on the curve relative to other control points. If the weights for all the control points of a rational Bezier curve are equal, then the curve

becomes a simple Bezier curve. Weights allow construction of exact conic sections, which cannot be made with simple Bezier curves.

Features of NURBS and Bezier Curves

Bezier curves have the following properties:

- They are “nice” polynomial curves whose *degree* is one less than the number of control points.

For a polynomial curve, each of the components is a polynomial function of the parameter t . The number of coefficients in the polynomial, the *order* of the polynomial, is equal to the number of control points.

- The control points determine the shape of the Bezier curve, but they do not lie on the curve, except the first and last control points.

NURBS curves differ in the following ways:

- The order of the polynomial pieces that make up the NURBS curve depends on the number of control points *and* the number of knot points. The order of a NURBS curve is the difference between the number of knots, accounting for multiplicity, and the number of control points. That is,
$$\text{order} = \text{number of knot points} - \text{number of control points}$$
- The relationship between the curves and the control points is looser than for a Bezier curve. It also depends on the knot sequence and the sequence of weights.

Equation Used to Calculate a NURBS Curve

The equation that defines the NURBS curve is

$$p(t) = \frac{\sum_i B_i^n(t) C_i}{\sum_i B_i^n(t) W_i}$$

- $p(t)$ is a point on the surface $p(t)$
- $B_i^n(t)$ is the i^{th} B-spline basis function of degree n
- C_i is a control point
- W_i is the weight for the control point

Alternative Equation for a NURBS Curve

If you have a surface developed from the alternative expression for a NURBS surface:

$$p(u, v) = \frac{\sum_i B_i^n(u) W_i C_i}{\sum_i B_i^n(u) W_i}$$

you must change the coordinates of the control points to get the same surface from OpenGL Performer; you convert the coordinates of the control points from (x, y, z) to (wx, wy, w) .

NURBS Curves in the Plane

The class `pfNurbCurve2d` defines a nonuniform rational B-spline curve in the plane, the simplest NURBS object provided by OpenGL Performer.

Class Declaration for `pfNurbCurve2d`

The class has the following main methods:

```
class pfNurbCurve2d : public pfCurve2d
{
public:
// Creating and destroying
pfNurbCurve2d( );
pfNurbCurve2d( pfReal tBegin, pfReal tEnd );
virtual ~pfNurbCurve2d( );

// Accessor functions
void setControlHull( int i, const pfRVec2 &p );
void setControlHull( int i, const pfRVec3 &p );
void setWeight( int i, pfReal w );
void setKnot( int i, pfReal t );
void setControlHullSize( int s );

pfRVec2* getControlHull( int i );
pfReal getWeight( int i );
int getControlHullSize( );
int getKnotCount( );
pfReal getKnot( int i );
int getOrder( );

void removeControlHullPnt( int i );
void removeKnot( int i );

// Evaluator
virtual void evalPt( pfReal t, pfRVec2 &pnt );
};
```

Main Features of the Methods in `pfNurbCurve2d`

`pfNurbCurve2d(tBegin, tEnd)`

Creates a NURBS curve in the plane with the specified parameter domain. The default parameter domain is 0.0 to 1.0.

- evalPt()** Is a pure virtual function inherited from `pfCurve2d`, and produces unpredictable results until you set the control parameters.
- setControlHull(i, p)** and **getControlHull(i)**
Set and get the two-dimensional control point with index i to the value p . If you supply `pfRVec3` arguments, the location of the control points is set by the first two components; the last component is their weight.
- setControlHullSize()**
Gives a hint about how big the control hull array is. This is not mandatory but uses time and space most efficiently.
- setKnot(i, t)** and **getKnot(i)**
Set and get the knot point with index i and the value t .
- setWeight(i, w)** and **getWeight(i)**
Set and get the weight of the control point with index i and weight w .

Piecewise Polynomial Curves: pfPieceWisePolyCurve2d

A piecewise polynomial curve consists of an array of polynomial curves. Each polynomial curve is a polynomial mapping from t to UV plane, where the domain is a subinterval of $[0,1]$. The polynomial coefficients are set by `setControlHull()`.

Notice that an `pfPieceWisePolyCurve2d` is a subclass of `pfCurve2d`. The domain of a `pfPieceWisePolyCurve2d` is defined to be $[0, n]$ where n is the number of pieces.

If `reverse` is 0, then for any given t in $[0, n]$, its corresponding uv is evaluated in the following way: The index of the piece that corresponds to t is $\text{floor}(t)$, and the polynomial of that piece is evaluated at $w1 + (t - \text{floor}(t)) * (w2 - w1)$ to get the (u,v) , where $[w1, w2]$ is the domain interval (set by `setLimitParas()`) of this piece.

If `reverse` is 1, then for any given t in $[0, n]$, we first transform t into $n - t$, then perform the normal evaluation (at $n - t$) as described in the preceding paragraph.

Class Declaration for pfPieceWisePolyCurve

The class has the following main methods:

```
class pfPieceWisePolyCurve2d : public pfCurve3d
{
public:
// Creating and destroying
pfPieceWisePolyCurve2d ( );
virtual ~pfPieceWisePolyCurve2d ( );

//Accessor functions
void setControlHull ( int piece, int i, const pfRVec2& p);
pfRVec2& getControlHull ( int piece, int i);
void setLimitParas ( int piece, pfReal w1, pfReal w2);
void setReverse ( int _reverse);
pfRVec2& getLimitParas ( int piece);
int getReverse ( ) const;
int getPatchCount ( ) const;
int getOrder ( int piece);
virtual void evalPt ( pfReal t, pfRVec2& pnt);
virtual void evalBreakPoints ( pfParaSurface* sur);
};
```

setControlHull(*piece*, *i*, *p*) defines the *i*th polynomial coefficient of the *piece*th polynomial curve to *p*. *p*[0] is for the *u* coefficient and *p*[1] is for the *v* coefficient. **setLimitParas**() sets the domain interval.

The class `pfPieceWisePolyCurve3d` has parallel functionality and declaration.

Discrete Curves in the Plane

The class `pfDisCurve2d` is the base class for making a discrete curve from line segments connecting a sequence of points in the plane. Because `pfDisCurve2d` is not derived from `pfCurve2d`, it does not inherit that class's finite difference functions for calculating derivatives, therefore, `pfDisCurve2d` includes member functions that calculate arc length, tangents, principal normals, and curvatures using finite central differences. Figure 9-7 illustrates the definition of the curve by a set of points.

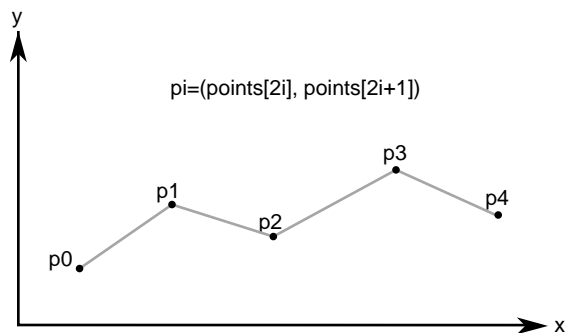

Figure 9-7 Discrete Curve Definition

Class Declaration for pfDisCurve2d

The class has the following main methods:

```
class pfDisCurve2d : public pfRep
{
public:
// Creating and destroying
pfDisCurve2d( void );
pfDisCurve2d( int nPoints, pfReal *points );

virtual ~pfDisCurve2d( void );

// Accessor functions
void set (int nPoints, pfReal* points);
pfRVec2 getBeginPt() const;
pfRVec2 getEndPt() const;

pfLoop getClosed();
void setClosed( pfLoop c );

void setPoint( int i, const pfRVec2& pnt );
pfRVec2 getPoint( int i) const;
int getPointCount(); const;
pfRVec2 getTangent(int i) const;
pfRVec2 getNormal(int i) const;
pfReal getCurvature(int i) const;

// Evaluators
void computeTangents( );
void computeNormals( );
void computeCurvatures( );
void computeDerivatives( );
};
```

Main Features of the Methods in pfDisCurve2d**pfDisCurve2d(*nPoints*, *points*)**

Creates a discrete curve from an array of point coordinates. The constructor assumes that the coordinates of the points are stored in pairs sequentially; thus the *points* array is $nPoint*2$ in length.

computeCurvatures()

Computes the curvature, which is the magnitude of the normal vector.

computeDerivatives()

Is a convenience function that calls (in order) the tangent, normal, and curvature functions.

computeNormals()

Computes the principal normal at a point using finite central differences and stores the result in the class member pfDvector *n*. For the point $\mathbf{p}[i]$, the normal vector is computed to be the difference vector between the tangents at the two neighboring points, $\mathbf{t}[i+1] - \mathbf{t}[i-1]$, divided by the sum of the distances from $\mathbf{p}[i]$ to the two neighboring points.

computeTangents()

Computes the arc lengths of segments and then uses finite central differences to compute the tangents. For the point $\mathbf{p}[i]$, the tangent vector is computed to be the vector between its two neighboring points, $\mathbf{p}[i+1] - \mathbf{p}[i-1]$, divided by the sum of the distances from $\mathbf{p}[i]$ to the two neighboring points. The tangents are stored in the pfDvector *t*, the arc lengths in the pfDvector *ds*, and the total arc length in *arcLength*.

getCurvature() Returns the value of the curvature at the i^{th} point.

getNormal() Returns the value of the normal at the i^{th} point.

getPoint() Returns the value of the i^{th} point.

getPointCount()
Returns the value of the i^{th} point.

getTangent() Returns the value of the tangent at the i^{th} point.

Spatial Curves

The class `pfCurve3d` is the base for parametric curves that lie in three-dimensional space. Among other uses, a curve in space could locate a moving viewpoint in a CAD walk-through.

The nature of these curves is essentially the same as those of `pfCurve2d` curves, except `pfCurve3d` curves are made of points described by `pfRVec3s`. The components of the points are assumed to be x , y , and z coordinates. Refer to the section “Planar Curves” on page 354 for a discussion of the basic features of parametric curves.

This section parallels the discussion in “Planar Curves” on page 354, and emphasizes the (not very great) differences that distinguish spatial curves:

- “Lines in Space” on page 377
- “Circles in Space” on page 378
- “Superquadrics in Space” on page 378
- “Hermite Spline Curves in Space” on page 379
- “NURBS Curves in Space” on page 379
- “Curves on Surfaces: `pfCompositeCurve3d`” on page 380
- “Discrete Curves in Space” on page 381

The class declaration for `pfCurve3d` is in the file `/usr/include/Performer/pf/pfCurve3d.h` on IRIX and Linux and `%PFROOT%\Include\pf\pfCurve3d.h` on Microsoft Windows. Its declaration is essentially identical to the declaration for `pfCurve2d`. The difference is that all `pfRVec2` variables are replaced by `pfRVec3` variables.

Lines in Space

The base class for lines in space, `pfLine3d`, is essentially the same as `pfLine2d`, discussed in “Lines in the Plane” on page 359. The main differences are due to the need to manage three-dimensional vectors. Thus all vector variables are `pfRVec3` and the constructor takes six variables to define the endpoints of the line.

The default orientation of the curve is identical to that for the planar curve `pfLine2d`; you can translate and rotate the line in three-dimensional space with the methods `setOrigin()` and `setOrient()` inherited from `pfRep`.

pfOrientedLine3d

The class `pfOrientedLine3d` is derived from `pfLine3d`, and adds vectors to define a moving three-dimensional reference frame for the line. This object is useful if you want a straight-line path for an `pfFrenetSweptSurface` (see “Swept Surfaces” on page 401 and, in particular, “Class Declaration for `pfFrenetSweptSurface`” on page 405).

The methods of `pfOrientedLine3d` add to the description of the line an “up” vector, which you specify. The normal to the line is calculated from the direction of the line and the up vector.

Circles in Space

The class `pfCircle3d` defines a parametric circle with an arbitrary location and orientation in space. The parameterization of the circle, before you change its location or orientation, is such that t is the angular displacement, in radians, in a counterclockwise direction from the x axis.

The class declaration for `pfCircle3d` is identical to that for `pfCircle2d`, discussed in “Circles in the Plane” on page 360, except for the changes from `pfRVec2` to `pfRVec3`. The member functions perform the same operations. For more information, see the discussion in the section “Circles in the Plane” on page 360.

If the matrix you use to orient an `pfCircle3d` does not correspond to a rotation about an axis—that is, the matrix is not orthonormal—you not only change the tilt of the plane in which the circle lies but also change the radius, and may distort the circle into an ellipse. .

Superquadrics in Space

The class `pfSuperQuadCurve3d` provides methods to define a superquadric in space (see “Superquadric Curves: `pfSuperQuadCurve2d`” on page 362). The class declaration is identical to that for `pfSuperQuad2d` except that position on the curve is defined by an `pfRVec3`.

The default orientation of the curve is identical to that for the planar curve `pfSuperQuad2d`; you can translate and rotate the curve in three-dimensional space with the methods `setOrigin()` and `setOrient()` inherited from `pfRep`.

Hermite Spline Curves in Space

The class `pfHsplineCurve3d` provides methods to define a Hermite spline curve in space. The definition of the curve is the same as that for a Hermite spline curve in the plane, discussed in “Hermite-Spline Curves in the Plane” on page 365. The class declaration is the same as that for `pfHsplineCurve2d`, but the position and tangent vectors are `pfRVec3s`.

NURBS Curves in Space

The basic properties of NURBS are discussed in the section “NURBS Overview” on page 366. In an effort to keep things as simple as possible, the discussion in that section has a bias toward curves in the plane. But the principles and control parameters are, with one difference, the same for NURBS curves in space.

The difference is that control points for NURBS curves in space can be anywhere in space instead of being restricted to a plane. The section “Examples of NURBS Curves” in Chapter 8 of *The Inventor Mentor* presents illustrations of NURBS curves in space, along with their control parameters.

The class `pfNurbCurve3d` is the base class for NURBS curves in space. Its class declaration is practically identical to that for `pfNurbCurve2d` but all occurrences of `pfRVec2` are changed to `pfRVec3`. In addition, the vector argument of `setControlHull()` can be an `pfRVec3`, if you just want to specify control point locations, or an `pfRVec4`, if you want to append weighting information as a fourth component. See the discussion in the section “NURBS Curves in the Plane” on page 371.

Curves on Surfaces: pfCompositeCurve3d

A planar curve in the u - v plane describes a curve on the surface, given a parameterized surface (see the section “Parametric Surfaces” on page 381). Each point on the curve in the parameter plane is “lifted up” to the surface. Such curves are known as composite curves because they are described mathematically as the composition of the function describing the curve and the function describing the surface. The edge of a surface defined by a trim curve is a composite curve.

pfCompositeCurve3d is the base class for composite curves. This class is useful for defining trim curves and surface silhouettes in the parametric surface’s coordinate system.

Class Declaration for pfCompositeCurve3d

The class has the following main methods:

```
class pfCompositeCurve3d : public pfCurve3d
{
public:
// Creating and destroying
pfCompositeCurve3d( );
pfCompositeCurve3d( pfParaSurface *sur, pfCurve2d *cur );
virtual ~pfCompositeCurve3d( );

// Accessor functions
void set( pfParaSurface *sur, pfCurve2d *cur );
pfParaSurface* getParaSurface() const;
pfCurve2d* getCurve2d() const;

// Evaluator
void evalPt( pfReal u, pfRVec3 &pnt );
};
```

Main Features of the Methods in pfCompositeCurve3d

The constructor takes two arguments: the first is the surface on which the curve lies, the second is the curve in the coordinate system of the surface. The returned object is a curve in space.

Discrete Curves in Space

The class `pfDisCurve3d` is the base class for making a discrete curve of line segments connecting a sequence of points in space. The class declaration for `pfDisCurve3d` is identical to that for `pfDisCurve2d`, discussed in “Discrete Curves in the Plane” on page 374, but `pfRVec2` changes to `pfRVec3`. The member functions perform the same operations.

Example of Using `pfDisCurve3d` and `pfHsplineCurve3d`

One application of an `pfDisCurve3d` and `pfHsplineCurve3d` is to use them to interactively specify routing for tubing. These are the operations to perform:

1. Create a `pfDisCurve3d` from a set of points. See “Discrete Curves in Space” on page 381.
2. Use the points and tangents to the discrete curve to create a continuous path with an `pfHsplineCurve3d`. See “Hermite Spline Curves in Space” on page 379
3. Use the continuous path in an `pfFrenetSweptSurface` with a circular cross section. See “`pfFrenetSweptSurface`” on page 405.

Parametric Surfaces

A parametric surface can be thought of as the result of taking a piece of a plane, twisting and stretching it, maybe gluing edges of the piece together, and placing it in space.

The introductory discussion of parametric surfaces occurs in the following sections:

- “Mathematical Description of a Parametric Surface” on page 382
- “Defining Edges of a Parametric Surface: Trim Loops and Curves” on page 383
- “Adjacency Information: `pfEdge`” on page 385
- “Base Class for Parametric Surfaces: `pfParaSurface`” on page 386

The subclasses of `pfParaSurface` are discussed in the subsequent sections:

- “`pfPlaneSurface`” on page 390
- “`pfSphereSurface`” on page 392
- “`pfCylinderSurface`” on page 395
- “`pfTorusSurface`” on page 397
- “`pfConeSurface`” on page 399
- “Swept Surfaces” on page 401
- “Ruled Surfaces” on page 406
- “Coons Patches” on page 408
- “NURBS Surfaces” on page 410
- “Hermite-Spline Surfaces” on page 418

Instances of most of the `pfParaSurface` subclasses are used in the sample application `/usr/share/Performer/src/pguide/libpf/C++/repTest.C` on IRIX and Linux and `%PFROOT\Src\pguide\libpf\C++\repTest.cxx` on Microsoft Windows.

Mathematical Description of a Parametric Surface

To locate a point on a parametric surface, you need two parameters, referred to as u and v in OpenGL Performer. The set of u and v values that describe the surface are known as the *parameter space*, or *coordinate system*, of the surface (see Figure 9-8).

More precisely, the coordinates of the points in space that define a parametric surface are described by a set of three functions of two parameters: $(x(u,v), y(u,v), z(u,v))$.

Well-known examples of a parametric surface are a sphere or a globe. On a globe you can locate points with two parameters: latitude and longitude. The rectangular grid of latitude and longitudes is the coordinate system that describes points on the globe.

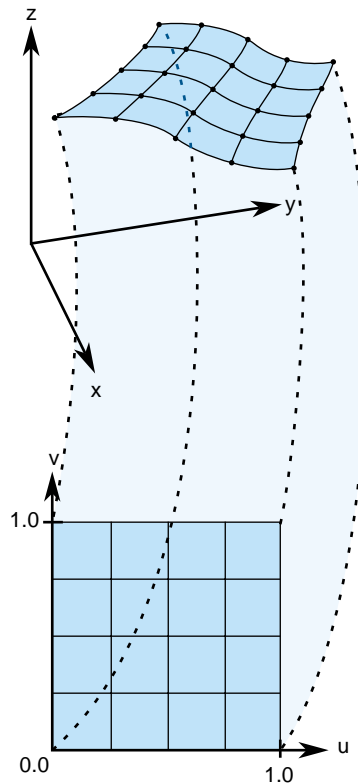

Figure 9-8 Parametric Surface: Unit-Square Coordinate System

Defining Edges of a Parametric Surface: Trim Loops and Curves

To define the extent of a parametric curve, pick an interval. For accurate trimming of a parametric surface, you need more complex tools. You are likely to need:

- Edges for the surface other than those defined by the limits of the coordinate system. For example, to define a pipe elbow, you might join two cylinders by a piece cut from a torus.
- Holes in a surface, for example, to define a T-joint intersection of pipes.

OpenGL Performer keeps the trim loop side on the left as you look down on the u - v plane while a point moves along the curve in the direction of increasing t ; you can hold on to

the surface with your left hand as you go along the trim loop. Thus a clockwise loop removes a hole; a counterclockwise loop keeps the enclosed region and eliminates everything outside. Do not create a trim loop that crosses itself like a figure eight.

OpenGL Performer allows you to maintain curves to define the edges of a surface. These curves are `pfCurve2d` objects defined in the u - v plane that are “lifted” to the surface by the parameterization. The main use of these curves is to eliminate a portion of the surface on one side of the curve. The name of a curve in the coordinate system that is used to define (possibly a piece of) such a surface edge is a *trim curve*. One or more joined trim curves form a sequence called a *trim loop*. To be of use, trim curves should form a closed loop or reach the edges of the coordinate system for the surface. Figure 9-9 illustrates trim loops and their effect on a surface.

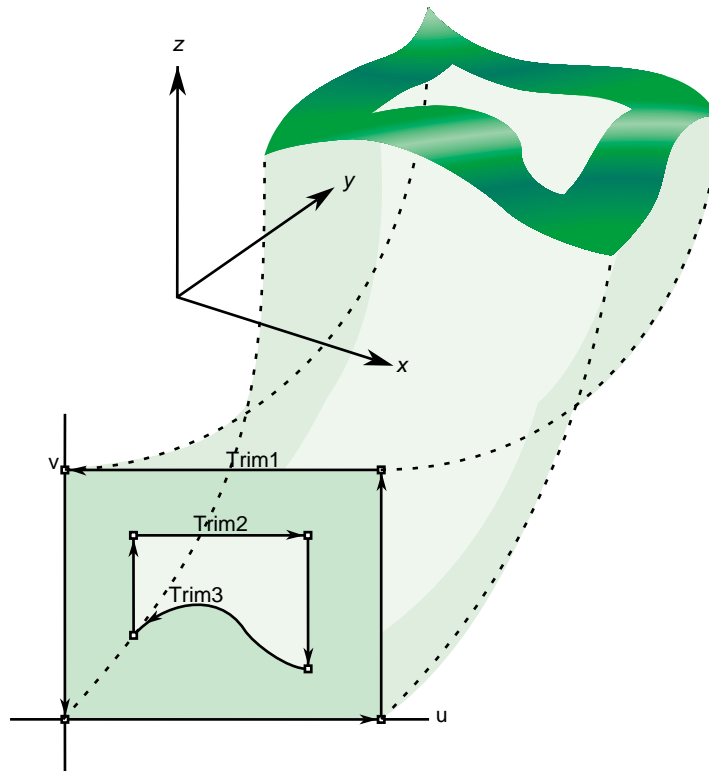

Figure 9-9 Trim Loops and Trimmed Surface: Both Trim Loops Made of Four Trim Curves

Adjacency Information: pfEdge

An pfEdge defines a trim curve in u, v space. pfEdge holds information about a surface's adjacency. Each pfEdge identifies an pfBoundary, which the class pfTopo uses to keep track of surface connectivity, and continuous and discrete versions of the trim curve associated with the boundary. The members of an pfEdge are set by the topology building tools; the methods of pfEdge access the members. Topology building and the classes pfTopo and pfBoundary are discussed further in Chapter 10, "Creating and Maintaining Surface Topology".

The information held in pfEdge allows tessellators to determine whether a set of vertices has already been developed for points shared with other surfaces. You can also find other surfaces that have the same edge or trim-curve endpoint as that defined by a given trim curve.

The `set*()` methods are mainly used when reading surface data from a file and creating OpenGL Performer data structures.

Class Declaration for pfEdge

The class has the following main methods:

```
class pfEdge : public pfObject
{
public:
// Creating and destroying
pfEdge();
~pfEdge();

pfCurve2d *getContCurve();
void setContCurve(pfCurve2d *c);

pfDisCurve2d *getDisCurve();
void setDisCurve( pfDisCurve2d *d);

int getBoundary();

void setBoundaryDir( int dir );
int getBoundaryDir();
};
```

Base Class for Parametric Surfaces: pfParaSurface

pfParaSurface is the base class for parametric surfaces in OpenGL Performer. As for the base classes pfCurve2d and pfCurve3d, pfParaSurface includes a pure virtual function to evaluate points on the surface and default evaluator functions that calculate derivatives using finite central differences. The surface normal at a point is the cross product of the partial derivatives.

For parametric curves whose extent is defined by the interval of values for t , the extent of an pfParaSurface is, initially, defined by all the points in its parameter space.

Class Declaration for pfParaSurface

The class has the following main methods:

```
class pfParaSurface : public pfRep
{
public:
    // Creating and destroying
    pfParaSurface( pfReal _beginU = 0, pfReal _endU = 1,
                  pfReal _beginV = 0, pfReal _endV = 1,
                  int _topoId = 0, int _solid_id = -1 );

    virtual ~pfParaSurface();

    // Accessor functions
    void setBeginU( pfReal u );
    void setEndU( pfReal u );
    void setBeginV( pfReal v );
    void setEndV( pfReal v );
    void setSolidId( int solidId);
    void SetTopoId( int topoId);
    void setSurfaceId (int surfaceId);
    pfReal getBeginU() const;
    pfReal getEndU() const;
    pfReal getBeginV() const;
    pfReal getEndV() const;

    int getTrimLoopCount();
    pfLoop getTrimLoopClosed( int loopNum );
    int getTrimCurveCount( int loopNum );
    pfEdge* getTrimCurve( int loopNum, int curveNum );

    int getTopoId();
```

```

int    getSolidId();
int    getSurfaceId();

void setHandednessHint( pbool _clockWise );
pbool getHandednessHint() const;

pGeoState* getGState( ) const;
int setGState( pGeoState *gState );

void insertTrimCurve( int loopNum, pCurve2d *c, pDisCurve2d *d );

// Explicit add a trim curve to a trim loop
void addTrimCurve(int loopNum, pCurve2d *c, pDisCurve2d *d );
void setTrimLoopClosed( int loopNum, pLoop closed );

// Surface evaluators
virtual void evalPt(   pReal u, pReal v, pRVec3 &pnt ) = 0;
virtual void evalDu(   pReal u, pReal v, pRVec3 &Du );
virtual void evalDv(   pReal u, pReal v, pRVec3 &Dv );
virtual void evalDuu(  pReal u, pReal v, pRVec3 &Duu );
virtual void evalDvv(  pReal u, pReal v, pRVec3 &Dvv );
virtual void evalDuv(  pReal u, pReal v, pRVec3 &Duv );
virtual void evalNorm( pReal u, pReal v, pRVec3 &norm );

// Directional derivative evaluators
virtual void evalD( pReal u, pReal v, pReal theta, pRVec3 &D );
virtual void evalDD( pReal u, pReal v, pReal theta, pRVec3 &DD );

virtual void eval( pReal u, pReal v,
pRVec3 &p,           // The point
pRVec3 &Du,         // The derivative in the u direction
pRVec3 &Dv,         // The derivative in the v direction
pRVec3 &Duu,        // The 2nd derivative in the u direction
pRVec3 &Dvv,        // The 2nd derivative in the v direction
pRVec3 &Duv,        // The cross derivative
pReal &s,           // Texture coordinates
pReal &t );

void clearTessellation();
};

```

Main Features of the Methods in pfParaSurface**addTrimCurve(*j*, *curve*, *discurve*)**

Is a quick function for building a trim loop that assumes you know the order of trim curves. It adds *curve* to the end of the list of continuous trim curves for the j^{th} trim loop, and adds *discurve* to the list of discrete trim curves.

For example, you could build the trim loops in Figure 9-9 by starting with one segment and successively adding segments. If the beginning of *curve* does not match the end of the previously added curve, use **insertTrimCurve()**, which finds the right place for the curve by assuming topological consistency.

eval() Returns the evaluator functions. The last two arguments of **eval()** are the same as the input coordinates *u* and *v*.

evalDu(), evalDv(), evalDuu(), evalDvv(), and evalDuv()

Are evaluator functions that use central differences to calculate the first and second derivatives, identified by the lowercase **u** and **v** in the function names, at a point on the surface.

evalD() and evalDD()

Calculate the first and second directional derivatives in the direction given by an angle *theta* from the *u* axis in the parameter space.

evalNorm() Calculates the unit normal to the surface.

evalPt() Is a pure virtual function that you define to specify a surface.

pfParaSurface()

Constructs a parametric surface. You can specify the topology and the surface to which the parametric surface belongs. See “Summary of Scene Graph Topology: pfTopo” on page 434.

insertTrimCurve(*j*, *curve*, *discurve*)

Is a slower function than **addTrimCurve()** for building a trim loop that attempts to guarantee all curves form a sensible trim loop sequence. It compares the ends of *curve* with the ends of the trim curves that are already in the j^{th} trim loop and inserts *curve* at the appropriate point in the list. Similarly, **addTrimCurve()** inserts the discrete curve *discurve*. If **insertTrimCurve()** cannot find an endpoint match, it adds *curve* to the end of the list of trim curves. If you are building a trim loop by inserting trim curves end to end, then **addTrimCurve()** gives the same result but more quickly.

setBeginU(), setBeginV(), etc.

Set and get the start and end values for the coordinate space of the surface. The coordinate space is a rectangle in the UV plane. The default is the unit square; u and v both lie in the interval (0,1).

getTrimLoopCount()

Returns the number of trim loops for the pfParaSurface.

getTrimLoopClosed() and setTrimLoopClosed()

Get and set the flag indicating whether a given trim loop is closed. OpenGL Performer determines this for you, so use **setTrimLoopClosed()** with caution; you could get a meaningless result.

getTrimCurveCount()

Returns the number of trim curves in the specified trim loop.

getTrimCurve(i,j)

Returns the pfEdge for the trim curve with index i in the trim loop with index j .

clearTessellation()

Removes all data that resulted from previous tessellation. This removal allows the surface to be retessellated with a different tolerance. For each trim curve, the disCurve is deleted if the contCurve is not NULL. The xyzBoundary in its boundary structure is deleted. Also, the tessellated triangles (**csGeometry**) are removed.

getGState() and setGState()

Get and set the pfGeoState to be used when tessellating the surface and setting pfGeoStates on generated geometry (pfGeoSets). **setGState()** returns 1 if successful, -1 otherwise.

pfPlaneSurface

The simplest parametric surface is a plane. The class `pfPlaneSurface` defines a plane by two parameter intervals and three points that define the two coordinate directions. Figure 9-10 illustrates the parameterization of an `pfPlaneSurface`.

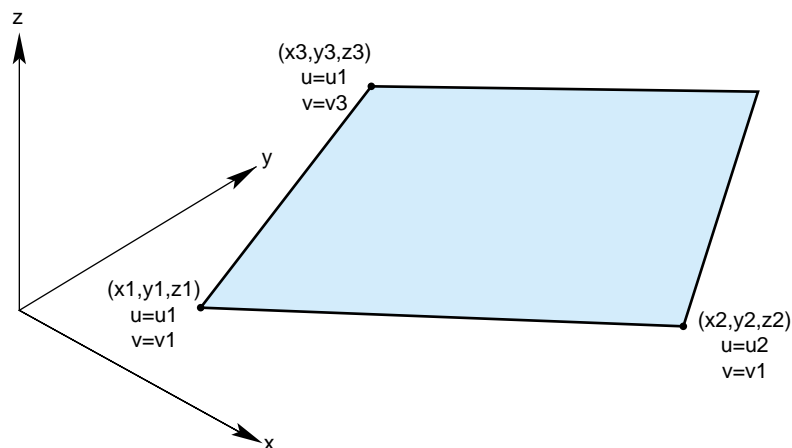

Figure 9-10 Plane Parameterization

Class Declaration for `pfPlaneSurface`

The class has the following main methods:

```
class pfPlaneSurface : public pfParaSurface
{
public:
    // Creating and destroying
    pfPlaneSurface();
    pfPlaneSurface( pfReal x1, pfReal y1, pfReal z1, pfReal u1, pfReal v1,
                   pfReal x2, pfReal y2, pfReal z2, pfReal u2,
                   pfReal x3, pfReal y3, pfReal z3, pfReal v3 );
    virtual ~pfPlaneSurface();

    // Accessor functions
    void setPoint1( pfReal x1, pfReal y1, pfReal z1, pfReal u1, pfReal v1);
    void setPoint2( pfReal x2, pfReal y2, pfReal z2, pfReal u2 );
    void setPoint3( pfReal x3, pfReal y3, pfReal z3, pfReal v3 );
};
```

```

void getPoint1( pfReal *x1, pfReal *y1, pfReal *z1,
               pfReal *u1, pfReal *v1 );
void getPoint2( pfReal *x2, pfReal *y2, pfReal *z2, pfReal *u2 );
void getPoint3( pfReal *x3, pfReal *y3, pfReal *z3, pfReal *v3 );

// Evaluators
void evalPt( pfReal u, pfReal v, pfRVec3 &pnt );
void evalDu( pfReal u, pfReal v, pfRVec3 &Du );
void evalDv( pfReal u, pfReal v, pfRVec3 &Dv );
void evalNorm( pfReal u, pfReal v, pfRVec3 &norm );
}

```

Main Features of the Methods in pfPlaneSurface

pfPlaneSurface()

When you construct the class, you can specify the plane with three points and two parameter intervals or you can use the **setPoint*()** methods. Those parameters have the following meanings:

- the point (x_1, y_1, z_1) and its parameter values, (u_1, v_1)
- the point (x_2, y_2, z_2) , which defines the u direction, $(x_2 - x_1, y_2 - y_1, z_2 - z_1)$, and its parameter values (u_2, v_1)
- the point (x_3, y_3, z_3) , which defines the v direction, $(x_3 - x_1, y_3 - y_1, z_3 - z_1)$ and its parameter values (u_1, v_3) .

setPoint*() and getPoint*()

Set and get each of the points that define the plane and their corresponding parameter values (see **pfPlaneSurface()**).

pfSphereSurface

The surface of the sphere is parameterized by angles, in radians, for latitude and longitude; v corresponds to longitude, u to latitude. Figure 9-11 illustrates the parameterization of an `pfSphereSurface`.

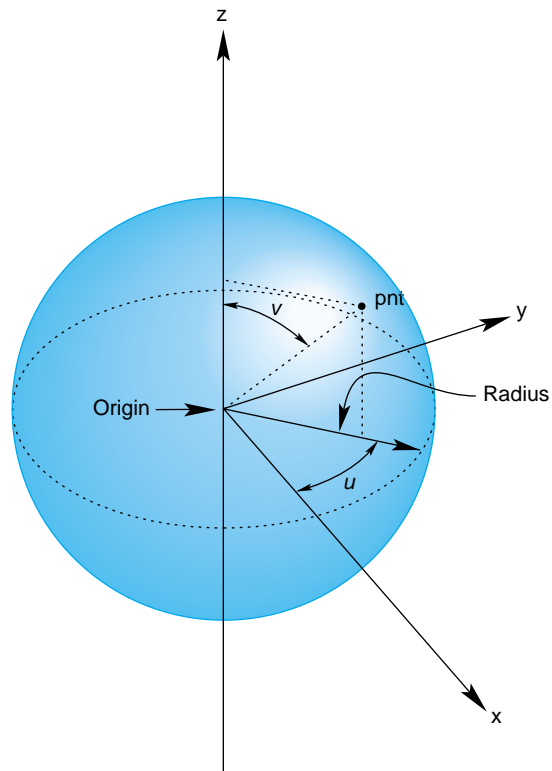

Figure 9-11 Sphere Parameterization

Class Declaration for pfSphereSurface

The class has the following main methods:

```
class pfSphereSurface : public pfParaSurface
{
public:
// Creating and destroying
pfSphereSurface( );
pfSphereSurface( pfReal radius );
virtual ~pfSphereSurface( );

// Accessor functions
void setRadius( pfReal radiusVal );
pfReal getRadius( ) const;

// Evaluators
void evalPt( pfReal u, pfReal v, pfRVec3 &pnt );
void evalNorm( pfReal u, pfReal v, pfRVec3 &norm );
}
```

Main Features of the Methods in pfSphereSurface

The constructor defines a sphere centered on the origin with the specified radius. The default radius is 1. The evaluator functions do not use finite-difference calculations for derivatives.

Any point on the sphere is represented as:

$$\begin{aligned}x &= \text{radius} * \cos(u) * \sin(v) \\y &= \text{radius} * \sin(u) * \sin(v) \\z &= \text{radius} * \cos(v)\end{aligned}$$

pfSphereSurface Example

The following code from the sample application `repTest` illustrates how an instance of an `pfSphereSurface` of radius three would be created:

```
pfSphereSurface *sphere = new pfSphereSurface( 3 );

// under certain conditions, a trim curve is added that keeps only the
// portion of the surface above a circle
if ( nVersions <= 0 )
{
pfCircle2d *trimCircle2d =
    new pfCircle2d( 1.0, new pfRVec2(M_PI/2.0,M_PI) );
sphere->addTrimCurve( 0, trimCircle2d );
}
setUpShape( sphere, PF_XDIST*numObject++, Y, PF_VIEWDIST );
```

setUpShape() locates the sphere in the scene, tessellates it, and places it in the scene graph (see `/usr/share/Performer/src/pguide/libpf/C++/repTest.C` on IRIX and Linux and `%PFROOT%\Src\pguide\libpf\C++\repTest.cxx` on Microsoft Windows). Creating an instance of any `pfRep` is basically the same, as subsequent examples in the discussions of other `pfReps` will show.

pfCylinderSurface

The `pfCylinderSurface` class provides methods for describing a cylinder.

A cylinder can be defined geometrically as the surface in space that is swept by moving a circle along an axis that is perpendicular to the plane of the circle and passes through the center of the circle.

The parameterization of an `pfCylinderSurface` is as follows: u represents the position on the circle and that v represents the position along the axis.

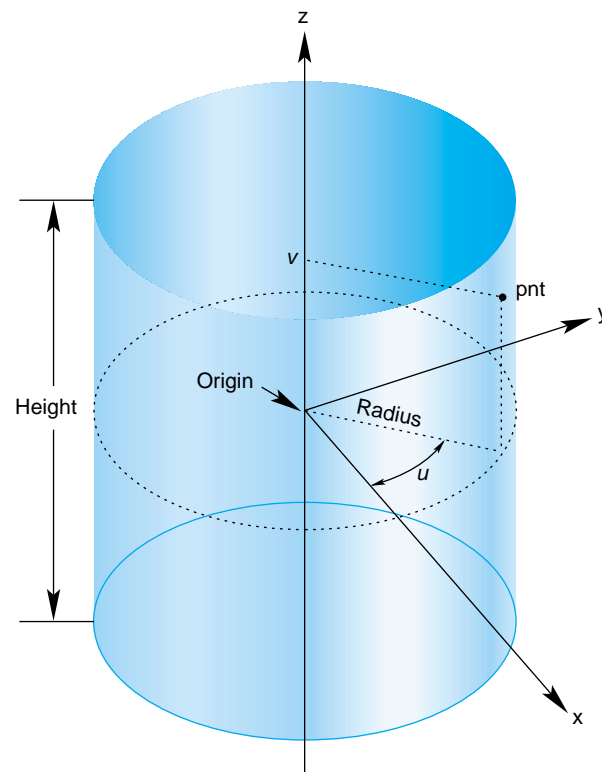

Figure 9-12 Cylinder Parameterization

Class Declaration for pfCylinderSurface

The class has the following main methods:

```
class pfCylinderSurface : public pfParaSurface
{
public:
// Creating and destroying
pfCylinderSurface( void );
pfCylinderSurface( pfReal radius, pfReal height );
virtual ~pfCylinderSurface();

// Accessor functions
void setRadius( pfReal radiusVal ) ;
void setHeight( pfReal heightVal );

pfReal getRadius( ) const;
pfReal getHeight( ) const;

// Evaluators
void evalPt( pfReal u, pfReal v, pfRVec3 &pnt );
void evalNorm( pfReal u, pfReal v, pfRVec3 &norm );
};
```

Main Features of the Methods in pfCylinderSurface

pfCylinderSurface(*radius*, *height*) constructs a cylinder with the specified height and radius. By default, the *z* axis is the cylinder's axis and the cylinder is centered on the origin, extending in the positive and negative *z* directions for one-half the height.

For the default orientation, *u* measures the angle from the *x-z* plane in a counterclockwise direction as you look down on the *x-y* plane and *v* measures the distance along the *z*-axis. The default radius is 1 and the default height is 2.

pfTorusSurface

The `pfTorusSurface` class provides methods to describe a torus. Figure 9-13 illustrates a torus, and how it is parameterized in `pfTorusSurface`.

A torus can be defined geometrically as the surface in space that is swept by moving a circle, the *minor circle*, through space such that its center lies on a second circle, the *major circle*, and the planes of the two circles are always perpendicular to each other, with the plane of the minor circle aligned along radii of the major circle. The parametrization of the surface is that u represents a position on the major circle and v represents a position on the minor circle.

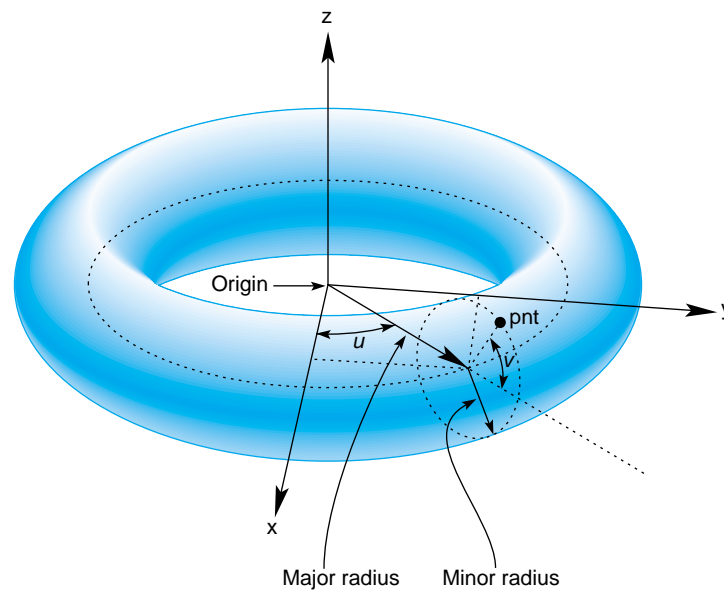

Figure 9-13 Torus Parameterization

Class Declaration for `pfTorusSurface`

The class has the following main methods:

```
class pfTorusSurface : public pfParaSurface
{
public:
// Creating and destroying
```

```
pfTorusSurface( );
pfTorusSurface( pfReal majorRadius, pfReal minorRadius );
virtual ~pfTorusSurface();

// Accessor functions
void setMajorRadius( pfReal majorRadiusVal );
void setMinorRadius( pfReal minorRadiusVal );
pfReal getMajorRadius( ) const;
pfReal getMinorRadius( ) const;

// Evaluators
virtual void evalPt( pfReal u, pfReal v, pfRVec3 &pnt );
virtual void evalNorm( pfReal u, pfReal v, pfRVec3 &norm );
}
```

Main Features of the Methods in `pfTorusSurface`

The constructor `pfTorusSurface(majorRadius, minorRadius)` defines a torus with the specified radii such that the major circle is in the x - y plane and the minor circle is initially in the x - z plane. The default value for the major radius is 1; the default for the minor radius is 0.1.

pfConeSurface

You can define a cone geometrically by sweeping a circle along an axis in a way similar to the way a cylinder is defined; however, as the circle is swept along the axis, the radius changes linearly with distance.

The parameterization of a point on an pfConeSurface is that u measures the angle, in radians, of the point on the circle, and that v measures the distance along the axis from the origin. To truncate a cone, yielding a frustum, adjust the value for v .

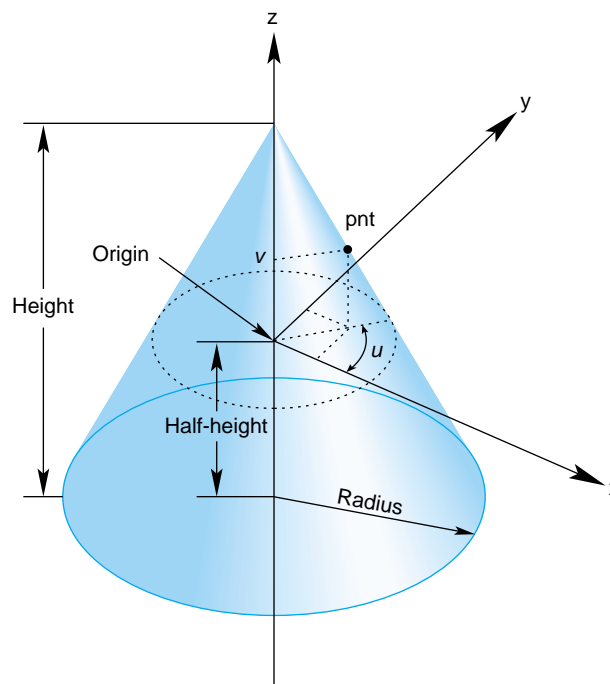

Figure 9-14 Cone Parameterization

Class Declaration for `pfConeSurface`

The class has the following main methods:

```
class pfConeSurface : public pfParaSurface
{
public:
// Creating and destroying
pfConeSurface( void );
pfConeSurface( pfReal radius, pfReal height );
virtual ~pfConeSurface();

// Accessor functions
void setRadius( pfReal radius );
void setHeight( pfReal height );
pfReal getRadius( ) const;
pfReal getHeight( ) const;

// Evaluators
void evalPt( pfReal u, pfReal v, pfRVec3 &pnt );
void evalNorm( pfReal u, pfReal v, pfRVec3 &norm );
}
```

Main Features of the Methods in `pfConeSurface`

The constructor `pfConeSurface(radius, height)` creates a parametric cone with the specified height and a circular base with the specified radius. By default, the base of the cone is parallel to the x - y plane and centered on the z axis and the apex of the cone is on the positive z -axis. The cone extends from the origin in the positive and negative z directions for one half the height. The default for the radius of the base is 1 and the default height is 2.

Swept Surfaces

The class `pfSweptSurface` provides methods to describe a general swept surface. Three examples of swept surfaces have been presented: a cylinder, a torus, and a cone. In the first two cases a simple cross-section, a circle of constant radius, was swept along a path. For a cone, the radius of the circle varied according to a simple profile.

To describe a swept surface, you specify a *path*, a *cross section*, and a coordinate frame in which the graph of the cross section is drawn at each point on the path. The parameterization of the surface is that u denotes the position along the path and v denotes the position on the cross-section curve. You can also specify a *profile*, which adjusts the size of the cross-section curve. Thus, for example, with a simple profile method you could generate a sphere from a straight-line path and a circular cross section. Figure 9-15 illustrates the feature of a swept surface.

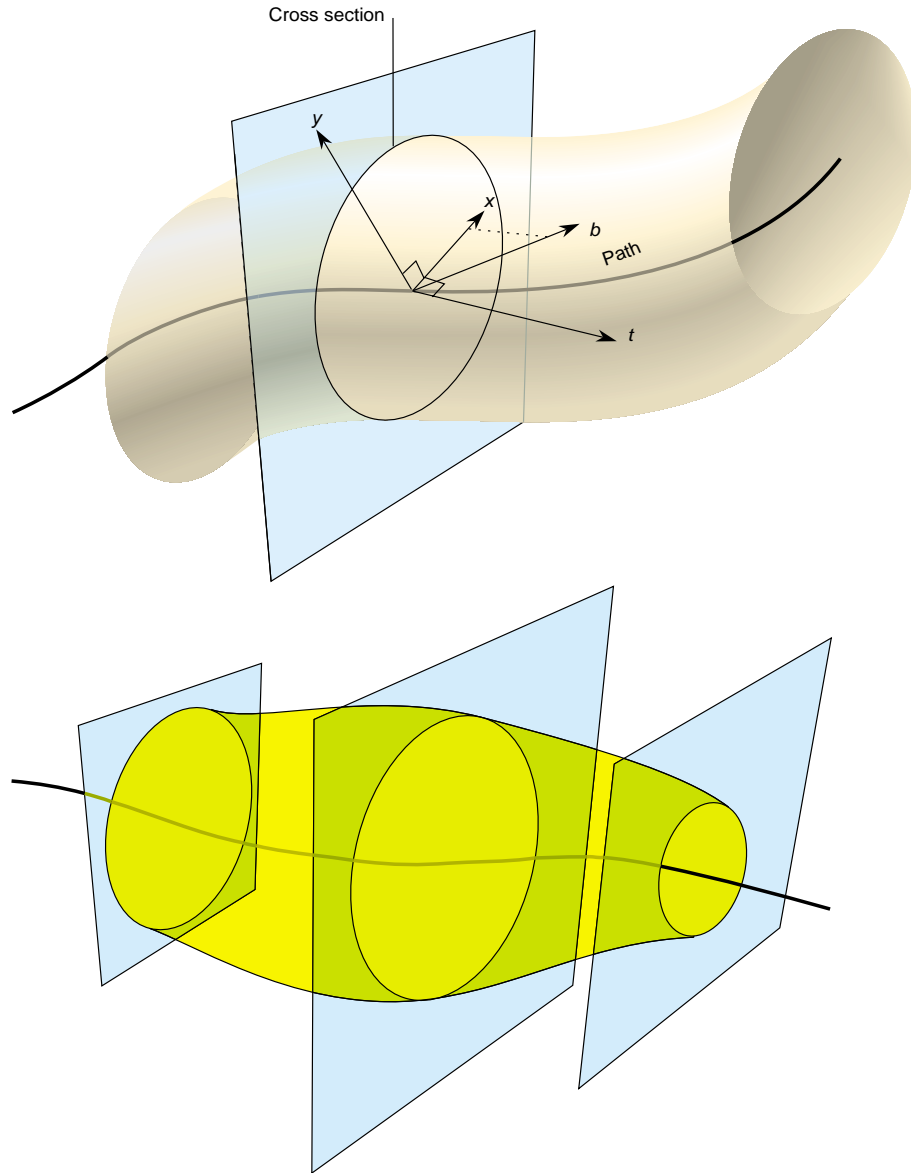

Figure 9-15 Swept Surface: Moving Reference Frame and Effect of Profile Function

Orientation of the Cross Section

Unlike the examples of the cylinder, torus, and cone, the cross-section in an `pfSweptSurface` generally is not necessarily perpendicular to the path. You set the orientation of the cross-section with two additional instances of `pfCurve3d`. For a point on the path corresponding the parameter value t_0 , the vectors on these two additional curves that have the same parameter value define the local coordinate system used to draw the profile: one vector defines the normal to the plane of the graph, the second the x axis for the graph, and their cross product determines the direction of the y axis for the graph. For more details, see the discussion of the constructor below.

Class Declaration for `pfSweptSurface`

The class has the following main methods:

```
class pfSweptSurface : public pfParaSurface
{
public:
// Creating and destroying
pfSweptSurface( void );
pfSweptSurface( pfCurve3d *crossSection,
                pfCurve3d *_path,
                pfCurve3d *_t,
                pfCurve3d *_b,
                pfScalar *_profile );
virtual ~pfSweptSurface( );

// Accessor functions
void setCrossSection( pfCurve3d *_crossSection );
void setPath( pfCurve3d *_path );
void setT( pfCurve3d *_tng );
void setB( pfCurve3d *_b );
void setProf( pfScalar *_profile );
pfCurve3d *getCrossSection() const;
pfCurve3d *getPath() const;
pfCurve3d *getT() const;
pfCurve3d *getB() const;
pfScalar *getProf()const;

virtual void evalPt( pfReal u, pfReal v, pfRVec3 &pnt );
};
```

Main Features of the Methods in pfSweptSurface**pfSweptSurface(*crossSection*, *path*, *t*, *b*, *profile*)**

Defines a swept surface with the given path, cross section, and profile. The arguments *t* and *b* are vector-valued functions of the path's parameter. They define the orientation of the profile at each point on the path.

The orientation at a particular point on the curve is determined by rendering the graph of *crossSection* in the coordinate plane perpendicular to *t*, which locally defines the *z* axis of an *x-y-z* coordinate system. The *x* axis is defined by the projection of *b* onto the plane, and the *y* axis forms a right-hand coordinate system with the other two axes. The cross section is plotted in the *x-y* plane.

If you specify a NULL value for *profile*, *crossSection* does not vary along *path*.

evalPt(*u*, *v*, *pnt*)

Calculates the point on the surface, *pnt*, as the vector sum of (a) the point on the path corresponding to the value *u* and (b) the point on the cross section corresponding to the value *v*. The vector locating the point on the cross section is scaled by the value at *u* of the *profile* function, if *profile* is not NULL.

pfFrenetSweptSurface

As a convenience, the class `pfFrenetSweptSurface` allows you to use the Frenet frame of the path to define the orientation vectors in a swept surface. The Frenet frame is defined by the three unit vectors derived from the tangent, the principal normal, and their cross product. This set of vectors facilitates orienting the cross section perpendicularly to the path at every point.

Note: The path for an `pfFrenetSweptSurface` must be at least a cubic to allow for the principal normal calculation, which requires a second derivative.

Class Declaration for pfFrenetSweptSurface

The class has the following main methods:

```
class pfFrenetSweptSurface : public pfSweptSurface
{
public:
// Accessor functions
pfFrenetSweptSurface( void );
pfFrenetSweptSurface( pfCurve3d *crossSection,
                    pfCurve3d *path,
                    pfScalar *profile );
virtual ~pfFrenetSweptSurface( );

// Accessor functions
void set( pfCurve3d *crossSection,
        pfCurve3d *path,
        pfScalar *profile );
};
```

Main Features of the Methods in pfFrenetSweptSurface

The arguments of the constructor for `pfFrenetSweptSurface` are the same as for `pfSweptSurface` and have the same effects, except for the orientation vectors, which are set to be the tangent and principal normal to *path*, and so do not appear as arguments. Use the inherited method `evalPt()` to locate points on the surface.

Making a Modulated Torus With pfFrenetSweptSurface

The following code uses an pfFrenetSweptSurface to define a torus whose minor radius varies with position on the ring. Other instances of pfFrenetSweptSurface appear in repTest.

```
// Scalar curve used by the swept surface primitive
static pfReal profile( pfReal t )
{
    return 0.5*cos(t*5.0) + 1.25;
};

pfCircle3d *cross =
    new pfCircle3d( 0.75, new pfRVec3( 0.0, 0.0, 0.0)
);
pfCircle3d *path =
    new pfCircle3d( 1.75, new pfRVec3( 0.0, 0.0, 0.0)
);
pfFrenetSweptSurface *fswept =
    new pfFrenetSweptSurface( cross, path, profile );
fswept->setHandednessHint( TRUE );
```

Ruled Surfaces

A ruled surface is generated from two curves in space, both parameterized by the same variable, u . A particular value of u specifies a point on both curves. A ruled surface is defined by connecting the two points with a straight line parameterized by v . The parameterization of the resulting surface is always the unit square in the UV plane, regardless of the parameterizations of the original curves.

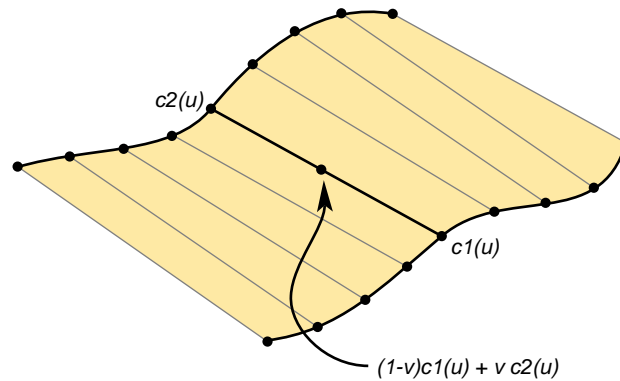

Figure 9-16 Ruled Surface Parameterization

A *bilinear interpolation* of four points is perhaps the simplest example of a ruled surface, one for which the “curves” that define the surface are in fact straight lines. Thus, you connect two pairs of points in space with lines and then develop the ruled surface. For a bilinear interpolation, the parameterization by u and v is such that, if one of them is held constant, a point “moves” along the connecting straight line at a uniform speed as the other parameter is varied.

Class Declaration for pfRuledSurface

The class has the following main methods:

```
class pfRuledSurface : public pfParaSurface
{
public:
// Creating and destroying
pfRuledSurface();
pfRuledSurface( pfCurve3d *c1, pfCurve3d *c2 );
virtual ~pfRuledSurface();
// Accessor functions
void setCurve1( pfCurve3d *_c1 );
void setCurve2( pfCurve3d *_c2 );
pfCurve3d *getCurve1( ) const;
pfCurve3d *getCurve2( ) const;

// Evaluators
void evalPt(   pfReal  u, pfReal  v, pfRVec3 &pnt );
};
```

The constructor `pfRuledSurface(c1, c2)` creates an instance of a ruled surface defined by the two curves *c1* and *c2*.

Coons Patches

A Coons patch is arguably the simplest surface you can define from four curves whose endpoints match and form a closed loop. Think of the four curves as defining the four sides of the patch, with one pair on opposite sides of the patch defining the top and bottom curves and the other pair defining the left and right curves (see Figure 9-17). The top and bottom curves are parameterized by *u*, and the left and right curves by *v*. Thus, *u* is the “horizontal” coordinate and *v* the “vertical” coordinate.

The patch is made by

1. Adding the points on the ruled surface defined by the top and bottom curves to the points on the ruled surface defined by the left and right curves.
2. Subtracting the bilinear interpolation of the four corner points.

Figure 9-17 illustrates the construction. To understand the result, notice that, after you add the two ruled surfaces, each side of the boundary of the resulting surface is the sum of the original bounding curve and the straight line connecting the bounding curve’s endpoints. The straight line was introduced by the construction of the ruled surface that did not include the boundary curve. Subtracting the bilinear interpolation eliminates the straight-line components of the sum, leaving just the original four curves as the boundary of the resulting surface.

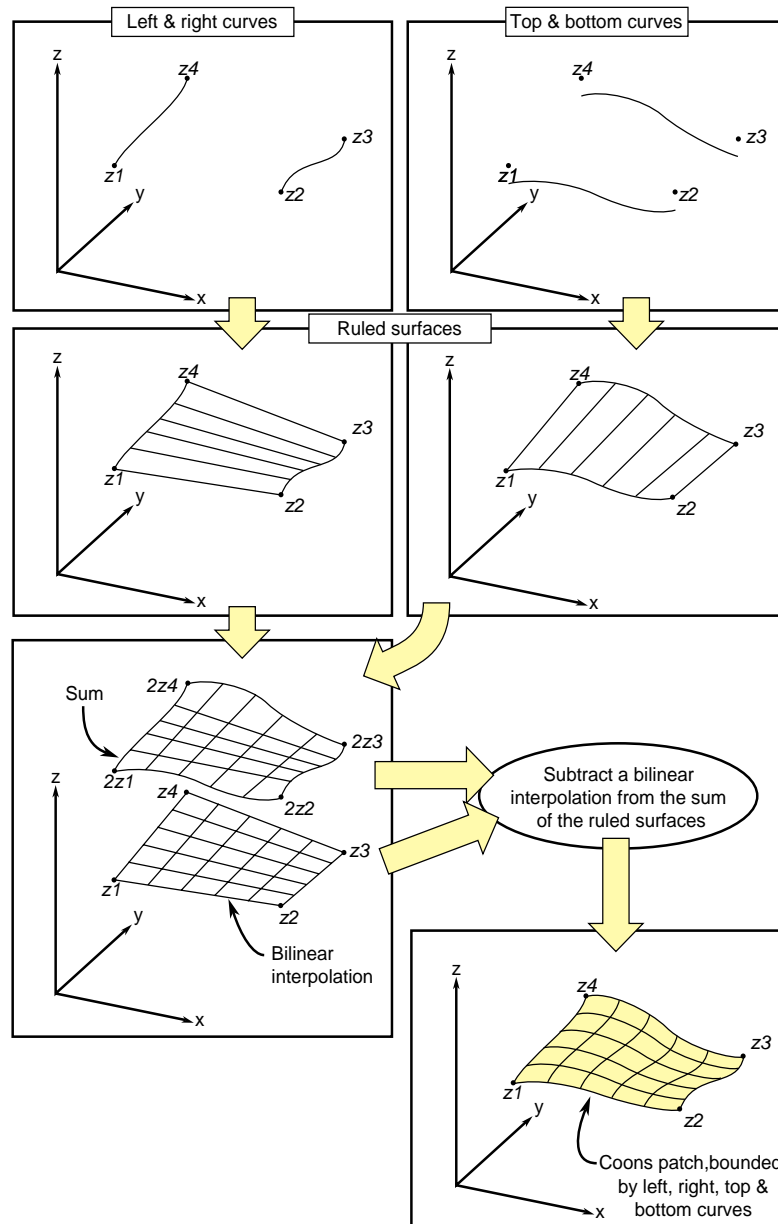

Figure 9-17 Coons Patch Construction

Class Declaration for pfCoonsSurface

The class has the following main methods:

```
class pfCoonsSurface : public pfParaSurface
{
public:
    pfCoonsSurface( );
    pfCoonsSurface( pfCurve3d *right,   pfCurve3d *left,
                  pfCurve3d *bottom,  pfCurve3d *top );
    virtual ~pfCoonsSurface( );

    // Accessor functions
    void setRight( pfCurve3d *right );
    void setLeft( pfCurve3d *left );
    void setBottom( pfCurve3d *bottom );
    void setTop( pfCurve3d *top );

    pfCurve3d* getTop() const;
    pfCurve3d* getBottom() const;
    pfCurve3d* getLeft() const;
    pfCurve3d* getRight() const;

    // Surface point evaluator
    void evalPt( pfReal u, pfReal v, pfRVec3 &pnt );
};
```

The constructor **pfCoonsSurface**(*right*, *left*, *bottom*, *top*) creates an instance of a Coons patch defined by the four curves *right*, *left*, *bottom*, and *top*. The top and bottom curves are parameterized by u and the left and right curves are parameterized by v .

NURBS Surfaces

Just as a NURBS curve consists of Bezier curves, a NURBS surface consists of Bezier surfaces. The set of control parameters is essentially the same for the curves and surfaces: a set of knots, a control hull, and a set of weights. However, for a NURBS surface, the knots form a grid in the coordinate system of the surface; that is, in the u - v plane, and the control hull is a grid of points in space that loosely defines the surface.

Understanding a Bezier surface helps you understand and use a NURBS surface. A Bezier surface is defined essentially as the surface formed by sweeping a Bezier cross

section curve through space, along a path defined by a Bezier curve. But, unlike an `pfSweptSurface`, the shape of the cross-section can be changed.

You define a Bezier surface as follows:

1. Start with a Bezier curve in space: the cross section parameterized by u .
2. Define a family of Bezier curves, a set of paths all of which are parameterized by v , that start at the control points of the initial cross section.

For each value of v , the set of control points defines a Bezier curve. As v changes, the cross-sectional curve “moves” through space, changing shape and defining a Bezier surface.

A NURBS surface joins Bezier surfaces in a smooth way, similar to NURBS curves joining Bezier curves. The class `pfNurbSurface` provides methods to describe a NURBS surface.

Class Declaration for `pfNurbSurface`

The class has the following main methods:

```
class pfNurbSurface : public pfParaSurface
{
public:
// Creating and destroying
pfNurbSurface( void );
virtual ~pfNurbSurface( );

// Accessor functions
void setControlHull( int iu, int iv, const pfRVec3 &p );
void setControlHull( int iu, int iv, const pfRVec4 &p );
void setWeight( int iu, int iv, pfReal w );
void setUknot( int iu, pfReal u );
void setVknot( int iv, pfReal v );
void setControlHullUSize( int s );
void setControlHullVSize( int s );

// Get the same parameters
pfRVec3& getControlHull( int iu, int iv ) ;
int      getControlHullUSize( void );
int      getControlHullVSize( void );
pfReal   getWeight( int iu, int iv)
pfReal   getUknot( int iu);
pfReal   getVknot( int iv);
int      getUknotCount( void );
```

```
int      getVknotCount( void );
int      getUorder( void );
int      getVorder( void );
void     removeControlHullElm(int ui, int iv);
void     removeUknot(int iu);
void     removeVknow(int iv);
void     flipUV();

// Evaluator
virtual void evalPt(   pfReal u, pfReal v, pfRVec3 &pnt );
virtual void evalDu(   pfReal u, pfReal v, pfRVec3 &Du );
virtual void evalDv(   pfReal u, pfReal v, pfRVec3 &Dv );
virtual void evalNorm( pfReal u, pfReal v, pfRVec3 &norm );
};
```

Main Features of the Methods in pfNurbSurface

The member functions are essentially the same as those for pfNurbCurve3d (see “NURBS Curves in Space” on page 379), however:

- The hull is a grid of pfRVec3s indexed by i and j .
- The set of knots is defined by points on the u and v axes.
- There are B-spline basis functions (of possibly differing orders) associated with each coordinate direction.

Note: pfNurbSurface redefines the virtual evaluators inherited from pfParaSurface for tangent and normal vectors; the methods use the NURBS equation rather than finite, central differences.

Indexing Knot Points and the Control Hull

Indexing of knot points in coordinate space and control hull points in three-dimensional space is illustrated in Figure 9-18. The indexing works as for gluNurbsSurface, that is, as follows:

- iu indexes knots on the u axis. The correspondence is established by **setUknot()**.
- iv indexes knots on the v axis. The correspondence is established by **setVknot()**.
- Each (iu,iv) thus indexes a knot point in the $u-v$ plane.

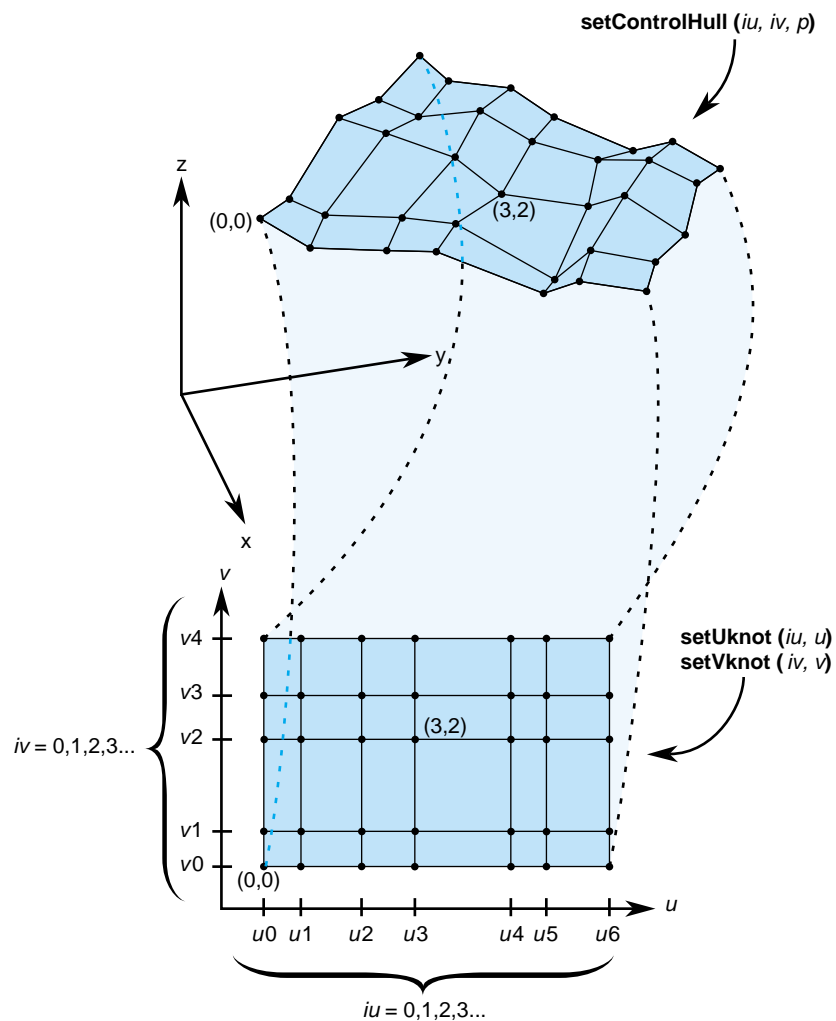

- Each (iu, iv) also indexes a point on the control hull in three-dimensional space. The correspondence is established by $\text{setControlHull}()$.
- Thus, $\text{setUknot}()$, $\text{setVknot}()$, and $\text{setControlHull}()$ establish a correspondence between an index pair (iu, iv) a knot point (u_{iu}, v_{iv}) , and a point on the control hull in three-dimensional space.

Figure 9-18 NURBS Surface Control Hull Parameterization

Equation Used to Calculate a NURBS Surface

Indexing is determined by the following equation that OpenGL Performer uses to calculate a NURBS surface (the index i corresponds to iu in the API, and j corresponds to iv):

$$p(u, v) = \frac{\sum_{i,j} B_i^m(u) B_j^n(v) C_{ij}}{\sum_{i,j} B_i^m(u) B_j^n(v) W_{ij}}$$

where

- $p(u, v)$ is a point on the surface
- $B_i^m(u)$ is the i^{th} B-spline basis polynomial of degree m
- C_{ij} is a control point
- W_{ij} is the weight for the control point

Alternative Equation for a NURBS Surface

A NURBS surface can also be developed from the following alternative expression:

$$p(u, v) = \frac{\sum_{i,j} B_i^m(u) B_j^n(v) W_{ij} C_{ij}}{\sum_{i,j} B_i^m(u) B_j^n(v) W_{ij}}$$

For this case, you must change the coordinates of the control points to get the same surface from OpenGL Performer. You convert the coordinates of the control points from (x,y,z,w) to (wx,wy,wz,w) .

Sample of a Trimmed pfNurbSurface From repTest

The following code fragment from the repTest sample application illustrates an instance of an pfNurbSurface. Toward the end of the example, an optional pfNurbCurve2d trim curve is created.

```
int i, j;

pfNurbSurface *nurb = new pfNurbSurface;

// Control hull dimensions
#define USIZE 4
#define VSIZE 5

// Set up the control hull size because we know a priori how big
// the nurb is. The next two lines are used for space
// efficiency but are functionally unnecessary.
nurb->setControlHullUSize(USIZE);
nurb->setControlHullVSize(VSIZE);

// Make the control hull be an oscillating grid
for ( i = 0; i < VSIZE; i++ )
{
    pfReal y = i/(float)(VSIZE - 1) * 2*M_PI - M_PI;

    for ( j = 0; j < USIZE; j++ )
    {
        pfReal x = j/(float)(USIZE - 1) * 2*M_PI - M_PI;
        pfReal val = 6*pow( cos(sqrt(x*x + y*y)), 2.0);

        // Make the control hull a box, j maps to u and i maps to v
        nurb->setControlHull( i, j, pfRVec3( x, y, val));

        // Add the weights
        nurb->setWeight( i, j, 1.0 );
    }
}

// Add the knot points
nurb->setUknot( 0, 0.0 );
nurb->setUknot( 1, 0.0 );
nurb->setUknot( 2, 0.0 );
nurb->setUknot( 3, 0.0 );
nurb->setUknot( 4, 1.0 );
nurb->setUknot( 5, 1.0 );
```

```
nurb->setUknot( 6, 1.0 );
nurb->setUknot( 7, 1.0 );

nurb->setVknot( 0, 0.0 );
nurb->setVknot( 1, 0.0 );
nurb->setVknot( 2, 0.0 );
nurb->setVknot( 3, 0.0 );
nurb->setVknot( 4, 1.0 );
nurb->setVknot( 5, 1.0 );
nurb->setVknot( 6, 1.0 );
nurb->setVknot( 7, 1.0 );

// Only trim reps in the first row
if ( nVersions <= 0 )
{
// Add a super quadric trim curve
pfSuperQuadCurve2d *trimCircle0 = new pfSuperQuadCurve2d( 0.25, new
pfRVec2(0.25, 0.50), 2.0 );
nurb->addTrimCurve( 0, trimCircle0, NULL );

// make a 4-th order nurb trim curve
pfNurbCurve2d *l = new pfNurbCurve2d;

l->setKnot(0,0.0);
l->setKnot(1,0.0);
l->setKnot(2,0.0);
l->setKnot(3,0.0);
l->setKnot(4,1.0);
l->setKnot(5,1.0);
l->setKnot(6,1.0);
l->setKnot(7,1.0);
l->setControlHull(0,pfRVec2(0.50,0.50));
l->setControlHull(1,pfRVec2(0.90,0.10));
l->setControlHull(2,pfRVec2(0.90,0.90));
l->setControlHull(3,pfRVec2(0.50,0.50));

nurb->addTrimCurve( 1, l, NULL );
}
```

Hermite-Spline Surfaces

Hermite-spline surfaces interpolate a grid of points; that is, they pass through the set of specified points under the constraint that you supply the tangents at each point in the u and v directions and the mixed partial derivative at each point. This surface definition is the natural generalization of Hermite-spline curves, discussed in “Hermite-Spline Curves in the Plane” on page 365.

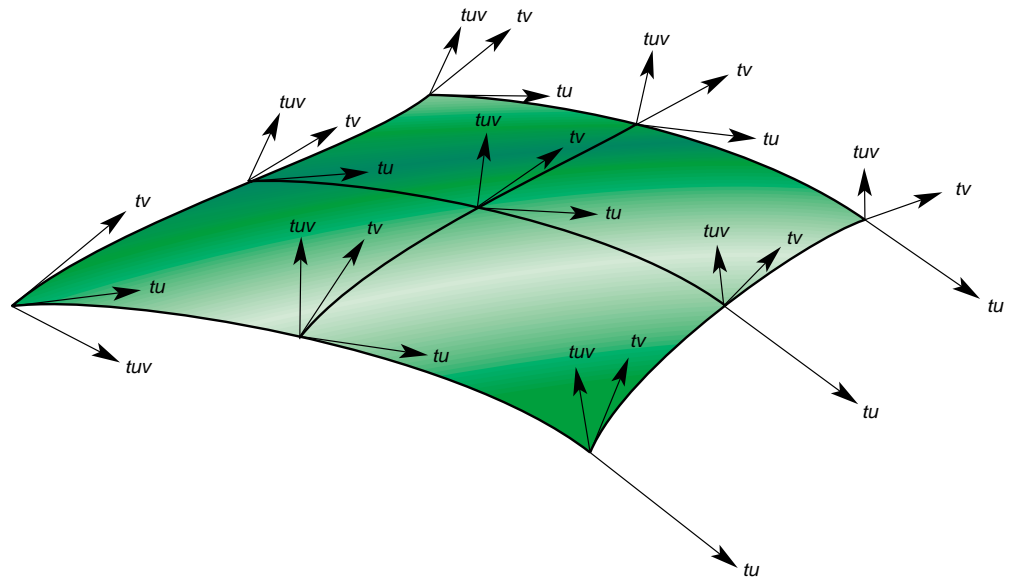

Figure 9-19 Hermite Spline Surface With Derivatives Specified at Knot Points

Hermite-spline surfaces are made of Hermite patches (see Figure 9-19). A bicubic *Hermite patch* expands the definition of a bilinear interpolation to include specification of first derivatives and mixed partial derivatives of the surface at each of the four corners. The adjective “bicubic” in the name of the patches refers to the mathematical definition, which includes products of the cubic Hermite polynomials that define a Hermite-spline curve.

An advantage of including the derivatives to constrain the surface is that it is simple to combine the patches into a smooth composite surface, that is, into a *Hermite-spline surface*.

Class Declaration for pfHsplineSurface

The class has the following main methods:

```
class pfHsplineSurface : public pfParaSurface
{
public:
// Creating and destroying
pfHsplineSurface();
pfHsplineSurface( pfReal *_p,
                  pfReal *_tu, pfReal *_tv, pfReal *_tuv,
                  pfReal *_uu, pfReal *_vv,
                  int uKnotCount, int vKnotCount );
virtual ~pfHsplineSurface();

// Accessor functions
pfRVec3& getP( int i, int j );
pfRVec3& getTu( int i, int j );
pfRVec3& getTv( int i, int j );
pfRVec3& getTuv( int i, int j );
pfReal  getUknot( int i );
pfReal  getVknot( int j );
int      getUknotCount();
int      getVknotCount();
pfBool   getCylindrical();

void setAll( pfReal *p,
            pfReal *tu,
            pfReal *tv,
            pfReal *tuv,
            pfReal *uu,
            pfReal *vv,
            int uKnotCount,
            int vKnotCount );
void setCylindrical( pfBool cylindrical );

// Surface point evaluator
void evalPt( pfReal u, pfReal v, pfRVec3 &pnt );
};
```

Main Features of the Methods in pfHsplineSurface

The pfHsplineSurface class has two important methods, the constructor and **set/getCylindrical()**.

The `pfHsplineSurface` constructor has the following arguments:

`_p` Specifies the grid of points on the surface.

`_tu`, `_tv`, and `_tuv`

Specify, respectively, the corresponding tangents in the u and v directions and the mixed partials.

The indexing of each of the arrays `_p`, `_tu`, `_tv`, and `_tuv` is as follows: the x , y , and z components of each vector are grouped in that order, and the sequence of points is defined so that the `vKnotCount` index changes more rapidly.

`uKnotCount` and `vKnotCount`

Specify the number of points in the grid. The surface is made of $(uKnotCount-1) \times (vKnotCount-1)$ Hermite patches.

`_uu` and `_vv`

Define the knot points, the parameter values corresponding to the patch corners; thus, they have `uKnotCount` and `vKnotCount` elements, respectively.

`setCylindrical()` and **`getCylindrical()`**

Control the flag for whether the coordinates and derivatives are assumed to be in cylindrical coordinates.

Meshes

A mesh, encapsulated in OpenGL Performer by the high-level class `pfMesh`, is used to store information about the topology of an object. A `pfMesh` is derived from a `pfObject` for memory allocation purposes. A `pfMesh` stores the object as a collection of vertices and flat faces (a vertex being encapsulated as a `pfMeshVertex` and a face as a `pfMeshFace`). It is possible to query the mesh to determine the information about neighbors of a given vertex or a face. This information is required by various algorithms—for example, for evaluating subdivision surfaces or for simplification of objects.

You can build a `pfMesh` for a given object in several ways:

- You can use the function **`pfAddNodeToMesh()`** that parses a given node and adds all its geometry to the mesh.
- You can write your own traverser and for each `pfGeoSet` you can call the function **`pfMeshAddGeoSet()`**.

- You can call the function **pfMeshAddTriangle()** or **pfMeshAddFace()** and add each face separately.
- Where you would like to have full control over the topology stored in the **pfMesh**, you can directly set the array of faces and vertices. To do that, you can create the corresponding arrays by calling **pfMeshNumFaces()** and **pfMeshNumVertices()** and then set each face and vertex separately. You can get the pointer to the array item by calling the function **pfGetMeshVertex()** and **pfGetMeshFace()**, respectively.

When using the function **pfMeshAddGeoSet()**, you can specify the **pfGeoSet**, the number of a mesh part, and the current transformation. The information about parts can be used to mark edges. Each edge is automatically marked with the following flags:

Flag	Description
PFM_EDGE_NORMAL	An edge with two adjacent faces
+PFM_EDGE_BOUNDARY	An edge with one adjacent face to the left of the edge
-PFM_EDGE_BOUNDARY	An edge with one adjacent face to the right of the edge
PFM_EDGE_SPLIT	An edge with more than one adjacent face (in the case of non-manifold surfaces).

You can mark edges between different parts as **PFM_EDGE_CREASE** if the flag **PFM_FLAG_CREASES_BETWEEN_PARTS**, described later in this section, is set. Note that edges between faces with different **pfGeoStates** are also usually marked as creases.

The part index and the transformation is also provided to functions **pfMeshAddTriangle()** and **pfMeshAddFace()**. In addition, you also need to set the **pfGeoState** of the triangle or face.

When setting vertices and faces directly and accessing them through a pointer, you need to set all vertex and face parameters. See the later sections “Mesh Faces” on page 423 and “Mesh Vertices” on page 424.

You must call the function **pfMeshSplitVertices()** after all vertices are set, regardless of the method used to build the mesh. This function performs extra post-processing that cleans the mesh in cases where the object is not a manifold (see section “Mesh Vertices” on page 424 for more details).

You can set the following flags to 0 or 1:

Flag

PFM_FLAG_TRIANGULATE

PFM_FLAG_TEST_ORIENTATION

PFM_FLAG_CREASES_BETWEEN_PARTS

PFM_FLAG_CREASES_BETWEEN_GEOSTATES

PFM_FLAG_QUAD_TSTRIPS

PFM_FLAG_USE_VERTEX_GRID

Description

If this flag is set, quads and polygons processed by **pfMeshAddGeoSet()** are triangulated. This flag can be used for Loop subdivision. It is off by default.

If this flag is set, the normal at the first vertex of a face is compared with the face normal. If they point in the opposite directions, the order of vertices is is changed. This flag is off by default.

If this flag is set, it automatically marks edges between different parts as creases. It is on by default.

If this flag is set, it automatically marks edges between pfGeoSets with different pfGeoStates. It is on by default.

If this flag is set, triangle strips processed by **pfMeshAddGeoSet()** are converted to quads even if the quads are not planar. It is off by default.

If this flag is set, a grid is used when adding faces and checking for existing vertices. You must set the bounding sphere of the mesh to use the grid established by **pfMeshGridBsphere()**. It is off by default.

You can set the following values:

Value	Description
PFM_EPSILON	Sets the epsilon to be used when comparing vertices. The default is $1e-6$ or if the grid is defined, $1e-6$ multiplied by a ratio of the grid diameter to the grid resolution along X axis.
PFM_VERTEX_GRID_SIZE_X	See the description for flag PFM_VERTEX_GRID_SIZE.
PFM_VERTEX_GRID_SIZE_Y	See the description for flag PFM_VERTEX_GRID_SIZE.
PFM_VERTEX_GRID_SIZE_Z	See the description for flag PFM_VERTEX_GRID_SIZE.
PFM_VERTEX_GRID_SIZE	Sets the resolution of the grid used for comparing vertices. You can set the grid size one value at the time or all three coordinates at once. The default grid size is 32x32x32.

You can also query the bounding box of the mesh using the function **pfGetMeshBbox()**. This bounding box is computed automatically around the mesh vertices.

You can use the function **pfMeshUpdateMesh()** to automatically detect which vertices have been changed and to mark them and the corresponding faces. This can be used in case of dynamically controlled meshes (see the section “Subdivision Surfaces” on page 427 for an example). Since each vertex stores both the pointer to the original vertex location and the vertex coordinates, any changes can be easily detected by comparing these values.

Mesh Faces

OpenGL Performer uses mesh faces and its vertices to describe a mesh, which in turn describes the topology of an object. The high-level class `pfMeshFace` encapsulates a face. Each face contains the following:

- An array of face vertices
The class `pfMeshVertex` represents a vertex. You can use the functions **pfMeshFaceNumVerts()** and **pfMeshFaceVertex()** to set face vertices. The parameters of the function **pfMeshFaceVertex()** are the vertex index in the array

stored with the face (which vertex you want to set) and the vertex index in the array of vertices associated with a `pfMesh`. The latter index identifies the vertex. You can use the functions `pfGetMeshFaceNumVerts()` and `pfGetMeshFaceVertex()` to query face vertices.

- A set of texture coordinates
You can use the function `pfMeshFaceTexCoord()` to specify texture coordinates as vertices.
- A `pfGeoSet`
- A part index
The part index is used by the `pfMesh` to determine which edges are marked as smooth and which, as creases (see the preceding section “Meshes” on page 420)
- Flags
There is only one flag used by a `pfMeshFace`: `PFMF_FLAG_FACE_CHANGED`. You set this flag with the function `pfMeshUpdateMesh()` to indicate that a vertex of the face has changed position.

Mesh Vertices

A `pfMeshVertex` is a high-level OpenGL Performer class used in a `pfMesh` to store information about vertices. A `pfMeshVertex` stores the following:

- Vertex coordinates
- The pointer to the original vertex coordinates (to be able to detect local changes in the mesh)
- An array of vertex neighbors
- A set of binary flags
- An index of another vertex at the same location (used for non-manifolds, as described later in the subsection “Vertex Neighbors” on page 425)

This section describes these items in the following subsections:

- “Vertex Coordinates”
- “Vertex Neighbors”
- “Binary Flags”

Vertex Coordinates

You can use the functions `pfMeshVertexCoord()` and `pfMeshVertexCoordPtr()` to set the vertex coordinates and the pointer to the original coordinates. The value set by `pfMeshVertexCoord()` should correspond to the value at the location set by `pfMeshVertexCoordPtr()`. If the specified pointer is `NULL` (for example, where a `pfGeoSet` was under a `pfSCS` node), it is not possible to automatically detect changes in position of vertices and you must modify all vertices manually by calling the function `pfMeshVertexCoord()`. If you do not plan to animate the mesh, you can set the pointer to `NULL`.

Vertex Neighbors

Each vertex stores an array of its neighbors. You can query the neighbors using the functions `pfMeshVertexNumNeighbors()` and `pfMeshVertexNeighbor()`. The structure of `pfMeshVertexNeighbor()` is defined in `pf.h` as follows:

```
typedef struct
{
    int vertex;
    int face;
    short int edgeType;
    short int next, prev;
} pfMeshVertexNeighbor;
```

This structure consists of the vertex index (in the array of vertices in `pfMesh`), face index (in the array of faces in `pfMesh`), edge type, and index of the next and previous neighbor in the array of neighbors.

The edge can be one of the following types:

Edge Type	Description
<code>PFM_EDGE_NORMAL</code>	Specifies a smooth edge with two adjacent faces.
<code>PFM_EDGE_CREASE</code>	Specifies a sharp edge with two adjacent faces.
<code>+PFM_EDGE_BOUNDARY</code>	Specifies an edge with one adjacent face to the left of the edge.
<code>-PFM_EDGE_BOUNDARY</code>	Specifies an edge with one adjacent face to the right of the edge.

The pertinent face is the face to the left of the edge (unless the edge is marked as `-PFM_EDGE_BOUNDARY`). The next neighbor is part of this face and the previous neighbor is part of the face to the right. If the edge is of type `-PFM_EDGE_BOUNDARY`, the next neighbor points to the corresponding edge of type `+PFM_EDGE_BOUNDARY` and the previous neighbors of the edge of type `+PFM_EDGE_BOUNDARY` point to the the corresponding edge of type `+PFM_EDGE_BOUNDARY`. Note that in the case of manifolds each vertex has exactly zero or two boundary edges.

In the case of arbitrary surfaces, there may be more than one loop of neighbors (if you follow the next links). That is why the class `pfMesh` provides the function **`pfMeshSplitVertices()`**, which splits each vertex where the surface behaves as non-manifold. The vertex is split into several vertices, each having a single loop of ordered neighbors and the same position.

You can access the next and previous neighbor for a given neighbor with vertex indexed `v1` by calling the functions **`pfPreviousNeighborMeshVertex()`** and **`pfNextNeighborMeshVertex()`**. You can also determine the index of such a neighbor in the array of neighbors by calling **`pfPreviousNeighborIndexMeshVertex()`** and **`pfNextNeighborIndexMeshVertex()`**.

Binary Flags

The following flags can be set for each `pfMeshVertex`:

Flag	Description
<code>PFMV_FLAG_VERTEX_CHANGED</code>	Set by the function <code>pfMeshUpdateMesh()</code> when the coordinate stored at the vertex does not match the value at the coordinate pointer.
<code>PFMV_FLAG_VERTEX_NEIGHBOR_CHANGED</code>	Set by the function <code>pfMeshUpdateMesh()</code> when the position of any neighbor changes.
<code>PFMV_FLAG_VERTEX_FACE_CHANGED</code>	Set by the function <code>pfMeshUpdateMesh()</code> when the position of any vertex on any of the faces associated with this vertex changes.
<code>PFMV_FLAG_VERTEX_SPLIT</code>	Set by the function <code>pfMeshSplitVertices()</code> when the surface around the vertex is not manifold and the vertex is split into several vertices (see the preceding section “Vertex Neighbors” on page 425).

Subdivision Surfaces

A subdivision surface is specified by a control mesh consisting of a set of connected faces (usually triangles or quads). The control mesh is stored as a `pfMesh`. The OpenGL Performer class `pfSubdivSurface` is used to define a subdivision surface.

Before rendering a subdivision surface, each face is recursively subdivided into a finer mesh. For example, in the case of Loop subdivision, each triangle is subdivided into four new triangles at each subdivision step. The positions of both original vertices and newly introduced vertices are determined by the subdivision rules. Usually the position is a linear combination of the positions of the original vertices of the face and the vertices of neighboring faces. The parameters of the linear combination are set in a such a way that, after a few subdivision steps, the resulting mesh smooths sharp edges. For example, if the control mesh is a tetrahedron after a few subdivision steps, you get an oval shape. Optionally, it is possible to mark selected edges not to be smooth. An excellent source of

information on subdivision surfaces is the SIGGRAPH 2000 course "Subdivision for Modeling and Animation" (<http://mrl.nyu.edu/publications/subdiv-course2000/>).

The remainder of this section describes the following topics:

- "Creating a Subdivision Surface"
- "Loop and Catmull-Clark Subdivisions"
- "Dynamic Modification of Vertices"
- "The libpfsubdiv Pseudo Loader"
- "Special Notes"

Creating a Subdivision Surface

The function **pfSubdivSurface()** creates and returns a handle to a **pfSubdivSurface**. Like other **pfNodes**, **pfSubdivSurfaces** are always allocated from shared memory and cannot be created statically on the stack or in arrays. Use the function **pfDelete()** rather than the delete operator to delete **pfSubdivSurfaces**.

To define a subdivision surface, you must specify its control mesh using the function **pfSubdivSurfaceMesh()**. The mesh is stored as a **pfMesh**. A **pfMesh** is a data structure that stores the connectivity between individual faces of the mesh. For each vertex and face, you can access neighboring vertices and faces, respectively. See the preceding section "Meshes" on page 420 for more details.

To create a **pfMesh**, you can either specify its faces and the connectivity one by one or use the function **pfAddNodeToMesh()**. This function takes a **pfNode**, parses all its **pfGeoSets**, splits all primitives into planar faces, and adds those faces into the specified **pfMesh** (see the **pfAddNodeToMesh** man page).

Before you set the mesh using **pfSubdivSurfaceMesh()**, you need to set various parameters of the subdivision because different internal data structures may be needed for different types of subdivision. You use the function **pfSubdivSurfaceVal()** to set the values and the function **pfSubdivSurfaceFlags()** to set the flags.

You can set the following values:

Parameter Value	Description
PFSB_SUBDIVISION_METHOD	Can be either PFSB_CATMULL_CLARK (Catmull-Clark subdivision, the default) or PFSB_LOOP (Loop subdivision).
PFSB_SUBDIVISION_LEVEL	Specifies the number of subdivision steps. Usually two or three steps are quite reasonable. The default is 0.
PFSB_MAX_DATA_HEIGHT_SW	Specifies the limit of data structures used to evaluate the subdivision surface in software. The default is unlimited. However, if you are running out of memory for large models evaluated in software, try a value like 10,000. This would mean that only 10,000 faces would be evaluated at a time.
PFSB_MAX_PBUFFER_HEIGHT	Specifies the maximum height of a pbuffer (off-screen memory on a GPU) used for evaluating the surface directly on the graphics hardware (GPU). The default is 512. It should be a power of two.

You can set the following flags to 0 or 1:

Flag	Description
PFSB_GPU_SUBDIVISION	Allows direct evaluation of the surface on the graphics hardware (GPU) if set to 1. The hardware must support floating point fragment shaders (for example, Onyx4 systems). The default is 0.
PFSB_CONTROL_VERTICES_DYNAMIC	Allows the modification of the vertices of the control surface (only their position) on the fly. See the later subsection “Dynamic Modification of Vertices” on page 431 for more information. The default is 0.
PFSB_USE_GEO_ARRAYS	Stores the resulting subdivided mesh (in the case of software evaluation) in pfGeoArrays. Otherwise, regular pfGeoSets are used. The default is 1.

The following examples set up a subdivision surface and add it into a scene.

Example 1:

```
pfSubdivSurface *subdivSurface;
pfMesh          *mesh;

subdSurf = pfNewSubdivSurface(arena);
mesh = pfNewMesh(arena);
if(method == PFSB_LOOP)
    pfMeshFlags(mesh, PFM_FLAG_TRIANGULATE, 1); // important!

pfdAddNodeToMesh(root, mesh, 0); // part 0

pfSubdivSurfaceVal(subdSurf, PFSB_SUBDIVISION_LEVEL, subdivLevel);
pfSubdivSurfaceVal(subdSurf, PFSB_SUBDIVISION_METHOD, method);
pfSubdivSurfaceFlags(subdSurf, PFSB_GPU_SUBDIVISION, GPUsubdivision);
```

Example 2:

```
pfSubdivSurfaceMesh(subdSurf, mesh);
pfAddChild(scene, subdSurf);

pfSubdivSurface *subdivSurface = new pfSubdivSurface;

pfMesh *mesh = new pfMesh;
if(method == PFSB_LOOP)
    mesh->setFlags(PFM_FLAG_TRIANGULATE, 1); // important!

pfdAddNodeToMesh(root, mesh, 0); // part 0

subdivSurface->setVal(PFSB_SUBDIVISION_LEVEL, subdivLevel);
subdivSurface->setVal(PFSB_SUBDIVISION_METHOD, method);
subdivSurface->setFlags(PFSB_GPU_SUBDIVISION, GPUsubdivision);

subdivSurface->setMesh(mesh);

scene->addChild(subdivSurface);
```

You can find sample code in the file

perf/samples/pguide/libpf/C++/subdivSurface.C. or in the file
 %PFROOT%\Src\pguide\libpf\C++\subdivSurface.cxx on Microsoft Windows.

Loop and Catmull-Clark Subdivisions

The major difference between Loop subdivision and Catmull-Clark subdivision is in the type of faces they process. Loop subdivision operates exclusively on triangles. Therefore, the control mesh has to be triangulated. Since a `pfMesh` does not know whether it is used in a `pfSubdivSurface` and what subdivision method is used, you must set the flag `PFM_FLAG_TRIANGULATE` on the `pfMesh` before specifying the faces (see the sample code in the preceding section “Creating a Subdivision Surface” on page 428).

Catmull-Clark subdivision, on the other hand, operates on quads. If the control mesh contains non-quads, the first subdivision step is performed using special rules so that an arbitrary face is divided into a set of quads. Note that this step cannot be performed on a GPU. This step introduces some discontinuities in the second derivative of the curvature. Consequently, the surface may appear more bumpy around the edges of the original control faces. For this reason, start with a control mesh containing only quads for optimal results. The advantage of Catmull-Clark subdivision is that it is supported by many modeling tools, including Maya.

Dynamic Modification of Vertices

If the flag `PFM_CONTROL_VERTICES_DYNAMIC` is set, you can modify the position of vertices of the control mesh to animate the surface. You need to call the function `pfSubdivSurfaceUpdateControlMesh()` at each frame to confirm the changes. Note that you cannot have in the node any transforms specifying the control mesh.

The `libpfsubdiv` Pseudo Loader

You can subdivide an arbitrary file loaded into OpenGL Performer by using the `libpfsubdiv` pseudo loader. It works similarly as the `libpftrans` or `libpfscale` pseudo loader. Suppose that you want to subdivide `truck.pfb` in Perfly. You enter the following command:

```
perfly truck.pfb.0,2,0.subdiv
```

The syntax of the `libpfsubdiv` loader is as follows:

```
<filename>.<method>,<subdivLevel>,<GPUon>.subdiv
```

The value for *method* is 0 for Catmull-Clark and 1 for Loop subdivision. The *subdivLevel* value is usually around 2 and *GPUon* is 1 if the evaluation should be done fully on a GPU.

Special Notes

Note the following limitations and anomalies regarding the use of subdivision surfaces:

- Subdivision level 0 may result in incorrect normals.
- Currently, the GPU subdivision supports only control meshes with vertices that have less than 11 neighbors.
- Current drivers on Onyx4 systems and Microsoft Windows platforms do not support super buffers. Therefore, the GPU evaluation of subdivision surfaces on those systems is too slow.

Creating and Maintaining Surface Topology

Most objects in a large model are made of many parametric surfaces. The OpenGL Performer classes that describe the connectivity of parametric surfaces—that is, their topology—allow you to “stitch” surfaces together by defining shared boundary curves, and to propagate surface contact information.

The main purpose for shared-boundary information is to generate tessellations of adjacent surfaces that are consistent, that is, no cracks develop between any pair of rendered surfaces. Tessellations are discrete approximations of surfaces in terms of renderable geometric primitives, typically triangles (see Chapter 11, “Rendering Higher-Order Primitives: Tessellators”).

These topics are covered in this chapter:

- “Overview of Topology Tasks” on page 433
- “Summary of Scene Graph Topology: pfTopo” on page 434
- “Collecting Connected Surfaces: pfSolid” on page 443

Overview of Topology Tasks

The topology classes provide definitions of boundary curves shared by adjacent parametric surfaces. Discrete versions of these curves are used by tessellators to prevent cracks. A rendered image can have artificial cracks due to the following:

- Difficulty sampling enough points on the boundary between two surfaces so that mismatches of the tessellations are imperceptible
- Finite-precision mismatches between coordinates of ideally identical points, for example at triple junctions where the edges of three surfaces meet at a point

Propagating surface contact information is useful for other tasks, such as

- Maintaining consistent normal vectors for adjacent surfaces

- Deforming a surface and consistently deform an adjacent surface
- Determining whether an edge of a surface is in fact a shared boundary
- Creating a mirror image of a compound surface (you can use topological information to reorient the surface)

Summary of Scene Graph Topology: pfTopo

The class pfTopo holds data that indicates whether, and how, two pfParaSurfaces are in contact. You can create several pfTopos for a particular scene: for example, one each for subassemblies. A static member of pfTopo lists all the pfTopos that you create.

pfTopo maintains lists of surfaces and boundaries (pfBoundary) that are shared by an arbitrary number of surfaces. Figure 10-1 illustrates how these data structures define relations between pfParaSurfaces.

When an edge has been tessellated, the associated pfBoundary holds a discrete version of the curve. This discrete version is needed for consistent tessellations because it specifies one set of boundary vertices for tessellating all the surfaces that share the boundary. The role of pfBoundary in determining a consistent tessellation is illustrated in Figure 10-2.

The classes pfTopo and pfBoundary are examples of *b-reps*, which identify objects in terms of their bounding objects. pfBoundary is also *winged data structures*, a particular form of b-rep.

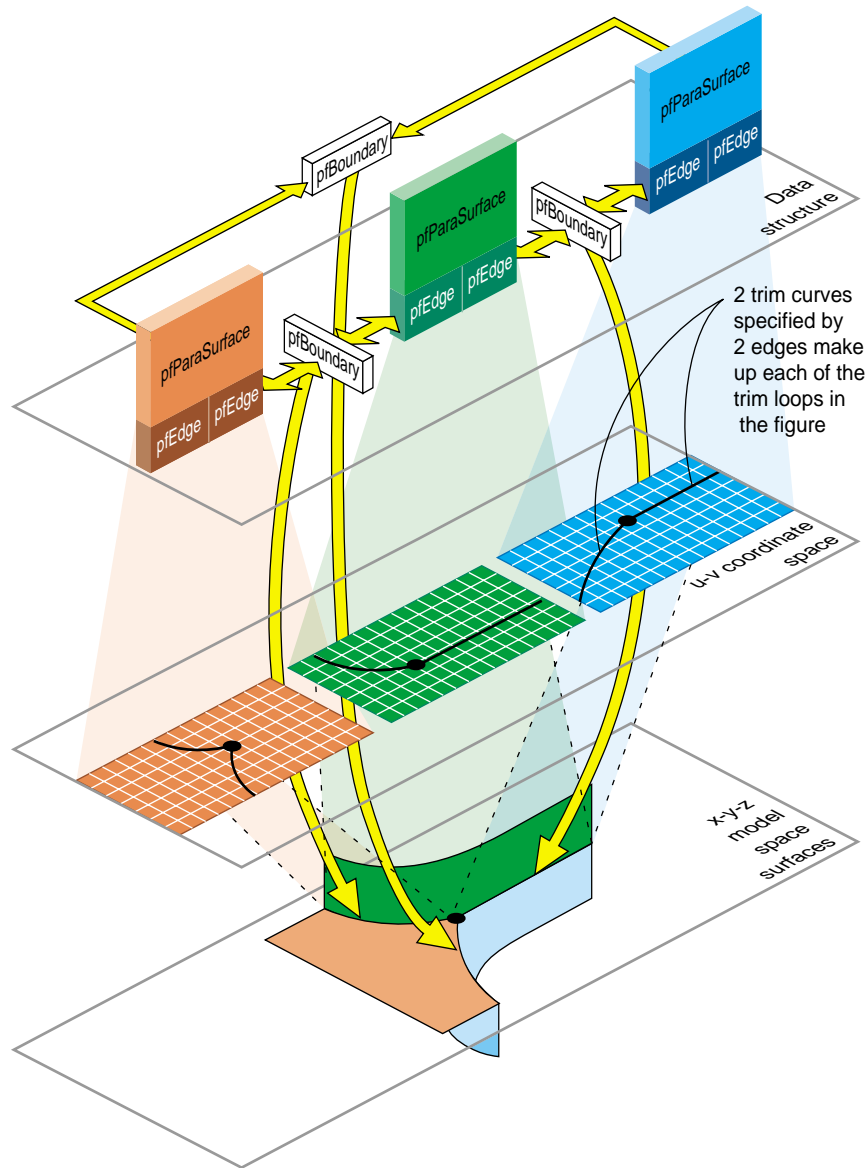

Figure 10-1 Topological Relations Maintained by Topology Classes

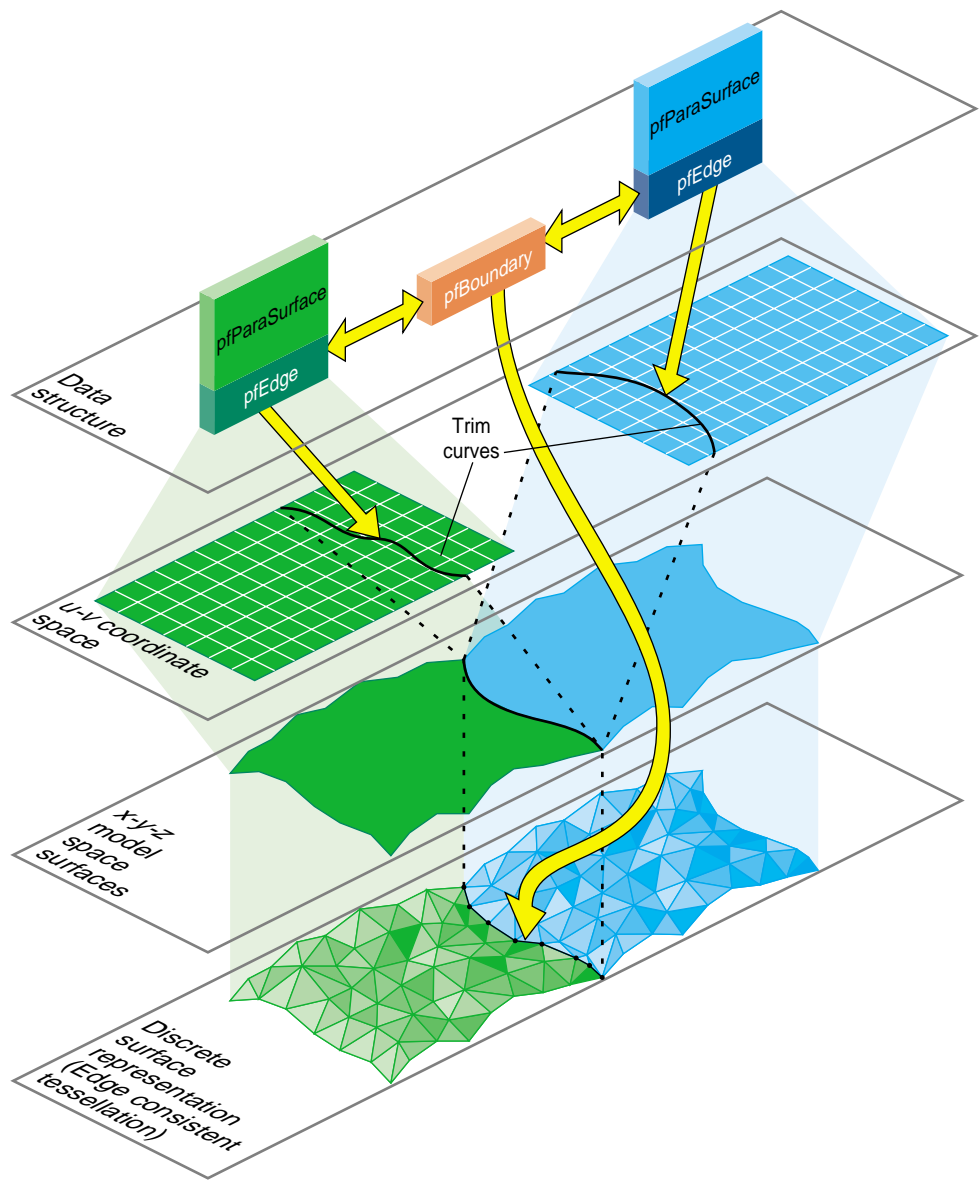

Figure 10-2 Consistently Tessellated Adjacent Surfaces and Related Objects

Building Topology: Computing and Using Connectivity Information

Given a set of pfParaSurfaces in a scene graph, there are several ways to develop a set of shared vertices to be held in pfBoundarys. The following sections describe the topology construction strategies (beyond the low-fidelity alternative of ignoring topology):

- “Building Topology Incrementally: A Single-Traversal Build” on page 437
- “Building Topology From All Scene Graph Surfaces: A Two-Traversal Build” on page 438
- “Building Topology From a List of Surfaces” on page 438
- “Building Topology “by Hand”: Imported Surfaces” on page 438
- “Summary of Topology Building Strategies” on page 439

Building Topology Incrementally: A Single-Traversal Build

As each surface is tessellated during a traversal, the tessellator checks for previously tessellated adjacent surfaces, uses existing vertices when it can, and adds necessary data to topology data structures.

Although OpenGL Performer’s incremental topology building tools attempt to avoid cracks, they can, in principle, appear: When a surface is added, a new junction on the boundary of an existing, tessellated surface may occur and the junction point may not be in the existing tessellation. The tessellation of the added surface introduces the junction point, necessarily at a finite distance from the existing tessellation, and a crack appears between the newly and previously tessellated surfaces.

Building Topology From All Scene Graph Surfaces: A Two-Traversal Build

Topology built with two passes is very clean; unlike a single-pass build, in principle no cracks due to unforeseen junctions can occur. The added cost of performing a two-traversal build is slight; it is the recommended way to build topology and perform tessellations if you want high-quality images. When building topology in two traversals, the following steps occur:

1. Connectivity of all surfaces is calculated during a topology building traversal of the scene graph, before a tessellation traversal.
2. The surfaces in the scene are tessellated during a second traversal.

Building Topology From a List of Surfaces

You can explicitly accumulate a list of surfaces for which to build topology and then tessellate the surfaces. The result is clean tessellations of the surfaces on the list. Cracks may appear if an adjacent surface was not included in the list.

Building Topology “by Hand”: Imported Surfaces

If you have a set of surfaces for which you know connectivity, you can explicitly develop the appropriate topological data structures and develop consistent tessellations.

The presence of cracks will depend on how good your input trim curves are. If three surfaces meet at a junction point that is not the shared endpoint of trim curves, a crack may appear.

Summary of Topology Building Strategies

Table 10-1 lists the methods required for each of the topology building strategies. See “Base Class pfTessellateAction” on page 449 for more information about the tessellation methods listed.

Table 10-1 Topology Building Methods

Topology Building Strategy	Methods
Ignore topology information and let cracks appear as they will.	<ol style="list-style-type: none"> 1. Do not create an pfTopo or build topology. 2. pfTessellateAction::setBuildTopoWhileTess(FALSE). 3. pfdTessellateGeometry(<i>root</i>, <i>tessAction</i>)
Build topology incrementally.	<ol style="list-style-type: none"> 1. Create an pfTopo. 2. pfTessellateAction::setBuildTopoWhileTess(TRUE). 3. pfTessellateAction::setTopo(<i>topo</i>). 4. pfdTessellateAction(<i>root</i>, <i>tessAction</i>).
Two-traversal build.	<ol style="list-style-type: none"> 1. Create an pfTopo. 2. pfTopo::buildTopologyTraverse(<i>root</i>). 3. pfTessellateAction::setBuildTopoWhileTess(FALSE). 4. pfdTessellateAction(<i>root</i>, <i>tessAction</i>).
Assemble a list of surfaces, build the topology, and then tessellate.	<ol style="list-style-type: none"> 1. Create an pfTopo. 2. Assemble list of surfaces: pfTopo::addSurface(<i>surf</i>). 3. pfTopo::buildTopology(). 4. pfTessellateAction::setBuildTopoWhileTess(FALSE). 5. pfdTessellateGeometry(<i>shape</i>, <i>tessAction</i>).
Build the topology “by hand.” See the file <code>/usr/share/Performer/src/pguide/libpf/C++/topoTest.C</code> (IRIX and Linux) <code>%PFROOT\Src\pguide\libpf\C++\topoTest.cxx</code> (Microsoft Windows)	<ol style="list-style-type: none"> 1. Create an pfTopo. 2. Assemble list of surfaces: pfTopo::addSurface(). 3. Create pfBoundarys. 4. Add to list of boundaries: pfTopo::addBoundary(). 5. Add edges to boundaries: pfBoundary::addEdge(). 6. Set boundary orientation: pfEdge::setBoundaryDir(). 7. pfTessellateAction::setBuildTopoWhileTess(FALSE). 8. pfdTessellateGeometry(<i>shape</i>, <i>tessAction</i>).
Step 7 does not appear in the code because FALSE is the default.	

Reading and Writing Topology Information: Using Pseudo Loaders

You can add topological information to an existing set of connected, higher-order surfaces in a file—for example, NURBS in an *.iv* or *.csb* file—and save the information for future, crack-free surface rendering. As a result, you do not have to repeat the topology build. The function `pfLoadFile()` reads the topological information in a *.pfb* file.

Before you save the scene graph data, you can also add tessellations that use the topology to give crack-free images (see Chapter 11, “Rendering Higher-Order Primitives: Tessellators”).

Table 10-2 shows three possible file conversions that you can apply to *.iv* or *.csb* files that contain reps but no topology or tessellation; they are listed with example `pfconv` command lines, which demonstrate how to use both the `pfctol` and `pfttl` pseudo loaders.

Table 10-2 Adding Topology and Tessellations to *.iv* and *.csb* Files

Conversion	Example Command Line
Format change only.	<code>pfconv sur.csb sur.pfb</code>
Add topology information to scene graph: save reps and topology information but not tessellations.	<code>pfconv sur.iv.topoTol.ttol surTopo.pfb</code> or <code>pfconv sur.csb.topoTol.ttol surTopo.pfb</code>
Add topology information and tessellations to scene graph: save reps, topology, and tessellations.	<code>pfconv sur.iv.topoTol.ttol.tessTol.ctol surTopoTess.pfb</code> or <code>pfconv sur.csb.topoTol.ttol.tessTol.ctol surTopoTess.pfb</code>
Add topology, tessellate, but do not save reps.	<code>pfconv sur.csb.topoTol.ttol.tessTol.ctol geodes.pfb.~.ctol</code>

If you perform conversion, you may have files with or without tessellations. Depending on the type of file you read, use one of the command lines in Table 10-3.

Table 10-3 Reading and Writing *.pfb* Files: with and without Tessellations

To read a <i>.pfb</i> file and perform tessellation (without having to build topology):	<code>perfly surTopo.pfb.tessTol.ctol</code>
To read a <i>.pfb</i> file that already has tessellations	<code>perfly surTopoTess.pfb</code>
To read a <i>.pfb</i> file that already has tessellations and force retessellation (thus, removing any existing geometry associated with the higher order primitives)	<code>perfly surTopoTess.pfb.+tessTol.ctol</code>
To read a <i>.pfb</i> file that already has tessellations and store it without reps	<code>perfly surTopoTess.pfb.geodes.pfb.~.ctol</code>

To delete the tessellation data, use the method `clearTessellation()`.

Class Declaration for pfTopo

The class has the following main methods:

```
class pfTopo : public pfObject
{
public:
// Creating and destroying
pfTopo( );
virtual ~pfTopo();

// Accessor functions
void setDistanceTol( pfReal tol, pfLengthUnits u )
pfReal getDistanceTol( ) const;

pfLengthUnits getLengthUnits() const;

static pfTopo* getGlobalTopo(int n);
```

```
static int getNumTopos();

pfParaSurface* getSurface( int i );
int getSurfaceCount( ) const;

pfBoundary* getBoundary( int i );
int getBoundaryCount( ) const;

int getSolidCount() const;
pfSolid* getSolid( int i )

//Adding topological elements
int addSurface( pfParaSurface *sur );
int addBoundary( pfBoundary *bnd );

//Topology construction
void buildTopology();
int buildSolids();
};
```

Main Features of the Methods in pfTopo

buildSolids() Collects connected surfaces in the pfTopo into pfSolids (see “Collecting Connected Surfaces: pfSolid” on page 443).

buildTopology() Builds consistent set of boundaries from the list of surfaces accumulated by calls to **addSurface()**. Previously developed boundaries are deleted.

pfTopo(tol,u,sizeEstimate)
Construct a topological data structure.
tol specifies a tolerance for calculating when points are close enough together to be considered the same. Default is 1 millimeter.
u specifies the system of units for *tol*. Default is meters.

getLengthUnits() and **setLengthUnits()**
Gets and sets the measurement units in object space for this pfTopo.

getNumTopos()
Returns the number of pfTopo structures in the global array of pfTopos.

getGlobalTopo()
Returns the specified pfTopo ID from the global array of pfTopos.

Note: In addition, it is possible to traverse the scene graph and build a consistent set of boundaries for all the surfaces under a specified node by using the **pfBuildTopologyTraverse**(pfTopo *topo, pfNode *root) function.

The static member topology is an array of all topologies that have been created.

Collecting Connected Surfaces: pfSolid

To maintain consistent normals or propagate deformation information, organize connected pfParaSurfaces in an pfSolid. With an pfSolid, you can collect connected surface patches in one object for convenient access and manipulation.

Despite the name of the class, the set of surfaces need not form a closed surface, that is the boundary of a volume. They can be a set of patches joined to form a surface, for example, you might generate a hood of a car from two pfParaSurfaces that are mirror images of each other.

To create solids, collect them in an pfTopo and then call **pfTopo::buildSolid()** (see “Summary of Scene Graph Topology: pfTopo” on page 434).

Class Declaration for pfSolid

The class has the following main methods:

```
class pfSolid : public pfObject
{
public:

    // Creating and destroying
    pfSolid()
    virtual ~pfSolid()

    // Accessor functions
    int addSurface( pfParaSurface *sur );
    pfParaSurface* getSurface( int i);
    int getSurfaceCount( ) const;
    int getSolidId() const;
};
```

Main Features of the Methods in `pfSolid`

Use the methods only after you have created an `pfSolid` with `pfTopo::buildSolid()`.

Treat the method `setSolidId()` that appears in `pfSolid.h` as private: it is used by `pfTopo::buildSolid()` when building the solid.

Rendering Higher-Order Primitives: Tessellators

To render a curve or surface, you must develop an approximation of it with `pfGeoSets`. The tool that translates these reps into a mesh of contiguous triangles is called a *tessellator*.

Tessellation is interpretive; there is necessarily a difference between the original surface and the tessellated mesh. You can control how closely you want the mesh to resemble the surface.

- Close resemblance, requiring many triangles, produces a realistic shape but incurs slow graphic processing.
- A gross approximation of the original surface results in fast processing.

Applications often create a series of tessellated representations of a shape, each one called a level of detail (LOD). High resolution LODs are used when shapes are close to the viewer and low resolution LODs are used when shapes are far from the viewer. Because distance obscures detail, high resolution LODs are not necessary to represent distant shapes.

This chapter describes how to control the tessellation of shapes in the following sections:

- “Features of Tessellators” on page 446
- “Base Class `pfTessellateAction`” on page 449
- “Tessellating Parametric Surfaces” on page 451

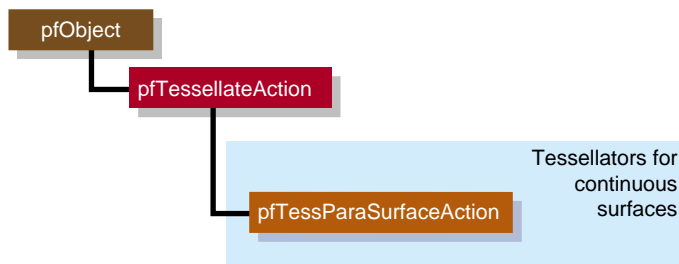

Figure 11-1 Class Hierarchy for Tessellators

Features of Tessellators

Tessellators generate a sequence of straight-line segments to approximate an edge curve of a surface, then cover the surface with triangular tiles. With each triangle vertex it creates, a tessellator also stores the normal vector at the point from original surface. The normal vectors are necessary for lighting and shading calculations.

Tessellations necessarily burden the entire graphics pipeline; they provide a first definition of the rendering task by specifying a maximal set of vertices to be sent to the graphics hardware.

Tessellators for Varying Levels of Detail

Ideally, you would quickly generate the simplest tessellation that adequately represents surfaces of interest. What is adequate depends on your particular rendering task. You may want to generate several tessellations with varying degrees of complexity and accuracy for one pfRep and place them in level-of-detail nodes, as discussed in “Level-of-Detail Management” in Chapter 5. The tessellators include accessor functions to help you assess the load they create for the graphics hardware.

The control parameter for tessellations specifies the maximum deviation from the exact surface. Figure 11-2 illustrates the effects of varying the deviation. The upper left image is appropriate for accurate representation of the surface, the lower right image would be appropriate if the object were in the distant background of a scene.

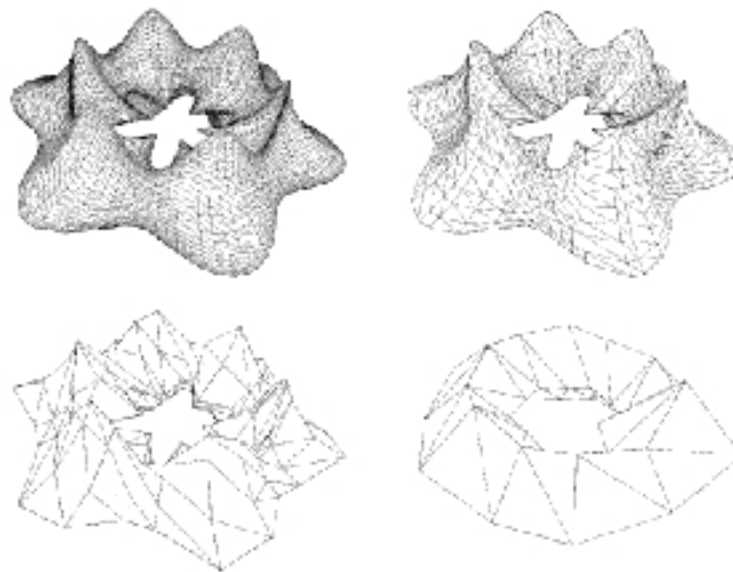

Figure 11-2 Tessellations Varying With Changes in Control Parameter

Details of Figure 11-2

The surface shown in Figure 11-2 was made with the repTest application using an pfFrenetSweptSurface as follows (see “pfFrenetSweptSurface” on page 405):

```
pfReal profile( pfReal t ) { return 0.5*cos(t*6.0) + 1.25; };
pfSuperQuadCurve3d *cross =
    new pfSuperQuadCurve3d( 0.75, new pfRVec3(0.0, 0.0, 0.0), 3.0
);
pfCircle3d *path = new pfCircle3d( 1.75, new pfRVec3(0.0, 0.0, 0.0) );
pfFrenetSweptSurface *fswept =
    new pfFrenetSweptSurface( cross, path, profile );
fswept->setHandednessHint( true );
```

The number of triangles in Figure 11-2 decreases as the maximum-deviation parameter *chordalDevTol* varies from .001 to .01 to .1 to .5 (see “Tessellating Parametric Surfaces” on page 451). These numbers should be compared to the scale of the object, which has a maximum diameter of $6.125 = 2(1.75 + 1.75 \times .75)$, a minimum diameter of $.875 = 2(1.75 - 1.75 \times .75)$, a maximum height of $2.625 = 2(1.75 \times .75)$, and a minimum height of $1.125 = 2(.75 \times .75)$.

Tessellators Act on a Whole Graph or Single Node

You can apply a tessellator either to a scene graph or to just one node. The tessellators produce a pfGeoSet from an pfRep and place that pfGeoSet in the pfGeode that holds the pfRep.

Tessellators and Topology: Managing Cracks

A tessellation begins with a discrete set of vertices at surface edges. To prevent cracks from appearing between adjacent surfaces, the same set of vertices should be used to tessellate both surfaces.

To address the crack problem, you have several options, which are discussed in “Building Topology: Computing and Using Connectivity Information” on page 437. Table 10-1 on page 439 lists the different approaches to topology building, and the methods to use for each.

Base Class pfTessellateAction

The pfTessellateAction class itself primarily stores statistics concerning the current tessellation. The pfTessParaSurfaceAction class performs the tessellation of surfaces. You can invoke the tessellation on a single surface by calling the following method:

```
pfTessParaSurfaceAction::tessellator(pfNode *n)
```

You can invoke the tessellation on the entire scene graph by using the following function:

```
pfdTessellateGeometry(pfNode *root, pfTessParaSurfaceAction *tessAction)
```

Nodes which do not derive from pfParaSurface will be left untouched by the **pfdTessellateGeometry()** function call.

Retessellating a Scene Graph

A tessellator will not tessellate a pfRep if the geoset count (**pfGeode::getNumGSets()**) is not zero. If you want to retessellate a pfParaSurface, you must call **pfParaSurface::clearTessellation()**. Note that you can also load a file and force retessellation to occur by using the libpfcTo1 pseudo loader and specifying the + symbol in front of the cTo1 value you wish to use during tessellation, as shown in the following:

```
perfly surfaces.pfb.+0.01.cTo1
```

Class Declaration for pfTessellateAction

The class has the following main methods:

```
class pfTessellateAction : public pfObject
{
public:
// Creating and destroying
pfTessellateAction( void );
virtual ~pfTessellateAction( void );

// Accessor functions
void setExtSize( int s );
int getExtSize( );
int getTriangleCount() const;
int getTriStripCount() const;
```

```
int getTriFanCount() const;

void setReverseTrimLoop(const pfBool enable );
pfBool getReverseTrimLoop() const;

void setBuildTopoWhileTess(pfBool _buildTopoWhileTess);
pfBool getBuildTopoWhileTess() const;

void setTopo(pfTopo * _topo);
pfTopo *getTopo( void )const;

};
```

Main Features of the Methods in pfTessellateAction

getTriangleCount()

Returns the number of all triangles generated by this instance of the tessellator.

getTriStripCount() and **getTriFanCount()**

Return the number of tristrips or trifans in the tessellation.

setBuildTopoWhileTess() and **getBuildTopoWhileTess()**

Sets a flag whether surface connectivity is computed during the tessellation traversal. Set the topology data structure to use with **setTopo()**.

If TRUE, before tessellating each surface, the connectivity of all previously tessellated surfaces is used to avoid cracks when tessellating. Notice that the final tessellations of the surfaces in the scene graph may still have cracks because of unforeseen junctions between surfaces.

If FALSE, no topology is constructed while tessellating. This leads to two very different possible results:

- If topology information for the surfaces to be tessellated was developed before the tessellation, by calling **pfdBuildTopologyBuildTraverse()** or **pfTopo::buildTopology()** or by constructing topology by hand, the tessellator uses the information and avoids cracks between surfaces. This option provides the most crack-free tessellations possible.

- If topology information was not developed before the tessellation traversal, then surfaces are tessellated without regard to connectivity and cracks appear between all adjacent surfaces. This option provides the least crack-free tessellations possible.

setReverseTrimLoop() and getReverseTrimLoop()

Set and recover the orientation of trim loops. Recall that the side of the surface to the left of the trim loop is rendered (see the section “Parametric Surfaces” on page 381).

setTopo() and getTopo()

Set and get the pfTopo that holds the topology information used by the tessellator (see “Summary of Scene Graph Topology: pfTopo” on page 434).

Tessellating Parametric Surfaces

This section discusses the two classes OpenGL Performer provides for tessellating parametric surfaces. The class pfTessParaSurfaceAction has methods for any parametric surface.

pfTessParaSurfaceAction

The pfTessParaSurfaceAction class develops tessellations of any pfParaSurface. If a surface has boundary curves, the tessellator starts there and specifies vertices at the edges of the surface. The tessellator then covers the surface with pfGeoSets using the boundary vertices to “pin” the edges of the tessellation. If necessary, the tessellator creates edge vertices by constructing a discrete version of the boundary curve associated with each of the surface’s pfEdges. An advantage of starting all tessellations at boundaries is easy coordination of tessellations by several processors.

As part of the tessellation process, you can generate the UV coordinates for each vertex created by the tessellator.

To control the accuracy of a tessellation, you specify a chordal deviation parameter which constrains the distance of edges in the tessellation from the original surface.

Class Declaration for pfTessParaSurfaceAction

The class has the following main methods:

```
class pfTessParaSurfaceAction : public pfTessellateAction
{
public:
pfTessParaSurfaceAction();
pfTessParaSurfaceAction( pfReal chordalDevTol,
                        pfBool scaleTolByCurvature, int samples);
virtual ~pfTessParaSurfaceAction();

// Accessor functions
void  setChordalDevTol( const pfReal chordalDevTol );
pfReal getChordalDevTol( ) const;

void  setScaleTolByCurvature( const pfReal scaleTolByCurvature )
pfBool  getScaleTolByCurvature() const;

void setSampling( const int samples );
int  getSampling( );

void setNonUniformSampling(const pfBool samples);
pfBool getNonUniformSampling() const;

void setGenUVCoordinates( const pfBool genUVCoordinates );
pfBool getGenUVCoordinates( ) const;

void setGenGeoArrays(pfBool enable);
pfBool getGenGeoArrays() const;

void tessellator(pfParaSurface *sur);
};
```

Main Features of the Methods in `pfTessParaSurface`

`pfTessParaSurface()`

Creates the class and provides a hint for the maximum deviation of the tessellation from the original surface, indicates whether the tolerance should be scaled by curvature, and provides a hint for how many vertices to include in the tessellation.

`setChordalDevTol()` and `getChordalDevTol()`

Set and get the maximum distance from the original surface to the edges produced by the tessellation.

`setGenUVCoordinates()` and `getGenUVCoordinates()`

Set and get a flag that indicates whether to generate UV coordinates for the vertices produced in the tessellation. The coordinates for each vertex are stored as the vertex's texture coordinates.

`setSampling()` and `getSampling()`

Set and get the hint for the number of triangle vertices in the tessellation along each boundary of the surface. If the surface has no trim curves defining its "outer" edges, then the sampling is along the edges of the UV rectangle that parameterizes the surface.

`setScaleTolByCurvature()` and `getScaleTolByCurvature()`

Set and get a flag to control whether the chordal deviation parameter should be scaled by curvature. If nonzero, the tessellation of highly curved areas improves.

`setGenGeoArrays()` and `getGenGeoArrays()`

Set and get a flag that determines whether or not the tessellator should generate `pfGeoArrays` instead of `pfGeoSets`. By default, this is set to true.

`tessellator()`

Tessellates an individual surface.

Although `pfTessParaSurface::tessellator()` may be used to tessellate an individual surface, it is more common to tessellate a set of surfaces using the `pfdTessellateGeometry()` function.

Sample From repTest: Tessellating and Rendering a Sphere

The sample code in this section demonstrates how to create higher-level reps such as `pfParaSurfaces` and `pfCurve2ds` and to save the output to a file. The lines of code perform the following procedures:

- Initializing OpenGL Performer
- Creating and tessellating a `pfSphereSurface`
- Saving the scene graph to a `.pfb` file

The code that follows can be found in the file `/usr/share/Performer/src/pguide/libpf/C++/repTest.C` on IRIX and Linux and `%PFROOT%\Src\pguide\libpf\C++\repTest.cxx` on Microsoft Windows.

From `main()`

Initialize OpenGL Performer and prepare for the creation of higher-level reps.

```
pfInit();
pfdInitConverter(argv[1]?argv[1]:"pfb");
shared = (SharedData *)pfCalloc(1,
                                sizeof(SharedData),
                                pfGetSharedArena());
shared->count = 10;
pfConfig();
pfGroup *root = new pfGroup();
```

Create Geometry

Create the geometry by calling `makeObjects()`, which in turn calls `setupShape()` to position the reps and specify their geostate.

```
makeObjects(root);
```

Define setUpShape()

The function `setUpShape()` creates a new `pfGeode`, applies a `pfGeoState`, and positions the `pfRep` using `pfRep::setOrigin()`.

```
static void
    setUpShape(pfGroup *p,
              pfParaSurface *rep, pfReal x,
              pfReal y, pfReal z)
{
    // Get the current origin of the object
    pfRVec3 org;
    rep->getOrigin(org);
    // Add the incoming offset to it
    org[0] += x;
    org[1] += y;
    org[2] += z;

    // Now reset the origin to include the
    // incoming offset
    rep->setOrigin(org);

    // Set the appearance of this shape to
    // be a random color
    pfGeoState *gState
makeColor((float)rand()/((2<<15) - 1.0f),
          (float)rand()/((2<<15) - 1.0f),
          (float)rand()/((2<<15) - 1.0f));

    // Set the geostate for the surface to
    // be used during tessellation
    rep->setGState(gState);

    // Attach the rep to the scene graph
    p->addChild(rep);
}
```

Define makeObjects()

The function **makeObjects()** sets up the scene graph, defines the grid of reps, and places the surfaces in the scene graph by calling **setupShape()**.

The code here shows the initial lines of **makeObjects()** (omitting code that controls the grid definition) and the example of defining a trimmed and untrimmed `pfSphereSurface`.

```
pfGroup *makeObjects(pfGroup *root)
{
    ....

    pfSphereSurface *sphere = new
        pfSphereSurface(3.0);

    if(nVersions <= 0) {
        pfCircle2d *trimCircle2d = new
pfCircle2d(1.0, pfRVec2(M_PI/2.0, M_PI));

        sphere->addTrimCurve(0, trimCircle2d,
            NULL);
    }

    setupShape(sphere, PF_XDIST*numObject++,
        Y, PF_VIEWDIST);

    ....
}
```

Graphics State

The graphics state is a class of fields that defines everything about the shape and texture of an object in an OpenGL Performer scene. Fields include such things as transparency, shading, reflectance, and texture. The graphics state is set globally for all objects in the scene graph. Individual objects, however, can override graphics state settings. The cost, however, is efficiency. For performance reasons, therefore, it is important to set the fields in the graphics state to satisfy the greatest number of objects in the scene.

This chapter describes in detail all of the fields in the graphics state.

Immediate Mode

The graphics libraries are immediate-mode state machines; if you set a mode, all subsequent geometry is drawn in that mode. For the best performance, mode changes need to be minimized and managed carefully. `libpr` manages a subset of graphics library state and identifies bits of state as *graphics state elements*. Each state element is identified with a `PFSTATE` token; for example, `PFSTATE_TRANSPARENCY` corresponds to the transparency state element. State elements are loosely partitioned into three categories: modes, values, and attributes.

Modes are the graphics state variables, such as transparency and texture enable, that have simple values like `ON` and `OFF`. An example of a mode command is **`pfTransparency(mode)`**.

Values are not modal, rather they are real numbers which signify a threshold or quantity. An example of a value is the reference alpha value specified with the **`pfAlphaFunc()`** function.

Attributes are references to encapsulations (structures) of graphics state. They logically group the more complicated elements of state, such as textures and lighting models. Attributes are structures that are modified through a procedural interface and must be

applied to have an effect. For example, **pfApplyTex**(*tex*) applies the texture map, *tex*, to subsequently drawn geometry.

In `libpr`, there are three methods of setting a state:

- Immediate mode
- Display list mode
- `pfGeoState` mode

Like the graphics libraries, `libpr` supports the notion of both immediate and display-list modes. In immediate mode, graphics mode changes are sent directly to the Geometry Pipeline; that is, they have an immediate effect. In display-list mode, graphics mode changes are captured by the currently active `pfDispList`, which can be drawn later. `libpr` display lists differ from graphics library objects because they capture only `libpr` commands and are reusable. `libpr` display lists are useful for multiprocessing applications in which one process builds up the list of visible geometry and another process draws it. “Display Lists” on page 485 describes `libpr` display lists.

A `pfGeoState` is a structure that encapsulates all the graphics modes and attributes that `libpr` manages. You can individually set the state elements of a `pfGeoState` to define a *graphics context*. The act of applying a `pfGeoState` with **pfApplyGState()** configures the state of the Geometry Pipeline according to the modes, values, and attributes set in the `pfGeoState`. For example, the following code fragment shows equivalent ways (except for some inheritance properties of `pfGeoStates` described later) of setting up some lighting parameters suitable for a glass surface:

```
/* Immediate mode state specification */
pfMaterial *shinyMtl;
pfTransparency(PFTR_ON);
pfApplyMtl(shinyMtl);
pfEnable(PFEN_LIGHTING);

/* is equivalent to: */

/* GeoState state specification */
pfGeoState *gstate;
pfGStateMode(gstate, PFSTATE_TRANSPARENCY, PFTR_ON);
pfGStateAttr(gstate, PFSTATE_FRONTMTL, shinyMtl);
pfGStateMode(gstate, PFSTATE_ENLIGHTING, PF_ON);
pfApplyGState(gstate);
```

In addition, `pfGeoStates` have unique state inheritance capabilities that make them very convenient and efficient; they provide independence from ordered drawing. `pfGeoStates` are described in the section “`pfGeoState`” on page 488 of this chapter.

The `libpr` routines have been designed to produce an efficient structure for managing graphics state. You can also set a graphics state directly through the GL. However, `libpr` will have no record of these settings and will not be able to optimize them and may make incorrect assumptions about current graphics state if the resulting state does not match the `libpr` record when `libpr` routines are called. Therefore, it is best to use the `libpr` routines whenever possible to change a graphics state and to restore the `libpr` state if you go directly through the GL.

The following sections will describe the rendering geometry and state elements in detail. There are three types of state elements: modes, values, and attributes. Modes are simple settings that take a set of integer values that include values for enabling and disabling the mode. Modes may also have associated values that allow a setting from a defined range. Attributes are complex state structures that encapsulate a related collection of modes and values. Attribute structures will not include in their definition an enable or disable as the enabling or disabling of a mode is orthogonal to the particular related attribute in use.

Rendering Modes

The `libpr` library manages a subset of the rendering modes found in OpenGL. In addition, `libpr` abstracts certain concepts like transparency, providing a higher-level interface that hides the underlying implementation mechanism.

The `libpr` library provides tokens that identify the modes that it manages. These tokens are used by `pfGeoStates` and other state-related functions like `pfOverride()`. The following table enumerates the `PFSTATE_*` tokens of supported modes, each with a brief description and default value.

Table 12-1 lists and describes the mode tokens.

Table 12-1 `pfGeoState` Mode Tokens

Token Name	Description	Default Value
<code>PFSTATE_TRANSPARENCY</code>	Transparency modes	<code>PFTR_OFF</code>
<code>PFSTATE_ALPHAFUNC</code>	Alpha function	<code>PFAF_ALWAYS</code>

Table 12-1 pfGeoState Mode Tokens (continued)

Token Name	Description	Default Value
PFSTATE_ANTIALIAS	Antialiasing mode	PF_AA_OFF
PFSTATE_CULLFACE	Face culling mode	PF_CF_OFF
PFSTATE_DECAL	Decaling mode for coplanar geometry	PF_DECAL_OFF
PFSTATE_SHADEMODEL	Shading model	PF_SM_GOURAUD
PFSTATE_ENLIGHTING	Lighting enable flag	PF_OFF
PFSTATE_ENTEXTURE	Texturing enable flag	PF_OFF
PFSTATE_ENFOG	Fogging enable flag	PF_OFF
PFSTATE_ENWIREFRAME	pfGeoSet wireframe mode enable flag	PF_OFF
PFSTATE_ENCOLORTABLE	pfGeoSet colortable enable flag	PF_OFF
PFSTATE_ENHIGHLIGHTING	pfGeoSet highlighting enable flag	PF_OFF
PFSTATE_ENLPOINTSTATE	pfGeoSet light point state enable flag	PF_OFF
PFSTATE_ENTEXGEN	Texture coordinate generation enable flag	PF_OFF
PFSTATE_ENFRAGPROG	Fragment program enable flag	PF_OFF
PFSTATE_ENVTXPROG	Vertex program enable flag	PF_OFF

The mode control functions described in the following sections should be used in place of their graphics library counterparts so that OpenGL Performer can correctly track the graphics state. Use **pfGStateMode()** with the appropriate PFSTATE token to set the mode of a pfGeoState.

Transparency

You can control transparency using **pfTransparency()**. Possible transparency modes are listed in the following table.

Table 12-2 pfTransparency Tokens

Transparency mode	Description
PFTR_OFF	Transparency disabled.
PFTR_ON PFTR_FAST	Use the fastest, but not necessarily the best, transparency provided by the hardware.
PFTR_HIGH_QUALITY	Use the best, but not necessarily the fastest, transparency provided by the hardware.
PFTR_MS_ALPHA	Use screen-door transparency when multisampling. Fast but limited number of transparency levels.
PFTR_BLEND_ALPHA	Use alpha-based blend with background color. Slower but high number of transparency levels.

In addition, the flag `PFTR_NO_OCCLUDE` may be logically ORed into the transparency mode in which case geometry will not write depth values into the frame buffer. This will prevent it from occluding subsequently rendered geometry. Enabling this flag improves the appearance of unordered, blended transparent surfaces.

There are two basic transparency mechanisms: screen-door transparency, which requires hardware multisampling, and blending. Blending offers very high-quality transparency but for proper results requires that transparent surfaces be rendered in back-to-front order after all opaque geometry has been drawn. When using transparent texture maps to “etch” geometry or if the surface has constant transparency, screen-door transparency is usually good enough. Blended transparency is usually required to avoid “banding” on surfaces with low transparency gradients like clouds and smoke.

Shading Model

You can select either flat shading or Gouraud (smooth) shading. **pfShadeModel()** takes one of two tokens: `PFSM_FLAT` or `PFSM_GOURAUD`. On some graphics hardware flat shading can offer a significant performance advantage.

Alpha Function

The **pfAlphaFunc()** function is an extension of the **glAlphaFunc()** function; it allows OpenGL Performer to keep track of the hardware mode. The alpha function is a pixel test that compares the incoming alpha to a reference value and uses the result to determine whether or not the pixel is rendered. The reference value must be specified in the range [0, 1]. For example, a pixel whose alpha value is 0 is not rendered if the alpha function is `PFAF_GREATER` and the alpha reference value is also 0. Note that rejecting pixels-based alpha can be faster than using transparency alone. A common technique for improving the performance of filling polygons is to set an alpha function that will reject pixels of low (possibly nonzero) contribution. The alpha function is typically used for see-through textures like trees.

Decals

On Z-buffer-based graphics hardware, coplanar geometry can cause unwanted artifacts due to the finite numerical precision of the hardware which cannot accurately resolve which surface has visual priority. This can result in *flimmering*, a visual “tearing” or “twinkling” of the surfaces. **pfDecal()** is used to accurately draw coplanar geometry on SGI graphics platforms and it supports two basic implementation methods: *stencil decaling* and *displace decaling*.

The *stencil decaling* method uses a hardware resource known as a stencil buffer and requires that a single stencil plane (see the man page for **glStencilOp()**) be available for OpenGL Performer. This method offers the highest image quality but requires that geometry be coplanar and rendered in a specific order which reduces opportunities for the performance advantage of sorting by graphics mode.

A potentially faster method is the *displace decaling* method. In this case, each layer is displaced towards the eye so it hovers slightly above the preceding layer. Displaced decals need not be coplanar, and can be drawn in any order, but the displacement may cause geometry to incorrectly poke through other geometry.

The specification of a decal plane can improve the displace decaling method. The object geometry will be projected onto the specified plane and if the same plane is specified for base and layer geometry, the base and layer polygons will be generated with identical depth values. If the objects are drawn in priority order, no further operation is necessary. Otherwise, displace can be applied to the planed geometry for a superior result. Decal planes can be specified on `pfGeoSets` with **pfGSetDecalPlane()**, on a `pfGeoState` with the `PFSTATE_DECALPLANE` attribute to **pfGStateAttr()**, or globally with **pfApplyDecalPlane()**.

Decals consist of *base geometry* and *layer geometry*. The base defines the depth values of the decal while layer geometry is simply inlaid on top of the base. Multiple layers are supported but limited to eight when using displaced decals. Realize that these layers imply superposition; there is no limit to the number of polygons in a layer, only to the number of distinct layers.

The decal mode indicates whether the subsequent geometry is base or layer and the decal method to use. For example, a mode of `PFDECAL_BASE_STENCIL` means that subsequent geometry is to be considered as base geometry and drawn using the stencil method. All combinations of base/layer and displace/stencil modes are supported but you should make sure to use the same method for a given base-layer pair.

Example 12-1 illustrates the use of `pfDecal()`.

Example 12-1 Using `pfDecal()` to a Draw Road with Stripes

```
pfDecal(PFDECAL_BASE_STENCIL);

/* ... draw underlying geometry (roadway) here ... */

pfDecal(PFDECAL_LAYER_STENCIL);

/* ... draw coplanar layer geometry (stripes) here ... */

pfDecal(PFDECAL_OFF);
```

Note: `libpf` applications can use the `pfLayer` node to include decals within a scene graph.

Frontface / Backface

The `pfCullFace()` function controls which side of a polygon (if any) is discarded in the Geometry Pipeline. Polygons are either front-facing or back-facing. A front-facing polygon is described by a counterclockwise order of vertices in screen coordinates, and a back-facing one has a clockwise order. `pfCullFace()` has four possible arguments:

<code>PF_CF_OFF</code>	Disable face-orientation culling.
<code>PF_CF_BACK</code>	Cull back-facing polygons.
<code>PF_CF_FRONT</code>	Cull front-facing polygons.

`PF_CF_BOTH` Cull both front- and back-facing polygons.

In particular, back-face culling is highly recommended since it offers a significant performance advantage for databases where polygons are never be seen from both sides (databases of “solid” objects or with constrained eyepoints).

Antialiasing

The `pfAntialias()` function is used to turn the antialiasing mode of the hardware on or off. Currently, antialiasing is implemented differently by each different graphics system. Antialiasing can produce artifacts as a result of the way OpenGL Performer and the active hardware platform implement the feature. See the man page for `pfAntialias()` for implementation details.

Rendering Values

Some modes may also have associated values. These values are set through `pfGStateVal()`. Table 12-3 lists and describes the value tokens.

Table 12-3 pfGeoState Value Tokens

Token Name	Description	Range	Default Value
<code>PFSTATE_ALPHAREF</code>	Set the alpha function reference value.	0.0 - 1.0	0.0

Enable / Disable

The `pfEnable()` and `pfDisable()` functions control certain rendering modes. Certain modes do not have effect when enabled but require that other attribute(s) be applied.

Table 12-4 lists and describes the tokens and also lists the attributes required for the mode to become truly active.

Table 12-4 Enable and Disable Tokens

Token	Action	Attribute(s) Required
PFEN_LIGHTING	Enable or disable lighting.	pfMaterial pfLight pfLightModel
PFEN_TEXTURE	Enable or disable texture.	pfTexEnv pfTexture
PFEN_FOG	Enable or disable fog.	pfFog
PFEN_WIREFRAME	Enable or disable pfGeoSet wireframe rendering.	none
PFEN_COLORTABLE	Enable or disable pfGeoSet colortable mode.	pfColortable
PFEN_HIGHLIGHTING	Enable or disable pfGeoSet highlighting.	pfHighlight
PFEN_TEXGEN	Enable or disable automatic texture coordinate generation.	pfTexGen
PFEN_LPOINTSTATE	Enable or disable pfGeoSet light points.	pfLPointState
PFEN_FRAGPROG	Enable or disable fragment program.	pfFragmentProgram
PFEN_VTXPROG	Enable or disable vertex program.	pfVertexProgram

By default all modes are disabled.

Rendering Attributes

Rendering attributes are state structures that are manipulated through a procedural interface. Examples include pfTexture, pfMaterial, and pfFog. `libpr` provides tokens that enumerate the graphics attributes it manages. These tokens are used by pfGeoStates

and other state-related functions like **pfOverride()**. Table 12-5 lists and describes the tokens.

Table 12-5 Rendering Attribute Tokens

Attribute Token	Description	Apply Routine
PFSTATE_LIGHTMODEL	Lighting model	pfApplyLModel()
PFSTATE_LIGHTS	Light source definitions	pfLightOn()
PFSTATE_FRONTMTL	Front-face material	pfApplyMtl()
PFSTATE_BACKMTL	Back-face material	pfApplyMtl()
PFSTATE_TEXTURE	Texture	pfApplyTex()
PFSTATE_TEXENV	Texture environment	pfApplyTEnv()
PFSTATE_FOG	Fog model	pfApplyFog()
PFSTATE_COLORTABLE	Color table for pfGeoSets	pfApplyCtab()
PFSTATE_HIGHLIGHT	Definition of pfGeoSet highlighting style	pfApplyHlight()
PFSTATE_LPOINTSTATE	pfGeoSet light point definition	pfApplyLPState()
PFSTATE_TEXGEN	Texture coordinate generation definition	pfApplyTGen()
PFSTATE_FRAGPROG	Fragment program definition	pfGProgramApply()
PFSTATE_VTXPROG	Vertex program definition	pfGProgramApply()
PFSTATE_GPROGPARGS	GPU program parameters definition	pfGPParamsApply()

Rendering attributes control which attributes are applied to geometric primitives when they are processed by the hardware. All OpenGL Performer attributes consist of a control structure, definition routines, and an apply function, **pfApply*** (except for lights which are “turned on”).

Each attribute has an associated **pfNew*()** routine that allocates storage for the control structure. When sharing attributes across processors in a multiprocessor application, you should pass the **pfNew*()** routine a shared memory arena from which to allocate the structure. If you pass NULL as the arena, the attribute is allocated from the heap and is not sharable in a nonshared address space (**fork()**) multiprocessing application.

All attributes can be applied directly, referenced by a `pfGeoState` or captured by a display list. When changing an attribute, that change is not visible until the attribute is reapplied. Detailed coverage of attribute implementation is available in the man pages.

Texture

OpenGL Performer supports texturing through `pfTextures` and `pfTexEnvs`, which provide encapsulated support for graphics library textures (see `glTexImage2D()`) and texture environments (see `glTexEnv()`). A `pfTexture` defines a texture image, format, and filtering. A `pfTexEnv` specifies how the texture should interact with the colors of the geometry where it is applied. You need both to display textured data, but you do not need to specify them both at the same time. For example, you could have `pfGeoStates` each of which had a different texture specified as an attribute and still use an overall texture environment specified with `pfApplyTEnv()`.

A `pfTexture` is created by calling `pfNewTex()`. If the desired texture image exists as a disk file in IRIS RGB image format (the file often has a “.rgb” suffix) or in the OpenGL Performer fast-loading image format (a “.pfi” suffix), you can call `pfLoadTexFile()` to load the image into CPU memory and completely configure the `pfTexture`, as shown in the following:

```
pfTexture *tex = pfLoadTexFile("brick.rgb");
```

Otherwise, `pfTexImage()` lets you directly provide a GL-ready image array in the same external format as specified on the `pfTexture` and as expected by `glTexImage2D()`, as shown in the following:

```
void pfTexImage(pfTexture* tex, uint* image,
               int comp, int sx, int sy, int sz);
```

OpenGL expects packed texture data with each row beginning on a long word boundary. However, OpenGL expects the individual components of a texel to be packed in opposite order. For example, OpenGL expects the texels to be packed as RGBA. If you provide your own image array in a multiprocessing environment, it should be allocated from shared memory (along with your `pfTexture`) to allow different processes to access it. A basic example demonstrating loading a image file and placing the resulting `pfTexture` on scene graph geometry is at

```
/usr/share/Performer/src/pguide/libpf/C/texture.c on IRIX and Linux
and %PFROOT%\Src\pguide\libpf\C\texture.c on Microsoft Windows.
```

Note: The size of your texture must be an integral power of two on each side. OpenGL refuses to accept badly sized textures. You can rescale your texture images with the *izoom* or *imgworks* programs (shipped with IRIX 5.3 in the *eo2.sw.imagetools* and *imgtools.sw.tools* subsystems; and with IRIX 6.2 in the *eo2.sw.imagetools* and *imgworks.sw.tools* subsystems).

Your texture source does not have to be a static image. **pfTexLoadMode()** can be used to set one of the sources listed in Table 12-6 with `PFTEX_LOAD_SOURCE`. Note that sources other than CPU memory may not be supported on all graphics platforms, or may have some special restrictions. There are several sample programs that demonstrate paging sequences of texture from different texture sources. For paging from host memory there are the following:

- On IRIX and Linux:
 - `/usr/share/Performer/src/pguide/libpr/C/textlist.c`
 - `/usr/share/Performer/src/pguide/libpr/C/mipmap.c`
 - `/usr/share/Performer/src/pguide/libpfutil/movietex.c`
- On Microsoft Windows:
 - `%PFROOT%\Src\pguide\libpr\C\textlist.c`
 - `%PFROOT%\Src\pguide\libpr\C\mipmap.c`
 - `%PFROOT%\Src\pguide\libpfutil\movietex.c`

These examples demonstrate the use of different texture sources for paging textures, and `libpfutil` utilities for managing texture resources. One thing these examples do is use **pfTexLoadImage()** to update the pointer to the image data to avoid the expensive reformatting the texture. This requires that the provided image data be the same size as the original image data, as well as same number of components and same formats.

Table 12-6 Texture Image Sources

<code>PFTEX_SOURCE</code> Token	Source of the Texture Image
IMAGE	CPU memory location specified by pfTexLoadImage() or pfTexImage()

Table 12-6 (continued) Texture Image Sources

PFTEX_SOURCE_ Token	Source of the Texture Image
FRAMEBUFFER	Framebuffer location offset from window origin as specified by pfTexLoadOrigin()
VIDEO	Default video source on the system

Video Texturing

The source of texture image data can be live video input. OpenGL Performer supports the video input mechanisms of Sirius Video on RealityEngine and InfiniteReality, DIVO on InfiniteReality, and Silicon Graphics O2 and Octane video input. OpenGL Performer includes a sample program that features video texturing:

```
/usr/share/Performer/src/pguide/libpf/movietex.c (IRIX and Linux)
%PFROOT%\Src\pguide\libpf\movietex.c (Microsoft Windows)
```

This example demonstrates that all video initialization, including the creation of video library resources, is done in the draw process, as required by the video library. Part of that initialization includes setting the proper number of components on the pfTexture and choosing a texture filter and potentially internal format. Those basic operations are discussed further in this section.

OpenGL Performer will automatically download the frame of video when the texture object is applied through the referencing pfGeoState. Alternatively, you may want to schedule this download to happen at the beginning or end of the rendering frame; you can force it with **pfLoadTex()**.

Textures must be created with sizes that are powers of 2; the input video frame is usually not in powers of 2. The [0,1] texture coordinate range can be scaled into the valid part of the pfTexture with a texture matrix. This matrix can be applied directly to the global state with **pfApplyTMat()** to affect all pfGeoSets, or can be set on a pfGeoState with the PFTSTATE_TEXMAT attribute to **pfGStateAttr()**.

Texture Management

Texture storage is limited only by virtual memory, but for real-time applications you must consider the amount of texture storage the graphics hardware supports. Textures that do not fit in the graphics subsystem are paged as needed when **pfApplyTex()** is called. The libpr library provides routines for managing hardware texture memory so

that a real-time application does not have to get a surprise texture load. **pfIsTexLoaded()**, called from the drawing process, tells you if the pfTexture is currently properly loaded in texture memory. The initially required textures of an application, or all of the textures if they fit, can be preloaded into texture memory as part of application initialization. **pfuMakeSceneTexList()** makes a list of all textures referenced by a scene graph and **pfuDownloadTexList()** loads a list of textures into hardware texture memory (and must be called in the draw process). The Perfly sample program does this as part of its initialization and displays the textures as it preloads them.

There are additional routines to assist with the progressive loading and unloading of pfTextures. **pfIdleTex()** can be used to free the hardware texture memory owned by a pfTexture. GL host and hardware texture memory resources can be freed with **pfDeleteGLHandle()** from the drawing process. OpenGL Performer will automatically re-allocate those resources if the pfTexture is used again. For an example of management of texture resources, see the example program `/usr/share/Performer/src/pguide/libpfutil/txmem.c` for IRIX and Linux or `%PFROOT%\Src\pguide\libpfutil\txmem.c` for Microsoft Windows. The program uses the pfTextureManager from `libpfutil` for basic texture paging support.

The **pfLoadTex()** function, called from the drawing process, can be used to explicitly load a texture into graphics hardware texture memory (which includes doing any necessary formatting of the texture image). By default, **pfLoadTex()** loads the entire texture image, including any required minification or magnification levels, into texture memory. **pfSubloadTex()** and **pfSubloadTexLevel()** can also be used in the drawing process to do an immediate load of texture memory managed by the given pfTexture and these routines allow you to specify all loading parameters (source, origin, size, etc.). This is useful for loading different images for the same pfTexture in different graphics pipelines. **pfSubloadTex()** allows you to load a subsection of the texture tile by tile.

A special **pfTexFormat()** formatting mode, `PFTEX_SUBLOAD_FORMAT`, allows part or all of the image in texture memory owned by the pfTexture to be replaced using **pfApplyTex()**, **pfLoadTex()**, or **pfSubloadTex()**, without having to go through the expensive reformatting phase. This allows you to quickly update the image of a pfTexture in texture memory. The `PFTEX_SUBLOAD_FORMAT` used with an appropriate **pfTexLoadSize()** and **pfTexLoadOrigin()** allows you to control what part of the texture will be loaded by subsequent calls to **pfLoadTex()** or **pfApplyTex()**. There are also different loading modes that cause **pfApplyTex()** to automatically reload or subload a texture from a specified source. If you want the image of a pfTexture to be updated upon every call to **pfApplyTex()**, you can set the loading mode of the pfTexture with **pfTexLoadMode()** to be `PFTEX_BASE_AUTO_REPLACE`. **pfTexLoadImage()** allows you

to continuously update the memory location of an IMAGE source texture without triggering any reformatting of the texture.

Hint: There are texture formatting modes that can improve texture performance and these are the modes that are used by default by OpenGL Performer. Of most importance is the 16-bit texel internal formats. These formats cause the resulting texels to have 16 bits of resolution instead of the standard 32. These formats can have dramatically faster texture-fill performance and cause the texture to take up half the hardware texture memory. Therefore, they are strongly recommended and are used by default. There are different formats for each possible number of components to give a choice of how the compression is to be done. These formats are described in the `pfTexFormat(3pf)` man page.

There may also be formatting modes for internal or external image formats for which OpenGL Performer does not have a token. However, the GL value can be specified. Specifying GL values will make your application GL-specific and may also cause future porting problems; so, it should only be done if absolutely necessary.

The `pfTexture` class also allows you to define a set of textures that are mutually exclusive; they should always be applied to the same set of geometry; and, thus, they can share the same location in hardware texture memory. With `pfTexList(tex, list)` you can specify a list of textures to be in a texture set managed by the base texture, *tex*. The base texture is what gets applied with `pfApplyTex()`, or assigned to geometry through `pfGeoStates`. With `pfTexFrame()`, you can select a given texture from the list (-1 selects the base texture and is the default). This allows you to define a texture movie where each image is the frame of the movie. You can have an image on the base texture to display when the movie is not playing. There are additional loading modes for `pfTexLoadMode()` described in

Table 12-7 to control how the textures in the texture list share memory with the base texture.

Table 12-7 Texture Load Modes

PFTEX_LOAD_ modeToken	Load Mode Values	Description
SOURCE	SOURCE_IMAGE, SOURCE_FRAMEBUFFER PFTEX_SOURCE_VIDEO PFTEX_SOURCE_DMBUF PFTEX_SOURCE_DMVIDEO	Source of image data is host memory image, framebuffer, default video source, digital media buffer, or a video library digital media buffer.
BASE	BASE_APPLY BASE_AUTO_SUBLOAD	Loading of image for pfTexture is done as required for pfApply, or automatically subloaded upon every pfApply() .
LIST	LIST_APPLY LIST_AUTO_IDLE LIST_AUTO_SUBLOAD	Loading of list texture image is done as separate apply, causes freeing of previous list texture in hardware texture memory, or is subloaded into memory managed by the base texture.
VIDEO_ INTERLACED	OFF, INTERLACED_ODD, INTERLACED_EVEN,	Video input is interlaced or not and if so, which field (even or odd) is spatially higher.

Texture list textures can share the exact graphics texture memory as the base texture but this has the restriction that the textures must all be the exact same size and format as the base texture. Texture list textures can also indicate that they are mutually exclusive, which will cause the texture memory of previous textures to be freed before applying the new texture. This method has no restrictions on the texture list, but is less efficient than the previous method. Finally, texture list textures can be treated as completely independent textures that should all be kept resident in memory for rapid access upon their application.

The **pfTexFilter()** function sets a desired filter to a specified filtering method on a pfTexture. The minification and magnification texture filters are described with bitmask tokens. If filters are partially specified, OpenGL Performer fills the rest with machine-dependent fast defaults. The **PFTEX_FAST** token can be included in the bitmask to allow OpenGL Performer to make machine dependent substitutions where there are large performance differences.

There are a variety of texture filter functions that can improve the look of textures when they are minified and magnified. By default, textures use MIPmapping when minified (though this costs an extra 1/3 in storage space to store the minification levels). Each level of minification or magnification of a texture is twice the size of the previous level. Minification levels are indicated with positive numbers and magnification levels are indicated with nonpositive numbers. The default magnification filter for textures is bilinear interpolation. The use of detail textures and sharpening filters can improve the look of magnified textures. Detailing actually uses an extra detail texture that you provide that is based on a specified level of magnification from the corresponding base texture. The detail texture can be specified with the **pfTexDetail()** function. By default, MIPmap levels are generated for the texture automatically. OpenGL operation allows for the specification of custom MIPmap levels. Both MIPmap levels and detail levels can be specified with **pfTexLevel()**. The level number should be a positive number for a minification level and a nonpositive number for a magnification (detail) level. If you are providing your own minification levels, you must provide all $\log_2(\text{MAX}(\text{texSizeX}, \text{texSizeY}))$ minification levels. There is only one detail texture for a pfTexture.

Standard MIPmap filtering can induce blurring on a texture if the texture is applied to a polygon which is angled away from the viewer. To reduce this blurring, an anisotropic filter can be used to improve visual quality. **pfTexAnisotropy()** sets the degree of anisotropy to be used by the specified pfTexture. The default degree of anisotropy is 1, which is the same as the standard isotropic filter. A value of 2 will apply a 2:1 anisotropic filter. The maximum degree of anisotropy can be queried with **pfQuerySys()**. Anisotropic filtering is supported on OpenGL implementations that support the `GL_EXT_texture_filter_anisotropic` extension. **pfQueryFeature()** can be used to determine if anisotropic filtering is supported on the current platform. If the environment variable `PF_MAX_ANISOTROPY` is set, then an anisotropic filter of the value specified by `PF_MAX_ANISOTROPY` will be applied to pfTextures that do not set the degree of anisotropy.

The magnification filters use spline functions to control their rate of application as a function of magnification and specified level of magnification for detail textures. These splines can be specified with **pfTexSpline()**. The specification of the spline is a set of control points that are pairs of nondecreasing magnification levels (specified with nonpositive numbers) and corresponding scaling factors. Magnification filters can be applied to all components of a texture, only the RGB components of a texture, or to just the alpha components. OpenGL does not allow different magnification filters (between detail and sharpen) for RGB and alpha channels.

Note: The specification of detail textures may have GL dependencies and magnification filters may not be available on all hardware configurations. The `pfTexture` man page describes these details.

Texture Formats

The format in which an image is stored in texture memory is defined with `pfTexFormat()`:

```
void pfTexFormat(pfTexture *tex, int format, int type)
```

The *format* variable specifies which format to set. Valid formats and their basic types include the following:

- `PFTEX_INTERNAL_FORMAT`— Specifies how many bits per component are to be used in internal hardware texture memory storage. The default is 16 bits per full texel and is based on the number of components and external format. See the `pfTexture` man page for the list of supported formats. Floating point formats are supported only on selected platforms (for example, Onyx4 systems).
- `PFTEX_IMAGE_FORMAT`— Describes the type of image data and must match the number of components, such as `PFTEX_LUMINANCE`, `PFTEX_LUMINANCE_ALPHA`, `PFTEX_RGB`, and `PFTEX_RGBA`. The default is the token in this list that matches the number of components. Other OpenGL selections can be specified with the GL token.
- `PFTEX_EXTERNAL_FORMAT`— Specifies the format of the data in the `pfTexImage` array. The default is packed 8 bits per component. There are special, fast-loading hardware-ready formats, such as `PFTEX_UNSIGNED_SHORT_5_5_5_1`.
- `PFTEX_SUBLOAD_FORMAT`— Specifies if the texture will be a subloadable paging texture. The default is `FALSE`.
- `PFTEX_CUBE_MAP`— Specifies that the texture is a cube map texture that contains six images. The default is `FALSE`. Cube maps are supported only on selected platforms (for example, Onyx4 systems).

In the case of cube maps, where there are six images, the images are specified using the function `pfTexMultiImage()`. The parameter `imageIndex` with value 0–5 specifies the cube face in the following order:

```
min_x, max_x, min_y, max_y, min_z, max_z
```

For the order of faces and how the vector from the cube center to each texel is computed, see the sample program in following file:

```
/usr/share/Performer/src/pguide/libpf/C++/cubeMap.C
(IRIX and Linux)
%PFROOT%\Src\pguide\libpf\C++\cubeMap.C
(Microsoft Windows)
```

All six images have to be specified, they must have the same size, and the value `ns` has to be equal to `nt`.

The following are other variants of functions that are used by the cube maps:

- **pfTexMultiName()**
- **pfGetTexMultiName()**
- **pfLoadMultiTexFile()**
- **pfSaveMultiTexFile()**
- **pfSubloadMultiTex()**
- **pfSubloadTexMultiLevel()**

Other than having six images, the cube maps are used as any other `pfTexture`. The exception is that subloads from other sources than user specified memory are not supported.

In general, you will just need to specify the number of components in **pfTexImage()**. You may want to specify a fast-loading hardware-ready external format, such as `PFTEX_UNSIGNED_SHORT_5_5_5_1`, in which case OpenGL Performer automatically chooses a matching internal format. See the `pfTexFormat(3pf)` man page for more informaton on texture configuration details.

Controlling Texture LOD with `pfTexLOD`

You can control the levels of detail (LODs) of a texture that are accessed and used with `pfTexLOD` to force higher or lower MIPmap levels to be used when minifying. You can use this to give the graphics hardware a hint about what levels can be accessed (Impact hardware takes great advantage of such a hint) and you can use this to have multiple textures sharing a single MIPmap pyramid in texture memory. For example, a distant object and a close one may use different LODs of the same `pfTexture` texture. The `pfGeoStates` of those `pfGeoSets` would have different `pfTexLOD` objects that referenced

the proper texture LODs. **pfTexLevel()** would be used to specify and update the proper image for each LOD in the **pfTexture**. You can use LODs to specify to yourself and the GL which LODs of texture should be loaded from disk into main memory. For example, if the viewer is in one LOD, most of the texture in that LOD can often be viewed and, consequently, should be paged into texture memory. You can set LOD parameters on a **pfTexture** directly or use **pfTexLOD**.

To use a **pfTexLOD** object, you do the following:

1. Set the ranges of the LOD using **pfTLODRange()** and their corresponding minimum and maximum resolution MIPmap. Because the minimum and maximum limits can be floating-point values, new levels can be smoothly blended in when they become available to avoid popping from one LOD to another.
2. Optionally, set the bias levels using **pfTLODBias()** to force blurring of a texture to simulate motion blur and depth of field, to force a texture to be sharper, or to compensate for asymmetric minification of a MIPmapped texture.

Note: Any LOD settings on **pfTexture** take priority over current **pfTexLOD** settings.

3. Enable LOD control over texture by using the following methods:

```
pfEnable(PFEN_TEXLOD);  
pfGeoState::pfGStateMode(myTxLOD, PFSTATE_ENTEXLOD, ON);
```

where *myTxLOD* is an instance of **pfTexLOD**, and *ON* is a nonzero integer.

4. Apply the LOD settings to the texture using **pfApplyTLOD()**.

See the following sample program for an example of using a **pfTexLOD**:

```
/usr/share/Performer/src/pguide/libpr/C/texlod.c (IRIX and Linux)  
%PFROOT%\Src\pguide\libpr\C\texlod.con (Microsoft Windows)
```

Setting the Texture Environment with **pfTexEnv**

The environment specifies how the colors of the geometry, potentially lit, and the texture image interact. This is described with a **pfTexEnv** object. The mode of interaction is set with **pfTexEnvMode()** and valid modes include the following:

- **PFTE_MODULATE**—The gray scale of the geometry is mixed with the color of the texture (the default).

This option multiplies the shaded color of the geometry by the texture color. If the texture has an alpha component, the alpha value modulates the geometry's transparency; for example, if a black and white texture, such as text, is applied to a green polygon, the polygon remains green and the writing appears as dark green lettering.

- **PFTE_DECAL**—The texture alpha component acts as a selector between 1.0 for the texture color and 0.0 for the base color to decal an image onto geometry.
- **PFTE_BLEND**—The alpha acts as a selector between 0.0 for the base color and 1.0 for the texture color modulated by a constant texture blend color specified with **pfTEEnvBlendColor()**. The alpha/intensity components are multiplied.
- **PFTE_ADD**—The RGB components of the base color are added to the product of the texture color modulated by the current texture environment blend color. The alpha/intensity components are multiplied.

Automatic Texture Coordinate Generation

Automatic texture coordinate generation is provided with the **pfTexGen** state attribute. **pfTexGen** closely corresponds to OpenGL's **glTexGen()** function. When texture coordinate generation is enabled, a **pfTexGen** applied with **pfApplyTGen()** automatically generates texture coordinates for all rendered geometry. Texture coordinates are generated from geometry vertices according to the texture generation mode set with **pfTGenMode()**. Available modes and their function are listed in Table 12-8.

Table 12-8 Texture Generation Modes

Mode Token	Description
PFTG_OFF	Disables texture coordinate generation.
PFTG_OBJECT_LINEAR	Generates the texture coordinate as the distance from plane in object space.
PFTG_EYE_LINEAR	Generates the texture coordinate as the distance from plane in eye space. The plane is transformed by the inverse of the ModelView matrix when tgen , the pfTexGen , is applied.

Table 12-8 Texture Generation Modes (continued)

Mode Token	Description
PFTG_EYE_LINEAR_IDENT	Generates the texture coordinate as the distance from plane in eye space. The plane is not transformed by the inverse of the ModelView matrix.
PFTG_SPHERE_MAP	Generates the texture coordinate based on the view vector reflected about the vertex normal in eye space.
PFTG_OBJECT_DISTANCE_TO_LINE	Sets the texture coordinate as the distance in object space from the vertex to a line specified with a point and direction vector through pfTGenPoint.
PFTG_EYE_DISTANCE_TO_LINE	Sets the texture coordinate as the distance in eye space from the eye to a line specified with pfTGenPoint through the vertex.
PFTG_REFLECTION_MAP	Sets the texture coordinate to the view vector reflected about the vertex normal in eye space.
PFTG_NORMAL_MAP	Sets the texture coordinate to the vertex normal in eye space.

Some modes refer to a plane which is set with **pfTGenPlane()** and to a line that is specified as a point and direction with **pfTGenPoint()**. The default texture generation mode for all texture coordinates is `PFTG_OFF`. The function **pfGetTGenMode()** returns the mode of the `pfTexGen`.

See the man page for the OpenGL function **glTexGen()** for the specific mathematics of the generation modes for texture coordinates.

Lighting

OpenGL Performer lighting is an extension of graphics library lighting (see **glLight()** and related functions in OpenGL). The light embodies the color, position, and type (for example, infinite or spot) of the light. The light model specifies the environment for infinite (the default) or local viewing, and two-sided illumination.

The lighting model describes the type of lighting operations to be considered, including local lighting, two-sided lighting, and light attenuation. The fastest light model is

infinite, single-sided lighting. A `pfLightModel` state attribute object is created with `pfNewLModel()`. A light model also allows you to specify ambient light for the scene, such as might come from the sun with `pfLModelAmbient()`.

The `pfLights` are created by calling `pfNewLight()`. A light has color and position. The light colors are specified with `pfLightColor()` as follows:

```
void pfLightColor(pfLightSource* lsource, int which, float r,
                 float g, float b);
```

which specifies one of three light colors as follows:

- PFLT_AMBIENT
- PFLT_DIFFUSE
- PFLT_SPECULAR

You to position the light source using `pfLightPos()`:

```
void pfLightPos(pfLight* light, float x, float y,
                float z, float w);
```

The variable w is the distance between the location in the scene defined by (x, y, z) and the light source *lsource*. If w equals 0, *lsource* is infinitely far away and (x, y, z) defines a vector pointing from the origin in the direction of *lsource*; if w equals 1, *lsource* is located at the position (x, y, z) . The default position is $(0, 0, 1, 0)$, directly overhead and infinitely far away.

The `pfLights` are attached to a `pfGeoState` through the `PFSTATE_LIGHTS` attribute.

The transformation matrix that is on the matrix stack at the time the light is applied controls the interpretation of the light source direction:

- To attach a light to the viewer (like a miner's head-mounted light), call `pfLightOn()` only once with an identity matrix on the stack.
- To attach a light to the world (like the sun or moon), call `pfLightOn()` every frame with only the viewing transformation on the stack.
- To attach a light to an object (like the headlights of a car), call `pfLightOn()` every frame with the combined viewing and modeling transformation on the stack.

The number of lights you can have turned on at any one time is limited by `PF_MAX_LIGHTS`, just as is true with the graphics libraries.

Note: In previous versions, attenuation was also part of the light model definition. In OpenGL, attenuation is defined per light. The `libpr` API for setting it is `pfLightAtten()`.

Note: `libpf` applications can include light sources in a scene graph with the `pfLightSource` node.

Materials

OpenGL Performer materials are an extension of graphics library material (see `glMaterial()`). `pfMaterials` encapsulate the ambient, diffuse, specular, and emissive colors of an object as well as its shininess and transparency. A `pfMaterial` is created by calling `pfNewMtl()`. As with any of the other attributes, a `pfMaterial` can be referenced in a `pfGeoState`, captured by a display list, or invoked as an immediate mode command.

The `pfMaterials`, by default, allow object colors to set the ambient and diffuse colors. This allows the same `pfMaterial` to be used for objects of different colors, removing the need for material changes and thus improving performance. This mode can be changed with `pfMtlColorMode(mtl, side, PFMTL_CMODE_*)`. OpenGL allows front or back materials to track the current color. If the same material is used for both front and back materials, there is no difference in functionality.

With the function `pfMtlSide()` you can specify whether to apply the the material on the side facing the viewer (`PFMTL_FRONT`), the side not facing the viewer (`PFMTL_BACK`), or both (`PFMTL_BOTH`). Back-sided lighting will only take affect if there is a two-sided lighting model active. Two-sided lighting typically has some significant performance cost.

Object materials only have an effect when lighting is active.

Color Tables

A `pfColortable` substitutes its own color array for the normal color attribute array (`PFGS_COLOR4`) of a `pfGeoSet`. This allows the same geometry to appear differently in different views simply by applying a different `pfColortable` for each view. By leaving the selection of color tables to the global state, you can use a single call to switch color tables for an entire scene. In this way, color tables can simulate time-of-day changes, infrared imaging, psychedelia, and other effects.

The **pfNewCtab()** function creates and returns a handle to a pfColortable. As with other attributes, you can specify which color table to use in a pfGeoState or you can use **pfApplyCtab()** to set the global color table, either in immediate mode or in a display list. For an applied color table to have effect, color table mode must also be enabled.

Fog

A pfFog is created by calling **pfNewFog()**. As with any of the other attributes, a pfFog can be referenced in a pfGeoState, captured by a display list, or invoked as an immediate mode command. Fog is the atmospheric effect of aerosol water particles that occlude vision over distance. SGI graphics hardware can simulate this phenomenon in several different fashions. A fog color is blended with the resultant pixel color based on the range from the viewpoint and the fog function. pfFog supports several different fogging methods. Table 12-9 lists the pfFog tokens and their corresponding actions.

Table 12-9 pfFog Tokens

pfFog Token	Action
PFFOG_VTX_LIN	Compute fog linearly at vertices.
PFFOG_VTX_EXP	Compute fog exponentially at vertices (e^x).
PFFOG_VTX_EXP2	Compute fog exponentially at vertices (e^{x^2}).
PFFOG_PIX_LIN	Compute fog linearly at pixels.
PFFOG_PIX_EXP	Compute fog exponentially at pixels (e^x).
PFFOG_PIX_EXP2	Compute fog exponentially at pixels (e^{x^2}).
PFFOG_PIX_SPLINE	Compute fog using a spline function at pixels.

The **pfFogType()** function uses these tokens to set the type of fog. A detailed explanation of fog types is given in the man pages `pfFog(3pf)` and `glFog(3g)`.

You can set the near and far edges of the fog with **pfFogRange()**. For exponential fog functions, the near edge of fog is always zero in eye coordinates. The near edge is where the onset of fog blending occurs, and the far edge is where all pixels are 100% fog color.

The token `PFFOG_PIX_SPLINE` selects a spline function to be applied when generating the hardware fog tables. This is further described in the `pfFog(3pf)` man page. Spline fog allows you to define an arbitrary fog ramp that can more closely simulate real-world phenomena like horizon haze.

For best fogging effects, the ratio of the far to the near clipping planes should be minimized. In general, it is more effective to add a small amount to the near plane than to reduce the far plane.

Highlights

OpenGL Performer provides a mechanism for highlighting geometry with alternative rendering styles, useful for debugging and interactivity. A `pfHighlight`, created with `pfNewHighlight()`, encapsulates the state elements and modes for these rendering styles. A `pfHighlight` can be applied to an individual `pfGeoSet` with `pfGSetHighlight()` or can be applied to multiple `pfGeoStates` through a `pfGeoState` or `pfApplyHighlight()`. The highlighting effects are added to the normal rendering phase of the geometry. `pfHighlights` make use of special outlining and fill modes and have a concept of a foreground color and a background color that can both be set with `pfHighlightColor()`. The available rendering styles can be combined by ORing together tokens for `pfHighlightMode()` and are described in Table 12-10.

Table 12-10 `pfHighlightMode()` Tokens

PFHL_Mode Bitmask Token	Description
LINES	Outlines the triangles in the highlight foreground color according to <code>pfHighlightLineWidth()</code> .
LINESPAT LINESPAT2	Outlines triangles with patterned lines in the highlight foreground color or in two colors using the background color.
FILL	Draws geometry with the highlight foreground color. Combined with <code>SKIP_BASE</code> , this is a fast highlighting mode.
FILLPAT FILLPAT2	Draws the highlighted geometry as patterned with one or two colors.
FILLTEX	Draws a highlighting fill pass with a special highlight texture.
LINES_R FILL_R	Reverses the highlighting foreground and background colors for lines and fill, respectively.

Table 12-10 pfHlightMode() Tokens (continued)

PFHL_Mode Bitmask Token	Description
POINTS	Renders the vertices of the geometry as points according to pfHlightPntSize() .
NORMALS	Displays the normals of the geometry with lines according to pfHlightNormalLength() .
BBOX_LINES BBOX_FILL	Displays the bounding box of the pfGeoSet as outlines and/or a filled box. Combined with PFHL_SKIP_BASE, this is a fast highlighting mode.
SKIP_BASE	Causes the normal drawing phase of the pfGeoSet to be skipped. This is recommended when using PFHL_FILL or PFHL_BBOX_FILL.

For a demonstration of the highlighting styles, see the sample program `/usr/share/Performer/pguide/src/libpr/C/hlcube.c` on IRIX and Linux and `%PFROOT%\Src\pguide\libpr\C\hlcube.c` on Microsoft Windows.

Graphics Library Matrix Routines

OpenGL Performer provides extensions to the standard graphics library matrix-manipulation functions. These functions are similar to their graphics library counterparts, with the exception that they can be placed in OpenGL Performer display lists. Table 12-11 lists and describes the matrix manipulation routines.

Table 12-11 Matrix Manipulation Routines

Routines	Action
pfScale()	Concatenate a scaling matrix.
pfTranslate()	Concatenate a translation matrix.
pfRotate()	Concatenate a rotation matrix.
pfPushMatrix()	Push down the matrix stack.
pfPushIdentMatrix()	Push the matrix stack and load an identity matrix on top.
pfPopMatrix()	Pop the matrix stack.

Table 12-11 Matrix Manipulation Routines (**continued**)

Routines	Action
pfLoadMatrix()	Add a matrix to the top of the stack.
pfMultMatrix()	Concatenate a matrix.

Sprite Transformations

A sprite is a special transformation used to efficiently render complex geometry with axial or point symmetry. A classic sprite example is a tree which is rendered as a single, texture-mapped quadrilateral. The texture image is of a tree and has an alpha component whose values “etch” the tree shape into the quad. In this case, the sprite transformation rotates the quad around the tree trunk axis so that it always faces the viewer. Another example is a puff of smoke which again is a texture-mapped quad but is rotated about a point to face the viewer so it appears the same from any viewing angle. The **pfSprite** transformation mechanism supports both these simple examples as well as more complicated ones involving arbitrary 3D geometry.

A **pfSprite** is a structure that is manipulated through a procedural interface. It is different from attributes like **pfTexture** and **pfMaterial** since it affects transformation, rather than state related to appearance. A **pfSprite** is activated with **pfBeginSprite()**. This enables sprite mode and any **pfGeoSet** that is drawn before sprite mode is ended with **pfEndSprite()** will be transformed by the **pfSprite**. First, the **pfGeoSet** is translated to the location specified with **pfPositionSprite()**. Then, it is rotated, either about the sprite position or axis depending on the **pfSprite**’s configuration. Note that **pfBeginSprite()**, **pfPositionSprite()**, and **pfEndSprite()** are display listable and this will be captured by any active **pfDispList**.

A `pfSprite`'s rotation mode is set by specifying the `PFSPRITE_ROT` token to `pfSpriteMode()`. In all modes, the Y axis of the geometry is rotated to point to the eye position. Rotation modes are listed below.

Table 12-12 `pfSprite` Rotation Modes

<code>PFSPRITE_</code> Rotation Token	Rotation Characteristics
<code>AXIAL_ROT</code>	Geometry's Z axis is rotated about the axis specified with <code>pfSpriteAxis()</code> .
<code>POINT_ROT_EYE</code>	Geometry is rotated about the sprite position with the object coordinate Z axis constrained to the window coordinate Y axis; that is, the geometry's Z axis stays "upright."
<code>POINT_ROT_WORLD</code>	Geometry is rotated about the sprite position with the object coordinate Z axis constrained to the sprite axis.

Rather than using the graphics hardware's matrix stack, `pfSprites` transform small `pfGeoSets` on the CPU for improved performance. However, when a `pfGeoSet` contains a certain number of primitives, it becomes more efficient to use the hardware matrix stack. While this threshold is dependent on the CPU and graphics hardware used, you may specify it with the `PFSPRITE_MATRIX_THRESHOLD` token to `pfSpriteMode()`. The corresponding value is the minimum vertex requirement for hardware matrix transformation. Any `pfGeoSet` with fewer vertices will be transformed on the CPU. If you want a `pfSprite` to affect non-`pfGeoSet` geometry, you should set the matrix threshold to zero so that the `pfSprite` will always use the matrix stack. When using the matrix stack, `pfBeginSprite()` pushes the stack and `pfEndSprite()` pops the matrix stack so the sprite transformation is limited in scope.

The `pfSprites` are dependent on the viewing location and orientation and the current modeling transformation. You can specify these with calls to `pfViewMat()` and `pfModelMat()`, respectively. Note that `libpf`-based applications need not call these routines since `libpf` does it automatically.

Display Lists

The `libpr` library supports display lists, which can capture and later execute `libpr` graphics commands. `pfNewDList()` creates and returns a handle to a new `pfDispList`. A `pfDispList` can be selected as the current display list with `pfOpenDList()`, which puts the system in display list mode. Any subsequent `libpr` graphics commands, such as

pfTransparency(), **pfApplyTex()**, or **pfDrawGSet()** are added to the current display list. Commands are added until **pfCloseDList()** returns the system to immediate mode. It is not valid to have multiple **pfDispLists** open at a given time but a **pfDispList** may be reopened, in which case, commands are appended to the end of the list.

Once a display list is constructed, it can be executed by calling **pfDrawDList()**, which traverses the list and sends commands down the Geometry Pipeline.

The **pfDispLists** are designed for multiprocessing, where one process builds a display list of the visible scene and another process draws it. The function **pfResetDList()** facilitates this by making **pfDispLists** reusable. Commands added to a reset display list overwrite any previously entered commands. A display list is typically reset at the beginning of a frame and then filled with the visible scene.

The **pfDispLists** support concurrent multiprocessing, where the producer and consumer processes simultaneously write and read the display list. The **PFDL_RING** argument to **pfNewDList()** creates a ring buffer or FIFO-type display list. **pfDispLists** automatically ensure ring buffer consistency by providing synchronization and mutual exclusion to processes on ring buffer full or empty conditions.

For more information and the application of display lists, see Chapter 15, “ClipTextures.”

Combining Display Lists

The contents of one **pfDispList** may be appended to a second **pfDispList** by using the function, **pfAppendDList()**. All **pfDispList** elements in *src* are appended to the **pfDispList** *dlist*.

Alternately, you can append the contents of one **pfDispList** to a second **pfDispList** by using the function **pfDispList::append()**. All **pfDispList** elements in *src* are appended to the **pfDispList** on which the append method is invoked.

State Management

A **pfState** is a structure that represents the entire **libpr** graphics state. A **pfState** maintains a stack of graphics states that can be pushed and popped to save and restore the state. The top of the stack describes the current graphics state of a window as it is known to OpenGL Performer.

The **pfInitState()** function initializes internal `libpr` state structures and should be called at the beginning of an application before any `pfStates` are created. Multiprocessing applications should pass a **usinit()** semaphore arena pointer to **pfInitState()**, such as **pfGetSemaArena()**, so OpenGL Performer can safely manage state between processes. **pfNewState()** creates and returns a handle to a new `pfState`, which is typically used to define the state of a single window. If using `pfWindows`, discussed in Chapter 16, “Windows,” a `pfState` is automatically created for the `pfWindow` when the window is opened and the current `pfState` is switched when the current `pfWindow` changes. **pfSelectState()** can be used to efficiently switch a different, complete `pfState`. **pfLoadState()** forces the full application of a `pfState`.

Pushing and Popping State

The **pfPushState()** function pushes the state stack of the currently active `pfState`, duplicating the top state. Subsequent modifications of the state through `libpr` routines are recorded in the top of the stack. Consequently, a call to **pfPopState()** restores the state elements that were modified after **pfPushState()**.

The code fragment in Example 12-2 illustrates how to push and pop state.

Example 12-2 Pushing and Popping Graphics State

```
/* set state to transparency=off and texture=brickTex */
pfTransparency(PFTR_OFF);
pfApplyTex(brickTex);

/* ... draw geometry here using original state ... */

/* save old state. establish new state */
pfPushState();
pfTransparency(PFTR_ON);
pfApplyTex(woodTex);

/* ... draw geometry here using new state ...*/

/* restore state to transparency=off and texture=brickTex */
pfPopState();
```

State Override

The **pfOverride()** function implements a global override feature for `libpr` graphics state and attributes. **pfOverride()** takes a mask that indicates which state elements to affect and a value specifying whether the elements should be overridden. The mask is a bitwise OR of the state tokens listed previously.

The values of the state elements at the time of overriding become fixed and cannot be changed until **pfOverride()** is called again with a value of zero to release the state elements.

The code fragment in Example 12-3 illustrates the use of **pfOverride()**.

Example 12-3 Using **pfOverride()**

```
pfTransparency(PFTR_OFF);
pfApplyTex(brickTex);

/*
 * Transparency will be disabled and only the brick texture
 * will be applied to subsequent geometry.
 */
pfOverride(PFSTATE_TRANSPARENCY | PFSTATE_TEXTURE, 1);
/* Draw geometry */

/* Transparency and texture can now be changed */
pfOverride(PFSTATE_TRANSPARENCY | PFSTATE_TEXTURE, 0);
```

pfGeoState

A `pfGeoState` encapsulates all the rendering modes, values, and attributes managed by `libpr`. See “Rendering Modes” on page 459, “Rendering Values” on page 464, and “Rendering Attributes” on page 465 for more information. `pfGeoStates` provide a mechanism for combining state into logical units and define the appearance of geometry. For example, you can set a brick-like texture and a reddish-orange material on a `pfGeoSet` and use it when drawing brick buildings.

You can specify texture matrices on `pfGeoSets`.

Local and Global State

There are two levels of rendering state: local and global. A record of both is kept in the current `pfState`. The local state is that defined by the settings of the current `pfGeoState`. The rendering state and attributes of a `pfGeoState` can be either locally set or globally inherited. If all state elements are set locally, a `pfGeoState` becomes a full graphics context—that is, all state is then defined at the `pfGeoState` level. Global state elements are set with `libpr` immediate-mode routines like `pfEnable()`, `pfApplyTex()`, `pfDecal()`, or `pfTransparency()` or by drawing a `pfDispList` containing these commands with `pfDrawDList()`. Local state elements for subsequent `pfGeoSets` are set by applying a `pfGeoState` with `pfApplyGState()` (note that `pfDrawGSet()` automatically calls `pfApplyGState()` if the `pfGeoSet` has an attached `pfGeoState`). The state elements applied by a `pfGeoState` are those modes, enables, and attributes that are explicitly set on the `pfGeoState`. Those settings revert back to the `pfState` settings for the next call to `pfApplyGState()`. A `pfGeoState` can be explicitly loaded into a `pfState` to affect future `pfGeoStates` with `pfLoadGState()`.

Note: By default, all state elements are inherited from the global state. Inherited state elements are evaluated faster than values that have been explicitly set.

While it can be useful to have all state defined at the `pfGeoState` level, it usually makes sense to inherit most state from global default values and then explicitly set only those state elements that are expected to change often.

Examples of useful global defaults are lighting model, lights, texture environment, and fog. Highly variable state is likely to be limited to a small set such as textures, materials, and transparency. For example, if the majority of your database is lighted, simply configure and enable lighting at the beginning of your application. All `pfGeoStates` will be lighted, except the ones for which you explicitly disable lighting. Then, attach different `pfMaterials` and `pfTextures` to `pfGeoStates` to define specific state combinations.

Note: Use caution when enabling modes in the global state. These modes may have cost even when they have no visible effect. Therefore, geometry that cannot use these modes should have a `pfGeoState` that explicitly disables the mode. Modes that require special care include the texturing enable and transparency.

You specify that a `pfGeoState` should inherit state elements from the global default with `pfGStateInherit(gstate, mask)`. *mask* is a bitmask of tokens that indicates which state

elements to inherit. These tokens are listed in the “Rendering Modes” on page 459, “Rendering Values” on page 464, and “Rendering Attributes” on page 465 sections of this chapter. For example, `PFSTATE_ENLIGHTENING | PFSTATE_ENTEXTURE` makes *gstate* inherit the enable modes for lighting and texturing.

A state element ceases to be inherited when it is set in a `pfGeoState`. Rendering modes, values, and attributes are set with `pfGStateMode()`, `pfGStateVal()`, and `pfGStateAttr()`, respectively. For example, to specify that *gstate* is transparent and textured with *treeTex*, use the following:

```
pfGStateMode(gstate, PFSTATE_TRANSPARENCY, PFTR_ON);
pfGStateAttr(gstate, PFSTATE_TEXTURE, treeTex);
```

Applying `pfGeoStates`

Use `pfApplyGState()` to apply the state encapsulated by a `pfGeoState` to the Geometry Pipeline. The effect of applying a `pfGeoState` is similar to applying each state element individually. For example, if you set a `pfTexture` and enable a decal mode on a `pfGeoState`, applying it essentially calls `pfApplyTex()` and `pfDecal()`. If in display-list mode, `pfApplyGState()` is captured by the current display list.

State is (logically) pushed before and popped after `pfGeoStates` are applied so that `pfGeoStates` do not inherit state from each other. This is a very powerful and convenient characteristic since, as a result, `pfGeoStates` are order-independent, and you do not have to worry about one `pfGeoState` corrupting another. The code fragment in Example 12-4 illustrates how `pfGeoStates` inherit state.

Example 12-4 Inheriting State

```
/* gstateA should be textured */
pfGStateMode(gstateA, PFSTATE_ENTEXTURE, PF_ON);

/* gstateB inherits the global texture enable mode */
pfGStateInherit(gstateB, PFSTATE_ENTEXTURE);

/* Texturing is disabled as the global default */
pfDisable(PFEN_TEXTURE);

/* Texturing is enabled when gstateA is applied */
pfApplyGState(gstateA);
/* Draw geometry that will be textured */

/* The global texture enable mode of OFF is restored
```

```

so that gstateB is NOT textured. */
pfApplyGState(gstateB);
/* Draw geometry that will not be textured */

```

The actual `pfGeoState` pop is a "lazy" pop that does not happen unless a subsequent `pfGeoState` requires the global state to be restored. This means that the actual state between `pfGeoStates` is not necessarily the global state. If a return to global state is required, call **`pfFlushState()`** to restore the global state. Any modification to the global state made using `libpr` functions—**`pfTransparency()`**, **`pfDecal()`**, and so on—becomes the default global state.

For best performance, set as little local `pfGeoState` state as possible. You can accomplish this by setting global defaults that satisfy the majority of the requirements of the `pfGeoStates` being drawn. By default, all `pfGeoState` state is inherited from the global default.

pfGeoSets and pfGeoStates

There is a special relationship between `pfGeoSets` and `pfGeoStates`. Together they completely define both geometry and graphics state. You can attach a `pfGeoState` to a `pfGeoSet` with **`pfGSetGState()`** to specify the appearance of geometry. Whenever the `pfGeoSet` is drawn with **`pfDrawGSet()`**, the attached `pfGeoState` is first applied using **`pfApplyGState()`**. If a `pfGeoSet` does not have a `pfGeoState`, its state description is considered undefined. To inherit all values from the global `pfState`, a `pfGeoSet` should have a `pfGeoState` with all values set to inherit, which is the default.

This combination of routines allows the application to combine geometry and state in high-performance units that are unaffected by rendering order. To further increase performance, sharing `pfGeoStates` among `pfGeoSets` is encouraged.

Table 12-13 lists and describes the `pfGeoState` routines.

Table 12-13 `pfGeoState` Routines

Routiine	Description
<code>pfNewGState()</code>	Create a new <code>pfGeoState</code> .
<code>pfCopy()</code>	Make a copy of the <code>pfGeoState</code> .
<code>pfDelete()</code>	Delete the <code>pfGeoState</code> .
<code>pfGStateMode()</code>	Set a specific state mode.

Table 12-13 pfGeoState Routines (**continued**)

Routine	Description
pfGStateVal()	Set a specific state value.
pfGStateAttr()	Set a specific state attribute.
pfGStateInherit()	Specify which state elements are inherited from the global state.
pfApplyGState()	Apply pfGeoState's non-inherited state elements to graphics.
pfLoadGState()	Load pfGeoState's settings into the pfState, inherited by future pfGeoStates.
pfGetCurGState()	Return the current pfGeoState in effect.
pfGStateFuncs()	Assign pre/post callbacks to pfGeoState.
pfApplyGStateTable()	Specify a table of pfGeoStates used for indexing.

Figure 12-1 diagrams the conceptual structure of a pfGeoState.

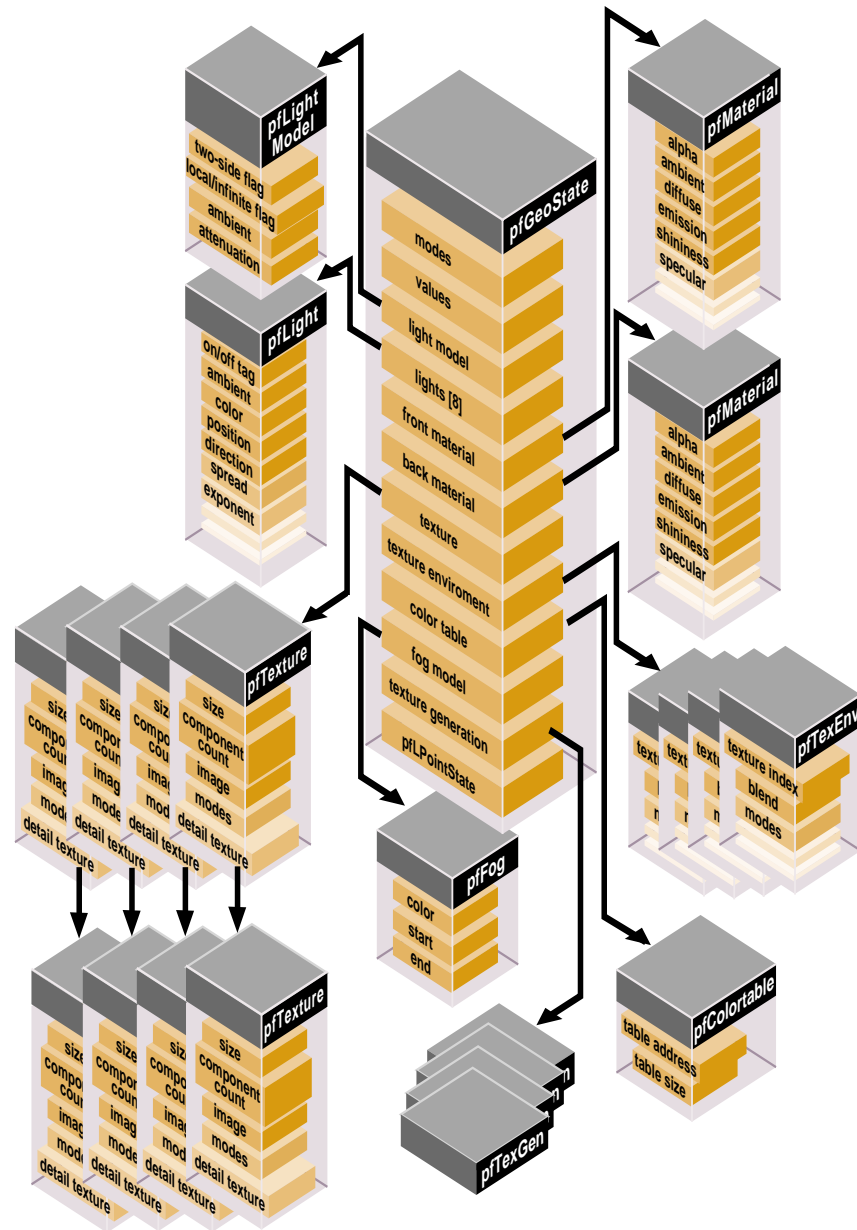

Figure 12-1 pfGeoState Structure

Multitexture Support in pfGeoState

Some graphic hardware supports the use of multiple texture maps on a single polygon. These multiple texture maps are blended together according to a collection of texture environments. Figure 12-2 demonstrates the OpenGL definition for generating the color of a multitextured pixel. The figure assumes that the hardware has four texture units and so each pixel can receive contribution from four texture maps.

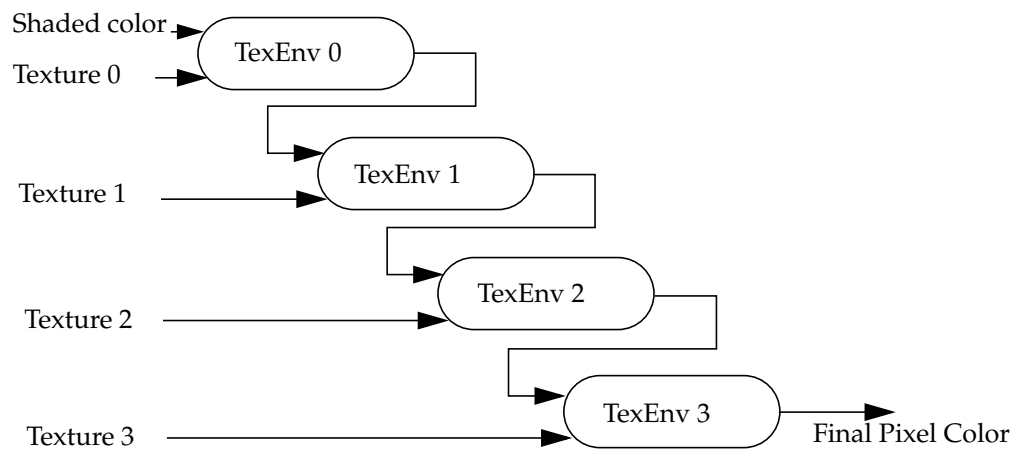

Figure 12-2 Generating the Color of a Multitextured Pixel

In the figure, the shaded and un-textured color of a pixel enters the first texture blending unit together with the texture color computed by the first texture unit. The texture environment marked TexEnv 0 determines the math operation between the two. The output color of this operation feeds the second texture blending unit together with the texture color computed by the second texture unit. This process continues four times until the final color of the pixel is generated.

The pfGeoState class allows specifying multiple texture maps on a single pfGeoSet. All these texture maps will be applied when the pfGeoSet is applied (providing that the graphic hardware has enough texture mapping units). pfGeoState also allows specifying multiple pfTexEnv, pfTexGen, pfTexMat, and pfTexLOD objects—one for each pfTexture.

The following code fragment shows how to add multiple textures to a `pfGeoState`:

```

{
    pfGeoState *gstate;
    pfTexture  *tex;
    pfTexEnv   *tev;

    gstate = pfNewGState (pfGetSharedArena());
    for (i = 0 ; i < PF_MAX_TEXTURES ; i ++ )
    {
        /* Load texture # i from a file */
        tex = pfNewTex (pfGetSharedArena());
        pfLoadTexFile (tex, texture_file_name[i]);

        tev = pfNewTEnv (pfGetSharedArena());

        /* Enable texture unit # i on the pfGeoState. */
        pfGStateMultiMode (gstate, PFSTATE_ENTEXTURE, i, 1);

        /* Attach texture for texture unit # i */
        pfGStateMultiAttr (gstate, PFSTATE_TEXTURE, i, tex);

        /* Attach texture environment for texture unit # i */
        pfGStateMultiAttr (gstate, PFSTATE_TEXENV, i, tev);
    }
}

```

Notes:

- `pfGeoState` recognizes texture units starting at the first array (index of 0) and ending immediately before the first disabled texture unit. For example, enabling texture units 0, 1, and 3 is equivalent to enabling only texture units 0 and 1.
- `pfGeoState` can inherit all or none of the texture units. It is enough to specify one texture unit in order to avoid inheriting any other texture unit. In order to inherit all texture units, one must specify no texture units on the `pfGeoState`.
- For every texture unit enabled, the application must provide texture coordinates. Neither OpenGL Performer nor OpenGL will share texture coordinates between texture units. There are two ways to set texture coordinates:
 - Specifying a `pfTexGen` for a texture unit
 - Specifying a texture-coordinate attribute array for a texture unit on a `pfGeoSet`. See section “Attributes” in Chapter 8.

Shaders

This chapter describes the OpenGL Shader, a mechanism which allows complex rendering equations to be applied to OpenGL Performer objects. See Chapter 14, “Using Scalable Graphics Hardware” for the use of fragment and vertex programs.

OpenGL Performer 3.0 introduces a completely new dynamic shader implementation. The OpenGL Performer 3.0 approach is provide a minimal wrapping of the OpenGL Shader API and to use OpenGL Shader to directly render shaded pfGeoSets.

The following description of the new API assumes an understanding of the OpenGL Shader API. OpenGL Shader is available at no charge at the following URL: <http://www.sgi.com/software/shader>. OpenGL Shader documentation is installed in the directory `/usr/share/shader/doc/developer` on IRIX and Linux and in `%PFROOT\shader\doc\developer` on Microsoft Windows.

The OpenGL Performer and OpenGL Shader integration is documented in the following OpenGL Performer man pages:

- `pfISL`
- `pfISLTexCoordData`
- `pfGeoSet`
- `pfdLoadAppearance`

Setting Up Shaded pfGeoSets

In the OpenGL Shader API, an `islAppearance` embodies the complete description of the appearance of an object and that appearance can be applied to a `pfGeoSet`. A `pfGeoSet` gains the following functions:

```
pfGeoSet::setAppearance(islAppearance *appearance);
islAppearance* pfGeoSet::getAppearance();
```

These functions set and query the appearance that renders a `pfGeoSet`. The `islAppearances` are mutually exclusive with `pfGeoStates`; hence, only one of the two can be used to define the appearance of the `pfGeoSet`. To preserve the `pfGeoSet` cache-line behavior, the `islAppearance` and the `pfGeoState` share the same pointer. Hence, adding an appearance to a `pfGeoSet` removes the `pfGeoState` and conversely so.

Because OpenGL Performer only minimally wraps the OpenGL shader API, OpenGL Performer cannot indicate when run-time parameters are changed on any `islShaders` contained within the `islAppearance`. Shader changes cannot be propagated in the APP process to the DRAW without knowing run-time parameters. Therefore, the following two functions are available to solve this problem:

```
pfAppearanceChanged( islAppearance *appearance );
pfShaderChanged( islAppearance *appearance, islShader *shader );
```

The `pfShaderChanged()` function tells OpenGL Performer that the parameters of the specified shader within the specified appearance have changed. The function `pfAppearanceChanged()` tells OpenGL Performer that the specified appearance has changed (that is, that shaders have been added or removed

Textures and Texture Coordinates

OpenGL Shader is a callback-based API that calls user-supplied functions to apply textures and to draw geometry with specific texture coordinates. OpenGL Performer supplies its own internal functions for these callbacks in order to render shaded `pfGeoSets` and perform internal bookkeeping of the resources that OpenGL Shader uses. As a result, when using OpenGL Shader within OpenGL Performer, you must use callbacks "friendly" to OpenGL Performer in order to specify textures and texture coordinates. The following API allows you to do this:

```
pfShaderTexCoordFunc( islAppearance *a, pfTexCoordCallbackType *func,
void *udata )
pfShaderTexApplyFunc( islAppearance *a, pfTexApplyCallbackType *func,
void *udata )
pfShaderTexComputeFunc( islAppearance *a, int where,
pfTexComputeCallbackType *func, void *udata )
typedef int (*pfTexApplyCallbackType)(const islAppearance *app, const
char *texName, void *userData);
typedef void (*pfTexComputeCallbackType)(pfISLTexCoordData *d, const
char *texName, void *userData);
typedef pfVec2* (*pfTexCoordCallbackType)(pfISLTexCoordData *d, const
float texCoordID, void *userData);
```

The function **pfShaderTexCoordFunc()** allows you to specify a callback to invoke whenever the specified `islAppearance` requests geometry to be drawn with specific texture coordinates. This callback is analogous to the **islShape::setDrawGeometryFunc()** OpenGL Shader function.

One of the parameters that OpenGL Performer passes into your callback is a pointer to a `pfISLTexCoordData` class. This class holds data that is useful in computing the requested texture coordinates such as the `pfGeoSet` that is being rendered, the `islAppearance` that triggered the callback, the modelview matrix, and others. See the `pfISLTexCoordData` man page for a description of this class.

Your callback will return a set of texture coordinates for OpenGL Performer to use in place of those already on the `pfGeoSet`. When allocating new coordinates per-frame, allocate the memory with the `pfISLTexCoordData` class that OpenGL Performer passed in. This memory is automatically deallocated when OpenGL Performer finishes with it.

The function **pfShaderTexComputeFunc()** allows you to set an optional callback that is invoked to compute the specified texture. This callback offloads the work of generating procedural textures from the `DRAW` process if possible. OpenGL Performer queries the OpenGL Shader ahead of time about which textures it will request in the `DRAW` process and will try to call your callback in the `CULL` process. The parameters that are passed into this callback are the same as for the **pfShaderTexCoordFunc()** function described in the preceding paragraph.

The function **pfShaderTexApplyFunc()** is called whenever OpenGL Shader asks for a texture to be applied. This callback is analogous to the **islDrawAction::setLoadTextureFunc()** OpenGL Shader function. When invoking this callback, OpenGL Performer passes in the `islAppearance` that requested the texture, the name of the texture, and whatever user data specified to **pfShaderTexApplyFunc()**. This function returns the number of texture dimensions (1, 2, or 3). When calling this function, OpenGL Performer attempts to do so in the `CULL` process.

OpenGL Shader and OpenGL Performer

As of OpenGL Performer 3.0, the OpenGL Shader library performs all of the rendering state management for `pfGeoSets` that have been assigned an `islAppearance`; OpenGL Performer draws the appropriate `pfGeoSets` when the OpenGL Shader library calls the OpenGL Performer `DrawGeometry` callback.

The rendering of a shaded `pfGeoSet` has the following flow through OpenGL Performer:

1. A new `islAppearance` is created and compiled.

For more details, see the OpenGL Shader documentation installed in the directory `/usr/share/shader/doc/developer` on IRIX and Linux and in `%PFROOT\shader\doc\developer` on Microsoft Windows.

2. The newly created `islAppearance` is assigned to a `pfGeoSet`.

OpenGL Performer uses an OpenGL Shader `islCopyAction` to create a shared-memory representation of the `islAppearance`, which can be used in processes other than the APP process.

3. In the CULL process, OpenGL Performer computes the correct shader matrix and passes it to each `islShader` that comprises the `islAppearanceCopy` that was just created.

4. OpenGL Performer uses the OpenGL Shader `islSnapshotAction` to create an `islAppearanceSnapshot` from the `islAppearanceCopy` in the previous step.

The `islSnapshotAction` tells OpenGL Performer which sets of texture coordinates will be required at DRAW time so that OpenGL Performer can call any callbacks that have been registered with the `pfShaderTexComputeFunc()` and `pfShaderTexCoordFunc()` functions.

5. At DRAW time, OpenGL Performer creates an `islShape` and an `islDrawAction` and invoke `islShape::draw()`.

Each time `islDrawAction` requests that the shaded objects be drawn, OpenGL Performer draws the corresponding `pfGeoSets` using any data that was computed using the user callbacks invoked in the previous step. If the `islDrawAction` requests that any textures be applied, OpenGL Performer calls any functions registered by using the `pfShaderTexApplyFunc()` function to do the job.

Using Scalable Graphics Hardware

Scalable graphics hardware provides nearly perfect scaling of both geometry rate and fill rate on some applications. This chapter describes how you use OpenGL Performer in conjunction with an SGI Video Digital Multiplexer (DPLEX), an SGI Scalable Graphics Compositor, and graphics processing units (GPUs). The corresponding sections are the following:

- “Using OpenGL Performer with a DPLEX” on page 501
- “Using OpenGL Performer with an SGI Scalable Graphics Compositor” on page 514
- “Using OpenGL Performer with GPUs” on page 523

Using OpenGL Performer with a DPLEX

A DPLEX is an optional daughtercard that permits multiple graphics hardware pipelines to work simultaneously on a single visual application. DPLEX hardware is available on Silicon Graphics Onyx2, SGI Onyx 3000, and SGI Onyx 300 systems. For an overview of the DPLEX hardware, see the document *Onyx2 DPLEX Option Hardware User's Guide*.

OpenGL Performer taps the power of a DPLEX by using hyperpipes. The following sections describe how to use hyperpipes:

- “Hyperpipe Concepts” on page 502
- “Configuring Hyperpipes” on page 502
- “Configuring pfPipeWindows and pfChannels” on page 509
- “Programming with Hyperpipes” on page 513

Hyperpipe Concepts

A pfHyperpipe is a combination of pfPipes or pfMultipipes; there is one pfPipe for each graphics pipe in a DPLEX ring or chain. A DPLEX ring or chain is a collection of interconnected graphic boards.

A key concept with hyperpipes is that of temporal decomposition. Think of a rendered sequence as a 3D data set with time being the third axis. With temporal decomposition, the dataset is subdivided along the time axis and distributed across, in this case, each of the graphic pipes in the hyperpipe group.

Temporal decomposition is different from spatial decomposition, in which the dataset is subdivided along the X axis, Y axis, or both X and Y axes.

Configuring Hyperpipes

It is the responsibility of the application to establish the hyperpipe group configuration for OpenGL Performer. There are two steps in the configuration process:

1. Establish the number of graphic pipes (or pfPipes because there is a one-to-one correspondence) in each hyperpipe group.
2. Map the pfPipes to specific graphic pipes.

Establishing the Number of Graphic Pipes

Use the argument in the **pfHyperpipe()** function to establish the number of graphic pipes in the hyperpipe group, for example:

```
pfHyperpipe(2);  
pfConfig();
```

In this example, two pfPipes combine to create the pfHyperpipe, as shown in Figure 14-1.

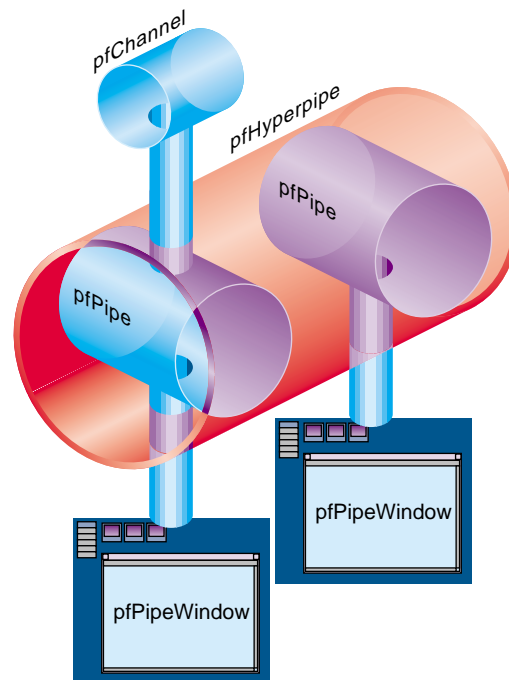

Figure 14-1 pfPipes Creating pfHyperpipes

Like the `pfMultiPipe()` function, `pfHyperpipe()` must be invoked prior to configuring the `pfPipes` using `pfConfig()` and after the call to `pfInit()`.

The number of pipes is used by `pfConfig()` to associate the configured `pfPipes`. The `pfHyperpipe()` function can be invoked multiple times to construct multiple hyperpipe groups, as shown in Figure 14-2.

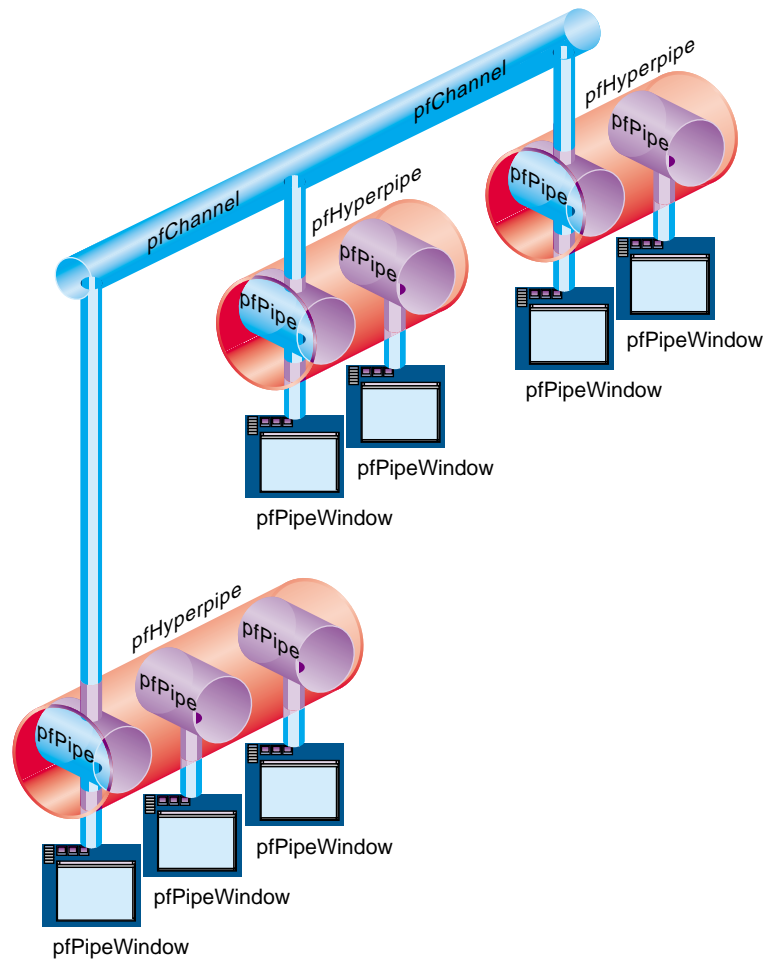

Figure 14-2 Multiple Hyperpipes

Additionally, the `pfHyperpipe()` function can be combined with the `pfMultipipe()` call to configure `pfPipes` that are not associated with a hyperpipe group. The `num` argument to the `pfMultipipe()` function defines the total number of `pfPipes` to configure (including those in hyperpipe groups).

Example 14-1, diagrammed in Figure 14-2, shows the configuration of a system with three hyperpipe groups. The first hyperpipe group consists of three graphic pipes. The

remaining two hyperpipe groups have two graphic pipes each. This example also configures one non-hyperpipe group graphic pipe.

Example 14-1 Configuring a System with Three Hyperpipe Groups

```
pfInit();
pfMultipipe(8); /* need eight pfPipes 3-2-2-1 */
pfHyperpipe(3); /* pfPipes 0, 1, 2 are the first group */
pfHyperpipe(2); /* pfPipes 3, 4 are the second group */
pfHyperpipe(2); /* pfPipes 5, 6 are the third group */
pfConfig(); /* construct the pfPipes */
```

If the target configuration includes only hyperpipe groups, it is not necessary to invoke **pfMultipipe()**. OpenGL Performer correctly determines the number of pfPipes from the **pfHyperpipe()** calls.

Using the Default Hyperpipe Mapping to Graphic Pipes

The pfPipes constructed by **pfConfig()** are ordered into a linear array and are selected with the **pfGetPipe()** function. The pfPipes that are part of a hyperpipe group always appear in this array before any non-hyperpipe group pfPipes.

The **pfHyperpipe()** function groups pfPipes together starting, by default, with pfPipe number 0. In the following example, there are four pfPipes; the first two are combined into a hyperpipe group:

```
pfMultipipe(4);
pfHyperpipe(2);
pfConfig();
```

OpenGL Performer maps each pfPipe to a graphic pipe, which is associated with a specific X display, as shown in Figure 14-3:

	Hyperpipe		Single pipes	
pfPipe	0	1	2	3
Graphic pipe	0	1	2	3

Figure 14-3 Default Hyperpipe Mapping to Graphic Pipes

Using Nondefault Hyperpipe Mappings to Graphics Pipes

Each graphics pipe is associated with only one X screen. By default, OpenGL Performer assigns each pfPipe to the screen of the default X display that matches the pfPipe index in the pfPipe array; in other words, pfPipe(0) in the hyperpipe is mapped to X screen 0.

In most configurations, this default mapping is not sufficient. The second phase, therefore, involves associating the configured pfPipes with the graphic pipes. This is achieved through the **pfPipeScreen()** or **pfPipeWSConnectionName()** function on the pfPipes of the hyperpipe group.

Example 14-2 shows, given the configuration in Example 14-1, how to map the pfPipes to the appropriate screens. In this example, all of the graphic pipes are managed under the same X display, that is, a different screen on the same display.

Example 14-2 Mapping Hyperpipes to Graphic Pipes

```
/* assign the single pfPipe to screen 0 */
pfPipeScreen(pfGetPipe(7), 0);

/* assign the pfPipes of hyperpipe group 0 to screens 1,2,3 */
for (i=0; i < 3; i++)
    pfPipeScreen(pfGetPipe(i), i+1);

/* assign the pfPipes of hyperpipe group 1 to screens 4,5 */
for (i=3; i<5; i++)
    pfPipeScreen(pfGetPipe(i), i+1);

/* assign the pfPipes of hyperpipe group 2 to screens 6,7 */
for (i=5; i<7; i++)
    pfPipeScreen(pfGetPipe(i), i+1);
```

The following is a more complex example that uses GLXHyperpipeNetworkSGIX returned from **glXQueryHyperpipeNetworkSGIX()** to configure the pfPipes. This example is much more complete and is referred to in the following sections.

Example 14-3 More Complete Example: Mapping Hyperpipes to Graphic Pipes

```
int hasHyperpipe;
GLXHyperpipeNetworkSGIX* hyperNet;
int numHyperNet;
int i;
Display* dsp;
int numNet;
```

```

int pipeIdx;
pfChannel* masterChan;

/* initialize Performer */
pfInit();

/* does this configuration support hyperpipe */
pfQueryFeature(PFQFTR_HYPERPIPE, &hasHyperpipe);
if (!hasHyperpipe) {
    pfNotify(PFNFY_FATAL, PFNFY_RESOURCE, "no hyperpipe support");
    exit(1);
}

/* query the network */
dsp = pfGetCurWSCConnection();
hyperNet = glXQueryHyperpipeNetworkSGIX(dsp, &numHyperNet);
if (numHyperNet == 0) {
    pfNotify(PFNFY_FATAL, PFNFY_RESOURCE, "no hyperpipes");
    exit(1);
}

/*
 * determine the number of distinct hyperpipe networks. network
 * ids are monotonically increasing from zero. a value < 0
 * is used to indicate pipes that are not members of any hyperpipe.
 */
for (i=0, numNet=-1; i<numHyperNet; i++)
    if (numNet < hyperNet[i].networkId)
        numNet = hyperNet[i].networkId;
numNet += 1;

/*
 * configure all of the hyperpipes in the net
 *
 * NOTE -
 * while it is possible to be selective about which hyperpipe(s)
 * to configure, that is left as an exercise.
 */
for (i=0; i<numNet; i++) {
    int count = 0;
    int j;
    for (j=0; j<numHyperNet; j++)
        if (hyperNet[j].networkId == i) count++;
    pfHyperpipe(count);
}

```

```
pfConfig();

/* associate pfPipes with screens */
for (i=0, pipeIdx=0; i<numNet; i++) {
    int j;
    for (j=0; j<numHyperNet; j++)
        if (hyperNet[i].networkId == i)
            pfPipeWSCoNNECTIONName(pfGetPipe(pipeIdx++),
                hyperNet[i].pipeName);
}

/* construct the pfPipeWindows for each hyperpipe */
masterChan = NULL;
for (i=0, pipeIdx=0; i<numNet; i++) {
    pfPipe* pipe;
    pfPipeWindow* pwin;
    pfChannel* chan;
    PFVEC3 xyz, hpr;

    pipe = pfGetPipe(pipeIdx);
    pwin = pfNewPWin(pipe);
    pfPWinName(pwin, "Hyperpipe Window");

    /*
     * void
     * openPipeWindow(pfPipeWindow* pwin)
     * {
     *     pfPWinOpen(pwin);
     * }
     */
    pfPWinConfigFunc(pwin, openPipeWindow);
    pfPWinFullScreen(pwin);
    pfPWinMode(pwin, PFWIN_NOBORDER, 1);
    pfPWinConfig(pwin);

    chan = pfNewChan(pipe);
    pfPWinAddChan(pwin, chan);

    /*
     * layout channels left to right in hyperpipe order. this
     * ordering is arbitrary and should be redefined for the
     * specific application.
     */
    pfChanShare(chan,
```

```

pfGetChanShare() | PFCHAN_VIEWPORT |
PFCHAN_SWAPBUFFERS | PFCHAN_SWAPBUFFERS_HW);
pfMakeSimpleChan(chan, 45);
pfChanAutoAspect(chan, PFFRUST_CALC_VERT);

xyz[0] = xyz[1] = xyz[2] = 0;
hpr[0] = (((numNet-1)*.5f)-i)*45.f;
hpr[1] = hpr[2] = 0;
pfChanViewOffsets(chan, xyz, hpr);
pfChanNearFar(.000001, 100000);

/*
 * void
 * drawFunc(pfChannel* chan, void* notUsed)
 * {
 *     pfClearChan(chan);
 *     pfDraw();
 * }
 */
pfChanTravFunc(PFTRAV_DRAW, drawFunc);
if (i == 0)
    masterChan = chan;
else
    pfAttachChan(masterChan, chan);

/* bump to the first pipe of the next hyperpipe */
pipeIdx += pfGetHyperpipe(pipe);
}

/*
 * the next step is to construct the scene, attach it to
 * masterChan and start the main loop. this bit of code
 * is not included here since it follows other demonstration
 * applications included elsewhere in the Programmer's Guide.
 */

```

Configuring pfPipeWindows and pfChannels

The pfPipes grouped into a pfHyperpipe are indexed; the first pfPipe is pfPipe(0) and it is referred to as the master pfPipe. Most actions taken on the hyperpipe group are effected through this pfPipe; for example, all objects, such as pfPipeWindows and pfChannels, are attached to the master pfPipe. OpenGL Performer automatically clones

all objects, except pfChannels, across all of the pfPipes in the pfHyperpipe, as shown in Figure 14-4.

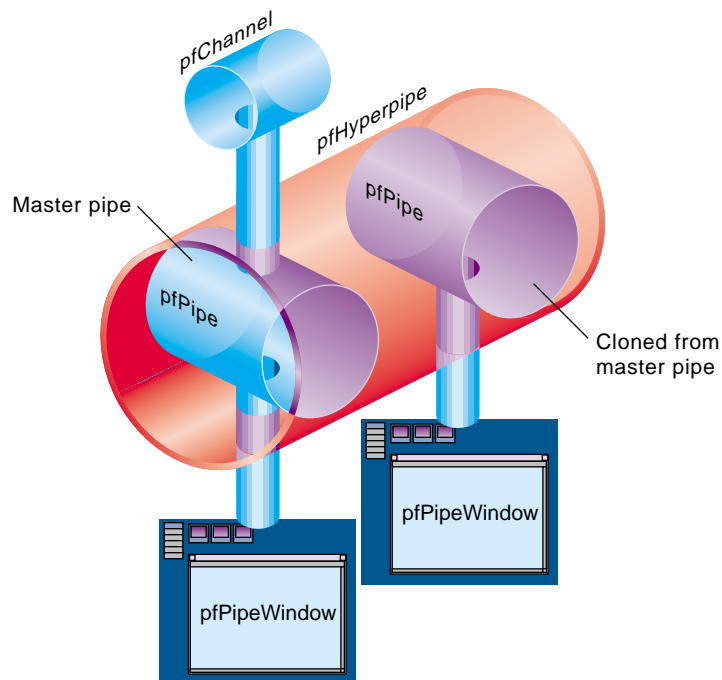

Figure 14-4 Attaching Objects to the Master pfPipe

When constructing pfPipeWindows or pfChannels, the pfPipe argument should be the master pfPipe. OpenGL Performer ensures that the constructed objects are cloned (pfPipeWindows) or attached (pfChannels) as needed to the other pfPipes in the hyperpipe group.

With the exception of certain attributes, detailed in Table 14-1, OpenGL Performer propagates attribute updates to the cloned `pfPipeWindows` when they occur. The following is a list of `pfPipeWindow` functions for which the attributes do not propagate.

Table 14-1 `pfPipeWindow` Functions That Do Not Propagate

C Function	C++ Member Function
<code>pfPWinSwapBarrier()</code>	<code>setSwapBarrier()</code>
<code>pfPWinWSConnectionName()</code>	<code>setWSConnectionName()</code>
<code>pfPWinOverlayWin()</code>	<code>setOverlayWin()</code>
<code>pfPWinStatsWin()</code>	<code>setStatsWin()</code>
<code>pfPWinScreen()</code>	<code>setScreen()</code>
<code>pfPWinWSWindow()</code>	<code>setWSWindow()</code>
<code>pfPWinWSDrawable()</code>	<code>setWSDrawable()</code>
<code>pfPWinFBConfigData()</code>	<code>setFBConfigData()</code>
<code>pfPWinFBConfigAttrs()</code>	<code>setFBConfigAttrs()</code>
<code>pfPWinFBConfig()</code>	<code>setFBConfig()</code>
<code>pfPWinFBConfigId()</code>	<code>setFBConfigId()</code>
<code>pfPWinGLCxt()</code>	<code>setGLCxt()</code>
<code>pfPWinList()</code>	<code>setWinList()</code>
<code>pfPWinPVChan()</code>	<code>setPVChan()</code>
<code>pfPWinAddPVChan()</code>	<code>addPVChan()</code>
<code>pfPWinRemovePVChan()</code>	<code>removePVChan()</code>
<code>pfPWinRemovePVChanIndex()</code>	<code>removePVChanIndex()</code>
<code>pfBindPWinPVChans()</code>	<code>bindPVChans()</code>
<code>pfUnbindPWinPVChans()</code>	<code>unbindPVChans()</code>
<code>pfSelectPWin()</code>	<code>select()</code>
<code>pfAttachPWinWin()</code>	<code>attachWin()</code>

Table 14-1 pfPipeWindow Functions That Do Not Propagate **(continued)**

C Function	C++ Member Function
<code>pfDetachPWinWin()</code>	<code>detachWin()</code>
<code>pfAttachPWin()</code>	<code>attach()</code>
<code>pfAttachPWinSwapGroup()</code>	<code>attachSwapGroup()</code>
<code>pfAttachPWinWinSwapGroup()</code>	<code>attachWinSwapGroup()</code>
<code>pfDetachPWinSwapGroup()</code>	<code>detachSwapGroup()</code>
<code>pfChoosePWinFBConfig()</code>	<code>chooseFBConfig()</code>

When using any of the preceding interfaces within an application, set the appropriate attribute in the cloned `pfPipeWindow`.

Clones

Clones are identified by an index value. The index of a clone matches that of the master `pfPipeWindow`. This index is used to retrieve the clone `pfPipeWindow` from the other `pfPipes` in the hyperpipe group. Example 14-4 sets the `FBConfigAttrs` for each of the `pfPipeWindows` in the first hyperpipe group.

Example 14-4 Set `FBConfigAttrs` for Each `pfPipeWindow`

```
static int attr[] = {
    GLX_RGBA,
    GLX_DOUBLEBUFFER,
    GLX_LEVEL, 0,
    GLX_RED_SIZE, 8,
    GLX_GREEN_SIZE, 8,
    GLX_BLUE_SIZE, 8,
    GLX_ALPHA_SIZE, 8,
    GLX_DEPTH_SIZE, 16,
    GLX_STENCIL_SIZE, 0,
    GLX_ACCUM_RED_SIZE, 0,
    GLX_SAMPLE_BUFFERS_SGIS, 1,
    GLX_SAMPLES_SGIS, 4,
    None
};

int numHyper = pfGetHyperpipe(pfGetPipe(0));
```



```

for (i=0; i<numHyper; i++) {
    /* get the first pfPipeWindow on pfPipe */
    pfPipeWindow* pwin = pfGetPipePWin(pfGetPipe(i), 0);
    pfPipeFBConfigAttrs(pwin, attr);
}

```

The current API has no support for directly querying the pfPipeWindow index within the pfPipe. The only mechanism to determine an index value is to track it in the application or search the pfPipeWindow list of the pfPipe. Example 14-5 performs such a search.

Example 14-5 Search the pfPipeWindow List of the pfPipe

```

/* search the master pfPipe pipe for the pfPipeWindow in pwin */
int pwinIdx;
int numPWins = pfGetPipeNumPWins(pipe);
for (i=0; i<numPWins; i++)
    if (pfGetPipePWin(pipe) == pwin) break;
if (i == numPWins)
    pfNotify(PFNFY_FATAL, PFNFY_PRINT, "oops!");
pwinIdx = i;

```

Synchronization

When working with pfPipeWindows, it is possible for some updates to occur within the DRAW process. For this release (and possibly future releases) of OpenGL Performer, these updates are not automatically propagated to the clone pfPipeWindows. It is the responsibility of the application to ensure that the appropriate attributes are propagated or that similar actions occur on the clones.

The CULL and DRAW stages of different pfPipes within a hyperpipe group can run in parallel. For this reason, applications that assume a fixed pfChannel to pfPipe relationship or maintain global configuration data associated with a pfChannel that is updated in either the CULL or DRAW stages may fail. It is currently impossible (or at least very difficult) to transmit information from the CULL or DRAW stages of one pfPipe to another CULL or DRAW stage of another pfPipe within a hyperpipe group. All changes should be affected by the APP stage.

Programming with Hyperpipes

Programming with hyperpipes, as described in the preceding sections, generally involves the following steps:

1. Configure the hyperpipe either on the fly or using a configuration file.
2. Map screens to hyperpipes, if necessary.
3. Allocate `pfPipeWindow` and `pfChannels`:
 - Create one `pfPipeWindow` for each `pfHyperpipe`.
 - Attach a `pfPipeWindow` to the master `pfPipe`.
 - Create a `pfChannel` for each `pfHyperpipe`.
4. Start the main loop (`pfFrame()...pfSync()`).

There are two additional requirements for DPLEX:

- You cannot use single buffer visuals.

The DPLEX option uses the `glXSwapBuffers()` call as an indication to switch the multiplexer. This logic is bypassed for single buffered visuals.
- `glXSwapBuffers()` and `pfSwapWinBuffers()` functions must not be invoked outside of the internal draw synchronization logic.

Because the `pfuDownloadTexList()` function with the style parameter set to `PFUTEX_SHOW` calls `glXSwapBuffers()`, this feature must be disabled. (Simply set the style parameter to `PFUTEX_APPLY`).

Also, the Perfly application displays a message at startup which also swaps the buffers. Again, this function must be disabled when using hyperpipe groups. The version of Perfly that ships with `performer_demo` correctly disables these features.

Each `pfPipe` software rendering pipeline runs at a fraction of the target frame rate as defined by `pfFrameRate()`. The fraction is $1/(\text{number of pipes in hyperpipe group})$. For example, if there are two `pfPipes` in the `pfHyperpipe`, each `pfPipe` runs at one half of the `pfFrameRate()`. Although the CULL and DRAW stages run at a slower rate, the APP stage must run at the target frame rate.

Using OpenGL Performer with an SGI Scalable Graphics Compositor

This section gives a brief overview of the SGI Scalable Graphics Compositor and how to use it with OpenGL Performer. For more information on the compositor, including the details of the hardware setup, see the document *SGI InfinitePerformance: Scalable Graphics Compositor User's Guide*.

Note: The compositor is currently supported by InfinitePerformance graphics systems only.

This section contains the following subsections:

- “How the Compositor Functions” on page 515
- “Using the pfCompositor Class” on page 516
- “Load Balancing” on page 520

How the Compositor Functions

The compositor receives two to four input signals and outputs a single signal either in analog or digital format. Hence, it can handle spatial composition of four inputs which enables multiple pipes to contribute to a single output. Four different composition schemes are available:

- Vertical stripes
- Horizontal stripes
- 2D tiles
- Cut-ins

Figure 14-5 illustrates the various hardware composition schemes.

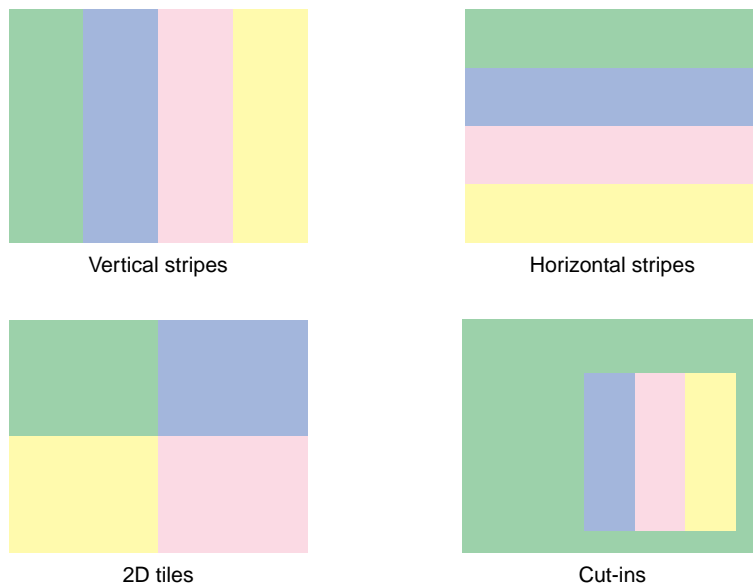

Figure 14-5 Hardware Composition Schemes

The following items are noteworthy regarding the compositor's capabilities:

- For every output pixel, the compositor averages all values from all the pipes. Among other things, this provides applications with the means to do full-scene antialiasing (FSAA) in hardware.
- Stereo through the compositor and cut-ins are not supported in OpenGL Performer 3.0.

Note: For more information on the current limitations and anomalies associated with the use of the SGI Scalable Graphics Compositor, refer to the hardware documentation.

Using the pfCompositor Class

The pfCompositor class provides methods for controlling a single compositor or a hierarchy of compositors. The class provides methods for setting the subdivision of the

inputs for the compositor to use. The subdivision is set by specifying the viewports and frusta for each input.

The `pfCompositor` class also allows for automatically setting the subdivision based on the load of each `pfPipe` providing an input. The subdivision `pfCompositor` performs can be controlled by setting the subdivision mode. By default, automatic load balancing is enabled and the subdivision mode is a 2x2 arrangement. Figure 14-6 illustrates some decomposition modes available for `pfCompositor`.

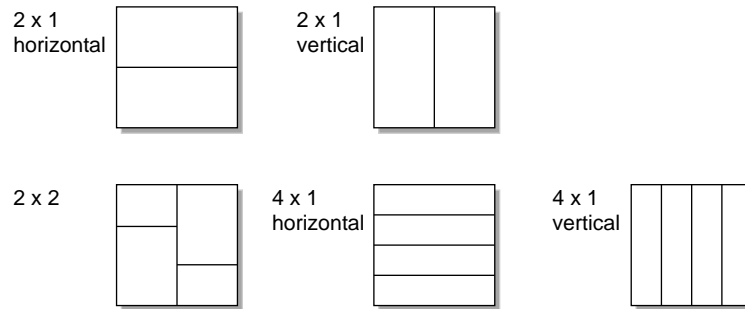

Figure 14-6 Decomposition Modes for `pfCompositor`

A `pfCompositor` requires a `pfLoadBalance` class for doing the load balancing of each of its children. The `pfLoadBalance` class determines the resulting workload for each pipe. The behavior can be customized by subclassing `pfLoadBalance` and overriding the appropriate methods. A `pfCompositor` can use a customized `pfLoadBalance` class specified using the `pfCompositorLoadBalancer()` function. If a load balancer is not specified, one will automatically be created and used. See the `pfLoadBalance` man page for more information on `pfLoadBalance`.

Antialiasing is supported as another type of subdivision mode and is enabled with the function `pfCompositorMode()`.

Table 14-2 describes the functions for managing compositors.

Table 14-2 Functions for Managing Compositors

Function	Description
pfCompositorAddChild()	Adds a pipe (specified by pipe number) to the heirarchy.
pfCompositorReconfig()	Tells the compositor to look at its child pipes and their channels and configure itself to manage them. This function is required and should be called once all the pipes and channels have been created.
pfCompositorPerspective() pfCompositorOrtho()	Sets the frustum of the indexed channel that this pfCompositor manages. The default is a perspective frustum with <code>left</code> , <code>right</code> , <code>bottom</code> , and <code>top</code> set to <code>-1</code> , <code>1</code> , <code>-1</code> , and <code>1</code> , respectively.
pfGetCompositorFrustum()	Returns the <code>left</code> , <code>right</code> , <code>bottom</code> , and <code>top</code> values of the frustum that was set by pfCompositorPerspective() or pfCompositorOrtho() .
pfCompositorNearFar()	Sets the near and far planes for the indexed channel that the compositor manages.
pfGetCompositorNearFar()	Returns the near and far planes for the indexed channel that the compositor manages.
pfGetCompositorFrustType()	Returns the type of frustum currently in use. The return value can be <code>PF_PERSPECTIVE</code> or <code>PF_ORTHO</code> .
pfCompositorViewport()	Sets the viewport (<code>left</code> , <code>right</code> , <code>bottom</code> , <code>top</code>) that this pfCompositor will encompass. The default viewport is <code>(0, 1, 0, 1)</code> .
pfGetCompositorViewport()	Returns the <code>left</code> , <code>right</code> , <code>bottom</code> , and <code>top</code> values that were set by pfCompositorViewport() .
pfCompositorChannelClipped()	Enables or disables clipping for a specific channel. This can be useful when you want clipping enabled on all channels except one; for example, the graphical user interface (GUI) channel of Perfly has clipping disabled while all others are subjected to clipping.
pfGetCompositorChannelClipped()	Returns the value set by pfCompositorChannelClipped() .

Table 14-2 Functions for Managing Compositors (**continued**)

Function	Description
pfCompositorVal()	Accepts the values PFLOAD_COEFF and PFCOMP_CLIPPING. PFLOAD_COEFF passes the value to the pfLoadBalance class. This coefficient determines how quickly the balancer transitions from the current state to the desired balanced state. PFCOMP_CLIPPING enables and disables channel viewport and frustum clipping to the composited area. Clipping is enabled by default.
pfGetCompositorVal()	Returns the values set by pfCompositorVal() .
pfCompositorMode()	Accepts PFCOMP_TYPE and PFLOAD_BALANCE as arguments. PFCOMP_TYPE can be one of the following: PFCOMP_2x1HORIZ PFCOMP_2x1VERT PFCOMP_2x2 PFCOMP_4x1HORIZ PFCOMP_4x1VERT PFCOMP_4xAA PFCOMP_TYPE specifies the type of load balancing and subdivision the compositor should be using. PFLOAD_BALANCE can be either PF_ON or PF_OFF. PFLOAD_BALANCE specifies whether the pfCompositor should be performing automatic load balancing. If it is PF_OFF, no load balancing computations are made and no glXHyperpipe calls are made unless specified otherwise with pfCompositorChildViewport() or pfCompositorChildSubdivision() .
pfGetCompositorMode()	Returns the values set by pfCompositorMode() .
pfCompositorLoadBalancer()	Allows the pfLoadBalance class to be used by the pfCompositor. The pfCompositorLoadBalancer() call must happen before pfConfig() .
pfGetCompositorLoadBalancer()	Returns the value set by pfCompositorLoadBalancer() .

Table 14-2 Functions for Managing Compositors (**continued**)

Function	Description
pfCompositorChildViewport()	Allows you to manually set the viewport that the indexed child of this pfCompositor should use. This method will also calculate the necessary subdivision information from the viewport information and send the subdivision information to the compositor hardware.
pfGetCompositorChildViewport()	Returns the viewport information for the indexed child of this pfCompositor.
pfCompositorChildFrustum()	Allows you to manually set the frustum that the indexed child of this pfCompositor should use.
pfGetCompositorChildFrustum()	Returns the frustum information for the indexed child of this pfCompositor.
pfCompositorChildSubdivision()	Allows you to manually set the subdivision that the indexed child of this pfCompositor should use. This method will also calculate the necessary channel viewport information from the subdivision information and send the viewport information to the appropriate pfChannel.
pfGetCompositorChildSubdivision()	Returns the subdivision information for the indexed child of this pfCompositor.
pfCompositorMasterPipe()	Specifies a pipe as the master pipe. All changes to the channels on the master pipe will be appropriately propagated to the other channels that pfCompositor manages. If a master pipe is not specified, pfCompositor uses the pipe specified as its first child.

Load Balancing

The pfLoadBalance class encapsulates an algorithm for distributing any incoming workload among multiple servants. The class maintains history information about the following:

- Workload distribution among servants
- The time it takes each servant to complete its workload allocation

Based on this information, `pfLoadBalance` computes a new workload distribution to minimize the time needed for completing the input workload.

The default implementation keeps track of a single frame of history. Subclasses of `pfLoadBalance` could track history information through multiple frames. Using multiple frames, the subclasses can compute the rate of change in the work allocation to workload ratio.

The default implementation tries to smooth the transition as workload allocation changes for each servant. Subclasses of `pfLoadBalance` could also change the smoothing factors to match the rate of change in workload between consecutive frames.

The following psuedo code illustrates a typical use of `pfLoadBalance` from `pfCompositor`:

```
// Set the number of servants to balance this frame.

pfLoadBalanceNumActive()

foreach child

// Tell the load balancer what the current load is on the child.

    pfLoadBalanceLoad()

end

balance()

foreach child

// Get the percentage of the work this child should perform.

    pfGetLoadBalanceWork()

end
```

Table 14-3 describes the functions you can use to manage load balancing.

Table 14-3 Load Balancing Functions

Function	Description
pfLoadBalanceLoad()	Sets the load on a specified servant. This is the load to be used during the load balancing calculations in pfLoadBalanceBalance() .
pfGetLoadBalanceLoad()	Returns the load that was set by pfLoadBalanceLoad() for a specified servant.
pfLoadBalanceBalance()	Takes the new load values specified by pfLoadBalanceLoad() and figures out the desired workload for each servant. Then pfLoadBalanceBalance() takes the load coefficient (PFLOAD_COEFF) into account while calculating the percentage of the workload this servant should perform.
pfGetLoadBalanceWork()	Returns the percentage of work (a value from 0 to 1) to be done by the specified servant.
pfLoadBalanceVal()	Accepts PFLOAD_COEFF as an argument, the value of which determines how fast or how slow the balancer transitions from the current workload to the desired workload.
pfGetLoadBalanceVal()	Returns the value set by pfLoadBalanceVal() .
pfLoadBalanceNumActive()	Sets the number of servants to balance.
pfGetLoadBalanceNumActive()	Returns the value set by pfLoadBalanceNumActive() .

Using OpenGL Performer with GPUs

GPUs are used widely in commodity graphics hardware and also in graphics platforms like SGI Onyx4 systems. OpenGL Performer supports GPU programming through the use of vertex programs and fragment programs.

Vertex programs are used by the GPU to modify various parameters of each vertex. Similarly, fragment programs are used to modify the color and depth value of each fragment (pixel) as it is being rendered. A description of vertex and fragment program instruction sets is beyond the scope of this guide. You can find a description of these instruction sets in the OpenGL extension registry at <http://oss.sgi.com/projects/ogl-sample/registry/> under `GL_ARB_vertex_program` and `GL_ARB_fragment_program`.

This chapter describes how you can use GPU programs in OpenGL Performer in the following sections:

- “The `pfGProgram` Class” on page 523
- “The `pfGProgramParms` Class” on page 525
- “The `pfVertexProgram` and `pfFragmentProgram` Classes” on page 526

The `pfGProgram` Class

OpenGL Performer implements GPU programming through the general class `pfGProgram`. This class allows you to set GPU programs, vertex programs and fragment programs.

The function `pfNewGProgram()` creates and returns a handle to a `pfGProgram`. The parameter `arena` specifies a `malloc()` arena out of which the `pfGProgram` is allocated or the value `NULL` specifies allocation off the process heap. `pfGPrograms` can be deleted with `pfDelete()`.

The call `new(arena)` allocates a `pfGProgram` from the specified memory arena or from the heap if `arena` is `NULL`. The `new()` call allocates a `pfGProgram` from the default memory arena (see function `pfGetSharedArena()` in the `pfSharedMem(3pf)` man page). Like other `pfObjects`, `pfGPrograms` cannot be automatically created statically on the stack or in arrays. `pfGPrograms` should be deleted with `pfDelete()` rather than the `delete` operator.

The function **pfGetGProgramClassType()** returns the `pfType*` for the class `pfGProgram`. The `pfType*` returned by **pfGetGProgramClassType()** is the same as the `pfType*` returned by invoking **pfGetType()**, the virtual function **getType()** on any instance of class `pfGProgram`. Because OpenGL Performer allows subclassing of built-in types, when decisions are made based on the type of an object, it is usually better to use **pfIsOfType()**, the member function **isOfType()**, to test if an object is of a type derived from an OpenGL Performer type rather than to test for strict equality of the types.

A `pfGProgram` is a sequence of assembly-like instructions. You can specify the instructions in two ways:

- In a string with new line characters separating instructions
- In a text file

If the program is specified in a string, you use the function **pfGProgramProgram()** or **pfGProgramProgramLen()**. The first parameter of each is the string defining the program. In the second function, you can specify the length when you want to load only part of the string.

If the program is loaded from a text file, you use the function **pfGProgramLoadProgram()**.

Using the function **pfGProgramApplypfGProgram()**, you can apply the `pfGProgram` but only in the draw process. Once the `pfGProgram` has been applied, you can query its state using the following functions:

pfGetGProgramProgramLength()	Returns the number of instructions of the program.
pfGetGProgramNativeProgramLength()	Returns the number of instructions used by the specific GPU.
pfGProgramIsValidpfGProgram()	Returns 1 if the program has been successfully loaded into the GPU.

You should not use a `pfGProgram` directly but one of its subclasses. There are two classes of specific GPU programs subclassed from `pfGProgram`: `pfVertexProgram` and `pfFragmentProgram`. A `pfVertexProgram` or a `pfFragmentProgram` is set in a `pfGeoState` and is enabled in a `pfGeoState`. The user parameters for the vertex and fragment programs can be defined using the class `pfGProgramParams`, which is described in the following section.

For sample code, see the following file:

```
/usr/share/Performer/src/pguide/libpf/C++/gprogram.C
(IRIX and Linux)
%PFROOT\Src\pguide\libpf\C++\gprogram.cxx
(Microsoft Windows)
```

The pfGProgramParms Class

The pfGProgramParms is a class that is used to store parameters of GPU programs, specifically of pfVertexPrograms and pfFragmentPrograms. The function **pfNewGProgramParms()** creates and returns a handle to a pfGProgramParms. The parameter arena specifies a **malloc()** arena out of which the pfGProgram is allocated or NULL for allocation off the process heap. You can delete pfGPrograms with **pfDelete()**.

A pfGProgramParms is a set of indexed quadruples of floating point values that are used as parameters for vertex and fragment programs. You can specify the values using the function **pfGPParmsParameters()** which has the following syntax:

```
pfGPParmsParameters(pfGProgramParms* gpparms, int index, int type, int count, void* ptr);
```

The parameter index specifies the first index of the specified parameters (the index by which the parameters are accessed in the GPU program) and the the parameter count specifies how many indices will be set.

The parameter type may be one of the following:

PFGP_FRAGMENT_LOCAL	Local parameters of a single fragment program.
PFGP_FRAGMENT_ENV	Environment parameters. Shared between all fragment programs.
PFGP_VERTEX_LOCAL	Environment parameters of a single vertex program.
PFGP_VERTEX_ENV	Environment parameters. Shared between all vertex programs.

The pointer ptr points to the parameter data.

Using the following functions, you can query the existing parameters in a `pfGProgramParms`:

<code>pfGetGPParmsNumParameters()</code>	Returns the number of parameters.
<code>pfGetGPParmsParameters()</code>	Returns the parameters in the order of their specification.
<code>pfGetGPParmsParametersByIndex()</code>	Returns the parameters by the index by which the parameters are accessed.

You can apply the `pfGProgramParms` using **`pfGProgramParmsApply()`** but only in the draw process. If you modify the `pfGProgramParms` after they have been applied, you must call **`pfGProgramParmsUpdate()`** for the change to take effect.

A `pfGProgramParms` is set in a `pfGeoState`. Each `pfGeoState` can have one `pfGProgramParms` of each of the four types, two for the `pfVertexProgram` associated with the `pfGeoState` and two for the `pfFragmentProgram`.

The `pfVertexProgram` and `pfFragmentProgram` Classes

The `pfVertexProgram` and `pfFragmentProgram` classes are derived from the class `pfGProgram`. These subclasses do not add any new methods. A vertex program or a fragment program is used by the GPU to modify various parameters of each vertex or fragment (pixel), respectively. The GPU allows you to specify a sequence of floating-point 4-component operations that are executed for each vertex or fragment. These operations transform an input set of per-vertex or per-fragment parameters to another set of per-vertex or per-fragment parameters.

A vertex program replaces the standard OpenGL set of lighting and texture coordinate generation modes. Consequently, the vertex program must take care of the basic transformation of vertex coordinates to the screen coordinates, the generation of texture coordinates, and the application of the lighting equation. This programming model allows you to modify the position of each vertex, producing, for example, a displacement mapping.

Similar to a vertex program, a fragment program replaces the standard OpenGL set of texture and fog application modes. The fragment program has to access the textures and to modulate the resulting color according to the fog equation, if necessary. This programming model allows you to modify the resulting color and depth of each pixel, making it possible, for example, to apply a complex per-pixel shading.

You can find the instruction sets for vertex and fragment programs in the OpenGL extension registry at <http://oss.sgi.com/projects/ogl-sample/registry/> under the `GL_ARB_vertex_program`.

As subclasses of `pfGProgram`, `pfVertexPrograms` and `pfFragmentPrograms` can use the management methods of a `pfGProgram` to set, load, and apply programs. Section “The `pfGProgram` Class” on page 523 describe these methods.

You set and enable `pfVertexPrograms` and `pfFragmentPrograms` in a `pfGeoState`. As described in section “The `pfGProgramParms` Class” on page 525, the user parameters for GPU programs can be defined using the `pfGProgramParms` class.

For sample code, see the following file:

```
/usr/share/Performer/src/pguide/libpf/C++/gprogram.C  
(IRIX and Linux)  
%PFROOT\Src\pguide\libpf\C++\gprogram.cxx  
(Microsoft Windows)
```

ClipTextures

As CPUs get faster and storage gets cheaper, applications are moving away from scenes with small, synthetic textures to large textures, taken from real environments, giving the viewer realistic renderings of actual locations.

There has customarily been a trade-off between the complexity of a texture and the area it covers: if a texture covers a large area, its resolution must be limited so that it can fit into texture memory; high-resolution textures are limited to small regions for the same reason.

A cliptexture allows you to circumvent many of these system resource restrictions by virtualizing MIPmapped textures. Only those parts of the texture needed to display the textured geometry from a given location are stored in system and texture memory. OpenGL Performer provides support for this technique, called *cliptexturing*, as a subclass of a `pfTexture` called a `pfClipTexture`. This functionality allows you to display textures too large to fit in texture memory or even in system memory; you can put the entire world into a single texture.

OpenGL Performer supports texture load management from disk to system memory and from system to texture memory, synchronizing clipped regions with the viewpoint, and with the many other tasks needed to virtualize a texture relative to the viewer location.

This chapter describes cliptextures in the following parts:

- “Overview” on page 530
- “Cliptexture API” on page 545
- “Preprocessing ClipTextures” on page 545
- “Cliptexture Configuration” on page 548
- “Configuration API” on page 549
- “Post-Scene Graph Load Configuration” on page 571
- “Manipulating Cliptextures” on page 579
- “Using Cliptextures” on page 593

Overview

Cliptexturing avoids the size limitations of normal MIPmaps by clipping the size of each level of a MIPmap texture to a fixed area, called the clip region. A MIPmap contains a range of levels, each four times the size of the previous one. If the clip region is larger than a particular level, the entire level is kept in texture memory. Levels larger than the clip region are clipped to the clip region's size. The clip region is set by the application, trading off texture memory consumption against image quality. The clip region size is set through the clip size, which is the length of the clip regions's sides (in texels).

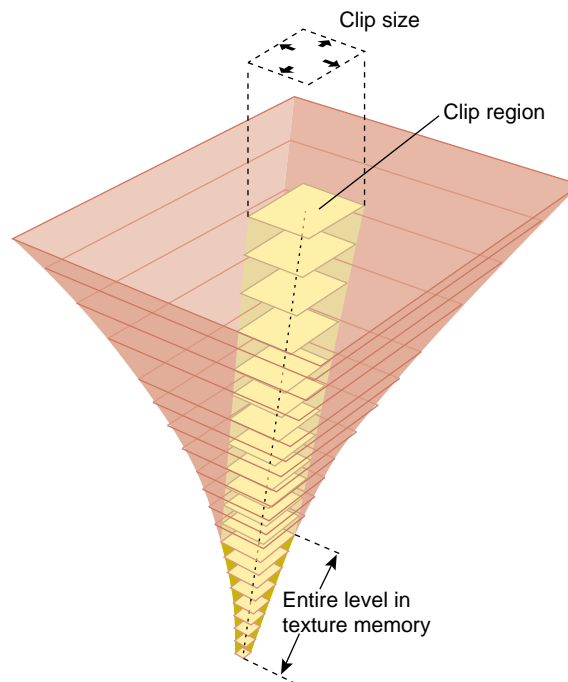

Figure 15-1 Cliptexture Components

The clip region positioned so as to be centered about the clip center, or as close as possible to the clipcenter while remaining entirely within the cliptexture. The clipcenter is set by the application, usually to the location on the texture corresponding to the location closest to the viewer on the cliptextured geometry. The clipcenter is specified in texel coordinates, which is the texture coordinates (s and t values, ranging from 0.0 to 1.0, scaled by the dimensions of the finest level of the cliptexture, level 0).

Cliptexture Levels

Texture memory contains the MIPmap levels, the larger ones clipped to the clip region size; the rectangle of texture memory corresponding to each clipped level is called a tex region. As the viewer moves relative to the cliptextured geometry, the clipcenter must be updated. When this happens, the clipped MIPmap levels must have their texture data updated, in order to represent the area closest to the center. This updating usually must happen every frame, and is done by OpenGL Performer image caches.

To facilitate loading only portions of the texture at a time, the texture data must first be subdivided into a contiguous set of rectangular areas, called tiles. These tiles can then be loaded individually from disk into texture memory.

Texture memory must be loaded from system memory; it can't be loaded directly from disk. In order to improve the performance of texel downloading, the region in system memory is made larger than the destination texture memory and organized into a lookahead cache, called the mem region.

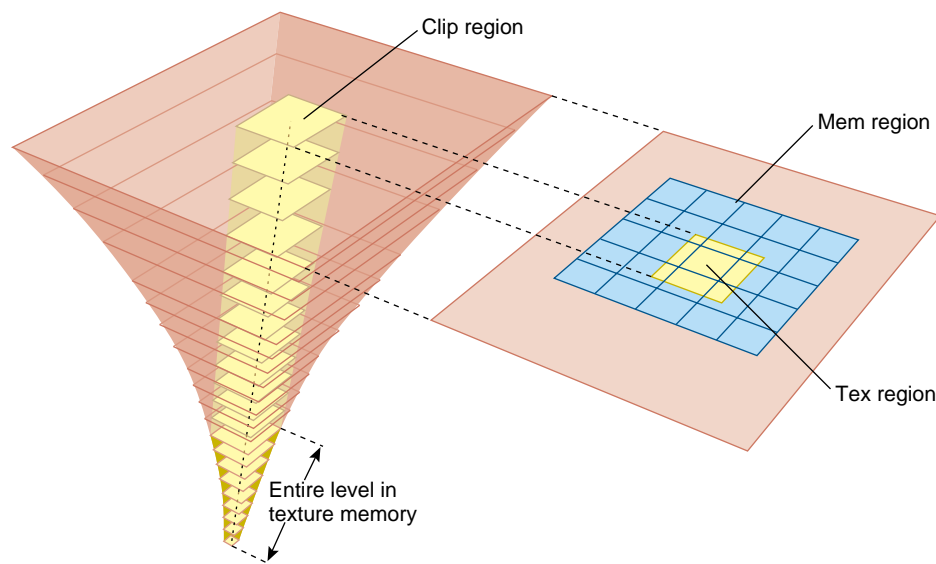

Figure 15-2 Image Cache Components

Image caches must know three things in order to update clipped texture levels:

- Where and how the data is stored on disk, so they can retrieve it,
- Location and size of system memory cache, called the mem region,
- The texture memory they are responsible to update when the clipcenter moves (the tex region).

Cliptexture Assumptions

For the cliptexture algorithm to work seamlessly, applications must abide by the following assumptions:

- An application can only view a clip region's worth of high resolution texel data on its textured geometry from any viewpoint.
- The application views the texture from one location at a time. Multiple views require multiple cliptextures.
- The viewer must move smoothly relative to the cliptextured geometry; no "teleporting" (abrupt changes in position).

Given these assumptions, your application can maintain a high-resolution texture by keeping only those parts of the texture closest to the viewer in texture memory; the remainder of the texture is on disk and cached in system memory.

Why Do These Assumptions Work?

Only the textured geometry closest to the viewer needs a high-resolution texture. Far away objects are smaller on the screen, so the texels used on that object also appear smaller (cover a smaller screen area). In normal MIPmapping, coarser MIPmap levels are chosen as the texel size gets smaller relative to the pixel size. These coarser levels contain less texels, since each texel covers a larger area on the textured geometry.

Cliptextures take advantage of this fact by storing only part of each large MIPmap level in texture memory, just enough so that when you look over the geometry, the MIPmap algorithm starts choosing texels from a lower level (because the texels are getting small on the screen) before you run out of texels on the clipped level. Because coarser levels have texels that cover a larger area, at a great enough distance, MIPmapping is choosing texels from the unclipped, smaller levels.

When a clip size is chosen, clip texture levels can be thought of as belonging to one of two categories:

- Clipped levels, which are texture levels that are larger than the clip size.
- Non-clipped levels, which are small enough to fit entirely within the clip region.

The non-clipped levels are viewpoint independent; each non-clipped texture level is complete. Clipped levels, however, must be updated as the viewer moves relative to the textured geometry.

Image Cache

The image cache organizes its system memory as a grid of fixed size texture tiles. This grid of texture data forms a lookahead cache, called the mem region. The cache automatically anticipates texture download requirements, updating itself with texture tiles it expects to use soon.

Image caches update texture memory by transferring image data from disk files. The data is transferred in two steps. Data is moved from disk files a tile at a time into the mem region in system memory. The mem region is updated so that it always contains the image data corresponding to the tex region and its immediate surroundings. The border of extra surrounding data allows the image cache to update the tex region as necessary without having to wait for tiles to be loaded into the mem region from disk.

The image cache also contains a tex region, the rectangle of texel data in a given level's texture memory. This rectangle of data is in texture memory, and is being updated from a corresponding rectangle of data in the mem region. As the center moves, the tex region being loaded into texture memory can get close to the edge of the mem region. When this happens, tiles in the mem region are updated with new data from disk so that the tex region is moved closer to the center of the image data.

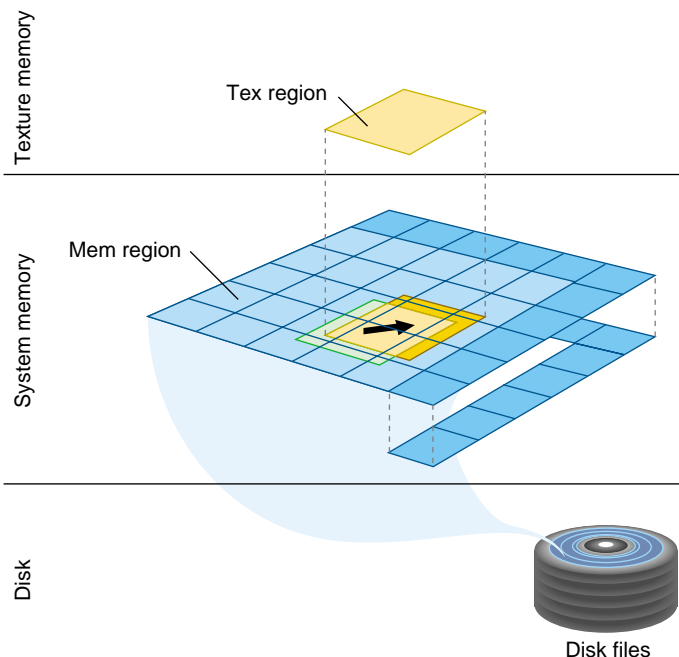

Figure 15-3 Mem Region Update

As the center moves, the clipped region on each clipped level of the image cache shifts position. The clipped regions on each level move at different rates; each coarser level only moves at one half the speed of the level above it. The image cache reflects the change on its level by tracking the position of the clipped region with its tex region. Data in texture memory must be updated to match the texel data in the translated tex region.

This updating is done by copying rectangles of texel data from the shifted tex region area in the mem region to the appropriate locations in texture memory. The amount of updating is minimized by only updating the portions of the texture memory that actually need new data. The majority of the tex region data only has to shift position in texture memory; this is done by translating texture coordinates, and taking advantage of the wrap mode when accessing texels from texture memory.

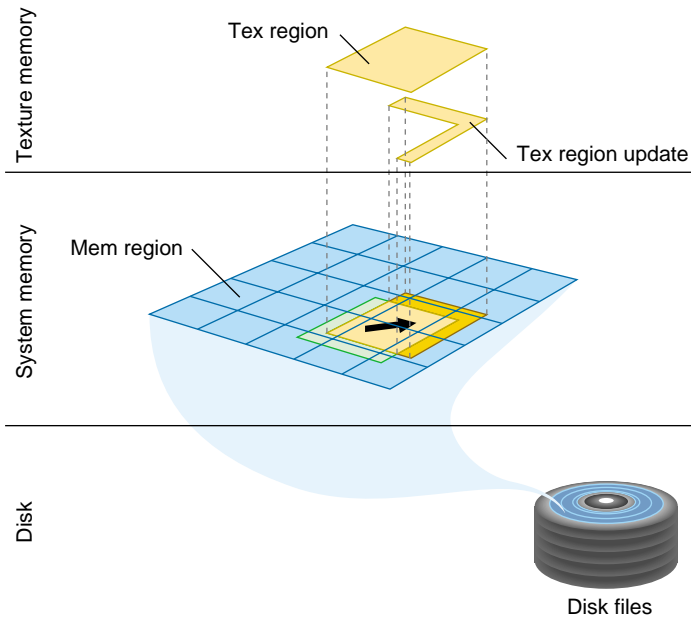

Figure 15-4 Tex Region Update

By loading textures to system memory before they are needed in texture memory, the latency caused by waiting for tiles downloading from a disk is reduced.

1. Texture data on disk is cached into system memory in an image cache's mem region.
2. Texture data in the tex region part of the mem region is used to update texture memory.

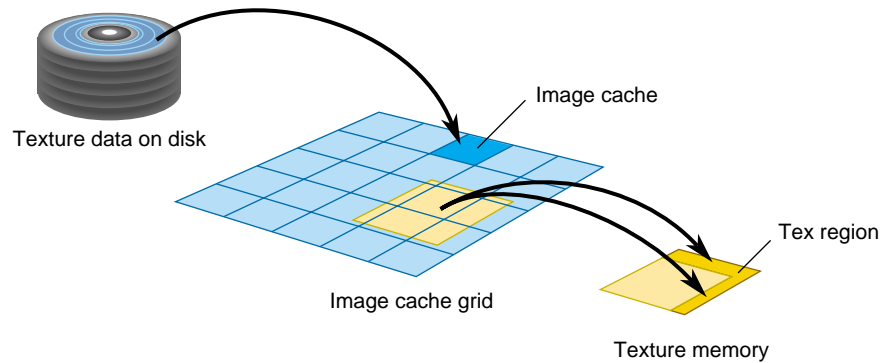

Figure 15-5 Cliptexture Cache Hierarchy

Toroidal Loading

In order to minimize the bandwidth required to download texels from system to texture memory, the image cache's tex regions are updated using **toroidal loading**. A toroidal load assumes that changes in the contents of the clip region are incremental, such that the update consists of:

- New texels that need to be loaded.
- Texels that are no longer valid.
- Texels that are still in the clip region, but have shifted position.

Toroidal loading minimizes texture downloading by only updating the part of the texture region that needs new texels. Shifting texels that remain visible is not necessary, since the coordinates of the clip region wrap around to the opposite side.

Invalid Borders

Being able to impose alignment requirements to the regions being downloaded to texture memory improves performance. Cliptextures support the concept of an *invalid border* to provide this feature. It is the area around the perimeter of a clip region that can't be used. The invalid border shrinks the usable area of the clip region, and can be used to dynamically change the effective size of the clip region. Shrinking the effective clip size can be a useful load control technique.

When texturing requires texels from a portion of an invalid border at a given MIPmap level, the texturing system moves down a level, and tries again. It keeps going down to coarser levels until it finds texels at the proper coordinates that are not in the invalid region. This is always guaranteed to happen, since each level covers the same area with less texels (coarser level texels cover more area on textured geometry). Even if the required texel is clipped out of every clipped level, the unclipped pyramid levels will contain it.

You can use an invalid border to force the use of lower levels of the MIPmap to do the following:

- Reduce the abrupt discontinuity between MIPmap levels if the clip region is small: using coarser LODs blends MIPmap levels over a larger textured region.
- Improve performance when a texture must be roamed very quickly.

Since the invalid border can be adjusted dynamically, it can reduce the texture and system memory loading requirements at the expense of a blurrier image.

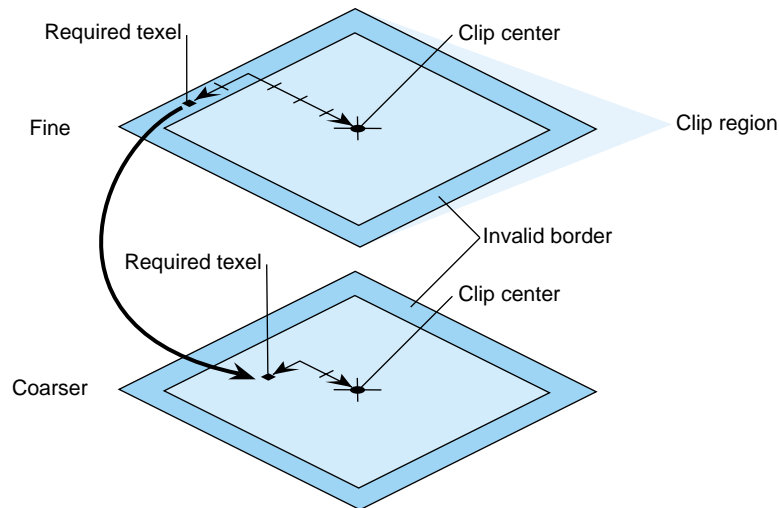

Figure 15-6 Invalid Border

Updating the Clipcenter

To figure out what part of the texture must be loaded in each of the clipped levels, you must know where the viewer is relative to the geometry being textured. Often this position is computed by finding the location of the cliptextured geometry that is closest to the viewer, and converting that to a location on the texture. This position is called the cliptexture center and it must be updated every frame as the viewer moves relative to the cliptextured geometry.

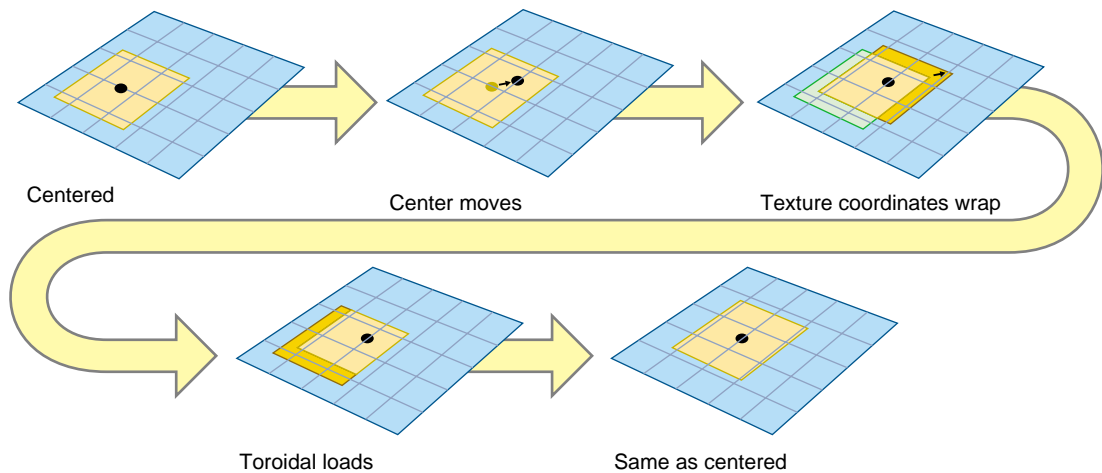

Figure 15-7 Clipcenter Moving

The clipcenter is set by the application for level 0, The cliptexture code then derives the clipcenter location on all MIPmap levels. As the viewer roams over a cliptexture, the centers of each MIPmap level move at a different rate. For example, moving the clipcenter one unit corresponds to the center moving one half that distance in each dimension in the next-coarser MIPmap level.

Most of the work of cliptexturing is updating the center properly and updating the texture data in the clipped levels reliably and efficiently each frame.

Virtual Cliptextures on InfiniteReality Systems

Cliptextures save texture memory by limiting the extent of texture levels. Every level in the mipmap is represented in texture memory, and can be accessed as the geometry is

textured. On InfiniteReality systems, there are limits to the number of levels the cliptexturing hardware can access while rendering, which restricts the cliptextures maximum size.

This limit can be exceeded by only accessing a subset of all the MIPmap's levels in texture memory on each piece of geometry, "virtualizing" the cliptexture. The virtual offset is sets a virtual "level 0" in the MIPmap, while the number of effective levels indicates how many levels starting from the new level 0 can be accessed. The minlod and maxlod parameters are used to ensure that only valid levels are displayed. The application typically divides the cliptextured terrain into pieces, using the relative position of the viewer and the terrain to update the parameter values as each piece is traversed.

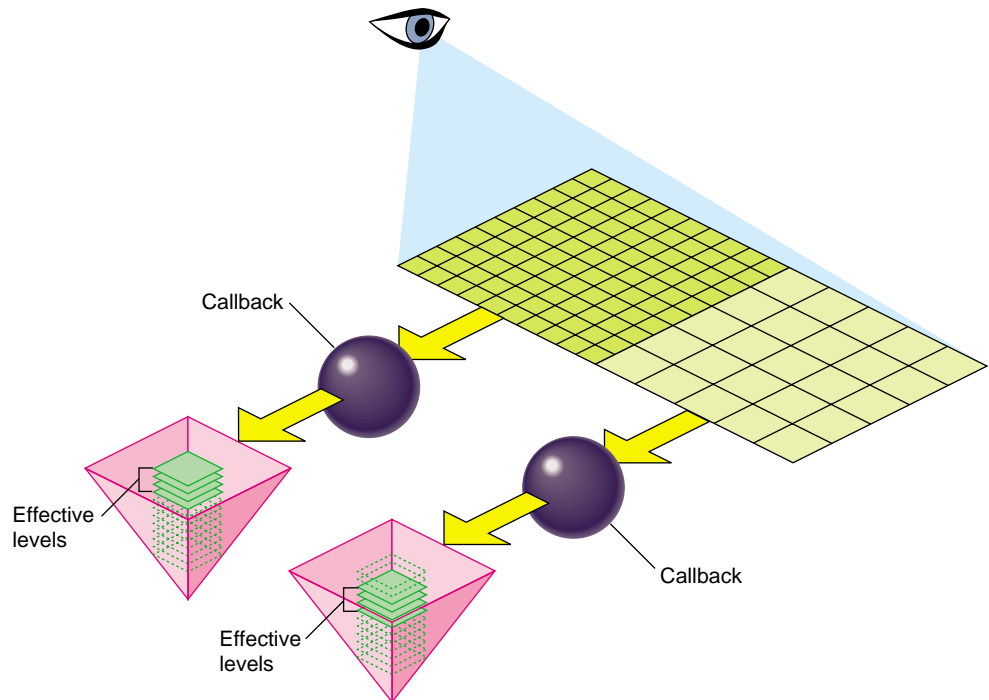

Figure 15-8 Virtual Cliptexture Concepts

For more information about virtual cliptextures, see "Virtual ClipTextures" on page 585.

Cliptexture Support Requirements

Ideally, pfClipTextures would be interchangeable with pfTextures in OpenGL Performer. Unfortunately, this is only partially true. The following sections describe some of the differences between OpenGL Performer textures and cliptextures.

Centering

Every level is complete in a regular texture. Cliptextures have clipped levels, where only the portion of the level near the cliptexture center is complete. In order to look correct, a cliptextures center must be updated as the channel's viewport moves relative to the cliptextured geometry.

Cliptextures require functionality that recalculates the center position whenever the viewer moves (essentially each frame). This means that a relationship has to exist between the cliptexture and a channel.

Applying

Textures only need to be applied once. Cliptextures must be applied every time the center moves (essentially each frame). In order to apply at the right time, cliptextures need to be connected to a pfPipe.

Texel Data

A texture does not know where its data comes from. The application just supplies it as a pointer to a region of system memory when the texture is applied.

Cliptextures need to update their contents as the center moves and they are reapplied each frame. As a result, they need to know where their image data resides on the disk. In order to maximize performance, cliptextures also cache their texel data in system memory. As a result, cliptextures are a lot more work to configure, since you have to tell them how to find their data on disk, and how you want the data cached in system memory.

Special Features

Since cliptexture levels are so large, OpenGL Performer offers additional features not available to regular textures.

Insets

With certain restrictions, cliptexture levels can be partially populated, containing “islands” of high resolution data. This can be useful if the application only needs high-resolution texel data in relatively small, widely scattered areas of a large cliptexture. An example of this might be an airline flight simulator, where high resolution data is only needed in the vicinity of the airports used by the simulator.

For more information about insets, see “Cliptexture Insets” on page 593.

Virtualization on InfiniteReality Systems

To further increase the size of cliptextures that OpenGL Performer can use, the levels themselves can be virtualized; It then selects a subset of all the available texture levels to be loaded into memory. This requires additional support by the application. Virtual cliptextures are described in detail in “Virtual ClipTextures” on page 585.

Multiple Pipe Support

Since cliptextures require both system and texture memory resources, OpenGL Performer has provided functionality to share the system memory resources when a cliptexture is used in a multipipe application. “Slave” cliptextures and a “master” cliptexture share system memory resources, but have their own classes and texture memory.

How Cliptextures Interact with the Rest of the System

As a result of their special requirements, cliptextures are used differently than pfTextures with many different OpenGL Performer classes. The following sections describe these differences.

Geostates

When everything is configured properly, a pfClipTexture is interchangeable with a pfTexture when used in a geostate. Note that when using emulated cliptextures, the pfClipTexture must be assigned to the pfGeoState before the pfGeoState is associated with any pfGeoSet.

Pipes

A `pfClipTexture` can be connected to a `pfMPClipTexture`, a multiprocessing component, which is connected to a `pfPipe`. From the pipe's point of view, a `pfMPClipTexture` is something it can apply to.

Channels

Some functionality must be supplied to update a cliptexture's center as the channel moves with respect to the cliptextured geometry. This functionality can be supplied by the application, or OpenGL Performer can do it automatically if the application uses clipcenter nodes.

A clipcenter node is added to the scenegraph and is traversed by the APP process just like every other node in the scenegraph. When the clipcenter node is traversed by a channel, the clipcenter node computes the relationship between the cliptextured geometry and the channel's eyepoint, and updates the cliptexture's center appropriately.

Cliptexture Support in OpenGL Performer

Cliptexture is a large and diverse piece of functionality. As a result, cliptexture support is found in nearly every major library in OpenGL Performer.

`libpr` Support

The `pfImageCache` class defines image caches which manage the updating of clipped levels, `pfImageTile` classes are used to define non-clipped cliptexture levels and define pieces of clipped levels downloaded from disk to system memory. The `pfQueue` class supports read queues, which manage the read requests from disk to system memory in image caches, while the `pfClipTexture` class itself defines cliptextures themselves, virtual mipmaps composed of image caches and image tile levels. The `pfTexLoad` class defines download requests when image caches download texels from system to texture memory.

`libpf` Support

The `libpf` library adds multiprocessing support for using cliptextures in scene graphs. the `pfMPClipTexture` class ties together `pfClipTextures`, `pfPipes`, cliptexture centering functionality (often `pfuClipCenterNode` nodes) and the application itself in a

multiprocessing environment. additional functionality in the `pfPipe` class ensures that cliptextures are applied properly.

`libpfutil` Support

The `libpfutil` library provides easy to use clipcentering functionality through the `pfuClipCenterNode` class, a subclass of the `pfGroup` class. This library also provides traversals to simplify the work of finding cliptextures in a scene graph using `pfuFindClipTextures()`, code for post loader configuration, where `pfMPClipTextures` are created, and attached to pipes and clipcenter nodes using `pfuProcessClipCenters()` and `pfuProcessClipCentersWithChannel()`. The `pfuAddMPClipTextureToPipes()` and `pfuAddMPClipTexturesToPipes()` routines connect `pfMPClipTextures` to the proper pipes, handling multipipe issues in a clean way. Load time configuration is simplified using the `pfuInitClipTexConfig()`, `pfuMakeClipTexture()`, and `pfuFreeClipTexConfig()` along with the appropriate callbacks for image caches and image tiles. Image cache configuration is supported with `pfuInitImgCacheConfig()`, `pfuMakeImageCache()`, and `pfuFreeImgCacheConfig()` routines.

`libpfdu` Support

The cliptexture configuration file parsers are supported here; `pfdLoadClipTexture()` and `pfdLoadClipTextureState()` work with cliptexture configuration files to simplify the creation and configuration of cliptextures. The companion programs that create and configure `pfdLoadImageCache()` and `pfdLoadImageCacheState()`. All of these parsers use the `pfuMakeClipTexture()` and `pfuMakeImageCache()` configuration routines.

`libpfdb` Support

Example cliptexture loaders, including the `libpfim` example cliptexture loader, the `libpfct` demo loader, the `libpfspherepatch` loader, and the `libpfvct` virtual pseudo loader are all included here.

Sample Applications

Performer also ships with examples of applications that support cliptexturing. The main example is `clipfly` (a modified version of `perfly`). Another program that uses cliptextures is the `clipdemo` sample.

Cliptexture Manipulation

While the scene graph is being viewed, the application may want to dynamically alter the appearance or performance characteristics of the cliptexture. The `mpcliptexture` provides functionality to support parameter changes in the APP process, providing frame-accurate updating. Here are some of the parameters that might be changed.

Load Control

The DTR functionality (described in detail elsewhere in this chapter) is largely automatic. Some high performance applications may need to adjust DTR parameters to improve appearance performance trade-offs.

Invalid Border

The invalid border can be adjusted at runtime to shrink the effective size of the clip region. This might be done to provide additional load control beyond the per-level control that DTR provides.

Share Masks

When operating master and slave cliptextures in a multipipe application, the application may want to change the sharemask, which controls the synchronization of parameters between master and slave cliptextures.

Read Function

The image cache creates requests to read image tiles from disk to the image cache's system memory cache. The read function processes these requests and actually does the data transfer. OpenGL Performer provides set of read functions that attempts to do direct-IO reads for speed, but falls back to normal reads if direct IO is not possible.

The application can replace the OpenGL Performer default function with its own custom read function. This could be useful for implementing special functionality, such as dynamic decompression `pfClipTexture` data.

Read Queue Sorting

The read queue provides dynamic sorting of the read requests to improve performance and minimize latency. The application can provide custom sorting routines.

Cliptexture API

Cliptexturing has a large API. Not only is there are lot of cliptexture functionality scattered throughout the library, but there is often more than one way to use a particular piece of functionality. In order to make things clearer, and make it easier to use the API described here, the cliptexture API is grouped and ordered in the same way an application writer would use it.

The API is grouped into four sections:

- Preprocessing the cliptexture data.
- Configuring cliptextures and image caches.
- Post-load-time configuration.
- Run-time manipulation.

Preprocessing ClipTextures

Before using cliptextures, large textures must be preprocessed, as follows:

1. Start with the highest-resolution version of the image (texture) and build a MIPmap of the image.
2. Choose a clip size.
3. Tile each MIPmap level.

Every image that is larger than the clip size must be cut into tiles. All of the tiles in one MIPmap level must be equal in size. You generally choose a tile size that is about 1/4 of the clip size or less.

4. Divide the levels into separate files to maximize download performance.

The files should be named properly so that the image caches can access them.

5. If the configuration parsers are used, cliptexture configuration files are also created at this time.

The following sections describe the steps in this procedure in greater detail.

Building a MIPmap

Building a MIPmap of an image requires an algorithm that performs the following tasks:

1. Start with the highest-resolution version of the image (texture). The image dimensions in pixels must be in powers of 2, for example, 8192 X 8192.
2. Average every four adjacent texels of a high resolution image into a single texture (essentially blurring it and shrinking it by a factor of two in both dimensions).
3. Save the result as a new, blurrier, smaller image.
4. Convert the MIPmaps into a compatible format.
5. Repeat the first two steps with each blurrier image until you have a single texel whose color is the average of all the texel colors in the original image.

Each successive reduction is called a level of detail (LOD). The more the reduction, the higher the level of detail, the coarser the image.

There are a variety of tools that tile textures. OpenGL Performer provides some simple ones available in the `/usr/share/Performer/src/tools` directory for IRIX and Linux and in `%PFROOT%\Src\tools` for Microsoft Windows. They are listed in Table 15-1.

Table 15-1 Tiling Algorithms

Program	Description
<code>rsets</code>	Shrinks and tiles one or more <code>.rgb</code> image files recursively. <code>rsets</code> stops tiling when it reaches the clip size you give it. <code>rsets</code> assumes that the original image is square.
<code>rgb2raw</code>	Converts <code>.rgb</code> images into a raw format that can be downloaded directly into texture memory. Files should be in a raw format to avoid conversions at download time.
<code>shrink</code>	Is a subset of <code>rsets</code> functionality; makes a tree-like structure of LOD images from an <code>.rgb</code> image.
<code>to5551</code>	Converts from <code>.rgb</code> to the 5551 raw format.

Table 15-1 Tiling Algorithms (**continued**)

Program	Description
<code>to888</code>	Converts from <code>.rgb</code> to the 888 raw format.
<code>to8888</code>	Converts from <code>.rgb</code> to the 8888 raw format.
<code>viewtile</code>	Enables you to view a raw format image tile.

For more information about MIPmaps, see the *OpenGL Programming Guide*.

Formatting Image Data

The texel data must be in a format that can be used in OpenGL Performer textures. This means the texels must have contiguous color components, whose size and type match a supported format. Keep in mind that these texels will be loaded dynamically, on an as-needed basis, so the smaller the size of each texel, the better the performance of the cliptexture. You should choose the smallest texel format that provides acceptable color quality. A good choice might be RGBA 5551, which takes up 16 bits per texel. OpenGL Performer provides some tools for converting from `rgb` format to 5551 or 888 RGBA. They are named `to5551` and `to888` and are found in `/usr/share/Performer/src/tools` for IRIX and Linux and in `%PFROOT%\Src\tools` for Microsoft Windows.

For more information about file formats, see “Building a MIPmap” on page 546.

Tiling an Image

Dividing a texture into tiles allows you to look at a subset of all texels in the texture. In this way, you can selectively download from disk into the texture memory only those texels that the user is viewing and those they might soon look at. Since downloading texture tile files from disk to texture memory takes a long time, the image caches decide which tiles a viewer might need next and download them in advance.

Note: In the highest resolution LOD, one texel corresponds to one pixel.

Texel tiles in each level are loaded into memory separately, from coarsest to finest. The high-resolution tiles take longer to download than the coarser tiles. If a viewer advances through a scene so quickly that the high-resolution tiles cannot download from disk into texture memory in time, lower-resolution tiles are displayed instead. The effect is that if the viewer goes too fast, the tiles become blurry. When the viewer slows down, the tiles displayed are less coarse.

Using lower instead of higher-resolution levels is controlled by cliptexture's load control mechanism, DTR. Without DTR, OpenGL Performer waits for **all** of the levels to download before displaying any one of them. DTR removes this restriction, displaying the levels that have been downloaded.

If you want to break up a .rgb image into tiles, OpenGL Performer provides the `subimg` program in `/usr/share/Performer/src/tools` for IRIX and Linux and in `%PFROOT%\Src\tools` for Microsoft Windows.

Tile Size

Small tiles, while less efficient, are better at load leveling, since the time it takes to load a new tile into system memory is smaller. It also means that the total size of an image cache in system memory can be smaller. We've found that tile sizes of 512 x 512 and 1024 x 1024 provide a good trade-off between download efficiency and low latency, but download performance is very sensitive to system configuration. Experimenting is the best way to find a good tile size.

Cliptexture Configuration

After preprocessing the texture data, you need to configure cliptextures. Configuration is actually a two step process; the configuration that can be done by the scenegraph loader, and the configuration that requires `pfPipes` and `pfChannels` to be present. This section describes the first stage of configuration.

Configuration Considerations

An application must configure the cliptexture in two steps:

- Loader—when the scene graph is constructed.
- Post-loading—when the channel and pipes are known to the application.

This process is complex. OpenGL Performer supplies a number of utilities to make the job easier.

To manipulate cliptexture parameters, the application makes calls to the `pfMPClipTexture` in the APP process. The `pfMPClipTexture` updates the cliptexture in a frame-accurate manner.

Load-Time Configuration

This is the time the scene graph is being constructed. Geostates are pointed to cliptextures; the cliptextures themselves are created and configured using the cliptexture configuration files and the `libpfdu` parsers. If the application does its own configuration, it should use the `libpfutil` routines to simplify the process and to ensure adequate error checking. If the application opts to use OpenGL Performer clipcentering support, clipcenter nodes are inserted into the scene graph at the root of the cliptextured geometry and connected to the corresponding cliptexture.

Note: When using emulated cliptextures, assign the cliptexture to the `pfGeoState` first, then assign the `pfGeoState` to `pfGeoSets`.

Post-Load-Time Configuration

At this stage the scene graph has been created and the channels and pipes have been defined. The `libpfutil` traversers (**`pfuProcessClipCenters()`** or **`pfuProcessClipCentersWithChannel()`**) are used to create `pfMPClipTextures`, connecting them with the appropriate cliptextures and clipcenter nodes. These routines return a list of `pfMPClipTextures`, which can be used with **`pfuAddMPClipTextureToPipes()`** and **`pfuAddMPClipTexturesToPipes()`** to attach the `pfMPClipTextures` to the appropriate `pfPipes`. These routines can be used for single pipe and multipipe applications with little or no change to the calling sequence.

Configuration API

Since cliptexture configuration is complex, we provide three different cliptexture configuration API layers, allowing different trade-offs between flexibility and simplicity.

libpr **Functionality**

The lowest layer, using the `libpr` calls, is the most complex and difficult. A cliptexture has the same configuration requirements as a MIPmapped `pfTexture`, where `texel` format, type and texture dimensions must be configured. In addition, cliptextures have to know about system memory caching, the file configuration of the texture data, load control, read queue, and other cliptexture specific configurations.

Using the `libpr` layer directly is not recommended, since it is error prone and does not buy much flexibility compared to the `libpfutil` configuration routines. In the following subsections are the `libpr` calls you must consider when configuring a cliptexture directly.

These are the functions needed to configure the cliptexture itself. The cliptexture contains two types of levels: image cache levels and image tile levels. Image caches support clipped levels in a cliptexture. They know where their texture data resides on disk, they understand clip regions, and set up system memory caching and updating. Every properly-configured image cache points to an image tile, called a proto tile, which contains global information about the `texel` format, size, and file information about the image tiles the image cache uses to update clipped texture levels.

Configuring an Image Cache Level

Image tiles can be used by themselves to represent unclipped levels. Essentially the unclipped level is represented by a single tile covering the entire level. Because image tiles do not understand clip regions and cannot do dynamic updating, image tiles cannot be used to represent clipped levels.

To configure an image cache level, use the following calls:

- `pfNewClipTexture()`
- `pfTexName()`
- `pfClipTextureVirtualSize()`
- `pfClipTextureClipSize()`
- `pfTexImage()`
- `pfTexFormat()`
- `pfClipTextureInvalidBorder()`
- `pfClipTextureEffectiveLevels()`

- **pfClipTextureAllocatedLevels()**
- **pfClipTextureLevel()**

Configuring an Image Cache Proto Tile

There are also image tile calls in this sequence. They are used to configure the image cache's proto tile, which is used as a template for the tiles the image cache will use to load texel data from disk to system memory cache.

To configure an image cache proto tile, use the following calls:

- **pfNewImageTile()**
- **pflImageTileReadFunc()**
- **pfGetImageTileMemInfo** (*page size*)
- **pflImageTileMemInfo()**
- **pflImageTileReadQueue()**
- **pflImageTileHeaderOffset()**
- **pflImageTileNumFileTiles()**
- **pflImageTileSize()**
- **pflImageTileFileName()**
- **pflImageTileFileImageType()**
- **pflImageTileMemImageType()**

Configuring an Image Cache

To configure an image cache, use the following calls:

- **pflImageCacheName()**
- **pflImageCacheTexRegionOrigin()**
- **pflImageCacheMemRegionOrigin()**
- **pflImageCacheImageSize()**
- **pflImageCacheMemRegionSize()**
- **pflImageCacheTileFileNameFormat()**

- **pfImageCacheTexRegionSize()**
- **pfImageCacheMemRegionSize()**
- **pfImageCacheTex()**
- **pfImageCacheTexSize()**
- **pfImageCacheFileStreamServer()**
- **pfImageCacheProtoTile()**—Copies the information into the image cache’s proto tile.
- **pfDelete** (*tmp_proto_tile*)—Now that it is copied into the image cache, you can delete it.

Configuring a pfTexture

Image caches can be used independently of cliptextures, if they are, they need to be associated with a pfTexture, and that texture needed to be configured.

To configure a pfTexture, use the following calls:

- **pfTexImage()**
- **pfTexFormat()**

Configuring the Default Tile

Image caches can have a default tile defined, which is the tile to use if a tile on disk can’t be found. Default tiles can be useful for “filling in” border regions of a cliptexture level. Default tiles are covered in more detail in section “default_tile” on page 564.

To configure the default tile, use the following calls:

- **pfNewImageTile()**
- **pfCopy()** (proto to default)
- **pfImageTileFileName()**
- **pfImageTileReadQueue()**
- **pfImageTileDefaultTile()**

Configuring Image Tiles

Image tiles need their own configuration, since they need to know about the file they should load from texel formats, etc.

To configure an image tile, use the following calls:

- **pfNewImageTile()**
- **pflImageTileMemImageFormat()**
- **pflImageTileFileImageFormat()**
- **pflImageTileMemImageType()**
- **pflImageTileSize()**
- **pflImageTileHeaderOffset()**
- **pfClipTextureLevel()**
- **pfLoadImageTile()**

Configuration Utilities

Using the `libpr` calls to configure a cliptexture is difficult and error prone. OpenGL Performer provides utilities to make cliptexture configuration easier and more robust. The configuration utility API is broken into two groups. One group is used to configure cliptextures, the other configures image caches. Each group contains three functions, an init function, a config function, and a free function. These functions work with a structure that the application fills in.

The initialize function initializes the optional fields in the structure with default values, and the mandatory fields with invalid values. Configuring the structure allows the configuration function to do more error checking, and to allow the application to avoid the tedium of filling in optional field. The application then sets fields in the structure to parameterize how the cliptexture or image cache should be configured. The application then calls the configuration function on the filled in structure. The free function is then called with the structure to ensure that all allocated values are freed.

Cliptexture Configuration

Methods to configure the cliptexture include the following:

pfuInitClipTexConfig(pfuClipTexConfig *config)

Initialize the values of the pfuClipTexConfig structure that has been allocated by the application.

pfuMakeClipTexture(pfuClipTexConfig *config)

Return a cliptexture configured as directed by the values in the pfuClipTexConfig structure.

pfuFreeClipTexConfig(pfuClipTexConfig *config)

Free any malloc'd structures that the application or the initialize function may have created.

Image Cache Configuration

Methods to configure the image cache include the following:

pfuInitImgCacheConfig(pfuImgCacheConfig *config)

Initialize the values of the pfuClipTexConfig structure that has been allocated by the application.

pfuMakeImageCache(pfuImgCacheConfig *config)

Return a cliptexture configured as directed by the values in the pfuClipTexConfig structure.

pfuFreeImgCacheConfig(pfuImgCacheConfig *config)

Free any malloc'd structures that the application or the **init()** function may have created.

All of these functions are defined in `libpfutil/cliptexture.c`. The structures themselves are defined in `pfutil.h`.

Filling in the Structures

Filling the pfuImgCacheConfig structure to create and configure the image cache is considerably simpler than setting fields in the pfuClipTexConfig structure. This is because the cliptexture configuration must also create and configure image cache and image tiles to populate its levels. The configuration code does this supplying a function pointer to configure the image cache levels and a function pointer for configuring image tile levels. Each function pointer also has a void data pointer so you can pass data to the functions. The function pointers expect functions with the following forms:

```
pfImageCache *exampleICacheConfigFunction(pfClipTexture *ct,  
int level, struct _pfuClipTexConfig *icInfo)
```

```
pfImageTile *exampleITileConfigFunction(pfClipTexture *ct,
    int level, struct _pfuClipTexConfig *icInfo)
```

The cliptexture and image cache configuration parsers, described in the next section, use the configuration utilities. You can look at the parsers as example code. For example, you may want to look at **pfLoadImageTileFormat()** and **pfLoadImageCache()** formats for example functions for the function pointers. The parsers are in the `/usr/share/Performer/src/lib/libpfdu/pfdLoadImage.c` file for IRIX and Linux and in file `%PFROOT%\Src\lib\libpfdu\pfdLoadImage.c` for Microsoft Windows.

Configuration Files

The easiest and most commonly used method to configure cliptextures is to create cliptexture and image cache configuration files, then use the configuration parsers to create and configure cliptextures. The configuration files can be created and stored along with the texture data files. Configuration files allow an application or loader to simply call a single function to create and configure cliptextures.

Configuration files are ascii text files containing a token parameter format. Values are separated by white space and the token parameter sequences can be placed in the file in arbitrary order. Comments can also be added to the configuration files, making them self-documenting.

Using Configuration Files

Four parser functions are available to create and configure cliptextures and image caches using configuration files:

```
pfClipTexture *pfdLoadClipTexture(const char *fileName)
```

```
pfImageCache *pfdLoadImageCache(const char *fileName)
```

These parser functions take a configuration file name, and use it to configure and create a cliptexture or an image cache respectively. The cliptexture configuration file may refer to image cache configuration files, which will be searched for and used automatically.

Two other versions of these parsers also take a pointer to a configuration utility structure. This allows you to preconfigure using the configuration structure and then finish with the parser and configuration files.

```
pfClipTexture *pfdLoadClipTextureState(const char *fileName,  
    pfuClipTexConfig *state)  
  
pfImageCache *pfdLoadImageCacheState(const char *fileName,  
    pfuImgCacheConfig *state)
```

The parsers use OpenGL Performer's **pfFindFile()** functionality to search for the configuration files. The parsers support environment variable expansion and relative pathnames to make it simpler to create configuration files that refer to other configuration or data files.

Creating Configuration Files

To successfully use cliptextures, you must first prepare the texture data and create the configuration files:

1. Create an image cache configuration file for each level using an image cache in the cliptexture.

The configuration file should describe the following:

- Format and tiling of the texture data.
- Location and names of the files containing the texture data.
- Size of the tex region in texture memory.
- Size and layout of the mem region in system memory.

2. Create a cliptexture configuration file.

It contains the following:

- Name and location of each image cache configuration file.
- Names and locations of the texture data for each image tile level in the cliptexture. Remember, image tile levels cannot be clipped levels; so, they can only be used in the pyramid levels. Image cache levels can be used anywhere.
- General properties of the cliptexture.
- Look at the example cliptexture configuration files in the `/usr/share/Performer/data/clipdata` directory for IRIX and Linux and in `%PFROOT%\Data\clipdata` for Microsoft Windows. The cliptexture configuration files use the `.ct` suffix. The image cache configuration files use `.ic` for their suffixes.

3. Test the image cache configuration files individually, using the `pguide/libpr/C/icache` program.
4. Test the `cliptexture` configuration file using the `/sample/C/clipfly` or `/sample/C++/clipdemo` sample applications or the `/pguide/libpr/C/cliptex` or the `/pguide/libpf/C/cliptex` programs.
5. When the configuration and data files are complete and tested, your application can create and configure a `cliptexture` by calling `pfdLoadClipTexture(fname)` using the name of the `cliptexture` configuration file. If more control is needed, you can use `pfdLoadClipTextureState(fname, state)` initializing and configuring the configuration utility `cliptexture` structure, `pfuClipTexConfig`.

Configuration File Tips

Unfortunately, `cliptexture` configuration is not trivial, even with documentation and example programs. Success in creating working configuration files requires a two-prong approach:

- Keep them simple: set the minimum number of fields possible. Take advantage of the default values. Try to find a similar example configuration file to copy from.
- Work bottom-up: create and test image cache configuration files first, gradually building up to the `cliptexture` configuration file.

We have found that parameterized naming of the image caches and tile files works the best. If you have named your files consistently, this can be easy. If things do not work, you can fall back and name your file explicitly as a sanity check. Read the error messages carefully; they try to point out where in the configuration file the parser found problems. If you need more information, try rerunning the program with `PFNFYLEVEL` set to 5 or 9.

A number of example configuration files and `cliptextures` are available on the OpenGL Performer release. Working from one of them can save a lot of time. Some places to look are the following:

- `data/clipdata/hunter`
- `data/clipdata/moffett`
- `data/asddata`

Note that emulated `cliptextures` are currently incompatible with `pfASD`.

Cliptexture Loaders

Finally, your application might be able to take advantage of some of the cliptexture loaders. The `libpfim` loader supports loading a cliptexture, and updating its center as a function of viewposition. The `libpfct` loader creates a cliptexture with simple terrain. Virtual cliptextures, mentioned in “Virtual ClipTextures” on page 585, can also be created using the `libpfspherepatch` or `libpfvct` loaders. These loaders can be used as examples if you need to write your own loader that supports cliptextures. The `libpfct` and the `libpfspherepatch` loaders are the most up-to-date cliptexture loaders and include support for emulated cliptextures as well as support for virtual cliptextures on InfiniteReality systems.

Image Cache Configuration File Details

Image cache configuration files supply the following information to OpenGL Performer:

- Format of the texel data.
- Size of the entire texture at a particular MIPmap level.
- How to find the files containing the texel data for this image cache.
- Size and layout of image cache tiles in memory.
- Size of the image cache that should be kept in texture memory.
- A default image tile to use if one is missing.
- The size each level should be clipped to.
- The amount of border that should be invalidated at each level.

Configuration Fields

Configuration fields are either tokens or parameter values, as listed in Table 15-2. All fields are character strings and all parameters must be separated by white space. The token names marked with an asterisk (*) are optional and default to reasonable values.

Table 15-2 Image Cache Configuration File Fields

Token Name	Parameters	Description
<code>ic_version2.0</code>	no data field	Start of image cache config files: type and version
* <code>tex_size</code>	3 integers	Area of tex memory for level if not <code>tex_region_size</code>
* <code>header_offset</code>	integer	Beginning of file to skip over in bytes

Table 15-2 Image Cache Configuration File Fields (**continued**)

Token Name	Parameters	Description
*tiles_in_file	3 integers	Dimensions of grid of tiles stored in each file
*s_streams	filepath list	List of streams used to access files in S dimension
*t_streams	filepath list	List of streams used to access files in T dimension
*r_streams	filepath list	List of streams used to access files in R dimensions
*default_tile	filepath string	Tile to use if expected tile is not available
*page_size	integer	System page size; memory allocation alignment
*read_func	1 or 2 strings	Custom read function; library, func or func in app
*lookahead	integer	Extra tiles in mem region for lookahead caching
ext_format	string	External format of stored texels
int_format	string	Internal format used by graphics hw
img_format	string	Image format of stored texels
icache_size	3 integers	Size of complete image level in texels
tex_region_size	3 integers	Area to load in texture memory; matches clip size
mem_region_size	3 integers	Dimensions of system memory cache in tiles
tile_size	3 integers	Dimensions of each file in texels
tile_format	scanf-style string	Parameterized path to tile files
tile_params	list of symbols	Parameter types in order in tile_format string

Image Cache Configuration File Description

The **ic_version2.0** token must be first in an image cache configuration file. This token identifies the file as an image cache configuration file and the format (version) of the configuration file.

Next the parser looks for tokens and any associated data values. In general, the order of the tokens in the file must follow the sequence specified in the table above. The tokens marked with an asterisk are optional. Optional tokens have default values, which are used if the token and value are omitted. Tokens can have the following:

- No arguments
- A fixed number of arguments
- A variable number of arguments

If a token has a fixed number of arguments, the token must be followed by a white space-separated list containing the specified number of arguments. If the token has a variable number of arguments, one of its arguments specifies the number of arguments used.

Any time a token is expected by the parser, a comment can be substituted. A comment cannot be put anywhere in the file, however. For example, if a token expects arguments, you cannot place a comment between any of them; you have to place it after all of the previous tokens arguments. There are a variety of supported comment tokens; they are interchangeable. The comment tokens are `#`, `//`, `;`, `comment`, or `rem`.

ext_format, int_format, and img_format

One of the first things that must be specified in an image cache is the format of the texel data. This includes the external format (`ext_format`), internal format (`int_format`) and image format (`img_format`). The arguments expected by these format parameters are the ASCII string names of the format's enumerates. For example, a valid external format would be `ext_format PFTEX_FLOAT`. Consult the `pfTexture` man pages for a list of the valid formats of each type.

icache_size, mem_region_size, and tex_region_size

The next set of parameters that must be specified in the image cache configuration file is its size on disk, in system memory, and in texture memory. The `icache_size` token requires the size of the image cache. This means the dimensions, in texels, in the `s`, `t`, and `r` dimensions of the complete texture at this level. Since three dimensional textures are not currently supported, the `r` parameter will always be 1.

An image cache's texels are organized into a set of fixed sized pieces, called tiles. Both in system memory and on disk, the texels are broken up this way. At any given time, an array of these texel tiles are cached in system memory. They are arranged as an array in system memory. If the center of the image cache nears the edge of this array, the most distant tiles are dropped out, and new tiles are read in from disk. The larger the array of tiles in system memory, the more of the complete texture is cached there, and the less

likely new tiles may need to be swapped in. The benefit is offset by the cost of tying up more system memory to hold the texel tiles.

The arrangement and dimensions of tiles in system is defined for each image cache, and is set with the `mem_region_size` token. This token expects three arguments which determine the number of tiles in the *s*, *t*, and *r* dimensions of the grid. Since three dimensional textures aren't currently supported, the *r* dimension is always 1.

A subset of the texels in system memory are cached in the texture memory itself. These texels are arranged in a rectangular region. The dimensions of this region are defined by the `tex_region_size` token. It expects three arguments, the number of texels in the *s*, *t*, and *r* dimensions. Again, since three dimensional textures are not supported, the *r* value is always 1.

The image cache configuration file allows some leeway in the arrangement of texel tiles on disk. There can be one or more tiles on each disk file, and the file itself could contain non-texel information at the beginning of the file. The tiles themselves can have user-specified dimensions. While there is some flexibility in how tiles are stored in files on disk, there are restrictions also. Any header must be the same size for every file in an image cache. The same is true for the tile size, and the number and layout of tiles in each file. If there is more than one tile in a file, the tiles must be arranged in row-major order. In other words, as you pass from the first tile to the last, the *s* dimension must be incrementing fastest.

tile_format and tile_params

The image cache texel data is stored in one or more files. The configuration file provides a way for OpenGL Performer to find these files. The files usually have similar names, varying in a predictable way, such as by tile position in the image cache array and size of the image cache. The files themselves are grouped in on or more directories. The file name and file path information is divided into a number of groups within the configuration file. There is a `scanf`-style string specifying the path to find image cache files. There are a number of parameters in the string that vary as a function of the tile required and the characteristics of the image cache.

The next group of tokens describes the location of the configuration files defining the location of the texture data tiles for the image cache. You can define the texture tile configuration filenames with a `scanf`-style string containing parameter values, as is done with image caches. To create parameterized image cache names, you must define the `tile_format` and `tile_params` tokens.

The `tile_format` token is followed by a `scanf`-style string describing the file path and filename of the image cache configuration files. The argument contains constant parts, interspersed with `%d` or `%s` parameters. The number of parameters must match the number of symbols supplied as parameters to the `tile_params` token. If the `tile_format` string starts with the pattern `$(ENVNAME)`, `${ENVNAME}`, or `$(ENVNAME)`, then the value of `ENVNAME` will be assumed to be an environment variable and expanded into the base name.

The possible values of the image tile file name parameters is given in the table below.

Table 15-3 Image Tile Filename Tokens

Image Tile Filename Tokens	Description
<code>PFIMAGECACHE_TILE_FILENAMEARG_VSIZE_S</code>	Virtual size S width
<code>PFIMAGECACHE_TILE_FILENAMEARG_VSIZE_T</code>	Virtual size T width
<code>PFIMAGECACHE_TILE_FILENAMEARG_VSIZE_R</code>	Virtual size R width
<code>PFIMAGECACHE_TILE_FILENAMEARG_TILENUM_S</code>	Tiles from origin in S
<code>PFIMAGECACHE_TILE_FILENAMEARG_TILENUM_T</code>	Tiles from origin in T
<code>PFIMAGECACHE_TILE_FILENAMEARG_TILENUM_R</code>	Tiles from origin in R
<code>PFIMAGECACHE_TILE_FILENAMEARG_TILEORG_S</code>	Texels from origin in S
<code>PFIMAGECACHE_TILE_FILENAMEARG_TILEORG_T</code>	Texels from origin in T
<code>PFIMAGECACHE_TILE_FILENAMEARG_TILEORG_R</code>	Texels from origin in R
<code>PFIMAGECACHE_TILE_FILENAMEARG_STREAMSERVERNAME</code>	From streams
<code>PFIMAGECACHE_TILE_FILENAMEARG_CACHENAME</code>	The <code>tile_base</code> value
<code>PFIMAGECACHE_TILE_FILENAMEARG_FILENUM_S</code>	Files from origin in S
<code>PFIMAGECACHE_TILE_FILENAMEARG_FILENUM_T</code>	Files from origin in T
<code>PFIMAGECACHE_TILE_FILENAMEARG_FILENUM_R</code>	Files from origin in R

header_offset, tiles_in_file, and tile_size

The `header_offset` argument specifies the size of the file's header in bytes. This many bytes will be skipped over as a file is read. The `tiles_in_file` token requires three arguments, specifying the number of tiles in the `s`, `t`, and `r` dimensions. The `r` dimension

must always be 1, since 3D textures are not supported. The `tile_size` parameter defines the texel dimensions of each tile in `s`, `t`, and `r`. Again, `r` must be 1. Both the `header_offset` and the `tiles_in_file` tokens are optional. They default to the values 0 and 1 1 1, respectively, specifying no header and a single tile in each file.

One of the major bottlenecks to sustained cliptexture performance is the speed of copying texels from disk to system memory. Cliptextures can be configured to maximize the bandwidth of this transfer by distributing image tiles over multiple disks and downloading them in parallel. The streams section of the configuration file is used for this purpose.

num_streams, s_streams, t_streams, and r_streams

A stream, short for stream device, can be thought of as a separate disk that can be accessed in parallel with other disks. Each disk is mounted in a file system and, therefore, has a unique filepath segment. The streams tokens allow you to identify these stream filepath segments and how the image tiles are distributed among them. The stream devices are arranged in a three dimensional grid with `s`, `t`, and `r` dimensions just like the image tiles are in memory. The stream device is accessed by taking the position of the tile, counting tiles from the origin in the `s`, `t`, and `r` directions, and generating a coordinate, modulo the number of stream devices in the corresponding `s`, `t`, and `r` directions. The `s`, `t`, and `r` values generated are used to look up the appropriate stream device. If the stream server name is part of the tile file name format string, it effects which disk is used to find the tile.

Stream servers improve bandwidth at the expense of duplicating image tiles over multiple disks. You must insure that the proper image tiles are available for any disk which is addressed by the tile's `s`, `t`, and `r` coordinates modulo the available number of stream servers for each of those dimensions. The stream server tokens are optional. The `s_streams` token is followed by a list of filepaths. These are the names that will be indexed from the list by taking the `s` coordinate of the tile's position in the image cache grid, modulo the number of `s` stream devices. The names in the `s_stream` list do not have to be unique.

The `t_streams` and `r_streams` tokens work in exactly the same way, in the `t` and `r` directions, respectively.

Sometimes only a subregion of the entire cliptexture is of interest to the application. This is especially true when you consider that the number of tiles in the `s`, `t`, and `r` directions must all be a power of two. To save space, improve performance, and make creating image caches more convenient, a default tile can be defined, and tiles of no interest can

simply be omitted. If a tile cannot be found and a default tile is defined, then the default one is used in place of the missing one.

default_tile

Unlike normal tiles, which are read from disk as they are needed, the default tile is loaded as part of the configuration process. The tile is named in the configuration file as the argument to the `default_tile` token. The argument is a filepath to the default tile. If the `tile_base` token has been defined, it is pre-pended to the file path; otherwise, it is used as is.

Cliptexture Configuration File Details

Image cache configuration files supply the following information to OpenGL Performer:

- format of the texel data
- Size of the highest resolution level (level 0)
- Size of clipped levels in texture memory
- How to find the configuration files for each image cache
- Size of the smallest level to be loaded as an image cache
- Number of effective levels for virtual cliptextures
- Number of allocated levels for virtual cliptextures

Additionally, if no image-cache configurations are used, the cliptexture configuration file will include the following:

- Size of image tiles on disk
- Number of tiles to be stored in RAM for each level
- Format of tile filenames
- Size of header in tile files

Configuration Fields

Configuration fields are either tokens or parameter values, as listed in Table 15-4. All fields are character strings and all parameters must be separated by white space.

Table 15-4 Cliptexture Configuration File Fields

Token Name	Parameters	Description
# or // or ; or comment	comment	comment symbols; comment to end of line
ct_version2.0	no data field	the beginning of the file: type and version
ext_format	string	external format of stored texels
int_format	string	internal format used by graphics hw
img_format	string	image format of stored texels
virt_size	3 integers	size of complete texture at level 0 (finest level)
clip_size	integer	size of clip region square for clipped levels
*invalid_border	integer	width of clip region perimeter to not use
*tile_size	3 integers	size of tiles (used if no icache config files)
*smallest_icache	3 integers	smallest icache-level dimensions
*lookahead	integer	extra tiles in mem region
*icache_format	scanf string	icache fnames: no field? list files
*effective_levels	integer	levels used for texturing in virtual cliptexture
*icache_params	string list	format tokens in order
*icache_files	list of filenames	only if icache_format is default
*tile_files	list of filenames	pyramid; only if tile_format default
*effective_levels	integer	levels used for texturing in virtual cliptexture
*allocated_levels	integer	total virtual cliptexture levels in texture memory
*header_offset	1 integer	byte offset to skip user's file header
*tiles_in_file	3 integers	Image tile arrangement in each file
*read_func	1 or 2 strings	custom read function; lib & func or func in app

Table 15-4 Cliptexture Configuration File Fields (**continued**)

Token Name	Parameters	Description
<code>*tile_format</code>	scanf string	Tile filename format
<code>*tile_params</code>	string list	format parameter tokens in order
<code>*page_size</code>	integer	system page size; memory allocation alignment

Cliptexture Configuration File Description

The `ct_version2.0` token must be first in an cliptexture configuration file. This token identifies the file as an cliptexture configuration file and the format (version) of the configuration file.

Next the parser looks for tokens and any associated data values. In general, the order of the tokens in the file must follow the sequence specified in the table above. The tokens marked with an asterisk are optional. Optional tokens have default values, which are used if the token and value are omitted.

Tokens can have the following:

- No arguments
- A fixed number of arguments
- A variable number of arguments

If a token has a fixed number of arguments, the token must be followed by a white space-separated list containing the specified number of arguments. If the token has a variable number of arguments, one of its arguments specifies the number of arguments used.

Any time a token is expected by the parser, a comment can be substituted. A comment can't be put anywhere in the file, however. For example, if a token expects arguments, you can't place a comment between any of them; you have to place it after all of the previous tokens arguments. There are a variety of supported comment tokens; they are interchangeable. The comment tokens are `#`, `//`, `;`, `comment`, or `rem`.

ext_format, int_format, and img_format

One of the first things that must be specified in a cliptexture is the format of the texel data. This includes the external format (`ext_format`), internal format (`int_format`) and image format (`img_format`). The arguments expected by these format parameters are the ASCII string names of the format's enumerates. For example, a valid external format would be `ext_format PFTEX_FLOAT`. Consult the `pfTexture` man pages for a list of the valid formats of each type.

virt_size and clip_size

The next group of tokens characterizes the image cache itself. The `virt_size` token expects three integer arguments. They define the *s*, *t*, and *r* dimensions of the level 0 layer of the cliptexture in texels. The `clip_size` token describes the size of each layer that exists in texture memory. It takes one integer, describing the *s* and *t* dimensions of the clipped region. This value is the same for all levels of a cliptexture. If the image cache configuration files' `clip_size` differs from this value, the cliptexture overrides it.

invalid_border

The `invalid_border` defines the region of each clipped level that should not be used. If a texel is needed in that region, the next level down is used instead. If the invalid border is large, the system may have to go down multiple levels, or even down to the pyramidal, unclipped part of the MIPmap. The invalid border argument is a single integer, describing the width of the border in texels.

smallest_icache

The `smallest_icache` token describes the *s*, *t*, and *r* dimensions of the lowest level that is described as an image cache. This parameter is needed because the unclipped, pyramidal part of the MIPmap can also be configured as image caches. This is an optional token. If it is not included in the file, the last clipped level is considered the smallest image cache in the cliptexture.

icache_files, icache_format and icache_params

The next group of tokens describes the location of the configuration files defining the image cache levels of the cliptexture. There are two methods of describing where the image cache configuration files. You can explicitly list the filenames in order with `icache_files`.

The other method is to define the image cache configuration filenames with a `scanf`-style string containing parameter values, as is done with image caches. This is usually the preferred method. To create parameterized image cache names, you must define the `icache_format` and `icache_params` tokens. If the format string starts with the pattern `ENVNAME`, `{ENVNAME}` or `(ENVNAME)`, then the value of `ENVNAME` will be assumed to be an environment variable and expanded into the base name.

The `icache_format` token is followed by a `scanf`-style string describing the file path and filename of the image cache configuration files. The argument contains constant parts, interspersed with `%d` or `%s` parameters. The number of parameters must match the integer given with the `num_icache_params` token. The tile parameters themselves follow the `icache_params` token.

icache_files

The number of parameters must match the number of parameters in `icache_format`. All of these parameters are optional. The list of available parameter tokens is given in Table 15-5.

Table 15-5 Parameter Tokens

Parameter Token Name	Description
<code>PFCLIPTEX_FNAMEARG_LEVEL</code>	Cliptexture level (top is 0)
<code>PFCLIPTEX_FNAMEARG_LEVEL_SIZE</code>	Largest value of level's virtual size
<code>PFCLIPTEX_FNAMEARG_IMAGE_CACHE_BASE</code>	Value of <code>icache_base</code>
<code>PFCLIPTEX_FNAMEARG_TILE_BASE</code>	Value of <code>tile_base</code>

Uniquely naming that file for each level of the cliptexture, the parameter values are used to construct the name of the image cache configuration file.

Near the bottom of the cliptexture, the size of lower levels are too small to warrant image caches. These levels are specified directly, referring to a single filename containing a single image tile for each level. The filenames for these tile files are specified in exactly the same way as the image cache configuration files are. Instead of `icache_base`, `icache_format`, `num_icache_parameters`, and `icache_parameters`, `tile_base`, `tile_format`, `num_tile_parameters`, and `tile_parameters` are used. The parameters available for use in the `tile_format` string are identical to the ones used for `icache_format`.

tile_files

If image cache configuration files and/or image tiles are to be explicitly named, they are listed in order, from the top (largest) level to the bottom, using the `icache_files` and `tile_files` tokens. These tokens can only be used if the corresponding `format`, `num_parameters`, and `parameter` tokens are not. The number of filenames listed after `icache_files` and `tile_files` must exactly match the number of cached and uncached levels, respectively, in the `cliptexture`.

header_offset, tiles_in_file, and tile_size

The `header_offset` argument specifies the size of the file's header in bytes. This many bytes will be skipped over as a file is read. The `tiles_in_file` token requires three arguments, specifying the number of tiles in the `s`, `t`, and `r` dimensions. The `r` dimension must always be 1, since 3D `cliptextures` are not supported. The `tile_size` parameter defines the texel dimensions of each tile in `s`, `t`, and `r`. Again, `r` must be 1. Both the `header_offset` and the `tiles_in_file` tokens are optional. They default to the values 0 and 1 1 1, respectively, specifying no header and a single tile in each file.

The image cache texel data is stored in one or more files. The configuration file provides a way for OpenGL Performer to find these files. The files usually have similar names, varying in a predictable way, such as by tile position in the image cache array and size of the image cache. The files themselves are grouped in one or more directories. The file name and file path information is divided into a number of groups within the configuration file. There is a `scanf`-style string specifying the path to find image cache files. There are a number of parameters in the string that vary as a function of the tile required, and characteristics of the image cache.

tile_base, tile_format and tile_params

The `tile_format` token expects a `scanf`-style argument. If the string starts with the pattern `$ENVNAME`, `{ENVNAME}` or `(ENVNAME)`, then the value of `ENVNAME` will be assumed to be an environment variable and expanded into the base name.

The argument contains constant parts, interspersed with `%d` or `%s` parameters. The tile parameters themselves follow the `tile_params` token. The number of parameters must match the number of parameters in `tile_format`.

The possible values of the image tile file name parameters are given in the table below.

Table 15-6 Image Tile Filename Tokens

Image Tile Filename Tokens	Description
PFIMAGECACHE_TILE_FILENAMEARG_VSIZE_S	Virtual size S width
PFIMAGECACHE_TILE_FILENAMEARG_VSIZE_T	Virtual size T width
PFIMAGECACHE_TILE_FILENAMEARG_VSIZE_R	Virtual size R width
PFIMAGECACHE_TILE_FILENAMEARG_TILENUM_S	Tiles from origin in S
PFIMAGECACHE_TILE_FILENAMEARG_TILENUM_T	Tiles from origin in T
PFIMAGECACHE_TILE_FILENAMEARG_TILENUM_R	Tiles from origin in R
PFIMAGECACHE_TILE_FILENAMEARG_TILEORG_S	Texels from origin in S
PFIMAGECACHE_TILE_FILENAMEARG_TILEORG_T	Texels from origin in T
PFIMAGECACHE_TILE_FILENAMEARG_TILEORG_R	Texels from origin in R
PFIMAGECACHE_TILE_FILENAMEARG_STREAMSERVERNAME	From streams
PFIMAGECACHE_TILE_FILENAMEARG_CACHENAME	The <code>tile_base</code> value
PFIMAGECACHE_TILE_FILENAMEARG_FILENUM_S	Files from origin in S
PFIMAGECACHE_TILE_FILENAMEARG_FILENUM_T	Files from origin in T
PFIMAGECACHE_TILE_FILENAMEARG_FILENUM_R	Files from origin in R

Optional Image Cache Configuration Files

If the cliptexture has a very regular structure from level to level, the cliptexture configuration file can be augmented with some extra fields, and the image cache configuration files dispensed with. We recommend you start with the image cache configuration files, however, because it makes it easier to gradually create and test your configuration files using the `icache` and `cliptex` utilities in the `/usr/share/Performer/src/pguide/libpr/C` directory for IRIX and Linux and in `%PFROOT%\Src\pguide\libpr\C` for Microsoft Windows.

Image cache configuration files can be removed if the image caches of the cliptexture are essentially the same, and configuration of each image cache is simple. The image caches should only differ in size between levels; the tile size, formats, tile filename format, etc.

should be the same. Also image cache configuration files are not optional when features like streams are configured.

To stop using image cache configuration files, you should add a `tile_size` token to the cliptexture configuration file, and be sure to have `tile_format` and `tile_params` specified. The tile specification in the cliptexture configuration file will be used for all tile files: the ones used by the image caches and the ones representing pyramid levels.

In order to make the parser stop using the image cache configuration files, remove the entries referring to them such as `icache_format`, `icache_params`, or `icache_tiles`.

An example of a cliptexture configuration file that does not use image cache configuration files is

```
/usr/share/Performer/data/clipdata/hunter/hl.noic.ct for IRIX and  
Linux and %PFROOT%\Data\clipdata\hunter\hl.noic.ct for Microsoft  
Windows.
```

Post-Scene Graph Load Configuration

There are a number of cliptexture configuration steps that cannot be completed until the OpenGL Performer application's pipes and channels have been created. This configuration stage centers around configuring cliptextures to be properly applied and centered each frame.

Two jobs must be accomplished. Each cliptexture must be attached to a pipe through its own `pfMPClipTexture` so it can be applied each frame, and a centering callback must be established to update the cliptexture as the channel's viewpoint moves with respect to the cliptextured geometry.

MPClipTextures

`pfMPClipTexture` is a multiprocess wrapper for a `pfClipTexture`. A `pfMPClipTexture` allows you to do the following:

- Change the center of the `pfClipTexture` in the APP process.
- Automatically schedule the necessary texture downloading (applying) in the CULL process. Downloads are then performed in the DRAW process.

- Control the cliptexture parameters in the APP process.

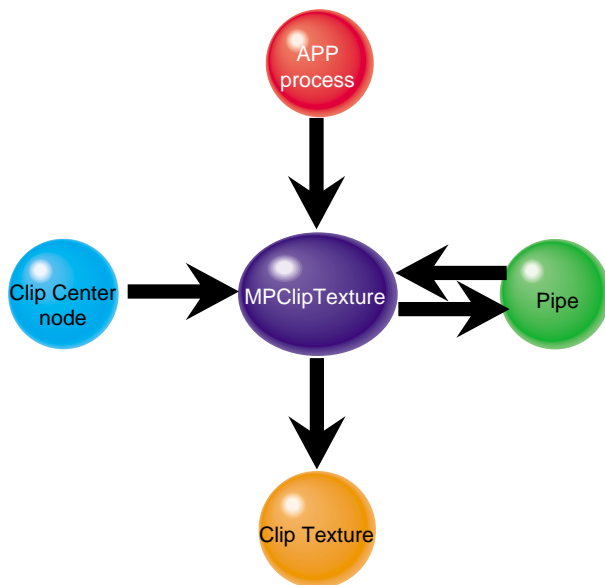

Figure 15-9 pfMPClipTexture Connections

Connecting MPcliptextures to pfPipes

To automatically apply of the pfClipTexture at the correct times and in the correct processes, you must do the following:

1. Create a pfMPClipTexture object.
2. Attach the pfMPClipTexture to the cliptexture you want to control.
3. Attach the pfMPClipTexture object to a pfPipe using the pfPipe.

Note: If you use pfMPClipTexture, you should never call either **pfUpdateMPClipTexture()** or **pfApplyMPClipTexture()**; the pfPipe should do the applying.

When you attach a pfMPClipTexture to a pfPipe using **pfAddMPClipTextureToPipes()** or **pfAddMPClipTexturesToPipes()**, pfPipe automatically updates and applies

pfClipTexture at the correct time. The functions take three arguments: a pfMPClipTexture or list of pfMPClipTextures, a pipe to which to attach (called the master pipe), and a list of other pipes the application wants to use with the pfMPClipTextures.

- **pfAddMPClipTextureToPipes**(*pfMPClipTexture, masterpipe, pipe_list*)
- **pfAddMPClipTexturesToPipes**(*pfMPClipTexture_list, masterpipe, pipe_list*)

The *pipe_list* is used for multipipe applications. It is the list of pipes that slave pfMPClipTextures should be attached to. Setting *pipe_list* to NULL is equivalent to adding slave pfMPClipTextures to every other pipe in the application.

There are additional `libpf` routines that can be useful:

- **pfRemoveMPClipTexture()** detaches a pfMPClipTexture from a pfPipe. If a pfMPClipTexture is removed that is the master of other pfMPClipTextures, the slaves will be removed from their pipes as well.
- **pfGetNumMPClipTextures()** returns the number of pfMPClipTextures attached to a pfPipe.
- **pfGetMPClipTexture()** returns a pointer to the pfMPClipTexture that is attached to a pfPipe.

libpf Functionality

You can do this directly with the `libpf` API using the following calls:

- **pfNewMPClipTexture()**—Create a new pfMPClipTexture.
- **pfMPClipTextureClipTexture()**—Attach the pfMPClipTexture to the cliptexture.
- **pfAddMPClipTexture()** - (a pfPipeCall)—Attach the pfMPClipTexture to a pipe.
- **pfMPClipTexturePipe()**—Specifies to the pfMPClipTexture the pipe to which it is attached.

pfMPClipTexture Utilities

OpenGL Performer provides utilities to make it easy to attach pfMPClipTextures to pipes, and to automatically do pfMPClipTexture centering as well. As a bonus, the utility code requires little or no changes to convert a single pipe application to a multipipe one.

To use the `pfMPClipTexture` utilities, you need to use OpenGL Performer's clipcenter nodes to center the `pfMPClipTexture`. clipcenter nodes are a subclass of `pfGroup` nodes. They have additional functionality that allows them to connect to a `pfMPClipTexture`, the cliptextured geometry (through their child nodes), and properly update the `pfMPClipTexture`'s center each frame. At load time, clipcenter nodes are placed at the root of the subtree containing the cliptextured geometry. All the cliptextures in the scene are created configured and attached to the clipcenter node at this time as well.

Once you have a scenegraph with geometry, cliptextures, and clipcenter nodes, it is easy to make `pfMPClipTextures`, attach them to pipes and to centering callbacks. The function `pfuProcessClipCenters()` traverses the scene graph, looking for clipcenter nodes. As each node is encountered, the function creates an MP cliptexture, attaches it to the associated cliptexture and the clipcenter node, and saves a pointer to the MP cliptexture in a `pfList`. When the function returns, it provides the list of MP cliptextures that were created. The `pfuProcessClipCentersWithChannel()` routine performs the same operations but also sets a channel pointer in the clipcenter node. When the channel pointer is set, the clipcenter node only will update a `pfMPClipTexture` center when that channel traverses it. This is useful for multichannel applications.

Clipcenter Node

In order for cliptextures to be rendered correctly, the clipcenter must move along with the viewer. OpenGL Performer has made this task simpler by providing a special node for the scene graph that does this calculation and applies it to the cliptexture each frame. This node, called the **clipcenter node**, is a subclass of a `pfGroup` node. In addition to `pfGroup` functionality, `pfuClipCenterNode`'s can do the following:

- Points to the cliptexture. This allows cliptextures to be attached to clipcenter nodes at load time.
- Points to the geometry textured by the clipcenter node's cliptexture. The clipcenter node is assumed rooted in the subtree containing the cliptextured geometry.
- Points to an optional simplified version of the cliptextured geometry to make centering calculations go faster.
- Points to the `pfMPClipTexture` attached to the cliptexture. The node also has API to automatically create an `pfMPClipTexture` and attach it to the cliptexture.
- Contains a replaceable post-APP callback function for updating a `pfMPClipTexture`'s center.
- Can point to a `pfChannel` and only update the `pfMPClipTexture` center when that `pfChannel` traverses the clipcenter node.

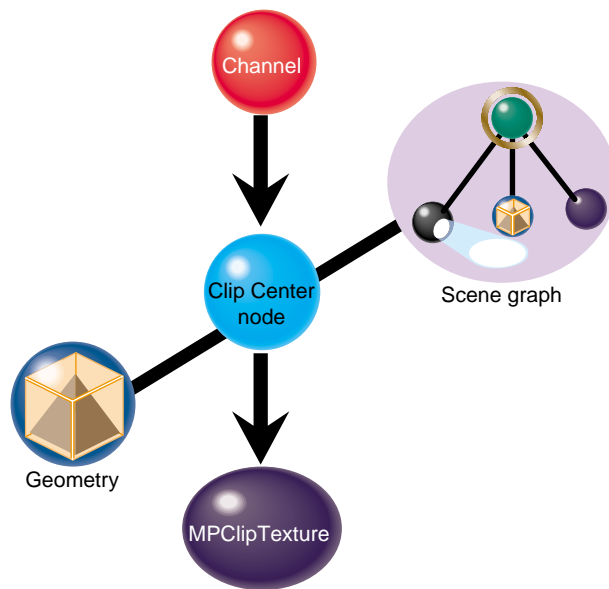

Figure 15-10 pfuClipCenterNode Connections

The clipcenter node uses a simple algorithm, setting the cliptexture center to be the point on the textured geometry closest to the viewer. Other algorithms can be used by replacing the callback function.

Clipcenter nodes can be created by calling the utility routine `pfuNewClipCenterNode()`. There are set and get functions to attach cliptextures, channels, custom centering callbacks, simplified cliptextured geometry, as well as a get to return the `pfMPClipTexture`. See the `pfuClipCenterNode` man page for details on the API.

The clipcenter node source code is available in `pfuClipCenterNode.C` and `pfuClipCenterNode.h` in the `/usr/share/Performer/src/lib/libputil` directory for IRIX and Linux and in `%PFROOT%\src\lib\libpfutil` for Microsoft Windows. It is implemented as a C++ class with C++ and C API. It also has example code illustrating how to subclass the clipcenternode further to customize it.

If the configuration has been done properly, and if `pfuClipCenterNodes` have been used for centering, most of the per-frame operations for cliptextures is automatic. Centering is computed and applied by the clipcenter nodes during the APP traversal, and cliptexture application is automatically handled by the `pfPipes` attached to the `pfMPClipTextures`.

Using Cliptextures with Multiple Pipes

Cliptextures use a lot of texture memory, system memory (for their caches) and disk I/O bandwidth. Many multipipe applications produce multiple views from the same location, looking in different directions. It would be very inefficient to create a completely separate cliptexture for each pipe; although there is separate texture memory and graphics hardware from each pipe, the system memory and disk resources are shared by the entire system.

Cliptextures have been designed to support multipipe rendering without excessive drain on system memory and disk I/O bandwidth. Cliptextures that are to be used in multiple pipes can be split into *master* and *slave* cliptextures. The master cliptexture is complete; it contains an image cache and a region of texture memory to control. A slave cliptexture points to its master and shares its image cache, using it to download into its own texture memory. All the slave cliptextures share their master's system memory cache and disk I/O resources, reducing the load on the system.

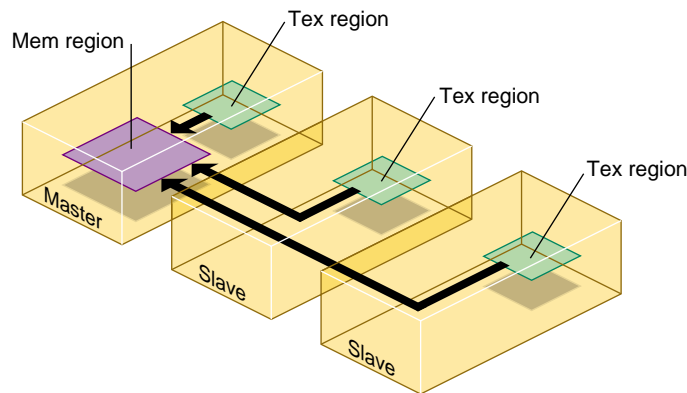

Figure 15-11 Master and Slave Cliptexture Resource Sharing

Making Masters and Slaves

Master and slave relationships can be established between image caches, cliptextures, and pfMPClipTextures. The process starts with an object already configured the way you want. Then another object of the same type is created and is set to be a slave of the configured object. This is done with the `setMaster()` function. When an object is made the slave of another object, it automatically configures itself to match its master. It also makes all the connections necessary to share its master's resources.

If two cliptextures are made into a master and slave, all of their image caches must have the same master-slave relationship. This is done automatically. This is also true for `pfMPClipTextures`. The `pfMPClipTextures` that will be the master and slave must be connected to cliptextures. Only the masters have to be configured, however. When the other `pfMPClipTexture` becomes a slave, it configures its cliptexture and makes it and its image caches slaves as well.

Multipipe Cliptexture API

OpenGL Performer tries to make multipipe cliptexturing as transparent as possible. Simply call `setMaster()` on a cliptexture and pass it a pointer to the cliptexture that should be its master:

- `pfMPClipTexture *slave_mct = pfNewMPClipTexture()`
- `pfClipTexture *slave_ct = pfNewClipTexture()`
- `pfMPClipTextureClipTexture(slave_mct, slave_ct)`
- `pfMPClipTextureMaster(slave_mct, master_mct)`

master_mct is a `pfMPClipTexture` that is already configured.

At this point, *slave_mct* and *master_mct* are connected; *slave_mct* is configured to match *master_mct* and shares its image cache resources. The cliptextures and image caches are also configured and linked. To make `pfClipTextures` or `pfImageCaches` masters and slaves, use the same procedure.

Attaching a `pfMPClipTexture` to a `pfPipe` with `pfAddMPClipTexture()` provides automatic multipipe support. If a `pfMPClipTexture` is added to a pipe that is already connected to another pipe, the function silently creates a new `pfMPClipTexture`, makes it a slave of the `pfMPClipTexture` that is already connected to another pipe, and adds the slave to the pipe in place of the one passed as an argument to the function.

Multipipe Utilities

Although it is not difficult to set up master and slave cliptextures directly, it is usually not necessary. The previously described utility routines, `pfuAddMPClipTextureToPipes()` and `pfuAddMPClipTexturesToPipes()` can take multiple pipe arguments. A master pipe and a list of slave pipes is specified. The routine makes the `pfMPClipTexture` a master and attaches it to the master pipe. It then creates slave `pfMPClipTextures`, attaches them to the master cliptexture, and attaches a slave cliptexture to each pipe in the slave pipes

list. This routine does extra checking of pipe and cliptexture state, and is guaranteed not to generate errors, even if the function is applied more than once.

Master/Slave Share Masks

A group of cliptextures grouped by master-slave relationships can do more than share mem region resources. By default, slave cliptextures also track a number of their master's attribute values. This means changing a master's center, for example, automatically causes the slaves to change their center locations to match their master's. The attributes that a slave can track are divided into groups called *share groups*. The application can control which groups are shared by setting a slave's *share mask*. Changing the sharing of a slave only affects that slave's sharing with its master. Changing the master share mask has no effect. The share mask is set with the following call:

```
pfMPClipTextureShareMask(uint mask)
```

The mask can be set using one or more of the following values:

- PFMPCLIPTEXTURE_SHARE_CENTER—Slaves track the master's center.
- PFMPCLIPTEXTURE_SHARE_DTR—Slaves track DTR: DTR mode, tex load time (actual or calculated), fade count, and blur margin.
- PFMPCLIPTEXTURE_SHARE_EDGE—Slaves track texture level parameters, LODbias invalid border.
- PFMPCLIPTEXTURE_SHARE_LOD—Slaves track minLOD and maxLOD.
- PFMPCLIPTEXTURE_SHARE_VIRTUAL—Slaves track lodOffset and num effective levels.
- PFMPCLIPTEXTURE_SHARE_DEFAULT—A bit-wise OR of all the masks listed above.

PFMPCLIPTEXTURE_SHARE_DEFAULT is the default share-mask value, which provides maximum sharing between master and slave cliptextures. If an application would like to control one or more slaves independently, it needs to change the slave's share mask; then start setting the slaves parameters directly as needed.

Texture Memory and Hardware Support Checking

At the first application or formatting of a cliptexture, OpenGL Performer compares the expected size of the cliptexture texel data in texture memory against the systems texture

memory size. If it looks like the cliptexture will not fit into texture memory, it shrinks the clip size by two and tries again. It will keep shrinking the clip size until either the cliptexture will fit or the clip size is zero. The system takes into account texture memory banking and paging to come up with a more accurate estimate.

Note that the resizing mechanism does not take into account other textures or cliptextures in use by the application. You should adjust your application so that OpenGL Performer does not have to auto-shrink the cliptexture. See “Estimating Cliptexture Memory Usage” on page 597 for calculating cliptexture system memory and texture memory usage.

During the checking phase, OpenGL Performer also checks to see if cliptextures are supported in hardware. If cliptexturing is not supported, one of two emulation modes will be selected: `PFCTEMODE_FRAGPROG` or `PFCTEMODE_BASIC`. `PFCTEMODE_FRAGPROG` uses ARB fragment programs to blend imagery stored in multiple texture units and is automatically selected on systems that support the ARB fragment program extension. The `BASIC` cliptexture emulation mode is selected on all other platforms and only requires OpenGL 1.0 functionality. Both emulation modes work by transparently assigning cliptextured geometry (`pfGeoSets`) to dedicated `pfDrawBins` that are managed internally within the library. Pre- and post-draw callbacks for such `pfDrawBins` are used to override and restore graphics state and to render cliptextured geometry using the cliptexture emulation state.

Manipulating Cliptextures

Once cliptextures have been configured and connected into the application, they can be manipulated by the application in the APP process. Applying and centering cliptextures happens each frame, and is usually an automatic process, set up during post-load configuration. Other parameters that can be adjusted include load control parameters, min and max LOD levels, and virtual cliptexture control. Some of these parameters may only need to be set once in the application, others, like the parameter setting for virtual cliptextures, need to happen multiple times per frame.

Cliptexture Load Control

The virtualization of `pfTextures` into `pfClipTextures`, allowing very large texture maps, comes at a price. As the clipcenter moves, cliptextures have to download data from disk to system memory, and from system memory to texture memory. Because of these

download requirements, cliptextures are sensitive to available system bandwidth. Without some sort of download load control, a fast moving center would cause a cliptextures to “freeze”, waiting for the system to catch up with its updates.

While mem region updates happen asynchronously, tex region updates must happen in the DRAW process, competing with geometry rendering and individual texture loading. Real time applications require that cliptextures, like other OpenGL Performer features, must be controlled in a way such that an upper bound can be set on their use of resources. OpenGL Performer’s cliptexture load control, called Dynamic Texture Resolution (DTR), provides this functionality.

Dynamic Texture Resolution

Dynamic Texture Resolution (DTR) is similar to Dynamic Visual Resolution (DVR): the bandwidth requirements are adjusted to meet system limitations by lowering the resolution of the texture data displayed by the cliptexture.

DTR controls bandwidth by analyzing the cliptexture in the CULL process. It checks each cliptexture level, ensuring that the mem region contains updated tiles corresponding to the tex region, and that there is enough time to update the tex region within the download time limit.

This checking goes from level to level, from coarser levels to finer ones. When a level is found that cannot be displayed, DTR adjusts the cliptexture parameters so that no levels above the finest complete level are displayed. At that point, DTR stops checking levels until the next frame. In order not to waste CULL processing time on levels that are not visible, DTR will not try to sharpen more than one level beyond the current minLOD and virtualLODoffset values. It will go one level beyond these values so that it can react quickly if the values change.

In this way the cliptexture updating will always keep up with the movement of the clipcenter, and will never display invalid data. When the center moves too quickly, DTR will “blur down” to coarser complete levels, then “sharpen up” to finer levels when the center slows down and the system can catch up. In this way DTR can trade visual quality against updating bandwidth. The visual result is that the faster a viewer goes, the less time there is to download texture and the blurrier the texture data gets.

The nature of cliptexturing makes load control work. When the clipcenter moves, this change is reflected at every clipped level of the cliptexture. But because each texel in a level covers four times the geometry of the texel in the next finer level, the clipcenter only

moves half the distance each time you go down a level. This translates into less demanding texture download requirement.

DTR has other features, such as read queue sorting, which prioritize the order in which read requests are done to improve mem region update performance. The rate at which levels are blurred and sharpened can also be controlled to minimize visual artifacts.

Load Control API

DTR controls three aspects of load control, which can be turned on and off independently: tex region updating (from the mem region in system memory), mem region updating (loading from disks), and read queue sorting (reducing the latency of read requests for downloads from disk to the mem region).

pfMPClipTextureDTRMode(*DTRMode*)

DTRMode is a bitmask; if a bit is set, that DTR feature is enabled. It has the following bits defined:

- PF_DTR_MEMLOAD - Enable mem region load control from disk.
- PF_DTR_TEXLOAD - Enable tex region load control; DRAW download time.
- PF_DTR_READSORT - Enable priority sorting of the read queue.

All three bits are enabled by default, which means that DTR has all modes enabled. Besides the bitmask to control what parts of DTR are enabled, there are parameters to available to adjust load control performance. The DTR parameters and how they affect DTR functionality are discussed the following subsections.

Download Time

The memload component of DTR is relatively simple; it computes whether all the tiles in a level's mem region that cover the tex region are valid. If any are not, the tex region cannot be updated and DTR invalidates that level. If the texload component of DTR is enabled, DTR must also compute the time it takes to download from the mem region to the tex region. The application provides the load control with a total download time in milliseconds:

```
pfMPClipTextureTexLoadTime(float _msec)
```

This is the total time DTR has available to update the cliptexture's texture memory each frame. As DTR analyzes each cliptexture level that needs updating, it computes all the

regions in the level's texture memory that need updating. If a level can be updated, DTR determines whether there is enough download time left to update the level. If there is, DTR marks that level valid, subtracts the time needed to download that level from the total, and starts analyzing the next finest level in the cliptexture.

Cost Tables

OpenGL Performer contains texture download *cost tables*, which DTR uses to estimate the time it will take to carry out those texture subloads. These tables are a 2D array of floating point values, indexed by width and height of the texture rectangle being subloaded. The cost tables themselves are indexed by machine type and can be read by the application. The application can also define its own cost tables and configure the system to use it. The cost table API is shown below:

```
pfPerf(int type, void *table)
pfQueryPerf(int type, void **table)
```

The text field indicates whether the cost table should be the one chosen by the system:

- PFQPERF_DEFAULT_TEXLOAD_TABLE - The one supplied by the application
- PFQPERF_USER_TEXLOAD_TABLE - The one currently in use.
- PFQPERF_CUR_TEXLOAD_TABLE - The default table is the current one unless a application supplies a cost table, in which case, the application's cost table takes precedence.

For more details on cost tables, see the man pages for **pfPerf()** and **pfQueryPerf()**. The cost table structure is named `pfTexSubloadCostTable`, defined in `/usr/include/Performer/pr.h` for IRIX and Linux and in `%PFROOT%\Include\pr.h` for Microsoft Windows.

Changing Levels

The DTR load control system is designed to minimize visual artifacts as it adjusts for different download demands. Instead of abruptly sharpening the texture as new levels with valid texture data become available, DTR blurs in new levels over a number of frames, making the process of load control less noticeable. The application can control the rate at which newly valid levels are displayed. The application sets a *fade count*, which controls the number of frames it takes to fade in a new level. Each frame, the cliptexture will sharpen $1/\text{fadecount}$ of the way from its current (possible fractional) level to the next level. This process is repeated each frame, resulting in an exponential fade-in function. If the fade count is 0, then fading is disabled, and DTR will show new levels immediately.

```
pfMPClipTextureFadeCount(int _frames)
```

If the clipcenter roaming speed leaves barely enough bandwidth to bring in a new cliptexture level, a distracting “LOD flicker” between two cliptexture LOD levels can result. Since DTR must blur immediately if a level becomes invalid, the only way to prevent flicker is to be conservative when sharpening, building in a hysteresis factor. The parameter called *blur margin* helps determine when DTR should sharpen.

The `blurmargin` parameter also helps cliptextures blur smoothly when DTR cannot keep up. It is a floating point value, which can be interpreted as a fraction of the cliptexture’s tex load time. When `blurmargin` is not zero, DTR will load all the levels it can within the texload time, but not display all of them. Instead it will only sharpen to the level that would have been reached if the texload time was scaled by `blurmargin`. This leaves a cushion of extra time that can be used up before DTR will be forced to blur to a coarser level. The default `blurmargin` value of .5 usually causes the finest level displayed to be one level coarser than the finest level loaded. The application can adjust `blurmargin` with this call:

```
pfMPClipTextureBlurMargin(float margin)
```

DTR needs this cushion in order to fade smoothly. A cliptexture can only fade between two valid levels; if it waits until its current level is invalid, the cliptexture must immediately jump to the next coarser level or it will show invalid data. This abrupt blurring is very noticeable. The blur margin allows the DTR system to anticipate when it will lose a level, and smoothly fade to the next coarser level over a number of frames.

Total Texload Time and Texload Time Fraction

Using the texload time, blur margin, and fade count parameters is sufficient to control a single cliptexture from a pipe, but the interface is awkward if multiple cliptextures are applying from the same pipe. Since each pipe has the same amount of DRAW process time available per frame, no matter how many cliptextures are applied from it, it would be more convenient to provide a total amount of download time, then divide it among the cliptextures using the pipe.

OpenGL Performer provides this interface using the total texload time and texload time fraction parameters. The application can set the total texture download time available on a pipe, then assign fractional values for each cliptexture, indicating how the download time should be divided. The total texload time is a `pfPipe` call, while the fractional values are set on `pfMPClipTextures`:

```
pfPipeTotalTexLoadTime(float msec)  
pfMPClipTextureTexLoadTimeFrac(float frac)
```

The fractional values should indicate the relative priority of each pfMPClipTexture on the pipe. The fractional values do not have to add up to 1; the DTR code will normalize them against the sum of all the fractional values set on the pipe's pfMPClipTextures.

The total tex load time on the pipe is scaled by the normalized fractional value on each cliptexture. The scaled tex load time is then used as the cliptexture's texture download time. Explicitly setting the tex load time on a pfMPClipTexture will override the computed fractional time.

Read Queue Sorting

When the clipcenter moves quickly, the number of read requests for texture data tiles that move into the clipped levels mem regions can grow much faster than the read function can service them. If there is not enough bandwidth to display a particular level, its read requests may become "stale", becoming obsolete as the location of the requested tile moves into, then passes out of a level's mem region. For DTR to be robust, the read queue must be culled and sorted to remove stale read requests, and move the requests for tiles closest to the clipcenter to the front of the queue. The cliptexture's read queue is a sorting queue, which means that a function can process the elements of the queue asynchronously. DTR uses the read queue to cull read requests for tiles that are no longer in their mem region, and to prioritize the other requested tiles as a function of level and distance from the clipcenter. Sophisticated applications can provide their own sorting function.

Invalidating Cliptextures

Sometimes an application may want to force a cliptexture to completely reload itself. For example, The **pfuGridifyClipTexture()** function modifies the cliptexture's texel data in system memory with a system of grid marks to make debugging and analysis easier. It modifies the read function to add a grid to every tile as it's loaded into system memory, then invalidates the cliptexture. For more information on gridify, look at the source code in the `/usr/share/Performer/src/lib/libpfutil/gridify.C` file for IRIX and Linux and in `%PFROOT%\Src\lib\libpfutil\gridify.C` for Microsoft Windows.

Invalidating a cliptexture forces it to completely reload its texture memory. Invalidating is only supported for cliptextures, not MPcliptextures. This means that an application

cannot call `invalidate` from the APP process. Instead, it must call `invalidate` from the CULL process, usually in a pre-cull callback. The `invalidate` call itself is simple:

```
pfInvalidateCliptexture(pfCliptexture *cliptex)
```

Invalidation is not needed for normal operation, but it is useful as a way to immediately update a cliptexture's texture memory.

Virtual Cliptextures

Note: Emulated cliptextures on systems other than InfiniteReality systems are never virtual.

Regular cliptextures limit the size of each level but do not restrict the number of levels you can access. Virtual cliptextures take the virtualization a step further by allowing you to use only a subset of all the levels for which you have data.

Although InfiniteReality supports cliptextures of virtual size up to $8M \times 8M = 2^{23} \times 2^{23}$ texels (that is, 24 levels), the hardware is only capable of addressing a region of at most $32K \times 32K = 2^{15} \times 2^{15}$ texels (that is, 16 levels). By limiting the set of texture MIPMap levels, the cliptextures can be enlarged. A larger, virtual, cliptexture is defined just like a normal cliptexture, except that the size of the cliptexture can exceed the $32K \times 32K$ maximum level size dictated by the hardware.

Virtual cliptextures do use more texture memory and require more callbacks in the CULL process, but they allow enormous cliptextures that are limited only by the precision of the texture coordinates. Cliptextures over one million texels on a side have been demonstrated.

Although virtual cliptextures require dividing the cliptextured geometry into sections for a given MIPmap *levelrange*, the division is much coarser and less restrictive than texture tiling. Cliptextured geometry usually does not need to be clipped to sectional boundaries, for example, since there is a lot of leeway when there are more MIPmap levels available than are needed for a given section of geometry.

For a sample application implementing virtual cliptextures, see `/usr/share/Performer/src/pguide/libpf/C/virtcliptex.c` for IRIX and Linux.

Selecting the Levels

The application is responsible for choosing which 16 (or less) levels can be accessed at any given time by setting two parameters: *virtualLODOffset* and *numEffectiveLevels*. Most applications make *numEffectiveLevels* the maximum number allowed by the hardware, 16 on InfiniteReality. Smaller values may be chosen in some cases to improve stability. *VirtualLODOffset* sets the initial level in the cliptexture where 0 is the finest level.

For example, if *numEffectiveLevels* = 16 and *virtualLODOffset* = 0 then the texels the hardware can access are limited to the 32Kx32K region surrounding the current clipcenter, measured in finest-level texels (actually somewhat less than this. On IRIX and Linux, see the file `/usr/share/Performer/doc/clipmap/IRClipmapBugs.html` or `/usr/share/Performer/doc/clipmap/IRClipmapBugs.txt` for details on cliptexture limitations on InfiniteReality graphics). On Microsoft Windows, see the file `%PFROOT%\Doc\clipmap\IRClipmapBugs.html` or `%PFROOT%\Doc\clipmap\IRClipmapBugs.txt`. Attempting to access outside this range results in the value of the nearest texel in the good region; that is, the texels forming the border of the 32Kx32K area will appear to be “smeared” out to fill the virtual cliptexture.

Increasing *virtualLODOffset* from 0 to 1 doubles the size of the accessible region in both S and T (so that it is 32Kx32K level 1 texels, which are twice as big as level 0 texels) but makes the finest level inaccessible.

The maximum *virtualLODOffset* allowable is $\text{numVirtualLevels} - \text{numEffectiveLevels}$; when set to that value, the entire S,T range of the virtual cliptexture is accessible, and the finest level from which texels are available is the 32Kx32K level.

In general, it is appropriate to choose a large value of *virtualLODOffset* when the viewpoint is far away from the scene and more S,T area is visible; smaller values of *virtualLODOffset* are appropriate as the eye moves closer to the scene, gaining needed higher resolution at the expense of range in S,T.

Changing *virtualLODOffset* and *numEffectiveLevels* has no effect on the contents of texture memory nor any effect on the texture coordinates stored in the geosets and passed to the graphics: the texture coordinates, as well as the clipcenter, are always expressed in the space of the entire virtual cliptexture rather than the smaller “effective” cliptexture of up to 16 levels within it. (In contrast, changing the clipcenter requires texture downloading; thus it is a much more expensive operation and therefore it is not practical to change the clipcenter more than once per frame, whereas *virtualLODOffset* and *numEffectiveLevels* can be changed multiple times per frame, as we will see in the following subsections.)

How to Set Virtual Cliptexture Parameters

OpenGL Performer supports two different methods for managing *virtualLODOffset* and *numEffectiveLevels* of a cliptexture. The simpler of the two methods allows the parameters to be set and changed at most once per frame; the more sophisticated method allows them to be changed multiple times per frame (different values for different parts of the scene). In addition to *virtualLODOffset* and *numEffectiveLevels* described earlier, the parameters *minLOD*, *maxLOD*, *LODBiasS* and *LODBiasT* often need to be set in the same way; so, we will show how to set those as well.

Per-Frame Setting of Virtual Cliptexture Parameters

The easy way to manage the virtual cliptexture parameters is to set the values of the parameters on the `pfMPClipTexture` controlling the `pfClipTexture`:

```
int LODOffset, numEffectiveLevels;
float minLOD, maxLOD;
float LODBiasS, LODBiasT, LODBiasR;
...
mpcliptex->setVirtualLODOffset(LODOffset);
mpcliptex->setNumEffectiveLevels(numEffectiveLevels);
mpcliptex->setLODRange(minLOD, maxLOD);
mpcliptex->setLODBias(LODBiasS, LODBiasT, LODBiasR);
```

You make these calls in the APP process, either in the main program loop, a channel APP func, or a pre- or post-node APP func. The last value you give during the APP in a particular frame will be used for rendering that frame and all subsequent frames until you change the value again.

This simple technique is the one that is used by the `clipfly` program when you manipulate the *LODOffset* and *EffectiveLevels* sliders (when using a naive scene loader such as the `.im` loader that does not do its own management of *virtualLODOffset* and *numEffectiveLevels*): `clipfly` makes these calls in its channel pre-APP function.

This technique is also used by the `.spherepatch` loader; in this case, the calls are made in a post-APP function of a node in the scene graph, using parameters that are intelligently chosen based on the current distance from the eye to the closest point on the textured geometry and are updated every frame.

Notice that even though the `.spherepatch` loader manages the *virtualLODOffset* and *numEffectiveLevels*, you can still modify or override its behavior with the `clipfly` GUI controls. This is accomplished using a special set of “limit” parameters that are provided

as a convenience and stored on the `pfMPClipTexture`. The intended use is for applications such as `clipfly` to set the limits based on GUI input or other criteria:

```
mpcliptex->setLODOffsetLimit(lo, hi);
mpcliptex->setEffectiveLevelsLimit(lo, hi);
mpcliptex->setMinLODLimit(lo, hi);
mpcliptex->setMinLODLimit(lo, hi);
mpcliptex->setLODBiasLimit(Slo, Shi, Tlo, Thi, Rlo, Rhi);
```

Then the callback functions of intelligent loaders such as `.spherepatch` query the limits:

```
mpcliptex->getLODOffsetLimit(&lo, &hi);
mpcliptex->getEffectiveLevelsLimit(&lo, &hi);
mpcliptex->getMinLODLimit(&lo, &hi);
mpcliptex->getMinLODLimit(&lo, &hi);
mpcliptex->setLODBiasLimit(&Slo, &Shi, &Tlo, &Thi, &Rlo, &Rhi);
```

The loaders use the limits to modify the selection of the final parameters sent to `pfMPClipTexture`.

The limits are not enforced by `pfMPClipTexture`; they are provided merely to facilitate communication from the application to the function controlling the parameters. That function is free to ignore or only partially honor the limits if it wishes.

The limits may also be queried frame-accurately from the `pfMPClipTexture` in the CULL process, so they can also be used by scene loaders such as the `.ct` loader that use the per-tile method described in the next section.

Per-Tile Setting of Virtual Cliptexture Parameters

Many applications require accessing a wider range of the `cliptexture`'s data than can be obtained by a single setting of `virtualLODOffset` and `numEffectiveLevels`. This can be accomplished by partitioning the database into "tiles" roughly according to distance from the eye or from the texture's clipcenter and setting the parameters for each tile every frame in the pre-CULL func of the `pfGroup` or `pfGeode` representing that tile by calling `pfClipTexture::applyVirtual()`, `pfTexture::applyMinLOD()`, `pfTexture::applyMaxLOD()`, and `pfTexture::applyLODBias()`.

Tiling Strategies

Choosing a database tiling strategy requires careful thought and tuning. The most conceptually straightforward method is to use a static 2D grid-like spatial partitioning. This method requires tuning the granularity of the partitioning for the particular database and capabilities of the machine: if a tile is too big and sufficiently close to the eye, there may be no possible combination of *virtualLODOffset* and *numEffectiveLevels* that allows access to both the necessary spatial range and texture LOD range without garbage in the distance or excess bluriness in the foreground; but if there are too many tiles, the overhead of changing the parameters for each tile can become excessive.

In general, assuming the maximum active area is 32Kx32K (as it is on InfiniteReality), each tile should be small enough so that it covers at most approximately 16K texels at the finest texture LOD that will be used when rendering it; this is so that when the clipcenter is close enough to the tile to require accessing that finest texture LOD, the 32Kx32K good area centered at approximately the clipcenter will be able to cover it with some slop left over to account for the inexact placement of the good area (see the IR cliptexture bugs doc). (Finer tiles such as 8Kx8K or even 4Kx4K can be used for improved stability under extreme magnification; see the IR cliptexture bugs doc).

This rule has two important consequences:

- If your cliptexture has insets (that is, localized regions in which higher-resolution data is available) you can make the tiling coarser in the regions where only low-resolution data is available and finer at the insets.
- If you use pFLODs to optimize your database, the coarse LODs of the pFLOD can (and should) be tiled more coarsely than the fine ones.

This is because the coarser LODs are used at far distances, and at those far distances the Mipmapping hardware will only want to access correspondingly coarse texture levels anyway, so the 16Kx16K can be measured in terms of the texels of those coarse texture levels.

A more general tiling strategy that requires less empirical database tuning than the static tiling method is to make the tiles be concentric rings around the texture's clipcenter (in 2D) or around the eye point (in 3D), with sizes increasing in approximately powers of 2. However, since the clipcenter and view position changes, this means the tiles must move as well, which requires dynamically changing the topology of the scene graph and/or morphing the geometry so that the tiles always form those concentric rings around the current focus.

The `.ct` loader and `pfASD`'s `ClipRings` both use this dynamic strategy. The `.ct` loader is interesting in that the morphing is done for the sole purpose of forming these concentric tiles for virtual-cliptexturing an otherwise trivial scene. It looks like simply a square textured by the cliptexture, but if you turn on scribed mode in `perfly` or `clipfly`, you can see the morphing rings that make up the square.

Doing Per-tile Updates

To do per-tile updates, use the following procedure:

1. On each tile (typically a `pfGroup` or `pfGeode`) put a pre-node CULL func:

```
tile->setTravFuncs(PFTRAV_CULL, tilePreCull, NULL);
```

2. Make sure the effect of the tile's pre-CULL func happens in the DRAW before the contents of the tile are rendered, and that the tile's contents do not co-mingle with other tiles (this is not guaranteed by default, for the benefit of CULL whose sole purpose is to return a CULL result without losing the advantages of uncontained CULL sorting):

```
tile->setTravMode(PFTRAV_CULL, PFTRAV_CULL_SORT,  
                PFN_CULL_SORT_CONTAINED);
```

3. In the pre-node CULL func for the tile, set the parameters:

```
static int tilePreCull(pfTraverser *trav, void *)  
{  
    int virtualLODOffset, numEffectiveLevels;  
    float minLOD, maxLOD;  
    float biasS, biasT, biasR;  
  
    //Choose intelligent values for parameters.  
  
    cliptex->applyVirtualParams(virtualLODOffset,  
                               numEffectiveLevels);  
    cliptex->applyMinLOD(minLOD);  
    cliptex->applyMaxLOD(maxLOD);  
    cliptex->applyLODBias(biasS, biasT, biasR);  
}
```

The values given to the apply functions are not stored in the `pfClipTexture` or retained from frame to frame; when you call these functions, they override the corresponding values stored in the cliptexture.

It is not necessary to call all four of the **apply...()** functions; only use the ones you care about (for example, most applications would not care about `LODBias`). However, if you ever call a given one of these functions, **applyMinLOD()**, for example, on a particular cliptexture for any tile, then you must call **applyMinLOD()** for every tile on that cliptexture during that frame and forever after; if you omit it, the tile will not necessarily get the value stored on the `pfMPClipTexture` or `pfClipTexture`; rather, it will get whatever value happened to be most recently set when rendering that tile in the DRAW (which may be nondeterministic due to CULL sorting of the scene graph).

How to Choose Virtual Cliptexture Parameters

The `libpfutil` library provides the function `pfuCalcVirtualClipTexParams()`, which can be very useful in selecting the virtual cliptexture parameters, regardless of whether you are updating per-frame or per-tile.

Essentially, you give to `pfuCalcVirtualClipTexParams()` every piece of information you know about the cliptexture:

- the tile in question
- the limits specified elsewhere, for example, by the `clipfly` GUI

`pfuCalcSizeFinestMipLOD()` returns the lower bounds on `minLODPixTex`, which is one of the input parameters to `pfuCalcVirtualClipTexParams()`.

The function returns optimal values for `virtualLODOffset`, `numEffectiveLevels`, `minLOD`, `maxLOD`. You can do the following with them:

- Set on the `pfMPClipTexture` in the APP process if your application is using the per-frame method.
- Apply to the `pfClipTexture` per-tile in the CULL process if using the per-tile method.

For more details, you may also want to read the commented source code to understand its constraints and heuristics, and how to modify `pfuCalcVirtualClipTexParams` to implement your own algorithm if it does not exactly suit your needs.

Custom Read Functions

Sometimes the read function supplied by OpenGL Performer to download texture data from disk to mem region is not good enough. The application may need to do additional operations at read time, such as uncompression, or may need a more sophisticated read

function, such as an interruptible one for reading large tiles from slow storage devices. A read function may need to signal an applications secondary caching system; for example, reading from tape storage to disk.

OpenGL Performer provides support for application supplied custom read functions. The read function is supplied at configuration time, and there is API in both the configuration utilities and the cliptexture and image cache configuration files for supplying a read function.

A read function is called by the image caches read queue. The read queue expects a read function with the following function signature:

```
int ExampleReadFunction(pfImageTile *it, int ntexels)
```

The image tile pointer provides information about the read request, such as the disk to read from, the dimensions and format of the texel data, and the destination tile in system memory to write to. The *ntexels* argument is an integer indicating the number of texels to read from disk. The read function returns another integer indicating the number of texels actually read. Two example read functions, **ReadNormal()** and **ReadDirect()**, are supplied in `/usr/share/Performer/src/lib/libpfd/pfdLoadImage.c` for IRIX and Linux and in `%PFROOT%\Src\lib\libpfd\pfdLoadImage.c` for Microsoft Windows. These functions are C versions of the C++ functions that OpenGL Performer uses to read texture data. In OpenGL Performer, the **ReadDirect()** function is called by the read queue; it tries to use direct I/O to get the highest possible disk read performance. If the read direct call fails, it calls **ReadNormal()**, which uses normal **fopen()**-style read.

When providing a read function at configuration time, You supply the function name, and optionally the name of a DSO library containing the function. If no dynamic shared library is supplied, the read function is searched for in the application's executable.

To set custom read functions using the configuration utilities, simply fill in the *readFunc* field in the *pfuImgCacheConfig* or *pfuClipTexConfig* structure (the first structure has priority over the second if both are set). The field should contain a pointer to the custom read function. Be sure the function has the proper signature.

When supplying custom read functions in the configuration files, you simply provide an entry in one of two formats:

```
read_func ReadFunctionName  
read_func DSOLibraryName ReadFunctionName
```

For hints on when and how to use custom read functions, see the customizing read functions in “Custom Read Functions” on page 604.

Using Cliptextures

This section provides guidelines for using cliptextures, describing common cliptexture application techniques, ways to solve problems, and some hints and tips to make using cliptextures easier.

Cliptexture Insets

Cliptexture load control makes it possible to create cliptextures with incompletely filled levels. A cliptexture, being much larger than an ordinary texture, may not be used in a homogeneous way. Some areas of the cliptexture may be viewed in detail, others only at a distance. A good example of this usage pattern is flight simulation. The terrain around an airport will be seen from low altitude, terrain far from population centers may never be seen below 40,000 feet. It is also possible that high resolution data is simply not available for the entire cliptexture. Both of these cases make it valuable to create cliptextures with incompletely populated levels.

Regions of filled in data are called insets. Insets can be any shape, and do not need to match tile boundaries (although this requires filling the rest of the tile with super sampled data). For an inset to work properly, all of the levels from the pyramid up to the finest level desired, must be available within the inset boundaries.

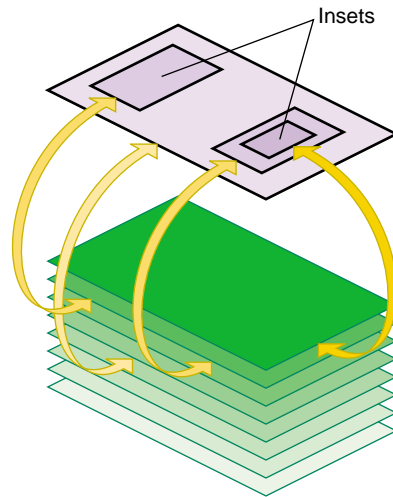

Figure 15-12 Cliptexture Insets

Insets are supported in cliptextures as a natural consequence of load control. As the clipped region moves from a region that has texel data to one that does not, DTR will blur the texture down to the highest level that can completely fill the clipped region.

Adding Insets to Cliptextured Data

In large cliptextures, it may not be practical or even desirable to completely fill each level with texel data. Cliptexture's load control, DTR, automatically adjusts the finest visible level based on what texels are available. If finer levels are not available, DTR automatically "blurs down" to the highest complete level in the clip region.

Applications may use insets if there are only limited areas where the viewer is close to the terrain. An example application would be a commercial flight simulator, where the inset high-resolution data would be around the airports where the aircraft takes off and lands. The terrain over which the aircraft cruises can be lower resolution.

Insets and DTR

To create insets properly, you have to understand how DTR load control works. At the beginning of each frame, DTR examines a level's mem region to see if the tiles covering the tex region are all loaded. If the tiles are all available, DTR will make that level visible.

DTR does this examination starting with the coarsest clipped level. If the current level is complete, it marks that level as visible and repeats the process for the next finest level, until it gets to the top level or finds an incomplete level.

Building Insets

To create an inset, assume you have a cliptexture that is complete at a coarse level. You choose an area of the clipmap that you would like to have visible at some finer level. In order to make that area available, you have to provide texel data in that area for each level from the coarse complete level to the finer level you want to show.

When the clip region is completely enclosed by the finer level data, DTR checks all the levels from the pyramid level on up, and allows the finer level to be shown in that area. (The pyramid levels are always complete; see Figure 15-1.)

Because DTR works from the bottom up (coarser to finer levels), an inset area must have texel data available from the finest level all the way down to the pyramid level. If a level's clip region is missing or incomplete, DTR does not allow the image to sharpen up to that level; the inset gets blurry.

Inset Boundaries

When the clipcenter is set such that the clip region is completely enclosed by the insetted area, a properly constructed inset is sharp, using the finer resolution texel data. But what happens when the clip region only partially covers an inset? In that case, DTR does not sharpen up beyond the finest complete level, and the clip region gets blurry, including the part of the clip region covered by the inset. Remember, the clip region only sharpens to the finest level that is complete within the clip region.

This bluriness may not be a problem. If you know that the application moves far enough away from the terrain before the clip region crosses an inset border, MIPmapping uses the coarser texture levels before DTR forces the texture to use them. Sometimes, the application would like a static boundary between the inset and the surrounding coarser data, even when crossing an inset boundary close to the textured geometry.

Supersampled Data

Getting a static inset border requires creating a boundary of supersampled data around the inset. This means creating texel data for the insetted levels that is deliberately made

as blurry as the surrounding base level. This border of blurry data must be at least as wide as the clip region to ensure a smooth transition.

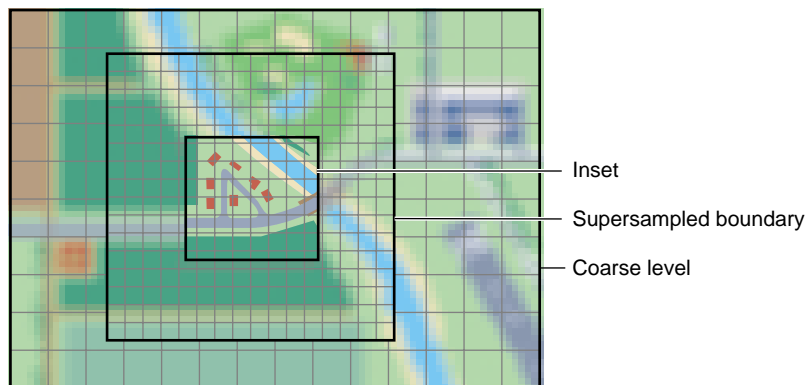

Figure 15-13 Supersampled Inset Boundary

How does this work? When the clip region crosses an inset border, it starts to cover the boundary region. Since the boundary region has the same levels filled in as the inset region, DTR still sees complete data up to the same finer level. The texel data of the border has been blurred, however, so it looks like the coarser base level. This allows a hard transition between the finer inset data and the surrounding coarse data. Since DTR still sees complete levels, as you move away from the inset, it does not suddenly blur.

Since the boundary data is at least as wide as the clip region, the inset boundary has moved out of the clip region before the clip region hits the far edge of the boundary region. At this point, DTR blurs down to the coarser base level, since the finer data is no longer incomplete, but there is no visual change, since the boundary texels were blurry already.

Note: Supersampled borders do not guarantee a seamless transition between insets and their surroundings, only that the inset region does not suddenly blur or sharpen as the clip region crosses the inset border. Seamless transitions only happen if the application is careful to get far enough from the clipmapped terrain to already be using the coarse levels before crossing the inset border.

Multiple Insets

Insets do not have to be any particular size or shape, although they are usually multiples of the tile size, and at least as big as the clip region so they can be viewed without a seam of bluriness. Typically, insets are designed so when the application is close enough to view the finer inset levels, the clip region is already completely enclosed by the inset region.

Keep in mind that insets are not the same size on each level, since texels from coarser levels cover more geometry. If an inset is not a multiple of the tile size at a given level, the tile has to be partially inset data, and partially supersampled data, or all fine data, since DTR does not work with partial tiles.

Estimating Cliptexture Memory Usage

Because cliptextures are a voracious consumer of system and texture memory, it is important to accurately predict the system resources required to run a cliptexture application. It is better to customize your application than to rely on the cliptexture auto-resizing feature, since auto-resizing does not take into account multiple cliptextures or pftTextures in your application.

Cliptextures use both system memory (texel caching, read queue elements as well object overhead) and texture memory. The following estimation ignores the smaller contributors to system memory overhead and concentrates on image cache consumption of system memory for mem regions and tex regions in texture memory.

System Memory Estimation

The following values are required to estimate system memory requirements:

- Size of clipmap level 0
- Clip size (in texels)
- Tile size (in texels; assuming tile size is the same for all levels)
- Texel size in bytes
- The value of parameter `lookahead` in the cliptexture configuration file

Given these values, compute the estimate for system memory requirements using the following procedure:

1. Round up clip size to even multiple of tile size in each dimension.
2. Divide each dimension by tile size in that dimension.
3. Add the number of tiles specified by parameter `lookahead` to each dimension.
You now have the number of tiles in each dimension per clipped level.
4. Multiply the texel dimensions together.
5. Scale by the size of each texel.
6. Add in the fixed cost of image cache structs.
You now have the system memory cost in bytes for each clipped level.
7. Treat each level bigger than clip size as clipped. Add $4/3$ of the clip size scaled by the texel size for the pyramid levels.
This estimate is a bit too conservative, since the lowest clipped levels may exceed the entire level size with a border of two tiles. It is a function of tile size and clip size.
8. Scale the clipped level size by the number of clipped levels.

Example of Estimating System Memory Requirements

The example uses the following values in its estimation:

- 2M top level
- 1K clip size
- 512 tile size (everything square)
- 1 byte texel size (LMV example)
- 4 for parameter `lookahead`

Example 15-1 estimates system memory requirements using the preceding procedure.

Example 15-1 Estimating System Memory Requirements

1. No-op: 1K, 1K (for both s and t).
2. $1K/512 = 2$, 2 (for both s and t).
3. $2+4 = 6$, 6 (for both s and t; add `lookahead`)
4. $6 * 512 = 3K$, 3K (for both s and t)

5. $3K * 3K = 9M$
6. $9M * 1 = 9M$
7. $9M * 10 = 90M$ (for 2M -> 4K levels) + $2M$ (for 2K level) = $92M$
8. $4/3 * 1K * 1K = 1.3M$
9. Total Size $92M + 1.3M = 93.3M$

Texture Memory Estimation

The following values are required to estimate texture memory requirements:

- clip size (in texels)
- whether the clipmap is virtual or non-virtual
- number of levels in use (if less than 16)

Given these values, you can compute the estimate for texture memory requirements using one of the following guidelines:

- If the clipmap is virtual, multiply the number of levels by the square of the clip size.
- If the clipmap is non-virtual, do the following:
 1. Multiply the number of levels bigger than the clip size by the square of the clip size.
 2. Add $4/3$ times the clip size squared.

There is, however, a further complication involved in accurately estimating texture memory requirements. The following subsection describes it.

Texture Memory Usage: A Further Complication

InfiniteReality rendering boards come with either 16, 64, 256, or 1024 megabytes of texture memory. Unfortunately, you cannot just use the texture memory any way you want. The texture memory is divided into two equal banks. Each adjacent Mipmap level, clipmapped or not, must be placed in opposite banks. This ends up restricting the amount of texture memory available for clipmapping.

A further restriction is that texture formats can take up 16 bits or 32 bits of data per texel, but nothing in between. This means an 888 RGB format takes up 32 bits per texel, just like an 8888 RGBA format.

To give you an example of this restriction, consider an example using RGB texel data, 8 bits per component, and a clip size of 2048 by 2048. The largest level is 8K by 8K. The system has an RM board with 64M of texture memory; so, it would seem that there is plenty room, but the following calculation shows otherwise:

1. The cliptexture is non-virtual; so, the total texture memory requirement is the clip size times the number of clipped levels plus $4/3$ of the pyramid.
2. 4K, 4K levels are clipped to 2K X 2K: RGB, 8 bits per channel 4 bytes (not 3) per texel times $2K \times 2K = 4M$ of texels per level.
3. There is 6M of texture memory per clipped level.
4. So, that is 32M of texture memory.
5. 2K and below is the pyramid; so, $4/3$ of $16M = 21\frac{1}{3}M$.
6. The total is $53\frac{1}{3}M$ of texture memory.

Unfortunately, the texture does not fit into texture memory because of the following:

1. 64M of texture memory means two 32M banks.
2. Each level must be in the opposite 32M bank.
3. Consequently, 8K level becomes 16M in bank 0 (16M left).
4. At the 4K level, 16M goes into bank 1 (16M left).
5. At the 2K level, 16M goes into bank 0 (0M left).
6. At the 1K level, 8M goes into bank 1 (8M left).
7. At the 512 level, there is no room in bank 0

The best you could do is to have only one clipped level, as follows:

1. At the 4K level, 16M goes into bank 0 (16M left).
2. At the 2K level, 16M goes into bank 1 (16M left).
3. At the 1K level, 8M goes into bank 0 (8M left).
4. At the 512 level, 4M goes into bank 1 (12M left).
5. At the 256 level, 2M goes into bank 0 (6M left) and so on.

Probably a better solution would be to use the 5551 format RGBA texels, which only use 16 bits per texel, allowing more levels, as follows:

1. At the 32K level, 8M goes into bank 0 (24M left).
2. At the 16K level, 8M goes into bank 1 (24M left).
3. At the 8K level, 8M goes into bank 0 (16M left).
4. At the 4K level, 8M goes into bank 1 (16M left).
5. At the 2K level, 8M goes into bank 0 (8M left).
6. At the 1K level, 4M goes into bank 1 (12M left).
7. At the 512 level, 2M goes into bank 0 (6M left).
8. At the 256 level, 1M goes into bank 1 (11M left) and so on.

You can get a lot more mileage out of smaller texel formats than fewer levels. This becomes even more true for RMs with only 16M of texture memory.

Using Cliptextures in Multipipe Applications

OpenGL Performer provides good support for multipipe cliptextures, allowing applications to ignore many of the differences between single pipe and multipipe operations. The primary issue in multipipe applications is knowing when to make master/slave cliptextures, what parameters should be shared, and when and how to create separate centers in different master and slave cliptextures.

When to Make Master/Slave Cliptexture Groups

When it is possible, it is desirable to make master/slave cliptexture groups in multipipe applications. Master/slave groups share the same mem regions and disk access bandwidth, reducing the load on the system. Masters and slave can also take advantage of sharegroups, automating some of the work of synchronizing slave cliptextures with their masters.

Master and slave cliptextures do not work when the different cliptextures represent different textures. Separate cliptextures must be created for each texture that has to be displayed. Another condition that prevents using master/slave cliptexture groups is when the center for the cliptexture in each pipe is completely independent. Master and slave cliptextures assume that the tex region for each cliptexture is always completely enclosed by the shared mem region. If that assumption is violated, the cliptexture data will be invalid for the parts of the tex region outside of the shared mem region, and the cliptextures will print error messages.

Slave Cliptextures with Offset Centers

There is no reason for the slave cliptextures to have the same centers as the master, as long as the tex regions always stay within the mem region. Sometimes it is desirable for an application to have views with slightly different viewpoints for each pipe. This can be done by turning off clipcenter sharing and having the application set a slave's center directly. The application is responsible for keeping the tex region inside the master's mem region at all times. The position of the master's center determines the groups mem region, so the master's center can not be offset from the center of the mem region.

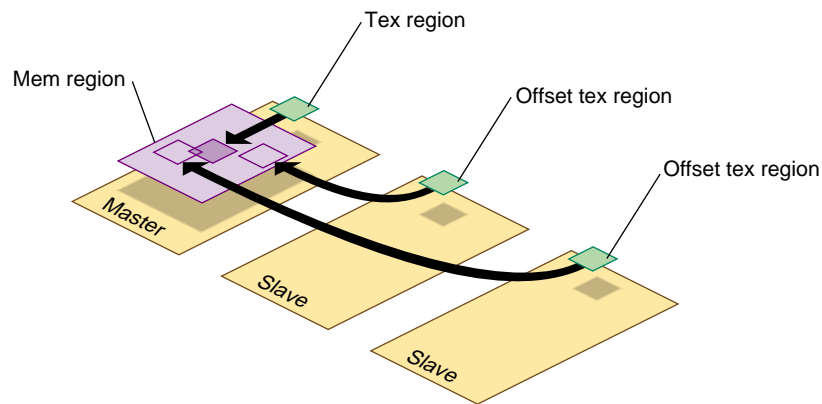

Figure 15-14 Offset Slave Tex Regions

Virtualizing Cliptextures

Virtual cliptextures are one of the most challenging features to use in an OpenGL Performer application. Cliptextures themselves are challenging enough, since they tie together functionality in the scene graph, pfPipes and pfChannels. Virtual cliptextures add an additional level of complication, since they require that the application segment the terrain, estimate the texture LOD levels needed for each terrain segment based on the current eyepoint, and update the virtual cliptexture parameters appropriately.

Some tips to consider when working with virtual cliptextures:

- Get your application working with a non-virtual cliptexture first. It is hard to separate virtual cliptexture problems from basic cliptexture configuration problems (which are usually easier to fix).

- Start off with a single segment and as little complexity in the application as possible; then get that working. It makes debugging much simpler.
- When in doubt, print it out. For debugging purposes, a well placed set of `pfNotify()` statements can be really helpful. It is also useful to set up a canonical scene, where you know what parameters should be generated, then compare them against what the program does.
- Take maximum advantage of sample code and utilities. Try to re-use some of the example code provided by OpenGL Performer. Using (or just reading) through the loaders, example programs, and utilities listed in this section “Cliptexture Sample Code” on page 604 can save you hours of work.

Customizing Load Control

Normally, bandwidth from disk to system memory is optimized by image cache configuration. You can use the streams feature in image cache configuration files to maximize bandwidth by configuring the system with more disks and disk controllers, and copying the texture data files over multiple disks. By using the streams feature in image cache configuration files, you can then parallelize the disk downloads over separate disks and disk controllers. You can also stripe disks to increase disk download bandwidth.

Texture memory bandwidth is more a matter of careful rationing of DRAW process time each frame. You will have to ration between sending geometry and texture data to the graphics pipeline. You can adjust the cliptexture’s `texload` time to minimize idle time in the draw process. DTR computes texture download time using a cost table to estimate what the download updates will cost each frame. It is a good estimate but not a perfect one. You may have to build in some time margin in the DRAW process to avoid dropping frames.

Download time setting can be as simple as finding the minimum time that still allows the cliptexture to be completely sharpened when the clipcenter is stationary. If the `texload` time is too small, a cliptexture can get “stuck” and never sharpen beyond a given level.

If you are a sophisticated user, you might consider adjusting the invalid border as well, which will change the effective clip size of the cliptexture. This could be used to allow a new level to be gradually loaded over a number of frames, trading off a finer visible level against a smaller effective clip region.

Custom Read Functions

Custom read functions allow the application to control what happens when texture data is downloaded from disk. Operations include: texture data decompression, texture data image processing, signaling an update of a disk cache from tape, etc. As described in the API section, replacing the read function is fairly easy to do in OpenGL Performer.

There is one caveat: increasing the overhead of read functions can have undesirable consequences. The latency of read operations determines the minimum size of the image cache mem regions, since they need to lookahead to compensate for high latency reads. Low bandwidth read operations affect how fast the center can move before DTR must blur down to coarser levels.

One way around these problems is to implement a lookahead disk cache. Rather than have the read function decompress files, have it read files from a cache of files that have already been decompressed by an asynchronous process. The read function can signal the other process to decompress more files as it gets close to the edge of the cache.

Texture data image processing, since it is relatively fast compared to disk reads, usually does not require such elaborate measures. Changing the read function can be done in conjunction with modifying the image cache mem region data to ensure that all data read from disk is processed. A good example of this technique is the gridify feature, described in "Invalidating Cliptextures" on page 584.

Cliptexture Sample Code

The best way to learn to use cliptextures is to work from existing code. OpenGL Performer has a number of demo programs, test programs, loader code, and utilities, with different levels of sophistication:

Test and Demo Programs

- `/usr/share/Performer/src/pguide/libpr/C/icache.c` for IRIX and Linux and `%PFROOT%\Src\pguide\libpr\C\icache.c` for Microsoft Windows

This is a simple `libpr`-style program that uses an image cache and the texture transform matrix to scroll texture across a polygon.

- `/usr/share/Performer/src/pguide/libpr/C/icache_mwin.c` for IRIX and Linux and `%PFROOT%\Src\pguide\libpr\C\icache_mwin.c` for Microsoft Windows

This program is a multiwindow version of `icache`; it uses master and slave image caches. Note that the tex regions of the slaves image caches are offset from the master.

- `/usr/share/Performer/src/pguide/libpr/C/cliptex.c` for IRIX and Linux and `%PFROOT%\Src\pguide\libpr\C\cliptex.c` for Microsoft Windows

This is a simple `libpr`-style program that uses a cliptexture to display a bird's eye view of data. On a system that supports cliptexturing, it moves the clipcenter, allowing the user to see the rectangle of texture resolution move as the center translates between opposite diagonals.

- `/usr/share/Performer/src/pguide/libpr/C/cliptex_mwin.c` for IRIX and Linux and `%PFROOT%\Src\pguide\libpr\C\cliptex_mwin.c` for Microsoft Windows

This is a multiwindow version of `cliptex`. It uses master and slave cliptextures.

- `/usr/share/Performer/src/pguide/libpf/C/cliptex.c` for IRIX and Linux and `%PFROOT%\Src\pguide\libpf\C\cliptex.c` for Microsoft Windows

This is a `libpf` implementation using cliptextures. Rather than use clipcenter nodes, it uses a simple centering mechanism based on the x and y coordinates of the channel's viewpoint.

- `/usr/share/Performer/src/pguide/libpf/C/virtcliptex.c` for IRIX and Linux and `%PFROOT%\Src\pguide\libpr\C\virtcliptex.c` for Microsoft Windows

This is the virtual cliptexture version of the `cliptex` program. It will take any size cliptexture and virtualize it. It divides a flat terrain in the x,y plane into a rectangular grid, attaching geodes with callbacks to each grid square. The callback calculates the virtual cliptexture parameters and applies them.

OpenGL Performer Cliptexture Applications

- `/usr/share/Performer/src/sample/C/perfly` for IRIX and Linux and `%PFROOT%\Src\sample\C\perfly` for Microsoft Windows

This sample application supports cliptextured scene graphs. It assumes that the loaders will do the basic configuration, but it does the post loading cliptexture configuration, creating `pfMPClipTextures` and attaching them to pipes. It assumes that clipcenter nodes are in the scene graph and that they will do the centering work. Pressing `g` will toggle the gridify feature.

- `/usr/share/Performer/src/sample/C/clipfly` for IRIX and Linux and `%PFROOT%\Src\sample\C\clipfly` for Microsoft Windows

This is the cliptexture version of the `perfly` sample application. It contains extra interface sliders and buttons that allow you to control many more cliptexture parameters.

- `/usr/share/Performer/src/sample/C++/clipdemo` for IRIX and Linux
It demonstrates how to set up a virtual cliptexture on regularly tiled terrain.

Loaders that Support Cliptextures

- `/usr/share/Performer/src/lib/libpfdb/libpfim/pfim.c` for IRIX and Linux and `%PFROOT%\Src\lib\libpfdb\libpfim\pfim.c` for Microsoft Windows

This is the OpenGL Performer example loader. It contains simple tokens to create clipcenter nodes and cliptextures. It is a good starting point for cliptexture configuration in the loader.

- `/usr/share/Performer/src/lib/libpfdb/libpfct/pfct.C` for IRIX and Linux and `%PFROOT%\Src\lib\libpfdb\libpfct\pfct.C` for Microsoft Windows

This is a more sophisticated cliptexture sample loader. It automatically creates some simple cliptextured geometry, and supports virtual cliptextures, providing the geometry segmentation and scene graph callbacks.

- `/usr/share/Performer/src/lib/libpfdb/libpfvct/pfvct.C` for IRIX and Linux and `%PFROOT%\Src\lib\libpfdb\libpfvct\pfvct.C` for Microsoft Windows

This is a very simple pseudo loader that will adjust a cliptextures parameters so it can be used as a virtual cliptexture, even if its dimensions are smaller than 32K by 32K.

- `/usr/share/Performer/src/lib/libpfspherepatch/pfspherepatch.C` for IRIX and Linux and `%PFROOT%\Src\lib\libpfspherepatch\pfspherepatch.C` for Microsoft Windows

This is a cliptexture loader designed to apply a cliptexture to a sphere. It is a good example of a specific cliptexture application.

Cliptexture Utility Code

- `/usr/share/Performer/src/lib/libpfutil/gridify.C` for IRIX and Linux and `%PFROOT%\Src\lib\libpfutil\gridify.C` for Microsoft Windows

The `gridify` functionality illustrates techniques for dynamically modifying cliptexture data and illustrates how to replace the cliptexture's read function.

- `/usr/share/Performer/src/lib/libpfutil/trav.c` for IRIX and Linux and `%PFROOT%\Src\lib\libpfutil\trav.c` for Microsoft Windows

The function `pfuFindClipTextures()` illustrates how to traverse the scene graph to find cliptextures.

- `/usr/share/Performer/src/lib/libpfutil/pfuClipCenterNode.C` for IRIX and Linux and `%PFROOT%\Src\lib\libpfutil\pfuClipCenterNode.C` for Microsoft Windows

This code defines the clipcenter node and contains example code for creating customized clipcenters by subclassing.

- `/usr/share/Performer/src/lib/libpfutil/clipcenter.c` for IRIX and Linux and `%PFROOT%\Src\lib\libpfutil\clipcenter.c` for Microsoft Windows

The `pfuProcessClipCenters()` and `pfuProcessClipCentersWithChannel()` functions illustrate how to use clipcenters in an application.

- `/usr/share/Performer/src/lib/libpfutil/cliptexture.c` for IRIX and Linux and `%PFROOT%\Src\lib\libpfutil\cliptexture.c` for Microsoft Windows

The `pfuAddMPClipTextureToPipes()` and `pfuAddMPClipTexturesToPipes()` functions illustrate how to work with cliptextures and pipes.

Windows

Rendering to the graphics hardware requires a window. A window is an allocated area of the screen with associated framebuffer resources.

For IRIX and Linux, the X window system manages the use of shared resources among the different windows. Windows can be requested directly from an X window server. By use of the GLX extension, OpenGL Performer-based OpenGL graphics contexts can render into X windows.

For Microsoft Windows, HWNDs and OpenGL/WGL contexts are used.

This chapter describes how to create, configure, manipulate, and communicate with a window using `pfWindow` in OpenGL Performer. The extended `libpf` object `pfPipeWindow`, based on `pfWindow`, is also mentioned in this chapter as the two objects share much functionality. Likewise, for good understanding of windowing issues, read the next chapter, Chapter 17, “`pfPipeWindows` and `pfPipeVideoChannels`.”

pfWindows

The `pfWindow` object provides an efficient windowing interface between your application and the X Window System or the Microsoft Windows GUI. `pfWindows` typically create an X window (an HWND on Microsoft Windows) or can also be configured to embed your rendering area within a window created with Motif® or other windowing toolkits. `libpr` provides utilities to shield you from the differences between the different types of windows and guide you in your dealings with the window system. `pfWindows` also keep track of your graphics state: they include a `pfState` which is automatically initialized when you open a window and switched for you when you change windows. Simple `libpr` windowing support centers around the `pfWindow`. The `libpf` windowing support utilizes a `pfWindow` as part of a `pfPipeWindow`.

OpenGL Performer automatically configures and initializes your window so that it will be ready to start rendering efficiently. In the simplest case, `pfWindows` make creating a

graphics application that can run on any SGI machine with OpenGL a snap. `pfWindows` do not limit your ability to configure any part or all of your windowing environment yourself; you can use the `libpr pfWindows` to manage your GL windows even if you create and configure the actual windows yourself.

Creating a `pfWindow`

A `pfWindow` structure is created with `pfNewWin()`. It can then be immediately opened with `pfOpenWin()`. Example 16-1 shows the most basic `pfWindow` operations in `libpr` program: to open and clear a `pfWindow` and swap front and back color buffers.

Example 16-1 Opening a `pfWindow`

```
int main (void)
{
    pfWindow *win;
    /* Initialize Performer */
    pfInit();
    pfInitState(NULL);

    /* Create and open a Window */
    win = pfNewWin(NULL);
    pfWinName(win, "Hello from OpenGL Performer");
    pfOpenWin();

    /* Rendering loop */
    while (1)
    {
        /* Clear to black and max depth */
        pfClear(PFCL_COLOR | PFCL_DEPTH, NULL);
        ...
        pfSwapWinBuffers(win);
    }
}
```

The `pfWindow` in Example 16-1 will have the following configuration:

Window system interface

An OpenGL window using the OpenGL/X GLX interface on IRIX and Linux or an OpenGL HWND on Microsoft Windows.

Screen	On IRIX and Linux, the pfWindow will open a window on the screen specified by the DISPLAY environment variable or else on screen 0. On Microsoft Windows, screen 0 will always be used.
Position and size	The position and size will be undefined and the window will come up as a rubber-band for the user to place and stretch.
Framebuffer configuration	The window will be double-buffered RGBA with depth and stencil buffers allocated. The size of these buffers will depend on the available resources of the current graphics hardware platform. pfWindows will also have multisample buffers allocated if they are available on current hardware platform.
libpr state	A pfState will be created and initialized with all modes disabled and no attributes set.
Graphics state	The pfWindow will be in RGBA color mode with subpixel vertex positioning, depth testing and viewport clipping enabled. The viewing projection will be a two-dimensional one-to-one orthographic mapping from eye coordinates to window coordinates with distances to near and far clipping planes -1 and 1, respectively. The model matrix will be the current matrix and will be initialized to the identity matrix.

Typically, pfWindows go through a bit more initialization than that of Example 16-1. The pfWindow type, set with **pfWinType()**, is a bitmask that selects the window system interface and the type of rendering window. Table 16-1 lists the possible selectors that can be ORed together for specification of the window type.

Table 16-1 pfWinType() Tokens

PFWIN_TYPE_ Bitmask Token	Description
X	Window will be an X window on IRIX and Linux but will be an HWND on Microsoft Windows. This is the default.
STATS	Window will have framebuffer resources to accommodate hardware statistics modes. This type cannot be combined with PFWIN_TYPE_OVERLAY or PFWIN_TYPE_NOPORT.
OVERLAY	Window will have only overlay planes for rendering. This type cannot be combined with PFWIN_TYPE_STATS or PFWIN_TYPE_NOPORT.

Table 16-1 **pfWinType() Tokens (continued)**

PFWIN_TYPE_ Bitmask Token	Description
NOPORT	Window will have a graphics context but no physical window or graphics or framebuffer rendering resources and will not be placed on the screen. This token can not be used in combination with any other type token.
PBUFFER	The pfWindow drawable will be created as a pbuffer and will not be visible.
UNMANAGED	Other than select upon open, no unrequested window management operations are done automatically on the pfWindow.

The selection of screen can be done explicitly with **pfWinScreen()**, or implicitly by opening a connection to the window system using **pfOpenScreen()** with the desired screen as the default screen. A window system connection can communicate with any screen on the system; the default screen only determines the screen for windows that do not have a screen explicitly set for them. Only one window system connection should be opened for a process. See “Communicating with the Window System” later in this section for details on efficient interaction with the window system.

The position and/or size, is set with **pfWinOriginSize()**. If the x and y components of the origin are (-1), the window will open with position undefined for the user to place. If the x or y components of the size are (-1), the window will open with both position and size undefined (the default) for the user to place and stretch. On IRIX and Linux, the X window manager may override negative origins and place the window at (0,0). If the window is already opened when **pfWinOriginSize()** is called, the window will be reconfigured to the specified origin and size upon the next **pfSelectWin()**. Similarly, **pfWinFullScreen()** causes a window to open as full screen or to become full screen upon the next call to **pfSelectWin()**. A full screen window will have its border automatically removed so that the drawing area truly gets the full rendering surface. The routines for querying the position and size work a bit differently than the pattern established by the rest of `libpr` get and set pairs of routines. This is because a user may change the origin or size independently of the program and under certain conditions, querying the true current X window size and origin can be expensive. **pfGetWinOrigin()** and **pfGetWinSize()** will always be fast and returns the last explicitly set origin and size, such as by **pfOpenWin()**, **pfWinOriginSize()**, or **pfWinFullScreen()**. If the window origin or size has been changed, but not through a pfWindow routine, the values returned by **pfGetWinOrigin()** and **pfGetWinSize()** may not be correct. **pfGetWinCurOriginSize()** returns an accurate size and origin relative to the pfWindow parent. For X windows, note that it requires an expensive query to the X server and should not be done in real-time situations. **pfGetWinCurScreenOriginSize()** returns the size and the screen-relative

origin of the pfWindow. As with **pfGetWinCurOriginSize()**, this command will be quite expensive and is not recommended except for rare use or initialization purposes.

pfPipeWindows, discussed in Chapter 17, “pfPipeWindows and pfPipeVideoChannels,” take advantage of the multiprocessed `libpf` environment to always be able to return an accurate window size and origin relative to the window parent. However, even for pfPipeWindows, getting a screen-relative origin can be an expensive operation.

Hint: Write programs that are window-relative and do not depend on knowing the current exact location of a window relative to its parent or screen.

Configuring the Framebuffer of a pfWindow

OpenGL Performer provides a default framebuffer configurations for the current graphics hardware platform for the standard window types: normal rendering, statistics (stats), and overlay. You may want to define your own framebuffer configuration, such as single-buffered, stereo, etc. You can use utilities in `libpr` to help you with this task, or create your own framebuffer configuration structure with X utilities, or even create the window yourself and apply it to the pfWindow. **pfOpenWin()** respects any specified framebuffer configuration. Additionally, **pfOpenWin()** uses any window or graphics context that is assigned to it and only creates what is undefined.

pfWinFBConfigAttrs() can be used to specify an array of framebuffer attribute tokens listed in Table 16-2. The tokens correspond to OpenGL/X tokens. Note that if an attribute array is specified, the tokens modify configuration with no attributes set, not the default OpenGL Performer framebuffer configuration.

Table 16-2 pfWinFBConfigAttrs() Tokens

PFFB_Token	Value	Description
BUFFER_SIZE	integer > 0	The size of the color index buffer.
LEVEL	integer > 0	The color plane level: normal color planes have level = 0 overlay color planes have level > 0 underlay color planes have level < 0 There may be only one or no levels for overlay and underlay color planes on some graphics hardware configurations.
RGBA	Boolean: true if present	Use RGBA color planes (instead of color index).
DOUBLEBUFFER	Boolean: true if present	Use double-buffered color buffers.
STEREO	Boolean: true if present	Allocate left and right stereo color buffers (allocates back left and back right if DOUBLEBUFFER is specified).
AUX_BUFFER	integer > 0	Number of additional color buffers to allocate.
RED_SIZE GREEN_SIZE BLUE_SIZE ALPHA_SIZE	integer > 0	Minimum number of bits color for components R, G, and B will all be the same and be the maximum specified. Alpha may be different.
DEPTH_SIZE	integer > 0	Number of bits in the depth buffer.
STENCIL	integer > 0	Number of bits allocated for stencil. One is used by pfDecal rendering and three or four are used by the hardware fill statistics in pfStats.
ACCUM_RED_SIZE ACCUM_GREEN_SIZE ACCUM_BLUE_SIZE ACCUM_ALPHA_SIZE	integer > 0	Number of bits per RGBA component for the accumulation color buffer.
USE_GL	Boolean: true if present	Exists for historical reasons. Has no effect.

If you desire more control over the exact framebuffer configuration of your pfWindow, you have several options. For OpenGL/X windows you can provide the appropriate framebuffer description for the current GL operation to the pfWindow using **pfWinFBConfig()**. X uses *visuals* to describe available framebuffer configurations. XVisualInfo pointer with **XGetVisualInfo()** returns a list of all visuals on the system and you can search through them to find the appropriate configuration. On IRIX-based systems, OpenGL/X also uses GLXFBConfigSGIX to describe framebuffer configurations. You can select either the visual or the GLXFBConfigSGIX for your window and set it on the pfWindow with **pfWinFBConfig()**. **pfGetWinFBConfig()** always returns the corresponding X visual.

libpr also offers utilities for creating framebuffer configurations (pfFBConfig) independently of a pfWindow. **pfChooseFBConfig()** takes an attribute array of tokens from Table 16-2 and will return a pfFBConfig structure that can be used with your pfWindows, or with X Windows created outside of libpr, such as with Motif. You may get back a framebuffer configuration that is better than the one you requested. OpenGL Performer will give you back the maximum framebuffer configuration that meets your request that will not add any serious performance degradations. There are specific machine-dependent instances where, for performance reasons, we do limit the framebuffer configuration. See the man page for **pfChooseWinFBConfig()** for the specific details. The libpfutil utility **pfuChooseFBConfig()** in `/usr/share/Performer/src/lib/libpfutil/xwin.c` (IRIX and Linux) and `%PFRONT%\Src\lib\libpfutil\xwin.c` (Microsoft Windows) provides a limiting framebuffer configuration selector, complete with source code.

You can use **pfQuerySys()** to query particular framebuffer resources in the current hardware configuration and then use **pfQueryWin()** to query your resulting framebuffer configuration.

pfWindows and GL Windows

Note: This is an advanced topic.

For IRIX and Linux, libpr allows you to use X window handles and OpenGL/X graphics contexts to create your own windows and to set them on the pfWindow. These handles can be assigned to the pfWindow with **pfWinWSDrawable()** or **pfWinGLCxt()**.

For Microsoft Windows, you can do the same, but you must use HWNDs (instead of X window handles) and OpenGL/WGL graphics contexts.

pfOpenWin() will automatically call **pfInitGfx()** and will automatically create a new **pfState** for your window. If you have your own window management and do not call **pfOpenWin()**, then you should definitely call **pfInitGfx()** to initialize the window's graphics state for OpenGL Performer rendering. You will also need to call **pfNewState()** to create a **pfState** for OpenGL Performer's state management.

For X windows, OpenGL Performer maintains two windows and a graphics context. The top level X window is placed on the screen and is the one that you should use in your application for selecting X events. This top level window is very lightweight and has minimal resources allocated to it. OpenGL Performer then maintains a separate X window that is a child of the parent X window and is the one that is attached to the graphics context. This allows you to select different framebuffer resources for the same drawing area by just selecting a different graphics window and graphics context pair for the parent X window. **pfWindows** directly support this functionality and this is discussed in the next section, "Manipulating a **pfWindow**". Finally, with OpenGL, you may choose to draw to a different X Drawable than a window. X windows are created with the X function **XCreateWindow()**. OpenGL graphics contexts are created with **glXCreateContext()**. The parent X Window can be set with **pfWinWSWindow()**, the graphics window or X Drawable is set with **pfWinWSDrawable()** and can be an X window, **pbuffer**, or **pixmap**. The graphics context is set with **pfWinGLCxt()**. OpenGL Performer defines the following window-system-independent types defined in Table 16-3. If you create your own window but want to use **pfQueryWin()**, you must also provide the framebuffer configuration information with **pfWinFBConfig()**. **pfQueryWin()** uses the internally stored visual.

Table 16-3 Window System Types

pfWS Type	X Type	pfWindow Set/Get Routine
pfWSWindow	X Window for IRIX and Linux HWND for Microsoft Windows	pfWinWSWindow() pfGetWinWSWindow()
pfWSDrawable	Drawable (window, pbuffer , pixmap) for IRIX and Linux	pfWinWSDrawable() pfGetWinWSDrawable()
	HANDLE (to window or buffer) for Microsoft Windows	

Table 16-3 Window System Types (**continued**)

pfWS Type	X Type	pfWindow Set/Get Routine
pfGLContext	OpenGL: GLXContext for IRIX and Linux HGLRC for Microsoft Windows	pfWinGLCxt() pfGetWinGLCxt()
pfFBConfig	XVisualInfo* or GLXFBConfigSGIX* for IRIX and Linux int (pixel format ID) for Microsoft Windows	pfWinFBConfig() pfGetWinFBConfig()
pfWSCconnection	Display* for IRIX and Linux only	pfGetCurWSCconnection()

Manipulating a pfWindow

Windows are opened with **pfOpenWin()** and closed with **pfCloseWin()**. When a window is closed, its graphics context is deleted. If you have multiple windows, you select the window to draw to with **pfSelectWin()**. Multiple windows can be made more efficient using share groups configured with **pfWinShare()** to share hardware resources. Multiple windows can be made to have swapbuffers execute simultaneously through window swap groups created with **pfAttachWinSwapGroup()**. There are also some additional modes on pfWindows to control their behavior under various operations. This section goes through the basics of these important features.

There are some modes you can set that can effect the general look and behavior of your window and alternate configuration windows. These boolean modes can be individually set and changed at any time with **pfWinMode()** and the tokens in Table 16-4.

Table 16-4 pfWinMode() Tokens

PFWIN_Token	Description
NOBORDER	Window will be without normal window system border
HAS_OVERLAY	Overlay alternate configuration window will be managed by the pfWindow. pfOpenWin() will automatically create an overlay window if one has not already been set. pfWinIndex(win, PFWIN_OVERLAY_WIN) will also automatically create and open an overlay window if one has not already been set.
HAS_STATS	Statistics alternate configuration window will be managed by the pfWindow. pfOpenWin() will automatically create a statistics window if one has not already been set. pfWinIndex(win, PFWIN_OVERLAY_WIN) will also automatically create and open a statistics window if one has not already been set and if the current window cannot support statistics.
AUTO_RESIZE	The graphics window and active alternate configuration windows are automatically resized to match the parent pfWinWSWindow() . This mode is enabled by default.
ORIGIN_LL	The origin of the pfWindow, for placement purposes, will be the lower-left corner. X and the Microsoft Windows GUI use the upper left corner as the origin. This mode is enabled by default.
EXIT	The application will receive a DeleteWindow message upon selection of the "Exit" from the window system menu on the window border.

Alternate Framebuffer Configuration Windows

OpenGL Performer supports multiple framebuffer configurations for the same drawing area with alternate configuration windows. An OpenGL Performer alternate configuration window has the same window parent (**pfWinWSWindow()**) but may have a different drawable and graphics context. There are standard alternate configuration windows for overlay and statistics windows that can be automatically created upon demand.

An alternate configuration window is created as a full pfWindow and is an alternate configuration window by virtue of being given to a base window in a pfList of alternate configuration windows, or being directly assigned as one of the standard alternate

configuration windows with either of **pfWinOverlayWin()** or **pfWinStatsWin()**. A pfWindow may be an alternate configuration window of only one base window at a time; alternate configuration windows may not be instanced between base windows. The sharing of window attributes between alternate configuration windows, such as the parent X window and GL objects (for OpenGL windows), must be set with **pfWinShare()** on the base window and applied to the alternate configuration windows with **pfAttachWin()**. You select the desired alternate configuration window to draw into with **pfWinIndex()** and provide an index into your alternate configuration window list or one of the standard indices (PFWIN_GFX_WIN, PFWIN_OVERLAY_WIN, or PFWIN_STATS_WIN). PFWIN_GFX_WIN is the default window index and selects the base window. If the alternate configuration window has not been opened, it will be opened automatically upon being selected for rendering. Example 16-2 demonstrates creating a pfWindow using the default overlay window. The graphics drawable and graphics context of an alternate configuration window of a pfWindow can be closed with **pfCloseWinGL()**. This can be called on the base window, in which case the active alternate configuration window's GL window and context will be closed, or it can be called on the alternate configuration window pfWindow directly. The main parent window will remain on the screen and a new alternate configuration window can be applied to it or **pfOpenWin()** can be called to create a new graphics window and context.

Window Share Groups

Multiple windows on a screen will require duplicate processing and resources unless they are set up as share groups. A pfWindow is attached to the group of another with **pfAttachWin(*groupWin, attachee*)**. The attributes to be shared are set with **pfWinShare()** on any of the windows in the group. The full list of attributes are in the man page for pfWindow (and similarly for pfPipeWindow) but most notably are PFWIN_SHARE_GL_CXT for using the same graphics context across multiple windows, PFWIN_SHARE_STATE for sharing full state information, and PFWIN_SHARE_GL_OBJS for sharing display lists and textures across windows. In particular, sharing GL objects is important if a display list (such as for fonts) are to be created for one context and used in multiple contexts. When default alternate configuration windows are automatically created (overlay and stats) they are configured to share GL objects with the base window. A libpf pfPipeWindow example of window share groups is in `/usr/share/Performer/src/pguide/libpf/C/multiwin.c` for IRIX and Linux and in `%PFROOT%\Src\pguide\libpf\C\multiwin.c` for Microsoft Windows.

Synchronization of Buffer Swap for Multiple Windows

On IRIX systems, double-buffered `pfWindows` in window swap groups will have simultaneous hardware execution of the buffer swap. There is a similar mechanism for `pfPipeWindows` activated through `pfChannel` share groups sharing `PFCHAN_SWAPBUFFERS_HW` that is discussed in Chapter 2, “Setting Up the Display Environment.”

A window swap group is created by attaching windows with **`pfAttachWinSwapGroup(groupWin, attachee)`**. There is no global list maintained for the swap group and their status so you cannot get back a list of windows in the group. However, **`pfWinInSwapGroup()`** returns 1 if the specified window has been synchronized to a swap group and 0 otherwise. This synchronization configuration will actually take place upon a call to **`pfSelectWin()`** for the window. Windows of separate screens can be attached but this also requires a BNC cable (of any Ohms) to be attached to the swap ready connectors of the graphics pipelines. Detach from swap groups is not supported. GLX barriers are used for multi-pipeline synchronization. If necessary, you can have a `pfWindow` explicitly join a specific barrier group with **`pfWinSwapBarrier()`**. When windows of multiple screens are attached, the video vertical retrace of those screens should also be synchronized with `genLock(7)`.

Communicating with the Window System

You can communicate with a local or remote window server by means of a window system connection, a `pfWSConnection` (in X, also known as a Display connection). You can use your `pfWSConnection` for selecting X events for your window, as is demonstrated in Example 16-4.

`libpr` offers several utilities for creating a connection to a window server. A given connection can communicate with any screen managed by that window server so usually a process only needs one connection. A process should not share the connection of another process, so you will need a connection per process. Typically, there is exactly one window server on a machine but that is not required. `libpr` maintains a `pfWSConnection` for the current process. By default, this connection obeys the setting of the `DISPLAY` environment variable which can point to a window server on a local or a remote machine. The current connection can be requested with **`pfGetCurWSConnection()`** and can be set with **`pfSelectWSConnection()`**. Whenever possible, use this connection to limit the total number of open connections. **`pfOpenScreen()`** is a convenient mechanism for opening a connection with a specified

default screen. **pfOpenWSConnection()** allows you to specify the exact name specifying the desired target for the connection. Both **pfOpenScreen()** and **pfOpenWSConnection()** allow you to specify if you would like the new connection to automatically be made the current `libpr` `pfWSConnection`; this is recommended.

More pfWindow Examples

Example 16-2 demonstrates the creation of a window with a default overlay window.

Example 16-2 Using the Default Overlay Window

```
int main (void)
{
    pfWindow *win, *over;
    /* Initialize Performer */
    pfInit();
    pfInitState(NULL);

    /* Initialize the window. */
    win = pfNewWin(NULL);
    pfWinOriginSize(win, 100, 100, 500, 500);
    pfWinName(win, "OpenGL Performer");
    pfWinType(win, PFWIN_TYPE_X);
    pfWinMode(win, PFWIN_HAS_OVERLAY, 1);
    pfOpenWin(win);
    /* First select and draw into the overlay window */
    pfWinIndex(win, PFWIN_OVERLAY_WIN);
    /* Select causes the index to be applied */
    pfSelectWin(win);
    ...
    /* Then select the main gfx window */
    pfWinIndex(win, PFWIN_GFX_WIN);
    pfSelectWin(win);
    ...
}
```

Example 16-3 demonstrates creating a custom overlay window and is taken from the sample program

`/usr/share/Performer/src/pguide/libpr/C/winfbconfig.c` for IRIX and Linux and `%PFROOT%\Src\pguide\libpr\C\winfbconfig.c` for Microsoft Windows.

Example 16-3 Creating a Custom Overlay Window

```
static int OverlayAttrs[] = {
    PFFB_LEVEL, 1, /* Level 1 indicates overlay visual */
    PFFB_BUFFER_SIZE, 8,
    None,
};

int main (void)
{
    pfWindow *win, *over;
    /* Initialize Performer */
    pfInit();
    pfInitState(NULL);

    /* Initialize the window. */
    win = pfNewWin(NULL);
    pfWinOriginSize(win, 100, 100, 500, 500);
    pfWinName(win, "OpenGL Performer");
    pfWinType(win, PFWIN_TYPE_X);
    pfWinMode(win, PFWIN_HAS_OVERLAY, 1);

    over = pfNewWin(NULL);
    pfWinName(over, "OpenGL Performer Overlay");
    pfWinType(over, PFWIN_TYPE_X | PFWIN_TYPE_OVERLAY);
    /* See if we can get the desired overlay visual */
    if (!(pfChooseWinFBConfig(over, OverlayAttrs)))
        pfNotify(PFNFY_NOTICE, PFNFY_PRINT,
            "pfChooseWinFBConfig failed for OVERLAY win");
    pfOpenWin(win);
    /* First select and draw into the overlay window */
    pfWinIndex(win, PFWIN_OVERLAY_WIN);
    /* Select causes the index to be applied */
    pfSelectWin(win);
    ...
    /* Then select the main gfx window */
    pfWinIndex(win, PFWIN_GFX_WIN);
    pfSelectWin(win);
    ...
}
```

Example 16-4 demonstrates the selection of X input events on a pfWindow. This example is taken from `/usr/share/Performer/src/pguide/libpr/C/hlcube.c` for IRIX and Linux and from `%PFROOT%\Src\pguide\libpr\C\hlcube.c` for Microsoft Windows. See the `/usr/share/Performer/src/pguide/libpf/C/complex.c` sample program for a detailed example of using either standard or forked X input on pfWindows for IRIX and Linux and sample program `%PFROOT%\Src\pguide\libpf\C\complex.c` for Microsoft Windows.

Example 16-4 pfWindows and X Input

```

    pfWSConnection Dsp;

void main (void)
{
    pfWindow *win;
    pfWSWindow xwin;

    /* Initialize Performer */
    pfInit();
    pfInitState(NULL);

    /* Initialize the window. */
    win = pfNewWin(NULL);
    pfWinOriginSize(win, 100, 100, 500, 500);
    pfWinName(win, "OpenGL Performer");
    pfWinType(win, PFWIN_TYPE_X);
    pfOpenWin(win);
    ...
    /* set up X input event handling on pfWindow */
    Dsp = pfGetCurWSConnection();
    xwin = pfGetWinWSWindow(win);
    XSelectInput(Dsp, xwin, KeyPressMask );
    XMapWindow(Dsp, xwin);
    XSync(Dsp, FALSE);
    ...
    do_events(win);
}

static void
do_events(pfWindow *win)
{
    while (1) {
        while (XPending(dsp))
        {
            XEvent event;
            XNextEvent(Dsp, &event);

```

```
        switch (event.type)
        {
        case KeyPress:
            ....
        }
    }
}
```

pfPipeWindows and pfPipeVideoChannels

This chapter describes the additional windowing and video-channel based functionality provided by pfPipeWindows and pfPipeVideoChannels. These `libpf` objects, based on their `libpr` counterparts, pfWindows and pfVideoChannels, provide automatic configuration, multiprocessing, and extended functionality by being hooked together with pfChannels.

Using pfPipeWindows

OpenGL Performer can automatically create and open a full screen window with a default configuration for your pfPipe. At the other extreme, you can create and configure your own windows and set them on a pfPipe. There is a single interface for creating, configuring, and managing the windows. The pfPipeWindow is the mechanism by which a pfPipe knows about and keeps track of the windows to which it is to render, the size of the render area, and the framebuffer configuration. pfPipes and pfChannels need this information for proper viewport and frustum management and for using rendering features like antialiasing, transparency for fade LOD, and layers for decal geometry that are all affected by framebuffer configuration.

In the simplest case, OpenGL Performer automatically creates a pfPipeWindow for the application and automatically open a full screen window upon the first call to **pfFrame()**. This trivial case is demonstrated in Example 17-1.

Creating, Configuring and Opening pfPipeWindow

In most cases, there are some window parameters, such as size and origin, that you will want to set. You may also have custom graphics state that you need to set to fully initialize your rendering window. This section describes the basics for setting up windows through the pfPipeWindow mechanism.

A pfPipeWindow can be created for a pfPipe using **pfNewPWin(pipe)**. If you create a pfPipeWindow, then you are responsible for explicitly opening it. The call to **pfOpenPWin(pwin)** from the application process causes the next call to **pfFrame()** to trigger the opening of the pfPipeWindow in the draw process. A pfPipeWindow created in the application will be a rubber-band window of undefined size for the user to stretch out. This is in contrast to the full screen window that OpenGL Performer creates on your behalf in the fully automatic case. To easily get a full screen window, you can use the **pfPWinFullScreen()** function. **pfPWinOriginSize()** can be used to set a fixed position and size for the window. The code in Example 17-1, placed in the application process, creates and opens a window in the lower-left corner of the screen of size 500 pixels on each side.

Example 17-1 Creating a pfPipeWindow

```
main()
{
    pfPipe *pipe;
    pfPipeWindow *pwin;
    pfInit();
    ....
    pfConfig();
    /* Create pfPipeWindow for pfPipe 0 */
    pipe = pfGetPipe(0);
    pwin = pfNewPWin(pipe);
    /* Set the origin and size of the pfPipeWindow */
    pfPWinOriginSize(pwin, 0, 0, 500, 500);
    /* Tell OpenGL Performer that the pfPipeWindow is ready to
     * be opened
     */
    pfOpenPWin(pwin);
    /* trigger the opening of the pfPipeWindow
     * in the draw process
     */
    pfFrame();
    ...
    while(!SimDone())
    { ... }
}
```

The pfPipeWindow is always physically opened in the draw process when processing the application frame that requested the window to be opened. When both the cull and draw processes are running as separate processes, there might be a 2-frame delay (two additional calls to **pfFrame()**) for the window to actually be opened. Additionally, if the draw is running as a separate process, the window will not be opened right after pfFrame

but some time in that following frame. If the pfPhase is such that the application process is allowed to spin ahead while the draw process does expensive initialization (anything but PPHASE_FREE_RUN), the application process may execute many **pfFrame()** calls before the window is physically opened in the draw process. If in the application process you need to check on a result from opening the window, such as framebuffer configuration, you will want to do something that is in effect equivalent to the following:

```
while (!pfIsPWinOpen(pwin)) pfFrame();
```

pfPipeWindows are actually built upon `libpr` pfWindows, but have added support for handling the multiprocessed environment of `libpf` applications and fit into the `libpf` display hierarchy of pfPipes, pfPipeWindows, and pfChannels. Additionally, pfPipeWindows support the multiprocessing environment of `libpf` by having a separate copy of each pfPipeWindow in each pipeline process. All of the “windowness” of pfPipeWindows really comes from the fact that there is a pfWindow internal to the pfPipeWindow. Many of the basic support routines, such as **pfPWinFullScreen()** and **pfWinFullScreen()**, have very similar functionality for pfWindows and pfPipeWindows. However, there are situations where pfPipeWindows are able to provide the same functionality in a much more efficient manner. Management of dynamic window origin and size is one case where pfPipeWindows have a real advantage over pfWindows. pfPipeWindows are able to take advantage of the multiprocessed `libpf` environment to always be able to return an accurate window size and origin relative to the window parent. A process separate from the rendering process is notified by the window system of changes in the pfPipeWindow’s size in an efficient manner without impacting the window system or the rendering process. This can be forced off for the real-time static displays of a deployed visual simulation system by making the pfPipeWindow of type PFPWIN_TYPE_NOXEVENTS, which prevents OpenGL Performer from tracking the window. Further details regarding basic window creation and configuration are discussed with pfWindows in Chapter 16, “Windows.”

Note: **pfPWin*()** routines expect a pfPipeWindow and the **pfWin*()** routines a pfWindow. These routines are not interchangeable: pfWindow routines cannot accept pfPipeWindows nor the reverse. The PFWIN_* tokens can be used with the pfPipeWindow routines.

Windows have some intrinsic type attributes that must be set before the window is opened. The selection of the screen of a window is determined by the pfPipe that it is opened on, set for both the pfWindow and its pfPipe with the call **pfPWinScreen()**, or else set by the value of the DISPLAY variable when the window is finally opened. The window system configuration of the window must also be set before the window is

opened. Windows under OpenGL operation on IRIX and Linux systems will always be X windows. On Microsoft Windows, the windows will be HWNDS.

Note: Microsoft Windows virtualizes the concept of a screen as well as all available hardware. Hence, on such systems, you cannot specify the screen connection in a manner similar to using the DISPLAY environment variable.

An open window must be closed for its type to be changed. The window type argument is actually a bitmask and the type of a pfPipeWindow can include the attributes listed in Table 17-1.

Table 17-1 pfPWinType Tokens

PFPWIN_TYPE_*	
Bitmask Token	Type Attributes
X	The default. Rendering will be done to an X window. Ignored by OpenGL as all OpenGL rendering is done to X windows.
STATS	The window's normal drawing configuration supports graphics statistics. This affects framebuffer configuration and fill statistics.
SHARE	The pfPipeWindow automatically attaches to the first pfPipeWindow of the parent pipe with pfAttachPWin() .
PBUFFER	The window drawable is a pbuffer (not visible on the screen).
NOXEVENTS	Window size and position tracking is not done.
UNMANAGED	No automatic window management operations other than select for rendering happens. Window is not auto-sized or tracked. Swapbuffers will not automatically be done.

pfPipeWindows have a target default framebuffer configuration. The ability to meet this target depends on the current graphics hardware configuration, as well as their type. The following parameters are part of the target default configuration and are listed in their order of priority. If the goal framebuffer configuration cannot be created on the current graphics hardware configuration, lower priority parameters are downgraded as specified in the following:

1. double buffered
2. RGB mode with 8 bits per color component (4 if 8 cannot be supported)

3. z-buffer with depth of 23 or 24 bits, as available
4. one-bit stencil buffer (window type PFWIN_TYPE_STATS still requires four bits of stencil)
5. multisample buffer of 8, 4, or 0 samples as available
6. four-bit stencil buffer if still available after the above is satisfied

pfPipeWindows have OpenGL Performer `libppr` rendering state automatically initialized when they are opened. Additionally the following graphics state is automatically initialized when a window is opened or upon any call to **pfInitGfx()** for an open window:

1. RGB mode is enabled.
2. z-buffer is enabled and a z range is set.
3. Viewport clipping is enabled.
4. subpixel vertex accuracy is enabled.
5. The viewing matrix is initialized to a two-dimension, one-to-one mapping from eye coordinates to window coordinates.
6. The model matrix is initialized to the identity matrix and made the current GL matrix.
7. Backface removal is enabled.
8. Smooth shading is enabled.
9. If the current graphics hardware platform supports multisampling, multisampled antialiasing will be enabled with **pfAntialias(PFAA_ON)**.
10. A default modulating texture environment is created.
11. A default lighting model is created.

Custom framebuffer configuration for a pfPipeWindow can be specified with **pfPWinFBConfigAttrs()**, **pfPWinFBConfig()**, and **pfChoosePWinFBConfig()**. These routines have identical functionality as each of the corresponding pfWindow routines. However, the function **pfChoosePWinFBConfig()** has the constraint that it be called in the draw process because it creates and stores internal data from the window server that must be kept local to the process in which it is called. Table 17-2 lists the different pfPipeWindow routines and describes multiprocessing constraints.

The flexibility in changing the framebuffer configuration of OpenGL/X windows or OpenGL/HWNDs is complex. The main window can remain in place but structures under it must be switched or replaced. If multiple framebuffer configurations are likely to be desired, multiple graphics contexts can be created for the window using pfWindows. pfPipeWindows and pfWindows both allow you to have a list of alternate pfWindows that render to exactly the same screen area but may have different framebuffer configuration. You then select the current configuration for a pfPipeWindow with **pfPWinIndex()**. There are two kinds of common alternate configuration windows that can be created automatically for you: overlay windows created in the overlay planes and windows to support hardware fill statistics (discussed in Chapter 23, “Statistics”). You can use **pfPWinMode()** to indicate that you would like these windows created for you automatically. Special tokens to **pfPWinIndex()** are used to select these common special alternate configuration windows—PFWIN_GFX_WIN, PFWIN_OVERLAY_WIN and PFWIN_STATS_WIN—where PFWIN_GFX_WIN selects the normal default drawing window. Note that only a pfWindow, never a pfPipeWindow, can be an alternate configuration window. The source code in Example 17-2 is taken from

/usr/share/Performer/src/pguide/libpf/C/pipewin.c for IRIX and Linux and from %PFROOT%\Src\pguide\libpf\C\pipewin.c for Microsoft Windows. It demonstrates the automatic creation and selection of overlay and statistics windows for a pfPipeWindow. This also shows usage of pfChannels and interaction between pfPipeWindows and pfChannels discussed in the section “Creating and Configuring a pfChannel” in Chapter 2.

Example 17-2 pfPipeWindow With Alternate Configuration Windows for Statistics

```
main()
{
    pfPipe *pipe;
    pfPipeWindow *pwin;
    pfInit();
    ....
    pfConfig();

    /* Create pfPipeWindow for pfPipe 0 */
    pipe = pfGetPipe(0);
    pwin = pfNewPWin(pipe);
    /* request automatic default overlay and stats windows */
    pfPWinMode(pwin, PFWIN_HAS_OVERLAY, PF_ON);
    pfPWinMode(pwin, PFWIN_HAS_STATS, PF_ON);
    /* Open the main graphics window */
    pfOpenPWin(pwin);
    pfFrame();
}
```

```

while(!SimDone())
{
...
if (Shared->winSel == PFWIN_STATS_WIN)
{
    /* select statistics window and enable fill stats */
    pfPWinIndex(Shared->pw, PFWIN_STATS_WIN);
    pfFStatsClass(fstats,
        PFSTATSHW_ENGFPIPE_FILL, PFSTATS_ON);
    pfEnableStatsHw(PFSTATSHW_ENGFPIPE_FILL);
}
else
{
    /* we are not doing statistics so turn them off */
    pfFStatsClass(fstats,
        PFSTATSHW_ENGFPIPE_FILL, PFSTATS_OFF);
    pfDisableStatsHw(PFSTATSHW_ENGFPIPE_FILL);
    pfPWinIndex(Shared->pw, Shared->winSel);
...
}
}

/* Channel draw process drawing function */
void DrawFunc(void pfChannel *chan)
{
    pfPipeWindow *pwin;
    pwin = pfGetChanPWin(chan);
    if (pfGetPWinIndex(pwin) == PFWIN_OVERLAY_WIN)
    {
        /* Draw overlay image */
        DrawOverlay();
        /* Put back the normal drawing window */
        pfPWinIndex(pwin, PFWIN_GFX_WIN);
        /* Indicate that we will now draw to the window */
        pfSelectPWin(pwin);
    }
    /* call the main OpenGL Performer drawing function */
    pfDraw();
}

```

Notice that in Example 17-2, although the pfPipeWindow is double buffered, the front and back color buffers are never explicitly swapped. For pfPipeWindows, this operation is done automatically after all channels on the parent pfPipe have completed their

drawing for the given frame. The color buffers of a pfPipeWindow may be swapped explicitly with pfSwapWinBuffers. This call may be placed in a user-swap function call back placed on the pfPipe with **pfPipeSwapFunc()** to replace the pfPipe normal swap behavior. The swap callback will be called in the draw process at the end of the frame after all pfChannels in all pfWindows have been drawn for the pfPipe. The function is called for all of the pfPipeWindows on the pfPipe. This is additionally useful for doing end-of-frame rendering or readbacks from the framebuffer.

You may need to set additional window and graphics state to complete the initialization of your pfPipeWindow. Calling **pfOpenPWin()** from the application process does not give you the opportunity to do this. However, with **pfPWinConfigFunc()**, you can supply a window configuration callback function that will enable you to open and initialize your pfPipeWindow in the draw process. A call to **pfConfigPWin()** triggers one call of the window configuration callback in the draw process upon the next call to **pfFrame()**. **pfConfigPWin()** can be called at any time to trigger the calling of the current window configuration function in the draw process. Example 17-3 demonstrates initializing a pfPipeWindow from a draw process window configuration callback. It creates a global light to serve as the Sun in the window configuration callback. (see the /usr/share/Performer/src/pguide/libpf/C/complex.c example for IRIX and Linux and %PFROOT%\Src\pguide\libpf\C\complex.c for Microsoft Windows).

Example 17-3 Custom Initialization of pfPipeWindow State

```
main()
{
    pfPipe *pipe;
    pfPipeWindow *pwin;
    pfInit();
    ....
    pfConfig();

    /* Create pfPipeWindow for pfPipe 0 */
    pipe = pfGetPipe(0);
    pwin = pfNewPWin(pipe);
    /* Set the configuration function for the pfPipeWindow */
    pfPWinConfigFunc(pwin, OpenPipeWindow);
    /* Indicate that OpenPipeWindow should be called in the
     * draw process.
     */
    pfConfigPWin(pwin);

    /* trigger OpenPipeWindow to be called in the draw process */
```



```

    pfFrame();
    while(!SimDone())
    { ... }
}

/* Initialize graphics state in the draw process */
void
OpenPipeWindow(pfPipeWindow *pw)
{
    /* Set some configuration stuff */
    pfPWinOriginSize(pw, 0, 0, 500, 500);
    /* Open the window - will give us initialized libpr and graphics state
    */
    pfOpenPWin(pw);

    /* create a global light in the "south-west" (QIII) */
    Sun = pfNewLight(NULL);
    pfLightPos(Sun, -0.3f, -0.3f, 1.0f, 0.0f);
}

```

In Example 17-3 the functions **pfPWinOriginSize()** and **pfOpenPWin()** are now called in the draw process, as opposed to the application process as in Example 17-1. In general, configuring or editing any `libpf` object must be done in the application process. `pfPipeWindows` must be created in the application process. However, `pfPipeWindows` may be configured, edited, opened and closed in the **pfPWinConfigFunc()** configuration callback which will be called in the draw process. Window operations are best done in a configuration callback, though they can also be done in the drawing callback for a `pfChannel` on the window. Any function which aspires to directly affect the graphics context must be called in the drawing process. Table 17-2 shows which processes (application or draw via a configuration function) that `pfPipeWindow` calls can be made from and further detail about these functions can be found in the discussion of `pfWindows` in Chapter 16, "Windows."

Table 17-2 Processes From Which to Call Main `pfPipeWindow` Functions

pfPipeWindow Function	Application Process	Draw Process
pfNewPWin()	Yes	No
pfPWinMode()	Yes	Yes
pfPWinIndex()	Yes	Yes

Table 17-2 Processes From Which to Call Main pfPipeWindow Functions (**continued**)

pfPipeWindow Function	Application Process	Draw Process
pfPWinConfigFunc()	Yes	No
pfOpenPWin() pfClosePWin() pfClosePWinGL()	Yes	Yes
pfPWinOriginSize() pfPWinFullScreen()	Yes	Yes
pfGetPWinCurOriginSize()	Yes	Yes.
pfPWinFBConfigAttrs()	Yes	Yes.
pfChoosePWinFBConfig()	No	Yes.
pfPWinFBConfig()	Yes, but the pfFBConfig* must be valid for access in the draw process.	Yes.
pfPWinType() pfPWinScreen() pfPWinShare(), pfAttachWin()	Yes (before opened)	Yes (before opened).
pfPWinWSWindow()	Yes	Yes.
pfPWinGLCxt()	Yes, but the context must be created in the draw process.	Yes.
pfQueryWin() pfMQueryWin()	No	Yes.
pfAddPWinPVChan()	Yes	Yes.
pfAttachPWinSwapGroup()	Yes	Yes

OpenGL Performer provides GL-independent framebuffer configuration utilities. In most cases, **pfPWinFBConfigAttrs**(*pwin*, *attrs*) can be used to select a framebuffer configuration for your pfPipeWindow based on the array of attribute tokens *attrs*. If *attrs* is NULL, the default framebuffer configuration will be selected. If *attrs* is not NULL, the rules for default values follow the rules for configuring windows in OpenGL and X, which are different from values in the OpenGL Performer default window configuration. Such window framebuffer configuration should be done in the draw process in a window configuration callback function before the call to **pfOpenPWin()**. Window

framebuffer configuration for pfPipeWindows is identical to that of pfWindows and is discussed in more detail in Chapter 16, “Windows,” but the following is a simple example of the specification of framebuffer configuration taken from the sample source code example program

/usr/share/Performer/src/pguide/libpf/C/pipewin.c for IRIX and Linux and from %PFROOT%\Src\pguide\libpf\C\pipewin.c for Microsoft Windows:

Example 17-4 Configuration of a pfPipeWindow Framebuffer

```
static int FBAttrs[] = {
    PFFB_RGBA,
    PFFB_DOUBLEBUFFER,
    PFFB_DEPTH_SIZE, 24,
    PFFB_RED_SIZE, 8,
    PFFB_SAMPLES, 8,
    PFFB_STENCIL_SIZE, 1,
    NULL,
};

main()
{
    pfPipe *pipe;
    pfPipeWindow *pwin;
    pfInit();
    ....
    pfConfig();

    /* Create pfPipeWindow for pfPipe 0 */
    pipe = pfGetPipe(0);
    pwin = pfNewPWin(pipe);
    /* Set the framebuffer configuration */
    pfPWinFBConfigAttrs(Shared->pw, FBAttrs);
    /* Indicate that the window is ready to open */
    pfOpenPWin(pwin);
    /* trigger the opening of the window in the draw */
    pfFrame();
    ...
}
```

If you want to do all of your own window creation and management you can do so and just give OpenGL Performer the handles to your windows with the **pfPWinWSDrawable()** function; you may also provide a parent X window (or HWND on Microsoft Windows) with the **pfPWinWSWindow()** function. **pfOpenPWin()** makes use of any windows that have already been provided. More details regarding the creation

and configuration of pfPipeWindows and pfWindows are discussed in Chapter 16, "Windows."

pfPipeWindows in Action

pfPipeWindows allow for a reasonable amount of flexibility in the running application. pfPipeWindows can be re-ordered on their parent pfPipe to control the order that they are drawn in with the command **pfMovePWin**(*pipe, index, pwin*). pfPipeWindows can be dynamically opened and closed in the application or draw processes with **pfOpenPWin**() and **pfClosePWin**(). Additionally, **pfConfigPWin**() can be re-issued at any time from the application process to call the current window configuration function to dynamically open, close, and reconfigure pfPipeWindows.

The following example is taken from the distributed source code example file /usr/share/Performer/src/pguide/libpf/C/pipewin.c for IRIX and Linux and from %PFROOT%\Src\pguide\libpf\C\pipewin.c for Microsoft Windows. It demonstrates the dynamic closing of a window from the application process in the simulation loop and the reuse of **pfConfigPWin**() to reopen the window.

Example 17-5 Opening and Closing a pfPipeWindow

```
main()
{
    ...
    /* main simulation loop */
    while (!Shared->exitFlag)
    {
        /* wait until next frame boundary */
        pfSync();
        pfFrame();
        /* Set view parameters for next frame */
        UpdateView();
        pfChanView(chan, Shared->view.xyz, Shared->view.hpr);

        /* Close pfPipeWindow */
        if (Shared->closeWin == 1)
        {
            pfClosePWin(Shared->pw);
            ct = pfGetTime();
            Shared->closeWin = 2;
        }
        /* then wait two seconds and reconfig window */
    }
}
```

```

else if ((Shared->closeWin == 2) &&
        (pfGetTime() - ct > 2.0f))
{
    pfConfigPWin(Shared->pw);
    Shared->closeWin = 3;
    pfNotify(PFNFY_NOTICE, PFNFY_PRINT, "OPEN");
} }
...
}

```

Motif

You may want your windows to reside within a larger Motif interface and window hierarchy. OpenGL Performer supports this and allows you to run the Motif main loop in a separate process so that you can maintain control of your simulation loop. The Motif interface is created in its own process and Motif event handlers and callbacks will be executed in that process. The Motif callbacks set flags in shared memory to communicate with the main application. Part of this communication is the sharing of X windows between OpenGL Performer and Motif. The example program `/usr/share/Performer/src/pguide/libpf/C/motif.c` for IRIX and Linux and program `%PFROOT%\Src\pguide\libpf\C\motif.c` for Microsoft Windows demonstrate the basic elements of this integrated OpenGL Performer-Motif hook-up.

Multiple pfPipeWindows and Multiple pfPipes

The use of multiple windows on a single graphics pipe can add overhead. The sharing of the graphics context between windows consumes almost all of this overhead. To simply share a single graphics context across windows of two pfPipe objects, include `PFPWIN_TYPE_SHARE` in the `pfPWinType0` call. The sharing of pfPipeWindows and attributes can be completely controlled by setting up the sharing manually to create pfPipeWindow share groups with `pfPWinAttach(groupPWin, attachee)` and `pfPWinShare0` as is done with pfWindows, discussed in Chapter 16, "Windows." pfPipeWindows can have pfWindows in their share group if a pfPipeWindow is the main group window.

Multiple windows, particularly those on separate graphics pipelines, that are intended to produce results that can be seen as a single image, such as projected side by side on a large screen or to video outputs used for a stereo display, must have their video vertical retraces synchronized with `genlock(7)` and their double buffering synchronized. This is necessary for both image quality and performance reasons as the last window to finish operation can hold up all of the rendering processes. Window double-buffering

synchronization can be done through pfChannel share groups with the PFCHAN_SWAPBUFFERS_HW token, as discussed in Chapter 2, “Setting Up the Display Environment,” or explicitly by attaching the windows to form window swap groups with **pfAttachPWinSwapGroup**(*groupPWin, attachee*) as discussed in Chapter 16, “Windows.” pfPipeWindows can have pfWindows in their swap groups if a pfPipeWindow is the main group window. The sample program in file /usr/share/Performer/src/pguide/libpf/C/multipipe.c for IRIX and Linux and in file %PFROOT%\Src\pguide\libpf\C\multipipe.c for Microsoft Windows demonstrates multipipe synchronization.

Controlling Video Displays

You use pfPipeVideoChannel to direct the output of pfChannels to specified video displays, as shown in Figure 17-1. OpenGL Performer uses the XSGIvc(3), which is a Silicon Graphics extension of the X library, for video channel management.

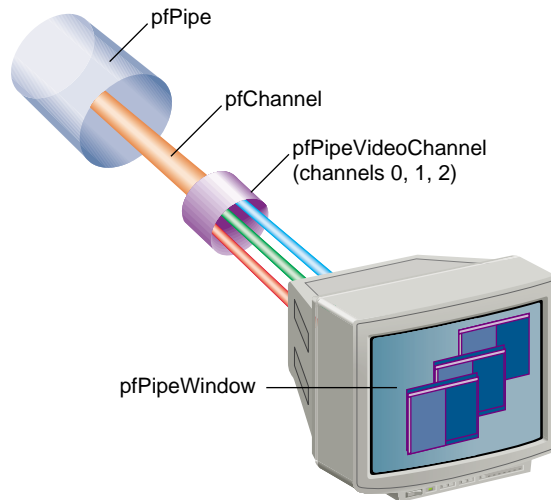

Figure 17-1 Directing Video Output

pfPipeVideoChannels are based on pfVideoChannels; however, pfPipeVideoChannels are maintained by libpf and are used by libpf to render the output of pfChannels within a pfPipeWindow. The pfVideoChannel API is duplicated for

pfPipeVideoChannels. **pfPVChan*()** methods operate on a pfPipeVideoChannel and **pfVChan*()** methods operate on a pfVideoChannel.

There are several sample programs to help understand the use of pfVideoChannels and pfPipeVideoChannels. The `libpr` program `/usr/share/Performer/src/pguide/libpr/C/queryvchan.c` for IRIX and Linux and the program `%PFROOT%\Src\pguide\libpr\C\queryvchan.c` for Microsoft Windows show how to query video channel attributes through OpenGL Performer and how to query additional attributes directly through the XSGIvc interface. The program `/usr/share/Performer/src/pguide/libpr/C/vchan.c` for IRIX and Linux and the program `%PFROOT%\Src\pguide\libpr\C\vchan.c` for Microsoft Windows show basic video channel creation. On an InfiniteReality, this example does resizing and translation of the video channel output area. The `libpf` program `/usr/share/Performer/src/pguide/libpf/C/pvchan.c` for IRIX and Linux and the program `%PFROOT%\Src\pguide\libpf\C\pvchan.c` for Microsoft Windows show basic pfPipeVideoChannel creation and hookup.

Creating a pfPipeVideoChannel

You create a pfPipeVideoChannel from a pfPipe using **pfNewPVChan()** and providing the parent pfPipe. The pfPipeVideoChannel is then attached to a pfPipeWindow with **pfAddPWinPVChan()**, which returns an index into the pfPipeWindow's video channel list. Additionally, if the pfPipeVideoChannel has not already been assigned a hardware video channel with **pfPVChanId()**, the next active video channel will be assigned.

```
pfPipe *p = pfGetPipe(0);
pfPipeVideoChannel *pvc = pfNewPVChan(p);
pfPVChanId(pvc, 0);
pvcIndex = pfPWinAddPVChan(pwin, pvc);
```

To find out if a pfPipeVideoChannel with its current video channel assignment is active for displaying output, call **pfIsPVChanActive()**, which returns 0 if the video channel assignment is not fully defined or if the channel is not active and returns 1 otherwise. The assignment of a hardware video channel is not complete until the screen of the pfPipe is known and so might not be done immediately if the pfPipe screen has not been set with **pfPipeScreen()** or if the pfPipeWindow is not open. Even if you have explicitly assigned a hardware video channel ID, it is only meaningful relative to a known screen. The hardware video channel assignment can be changed at any time with **pfPVChanId()**. It is an error to have multiple pfPipeWindows and pfPipeVideoChannels attempt to manage the same hardware video channel. The index returned by **pfAddPWinPVChan()** is then used for a pfChannel to reference this pfPipeVideoChannel. pfPipeWindows

always have an initial pfPipeVideoChannel already attached whose default video channel will be the first active video channel on the screen of the pfPipe. So, only add pfPipeVideoChannels if you actually need additional video channels.

Multiple pfPipeVideoChannels in a pfPipeWindow

The only video channels a pfPipeVideoChannel can manage are those of the screen of the pfPipe. Use **pfGetNumScreenPVChans()** to find out how many active video channels are on a given screen.

To add additional pfPipeVideoChannels to a single pfPipeWindow, use **pfPWinAddPVChan()**. The routine returns an index number associated with the pfPipeWindow, or -1 if an error occurs. If the pfPipeVideoChannel does not already have an assigned hardware video channel, the next active video channel relative to the video channels already attached to the pfPipeWindow will be assigned.

There are list routines to manage the list of pfPipeVideoChannels on a pfPipeWindow. Use **pfGetPWinNumPVChans()** to find out how many pfPipeVideoChannels are being managed by the pfPipeWindow. **pfPWinRemovePVChan()** and **pfPWinRemovePVChanIndex()** disassociate a pfPipeVideoChannel from a pfPipeWindow, using either the pfPipeWindow object or an index number to specify the pfPipeWindow.

There are additional utilities to find pfPipeVideoChannels on pfPipeWindows. You can obtain the index value of a pfPipeVideoChannel for a pfPipeWindow using **pfGetPWinPVChanIndex()**, which returns the index of a pfPipeVideoChannel, or -1 if the pfPipeVideoChannel is not registered with the pfPipeWindow. Use **pfGetPWinPVChanId()** to find a pfPipeVideoChannel on a pfPipeWindow with the specified hardware Id. NULL will be returned if no such pfPipeVideoChannel exists on the specified pfPipeWindow.

Configuring a pfPipeVideoChannel

pfPipeVideoChannels are bound to their hardware video channels in a lazy fashion as needed by configuration requests. Basic queries of a video channel do not require any explicit binding. Changing a video channel's properties does require explicit binding. pfPipeWindows manage this process. However, explicit binding and unbinding might be necessary if changes are made to video channels directly through the XSGIvc API and not through the pfPipeVideoChannel API. This is quite reasonable since

`pfPipeVideoChannels` do not duplicate all of `XSGIvc`. A `pfPipeVideoChannel` is bound to its hardware video channel with `pfBindPVChan()`. All of the `pfPipeVideoChannels` associated with a `pfPipeWindow` can be bound in one step with `pfBindPWinPVChans()` and unbound with `pfUnbindPWinPVChans()`. You can get the `XSGIvc` handle from a `pfPipeVideoChannel` to do your own configuration or extended queries with `pfGetPVChanInfo()`.

Use `pfPipeVideoChannels` to Control Frame Rate

There are two mechanisms by which `pfPipeVideoChannels` can help you maintain constant frame rate in your application. Dynamic Video Resolution (DVR) addresses reducing load caused by filling to many pixels. Pan/Zoom video scan-out to sample different parts of the frame buffer, under resize, to be selected asynchronously to a draw process. Both of these mechanisms make use of editing the size and or origin of the output area of a `pfPipeVideoChannel`, supported by InfiniteReality graphics platforms. Using `pfPVChanOutputSize()` and `pfPVChanOutputAreaScale()` changes the output area size of the bound video channel. `pfPVChanOutputOrigin()` changes the origin of the output area. The `pfPipeVideoChannel(3)` references more routines to manage video channel origin and size.

On InfiniteReality graphics platforms, you can use `pfPipeVideoChannels` to dynamically adjust the size of the output area of the video channel. The output area is then automatically zoomed up to full video channel size by the InfiniteReality hardware using bilinear filtering. This operation has no added performance cost or latency. This feature can be used to allow `pfChannels` to reduce their viewport size to the reduced video channel output area. Reducing the number of pixels drawn reduces the fill load for the `pfPipe` and can be used as a load management technique for maintaining constant frame rates. `pfPipeVideoChannels` support manual resizing, allowing you to implement your own load management, or automatically resizes the output area and the `pfChannel` viewports. You can enable and select a resizing mode with `pfPVChanDVRMode()` and providing `PPVC_DVR_MANUAL` or `PPVC_DVR_AUTO`. The default value is `PPVC_DVR_OFF`. For more information, see “Level-of-Detail Management” in Chapter 5.

`pfPipeVideoChannels` also support asynchronous editing of their size and origin. This can be used in an asynchronous process, or in an application process that is reliably running at frame rate, to edit the origin and size of the video channel. These changes will affect the following video field if the `pfPVChanMode()` for `PFVCHAN_AUTO_APPLY` is set to 1 (default is 0) and the `PFVCHAN_SYNC` mode is set to

PFVCHAN_SYNC_FIELD (default is PFVCHAN_SYNC_FRAME which selects apply upon swapbuffers).

Real-time changes to pfPipeVideoChannel origin or size should be done between **pfSync()** and **pfFrame()** to affect the next draw frame or video field.

Managing Nongraphic System Tasks

This chapter describes objects that manage nongraphic tasks, including the following:

- Queues
- Clocks
- Memory allocation
- Asynchronous I/O
- Error handling and notification
- File search paths

Handling Queues

A pfQueue object is a queue of elements, which are all the same type and size; the default size is the size of a void pointer. A pfQueue object actually consists of three interrelated queues, as shown in Figure 18-1.

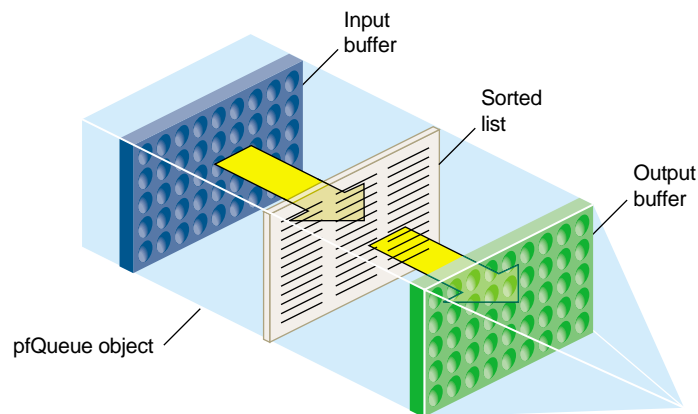

Figure 18-1 pfQueue Object

- Input buffer—where processes dump values to be added to the pfQueue object
- Output buffer—values at one end of the queue that processes may remove from the output buffer pfQueue object
- Sorted list—sorted values that processes may not remove from the pfQueue object

Note: In nonsorting mode, there is only the input buffer; values in the output buffer and the sorted list are transferred into the input buffer.

Values in the input buffer are not sorted and are not part of the sorted list. Values in the sorted list and the output buffer are sorted (when the pfQueue object is in sort mode) according to a user-defined sorting function. Sorted values of highest priority are automatically moved from the sorted list to the output buffer whenever the pfQueue object is sorted. Priority is defined by the sorting function, for example, if a pfQueue object contains pointers to tiles of texture, the sorting function might sort according to the proximity of the viewer and the tile: the closer the tile is to the viewer, the higher its priority, and the more likely the pointer to the tile will be in the output buffer. Processes do not have access to values in the sorted list; only to those values in the output buffer.

Multiprocessing

Because there are separate input and output buffers, multiple processes can add or retrieve elements, but only one process can actually insert elements into the input buffer and one process retrieve elements from the output buffer at one time. The process adding elements to the input buffer can be different from the process removing elements from the output buffer.

Queue Contents

The contents of the pfQueue object can be any fixed-size object; for example, pfQueues often contain pointers to OpenGL Performer objects. You might use a pfQueue object, for example, to organize tiles of texture according to the direction the viewer is looking and the proximity of the viewer to the tiles. Because you declare the size and type of objects in the pfQueue in the constructor, you cannot change the type or size of its elements after its creation.

Adding or Retrieving Elements

You can insert elements into the input buffer or remove them from the output buffer using the following methods, respectively:

- `pfQueue::insert()`
- `pfQueue::remove()`

These methods can be used by multiple processes asynchronously without collision.

Warning: Do not insert NULL elements into the queue.

The `pfQueue` object is resized dynamically when the number of elements inserted into the queue exceeds its declared size; the size is doubled automatically. Doubling the size prevents repeated, incremental, costly resizing of the queue.

Tip: Doubling the size of the queue can cause excessive memory allocation. It is important therefore to accurately declare the size of the queue.

You can set the size of the queue in the constructor of the `pfQueue` object or afterwards by using `pfQueue::setArrayLen()`. `pfQueue::getNum()` returns the number of elements in the queue.

Retrieving Elements from the Queue

It is possible for you to do the following:

1. Create a thread to retrieve elements from the output buffer.
2. Use the `pfQueue::remove()` method to retrieve the element.
3. Delete the thread.

It is much easier, however, to use the `pfQueue::addServiceProc()` method to perform all of those tasks. This method does the following:

- Creates a thread.
- Returns the thread ID.

- Invokes the developer-supplied function in the argument of the function.
- Deletes the thread.

The developer-supplied function must take as its argument an element from the output buffer and process it. For example, if the queue contains pointers to tiles of texture, the function might download a tile from disk to the image cache.

Related Methods

The `pfQueue` class provides a variety of other methods, described in Table 18-1, that return information about the threads created to process the elements in the output buffer of the `pfQueue` object.

Table 18-1 Thread Information

Method	Description
<code>getServiceProcPID()</code>	Returns the ID of the created thread.
<code>pfGetGlobalQueueServiceProcPID()</code>	Returns the ID of the nth thread.
<code>getNumServiceProcs()</code>	Returns the number of currently active threads.
<code>pfGetNumGlobalQueueServiceProcs()</code>	Returns the number of processes that have been spawned by all <code>pfQueues</code> .
<code>pfGetGlobalQueueServiceProcQueue()</code>	Returns the <code>pfQueue</code> associated with a particular thread.
<code>exitServiceProc()</code>	Terminates a specific thread.
<code>exitAllServiceProcs()</code>	Terminates all <code>pfQueue</code> object threads.

pfQueue Modes

The `pfQueue` objects can run in one of two modes:

- Nonsorting
- Sorting

Either the elements in the queue are sorted according to some criteria specified by a developer-supplied sorting function or not.

The sorting function is `NULL` and the sorting mode is nonsorting by default.

NonSorting Mode

In nonsorting mode, the sorted list and the output buffer are empty; all pfQueue elements are in the input buffer. Processes append new input objects to the front of the queue while (potentially) other processes read and remove pfQueue objects from the other end of the queue.

A process can potentially read and remove all of the elements in a nonsorted queue. Access to the elements is not random, however; it is sequential and ordered according to FIFO.

Sorting the pfQueue

Multiple processes can add to the input buffer asynchronously. The objects remain unsorted and separate from the sorted list and output buffer until the sorting function is triggered. At that time, the following events occur:

1. The objects in the input buffer are flushed into the sorted list.
2. The objects in the sorted list and the output buffer are resorted together.

To sort the elements in a pfQueue, you do the following:

1. Specify a developer-supplied sorting function using `pfQueue::setSortFunc()`.
2. Enable sorting by passing a non-NULL argument to `pfQueue::setSortMode()`.
3. Specify the maximum and minimum number of values for the input and output of the sorting function using `pfQueue::setInputRange()` and `pfQueue::setOutputRange()`.

Tip: You must specify the sorting function before enabling sorting; otherwise, sorting remains disabled and pfQueue returns a warning.

The sorting function runs in a separate thread parallel to the function specified in the argument of pfQueue. You can even specify that the sorting function run on a CPU different from the one processing the pfQueue object, as described in “Running the Sort Process on a Different CPU” on page 649.

In sorting mode, only those elements in the output buffer are available to processes. Access to the elements in the output buffer is not random, but sequential and in a FIFO order.

Sorting Function

The sorting function sorts, according to its own criteria, the elements in the sorted list and the output buffer. To sort the queue, you must do the following:

- Implement your own function to sort the `pfQueue` object.
- Identify the function in your application using `pfQueue::setSortFunc()`.
- Make the function return a value of type that matches that of `pfQueueSortFuncType`.
- Make the function handle an input data structure of type `pfQueueSortFuncData()`, defined as follows:

```
typedef struct {
    pfList *sortList; //list of elements to sort
    volatile int *inSize; //number of elements on input queue
    volatile int *outSize; //number of elements on output queue
    int inHi; // maximum number of elements at the input
    int inLo; // minimum number of elements at the input
    int outHi; // maximum number of elements at the output
    int outLo; // minimum number of elements at the output
} pfQueueSortFuncData;
```

The actual data in the `pfQueue` object is maintained in a `pfList`, to which the `pfQueueSortFuncData` structure points.

Input and Output Ranges

The range values work as triggers to start the sorting function, which sleeps otherwise. For example, when the number of unprocessed inputs is greater than `inHi`, `pfQueue` calls the sorting function to sort the `pfQueue` object.

You can set the minimum and maximum number of input and output elements entered before the sort is triggered using the following methods:

- `pfQueue::setInputRange()`
- `pfQueue::setOutputRange()`

Table 18-2 shows the default range values:

Table 18-2 Default Input and Output Ranges

Range	Minimum	Maximum
Input	0	3
Output	2	5

The range values have no effect in nonsorting mode.

Triggering the Sort

The sorting function sleeps until one of the following conditions occurs:

- The number of elements in the input buffer exceeds the input maximum range value.
- The number of elements in the output buffer drops below the output minimum range value.
- `pfQueue::notifySortProc()` is called.

By increasing the maximum number of values allowed in the input buffer, or reducing the minimum number of values allowed in the output buffer, the sorting function is potentially called fewer times.

Table 18-2 shows that, using default range values, the queue is sorted when three or more elements are added to the input buffer or when two or less values remain in the output buffer.

The `pfQueue::notifySortProc()` method is provided for those times when the queue should be sorted without regard to the number of elements in the input or output buffers. For example, if an element in the queue changes, it might be necessary to re-sort the queue. If, for example, the elements are sorted alphabetically, the sort function should be explicitly called when one of the elements is renamed.

Running the Sort Process on a Different CPU

You can run the sorting process on a different CPU from the one processing the `pfQueue` by doing one the following:

- Use **getSortProcPID()** to get the process ID of the sorting function and assigning the process to run on a specified CPU with OpenGL Performer or operating system utilities.
- Use the `pfuProcessManager` provided in `libpfutil`. See the `pfuInitDefaultProcessManager(3)` man page for more information.

High-Resolution Clocks

OpenGL Performer provides access to a high-resolution clock that reports elapsed time in seconds to support for timing operations. To start a clock, call **pfInitClock()** with the initial time in seconds—usually 0.0—as the parameter. Subsequent calls to **pfInitClock()** reset the time to whatever value you specify. To read the time, call **pfGetTime()**. This function returns a double-precision floating point number representing the seconds elapsed from initialization added to the latest reset value.

The resolution of the clock depends on your system type and configuration. In most cases, the resolved time interval is under a microsecond, and so is much less than the time required to process the **pfGetTime()** call itself. Silicon Graphics Onyx, Crimson, Indigo2, Indigo, and Indy™ systems all provide submicrosecond resolution. Newer systems, including Silicon Graphics Onyx2, Silicon Graphics Onyx3, Silicon Graphics Octane, Silicon Graphics Octane2, and Silicon Graphics O2 have even higher resolution clocks and use the `CYCLE_COUNTER` functionality through the `syssgi(2)`. On a machine that uses a fast hardware counter, the first invocation of **pfInitClock()** forks off a process that periodically wakes up and checks the counter for wrapping. This additional process can be suppressed by using **pfClockMode()**.

If OpenGL Performer cannot find a fast hardware counter to use, it defaults to the time-of-day clock, which typically has a resolution between one and ten milliseconds. This clock resolution can be improved by using fast timers. See the `ftimer(1)` man page for more information on fast timers.

By default, processes forked after the first call to **pfInitClock()** share the same clock and will all see the results of any subsequent calls to **pfInitClock()**. All such processes receive the same time.

Unrelated processes can share the same clock by calling **pfClockName()** with a clock name before calling **pfInitClock()**. This provides a way to name and reference a clock. By default, unrelated processes do not share clocks.

Video Refresh Counter (VClock)

The video refresh counter (VClock) is a counter that increments once for every vertical retrace interval. There is one VClock per system. In systems where multiple graphics pipelines are present, but not genlocked (synchronized, see the `setmon(3)` man page), screen 0 is used as the source for the counter. A process can be blocked until a certain count, or the count modulo some value (usually the desired number of video fields per frame) is reached.

Table 18-3 lists and describes the pfVClock routines.

Table 18-3 pfVClock Routines

Routine	Action
<code>pfInitVClock()</code>	Initialize the clock to a value.
<code>pfGetVClock()</code>	Get the current count.
<code>pfVClockSync()</code>	Block the calling process until a count is reached.

When using `pfVClockSync()`, the calling routine is blocked until the current count modulo *rate* is *offset*. The VClock functions can be used to synchronize several channels or pipelines.

Memory Allocation

You can use OpenGL Performer memory-allocation functions to allocate memory from the heap, from shared memory, and from data pools.

Note: On Microsoft Windows systems, all memory allocation is from the heap.

Table 18-4 lists and describes the OpenGL Performer shared-memory routines.

Table 18-4 Memory Allocation Routines

Routine	Action
pfInitArenas()	Create arenas for shared memory and semaphores.
pfSharedArenaSize()	Specify the size of a shared-memory arena.
pfGetSharedArena()	Get the shared-memory arena pointer.
pfGetSemaArena()	Get the shared-semaphore/lock arena pointer.
pfMalloc()	Allocate from an arena or the heap.
pfFree()	Release memory allocated with pfMalloc() .

Allocating Memory With **pfMalloc()**

The **pfMalloc()** function can allocate memory either from the heap or from a shared memory arena. Multiple processes can access memory allocated from a shared memory arena, whereas memory allocated from the heap is visible only to the allocating process. Pass a shared-memory arena pointer to **pfMalloc()** to allocate memory from the given arena. **pfGetSharedArena()** returns the pointer for the arena allocated by **pfInitArenas()** or NULL if the given memory was allocated from the heap. Alternately, an application can create its own shared-memory arena; see the `acreate(3P)` man page for information on how to create an arena.

To allocate memory from the heap, pass NULL to **pfMalloc()** instead of an arena pointer.

Under normal conditions **pfMalloc()** never returns NULL. If the allocation fails, **pfMalloc()** generates a **pfNotify()** of level `PFNFY_FATAL`; so, unless the application has set a **pfNotifyHandler()**, the application will exit.

Memory allocated with **pfMalloc()** must be freed with **pfFree()**, not with the standard C library's `free()` function. Using `free()` with data allocated by **pfMalloc()** will have devastating results.

Memory allocated with **pfMalloc()** has a reference count (see “`pfDelete()` and Reference Counting” in Chapter 1 for information on reference counting). For example, if you use **pfMalloc()** to create attribute and index arrays, which you then attach to `pfGeoSets` using

pfGSetAttr(), OpenGL Performer automatically tracks the reference counts for the arrays; this allows you to delete the arrays much more easily than if you create them without **pfMalloc()**. All the reference-counting routines (including **pfDelete()**) work with data allocated using **pfMalloc()**. Note, however, that **pfFree()** does not check the reference count before freeing memory; use **pfFree()** only when you are sure the data you are freeing is not referenced.

The **pfGetSize()** function returns the size in bytes of any data allocated by **pfMalloc()**. Since the size of such data is known, **pfCopy()** also works on allocated data.

Although data allocated by **pfMalloc()** behaves in many ways like a `pfObject` (see “Nodes” in Chapter 3), such data does not contain a user-data pointer. This omission avoids requiring an extra word to be allocated with every piece of **pfMalloc()** data.

Note: All `libpr` objects are allocated using **pfMalloc()**; so, you can use **pfGetArena()**, **pfGetSize()**, and **pfFree()** on all such objects. However, use **pfDelete()** instead of **pfFree()** for `libpr` objects in order to maintain reference-count checking.

Shared Arenas

Note: Shared arenas are not pertinent to Microsoft Windows systems.

The **pfInitArenas()** function creates two arenas, one for the allocation of shared memory with **pfMalloc()** and one for the allocation of semaphores and locks with **usnewlock()** and **usnewsema()**. The arenas are visible to all processes forked after **pfInitArenas()** is called.

Applications using `libpf` do not need to explicitly call **pfInitArenas()**, since it is invoked by **pfInit()**.

The shared memory arena can be allocated by memory-mapping either swap space (`/dev/zero`, the default) or an actual disk file (in the directory specified by the environment variable `PFTMPDIR`). The latter requires sufficient disk space for as much of the shared memory arena as will be used, and disk files are somewhat slower than swap space in allocating memory.

By default, OpenGL Performer creates a large shared memory arena (256 MB on IRIX and 64 MB on Linux). Though this approach makes large numbers appear when you run `ps(1)`, it does not consume any substantial resources, since swap or file system space is not actually allocated until accessed (that is, until `pfMalloc()` is called).

Note: The following description applies only to IRIX systems.

Because OpenGL Performer cannot increase the size of the arena after initialization, an application requiring a larger shared memory arena should call `pfSharedArenaSize()` to specify the maximum amount of memory to be used. Arena sizes as large as 1.7 GB are usually acceptable; but you may need to set the virtual-memory-use and memory-use limits, using the shell `limit` command or the `setrlimit()` function, to allow your application to use that much memory. To use arenas larger than 4 GB, you must use 64-bit operation.

If you are having difficulties in creating a large arena, it could be due to fragmentation of the address space from too many DSOs. You can reduce the number of DSOs you are using by compiling some of them statically. You can also change the default address of the DSOs by running the `rqs(1)` with a custom `so_locations` file.

Allocating Locks and Semaphores

An application requiring lockable pieces of memory should consider using `pfDataPools`, described in the following section. Alternatively, when a lock or semaphore is required in an application that has called `pfInitArenas()`, you can call `pfGetSemaArena()` to get an arena pointer, and you can allocate locks or semaphores using `usnewlock()` and `usnewsema()`.

Datapools

Datapools, or `pfDataPools`, are also a form of shared memory, but they work differently from `pfMalloc()`. Datapools allow unrelated processes to share memory and lock out access to eliminate data contention. They also provide a way for one process to access memory allocated by another process.

Any process can create a datapool by calling `pfCreateDPool()` with a name and byte size for the pool. If an unrelated process needs access to the datapool, it must first put the

datapool in its address space by calling **pfAttachDPool()** with the name of the datapool. The datapool must reside at the same virtual address in all processes. If the default choice of an address causes a conflict in an attaching process, **pfAttachDPool()** will fail. To avoid this, call **pfDPoolAttachAddr()** before **pfCreateDPool()** to specify a different address for the datapool.

Any attached process can allocate memory from the datapool by calling **pfDPoolAlloc()**. Each block of memory allocated from a datapool is assigned an ID so that other processes can retrieve the address using **pfDPoolFind()**.

Once you have allocated memory from a datapool, you can lock the memory chunk (not the entire `pfDataPool`) by calling **pfDPoolLock()** before accessing the memory. This locking mechanism works only if all processes wishing to access the datapool memory use **pfDPoolLock()** and **pfDPoolUnlock()**. After a piece of memory has been locked using **pfDPoolLock()**, any subsequent **pfDPoolLock()** call on the same piece of memory will block until the next time a **pfDPoolUnlock()** function is called for that memory.

The `pfDataPools` are `pfObjects`; so, call **pfDelete()** to delete them. Calling **pfReleaseDPool()** unlinks the file used for the datapool—it does not immediately free the memory that was used or prevent further allocations from the datapool; it just prevents processes from attaching to it. The memory is freed when the last process referring to the datapool **pfDelete()** to remove it.

CycleBuffers

A multiprocessed environment often requires that data be duplicated so that each process can work on its own copy of the data without adversely colliding with other processes. `pfCycleBuffer` is a memory structure which supports this programming paradigm. A `pfCycleBuffer` consists of one or more `pfCycleMemories`, which are equally-sized memory blocks. The number of `pfCycleMemories` per `pfCycleBuffer` is global, is set once with **pfCBufferConfig()**, and is typically equal to the number of processes accessing the data.

Note: `pfFlux` replaces the functionality of `pfCycleBuffer`.

Each process has a global index, set with **pfCurCBufferIndex()**, which indexes a `pfCycleBuffer`'s array of `pfCycleMemories`. When each process has a different index (and

its own address space), mutual exclusion is ensured if the process limits its pfCycleMemory access to the currently indexed one.

The “cycle” term of pfCycleBuffer refers to its suitability for pipelined multiprocessing environments where processes are arranged in stages like an assembly line and data propagates down one stage of the pipeline each frame. In this situation, the array of pfCycleMemories can be visualized as a circular list. Each stage in the pipeline accesses a different pfCycleMemory and at frame boundaries the global index in each process is advanced to the next pfCycleMemory in the chain. In this way, data changes made in the head of the pipeline are propagated through the pipeline stages by “cycling” the pfCycleMemories.

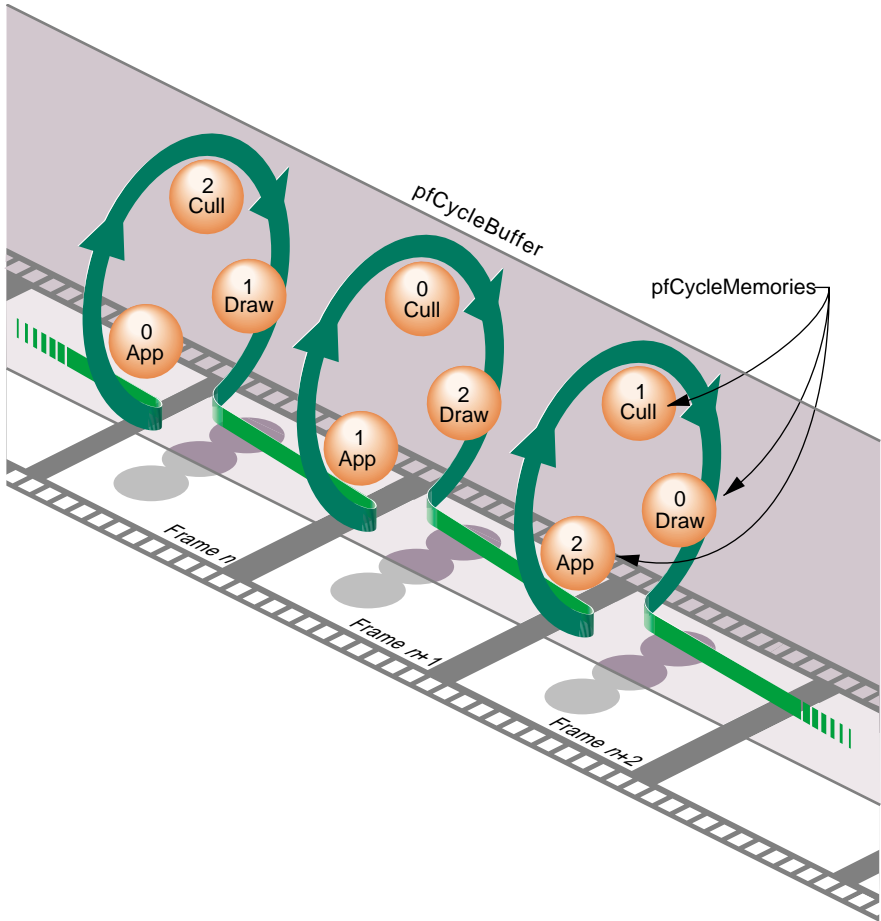

Figure 18-2 pfCycleBuffer and pfCycleMemory Overview

Cycling the memory buffers works if each current pfCycleMemory is completely updated each frame. If this is not the case, buffer cycling will eventually access a “stale” pfCycleMemory whose contents were valid some number of frames ago but are invalid now. pfCycleBuffers manage this by frame-stamping a pfCycleMemory whenever **pfCBufferChanged()** is called. The global frame count is advanced with **pfCBufferFrame()**, which also copies most recent pfCycleMemories into “stale” pfCycleMemories, thereby automatically keeping all pfCycleBuffers current.

A `pfCycleBuffer` consisting of `pfCycleMemories` of `nbytes` size is allocated from memory arena with `pfNewCBuffer(nbytes, arena)`. To initialize all the `pfCycleMemories` of a `pfCycleBuffer` to the same data call, `pfInitCBuffer()`. `pfCycleMemory` is derived from `pfMemory` so you can use inherited routines like `pfCopy()`, `pfGetSize()`, and `pfGetArena()` on `pfCycleMemories`.

While `pfCycleBuffers` may be used for application data, their primary use is as `pfGeoSet` attribute arrays, for example, coordinates or colors. `pfGeoSets` accept `pfCycleBuffers` (or `pfCycleMemory`) references as attribute references and automatically select the proper `pfCycleMemory` when drawing or intersecting with the `pfGeoSet`.

Note: `libpf` applications do not need to call `pfCBufferConfig()` or `pfCBufferFrame()` since the `libpf` routines `pfConfig()` and `pfFrame()` call these, respectively.

Asynchronous I/O (IRIX only)

A nonblocking file interface is provided to allow real-time programs access to disk files without affecting program timing. The system calls `pfOpenFile()`, `pfCloseFile()`, `pfReadFile()`, and `pfWriteFile()` work in an identical fashion to their IRIX counterparts `open()`, `close()`, `read()`, and `write()`.

When `pfOpenFile()` or `pfCreateFile()` is called, a new process is created using `sproc()`, which manages access to the file. Subsequent calls to `pfReadFile()`, `pfWriteFile()`, and `pfSeekFile()` place commands in a queue for the file manager to execute and return immediately. To determine the status of a file operation, call `pfGetFileStatus()`.

Error Handling and Notification

OpenGL Performer provides a general method for handling errors both within OpenGL Performer and in the application. Applications can control error handling by installing their own error-handling functions. You can also control the level of importance of an error.

Table 18-5 lists and describes the functions for setting notification levels.

Table 18-5 pfNotify Routines

Routine	Action
pfNotifyHandler()	Install user error-handling function.
pfNotifyLevel()	Set the error-notification level.
pfNotify()	Generate a notification.

The **pfNotify()** function allows an application to signal an error or print a message that can be selectively suppressed. **pfNotifyLevel()** sets the notification level to one of the values listed in Table 18-6.

Table 18-6 Error Notification Levels

Token	Meaning
PFNFY_ALWAYS	Always print regardless of notify level.
PFNFY_FATAL	Fatal error.
PFNFY_WARN	Serious warning.
PFNFY_NOTICE	Warning.
PFNFY_INFO	Information and floating point exceptions.
PFNFY_DEBUG	Debug information.
PFNFY_FP_DEBUG	Floating point debug information.

The environment variable PFNFYLEVEL can be set to override the value specified in **pfNotifyLevel()**. Once the notification level is set via PFNFYLEVEL, it cannot be changed by an application.

Once the notify level is set, only those messages with a priority greater than or equal to the current level are printed or handed off to the user function. Fatal errors cause the program to exit unless the application has installed a handler with **pfNotifyHandler()**.

Setting the notification level to PFNFY_FP_DEBUG has the additional effect of trapping floating point exceptions such as overflows or operations on invalid floating point numbers. It may be a good idea to use a notification level of PFNFY_FP_DEBUG while

testing your application so that you will be informed of all floating-point exceptions that occur.

File Search Paths

OpenGL Performer provides a mechanism to allow referencing a file via a set of path names. Applications can create a search list of path names in three ways: the PFPATH environment variable, the function **pfFilePath()**, or the function **pfFilePathv()**. (Note that the PFPATH environment variable controls file search paths and has nothing to do with the pfPath data structure.)

Table 18-7 describes the routines for working with pfFilePaths.

Table 18-7 pfFilePath Routines

Routine	Action
pfFilePath() pfFilePathv()	Create a search path.
pfFindFile()	Search for the file using the search path.
pfGetFilePath()	Supply current search path.

You can specify a search path using **pfFilePath(*path*)**, **pfFilePathv(*path0*, *path1*, ..., *pathn*, NULL)**, or with the environment variable PFPATH. You can specify any number of directories using **pfFilePath()** and a maximum of 64 using **pfFilePathv()**. Colons separate path names on IRIX and Linux and semicolons on Windows. Since **pfFilePathv()** allows you to specify path names delimited by commas, it provides much more economy in coding compared to the use of **pfFilePath()**, where you must employ conditional code to accommodate cross-platform use.

Directories are searched in the order given, beginning with those specified in PFPATH, followed by those specified by **pfFilePath()** or **pfFilePathv()**. Calling **pfFilePath()** or **pfFilePathv()** a second time replaces the current path list rather than appending to it.

The function **pfFindFile()** searches the paths in PFPATH first, then those given in the most recent **pfFilePath()** call; it returns the complete path name for the file if the file is found. OpenGL Performer applications should use **pfFindFile()** (either directly or through routines such as **pfdLoadFile()**) to look for input data files.

The **pfGetFilePath()** function returns the last search path specified by a **pfFilePath()** or **pfFilePathv()** call. It does not return the path specified by the PFPATH environment variable. If you want to find out that value, call **getenv()**.

Dynamic Data

Making your data dynamic allows your scenes to change. Geometries can change location, orientation, color, texture, or change into different things altogether. This chapter explains how to create dynamic structures that can generate and manipulate their own dynamic data using pfFlux, pfEngine, and pfFCS. A pfEngine computes the changes and a pfFlux is a container for the output of the pfEngines.

pfFlux

A pfFlux is a container for dynamic data that enables multiprocessed generation and use of data in the scene graph. A pfFlux internally consists of multiple buffers of data, each of which is associated with a frame number. The numbering allows multiple processes to each have a copy of the data containing the frame on which they are working. Multiple reader processes can share a copy of the current results or use the frame of results that is appropriate for that process. Figure 19-1 illustrates how pfFlux and processes use frame numbers.

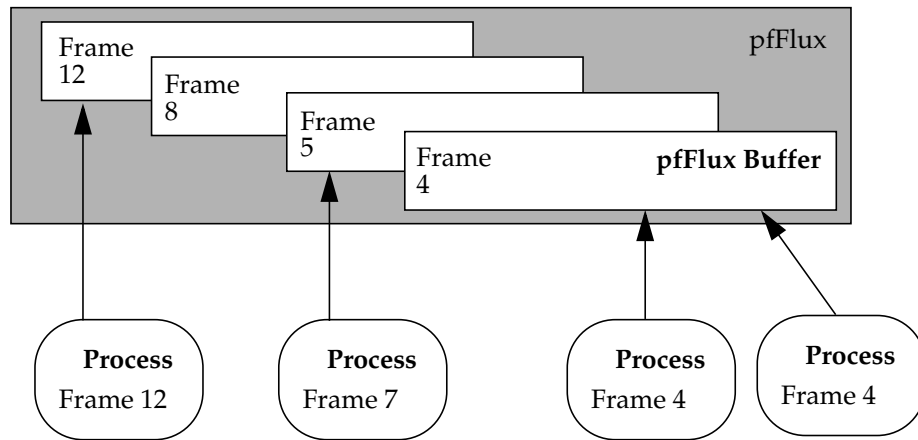

Figure 19-1 How pfFlux and Processes Use Frame Numbers

The pfFlux in the figure has four buffers. Each buffer shows the frame number associated with it. The figure shows four processes reading from the pfFlux. The process with frame 12 reads from a buffer with frame 12—the newest available buffer and an exact match to the process frame number. The process with frame number 7 reads from a buffer with frame 5—the latest buffer that is not too new for frame 7. Both processes with frame 4 share a buffer with frame number 4—an exact match.

One popular use of a pfFlux is to manage the attributes of a pfGeoSet. Each of the attribute lists of a pfGeoSet can independently be a pfFlux. This means that an application can change the position of geometry vertices on the fly in a safe, multiprocessing manner.

Other uses include using a pfFlux as a matrix of a pfFCS node. This enables modifying the transformation of some target geometry from an asynchronous process in a safe, multiprocessing manner.

Creating and Deleting a pfFlux

The **pfNewFlux()** function creates and returns a handle to a pfFlux. Each pfFlux buffer is a pfFluxMemory. When you create a pfFlux, you specify the number of buffers it contains as well as the size of each buffer. The pfFlux buffers are automatically allocated from the same arena as the parent pfFlux. When creating a pfFlux, you must specify how many

buffers this pfFlux contains. Instead of specifying an exact number, you may specify the symbol `PFFLUX_DEFAULT_NUM_BUFFERS`. In this case, the system will pick an appropriate number of buffers based on the multiprocess configuration of your application (set by `pfMultiprocess`). You can globally redefine this default number of buffers for successive creation of pfFluxes using `pfFluxDefaultNumBuffers()`. If you change the default number of buffers, the effect takes place only for pfFluxes created after the change.

Note: OpenGL Performer sets the default number of pfFlux buffers when `pfConfig()` is called according to the number and type of processes requested with `pfMultiprocess()`. Generally, the number of buffers is equal to one more than the number of running processes that typically might generate pfFlux data or use pfFluxed results. `LPOINT` processes are not included in the count; but `DBASE`, `ISECT`, and `COMPUTE` processes and additional graphic pipes, creating additional `DRAW` and possibly `CULL` processes, do add to the default number of pfFlux buffers.

You can return the number of buffers in a pfFlux and the number of bytes in the buffers using the `pfGetFluxDefaultNumBuffers()` and `pfGetFluxDataSize()` routines, respectively.

To delete a pfFlux, as with all pfObjects, use `pfDelete()`.

Initializing the Buffers

Generally, pfFlux buffers do not require initialization because they are fully recomputed for every frame. One case where you would want to initialize them is when the data in the buffers is static. For example, if you have a pfFlux of coordinates where most do not change, rather than continuously updating this static data, it is far more efficient to initialize the buffers. You cannot depend on the order in which you get pfFlux buffers at run time and coordinates in the buffer cannot assume results from the previous frame. If an element in the buffer is ever to be dynamic, it should always be recomputed.

OpenGL Performer provides two ways of initializing or setting the data held in the pfFlux buffers:

- `pfFluxInitData()` to provide a template
- `pfFluxCallDataFunc()` to provide a callback function

You can immediately initialize all pfFlux buffers by calling the **pfFluxInitData()** routine and providing a template data buffer that will be directly copied into the pfFlux buffers.

In the argument of **pfFluxCallDataFunc()**, you pass a pointer to data and a pointer to a callback function that operates on the buffers in a pfFlux. This function will be immediately called on each buffer of the pfFlux.

An initialization callback can also be provided when the pfFlux is created as shown in the following:

```
pfFlux *flux = new pfFlux(initFunc, PFFLUX_DEFAULT_NUM_BUFFERS);
```

The function will be called for each flux buffer. If the pfFlux is not created with enough buffers and a new pfFluxMemory buffer must be created at run time, the callback function will be called. For better and more reliable performance, you generally want to ensure that you have given yourself enough buffers up front.

pfFlux Buffers

A pfFlux buffer is of type pfFluxMemory. Each buffer consists of the following:

- Header
- Data

The header portion consists of the following:

- Pointer to the data portion of the pfFluxMemory
- Frame number set automatically or explicitly by **pfFluxFrame()**
- Set of flags, including read and write

The data portion of a pfFluxMemory contains one frame of information. The **pfGetFluxMemory()** function returns a pointer to the data portion of a pfFluxMemory. Figure 19-2 demonstrates these relationships.

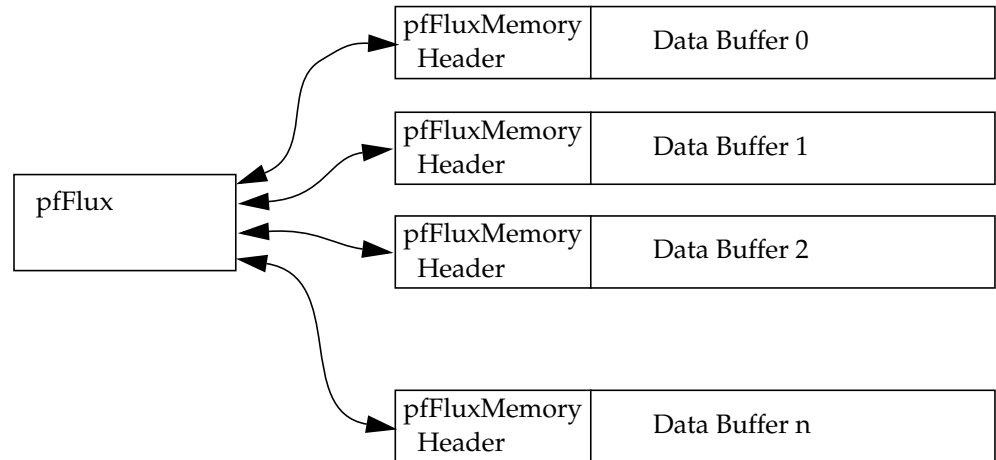

Figure 19-2 pfFlux Buffer Structure

To return the parent pfFlux containing the buffer, use **pfGetFFlux()**, which returns NULL if the specified data is not part of a pfFlux. This is useful to find out, for example, if an attribute buffer of a pfGeoSet is a pfFlux.

At a given moment, a pfFlux buffer is either readable or writable, but never both. When a buffer is writable, its data can be changed. When a buffer is readable, its data should not be changed because there might be other processes reading that same buffer that would then be immediately affected by any changes. For performance reasons, a buffer marked readable is not locked.

Reading pfFlux Buffers

To get the current results for reading from a pfFlux, you can use the **pfGetFluxCurData()** method with code similar to the following C example:

```
pfVec3 *cur_verts;

cur_verts = (pfVec3*)pfGetFluxCurData(flux);
```

In this example, **pfGetFluxCurData()** does the following:

- Finds a readable buffer in the pfFlux, *flux*, whose frame number is the closest to the current flux frame number but not greater than the current flux frame number.
- Returns a pointer, *cur_verts*, to that buffer.

If you have an old copy of a data buffer from a previous call to **pfGetFluxCurData()** and now just want to update to a new version and no longer have a pointer to the parent flux, you can use **pfGetFluxWritableData()** and provide your data pointer. For performance reasons, it is better to save your pfFlux pointer and not depend on this convenience.

When **pfGetFluxCurData()** is called, it is expected to hold previous results of computation. This computation might be done explicitly by your code in another process or might be done automatically if the pfFlux is the destination of a pfEngine. Additionally, the pfEngine computation might be triggered immediately if the pfFlux is a pfEngine destination and if the pfFlux mode PFFLUX_ON_DEMAND mode is set by the **pfFluxMode()** function and if the client pfEngine sources are dirty. pfEngine details are discussed more later in this chapter.

Writing to pfFlux Buffers

When you want to write data to a pfFlux buffer, use the **pfGetFluxWritableData()** function with code similar to the following C++ example:

```
pfVec3 *verts;
int i, num_verts;

verts = (pfVec3*)flux->getWritableData();

/* Set all verts to 1.0, 2.0, 3.0 */
num_verts = flux->getDataSize() / sizeof(pfVec3);
for (i = 0; i < num_verts; i++)
    verts[i].set(1.0f, 2.0f, 3.0f);

flux->writeComplete();
```

When **pfGetFluxWritableData()** is called, pfFlux searches for the buffer whose frame number is equal to the pfFlux frame number. There are three possible results:

- If there is a match and the buffer is writable, **pfGetFluxWritableData()** returns a pointer to that buffer.

- If there is a match but the buffer is readable, **pfGetFluxWritableData()** causes one of the following actions to occur, according to whether the PFLUX_WRITE_ONCE mode specified in **pfFluxMode()** is set to the following:

PF_ON	The pfGetFluxWritableData() function returns NULL if there is already a readable buffer with a frame number that matches the current flux frame number.
PF_OFF	The pfGetFluxWritableData() function returns a pointer to the readable data buffer.
- If there is no match, an unused buffer is made writable and its frame buffer number is set to that of the current pfFlux frame number.

If **pfGetFluxWritableData()** is called again for the same frame and the PFLUX_WRITE_ONCE mode is PF_ON (off by default), information is not copied again into the same buffer; instead, NULL is returned. In this way, the mode can prevent modified data from being destroyed by a second call to **pfGetFluxWritableData()** and the NULL return value can be used to avoid needlessly recomputing unused data.

The **pfFluxWriteComplete()** function should be called when computation for a writable pfFlux buffer is complete. This method changes the specified buffer from writable to readable.

Note: OpenGL Performer computes a cache of geometric attributes for each pfGeoSet. It uses this cache when intersecting line segments with the pfGeoSet. When using a pfFlux as the PFGS_COORD3 attribute of a pfGeoSet, the cache is not notified if pfFlux changes; so, intersection is incorrect. In order to avoid this problem, the application should always disable caching in pfGeoSets with pfFluxed PFGS_COORD3 attributes. Use the pfGeoSet function **pfGSetIsectMask(gset, PFTRAV_IS_UNCACHE, ...)** to disable caching.

Coordinating pfFlux and Connected pfEngines

The pfFluxes maintain pointers to the following:

- pfEngines, called source engines, whose destinations are this pfFlux.
- A list of pfEngines, called client engines, that use this pfFlux as a source.

To return a handle to these engines, use **pfGetFluxSrcEngine()** and **pfGetFluxClientEngine()**, respectively.

To return the number of connected source and client pfEngines, use **pfGetFluxNumSrcEngines()** and **pfGetFluxNumClientEngines()**, respectively.

The **pfFluxWriteComplete()** function triggers client pfEngine evaluation according to whether the PFFLUX_PUSH mode specified in **pfFluxMode()** is set to the following:

- | | |
|--------|---|
| PF_ON | The pfEngineEvaluate() function is performed on its client pfEngines to push the results through a chain of computation. |
| PF_OFF | The pfEngineSrcChanged() function is performed on its clients to tell those pfEngines that they have dirty sources. |

Triggering pfFlux Evaluation

pfFlux evaluation is really a convenient one-step combined evaluation of a source pfEngine combined with getting and completing a writable buffer of data. Triggering the evaluation of pfFlux may trigger the evaluation of the pfFlux's source pfEngines, particularly if the PFFLUX_ON_DEMAND mode is set to PF_ON.

To explicitly trigger a pfFlux, the evaluate method can be used with a mask that is provided and passed through evaluation chains to potentially limit which pfFluxes in a chain are evaluated. For a pfFlux to be evaluated, both of the following conditions must be satisfied:

- The bits in the current mask must match any of the bits in the evaluation mask associated with a pfFlux.
- The **pfFluxEvaluate()** or **pfFluxEvaluateEye()** function is called.

The mask is a bitmask that you use to trigger the evaluation of the source pfEngines of a pfFlux. The functions **pfFluxMask()** and **pfGetFluxMask()** set and get, respectively, the evaluation mask of a pfFlux. The default mask is PFFLUX_BASIC_MASK. Masks enable selective evaluation of pfFlux source pfEngines.

The **pfFluxEvaluate()** function triggers an evaluation of pfFlux source pfEngines if any of the bits in the current mask match any of the bits in the evaluation mask of the pfFlux.

The **pfFluxEvaluateEye()** function is the same as **pfFluxEvaluate()** but also makes it easy to pass the current eyepoint through a chain of computation. This is a particularly common case in scene graphs and one very common use is morphing level of detail based on distance from the current eyepoint.

Calling **pfFluxEvaluate()** or **pfFluxEvaluateEye()** is the equivalent of calling **pfEngineEvaluate()** on the source engines followed by calling **pfFluxWriteComplete()** on the pfFlux.

For more information about pfEngine, see “pfEngine” on page 678.

Synchronized Flux Evaluation

There are times when you want to ensure that the dynamic data for a given frame in a number of pfFluxes becomes readable at precisely the same time. Particularly when computations are so complicated that they must be completed over multiple frames, you might want the computations of vertices for the different pfGeoSets for a given frame to be made usable at the same time. Consider the following example:

Suppose that you are using pfASD and you need shapes comprised of multiple pfGeoSets to move together in response to morphing terrain. One pfGeoSet might encapsulate the texture of a roof, another a wall, another a window, and another a door. Since a pfGeoSet can only encompass one texture, each of these parts of a house must remain separate pfGeoSets whose data must be encapsulated in separate pfFluxes. If, for rendering, the roof of one frame was used with the wall of another, it might appear that the house is breaking apart.

OpenGL Performer uses sync flux groups to ensure that the same frame of data is being used from all fluxes in a group.

Synchronizing pfFluxes with Flux Sync Groups

You can add one or more pfFluxes to a flux sync group using the pfFlux **pfFluxSyncGroup()** function and providing the integer identifier of the desired group. To get the flux sync group identifier of a pfFlux, use the **pfGetFluxSyncGroup()** function.

Note: OpenGL Performer does not maintain a list of pfFluxes in a flux group; instead, an internal field in pfFlux identifies the flux sync group to which it belongs. For this reason, there is no way to get a list from OpenGL Performer of all of the fluxes in a sync group.

For convenience, a flux sync group can be identified by a string name, set with **pfGetFluxSyncGroupName()**. The unsigned integer identifier can be obtained from the string name using **pfGetFluxNamedSyncGroup()**. The **pfGetFluxNamedSyncGroup()**

function also automatically generates a new sync group identifier for a new name. The identifier of the first flux sync group you create is automatically one.

Note: Once you name a sync group, the name cannot be changed.

The **pfGetFluxNumNamedSyncGroups()** function returns the number of named sync groups.

Enabling a Flux Sync Group

To enable group synchronization of the pfFluxes in the flux sync group, enable the sync group using **pfFluxEnableSyncGroup()**. You can disable group synchronization using **pfFluxDisableSyncGroup()**.

The **pfGetFluxEnableSyncGroup()** function returns whether or not a sync group is enabled.

Initially, all pfFluxes are all part of flux sync group 0, which can never be enabled.

Evaluating a Synchronized Flux Group

After all of the pfFluxes in an enabled flux sync group are calculated, you must call **pfFluxSyncGroupReady()** to specify that the fluxes are ready to be read.

When **pfFrame()** is called, **pfFluxSyncComplete()** is called on flux sync groups, which does the following:

- Marks the writable buffers with the current flux frame number.
- Makes their writable buffers readable.

Figure 19-3 is a timing diagram that shows a typical use for sync groups.

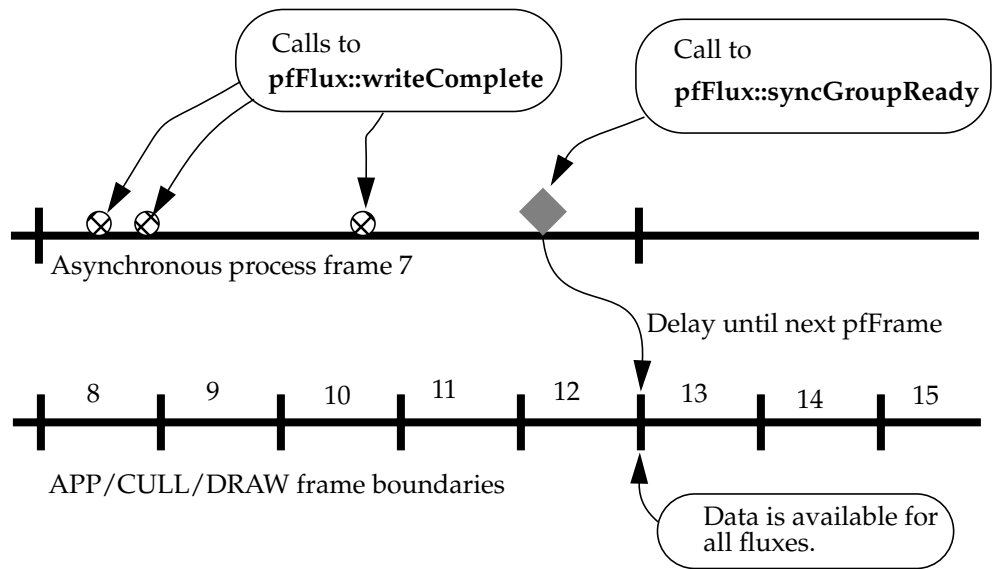

Figure 19-3 Timing Diagram Showing the Use of Sync Groups

The diagram shows calls to **pfFluxWriteComplete()** on three pfFluxes during the course of a single asynchronous frame 7 (for example, a COMPUTE frame). Although the main processes APP, CULL, and DRAW run in frame numbers higher than 7, they cannot access the pfFlux results of the asynchronous process until the first **pfFrame()** after the call to **pfFluxSyncGroupReady()**. APP, CULL, and DRAW start seeing the results at frame 13. In this way an application can synchronize multiple results generated by an asynchronous frame. They all become visible at exactly the same frame boundary.

Note: Using sync groups adds some processing to pfFrame. When a pfFlux is not a member of a sync group, OpenGL Performer spends no per-frame processing on it. The only time a pfFlux consumes CPU time is during its API calls. However, when a pfFlux is on a sync group, OpenGL Performer incurs extra processing time at frames where the pfFlux data becomes available to the APP process (the **pfFrame()** following a call to **pfFluxSyncGroupReady()**).

Fluxed Geosets

Most often you use dynamic data to change the attributes, location, or the orientation of geometries. Morphing geometries, for example, is a matter of repositioning the vertices of a geometry.

You can, however, use dynamic data to change the higher level description of geometries. You might, for example, create a geometry editor that adds or subtracts triangles to and from geometries.

Note: While OpenGL Performer is set up to flux any object derived from `pfMemory`, only `pfGeode` and `pfGeoSet` are currently modified to accept fluxed and unfluxed forms without any special `pfFlux` method.

To dynamically change a `pfGeoSet`, you must operate on the data held in the `pfFlux` buffers usually when the buffers are initialized.

Example 19-1 shows how to turn the data portion of a `pfFluxMemory` into a fluxed `pfGeoSet` using **`pfFluxedGSetInit()`**.

Example 19-1 Fluxed `pfGeoSet`

```
int make_fluxed_gset(pfFluxMemory *fmem)
{
    pfGeoSet *gset;
    pfVec3 *coords;

    if (fmem == NULL)
        return pfFluxedGSetInit(fmem);

    pfFluxedGSetInit(fmem);

    gset = (pfGeoSet*)fmem->getData();

    gset->setPrimType(PFGS_TRIS);

    ... // finish initializing pfGeoSet

    return 0;
}
```

```

main()
{
    pfFlux *fluxed_gset;
    pfGeoSet *gset;

    pfInit();
    pfMultiprocess(PFMP_DEFAULT);
    pfConfig();

    fluxed_gset = new pfFlux(make_fluxed_gset,
        PFFLUX_DEFAULT_NUM_BUFFERS);
    gset = (pfGeoSet*)fluxed_gset->getCurData();

    ...
}

```

Fluxed Coordinate Systems

A pfFCS is similar to a pfDCS node in that both nodes contain dynamic data. In addition to pfDCS functionality, however, a pfFCS uses a pfFlux to hold its matrix. This fluxed matrix can then be computed by a pfEngine, potentially asynchronously. This is the structure shown in Figure 19-4.

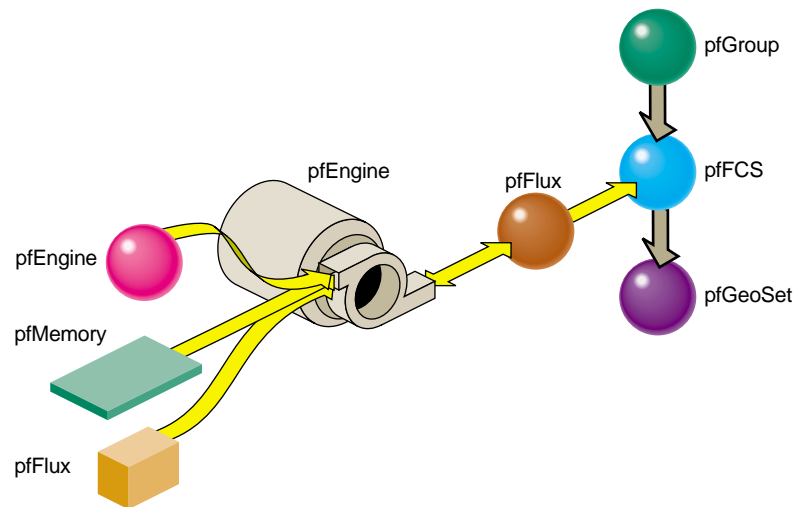

Figure 19-4 pfEngine Driving a pfFlux That Animates a pfFCS Node

In this figure, the pfEngine performs calculations on the data input from multiple sources, including a pfMemory, a container for static data, a pfFlux, and an additional source pfEngine. The main pfEngine sends its resulting matrix to a pfFlux. The pfFlux is attached to the pfFCS with the pfFCS **pfFlux()** function. This flux then can do the following:

- Trigger the pfEngine to directly recompute its data if in PFFLUX_ON_DEMAND mode when the pfFCS calls **pfGetFluxCurData()** on the flux
- Use frame accurate results with other fluxes if a member of a flux sync group
- Contain the matrix for the pfFCS node to produce a transformed coordinate system for the current frame for children of the node in the scene graph.

Since a pfFCS node is of type pfGroup, you can connect many nodes to it. This functionality is valuable if many geometries need to share a transformation, such as the moving limbs of a walking character whose overall location is changing every frame.

Unlike pfDCS nodes, pfFCS nodes do not detect changes in their matrix. A change to the matrix can move the children of a pfFCS node and change their visibility. This means that changing a pfFCS matrix may result in a visible node being culled out or invisible nodes being drawn. Both potential results are undesirable. In order to avoid them, an application has two options:

- If the objects under the pfFCS node move in some known and confined space, the application can pre-calculate the bounding sphere of that space and set the bounding sphere of the pfFCS node statically to that sphere. In this way, changes to the pfFCS matrix will not change the visibility of the objects under the pfFCS node. The smaller the extent of the motion, the more efficient this method is. If there is no prior knowledge of the extent, this method is very wasteful because the application has to set a very large bounding sphere that is always visible.
- In the APP process, change the bounding sphere of the pfFCS node every frame. This is not very desirable. If an application changes the bounding sphere every frame, it may just as well use a pfDCS node instead of a pfFCS node.

For an example of pfEngine, pfFlux, and pfFCS use, see `fcs_engine.C` in `sample/pguide/libpf/C++`.

Replacing pfCycleBuffer with pfFlux

Prior to version 2.2 of OpenGL Performer, the customary way of manipulating dynamic data was to use a pfCycleBuffer. Morphing was accomplished using pfCycleBuffer and pfMorph. While pfCycleBuffer and pfMorph are still supported for compatibility, they are obsoleted by pfEngine and pfFlux.

Note: If your applications do not contain pfCycleBuffer or pfMorph, skip to the next section. This section explains how to replace pfCycleBuffer and pfMorph with pfFlux and pfEngine.

pfFlux Differences

A pfFlux is similar to, but far more powerful than, a pfCycleBuffer:

- Where pfCycleBuffer is unaware of the nodes driving it, pfFlux is aware of its parent nodes. When attached to a pfEngine, for example, a pfFlux can trigger a pfEngine to recompute its output.
- A pfFlux provides a mechanism for updating data in processes that are completely asynchronous to the main APP, CULL, and DRAW pipeline stages.

Converting to pfFlux

To convert from pfCycleBuffer to pfFlux, use code similar to the following:

```
/* Replace pfCyclebuffer creation with pfFlux: */
pfFlux *flux = pfFlux(size, PFFLUX_DEFAULT_NUM_BUFFERS);

/* replace getting of read-only data
 * pfCBufGetCurData() for read becomes:
 */
curData = flux->getCurData();

/* replace getting of data to edit.*/

/* get writable buffer BEFORE editing data */
data = flux->getWritableData();

/* ... edit data */
```

```
/* declare data edited after editing for the frame is done.  
* Replace pfCBufferChanged(pfCycleBuffer *cbuf) becomes:  
*/  
flux->WriteComplete();
```

pfEngine

A pfEngine performs calculations. The source can either be static data, such as a pfMemory, or dynamic data, such as a pfFlux. The destination of a pfEngine is fed into a pfFlux, as shown in Figure 19-4 on page 675.

Creating and Deleting Engines

The constructor for pfEngine requires that you specify the computation type of pfEngine you are creating. OpenGL Performer provides many types of engines, each performing a different calculation on the input data. Table 19-1 describes the engine types:

Table 19-1 pfEngine Types

Engine	Description
PFENG_SUM	Sums the input array of floats into a destination array of floats.
PFENG_MORPH	Morphs between the input data
PFENG_BLEND	Is a lightweight version of PFENG_MORPH.
PFENG_TRANSFORM	Translates a set of data with a matrix operation.
PFENG_ALIGN	Generates a translation matrix from the input data.
PFENG_MATRIX	Generates a matrix of type rotation, translation, scale, non-uniform scaling, or combine, using pre or post multiplication.
PFENG_ANIMATE	Same as PFENG_MATRIX, except that the sources are arrays of animation frames.
PFENG_BBOX	Computes the bounding box of the input array of data.
PFENG_TIME	Takes a time, in seconds, and makes it into a frame number that is useful in driving the frame source of PFENG_MORPH, PFENG_BLEND, and PFENG_ANIMATE.

Table 19-1 pfEngine Types (**continued**)

Engine	Description
PFENG_STROBE	Switches iteration sets of floats, called <i>items</i> , between an on and off based on time.
PFENG_USER_FUNCTION	User-defined function.

The **pfGetEngineFunction()** function returns the pfEngine type. These engine types are described in further detail in “Setting Engine Types and Modes” on page 679.

To delete a pfEngine, as with all pfObjects, use **pfDelete()**.

Setting Engine Types and Modes

Table 19-1 lists the different types of pfEngines supplied by OpenGL Performer. Many of the pfEngines have different modes of operation. For example, PFENG_ANIMATE offers the following modes:

- PFENG_ANIMATE_ROT
- PFENG_ANIMATE_TRANS
- PFENG_ANIMATE_SCALE_UNIFORM
- PFENG_ANIMATE_SCALE_XYZ
- PFENG_ANIMATE_BASE_MATRIX

All of these modes specify what the engine changes. PFENG_ANIMATE_ROT, for example, specifies that the engine rotates a geometry, PFENG_ANIMATE_TRANS translates a geometry, and PFENG_ANIMATE_SCALE_UNIFORM scales a geometry.

The **pfEngineMode()** function sets the mode value; **pfGetEngineMode()** returns the mode value.

The following sections describe the engine types and their mode values, if any.

PFENG_SUM Engines

A PFENG_SUM engine adds arrays of floats to form a destination array of floats. One use for PFENG_SUM is aligning geometries to height, such as buildings, to a pfASD terrain.

Since PFENG_SUM can have as few as one source, it can be used to simply copy data from one location to another.

PFENG_MORPH Engines

Morphing is the smooth transition from one appearance to another. The effect is achieved through the reorientation of the vertices in pfGeoSets. Morphing can refer to geometries and their attributes. For example, you could “morph” the following:

- Color to simulate a flickering fire.
- Texture coordinates to simulate rippling ocean waves.
- Coordinates to make a 3D model of a face smile or frown.

A PFENG_MORPH engine sets the destination of the pfEngine to a weighted sum of its sources. To specify the weighting, you use one of the following:

- PFENG_MORPH_WEIGHTS
- PFENG_MORPH_FRAME

The token PFENG_MORPH_WEIGHTS contains an array of floats or weighting values. PFENG_MORPH_SRC(*n*) is also an array; there is one element for each pfEngine source. To create the morph weighting, element 0 of PFENG_MORPH_WEIGHTS is multiplied by PFENG_MORPH_SRC(0); element 1 is multiplied by PFENG_MORPH_SRC(1), and so on.

PFENG_MORPH_FRAME contains a single float. This float specifies the weighting between two pfEngine sources, PFENG_MORPH_SRC(*n*). The integer portion of the float specifies the first of the two consecutive sources, and the decimal portion of the float specifies the weighting between those sources. For example, a PFENG_MORPH_FRAME of 3.8 would mean PFENG_MORPH_SRC(3) * 0.2 + PFENG_MORPH_SRC(4) * 0.8.

For an example of a morph engine, see `morph_engine.C` in `sample/pguide/libpf/C++`.

PFENG_BLEND Engines

A PFENG_BLEND engine is a lightweight version of PFENG_MORPH. PFENG_BLEND sets the pfEngine destination to a weighted sum of elements of the pfEngine sources.

To specify the weighting, you use one of the following:

- PFENG_BLEND_WEIGHTS
- PFENG_BLEND_FRAME

These weighting mechanisms work identically to those in “PFENG_MORPH Engines,” with the following exception: the source, PFENG_BLEND_SRC(*n*), should contain iteration elements. Each element is a set of floats, called *items*. The number of elements in each set is called a *stride*. So, the iteration items for pfEngine source 0 begin at *items* number 0 * *stride*; for source 1, at *items* number 1 * *stride*, and so on.

PFENG_BLEND_WEIGHTS contains an array of floats, one for each of the pfEngine sources, PFENG_BLEND_SRC(*n*).

PFENG_BLEND_WEIGHTS(0) is multiplied by the items starting at PFENG_BLEND_SRC(0*stride); PFENG_BLEND_WEIGHTS(1) is multiplied by the items starting at PFENG_BLEND_SRC(1*stride) and so on.

PFENG_BLEND_FRAME contains a single float. This float specifies the weighting between two consecutive PFENG_BLEND_SRC(*n*) sources. The integer portion of the float specifies the first of the two consecutive sources, and the decimal portion of the float specifies the weighting between those sources. For example, a PFENG_BLEND_FRAME of 3.8 would mean PFENG_BLEND_SRC(3) * 0.2 + PFENG_BLEND_SRC(4) * 0.8.

For an example of a blend engine, see `blend_engine.C` in `sample/pguide/libpf/C++`.

PFENG_TRANSFORM Engines

A PFENG_TRANSFORM engine transforms the PFENG_TRANSFORM_SRC(*n*) array of floats by the matrix contained in PFENG_TRANSFORM_MATRIX.

PFENG_ALIGN Engines

The following describes the PFENG_ALIGN engines:

- PFENG_ALIGN generates an alignment matrix based on the sources. One use for PFENG_ALIGN is to align moving objects, such as vehicles, to a pfASD.

- PFENG_ALIGN_POSITION determines the translational portion of the matrix. If PFENG_ALIGN_POSITION is NULL, the translational portion of the matrix is set to all zeros.
- PFENG_ALIGN_NORMAL and PFENG_ALIGN_AZIMUTH determine the rotation portion of the matrix. If either are NULL, the rotation portion of the matrix is set to all zeros.

PFENG_MATRIX Engines

A PFENG_MATRIX engine generates a matrix based on its sources. Applied to vertex coordinates of pfGeoSets, these routines provide the same mathematical effect as using pfDCSs in a scene graph. However, these pfEngines use the host to compute the vertices and, thus, eliminate the need for matrices to be evaluated in the graphics pipeline. This trade-off might produce a faster rendering frame rate if there are sufficient host CPU resources for the computation involved.

The following tokens specify the kind of action performed by the PFENG_MATRIX engine:

PFENG_MATRIX_RO

Rotates a geometry according to heading, pitch, and roll values; the equivalent is **pfDCSRot()**.

PFENG_MATRIX_TRANS

Transforms a geometry; the equivalent is **pfDCSTrans()**.

PFENG_MATRIX_SCALE_UNIFORM

Uniformly scales a geometry; the equivalent is **pfDCSScale()**.

PFENG_MATRIX_SCALE_XYZ

Non-uniformly scales a geometry; the equivalent is **pfDCSScaleXYZ(x,y,z)**.

PFENG_MATRIX_BASE_MATRIX

Contains a pfMatrix that is either pre- or post-multiplied against the matrix generated by the other sources, depending on the PFENG_MATRIX_MODE mode set by the **pfEngineMode()** function; PF_OFF specifies pre-multiplication; PF_ON specifies post-multiplication.

Any or all of the sources can be NULL, in which case they have no effect on the resulting matrix.

PFENG_ANIMATE Engines

A PFENG_ANIMATE engine animates a matrix based on its sources. This engine type is similar to PFENG_MATRIX, but instead of using single values for rotation, translation, and scaling, PFENG_ANIMATE uses arrays of values.

To specify the weighting, you use one of the following:

- PFENG_ANIMATE_WEIGHTS
- PFENG_ANIMATE_FRAME

PFENG_ANIMATE_WEIGHTS contains a float for each of the values in the rotation, translation, and scale sources. PFENG_ANIMATE_SRC(*n*) is also an array; there is one element for each pfEngine source.

To create an animation, element zero of PFENG_ANIMATE_WEIGHTS is multiplied by PFENG_ANIMATE_SRC(0); element one is multiplied by PFENG_ANIMATE_SRC(1), and so on.

PFENG_ANIMATE_FRAME contains a single float. This float specifies the weighting between two of the values in the rotation, translation, and scale sources. The integer portion of the float specifies the first of the two consecutive values, and the fractional portion of the float specifies the weighting between those values. For example, a PFENG_ANIMATE_FRAME of 3.8 would mean PFENG_ANIMATE_SRC(3) * 0.2 + PFENG_ANIMATE_SRC(4) * 0.8.

The following tokens specify the kind of action performed by the PFENG_ANIMATE engine:

PFENG_ANIMATE_ROT

Rotates a geometry according to heading, pitch, and roll values; the equivalent is **pfDCSRot()**.

PFENG_ANIMATE_TRANS

Transforms a geometry; the equivalent is **pfDCSTrans()**.

PFENG_ANIMATE_SCALE_UNIFORM

Uniformly scales a geometry; the equivalent is **pfDCSScale()**.

PFENG_ANIMATE_SCALE_XYZ

Non-uniformly scales a geometry; the equivalent is **pfDCSScaleXYZ(x, y, z)**.

PFENG_ANIMATE_BASE_MATRIX

Contains a `pfMatrix` that is either pre- or post-multiplied against the matrix generated by the other sources depending on the `PFENG_MATRIX_MODE` mode set by the `pfEngine` function **`pfEngineMode()`**.

Any or all of the sources can be `NULL`, in which case they have no effect on the resulting matrix.

For an example of an animate engine, see `fcs_animate.C` in `sample/pguide/libpf/C++`.

For more information about animation, see “Animating a Geometry” on page 688.

PFENG_BBOX Engines

A `PFENG_BBOX` engine generates a bounding box that contains the coordinates of the `pfEngine` source, `PFENG_BBOX_SRC`.

PFENG_TIME Engines

A `PFENG_TIME` engine takes a time in seconds and converts it to a frame number, which can drive the sources of the following engine types: `PFENG_MORPH`, `PFENG_BLEND`, and `PFENG_ANIMATE`.

`PFENG_TIME_TIME` is the source time in seconds. This is usually connected to the `pfFlux` returned from **`pfGetFluxFrame()`**.

`PFENG_TIME_SCALE` contains four floats that are used to modify the incoming time:

- `PFENG_TIME_SCALE[0]` is an initial offset.
- `PFENG_TIME_SCALE[1]` is a scale factor.
- `PFENG_TIME_SCALE[2]` is a range.
- `PFENG_TIME_SCALE[3]` is a final offset.

The `PFENG_TIME_MODE` mode, set with **`pfEngineMode()`**, determines how the destination number moves between its start and end point. The two mode values include the following:

- PFENG_TIME_CYCLE makes the destination number go from start to end then restarts again at the beginning.
- PFENG_TIME_SWING makes the destination number go back and forth between the start and end.

Note: This mode is related to the interval mode of a pfSequence.

If the PFENG_TIME_TRUNC mode is set to PF_ON, the result is truncated.

PFENG_STROBE Engines

A PFENG_STROBE engine switches iteration sets of floats, called *items*, between ON and OFF based on time. One use of PFENG_STROBE is light point animations.

PFENG_STROBE_TIME is the source time in seconds. This data is usually connected to the pfFlux returned from **pfGetFluxFrame()**.

PFENG_STROBE_TIMING contains iterations sets of three floats:

- PFENG_STROBE_TIMING[n*stride + 0] is the ON duration.
- PFENG_STROBE_TIMING[n*stride + 1] is the OFF duration.
- PFENG_STROBE_TIMING[n*stride + 2] is an offset.

PFENG_STROBE_ON contains iteration sets of floats, called *items*.

PFENG_STROBE_OFF contains iteration sets of floats, called *items*. If PFENG_STROBE_OFF is NULL, all off states are 0.0.

For an example of animation using a strobe engine, see `strobe_engine.C` in `sample/pguide/libpf/C++`.

PFENG_USER_FUNCTION Engines

When a pfEngine is of type PFENG_USER_FUNCTION, you specify the function of the pfEngine using **pfEngineUserFunction()**. The **pfGetEngineUserFunction()** function returns the pfEngine type.

For an example of animation using a user-defined engine, see `user_engine.C` in `sample/pguide/libpf/C++`.

Setting Engine Sources and Destinations

The pfEngine sources can be any number of objects, including pfFluxes, pfMemorys, and pfEngines. The sources provide the input data for the pfEngine. pfEngine destinations are pfFluxes, which contain the pfEngine output.

The **pfEngineSrc()** and **pfEngineDst()** functions set the pfEngine sources and destination, respectively; **pfGetEngineSrc()** and **pfGetEngineDst()** return the pfEngine sources and destination, respectively. Function **pfGetEngineNumSrcs()** returns the number of sources. A pfEngine can only have one destination.

Setting Engine Masks

The pfEngine masks are bit masks that provide a means of selectively triggering pfEngines. Only those pfEngines that have masks that match the evaluation mask can be triggered, as shown in the evaluation function:

```
pfEngineEvaluate(int mask)
```

The **pfEngineMask()** and **pfGetEngineMask()** functions set and return pfEngine masks, respectively.

Setting Engine Iterations

You can make pfEngines repeat their calculations, called *iterations*, when operating on an array of data instead of on a single piece of data. You also specify the unit of data, called an *item*, for example, a vector would have three *items* per unit. For example, if you want to add two arrays of 100 pfVec3s each, you set *iteration* to 100 and *item* to 3.

The **pfEngineIterations()** and **pfGetEngineIterations()** functions set and get iterations, respectively.

Setting Engine Ranges

There are times when you might like to reduce computation needs by not evaluating engines, for example, when the eyepoint is far from the geometry being animated by a pfEngine.

You establish the location of an animated geometry and an area located around the geometry using **pfEngineEvaluationRange()**. Only when the eye position is within that area can the pfEngine be evaluated.

The range functionality is only enabled when the PFENG_RANGE mode, created by **pfEngineMode()**, is set to PF_ON; the default is PF_OFF.

Evaluating pfEngines

To evaluate a pfEngine, you use one of the forms of **pfEngineEvaluate()** or **pfFluxEvaluate()**.

For more information about **pfFluxEvaluate()**, see “Triggering pfFlux Evaluation” on page 670.

The two forms of the evaluate functions are the following:

```
pfEngineEvaluate(pfEngine* _engine, int mask)
pfEngineEvaluateEye(pfEngine* _engine, int mask, pfVec3 eye_pos)
pfFluxEvaluate(pfFlux* _flux, int mask)
pfFluxEvaluateEye(pfFlux* _flux, int mask, pfVec3 eye_pos)
```

For more information about *mask*, see “Setting Engine Masks” on page 686.

The second form of the function specifies the location of the viewer. The engine is only evaluated if the location of the viewer, *eye_pos*, is within the range of the pfEngine, set by **pfEngineEvaluationRange()**. For more information about the range of a pfEngine, see “Setting Engine Ranges” on page 687.

Note: The eye position has no effect on evaluation of the pfEngine if the PFENG_RANGE_CHECK mode is PF_OFF, the default.

Animating a Geometry

To animate a geometry using a combination of pfFlux, pfFCS, and pfEngines nodes, use the following guidelines:

1. Initialize and populate the pfFluxes.
2. Connect pfMemory or pfFluxes as the sources of a pfEngine.
3. Connect a pfFlux to the output destination of the pfEngine.
4. Connect the pfFlux containing the output of the pfEngine to the scene graph in one of three ways:
 - Connect it as an attribute of a pfGeoSet using **pfGSetAttr()**.
 - Connect it as the bounding box of a pfGeoSet using **pfGSetBound()**, where the mode argument is set to PFBOUND_FLUX.
 - Connect it directly to a pfFCS using **pfFCSFlux()**.
5. Set up any needed flux sync groups for synchronizing transformations.

This scenario is the simplest set up; it is represented graphically in Figure 19-4 on page 675. More complicated scenarios include chaining pfEngines together or running multiple geometries off of one pfFCS node.

The following C++ code sample provides an implementation of the animation procedure:

Example 19-2 Connecting Engines and Fluxes

```
// create the nodes
pfFlux *myData1 = new pfFlux(100 * sizeof(pfVec3));
pfFlux *myData2 = new pfFlux(100 * sizeof(pfVec3));
pfEngine *myEngine = new pfEngine(PFENG_SUM);
pfFlux *engineOutput = new pfFlux(100 * sizeof(pfVec3));
pfFCS myFCS = new pfFCS();
pfGeode myGeode = new pfGeode();

// initialize and populate the flux nodes
myData1->init();
myData2->init();

// attach the pfFlux nodes as the source of the pfEngine
myEngine->setSrc(0, myData1, 0, 3);
```



```
myEngine->setSrc(0, myData12, 0, 3);

// attach a pfFlux to the output of the pfEngine
myEngine->setDst(engineOutput, 0, 3);
myEngine->iterations(100, 3);

// connect the pfFlux output node to the scenegraph
myFCS->setFlux(engineOutput);
// attach child geometry to be tranformed by the FCS
myFCS->addChild(myGeode);

...
// compute the data in the source pfFluxes to the engine
float *current = (float *)myData1->getWritableData();
... // compute data
myData1->writeComplete();
```

Active Surface Definition

Active Surface Definition (ASD) is a powerful real-time surface meshing and morphing library. It enables you to roam surfaces that are too large to hold in system memory very quickly. The surfaces, called meshes, are represented by triangles from more than one LODs.

ASD is a library that handles real-time surface meshing and morphing in a multiprocessing and multichannel environment. pfASD is an OpenGL Performer scene graph node that allows you to place ASD information in a scene graph.

This chapter describes how to create and use ASD.

Overview

In the past, OpenGL Performer applications have dealt with large surfaces in two ways:

- Level of detail (LOD), where the whole surface is one LOD.
- Patches, where the surface is broken into geometrical subunits, each of which can be at a different LOD level.

Each of these approaches has its disadvantages:

- When the entire surface is one LOD, with large surfaces, memory limitations often require such a high LOD that the resolution is poor.
- Patches can only morph between adjacent LODs, which is insufficient in large surfaces. The result is visible borders between LODs.

Active Surface Definition (ASD) is designed to solve these problems. ASD is a powerful real-time surface meshing and morphing library characterized by the following features:

1. Transitions between different levels of detail (LOD) appear smooth and void of spatial or temporal artifacts. Vertex position, normal, color, and texture coordinates can be morphed.
2. LODs can be generated using simple adaptations of well-known, non-uniform-tessellation surface subdivision algorithms.
3. ASD is real-time; in multiprocessor mode, it can sustain 60HZ operation while displaying complex surfaces.
4. Nearly-coplanar objects, such as road surfaces, are accurately represented in the non-uniform tessellation of each LOD using local textures.
5. Objects, such as buildings, may be modeled and rendered using alternate algorithms, yet remain attached to the surface.
6. Triangles substantially outside the viewing frustum are culled from rendering.
7. The evaluation function that specifies the morphing factor for each geometry is specified at run-time; this allows traversals to be optimized for different applications and data sets.
8. Huge surfaces, such as one-meter data of the entire United State, are supported using run-time paging from disk memory.

The pfASD approach uses a modeling surface that is a single, connected surface rather than a collection of patches.

An ASD surface contains several hierarchical level-of-detail (LOD) meshes, where one level encapsulates a coarser LOD than the next. When rendering an ASD surface, an evaluation function selects polygons from the appropriate LODs and constructs a valid meshing to best approximate the real surface on the screen.

Unlike existing LOD schemes, pfASD selects triangles from many different LODs and combines them into a final surface. This feature lets a fly-through over a surface use polygons from higher LODs for drawing nearby portions of the surface in combination with polygons from low LODs that represent distant portions of the surface.

To review an ASD application, see `perf/test/simpleASD/simpleASD.C`.

Using ASD

Modern computer graphics systems render objects represented by faceted surfaces comprised of triangles. While rendering performance is increasing steadily, it remains necessary to limit the number of triangles that are rendered if a real-time rendering rate of 60 frames per second or greater is to be maintained.

Triangles may be omitted with no loss of image quality if they represent objects that are not in the field of view (view frustum culling) or if they represent objects whose visibility is occluded by other, nearer objects.

The number of rendered triangles can also be dramatically reduced with little or no loss of image quality if multiple representations of each object are maintained, and the representation used has as little detail as is necessary for displaying a good-quality image. This technique and a body of others related to it are collectively referred to as level of detail (LOD) reduction, and the multiple-object representations are known as LODs.

LOD Reduction

LOD reduction is not a new idea, having been practiced in the field of real-time image generation for at least two decades. Early implementations eliminated the sudden, visible transition from one level of detail to another by alpha blending two models over a period of several frame times. More recently the fade transition has been replaced by a geometric morph solution, which eliminates the need to temporarily render additional triangles and interacts more nicely with depth buffer hidden surface elimination.

When the object being rendered is very large, there is no single level of detail that is optimal for the entire object. Instead, it is desirable to render the object with a smooth variation of level of detail; this allows nearer portions to be represented accurately, and farther portions to be represented efficiently.

The need for spatially varying level of detail is particularly acute when rendering terrain, which may range from several feet to hundreds of miles from the viewpoint. Early attempts to support multiple LOD terrain modeled the surface as separate tiles, each of which was rendered at a single level of detail. This approach results in physical discontinuities between neighboring tiles rendered with different levels of detail, which are visible as obvious “walls.”

Triangulated Irregular Networks

Triangulated irregular networks (TINs) can approximate a surface with fewer polygons than other uniformly-grided representations. However, TIN models are hard to create dynamically at interactive rates. Regular data, on the other hand, allows easier construction of LODs at interactive rates. We propose a new terrain framework, Active Surface Definition (ASD), that combines the advantages of both regular and irregular networks. The terrain database is pre-computed and stored in a hierarchical structure of efficient, irregular triangulations. LOD reduction is performed on the data structure at real-time frame rates, varying levels of detail both spatially and temporally.

Hierarchical Structure

Active Surface Definition defines a hierarchical structure that organizes all the LODs of a terrain. At run-time ASD traverses the structure, selecting triangles from different LODs to render the portion of the terrain that is within the culling frustum. Triangles are rendered either at pre-stored locations when they are in a particular fully-morphed portion of a LOD range or at computed morphed locations when they are in the morphing transition portions of the LOD range, as shown in Figure 20-1.

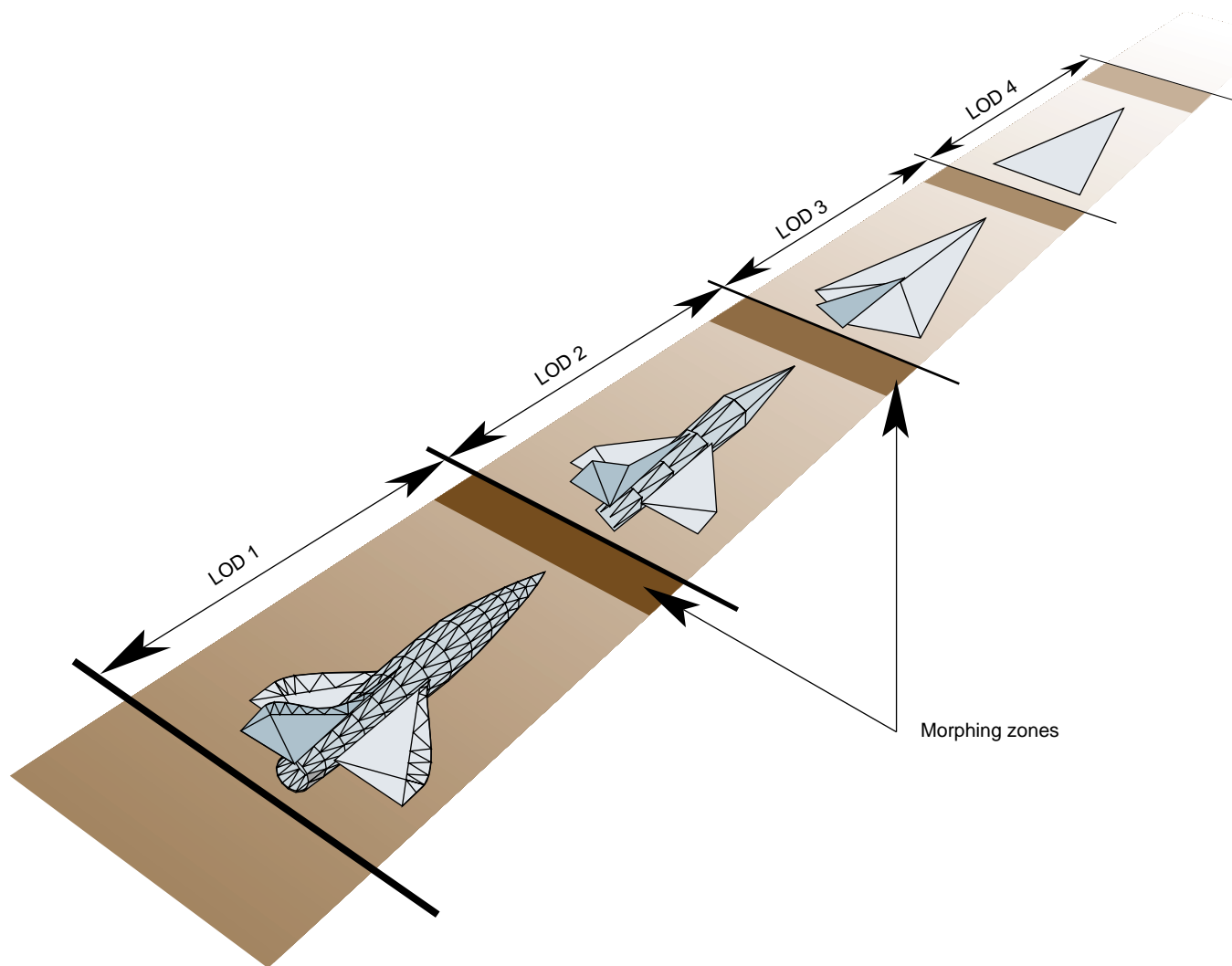

Figure 20-1 Morphing Range Between LODs

Figure 20-1 shows the complete object represented by an LOD. ASD is often used for very large terrains, like a map of the United States, where the entire terrain cannot fit into a single LOD range. In that case, parts of the large terrain would be represented by different LODs, as shown in Figure 20-2.

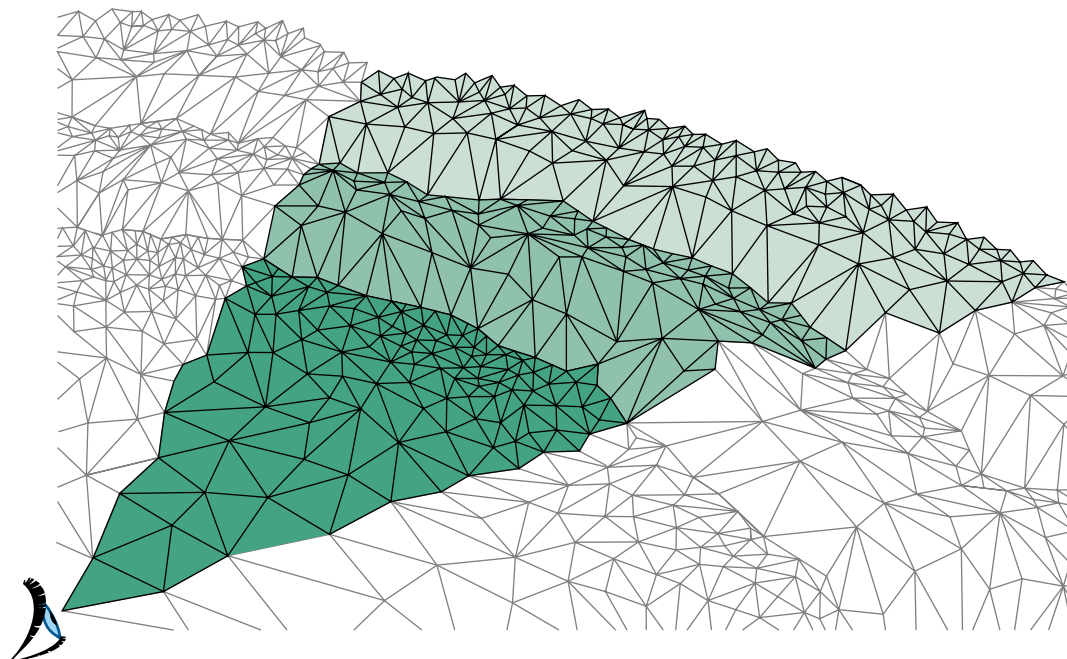

Figure 20-2 Large Geometry

In Figure 20-2, different parts of the terrain are displayed at different levels of resolution.

ASD Solution Flow Chart

To visualize large terrains using ASD, you use the following steps, which are portrayed in Figure 20-3:

1. Collect raw, elevation data.
2. Use a modeler to create ASD structures from the raw elevation data. There are various triangle tessellation algorithms that can be used to model the terrain into TINs. Adaptive tessellation and accurate representation and minimum visual distraction between LODs are potentially all supported by pfASD structures.
3. Place the ASD structures into a scene graph by attaching them to pfASD nodes.

4. Design an evaluation function that shows when a particular triangle on a particular LOD level in ASD structure should be selected.
5. OpenGL Performer traverses and evaluates pfASD structures at run-time to create an active mesh that is used for rendering.

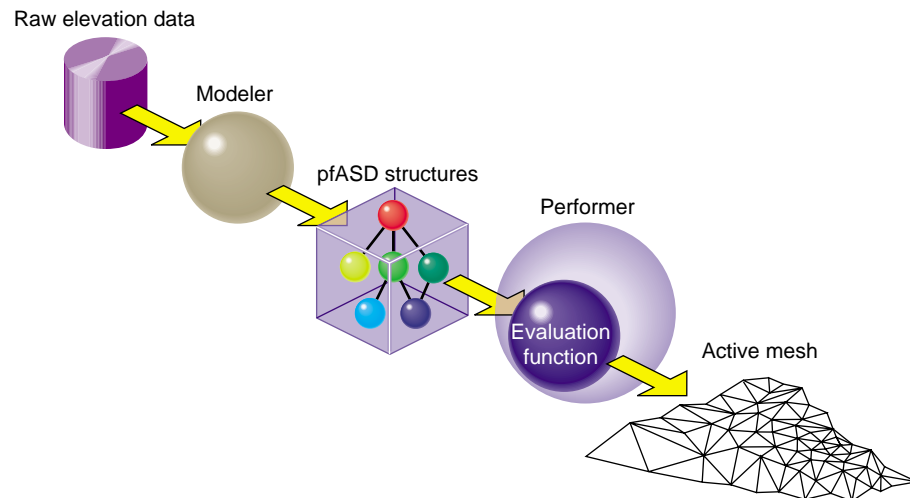

Figure 20-3 ASD Information Flow

A Very Simple ASD

To demonstrate the ASD concept, we shall now build a very simple ASD surface. The surface has two representations, which corresponds to two levels of detail (LOD). The coarser level, LOD 0, has only a single triangle: T0. The finer level, LOD 1, has four triangles: T1, T2, T3, T4, as shown in Figure 20-4.

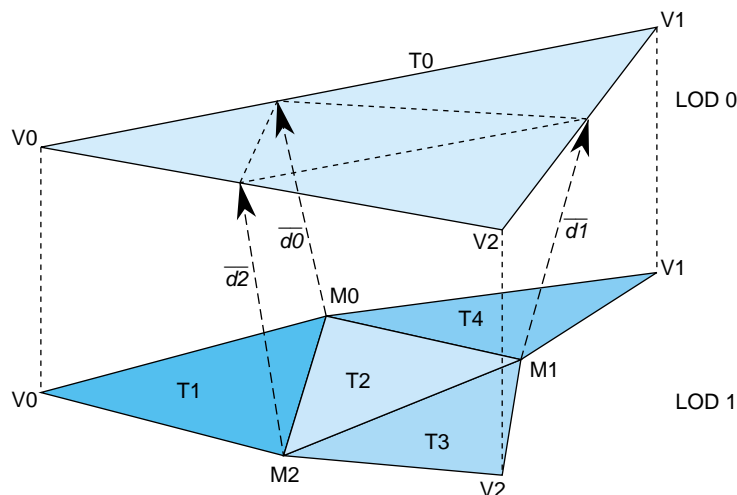

Figure 20-4 A Very Simple pfASD

pfASD requires that we specify a morphing relationship for the vertices in the two levels of detail. This relationship guides ASD to choose triangles from the appropriate LODs and place vertices in the correct positions.

Morphing Vector

Each triangle in LOD 0 can have up to four replacement triangles in a higher LOD. pfASD imposes the limitation that the replacement of T0 must include the vertices V0, V1, V2, and may include three more vertices. In our case, the replacement of T0 includes the vertices V0, V1, V2, M0, M1, M2. We express the morph behavior between two levels by describing the morph behavior of the triangle vertices.

Since V0, V1, and V2 remain unchanged, we need only specify the morphing behavior, or the morphing vector, M0, M1, and M2. The morphing vector of a vertex is a vector connecting the vertex to an edge of the lower resolution triangle. We specify morphing vectors \vec{d}_0 , \vec{d}_1 , and \vec{d}_2 for the vertices M0, M1, and M2, respectively. The triangles in LOD1 can now morph smoothly by morphing the vertex M0, M1, and M2 along their morphing vectors \vec{d}_0 , \vec{d}_1 , and \vec{d}_2 .

We call the edge position ($M1+d1$) unmorphed and, the $M1$ position fully morphed. The unmorphed position is the **reference position** of a vertex because it is a reference to show how a vertex should be coplanar with the triangle in the lower LOD when we replace the lower LOD triangle with a higher LOD triangles, while providing the least amount of visual distraction. The fully-morphed position is the **final position** of a vertex; that position should be chosen from the original raw data by various triangulation algorithms. It is recommended that the reference position be defined after the final position is chosen to most accurately design the adaptive tessellation of a terrain. pfASD handles the morphing of other attributes, such as normals, colors, and texture coordinates as well.

This completes the construction of a very simple pfASD. When flying over this model—for example, from $V0$ towards $M1$ —pfASD shall morph $M0$ and $M2$ first and continue to morph $M1$ as we get closer to the edge [$V1, V2$]. In other words, pfASD will morph closer triangles into their higher LOD first.

A Very Complex ASD

To view a complex ASD, run `perfly` with the `yosemite` data supplied in the images. Observe that the entire, visible terrain is represented by more than one LOD.

ASD Elements

pfASDs create active meshes to accurately and efficiently render terrains. A mesh is a surface tessellated into triangles, as shown in Figure 20-2. Each frame contains an active mesh. ASD reduces visual discontinuities between meshes by morphing geometry.

pfASD is defined by the following elements:

- vertices
- triangles
- evaluation function

Vertices

The triangles of all LODs share a single pool of vertices: those vertices that define the triangles of the highest LOD. A few vertices exist in all the LODs. These vertices define the triangles in LOD0 and are typically chosen as corners of the terrain or other significant features. Each of the remaining vertices exists in a contiguous set of LODs, including the highest LOD. In order to facilitate the gradual introduction of a vertex into the terrain, the actual position of each vertex is supplemented by a reference position. If i is the lowest LOD that includes a vertex, then that vertex is located at its actual position in LODs i through $(n-1)$ and is morphed between its reference position and its actual position during the morphing zone of LOD i , which is adjacent to LOD $(i-1)$ range.

Note: ASD could be extended to support multiple reference positions per vertex; this allows vertices to morph between multiple LODs. This extension may be supplied in the near future depending on demand.

A vertex is represented by its final position (V_0) and a morphing vector (V_d), which represents the difference between the final position and the reference position. The current position of a vertex is computed in this manner:

$$V_{\text{vertex}} = V_0 + mV_d$$

V_0 is the final position of a vertex, m is the current morphing weight, and V_d is the morphing vector. Notice that the reference position of a vertex is always chosen to lie on an edge of a triangle from the lower LOD, though not necessarily at the centers of these edges. This is to ensure that the replacement of the lower LOD by the higher LOD happens when they are at coplanar positions; this eliminates sudden popping artifacts.

Attributes are represented by final position as well, as shown in Figure 20-5.

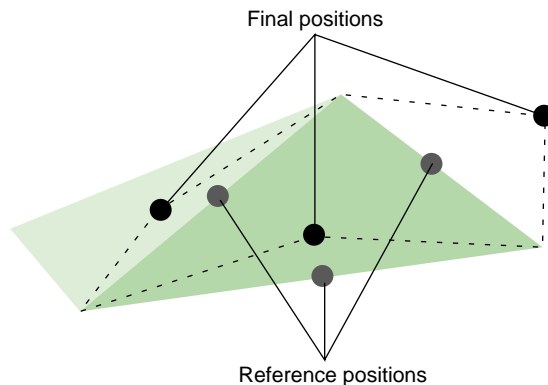

Figure 20-5 Reference Positions

Normals, colors, and texture coordinates can all be linearly interpolated, as specified.

A vertex always morphs along the morphing vector, v_d . When $m = 1$, the vertex is at a no-morph position, which means it most likely is not part of the active mesh, because it is on an edge of the parent triangle.

Triangles

A triangle exists in only one particular LOD. If the triangle is too coarse to accurately represent the current terrain, the triangle is removed from the active mesh. The position of a triangle is determined by the positions of its vertices, which may be morphed along the morphing vector.

In the pfASD structure, each triangle node, called an pfASDFace, can have up to four children. A sequence of frames may render the meshes shown in Figure 20-6.

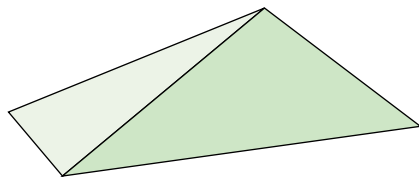

Figure 20-6 Triangulated Image

As the distance between a vertex, P , and a viewer changes through the morphing range, the side of the triangle associated with P is replaced by two edges from the next LOD. Figure 20-7 shows how the next LOD triangles replace the current LOD triangles.

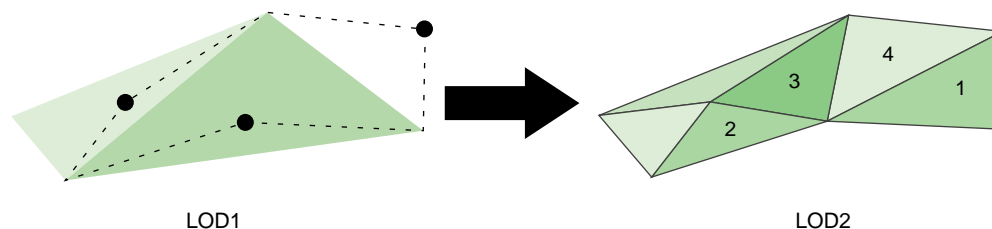

Figure 20-7 LOD1 Replaced by LOD2

Figure 20-7 shows the shapes of the triangles in two adjacent LODs.

Notice that only one side of the triangle on the left is changed; in this case, the original triangle is now replaced by two triangles. The triangle that was on the right is now completely gone; in its place are four triangles, as labeled. One triangle can be replaced by up to four child triangles, depending on whether one, two, or three sides of the triangles are replaced by two lines.

Sides shared by two triangles are evaluated only once. Morphing the shared side of one triangle necessarily morphs it to the same position in the neighboring triangle.

Evaluation Function

The evaluation function determines the morph weight of every vertex. This function returns a floating point value between 0.0 and 1.0 where 1.0 means the vertex is not morphed and therefore not active. Since it is not active, it is not in the current mesh; its geometry is represented by coarser LOD triangles. 0.0 means that the triangle is completely morphed. In this case, the vertices are in their final positions in the active mesh. Any number between 0.0 and 1.0 signifies a morphed position. OpenGL Performer constructs a smooth mesh, based on the results from the evaluation function.

You can customize an evaluation function so that it applies to your application. For example, instead of distance, your evaluation function might be based on altitude.

For more information about the evaluation function, see “Default Evaluation Function” on page 712.

Data Structures

Raw geometry data is converted into a tree-like, hierarchical structure of data, as shown in Figure 20-8.

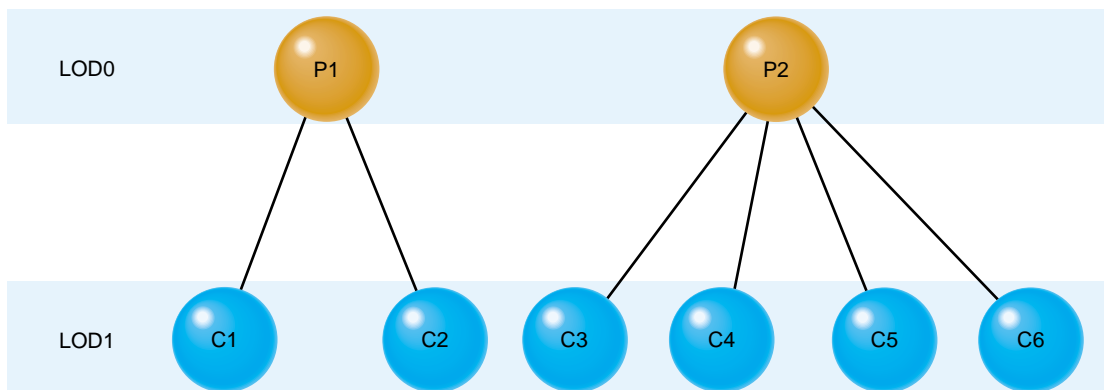

Figure 20-8 Data Structures

In Figure 20-8, each horizontal layer of triangles is equivalent to a single LOD mesh. The nodes in the tree structure represent triangles in LOD layers of the terrain. Each triangle contains three end vertices and up to three reference vertices. These vertices are indices into the vertex and attribute arrays.

A vertex may be shared by multiple triangles within a single LOD and by many more triangles throughout the data structure. A single position pair suffices for all the triangles that share a vertex, but each triangle may specify its own vertex attribute pairs. This is the reason that the vertex and attribute arrays are represented separately.

In Figure 20-8, the nodes in the top, root level represent the two LOD0 triangles shown in Figure 20-6. The six triangles from LOD1, labeled C1 through C6, correspond to nodes from the second level in the tree.

OpenGL Performer uses three data structures to encapsulate the triangle mesh information:

- Triangle—Encapsulates information about the sides, vertices, attributes, reference points, parent, and children of a triangle.
- Attributes—Encapsulates information about the attributes of each vertex, including the normal, color, and texture coordinates.
- Vertex—Encapsulates information about a morphing vector and the coordinates of its final position.

Figure 20-9 shows the data structures, their fields, and their relationships.

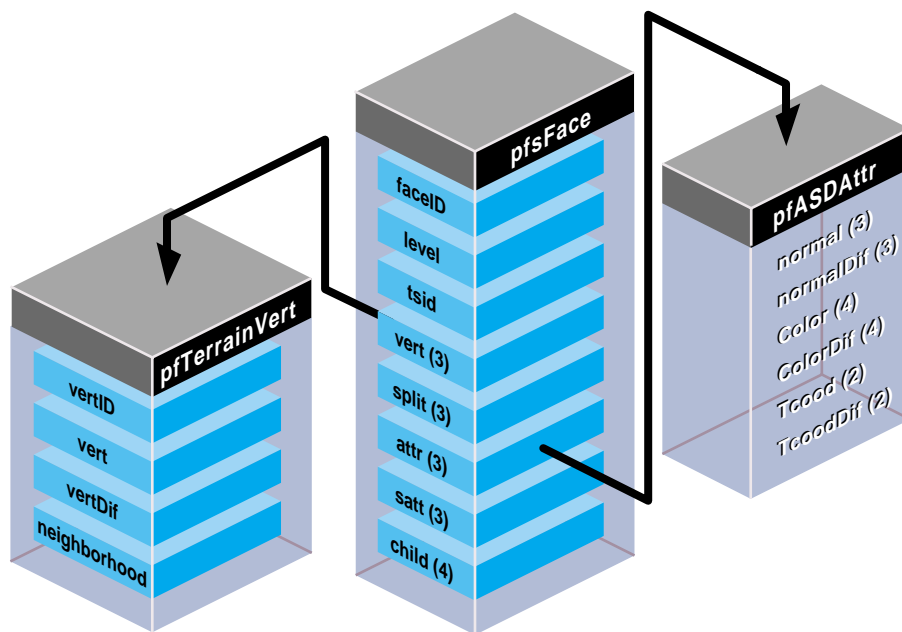

Figure 20-9 ASD Data Structures

The following sections describe these data structures in detail.

Triangle Data Structure

The triangle data structure in PFASD contains information about the triangles in the triangle mesh.

```
typedef struct pfASDFace
{
    int level;
    int tsid;
    int vert[3];
    int attr[3]
    int refvert[3];
    int refattr[3];
    int child[4];
    int refvert[3];
    ushort gstateid;
    ushort mask;
} pfASDFace;
```

Table 20-1 describes the fields in the triangle data structure.

Table 20-1 Fields in the Triangle Data Structure

Field	Definition
level	Triangle's LOD level.
tsid	Triangle strip ID.
vert[3]	Coordinates of the triangle's three vertices.
refvert[3]	Coordinates of the triangle's (up to) three reference points.
attr[3]	Pointer to attribute values for each of the triangle's three vertices.
refattr[3]	Pointer to attribute values for each of the triangle's (up to) three reference points.
child[4]	Triangle IDs of the triangle's (up to) four child triangles.
gstateid	GeoState ID.
mask	Specifies whether or not to render the triangle.

Triangle IDs and LOD Levels

Each triangle in the database has an ID. Since one triangle can be replaced by as many as four triangles, *child[4]* is an array of child triangle IDs. The child IDs may be listed in any order in the array. Do not list the same child more than once in the child array.

If a triangle does not have four children, as is the case of the triangle on the left in Figure 20-7, enter the token PFASD_NIL_ID in the *child[4]* array where normally you would enter the IDs of the child triangles.

An ASD node may very likely have more than one texture in it; so, it contains more than one pfGeoState; one for each texture. *gstateid* specifies the pfGeoState object the triangle face uses.

There are times when you might like to have a triangle face specified in the structure but not draw it. For example, you need the triangles of the ground under an airport so that you can place the airport on it. However, since the triangles are covered by the airport, you do not want to render them. *mask* allows you to prevent the rendering of the triangle face specified in the structure.

As shown in Figure 20-8, each triangle is resident in a particular LOD level. *level* defines the LOD of the triangle. If the viewer is moving within one LOD, chances are they need to see other triangles at the same LOD level.

Discontinuous, Neighboring LODs

There are many cases in which you can have neighboring triangles with discontinuous LOD levels; for example, a high-resolution insert of a scene might be LOD level 5 and surrounded by triangles of LOD 1.

When neighboring triangles have discontinuous LOD levels, the lower-resolution triangles must have the following, as shown in Figure 20-10:

- reference vertices on all triangle edges
- PFASD_NIL_ID entered in the fields for all four of its children

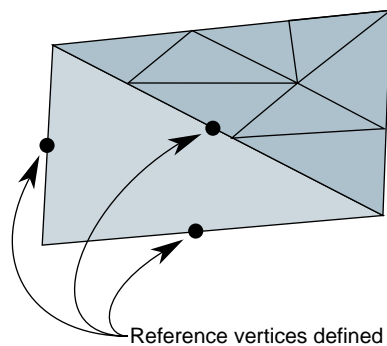

Figure 20-10 Discontinuous, Neighboring LODs

Triangle Strips

You can increase the rendering speed of your application by using triangle strips. Triangle strips are groups of contiguous triangles that together form a strip, as shown in Figure 20-11.

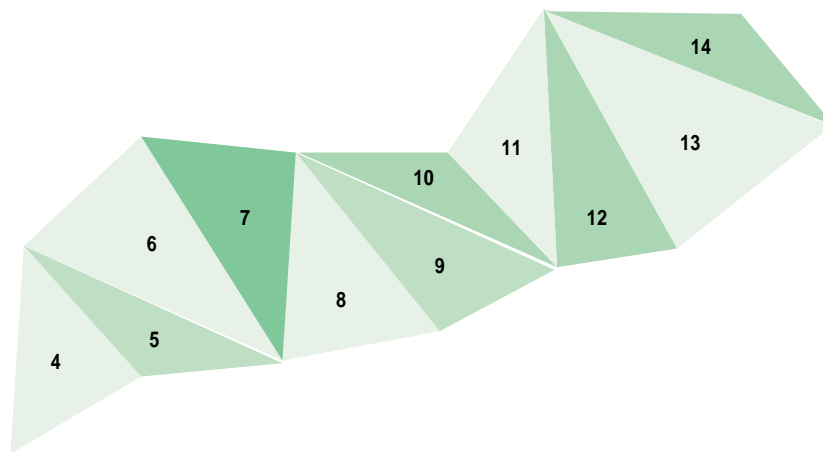

Figure 20-11 Triangle Mesh

Triangle strips improve rendering performance because, after the first triangle in the strip, each additional triangle can be added by defining only one additional vertex.

The pfASD does not generate triangle strips dynamically. Triangle strips are pre-generated at modeling time and represented using *tsid* in the pfASDFace structure. Only triangles from the same ASD face tree level can be in the same triangle strip. The *tsid* numbers are sorted at run-time to connect as many triangles from the same triangle strips together as possible. Triangles with consecutive *tsid* values are placed in one triangle strip.

The pfASD does the following:

1. Evaluates the LOD structure.
2. Picks the triangles at the desired LODs.
3. Culls the triangles to the visible frustum.
4. Sorts the triangles by their *tsid*.
5. Generates triangle strips of triangles with consecutive *tsid* values.

Figure 20-12 shows an example of a set of triangles with consecutive *tsid* values.

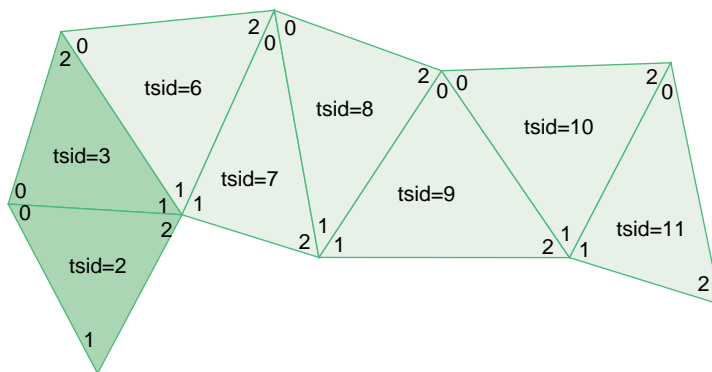

Figure 20-12 Using the *tsid* Field

pfASD generates a triangle strip from the vertices marked 0, 1, and 2 in the triangle with *tsid*=2, followed by the vertex marked 2 in the triangle with *tsid*=3. The triangle with *tsid*=6 marks the beginning of the next triangle strip, vertices marked 0, 1, and 2 in triangle with *tsid*=6, followed by vertices marked 2 from triangles with *tsid* 7, 8, 9, 10, and 11. It is very important to start a triangle strip on an even triangle strip ID. For example, triangles in the first triangle strip can have IDs 0, 1, 2...; but they cannot have 1, 2, 3... Vertices should be listed in pfASDFace in counter-clockwise order with the last vertex to be the vertex in the triangle strip.

At the termination of a triangle strip, there must be a non-consecutive *tsid* in the next triangle, as shown in Figure 20-12. Assigning the numbers 3 and 6 forces these triangles into separate triangle strips. Assigning all triangles to the same *tsid* would separate all of them into strips with only one triangle.

Note: pfASD sorts all the visible triangles by *tsid*. *tsid* values, therefore, must not overlap in different areas of the surface. pfASD does not check that triangles with consecutive *tsid* values are indeed neighboring.

Vertex and Reference Point Arrays

The vertex and reference point arrays, *vert[3]* and *refvert[3]*, each contain three pfASDVerts, which are the coordinates of the vertices and reference points. For more information on pfASDVert, see “Vertex Data Structure” on page 711.

The order of the vertices and the reference points in the arrays must be counter-clockwise, as shown in Figure 20-13.

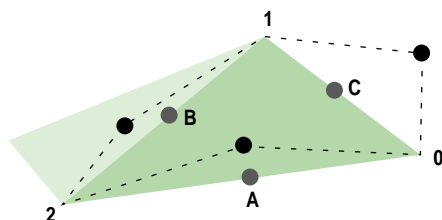

Figure 20-13 Vertex and Reference Point Arrays, Counter-Clockwise Ordering

Any of the vertices can be the first in the array. The first reference point in the array, however, must be the one on the side between the first and second vertex points; for example, the reference point on the hypotenuse of the triangle in Figure 20-13 should not be entered as the first reference point in the *refvert[3]* array because the bottom leg of the triangle contains the first two vertex points entered into the *vert[3]* array.

If a triangle does not have three reference points, as is the case of the triangle on the left in Figure 20-5 (where only the hypotenuse has a reference point), enter the token PFASD_NIL_ID in the *refvert[3]* array where normally you would enter the indices of the reference points.

Attributes

Each vertex can have its own set of attributes. The attribute format is described in “Attribute Data Array” on page 710. The arrays, *attr[3]* and *refattr[3]*, point to three vertex attribute array entries and three reference point attribute array entries.

If a vertex or reference point is not assigned an attribute, enter the token `PFASD_NIL_ID` in the *attr[3]* or *refattr[3]* arrays where normally you would enter the pointer to the attribute array.

Attribute Data Array

Each vertex and reference point can be assigned an attribute. An attribute is an interleaved list of floats that consists of normal, color, and texture definitions, as follows:

```
float normal[3];
float normalDif[3];
float Color[4];
float ColorDif[4];
float Tcood [2];
float TcoodDif [2]
```

If any attribute is not defined, it should not be represented in the array, in which case the stride is shorter.

Each attribute has two listings: the values of the attributes at the final positions and how much they change during morphing. For example, the *normal[3]* array specifies the vector that is normal to the vertex at the final position while the *normalDif[3]* array specifies the difference between the normal and its final position and the normal at its reference point.

Color[4] and *ColorDif[4]* similarly specify the RGBA values at a vertex and the color morphing vector.

The texture coordinates, *Tcood [2]* and *TcoodDif [2]*, specify the texture coordinates of vertices at their final position and the texture coordinates of the morphing vector.

Setting the Attributes

The attribute array of floats can contain normal, color, and texture coordinate information, or it can contain any combination of attributes. You specify which of the

attributes are in the attribute array of floats by setting the **pfASDAttr0** mask. To specify that you are including some or all of the attribute values in the attribute array, you use *pfASDAttr()* with one or more of the following tokens ORed together:

- PFASD_NORMALS
- PFASD_COLORS
- PFASD_TCOORDS

For example, to specify normal and color attributes only, use the following statement:

```
pfASDAttr(PFASD_NORMAL | PFASD_COLOR);
```

If certain attributes are not specified in *pfASDAttr*, they should not be included in the attribute array. *pfASD* only takes one set of per-vertex-per-face attributes and one set of overall attributes.

Global Attributes

If you want to use the same attribute value for all normals, colors, or texture coordinates, you can specify a global attribute value rather than making the same entry for each normal, color, or texture coordinate attribute. To specify a global attribute, use the following statement:

```
pfASDAttr(..., PFASD_OVERALL_ATTR, attr);
```

attr, an array of floats, holds a set of attributes and their morphing vectors. You can mix a global attribute with a different attribute that is per vector.

Vertex Data Structure

The vertex data structure, defined as follows, holds the coordinate information of vertices and their vertex vectors.

```
typedef struct pfASDVert
{
    pfVec3 v0, vd;
    int neighborid[2];
    int vertid;
} pfASDVert;
```

Each vertex has an ID, *vertid*; a set of coordinates, *vo*; and a vertex vector, *vd*. The vertex vector is the vector stretching from the final vertex toward the reference point.

In a triangle strip, a line segment is commonly shared by two adjoining triangles, as shown in Figure 20-14.

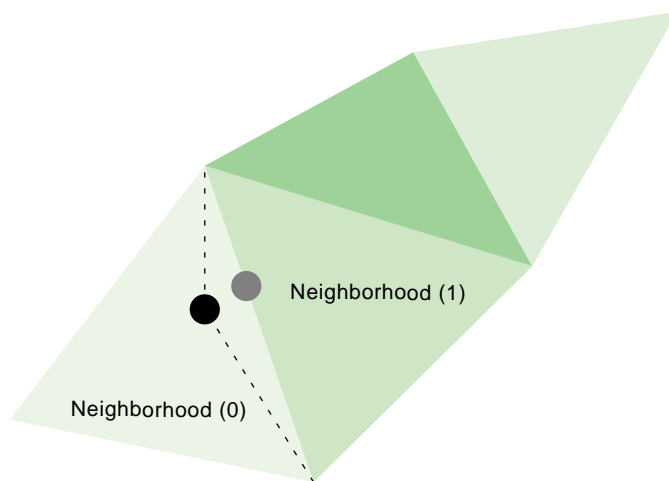

Figure 20-14 Vertex Neighborhoods

The new vertex is shared by the adjoining triangles. Those triangles are referred to as the neighborhoods of the vertex. The neighborhood array contains the triangle IDs of the adjoining triangles in the previous LOD.

If a side is not shared by two triangles, then one of the neighborhood array values should be `PFASD_NIL_ID`.

Default Evaluation Function

The default evaluation function, which returns a value between 0.0 and 1.0, is based on the distance between the vertex and the eyepoint: the farther away a vertex is, the lower its resolution.

To use the default evaluation function, you must fill in the `pfASDLODRange` structure for each LOD.

```
typedef struct pfASDLODRange
{
    float switchin;
    float morph;
} pfASDLODRange;
```

$LOD[i].switchin$ is the far edge of the $LOD[i]$. Take any vertex of a triangle in $LOD[i]$ and compute the distance between the vertex and eyepoint. If this distance is more than $LOD[i].switchin$, the morphing weight of this vertex is 1.0 (NO_MORPH). If it is less, the morphing weight is calculated against the morphing zone.

$LOD[i].morph$ is the length of the morphing zone from the $LOD[i].switchin$ far edge. The morph weight is $(1 - (LOD[i].switchin - dist) / LOD[i].morph)$. If the distance is less than $LOD[i].switchin - LOD[i].morph$, the morph weight is 0.0 (COMPLETE_MORPH).

Overriding the Default Evaluation Function

The evaluation function can be based on many things beside distance. For example, you might implement the evaluation function based on the following:

- Line of sight—Geometries directly in front of the camera have the highest resolution while geometries more peripheral have a lower resolution.
- Direction—High-resolution LODs appear only in one direction; for example, given the fuzzy nature of clouds, when a pilot looks straight ahead, the clouds do not need to be rendered with great detail. When the pilot looks down, however, you might like them to see the terrain in great detail.
- True size of projected triangle—Triangles are replaced when they physically reach a specified size on the projector screen.
- Event driven—An event triggers a change of LODs, for example, when a bomb explodes.
- Shape—Specific shapes in the scene, perhaps a tank, could be rendered in higher resolution than the surrounding countryside.

None of these evaluation criteria can use the default evaluation function. Instead, you must write your own evaluation function and register it as a callback function with pfASD using the following method:

```
extern void pfASDEvalFunc(pfASD* _asd, pfASDEvalFuncType _eval);
```

The evaluation function you provide, *eval*, must return a float between 0.0 and 1.0 and conform to a fixed format. **pfASDEvalFuncType** takes the argument *vertid*, which is the index of the vertex from the next LOD whose reference position is on this edge. Refer to `asdfly/pfuEvalFunc.c` for examples.

pfASD Queries

pfASD supplies a query mechanism for two kinds of objects:

- vertices with a down vector

A vertex query answers the question: Where does the ray through the vertex in the given down direction hit the surface?

- triangles with a projection vector and a down vector

A triangle query answers the question: given a triangle, how does it project onto the current morphing pfASD? Or, given a triangle, supply a list of triangles describing the projection of this triangle on the surface.

The pfASD has a mechanism for manipulating arrays of vertices and triangles and for reporting query results of surface geometries. Query results are kept in a pfFlux buffer. The application may read this buffer directly or connect it to a pfEngine for processing.

These query mechanisms must run in sync with the evaluation function. The query results must be used in the same frame that the morphing status of a pfASD becomes active. To synchronize the behavior of pfASD geometry and query points, you need to set the correct pfFlux flags, as described in “Aligning Light Points Above a pfASD Surface Example” on page 720.

Before describing the technical details of setting up a query array, the following section describes how to use these arrays.

Aligning an Object to the Surface

In the visual simulation arena, you often place objects on surfaces. Since the pfASD surfaces morph, the objects on top must move to remain on the surface. Some objects require only position changes. Others require angle changes as well. A building on top of a mountain side, for example, requires only a position change to match the current

altitude of the surface under it. A car standing on the same mountain side, however, requires changing both its position and its angle in order to remain aligned to the surface.

In the case of the building, it is enough to query the intersection between a query ray and the surface. In the case of the car, however, you must also calculate the surface normal at the intersection point.

Casting a Shadow

We often wish to cast the shadow of objects on the surface underneath them. Since the pfASD surface is morphing, we must morph the shadows accordingly. Given a triangle and a projection direction, we want to project the triangle on the surface and tessellate its projection so that we get a 3D representation of the shadow. We can later use these shadow triangles as decals to paint the shadow on the surface.

Generating Decals

Many times you wish to draw decals on a surface. In the context of surfaces, you may wish to add a road as a decal on the morphing surface. To make the road touch the surface, you must tessellate the polygons of the road so they conform to the shape of the surface. To tessellate the road, you project a triangle downwards and then tessellate the result.

Adding a Query Array

To add an array to the pool of queries, you use the following:

- `pfASD::addQueryArray()` to add an array of vertices.
- `pfASD::addQueryGeoSets()` to add an array of triangles.

Both methods require a pfFlux as input. After completing the evaluation of a pfASD frame, pfASD fills the specified pfFlux objects with query results for all the visible query arrays. The query results become relevant at the next pfFrame along with the newly evaluated pfASD geometry.

To make sure the query results are used only when their corresponding geometry is active, add the corresponding pfFlux and the pfASD node to the same sync group using `pfASD::setSyncGroup()` and `pfFlux::setSyncGroup()`.

Using ASD for Multiple Channels

A channel is a view of a scene. There are three approaches to linking multiple channels:

- Each channel uses the same database, the same viewpoint, the same evaluation function, and the same LODs, but the viewing angle is different for each channel.

The effect is multiple channels that together create a continuous view like that of a horizon. The views of the scenes in each channel move together. For more information on this approach to multiple channels, see “Controlling Video Displays” on page 638.

- Each channel uses the same database, a different viewpoint, the same evaluation function, and potentially different LODs.

The effect is two or more views of the same scene; for example, one view might look along the terrain and another view might look down at the same terrain from above. This approach uses the pfASD API for creating multiple channels, as described in “Connecting Channels” on page 716.

- Each channel uses the same database, a different viewpoint, different evaluation functions, and potentially different LODs.

The effect is two or more views of potentially unrelated parts of a scene; for example, if the database is the earth, one view might be of someone traveling around the north pole and another view might be of someone traveling around the south pole.

Because the only thing common to the two views is the database, you need to create two pfASD objects, one to handle each view.

The following section explains how to do the second approach to connecting channels.

Connecting Channels

When you have two channels that share the same database and evaluation function and differ only in that they have different viewing angles of the same part of a scene, you can save processing time and save memory by attaching the two channels using **pfChanASDattach()**; **pfChanASDdetach()** detaches two channels.

By making the two channels part of the same pfASD, processing time is improved because only one evaluation function is computed. Having one pfASD instead of two saves memory because two pfASDs requires maintaining two sets of the same scene.

Combining pfClipTexture and pfASD

A pfClipTexture is able to manage very large bodies of data, presenting only the part that is in view of the user. pfASD modifies the pfClipTexture such that the different parts of the pfClipTexture are presented using the correct LOD level.

To use a pfClipTexture as part of a pfASD, use the following procedure:

1. Put the pfClipTexture into a pfGeoState.
2. Set the pfGeoState to a pfASD.
pfASD accepts a list of pfGeoStates.
3. Define the center of the pfClipTexture in one of two ways:
 - Attach a pfuClipCenterNode to a pfASD, as shown in the .im loader.
Use pfuTexGenClipCenterNode and convert the eyepoint through texgen into texture space as the clipcenter. This technique should be used when cliptexture is applied using texgen.

Set the proxy box equal to the rough boundary of the pfASD database. The boundary of the pfASD can be queried by calling **pfGetASDBox(*asd*, *box*)**.
 - Use a PRE callback function with pfASD to set the clip center yourself. To see an example, refer to `terrain.c`.
4. If the clip texture is virtual, pfASD automatically sorts geometry into concentric cliprings to support the appropriate cliptexture limit and offset. Set the environment variable, PFASD_CLIPRINGS to activate this feature. See `libpfdem` and `libpfevt` for examples.

ASD Evaluation Function Timing

The pfASD evaluation function commonly runs as a separate, asynchronous process. This process does not necessarily finish its evaluation when the App-Cull-Draw frame finishes. The new pfASD geometry becomes active (visible) at the end of the pfFrame that follows the completion of the pfASD evaluation.

For example, if Draw frames 0, 1, 2, 3, 4... end at times 100, 200, 300, 400, 500... and the pfASD evaluation finishes at time 320, the new geometry is introduced into the scene graph at time 400, as shown in Figure 20-15.

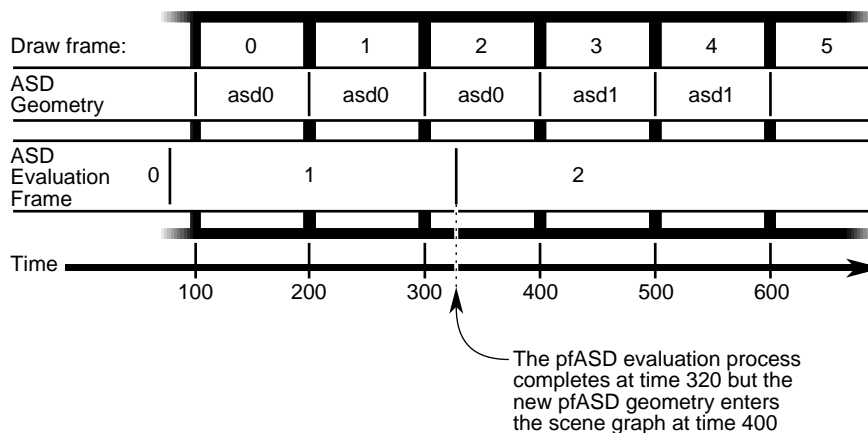

Figure 20-15 pfASD Evaluation Process

In Figure 20-15, it is important to align objects to the old geometry in Draw frame 2 and to align to the new geometry in Draw frame 3.

Query Results

The query results must affect the aligned geometry in the same frame that the pfASD geometry becomes active. To achieve this, you must connect both the pfASD node and Matrix-Flux to the same sync group. In this way, when pfASD changes the active surface geometry, it also activates the newly calculated query results.

In general, you should move as much processing to the pfASD process as possible. In Figure 20-15, all the query /alignment operations take place in the pfASD process. Since the entire evaluation is triggered by the query array writing to Result Flux, the generation of the new pfFCS matrix in Matrix Flux also takes place in the pfASD process. The only change to the time critical APP-CULL-DRAW sequence is a single `pfFlux::getCurData()` to get the updated pfFCS matrix.

Aligning a Geometry With a pfASD Surface Example

To align some geometry to a pfASD surface using query points, use the following procedure:

1. Pick an anchor point where you want the target geometry to go.
2. Generate a query array containing the anchor point and add it to pfASD.
3. Request pfASD to store the query results in the pfFlux marked *Result Flux*.
4. Generate an additional pfFlux and connect it to the pfFCS node matrix controlling the target geometry.

Figure 20-16 diagrams this procedure.

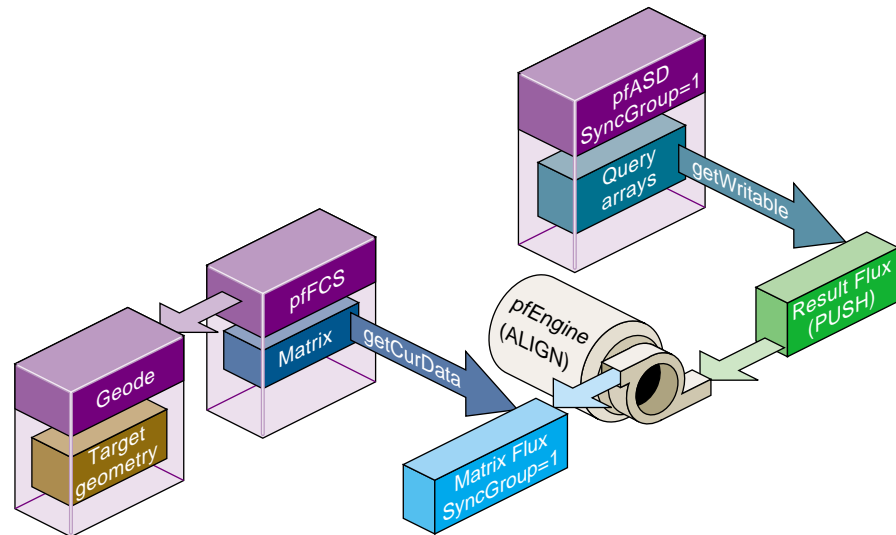

Figure 20-16 Example Setup for Geometry Alignment

At run-time pfASD does the following:

1. pfASD starts its frame by evaluating the ASD surface and generating optimized geometry for it.
2. pfASD calculates the query array values.
3. pfASD writes the results into the pfFlux marked *Result Flux*.
4. The write operation triggers a calculation of the pfEngine because the Result Flux is a PUSH flux.
5. The pfEngine generates a transformation matrix and stores it in the pfFlux marked *Matrix Flux*.

6. The pfFCS node controlling the transformation of the target geometry has a fluxed matrix.
7. When the pfFCS node is traversed, it retrieves the newly generated matrix from Matrix Flux and uses it to align its child geometry.

Note: If you run the pfASD evaluation function in a separate process, the evaluation of the query arrays may happen asynchronously at some point during the OpenGL Performer frame.

Aligning Light Points Above a pfASD Surface Example

The following example, diagramed in Figure 20-17 demonstrate how to link pfASD queries to a pfEngine. For a GeoSet containing light point primitives, this code places all the primitives at some offset above the surface.

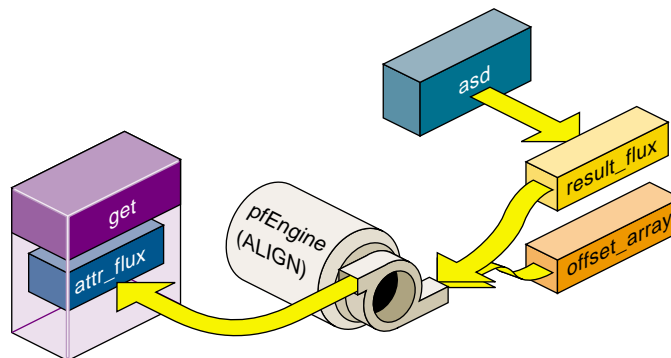

Figure 20-17 Aligning Light Points Above a pfASD Surface

Example 20-1 Aligning Light Points Above a pfASD Surface

```
// Generate a flux for pfASD to store the query results.
results_flux = pfNewFlux(nofLightPoints *
    sizeof(pfVec3), PFFLUX_DEFAULT_NUM_BUFFERS, pfGetSharedArena());

// Make so that writing into this flux will trigger evaluation of
// connected engines.
pfFluxMode(results_flux, PFFLUX_PUSH, PF_ON);
```



```
// Generate final flux - this flux will contain the final aligned
// light points.
attr_flux = pfNewFlux(nofLightPoints * 3 * sizeof(float),
    PFFLUX_DEFAULT_NUM_BUFFERS, pfGetSharedArena());

// Add flux to the same syncGroup as its aligning pfASD.
pfFluxSyncGroup(attr_flux, 1);

// Initialize the flux to the unaligned point positions.
// The engine will only modify a portion of the buffer (the Z
// values), so we must initialize the (X,Y) values now.
// Assume vertexList contains the original vertices.
FluxInitData(attr_flux, vertexList);

// Add the array of positions to pfASD. Request position-only
// queries.
query_id = pfASDAddQueryArray(asd_hook, vertexList, down,
    nofLightPoints, PR_QUERY_POSITION, results_flux);

// Get maximum bounding box of the vertex array - this box
// contains all possible positions of the query array points.
pfASDGetQueryArrayPositionSpan(asd, query_id, &box);

// Generate a SUM engine to sum the query vertex results with a
// constant array.
sum_engine = pfNewEngine(PFENG_SUM, pfGetSharedArena());
pfEngineIterations(sum_engine, nofLightPoints, 1);

// Inform pfEngine of its two sources and one destination.
// offset_array should contain a constant offset for each light
// point. We request sum_engine to modify the Z coordinate of
// each light point vertex.
pfEngineSrc(sum_engine, PFENG_SUM_SRC(0), offset_array, NULL,
    0, PF_Z, 3);
pfEngineSrc(sum_engine, PFENG_SUM_SRC(1), results, NULL,
    0, PF_Z, 3);
pfEngineDst(sum_engine, attr_flux, NULL, PF_Z, 3);

// Generate GeoSet to hold the final aligned geometry.
gset = pfNewGSet(pfGetSharedArena());

// standard pfGeoSet initialization code
// (GeoState, color, NumPrims, etc) omitted.
pfGSetPrimType(gset, PFGS_POINTS);
```

```
// Add flux_attr as the COORD3 attribute of the geoset.
pfGSetAttr(gset, PFGS_COORD3, PFGS_PER_VERTEX,
           (void *) attr_flux, NULL);

// Set the GeoSet bounding box statically. This will help avoiding
// recalculation or mis-calculation of bounding boxes for culling.
pfGSetBBox(gset, &box, PFBOUND_STATIC);

// Setup range based evaluation. assume 'center' contains the
// center of box.
pfEngineEvaluationRange(sum_engine, center, 0.0, 40000.0);
pfEngineMode(sum_engine, PFENG_RANGE_CHECK, PF_ON);
```

Paging

Large scale surface simulations require large amounts of memory to store high resolution surfaces. For example, the earth sampled from a height of 100m requires tens of gigabytes of disk space. Such large amounts of memory cannot reside entirely in system memory. Consequently, efficient database paging is essential in supporting a 30 Hz frame rate.

A common paging method is to page in tiles. Each area block contains all the LOD information describing an area. The problem with this method of paging is that in a surface that extends far into the distance, the large number of tiles visible to the viewer consumes more memory than is available on a system.

The hierarchical structure of ASD provides a different paging method: LOD paging. Each LOD is divided into a set of blocks; each block represents an area of the scene at a particular resolution. These tiles are paged in independently. All tiles for a single LOD are the same size; tiles for different LODs, however, can be different sizes.

Interest Area

In one LOD, the blocks most likely accessed, according to the view and position of the viewer, are called the interest area of the LOD. It is these blocks that get paged in.

The interest area for an LOD whose resolution is based on range is bounded by the maximum range value for that LOD. The interest area is smaller for higher resolution LODs, larger for lower resolution LODs. As a result, the memory requirements of ASD are reduced because not all LODs in an area are paged in: triangles closer to the viewer

are paged in at a higher resolution LOD than those triangles further from the viewer, as shown in Figure 20-18.

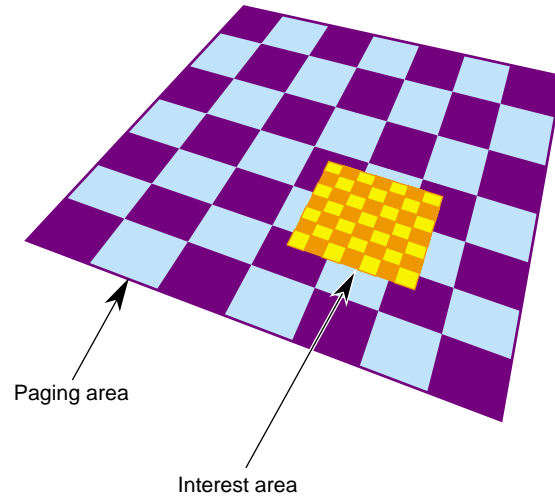

Figure 20-18 Tiles at Different LODs

Each square in Figure 20-18 holds the same amount of information: the large pages hold a large amount of low-resolution information while the small pages hold a small amount of high-resolution information.

If the observer does not make discontinuous jumps in location between 2 frames, you use an algorithm that anticipates what the viewer needs to see next based on the evaluation function. For example, if the evaluation function is based on distance, you would page blocks into memory in the direction you expect the viewer to go and release from memory those pages the viewer is leaving.

Preprocessing for Paging

Preprocessing pages improves performance.

1. Determine the appropriate tiles size for each LOD based on the evaluation function.
2. Assign triangles in each LOD into tiles and store each tile in a paging unit, such as a file.

Assign a triangle to one tile only. Triangles with the same parent node must be assigned to the same tile.

3. Generate a set of fast-paging files for a specific set of paging areas.

When the application is run, it should anticipate the pages the viewer will need and then page them into memory from disk and preprocess them.

Order of Paging

Paging in lower LOD pages before higher LOD pages ensures that a page at some level of LOD is always ready for the viewer. When you travel so fast through a surface that the higher resolution LODs do not have time to load, the surface has a lower resolution, which is what you would expect to see when traveling fast.

Multi-resolution Paging

pfASD supports multi-resolution paging. The format of a paging file, where all of the geometries are in one tile, is described by the following structure:

```
int numfaces
int numverts
/* numfaces of the following */
int faceid1
/* structure of the face faceid1 */
pfASDFace face
/* structure of the face faceid2 */
int faceid2
pfASDFace face
...
/* numfaces of the following */
/* face bounding box of faceid */
pfBox box1
/* face bounding box of faceid2 */
pfBox box2
...
/* numverts of the following */
int vertid1
/* structure of vertex vertid1 */
pfASDVert vert
int vertid2
/* structure of vertex vertid2 */
pfASDVert vert
```

...

To calculate the paging area, use the following code:

```
page[0] = (int)(lods[i].switchin/tilesize[0]) + lookahead[0];  
page[1] = (int)(lods[i].switchin/tilesize[1]) + lookahead[1];
```

lods[i] is the *pfASDLODRange* of **LOD[i]**. *tilesize* is the size of the tile in **LOD[i]**. *lookahead* is the number of extra tiles in one direction to page in to memory to overcome a paging delay

To process the paging tiles into a fast paging format, use **pfProcessASDTiles()** in `pfProcASD.c`. **pfProcessASDTiles()** returns a new set of files as `xxxx.asd`. These files are paged in real-time.

For an example of writing a file, see **pfWriteFile()** in `libpfdu/pfdBuildASD.c`.

Light Points

OpenGL Performer provides sophisticated light point objects:

- `pfLPointState` lights are emissive objects that do not illuminate their surroundings, such as stars, beacons, strobes, runway edge, and taxiway lights.
- `pfCalligraphic` light points are `pfLPointState` light objects with calligraphic extensions; they are intensely bright light points that require special display equipment.

Uses of Light Points

Light points are bright points of light that have the following characteristics:

- intensity
- directionality
- attenuation shape
- distance computation
- attenuation through fog
- size and fading

These attributes make light points excellent for use as stars, beacons, strobes, runway edge and end illumination, and taxiway lights.

For example, three light points with specific directionality may be used to create a VASI light system at an airport that appears as follows:

- Red when the pilot is above the landing glide path.
- Green when the pilot is below the landing glide path.
- White when the pilot is on the landing glide path, as shown in Figure 21-1.



Figure 21-1 VASI Landing Light

Creating a Light Point

To create a light point, do the following::

1. Create a pfGeoSet of points (PFGS_POINTS):

```
pfGeoSet *lpoint = pfNewGSet(arena);
pfGSetPrimType(lpoint, PFGS_POINTS);
```

2. Create a pfLPState and define its mode and values:

```
pfLPState *lpstate = pfNewLPState(arena);

pfLPStateMode(lpstate, PFLPS_SIZE_MODE, PFLPS_SIZE_MODE_ON);
pfLPStateVal(lpstate, PFLPS_SIZE_MIN_PIXEL, 0.25f);
pfLPStateVal(lpstate, PFLPS_SIZE_ACTUAL, 0.07f);
pfLPStateVal(lpstate, PFLPS_SIZE_MAX_PIXEL, 4.0f);
```

3. Attach the pfLPState to the pfGeoState associated with the pfGeoSet:

```
pfGStateMode( gstate, PFSTATE_ENLPOINTSTATE, PF_ON);
pfGStateAttr( gstate, PFSTATE_LPOINTSTATE, lpstate);
pfGSetGState( gset, gstate );
```

This pfGeoSet must have a PFGS_COLOR4 attribute binding of PFGS_PER_VERTEX.

Setting the Behavior of Light Points

The `pfLPointState` attached to a `pfGeoSet` controls the behavior of all light points in the `pfGeoSet`. For example, the color, position, and direction vector of each light point is set by the color, vertex, and normal stored in the `pfGeoSet`.

You use `pfLPStateMode`, to enable or disable the behavior, and `pfLPStateVal` to set the following `pfLPointState` values:

- Intensity—setting the intensity of light from no attenuation, 1, to fully attenuated, 0.
- Directionality—specifying the direction and the shape of the emanation of light. The shapes are either a single or a pair of opposite-facing elliptical cones. **`pfLPStateShape()`** specifies the shape of the emanation.
- Fading—specifying how the light point fades when receding into the distance. Fading is often more realistic than simply shrinking the point size to 0.
- Fog punch-through—specifying how a light point is obscured by fog.
- Size—setting the maximum and minimum size of the light point based on perspective.

The following sections describe how to set these values.

Intensity

The intensity of the light points in a `pfLPointState` can be attenuated using **`pfLPStateVal()`**, as follows:

```
pfLPStateVal(lpstate, PFLPS_INTENSITY, intensity)
```

The intensity value, *intensity*, must range between 0 and 1; 1, no attenuation, is the default.

The intensity of each light point is defined by its four component colors.

Directionality

Each light point has a normal, which defines the direction of its emanation. By default, all of the light points in a `pfLPointState` point in the same direction. That direction is defined as the “front” of the light point.

If all light points in a `pfGeoSet` share the same normal, use the `PFGS_OVERALL` attribute to optimize the light point computation.

If the light points are directional, the `pfGeoSet` attributes must specify normals.

Enabling Directionality

To enable or disable light point directionality, use the following method:

```
pfLPStateMode(lpstate, PFLPS_DIR_MODE, mode);
```

The *mode* value can be one of the following:

- `PFLPS_DIR_MODE_ON`, the default, turns on directionality computation.
- `PFLPS_FOG_MODE_OFF` disables directionality computation.

To specify whether or not the light point emanates towards the front and back, use the following method:

```
pfLPStateMode(PFLPS_SHAPE_MODE, mode);
```

The *mode* value can be one of the following:

- `PFLPS_SHAPE_MODE_UNI`, the default, makes the light point not visible from the back side.
- `PFLPS_SHAPE_MODE_BI` makes the light point bidirectional, the behavior is the same for both sides.
- `PFLPS_SHAPE_MODE_BI_COLOR` makes the light point bidirectional, but if seen from the back side, the light change its color. This color is set using `pfLPStateBackColor()`.

Emanation Shape

The emanation shape is an elliptical cone, as shown in Figure 21-2.

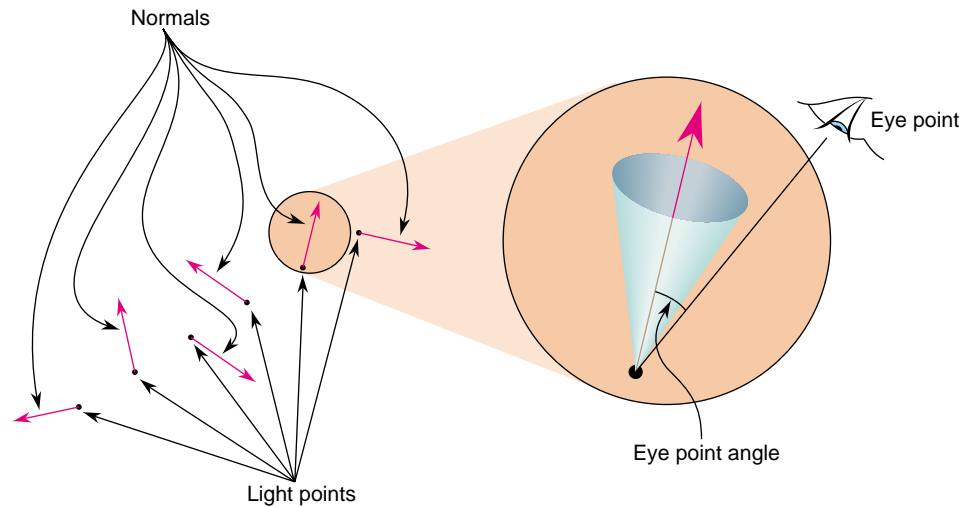

Figure 21-2 Attenuation Shape

Optionally, the intensity of light can fall off from the normal to the edge of the cone.

The direction of emanation is defined along the Y axis and the shape is defined in the local coordinate system. The coordinate system is rotated so that the Y axis aligns with the normal of each light point.

To specify the shape of emanation, use the following method:

```
pFLPStateShape(lpstate, horiz, vert, roll, falloff, ambient)
```

Shape

horiz and *vert* are total-angles (not angles to the normal) in degrees, which specify the horizontal and vertical dimensions of the cone about the normal. The maximum value for these angles is 180 degrees, which creates a non-directional light point. The default values for *horiz* and *vert* is 90 degrees.

Tip: A symmetric cone (where *horiz* and *vert* are equal) is faster to compute than an asymmetric cone.

Rotation

The cone is rotated by *roll* degrees through +Y. The default *roll* value is 0.

Falloff

When the vector from the light's position to the eye point is outside the cone, the light point's intensity is *ambient*. The default *ambient* value is 0.

If the vector from the light's position to the eye point is within the cone, the intensity of the light point is based on the angle between the normal and that vector. The intensity values range from 1.0, when the eye point lies on the normal, to *ambient*, at the edge of the cone. How the light attenuates between the normal and the edge of the cone is specified by *falloff*.

falloff is an exponent that modifies the light point's intensity. A value of 0 indicates that there is no falloff; a value of 1, the default, indicates a linear falloff; values greater than 1 indicate a progressively greater geometric *falloff*, as shown in Figure 21-3.

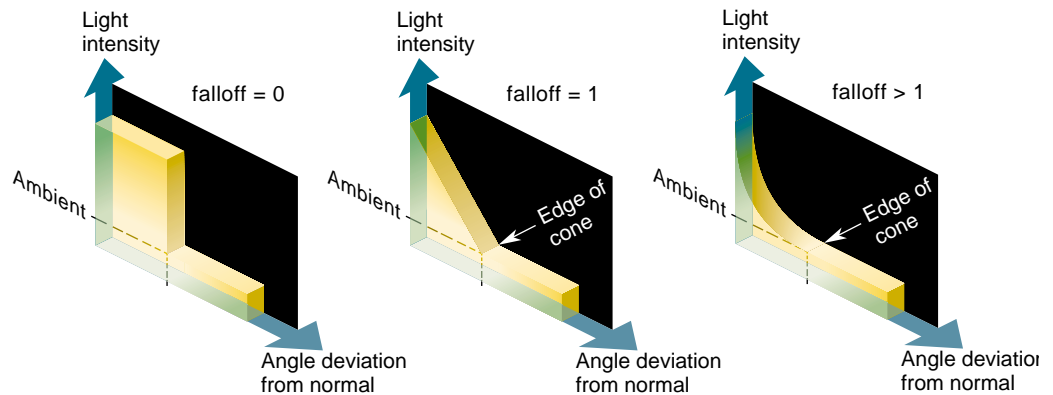

Figure 21-3 Attenuation of Light

Distance

The distance between the light point and the eye point is used when computing the light point's size and intensity through fog. Since these calculations are intensive, OpenGL

Performer provides an approximation for the distance between the light point and the eye point using the following method:

```
pFLPState(lpstate, PFLPS_RANGE_MODE, mode)
```

The *mode* value can be one of the following:

- PFLPS_RANGE_MODE_TRUE approximates the distance using the depth (Z) difference between the eye and the light point.
- PFLPS_RANGE_MODE_DEPTH, the default, uses the real distance between the eye and the light point.

Tip: The wider the field of vision (FOV), the less accurate is the approximation.

Attenuation through Fog

Light points are visible at greater distance than non-emissive polygons. For that reason, the light points appear to punch through fog. To account for this higher visibility, you can supply a *punch-through* value in the following method:

```
pFLPStateVal(PFLPS_FOG_SCALE, punch-through);
```

punch-through is a float that is multiplied times the distance. When *punch-through* is less than 1.0, the product of the distance and the *punch-through* value is less than the distance. The revised distance is used in calculating the apparent brightness of the light point; when the *punch-through* is less than 1.0, the light point appears brighter than it otherwise would. The default *punch-through* value is 0.25.

Enabling Punch-Through

To use *punch-through*, you must first enable it using the following method:

```
pFLPStateMode(lpstate, PFLPS_FOG_MODE, mode);
```

The *mode* value can be one of the following:

- PFLPS_FOG_MODE_ON, the default, enables fog *punch-through* computation.
- PFLPS_FOG_MODE_OFF does not modify the distance before fog is applied.

Size

Light points can exhibit perspective behavior. The following method sets the size of all the light points in a `pfGeoSet`:

```
pfLPStateVal(lpstate, PFLPS_SIZE_ACTUAL, real-size);
```

real-size is a float that is multiplied times the distance. When *real-size* is less than 1.0, the product of the distance and the *real-size* value is less than the distance. The revised distance is used in calculating the apparent size of the light point; when the *real-size* is less than 1.0, the light point appears larger than it otherwise would. The default *real-size* value is 0.25.

Size Limitations

The apparent size of a light point can only range between the minimum and maximum sizes specified by the following lines of code:

```
pfLPStateVal(lpstate, PFLPS_SIZE_MIN_PIXEL, min-size);  
pfLPStateVal(lpstate, PFLPS_SIZE_MAX_PIXEL, max-size);
```

Limiting Size Calculations

To optimize rendering, you can avoid changing the size (`glPointSize`) of each light point when the difference between the new and old sizes is less than a specified amount, called the *threshold*. To set the *threshold* value, use the following method:

```
pfLPStateVal(lpstate, PFLPS_SIZE_DIFF_THRESH, threshold);
```

Enabling Perspective

To use *real-size*, you must first enable it using the following method:

```
pfLPStateMode(lpstate, PFLPS_SIZE_MODE, mode);
```

The *mode* value can be one of the following:

- `PFLPS_SIZE_MODE_ON` makes *real-size* follow perspective so that light points closer to the eye are rendered larger than those points farther away.
- `PFLPS_SIZE_MODE_OFF`, the default value, disables perspective computations.

If perspective is not enabled, `pfGeoSet` (`pfGSetPntSize`) specifies the size of the rendered light points.

Fading

You can enhance the illusion of perspective by making the light point become more and more transparent as it recedes from view using the following method:

```
pflPStateVal(lpstate, PFLPS_TRANSP_PIXEL_SIZE, transp-size);
```

transp-size is a light point size. When the actual size is smaller than *transp-size*, the light point becomes transparent.

Using fading to simulate perspective is often more realistic than shrinking the light point size; fading avoids the aliasing problems that occur when light points become too small.

Fading Calculation

Fading is calculated as follows:

$$\text{Max}(\text{clamp}, 1 - \text{scale} * (\text{transp-size} - \text{computed-size})^{\text{exp}})$$

You set the values in this argument in the following lines of code:

```
pflPStateVal(lpstate, PFLPS_TRANSP_EXPONENT, exp);
pflPStateVal(lpstate, PFLPS_TRANSP_SCALE, scale);
pflPStateVal(lpstate, PFLPS_TRANSP_CLAMP, clamp);
```

Enabling Fading

To use fading, you must first enable it using the following method:

```
pflPStateMode(lpstate, PFLPS_TRANSP_MODE, mode)
```

The *mode* value can be one of the following:

- PFLPS_TRANSP_MODE_ON enables fading when the computed size is less than *transp-size*.
- PFLPS_TRANSP_MODE_OFF, the default, disables fading.

Callbacks

For each light point, two parameters are computed based on the location of the eye point, the location of the light point, and the fog:

- Alpha—Specifies the intensity and transparency of a light point. Non-transparent light points have the maximum intensity given by their four color components.
- Size—Specifies the diameter of each light point if the perspective mode, PFLPS_SIZE_MODE, is enabled; otherwise, the size is constant for all of the light points in a pfGeoSet.

Instead of accepting the calculations done by OpenGL Performer, you can use callback functions to supply your own calculations. Callback functions can be completed at the following times:

- Before OpenGL Performer calculates the parameters, thus replacing the Performer calculation completely.
- After OpenGL Performer calculates the parameters, thus modifying Performer's result.

You enable, disable, and specify the kind of callback used in the following method:

```
pfLPStateMode(lpstate, PFLPS_CALLBACK_MODE, mode)
```

The *mode* value can be one of the following:

- PFLPS_CALLBACK_MODE_OFF, the default, means that no callback is attached to *lpstate*.
- PFLPS_CALLBACK_MODE_PRE means that the callback is executed before OpenGL Performer has calculated the parameters. Your callback function must compute the size and alpha values for all the light points in the pfGeoSet.
- PFLPS_CALLBACK_MODE_POST means that the callback is executed after OpenGL Performer's computation.

To install a callback on a pfLPointState, use the following method:

```
pfRasterFunc(lpstate, (void *) yourCallback(pfRasterData*),  
             void **userData);
```

userdata is a pointer to the following structure, which is given to your callback and the function itself:

```
typedef struct {  
    pfLPointState *lpstate; /* Read Only LPState */  
    pfGeoSet *geoset; /* Read Only GeoSet */  
    void *userData; /* Provided when setting the callback */  
    float *sizes; /* Write Only - resulting sizes */
```



```

    float          *alphas;   /* Write Only - resulting alphas */
} pfRasterData;

```

geoset is the currently-preprocessed *pfGeoSet*. *lpstate* is the *pfLPointState* applied to that *pfGeoSet*. *userData* is the same data provided when declaring the callback.

sizes and *alphas* are pre-allocated arrays that contain the callback function results used by the DRAW process. If you use a pre-callback, you must provide a size and an alpha value for every light point in the *pfGeoSet*. A negative alpha value indicates that the backcolor must be used in place of the light point color.

Example 21-1 provides the skeleton of a raster callback. A more detailed example is on the *pfLPointState* man page.

Example 21-1 Raster Callback Skeleton

```

void myCallback(pfRasterData *rasterData)
{
    pfVec3* vertices;
    unsigned short *vindex;
    pfVec3* norms;
    unsigned short *nindex;
    int nbind;
    pfFog *fog;
    int fogEnabled = 0;
    int i,n;
    int sizeMode;
    pfMatrix ViewMat, InvModelView;

    /* get pointers to the geoset */
    pfGetGSetAttrLists(rasterData->gset,PFGS_COORD3, &vertices, &vindex);
    pfGetGSetAttrLists(rasterData->gset,PFGS_NORMAL3, &norms, &nindex);
    nbind = pfGetGSetAttrBind(rasterData->gset,PFGS_NORMAL3);
    /* get matrices */
    pfGetViewMat(ViewMat);
    pfGetInvModelMat(InvModelMat);

    /* get the number of lights */
    n = pfGetGSetNumPrims(rasterData->gset);

    /* see if there's fog */
    fog = pfGetCurFog();
    if (pfGetEnable(PFEN_FOG) && fog)
        fogEnabled = 1;
}

```

```
/* get information on the lpstate */
sizeMode = pfGetLPStateMode(rasterData->lpstate, PFLPS_SIZE_MODE);
.....
.....
/* do the computation */
for (i=0; i<n; i++)
{
    /* get the normal */
    if (vindex)
    {
        if (nbind & PFGS_OVERALL)
            nj=nindex[0];
        else if (nbind)
            nj=nindex[i];
        else
            nj=-1; /* this geoset has no normals */

        .....
        rasterData->alphas[i] = ....
        rasterData->sizes[i] = ....
    }
}
```

Multisample, Size, and Alpha

On InfiniteReality, light points of a given size, up to 100 multisamples, have the same number of multisamples even when the light points cross multiple pixels.

The intensity of a light point is defined by its alpha value. If pfTransparency is set to PFTR_MS_ALPHA_MASK, the alpha value modifies the number of multisamples lit in a light point. For example, if alpha= 0.5, size = 1.0, and the number of multisamples per pixel is 8, the number of illuminated multisamples per the light point is 3.0, as shown in Figure 21-4.

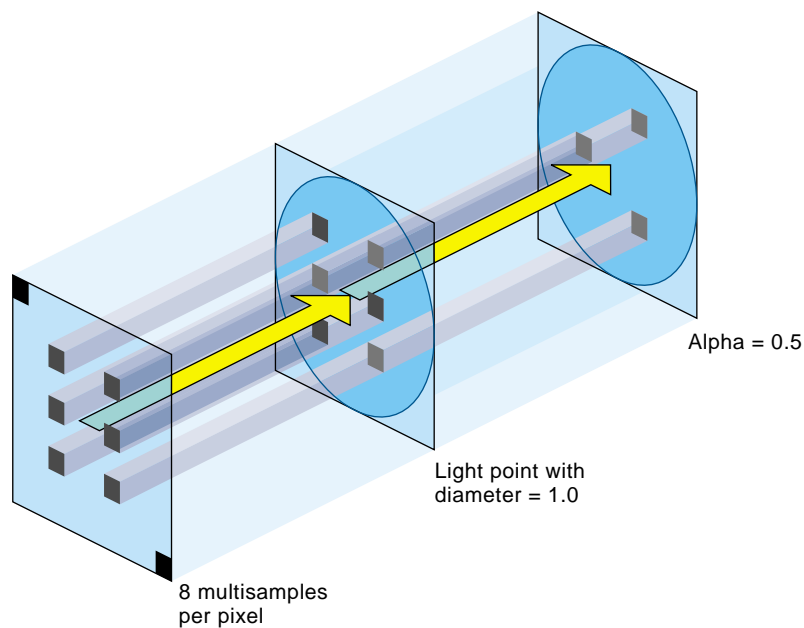

Figure 21-4 Lit Multisamples

The area of a circle with diameter 1.0 is 0.785. The number of multisamples per pixel is given in the frame buffer configuration. If there are 8 multisamples, only 0.785 of them, about 6, are in the light point. Since $\alpha = 0.5$, only half of the 6 multisamples are actually lit.

pfCalligMultisample() tells pfCalligraphic how many multisamples are used in the specified video channel. **pfGetCalligMultisample()** returns the current setting. Make this call as soon as the information is known or changed.

Minimum Number of Multisamples

If your light points move, you must have at least two multisamples lit per light point; if you only have one, the light point is either on or off. This condition creates flicker. With two multisamples, the light point can transition to a different location with one multisample on and the other off.

Reducing CPU Processing Using Textures

Light point computations are expensive. You can replace some of the computation by using a table lookup mechanism and the texture hardware to get an alpha value for each light point. This mechanism uses a precomputed texture and `glTexGen` to approximate:

- fog attenuation
- fading over distance
- falloff attenuation when the eye point is not on the normal

Because only one texture per polygon is supported by the hardware, it is not possible to approximate all three computations at once. The fading and the fog are combined in one texture, however, so it is possible to select both at the same time.

The following methods specify the attenuations:

```
pFLPStateMode(lpstate, PFLPS_DIR_MODE, PFLPS_DIR_MODE_XXX)
pFLPStateMode(lpstate, PFLPS TRANSP_MODE, PFLPS TRANSP_MODE_XXX)
pFLPStateMode(lpstate, PFLPS_FOG_MODE, PFLPS_MODE_XXX)
```

XXX is one of the following:

- TEX for texture lookup
- ALPHA for CPU computation

Default values are equivalent to ALPHA computation.

Tip: Falloff is the most expensive effect to compute on the CPU. For that reason, it is better to use `PFLPS_DIR_MODE_TEX` if the point is not omnidirectional.

Only use textures for low quality light points; textures are approximations with numerous limitations, including incorrect falloff attenuation if the emanation is not symmetric and incompatibility with callbacks.

Preprocessing Light Points

To optimize your application, you should fork off a light point process to preprocesses your light point computations. The light point process runs in parallel with the DRAW process but on a different CPU. Preprocessing the light points does the following:

- Computes the size and alpha of each light point and passes the result directly to the DRAW process.
- Executes callbacks attached to the `pfLPointState`.

To fork off a light point process, use the `PFMP_FORK_LPOINT` token in **`pfMultiprocess()`** and call it before **`pfConfig()`**.

Note: You can start a light point process in `perfly` using the `-m` option and adding 16 to your preferred multiprocess model.

Stage Configuration Callbacks

As with any other OpenGL Performer process, callback functions can configure the process stages using the following:

```
pfStageConfigFunc(-1, PFPROC_LPOINT, ConfigLPoint);  
pfConfigStage(-1, PFPROC_LPOINT | PFPROC_XXX ....);  
pfChanTravFunc(chan, PFTRAV_LPOINT, LpointFunc);
```

`pfStageConfigFunc()` specifies a callback function, and **`pfConfigStage()`** triggers it at the start of the current application frame; both are methods in `pfConfig`. Configuration callbacks are typically used for process initialization; for example, they are used to do the following:

- Assign non-degrading priorities and lock processes to CPUs.
- Download textures in the DRAW stage callback.

`pfStageConfigFunc()` identifies the OpenGL Performer stages, such as `PFPROC_ISECT`, `PFPROC_APP`, and `PFPROC_DBASE`, to configure.

pfChanTravFunc

The pfChannel method, **pfChanTravFunc()**, sets a callback function for either the APP, CULL, DRAW, or Light Point process using one of the following tokens: PFTRAV_APP, PFTRAV_CULL, PFTRAV_DRAW, or PFTRAV_LPOINT, respectively.

User data that is passed to these functions by **pfChanData()** is allocated on a per-channel basis by **pfAllocChanData()**.

How the Light Point Process Works

This section explains how the light point process works. All the functions exist in the API; however, all of the processing is done automatically by OpenGL Performer.

Note: Light point processing is not done automatically if your application is only using the libpr process model.

If the light point process is enabled, a special bin, PFSORT_LPSTATE_BIN, is created to sort all of the pfGeoSets that have a pfLPointState attached to their pfGeoState. This bin is directly used as a display list, *LPointBinDL*, as shown in Example 21-2.

All bins, except PFSORT_LPSTATE_BIN, are handed to the DRAW process. The DRAW process, after rendering everything in the other bins, renders a ring display list, called *DrawRingDL*, as shown in Example 21-2. The ring display list contains a synchronization mechanism: the DRAW process waits until it sees the PFDL_END_OF_FRAME token.

Example 21-2 Preprocessing a Display List - Light Point Process code

```
/* open the draw ring display list */
pfOpenDList(DrawRingDL);

/* preprocess the light points bin. */
/* so the results go in the DrawRingFL */
pfPreprocessDList(LPointBinDL, PFDL_PREPROCESS_LPSTATE);

/* Signal the end of the list to the Draw process */
pfAddDListCmd(PFDL_END_OF_FRAME);

/* close the draw display list */
pfCloseDList(DrawRingDL);
```

Calligraphic Light Points

Calligraphic light points are very bright lights that can be displayed only on specially-equipped display systems. Displaying calligraphic light points requires the following:

- A calligraphic light point board (LPB) with a special device driver. The driver is not part of the OpenGL Performer distribution.
- A calligraphic display system.
- Special cables running between the graphics pipe video synchronization and the raster manager (RM) boards on the LPB.
- A platform, such as an InfiniteReality, OnyxIR, or Onyx2/3, that has a visibility (VISI) bus.

Note: If you are not running on a system that has a VISI bus or you do not have this optional hardware, you are limited to raster light points, as supported by `pfLPointState`. The functionality described in the remainder of this chapter is not available on your system. Nevertheless, a program and database designed for calligraphic light points can be simulated on a non-calligraphic system.

Unlike raster displays, calligraphic displays direct the display system's electron beam at specified places on the screen. By directing the beam at specified places for specified durations, it is possible to produce extremely bright light sources.

Warning: It is possible to destroy your display system by allowing the electron beam to remain too long on the same screen location either by allotting too long a time or by an application hanging. Extreme caution is required.

Calligraphic Versus Raster Displays

Table 21-1 summarizes the differences between raster and calligraphic displays.

Table 21-1 Raster Versus Calligraphic Displays

Raster	Calligraphic
Requires no special hardware.	Requires special hardware, including a Light Point Board (LPB), cables, and a calligraphic-enabled display system. Applications using calligraphic light points must run on a machine that has a VISI board.
The electron beam sweeps across and down the screen left-to-right and top-to-bottom.	The beam lands only on those parts of the screen where calligraphic lights are located.
The electron beam stays on each pixel the same amount of time.	The electron beams stays on pixels for a variable length of time potentially producing exceedingly bright light sources.
A black dot produces a black pixel.	A black dot produces nothing; it is invisible.
If more than one point is drawn at the same location, only the last point drawn is visible.	Light points are added to whatever light is already falling on the pixel. A calligraphic light does not hide another calligraphic light.
Raster images are displayed within set time intervals, for example, 60 times a second.	When raster and calligraphic are displayed, the calligraphic light points are displayed in whatever time is left after the raster image is scanned. For more information, see "Display Modes" on page 745
No real dangers associated with raster displays.	A hanging application, for example, can leave the electron beam aimed at a single point on the screen and quickly burn it out. The same result is true if you programmatically light up a pixel for too long.
If the entire image is not drawn to the buffer, frames are dropped until the entire image is ready for display.	If all of the light points are not drawn, frames are not dropped; some light points are just not drawn. (If a raster image is repeated in successive frames, the light points are also repeated.)

Whenever the calligraphic mode renders a black pixel to the screen, it is completely transparent and the raster image shows through.

When a pixel on the screen is targeted for raster and calligraphic light, both the raster and calligraphic light points are displayed at the same pixel thus making it large (raster) and bright (calligraphic).

Display Modes

A calligraphic display system can run in three modes:

- calligraphic-only
- mixed mode
- raster-only

In calligraphic-only mode, only calligraphic points can be rendered by the display system.

In mixed mode, both raster and calligraphic images are rendered on the same display system; the raster image is displayed first and the calligraphic image is displayed in whatever time remains before the vertical sync. This mode requires a special video format used by the Video Format Compiler available on the SGI web site at <http://www.sgi.com/software/vfc/>.

You can combine a calligraphic-only display with a raster-only display on the same video channel; the effect is to give the full frame to the calligraphic display so that you can render the maximum number of light points. It is also more expensive and sometimes not convenient for mechanical reasons.

Light point modes are specified by **pflPStateMode()** and one of the following tokens:

- **PFLPS_DRAW_MODE_RASTER**, the default mode, forces the light points to be raster even if the system has a calligraphic display.
- **PFLPS_DRAW_MODE_CALLIGRAPHIC** enables the rendering of calligraphic light points on calligraphic display systems.

Maximum Number of Calligraphic Lights

The maximum number of calligraphic lights that can be displayed is related to the following:

- raster display time
- duration of the calligraphic display time
- time spent jumping from one calligraphic light point to another

The maximum number of calligraphic lights that can be displayed is inversely proportional to the raster display time. For example, in a mixed mode, if the screen refreshes every 1/60th of a second, the calligraphic display time is 1/60th of a second minus the time it takes for the raster mode to draw its image on the screen. The shorter the raster display time, the more calligraphic lights that can be displayed.

At night, it is possible to reduce the time for the raster display, which has the effect of reducing the global raster brightness. Reducing the raster display time increases the maximum number of calligraphic light points that can be displayed. To reduce the raster display time, you need to do the following:

- Two different video formats made using the Video Format Compiler.
- Preprogram the projector so it recognizes the format change when it happens on the fly by the application.

Changing the video format is done using the XSGIvc extension.

The maximum number of calligraphic lights that can be displayed is inversely proportional to the draw time of the calligraphic light points. Unlike raster lights, you can control the length of time the electron beam hits a specified location on the display system; the longer the duration, the brighter the light. Also, the longer the duration, the less time is left for drawing other calligraphic light points.

Finally, the time it takes the electron beam to jump between calligraphic light points also adversely affects the maximum number of light points that can be displayed; the more time spent jumping between calligraphic light points, the fewer light points that can be displayed.

LPB Hardware Configuration

A Light Point Board (LPB) is a circuitry card that enables the rendering of calligraphic lights by providing the interface with a calligraphic display. The LPB is configured as follows:

- Connected to one graphics pipeline only.
- Connected to all the video channels produced by a single pipe.
- Connected to all (1,2 or 4) raster manager (RM) boards of its pipe.

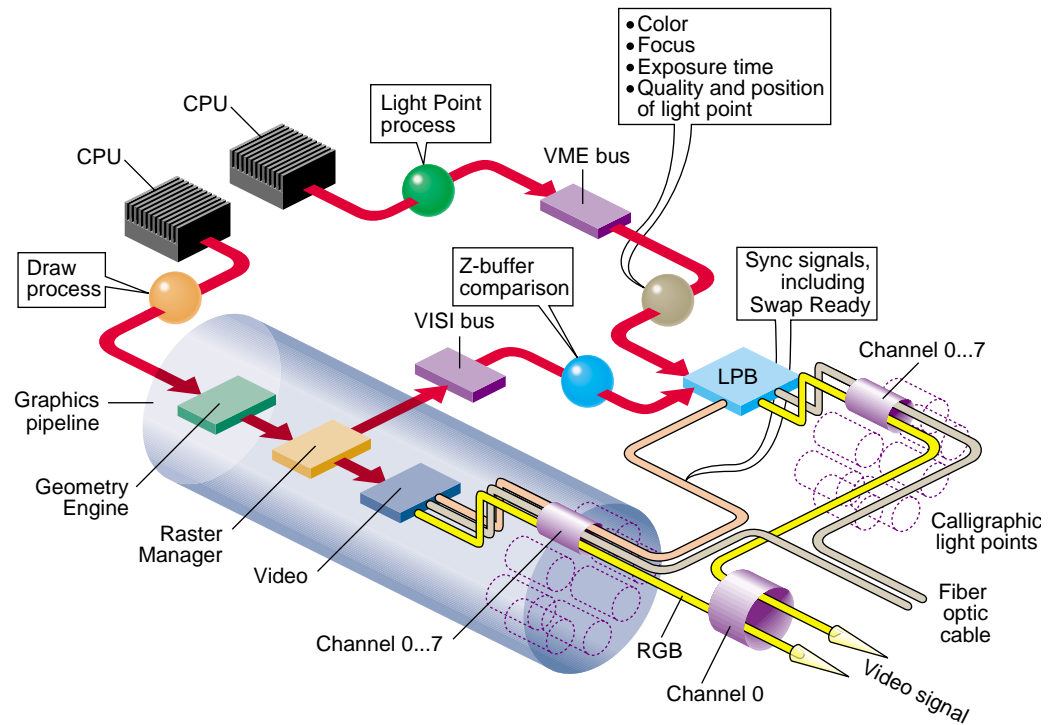

Figure 21-5 Calligraphic Hardware Configuration

The configuration in Figure 21-5 shows the following:

- A CPU is used for the light point process so the computation and the communication to the LPB through the VME bus are done in parallel to the DRAW process. It is mandatory to start a light point process for calligraphic; see “Preprocessing Light Points” on page 741.
- The VME bus transfers to the LPB all of the calligraphic light point information, including the color, focus, exposure time, quality, and position of each calligraphic light point. The only information not transferred by the VME bus is occlusion information, which is supplied by the VISI bus.
- The VISI (visibility) bus specifies whether all, part, or none of a calligraphic light point is displayed. A calligraphic light might be partially displayed, or not at all, if a geometry in the scene is between the light point and the viewer. Each light point has

a unique ID; this ID is used to match the information in the VISI bus with the correct light point.

The VISI bus is a connector on each RM board. The visibility information is available only to the LPB.

Note: The LPB board may be used in a system without a VISI bus (systems prior to InfiniteReality), in which case no Z-buffer information is given to the board; so, all light points are 100% visible.

- The LPB uses the vertical and horizontal (not the composite) synchronization signals to trigger the calligraphics display. Use *ircombine* to set the Hsync in place of the composite sync.
- The LPB receives the Swap Ready signal when the raster display has completed drawing to the display buffer; so, it should also swap its internal buffers.

If the LPB does not get a Swap Ready signal, the LPB redisplay the same calligraphic light points; since the raster frame is repeated, the calligraphic lights must remain unchanged. Do not forget to connect the SwapReady signal to the light point board even if you are using a single pipe configuration.

- The LPB receives the VISI and VME bus light point information and combines it and send the result to the calligraphic display.

Visibility Information

All the calligraphic light point information is computed by the light point process and goes directly to the LPB. The only missing information is knowing how much of each light point can be seen. To compute that value, the following events take place:

1. A footprint of the calligraphic light point is sent to the graphic pipe.
2. The footprint is compared against the Z-buffer.
3. The result of the test is sent to the LPB using the VISI bus.

The graphic pipe takes great care that the number of multisamples covered is a constant wherever the light point is. The number of multisamples is not constant after the footprint covers more than 100 multisamples, however. A footprint can cover numerous pixels but is limited to 256 multisamples by the LPB.

pfCalligZFootPrintSize() sets the diameter of the footprint and **pfGetCalligZFootPrintSize()** returns the diameter. The number of multisamples covered by a footprint is equal to the following:

$$(n \times \text{size}^2) / (4 \times ms)$$

ms is the number of multisamples per pixel.

Required Steps For Using Calligraphic Lights

To use calligraphic light points, you have to configure the channels on the LPB board and the corresponding channels using *ircombine*. *ircombine* operates on the following:

- video format combinations
- descriptions of raster sizes and timings used on video outputs
- configuration of the underlying frame buffer

You must also enable the channels on the LPB board before starting the application.

OpenGL Performer does not provide direct access to the LPB drivers. You can, however, write a program that does.

Now, in OpenGL Performer a few steps are still necessary.

1. Check and open the LPB on each pipe, as follows:

```
pfQueryFeature(PFQFTR_CALLIGRAPHIC, &q)
pfCalligInitBoard(pipe)
```

2. Start a light point process to process the light point calculations, as follows:

```
pfMultiprocess(PFMP_APP_CULL_DRAW | PFMP_FORK_LPOINT);
pfConfig();
```

3. Initialize the OpenGL Performer stages, as follows:

```
pfStageConfigFunc(-1, PPROC_LPOINT, ConfigLPoint)
pfFrame();
```

4. Set the callback function in the light point process, as follows:

```
pfChanTravFunc(chan, PFTRAV_LPOINT, LpointFunc);
```

5. Enable the calligraphic display on all of the channels, as follows:

```
pfChanCalligEnable(chan[i], 1);
```

6. Synchronize the VME and VISI bus signals on the LPB, as follows:

```
pfCalligSwapVME(pipe);  
pfCalligSwapVME(pipe);
```

You now have calligraphic light points in your application if you have calligraphic light points in your database.

Customizing LPB Initialization

Instead of using the default initialization, OpenGL Performer provides a set of functions that allow your application to customize the initialization of the LPB.

pfInitBoard() opens the LPB device and retrieves the current configuration. This function returns TRUE if successful, FALSE otherwise. You can also use **pfIsBoardInit()** to determine if the board has been initialized. Each LPB must be initialized before calling **pfConfig()**.

pfCalligCloseBoard() closes the device.

Note: The board number and the pipe number are the same because there is only one board per pipe.

To access to the LPB directly, return its ID using **pfGetCalligDeviceID()**. The ID allows you to make direct calls to the LPB driver.

pfGetCalligInfo() returns a pointer to the configuration information structure maintained by the LPB driver. To use this structure, *LPB_info*, you must include the driver `lpb.h` file before any OpenGL Performer include files.

Note: `lpb.h` is not distributed with OpenGL Performer; it is part of the LPB driver distribution.

Once a board is initialized, you can find out how much memory is available and allocate it among all of the enabled channels on the pipe. You can return the total amount of LPB memory in bytes by calling **pfGetCalligBoardMemSize()**.

By default, each channel receives the same amount of memory. To set up a different partitioning of memory, use **pfCalligPartition()**.

You can attach a **pfCalligraphic** to a specific **pfChannel** using the following code:

```
pfCalligraphic *callig = pfNewCallig(arena)
pfCalligChannel(callig, pipe, chan)
```

callig can then be attached to the **pfPipeVideoChannel** using **pfPVChanCallig()**.

You can also set the **pfCalligraphic** on individual **pfChannels** using **pfChanCallig()**. You must enable calligraphic light point processing on the specified channels so the GangSwap mechanism is correctly handled by OpenGL Performer, as follows:

```
pfChanCalligEnable(chan, 1);
```

Note: The video channel number does not have to be the same channel number as the calligraphic board.

pfCalligWin() changes the resolution of the X and Y data accepted by the projector. The default values are for an EIS projector (2^{16}). If you have a conversion interface between the LPB and your projector, the scaling may already be done by the conversion interface. You can use **pfCalligWin()** to display calligraphic points on only part of the screen or to make multiple viewports.

pfCalligXYSwap() switches the X and Y axes in the display. You can also reverse the X or Y axes by giving negative width and height values in **pfCalligWin()**.

Accounting for Projector Differences

Some display systems, such as the EIS projector, can calculate the following:

- Slew values, the time for the electron beam to go from one calligraphic point to another.
- Gamma correction, which takes into account that projectors differ in the colors they project.

If your system cannot perform those calculations, the light point board can calculate those values for your application.

Slew Values

A slew table is two dimensional; it gives the time in nanoseconds it takes the electron beam to go from one calligraphic point to another on one axis. A default, generic slew table, which contains conservative values, is loaded in the LPB when it is initialized.

The longer the slew time, the longer the electron beam has to reach a calligraphic light point on the display; any consequent wobble can dampen out in that time providing a very stable light point. Conversely, longer slew times subtract from the total time in which calligraphic light points can be drawn. Consequently, longer slew times could mean that fewer calligraphic points are drawn per frame.

There are eight slew tables defined by the `pfCalligSlewTableEnum`. For each axis, there are three slew tables: one table for high-quality (very stable) light points, one table for medium-quality (slightly shorter slew times) light points, and another for low-quality (very short slew times) light points.

You specify the drawing quality using `pfLPStateVal()` with one of the following mode values:

- `PFLPS_QUALITY_MODE_HIGH`
- `PFLPS_QUALITY_MODE_MEDIUM`
- `PFLPS_QUALITY_MODE_LOW`

Two other tables are used when the defocus value changes in between two points; one table is used for high-quality light points, another table for medium- and low-quality light points.

```
typedef enum {
    pfXSlewQuality0 = 0, /* High quality on the X axis */
    pfXSlewQuality1 = 1, /* Medium quality on the X axis */
    pfXSlewQuality2 = 2, /* Low quality on the X axis */
    pfYSlewQuality0 = 3, /* High quality on the Y axis */
    pfYSlewQuality1 = 4, /* Medium quality on the Y axis */
    pfYSlewQuality2 = 5, /* Low quality on the Y axis */
    pfDefocusQuality0 = 6, /* High quality if focus change */
    pfDefocusQuality1 = 7 /* Medium and Low quality if focus change */
} pfCalligSlewTableEnum;
```

To load or upload customized slew tables, use the following methods:

- `pfCalligDownloadSlewTable()` downloads a specified slew table into the LPB.
- `pfCalligUploadSlewTable()` returns a slew table.

Color Correction

Each projector has its own color characteristics; a light point that appears blue on one projector might appear aqua on another. To color correct the projected images, the light point board maintains one gamma table per channel. Each gamma table consists of three one-dimensional tables, one for each color component.

```
typedef enum {
    pfRedGammaTable = 0,
    pfGreenGammaTable = 1,
    pfBlueGammaTable = 2
} pfCalligGammaTableEnum;
```

The default value provided by OpenGL Performer is a linear ramp that can be modified with the following methods:

- **pfCalligDownLoadGammaTable()** downloads a specified gamma table into the LPB.
- **pfCalligUpLoadGammaTable()** returns a gamma table.

Callbacks

Like raster lights, calligraphic light points can have a callback function attached to the `pfLPointState` that can occur before (PRE) or after (POST) the light point processing. The calligraphic and raster callback functions compute different parameters.

If the stress test determines that a calligraphic light point is not going to be drawn as a raster light point, the calligraphic callback is not be called; the raster callback is called instead if set. For more information about the stress test, see “Significance” on page 756.

To install a calligraphic callback on a `pfLPointState`, you use a line of code similar to the following:

```
pfCalligFunc(lpstate, (void *) yourCallback(pfCalligData*),
    void **userData);
```

userData is a user pointer given to your callback identifying the callback function and the following structure:

```
typedef struct {
    pfLPointState *lpstate; /* Read Only LPState */
    pfGeoSet *geoset; /* Read Only GeoSet */
    void *userData; /* Provided when setting the callback */
}
```

```
    unsigned short *index;    /* Read Write - index visible lpoints */
    int *n;                  /* Read Write - # of visible lpoints */
    pfVec3 *coords2D; /* Read Write - screen space X,Y,Z */
    float *intensity; /* Write Only - resulting intensity */
    float **focus; /* Write Only - optional (de)focus */
    float **drawTime; /* Write Only - optional drawTime */
} pfCalligData;
} pfRasterData;
```

geoset is the `pfGeoSet` that is currently preprocessed. *lpstate* is the `pfLPointState` applied to that `pfGeoSet`. *userData* is the same as the data provided when declaring the callback.

index is a preallocated vector that points to light points that are visible. Even in a PRE callback the light points are projected on the screen before the user callback is called; the points outside of the screen are not in the index vector. See the `pfLPointState` man page on how to use the index vector in a callback.

n is a pointer to the number of elements in the *index* vector.

coords2D contains the coordinates of the light points on the screen, including the Z coordinates in screen space. The original coordinates can be accessed through the `pfGeoSet`. It is valid to change the values in *coord2D* in the callback, for example, to align the points on a grid.

intensity is a pre-allocated vector that contains the intensity of individual light points. A PRE callback must compute *intensity*.

focus is a NULL pointer. It is possible to provide an individual *focus* value for each point by doing the following:

1. Allocating from the arena an array of floats of size *n*.
2. Filling the array with the focus values.
3. Setting focus to point to that array.

You should not allocate an array in real-time; instead, allocate temporary memory beforehand and use *userData* to pass the memory address to the callback.

drawTime is a NULL pointer. With it you can provide an array of floats that give a draw time for each light point.

Frame to Frame Control

Before calling **pfLPoint()** in the light point process callback function, you can change the parameters in a **pfCalligraphic** object on a frame-by-frame basis, as shown in Example 21-3.

Example 21-3 Setting pfCalligraphic Parameters

```
myLPointFunc(pfChannel *chan, void *data)
{
    pfCalligraphic *calligraphic = pfGetCurCallig();

    if (calligraphic != NULL)
    {
        pfCalligFilterSize(calligraphic, FilterSizeX, FilterSizeY);
        pfCalligDefocus(calligraphic, Defocus);
        pfCalligRasterDefocus(calligraphic, rasterDefocus);
        pfCalligDrawTime(calligraphic, DrawTime);
        pfCalligStress(calligraphic, Stress)
    }
    pfLPoint();
}
```

FilterSizeX and *FilterSizeY* set the debunching distances along each axis. A filter size of 0 disables the debunching along that axis. Debunching can also be disabled on the **pfLPointState**. For more information about debunching, see “Debunching” on page 756.

Defocus sets the defocus applied to all calligraphic light points, unless a callback function returns a defocus array. In that case, each light point has a callback defocus value regardless of the one set on the **pfCalligraphic** object.

In a raster-plus-calligraphic video mode, a calligraphic system usually has the capability to apply a global defocus to the raster image, which is specified by the *rasterDefocus* parameter passed to the projector. This parameter affects the entire image, not just the raster light points.

For more information about defocus, see “Defocussing Calligraphic Objects” on page 757.

DrawTime is the time, in nano seconds, in which all calligraphic light points must be drawn, unless a callback returns a *DrawTime* array, which controls individual draw times. The overall effect of changing the draw time is to reduce or increase the intensity of all calligraphic light points.

The *Stress* value is compared against the *significance* value of a `pfLPointState` to determine whether the light points are displayed as calligraphic or raster. The *Stress* value should be as stable as possible to avoid having points going from raster to calligraphic or from calligraphic to raster each frame. For more information about stress, see “Significance” on page 756.

Significance

If there is not enough time to draw all of the calligraphic light points, some calligraphic light points can either not be drawn or, instead, drawn as raster light points, depending on the stress value of the calligraphic light point, described in “Frame to Frame Control” on page 755, and the *significance* value of the `pfLPointState`.

The stress value of a calligraphic light point is compared against the *significance* value of the `pfLPointState`. If the *significance* is greater or equal than the stress, the light is rendered as a calligraphic; otherwise, the light is rendered as a raster light.

To set the significance, use `pfLPStateVal(lpstate, PFLPS_SIGNIFICANCE, significance)`.

Debunching

Debunching eliminates some calligraphic points when they occur close together on the display system. Bunched calligraphic light points can create a heap effect, or worse, burn the display system where there is a group of calligraphic light points.

The debunching distances are set in `pfCalligraphic` on the X and Y axis, as described in “Frame to Frame Control” on page 755.

If two points in a `pfGeoSet` are within the debunching distance, the point with the lowest intensity is not rendered.

If you do not want a `pfLPointState` to be affected by debunching, you can disable it using `pfLPStateMode()` with the `PFLPS_DEBUNCHING_MODE_OFF` mode; `PFLPS_DEBUNCHING_MODE_ON`, the default, enables debunching.

Defocussing Calligraphic Objects

Defocussing a calligraphic light point is often done to produce a specific lighting effect, for example, to simulate rainy conditions, light points should appear defocussed. The defocus is set within pfCalligraphic (see “Frame to Frame Control” on page 755) for all light points for one Frame, but it is possible to clamp the defocussing values by setting a *min_defocus* and a *max_defocus* value in the pFLPState using the following methods:

```
pfLPStateVal(lpstate, PFLPS_MIN_DEFOCUS, min_defocus);  
pfLPStateVal(lpstate, PFLPS_MAX_DEFOCUS, max_defocus);
```

Using pfCalligraphic Without pfChannel

pfCalligraphic is a libpr object; so, programs based only on libpr can have access to pfCalligraphic without having access to a pfChannel, which is a libpf object. This section describes what pfChannel does automatically with pfCalligraphic objects.

The LPB is connected to the VME bus and the VISI bus. Both buses contain information for calligraphic light points buffered in the LPB. VISI and VME busses load their information into the LPB buffer. The SwapReady connection to the graphic pipe synchronizes the activity on the VISI bus; SwapReady tells the board when **glXSwapBuffers()** is called, and that at the next VSync, the next frame should be displayed.

pfCalligSwapVME() performs the same synchronization for the VME bus; whenever you call **pfSwapPWinBuffers()**, you must first call **pfCalligraphicSwapVME()**; otherwise, the light point board will not be synchronized with the rest of the system.

Tip: To resynchronize the LPB, make two consecutive calls to **pfCalligSwapVME()**; for example, *perfly* makes these calls after the OpenGL Performer logo has been displayed.

Note: These synchronization mechanisms are handled automatically in libpf, unless you override the channel swap buffer and call **pfSwapPWinBuffers()**.

Timing Issues

The SwapReady signal should always occur after a VME Swap signal. If this does not happen, the light point board starts a TooLate timer and two things may happen:

- Assuming the VME Swap signal has been lost, the LPB starts to draw the buffer .
In this instance, not all of the calligraphic lights are rendered. `pfCalligraphic` handles this exception by making sure the LPB buffer always contains an end-of-buffer token at the end of the valid data.
- The VME Swap signal is received shortly after the Swap Ready, making the LPB behave normally.

The LPB needs some time before it can accept new information from the VME, and the VISI bus needs some time after it has received the corresponding swap command. `pfWaitForVmeBus()` and `pfWaitForVisiBus()` allow the application to wait for the board to get ready before sending it new information.

Light Point Process and Calligraphic

The light point process is the same whether the light points are raster or calligraphic. The only difference is that, with calligraphic light points, `pfCalligraphic` has to be selected before calling `pfPreprocessDList`, which is done automatically by `pfChannel`.

`pfSelectCalligraphic()` selects the channel and LPB board to which the calligraphic light points are sent. `pfGetCurCalligraphic()` returns the current value set by `pfSelectCalligraphic()`.

Debugging Calligraphic Lights on Non-Calligraphic Systems

If you are developing on a non-calligraphics-enabled system but would like to see the effects of your `pfCalligraphics` programming, you can set the environment variable `PF_LPOINT_BOARD`. In this mode, the LPB is simulated, the calligraphic computations are performed, and raster light points are displayed in place of the calligraphic lights with the following limitations:

- Calligraphic defocus has no effect.
- A calligraphic light point size is defined with the Z-footprint.

Calligraphic Light Example

Example 21-4 shows a sample implementation of calligraphic lights. You can find the source code in `perf/sample/pguide/libpf/C/callig.c`.

Example 21-4 Calligraphic Lights

```
#include <stdlib.h>
#include <Performer/pf.h>
#include <Performer/pfutil.h>
#include <Performer/pfdu.h>

static NumScreens=1;
static NumPipes=1;

static void ConfigPipeDraw(int pipe, uint stage);
static void OpenPipeWin(pfPipeWindow *pw);
static void OpenXWin(pfPipeWindow *pw);
static void DrawChannel(pfChannel *chan, void *data);

/*
 * Usage() -- print usage advice and exit. This
 * procedure is executed in the application process.
 */
static void
Usage (void)
{
    pfNotify(PFNFY_FATAL, PFNFY_USAGE, "Usage: multipipe file.ext
    ...\n");

    exit(1);
}
int
main (int argc, char *argv[])
{
    float      t = 0.0f;
    pfScene    *scene;
    pfPipe     *pipe[4];
    pfChannel  *chan[4];
    pfNode root;
    pfSphere sphere;
    int loop;
```

```
/* Initialize Performer */
pfInit();
pfuInitUtil();

/* specify the number of pfPipes */
/* Configure and open GL windows */
if ((NumScreens = ScreenCount(pfGetCurWSConnection())) > 1)
{
    NumPipes = NumScreens;
}

pfMultipipe (NumPipes);

/* Initialize Calligraphic HW */
for (loop=0; loop < NumPipes; loop++)
{
    int q;
    pfQueryFeature(PFQFTR_CALLIGRAPHIC, &q);
    if (!q)
    {
        pfNotify(PFNFY_NOTICE, PFNFY_RESOURCE, "Calligraphic points
are NOT supported on this platform");
    }

    if (pfCalligInitBoard(loop) == TRUE)
    {
        /* get the memory size */
        pfNotify(PFNFY_NOTICE, PFNFY_RESOURCE, "StartCalligraphic:
board(%d) has %d Bytes of memory", 0, pfGetCalligBoardMemSize(loop));
    }
    else
    {
        pfNotify(PFNFY_NOTICE, PFNFY_RESOURCE, "Could not init
calligraphic board %d", loop);
    }
}

/* Force Multiprocessor mode to use the light point process */

pfMultiprocess(PFMP_APP_CULL_DRAW | PFMP_FORK_LPOINT);

/* Load all loader DSO's before pfConfig() forks */
if (argc > 1)
pfdInitConverter(argv[1]);
```



```

/* Configure multiprocessing mode and start parallel processes.*/

pfConfig();
/* Append to PFPATH additional standard directories where geometry
and textures exist */

scene = pfNewScene();
if (argc > 1)
{
    if (!(getenv("PFPATH")))
pfFilePathv(".", "./data", "../data", "../../data",
            "/usr/share/Performer/data", NULL);

    /* Read a single file, of any known type. */
    if ((root = pfdLoadFile(argv[1])) == NULL)
    {
        pfExit();
        exit(-1);
    }

    /* Attach loaded file to a pfScene. */
    pfAddChild(scene, root);

    /* determine extent of scene's geometry */
    pfGetNodeBSphere (scene, &bsphere);
    /* Create a pfLightSource and attach it to scene. */
    pfAddChild(scene, pfNewLSource());
}

for (loop=0; loop < NumPipes; loop++)

pfPipeWindow *pw;
char str[PF_MAXSTRING];

pipe[loop] = pfGetPipe(loop);
pfPipeScreen(pipe[loop], loop);
pw = pfNewPWin(pipe[loop]);
pfPWinType(pw, PFPWIN_TYPE_X);
sprintf(str, "OpenGL Performer - Pipe %d", loop);
pfPWinName(pw, str);
if (NumScreens > 1)
{
    pfPWinOriginSize(pw, 0, 0, 300, 300);
} else

```

```
    pfPWinOriginSize(pw, (loop&0x1)*315, ((loop&0x2)>>1)*340, 300,
300);

    pfPWinConfigFunc(pw, OpenPipeWin);
    pfConfigPWin(pw);

}

/* set up optional DRAW pipe stage config callback */
pfStageConfigFunc(-1 /* selects all pipes */, PFPROC_DRAW /* stage
bitmask */, ConfigPipeDraw);
pfConfigStage(-1, PFPROC_DRAW);

pfFrame();

/* Create and configure pfChannels - by default, channels are
placed in the first window on their pipe */

for (loop=0; loop < NumPipes; loop++)
{
    chan[loop] = pfNewChan(pipe[loop]);
    pfChanScene(chan[loop], scene);
    pfChanFOV(chan[loop], 45.0f, 0.0f);
    pfChanTravFunc(chan[loop], PFTRAV_DRAW, DrawChannel);
    pfChanCalligEnable(chan[loop], 1);
    /* synchronize the lpoint board with the swap ready signal */
    pfCalligSwapVME(loop);
    pfCalligSwapVME(loop);
}

/* Simulate for twenty seconds. */
while (t < 30.0f)
{
    pfCoord view;
    float      s, c;

    /* Go to sleep until next frame time. */
    pfSync();
    /* Initiate cull/draw for this frame. */
    pfFrame();

    pfSinCos(45.0f*t, &s, &c);
    pfSetVec3(view.hpr, 45.0f*t, -10.0f, 0);
}
```

```

        pfSetVec3(view.xyz, 2.0f * bsphere.radius * s, -2.0f *
        bsphere.radius * c, 0.5f * bsphere.radius);
        for (loop=0; loop < NumPipes; loop++)
            pfChanView(chan[loop], view.xyz, view.hpr);
    }

    /* Terminate parallel processes and exit. */
    pfExit();
    return 0;
}

/* ConfigPipeDraw() --
 * Application state for the draw process can be initialized
 * here. This is also a good place to do real-time
 * configuration for the drawing process, if there is one.
 * There is no graphics state or pfState at this point so no
 * rendering calls or pfApply*() calls can be made.
 */

static void
ConfigPipeDraw(int pipe, uint stage)
{
    pfPipe *p = pfGetPipe(pipe);
    int x, y;

    pfNotify(PFNFY_NOTICE, PFNFY_PRINT, "Initializing stage 0x%x of
    pipe %d on screen %d, connection \"%s\"", stage,
    pipe, pfGetPipeScreen(p), pfGetPipeWSConnectionName(p));

    pfGetPipeSize(p, &x, &y);
    pfNotify(PFNFY_NOTICE, PFNFY_PRINT, "Pipe %d size: %dx%d", pipe,
    x, y);
}

/*
 * OpenPipeWin() -- create a GL window: set up the
 * window system and OpenGL Performer. This
 * procedure is executed for each window in the draw process
 * for that pfPipe.
 */

void
OpenXWin(pfPipeWindow *pw)
{

```

```
    /* -1 -> use default screen or that specified by shell DISPLAY
variable */
    pfuGLXWindow      *win;
    pfPipe   *p;

    p = pfGetPWinPipe(pw);
    if (!(win = pfuGLXWinopen(p, pw, "TESTIN")))
        pfNotify(PFNFY_FATAL, PFNFY_RESOURCE, "OpenXPipeline: Could not
create GLX Window.");

    win = win; /* suppress compiler warn */

}

static void
OpenPipeWin(pfPipeWindow *pw)
{
    pfPipe *p;
    pfLight *Sun;

    p = pfGetPWinPipe(pw);

    /* open the window on the specified screen. By default,
* if a screen has not yet been set and we are in multipipe mode,
* a window of pfPipeID i will now open on screen i
*/
    pfOpenPWin(pw);
    pfNotify(PFNFY_NOTICE, PFNFY_PRINT,
PipeWin of Pipe %d opened on screen %d",
pfGetId(p), pfGetPipeScreen(p));

    /* create a light source in the "south-west" (QIII) */
    Sun = pfNewLight(NULL);
    pfLightPos(Sun, -0.3f, -0.3f, 1.0f, 0.0f);
}

static void
DrawChannel (pfChannel *channel, void *data)
{
    static int first = 1;

    if (first)
    {
        first = 0;
    }
}
```

```
        pfNotify(PFNFY_NOTICE, PFNFY_PRINT, "Calligraphics: 0x%p",
pfGetChanCurCallig(channel));
    }

    /* erase framebuffer and draw Earth-Sky model */
    pfClearChan(channel);

    /* invoke Performer draw-processing for this frame */
    pfDraw();
}
```

Math Routines

This chapter describes the OpenGL Performer math routines. Math routines let you create, modify, and manipulate vectors, matrices, line segments, planes, and bounding volumes such as spheres, boxes, and cylinders.

Vector Operations

A basic set of mathematical operations is provided for setting and manipulating floating point vectors of length 2, 3, and 4. The types of these vectors are `pfVec2`, `pfVec3`, and `pfVec4`, respectively. The components of a vector are denoted by `PF_X`, `PF_Y`, `PF_Z`, and `PF_W` with indices of 0, 1, 2, and 3, respectively. In the case of 4-vectors, the `PF_W` component acts as the homogeneous coordinate in transformations.

OpenGL Performer supplies macro equivalents for many of the routines described in this section. Inlining the macros instead of calling the routines can substantially improve performance. The C++ interface provides the same, fast performance as the inlined macros.

Table 22-1 lists the routines, what they do (in mathematical notation), and the macro equivalents (where available) for working with 3-vectors. Most of the same operations are also available for 2-vectors and 4-vectors, substituting “2” or “4” for “3” in the routine names. The only operations not available for 2-vectors are vector cross-products, point transforms, and vector transforms; the only operations unavailable for 4-vectors are vector cross-products and point transforms, that is, there are no such routines as `pfCrossVec20`, `pfCrossVec40`, `pfXformPt20`, `pfXformPt40`, or `pfXformVec20`.

Note: For the duration of this chapter, we use the following convention for denoting one-letter variables: bold lowercase letters represent vectors and bold uppercase letters represent matrices. “ \times ” indicates cross product, “ \cdot ” denotes dot product, and vertical bars indicate the magnitude of a vector.]

Table 22-1 Routines for 3-Vectors

Routine	Effect	Macro Equivalent
pfSetVec3 (d, x, y, z)	$\mathbf{d} = (x, y, z)$	PFSET_VEC3
pfCopyVec3 (d, v)	$\mathbf{d} = \mathbf{v}$	PFCOPY_VEC3
pfNegateVec3 (d, v)	$\mathbf{d} = -\mathbf{v}$	PFNEGATE_VEC3
pfAddVec3 ($d, v1, v2$)	$\mathbf{d} = \mathbf{v}_1 + \mathbf{v}_2$	PFADD_VEC3
pfSubVec3 ($d, v1, v2$)	$\mathbf{d} = \mathbf{v}_1 - \mathbf{v}_2$	PFSUB_VEC3
pfScaleVec3 (d, s, v)	$\mathbf{d} = s\mathbf{v}$	PFSCALE_VEC3
pfAddScaledVec3 ($d, v1, s, v2$)	$\mathbf{d} = \mathbf{v}_1 + s\mathbf{v}_2$	PFADD_SCALED_VEC3
pfCombineVec3 ($d, s1, v1, s2, v2$)	$\mathbf{d} = s_1\mathbf{v}_1 + s_2\mathbf{v}_2$	PFCOMBINE_VEC3
pfNormalizeVec3 (d)	$\mathbf{d} = \mathbf{d} / \mathbf{d} $	none
pfCrossVec3 ($d, v1, v2$)	$\mathbf{d} = \mathbf{v}_1 \times \mathbf{v}_2$	none
pfXformPt3 (d, v, m)	$\mathbf{d} = \mathbf{vM}$, where $\mathbf{v} = (v_x, v_y, v_z)$ and M is the 4×3 submatrix.	none
pfFullXformPt3 (d, v, M)	$\mathbf{d} = \mathbf{vM} / d_w$ where $\mathbf{v} = (v_x, v_y, v_z, 1)$	none
pfXformVec3 (d, v, M)	$\mathbf{d} = \mathbf{vM}$, where $\mathbf{v} = (v_x, v_y, v_z, 0)$	none
pfDotVec3 ($v1, v2$)	$\mathbf{v}_1 \cdot \mathbf{v}_2$	PFDOT_VEC3
pfLengthVec3 (v)	$ \mathbf{v} $	PFLLENGTH_VEC3
pfSqrDistancePt3 ($v1, v2$)	$ \mathbf{v}_2 - \mathbf{v}_1 ^2$	PFSQR_DISTANCE_PT3
pfDistancePt3 ($v1, v2$)	$ \mathbf{v}_2 - \mathbf{v}_1 $	PFDISTANCE_PT3

Table 22-1 Routines for 3-Vectors (continued)

Routine	Effect	Macro Equivalent
<code>pfEqualVec3(v1, v2)</code>	Returns TRUE if $\mathbf{v}_1 = \mathbf{v}_2$ and FALSE, otherwise.	PFEQUAL_VEC3
<code>pfAlmostEqualVec3(v1, v2, tol)</code>	Returns TRUE if each element of \mathbf{v}_1 is within <i>tol</i> of the corresponding element of \mathbf{v}_2 and FALSE, otherwise.	PFALMOST_EQUAL_VEC3

Matrix Operations

A `pfMatrix` is a 4x4 array of floating-point numbers that is used primarily to specify a transformation in homogeneous coordinates (x, y, z, w) . Transforming a vector by a matrix means multiplying the matrix on the right by the row vector on the left.

Table 22-2 describes the OpenGL Performer mathematical operations that act on matrices.

Table 22-2 Routines for 4x4 Matrices

Routine	Effect	Macro Equivalent
<code>pfMakeIdentMat(d)</code>	$\mathbf{D} = \mathbf{I}$.	PFMAKE_IDENT_MAT
<code>pfMakeVecRotVecMat(d, v1, v2)</code>	$\mathbf{D} = \mathbf{M}$ such that $\mathbf{v}_2 = \mathbf{v}_1\mathbf{M}$. $\mathbf{v}_1, \mathbf{v}_2$ are normalized.	none
<code>pfMakeQuatMat(d, q)</code>	$\mathbf{D} = \mathbf{M}$, where \mathbf{M} is the rotation of the quaternion q .	none
<code>pfMakeRotMat(d, deg, x, y, z)</code>	$\mathbf{D} = \mathbf{M}$, where \mathbf{M} rotates by <i>deg</i> around (x, y, z) .	none
<code>pfMakeEulerMat(d, h, p, r)</code>	$\mathbf{D} = \mathbf{RPH}$, where \mathbf{R} , \mathbf{P} , and \mathbf{H} are the transforms for roll, pitch, and heading.	none
<code>pfMakeTransMat(d, x, y, z)</code>	$\mathbf{D} = \mathbf{M}$, where \mathbf{M} translates by (x, y, z) .	PFMAKE_TRANS_MAT
<code>pfMakeScaleMat(d, x, y, z)</code>	$\mathbf{D} = \mathbf{M}$, where \mathbf{M} scales by (x, y, z) .	PFMAKE_SCALE_MAT

Table 22-2 Routines for 4x4 Matrices **(continued)**

Routine	Effect	Macro Equivalent
pfMakeCoordMat (d, c)	$\mathbf{D} = \mathbf{M}$, where \mathbf{M} rotates by (h, p, r) and translates by (x, y, z) with $h, p, r, x, y,$ and z all specified by c .	none
pfGetOrthoMatQuat (s, q)	Returns in q a quaternion with the rotation specified by s .	none
pfGetOrthoMatCoord (s, d)	Returns in d the rotation and translation specified by s .	none
pfSetMatRow (d, r, x, y, z, w)	Set r th row of \mathbf{D} equal to (x, y, z, w).	PFSET_MAT_ROW
pfGetMatRow (m, r, x, y, z, w)	(*x, *y, *z, *w) = r th row of \mathbf{M} .	PFGET_MAT_ROW
pfSetMatCol (d, c, x, y, z, w)	Set c th column of \mathbf{D} equal to (x, y, z, w).	PFSET_MAT_COL
pfGetMatCol (m, c, x, y, z, w)	(*x, *y, *z, *w) = c th column of \mathbf{M} .	PFGET_MAT_COL
pfSetMatRowVec3 (d, r, v)	Set r th row of \mathbf{D} equal to \mathbf{v} .	PFSET_MAT_ROWVEC3
pfGetMatRowVec3 (m, r, d)	\mathbf{d} = r th row of \mathbf{M} .	PFGET_MAT_ROWVEC3
pfSetMatColVec3 (d, c, v)	Set c th column of \mathbf{D} equal to \mathbf{v} .	PFSET_MAT_COLVEC3
pfGetMatColVec3 (m, c, d)	\mathbf{d} = c th column of \mathbf{M} .	PFGET_MAT_COLVEC3
pfCopyMat (d, m)	$\mathbf{D} = \mathbf{M}$.	PFCOPY_MAT
pfAddMat ($d, m1, m2$)	$\mathbf{D} = \mathbf{M}_1 + \mathbf{M}_2$	none
pfSubMat ($d, m1, m2$)	$\mathbf{D} = \mathbf{M}_1 - \mathbf{M}_2$	none
pfMultMat ($d, m1, m2$)	$\mathbf{D} = \mathbf{M}_1\mathbf{M}_2$	none
pfPostMultMat (d, m)	$\mathbf{D} = \mathbf{D}\mathbf{M}$.	none
pfPreMultMat (d, m)	$\mathbf{D} = \mathbf{M}\mathbf{D}$.	none
pfTransposeMat (d, m)	$\mathbf{D} = \mathbf{M}\mathbf{T}$.	none
pfPreTransMat (d, m, x, y, z)	$\mathbf{D} = \mathbf{T}\mathbf{M}$, where \mathbf{T} translates by (x, y, z).	none

Table 22-2 Routines for 4x4 Matrices (**continued**)

Routine	Effect	Macro Equivalent
<code>pfPostTransMat(<i>d, x, y, z, m</i>)</code>	$\mathbf{D} = \mathbf{MT}$, where \mathbf{T} translates by (x, y, z) .	none
<code>pfPreRotMat(<i>d, deg, x, y, z, m</i>)</code>	$\mathbf{D} = \mathbf{RM}$, where \mathbf{R} rotates by <i>deg</i> around (x, y, z) .	none
<code>pfPostRotMat(<i>d, m, deg, x, y, z</i>)</code>	$\mathbf{D} = \mathbf{MR}$, where \mathbf{R} rotates by <i>deg</i> around (x, y, z) .	none
<code>pfPreScaleMat(<i>d, x, y, z, m</i>)</code>	$\mathbf{D} = \mathbf{SM}$, where \mathbf{S} scales by (x, y, z) .	none
<code>pfPostScaleMat(<i>d, m, x, y, z</i>)</code>	$\mathbf{D} = \mathbf{MS}$, where \mathbf{S} scales by (x, y, z) .	none
<code>pfInvertFullMat(<i>d, m</i>)</code>	$\mathbf{D} = \mathbf{M}^{-1}$ for general matrices.	none
<code>pfInvertAffMat(<i>d, m</i>)</code>	$\mathbf{D} = \mathbf{M}^{-1}$ with \mathbf{M} affine.	none
<code>pfInvertOrthoMat(<i>d, m</i>)</code>	$\mathbf{D} = \mathbf{M}^{-1}$ with \mathbf{M} orthogonal.	none
<code>pfInvertOrthoNMat(<i>d, m</i>)</code>	$\mathbf{D} = \mathbf{M}^{-1}$ with \mathbf{M} orthonormal.	none
<code>pfInvertIdentMat(<i>d, m</i>)</code>	$\mathbf{D} = \mathbf{M}^{-1}$ with \mathbf{M} equal to the identity matrix.	none
<code>pfEqualMat(<i>d, m</i>)</code>	Returns TRUE if $\mathbf{D} = \mathbf{M}$ and FALSE, otherwise	PFEQUAL_MAT
<code>pfAlmostEqualMat(<i>d, m, tol</i>)</code>	Returns TRUE if each element of \mathbf{D} is within <i>tol</i> of the corresponding element of \mathbf{M} and FALSE, otherwise	PFALMOST_EQUAL_MAT

Some of the math routines that take a matrix as an argument are restricted to affine, orthogonal, or orthonormal matrices; these restrictions are noted by `Aff`, `Ortho`, and `OrthoN`, respectively. (If such a restriction is not noted in a `libpr` routine name, the routine can take a general matrix.)

An affine transformation is one that leaves the homogeneous coordinate unchanged—that is, in which the last column is $(0,0,0,1)$. An orthogonal transformation is one that preserves angles. It can include translation, rotation, and uniform scaling, but no

shearing or nonuniform scaling. An orthonormal transformation is an orthogonal transformation that preserves distances; that is, one that contains no scaling.

In the visual simulation library, `libpf`, most routines require the matrix to be orthogonal, although this is not noted in the routine names.

The standard order of transformations for a hierarchical scene involves post-multiplying the transformation matrix for a child by the matrix for the parent. For instance, assume your scene involves a hand attached to an arm attached to a body. To get a transformation matrix H for the hand, post-multiply the arm's transformation matrix (A) by the body's (B): $H = AB$. To transform the hand object (at location h in hand coordinates) to body coordinates, calculate $h' = hH$.

Example 22-1 Matrix and Vector Math Examples

```
/*
 * test Rot of v1 onto v2
 */
{
    pfVec3 v1, v2, v3;
    pfMatrix m1;

    MakeRandomVec3(v1);
    MakeRandomVec3(v2);
    pfNormalizeVec3(v1);
    pfNormalizeVec3(v2);
    pfMakeVecRotVecMat(m1, v1, v2);
    pfXformVec3(v3, v1, m1);
    AssertEqVec3(v3, v2, "Arb Rot To");
}

/*
 * test inversion of Affine Matrix
 */
{
    pfVec3 v1, v2, v3;
    pfMatrix m1, m2, m3;

    MakeRandomVec3(v3);
    pfMakeScaleMat(m2, v3[0], v3[1], v3[2]);
    pfPreMultMat(m1, m2);

    MakeRandomVec3(v1);
    pfNormalizeVec3(v1);
```

```

MakeRandomVec3(v2);
pfNormalizeVec3(v2);
pfMakeVecRotVecMat(m1, v1, v2);
s = pfLengthVec3(v2)/pfLengthVec3(v1);
pfPreScaleMat(m1, s, s, s, m1);

MakeRandomVec3(v1);
pfNormalizeVec3(v1);
MakeRandomVec3(v2);
pfNormalizeVec3(v2);
pfMakeVecRotVecMat(m2, v1, v2);

MakeRandomVec3(v3);
pfMakeTransMat(m2, v3[0], v3[1], v3[1]);
pfPreMultMat(m1, m2);

pfInvertAffMat(m3, m1);
pfPostMultMat(m3, m1);
AssertEqMat(m3, ident, "affine inverse");

```

Quaternion Operations

A `pfQuat` is the OpenGL Performer data structure (a `pfVec4`) whose floating point values represent the components of a quaternion. Quaternions have many beneficial properties. The most relevant of these is their ability to represent 3D rotations in a manner that allows relatively simple yet meaningful interpolation between rotations. Much like multiplying two matrices, multiplying two quaternions results in the concatenation of the transformations. For more information on quaternions, see the article by Sir William Rowan Hamilton *"On quaternions; or on a new system of imaginaries in algebra,"* in *Philosophical Magazine*, xxv, pp. 10-13 (July 1844), or refer to the sources noted in the `pfQuat(3pf)` man page.

The properties of spherical linear interpolation makes quaternions much better suited than matrices for interpolating transformation values from keyframes in animations. The most common usage then is to use `pfSlerpQuat()` to interpolate between two quaternions representing two rotational transformations. The quaternion that results from the interpolation can then be passed to `pfMakeQuatMat()` to generate a matrix for use in a subsequent OpenGL Performer call such as `pfDCSMat()`. While converting a quaternion to a matrix is relatively efficient, converting a matrix to a quaternion with `pfGetOrthoMatQuat()` is expensive and should be avoided when possible.

Because a pfQuat is also a pfVec4, all of the pfVec4 routines and macros may be used on pfQuats as well.

Table 22-3 Routines for Quaternions

Routine	Effect	Macro Equivalent
pfMakeRotQuat (<i>q, a, x, y, z</i>)	Sets <i>q</i> to rotation of <i>a</i> degrees about (<i>x, y, z</i>).	none
pfGetQuatRot (<i>q, a, x, y, z</i>)	Sets <i>*a</i> to angle and (<i>*x, *y, *z</i>) to axis of rotation represented by <i>q</i> .	none
pfConjQuat (<i>d, q</i>)	<i>d</i> = conjugate of <i>q</i> .	PFCONJ_QUAT
pfLengthQuat (<i>q</i>)	Returns length of <i>q</i> .	PFLENGTH_QUAT
pfMultQuat (<i>d, q1, q2</i>)	<i>d</i> = <i>q1</i> * <i>q2</i> .	PFMULT_QUAT
pfDivQuat (<i>d, q1, d2</i>)	<i>d</i> = <i>q1</i> / <i>q1</i> .	PFDIV_QUAT
pfInvertQuat (<i>d, q1</i>)	<i>d</i> = 1 / <i>q1</i> .	
pfExpQuat (<i>d, q</i>)	<i>d</i> = exp(<i>q</i>).	none
pfLogQuat (<i>d, q</i>)	<i>d</i> = ln(<i>q</i>).	none
pfSlerpQuat (<i>d, t, q1, q2</i>)	<i>d</i> = interpolation with weight <i>t</i> between <i>q1</i> (<i>t</i> =0.0) and <i>q2</i> (<i>t</i> =1.0).	none
pfSquadQuat (<i>d, t, q1, q2, a, b</i>)	<i>d</i> = quadratic interpolation between <i>q1</i> and <i>q2</i> .	none
pfQuatMeanTangent (<i>d, q1, q2, q3</i>)	<i>d</i> = mean tangent of <i>q1, q2</i> and <i>q3</i> .	none

Example 22-2 Quaternion Example

```

/*
 * test quaternion slerp
 */

    pfQuat q1, q2, q3;
    pfMatrix m1, m2, m3, m3q;
    pfVec3 axis;
    float angle1, angle2, angle, t;

    MakeRandomVec3(axis);

```

```

pfNormalizeVec3(axis);
angle1 = -drand48()*90.0f;
angle2 = drand48()*90.0f;
t = drand48();

pfMakeRotMat(m1, angle1, axis[0], axis[1], axis[2]);
pfMakeRotQuat(q1, angle1, axis[0], axis[1], axis[2]);
pfMakeQuatMat(m3q, q1);

pfMakeRotMat(m2, angle2, axis[0], axis[1], axis[2]);
pfMakeRotQuat(q2, angle2, axis[0], axis[1], axis[2]);
pfMakeQuatMat(m3q, q2);
AssertEqMat(m2, m3q, "make rot quat q2");

angle = (1.0f-t) * angle1 + t * angle2;
pfMakeRotMat(m3, angle, axis[0], axis[1], axis[2]);

pfMakeRotQuat(q1, angle1, axis[0], axis[1], axis[2]);
pfMakeRotQuat(q2, angle2, axis[0], axis[1], axis[2]);
pfSlerpQuat(q3, t, q1, q2);
pfMakeQuatMat(m3q, q3);
AssertEqMat(m3q, m3, "quaternion slerp");

```

Matrix Stack Operations

OpenGL Performer allows you to create a stack of transformation matrices, which is called a `pfMatStack`.

Table 22-4 lists and describes the matrix stack routines. Note that none of these routines has a macro equivalent. The matrix at the top of the matrix stack is denoted "TOS," for "Top of Stack."

Table 22-4 Matrix Stack Routines

Routine	Operation
<code>pfNewMStack()</code>	Allocate storage.
<code>pfResetMStack()</code>	Reset the stack.
<code>pfPushMStack()</code>	Duplicate the TOS and push it on the stack.

Table 22-4 Matrix Stack Routines (**continued**)

Routine	Operation
<code>pfPopMStack()</code>	Pop the stack.
<code>pfPreMultMStack()</code>	Premultiply the TOS by a matrix.
<code>pfPostMultMStack()</code>	Postmultiply the TOS by a matrix.
<code>pfLoadMStack()</code>	Set the TOS matrix.
<code>pfGetMStack()</code>	Get the TOS matrix.
<code>pfGetMStackTop()</code>	Get a pointer to the TOS matrix.
<code>pfGetMStackDepth()</code>	Return the current depth of the stack.
<code>pfPreTransMStack()</code>	Pre-multiply the TOS by a translation.
<code>pfPostTransMStack()</code>	Post-multiply the TOS by a translation.
<code>pfPreRotMStack()</code>	Pre-multiply the TOS by a rotation.
<code>pfPostRotMStack()</code>	Post-multiply the TOS by a rotation.
<code>pfPreScaleMStack()</code>	Pre-multiply the TOS by a scale factor.
<code>pfPostScaleMStack()</code>	Post-multiply the TOS by a scale factor.

Creating and Transforming Volumes

`libpr` provides a number of volume primitives, including sphere, box, cylinder, half-space (plane), and frustum. `libpf` uses the frustum primitive for a view frustum and uses other volume primitives for bounding volumes:

- `pfNodes` use bounding spheres.
- `pfGeoSets` use bounding boxes.
- Segments use bounding cylinders.

Defining a Volume

This section describes how to define geometric volumes.

Spheres

Spheres are defined by a center and a radius, as shown by the `pfSphere` structure's definition:

```
typedef struct {
    pfVec3 center;
    float radius;
} pfSphere;
```

A point \mathbf{p} is in the sphere with center \mathbf{c} and radius r if $|\mathbf{p} - \mathbf{c}| \leq r$.

Axially Aligned Boxes

An axially aligned box is defined by its two corners with the smallest and largest values for each coordinate. Its edges are parallel to the X, Y, and Z axes. It is represented by the `pfBox` data structure:

```
typedef struct {
    pfVec3 min;
    pfVec3 max;
} pfBox;
```

A point (x, y, z) is in the box if $min_x \leq x \leq max_x$, $min_y \leq y \leq max_y$, and $min_z \leq z \leq max_z$.

Cylinders

A cylinder is defined by its center, radius, axis, and half-length, as shown by the definition of the `pfCylinder` data structure:

```
typedef struct {
    pfVec3 center;
    float radius;
    pfVec3 axis;
    float halfLength;
} pfCylinder;
```

A point \mathbf{p} is in the cylinder with center \mathbf{c} , radius r , axis \mathbf{a} , and half-length h , if $|\mathbf{p} - \mathbf{c}| \cdot \mathbf{a}| \leq h$ and $|\mathbf{p} - \mathbf{c} - ((\mathbf{p} - \mathbf{c}) \cdot \mathbf{a}) \mathbf{a}| \leq r$.

Half-spaces (Planes)

A half-space is defined by a plane with a normal pointing away from the interior. It is represented by the `pfPlane` data structure:

```
typedef struct {  
    pfVec3 normal;  
    float offset;  
} pfPlane;
```

A point \mathbf{p} is in the half-space with normal \mathbf{n} and offset d if $\mathbf{p} \cdot \mathbf{n} \leq d$.

Frusta

Unlike the other volumes, a `pfFrustum` is not an exposed structure. You can allocate storage for a `pfFrustum` using `pfNewFrust()` and you can set the frustum using `pfMakePerspFrust()` or `pfMakeOrthoFrust()`.

Creating Bounding Volumes

The easiest and most efficient way to create a volume is to use one of the bounding operations. The routines in Table 22-5 create a bounding volume that encloses other geometric objects.

Table 22-5 Routines to Create Bounding Volumes

Routine	Bounding Volume
<code>pfBoxAroundPts()</code>	Box enclosing a set of points
<code>pfBoxAroundBoxes()</code>	Box enclosing a set of boxes
<code>pfBoxAroundSpheres()</code>	Box enclosing a set of spheres
<code>pfCylAroundSegs()</code>	Cylinder around a set of segments
<code>pfSphereAroundPts()</code>	Sphere around a set of points
<code>pfSphereAroundBoxes ()</code>	Sphere around a set of boxes
<code>pfSphereAroundSpheres ()</code>	Sphere around a set of spheres

Bounding volumes can also be defined by extending existing volumes, but in many cases the tightness of the bounds created through a series of extend operations is substantially inferior to that of the bounds created with a single **pf*Around*()** operation.

Table 22-6 lists and describes the routines for extending bounding volumes.

Table 22-6 Routines to Extend Bounding Volumes

Routine	Operation
pfBoxExtendByPt()	Extend a box to enclose a point.
pfBoxExtendByBox()	Extend a box to enclose another box.
pfSphereExtendByPt ()	Extend a sphere to enclose a point.
pfSphereExtendBySphere ()	Extend a sphere to enclose a sphere.

Transforming Bounding Volumes

Transforming the volumes with an orthonormal transformation—that is, with no skew or nonuniform scaling, is straightforward for all of the volumes except for the axially aligned box. A straight transformation of the vertices does not suffice because the new box would no longer be axially aligned; so, an aligned box must be created that encloses the transformed vertices. Hence, a transformation of a box is not generally reversed by applying the inverse transformation to the new box.

Table 22-7 lists and describes the routines that transform bounding volumes.

Table 22-7 Routines to Transform Bounding Volumes

Routine	Operation
pfOrthoXformPlane()	Transform a plane or half-space.
pfOrthoXformFrust()	Transform a frustum.
pfXformBox()	Transform and extend a bounding box.
pfOrthoXformCyl()	Transform a cylinder.
pfOrthoXformSphere()	Transform a sphere.

Intersecting Volumes

OpenGL Performer provides a number of routines that test for intersection with volumes.

Point-Volume Intersection Tests

The point-volume intersection test returns `PFIS_TRUE` if the specified point is in the volume and `PFIS_FALSE` otherwise. Table 22-8 lists and describes the routines that test a point for inclusion within a bounding volume.

Table 22-8 Testing Points for Inclusion in a Bounding Volume

Routine	Test
<code>pfBoxContainsPt()</code>	Point inside a box
<code>pfSphereContainsPt()</code>	Point inside a sphere
<code>pfCylContainsPt()</code>	Point inside a cylinder
<code>pfHalfSpaceContainsPt()</code>	Point inside a half-space
<code>pfFrustContainsPt()</code>	Point inside a frustum

Volume-Volume Intersection Tests

OpenGL Performer provides a number of volume-volume tests that are used internally for bounding-volume tests when culling to a view frustum or when testing a group of line segments against geometry in a scene (see “Intersecting with `pfGeoSets`” on page 784). You can intersect spheres, boxes, and cylinders against half-spaces and against frustums for culling. You can intersect cylinders against spheres for testing grouped segments against bounding volumes in a scene.

Table 22-9 lists and describes the routines that test for volume intersections.

Table 22-9 Testing Volume Intersections

Routine	Action: Test if A Inside B
<code>pfHalfSpaceContainsSphere()</code>	Sphere inside a half-space
<code>pfFrustContainsSphere()</code>	Sphere inside a frustum
<code>pfSphereContainsSphere()</code>	Sphere inside a sphere
<code>pfSphereContainsCyl()</code>	Cylinder inside a sphere
<code>pfHalfSpaceContainsCyl()</code>	Cylinder inside a half-space
<code>pfFrustContainsCyl()</code>	Cylinder inside a frustum
<code>pfHalfSpaceContainsBox()</code>	Box inside a half-space
<code>pfFrustContainsBox()</code>	Box inside a frustum
<code>pfBoxContainsBox()</code>	Box inside a box

The volume-volume intersection tests are designed to quickly locate empty intersections for rejection during a cull. If the complete intersection test is too time-consuming, the result `PFIS_MAYBE` is returned to indicate that the two volumes might intersect.

The returned value is a bitwise OR of tokens, as shown in Table 22-10.

Table 22-10 Intersection Results

Test Result	Meaning
<code>PFIS_FALSE</code>	No intersection.
<code>PFIS_MAYBE</code>	Possible intersection.
<code>PFIS_MAYBE PFIS_TRUE</code>	A contains at least part of B.
<code>PFIS_MAYBE PFIS_TRUE PFIS_ALL_IN</code>	A contains all of B.

This arrangement allows simple code such as that shown in Example 22-3.

Example 22-3 Quick Sphere Culling Against a Set of Half-Spaces

```
long
HSSContainsSphere(pfPlane **hs, pfSphere *sph, long numHS)
{
    long i, isect;

    isect = ~0;

    for (i = 0 ; i < numHS ; i++)
    {
        isect &= pfHalfSpaceContainsSphere(sph,hs[i]);
        if (isect == PFIS_FALSE)
            return isect;
    }
    /* if not ALL_IN all half spaces, don't know for sure */
    if (!(isect & PFIS_ALL_IN))
        isect &= ~PFIS_TRUE;
    return isect;
}
```

Creating and Working with Line Segments

A `pfSeg` represents a line segment starting at position *pos* and extending for a distance *length* in the direction *dir*:

```
typedef struct {
    pfVec3 pos;
    pfVec3 dir;
    float length;
} pfSeg;
```

The routines that operate on `pfSegs` assume that *dir* is of unit length and that *length* is positive; otherwise, the results of operations are undefined.

You can create line segments in four ways:

- Specify a point and a direction directly in the structure—`pfSeg()`.
- Specify two endpoints—`pfMakePtsSeg()`.
- Specify one endpoint and an orientation in polar coordinates—`pfMakePolarSeg()`.
- Specify starting and ending distances along an existing segment—`pfClipSeg()`.

Intersection tests are the most important operations that use line segments. You can test the intersection of segments with volumes (half-spaces, spheres, and boxes), with 2D geometry (planes and triangles), and with geometry inside pfGeoSets.

Intersecting with Volumes

OpenGL Performer supports intersections of segments with three types of convex volumes. **pfHalfSpaceIsectSeg()** intersects a segment with the half-space defined by a plane with an outward facing normal. **pfSphereIsectSeg()** intersects with a sphere and **pfBoxIsectSeg()** intersects with an axially aligned box.

The intersection test of a segment and a convex volume can have one of five results:

- The segment lies entirely outside the volume.
- The segment lies entirely within the volume.
- The segment lies partially inside the volume with the starting point inside.
- The segment lies partially inside the volume with the ending point inside.
- The segment lies partially inside the volume with both endpoints outside.

As with the volume-volume tests, the segment-volume intersection routines return a value that is the bitwise OR of some combination of the tokens PFIS_TRUE, PFIS_ALL_IN, PFIS_START_IN, and PFIS_MAYBE. (When PFIS_TRUE is set PFIS_MAYBE is also set for consistency with those routines that do quick intersection tests for culling.)

The functions take two arguments that return the distances along the segment of the starting and ending points. The return values are designed so that you can AND them together for testing for the intersection of a segment against the intersection of a number of volumes. For example, a convex polyhedron is defined as the intersection of a set of half-spaces. Example 22-4 shows how to intersect a segment with a polyhedron.

Example 22-4 Intersecting a Segment With a Convex Polyhedron

```
long
HSSIsectSeg(pfPlane **hs, pfSeg *seg, long nhs, float *d1,
            float *d2)
{
    long retval = 0xffff;
    for (long i = 0 ; i < nhs ; i++)
    {
```

```
        retval &= pfHalfSpaceIsectSeg(hs[i], seg, d1, d2);
        if (retval == 0)
            return 0;
        pfClipSeg(seg, *d1, *d2);
    }
    return retval;
}
```

Note that these routines do not actually clip the segment. If you want the segment to be clipped to the interior of the volume, you must call **pfClipSeg()**, as in the example above.

Intersecting with Planes and Triangles

Intersections with planes and triangles are simpler than those with volumes. **pfPlaneIsectSeg()** and **pfTriIsectSeg()** return either `PFIS_TRUE` or `PFIS_FALSE`, depending on whether an intersection has occurred. The distance of the intersection along the segment is returned in one of the arguments.

Intersecting with pfGeoSets

You can intersect line segments with the drawable geometry that is within `pfGeoSets` by calling **pfGSetIsectSegs()**. The operation is very similar to that of **pfNodeIsectSegs()**, except that rather than operating on an entire scene graph, only the triangles within the `pfGeoSet` are “traversed.”

pfGSetIsectSegs() takes a `pfSegSet` and tests to see whether any of the segments intersect the polygons inside the specified `pfGeoSet`. By default, information about the closest intersection along each segment is returned as a set of `pfHit` objects, one for each line segment in the request. Each `pfHit` object indicates the location of the intersection, the normal, and what element was hit. This element identification includes the index of the primitive within the `pfGeoSet` and the triangle index within the primitive (for tristrips and quads primitives), as well as the actual triangle vertices.

You can also extract information from a `pfHit` object using **pfQueryHit()** and **pfMQueryHit()**. (See “Intersection Requests: `pfSegSets`” and “Intersection Return Data: `pfHit` Objects” in Chapter 4 for more information about `pfSegSets` and `pfHit` objects.) The principal difference between those routines and **pfGSetIsectSegs()** is that with **pfGSetIsectSegs()** information concerning the `libpf` scene graph (such as transformation, geode, name, and path) is never used.

Two types of intersection testing are possible, as shown in Table 22-11.

Table 22-11 Available Intersection Tests

Test Name	Function
PFTRAV_IS_GSET	Intersect the segment with the bounding box of the pfGeoSet.
PFTRAV_IS_PRIM	Intersect the segment with the polygon-based primitives inside the pfGeoSet.

You can use PFTRAV_IS_GSET for crude collision detection and PFTRAV_IS_PRIM for fine-grained testing. You can enable both bits and dynamically choose whether to go down to the primitive level by using a discriminator callback (see “Discriminator Callbacks”). **pfGSetIsectSegs()** performs only primitive-level testing for pfGeoSets consisting of triangles (PFGS_TRIS), quads (PFGS_QUADS), and tristrrips (PFGS_TRISTRIPS), and all are decomposed into triangles.

Intersection Masks

Each pfGeoSet has an intersection mask that you set using **pfGSetIsectMask()**. The mask in the pfGeoSet is useful when pfGeoSets are embedded in a larger data structure; it allows you to define pfGeoSets to belong to different classes of geometry for intersection—for example, water, ground, foliage. **pfGSetIsectSegs()** also takes a mask, and an intersection test is performed only if the bitwise AND of the two masks is nonzero.

Discriminator Callbacks

If a callback is specified in **pfGSetIsectSegs()**, the callback function is invoked when a successful intersection occurs, either with the bounding box of the pfGeoSet or with a primitive. The discriminator can decide what action to take based on the information about the intersection contained in a pfHit object. The return value from the discriminator determines whether the current intersection is valid and should be copied into the return structure, whether the rest of the geometry in the pfGeoSet is examined, and whether the segment should be clipped before continuing.

Unless the return value includes the bit PFTRAV_IS_IGNORE, the intersection is considered successful and is copied into the array of pfHit structures for return.

The bits of the PFTRAV_* tokens determine whether to continue, as shown in Table 22-12.

Table 22-12 Discriminator Return Values

Result	Meaning
PFTRAV_CONT	Continue examining geometry inside the pfGeoSet.
PFTRAV_PRUNE	Terminate the traversal now.
PFTRAV_TERM	Terminate the traversal now.

The bits PFTRAV_IS_CLIP_END and PFTRAV_IS_CLIP_START cause the segment to be clipped at the end or at the start using the intersection point. By default, in the absence of a discriminator, segments are end-clipped at each successful intersection at the finest level (bounding box or primitive level) requested. Hence, the closest intersection point is always returned.

The discriminator is passed a pfHit. You can use **pfQueryHit()** to examine information about the intersection, including which segment number within the pfSegSet the intersection is for and the current segment as clipped by previous intersections.

General Math Routine Example Program

Example 22-5 demonstrates the use of many of the available OpenGL Performer math routines.

Example 22-5 Intersection Routines in Action

```

/*
 * simple test of pfCylIsectSeg
 */
{
    pfVec3 tmpvec;
    pfSetVec3(pt1, -2.0f, 0.0f, 0.0f);
    pfSetVec3(pt2, 2.0f, 0.0f, 0.0f);

    pfMakePtsSeg(&seg1, pt1, pt2);

    pfSetVec3(cyl1.axis, 1.0f, 0.0f, 0.0f);
    pfSetVec3(cyl1.center, 0.0f, 0.0f, 0.0f);
    cyl1.radius = 0.5f;
}

```

```

    cyll.halfLength = 1.0f;

    isect = pfCylIsectSeg(&cyll, &seg1, &t1, &t2);

    pfClipSeg(&clipSeg, &seg1, t1, t2);
    AssertFloatEq(clipSeg.length, 2.0f, "clipSeg.length");
    pfSetVec3(tmpvec, 1.0f, 0.0f, 0.0f);
    AssertVec3Eq(clipSeg.dir, tmpvec, "clipSeg.dir");
    pfSetVec3(tmpvec, -1.0f, 0.0f, 0.0f);
    AssertVec3Eq(clipSeg.pos, tmpvec, "clipSeg.pos");
}
/*
 * simple test of pfTriIsectSeg
 */
{
    pfVec3 tr1, tr2, tr3;
    pfSeg seg;
    float d = 0.0f;
    long i;

    for (i = 0 ; i < 30 ; i++)
    {
        float alpha = 2.0f * drand48() - 0.5f;
        float beta = 2.0f * drand48() - 0.5f;
        float lscale = 2.0f * drand48();
        float target;
        long shouldisect;

        MakeRandomVec3(tr1);
        MakeRandomVec3(tr2);
        MakeRandomVec3(tr3);
        MakeRandomVec3(pt1);
        pfCombineVec3(pt2, alpha, tr2, beta, tr3);
        pfCombineVec3(pt2, 1.0f, pt2, 1.0f - alpha - beta, tr1);

        pfMakePtsSeg(&seg, pt1, pt2);
        target = seg.length;
        seg.length = lscale * seg.length;

        isect = pfTriIsectSeg(tr1, tr2, tr3, &seg, &d);
        shouldisect = (alpha >= 0.0f &&
                      beta >= 0.0f &&
                      alpha + beta <= 1.0f &&
                      lscale >= 1.0f);
    }
    if (shouldisect)

```

```
    if (!isect)
        printf("ERROR: missed\n");
    else
        AssertFloatEq(d, target, "hit at wrong distance");
else if (isect)
    printf("ERROR: hit\n");
}

/*
 * simple test of pfCylContainsPt
 */
{
    pfCylinder cyl;
    pfVec3 pt;
    pfVec3 perp;

    pfSetVec3(cyl.center, 1.0f, 10.0f, 5.0f);
    pfSetVec3(cyl.axis, 0.0f, 0.0f, 1.0f);
    pfSetVec3(perp, 1.0f, 0.0f, 0.0f);
    cyl.halfLength = 2.0f;
    cyl.radius = 0.5f;

    pfCopyVec3(pt, cyl.center);
    if (!pfCylContainsPt(&cyl, pt))
        printf("center of cylinder not in cylinder!!!!\n");

    pfAddScaledVec3(pt, cyl.center, 0.9f*cyl.halfLength,
                    cyl.axis);
    if (!pfCylContainsPt(&cyl, pt))
        printf("0.9*halfLength not in cylinder!!!!\n");

    pfAddScaledVec3(pt, cyl.center, -0.9f*cyl.halfLength,
                    cyl.axis);
    if (!pfCylContainsPt(&cyl, pt))
        printf("-0.9*halfLength not in cylinder!!!!\n");

    pfAddScaledVec3(pt, cyl.center, -0.9f*cyl.halfLength,
                    cyl.axis);
    pfAddScaledVec3(pt, pt, 0.9f*cyl.radius, perp);
    if (!pfCylContainsPt(&cyl, pt))
        printf("0.9*halfLength not in cylinder!!\n");

    pfAddScaledVec3(pt, cyl.center, 0.9f*cyl.halfLength,
                    cyl.axis);
    pfAddScaledVec3(pt, pt, -0.9f*cyl.radius, perp);
}
```

```
if (!pfCylContainsPt(&cyl, pt))
    printf("-0.9*halfLength not in cylinder!!!!\n");

pfAddScaledVec3(pt, cyl.center, 1.1f*cyl.halfLength,
                cyl.axis);
if (pfCylContainsPt(&cyl, pt))
    printf("1.1*halfLength in cylinder!!!!\n");

pfAddScaledVec3(pt, cyl.center, -1.1f*cyl.halfLength,
                cyl.axis);
if (pfCylContainsPt(&cyl, pt))
    printf("-1.1*halfLength in cylinder!!!!\n");

pfAddScaledVec3(pt, cyl.center, -0.9f*cyl.halfLength,
                cyl.axis);
pfAddScaledVec3(pt, pt, 1.1f*cyl.radius, perp);
if (pfCylContainsPt(&cyl, pt))
    printf("1.1*radius in cylinder!!!!\n");

pfAddScaledVec3(pt, cyl.center, 0.9f*cyl.halfLength,
                cyl.axis);
pfAddScaledVec3(pt, pt, -1.1f*cyl.radius, perp);
if (pfCylContainsPt(&cyl, pt))
    printf("1.1*radius in cylinder!!!!\n");
}
```

Statistics

This chapter describes the OpenGL Performer profiling utilities. Statistics are available on nearly every aspect of OpenGL Performer's operation and can be used to diagnose both functionality and performance problems, as well as for writing benchmarks and for load management. For more detailed information on interpreting statistics to tune the performance of your application, refer to Chapter 24, "Performance Tuning and Debugging."

To collect most OpenGL Performer statistics, all you have to do is enable them; OpenGL Performer then collects them automatically for you in `pfStats` and `pfFrameStats` data structures (for `libpr` and `libpf`, respectively). You can query the contents of these structures from your program, or write the data to files. A `libpf` application can also display the contents of a `pfFrameStats` structure in a channel by calling **`pfDrawChanStats()`** or **`pfDrawFStats()`**. The statistics drawn for a channel are the statistics accumulated in the channel's own `pfFrameStats`. Such a display is not necessary for statistics collection. The pointer to the `pfFrameStats` structure for a channel can be obtained with **`pfGetChanFStats()`**. You can then control which statistics for the channel are being accumulated.

Most of the OpenGL Performer demo programs display some subset of these statistics. This chapter first explains some of the complex graphical displays and then discusses how to display statistics from a `libpf`-based application. Subsequent sections explain how to access and manipulate statistics from within an application. Topics include enabling and disabling statistics classes, printing, querying, and copying statistics data, as well as some basic examples showing common uses of statistics. At the end of this chapter is a discussion of the different statistics classes for `libpr` and `libpf` along with details of their use.

Interpreting Statistics Displays

Many types of statistics can be displayed in a channel. Most such displays consist simply of labeled numbers and are fairly self-explanatory; however, some of the displays, such as the stage timing graph, warrant further explanation.

OpenGL Performer tracks the time spent in the application, cull, and draw stages of the rendering pipeline. The basic statistics display shows a timing graph for each stage of the past several frames, as well as showing the current frame rate and load information. This profiling diagram is useful for optimizing both the database and application structure.

Figure 23-1 shows a sample stage timing graph from an OpenGL Performer demo program. It might be helpful to refer to a running example as well—by turning on a statistics display in `perfly`, for instance—while reading this section.

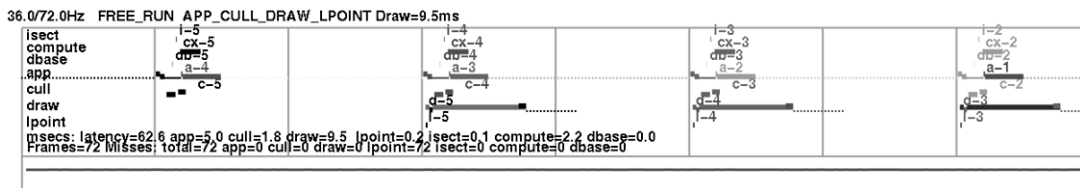

Figure 23-1 Stage Timing Statistics Display

The statistics diagram in Figure 23-1 is the simplest of the standard statistics displays. There are several other standard display formats, each emphasizing other classes of statistics. Statistics collection, though highly optimized, can take extra time in OpenGL Performer operations. Because of this, you have a great deal of fine control over exactly what statistics are currently being collected and what statistics are being displayed. Statistics are divided into *classes* (separated into vertically stacked boxes in a display), and into *modes* within each class. The next several sections describe the classes shown in a typical statistics display.

Status Line

The top line of a standard statistics display, above the box that contains the rest of the statistics, shows the current average frame rate followed by a slash and the target frame rate. (To set a target frame rate, call `pfFrameRate()`.) The rest of that status line indicates what frame-rate control method you are using (FLOAT, FREE, LIMIT, or LOCK—for

details, see “Achieving the Frame Rate” in Chapter 5), your multiprocess model (set with `pfMultiprocess()`), and the average time (in milliseconds) spent in the channel draw callback. An optional part of the status line indicates the number of triangles in the scene.

Stage Timing Graph

The main part of the timing display is the stage timing graph, occupying the top portion of the statistics display. The red vertical lines (the darker ones in Figure 23-1) mark video retrace intervals, which occur at the video refresh rate of the system (commonly 60 times per second); a **field** is the period of time between two video retrace boundaries. The green vertical lines (the lighter ones in the figure) indicate frame boundaries. Note that frame boundaries are always on field boundaries and are an integral number of fields.

The segmented horizontal line segments in the top portion of the timing graph show the time taken by each of the OpenGL Performer pipeline stages and additional processes: i (intersection), a (application), c (cull), d (draw), l (lpoint), db (dbase), and cx (compute) for each of the four frames shown (0 through 3). On screen, all stages belonging to a given frame are drawn in one color; different colors indicate different frames. You will notice that the application lines show a change in color. This point is where `pfFrame()` returned and is the start of the next application frame. At that point is a label for the stage name and the age of the frame being represented. The stages of the most recent frame, at the right of the graph, are marked a0, c0, and d0; previous frames have higher numbers (so “a-1” indicates the application stage of the immediately previous frame).

All stages performed by the same process are connected by vertical lines. If two stages are performed by different processes, they are not connected by a vertical line. In most multiprocessing modes, a stage of one frame occurs at the same time as another stage for a different frame, so that (for instance) d0 is directly below c-1 in the graph. The exception is the PFMP_CULLoDRAW model, in which the cull and draw stages for a given frame are performed in tandem; in this mode d0 is directly below c0 in the graph. (In Figure 23-1, the PFMP_APPCULLDRAW model was used and all stages are part of separate processes.)

These stage timings are helpful when choosing a process model and balancing the cull and draw tasks for a database. Furthermore, the timing graph can show you how close you are to an improvement in frame rate as you view the database.

The timing lines for each stage are broken into pieces displayed at slightly different heights and thicknesses to show the time taken by significant subtasks within each stage.

Raised segments reflect time spent in user code, intermediate lines reflect time spent in OpenGL Performer code, and lowered lines reflect time waiting on other operations.

Figure 23-2 illustrates the parts of a draw-stage timing line. Note that this figure is not drawn to scale; sizes are exaggerated in order to discuss the individual parts more easily.

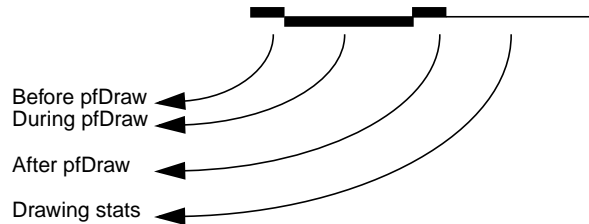

Figure 23-2 Conceptual Diagram of a Draw-Stage Timing Line

The following explains the potential displayed elements of each stage line in the timing graph. Note that if you run your application or `perf11y`, you may not see some parts if the corresponding operations are not needed.

The application stage is divided into five subsegments, starting at the point where `pfFrame()` returns and the new application frame is beginning:

- The time spent in the application's main loop between the `pfFrame()` call and the `pfSync()` call (highest segment in application line, drawn as a thick, bright line).
- The time spent cleaning the scene graph from application changes during `pfSync()`; drawn as mid-height thick, bright line. This will also include the time for `pfAppFrame()`, which is called from `pfSync()` if not already called for the current frame by the user. `pfSequences` are also evaluated as part of `pfAppFrame()`.
- The time spent sleeping in `pfSync()` while waiting for the next field or frame boundary (depending on `pfPhase` and process model); the lowest point in the application line, drawn as a thin pale dotted line. Note that in single process with `pfPhase` of `FREE_RUN`, there will be a sleep period to wait for the swapbuffer of the draw to complete before continuing with the application since any other graphics call would effectively force such a sleep anyway and in a place where its timing effect could not be measured.
- The time spent in the application code between calling `pfSync()` and calling `pfFrame()`; drawn as bright raised line. This is the critical path section and this line should be as small as possible or non-existent.

- The time spent in **pfFrame()** cleaning the scene graph after any changes that might have been made in the previous subsegment, and then checking intersections; drawn as mid-height thick bright line. This line should typically be very small or non-existent as it is part of the critical path and implies database changes between **pfSync()** and **pfFrame()** that would be an expensive place to do such changes.
- The time spent waiting while the cull and other downstream process copy updated information from the application and then starting the downstream stages on the now-finished frame (drawn as a low thin line). The end of this line is where **pfFrame()** returns and the user main application section (or post frame section) starts again.

The cull stage is divided into only two subsegments:

- The time spent receiving updates from the application (in some multiprocessing models, this overlaps with the last subsegment of the application stage). This time is displayed for all channels even though it is only done one time. This is drawn as a lowered thick line.
- The time spent in the channel cull callback for the given channel, including time spent in **pfCull()** (drawn as raised line). Note that there may be a large space between this and the update line if there are multiple channels on the same **pfPipe** that are processed first.

The draw stage has potentially six subsegments:

- The time spent in the channel draw callback before the call to **pfDraw()** (a very short thick dark raised segment). This includes the time for your call to **pfClearChan()**. However, under normal circumstances, this segment should barely be visible at all. Operations taking place during this time should only be latency-critical since they are holding off the draw for the current frame.
- The time spent by OpenGL Performer traversing the scene graph in **pfDraw()**; it is drawn as lowered bright thick segment. This should typically be the largest segment of the draw line.
- The time spent in the channel draw callback after **pfDraw()** (another short thick dark raised segment). On InfiniteReality, if graphics pipeline timing statistics have been enabled (PPFSTATS_ENGFXPFTIMES), this line will include the time to finish the fill for this channel. Otherwise, it only includes the time for the CPU to execute and send graphics commands, and graphics pipeline processing from this channel could impact the timing of other channels.

- The time to rendering raster light points computed by a forked lpoint process. This is drawn as a very raised bright line and if it exists will be the highest point in the draw line.
- The last channel drawn on the pipe will include the time for the graphics pipeline to finish its drawing. Even if you have no operations after **pfDraw()** in your draw callback, this line for the last channel might look quite long particularly if you are very fill-limited and do not have InfiniteReality graphics pipeline statistics enabled. It is possible for rendering calls issued in the previous section to fill up the graphics FIFO and have calls issued on this section have to wait while the graphics pipeline processes the commands and FIFO drains, making the time look longer than expected. If there is no forked lpoint process, this line will be combined with the post-draw line of the last pfChannel.
- The time spent waiting for the graphics pipeline to finish drawing the current frame, draw the channel statistics (for all channels), and make the call to swap color buffers. This is drawn as a pale dotted line. The hardware will complete the swapbuffers upon the following vertical field or frame line.

Below the stage timing lines, the average time for each stage (in milliseconds) is shown. Note that the time given for the draw stage is the same as the time shown for the draw stage on the status line above the statistics box.

Load and Stress

The lower portion of the channel statistics diagram shows the recent history of graphics load and stress management. The load measure is based on the amount of time taken to draw previous frames in the channel relative to the specified goal frame time. A wavy red horizontal line is drawn to show the last three seconds of graphics load. A pair of white horizontal lines represent the upper and lower bounds of graphics load for invoking stress management. Thus, when the red line wanders outside the boundaries set by the white lines, stress management is invoked.

Stress management causes scaling of LODs in the database to meet the target frame rate with maximum scene detail. The last three seconds of stress are shown in white while stress management is running. Thus, the channel statistics graph can be used to tune the upper and lower bounds of the hysteresis band for invoking stress management and for tuning LODs of objects in the database.

CPU Statistics

The CPU statistics keep track of system usage and require that the corresponding hardware statistics be enabled:

```
pfEnableStatsHw( PFSTATSHW_ENCPU );
```

The percentage of time CPUs spend idle, busy, in user code, waiting on the Graphics Pipeline, or on the swapping of memory is calculated. The statistics packages counts the number of the following:

- Context switches (process and graphics)
- System calls
- Times the graphics FIFO is found to be full
- Times a CPU went to sleep waiting on a full graphics FIFO
- Graphics pipeline IOCTLs issued (by the system)
- Swapbuffers seen

All of these statistics are computed over an elapsed period of time.

Note: Use an interval of at least one second.

PFSTATSHW_CPU_SYS

This mode calculates the above CPU statistics for the entire system. This mode is enabled by default.

PFSTATSHW_CPU_IND

This mode calculates the above CPU statistics for each individual CPU; it is much more expensive than using just the summed statistics.

CPU statistics, illustrated (with some other statistics) in Figure 23-3, give you information on system usage and load. The numbers shown correspond exactly to numbers given by `osview`; they are updated every update period just like other statistics (see “Setting Update Rate” on page 809 for information on how to change the update rate). These numbers represent averages (per second) across all CPUs; thus, if one or more CPUs is busy with some other task, the CPU statistics shown may not accurately reflect OpenGL Performer CPU use. Note that the top line of the CPU statistics panel shows the total number of frames during the last update period and the total time elapsed during that period.

RTMon Statistics (IRIX Only)

The IRIX kernel collects timestamps using the rtmon daemon, `rtmond(1)`. OpenGL Performer issues rtmon timestamps for all operations in the timing graph if the rtmon statistics are enabled with `pfStatsClass(PFFSTATS_ENRTMON, PF_ON)`.

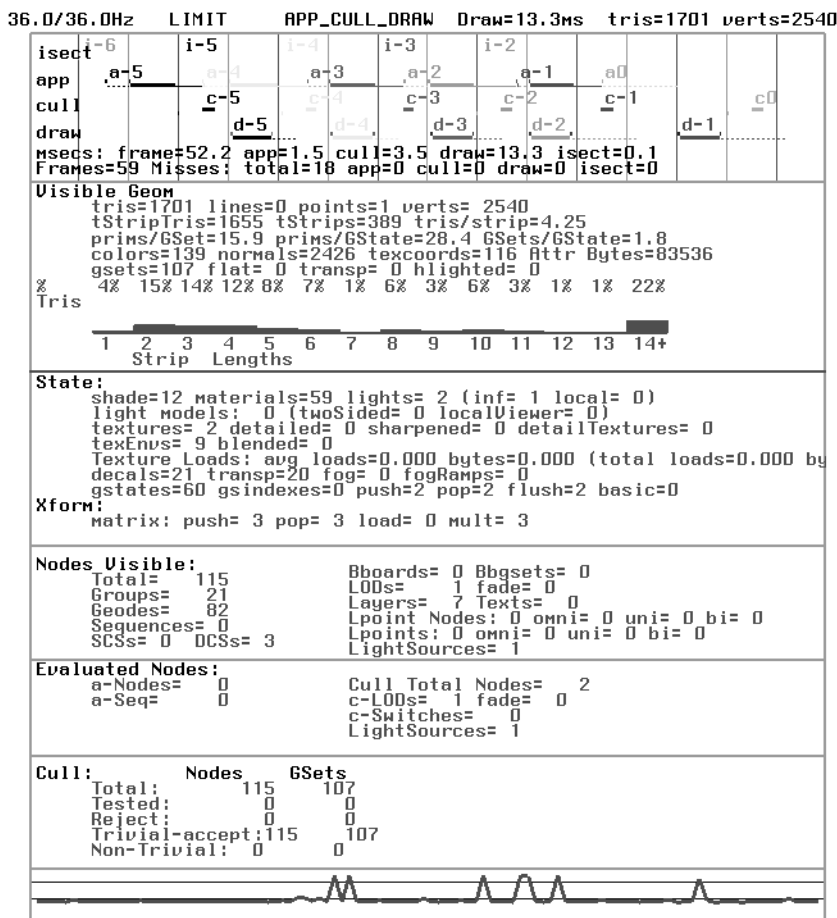

Figure 23-3 Other Statistics Classes

Rendering Statistics

Several other classes of statistics can be shown, each representing a different aspect of rendering performance. Some of these classes show the following:

- Data about visible geometry, including a histogram showing the percentage of triangles in the scene that are part of strips of a given length (from 1 to 14). Quads are counted as strips of length two; independent triangles count as strips of length one. This histogram is mostly useful as a diagnostic to see how well your database is structured for drawing efficiency; if it shows too many very short strips, you may want to go back and restructure your database. (As a general rule of thumb, consider a “very short strip” to be one that is less than four triangles long but that number may vary depending on your database). To enable these statistics on a channel do the following:

```
pfFStatsClass(pfGetChanFStats(chan),
             PFSTATS_ENGFX, PFSTATS_ON);
```

- A summary of the graphics state operations (including loading of textures) and of the number of operations that have recently been performed on the transformation stack (also part of the GFX stats class), the number of `libpf` nodes being drawn in several categories (including billboards, light points, and geodes), plus the number of nodes of each type evaluated in the application and cull stages. The following enables these statistics:

```
pfFStatsClass(pfGetChanFStats(chan),
             PFSTATS_ENDB, PFSTATS_ON);
```

- Cull statistics, including how many nodes and `pfGeoSets` are being tested, how many are accepted, and how many are rejected by the `libpf` culling task. plus the number of nodes of each type evaluated in the application and cull stages. The following enables these statistics:

```
pfFStatsClass(pfGetChanFStats(chan),
             PFFSTATS_ENDB, PFSTATS_ON);
```

- Graphics pipeline timing statistics showing the time spent rendering as measured by the graphics pipeline. This timing is then used internally for more accurate load management. This is supported by InfiniteReality graphics platforms. These statistics are enabled as follows:

```
pfFStatsClass(pfGetChanFStats(chan),
             PFSTATSHW_ENGFXPIPE_TIMES, PFSTATS_ON);
```

Fill Statistics

The fill statistics display indicates how many millions of pixels have been drawn since the last statistics update. (For information on setting the length of time between statistics updates, see “Setting Update Rate” on page 809). It also computes the average *depth complexity* of the image, which is the average number of times each pixel was touched per frame.

The depth complexity of a scene is also displayed in the main channel. Each pixel will be colored according to how many times that pixel was written to during display, rather than according to the current rendering modes. The colors used range from dark blue (not written to at all) to bright pink (written over many times). This color scheme is used in calculating fill statistics; the coloring is done whenever you gather fill statistics even when you are not displaying the totals in your channel statistics display.

Stencil planes are used to store the number of times a pixel is written and, thus, to calculate fill statistics. If n stencil planes are available, no more than 2^n writes to any given pixel will be counted. By default, the calculation of fill statistics uses three stencil planes; to change that default, call `pfStatsHwAttr()`.

Fill statistics are part of the `libpr` `pfStats` statistics but can be enabled on both `pfStats` and `pfFrameStats` classes. To enable fill statistics, simply use the following:

```
pfStatsClass(statsptr,  
             PFSTATSHW_ENGFPIPE_FILL, PFSTATS_ON);
```

To enable fill statistics for a channel's `pfFrameStats`, use the following:

```
pfFStatsClass(pfGetChanFStats(chan),  
             PFSTATSHW_ENGFPIPE_FILL, PFSTATS_ON);
```

Examples of fill statistics can be found in `perfly` and in `/usr/share/Performer/src/pguide/libpr/C/fillstats.c` for IRIX and Linux and in `%PFROOT%\Src\pguide\libpr\C\fillstats.c` for Microsoft Windows.

Collecting and Accessing Statistics in Your Application

If you just want to bring up a statistics display in your application, you may not need to know details about the data structures used for statistics. If, however, you want to do more complicated statistics-handling (including collecting statistics without displaying

them), you need more advanced information. This section provides a general overview of statistics manipulation, followed by subsections containing specific information.

If you use `libpf`, a wide variety of statistics-manipulation functions is available. If you use `libpr`, however, you must do some things on your own. For instance, you have to bind your own `pfStats` structure in which to accumulate statistics.

Furthermore, you cannot access some kinds of statistics except through `libpf` calls—for instance, you cannot get culling statistics using `libpr` calls. If you want full access to statistics, you must use `libpf`. There are, however, `libpr` routines that allow you to do your own cumulative totaling and averaging of collected statistics.

To create your own statistics display, enable the statistics classes you want to use and disable any modes you do not want to use. Then enable any relevant hardware, if necessary, with `pfEnableStatsHw()`.

To ensure the accuracy of timing with your rendering statistics, you want to flush the graphics pipeline before calling `pfGetTime()`. You can do this with `glFinish()`. These calls are expensive and should not be done more than at the start and end of drawing in the frame.

Displaying Statistics Simply

To put up a simple statistics display, all you have to do is call the function `pfDrawChanStats()` and pass it a pointer to the `pfChannel` whose statistics you want to display. The `pfDrawChanStats()` routine can be called from any process within the application; the statistics will be displayed in the channel specified.

If you want to display one channel's statistics in another channel, call `pfDrawFStats()`; for an example of this technique, as well as the enabling and disabling of every statistics class, see the statistics programming example in the file `/usr/share/Performer/src/pguide/libpf/C/stats.c` for IRIX and Linux and in file `%PFROOT%\Src\pguide\libpf\C\stats.c` for Microsoft Windows.

By default, a statistics display shows all enabled statistics. If you want to show only a subset of the statistics you are collecting, call `pfChanStatsMode()` with an enabling bitmask indicating which classes are to be displayed.

Enabling and Disabling Statistics for a Channel

For efficiency, you may want to turn off statistics collection for a given channel when you are not displaying that channel's statistics. In particular, the stage timing statistics are enabled by default; so, if you are using a channel whose statistics you do not care about, you should disable statistics for that channel. To turn off statistics for a channel, use the following:

```
pfFStatsClass(pfGetChanFStats(chan),  
             PFSTATS_ALL, PFSTATS_OFF);
```

Use the same function with different parameters to enable all or specific classes of statistics for a channel. You can specify which classes to enable in order to minimize statistics collection overhead.

Statistics in `libpr` and `libpf`—`pfStats` Versus `pfFrameStats`

`libpf` statistics accumulate into a `pfFrameStats` structure to later be displayed, printed, queried, or otherwise processed. The `pfFrameStats` structure actually contains four buffers of statistics: a buffer for the previous frame's statistics, a buffer of averaged statistics for the previous update period, a buffer of accumulated statistics for the current update period, and a buffer of statistics being accumulated for the current frame.

The `pfFrameStats` structure is built upon the `libpr` `pfStats` structure; so, the `pfFrameStats` API includes routines to duplicate the functionality of `pfStats`. The duplicated API exists because the routines cannot be intermixed. `pfStats` routines can only be used on `pfStats` structures and `pfFrameStats` routines can only be called with `pfFrameStats` structures. However, `pfstats` classes and class modes (designated with the `PFSTATS_` prefix) can be enabled on a `pfFrameStats` structure.

The `pfStats` statistics classes include the system and hardware statistics for the graphics pipeline and the CPU, as well as the pixel fill statistics and rendering statistics on geometry, graphics state, and matrix transformations. Some of the `libpr` statistics commands, such as `pfEnableStatsHw(PFSTATSHW_ENGFPIPE_FILL)`, require an active graphics context and thus should only be called from the draw process. However, these commands are usually never necessary in a `libpf` application because the `pfFrameStats` operation will handle these commands automatically.

Statistics Class Structures

The `pfFrameStats` structure and the `pfStats` structure are both inherited from the `pfObject` structure. Thus, you can use the `pfObject` routines (**`pfCopy()`**, **`pfPrint()`**, **`pfDelete()`**, **`pfUserData()`**, **`pfGetType()`**, and so on) with `pfStats` and `pfFrameStats` structures. However, some `pfObject` routines will not support all of the semantics of a `pfStats` or `pfFrameStats` structure; so, some `pfStats` versions of a few of these routines take extra arguments. These routines will have a `pfFrameStats` version as well. In particular, **`pfCopyStats()`** and **`pfCopyFStats()`** should be used to copy `pfStats` and `pfFrameStats` structures, respectively.

Routines that have “FStats” in their names (rather than just “Stats”) expect to be passed a full `pfFrameStats` structure rather than a `pfStats` structure. The `pfFrameStats` API includes additional routines beyond `pfStats` for supporting `libpf` statistics. For example, **`pfDrawFStats()`** displays statistics in a channel and **`pfFStatsCountNode()`** accumulates the static database statistics for the scene graph rooted at the provided node. Additionally, `pfFrameStats` has special support for the multiprocessed environment of `libpf` and ensures that the statistics operations are all done in the correct process. All modifying of a `pfFrameStats` structure, including enabling and disabling of classes, printing, and copying, should all be done in the application process. **`pfDrawFStats()`** and **`pfDrawChanStats()`** can be called in either the application process or the draw process.

Statistics Rules of Use

Enabling and disabling of statistics and setting of modes and attributes on a statistics structure should always be done in the application process; the settings will automatically be passed down the process pipeline. To enable classes of statistics on a `pfFrameStats`, call **`pfFStatsClass()`** and provide a statistics structure, a bitmask of statistics-enabling tokens (tokens with “STATS_EN” in their names) for the desired classes, and the token `PFSTATS_ON`. Obtain the statistics structure from the desired channel by calling **`pfGetChanFStats()`** as follows:

```
pfFStatsClass(pfGetChanFStats(chan), PFFSTATS_ENCULL |
             PFFSTATS_ENDB, PFSTATS_ON);
```

It enables the cull statistics and database statistics classes, leaving settings alone for any other classes. Notice that the classes specific to `pfFrameStats` have a `PFFSTATS_` prefix. You can use `PFSTATS_SET` instead of `PFSTATS_ON` to enable only the specified classes (disabling any others that might already be enabled).

Statistics Tokens

There are five main types of statistics tokens:

- Statistics class-enable bitmasks, used for selecting a set of classes to enable with **pfStatsClass()**. Class enables and disables are specified with bitmasks. Each statistics class has an enable token: a PFSTATS_EN* token that can be ORed with other statistics enable tokens and the result passed in to enable and disable statistics operations. These bitmasks are also used when printing with **pfPrint()** or copying with **pfCopy()** and **pfCopyStats()** as well as with the **pfResetStats()**, **pfClearStats()**, **pfAverageStats()**, and **pfAccumulateStats()** routines (and their pfFrameStats counterparts). These tokens are of the form PFSTATS_EN* and PFFSTATS_EN* for pfStats and pfFrameStats class, respectively. The PFSTATS_ALL token selects all statistics classes and also all statistics buffers in the case of a pfFrameStats structure. The token PFSTATS_EN_MASK selects all pfStats classes and the token PFFSTATS_EN_MASK selects all pfFrameStats statistics classes, which includes all pfStats classes.
- Value tokens, used to specify how to set a value for a specified pfStats or pfFrameStats class enable or mode. Value tokens include PFSTATS_ON, PFSTATS_OFF, and PFSTATS_DEFAULT. Another value token, PFSTATS_SET, is used to specify that the entire class enable or mode bitmask should be set to the specified mask. These tokens are used in conjunction with the class bitmasks and the class name tokens for **pfStatsClass()** and **pfStatsClassMode()**.
- Class name tokens, used to name a specific class. For instance, these tokens can be passed to **pfStatsClassMode()** to set individual modes of a statistics class.
- Class mode tokens, of which each statistics class has its own and which have the form PFSTATS_class_mode and PFFSTATS_class_mode for pfStats and pfFrameStats class modes, respectively.
- Statistics query tokens, used with **pfQueryStats()**, **pfMQueryStats()**, **pfQueryFStats()**, and **pfMQueryFStats()**. These tokens are of the form PFSTATSVAL_* and PFFSTATSVAL_* and have matching pfStatsVal* types for holding the returned data. The token PFFSTATS_BUF_MASK selects the pfFrameStats statistics buffers.

Statistics Buffers

You can only access the PREV and CUM statistics buffers from the OpenGL Performer application process. Statistics from desired buffers in other processes should be queried

in the application process and then passed down the process pipeline. You can do this using the channel data utility.

The AVG buffer is copied down the process pipeline at the end of each update period and, so, is available to be queried by other processes. The CUR statistics buffer is the current working area and contains the statistics accumulated so far from previous stages current frame; the contents of the CUR buffer is very dependent on the multiprocess configuration (but is almost always empty in the application process, so queries should access the PREV buffer). Statistics that are added to the CUR buffer by copying, accumulation, or immediate-mode collection (such as with **pfStatsCountGSet()** and **pfFStatsCountNode()**) are propagated down the process pipeline and then back up to the application process to be included in the PREV buffer.

In a `libpf` application, most statistics collection is completely automatic. The application must simply enable the desired classes of statistics with **pfStatsClass()** and/or **pfStatsClassMode()**.

The OpenGL Performer processes are responsible for actually opening the `pfFrameStats` structure in which to accumulate the enabled statistics classes as well as for managing any statistics hardware resources. All types of `libpf` statistics can be accumulated without ever making specific calls to open a structure for accumulation or enabling statistics hardware.

When using only `libpr` statistics, however, one must explicitly open a `pfStats` structure for statistics accumulation by calling **pfOpenStats()**.

Hardware statistics resources must also be managed by an application using only `libpr` statistics. Statistics function calls that have “HW” in their names, such as **pfEnableStatsHw()** and **pfStatsHwAttr()**, directly access system hardware (such as graphics hardware and CPU); be careful to make such calls only from the relevant process. **pfEnableStatsHw()** expects `PFSTATSHW_EN*` bitmask tokens. Statistics classes which have corresponding statistics hardware have a `PFSTATSHW_` prefix in their token names.

In a `libpf` application, OpenGL Performer takes care of enabling the correct hardware modes that correspond to enabled classes of statistics. For more information about specific statistics classes, see the `pfFrameStats(3pf)` and `pfStats(3pf)` man pages.

Reducing the Cost of Statistics

Collecting and displaying statistics can have a big impact on performance. This section describes ways to reduce that impact.

Enabling Only Statistics of Interest

Each channel has its Process Frame Times (PFTIMES) statistics class enabled by default. This class maintains a short history of process frame times and averages the frame times over the default update period of two seconds.

To minimize unnecessary overhead, turn off statistics on channels when you are not using them. To turn off all statistics for a channel, call **pfFStatsClass()** in the application process with the statistics structure of the given channel:

```
pfFStatsClass(pfGetChanFStats(chan), PFSTATS_ALL,  
             PFSTATS_OFF);
```

Each statistics class has default mode settings. The short history of process frame time is used to draw the timing graph. By default, this history consists of four frames of each OpenGL Performer process (app, cull, draw, intersections).

Maintaining this short history of statistics can be disabled by calling **pfStatsClassMode()** with the token **PFSTATS_PFTIMES_HIST**:

```
pfStatsClassMode(fstats, PFFSTATS_PFTIMES,  
                PFFSTATS_PFTIMES_HIST, PFSTATS_OFF);
```

This is useful if you are only interested in the average frame times of each task with minimal overhead and you do not need to display the timing graph. However, for most applications, the overhead incurred by keeping the timing history is not noticeable.

Controlling Update Rate

The update rate controls how often statistics are averaged and new results are made available in the AVG buffer for display or query. Change the update rate by using the following call:

```
pfFStatsAttr(fstats, {PFFSTATS_UPDATE_FRAMES,  
                    PFFSTATS_UPDATE_SECS}, val);
```

When the update rate is nonzero, statistics are accumulated every frame. When the update period is set to zero, no statistics accumulation or averaging is done and only statistics in the PREV and CUR buffers are maintained.

When statistics are accumulated and averaged, the averaging happens only in the application process, but accumulation is done in each OpenGL Performer process.

Statistics Output

Once you have collected some statistics, you need to be able to access and manipulate them.

Printing

To print the contents of `pfStats` and `pfFrameStats` structures, use the general `pfPrint()` routine. The verbosity-level parameter to `pfPrint()` sets the level of detail to use in printing statistics. Statistics class-enable bitmasks can be used to select a subset of statistics to print. For instance, to print only the enabled statistics, use the following:

```
pfPrint(stats, pfGetStatsClass(stats, PFSTATS_ALL),  
        PFPRINT_VB_INFO, 0);
```

When printing the contents of `pfFrameStats` structures, you can select which buffers are to be printed: PREV, CUR, AVG, or CUM. The selected statistics from all selected buffers are printed. The following call prints the currently enabled statistics from the previous frame and from the averaged statistics buffer:

```
pfPrint(stats, PFFSTATS_BUF_PREV | PFFSTATS_BUF_AVG |  
        pfGetStatsClass(stats, PFSTATS_ALL),  
        PFPRINT_VB_INFO, 0);
```

Copying

You can copy entire `pfStats` and `pfFrameStats` structures with the general `pfCopy()` command. `pfCopy()` copies all of the statistics data as well as information on mode settings and which classes are enabled. The source and destination structures must be of the same type. If both statistics structures are `pfFrameStats` structures, then all statistics from all buffers are copied.

The **pfCopyStats()** and **pfCopyFStats()** routines copy only statistics data (not class enables or mode settings) and accept a class enable bitmask to select statistics classes for the copy, as shown in the following:

```
pfCopyStats(statsA, statsB, pfGetStatsClass(statsB,  
PFSTATS_ALL));
```

For a `pfFrameStats` structure, a `PFSTATS_BUF_*` token can be included in the stats enable bitmask to select the buffer to be accessed. If no buffer is specified, the CUR buffer is used. The following call copies the currently enabled classes of *stats* to the PREV `pfStats` in *fstats*:

```
pfCopyFStats(fstats, stats, PFSTATS_BUF_PREV |  
pfGetStatsClass(stats, PFSTATS_ALL));
```

In this case, it is an error to select more than one statistics buffer; so, `PFSTATS_ALL` cannot be used as the select. If you specify two `pfFrameStats` structures, the buffer select is used for both structures; if you select multiple buffers, then each selected statistics class from each selected buffer is copied. The **pfCopyFStats()** routine allows you to copy between two different buffers of two `pfFrameStats` structures.

This routine takes explicit specification of `PFSTATS_BUF_*` selects for source and destination. Any `PFSTATS_BUF_*` included with the class-enable bitmask is simply ignored, making it safe to specify `PFSTATS_ALL`. This routine will not accept a `pfStats` structure.

Querying

pfQueryStats() and **pfMQueryStats()** (and corresponding `pfFrameStats` versions) can be used to get values from a `pfStats` or `pfFrameStats` structure and into an exposed structure.

These routines are useful when you want to use specific statistics for your own custom load management or for benchmarking, and you can use them to implement your own custom statistics utility routines. **pfQueryStats()** and **pfMQueryStats()** both take a `pfStats` (or `pfFrameStats` for **pfQueryFStats()** and **pfMQueryFStats()**) and return the number of bytes written to the provided destination buffer. **pfQueryStats()** takes a token that specifies a single query while **pfMQueryStats()** expects a token buffer for multiple queries. If an error is encountered, both query routines immediately halt and return with the total number of bytes successfully written.

There are specific tokens for querying individual values or entire classes of statistics. The query tokens are of the forms `PFSTATSVAL_*` and `PPFSTATSVAL_*`, and the corresponding exposed structure names are of the form `pfStatsVal*` and `pfFStatsVal*`. Queries on `pfFrameStats` structures with `PPFSTATSVAL_*` tokens expect a `PPFSTATS_BUF_*` select token to be ORed with the query select. It is an error to include more than one `pfFrameStats` buffer select token. If no buffer select token is provided, the CUR buffer will be queried. The statistics query tokens and structures are defined in `prstats.h` and `pfstats.h`.

Customizing Displays

The standard statistics displays have several parameters hard-wired. For instance, you cannot change the colors used in such displays. If you want to use different colors, you will have to use your own display routines.

Setting Update Rate

To set the frequency at which statistics are automatically collected, use `pfFStatsAttr()`. See the `pfFrameStats(3pf)` man page for details. If you want to turn off cumulative statistics collection (and, thus, running averages) entirely, set the update rate to zero. (Note that doing this will change your statistics display; in particular, your actual frame rate will be changed and other averages will not be displayed.)

The pfStats Data Structure

The `pfStats` data structure contains four statistics buffers: one for current statistics, one for previous statistics, one for cumulative statistics, and one for averages.

If you are using `libpf` calls to have OpenGL Performer keep track of statistics for you, you should always look at the previous-stats buffer; the current-stats buffer is kept in a state of flux, and if you look at it you are likely to find meaningless numbers there.

If, on the other hand, you are using `libpr` and keeping track of your own statistics, the current-stats buffer does contain accurate information.

Setting Statistics Class Enables and Modes

This section contains some examples of statistics calls.

- Set all statistics class enables on a `pfStats` to their default values:

```
pfStatsClass(stats, PFSTATS_ALL, PFSTATS_DEFAULT);
```

- Set all modes for the `PFSTATS_GFX` class on a `pfFrameStats` to their default values:

```
pfFStatsClassMode(fstats, PFSTATS_GFX, PFSTATS_ALL,  
PFSTATS_DEFAULT);
```

Note that `pfStatsClassMode()` takes a class name as its class specifier (second argument) and not a bitmask. However, you can use `PFSTATS_CLASS` to refer to the modes of all classes.

- Set all modes of all `pfStats` classes to their default values:

```
pfFStatsClassMode(fstats, PFSTATS_MODE, PFSTATS_ALL,  
PFSTATS_DEFAULT);
```

For `pfFrameStats` classes, there is `PFFSTATS_CLASS`.

- Set the entire class enable mask to all `PFSTATS_ALL`, effectively enabling all statistics classes:

```
pfFStatsClass(fstats, PFFSTATS_ALL, PFSTATS_SET);
```

- Force off all modes of the `PFSTATS_GFX` class of a `pfStats`:

```
pfStatsClassMode(stats, PFSTATS_GFX, PFSTATS_OFF,  
PFSTATS_SET);
```

- To track triangle strip lengths on a `pfFrameStats`, enable the graphics statistics class mode:

```
pfFStatsClassMode(fstats, PFSTATS_GFX,  
PFSTATS_GFX_TSTRIP_LENGTHS, PFSTATS_ON);
```

Performance Tuning and Debugging

This chapter provides some basic guidelines to follow when tuning your application for optimal performance. It also describes how to use debugging tools like `pixie`, `prof`, and `ogldebug` to debug and tune your applications on IRIX. It concludes with some specific notes on tuning applications on systems with RealityEngine graphics.

Performance Tuning Overview

This section contains some general performance tuning principles. Some of these issues are discussed in more detail later in this chapter.

- Remember that high performance does not come by accident. You must design your programs with speed in mind for optimal results.
- Tuning graphical applications, particularly OpenGL Performer applications, requires a pipeline-based approach. You can think of the graphics pipeline as comprising three separate stages; the pipeline runs only as fast as the slowest stage; so, improving the performance of the pipeline requires improving the slowest stage's performance. The three stages are the following:
 - The host (or CPU) stage, in which routines are called and general processing is done by the application. This stage can be thought of as a software pipeline, sometimes called the *rendering pipeline*, itself comprising up to three sub-stages—the application, cull, and draw stages—as discussed at length throughout this guide.
 - The transformation stage, in which transformation matrices are applied to objects to position them in space (this includes matrix operations, setting graphics modes, transforming vertices, handling lighting, and clipping polygons).
 - The fill stage, which includes clearing the screen and then drawing and filling polygons (with operations such as Gouraud shading, z-buffering, and texture mapping).

- You can estimate your expected frame rate based on the makeup of the scene to be drawn and graphics speeds for the hardware you are using. Be sure to include fill rates, polygon transform rates, and time for mode changes, matrix operations, and screen clear in your calculations.
- Measure both the performance of complex scenes in your database and of individual objects and drawing primitive to verify your understanding of the performance requirements.
- Use the OpenGL Performer diagnostic statistics to evaluate how long each stage takes and how much it does. See Chapter 23, “Statistics,” for more information. These statistics are referred to frequently in this chapter.
- Tuning an application is an incremental process. As you improve one stage’s performance, bottlenecks in other stages may become more noticeable. Also, do not be discouraged if you apply tuning techniques and find that your frame rate does not change—frame rates only change by a field at a time (which is to say in increments of 16.67 milliseconds for a 60 Hz display) while tuning may provide speed increases of finer granularity than that. To see performance improvements that do not actually increase frame rate, look at the times reported by OpenGL Performer statistics on the cull and draw processes (see Chapter 23 for more information).

How OpenGL Performer Helps Performance

OpenGL Performer uses many techniques to increase application performance. Knowing about what OpenGL Performer is doing and how it affects the various pipeline stages may help you write more efficient code. This section lists some of the things OpenGL Performer can do for you.

Draw Stage and Graphics Pipeline Optimizations

During drawing, OpenGL Performer does the following:

- Sets up an internal record of what routines and rendering methods are fastest for the current graphics platform. This information can be queried in any process with **pfQueryFeature()**. You can use this information at run time when setting state properties on your **pfGeoStates**.
- Has machine-dependent fast options for commands that are very performance-sensitive. Use the **_ON** and **_FAST** mode settings whenever possible to

get machine-dependent high-performance defaults. Some examples include the following:

- **pfAntialias(PFAA_ON)**
- **pfTransparency(PFTR_ON)**
- **pfDecal(PFDECAL_BASE_TEST)**
- **pfTexFilter(*tex, filt*, PFTEX_FAST)**
- **pfTevMode(*tev*, PFTEV_FAST)**
- Sets up default modes for drawing, multiprocessing, statistics, and other areas, that are chosen to provide high scene quality and performance. Some rendering defaults differ from GL defaults: backface elimination is enabled by default (**pfCullFace(PFCF_BACK)**) and lighting materials use **glColorMaterial()** to minimize the number of materials required in a database (**pfMtlColorMode(*mtl, side*, PFMTL_CMODE_AD)**).
- Uses a large number of specialized routines for rendering different kinds of objects extremely quickly. There is a specialized drawing routine for each possible **pfGeoSet** configuration (each choice of primitive type, attribute bindings, and index selection). Each time you change from one **pfGeoSet** to another, one of these specialized routines is called. However, this happens even if the new **pfGeoSet** has the same configuration as the old one, so larger **pfGeoSets** are more efficient than smaller ones—the function-call overhead for drawing many small **pfGeoSets** can reduce performance. As a rule of thumb, a **pfGeoSet** should contain at least 4 triangles, preferably between 8 and 64. If the **pfGeoSet** is too large, it can reduce the efficiency of other parts of the process pipeline.
- Caches state changes, because applying state changes is costly in the draw stage. OpenGL Performer accumulates state changes until you call one of the **pfApply*()** functions, at which point it applies all the changes at once. Note that this differs from the graphics libraries, in which state changes are immediate. If you have several state changes to make in OpenGL Performer, set up all the changes before applying them, rather than using the one-change-at-a-time approach (with each change followed by an apply operation) that you might expect if you are used to graphics library programming.
- Evaluates state changes lazily—that is, it avoids making any redundant changes. When you apply a state change, OpenGL Performer compares the new graphics state to the previous one to see if they are different. If they are, it checks whether the new state sets any modes. If it does, OpenGL Performer checks each mode being set to see whether it is different from the previous setting. To take advantage of this

feature, share `pfGeoStates` and inherit states from the global state wherever possible. Set all the settings you can at the global level and let other nodes inherit those settings, rather than setting each node's attributes redundantly. To do this within a database, you can set up `pfGeoStates` with your desired global state and apply them to the `pfChannel` or `pfScene` with `pfChanGState()` or `pfSceneGState()`. You can do this through the database loader utilities in `libpfdu` trivially for a given scene with `pfdMakeSharedScene()` or have more control over the process with `pfdDefaultGState()`, `pfdMakeSceneGState()`, and `pfdOptimizeGStateList()`.

- Provides an optimized immediate mode rendering display list data type, `pfDispList`, in `libpfr`. The `pfDispList` type reduces host overhead in the drawing process and requires much less memory than a graphics library display list. `libpfr` uses `pfDispLists` to pass results from the cull process to the draw process when the `PFMP_CULL_DL_DRAW` mode is turned on as part of the multiprocessing model. For more information about display lists, see “Display Lists” in Chapter 12; for more information about multiprocessing, see “Successful Multiprocessing with OpenGL Performer” in Chapter 5.

Cull and Intersection Optimizations

To help optimize culling and intersection, OpenGL Performer does the following:

- Provides `pfFlatten()` to resolve instancing (via cloning) and static matrix transformations (by pre-transforming the cloned geometry). It can be especially important to flatten small `pfGeoSets`; otherwise, matrix transformations must be applied to each small `pfGeoSet` at significant computational expense. Note that flattening resolves only static coordinate systems, not dynamic ones, but that, where desired, `pfDCS` nodes can be converted to `pfSCS` nodes automatically using the OpenGL Performer utility function `pfdFreezeTransforms()`, which allows for subsequent flattening. Using `pfFlatten()`, of course, increases performance at the cost of greater memory use. Further, the function `pfdCleanTree()` can be used to remove needless nodes: identity matrix `pfSCS` nodes, single child `pfGroup` nodes, and the like.
- Uses bounding spheres around nodes for fast culling—the intersection test for spheres is much faster than that for bounding boxes. If a node's bounding sphere does not intersect the viewing frustum, there is no need to descend further into that node. There are bounding boxes around `pfGeoSets`; the intersection test is more expensive but provides greater accuracy at that level.

- Provides the `pfPartition` node type to partition geometry for fast intersection testing. Use a `pfPartition` node as the parent for anything that needs intersection testing.
- Provides level-of-detail (LOD) capabilities in order to draw simpler (and thus cheaper) versions of objects when they are too far away for the user to discern small details.
- Allows intersection performance enhancement by precomputation of polygon plane equations within `pfGeoSets`. This pre-computation is in the form of a traversal that is nearly always appropriate—only in cases of non-intersectable or dynamically changing geometry might these cached plane equations be disadvantageous. This optimization is performed by `pfCollideSetup()` using the `PFTRAV_IS_CACHE` bit mask value.
- Sorts `pfGeoSets` by graphics state in the cull process, in order to minimize state changes and flatten matrix transformations when `libpf` creates display lists to send to the draw process (as occurs in the `PFMP_CULL_DL_DRAW` multiprocessing mode). This procedure takes extra time in the cull stage but can greatly improve performance when rendering a complex scene that uses many `pfGeoStates`. The sorting is enabled by default; it can be turned off and on by calling the function `pfChanTravMode(chan, PFTRAV_CULL, mode)` and including or excluding the `PFCULL_SORT` token. See “`pfChannel Traversal Modes`” in Chapter 4 and “`Sorting the Scene`” in Chapter 4 for more information on sorting.

Application Optimizations

During the application stage, OpenGL Performer does the following:

- Divides the application process into two parts: the latency-critical section (which includes everything between `pfSync()` and `pfFrame()`), where last-minute latency-critical operations are performed before the cull of the current frame can start; and the noncritical portion, after `pfFrame()` and before `pfSync()`. The critical section is displayed in the channel statistics graph drawn with `pfDrawChanStats()`.
- Provides an efficient mechanism to automatically propagate database changes down the process pipeline and provides `pfPassChanData()` for passing custom application data down the process pipeline.
- Minimizes overhead in copying database changes to the cull process by accumulating unique changes and updating the cull once inside `pfFrame()`. This updated period is displayed in the MP statistics of the channel statistics graph drawn with `pfDrawChanStats()`.

- Provides a mechanism for performing database intersections in a forked process: pass the PFMP_FORK_ISECT flag to **pfMultiprocess()** and declare an intersection callback with **pfIsectFunc()**.
- Provides a mechanism for performing database loading and editing operations in a forked process, such as the DBASE process: pass the PFMP_FORK_DBASE flag to **pfMultiprocess()** and declare an intersection callback with **pfDBaseFunc()**.

Specific Guidelines for Optimizing Performance

While OpenGL Performer provides inherent performance optimization, there are specific techniques you can use to increase performance even more. This section contains some guidelines and advice pertaining to database organization, code structure and style, managing system resources, and rules for using OpenGL Performer.

Graphics Pipeline Tuning Tips

Tuning the graphics pipeline requires identifying and removing bottlenecks in the pipeline. You can remove a bottleneck either by minimizing the amount of work being done in the stage that has the bottleneck or, in some cases, by reorganizing your rendering to more effectively distribute the workload over the pipeline stages. This section contains specific tips for finding and removing bottlenecks in each stage of the graphics pipeline.

Host Bottlenecks

Here are some ways to minimize the time spent in the host stage of the graphics pipeline:

- Function calls, loops, and other programming constructs require a certain amount of overhead. To make such constructs cost-effective, make sure they do as much work as possible with each invocation. For instance, drawing a **pfGeoSet** of triangle strips involves a nested loop, iterating on strips within the set and triangles within each strip; it therefore makes sense to have several triangles in each strip and several strips in each set. If you put only two triangles in a **pfGeoSet**, you will spend all that loop overhead on drawing those two triangles, when you could be drawing many more with little extra cost. The channel statistics can display (as part of the graphics statistics) a histogram showing the percentage of your database that is drawn in triangle strips of certain lengths.

- Only bind vertex attributes that are actually in use. For example, if you bind per-vertex colors on a set of flat-shaded quads, the software will waste work by sending those colors to the graphics pipeline, which will ignore them. Similarly, it is pointless to bind normals on an unlit `pfGeoSet`.
- Nonindexed drawing has less host overhead than indexed drawing because indexed drawing requires an extra memory reference to get the vertex data to the graphics pipeline. This is most significant for primitives that are easily host-limited, such as independent polygons or very short triangle strips. However, indexed drawing can be very helpful in reducing the memory requirements of a very large database.
- Enable state sorting for `pfChannels` (this is the default). By sorting, the CPU does not need to examine as many `pfGeoStates`. The graphics channel statistics can be used to report the `pfGeoSet`-to-`pfGeoState` drawing ratio.

Transform Bottlenecks

A transform bottleneck can arise from expensive vertex operations, from a scene that is typically drawn with many very tiny polygons, from a scene modeled with inefficient primitive types, or from excessive mode or transform operations. Here are some tips on reducing such bottlenecks:

- Connected primitives will have better vertex rates than independent primitives, and quadrilaterals are typically much more efficient in vertex operations than independent triangles are.
- The expensive vertex operations are generally lighting calculations. The fastest lighting configuration is always one infinite light. Multiple lights, local viewing models, and local lights have (in that order) dramatically increasing cost. Two-sided lighting also incurs some additional transform cost. On some graphics platforms, texturing and fog can add further significant cost to per-vertex transformation. The channel graphics statistics will tell you what kinds of lights and light models are being used in the scene.
- Matrix transforms are also fairly expensive and definitely more costly than one or two explicit scale, translate, or rotate operations. When possible, flatten matrix operations into the database with `pfFlatten()`.
- The most frequent causes of mode changes are `glShadeModel()`, textures, and object materials. The speed of these changes depends on the graphics hardware; however, material changes do tend to be expensive. Sharing materials among different objects can be increased with the use of `pfMtlColorMode()`, which is `PFMTL_CMODE_AD` by default. However, on some older graphics platforms (such

as the Elan, Extreme, and VGX), the use of **pfMtlColorMode()** (which actually calls the function **glColorMaterial()**) has some associated per-vertex cost and should be used with some caution.

- If your cull stage is not a bottleneck, make sure your **pfChannels** sort the scene by graphics state. Even if you are running in single process mode, the extra time taken to sort the database is often more than offset by the savings in rendering time. See “Sorting the Scene” in Chapter 4 for more details on how to configure sorting.

Fill Bottlenecks

Here are some methods of dealing with fill-stage bottlenecks:

- One technique to hide the cost of expensive fill operations is to fill the pipeline from the back forward so that no part is sitting idle waiting for an upstream stage to finish. The last stage of the pipeline is the fill stage; so, by drawing backgrounds or clearing the screen using **pfClearChan()** first, before **pfDraw()**, you can keep the fill stage busy. In addition, if you have a couple of large objects that reliably occlude much of the scene, drawing them very early on can both fill up the back-end stage and also reduce future fill work, because the occluded parts of the scene will fail a z-buffer test and will not have to write z values to the z-buffer or go on to more complex fill operations.
- Use the **pfStats** fill statistics (available for display through the channel statistics) to visualize your depth complexity and get a count of how many pixels are being computed each frame.
- Be aware of the cost of any fill operations you use and their relative cost on the relevant graphics hardware configuration. Quick experiments you can do to test for a fill limitation include:
 - Rendering the scene into a smaller window, assuming that doing so will not otherwise affect the scene drawn (a non-zero **pfChannel** LOD scale will cause a change in object LODs when you shrink the window).
 - Using **pfOverride()** to force the disabling of an expensive fill mode.

If either of these tests causes a significant reduction in the time to draw the scene, then a significant fill bottleneck probably exists.

Note: Some features may invoke expensive modes that need to be used with caution on some hardware platforms. **pfAntialias()** and **pfTransparency()** enable blending if multisampling is not available. Globally enabling these functions on machines without multisampling can produce significant performance degradation due to the

use of blending for an entire scene. Blending of even opaque objects incurs its full cost. **pfDecal()** may invoke stenciling (particularly if you have requested the decal mode `PFDECAL_BASE_HIGH_QUALITY` or if there is no faster alternative on the current hardware platform), which can cause performance degradations on some systems. **pfFeature()** can be used to verify the availability and speed of these features on the current graphics platform.

- The cost of specific fill operations can vary greatly depending on the graphics hardware configuration. As a rule of thumb, flat shading is much faster than Gouraud shading because it reduces both fill work and the host overhead of specifying per-vertex colors. Z-buffering is typically next in cost, and then stencil and blending. On a RealityEngine, the use of multisampling can add to the cost of some of these operations, specifically z-buffering and stenciling. See “Multisampling” on page 836 for more information. Texturing is considered free on RealityEngine and Impact systems but is relatively expensive on a VGX and is actually done in the host stage on lower-end graphics platforms, such as Extreme and XZ. Some of the low-end graphics platforms also implement z-buffering on the host.
- You may not be able to achieve benchmark-level performance in all cases for all features. For instance, if you frequently change modes and you use short triangle strips, you get much less than the peak triangle mesh performance quoted for the machine. Fill rates are sensitive to both modes, mode changes, and polygon sizes. As a general rule of thumb, assume that fill rates average around 70% of peak on general scenes to account for polygon size and position as well as for pipeline efficiency.

Process Pipeline Tuning Tips

These simple tips will help you optimize your OpenGL Performer process pipeline:

- Use **pfMultiprocess()** to set the appropriate process model for the current machine.
- You usually should not specify more processes with **pfMultiprocess()** than there are CPUs on the system. The default multiprocess mode (`PFMP_DEFAULT`) attempts an optimal configuration for the number of unrestricted CPUs. However, if there are fewer processors than significant tasks (consider APP, CULL, DRAW, ISECT, and DBASE), you will want experiment with the different two-process models to find the one that will yield the best overall frame rate. Use of **pfDrawChanStats()**, described in Chapter 23, “Statistics,” will greatly help with this task.

- Put only latency-critical tasks between the **pfSync()** and **pfFrame()** calls. For example, put latency-critical updates, like changes to the viewpoint, after **pfSync()** but before **pfFrame()**. Put time-consuming tasks, such as intersection tests and system dynamics, after **pfFrame()**.
- You will also want to refer to the IRIX REACT documentation for setting up a real-time system.
- For maximum performance, use the OpenGL Performer utilities in `libpfutil` for setting non-degrading priorities and isolating CPUs (**pfuPrioritizeProcs()**, **pfuLockDownProc()**, **pfuLockDownApp()**, **pfuLockDownCull()**, and **pfuLockDownDraw()**). These facilities require that the application runs with root permissions. The source code for these utilities is in `/usr/share/Performer/src/lib/libpfutil/lockcpu.c` for IRIX and Linux and in `%PFROOT%\Src\lib\libpfutil\lockcpu.c` for Microsoft Windows. For an example of their use, see the sample source code in `/usr/share/Performer/src/pguide/libpf/C/bench.c` for IRIX and Linux and in `%PFROOT%\Src\pguide\libpf\C\bench.c` for Microsoft Windows. For more information about priority scheduling and real-time programming on IRIX systems, see the chapter of the *IRIX System Programming Guide* entitled “Using Real-Time Programming Features” and the IRIX REACT technical report.
- Make sure you are not generating any floating-point exceptions. Floating-point exceptions can cause an individual computation to incur tens of times its normal cost. Furthermore, a single floating point exception can lead to many further exceptions in computations that use the exceptional result and can even propagate performance degradation down the process pipeline. OpenGL Performer will detect and tell you about the existence of floating point exceptions if your **pfNotifyLevel()** is set to `PFNFY_INFO` or `PFNFY_DEBUG`. You can then run your application in `dbx` (on IRIX) or `gdb` (on Linux) and your application will stop when it encounters an exception, enabling you to trace the cause.
- Make sure the main pipeline (APP, CULL, and DRAW processes) do not make per-frame memory allocations or deallocations (asynchronous processes like DBASE can do per-frame allocations). On IRIX, you can use the debugging library’s tracing feature of `libdmalloc` run-time `malloc` to verify that no memory allocation routines are being called. On Linux, use the Electric Fence (`libefence`). See the “Memory Corruption and Leaks” section later in this chapter for more about `libdmalloc`.
- Minimize the amount of channel data allocated by **pfAllocChanData()** and call **pfPassChanData()** only when necessary to reduce the overhead of copying the data. Copying pointers instead of data is often sufficient.

Cull Process Tips

Here are a couple of suggestions for tuning the cull process:

- The default channel culling mode enables all types of culling. If your cull process is your most expensive task, you may want to consider doing less culling operations. When doing database culling, always use view-frustum culling (PFCULL_VIEW) and usually use graphics library mode database sorting (PFCULL_SORT) and pfGeoSet culling (PFCULL_GSET) as well:

```
pfChanTravMode(chan, root,
               PFCULL_VIEW | PFCULL_GSET | PFCULL_SORT);
```

A cull-limited application might realize a quick gain from turning off pfGeoSet culling. If you think your database has few textures and materials, you might turn off sorting. However, if possible it would be better to try improving cull performance by improving database construction. “Efficient Intersection and Traversals” on page 823 discusses optimizing cull traversals in more detail.

- Look at the channel-culling statistics for the following:
 - A large amount of the database being traversed by the culling process and being trivially rejected as not being in the viewing frustum. This can be improved with better spatial organization of the database.
 - A large number of database nodes being non-trivially culled. This can be improved with better spatial organization and breakup of large pfGeodes and pfGeoSets.
 - A surprising number of LODs in their fade state (the fade computations can be expensive, particularly if channel stress management has been enabled).
- Balance the database hierarchy with the scene complexity: the depth of the hierarchy, the number of pfGeoStates, and the depth of culling. See “Balancing Cull and Draw Processing with Database Hierarchy” on page 825 for details.
- pfNodes that have significant evaluation in the cull stage include pfBillboards, pfLightPoints, pfLightSources, and pfLODs.

Draw Process Tips

Here are some suggestions specific to the draw process:

- Minimize host work done in the draw process before the call to **pfDraw()**. Time spent before the call to **pfDraw()** is time that the graphics pipeline is idle. Any

graphics library (or X) input processing or mode changes should be done after **pfDraw()** to take effect in the following frame.

- Use only one **pfPipe** per hardware graphics pipeline and preferably one **pfPipeWindow** per **pfPipe**. Use multiple channels within that **pfPipeWindow** to manage multiple views or scenes. It is fairly expensive to simultaneously render to multiple graphics windows on a single hardware graphics pipeline and is not advisable for a real-time application.
- Pre-define and pre-load all of the textures in the database into hardware texture memory by using a **pfApplyTex()** function on each **pfTexture**. You can do this texture-applying in the **pfConfigStage()** draw callback or (for multipipe applications to allow parallelism) the **pfConfigPWin()** callback. This approach avoids the huge performance impact that results when textures are encountered for the first time while drawing the database and must then be downloaded to texture memory. Utilities are provided in `libpfutil` to apply textures appropriately; see the **pfuDownloadTexList()** routine in the distributed source code file `/usr/share/Performer/src/lib/libpfutil/tex.c` for IRIX and Linux and in file `%PFROOT%\Src\lib\libpfutil\tex.c` on Microsoft Windows. The Perfly application demonstrates this. For IRIX and Linux, see the Perfly source file `generic.c` in either the C language (`/usr/share/Performer/src/sample/C/common`) or C++ language (`/usr/share/Performer/src/sample/C++/common`) versions of Perfly. For Microsoft Windows, see the Perfly source file `generic.c` in either the C language (`%PFROOT%\Src\sample\C\common`) or C++ language (`%PFROOT%\Src\sample\C++\common`) versions of Perfly.
- Minimize the use of **pfSCSs** and **pfDCSs** and nodes with draw callbacks in the database since aggressive state sorting is kept local to subtrees under these nodes.
- Do not do any graphics library input handling in the draw process. Instead, use X input handling in an asynchronous process. OpenGL Performer provides utilities for asynchronous input handling in `libpfutil` with source code provided in `/usr/share/Performer/src/lib/libpfutil/input.c` for IRIX and Linux and in `%PFROOT%\Src\lib\libpfutil\input.c` for Microsoft Windows. For a demonstration of asynchronous X input handling, see provided sample applications, such as `perfly`, and also the distributed sample programs `/usr/share/Performer/src/pguide/libpf/C/motif.c` and `/usr/share/Performer/src/pguide/libpfui/C/motifxformer.c` for IRIX and Linux and the programs `%PFROOT%\Src\lib\pguide\libpf\C\motif.c` and `%PFROOT%\Src\lib\pguide\libpfui\C\motifxformer.c` for Microsoft Windows.

Efficient Intersection and Traversals

Here are some tips on optimizing intersections and traversals:

- Use `pfPartition` nodes on pieces of the database that will be handed to intersection traversal. These nodes impose spatial partitioning on the subgraph beneath them, which can dramatically improve the performance of intersection traversals.

Note: Subgraphs under `pfDCS`, `pfLOD`, `pfSwitch`, and `pfSequence` nodes are not partitioned; so, intersection traversals of these subgraphs will not be affected.

- Use intersection caching. For static objects, enable intersection caching at initialization—first call `pfNodeTravMask()`, specifying intersection traversal (`PFTRAV_ISECT`), and then include `PFTRAV_IS_CACHE` in the mode for intersections. You can turn this mode on and off for dynamic objects as appropriate.
- Use intersection masks on nodes to eliminate large sections of the database when doing intersection tests. Note that intersections are `sproc()`-safe in the current version of OpenGL Performer; you can check intersections in more than one process.
- Bundle segments for intersections with bounding cylinders. You can pass as many as 32 segments to each intersection request. If the request contains more than a few segments and if the segments are close together, the traversal will run faster if you place a bounding cylinder around the segments using `pfCylAroundSegs()` and pass that bounding cylinder to `pfNodeIsectSegs()`. The intersection traversal will use the cylinder rather than each segment when testing the segments against the bounding volumes of nodes and `pfGeoSets`.

Note: Bundling segments pertains only to IRIX and Linux.

Database Concerns

Optimizing your databases can provide large performance increases.

`libpr` Databases

The following tips will help you achieve peak performance when using `libpr`:

- Minimize the number of `pfGeoStates` by sharing as much as possible.

- Initialize each mode in the global state to match the majority of the database in order to set as little local state for individual `pfGeoStates` as possible.
- Use triangle strips wherever possible; they produce the largest number of polygons from a given number of vertices; so, they use the least memory and are drawn the fastest of the primitive types.
- Use the simplest possible attribute bindings and use flat-shaded primitives wherever possible. If you are not going to need an object's attributes, do not bind them—anything you bind will have to be sent to the pipeline with the object.
- Flat-shaded primitives and simple attribute bindings reduce the transformation and lighting requirements for the polygon. Note that the flat-shaded triangle-strip primitive renders faster than a regular triangle strip, but you have to change the index by two to get the colors right (that is, you need to ignore the first two vertices when coloring). See “Attributes” in Chapter 8 for more information.
- Use nonindexed drawing wherever possible, especially for independent polygon primitives and short triangle strips.
- When building the database, avoid fragmentation in memory of data to be rendered. Minimize the number of separate data and index arrays. Keep the data and index arrays for `pfGeoSets` contiguous and try to keep separate `pfGeoSets` contiguous to avoid small, fragmented `pfMalloc()` memory allocations.
- The ideal size of a `pfGeoSet` (and of each triangle strip within the `pfGeoSet`) depends a great deal on the specific CPU and system architecture involved; you may have to do benchmarks to find out what is best for your machine. For a general rule of thumb, use at least 4 triangles per strip on any machine, and 8 on most. Use 5 to 10 strips in each `pfGeoSet`, or a total of 24 to 100 triangles per `pfGeoSet`.

`libpf` Databases

When you are using `libpf`, the following tips can improve the performance of database tasks:

- Use `pfFlatten()`, especially when a `pfScene` contains many small instanced objects and billboards. Use `pfdCleanTree()` and (if application considerations permit) `pfdFreezeTransforms()` to minimize the cull traversal processing time and maximize state sorting scope.
- Initialize each mode in the scene `pfGeoState` to match the majority of the database in order to set as little local state for individual `pfGeoStates` as possible. The utility function `pfdMakeSharedScene()` provides an easy to use mechanism for this task.

- Minimize the number of very small pfGeoSets (that is, those containing four or fewer total triangles). Each tiny pfGeoSet means another bounding box to test against if you are culling down to the pfGeoSet level (that is, when PFCULL_GSET is set with **pfChanTravMode()**) as well as another item to sort during culling. (If your pfGeoSets are large, on the other hand, you should definitely cull down to the pfGeoSet level.)
- Be sparing in the use of pfLayers. Layers imply that pixels are being filled with geometry that is not visible. If fill performance is a concern, this should be minimized in the modeling process by cutting layers into their bases when possible. However, this will produce more polygons which require more transform and host processing; so, it should only be done if it will not greatly increase database size.
- Make the hierarchy of the database spatially coherent so that culling will be more accurate and geometry that is outside the viewing frustum will not be drawn. (See Figure 4-3 for an example of a spatially organized database.)

Balancing Cull and Draw Processing with Database Hierarchy

Construct your database to minimize the draw-process time spent traversing and rendering the culled part of the database without the cull-process time becoming the limiting performance factor. This process involves making tradeoffs as a simpler cull means a less efficient draw stage. This section describes these tradeoffs and some good rules to follow to give you a good start.

If the cull and draw processes are performed in parallel, the goal is to minimize the larger of the culling and drawing times. In this case, an application can spend approximately the same amount of time on each task. However, if both culling and drawing are performed in the same process, the goal is to optimize the sum of these two times, and both processes must be streamlined to minimize the total frame time. Important parameters in this optimization include the number of pfGeoSets, the average branching factor of the database hierarchy, and the enabled channel culling traversal modes. The **pfDrawChanStats()** function (see Chapter 23, “Statistics”) can easily provide diagnostic information to aid in this tuning.

The average number of immediate children per node can directly affect the culling process. If most nodes have a high number of children, the bounding spheres are more likely to intersect the viewing frustum and all those nodes will have to be tested for visibility. At the other extreme, a very low number of children per node will mean that each bounding sphere test can only eliminate a small part of the database and so many nodes may still have to be traversed. A good place to start is with a quad-tree type organization where each node has about four children and the bounding geometry of

sibling nodes are adjacent but have minimal intersection. In the ideal case, projected to a two-dimensional plane on the ground, the spatial extent of each node and its parents would form a hierarchy of boxes.

The transition from pfGeodes to pfGeoSets is an important point in the database structure. If there are many very small pfGeoSets within a single pfGeode, not culling down to pfGeoSets can actually improve overall frame time because the cost of drawing the tiny pfGeoSets may be small relative to the time spent culling them. Adding more pfGeodes to break up the pfGeoSets can help by providing a slightly more accurate cull at less cost than considering each pfGeoSet individually. In addition, pfGeodes are culled by their bounding spheres, which is faster than the culling of pfGeoSets, which are culled by their bounding boxes.

The size (both spatial extend and number of triangles) can also directly impact culling and drawing performance. If pfGeoSets are relatively large, there will be fewer to cull so pfGeoSet culling can probably be afforded. pfGeoSets with more triangles will draw faster. However, pfGeoSets with larger spatial extent are more likely to have geometry being drawn outside of the viewing frustum; this wastes time in the graphics stage. Breaking up some of the large pfGeoSets can improve graphics performance by allowing a more accurate cull.

With some added cost to the culling task, the use of level-of-detail nodes (pfLODs) can make a tremendous difference in graphics performance and image quality. LODs allow objects to be automatically drawn with a simplified version when they are in a state that yields little contribution to the scene (such as being far from the eyepoint). This allows you to have many more objects in your scene than if you always were drawing all objects at full complexity. However, you do not want the cull to be testing all LODs of an object every frame when only one will be used. Again, proper use of hierarchy can help. pfLODs (non-fading) can be inserted into the hierarchy with actual object pfLODs grouped beneath them. If the parent LOD is out of range for the current viewpoint, the child LODs will never be tested. The pfLODs of each object can be placed together under a pfGroup so that no LOD tests for the object will be done if the object is outside of the viewing frustum.

Calling **pfFlatten()**, **pfFreezeTransforms()**, or **pfCleanTree()** to remove extraneous nodes can often help culling performance. Use **pfFlatten()** to de-instance and apply pfSCS node transformations to leaf geometry—resulting in less work during the cull traversal. This allows both better database sorting for the draw and also better caching of matrix and bounding information, which can speed up culling. When these scene graph modifications are not acceptable, you may reduce cull time by turning off culling

of `pfGeoSets` but this will directly impact rendering performance by forcing the rendering of geometry that is outside the viewing frustum.

Tip: Making the scene into a graphics library object in the draw callback can show the result of the cull; this can give a visual check of what is actually being sent to the graphics subsystem. Check for objects that are far from the viewing frustum; this can indicate that the `pfGeodes` or `pfGeoSets` need to be broken up. Additionally, the rendering time of the GL object should be compared to the `pfDraw()` rendering time to see if the `pfGeoSets` have enough triangles in them to not incur host overhead. Alternately, the view frustum can be made larger than that used in the cull to allow simple *cull volume visualization* during real-time simulation. The OpenGL Performer sample program `perfly` supports this option. Press the z key while in `Perfly` to enable cull volume visualization and inspect the resulting images for excessive off-screen geometric content. Such content is a clear sign that the database could profitably be further subdivided into smaller components.

Graphics and Modeling Techniques to Improve Performances

On machines with fast-texture mapping, texture should be used to replace complex geometry. Complex objects, such as trees, signs, and building fronts, can be effectively and efficiently represented by textured images on single polygons in combination with applying `pfAlphaFunc()` to remove parts of the polygon that do not appear in the image. Using texture to reduce polygonal complexity can often give both an improved picture and improved performance. This is because of the following:

- The image texture provides scene complexity, and the texture hardware handles scaling of the image with MIPmap interpolation functions for minification (and, on RealityEngine systems, `Sharpen` and `DetailTexture` functions for magnification).
- Using just a few textured polygons rather than a complex model containing many individual polygons reduces system load.

In order to represent a tree or other 3D object as a single textured polygon, OpenGL Performer can rotate polygons to always face the eyepoint. An object of this type is known as a billboard and is represented by a `pfBillboard` node. As the viewer moves around the object, the textured polygon rotates so that the object appears three-dimensional. For more information on billboards, see “`pfBillboard` Nodes” in Chapter 3.

To determine if the current graphics platform has fast-texture mapping, look for a `PFQFTR_FAST` return value from the following call:

```
pfFeature(PFQFTR_TEXTURE, &ret);
```

pfAlphaFunc() with a function PFAF_GEQUAL and a reference value greater than zero can be used whenever transparency is used to remove pixels of low contribution and avoid their expensive processing phase.

Special Coding Tips

For maximum performance, routines that make extensive use of the OpenGL Performer linear algebra routines should use the macros defined in `prmath.h` to allow the compiler to in-line these operations.

Use single- rather than double-precision arithmetic where possible and avoid the use of short-integer data in arithmetic expressions. Append an 'f' to all floating point constants used in arithmetic expressions.

BAD In this example, values in both of the expressions involving the floating point variable *x* are promoted to double precision when evaluated:

```
float x;
if (x < 1.0)
    x = x + 2.0;
```

GOOD In this example, both of the expressions involving the floating point variable *x* remain in single-precision mode, because there is an 'f' appended to the floating point constants:

```
float x;
if (x < 1.0f)
    x = x + 2.0f;
```

Performance Measurement Tools

Performance measurement tools can help you track the progress of your application by gathering statistics on certain operations. OpenGL Performer provides run-time profiling of the time spent in parts of the graphics pipeline for a given frame. The **pfDrawChanStats()** function displays application, cull, and draw time in the form of a graph drawn in a channel; see Chapter 23, "Statistics," for more information on that and related functions. There are advanced debugging and tuning tools available from SGI that can be of great assistance. The WorkShop product in the CASEVision tools provides a complete development environment for debugging and tuning of host tasks. The

Performance Co-Pilot helps you to tune host code in a real-time environment. There is also the WindView product from WindRiver that works with IRIX REACT to do full system profiling in a real-time environment. However, progress can be made with the basic tools that are in the IRIX development environment: `prof` and `pixie`. On Linux, use `gprof` and on Microsoft Windows use VTune (see www.intel.com/software/products/vtune). The OpenGL debugging utility, `ogldebug`, can also be used to aid in performance tuning. This section briefly discusses getting started with these tools.

Note: See the graphics library manual available from SGI for complete instructions on using these graphics tools. See the *IRIX System Programming Guide* to learn more about `pixie` and `prof`.

Using `pixie`, `prof`, and `gprof` to Measure Performance

Note: This section does not pertain to Microsoft Windows systems.

You can use the IRIX performance analysis utilities `pixie` and `prof` to tune the application process. For Linux, use `gprof`. Use `pixie` for basic-block counting and use `prof` or `gprof` for program counter (PC) sampling. PC sampling gives run-time estimation of where significant amounts of time are spent, whereas basic-block counting will report the number of times a given instruction is executed.

To isolate statistics for the application process, even in single-process models, run the application through `pixie` or `prof` in `APP_CULL_DRAW` mode to separate out the process of interest. Both `pixie` and `prof` can generate statistics for an individual process.

When using OpenGL Performer DSO libraries with `prof` you may want to provide the `-dso` option to `prof` with the full pathname of the library of interest to have OpenGL Performer routines included in the analysis. When using `pixie`, you will need to have the `.pixie` versions of the DSO libraries in your `LD_LIBRARY_PATH`. Additionally, you will need a `.pixie` version of the loader DSO for your database in your `LD_LIBRARY_PATH`. You may have to `pixie` the loader DSO separately since `pixie` will not find it automatically if your executable was not linked with it. When using `prof` to do PC sampling, link with unshared libraries exclusively and use the `-p` option to `ld`.

Then set the environment variable `PROFDIR` to indicate the directory in which to put profiling data files.

When profiling, run the program for a while so that the initialization will not be significant in the profiling output. When running a program for profiling, run a set number of frames and then use the automatic exit described below.

Using `ogldebug` to Observe Graphics Calls

You can use the graphics utility `ogldebug` to both debug and tune OpenGL Performer applications. Note that `ogldebug` can handle multiprocessed programs.

Use `ogldebug` to do the following:

- Show which graphics calls are being issued.
- Look for frequent mode changes or unnecessary mode settings that can be caused if your initialization of the global state does not match the majority of the database.
- Look for unnecessary vertex bindings such as unneeded per-vertex colors or normals for a flat-shaded object.

Follow these steps to examine one frame of the application in an `ogldebug` session:

1. Start the profiler of your choice:
`ogldebug your_prog_name prog_options`
2. Turn off output and breakpoints from the control panel.
3. Under IRIX and Linux, set a breakpoint at `glXSwapBuffers()`. Under Microsoft Windows, set a breakpoint at `wglSwapBuffers()`.
4. Click the “Continue” button and go to the frame of interest.
5. Turn on breakpoints.
Execution stops at `glXSwapBuffers()`.
6. Turn on all trace output.
7. Click the “Continue” button.
Execution stops at the next `glSwapBuffers()`, outputting one full scene to `progname.pid.trace`.
8. Quit and examine the output.

Note: Since OpenGL Performer avoids unnecessary mode settings, recording one frame shows modes that are set during that frame, but it does not reflect modes that were set previously. It is, therefore, best to have a program that can come up in the desired location and with the desired modes, then grab the first two frames: one for initialization and one for continued drawing.

Guidelines for Debugging

This section lists some general guidelines to keep in mind when debugging OpenGL Performer applications.

Shared Memory

Because **malloc()** does not allocate memory until that memory is used, core dumps may occur when arenas do not find enough disk space for paging. On IRIX systems, the kernel can be configured to actually allocate space upon calling **malloc()**, but this change is pervasive and has performance ramifications for **fork()** and **exec()**. Reconfiguring the kernel is not recommended, so be aware that unexplained core dumps can result from inadequate disk space.

Be sure to initialize pointers to shared memory and all other nonshared global values before OpenGL Performer creates the additional processes in the call to **pfConfig()**. Values put in global variables initialized after **pfConfig()** will only be visible to the process that set them.

For detailed information about other aspects of shared memory, see “Memory Allocation” in Chapter 18.

Use the Simplest Process Model

When debugging an application that uses a multiprocess model, first use a single-process model to verify the basic paths of execution in the program. You do not have to restructure your code; simply select single-process operation by calling **pfMultiprocess(PFMP_APPCULLDRAW)** to force all tasks to initiate execution sequentially on a frame-by-frame basis.

If an application fails to run in multiprocess mode but runs smoothly in single-process mode, you may have a problem with the initialization and use of data that is shared among processes.

If you need to debug one of multiple processes, use the following command while the process is running:

```
IRIX% dbx -p progname
LINUX% gdb progname pid
```

For Microsoft Windows, use the following commands:

```
set PATH=%PFROOT%\Lib\Debug;%PATH%
msdev progname programParameters
```

The preceding is how you debug using Microsoft Developer Studio 6.0.

This will show the related processes and allow you to choose a process to trace. The application process will always be the process with the lowest process ID. In order after that will be the (default) clock process, then the cull process, and then the draw.

Once the program works, experiment with the different multiprocess models to achieve the best overall frame rate for a given machine. Do not specify more processes than CPUs. Use **pfDrawChanStats()** to compare the frame timings of the different stages and frame times for the different process models.

Avoid Floating-Point Exceptions

Arrange error handling for floating-point operations. To see floating-point errors, turn debug messages on and enable floating-point traps. Set **pfNotifyLevel(PFNFY_DEBUG)**.

The goal is to have no NaN (Not a Number), INF (infinite value), or floating-point exceptions resulting from numerical computations.

When the Debugger Will Not Give You a Stack Trace

If a NULL or invalid function pointer is called, the program dies with a segmentation fault, bus error, or invalid instruction, and the debugger is often unable to give a stack trace.

```
(dbx or gdb) where
> 0 <Unknown>() [< unknown >, 0x0]
```

When this happens on IRIX, you can usually still get a single level of trace by looking at the return address register.

```
(dbx) $ra/i
[main:6, 0x400c18] lw ra,28(sp)
```

Once you know this information, you may be able to set a breakpoint to stop just before the bad function pointer and then get a full stack trace from there.

On Microsoft Windows, do the following:

1. Ensure that the path to the debug libraries is set:

```
set PATH=%PFROOT%\Lib\Debug;%PATH%
```

2. Run the program from your normal development environment.
3. Enter the following command:

```
set _PF_DISPLAY_MODULES_LOADED=1
```

Tracing Members of OpenGL Performer Objects

Debuggers like dbx and gdb allow you to set a breakpoint or trace on a particular variable or address in memory.

However, this feature does not work well on programs that use atomic shared memory access functions like `test_and_set()` which are implemented on IRIX using the MIPS instructions `ll` and `sc`. Calling such a function on an address that is on the same memory page (typically 4096 bytes) as the address where a breakpoint is set results in the program being killed with a SIGTRAP signal.

OpenGL Performer uses `test_then_add()` to implement `pfMemory::ref()` and `pfMemory::unref()`; so, you almost always run into this problem if you try to trace a member of an OpenGL Performer object (anything derived from `pfMemory`).

You can get around the problem by setting the following environment variable before running the program.

Under IRIX and Linux:

```
% setenv _PF_OLD_REFCOUNTING
```

Under Microsoft Windows:

```
set _PF_OLD_REFCOUNTING=1
```

This tells OpenGL Performer to use an alternate (slower) implementation of shared memory reference counting that avoids the `ll` and `sc` operations so that breakpoints on variables can be used.

Memory Corruption and Leaks

A number of tools are available for debugging memory corruption errors and memory leaks; no single one is ideal for all purposes. We will briefly describe and compare two useful tools: `purify` and `libdmalloc`.

Purify

Purify is a product of PureAtria; see their Web site, <http://www.pureatria.com> for ordering information.

Purify works by rewriting your program (and all dynamic shared libraries it uses), intercepting `malloc` and associated functions, and inserting instruction sequences before each load and store instruction that immediately catch invalid memory accesses (that is, uninitialized memory reads, out-of-bounds memory reads or writes, freed memory reads or writes, and multiple frees) and also keeps track of memory leaks. When an error is encountered, a stack trace is given for the error as well as a stack trace from when the memory in question was originally allocated. When used in conjunction with a debugger like `dbx` or `gdb`, you can set a breakpoint to stop when Purify encounters an error so that you can examine the program state.

Purify is immensely useful for tracking down memory problems. Its main drawbacks are that it is very slow (to compile and run programs) and it currently does not know about the functions `amalloc()`, `afree()`, and `arealloc()`, which are very important in OpenGL Performer applications (`pfMalloc` and associated functions are implemented in terms of them).

You can trick Purify into telling you about some shared arena memory access errors by telling the run-time linker to use `malloc` in place of `amalloc`; however, this cannot work if there are forked processes sharing the arena, so to use this trick you must run in single-process (PFMP_APPCULLDRAW) mode. To do this, compile the following into a DSO called `pureamalloc.so`:

```
malloc(int n) {return malloc(n);}
afree(void*p) {free(p);}
arealloc(void*p, int n) {return realloc(p, n);}
```

Then tell the run-time linker to point to it:

```
% setenv _RLDN32_LIST `pwd`/pureamalloc.so:DEFAULT
```

This assumes you are using the N32 ABI; see the `rld` man page for the equivalents for the O32 and 64 ABIs. Then run `perfly -m0` or any other program in PFMP_APPCULLDRAW mode.

For more information on Purify, visit PureAtria's web site:
<http://www.pureatria.com>.

`libdmalloc` (IRIX only)

`libdmalloc` is a library that was developed internally at SGI. It is officially unsupported but you can get it through OpenGL Performer's ftp site.

`libdmalloc` is implemented as a dynamic shared object (DSO) that you can link in to your program at run-time. It intercepts all calls to `malloc()`, `free()`, and associated functions and checks for memory corruption of the particular piece of memory being accessed. It also attempts to purposely break programs that make bad assumptions: it initializes newly malloced (or amalloced) memory with a fill pattern to break programs that depend on it being 0's and similarly fills freed memory with a fill pattern to break programs that look at freed memory. Finally, the entire malloc arena and any shared arenas are checked for corruption during `exit()` and `execve()`. Error messages are printed to `stderr` whenever an error is detected (which is typically later than the error actually occurred, unlike Purify's immediate detection). `libdmalloc` does not know about UMRs (uninitialized memory reads) or stack variables, unlike Purify.

`libdmalloc`'s advantages are that it knows about `amalloc/afree/arealloc`, and it has virtually no overhead; so, you can leave it on all the time (it will check for errors in every program you run). If it uncovers a reproducible bug in an area that Purify knows about

too, then you can use Purify to trace the exact location of the problem—Purify is much better at that than `libdmalloc`.

When using `libdmalloc`, you can easily toggle verbose tracing of all calls to `malloc()/free()/realloc()` and `amalloc()/afree()/arealloc()` by sending the processes a signal at run time—there should be none of these calls per-frame in the main pipeline of a tuned OpenGL Performer application.

For more information, install `libdmalloc` from the OpenGL Performer ftp site and read the files `/usr/share/src/dmalloc/README` and, for OpenGL Performer-specific suggestions, `/usr/share/src/dmalloc/SOURCEME.dmalloc.performer`.

Notes on Tuning for RealityEngine Graphics

This section contains some specific notes on performance tuning with RealityEngine graphics.

Multisampling

Multisampling provides full-scene antialiasing with performance sufficient for a real-time visual simulation application. However, it is not free and it adds to the cost of some other fill operations. With RealityEngine graphics, most other modes are free until you add multisampling—multisampling requires some fill operations to be performed on every subpixel. This is most noticeable with z-buffering and stenciling operations but also applies to `glBlendFunc()`. Texturing is an example of a fill operation that can be free on a RealityEngine and is not affected by the use of multisampling.

The multisampling hardware reduces the cost of subpixel operations by optimizing for pixels that are fully opaque. Pixels that have several primitives contributing to their result are thus more expensive to evaluate and are called *complex pixels*. Scenes usually end up having a very low ratio of complex pixels.

Multisampling offers an additional performance optimization that helps balance its cost: a virtually free screen clear. Technically, it does not really clear the screen but rather allows you to set the z values in the framebuffer to be undefined. Therefore, use of this clear requires that every pixel on the screen be rendered every frame. This clear is

invoked with a `pfEarthSky` using the `PFES_TAG` option to `pfESkyMode()`. Refer to the `pfEarthSky(3pf)` man page for more detailed information.

Transparency

There are two ways of achieving transparency on a RealityEngine: blending and screen-door transparency with multisampling.

Blended transparency, using the routine `gIBlendFunc()`, can be used with or without multisampling. Blending does not increase the number of complex pixels but is expensive for complex pixels.

To reduce the number of pixels with very low alpha, one can use a `pfAlphaFunc()` that ignores pixels of low alpha, such as alpha less than 3 or 4. This will slightly improve fill performance and probably not have a noticeable effect on scene quality. Many scenes can use values as high as 60 or 70 without suffering degradation in image quality. In fact, for a scene with very little actual transparency, this can reduce the fuzzy edges on textures that simulate geometry (such as trees and fences) that arise from MIP-mapping.

Screen-door transparency gives order-independent transparent effects and is used for achieving the fade-LOD effect. It is a common misperception that screen-door transparency on RealityEngine gives you n levels of transparency for n multisamples. In fact, n samples gives you $4n$ levels of transparency, because RealityEngine uses 2-pixel by 2-pixel dithering. However, screen-door transparency causes a dramatic increase in the number of complex pixels in a scene, which can affect fill performance.

Texturing

Texturing is free on a RealityEngine if you use a 16-bit texel internal texture format. There are 16-bit texel formats for each number of components. These formats are used by default by OpenGL Performer but can be set on a `pfTexture` with `pfTexFormat()`. Using a 32-bit texel format will yield half the fill rate of the 16-bit texel formats.

Do not use huge ranges of texture coordinates on individual triangles. This can incur both an image quality degradation and a severe performance degradation. Keep the maximum texture coordinate range for a given component on a single triangle under the following value:

$$1 \ll (13 - \log_2(\text{TexCSize}))$$

where *TexCSize* is the size in the dimension of that component.

The use of Detail Texture and Sharpen can greatly improve image quality. Minimize the number of different detail and sharpen splines (or just use the internal default splines). Applying the same detail texture to many base textures can incur a noticeable cost when base textures are changed. Detail textures are intended to be derived from a high-resolution image that corresponds to that of the base texture.

Other Tips

Two final notes on RealityEngine performance:

- Changing the width of antialiased lines and points is expensive.
- `pfMtlColorMode()` (which calls the function `glColorMaterial()`) has a huge performance benefit.

EventView—A Performance Analyzer

It is often very difficult to analyze a single missed frame by using the `pfChannel` statistics displays. OpenGL Performer is instrumented to generate internal timing events and write them into a file upon an application program request. You can analyze these collected events at your own pace using a graphic analysis tool. EventView is such a tool.

Note: EventView was originally developed by Ran Yakir from BVR Systems.

Each event has a start time and an end time. Together they bind the execution of important parts of an OpenGL Performer frame in the various OpenGL Performer processes. The captured event durations are similar to the durations presented in `pfFrameStats`. However, EventView events can be written to a file and analyzed offline after the execution of an OpenGL Performer program completes. In addition, an application program can design its private set of events and can merge them into the same output file as the OpenGL Performer internal events.

The following subsections describe the use of EventView:

- “Viewing Events—evanalyzer” on page 839

- “Controlling the Collection of OpenGL Performer Internal Events” on page 840
- “Sample Use of EventView” on page 840
- “Using EventView Tools” on page 844
- “Understanding OpenGL Performer Internal Events” on page 851

Viewing Events—evanalyzer

EventView provides an analysis program called `evanalyzer` for generating a graphic display of the captured events. Figure 24-1 shows a sample screen from the `evanalyzer` program. Each row contains events of a single type. For each event, its start is marked by a vertical line, its duration is marked by a horizontal line, and its end is marked by another vertical line extending upward.

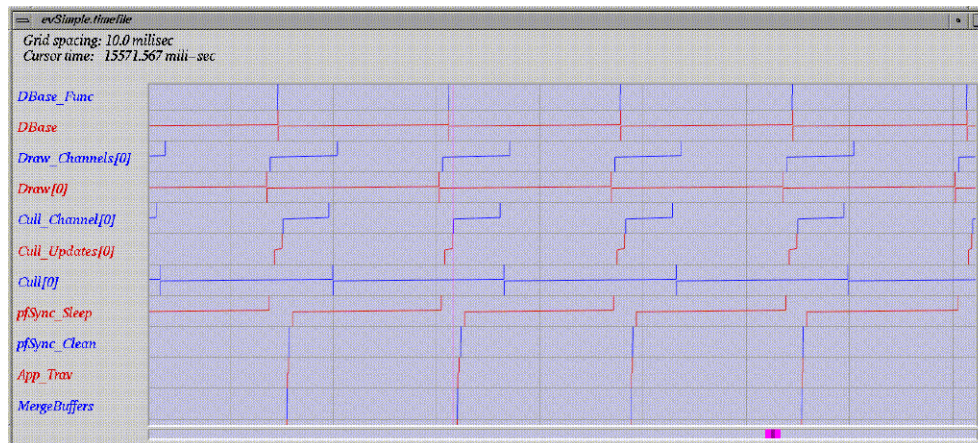

Figure 24-1 The `evanalyzer` Main Display

Controlling the Collection of OpenGL Performer Internal Events

Use the following functions in order to control EventView event collection:

Function	Description
pfInitializeEvents()	Initializes the internal event capturing mechanism of OpenGL Performer. An application must call this function before calling pfConfig() in order to initialize the event-capturing data structures. All other event-capturing functions should be called after pfInitializeEvents() .
pfEventSampleOn()	Starts event capturing. Immediately after this function is called, all timing events generated by OpenGL Performer are logged for future saving into a file. OpenGL Performer will log a limited number of events (currently 10,000 events). No events will be logged after this limit is reached.
pfEventSampleOff()	Stops event capturing. No events will be logged after this call.
pfWriteEvents()	Writes the currently logged events into a disk filename. The written events can be viewed later using <code>evanalyzer</code> .
pfResetEvents()	Resets the list of captured events.

Sample Use of EventView

This section provides samples of the simplest use of EventView and a more complex use.

The Simplest Case

The simplest way to use EventView is to use only OpenGL Performer internal events. In this case, an application program may look like the following:

```
main()
{
    pfInit();

    // Initialize event capture. Call between pfInit and pfConfig.
    pfInitializeEvents();

    pfConfig();

    // Create window & scene graph.
```



```

        ....

// Start event capture
pfEventSampleOn();

for (i = 0 ; i < numFrames ; i ++ )
{
    pfSync();
    pfFrame();
}

// Stop event capture.
pfEventSampleOff();

// Write to file.
pfWriteEvents("events.timefile");
}

```

After the program completes, you can analyze the generated events using the command `evanalyzer events.timefile`.

A More Complex Case

In a more complex case, an application has some private events that it wishes to add to the captured event file. Two stages are necessary:

Stage 1

You must define application's private events in a file. The following example defines a single event named `myDrawCB` and assigns a single information slot of type integer for this event:

```

file "myEvents.timefile";
max_events 10000;
c_file "myEvents.c";
h_file "myEvents.h";

active true;

conditional_sampling true;

malloc "pfSharedMalloc";

event "myDrawCB"

```

```
{
    info "CB_Info"
    {
        name "Something" ;
        type int ;
    };
};
```

Running the command `evpp` on the preceding file creates the two files `myEvents.c` and `myEvents.h`. The application should compile and link with the newly generated file `myEvents.c`. The file `myEvents.h` contains macros that the application uses to control event capturing.

Stage 2

The following application code generates an event of type `myDrawCB` in a `DRAW` callback of some node in the scene graph. Every time the program generates an event, the program assigns a value to its information slot:

```
int pre_draw_cb(pfTraverser *trav, void *userData)
{
    int someValue;

    // Mark the start of private event MyDrawCB.
    EVENT_START_MYDRAWCB;

    // Assign value to the information field of this event.
    EVENT_MYDRAWCB_INFO_CB_Info (someValue);

    ... Run callback code.

    // Mark the end of private event MyDrawCB.
    EVENT_END_MYDRAWCB;
}

main()
{
    pfGeode *geode;
    pfInit();

    // Initialize Performer-internal event capture.
    pfInitializeEvents();

    // Initialize application-private event capture.
```

```

EVENT_INIT;

pfConfig();

// Create window & scene graph.
....

// Setup DRAW callback on a node.
pfNodeTravFuncs(geode, PFTRAV_DRAW, pre_draw_cb, NULL);

// Start event capture on all initialized event sets
// (Performer-internal and application-private).
EVENT_SAMPLE_ALL_ON;

for (i = 0 ; i < numFrames ; i ++ )
{
    pfSync();
    pfFrame();
}

// Stop event capture on all initialized event sets..
EVENT_SAMPLE_ALL_OFF;

// Write all captured events from all initialized sets to a file.
// Since we named a file in the evpp input file,
// we need not specify it here.
EVENT_WRITE_ALL;
}

```

As in the first example, after the program completes, you can analyze the generated events using the command `evanalyzer myEvents.timefile`. This time the file contains both OpenGL Performer internal events and application-private events (`myDrawCB`). Clicking the right-hand mouse button on the line marked **myDrawCB** can toggle the display of the information field on this event. Figure 24-2 shows sample output with a user event. The top row of the display shows the user event `myDrawCB`.

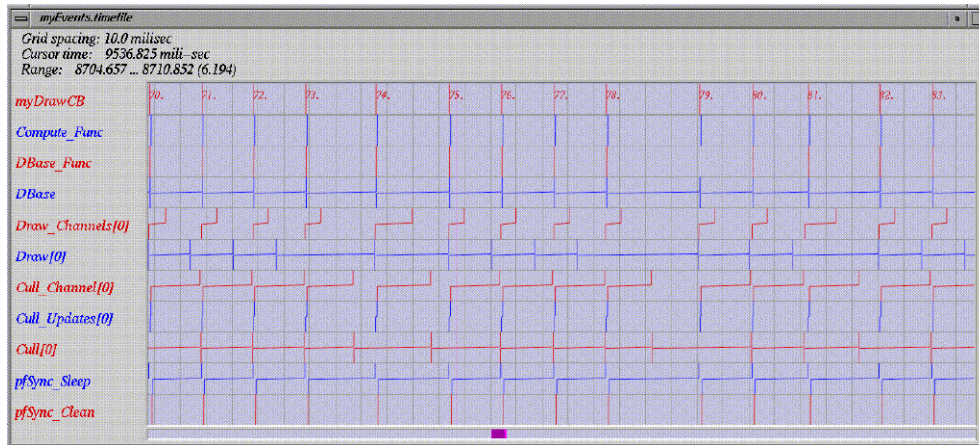

Figure 24-2 User Event myDrawCB

Note that it was not necessary to start and stop the sampling of OpenGL Performer internal events. The `EVENT_SAMPLE_ALL_ON` and `EVENT_SAMPLE_ALL_OFF` macros start and stop sampling for all currently initialized event sets.

Using EventView Tools

The EventView toolset contains the following tools:

Program	Description
evpp	An event preprocessor that takes a description of user events and generates a C program, adding the new events into an application program.
evanalyzer	A viewing program for captured events.
evhist	A display program for generating histograms of event durations. It is usually activated from within <code>evanalyzer</code> .
evgraph	A display program for plotting functions of event information slots.
evmerge	A utility program for merging event files.

The following sections describe these tools in more detail.

evpp—Event Pre-Processor

The program `evpp` is a preprocessor for adding user events to an OpenGL Performer program. As input, it expects a text file describing a set of new event types. It produces a C source file and a C include file. To enable the recording of the newly generated events, you must compile and link the new C source file in your program.

Sample Input File

The following is an example of an `evpp` input file:

```
file "out.timefile";
max_events 10000;
c_file "myEvents.c";
h_file "myEvents.h";

active true;

conditional_sampling true;

malloc "pfSharedMalloc";

group "my_APP"      0x000001;
group "my_Cull_CB" 0x000002;

group "my_APP"
{
    event "my_pfFrame";
    event "my_pfSync";
};

group "my_Cull_CB"
{
    event "my_Cull_Group_CB"
    {
        size 5;
    };

    event "my_Cull_DCS_CB"
    {
        size 5;
    };
};
```

```
event "myCB"
{
    info "myInfo"
    {
        type int;
        name "myInfoName" ;
    };
}
```

The preceding file defines two groups of events. Each group contains two events. In the second group (`my_Cull_CB`), each event is an array of five events. This is useful for generating the same event types from different processes. In this case, each CULL process will generate events on callbacks to `pfGroups` and `pfDCS`. The preceding file also defines an event called `myCB`, which does not belong to any group. This event contains a single information slot of type integer.

The input file contains the following directives

Directive	Description
<code>file</code>	Specifies the output filename. If the character <code>?</code> is used instead of a filename, the generated macros <code>EVENT_WRITE</code> and <code>EVENT_WRITE_ALL</code> will require a filename as a parameter.
<code>max_events</code>	Specifies the maximum number of events that will be allocated and captured.
<code>c_file</code>	Specifies the filename for the source code file that <code>evpp</code> generates.
<code>h_file</code>	Specifies the filename of the include file that <code>evpp</code> generates.
<code>active</code>	Determines whether <code>evpp</code> will generate empty macros. This directive may be true or false. This is useful when trying to avoid generating any macros without changing any application source code.
<code>conditional_sampling</code>	Determines whether events will be captured. This directive can be true or false. If false, events will be captured regardless of the call to <code>EVENT_SAMPLE_ON</code> .

<code>malloc</code>	Allows the defining of an alternative memory allocation for internal EventView use. If using anything other than <code>pfSharedMalloc</code> as the <code>malloc</code> value, the application must supply a function receiving an <code>int</code> and returning a <code>void*</code> pointer to newly allocated memory. The built-in function <code>pfSharedMalloc()</code> allocates memory from the OpenGL Performer shared arena.
<code>group</code>	Defines a group. When defining a group of events, you must first define a group mask. The <code>group</code> directive accepts a group name and a mask. Masks may overlap. This is useful for defining hierarchies of groups.
<code>event</code>	Defines single events. They may be inside or outside the definition of a group. An event must have a name and may have a size and information slots. In the preceding example, an event of size 5 is effectively an array of five independent events. This is useful for creating per-pipe events.

evpp Command-Line Options

The following are the `evpp` command-line options:

Option	Description
<code>-h</code>	Prints the usage string.
<code>-c</code>	Compiles the generated files. This option can make makefiles simpler.
<code>-n</code>	Sets all the events in the input file to inactive. The macros generated for all events will be empty. This flag is useful when trying to disable the instrumentation of a source file without removing the macros.

evanalyzer—EventView Graphical Analysis Program

The program `evanalyzer` generates a graphic display of captured events. Each line in its display contains events of a single type. The horizontal axis of the display denotes the time.

View of a Single Event

Figure 24-3 shows a graphic representation of a single event.

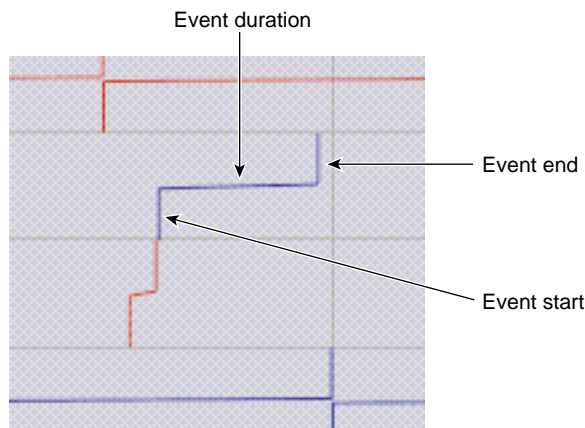

Figure 24-3 Up-Close View of a Single Event

An event starts at a vertical bar from the bottom of the event line to its middle, continues horizontally, and ends as a vertical bar from the middle of the event line to its top.

Keyboard and Mouse Controls

The following are the keyboard and mouse controls for `evanalyzer`:

Control	Description
Up/Down arrows	Changes the zoom factor of the display.
Right/Left arrows	Shifts the display window across the captured data.
Left mouse button	Picks an event start or end point. Clicking on one event start or end point and releasing on another prints the time difference between the two on the top of the display.
Middle mouse button	Drags the event display window across the captured data.
Right mouse button	If the mouse is on an event line and the event has information fields, allows toggling of their display. If the mouse is not on an event line, this button toggles events displayed and groups displayed.
h key	Brings up the histogram program (<code>evhist</code>) and runs it on the currently selected event.

f key	If the event line under the mouse has information slots, prompts for a slot. Brings up a function plot program (evgraph) and runs it on the selected information slot on the current event.
Esc key	Exits evanalyzer.

evhist—Histogram Generator

The display program `evhist` generates histograms of event durations. It is usually activated from within `evanalyzer`.

Moving the mouse across the window prints the number of samples that are on the histogram bar under the mouse and what time value it represents. Figure 24-4 contains a sample screen of `evhist`.

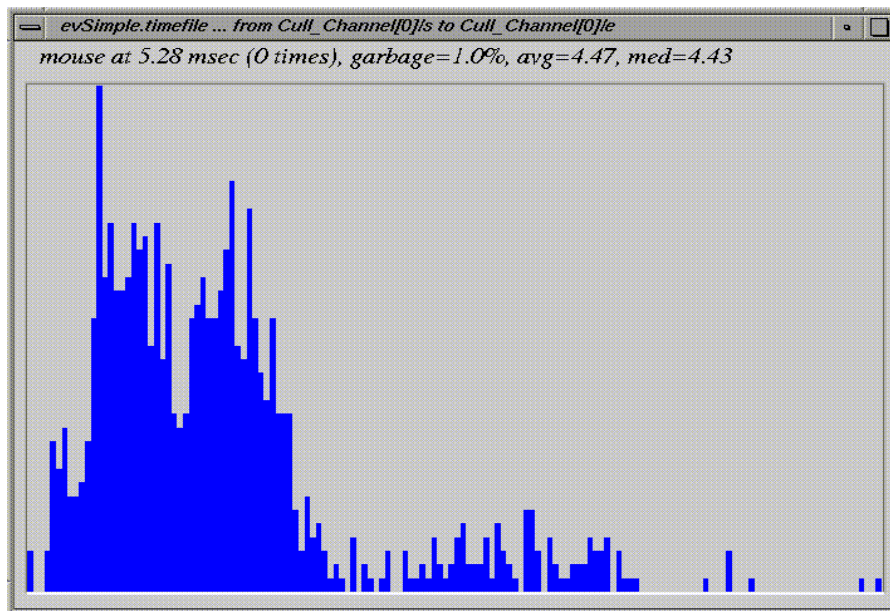

Figure 24-4 evhist Sample Screen

The following are the keyboard controls for `evhist`:

Control	Description
Up/Down arrows	Change the resolution of the histogram.
Right/Left arrows	Change the percentage of samples on both extremes of the histogram that we ignore (displayed as garbage on the top of the display).
Esc key	Exits <code>evhist</code> .

`evgraph`—Event Information Plotter

The display program `evgraph` plots the information slot of a given event type. It is usually activated by `evanalyzer`. Figure 24-5 shows a sample display of `evgraph`.

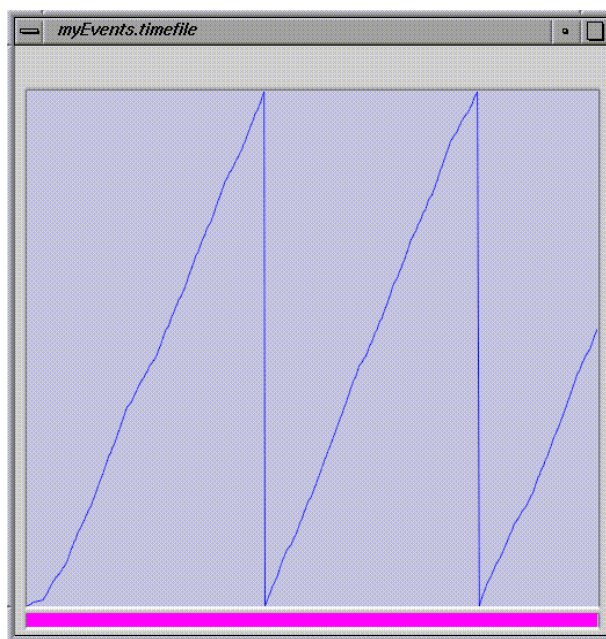

Figure 24-5 `evgraph` Sample Screen

The following are the keyboard and mouse controls for evgraph:

Control	Description
Up/Down arrows	Changes the resolution of the plot.
Right/Left arrows	Translates the plot horizontally.
Middle mouse button	Drags the plot horizontally.

Understanding OpenGL Performer Internal Events

Performance tuning typically requires finding a portion of the frame time that takes too long to execute and taking measures to shrink its duration. EventView enables bounding some major OpenGL Performer internal functions and measuring their duration.

To make the EventView toolset useful, you have to understand the position and relationships of the OpenGL Performer internal events and the OpenGL Performer internal processing that they bound. This section places the OpenGL Performer internal events in the context of OpenGL Performer functions.

pfSync() Events

An application calls the OpenGL Performer function **pfSync()** to synchronize with the hardware video frame rate. OpenGL Performer packs multiple internal management tasks into this function because the application process has already finished its processing for this frame; so, this is the least critical time in the frame. The following pseudo code describes the main processing units of **pfSync()** and shows what EventView events are generated during the **pfSync()** duration:

```
pfSync()
{
    EVENT_START - pfSync
        ... clean scene graph (first time).
        ... Recompute bounding spheres of nodes modified between the
        ... previous call to pfFrame and the present time.
    EVENT_START - New_Updatables
        ...process all newly generated nodes for this frame.
    EVENT_END - New_Updatables
    EVENT_START - MergeBuffers
        ... Process call to pfMergeBuffers from a DBASE process.
        ... Process new nodes that the DBASE process merged.
    EVENT_END - MergeBuffers
}
```

```
EVENT_START - App_Trav
    ... Run APP traversal on all nodes.
EVENT_END - App_Trav
EVENT_START - pfSync_Clean
    ... clean scene graph (second time)
    ... Recompute bounding spheres of nodes modified during the APP
    ... traversal.
EVENT_END - pfSync_Clean
    ... Update internal stats.
    ... Update pfASD positions.
    ... Update clip-texture emulation internals.
EVENT_START - pfSync_Sleep
    ... Sleep until start of next video frame.
EVENT_END - pfSync_Sleep
EVENT_END - pfSync
}
```

pfFrame Events

The OpenGL Performer function **pfFrame()** is responsible for initiating a new rendering frame. It contains the minimal necessary processing for spawning other OpenGL Performer processes for a new frame. The following pseudo code describes the main processing units that **pfFrame()** contains and the EventView events it generates:

```
pfFrame()
{
    EVENT_START - pfFrame
    EVENT_START - pfFrame_Clean
        ... Clean scene graph.
        ... Recompute bounding spheres of nodes modified between the
        ... previous call to pfSync and the present time.
    EVENT_END - pfFrame_Clean
        ... Check all CULL processes for completion of previous frame.
        ... Decide what CULL processes should start a new frame.
    EVENT_START - pfFrame_Updates
        ... Send forked processes (CULL, ISECT, DBASE, COMPUTE) to copy
        ... all scene graph changes from APP copy of the scene graph to
        ... their private copy of the scene graph.
        ... Wait for all above processes to finish updating their copy
        ... of the scene graph.
    EVENT_END - pfFrame_Updates
        ... Execute all unforked processes as part of the APP process.
    EVENT_END - pfFrame
}
```

CULL Process Events

The following pseudo code shows the main processing units of the CULL process and the EventView events that it generates. The code portion shown spans a single CULL process frame:

```
while(1)
{
    EVENT_START - Cull
    EVENT_START - Cull_Updates
        ... Copy all scene graph changes from the APP copy of the
        ... scene graph to the CULL copy of the scene graph.
    EVENT_END - Cull_Updates
    for each channel on this pipe do
        EVENT_START - Cull_Channel
            ... Call CULL traversal on this channel.
        EVENT_END - Cull_Channel
    EVENT_END - Cull
}
```

DRAW Process Events

The following pseudo code shows the main processing units of the DRAW process and the EventView events that it generates. The code portion shown spans a single DRAW process frame:

```
while (1)
{
    EVENT_START - Draw
        ... for each channel on this pipe do
        EVENT_START - Draw_Channels
            .... Call the drawing function on a channel.
        EVENT_END - Draw_Channels
    EVENT_END - Draw
}
```

Other Events

Each of the DBASE, COMPUTE, ISECT, and CULL_SIDEKICK processes has a single event starting at the top of its frame and ending at its bottom. Their names are self-explanatory.

Building a Visual Simulation Application Using `libpfv`

This chapter describes how to use the library `libpfv` to build an application using a graphical viewer.

The following sections appear:

- “Overview” on page 855
- “The Simplest `pfvViewer` Program” on page 856
- “Adding Interaction to a `pfvViewer` Program” on page 857
- “Reading XML Configuration Files” on page 858
- “Module Scoping, Multiple Worlds and Multiple Views” on page 862
- “Extending a `pfvViewer`—Writing Custom Modules” on page 865
- “Extending a `pfvViewer`—Module Entry Points” on page 867
- “Picking, Selection, and Interaction” on page 868
- “More Sample Programs, Configuration Files, and Source Code” on page 871

Overview

OpenGL Performer includes `libpfv`, a C++ library for easy construction of modular, interactive OpenGL Performer applications.

The library `libpfv` supports the following features:

- Reading and writing XML files
- Specifying complex display configuration (pipes, windows, and channels) from a file or through API calls
- Tracking mouse and keyboard input

- Setting up user interaction with 3D scene elements
- Managing multiple scene graphs (worlds)
- Managing multiple camera positions (views)
- Extending program functionality using program modules

The principal class in `libpfv` is `pfvViewer`. It allows complex multiworld and multiview applications to be implemented in a modular fashion, allowing individual features to be encapsulated into configurable and re-usable modules.

In addition to `libpfv`, OpenGL Performer includes ready-to-use modules that provide the following features:

- Loading geometry into a `pfvViewer` world
- Picking geometry under the mouse pointer
- Manipulating geometry (rotating, translating, scaling, deleting)
- Navigating through a world using mouse and keyboard controls
- Controlling the render style of models
- Setting up colorful earth and sky backgrounds
- Displaying 2D images in overlay
- Saving snapshots of the rendered images
- Smoothly transitioning from one world to another
- Collecting and displaying scene graph statistics

The Simplest `pfvViewer` Program

The `pfvViewer` class starts with a very simple programming interface. It maintains a very simple programming interface even when accessing high-level features. As shown in the following program, the simplest program using `pfvViewer` loads a model and places the camera at a comfortable viewing distance:

```
#include <Performer/pfdu.h>
#include <Performer/pf/pfLightSource.h>
#include <Performer/pfv/pfvViewer.h>

main (int argc, char *argv[])
```



```

{
    // Initialize Performer
    pfInit();

    // Create a new pfvViewer
    pfvViewer* viewer = new pfvViewer;

    // Initialize loading of a model file.
    pfdInitConverter(argv[1]);

    // Configure/Initialize pfvViewer
    viewer->config();

    // Add a light source to the world.
    viewer->addNode(new pfLightSource);

    // Add a model to the world
    viewer->addNode(pfdLoadFile(argv[1]));

    // Start viewing
    viewer->run();
}

```

Adding Interaction to a pfvViewer Program

To add interaction, load the following two standard modules into the viewer:

- `pfvmNavigator` module
Allows the user to move around the 3D scene through mouse and keyboard input.
- `pfvmPicker` module
Allows the user to select, manipulate, and delete portions of the 3D scene through mouse and keyboard input.

The following program shows the addition of these modules to the simple program in the preceding subsection:

```

#include <Performer/pfdu.h>
#include <Performer/pf/pfLightSource.h>
#include <Performer/pfv/pfvViewer.h>

main (int argc, char *argv[])

```

```
{
    pfvModule* module;

    // Initialize Performer
    pfvInit();

    // Create a new pfvViewer
    pfvViewer* viewer = new pfvViewer;

    // Add navigation module
    module = pfvModule::load("pfvmNavigator");
    viewer->addModule(module);

    // Add mouse-picking module
    module = pfvModule::load("pfvmPicker");
    viewer->addModule(module);

    // Initialize loading of model files.
    pfdInitConverter(argv[1]);

    // Configure/Initialize pfvViewer
    viewer->config();

    // Add a light source to the world.
    viewer->addNode(new pfLightSource);

    // Add a model to the world
    viewer->addNode(pfdLoadFile(argv[1]));

    // Start interaction
    viewer->run();
}
```

Reading XML Configuration Files

A `pfvViewer` can read most of its parameters from an XML configuration file. A `pfvViewer` configuration file, denoted by the `.pfv` extension, can contain any of the following items:

- Display configuration (pipes, windows, and channels)
- Specification of multiple worlds

- Specification of multiple views (camera positions)
- Extension modules to be loaded into the `pfvViewer` and their specific configuration parameters

The simplest `pfvViewer` program using an XML configuration file is `pfview`, which is provided as a precompiled executable with OpenGL Performer.

The source code for the `pfview` program looks like the following:

```
#include <Performer/pfv/pfvViewer.h>

int
main (int argc, char *argv[])
{
    // Initialize Performer
    pfInit();

    // Create a new pfvViewer and read XML configuration file argv[1]
    pfvViewer* viewer = new pfvViewer(argv[1]);

    // Configure/Initialize pfvViewer.
    viewer->config();

    // Start interaction
    viewer->run();
}
```

A minimal XML configuration file suitable for `pfview` has the following structure:

```
<?xml version="1.0" ?>
<viewer>
  <module>
    <!-- Loader module: loads models into world -->
    <class>pfvmLoader</class>
    <data>
      <Model>
        <FileName>esprit.flt</FileName>
      </Model>
    </data>
  </module>

  <!-- Add a trackball navigation module -->
  <module>
    <class>pfvmTrackball</class>
```

```
    </module>

    <!-- Add a picking module -->
    <module>
        <class>pfvmPicker</class>
    </module>

</viewer>
```

You can use a more complex XML configuration file, one including a `display` tag, to set up complex display configurations. The following file is an example that sets up a panoramic view over three channels, each rendered in a separate graphics pipe:

```
<?xml version="1.0" ?>

<viewer>
    <!-- Display specifications -->
    <display>
        <!-- Configure middle pipe -->
        <pipe>
            <!-- direct middle pipe to screen 0 -->
            <screen>0</screen>
            <!-- Configure a single pipe-window on middle pipe -->
            <pwin>
                <!-- set pipe-window to fullscreen, no border -->
                <fullscreen>1</fullscreen>
                <border>0</border>
                <!-- Configure a single channel on pipe-window -->
                <chan>
                    <viewrange>0.32,0.68,0.0,1.0</viewrange>
                    <hprOffset>0.0,0.0,0.0</hprOffset>
                    <fov>59.0,46.0</fov>
                </chan>
            </pwin>
        </pipe>

        <!-- Configure right pipe -->
        <pipe>
            <screen>1</screen>
            <pwin>
                <!-- set pipe-window to fullscreen, no border -->
                <fullscreen>1</fullscreen>
                <border>0</border>
                <!-- Configure a single channel on pipe-window -->
                <chan>
```

```
        <viewrange>0.64,1.0,0.0,1.0</viewrange>
        <hprOffset>-53.333,0.0,0.0</hprOffset>
        <fov>59.0,46.0</fov>
    </chan>
</pwin>
</pipe>

<!-- Configure left pipe -->
<pipe>
    <screen>2</screen>
    <pwin>
        <!-- set pipe-window to fullscreen, no border -->
        <fullscreen>1</fullscreen>
        <border>0</border>
        <!-- Configure a single channel on pipe-window -->
        <chan>
            <viewrange>0.0,0.36,0.0,1.0</viewrange>
            <hprOffset>53.333,0.0,0.0</hprOffset>
            <fov>59.0,46.0</fov>
        </chan>
    </pwin>
</pipe>
</display>

<module>
    <!-- Loader module: loads models into world -->
    <class>pfvmLoader</class>
    <data>
        <Model>
            <FileName>esprit.flt</FileName>
        </Model>
    </data>
</module>

<!-- Add a trackball navigation module -->
<module>
    <class>pfvmTrackball</class>
</module>

<!-- Add a picking module -->
<module>
    <class>pfvmPicker</class>
</module>

</viewer>
```

Module Scoping, Multiple Worlds and Multiple Views

In more complex pfvViewer applications, you can create multiple views and/or multiple worlds. Each view will always render (view) one of the specified worlds. Each world may be viewed by zero, one, or more views at any point during the life of the application.

Note: You can direct views from one world to another during the course of an application.

The following simple XML configuration file defines two worlds, each being rendered into a separate view:

```
<?xml version="1.0" ?>
<viewer>

    <!-- Specify two worlds, and assign each a unique name -->
    <world>
        <name>world0</name>
    </world>

    <world>
        <name>world1</name>
    </world>

    <!-- Specify two views, assign each a unique name,
        and direct to the corresponding world -->
    <view>
        <name>view0</name>
        <world>world0</world>
    </view>

    <view>
        <name>view1</name>
        <world>world1</world>
    </view>

    <!-- Specify two instances of the pfvmLoader module.
        By scoping these modules to different worlds,
        each loader module will add its geometry to the
        appropriate scene graph -->

    <module>
```

```

    <class>myLoader</class>
    <scope>world,world0</scope>
    <data>
        <Model>
            <FileName>esprit.flt</FileName>
        </Model>
    </data>
</module>

<module>
    <class>myLoader</class>
    <scope>world,world1</scope>
    <data>
        <Model>
            <FileName>truck.pfb</FileName>
        </Model>
    </data>
</module>

<!-- Specify two instances of the pfvmNavigator module.
     By scoping these modules to different views, each module
     will take care of navigation within the appropriate view -->

<module>
    <class>myNavigator</class>
    <scope>view,view0</scope>
</module>

<module>
    <class>myNavigator</class>
    <scope>view,view1</scope>
</module>

</viewer>

```

You can achieve the same result through API calls, as shown in the following program:

```

#include <Performer/pfdu.h>
#include <Performer/pfv/pfvViewer.h>

main (int argc, char *argv[])
{
    pfvModule* module;

    // Initialize Performer

```

```
pfInit();

// Initialize loading of model files.
pfdInitConverter("flt");
pfdInitConverter("pfb");

// Create a new pfvViewer.
pfvViewer* viewer = new pfvViewer;

//Create first world.
pfvWorld* w0 = viewer->createWorld();

//Create second world.
pfvWorld* w1 = viewer->createWorld();

//Create first view. v0 becomes viewer's current view.
pfvView* v0 = (pfvView*)(viewer->createView());

// Direct first view to first world.
v0->setTargetWorld(w0);

// Add navigation module to viewer's current view (v0).
module = pfvModule::load("pfvmNavigator");
viewer->addModule(module, PFV_SCOPE_VIEW);

//Create second view. v1 becomes viewer's current view.
pfvView* v1 = (pfvView*)(viewer->createView());

// Direct second view to second world
v1->setTargetWorld(w1);

// Add navigation module to viewer's current view (v1).
module = pfvModule::load("pfvmNavigator");
viewer->addModule(module, PFV_SCOPE_VIEW);

// Configure/Initialize pfvViewer
viewer->config();

// Add car model to first world
w0->addNode(pfdLoadFile("esprit.flt"));

// Add truck model to first world
w1->addNode(pfdLoadFile("truck.pfb"));

// Start viewing
```



```

        viewer->run();
    }

```

Extending a pfvViewer—Writing Custom Modules

A pfvViewer accepts user-written modules and incorporates their functions into its behavior. In order to extend a pfvViewer, you can write a new module. The following very simple module informs the pfvViewer to invoke the `handleEvent()` method and to print a message when the F1 key is pressed:

```

class myModule : public pfvModule
{
public:

    myModule::myModule()
    {
        char keys[64];

        // Declare what keyboard inputs this module is interested in.
        sprintf(keys, "%c", PFVKEY_F1);
        bindKeys(keys);
    }

    myModule::~myModule() {}

    // Keyboard event handler. pfvViewer calls this method every
    // time the user hits the F1 key.
    int handleEvent(int evType, char key)
    {
        printf("myModule::handleEvent called for key %s\n",
            pfvInputMngr::getKeyName(key) );
        return 0;
    }
};

```

In order to add this module to a pfvViewer program, add the following line:

```
viewer->addModule(new myModule);
```

Note that if this module is scoped to a view, pfvViewer will only inform the module of F1 key presses within channels belonging to that specific view. Similarly, if this module is scoped to a specific world, pfvViewer would inform the module of F1 key presses over any channel belonging to any view currently viewing such world.

You can scope this module to a world by making the following call:

```
pfvWorld* w;  
viewer->addModule(new myModule, PFV_SCOPE_WORLD);
```

You can scope this module to a view by making the following call:

```
pfvView* w;  
viewer->addModule(new myModule, PFV_SCOPE_VIEW);
```

The following example illustrates how to implement a basic custom module that controls the camera position (for the first view in `pfvViewer`'s list) based on the mouse position:

```
class myModule : public pfvModule  
{  
public:  
    myModule(){  
        bindCallback(PFV_CB_FRAME);  
    }  
  
    ~myModule(){}  
  
    void frame() {  
        // Only set eye for view0 if mouse is over view0  
        if(pfvInputMgr::getFocusViewIndex()!=0)  
            return;  
  
        pfVec3 xyz,hpr;  
        // Get current eye position (we don't want to change xyz)  
        viewer->getView(0)->getEye(xyz,hpr);  
  
        float mx, my;  
        // Get current mouse position in view-normalized values  
        // (0.0 to 1.0)  
        pfvInputMgr::getViewNormXY( &mx, &my );  
  
        // Compute new values for Heading and Pitch based on mouse  
        // position  
        hpr[0]= (mx-0.5f)*180.0f;  
        hpr[1]= (my-0.5f)*-90.0f;  
  
        // Set new eye position for view0  
        viewer->getView(0)->setEye(xyz,hpr);  
    }  
};
```

Extending a pfvViewer—Module Entry Points

A module can gain program control at the various stages of rendering. The following are some of these stages:

- Event-Driven methods

handleEvent()

Called in response to a key-press event. A pfvViewer invokes this method only if the pressed key was bound by this module and if the event was generated over a view relevant to the module.

- Configuration methods (called once in the life of the application)

- **preConfig()**

Called before pfvViewer calls **pfConfig()**.

- **postConfig()**

Called after the pfvViewer calls **pfConfig()**.

- Run-Time methods (called every frame):

- **sync()**

Called each frame immediately after pfvViewer calls **pfSync()**.

- **frame()**

Called each frame after pfvViewer calls **pfFrame()**.

- **preCull()**

Called in all CULL processes before calling **pfCull()**.

- **postCull()**

Called in all CULL processes after calling **pfCull()**.

- **preDraw()**

Called in all DRAW processes before calling **pfDraw()**.

- **postDraw()**

Called in all DRAW processes after calling **pfDraw()**.

- **overlay()**

Called in all DRAW processes after **postDraw()** callbacks.

- Enter and exit methods (called for scoped modules only)
 - **enterWorld()**

A `pfvViewer` invokes this method on view-scoped modules to inform them that their view is about to start viewing a new world.
 - **exitWorld()**

A `pfvViewer` invokes this method on view-scoped modules to inform them that their view is about to stop viewing current world.
 - **enterView()**

A `pfvViewer` invokes this method on world-scoped modules to inform them that a new view is about to start viewing their world.
 - **exitView()**

A `pfvViewer` invokes this method on world-scoped modules to inform them that a view is about to stop viewing their world.

Picking, Selection, and Interaction

The library `libpfv` also provides a framework for specifying custom interaction behavior through the `pfvPicker`, `pfvInteractor`, and `pfvSelector` classes.

A single `pfvPicker` instance will be able to coordinate multiple interaction classes derived from `pfvInteractor` and/or `pfvSelector`.

The following example illustrates how to derive entities from the `pfvInteractor` class in order to be able to highlight the geometry under the mouse cursor:

```
#include <Performer/pfv/pfvViewer.h>
#include <Performer/pfv/pfvInputMgrPicker.h>
#include <Performer/pr/pfHighlight.h>
#include <Performer/pf/pfLightSource.h>
#include <Performer/pfutil.h>
#include <Performer/pfdu.h>

class myInteractor : public pfvInteractor
{
public:

    myInteractor() {
```

```

        // create and configure a pfHighlight instance
        hl = new pfHighlight;
        hl->setMode( PFHL_LINES );
        hl->setColor( PFHL_FGCOLOR, 1.0f, 1.0f, 0.0f );
    }
~myInteractor(){ pfDelete(hl); }

// startHlite will be called by picker once whenever mouse cursor
// is moved over some geometry after being pointed away from all
// geometry.
int startHlite( pfvPicker*p, int prmsn ){
    // Obtain a pointer to the pfNode that was picked by picker
    p->getPickResults(&node);
    // Traverse picked node and highlight it
    pfuTravNodeHlight( node, hl );
    // return 1 indicating we accept highlighted state
    return 1;
}

// updateHlite will be called by picker on each frame as long as
// mouse cursor remains over some geometry.
int updateHlite( pfvPicker* p,int ev,int prmsn, pfvPickerRequest*r
){
    pfNode* curnode = node;
    // Obtain a pointer to the pfNode that was picked by picker
    p->getPickResults(&node);
    // if node picked by picker is not the node that is
    // currently highlighted
    if(node!=curnode)
    {
        // De-highlight previously highlighted node
        pfuTravNodeHlight( node, hl );
        // Traverse picked node and highlight it
        pfuTravNodeHlight( curnode, NULL );
    }
    return 1;
}

// endHlite will be called by picker once whenever mouse cursor is
// moved away from all geometry..
void endHlite( pfvPicker* p ){
    // De-highlight previously highlighted node
    pfuTravNodeHlight( node, NULL );
}

```

```
private:

    pfHighlight* hl;
    pfNode *node;
};

class myModule : public pfvModule
{
public:

    myModule(){
        // This module will use two callbacks (entry-points):
        bindCallback(PFV_CB_POSTCONFIG);
        bindCallback(PFV_CB_FRAME);
    }

    ~myModule(){;}

    // postConfig is called once by pfvViewer, after calling
    // pfConfig().
    void postConfig(){
        // Create a pfvInputMngrPicker instance
        picker = new pfvInputMngrPicker;
        // Set up picker so it will automatically isect scene and
        // allow interactors to highlight
        picker->setState(PFPICKER_ALLOW_HLITE, NULL, NULL);
        // Create an instance of our custom interactor
        ia = new myInteractor;
        // set up a pointer to our interactor on scene's root-node
        ia->nodeSetup( viewer->getWorld(0)->getScene(), picker);
    }

    // on every frame, call picker->update() from APP process.
    void frame() {
        picker->update();
    }

private:
    pfvInputMngrPicker* picker;
    myInteractor* ia;
};

int
main (int argc, char *argv[])
```

```
{
    pfInit();

    pfvViewer* viewer = new pfvViewer();

    pfFilePath( "./usr/share/Performer/data" );

    pfdInitConverter( "esprit.flt" );

    viewer->addModule( new myModule );
    viewer->addModule( pfvModule::load( "pfvmTrackball" ) );

    viewer->config();

    viewer->addNode( new pfLightSource );
    viewer->addNode( pfdLoadFile( "esprit.flt" ) );

    viewer->run();
}
```

More Sample Programs, Configuration Files, and Source Code

OpenGL Performer provides many `libpfv` sample programs, configuration files, and source code for modules in the following directories:

- `/usr/share/Performer/src/pguide/libpfv/picker` (IRIX and Linux)
`%PFROOT%\Src\pguide\libpfv\picker` (Microsoft Windows)

The samples in this directory demonstrate the use of `pfvPicker` and derived classes as well as how to extend the `pfvInteractor` and `pfvSelector` classes to implement your custom interaction behaviors.

- `/usr/share/Performer/src/pguide/libpfv/viewer` (IRIX and Linux)
`%PFROOT%\Src\pguide\libpfv\viewer` (Microsoft Windows)

The samples in this directory demonstrate how to do the following:

- Load models into `pfvViewer` applications.
- Load standard or custom modules.
- Create `pfvViewers` with multiple camera positions (views).
- Create `pfvViewers` with multiple independent scene graphs (worlds).

- Create complex multichannel display configurations.
- Load complex display configurations from an XML file.
- Write custom modules.
- Compile modules into re-usable DSOs.
- /usr/share/Performer/src/pguide/libpfv/viewer/modules (IRIX and Linux)
%PFROOT%\Src\pguide\libpfv\viewer\modules (Microsoft Windows)

This directory contains source code for the following modules:

- pfvmDrawStyle
 - pfvmEarthSky
 - pfvmLoader
 - pfvmLogo
 - pfvmNavigator
 - pfvmPicker
 - pfvmSnapshot
 - pfvmStats
 - pfvmTrackball
 - pfvmWorldSwitcher
 - /usr/share/Performer/config (IRIX and Linux)
%PFROOT%\Config (Microsoft Windows)
- This directory contains examples of pfvViewer configuration files, denoted by the .pfv filename extension.

Programming with C++

This chapter provides an overview of some of the differences between programming OpenGL Performer using the C++ Application Programming Interface (C++ API) rather than the C-language Application Programming Interface (C API), which is described in the earlier chapters of this guide.

Overview

Although this guide uses the C API throughout, the C++ API is in every way equal and in some cases superior in functionality and performance to the C API.

Every function available in the C API is available in the C++ API. All of the C API routines tightly associated with a class have a corresponding member function in the C++ API; for example, **pfGetDCSMat()** becomes **pfDCS::getMat()**. Routines not closely associated with a class are the same in both APIs. Examples include high-level global functions such as **pfMultiprocess()** and **pfFrame()** and low-level graphics functions such as **pfAntialias()**.

Most of the routines associated with a class can be divided into three categories: setting an attribute, getting attribute, and acting on the object. In the C API, sets were usually expressed as **pf<Class><Attribute>**, gets as **pfGet<Class><Attribute>** and simple actions as **pf<Action><Class>**, where **<Class>** is the abbreviation for the full name of the class. In some cases where there was no room for confusion or this usage was awkward, the routine names were shortened, for example, **pfAddChild()**.

The principal difference in the naming of member functions in the C++ API and the corresponding routine name in the C-language API is in the naming of member functions where the “pf” prefix and the **<Class>** identifier are dropped. In addition, the word “set” or “get” is prefixed when attribute values are being set or retrieved. Hence, value setting functions are usually have names of the form **pfClass::set<Attribute>**, value getting functions are named **pfClass::get<Attribute>**, and actions appear as **pfClass::<Action>**.

Table 26-1 Corresponding Routines in the C and C++ API

C Routine	C++ Member Function	Description
<code>pfMtlColor()</code>	<code>pfMaterial::setColor()</code>	Set material color.
<code>pfGetMtlColor()</code>	<code>pfMaterial::getColor()</code>	Get material color.
<code>pfApplyMtl()</code>	<code>pfMaterial::apply()</code>	Apply the material.

Note: Member function whose names begin with “pf_”, “pr_” or “nb_” are internal functions and should not be used by applications. These functions may have unpredictable side effects and also should not be overridden by application subclasses.

Class Taxonomy

There are three main types of C++ classes in OpenGL Performer. The following description is based on this categorization of the main types: public structs, `libpr` classes, and `libpf` classes. A fourth distinct class is `pfType`, the class used to represent the type of `libpr` and `libpf` classes.

Public Structs

These classes are public structs with exposed data members. They include `pfVec2`, `pfVec3`, `pfVec4`, `pfMatrix`, `pfQuat`, `pfSeg`, `pfSphere`, `pfBox`, `pfCylinder`, and `pfSegSet`.

`libpr` Classes

These classes derive from `pfMemory`. When multiprocessing, all processes share the same copy of the object’s data members.

libpf Classes

These classes derive from pfUpdatable and when multiprocessing, each APP, CULL, and ISECT process has a unique copy of the object's data members.

pfType Class

As with the C API, information about the class hierarchy is maintained with pfType objects.

Programming Basics

Header Files

For IRIX and Linux, the C++ include files for libpf and libpr are in /usr/include/Performer/pf and /usr/include/Performer/pr, respectively. For Microsoft Windows, the corresponding header files are in %PFROOT%\Include\pf and %PFROOT%\Include\pr. An application using a class should include the corresponding header file.

Table 26-2 Header Files for libpf Scene Graph Node Classes

libpf Class	Include File
pfASD	<Performer/pf/pfASD.h>
pfBillboard	<Performer/pf/pfBillboard.h>
pfDoubleDCS	<Performer/pf/pfDoubleDCS.h>
pfDoubleFCS	<Performer/pf/pfDoubleFCS.h>
pfDoubleSCS	<Performer/pf/pfDoubleSCS.h>
pfDCS	<Performer/pf/pfDCS.h>
pfFCS	<Performer/pf/pfFCS.h>
pfGeode	<Performer/pf/pfGeode.h>

Table 26-2 Header Files for libpf Scene Graph Node Classes (**continued**)

libpf Class	Include File
pfGroup	<Performer/pf/pfGroup.h>
pfIBRnode	<Performer/pf/pfIBRnode.h>
pfLOD	<Performer/pf/pfLOD.h>
pfLayer	<Performer/pf/pfLayer.h>
pfLightPoint	<Performer/pf/pfLightPoint.h>
pfLightSource	<Performer/pf/pfLightSource.h>
pfNode	<Performer/pf/pfNode.h>
pfPartition	<Performer/pf/pfPartition.h>
pfSCS	<Performer/pf/pfSCS.h>
pfScene	<Performer/pf/pfScene.h>
pfSequence	<Performer/pf/pfSequence.h>
pfSwitch	<Performer/pf/pfSwitch.h>
pfText	<Performer/pf/pfText.h>

Table 26-3 Header Files for Other libpf Classes

libpf Class	Include File
pfBuffer	<Performer/pf/pfBuffer.h>
pfChannel	<Performer/pf/pfChannel.h>
pfCullProgram	<Performer/pf/pfCullProgram.h>
pfEarthSky	<Performer/pf/pfEarthSky.h>
pfLODState	<Performer/pf/pfLODState.h>
pfMPClipTexture	<Performer/pf/pfMPClipTexture.h>
pfPipe	<Performer/pf/pfPipe.h>

Table 26-3 Header Files for Other libpf Classes (continued)

libpf Class	Include File
pfPipeWindow	<Performer/pf/pfPipeWindow.h>
pfRotorWash	<Performer/pf/pfRotorWash.h>
pfShader	<Performer/pf/pfShader.h>
pfShadow	<Performer/pf/pfShadow.h>
pfShaderManager	<Performer/pf/pfShaderManager.h>
pfPipeVideoChannel	<Performer/pf/pfPipeVideoChannel.h>
pfTraverser pfPath	<Performer/pf/pfTraverser.h>
pfVolFog	<Performer/pf/pfVolFog.h>

Table 26-4 Header Files for libpr Graphics Classes

libpr Class	Include File
pfColortable	<Performer/pr/pfColortable.h>
pfClipTexture	<Performer/pr/pfClipTexture.h>
pfDispList	<Performer/pr/pfDispList.h>
pfFog	<Performer/pr/pfFog.h>
pfFont	<Performer/pr/pfFont.h>
pfFBState	<Performer/pr/pfFBState.h>
pfGeoSet pfHit	<Performer/pr/pfGeoSet.h>
pfGeoState	<Performer/pr/pfGeoState.h>
pfHighlight	<Performer/pr/pfHighlight.h>
pfIBRtexture	<Performer/pr/pfIBRtexture.h>
pfPassList	<Performer/pr/pfPassList.h>

Table 26-4 Header Files for libpr Graphics Classes (**continued**)

libpr Class	Include File
pfLPointState	<Performer/pr/pfLPointState.h>
pfLight pfLightModel	<Performer/pr/pfLight.h>
pfMaterial	<Performer/pr/pfMaterial.h>
pfSprite	<Performer/pr/pfSprite.h>
pfState	<Performer/pr/pfState.h>
pfString	<Performer/pr/pfString.h>
pfTexture pfTexGen pfTexEnv	<Performer/pr/pfTexture.h>

Table 26-5 Header Files for Other libpr Classes

libpr Class	Include File
pfCycleBuffer pfCycleMemory	<Performer/pr/pfCycleBuffer.h>
pfDataPool	<Performer/pr/pfDataPool.h>
pfEngine	<Performer/pr/pfEngine.h>
pfFile	<Performer/pr/pfFile.h>
pfFlux	<Performer/pr/pfFlux.h>
pfSphere pfBox pfCylinder pfPolytope pfFrustum pfSeg pfSegSet	<Performer/pr/pfGeoMath.h>

Table 26-5 Header Files for Other libpr Classes (continued)

libpr Class	Include File
pfVec2	<Performer/pr/pfLinMath.h>
pfVec3	
pfVec4	
pfMatrix	
pfQuat	
pfMatStack	
pfList	<Performer/pr/pfList.h>
pfMemory	<Performer/pr/pfMemory.h>
pfObject	<Performer/pr/pfObject.h>
pfQueue	<Performer/pr/pfQueue.h>
pfStats	<Performer/pr/pfStats.h>
pfType	<Performer/pr/pfType.h>
pfWindow	<Performer/pr/pfWindow.h>
pfVideoChannel	<Performer/pr/pfVideoChannel.h>

There are additional C++ object classes in the utility libraries. Header files for those classes are similarly named with their own library name for the directory and prefix for the header file name. The libpui C++ has a full C++ API and its header files are named like the example <Performer/pfui/pfiTrackball.h>. The libpfutil library has some C++ classes and the header files are named as <Performer/pfu/pfuProcessManager.h>.

Creating and Deleting OpenGL Performer Objects

The OpenGL Performer base classes all provide *operator new* and *operator delete*. All libpr and libpf objects, except pfObject, pfMemory, and their derivatives, must be explicitly created with *operator new* and deleted with *operator delete*. Objects of these classes cannot be created statically on the stack or in arrays.

All objects of classes derived from pfObject or pfMemory are reference counted and must be deleted using **pfDelete()**, rather than the delete operator. **pfDelete()** checks the

reference count of the object and, when multiprocessing, delays the actual deletion until other processes are done with the object. To decrement the reference count and delete with a single call use **pfUnrefDelete()**.

Note: Public structs such as `pfVec3`, `pfSphere`, etc. may be deleted either with **pfDelete()** or the delete operator.

The default new operator creates objects in the current shared memory arena if one exists. `libpr` objects and public structures have an additional new operator that takes an arena argument. This new operator allows allocation from the heap (indicated by an arena of `NULL`) or from a shared memory arena created by the application with **acreate()**.

Example 26-1 Valid Creation of Objects in C++

```
// valid creation of libpf objects
pfDCS    *dcs = new pfDCS;           // only way

// valid creation of libpr objects
pfGeoSet *gs = new pfGeoSet;        // from default arena
pfGeoSet *gs = new(NULL) pfGeoSet; // from heap

// valid creation of public structs
pfVec3   *vert = new pfVec3;        // from default arena
pfVec3   *verts = new pfVec3[10];   // array from default
static pfVec3 vert(0.0f, 0.0f, 0.0f); // static
```

Example 26-2 Invalid Creation of Objects in C++

```
// invalid creation of libpf objects
pfDCS    *dcs = new(NULL) pfDCS;    // not in shared mem
pfDCS    *dcs = new pfDCS[10];      // array

// invalid creation of libpr objects
pfGeoSet *gs = new pfGeoSet[10];    // array

// invalid creation of public structs
pfVec3   *vert = new(NULL) pfVec3[10]; // array, non-default new
```

Caution: This last item in Example 26-2 is invalid because C++ does not provide a mechanism to delete arrays of objects allocated with a new operator defined to take additional arguments, for example, `operator new(size_ts, void *arena)`. Attempting to

delete an array of objects allocated in this manner can cause unpredictable and fatal results such as the invocation of the destructor a large number of times on pointers inside and outside of the original allocation.

Invoking Methods on OpenGL Performer Objects

Since `libpr` and `libpf` objects are allocated, they can only be maintained by reference.

Passing Vectors and Matrices to Other Libraries

Passing arrays of floats is very common in graphics programming. Calls to OpenGL often require an array of floats or a matrix. In the C API, the data types such as `pfMatrix` are arrays and so can be passed straight through to OpenGL routines; the following is an example:

```
pfMatrix ident;  
pfMakeIdentMat(ident);  
glLoadMatrix(ident);
```

In the C++ API, the data field of the `pfMatrix` must be passed instead, as in this example:

```
pfMatrix ident;  
ident.makeIdent();  
glLoadMatrix(ident.mat);
```

Porting from C API to C++ API

When compiled with C++, OpenGL Performer supports three usages of the API:

1. Pure C++ API. This is the default style of usage.
2. Pure C API. This can be achieved by defining the token `PF_CPLUSPLUS_API` to be 0, for example, by adding the following line in source files before they include any OpenGL Performer header files:

```
#define PF_CPLUSPLUS_API 0
```

In this mode all data types are the same as when compiling with C.

3. C++ API and C API. This mode can be enabled by defining the token `PF_C_API` to be 1, for example, by adding the following line in source files before they include any OpenGL Performer header files:

```
#define PF_C_API 1
```

In this mode, both C++ and C functions are available and data types are C++. See the section below concerning passing certain data types.

Typedefed Arrays Versus Structs

In the C API, the `pfVec2`, `pfVec3`, `pfVec4`, `pfMatrix` and `pfQuat` data types are all typedefed arrays. In the C++ API, they are all structs. When converting C code to use the C++ API or when compiling C API code with both APIs enabled, be sure to change routines in your code that pass objects of these types. In the C++ API, you almost always want to pass arguments of these types by reference rather than by value.

For example, the following C API routine should be rewritten for the C++ API to pass by reference:

```
void MyVectorAdd(pfVec2 dst, pfVec2 v1, pfVec2 v2)
{
    dst[0] = v1[0] + v2[0];
    dst[1] = v1[1] + v2[1];
}
```

Two possible alternatives follow:

```
void MyVectorAdd(pfVec2& dst, pfVec2& v1, pfVec2& v2)
{
    dst[0] = v1[0] + v2[0];
    dst[1] = v1[1] + v2[1];
}
```

or

```
void MyVectorAdd(pfVec2* dst, pfVec2* v1, pfVec2* v2)
{
    dst->vec[0] = v1->vec[0] + v2->vec[0];
    dst->vec[1] = v1->vec[1] + v2->vec[1];
}
```

Without this change, time will be wasted copying `v1` and `v2` by value and the result will not be returned to the routine calling `MyVectorAdd()`.

Interface Between C and C++ API Code

The same difference in passing conventions applies if you are calling a C function from code that uses the C++ API. Functions passing typedefed arrays with the C API must have a different prototype for use with the C++ API. Macros for use in C prototypes bilingual can be found in `/usr/include/Performer/prmath.h` for IRIX and Linux and in `%PFROOT%\Include\prmath.h` for Microsoft Windows.

```
#if PF_CPLUSPLUS_API
#define PFVEC2 pfVec2&
#define PFVEC3 pfVec3&
#define PFVEC4 pfVec4&
#define PFQUAT pfQuat&
#define PFMATRIX pfMatrix&
#else
#define PFVEC2 pfVec2
#define PFVEC3 pfVec3
#define PFVEC4 pfVec4
#define PFQUAT pfQuat
#define PFMATRIX pfMatrix
#endif /* PF_CPLUSPLUS_API */
```

These macros are used in the C API prototypes for OpenGL Performer that pass typedefed arrays, as shown in the following example:

```
extern float pfDotVec2(const PFVEC2 v1, const PFVEC2 v2);
```

But they are not necessary or appropriate for when passing pointers to typedefed arrays in C, because a pointer to a struct is passed in the same manner as a pointer to an array. This is shown in the following example:

```
extern void pfFontCharSpacing(pfFont *font, int ascii,
                             pfVec3 *spacing);
```

Subclassing pfObjects

With the C API, the main mechanism for extending the functionality of the classes provided in OpenGL Performer is the specification of the user data pointer on pfObjects with `pfUserData()` and the specification of callbacks on pfNodes with `pfNodeTravFuncs()` and `pfNodeTravData()`. The C++ API also supports these mechanisms, but also provides the additional capacity to subclass new data types from the classes defined in OpenGL Performer. Subclassing allows additional member data

fields and functions to be added to OpenGL Performer classes. At its simplest, subclassing merely provides a way of adding additional data fields that is more elegant than hanging new data structures off of a `pfObject`'s user data pointer. But in some uses, subclassing also allows significantly more control over the functional behavior of the new object because virtual functions can be overloaded to bypass, replace, or augment the processing handled by the parent class from OpenGL Performer.

Initialization and Type Definition

The new object should provide two static functions, a constructor that initializes the instances `pfType*`, and a static data member for the type system as shown in the following table:

Table 26-6 Data and Functions Provided by User Subclasses

Class Data or Function	Function
static void <code>init()</code>	Initializes the new class.
static <code>pfType*</code> <code>getClassType()</code>	Returns the <code>pfType*</code> of the new class.
static <code>pfType*</code> <code>classType</code>	Stores the <code>pfType*</code> of the new class.
constructor	Sets the <code>pfType*</code> for each instance.

The `init()` member function should initialize any data structures that are related to the class as a whole, as opposed to any particular instance. The most important of these is the entry of the class into the type system. For example, the Rotor class defined in the Open Inventor loader (see `Rotor.h` and `Rotor.C` in `/usr/share/Performer/src/lib/libpfdp/libpfdp` for IRIX and Linux and in `%PFROOT%\Src\lib\libpfdp\libpfdp` for Microsoft Windows) is a subclass of `pfDCS`. Its initialization function merely enters the class into the type system.

Example 26-3 Class Definition for a Subclass of `pfDCS`

```
public Rotor : public pfDCS
{
    static void init();
    static pfType* getClassType(){ return classType; };
    static pfType* classType;
}

pfType *Rotor::classType = NULL;
```

```

Rotor::Rotor()
{
    setType(classType); // set the type of this instance
    ...
}

void
Rotor::init()
{
    if (classType == NULL)
    {
        pfDCS::init();
        classType =
            new pfType(pfDCS::getClassType(), "Rotor");
    }
}

```

As described in the following section, the initialization function, **Rotor::init()** should be called before **pfConfig()**.

Defining Virtual Functions

Below is the example of the Rotor class, which specifies the traversal function for the libpf application traversal. When overloading a traversal function, it is usually desirable to invoke the parent class function, in this case, **pfDCS::app()**. It is not currently possible to overload libpf's intersection or culling traversals. See "Multiprocessing and libpf Objects" on page 889.

Example 26-4 Overloading the libpf Application Traversal

```

int
Rotor::app(pfTraverser *trav)
{
    if (enable)
    {
        pfMatrix mat;
        double now = pfGetFrameTimeStamp();

        // use delta and renorm for large times
        prevAngle += (now - prevTime)*360.0f*frequency;
        if (prevAngle > 360.0f)
            prevAngle -= 360.0f;
    }
}

```

```
        mat.makeRot(prevAngle, axis[0], axis[1], axis[2]);
        setMat(mat);
        prevTime = now;
    }

    return pfDCS::app(trav);
}

int
Rotor::needsApp(void)
{
    return TRUE;
}
```

The same behavior could also be implemented in either the C or C++ OpenGL Performer API using a callback function specified with **pfNodeTravFuncs()**.

Note: Classes of pfNodes that need to be visited during the application traversal even in the absence of any application callbacks should define the virtual function **needsApp()** to return TRUE.

Accessing Parent Class Data Members

Accesses to parent class data is made through the functions on the parent class. Data members on built-in classes should never be accessed directly.

Multiprocessing and Shared Memory

Note: This section does not pertain to Microsoft Windows.

Initializing Shared Memory

In general, to assure safe multiprocess operation with any DSOs providing C++ virtual functions or defining new pfTypes, initialization should be carried out in the following sequence:

1. Call **pfInit()**. This initializes the type system and, for `libpf` applications, sets up shared memory.
2. Call the init function for utility libraries that you are using if you use their C++ API. This includes **pfuInit()** for `libpfutil` and **pfInit()** for `libpfui`.
3. Initialize any application-supplied classes:
 - a. Load any application-specific C++ DSOs.
 - b. Call **pfInitConverter()** to initialize and load any converter DSOs and allow those DSOs to initialize any potential C++ classes.
 - c. Enter any user-supplied `pfTypes` into the type system; for example, call this function:

```
Rotor::init()
```
4. Call **pfConfig()**. This forks off other processes as specified by **pfMultiprocess()**. New `pfTypes` created after this point cannot be used in any forked processes.
5. Create `libpf` and `libpr` objects.

Note: Pure `libpr` applications that do their own multiprocessing outside of OpenGL Performer with **fork()** should explicitly create shared memory with **pfInitArenas()** before calling **pfInit()**. Otherwise, the type system will not be visible in the address space of other processes.

More on Shared Memory and the Type System

Note: This is an advanced section.

OpenGL Performer objects or other objects that use `pfTypes` can only be shared between related processes. Related processes are those created with **fork()** or **sproc()** from the main process after **pfInit()** in a `libpf` application, for example, processes created by **pfConfig()**.

New `pfTypes` should be added before **pfConfig()** forks off other processes so that the static data member containing the class type is visible in all processes, otherwise `pf<Class>::getClassType()` will return NULL in other processes. This effectively precludes the creation of subclasses of OpenGL Performer objects after **pfConfig()**.

Virtual Address Spaces and Virtual Functions

Note: This is an advanced section.

When using virtual functions, it is very important that the object code reside at the same address in all processes. Normally, this is not an issue since the object code for all OpenGL Performer classes is loaded (whether statically linked or loaded as dynamic shared objects, DSOs) before **pfConfig()** is called to fork off processes. For user-defined C++ classes with virtual functions, it is important that the object code reside at the same virtual address space in all processes that access them. For this reason, the DSOs for any user-defined classes should be loaded before **pfConfig()**, regardless of whether they use the pfType system or not.

Data Members and Shared Memory

Non-static Member Data

The default operator new for objects derived from pfObject causes all instances to be created in shared memory so that objects will be visible to other related processes that need to see them.

Static Member Data

Classes having static data members that may change value and need to be visible from all processes should allocate shared memory for the data (for example, pfMalloc or new pfMemory) and set the static data member to point to this memory before **pfConfig()** as shown in the following example.

Example 26-5 Changeable Static Data Member

```
class Rotor : public pfDCS
{
    static int* instanceCount;
}
Rotor::instanceCount = NULL;

void Rotor::init()
{
    ...
}
```



```
        instanceCount = new(sizeof(int)) pfMemory;
        *instanceCount = 0;
    }
Rotor::Rotor()
{
    ...
    (*instanceCount)++; // increment the creation counter
}
```

A static data member whose value is set before **pfConfig()** and never changes thereafter does not need to be allocated from shared memory. The classType member of Rotor is an example of this since the class should be initialized; that is, call **Rotor::init()** before **pfConfig()**.

Multiprocessing and libpf Objects

Note: This is an advanced topic.

The multiprocessing behavior of `libpf` objects (that is, those deriving from `pfNode` or `pfUpdatable`) differs from that of `libpr` objects. Both are typically created in shared memory but, with a `libpr` object, all processes share the same data members while `libpf` objects have a built-in multiprocessing data mechanism that provides different copies in the APP, CULL, and ISECT stages of the OpenGL Performer pipeline. The term *multibuffering* refers to the maintenance and frame-accurate updating of these data.

With a user-defined subclass of a `libpf` class, the original data elements of the `libpf` parent class are still multibuffered. However, the parallel multibuffer copies maintained in the other processes are instances of the parent class rather than the subclass. This is not normally visible to the application, since even for callbacks in the CULL and ISECT processes, the application always works from the pointer to the copy used in the APP process, in part, so that objects can be identified by comparison of pointers. However, this difference would be visible if the virtual traversal functions for culling or intersection were overloaded. These virtual functions should not be overloaded by the subclass since they will not have any effect when the CULL or ISECT stages are in separate processes. Node callbacks specified with **pfNodeTravFuncs()** should be used instead.

If you require multibuffering of your subclassed data members, use a `pfCycleBuffer` or a `pfFlux` to hold this data.

Performance Hints

Constructor Overhead

It is quite natural to frequently construct and destroy arrays of public structs such as `pfVec3` on the stack. Beware, even though the constructors for these classes are empty, it still requires a function call for each element of the array. The same applies to classes that contain arrays of structs; for example, `pfSegSet` contains an array of `pfSegs`.

Math Operators

Assignment operators, for example, `“+=”`, are significantly faster than their corresponding binary operators, for example, `“+”`, because the latter involves constructing a temporary object for the return value.

Glossary

alias

An alternate extension for a file type as processed by the **pfdLoadFile()** utility. For example, VRML “.wrl” files are in a sense an alias for Open Inventor “.iv” files since the Open Inventor loader can read VRML files as well. Once the alias is established, files with alternate extensions will be loaded by the designated loader.

application buffer

The main (and usually only) buffer of `libpf` data structures such as the nodes in the scene graph. Alternate buffers may be created and data can be constructed in these new buffers from parallel processes to support high-performance asynchronous database paging during real-time simulation.

arena

An area (allocation area) from which shared memory is allocated. Usually the arena is the default one created by **pflnit()** or **pflnitArenas()**, but some objects (for example, those in `libpr`) may be created in any arena returned by **acreate()**. OpenGL Performer calls that accept an arena pointer as an argument can also accept the NULL pointer, indicating that the memory should be allocated from the heap. See also *heap*.

asynchronous database paging

Asynchronous database paging, an advanced method of scene-graph creation, allows desired data to be read from a disk or network connection and OpenGL Performer internal data structures to be built for this data using one or more processes running on separate CPUs rather than performing these tasks in the application process. Once the data structures are created in these database processes, they must be explicitly merged into the application buffer.

attribute binding

The binding of an attribute specifies how often an attribute is specified and the scope of each specification. For example, given a collection of triangles for rendering, a color can be specified with each vertex of each triangle, with each triangle, or once for the entire collection of triangles.

base geometry

The object with the lowest visual priority in a `pfLayer` node's list of children. This would be the runway, for example, in a runway and stripes airport database example. See also *layer geometry*.

bezel

The beveled border region surrounding any item, but most notably, around the edge of a CRT monitor.

billboard

Geometry that rotates to follow the eyepoint. This is often simply a single texture-mapped quadrilateral used to represent an object that has roughly cylindrical or spherical symmetry, such as a tree or a puff of smoke, respectively. OpenGL Performer supports billboards that can rotate about an axis for cylindrical objects or a point for spherical objects.

binning

The action of the sort phase of `libpf`'s cull traversal that segregates drawable geometry into major sections (such as opaque and transparent) before the per-bin sorting based on the contents of associated `pfGeoStates` so that state changes can be reduced by drawing groups of similar geometry sequentially while still drawing semitransparent objects in the desired order within the frame.

bins

The unique collections into which the cull traversal segregates drawable geometry. The number of bins is defined by calls to `pfChanBinSort()` and `pfChanBinOrder()`. Typical bins are those for opaque and transparent geometry, where opaque objects are rendered first for superior image quality when using blended transparency.

blur margin

A parameterized value used to control blurring and flickering of textures.

bounding volume

A convex region that encompasses a geometric object or a collection of such objects. OpenGL Performer `pfGeoSets` have axis-aligned bounding boxes, which are rectangular boxes whose faces are along the X, Y, or Z axes. Each OpenGL Performer `pfGeode` has a bounding sphere that contains the bounding box of each `pfGeoSet` in the `pfGeode`. OpenGL Performer group nodes have hierarchical bounding spheres that contain (bound) the geometry in their descendent nodes. The purpose of bounding volumes is to

allow a quick test of a region for being off-screen or out of range of intersection search vectors.

buffer scope

All OpenGL Performer nodes are created in a `pfBuffer`, either the primary application buffer or in an alternate returned by `pfNewBuffer()`. Only one `pfBuffer` is considered “current,” and this buffer can be selected using `pfSelectBuffer()`. All new nodes are created in the current `pfBuffer` and will be visible only in the current buffer until that `pfBuffer` is merged into the application buffer using `pfMergeBuffer()`. A process cannot access nodes that do not have scope in its current buffer except through the special “buffer” commands: `pfBufferAddChild()`, `pfBufferRemoveChild()`, and `pfBufferClone()`. Thus, they are said to have buffer scope.

channel

A visual channel specifies how a geometric scene should be rendered to the display device. This includes the viewport area on the screen as well as the location, orientation, and field of view associated with the viewer or camera.

channel group

A set of channels that share attributes such as the eyepoint or callbacks. When a shared attribute is set on any member of the group, all members get the new value. Channel groups are most commonly used for adjacent displays making up a panorama.

channel share mask

A bit mask indicating the attributes that are shared by all channels in a *channel group*. Typical shared attributes are field of view, view specification, near and far clipping distances, the scene to be drawn, stress parameters, level of detail parameters, the earth/sky model, and swapbuffer timing.

children

OpenGL Performer’s hierarchical scene graph of `pfNodes` has internal nodes derived from the `pfGroup` class, and each node attached below a `pfGroup` type node is known as a child of that node. The complete list of child nodes are collectively termed the children of that node.

class hierarchy

The source through which OpenGL Performer classes are defined. This class hierarchy defines the data elements and member functions of these data types through the notion of *class inheritance*.

class inheritance

Class inheritance describes the process of defining one object as a special version of another. For example, a `pfSwitch` node is a special version of a `pfGroup` node in that it has control information about which children are active for drawing or intersection. In all other respects, a `pfSwitch` has the same capabilities as a `pfGroup`, and the OpenGL Performer API supports this notion directly in both the C and C++ API by allowing a `pfSwitch` node to be used wherever a `pfGroup` is called for in a function argument. This same flexibility is supported for all derived types.

clipped

Geometry is said to be clipped when some or all of its geometric extent crosses one or more clipping planes and the portion of the geometry beyond the clipping plane is mathematically trimmed and discarded.

clipping planes

The normal clipping planes are those that define the viewing frustum. These are the left, right, top, bottom, near, and far clipping planes. All rendered geometry is clipped to the intersection of the half-spaces defined by these planes and only the portion inside all six is displayed by the graphics hardware.

clip texture

This entity virtualizes MIPmapped textures using hardware and software support so that only the texels in the region close to the viewer (known as the clipped region) need to be loaded in texture memory. Also known as ClipMaP.

cloned instancing

The style of instancing that creates a (possibly partial) copy of a node hierarchy rather than simply making a reference to the parent node. This allows `pfDCS` nodes and other internal nodes to be changed in the copy without changing those in the original. Also see *shared instancing*.

cloning

Making a copy of a data structure recursively copying down to some specified level. In OpenGL Performer `pfCopy()` creates a shallow copy. `pfClone()` creates a deeper copy that creates new copies of internal nodes but not of leaf nodes. This means that the `pfDCS`, `pfSwitch`, and other internal nodes in the cloned hierarchy are separate from those in the original.

compiled mode

OpenGL Performer pfGeoSets are designed for rapid immediate-mode rendering and in most situations outperform OpenGL display list usage. In those cases where GL display lists are desired, pfGeoSets may be placed in compiled mode, whereby a GL display list will be created the first time the pfGeoSet is rendered and this display list will be used for subsequent renderings until the pfGeoSet compiled mode flag is explicitly reset. Once a pfGeoSet is compiled, any changes to its data arrays by the pfMorph node or other means will not be effective until the compiled-mode flag is cleared.

complex pixels

Pixels for which several different geometric primitives contribute to the pixel's assigned color value. Such pixels are rare in typical scenes and only exist at edges of polygons unless multisample blending is in use. When this blending mode is used, all pixels rendered as neither fully opaque nor fully transparent are complex pixels.

cost tables

OpenGL Performer contains texture download cost tables, which DTR uses to estimate the time it will take to carry out those texture subloads.

critically damped

A closed-loop control system notion where the feedback transfer function is just right: not so slow that the system goes out of range before correction is applied and not so fast that overcorrection causes rapid swings or variation. This should be the goal of any user-specified stress management function.

cull

See *culling*.

cull volume visualization

The visual display of the culling volume, usually the same as the viewing frustum, to which the scene is culled before rendering. Normally the projected culling volume fills the display area. By rendering with a larger field of view or from an eyepoint that differs from the origin of the frustum, the tightness of culling can be determined for database tuning. The culling volume itself is often drawn in wireframe.

culling

Discarding database objects that are not visible. Usually this refers to discarding objects located outside the current *viewing frustum*. This is done by comparing the bounding volume of these database objects with the six planes that bound the frustum. Objects

completely outside may be safely discarded. See also *occlusion culling*.

data fusion

OpenGL Performer's ability to read data in a variety of different database formats and convert it into the internal OpenGL Performer scene database format. Further, the ability of these different formats to provide special run-time behavior using callback functions or node subclassing and to have these different data formats all active in their native modes simultaneously.

database paging

Loading databases from disk or network into memory for traversal during real-time simulation. Database paging is implicit in large area simulations due to the huge database sizes inherent in any high-resolution earth database. A frequent component of database paging is texture paging, in which new textures are downloaded to the graphics system at the same time new geometry is loaded from disk.

debug libraries

OpenGL Performer libraries compiled with debugging symbols left in are known as debug libraries. These libraries provide greater and more accurate stack trace information when examining core dumps, such as during application development.

decal geometry

Objects that appear "above" other objects in pfLayer geometry. In a runways-and-stripes example, the stripes would be the decal geometry. There can be multiple layers of decals with successively higher visual priorities. See *layer geometry*.

depth complexity

The "pixel-rendering load" of a frame, which is defined as the total number of pixels written divided by the number of pixels in the image. For example, an image of two full-screen polygons would have a depth complexity of 2. It is often observed that different types of simulation images have predictable depth complexities with values ranging from a low of 2.5 for high altitude flight simulation to 4 or more for ground-based simulations. These figures can serve as a guide when configuring hardware and estimating frame rates for visual simulation systems. OpenGL Performer fill statistics provide detailed accounting and real-time visualization of depth complexity, as seen in *Perfly*.

displace decaling

An implementation method for decal geometry that uses a Z-displacement to render coplanar geometry. The actual displacement used is a combination of a fixed offset and a range-based scaled offset, which are combined to produce the effective offset.

display list

A list into which graphics commands are placed for efficient traversal. Both OpenGL Performer and the underlying OpenGL graphics library have their own display list structures.

DLL

See *dynamic link library*.

draw mask

A bitmask specified for both pfNodes and pfChannels, which together selects a subset of the scene graph for rendering. The node and channel draw masks are logically ANDed together during the CULL traversal, which prunes the node if the result is zero. Draw masks may be used to “categorize” the scene graph, where each bit represents a particular characteristic. Each node contains these masks, binary values whose bits serve as flags to indicate if the node and its children are considered drawable, intersectable, selectable, and so on. Most of these bits are available for application use.

drop

Refers to frame processing. When in locked or fixed phase and a processing stage takes too long, the frame is dropped and not rendered. Dropped frames are a sure sign of system overload.

DSO

See *dynamic shared object*.

dynamic

Something that is updated automatically when one of its attributes or children in a scene graph changes. Often refers to the update of hierarchical bounding volumes in the scene graph.

dynamic link library (DLL)

The Microsoft Windows equivalent of a DSO.

dynamic shared object (DSO)

A library that is not copied into the final application executable file but is instead loaded dynamically (that is, when the application is launched). Since DSOs are shared, only one copy of a given DSO is loaded into memory at a time, no matter how many applications are using it. DSOs also provide the dynamic binding mechanism used by the OpenGL Performer database loaders.

Euler angles

A set of three angles used to represent a rotation.

See *heading*, *pitch*, and *roll*.

fade count

The application sets a fade count to control the number of frames over which a new DTR level is faded in.

fixed frame rate

Rendering images at a consistent chosen frame rate. Fixed frame rates are a central theme of visual simulation and are supported in OpenGL Performer using the PFPHASE_LOCK and PFPHASE_FLOAT modes. Maintaining a fixed frame rate in databases of varying complexity is difficult and is the task of OpenGL Performer stress processing, which changes LOD scales based in measured system load.

flattening

Flattening consists of taking multiple instances of a single object and converting them into separate objects (deinstancing) and then applying any static transformations defined by pfSCS nodes to the copied geometry; this action improves performance at a cost in memory space.

flimmering

The visual artifact associated with improperly drawing coplanar Z-buffered geometry. For synonyms, consider *flutter*, *flicker*, *sparkle*, *twinkle*, and *vibrate*. One way to understand flimmering is to consider the screen space interpolation of Z-depth values, wherein a discrete difference of depth must be interpolated across a discrete number of pixels (or sub-pixels). When two polygons that would be coplanar in an infinite precision real-number context are considered in this discrete interpolation space, it is clear that the interpolated depth values will differ when the delta-Z to delta-pixels ratios are relatively prime. The image that results is essentially a Moirè pattern showing the modular relationship of the differences in the least significant bits of interpolated depth between the polygons. The `libpr pfDecal()` function and `libpf pfLayer()` node exist to handle

the drawing of coplanar geometry without flimmering.

floating phase

The style of frame overload management where the next frame after an overloaded frame is allowed to start at any vertical retrace boundary rather than being forced to wait for a specific boundary as in the LOCKED phase.

frame

The term frame is used to mean “image” in most OpenGL Performer contexts. The image being rendered by the hardware is drawn into a “frame buffer” which is simply an image memory. This image, when delivered by video signals to a monitor or projector, exists as one or two video fields. In the one-field case, also known as non-interlaced, each row of the image is read from the frame buffer and generated as video in sequential order. In the interlaced method, the first field of display comprises alternate lines, one field for the odd lines and one field for the even lines. In this mode a frame consists of two fields, as the norm for NTSC broadcast video. Also, the frame is the unit of work in OpenGL Performer; the main loop in any Performer application consists of calls to **pfFrame()**.

frame-accurate

In a pipelined multiprocessing model, at any particular time the different stages of the pipeline are working on different frames. Data in the pipeline is called frame-accurate when a change made to the data in a particular frame is not visible in downstream stages of the pipeline until those stages begin processing that frame. Processing of `libpf` objects are frame-accurate because multiple copies of data are retained for the different pipeline stages.

free-running

The unconstrained phase relationship of image generation where frame rendering is initiated as soon as the previous frame is complete without consideration of a minimum or maximum frame rate.

frustum

A truncated pyramid—two parallel rectangular faces, one smaller than the other, and four trapezoidal faces that connect the edges of one rectangular face with the corresponding edges of the other rectangular face.

gaze vector

The +Y axis from the eyepoint—informally, the direction the eye is facing.

graph

A network of nodes connected by arcs. An OpenGL Performer scene graph is so termed due to its having this form. In particular, an OpenGL Performer scene graph must be an acyclic graph. See also *scene graph*.

graphics context

The set of modes and other attributes maintained by OpenGL in both system software and the hardware graphics pipeline that defines how subsequent geometry is to be rendered. It is this information which must be saved and restored when drawing occurs in multiple windows on a single graphics pipeline.

graphics state elements

Individual `libpr` state components, such as material color, line stipple pattern, point size, current texture definition, and the other elements that comprise the graphics context.

heading

In the context of X-axis to the right, Y-axis forward, and Z-axis up, the heading is rotation about the Z-axis. This is the disturbing rotation that pivots your car clockwise or counterclockwise during a skid. Heading is also known as yaw, but OpenGL Performer uses the term heading to keep the H, P, and R abbreviations distinct from X, Y, and Z. Also see *Euler angles*.

heap

The process heap is the normal area from which memory is allocated by `malloc()` when more memory is required; `sbrk()` is automatically called to increase the process virtual memory. Also see *arena*.

identity matrix

A square matrix with ones down the main diagonal and zeroes everywhere else. This matrix is the multiplicative identity in matrix multiplication.

immediate-mode rendering

Immediate-mode rendering operations are those that immediately issue rendering commands and transfer data directly to the graphics hardware rather than compiling commands and data into data structures such as display lists. See *compiled mode*.

instancing

An object in the scene is called instanced if there is more than one path through the scene graph that reaches it. Instancing is most commonly used to place the same model in more than one location by instancing it under more than one pfDCS transformation node.

intersection pipeline

Like the rendering pipeline, OpenGL Performer supports a two-stage multiprocessing pipeline between the APP and ISECT processes. See also *rendering pipeline*.

latency

The amount of time between an input and the response to that input. For example, rendering latency is usually defined as the time from which the eyepoint is set until the display devices scan out the last pixel of the first field corresponding to that eyepoint.

latency-critical

Operations that must be performed during the current frame and that will reliably finish quickly. An example of this would be reading the current position of a head-tracking device from shared memory.

layer geometry

Objects that appear “above” other objects in pfLayer geometry. In a runways-and-stripes example, the stripes would be the decal geometry. There can be multiple layers of decals with successively higher visual priorities. See also *base geometry*.

level of detail (LOD)

The idea of representing a single object, such as a house, with several different geometric models (a cube, a simple house, and a detailed house, for example) that are designed for display at different distances. The models and ranges are designed such that the viewer is unaware of the substitutions being made. This is possible because distant objects appear smaller and thus can be rendered with less detail. The OpenGL Performer pfLOD node and the associated pfLODState implement this scheme.

libpf

One of OpenGL Performer’s two core libraries. libpf manages multiprocessing and scene graph traversals. Built on top of libpr. Multiple copies of libpf objects are automatically maintained so that the APP, CULL, and ISECT stages of the processing pipeline do not collide.

libpfdu

OpenGL Performer's database utilities library. It is layered on top of `libpbf` and `libpr` and includes functions for building and optimizing geometry before putting it into a scene graph.

libpfutil

OpenGL Performer's general utility library, which is distributed in source form for both usage and information.

libpr

One of OpenGL Performer's two core libraries. `libpr` manages graphics state and rendering, while also providing a number of math and shared memory utility functions. Provides the foundation for `libpbf`. All processes share the same copy of `libpr` objects.

libpr classes

The low-level structured data types of `libpr`. These objects—with the exception of `pfCycleBuffers`—lack the special multibuffered, multiprocess data-exclusion support that `libpbf` objects provide.

light point

A point of light such as a star or a runway light. Accurate display of light points requires that they attenuate and fog differently than other geometry (see *punch through*). In flight simulation, light points often have additional parameters concerning angular distributions of illumination.

load

The processing burden of rendering a frame. This includes both processing performed on the host CPU and in the graphics subsystem. It is the maximum of these times (sum in single process mode) that is used to compute the system stress level for adjusting `pfLODState` values.

locked phase

A style of frame-overload processing where drawing may only begin on specific vertical retraces, namely those that are an integer multiple of the basic frame rate.

morph attribute

One of the collections of arrays of floating point data used in the `pfMorph` node's linear combination processing. This process multiplies each element of each source array by a changeable weight value for that source array and sums the result of these products to

produce the destination array.

morphing

The mathematical manipulation of pfGeoSet data (positions, normals, colors, texture coordinates) to cause a shape-shifting behavior. This is very useful for animated characters, continuous terrain level of detail, smooth object level of detail, and a number of advanced applications. In OpenGL Performer, morphing is provided by the pfMorph node.

multiple inheritance

Deriving a class from more than one other class. This is in contrast to single inheritance in which a type hierarchy is a tree. OpenGL Performer does not use multiple inheritance.

multithreaded

In the context of OpenGL Performer culling, multithreading is an option for increased parallelism when multiple pfChannels exist in a single OpenGL Performer rendering pipeline. In this case, multiple cull processes are created to work on culling the channels of a pfPipe in parallel. For example, a single OpenGL Performer pipeline stage (such as the CULL) is multithreaded when configured as multiple, concurrent processes. These “threads” are not arranged in pipeline fashion but work in parallel on the same frame.

mutual exclusion

Controlling access to a data structure so that two or more threads in a multiprocessing application cannot simultaneously access a data structure. Mutual exclusion is often required to prevent a partially updated data structure from being accessed while it is in an invalid state.

node

An OpenGL Performer `libpf` data object used to represent the structure of a visual scene. Nodes are either leaf nodes that contain `libpr` geometry or are internal nodes derived from pfGroup that control and define part of the scene hierarchy.

nonblocking file access

A method of obtaining data from a file without having to wait for any other processes to finish using the file. Such accesses involve a two-step transaction in which the application first indicates the task to be performed and is given a handle. This handle can later be used to inquire about the status of the file action: it is in progress, it has completed, or there has been an error.

non-degrading priorities

Process priorities are used by the operating system to decide when and for how long processes should run. A non-degrading priority specifies that the process scheduling should not take into account how long the process has been running when deciding whether to let another process run. The use of non-degrading priorities is important for real-time performance.

occlusion culling

The discarding of objects that are not visible because they are occluded by other closer objects in the scene, for example, a city behind a mountain. See also *culling*.

opera lighting

The generic term for a powerful carbon-arc lamp producing an intense light such as that invented by John H. Kliegl and Anton T. Kliegl for use in public-staged events and cinematographic undertakings that is often mounted within a dual-gimballed exoskeletal framework to afford the lamp sufficient freedom of orientation that the projected beam can be made to track and highlight performers as they move across a stage. The temperature of the thermal plasma that develops between the carbon electrodes of such arc lamps can be determined by spectroscopic investigation of its dissociated condition and has been found to be between 20,000 °C and 50,000 °C. The term can also refer to a stage-lighting technique that projects an image of a background scene onto the stage or screen. Accurate visual simulation of both of these light types (as well as common vehicle headlights, airplane landing lights, and searchlights) is provided by the projected texture capability of the `pfLightSource` node.

overload

A condition where the time taken to process a frame is longer than the desired frame rate allows. This causes the goal of a fixed-frame rate to be unattainable and, thus, is an undesired situation.

overrun

A synonym for overload in the context of fixed frame rate rendering.

pair-wise morphing

The geometric blending of two topologically equivalent objects. Usually this is done by specifying weights for each object, for example, 90% of object A plus 10% of object B. Each vertex in the resulting object is a linear interpolation between the vertices in the original object. See *morphing*.

parent

The OpenGL Performer node directly above a given node is known as the parent node.

passthrough data

Data that is passed down the steps in the rendering pipeline until it reaches a callback. Such data provides the mechanism whereby an application can communicate information between the APP, CULL, and DRAW stages in a pipelined manner without code changes in single-CPU and multiprocessing applications.

path

A series of nodes from a scene graph's root down to a specific node defines a path to that node. When there are multiple paths to a node (thus, the scene graph is really a graph rather than a tree), this path can be important when interpreting an intersection or picking request. For example, if a car model uses instancing for the tires, just knowing that a tire is picked is not sufficient for further processing.

Perfly

The application distributed with OpenGL Performer that serves as a demonstration program. For IRIX and Linux, it is installed in `/usr/sbin` as well as a programming example found in `/usr/share/Performer/src/sample/apps/C` and `/usr/share/Performer/src/sample/apps/C++` for the C and C++ versions, respectively. For Microsoft Windows, it is installed in `%PFROOT%\Bin` as well as a programming example found in `%PFROOT%\Src\sample\apps\C` and `%PFROOT%\Src\sample\apps\C++` for the C and C++ versions, respectively.

phase

An application's synchronization mode—defining how the system behaves if the processing and drawing time for a given frame extends past the time allotted for a frame. See also *locked phase* and *floating phase*.

pipe

Used to refer to both an OpenGL Performer software rendering pipeline and to a graphics hardware rendering pipeline, such as a RealityEngine. See *rendering pipeline*.

pitch

In the context of X-axis to the right, Y-axis forward, and Z-axis up, the pitch is rotation about the X-axis. This is the rotation that would raise or lower the nose of an aircraft. Also see *Euler angles*.

popping

The term for the highly noticeable instantaneous switch from one level of detail to the next when morph or blend transitions are not used. This problem is distracting and should be eliminated in high-quality simulation applications.

process callbacks

The mechanism through which a developer takes control of processing activities in the various OpenGL Performer traversals and major processing stages: the application traversal, the cull traversal, the draw traversal, and the intersection traversal all provide a mechanism for registered process callbacks. These are user functions that are invoked at the beginning of the indicated processing stage and in the process handling the traversal.

projective texturing

A texture technique that allows texture images to be projected onto polygons in the same manner as a slide or movie projector would exhibit keystone distortion when images are cast non-obliquely onto a wall or screen. This effect is perfect for projected headlights and similar lighting effects.

prune

To eliminate a node from further consideration during *culling*.

punch through

Decreasing the rate at which intensely luminous objects such as light points are attenuated as a function of distance. Normal fogging is inappropriate for such objects because up close they are actually much brighter than can be rendered given the dynamic range of the framebuffer and raster display devices.

reference counting

The counter within each pfObject and pfMemory object that keeps track of how many other data structures are referencing the particular instance. The primary purpose is to indicate when an object may be safely deleted because it is no longer referenced.

rendering pipeline

An OpenGL Performer rendering pipeline, represented in an application by a pfPipe. Typically a rendering pipeline has three stages: APP, CULL, and DRAW. These stages may be handled in separate processes or combined into one or two processes.

right-hand rule

Derived from a simple visual example for the direction of positive rotation about an axis, the right-hand rule states that the curled fingers of the right hand indicate the direction of positive rotation when the right hand is placed about the desired axis with the thumb pointing in the positive direction. The positive angle is the one that rotates the primary axes toward each other. For example, a positive rotation (counterclockwise) about the X-axis takes the positive Y-axis into the position previously occupied by the positive Z-axis.

roll

In the context of X-axis to the right, Y-axis forward, and Z-axis up, the roll is rotation about the Y-axis. This is the rotation that would raise and lower the wings of an aircraft, leading to a turn. Also see *Euler angles*.

scene

A collection of geometry to be rendered into a pfChannel.

scene complexity

The complexity of the scene for rendering purposes, in particular the amount of geometry, transformations, and graphics state changes in the scene.

scene graph

A hierarchical assembly of OpenGL Performer nodes linked by explicit attachment arcs that constitutes a virtual world definition for traversal and subsequent display.

search path

A list of directory names given to OpenGL Performer to specify where to look for data files that are not specified as full path names.

sense

An indication of whether a positive angle is interpreted as representing a clockwise (CW) or counterclockwise (CCW) rotation with respect to an axis. All CCW rotations in OpenGL Performer are specified by positive (+) angles and negative angles represent CW rotations.

shadow map

A special texture map created by rendering a scene from the view of a light source and then recording the depth at each pixel. This Z-map is then used with projective texturing in a second pass to implement cast shadows. The entire process is automated by the

OpenGL Performer pfLightSource node.

share groups

The attributes that a slave share mask can track are divided into groups called share groups.

share mask

The share mask associates master and/or slave cliptextures.

shared instancing

The simplest form of instancing whereby two or more parent nodes share the same node as a child. In this situation, any change made to the child will be seen in each instance of that node. Also see *cloned instancing*.

shininess

The coefficient of specular reflectivity assigned to a pfMaterial that governs the appearance of highlights on geometry to which it is bound.

siblings

The name given to nodes that have the same parent in a scene graph.

skip

Refers to frame processing. See *drop*.

sorting

The grouping together of geometry with similar graphics state for more efficient rendering with fewer graphics state changes. OpenGL Performer sorts during scene graph traversal.

spacing

The relative motion required to move the starting point for subsequent pfFont rendering after drawing a particular character pfGeoSet in a pfFont. This motion is a pfVec3 to allow arbitrary escapement for character sets that use vertical rather than horizontal text layouts. Note that for vertically oriented fonts, the origin should be such that motion by the spacing value crosses the character; in other words, the origin should be on the left for left-to-right fonts, at the top for top-to-bottom fonts, on the bottom for bottom-to-top fonts, and on the right for right-to-left fonts.

spatial organization

The grouping together of geometric objects that are spatially close to each other in the scene graph. For optimal culling performance, the scene should be organized spatially.

sprite

A transformation that rotates a piece of geometry, usually textured, so that it always faces the eyepoint.

stage

This is a section of the OpenGL Performer software rendering pipeline, either application, culling, or drawing. Sometimes it is used to refer to either of the two non-pipeline tasks of intersection and asynchronous database processing.

state

Refers to attributes used to render an object that are managed during traversal. State commonly falls into two areas: traversal state that affects which portions of the scene graph are traversed, and graphics state that affects how something is rendered. Graphics state includes the current transformation, the graphics modes managed by `pfGeoStates`, and other states such as stenciling.

stencil decaling

An implementation method for `pfLayer` nodes that uses an extra bit per pixel in the frame buffer to record the Z-buffer pass or fail status of the base geometry. This bit is then used as a visibility determination (rather than the Z-buffer test) for each of the layers, which are rendered in bottom (lowest visual priority) to top (highest visual priority) order. Z-buffer updating is disabled during the stencil rendering operation and is restored when the `pfLayer` node has been completely rendered. Stencil-bit processing is the highest quality mode of `pfLayer` operation.

stress

OpenGL Performer stress processing is the closed-loop feedback mechanism that monitors cull and draw times to determine how `pfLODState` range scale factors should be adjusted to compensate for system load in order to maintain a chosen frame rate.

subgraph

A connected subset of a scene graph; usually, the set consisting of all descendants of a particular node.

texel

Short for “texture element”—a pixel of a texture.

texture mapping

Displaying a texture as though it were the surface of a given polygon.

tile

A section of a spatially subdivided database or a rectangular subregion of a larger texture image.

transformation

Homogeneous 4x4 matrices that define 3D transformations—some combination of scaling, rotation, and translation.

transition distance

The distance at which one level-of-detail model is switched for another. When fading or morphing between levels-of-detail, the distance at which 50% of each model is rendered. See *level of detail*.

traversals

One of OpenGL Performer’s pre-order visitations of a hierarchical scene graph. Traversals for application, culling, and intersection processing are internal to `libpf` and user-written traversals are supported by the `pfuTraverser` tools.

traversing

See *traversals*.

trigger routine

A routine that initiates a traversal or the invocation of a callback in another process. `pfCull()` triggers the cull traversal. `pfFrame()` triggers processing for the current frame.

up vector

The +Z axis of the eyepoint; it defines the display’s “up” direction. Must be perpendicular to the *gaze vector*.

view volume visualization

The display of the viewing frustum for a particular channel, usually done by rendering a wireframe version of the frustum with a different eyepoint or field-of-view. See *cull volume visualization*.

viewing frustum

The *frustum* containing the portion of the scene database visible from the current eyepoint.

viewpoint

The location of the camera or eye used to render the scene.

viewport

The portion of the framebuffer used for rendering. Each pfChannel has a viewport in the framebuffer of its corresponding pfPipeWindow.

visual

A construct that the X Window System uses to identify framebuffer configurations.

widget

A manipulable or decorative element of a graphical user interface. Much of the programming for GUI elements is associated with defining the reaction of widgets to user-mouse and keyboard events.

window manager

A special X Window System client that handles icons, window placement, and window borders and titles.

Index

Numbers

2D tiles, 515
3D characters, 341
3D text, 341
3DS format. See formats

A

accessing GL, 459
acreate(), 652, 880, 891
activation of traversals, 86
active database
 billboards, 75
active scene graph. See application traversal
active surface definition, 147, 691
adding surfaces, 437
addQueryArray, 715
addQueryGeoSets, 715
adjacency information, 385
adjacent surfaces
 tessellation, 433
affine transformations, 771
alias, definition, 891
align geometry, 718
allocating memory. See memory
alpha function, 462
animation, 67, 688
 using quaternions for, 773
anisotropic filtering, 473
antialiasing, 464, 517
APP, 21
application areas
 rapid rendering, xliii
 simulation-based design, xliii
 virtual reality, xliii
 virtual sets, xliii
 visual simulation, xliii
application buffer, 164
 defined, 891
application traversal, 88
ARB fragment programs, 579
ArchVision RPC database format, 273
arenas, 652
 defined, 891
 See also shared memory
arithmetic, precision of, 828
ASD, 147, 691, 699
 and pfEngine, 720
 cliptexture, 717
 flow chart, 696
 paging, 722
 simple example, 697
 vertices, 700
aspect ratio matching, 28
assembly mock-up, xliii
assignment operators, 890
asynchronous database paging, definition, 891
asynchronous database processing, 163

- asynchronous deletion, 164
- asynchronous I/O, 658
- atmospheric effects
 - enabling, 185
- attribute binding, definition, 891
- attribute data structure, 710
- attributes, 704, 710
 - bindings, 314, 824
 - flat-shaded, 315
 - global, 711
 - overview, 312
 - traversals, 86
- AutoCAD, 250
- automatic type casting, 7
- average statistics, 809
 - See also statistics
- avoiding cracks, 433
- axes, default, 30
- axially aligned boxes, 777

B

- backface culling, 160, 173, 174
- base classes, 6
- base geometry, 463
 - definition, 892
- basic-block counting, 829
- behaviors, 88
- bezel, definition, 892
- Bezier curves, 369
- bilinear interpolation, 407
- billboards, 75, 827
 - defined, 892
 - implementation using sprites, 484
- BIN format. See formats
- binary operators, 890

- binning, definition, 892
- bins, 97
 - definition, 892
- blended transparency, 461
- blur, 580
- blur margin, 583, 892
- bottlenecks, 172, 816
 - fill, 818
 - host, 816
 - transform, 817
- bounding volumes
 - defined, 892
 - example code, 59
 - See also volumes
- b-reps, 434
- B-splines See NURBS
- buffer scope, 164
 - defined, 893
- BYU format. See formats

C

- C++, See OpenGL Performer C++ API
- caching
 - intersections, 823
 - state changes, 813
- CAD applications
 - higher-order primitives, 347
 - moving viewpoint, 377
- CAD data
 - NURBS, 366
- callbacks
 - culling, 100, 113-115
 - customized culling, 90
 - discriminators for intersections, 785
 - draw, 113-115
 - function, 113
 - node, 113

- post-cull, 114
- post-draw, 114
- pre-cull, 113
- pre-draw, 114
- process, 116
- calligraphic light point, 743
- calligraphic lights, number of, 746
- calligraphic vs. raster displays, 744
- calligraphic, color correction, 753
- calligraphic, simulating, 758
- CASEVision, 828
- Catmull-Clark subdivision, 428, 430, 431
- channels, 542
 - channel share group, 40
 - definition, 893
 - configuring, 26
 - creating, 26
 - definition, 893
 - multiple, rendering, 35
 - share mask, definition, 893
- children, of a node, definition, 893
- circles
 - in space, 378
 - in the plane, 360
- class hierarchy, definition, 893
- class inheritance, 7
 - definition, 894
- classes
 - libpf
 - pfBillboard, 51, 75, 875
 - pfBuffer, 163, 876
 - pfChannel, 20, 26, 509, 876
 - pfDCS, 51, 62, 64, 88, 875
 - pfDoubleDCS, 51, 875
 - pfDoubleFCS, 51, 875
 - pfDoubleSCS, 51, 875
 - pfEarthSky, 27, 181, 876
 - pfFrameStats, 791
 - pfGeode, 51, 71, 875
 - pfGroup, 51, 876
 - pfIBRnode, 204, 273
 - pfIBRtexture, 206, 273
 - pfLayer, 51, 70, 876
 - pfLightPoint, 876
 - pfLightSource, 51, 876
 - pfLOD, 51, 70, 876
 - pfLODState, 876
 - pfMPClipTexture, 542, 876
 - pfNode, 49, 51, 52, 876
 - pfPartition, 51, 78, 876
 - pfPath, 877
 - pfPipe, 20, 23, 505, 876
 - pfPipeVideoChannel, 877
 - pfPipeWindow, 20, 509, 625, 877
 - pfRotorWash, 877
 - pfScene, 19, 51, 61, 876
 - pfSCS, 51, 62, 64, 88, 876
 - pfSequence, 51, 67, 876
 - pfShader, 877
 - pfShaderManager, 877
 - pfShadow, 199
 - pfSwitch, 51, 67, 876
 - pfText, 51, 876
 - pfTraverser, 877
 - pfVolFog, 186, 877
 - libpfd
 - pfdBuilder, 233
 - pfdGeom, 237
 - pfdPrim, 238
 - libpfv
 - pfvDisplayMgr, 44
 - pfvInteractor, 868
 - pfvPicker, 868
 - pfvSelector, 868
 - pfvViewer, 44, 856
 - libpr
 - prBox, 777, 878
 - prClipTexture, 542, 877
 - prColortable, 877
 - prCompositor, 516

- pfCycleBuffer, 655, 878
- pfCycleMemory, 655, 878
- pfCylinder, 777, 878
- pfDataPool, 654, 878
- pfDispList, 814, 877
- pfFBState, 877
- pfFile, 878
- pfFog, 877
- pfFont, 341, 877
- pfFrustum, 878
- pfGeoArray, 318
- pfGeoSet, 305, 813, 877
- pfGeoState, 877
- pfHighlight, 877
- pfHit, 784, 877
- pfLight, 878
- pfLightModel, 878
- pfList, 879
- pfLoadBalance, 520
- pfLPointState, 878
- pfMaterial, 878
- pfMatrix, 769, 879
- pfMatStack, 775, 879
- pfMemory, 879
- pfObject, 879
- pfPassList, 877
- pfPlane, 778
- pfPolytope, 878
- pfQuat, 773, 879
- pfQueue, 542
- pfSeg, 782, 878
- pfSegSet, 121, 878
- pfSphere, 777, 878
- pfSprite, 484, 878
- pfState, 878
- pfStats, 791, 809, 879
- pfString, 343, 878
- pfTexEnv, 878
- pfTexGen, 878
- pfTexture, 552, 878
- pfType, 879
- pfVec2, 767, 879
- pfVec3, 767, 879
- pfVec4, 767, 879
- pfWindow, 879
- clearTessellation(), 441
- clip center, 530, 538
- clip center node, 574
- clip region, 530
- clip size, 530
- clip_size, 567
- clipfly application, 543
- clipped level, 533
- clipped, definition, 894
- clipping planes, definition, 894
- cliptexture, 529, 549, 894
 - and ASD, 717
 - center, 540
 - configuration, 548, 553
 - inset, 593
 - invalidating, 584
 - load control, 580
 - loaders, 606
 - manipulating, 579
 - multipipe applications, 601
 - multiprocessing, 571
 - preprocessing, 545
 - read queue, 584
 - sample code, 604
 - slave, 602
 - slave and master, 576, 601
 - test and demo programs, 604
 - utility code, 607
 - virtual, 538, 585, 602
 - with multiple pipes, 576
- clocks
 - high-resolution, 650
- cloned instancing, 57
 - definition, 894
- clones, 512

- cloning, definition, 894
- close(), 658
- closed loop control system, 152
- code examples. See example code
- color correction, 753
- compiled mode, 308
 - definition, 895
- complex pixels, definition, 895
- composite curves, 380
- compositors, 501, 515, 516
- computer aided design, xliii
- cones, 399
- configuration
 - cliptexture, 548, 553
 - cliptexture files, 555
 - cliptexture utilities, 553
 - default tile, 552
 - files
 - cliptextures, 555
 - MPK, 44
 - XML, 858, 871
 - image cache, 551, 554, 558, 559
 - image cache levels, 550
 - image cache proto tile, 551
 - image tile, 553
 - load time, 549
 - optional image cache, 570
 - pfChannel, 26
 - pfFrustum, 28
 - pfPipe, 23
 - pfPipeWindow, 625
 - pfScene, 27
 - pfTexture, 552
 - viewpoint, 30
 - viewport, 27
- configuration file
 - creating, 556
- connecting surface patches, 443
- containment, frustum, 93
- control hull, NURBS, 368
- control parameters for NURBS, 367
- conventions
 - typographical, xlvii
- Coons patch, 408
- coordinate mismatches, 433
- coordinate systems, 30
 - dynamic. See pfDCS nodes
 - static. See pfSCS nodes
- coplanar geometry, 70, 462
- copying pfObjects, 15
- core dump
 - from aggregate pfObject allocation, 879
 - from mixing malloc() and pfFree(), 652
 - from mixing pfMalloc() and free(), 652
 - from static pfObject allocation, 879
 - from unshared pfObject allocation, 879
- Coryphaeus
 - DWB format, 222
- cost tables, 582, 895
- counter, video, 651
- counting, basic-block, 829
- CPU statistics, 797
- cracks
 - avoiding, 433
 - possible reasons, 433
- critically damped, definition, 895
- .csb files, 440
- cube map textures, 474, 475
- CULL, 21
 - backface culling, 160, 173, 174
 - sidekick processes, 159, 173-179
- cull programs, 103
- cull volume visualization, definition, 895
- culling
 - callbacks, 90
 - definition, 895

- efficient, 94
- multithreading, 159
- See also traversals
- traversal, 90
- cull-overlap-draw multiprocessing model, 157
- cumulative statistics, 809
 - See also statistics
- current statistics, 809
 - See also statistics
- curves
 - and trim loops, 383
 - composite, 380
 - discrete curves in space, 381
 - discrete curves in the plane, 374
 - Hermite spline, 379
 - in space, 377
 - in the plane, 354
 - NURBS, 348
 - NURBS curve, 410
 - superquadric, 378
 - trim curve, 384
 - using splines, 365
- cut-ins, 515
- cycle buffers, 171, 655
- cylinders, 395
 - as bounding volumes, 777
 - bounding, 823
- D**
- data fusion
 - defined, 896
- data structures, 703
- database loaders, 884
- database paging, 94, 163
 - definition, 896
- databases
 - importing, 221
 - optimization, 825
 - organization, 88, 94
 - traversals, 85-128
- datapools. See pfDataPool data structures
- dbx
 - See debugging
- DCS. See pfDCS nodes
- debug libraries, definition, 896
- debugging
 - dbx, 832
 - guidelines, 831
 - ogldebug, 830
 - shared memory and, 831
- decal geometry, definition, 896
- decals, 715
 - See also coplanar geometry
- decomposition
 - hardware decomposition, 515
 - spatial, 502
 - temporal, 502
- decomposition modes, 517
- default tile
 - configuration, 552
- deleting objects, 11
- depth complexity, definition, 896
- detail texture, 827
- device, streaming, 563
- disabling graphics modes, 464
- discrete curves
 - in space, 381
 - in the plane, 374
- discriminator callbacks
 - for intersections, 785
- displace decaling, 462
 - defined, 897
- display list, 485, 814
 - definition, 897
- display list mode, 308

- display, raster vs. calligraphic, 744
 - display, stereo, 38
 - displaying statistics. See statistics
 - DLL (dynamic link library) files, 223
 - dlopen(), 224, 228
 - dlsym(), 224, 228
 - double-precision arithmetic, 828
 - double-precision matrices, 64, 67
 - download time
 - cliptexture, 581
 - DPLEX (Video Digital Multiplexer), 501
 - DRAW, 21
 - DRaW Computing Associates, 287
 - draw mask, 112
 - draw mask, definition, 897
 - draw traversals. See traversals
 - drop, definition, 897
 - DSO (dynamic shared object) files, 223
 - DTR, 544, 580
 - DVR, 148
 - DWB format. See formats
 - DXF format. See formats
 - dynamic coordinate systems. See pfDCS nodes
 - dynamic link library (DLL) files, 223
 - dynamic shared object (DSO) files, 223, 898
 - Dynamic Texture Resolution, 580
 - dynamic video resolution, 148
 - dynamic, definition, 897
- E**
- earth/sky model, 27
 - edges
 - defining, 384
 - effective levels, 539
 - effects, atmospheric, enabling, 185
 - elastomeric propulsion system, 31
 - enabling
 - atmospheric effects, 185
 - fog, 185
 - graphics modes, 464
 - statistics classes, 803
 - engine, and ASD, 720
 - enterView(), 868
 - enterWorld(), 868
 - environment variables
 - DISPLAY, 620
 - LD_LIBRARY_PATH, 225, 829
 - PFHOME, 225
 - PFLD_LIBRARY_PATH, 225
 - PFNFYLEVEL, 659
 - PFPATH, 660, 661
 - PFTMPDIR, 653
 - PROFDIR, 830
 - environmental model, 27
 - error handling
 - floating-point operations, 832
 - notification levels, 658
 - Euler angles, 30
 - defined, 898
 - evaluation function, 702
 - default, 712
 - overriding, 713
 - timing, 717
 - evaluator functions, 356
 - evanalyzer program, 839
 - EventView performance analyzer, 838-853
 - evgraph program, 844
 - evhist program, 844
 - evmerge program, 844
 - evpp program, 844
 - example code
 - bounding volume, 59

C++

- invalid creation of objects, 880
- valid creation of objects, 880
- calligraphic lights, 759
- converting to pfFlux, 677
- convex polyhedrons, 783
- creating cloned instances, 59
- cull-process callbacks, 116
- database loaders, 884
- default stress function, 154
- fill statistics, 800
- frame control, 135
- graphics state, 487
- hierarchy construction, 55
- highlighting, 483
- hyperpipes, 505, 506
- intersection routines, 786
- libpf, 885
- libpfutil, 820, 822
- light point process, 742
- LOD, 143
- matrices and vectors, 772
- MIPmap, 468
- Motif, 637
- passthrough data, 119
- Perfly, 905
- pfASD, 720
- pfBillboard, 76
- pfCalligraphic, 755
- pfChannel, 32, 39, 42
- pfCopy(), 15
- pfDecal, 463
- pfDelete(), 13
- pfEarthSky(), 182
- pfFont, 342
- pfGeoSet, 674
- pfGeoSets, 72
- pfGeoStates, 490
- pfLayer, 71
- pfNode, 114
- pfOverride, 488

- pfPartition, 79
- pfPipe, 513
- pfPipe use, 25
- pfPipeWindow, 630, 632, 635, 636
- pfPipeWindows, 512
- pfScene, 53
- pfSequence, 68
- pfString, 343
- pfStrings, 73
- pfSwitch, 68
- pfTexture, 468
- pfWindow, 610, 621, 623
- raster callback, 737
- scene graph traverser, 17
- static member data, 888
- statistics, 801, 810
- transformation inheritance, 80
- user data, 11
- X input, 822

exceptions, floating-point, 832

exec(), 831

exitView(), 868

exitWorld(), 868

ext_format, 560, 567

extending bounding volumes, 779

extensibility

- callback functions, 886
- subclassing, 883
- user data, 10

F

- face culling, 463
- fade count, 582, 898
- field of view, 28
- field, video, 793
- file formats
 - conversions, 440

- files
 - database formats, 241
 - loading. See databases
- fill statistics, 800
 - See also statistics
- filter
 - stress filter, 151
- finite-precision coordinate mismatches, 433
- fixed frame rates, 129
 - defined, 898
- flat-shaded line strip, 311
- flat-shaded primitives, 308
- flatten, definition, 898
- FLIGHT format. See formats
- flimmering, 462, 898
- floating phase, definition, 899
- floating-point exceptions, 820, 832
- flux sync groups, 671
- fog, 186
 - atmospheric effects, 183
 - configuring, 481
 - data structures, 184, 481
 - enabling, 185
 - performance cost, 817
- fork(), 168, 831, 887
- formats
 - 3DS, 244
 - BIN, 244
 - BYU, 248
 - DWB, 249
 - DXF, 250
 - FLIGHT, 252
 - GDS, 254
 - GFO, 254
 - IM, 256
 - IRTP, 257
 - list of, 242
 - LSA, 259
 - LSB, 259
 - Maya databases, 290
 - MEDIT, 263
 - NFF, 263
 - OBJ, 265
 - Open Inventor, 258
 - PHD, 268
 - POLY, 246
 - PTU, 270
 - RPC, 273
 - SGF, 275
 - SGO, 276
 - SPF, 280
 - SPONGE, 280
 - STAR, 281
 - STL, 282
 - SV, 283
 - TRI, 287
 - UNC, 287
 - VRML, 258
- FOV. See field of view
- fragment programs, 460, 465, 466, 523, 579
- frame accurate, definition, 899
- frame rate, 148
- frame(), 867
- frames
 - definition, 899
 - management, 129
 - overrun, 132
 - synchronization, 132
- free(), 652
- free-store management, 11
- Frenet frame, 405
- frustum, 28
 - as camera. See channel
 - as culling volume, 778
 - definition of, 899
- FSAA (See full-scene antialiasing.)
- full-scene antialiasing (FSAA), 516

function callbacks, 113

functions

 naming, 2

 polynomials, 351

 scalar, 349

 See also routines and OpenGL functions.

 trigonometric, 350

G

gaze vector, definition, 899

GDS format. See formats

genlock, 651

geometric primitives, 347, 352

geometry

 coplanar. See coplanar geometry

 nodes, 71

 rotating, 75, 827

 volumes. See volumes

getenv(), 661

getting started, xliii

GFO format. See formats

global attribute, 711

global state, 489

GLXFBConfigSGIX, 615

GPUs (graphics processing units), 466, 501, 523

graph

 defined, 900

 stage timing. See stage timing graph

graphics

 attributes, 457

 load. See load management

 modes, 457, 459

 pipelines. See pipelines

 state, 457

 state elements, definition, 900

 statistics, 799

 See also statistics

 values, 457, 464

graphics context, definition, 900

graphics libraries

 database sorting, 821

 input handling, 822

 objects, 827

 OpenGL, xliii

 See also OpenGL

graphics pipe, 502

graphics processing units (GPUs). See GPUs.

grout, digital, 147

H

half-spaces, 778

handleEvent(), 865, 867

handling flimmering, 70

hardware composition schemes, 515

header file, 2, 875

header_offset, 569

heading, 30

 defined, 900

heap, 891

 defined, 900

help

 accessing the mailing list, xlvii

 C++ argument passing, 882

 channel groups, 40

 channels, 26

 clearing a channel, 118

 database formats, 241

 database paging, 163

 default shared arena size, 654

 display lists, 308

 drawing a background, xlv, 181

 drawing text, 73

 flimmering, 898

 frame rates, 129

- geometry specification, 305
- graphics attributes, 457
- inheriting transformations, 80
- instancing, 56
- interfacing C and C++ code, 883
- level of detail, 136
- morphing, 680
- multiple pipelines, 22
- multiprocess configuration, 23
- node callback functions, 113
- overview of chapter contents, xliv
- performance tuning, 811
- pipes, 21
- scene graph structure, 94
- scene graphs, 87
- shared memory, 651
- traversals, 85
- understanding process models, 160
- understanding statistics, 792
- view specification, 31
- viewports, 27
- where to start, xliii
- windows, 625
- writing a loader, 230
- help process callback functions, 116
- Hermite spline, 365
 - curves in space, 379
 - curves in the plane, 365
 - surfaces, 417
- higher-order geometric primitives, 347, 352
 - class hierarchy, 353
- high-resolution clocks, 650
- horizontal stripes, 515
- Hull parameterization, 413
- hyperpipe, 502, 509
 - programming with, 513
- hyperpipes
 - multiple, 504

I

- I3DM modeler, 283
- icache_files, 567, 568
- icache_format, 567
- icache_params, 567
- icache_size, 560
- identity matrix, definition, 900
- IM format. See formats
- image cache, 531, 550, 567
 - configuration, 551, 554, 556, 558, 559
 - levels, 550, 567
 - proto tile, 551
- image data, formatting, 547
- image tile, 550, 553
- image, tiling, 547
- image-based rendering, 204
- img_format, 560, 567
- immediate mode rendering, definition, 900
- immediate-mode, 308
- include files, 875
- index attributes, 316
- indexed pfGeoSets, 305
- industrial simulation, xliiii
- INF (infinite value) exception, 832
- InfinitePerformance graphics systems, 515
- info-performer, xlvii
- inheriting
 - attributes, 49
 - classes, 7
 - state, 87
- initializing
 - C++ virtual functions, 886
 - pfType system, 886
- inline, 767
- in-lining math functions, 828
- input handling, 822

inset, 541
 adding to cliptexture, 594
 and DTR, 594
 boundary, 595
 building, 595
 cliptexture, 593
 multiple, 597
inset views, 38
instancing, 56
 cloned, 57
 definition, 901
 shared, 56
int_format, 560, 567
Interest Area, 722
internal API, 874
interpolation, MIPmap, 827
intersections
 caching, 823
 masks, 122, 785
 performance, 823
 pipeline, definition, 901
 See also discriminator callbacks
 tests
 geometry sets, 784
 planes, 784
 point-volume, 780
 segments, 783
 segment-volume, 783
 triangles, 784
 volume-volume, 780
 traversals. See traversals
invalid border, 536, 544, 567
I/O
 asynchronous, 658
 handling, 822
IRIS IM, 637
IRIS Image Vision Library, 271
IRIS Inventor. See Open Inventor
IRIX kernel, 831

IRTP format. See formats
islDrawAction
 setLoadTextureFunc, 499
 setLoadTextureFunc(), 499
islShape
 draw(), 500
 setDrawGeometryFunc(), 499
.iv files, 440

K

Kaleido, polyhedron generator, 268
kernel, 831
keyframing
 using quaternions for, 773
knot points, 365
 Hermite spline, 365
 NURBS, 368

L

latency
 controlling, 820
 defined, 901
latency-critical
 definition, 901
 updates, 820
layer geometry, 462, 463
 definition, 901
layered fog, 186
level of detail, 546, 691
 blended transitions, 145
 canonical channel resolution, 142
 canonical field of view, 142
 defined, 901

- stress management, 796
- switching, 70
- use in optimization, 815
- libpf, 573
 - cliptextures, 542
 - defined, 901
 - display environment, 19
 - objects, 10
- libpfbreakup pseudo loader, 289
- libpfcliptile pseudo loader, 289
- libpfclosest pseudo loader, 289
- libpfct demo loader, 543, 558
- libpfctol pseudo loader, 449
- libpfdb, 222
 - cliptextures, 543
- libpfdu, 221, 222
 - cliptextures, 543
 - defined, 902
- libpfgeoa pseudo loader, 289, 341
- libpfim cliptexture loader, 543, 558
- libpfmpk library, 44
- libpfrot pseudo loader, 289
- libpfscale pseudo loader, 289
- libpfsphere pseudo loader, 289
- libpfspherepatch loader, 543, 558
- libpfsubdiv pseudo loader, 289, 430
- libpftrans pseudo loader, 289
- libpfutil, 222
 - cliptextures, 543
- libpfv library, 19, 855
- libpfvct pseudo loader, 289, 543, 558
- libpr
 - classes, 874, 902
 - cliptextures, 542, 550
 - defined, 902
 - graphics state, 457
 - objects, 10
- Light Point Board, 746
- light points, 108
 - definition, 902
- light shafts, 196
- lighting
 - overview, 478
- lights, bright, 743
- Lightscape Technologies, 259
- line segments, 782
 - See also pfSegSet data structures
- lines
 - in space, 377
 - in the plane, 359
- load balancing, 520
- load control, cliptextures, 544
- load management
 - level-of-detail scaling, 152-155
 - statistics, 796
- load, definition, 902
- loaders, 230
- loading files. See databases
- LoadLibrary(), 228
- load-time configuration, 549
- local state, 489
- locked phase, definition, 902
- locks, allocating, 654
- LOD, 445
- LOD (level of detail), 692
 - managing, 136
 - range, 695
 - reduction, 693
 - See also level of detail
 - See also load management
 - user control over evaluation, 147
- lookahead cache, 531, 533
- Loop subdivision, 426, 428, 430, 431
- loops

Coons patch, 408
trim loop, 384
trim loops, 383
LPB, 743, 746
LSA. See formats
LSB. See formats

M

macros, 828

PFADD_SCALED_VEC3, 768
PFADD_VEC3, 768
PFALMOST_EQUAL_MAT, 771
PFALMOST_EQUAL_VEC3, 769
PFCOMBINE_VEC3, 768
PFCONJ_QUAT, 774
PFCOPY_MAT, 770
PFCOPY_VEC3, 768
PFDISTANCE_PT3, 768
PFDIV_QUAT, 774
PFDOT_VEC3, 768
PFEQUAL_MAT, 771
PFEQUAL_VEC3, 769
PFGET_MAT_COL, 770
PFGET_MAT_COLVEC3, 770
PFGET_MAT_ROW, 770
PFGET_MAT_ROWVEC3, 770
PFLLENGTH_QUAT, 774
PFLLENGTH_VEC3, 768
PFMAKE_IDENT_MAT, 769
PFMAKE_SCALE_MAT, 769
PFMAKE_TRANS_MAT, 769
PFMATRIX, 883
PFMULT_QUAT, 774
PFNEGATE_VEC3, 768
PFQUAT, 883
PFSCALE_VEC3, 768
PFSET_MAT_COL, 770
PFSET_MAT_COLVEC3, 770

PFSET_MAT_ROW, 770
PFSET_MAT_ROWVEC3, 770
PFSET_VEC3, 768
PFSQR_DISTANCE_PT3, 768
PFSUB_VEC3, 768
PFVEC2, 883
PFVEC3, 883
PFVEC4, 883
mailing list, xlvii
makeIBRimages program, 219
makeProxyImages program, 215
malloc(), 831
See also memory, pfMalloc()
manifolds, 425, 426
masks, intersection, 122, 785
master cliptexture, 576
materials, 480
math routines, 767-789
in-lining, 828
matrices, 351
4 by 4, 769
affine, 771
composition order, 772
double-precision, 64, 67
manipulating, 483
stack functions, 775
matrix routines
transformations, 769
matrix. See transformation
matrix stack, 775
maxlod, 539
Maya databases, 290
measuring performance, 828
Medit, 222
MEDIT format. See formats
MEL (Maya Embedded Language), 296
mem region, 532

- mem_region_size, 560
 - member functions, 873
 - overloaded, 884
 - memory
 - allocating, 652, 831
 - multiprocessing, 168
 - shared. See shared memory
 - memory footprint
 - and reps, 348
 - memory mapping, for shared arena, 653
 - memory requirements, 597
 - Menger sponge, 280
 - mesh, 691, 699
 - methods (See routines.)
 - Microsoft Developer Studio, 832
 - Mies, 255
 - minification, 827
 - MIPmap, 530
 - building, 546
 - filtering, 473
 - interpolation functions, 827
 - level, 531
 - mode changes, 817
 - modelers
 - AutoCAD, 250
 - Designer's Workbench, 249
 - EasyScene, 249
 - EasyT, 249
 - I3DM, 283
 - Imagine, 258
 - Kaleido, 268
 - Model, 265
 - ModelGen, 252
 - MultiGen, 252
 - morph attribute, definition, 902
 - morphing, 680
 - defined, 903
 - morphing vector, 698, 700
 - Motif, 637
 - MPK (See OpenGL Multipipe SDK.)
 - MPK configuration files, 44
 - MPKConfig class, 47
 - multibuffering, 889
 - Multi-Channel Option, 39
 - multipass rendering, 103
 - multiple channels, 32, 39, 40
 - and ASD, 716
 - rendering, 35
 - multiple hardware pipelines, 22
 - multiple inheritance
 - avoidance of, 10
 - definition, 903
 - multiple pipelines. See pipelines
 - multiplexers, 501
 - multiprocess, cliptexture, 571
 - multiprocessing
 - display-list generation, forcing, 157
 - functions, invoking during, 166
 - memory management, 168
 - models of, 156
 - cull-overlap-draw, 157
 - timing diagrams, 160
 - order of calls, 160
 - pipelines, 116
 - pipelines, multiple, 159
 - uses for, 155
 - multisampling, 836
 - multi-texture support, 494
 - multithreading, 159
 - defined, 903
 - mutual exclusion, definition, 903
- N**
- NaN (Not a Number) exception, 832

- neighborhood array, 712
- NFF format. See formats
- node draw mask, 112
- nodes
 - callbacks, 113
 - defined, 903
 - pruning, 90
 - sequences, 67
 - types, 51
- nonblocking access, definition, 903
- nonblocking file interface, 658
- non-clipped level, 533
- non-degrading priorities, definition, 904
- notification levels for errors, 658
- num_streams, 563
- numEffectiveLevels, 587
- NURBS
 - and Bezier curves, 369
 - control hull, 368
 - control hull indexing, 412
 - control parameters, 367
 - curves, 348
 - curves in space, 379
 - curves in the plane, 371
 - equation for curve, 370
 - equation for surface, 414
 - introduction to, 366
 - knot points, 368
 - OpenGL Performer classes, 367
 - surfaces, 348, 410
 - weights for control points, 368
- O**
- OBJ format. See formats
- object creation, 4
- object derivation, 7
- object type, 17
 - determining, 17
- Objects, 879
- occlusion culling
 - definition, 904
 - using cull programs, 110
- ogldebug, 829, 830
 - utility, 830
- Onyx RealityEngine. See RealityEngine graphics
- opcodes, 105
- Open Inventor, 89, 226, 258
 - loader, C++ implementation, 884
- open(), 658
- OpenGL, xliii
 - functions
 - glAlphaFunc(), 462
 - glBlendFunc(), 836, 837
 - glColorMaterial(), 813, 818, 838
 - glColorPointer(), 322
 - glFinish(), 801
 - glFog(), 192, 481
 - glLight(), 478
 - glMaterial(), 480
 - glNormalPointer(), 322
 - glShadeModel(), 817
 - glStencilOp(), 462
 - glTexCoordPointer(), 322
 - glTexEnv(), 467
 - glTexGen(), 477, 478
 - glTexImage2D(), 467
 - glVertexAttribPointerARB(), 322
 - glVertexPointer(), 322
 - glXCreateContext(), 616
 - glXQueryHyperpipeNetworkSGIX(), 506
 - glXSwapBuffers(), 133, 514, 830
- OpenGL Multipipe SDK (MPK) product, 44
- OpenGL Performer
 - applications of, xliii
 - C API, 873
 - C++ API, 873

- accessor functions, 873
 - header files, 875
 - member functions, 873
 - new, 879
 - object creation, 879
 - object deletion, 879
 - public structs, 874
 - reserved functions, 874
 - static class data, 888
 - subclassing, 883
 - using both C and C++ API, 882
 - using the C API with C++, 881
 - differences between C and C++
 - error handling, 658
 - getting started, xliv
 - introduction, xliii
 - mailing list, xlvii
 - type system, 17, 874, 875, 884
 - OpenGL Performer API, 1
 - OpenGL Shader, 497
 - opera lighting
 - defined, 904
 - operator
 - delete, 879
 - new, 879
 - optimization
 - database parameters, 825
 - organization of databases. See databases
 - orthogonal transformations, 771
 - orthonormal transformations, 772, 779
 - overlay(), 867
 - overload, definition, 904
 - overrun, definition, 904
 - overrun, frame, 132
- P**
- paging
 - in ASD, 722
 - multi-resolution, 724
 - order of in ASD, 724
 - preprocessing, 723
 - parameterization
 - cones, 399
 - planes, 390
 - spheres, 392
 - torus, 397
 - parameters, virtual cliptexture, 587
 - parametric circles in the plane, 360
 - parametric curves
 - in space, 377
 - parametric lines in the plane, 359
 - parametric surfaces, 381
 - base class, 386
 - plane surfaces, 390
 - stitching, 433
 - tessellation, 451
 - parent, of a node, defined, 905
 - parser, 556
 - partitions, 78
 - pass-through data
 - defined, 905
 - passthrough data, 118, 170
 - patchy fog, 186
 - paths
 - definition, 905
 - search paths, 660
 - through scene graph, 100
 - perfly, 135, 792, 800
 - definition, 905
 - sample programs, 225
 - Perfly application, 209
 - performance
 - costs
 - lighting, 817
 - multisampling, 836

- EventView performance analyzer, 838-853
- intersection, 823
- measurement, 828
- tuning
 - database structure, 823
 - graphics pipeline, 816
 - guidelines, specific, 816
 - optimizations, built-m, 812
 - overview, 811
 - process pipeline, 819
 - RealityEngine graphics, 836
- Performance Co-Pilot, 829
- Performer Terrain Utilities, 270
- PF_DTR_MEMLOAD, 581
- PF_DTR_READSORT, 581
- PF_DTR_TEXLOAD, 581
- PF_MAX_ANISOTROPY, 473
- pfAddMPClipTexture(), 572, 577
- pfAddPWinPVChan(), 35, 634, 639
- pfAppearanceChanged(), 498
- pfAppFrame(), 794
- pfApplyDecalPlane(), 462
- pfApplyTLOD(), 476
- pfApplyTMat(), 469
- pfASD, 708
 - and pfEngine, 720
 - queries, 714
- PFASD_COLORS, 711
- PFASD_NORMALS, 711
- PFASD_TCOORDS, 711
- pfASDFace, 701
- pfASDLODRange, 712
- pfASDVert, 709
- pfAttachPWinSwapGroup(), 638
- pfAttachWin(), 619
- pfAttachWinSwapGroup(), 617, 620
- PFB file format, 240
- pfBillboard, 75
- pfBillboard nodes, 827
- pfBindPVChan(), 641
- pfBindPWinPVChans, 641
- pfBoundary class, 434
- pfBox, 777
- pfChannel data structures. See channels
- pfChanPixScale, 149
- pfChanPWinPVChanIndex(), 35, 151
- pfChanTravMode(), 110
- pfChoosePWinFBConfig(), 629
- pfCircle2d class
 - declared, 361
- pfCircle3d class, 378
- pfClipTexture, 529
 - and ASD, 717
- pfCompositeCurve3d class
 - declared, 380
- pfCompositeScalar class, 350
- pfCompositorAddChild(), 518
- pfCompositorChannelClipped(), 518
- pfCompositorChildFrustum(), 520
- pfCompositorChildSubdivision(), 520
- pfCompositorChildViewport(), 520
- pfCompositorLoadBalancer(), 519
- pfCompositorMasterPipe(), 520
- pfCompositorMode(), 519
- pfCompositorNearFar(), 518
- pfCompositorOrtho(), 518
- pfCompositorPerspective(), 518
- pfCompositorReconfig(), 518
- pfCompositorVal(), 519
- pfCompositorViewport(), 518
- pfCompute(), 158
- pfComputeFunc(), 159
- pfCone class

- declared, 400
- pfConfig(), 46, 47, 840, 867
- pfconv, 240
- pfconv command, 440
- pfCoons class
 - declared, 410
- pfCosScalar class, 350
- pfctol pseudo loader, 440
- pfCull(), 867
- pfCullProgramAddBinParent(), 109
- pfCullProgramAddPgmInstruction(), 105
- pfCullProgramAddPgmOpcode(), 105
- pfCullProgramIsSubbinOf(), 109
- pfCullProgramResetBinParents(), 109
- pfCullProgramResetPgm(), 105
- pfCullProgramTestPolytope(), 109
- pfCurve2d class, 354, 384, 385
 - declared, 357
- pfCurve2d evaluator functions, 356
- pfCurve3d class, 377
- pfCylinder, 777
- pfCylinder class
 - declared, 396
- pfDataPool data structures, 654
 - multiprocessing with, 170
- pfdBreakup(), 289
- pfdBUILDER, 256
- pfdBUILDTopologyTraverse(), 443, 450
- pfDConverterAttr_rpc(), 273
- pfDConverterMode_rpc(), 273
- pfDConverterVal_rpc(), 273
- pfDCS nodes, 814
- pfDeleteGLHandle(), 470
- pfDGetConverterAttr_rpc(), 273
- pfDGetConverterMode_rpc(), 273
- pfDGetConverterVal_rpc(), 273
- pfDInitConverter(), 223
- pfDisCurve2d class
 - declared, 375
- pfDisCurve3d class, 381
 - example, 381
- pfDispList, 485
- pfDispList data structures, 485
- pfDLoadClipTexture, 543
- pfDLoadClipTextureState, 543
- pfDLoadFile(), 440
- pfDLoadImageCache, 543
- pfDLoadImageCacheState, 543
- pfDLoadNeededDSOs(), 224
- pfDLoadNeededDSOs_EXT(), 228
- pfDoubleDCS nodes, 64
- pfDoubleFCS nodes, 67
- pfDoubleSCS nodes, 64
- pfDProcessASDTiles, 725
- pfDraw(), 867
- pfDTessellateGeometry(), 449, 453
- pfDWriteFile, 725
- pfEdge class, 385, 451
 - declared, 385
- pfEngine, 677
 - and ASD, 720
- pfEvaluateLOD(), 147
- pfEventSampleOff(), 840
- pfEventSampleOn(), 840
- pfFilePath(), 660
- pfFilePathv(), 660
- pfFlux, 663
- pfFog data structures, 184, 481
 - See also fog
- pfFont, 341
- pfFrame(), 625, 852, 867
- pfFrameStats data structures, 791

- See also pfStats data structures
- pfFrenetSweptSurface class, 381, 405, 448
 - declared, 405
 - example, 381, 406
- pfGeoArray, 318
- pfGeode, 71
 - getNumGSets(), 449
- pfGeoSet, 305
 - adding to pfGeode nodes, 12, 71
 - and bounding volumes, 776
 - compilation, 308
 - connectivity, 310
 - draw modes, 308
 - intersection mask, 785
 - intersections with segments, 784
 - optimal size, 813
 - primitive types, 307
- pfGeoState data structures
 - applying, 490
 - attaching to pfGeoSets, 491
 - overview, 488
- pfGetChanOrigin(), 149
- pfGetChanOutputOrigin(), 149
- pfGetChanOutputSize(), 149
- pfGetChanPixScale, 149
- pfGetChanPWinPVChanIndex, 151
- pfGetChanSize(), 149
- pfGetCompositorChannelClipped(), 518
- pfGetCompositorChildFrustum(), 520
- pfGetCompositorChildSubdivision(), 520
- pfGetCompositorChildViewport(), 520
- pfGetCompositorFrustType(), 518
- pfGetCompositorFrustum(), 518
- pfGetCompositorLoadBalancer(), 519
- pfGetCompositorMode(), 519
- pfGetCompositorNearFar(), 518
- pfGetCompositorVal(), 519
- pfGetCompositorViewport(), 518
- pfGetCurCalligraphic(), 758
- pfGetGSetPrimLength(), 306
- pfGetIBRnodeProxyTexCoords(), 206
- pfGetIBRtextureDefaultTexture(), 205
- pfGetLoadBalanceLoad(), 522
- pfGetLoadBalanceNumActive(), 522
- pfGetLoadBalanceVal(), 522
- pfGetLoadBalanceWork(), 522
- pfGetMPClipTexture(), 573
- pfGetNumMPClipTextures(), 573
- pfGetNumScreenPVChans(), 640
- pfGetPFChanStressFilter(), 152
- pfGetPVChanId, 151
- pfGetPVChanInfo(), 641
- pfGetPWinNumPVChans(), 640
- pfGetPWinPVChanId, 640
- pfGetPWinPVChanIndex, 640
- pfGetTexMultiName(), 475
- pfGetTGenMode(), 478
- PFGS_FLAT_TRIFANS, 315
- PFGS_PACKED_ATTRS, 309
- pfGSetDecalPlane(), 462
- pfGSetMultiAttr(), 306, 312
- pfGSetOptimize(), 179
- pfGSetQuickAttr(), 178
- pfGSetQuickMultiAttr(), 179
- pfGSetQuickPrimLengths(), 179
- pfHit, 784
- pfHsplineCurve2d class, 365, 379
- pfHsplineCurve3 class, 381
- pfHsplineCurve3d class, 379
 - example, 381
- pfHsplineSurface

- declared, 418
- pfHyperpipe, 509
- PFI image format, 240
- pfIBRnode class, 204, 273
- pfIBRnodeAngles(), 205
- pfIBRnodeFlags(), 206
- pfIBRnodeIBRtexture(), 205
- pfIBRnodeProxyTexCoords(), 206
- pfIBRtexture class, 206, 273
- pfIBRtextureDirection(), 208
- pfIBRtextureFlags(), 207, 208
- pfIBRtextureIBRdirections(), 206
- pfIBRtextureIBRtextures(), 207
- pfIBRtextureLoadIBRtexture(), 207
- pfIBRtextureNumRings(), 207
- pfIBRtextureRing(), 207
- pficonv, 241
- pfInit(), 887
- pfImageCache, 542
- pfInitBoard(), 750
- pfInitializeEvents(), 840
- pfIsBoardInit(), 750
- pfIsPVChanActive(), 639
- pfLayer, 70
- pfLine2d class
 - declared, 359
- pfLine3d class, 377
- pfLoadBalanceBalance(), 522
- pfLoadBalanceLoad(), 522
- pfLoadBalanceNumActive(), 522
- pfLoadBalanceVal(), 522
- pfLoadGState(), 489
- pfLoadMultiTexFile(), 475
- pfLOD nodes, 70
- pfLODRangeFlux(), 148
- pfLODUserEvalFunc, 147
- pfMatrix, 769
- pfMatrix4d, 64
- pfMatStack, 775
- pfMPClipTexture, 571
 - connecting to pfPipes, 572
- pfMPKImportConfig(), 45, 46
- pfMPKImportFile(), 45, 46, 47
- pfMPKPostConfig(), 47
- pfMPKPostDMConfig(), 47
- pfMPKPreConfig(), 47
- pfMQueryWin(), 634
- pfMultithread(), 160, 174
- pfMultithreadParami(), 174, 175, 176
- pfNewLModel(), 479
- pfNewPVChan(), 35, 639
- PFNFYLEVEL environment variable, 659
- pfNode, 52
 - and bounding volumes, 776
- pfNode data structures, 49
 - attributes, 52
 - operations, 52
- pfNurbCurve2d class, 367, 371
 - declared, 371
- pfNurbCurve3d class, 367, 379
- pfNurbSurface class, 367, 411
 - declared, 411
- pfObject data structures, 6
 - actual type of, 17
- pfOpenPWin(), 634
- pfOrientedLine3d class, 378
- pfParaSurface
 - clearTessellation(), 449
- pfParaSurface class, 386, 451
 - declared, 386
- pfPartition, 78

- pfPath data structures, 100
- PFPATH environment variable, 660, 661
- pfPieceWisePolyCurve2d class
 - declared, 373
- pfPipe
 - configuration, 23
 - data structures. See pipelines
- pfPipeScreen(), 35, 639
- pfPipeSwapFunc(), 632
- pfPipeVideoChannel, 638
- pfPlane, 778
- pfPlaneSurface class
 - declared, 390
- pfPolyScalar class, 350, 351
- pfPrint, 15
- pfProcessHighestPriority, 165
- pfProcessPriorityUpgrade, 165
- pfPVChanDVRMode(), 148
- pfPVChanId(), 35, 639
- pfPVChanMaxDecScale, 150
- pfPVChanMaxIncScale, 151
- pfPVChanMinDecScale, 151
- pfPVChanMinIncScale, 151
- pfPVChanMode(), 150
- pfPVChanOutputAreaScale(), 641
- pfPVChanOutputOrigin(), 641
- pfPVChanOutputSize(), 641
- pfPVChanStress, 151
- pfPVChanStress(), 151
- pfPVChanStressFilter, 151
- pfPVChanStressFilter(), 151
- pfPWinAddPVChan, 640
- pfPWinAttach(), 637
- pfPWinRemovePVChan, 640
- pfPWinRemovePVChanIndex(), 640
- pfPWinShare(), 637

- pfPWinType(), 637
- pfQueryWin(), 634
- pfQueue, 643
- pfQuickCopyGSet(), 178
- pfQuickResetGSet(), 179
- pfRemoveMPClipTexture(), 573
- pfRep, 352
- pfRep class
 - declared, 354
 - moving from default position, 352
- pfResetEvents(), 840
- pfRuled class
 - declared, 407
- pfSaveMultiTexFile(), 475
- pfScalar class, 349
- pfScene nodes, 27
- pfSCS, 62, 64
- pfSCS nodes, 814
- pfSeg, 782
 - and bounding volumes, 776
- pfSegSet
 - data structure, definition, 121
 - intersection with, 784
- pfSelectWin(), 617, 620
- pfSequence, 67
- pfsFace, 705
- pfShaderChanged(), 498
- pfShaderTexApplyFunc(), 499, 500
- pfShaderTexComputeFunc(), 499, 500
- pfShaderTexCoordFunc(), 499, 500
- pfShadow class, 199
- pfSharedMalloc(), 847
- pfSinScalar class, 350
- pfSolid class
 - methods, 443
- pfSphere, 777

- pfSphere class
 - declared, 393
- pfSphereSurface class, 394
- pfState data structures, 486
- pfString, 343
- pfSubloadMultiTex(), 475
- pfSubloadTexMultiLevel(), 475
- pfSuperQuad3d class, 378
- pfSuperQuadCurve2d class, 362
 - declared, 363
- pfSweptSurface class, 401
 - declared, 403
- pfSwitch, 67
- pfSwitchValFlux(), 148
- pfSync(), 794, 851, 867
- pfTEnvMode(), 476
- pfTerrainAttr(), 711
- pfTessellateAction class
 - declared, 449
- pfTessParaSurface
 - tessellator(), 453
- pfTessParaSurface class, 451
- pfTessParaSurfaceAction class
 - declared, 452
- pfTexAnisotropy(), 473
- pfTexEnv data structures. See texturing
- pfTexFormat(), 474
- pfTexGen, 314
- pfTexImage(), 475
- pfTexLOD, 476
- pfTexMultiImage(), 474
- pfTexMultiName(), 475
- pfTexture, 552
- pfTexture data structures. See texturing
- pfTGenPoint(), 478
- pfTopo class, 385, 434
 - declared, 441
- pfTorus class
 - declared, 397
- pfTtol pseudo loader, 440
- pfuAddMPClipTexturesToPipes, 543
- pfuAddMPClipTextureToPipes, 543, 549
- pfuCalcSizeFinestMipLOD, 591
- pfuCalcVirtualClipTexParams, 591
- pfuChooseFBConfig(), 615
- pfuClipCenterNode, 574
- pfuClipTexConfig structure, 554
- pfuDownloadTexList(), 470
- pfuFindClipTextures, 543
- pfuFreeClipTexConfig, 543
- pfuFreeImgCacheConfig, 543
- pfuImgCacheConfig, 554
- pfuInit(), 887
- pfuInitClipTexConfig, 543
- pfuInitImgCacheConfig, 543
- pfuMakeClipTexture, 543
- pfuMakeImageCache, 543
- pfuMakeSceneTexList(), 470
- pfUnbindPWinPVChans, 641
- pfuNewClipCenterNode, 575
- pfuProcessClipCenters, 543, 549, 574
- pfuProcessClipCentersWithChannel, 543, 549, 574
- pfvDisplayMgr class, 44
- pfVec2, 767
- pfVec2 class, 349
- pfVec3, 767
- pfVec3 class, 349
- pfVec4, 767
- pfVec4 class, 349
- pfVideoChannel, 34

- pfVideoChannelInfo(), 35
- pfview program, 859
- pfvInteractor class, 868
- pfvmDrawStyle module, 872
- pfvmEarthSky module, 872
- pfvmLoader module, 872
- pfvmLogo module, 872
- pfvmNavigator module, 857, 872
- pfvmPicker module, 857, 872
- pfvmSnapshot module, 872
- pfvmStats module, 872
- pfvmTrackball module, 872
- pfvmWorldSwitcher module, 872
- pfVolFog class, 186
- pfvPicker class, 868
- pfvSelector class, 868
- pfvViewer class, 44, 856
- pfWaitForVmeBus(), 758
- pfWinShare(), 619
- pfWinSwapBarrier(), 620
- pfWriteEvents(), 840
- phase
 - defined, 905
- PHD format. See formats
- PHIGS, 257
- picking, 100, 126
- pipe, 502
- pipe windows, 625
- pipe, definition, 905
- pipelines
 - functional stages, 21
 - multiple, 159, 651
 - multiprocessing, 116
 - overview, 21
- pitch, 30
 - defined, 905
- pixie, 829
- planar curves, 354
 - mathematical description, 355
- plane surfaces, 390
- planes
 - circles in the plane, 360
 - discrete curves, 374
 - lines in the plane, 359
 - NURBS curves, 371
 - superquadric curves in the plane, 362
- points, 349
- point-volume intersection tests, 780
- POLY format. See formats
- polynomials, 351
- polytopes, 103, 104
- popping
 - definition, 906
 - in LOD transitions, 145
- positive rotation, 30
- postConfig(), 867
- postCull(), 867
- postDraw(), 867
- preConfig(), 867
- preCull(), 867
- preDraw(), 867
- previous statistics, 809
 - See also statistics
- primitives
 - attributes, 312
 - connectivity, 310
 - flat-shaded, 308
 - higher-order geometric primitives, 352
 - orienting in reference frame, 351
 - types, 307
- printing objects, 15
- process callbacks, 116
 - defined, 906

process priority, 165, 820
 processor isolation, 820
 prof, 829
 profile of swept surface, 401
 profiling
 prof, 829
 program counter sampling, 829
 programming modules, 856
 projective texture
 defined, 906
 proto tile, 550, 551
 prune, definition, 906
 pruning nodes, 90
 pseudo loaders
 libpfbreakup, 289
 libpfcliptile, 289
 libpfclosest, 289
 libpfctol, 449
 libpfgeoa, 289, 341
 libpfrot, 289
 libpfscale, 289
 libpfsphere, 289
 libpfsubdiv, 289, 430
 libpftrans, 289
 libpfvct, 289, 543, 558
 list of, 289
 OpenGL Performer implementation, 288
 pfctol, 440
 pfttol, 440
 PTU format. See formats
 public structs, 874
 punch through, definition, 906

Q

quaternion, 773
 spherical linear interpolation, 773
 use in C++ API, 874

query array, 715
 queue, 643
 retrieving elements, 645

R

r_streams, 563
 rapid rendering, for on-air broadcast, xliii
 raster displays, 744
 REACT, 820, 829
 read function, 544
 custom, 591, 604
 sorting, 584
 read queue, 545, 584
 read(), 658
 ReadDirect, 592
 ReadNormal, 592
 RealityEngine graphics
 pipelines, multiple, 159
 tuning, 836
 real-time programming, 820
 real-time shadows, 198
 reference count, definition, 906
 reference counting, 11
 reference counts, 12
 reference frame, orienting primitive, 351
 reference point array, 709
 reference position, 701
 reference vertices, 706
 refresh rate, 132
 rendering
 modes, 459
 multiple channels, 35
 stages of, 155
 rendering pipelines
 definition, 906

- See pipelines
- rendering values, 464
- representations, 348
- reps, 348
 - and memory footprint, 348
 - base class, 352
 - using effectively, 348
- repTest sample application, 352, 382, 394, 415, 447
- reserved functions, 874
- right-hand rule, 30
 - defined, 907
- roll, 30
 - defined, 907
- rotating geometry to track eyepoint, 75, 827
- rotations
 - quaternion, 773
- routines, 767
 - enterView(), 868
 - enterWorld(), 868
 - exitView(), 868
 - exitWorld(), 868
 - for 3-Vectors, 768
 - for 4x4 Matrices, 769
 - for quaternions, 774
 - frame(), 867
 - handleEvent(), 865, 867
- libpr
 - pfCompositorAddChild(), 518
 - pfCompositorChildFrustum(), 520
 - pfCompositorChildSubdivision(), 520
 - pfCompositorChildViewport(), 520
 - pfCompositorLoadBalancer(), 519
 - pfCompositorMasterPipe(), 520
 - pfCompositorMode(), 519
 - pfCompositorNearFar(), 518
 - pfCompositorOrtho(), 518
 - pfCompositorPerspective(), 518
 - pfCompositorReconfig(), 518
 - pfCompositorVal(), 519
 - pfCompositorViewport(), 518
 - pfGetCompositorChildFrustum(), 520
 - pfGetCompositorChildSubdivision(), 520
 - pfGetCompositorChildViewport(), 520
 - pfGetCompositorFrustType(), 518
 - pfGetCompositorFrustum(), 518
 - pfGetCompositorLoadBalancer(), 519
 - pfGetCompositorMode(), 519
 - pfGetCompositorNearFar(), 518
 - pfGetCompositorVal(), 519
 - pfGetCompositorViewport(), 518
 - pfGetLoadBalanceLoad(), 522
 - pfGetLoadBalanceNumActive(), 522
 - pfGetLoadBalanceVal(), 522
 - pfGetLoadBalanceWork(), 522
 - pfLoadBalanceBalance(), 522
 - pfLoadBalanceLoad(), 522
 - pfLoadBalanceNumActive(), 522
 - pfLoadBalanceVal(), 522
- matrix stack, 775
- overlay(), 867
- pfAccumulateStats(), 804
- pfAddChan(), 44
- pfAddChild(), 54, 164, 231
- pfAddGSet(), 12, 72, 73
- pfAddMat(), 770
- pfAddScaledVec3(), 768
- pfAddVec3(), 768
- pfAllocChanData(), 118, 170, 820
- pfAllocSectData(), 170
- pfAlmostEqualMat(), 771
- pfAlmostEqualVec3(), 769
- pfAlphaFunc(), 457, 462, 827, 828
- pfAlphaFunction(), 837
- pfAntialias(), 464, 629, 813, 818, 873
- pfApp(), 168
- pfAppearanceChanged(), 498
- pfAppFrame(), 88
- pfApplyCtab(), 466, 481
- pfApplyFog(), 466
- pfApplyGState(), 327, 458, 489, 490, 491, 492

pfApplyGStateTable(), 328, 492
pfApplyHlight(), 466, 482
pfApplyLModel(), 466
pfApplyLPState(), 466
pfApplyMtl(), 167, 466
pfApplyTEnv(), 466, 467
pfApplyTex(), 167, 458, 466, 469, 471, 489, 822
pfApplyTGen(), 466, 477
pfApplyVolFog(), 187, 188, 193
pfAsynchDelete(), 164
pfAttachChan(), 40
pfAttachDPool(), 655
pfAttachPWin(), 512, 628
pfAttachPWinSwapGroup(), 512
pfAttachPWinWin(), 511
pfAttachPWinWinSwapGroup(), 512
pfAttachWin(), 619
pfAverageStats(), 804
pfBboardAxis(), 75
pfBboardMode(), 76
pfBboardPos(), 75
pfBeginSprite(), 484, 485
pfBindPWinPVChans(), 511
pfBoxAroundBoxes(), 778
pfBoxAroundPts(), 778
pfBoxAroundSpheres(), 778
pfBoxContainsBox(), 781
pfBoxContainsPt(), 780
pfBoxExtendByBox(), 779
pfBoxExtendByPt(), 779
pfBoxIsectSeg(), 783
pfBufferAddChild(), 164, 893
pfBufferClone(), 164, 893
pfBufferRemoveChild(), 164, 893
pfBuildPart(), 78, 79
pfCBufferChanged(), 657
pfCBufferConfig(), 655, 658
pfCBufferFrame(), 657, 658
pfChanBinOrder(), 99, 892
pfChanBinSort(), 99, 892
pfChanESky(), 27, 181, 185
pfChanFOV(), 29
pfChanGState(), 814
pfChanLODAttr(), 131
pfChanLODLODStateIndex(), 141
pfChanLODStateList(), 141
pfChanNearFar(), 30
pfChanNodeIsectSegs(), 120
pfChanPick(), 126
pfChanScene(), 27, 61
pfChanShare(), 41, 88, 628
pfChanStatsMode(), 801
pfChanStress(), 131
pfChanStressFilter(), 131, 154
pfChanTravFunc(), 100, 118, 171
pfChanTravFuncs(), 181
pfChanTravMask(), 112
pfChanTravMode(), 93, 102, 103, 110, 815, 825
pfChanView(), 30, 32
pfChanViewMat(), 31, 32
pfChanViewOffsets(), 40
pfChooseFBConfig(), 615
pfChoosePWinFBConfig(), 512, 629, 634
pfChooseWinFBConfig(), 615
pfClear(), 167
pfClearChan(), 118, 181, 795, 818
pfClearStats(), 804
pfClipSeg(), 782, 784
pfClipTextureAllocatedLevels(), 551
pfClipTextureClipSize(), 550
pfClipTextureEffectiveLevels(), 550
pfClipTextureInvalidBorder(), 550
pfClipTextureLevel(), 551, 553
pfClipTextureVirtualSize(), 550
pfClockMode(), 650
pfClockName(), 650
pfClone(), 164
pfCloseDList(), 486
pfCloseFile(), 658
pfClosePWin(), 634, 636
pfClosePWinGL(), 634
pfCloseWin(), 617

- pfCloseWinGL(), 619
- pfCombineVec3(), 768
- pfCompositorChannelClipped(), 518
- pfConfig(), 23, 46, 47, 160, 163, 658, 665, 831, 840, 867, 887, 888
- pfConfigPWin(), 632, 636, 822
- pfConfigStage(), 24, 822
- pfConjQuat(), 774
- pfCopy(), 15, 318, 653, 807
- pfCopyFStats(), 803, 808
- pfCopyGSet(), 306
- pfCopyGState(), 491
- pfCopyMat(), 770
- pfCopyStats(), 803, 804, 808
- pfCopyVec3(), 768
- pfCreateDPool(), 654, 655
- pfCreateFile(), 658
- pfCrossVec3(), 768
- pfCull(), 118, 158, 168, 795, 867
- pfCullFace(), 463, 813
- pfCullPath(), 100
- pfCullProgramAddBinParent(), 109
- pfCullProgramAddPgmInstruction(), 105
- pfCullProgramAddPgmOpcode(), 105
- pfCullProgramIsSubbinOf(), 109
- pfCullProgramResetBinParents(), 109
- pfCullProgramResetPgm(), 105
- pfCullProgramTestPolytope(), 109
- pfCullResult(), 113
- pfCurCBufferIndex(), 655
- pfCylAroundSegs(), 332, 778, 823
- pfCylContainsPt(), 780
- pfdAddExtAlias(), 226
- pfdAddNodeToMesh(), 419, 427
- pfDBase(), 165, 168
- pfDBaseFunc(), 163, 816
- pfdBldrStateAttr(), 233
- pfdBldrStateMode(), 233
- pfdBldrStateVal(), 233
- pfdBreakup(), 289
- pfdBldTopoTraversal(), 443, 450
- pfdBldCleanTree(), 232, 814, 824, 826
- pfdBldConverterAttr(), 226
- pfdBldConverterAttr_rpc(), 273
- pfdBldConverterMode(), 226
- pfdBldConverterMode_rpc(), 273
- pfdBldConverterVal(), 226
- pfdBldConverterVal_rpc(), 273
- pfdBldConvertFrom(), 223
- pfdBldConvertGeoSetToGeoArray(), 340
- pfdBldConvertNodeGeoSetsToGeoArrays(), 340
- pfdBldConvertTo(), 223
- pfDCSCoord(), 63
- pfDCSMat(), 63
- pfDCSRot(), 63, 683
- pfDCSScale(), 63, 682, 683
- pfDCSScaleXYZ(), 682, 683
- pfDCSTrans(), 63, 682, 683
- pfdBldDefaultGState(), 814
- pfdBldDecal(), 462, 489, 813, 819, 898
- pfdBldDelete(), 11, 13, 165, 306, 318, 341, 491, 653, 655
 - datapools, 655
- pfdBldDetachChan(), 40
- pfdBldDetachPWinSwapGroup(), 512
- pfdBldDetachPWinWin(), 512
- pfdBldExitConverter(), 226
- pfdBldFreezeTransforms(), 814, 824, 826
- pfdBldGetConverterAttr(), 226
- pfdBldGetConverterAttr_rpc(), 273
- pfdBldGetConverterMode(), 226
- pfdBldGetConverterMode_rpc(), 273
- pfdBldGetConverterVal(), 226
- pfdBldGetConverterVal_rpc(), 273
- pfdBldInitConverter(), 226, 887
- pfdBldDisable(), 167, 464
- pfdBldDistancePt3(), 768
- pfdBldDivQuat(), 774
- pfdBldLoadBldrState(), 233
- pfdBldLoadClipTexture(), 557
- pfdBldLoadClipTextureState(), 557
- pfdBldLoadFile(), 223, 225, 228, 238, 440, 660
- pfdBldLoadImageCache(), 555

- pfdLoadImageTileFormat(), 555
 pfdMakeSceneGState(), 61, 814
 pfdMakeSharedScene(), 61, 814, 824
 pfdOptimizeGStateList(), 61, 814
 pfDotVec3(), 768
 pfDPoolAlloc(), 655
 pfDPoolAttachAddr(), 655
 pfDPoolFind(), 655
 pfDPoolLock(), 655
 pfDPoolUnlock(), 655
 pfdPopBldrState(), 233
 pfdPushBldrState(), 233
 pfDraw(), 118, 158, 168, 795, 818, 821, 827, 867
 pfDrawChanStats(), 791, 801, 803, 815, 825, 828, 832
 pfDrawDList(), 317, 486, 489
 pfDrawFStats(), 791, 801, 803
 pfDrawGSet(), 167, 306, 308, 309, 317, 329, 489, 491
 pfDrawHighlightedGSet(), 329
 pfDrawString(), 167, 343, 345
 pfDrawVolFog(), 188, 191
 pfdSaveBldrState(), 233
 pfdStoreFile(), 223
 pfdTessellateGeometry(), 449, 453
 pfEarthSky(), 118
 pfEnable(), 167, 464, 489
 pfEnableStatsHw(), 801, 802, 805
 pfEndSprite(), 484, 485
 pfEngineDst(), 686
 pfEngineEvaluate(), 670, 687
 pfEngineEvaluationRange(), 687
 pfEngineIterations(), 686
 pfEngineMask(), 686
 pfEngineMode(), 679, 682, 684, 687
 pfEngineSrc(), 686
 pfEngineSrcChanged(), 670
 pfEngineUserFunction(), 685
 pfEqualMat(), 771
 pfEqualVec3(), 769
 pfESkyAttr(), 184
 pfESkyColor(), 184
 pfESkyFog(), 184
 pfESkyMode(), 184, 837
 pfevaluateLOD(), 147
 pfEventSampleOff(), 840
 pfEventSampleOn(), 840
 pfExpQuat(), 774
 pfFCSFlux(), 688
 pfFeature(), 819, 828
 pfFilePath(), 660
 pfFilePathv(), 660
 pfFindFile(), 660
 pfFlatten(), 62, 164, 232, 814, 817, 824, 826
 pfFlattenString(), 345
 pfFlushState(), 491
 pfFluxCallDataFunc(), 665, 666
 pfFluxDefaultNumBuffers(), 665
 pfFluxDisableSyncGroup(), 672
 pfFluxedGSetInit(), 674
 pfFluxEnableSyncGroup(), 672
 pfFluxEvaluate(), 670, 687
 pfFluxEvaluateEye(), 670
 pfFluxFrame(), 666
 pfFluxInitData(), 665
 pfFluxMask(), 670
 pfFluxMode(), 668
 pfFluxSyncComplete(), 672
 pfFluxSyncGroup(), 671
 pfFluxSyncGroupReady(), 672, 673
 pfFluxWriteComplete(), 669, 673
 pfFogRange(), 481
 pfFogType(), 481
 pfFontAttr(), 342
 pfFontCharGSet(), 341
 pfFontCharSpacing(), 341
 pfFontMode(), 342
 pfFrame(), 88, 90, 116, 118, 131, 158, 159, 163, 171, 626, 632, 658, 794, 815, 852, 867, 873
 pfFrameRate(), 130, 131, 792
 pfFree(), 652, 653
 pfFrustContainsBox(), 781
 pfFrustContainsCyl(), 781

pfFrustContainsPt(), 780
pfFrustContainsSphere(), 781
pfFSatsClass(), 803
pfFStatsAttr(), 809
pfFStatsClass(), 800, 806
pfFStatsCountNode(), 803, 805
pfFullXformPt3(), 768
pfGArrayAddAttr(), 319, 320, 321
pfGArrayAddAttrType(), 322
pfGArrayAddColorAttrType(), 322
pfGArrayAddGenericAttrType(), 320, 322
pfGArrayAddNormalAttrType(), 322
pfGArrayAddTextureAttrType(), 320, 322
pfGArrayAddVertexAttrType(), 322
pfGArrayAllowCache(), 321
pfGArrayAttrPtr(), 319, 320, 321
pfGArrayAttrSize(), 319
pfGArrayAttrStride(), 319
pfGArrayAttrType(), 319
pfGArrayIndexArray(), 320
pfGArrayRemoveAttr(), 319
pfGArrayUpdateData(), 321
pfGeoSetIsectMask(), 669
pfGetArena(), 653
pfGetBboardAxis(), 75
pfGetBboardMode(), 76
pfGetBboardPos(), 75
pfGetChanFStats(), 791, 803
pfGetChanLoad(), 131
pfGetChanView(), 32
pfGetChanViewMat(), 32
pfGetChanViewOffsets, 32
pfGetCompositorChannelClipped(), 518
pfGetCullResult(), 114
pfGetCurGState(), 492
pfGetCurWSCConnection(), 617, 620
pfGetDCSMat(), 63
pfGetEngineDst(), 686
pfGetEngineFunction(), 679
pfGetEngineIterations(), 686
pfGetEngineMask(), 686
pfGetEngineMode(), 679
pfGetEngineNumSrcs(), 686
pfGetEngineSrc(), 686
pfGetEngineUserFunction(), 685
pfGetFFlux(), 667
pfGetFilePath(), 660
pfGetFileStatus(), 658
pfGetFluxClientEngine(), 669
pfGetFluxCurData(), 667, 668, 676
pfGetFluxDataSize(), 665
pfGetFluxDefaultNumBuffers(), 665
pfGetFluxEnableSyncGroup(), 672
pfGetFluxFrame(), 684, 685
pfGetFluxMask(), 670
pfGetFluxMemory(), 666
pfGetFluxNamedSyncGroup(), 671
pfGetFluxNumClientEngines(), 670
pfGetFluxNumNamedSyncGroups(), 672
pfGetFluxNumSrcEngines(), 670
pfGetFluxSrcEngine(), 669
pfGetFluxSyncGroup(), 671
pfGetFluxSyncGroupName(), 671
pfGetFluxWritableData(), 668
pfGetGSet(), 72, 73
pfGetGSetClassType(), 335
pfGetGSetLineWidth(), 327
pfGetGSetPntSize(), 327
pfGetGSetPrimLength(), 306, 324
pfGetGSetPrimLengths(), 324
pfGetIBRnodeProxyTexCoords(), 206
pfGetIBRtextureDefaultTexture(), 205
pfGetImageTileMemInfo(), 551
pfGetLayerBase(), 71
pfGetLayerDecal(), 71
pfGetLayerMode(), 71
pfGetLODCenter(), 70
pfGetLODRange(), 70
pfGetMatCol(), 770
pfGetMatColVec3(), 770
pfGetMatRow(), 770
pfGetMatRowVec3(), 770

pfGetMeshBbox(), 422
pfGetMeshFace(), 420
pfGetMeshFaceNumVerts(), 423
pfGetMeshFaceVertex(), 423
pfGetMeshVertex(), 420
pfGetMStack(), 776
pfGetMStackDepth(), 776
pfGetMStackTop(), 776
pfGetNumChildren(), 54
pfGetNumGSets(), 72, 73
pfGetOrthoMatCoord(), 770
pfGetOrthoMatQuat(), 770
pfGetParent(), 100
pfGetParentCullResult(), 114
pfGetPartAttr(), 79
pfGetPartType(), 79
pfGetPipe(), 23, 505
pfGetPipeScreen(), 24
pfGetPipeSize(), 24
pfGetPWinCurOriginSize(), 634
pfGetQuatRot(), 774
pfGetRef(), 12
pfGetSCSMat(), 62
pfGetSemaArena(), 170, 652, 654
pfgetSemaArena(), 487
pfGetSeqDuration(), 68
pfGetSeqFrame(), 68
pfGetSeqInterval(), 68
pfGetSeqMode(), 68
pfGetSeqTime(), 67
pfGetSharedArena(), 169, 312, 652
pfGetSize(), 653
pfGetSwitchVal(), 67
pfGetTexMultiName(), 475
pfGetTGenMode(), 478
pfGetTime(), 650
pfGetType(), 17
pfGetType_name(), 17
pfGetUserData(), 333
pfGetVClock(), 651
pfGetVolFogTexture(), 188
pfGetWinCurOriginSize(), 612, 613
pfGetWinCurScreenOriginSize(), 612
pfGetWinFBConfig(), 617
pfGetWinGLCxt(), 617
pfGetWinOrigin(), 612
pfGetWinSize(), 612
pfGetWinWSDrawable(), 616
pfGetWinWSWindow(), 616
pfGPPParamsApply(), 466
pfGProgramApply(), 466
pfGSetAttr(), 12, 306, 312, 653, 688
pfGSetBBox(), 306, 331
pfGSetBBoxFlux(), 331
pfGSetBound(), 688
pfGSetCalcTexBBox(), 335
pfGSetDecalPlane(), 328
pfGSetDrawBin(), 330
pfGSetDrawMode(), 306, 308, 309, 317, 326, 327
pfGSetDrawOrder(), 330
pfGSetGState(), 12, 306, 327, 328, 335, 491
pfGSetGStateIndex(), 306, 327, 328
pfGSetHlight(), 12, 306, 328, 482
pfGSetIsectMask(), 127, 306, 330, 785
pfGSetIsectSegs(), 306, 318, 330, 331, 784, 785
pfGSetLineWidth(), 306, 327
pfGSetMultiAttr(), 306, 312
pfGSetNumPrims(), 306, 307, 308
pfGSetOptimize(), 179, 336
pfGSetPntSize(), 306, 327
pfGSetPrimLengths(), 306, 307, 308, 323
pfGSetPrimType(), 306, 323
pfGSetQuickAttr(), 178
pfGSetQuickMultiAttr(), 179
pfGSetQuickPrimLengths(), 179
pfGSetTexBBox_f(), 335
pfGSetTexBBox_i(), 335
pfGSetUpdateCteRefs(), 335
pfGStateAttr(), 12, 490, 492
pfGStateFuncs(), 492
pfGStateInherit(), 489, 492
pfGStateMode(), 460, 490, 491

pfGStateVal(), 464, 492
pfHalfSpaceContainsBox(), 781
pfHalfSpaceContainsCyl(), 781
pfHalfSpaceContainsPt(), 780
pfHalfSpaceContainsSphere(), 781
pfHalfSpaceIsectSeg(), 783
pfHideGSetStripPrim(), 324
pfHlightColor(), 482
pfHlightLineWidth(), 482
pfHlightMode(), 482
pfHlightNormalLength(), 483
pfHlightPntSize(), 483
pfHyperpipe(), 166, 502, 503
pfIBRnodeAngles(), 205
pfIBRnodeFlags(), 206
pfIBRnodeIBRtexture(), 205
pfIBRnodeProxyTexCoords(), 206
pfIBRtextureDirection(), 208
pfIBRtextureFlags(), 207, 208
pfIBRtextureIBRdirections(), 206
pfIBRtextureIBRtextures(), 207
pfIBRtextureLoadIBRtexture(), 207
pfIBRtextureNumRings(), 207
pfIBRtextureRing(), 207
pfIdleTex(), 470
pfImageCacheFileStreamServer(), 552
pfImageCacheImageSize(), 551
pfImageCacheMemRegionOrigin(), 551
pfImageCacheMemRegionSize(), 551, 552
pfImageCacheName(), 551
pfImageCacheProtoTile(), 552
pfImageCacheTex(), 552
pfImageCacheTexRegionOrigin(), 551
pfImageCacheTexRegionSize(), 552
pfImageCacheTexSize(), 552
pfImageCacheTileFileNameFormat(), 551
pfImageTileDefaultTile(), 552
pfImageTileFileImageFormat(), 553
pfImageTileFileImageType(), 551
pfImageTileFileName(), 551, 552
pfImageTileHeaderOffset(), 551, 553
pfImageTileMemImageFormat(), 553
pfImageTileMemImageType(), 551, 553
pfImageTileMemInfo(), 551
pfImageTileNumFileTiles(), 551
pfImageTileReadFunc(), 551
pfImageTileReadQueue(), 551, 552
pfImageTileSize(), 551, 553
pfIndex(), 795
pfInit(), 160, 169, 653, 887, 891
pfInitArenas(), 652, 653, 654, 887, 891
pfInitCBuffer(), 658
pfInitClock(), 650
pfInitGfx(), 616, 629
pfInitializeEvents(), 840
pfInitState(), 487
pfInitVClock(), 651
pfInsertChan(), 38, 44
pfInsertChild(), 54
pfInsertGSet(), 12, 72, 73
pfInvertAffMat(), 771
pfInvertFullMat(), 771
pfInvertIdentMat(), 771
pfInvertOrthoMat(), 771
pfInvertOrthoNMat(), 771
pfInvertQuat(), 774
pfIsectFunc(), 158, 171, 816
pfIsGSetStripPrimHidden(), 324
pfIsOfType(), 17
pfIsTexLoaded(), 470
pfLayer(), 898
pfLayerBase(), 71
pfLayerDecal(), 71
pfLayerMode(), 71
pfLengthQuat(), 774
pfLengthVec3(), 768
pfLightAtten(), 480
pfLightOn(), 167, 466, 479
pfLoadImageTile(), 553
pfLoadMatrix(), 484
pfLoadMStack(), 776
pfLoadMultiTexFile(), 475

pfLoadState(), 487
pfLoadTex(), 470
pfLoadTexFile(), 467
pfLODCenter(), 70
pfLODLLODState(), 140
pfLODLLODStateIndex(), 140
pfLODRange(), 70
pfLODTransition(), 145
pfLODUserEvalFunc(), 147
pfLogQuat(), 774
pfMakeCoordMat(), 770
pfMakeEulerMat(), 769
pfMakeOrthoFrust(), 778
pfMakePerspFrust(), 778
pfMakePolarSeg(), 782
pfMakePtsSeg(), 782
pfMakeQuatMat(), 769
pfMakeRotMat(), 769
pfMakeRotOntoMat(), 769
pfMakeRotQuat(), 774
pfMakeScaleMat(), 769
pfMakeTransMat(), 769
pfMalloc(), 12, 169, 312, 652, 653, 654, 824
pfMergeBuffer(), 163, 164, 893
pfMeshAddFace(), 420
pfMeshAddGeoSet(), 419, 420, 421
pfMeshAddTriangle(), 420
pfMeshFaceNumVerts(), 422
pfMeshFaceTexCoord(), 423
pfMeshFaceVertex(), 422
pfMeshGridBsphere(), 421
pfMeshNumFaces(), 420
pfMeshNumVertices(), 420
pfMeshSplitVertices(), 420, 425
pfMeshUpdateMesh(), 422, 423
pfMeshVertexCoord(), 424
pfMeshVertexCoordPtr(), 424
pfMeshVertexNeighbor(), 424
pfMeshVertexNumNeighbors(), 424
pfModelMat(), 485
pfMoveChan(), 38, 44
pfMovePWin(), 636
pfMPKImportConfig(), 45, 46
pfMPKImportFile(), 45, 46, 47
pfMPKPostConfig(), 47
pfMPKPostDMConfig(), 47
pfMPKPreConfig(), 47
pfMQueryFStats(), 804, 808
pfMQueryGSet(), 334
pfMQueryHit(), 121, 122, 784
pfMQueryStats(), 804, 808
pfMtlColorMode(), 480, 813, 817, 838
pfMultipipe(), 159, 160, 503, 504
pfMultiprocess(), 23, 156, 157, 158, 160, 163, 665,
793, 816, 831, 873, 887
pfMultithread(), 159, 160, 174
pfMultithreadParami(), 174, 175, 176
pfMultMat(), 770
pfMultMatrix(), 167, 484
pfMultQuat(), 774
pfNegateVec3(), 768
pfNewBboard(), 75
pfNewBuffer(), 163, 893
pfNewCBuffer(), 658
pfNewChan(), 27
pfNewClipTexture(), 550
pfNewCtab(), 481
pfNewDCS(), 63
pfNewDList(), 485
pfNewDPool(), 654
pfNewESky(), 184
pfNewFlux(), 664
pfNewFog(), 481
pfNewFont(), 341
pfNewFrust(), 778
pfNewGArray(), 318
pfNewGeode(), 72, 73
pfNewGSet(), 306
pfNewGState(), 491
pfNewHlight(), 482
pfNewImageTile(), 551, 552, 553
pfNewLayer(), 71

pfNewLight(), 479
pfNewLModel(), 479
pfNewLOD(), 70
pfNewMaterial(), 480
pfNewMStack(), 775
pfNewMtl(), 480
pfNewPart(), 79
pfNewPath(), 100
pfNewPWin(), 626, 633
pfNewScene(), 61
pfNewSCS(), 62
pfNewSeq(), 67
pfNewState(), 487, 616
pfNewString(), 344
pfNewSwitch(), 67
pfNewTex(), 467
pfNewVolFog(), 188
pfNewWin(), 610
pfNextNeighborIndexMeshVertex(), 425
pfNextNeighborMeshVertex(), 425
pfNodeBSphere(), 60
pfNodeIsectSegs(), 120, 121, 122, 126, 158, 784, 823
pfNodeTravData(), 883
pfNodeTravFuncs(), 113, 883, 886, 889
pfNodeTravMask(), 112, 122, 126, 823
pfNormalizeVec3(), 768
pfNotify(), 652, 659
pfNotifyHandler(), 652, 659
pfNotifyLevel(), 659, 820, 832
pfOpenDList(), 485
pfOpenFile(), 658
pfOpenPWin(), 626, 632, 633, 634, 635, 636
pfOpenScreen(), 612, 620
pfOpenStats(), 805
pfOpenWin(), 610, 613, 616, 617, 618, 619
pfOpenWConnection(), 621
pfOrthoXformCyl(), 779
pfOrthoXformFrust(), 779
pfOrthoXformPlane(), 779
pfOrthoXformSphere(), 779
pfOverride(), 459, 466, 488, 818
pfPartAttr(), 79
pfPassChanData(), 118, 171, 815, 820
pfPassIsectData(), 171
pfPhase(), 131, 133
pfPipeScreen(), 24, 506
pfPipeWConnectionName(), 506
pfPlaneIsectSeg(), 784
pfPopMatrix(), 114, 483
pfPopMStack(), 776
pfPopState(), 487
pfPositionSprite(), 484
pfPostMultMat(), 770
pfPostMultMStack(), 776
pfPostRotMat(), 771
pfPostRotMStack(), 776
pfPostScaleMat(), 771
pfPostScaleMStack(), 776
pfPostTransMat(), 771
pfPostTransMStack(), 776
pfPreMultMat(), 770
pfPreMultMStack(), 776
pfPreRotMat(), 771
pfPreRotMStack(), 776
pfPreScaleMat(), 771
pfPreTransMat(), 770
pfPreviousNeighborIndexMeshVertex(), 425
pfPreviousNeighborMeshVertex(), 425
pfPrint(), 306, 318, 807
pfProcessHighestPriority, 165
pfProcessPriorityUpgrade(), 165
pfPushIdentMatrix(), 483
pfPushMatrix(), 114, 483
pfPushMStack(), 775
pfPushState(), 167, 487
pfPWinAddPVChan(), 511
pfPWinConfigFunc(), 632, 633, 634
pfPWinFBConfig(), 511, 629, 634
pfPWinFBConfigAttrs(), 511, 629, 634
pfPWinFBConfigData(), 511
pfPWinFBConfigId(), 511
pfPWinFullScreen(), 626, 627, 634

pfPWinGLCxt(), 511, 634
 pfPWinIndex(), 630, 633
 pfPWinList(), 511
 pfPWinMode(), 630, 633
 pfPWinOriginSize(), 626, 633, 634
 pfPWinOverlayWin(), 511
 pfPWinPVChan(), 511
 pfPWinRemovePVChan(), 511
 pfPWinRemovePVChanIndex(), 511
 pfPWinScreen(), 511, 627, 634
 pfPWinShare(), 634
 pfPWinStatsWin(), 511
 pfPWinSwapBarrier(), 511
 pfPWinType(), 634
 pfPWinWSCConnectionName(), 511
 pfPWinWSDrawable(), 511, 635
 pfPWinWSWindow(), 511
 pfPWinWSWindow(), 634, 635
 pfQuatMeanTangent(), 774
 pfQueryFeature(), 812
 pfQueryFStats(), 804, 808
 pfQueryGSet(), 306, 334
 pfQueryHit(), 121, 122, 784, 786
 pfQueryStats(), 804, 808
 pfQuerySys(), 615
 pfQueryWin(), 615, 616
 pfQuickCopyGSet(), 178
 pfQuickResetGSet(), 179
 pfReadFile(), 658
 pfRef(), 12
 pfReleaseDPool(), 655
 pfRemoveChan(), 44
 pfRemoveChild(), 54, 164
 pfRemoveGSet(), 72, 73
 pfReplaceGSet(), 12, 72, 73
 pfResetDList(), 486
 pfResetEvents(), 840
 pfResetMStack(), 775
 pfResetStats(), 804
 pfRotate(), 483
 pfSaveMultiTexFile(), 475
 pfScale(), 483
 pfScaleVec3(), 768
 pfSceneGState(), 61, 814
 pfSeekFile(), 658
 pfSegIsectPlane(), 784
 pfSegIsectTri(), 784
 pfSelectBuffer(), 163, 893
 pfSelectPWin(), 511
 pfSelectState(), 487
 pfSelectWin(), 612
 pfSelectWSCConnection(), 620
 pfSeqDuration(), 68
 pfSeqInterval(), 68
 pfSeqMode(), 68
 pfSeqTime(), 67
 pfSetMatCol(), 770
 pfSetMatColVec3(), 770
 pfSetMatRow(), 770
 pfSetMatRowVec3(), 770
 pfSetVec3(), 768
 pfShadeModel(), 461
 pfShaderChanged(), 498
 pfShaderTexApplyFunc(), 499, 500
 pfShaderTexComputeFunc(), 499, 500
 pfShaderTexCoordFunc(), 499, 500
 pfShadow routines, 200
 pfSharedArenaSize(), 652, 654
 pfSharedMalloc(), 847
 pfSlerpQuat(), 774
 pfSphereAroundBoxes(), 778
 pfSphereAroundPts(), 778
 pfSphereAroundSpheres(), 778
 pfSphereContainsCyl(), 781
 pfSphereContainsPt(), 780
 pfSphereContainsSphere(), 781
 pfSphereExtendByPt(), 779
 pfSphereExtendBySphere(), 779
 pfSphereIsectSeg(), 783
 pfSpriteAxis(), 485
 pfSpriteMode(), 485
 pfSqrDistancePt3(), 768

pfSquadQuat(), 774
pfStageConfigFunc(), 24
pfStatsClass(), 800, 805
pfStatsClassMode(), 804, 805, 806
pfStatsCountGSet(), 805
pfStatsHwAttr(), 800, 805
pfStringColor(), 345
pfStringFont(), 343
pfStringMat(), 345
pfStringMode(), 345
pfSubdivSurface(), 427
pfSubdivSurfaceFlags(), 427
pfSubdivSurfaceMesh(), 427
pfSubdivSurfaceUpdateControlMesh(), 430
pfSubdivSurfaceVal(), 427
pfSubloadMultiTex(), 475
pfSubloadTex(), 470
pfSubloadTexLevel(), 470
pfSubloadTexMultiLevel(), 475
pfSubMat(), 770
pfSubVec3(), 768
pfSwapWinBuffers(), 514
pfSwitchVal(), 67
pfSync(), 88, 131, 794, 815, 851, 867
pfTEnvBlendColor(), 477
pfTevMode(), 813
pfTexAnisotropy(), 473
pfTexDetail(), 12, 473
pfTexFilter(), 472, 813
pfTexFormat(), 470, 471, 474, 550, 552, 837
pfTexFrame(), 471
pfTexImage(), 12, 467, 468, 475, 550, 552
pfTexLevel(), 473
pfTexList(), 471
pfTexLoadImage(), 470
pfTexLoadMode(), 468, 470, 471
pfTexLoadOrigin(), 469
pfTexLoadSize(), 470
pfTexMultiImage(), 474
pfTexMultiName(), 475
pfTexName(), 550
pfTexSpline(), 473
pfTGenMode(), 477
pfTGenPlane(), 478
pfTranslate(), 483
pfTransparency(), 167, 457, 461, 489, 813, 818
pfTransposeMat(), 770
pfTriIsectSeg(), 784
pfuAddMPClipTexturesToPipes, 549
pfuCollideSetup(), 815
pfuDownloadTexList(), 514, 822
pfuFreeClipTexConfig(), 554
pfuFreeImgCacheConfig(), 554
pfuInitClipTexConfig(), 554
pfuInitImgCacheConfig(), 554
pfuLockDownApp(), 820
pfuLockDownCull(), 820
pfuLockDownDraw(), 820
pfuLockDownProc(), 820
pfuMakeClipTexture(), 554
pfuMakeImageCache(), 554
pfUnbindPWinPVChans(), 511
pfUnhideGSetStripPrim(), 324
pfUnref(), 12
pfUnrefDelete(), 14
pfUpdatePart(), 78, 79
pfuPrioritizeProcs(), 820
pfUserData(), 883
pfVClockSync(), 651
pfViewMat(), 485
pfVolFogAddChannel(), 188, 191
pfVolFogAddColoredPoint(), 187, 188, 192
pfVolFogAddNode(), 187, 188, 194
pfVolFogAddPoint(), 187, 188, 192
pfVolFogSetAttr(), 188, 192, 193
pfVolFogSetColor(), 188, 192
pfVolFogSetDensity(), 188
pfVolFogSetFlags(), 188, 193
pfVolFogSetVal(), 188, 192, 193, 195
pfVolFogUpdateView(), 188, 191
pfWinFBConfig(), 616, 617
pfWinFBconfig(), 615

pfWinFBConfigAttrs(), 613
 pfWinFullScreen(), 612, 627
 pfWinGLCxt(), 615, 616, 617
 pfWinIndex(), 618, 619
 pfWinMode(), 617
 pfWinOriginSize(), 612
 pfWinOverlayWin(), 619
 pfWinScreen(), 612
 pfWinShare(), 619
 pfWinStatsWin(), 619
 pfWinType(), 611
 pfWinWSDrawable(), 615, 616
 pfWinWSWindow(), 616, 618
 pfWriteEvents(), 840
 pfWriteFile(), 658
 pfXformBox(), 779
 pfXformPt3(), 768
 pfXformVec3(), 768
 postConfig(), 867
 postCull(), 867
 postDraw(), 867
 preConfig(), 867
 preCull(), 867
 preDraw(), 867
 sync(), 867
 RPC database format, 273
 ruled surfaces, 406

S

s_streams, 563
 sample applications
 repTest, 352, 382, 394, 415
 topoTest, 439
 sample code, 871
 repTest, 415
 sample code. See example code
 sampling, program counter, 829
 Scalable Graphics Compositor, 501, 514
 scalar functions, 349
 see functions, 349
 scalars
 defining, 349
 scan rate, 132
 scene complexity, definition, 907
 scene graph
 defined, 907
 state inheritance, 88
 scene graph topology tools, 434
 scene graphs, 87
 scene, definition, 907
 screen-door transparency, 461
 SCS. See pfSCS nodes
 search paths, 660
 definition, 907
 See formats., 221
 segments, 782
 See also pfSegSet
 self-shadowing, 195
 semaphores, allocating, 654
 sense, definition of, 907
 setmon(), 651
 setrlimit(), 654
 setSyncGroup, 715
 SGF database format, 275
 SGO format. See formats
 Shader
 flow through Performer, 500
 man pages, 497
 shaders, 497
 shading
 flat, 461
 Gouraud, 461
 shadow, 715
 shadow map
 defined, 907

- shadows, 198
- share groups, 578, 908
- share mask, 544, 578, 908
- shared arena, memory mapping, 653
- shared instancing, 56
 - defined, 908
- shared memory
 - allocation, 880
 - arenas, 652
 - datapools, 654
 - debugging and, 831
- sharing channel attributes, 40
- sharpen texture, 827
- shininess, definition, 908
- siblings, of a node, defined, 908
- Sierpinski sponge, 280
- Silicon Graphics Object format. See formats
- Simplify application, 209
- simulation, xliii
- simulation-based design, xliii
- single inheritance, 10
- single-precision arithmetic, 828
- slave cliptexture, 576
- slew table, 752
- smallest_icode, 567
- Software Systems, 252
- solids, 443
 - forming with surface patches, 443
- Soma cube puzzle, 249
- sorting, 646
 - defined, 908
- sorting for transparency, 461
- source code
 - See also example code
 - database loaders, 230, 884
 - database loading, 225
 - database processing tools, 221
 - fill statistics, 800
 - libpfutil, 820, 822
 - MIPmap, 468
 - Perfly, 905
 - pfPipeWindow, 630, 635, 636
 - pfTexture, 468
 - statistics, 801, 810
 - X input, 822
- spacing
 - character, 341
 - definition, 908
- spatial curves, 377
- spatial decomposition, 502
- spatial organization, 94
 - definition, 909
- specifying surface cross sections, 355
- SPF format. See formats
- spheres, 392
 - as bounding volumes, 777
- splines, 365
 - Hermite spline, 417
- SPONGE format. See formats
- sprite, 484
 - defined, 909
- sproc(), 168, 658, 823, 887
- stack, 879
- stage timing graph, 792, 793
 - See also statistics
- stage, definition, 909
- stages of rendering, 155
- STAR format. See formats
- state
 - changes, 813
 - defined, 909
 - inheritance, 87
 - local and global, 489
- state elements, 457
- state specification

- global, 489
- local, 489
- static coordinate systems. See pfSCS nodes
- static data in C++ classes, 888
- statistics, 791
 - average, 809
 - CPU, 797
 - cumulative, 809
 - current, 809
 - data structures, 791, 809
 - displaying, 791, 792, 801
 - enabling, 803
 - fill, 800
 - graphics, 799
 - previous, 809
 - stage timing
 - defaults, 802
 - graph, 793
 - use in applications, 801
- stencil decaling, 462
 - defined, 909
- stereo display, 38
- stitching surfaces, 433
- STL format. See formats
- stream, 563
- stress filter, 151
- stress filter for DVR, 151
- stress management, 152
- stress management. See load management
- stress, definition, 909
- structures
 - libpfd
 - pfdBuilder, 256
- sub-bin, 98
- subclassing, 883
- subdivision surfaces, 426
- subgraph, definition, 909
- superquadric curves

- in space, 378
- in the plane, 362
- supersampled data, 595
- SuperViewer, 283
- surface contact information, 433
- surface edges, 385
- surfaces
 - adding, 437
 - adjacency information, 385
 - Coons patch, 408
 - defining edges, 384
 - Hermite spline, 417
 - NURBS, 348
 - NURBS curve, 410
 - parametric, 381
 - ruled surface, 406
 - specifying cross sections, 355
 - swept surfaces, 401
- SV format. See formats
- swept surfaces, 401
 - Frenet frame, 405
 - specifying cross sections, 355
- switch nodes, 67
- sync(), 867
- synchronization of frames, 132

T

- t_streams, 563
- tearing, 462
- temporal decomposition, 502
- tessalation
 - illustration, 447
- tessellation
 - adjacent surfaces, 433
 - consistent, 434
 - controlling cracks, 448
 - deleting data, 441

- parametric surfaces, 451
- tessellator
 - definition, 445
- testing
 - intersections. See intersections
 - visibility, 93
- tex region, 532
- tex_region_size, 560
- texel coordinates, 530
- texel data, 540, 547
- texel format, 550
- texel tile, 548
- texel, definition, 910
- texload time, 583
- text, 73
- texture
 - coordinate generation, 477
 - coordinates, 710
 - detail, 827
 - loading, 476
 - magnification, 827
 - mapping, defined, 910
 - memory, 535
 - minification, 827
 - paging, 470
 - sharpen, 827
 - tiling, 547
- texturing
 - overview, 467
 - performance cost, 817, 836
 - RealityEngine graphics, 837
 - representing complex objects, 827
- tile size, 548
- tile, algorithm, 546
- tile, default, 552
- tile, defined, 910
- tile, updates, 590
- tile_base, 569
- tile_files, 569
- tile_format, 561, 569
- tile_params, 561, 569
- tile_size, 569
- tiles, 531
- tiles_in_file, 569
- tiling an image, 547
- tiling, strategy, 589
- TIN, 694
- tokens
 - APP_CULL_DRAW, 829
 - PF_MAX_ANISOTROPY, 473
 - PF_MAX_LIGHTS, 479
 - PF_OFF, 460
 - PFAA_OFF, 460
 - PFAF_ALWAYS, 459
 - PFAF_GREATER, 462
 - PFBOUND_FLUX, 688
 - PFBOUND_STATIC, 60
 - PFCF_BACK, 463
 - PFCF_BOTH, 464
 - PFCF_FRONT, 463
 - PFCF_OFF, 460, 463
 - PFCHAN_EARTHSKY, 41
 - PFCHAN_FOV, 41
 - PFCHAN_LOD, 41
 - PFCHAN_NEARFAR, 41
 - PFCHAN_SCENE, 41
 - PFCHAN_STRESS, 41
 - PFCHAN_SWAPBUFFERS, 41
 - PFCHAN_SWAPBUFFERS_HW, 620, 638
 - PFCHAN_VIEW, 41
 - PFCHAN_VIEW_OFFSETS, 41
 - PFCULL_GSET, 102
 - PFCULL_IGNORE_LSOURCES, 102
 - PFCULL_PROGRAM, 102
 - PFCULL_SORT, 102, 815
 - PFCULL_VIEW, 102
 - PFDECAL_BASE_STENCIL, 463

PFDECAL_LAYER_STENCIL, 463
PFDECAL_OFF, 460, 463
PFDL_RING, 486
PFDRAW_OFF, 103
PFDRAW_ON, 103
PFEN_COLORTABLE, 465
PFEN_FOG, 465
PFEN_FRAGPROG, 465
PFEN_HIGHLIGHTING, 465
PFEN_LIGHTING, 465
PFEN_LPOINTSTATE, 465
PFEN_TEXGEN, 465
PFEN_TEXTURE, 465
PFEN_VTXPROG, 465
PFEN_WIREFRAME, 465
PFENG_ALIGN, 678
PFENG_ANIMATE, 678
PFENG_ANIMATE_BASE_MATRIX, 679
PFENG_ANIMATE_ROT, 679
PFENG_ANIMATE_SCALE_UNIFORM, 679
PFENG_ANIMATE_SCALE_XYZ, 679
PFENG_ANIMATE_TRANS, 679
PFENG_BBOX, 678
PFENG_BLEND, 678
PFENG_MATRIX, 678
PFENG_MORPH, 678
PFENG_MORPH_FRAME, 680
PFENG_MORPH_SRC(n), 680
PFENG_MORPH_WEIGHTS, 680
PFENG_RANGE_CHECK, 687
PFENG_STROBE, 679
PFENG_TIME, 678
PFENG_TRANSFORM, 678
PFENG_USER_FUNCTION, 679
PFES_BUFFER_CLEAR, 182
PFES_FAST, 184
PFES_GRND_FAR, 182
PFES_GRND_HT, 182
PFES_GRND_NEAR, 182
PFES_SKY, 185
PFES_SKY_CLEAR, 185
PFES_SKY_GRND, 182, 185
PFFB_ACCUM_ALPHA_SIZE, 614
PFFB_ACCUM_BLUE_SIZE, 614
PFFB_ACCUM_GREEN_SIZE, 614
PFFB_ACCUM_RED_SIZE, 614
PFFB_ALPHA_SIZE, 614
PFFB_AUX_BUFFER, 614
PFFB_BLUE_SIZE, 614
PFFB_BUFFER_SIZE, 614
PFFB_DEPTH_SIZE, 614
PFFB_DOUBLEBUFFER, 614
PFFB_GREEN_SIZE, 614
PFFB_RED_SIZE, 614
PFFB_RGBA, 614
PFFB_STENCIL, 614
PFFB_STEREO, 614
PFFB_USE_GL, 614
PFFLUX_BASIC_MASK, 670
PFFLUX_DEFAULT_NUM_BUFFERS, 665
PFFLUX_ON_DEMAND, 668, 676
PFFOG_PIX_EXP, 481
PFFOG_PIX_EXP2, 481
PFFOG_PIX_LIN, 481
PFFOG_PIX_SPLINE, 481, 482
PFFOG_VTX_EXP, 481
PFFOG_VTX_EXP2, 481
PFFOG_VTX_LIN, 481
PFFONT_BBOX, 342
PFFONT_CHAR_SPACING, 342
PFFONT_CHAR_SPACING_FIXED, 342
PFFONT_CHAR_SPACING_VARIABLE, 342
PFFONT_GSTATE, 342
PFFONT_NAME, 342
PFFONT_NUM_CHARS, 342
PFFONT_RETURN_CHAR, 342
PFFONT_SPACING, 342
PFGS_COLOR4, 480
PFGS_COMPILE_GL, 309, 317
PFGS_COORD3, 669
PFGS_FLAT_LINESTRIPS, 307, 315
PFGS_FLAT_TRISTRIPS, 307, 315

PFGS_FLATSHADE, 308
PFGS_LINES, 307
PFGS_LINESTRIPS, 307
PFGS_OFF, 314
PFGS_OVERALL, 314
PFGS_PER_PRIM, 314
PFGS_PER_VERTEX, 314, 315
PFGS_POINTS, 307
PFGS_POLYS, 307
PFGS_QUADS, 307, 785
PFGS_TRIS, 307, 785
PFGS_TRISTRIPS, 307, 785
PFGS_WIREFRAME, 308
PFHL_BBOX_FILL, 483
PFHL_BBOX_LINES, 483
PFHL_FILL, 482
PFHL_FILL_R, 482
PFHL_FILLPAT, 482
PFHL_FILLPAT2, 482
PFHL_FILLTEX, 482
PFHL_LINES, 482
PFHL_LINES_R, 482
PFHL_LINESPAT, 482
PFHL_LINESPAT2, 482
PFHL_NORMALS, 483
PFHL_POINTS, 483
PFHL_SKIP_BASE, 483
PFIS_ALL_IN, 114, 781, 783
PFIS_FALSE, 113, 780, 781, 784
PFIS_MAYBE, 781, 783
PFIS_PICK_MASK, 126
PFIS_START_IN, 783
PFIS_TRUE, 780, 781, 783, 784
PFLUX_WRITE_ONCE, 669
PFMP_APP_CULL_DRAW, 157, 159, 167, 169, 793
PFMP_APP_CULLDRAW, 156, 158, 167
PFMP_APPCULL_DRAW, 157, 159
PFMP_APPCULLDRAW, 156, 158, 159, 831
PFMP_CULL_DL_DRAW, 157, 158, 814, 815
PFMP_CULLoDRAW, 157, 793
PFMP_FORK_COMPUTE, 158
PFMP_FORK_CULL, 156, 157
PFMP_FORK_DBASE, 163
PFMP_FORK_DRAW, 156, 157
PFMP_FORK_ISECT, 158
PFMTL_CMODE_AD, 817
PFNFY_ALWAYS, 659
PFNFY_DEBUG, 225, 659, 832
PFNFY_FATAL, 652, 659
PFNFY_FP_DEBUG, 659
PFNFY_INFO, 659
PFNFY_NOTICE, 659
PFNFY_WARN, 659
PFPB_LEVEL, 614
PFPHASE_FLOAT, 133
PFPHASE_FREE_RUN, 133, 627
PFPHASE_LIMIT, 133
PFPHASE_LOCK, 133
PFPK_M_ALL, 126
PFPK_M_NEAREST, 126
PFPROC_APP, 24
PFPROC_CULL, 24
PFPROC_DBASE, 24
PFPROC_DRAW, 24
PFPROC_ISECT, 24
PFPVC_DVR_AUTO, 148, 150, 641
PFPVC_DVR_MANUAL, 150, 641
PFPWIN_TYPE_NONEVENTS, 627
PFPWIN_TYPE_NOPORT, 612
PFPWIN_TYPE_OVERLAY, 611
PFPWIN_TYPE_SHARE, 628, 637
PFPWIN_TYPE_STATS, 611, 628
PFPWIN_TYPE_X, 611, 628
PFQHIT_FLAGS, 121, 122
PFQHIT_GSET, 122
PFQHIT_NAME, 122
PFQHIT_NODE, 122
PFQHIT_NORM, 121
PFQHIT_PATH, 122
PFQHIT_POINT, 121
PFQHIT_PRIM, 122
PFQHIT_SEG, 121

PFQHIT_SEGNUM, 121
PFQHIT_TRI, 122
PFQHIT_VERTS, 122
PFQHIT_XFORM, 122
PFSM_FLAT, 461
PFSM_GOURAUD, 460, 461
PFSORT_BACK_TO_FRONT, 99
PFSORT_BY_STATE, 99
PFSORT_END, 99
PFSORT_FRONT_TO_BACK, 99
PFSORT_NO_ORDER, 99
PFSORT_QUICK, 99
PFSORT_STATE_BGN, 99
PFSORT_STATE_END, 99
PFSPRITE_AXIAL_ROT, 485
PFSPRITE_MATRIX_THRESHOLD, 485
PFSPRITE_POINT_ROT_EYE, 485
PFSPRITE_POINT_ROT_WORLD, 485
PFSPRITE_ROT, 485
PFSTATE_ALPHAFUNC, 459
PFSTATE_ALPHAREF, 464
PFSTATE_ANTIALIAS, 460
PFSTATE_BACKMTL, 466
PFSTATE_COLORTABLE, 466
PFSTATE_CULLFACE, 460
PFSTATE_DECAL, 460
PFSTATE_ENCOLORTABLE, 460
PFSTATE_ENFOG, 460
PFSTATE_ENFRAGPROG, 460
PFSTATE_ENHIGHLIGHTING, 460
PFSTATE_ENLIGHTING, 460, 490
PFSTATE_ENLPOINTSTATE, 460
PFSTATE_ENTEXGEN, 460
PFSTATE_ENTEXTURE, 460, 490
PFSTATE_ENVTXPROG, 460
PFSTATE_ENWIREFRAME, 460
PFSTATE_FOG, 466
PFSTATE_FRAGPROG, 466
PFSTATE_FRONTMTL, 466
PFSTATE_GPROGPARGS, 466
PFSTATE_HIGHLIGHT, 466
PFSTATE_LIGHTMODEL, 466
PFSTATE_LIGHTS, 466
PFSTATE_LPOINTSTATE, 466
PFSTATE_SHADEMODEL, 460
PFSTATE_TEXENV, 466
PFSTATE_TEXGEN, 466
PFSTATE_TEXTURE, 466
PFSTATE_TRANSPARENCY, 457, 459
PFSTATE_VTXPROG, 466
PFSTATS_ENGF, 799
PFSTATS_ON, 799
PFSTR_CENTER, 345
PFSTR_CHAR, 345
PFSTR_CHAR_SIZE, 345
PFSTR_FIRST, 345
PFSTR_INT, 345
PFSTR_JUSTIFY, 345
PFSTR_LAST, 345
PFSTR_LEFT, 345
PFSTR_MIDDLE, 345
PFSTR_RIGHT, 345
PFSTR_SHORT, 345
PFSWITCH_OFF, 67
PFSWITCH_ON, 67
PFTEX_BASE_APPLY, 472
PFTEX_BASE_AUTO_REPLACE, 470
PFTEX_BASE_AUTO_SUBLOAD, 472
PFTEX_FAST, 472
PFTEX_LIST_APPLY, 472
PFTEX_LIST_AUTO_IDLE, 472
PFTEX_LIST_AUTO_SUBLOAD, 472
PFTEX_LOAD_BASE, 472
PFTEX_LOAD_LIST, 472
PFTEX_LOAD_SOURCE, 468
PFTEX_SOURCE_FRAMEBUFFER, 469
PFTEX_SOURCE_IMAGE, 468
PFTEX_SOURCE_VIDEO, 469
PFTEX_SUBLOAD_FORMAT, 470
PFTG_EYE_DISTANCE_TO_LINE, 478
PFTG_EYE_LINEAR, 477
PFTG_EYE_LINEAR_IDENT, 478

- PFTG_NORMAL_MAP, 478
- PFTG_OBJECT_DISTANCE_TO_LINE, 478
- PFTG_OBJECT_LINEAR, 477
- PFTG_OFF, 477
- PFTG_REFLECTION_MAP, 478
- PFTG_SPHERE_MAP, 478
- PFTR_BLEND_ALPHA, 461
- PFTR_FAST, 461
- PFTR_HIGH_QUALITY, 461
- PFTR_MS_ALPHA, 461
- PFTR_NO_OCCLUDE, 461
- PFTR_OFF, 459, 461
- PFTR_ON, 461
- PFTRAV_CONT, 113, 125, 786
- PFTRAV_CULL, 102, 118
- PFTRAV_DRAW, 118
- PFTRAV_IS_BCYL, 127
- PFTRAV_IS_CACHE, 815
- PFTRAV_IS_CLIP_END, 125, 786
- PFTRAV_IS_CLIP_START, 125, 786
- PFTRAV_IS_CULL_BACK, 126
- PFTRAV_IS_GEODE, 124
- PFTRAV_IS_GSET, 124, 127, 785
- PFTRAV_IS_IGNORE, 125, 785
- PFTRAV_IS_NO_PART, 78
- PFTRAV_IS_NODE, 127
- PFTRAV_IS_PRIM, 124, 785
- PFTRAV_IS_UNCACHE, 669
- PFTRAV_PRUNE, 113, 125, 786
- PFTRAV_TERM, 113, 125, 786
- PFVCHAN_AUTO_APPLY, 641
- PFVCHAN_SYNC, 641
- PFVCHAN_SYNC_FIELD, 642
- PFVFOG_3D_TEX_SIZE, 189
- PFVFOG_COLOR, 189
- PFVFOG_DENSITY, 189
- PFVFOG_DENSITY_BIAS, 189
- PFVFOG_EXP, 193
- PFVFOG_EXP2, 193
- PFVFOG_FLAG_CLOSE_SURFACES, 190
- PFVFOG_FLAG_FORCE_2D_TEXTURE, 190
- PFVFOG_FLAG_FORCE_PATCHY_PASS, 190
- PFVFOG_FLAG_LAYERED_PATCHY_FOG, 190
- PFVFOG_LAYERED_MODE, 189
- PFVFOG_LIGHT_SHAFT_ATTEN_SCALE, 189
- PFVFOG_LIGHT_SHAFT_ATTEN_TRANSLATE, 189
- PFVFOG_LIGHT_SHAFT_DARKEN_FACTOR, 189
- PFVFOG_LINEAR, 189, 193
- PFVFOG_PATCHY_MODE, 189
- PFVFOG_PATCHY_TEXTURE_BOTTOM, 189
- PFVFOG_PATCHY_TEXTURE_TOP, 189
- PFVFOG_RESOLUTION, 189
- PFVFOG_ROTATE_NODE, 189
- PFWIN_AUTO_RESIZE, 618
- PFWIN_EXIT, 618
- PFWIN_GFX_WIN, 619, 630
- PFWIN_HAS_OVERLAY, 618
- PFWIN_HAS_STATS, 618
- PFWIN_NOBORDER, 618
- PFWIN_ORIGIN_LL, 618
- PFWIN_OVERLAY_WIN, 618, 619, 630
- PFWIN_SHARE_GL_CXT, 619
- PFWIN_SHARE_GL_OBJS, 619
- PFWIN_SHARE_STATE, 619
- PFWIN_STATS_WIN, 619, 630
- PFWIN_TYPE_NOPORT, 611
- PFWIN_TYPE_OVERLAY, 611
- PFWIN_TYPE_STATS, 611
- topology
 - adding to file, 440
 - information, reading and writing, 440
 - solids, 443
 - tools, 434
- topology-building
 - from list of surfaces, 438
 - general tasks, 433
 - imported surfaces, 438
 - strategies, 437
 - summary, 439
 - two traversals, 438

- topoTest sample application, 439
 tori, 397
 toroidal loading, 536
 transformations
 - affine, 771
 - defined, 910
 - inheritance through scene graph, 88
 - order of composition, 772
 - orthogonal, 771
 - orthonormal, 772, 779
 - specified by matrices, 769
 transition distance, definition, 910
 transparency, 461, 837
 traversals
 - activation, 86
 - application, 88
 - attributes, 86
 - culling, 85, 90, 97
 - customizing, 90, 97
 - node pruning, 90
 - visibility testing, 91-94
 - database. See databases
 - definition, 910
 - draw, 85, 100-101
 - intersection, 85, 120-128
 - two traversal topology, 438
 TRI format. See formats
 Triangle data structure, 705
 triangle strip, 707
 triangulated irregular networks, 694
 trigger routine, definition, 910
 trigonometric functions, 350
 trim curve, 355, 384
 trim loop, 384
 trim loops and curves, 383
 trisrip, 707
 tsid, 709
 - values, 708
 two traversal topology, 438
 type system
 - multiprocessing implications, 887
 type, actual, of objects, 17
 typographical conventions, xlvii
- ## U
- UNC format. See formats
 up vector, defined, 910
 updatable objects, 889
 updates, latency-critical, 820
 user data, 10
 usinit(), 487
 usnewlock(), 170, 653, 654
 usnewsema(), 653, 654
 ussetlock(), 170
 usunsetlock(), 170
 utilities
 - cliptexture configuration, 553
- ## V
- VClock. See video counter
 vector routines, 767
 vectors, 349
 - 2-component, 767
 - 3-component, 767
 - 4-component, 767
 vertex data structure, 711
 vertex neighborhoods, 712
 vertex programs, 460, 465, 466, 523
 vertical stripes, 515
 video
 - counter, 651
 - dynamic video resolution, 148

- field, 793
- multiple outputs, 638
- output, 638
- scan rate, 132
- Video Digital Multiplexer (DPLEX), 501
- video splitting, 39
- view
 - inset, 38
 - matrix, 31
 - offset, 32
- view volume visualization, definition, 911
- viewing angles, 30
- viewing frustum
 - definition, 911
 - intersection with, 93
- viewing offsets, 32
- viewing parameters, 28, 30
- viewpoint, 30
 - definition, 911
- viewports, 27
 - defined, 911
- virt_size, 567
- virtual addresses and multiprocessing, 888
- virtual cliptexture, 538, 585, 602
 - parameters, 591
 - set parameters, 587
- virtual functions, address space issues, 888
- virtual offset, 539
- virtual reality, xliii
- virtual reality markup language, 89
 - See also VRML, 89
- virtual set, xliii
- virtualLODOffset, 588
- VISI bus, 743
- visibility culling, 91-94
- visual priority. See coplanar geometry
- visual simulation, xliii

- visual, defined, 911
- VME bus, 747
- void, 114
- volumes
 - bounding, 59
 - boxes, 776
 - creating, 778
 - cylinders, 776, 823
 - dynamic, 59
 - extending, 779
 - hierarchical, 91
 - intersection testing, 780
 - spheres, 776
 - visibility testing, 93
 - boxes, axially aligned, 777
 - cylinders, 777
 - geometric, 776
 - half-spaces, 778
 - intersections. See intersections
 - primitives, 776
 - spheres, 777
 - transforming, 779
- VRML, 89, 258
- VRML 2.0, 287

W

- Wavefront, 265
- weights for NURBS control points, 368
- wglSwapBuffers(), 830
- widget, defined, 911
- windows, 625
- WindRiver, 829
- WindView, 829
- winged data structures, 434
- wireframe, 308
- workload balancing, 520

WorkShop, 828
write(), 658
wrl format, 287

X

X Windows, 637
XCreateWindow(), 616
XML configuration files, 858, 871
XSGIvc library, 638

Z

z-fighting, 462

