

# SGI® InfiniteStorage TPSSM Administration Guide

007-4748-001

---

## CONTRIBUTORS

Written by Jenn Byrnes, Steven Levine

Illustrated by Chrystie Danzer

Production by Karen Jacobson

Engineering contributions by Bill Andrews, Bill McKeivitt, Robert Novak, Henry Ortiz, and Sammy Wilborn

---

## COPYRIGHT

© 2002-2005 Silicon Graphics, Inc. All rights reserved; provided portions may be copyright in third parties, as indicated elsewhere herein. No permission is granted to copy, distribute, or create derivative works from the contents of this electronic documentation in any manner, in whole or in part, without the prior written permission of Silicon Graphics, Inc.

---

## LIMITED RIGHTS LEGEND

The software described in this document is “commercial computer software” provided with restricted rights (except as to included open/free source) as specified in the FAR 52.227-19 and/or the DFAR 227.7202, or successive sections. Use beyond license provisions is a violation of worldwide intellectual property laws, treaties and conventions. This document is provided with limited rights as defined in 52.227-14.

---

## TRADEMARKS AND ATTRIBUTES

Silicon Graphics, SGI, the SGI logo, and IRIX are registered trademarks of Silicon Graphics, Inc., in the United States and/or other countries worldwide.

Java is a trademark or registered trademark of Sun Microsystems, Inc., in the U.S. and other countries. Windows and Windows NT are registered trademarks of Microsoft Corporation. All other trademarks mentioned herein are the property of their respective owners.

---

# What's New in This Guide

## New Features Documented

This update includes documentation for SGI InfiniteStorage TP9700 RAID support and additional small technical updates.



---

## Record of Revision

<b>Version</b>	<b>Description</b>
001	February 2005 Initial Revision.





Preparing for a Network Installation . . . . .	. 13
Naming the Storage Arrays . . . . .	. 16
Identifying the Controller Hardware Ethernet Address . . . . .	. 16
Obtaining IP Addresses and Host Names . . . . .	. 19
Network Setup Using the RS-232 Interface . . . . .	. 19
Setting Up the DNS or Host Table . . . . .	. 24
<b>3. Installing the TPSSM Software . . . . .</b>	<b>. 25</b>
Uninstalling the TPSSM7 Software . . . . .	. 25
TPSSM Software Installation Procedure . . . . .	. 26
IRIX Installation . . . . .	. 26
Linux Installation . . . . .	. 28
Windows Installation . . . . .	. 28
Completing the Installation . . . . .	. 29
Starting the Enterprise Management Window . . . . .	. 29
Adding Devices . . . . .	. 33
Setting Up Alert Notifications . . . . .	. 33
Starting the Array Management Window . . . . .	. 34
Renaming Storage Arrays . . . . .	. 35
Other Storage Array Management Tasks . . . . .	. 36
<b>4. Operating System Support . . . . .</b>	<b>. 37</b>
Understanding the Restrictions . . . . .	. 37
Identifying Volumes by Operating System Device Names . . . . .	. 39
Stopping and Starting the Host-Agent Software on IRIX Systems . . . . .	. 40
Starting and Stopping the Host-Agent Software on Linux Systems . . . . .	. 41
Disabling and Enabling the Event Monitor . . . . .	. 42
Disabling the Event Monitor . . . . .	. 42
Enabling the Event Monitor . . . . .	. 42
Disabling Boot-time Loading of the Event Monitor . . . . .	. 43
Enabling Boot-time Loading of the Event Monitor . . . . .	. 43
Uninstalling the TPSSM Software . . . . .	. 43
<b>Index . . . . .</b>	<b>. 45</b>



---

# Figures

<b>Figure 1-1</b>	Typical Storage Management Configuration . . . . .	4
<b>Figure 2-1</b>	Host-Agent Managed Storage Arrays . . . . .	8
<b>Figure 2-2</b>	Direct Managed Storage Arrays . . . . .	10
<b>Figure 2-3</b>	Network Using Directly and Host-Agent Managed Storage Arrays .	12
<b>Figure 2-4</b>	Removing the Front Panel of the SGI InfiniteStorage TP9500 Controller Enclosure . . . . .	17
<b>Figure 2-5</b>	Identifying the Controller Ethernet Address on the SGI InfiniteStorage TP9500 RAID Controller. . . . .	18
<b>Figure 2-6</b>	Identifying the Controller Ethernet address on the SGI InfiniteStorage TP9300 RAID Controller. . . . .	18
<b>Figure 3-1</b>	The <b>Add Storage Arrays Dialog Box</b> of the <b>Enterprise Management Window Task Assistant</b> . . . . .	30
<b>Figure 3-2</b>	<b>Enterprise Management Window</b> . . . . .	32
<b>Figure 3-3</b>	<b>Array Management Window</b> . . . . .	35



---

## Tables

<b>Table 1-1</b>	Hardware Requirements for Software Components . . . . .	3
<b>Table 1-2</b>	Operating System Requirements . . . . .	5
<b>Table 1-3</b>	Hardware Requirements . . . . .	5
<b>Table 2-1</b>	Summary of Network Preparation Tasks . . . . .	13
<b>Table 2-2</b>	Sample Information Record . . . . .	14
<b>Table 2-3</b>	Storage Array and Controller Information Record . . . . .	15
<b>Table 2-4</b>	Management Method . . . . .	19
<b>Table 2-5</b>	IP Address and Controller Host Name . . . . .	24
<b>Table 4-1</b>	Restrictions for the IRIX Operating Environment . . . . .	38
<b>Table 4-2</b>	Device Identification Information . . . . .	40



---

## About This Guide

This guide provides information on preparing, installing, configuring, and starting the Total Performance Storage System Manager (TPSSM) in an IRIX, Linux, or Windows environment.

This is part of a document set that supports TPSSM. To get the most out of this book, consult the following documentation first:

- `README` file — Read this text file first. It contains late-breaking installation and user information about the storage management software.
- *SGI InfiniteStorage TPSSM Software Concepts Guide* — Use this reference document to become familiar with new terminology and features of the storage management software.

When you have finished the entire installation process, see the following online Help systems, which contain information common to all operating environments. For information specific to IRIX, see the Administration Guide.

- Enterprise Management window Help — Use this online Help system to learn more about working with the management domain.
- Array Management window Help — Use this online Help system to learn more about managing Storage Arrays.

### Audience

This guide is intended for system administrators. Use this guide to:

- Gain a basic understanding of the TPSSM software.
- Understand the two different storage array management methods.
- Learn about hardware and software requirements.
- Follow procedures to install the TPSSM software.

## Structure of this Guide

This guide contains the following chapters:

- Chapter 1, “Introduction” — Introduces the Total Performance Storage System Manager (TPSSM) software and provides information about system requirements.
- Chapter 2, “Preparing for Installation” — Describes the two Storage Array management methods and the procedures necessary to prepare the SGI InfiniteStorage TP9500 and SGI InfiniteStorage TP9700 for installing the TPSSM software.
- Chapter 3, “Installing the TPSSM Software” — Describes the procedures for installing the TPSSM Agent and Client software.
- Chapter 4, “Operating System Support” — Describes the restrictions of using TPSSM in the IRIX environment, identifying volumes by device name, stopping and starting TPSSM, and uninstalling specific software components.

## Related Publications

This Administration Guide is part of a product book set. To get the most out of this guide, consult the following documentation before using this guide.

- *SGI InfiniteStorage TPSSM Software Concepts Guide*  
This guide explains the terminology and features of the TPSSM storage management software for the SGI InfiniteStorage TP9300, the SGI InfiniteStorage TP9500 and the SGI InfiniteStorage TP9700.
- *SGI InfiniteStorage TP9300 and TP9300S RAID Installation and Upgrade Guide*  
This guide gives complete instructions on how to unpack, install, and configure the SGI InfiniteStorage TP9300 and its components. It also contains component upgrade information.
- *SGI InfiniteStorage TP9300 and TP9300S RAID User's Guide*  
A complete user guide for the SGI InfiniteStorage TP9300 that gives an overview of all components of the rack. It contains procedures for replacing failed components and complete specifications.
- *SGI TP9500 Installation and Upgrade Guide*  
This guide gives complete instructions on how to unpack, install, and configure the SGI InfiniteStorage TP9500 and its components. It also contains component upgrade information.

- *SGI TP9700 Installation and Upgrade Guide*  
This guide gives complete instructions on how to unpack, install, and configure the SGI InfiniteStorage TP9700 and its components. It also contains component upgrade information.
- *SGI InfiniteStorage TP9500 and SGI InfiniteStorage TP9700 RAID User's Guide*  
A complete user guide for the SGI InfiniteStorage TP9500 and SGI InfiniteStorage TP9700 that gives an overview of all components of the rack. It contains procedures for replacing failed components and complete specifications.
- *SGI InfiniteStorage TP9500 and TP9500S RAID Installation and Upgrade Guide*  
This guide gives complete instructions on how to unpack, install, and configure the SGI InfiniteStorage TP9500 and its components. It also contains component upgrade information.
- *SGI Storage Area Network Installation Instructions*  
This guide is available through Supportfolio Online and provides information on Storage Area Network installation and topologies.
- See also the SGI online technical bulletin TIB #200121 at:  
<http://bits.csd.sgi.com/cgi-bin/site.cgi>  
This describes the most recent procedures for controller replacement and controller hot swap procedures.

## Product Support

SGI provides a comprehensive product support and maintenance program for its products. If you are in North America and would like assistance with your SGI-supported products, contact the Customer Support Center (CSC) at 1-800-800-4SGI (1-800-800-4744) or your authorized service provider. If you are outside North America, contact the SGI subsidiary or authorized distributor in your country.

## Obtaining Publications

To obtain SGI documentation, go to the SGI Technical Publications Library at:

<http://docs.sgi.com>

## Reader Comments

If you have comments about the technical accuracy, content, or organization of this document, please tell us. Be sure to include the title and document number of the manual with your comments. (Online, the document number is located in the front matter of the manual. In printed manuals, the document number can be found on the back cover.)

You can contact us in any of the following ways:

- Send e-mail to the following address:  
techpubs@sgi.com
- Use the Feedback option on the Technical Publications Library World Wide Web page:  
<http://docs.sgi.com>
- Contact your customer service representative and ask that an incident be filed in the SGI incident tracking system.
- Send mail to the following address:  
Technical Publications  
SGI  
1500 Crittenden Lane., M/S 535  
Mountain View, California 94043-1351

We value your comments and will respond to them promptly.



## Introduction

This chapter introduces the Total Performance Storage System Manager (TPSSM) software, and provides information about hardware, software, and operating system requirements for the installation.

---

**Note:** Please review the README file on the CD-ROM for the latest information, updates, supported configuration changes, and bug fixes.

---

TPSSM is a Java-based application for SGI InfiniteStorage TP9300, SGI InfiniteStorage TP9400, SGI InfiniteStorage TP9500, and SGI InfiniteStorage TP9700 RAID subsystems. It provides a graphical interface for configuring and monitoring the RAID hardware subsystem.

## About the Storage Management Software

The storage management software is composed of the following components:

- “The Client Software” on page 1
- “The Host-Agent Software” on page 2
- “The Host-Util Software” on page 2
- “The Runtime Software” on page 2

## The Client Software

The TPSSM GUI client provides the graphical user interface for managing storage arrays. It features the following components:

- **Enterprise Management** window — Used to add, remove, and monitor storage arrays within the management domain.

- **Array Management** window — Used to manage the various components of an individual storage array.

The TPSSM CLI client provides the command line interface for managing storage arrays.

The TPSSM Event monitor is packaged with TPSSM client software. It monitors storage arrays and handles error notification through e-mail or SNMP traps when the storage array management software is not actively running on the storage management station or host.

## The Host-Agent Software

The TPSSM agent lets you manage Storage Arrays through the host's Fibre Channel connection. This is described in "Storage Array Management Methods" on page 7.

## The Host-Util Software

The `tpssmdevices` utility lets you associate Storage Array volumes with operating system device names. This is described in "Identifying Volumes by Operating System Device Names" on page 39.

## The Runtime Software

The TPSSM runtime provides the JAVA runtime environment, which is required in order to use the storage management software.

## Software Component Installation Requirements

Table 1-1 lists the hardware required for installing the storage management software components.

**Table 1-1** Hardware Requirements for Software Components

Software Component	Hardware Requirement	Notes
TPSSM Client	- Management station - Host	<p>Management stations:</p> <ul style="list-style-type: none"> <li>- If you install the client software on one or more management stations, you can use the direct managed method, the host-agent managed method, or a combination of both.</li> </ul> <p>Hosts:</p> <ul style="list-style-type: none"> <li>- If you install the client software on the host and only plan to manage the Storage Arrays connected to this host via the I/O (Fibre Channel) path, you do not need to connect to the network if the host-agent software is installed.</li> <li>- You must assign a static IP address to the host.</li> </ul>
TPSSM Agent	- Host	Install the host-agent software if you will be managing the Storage Arrays with the agent software.
TPSSM Util	- Host	The host-util software includes the <code>tpssmdevices</code> utility, which you use to associate volumes with operating system device names.
TPSSM Runtime	- Management station - Host	Installation of the runtime software is a prerequisite to install TPSSM Client, Agent, and Util.

Figure 1-1 shows an example of a typical Storage Array configuration.

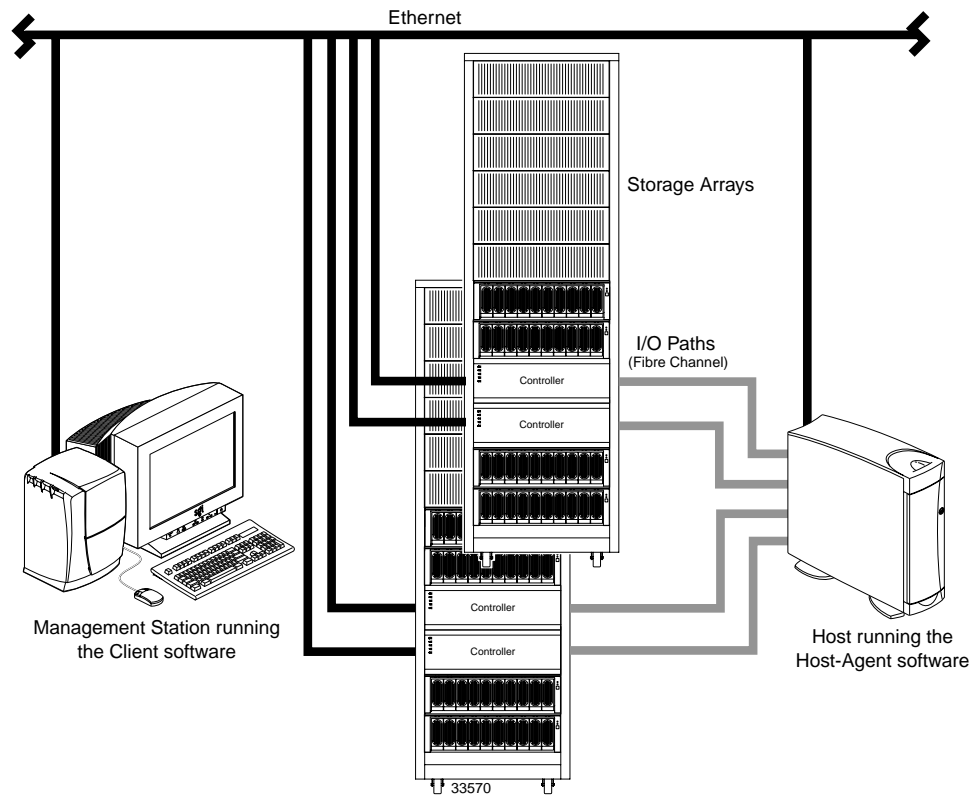

**Figure 1-1** Typical Storage Management Configuration

## System Requirements

This section provides information on the hardware, software, and operating system requirements for TPSSM.

Table 1-2 lists the permissions and operating system requirements for installing TPSSM.

**Table 1-2** Operating System Requirements

Requirement	Description
Permissions	Root (superuser) level permissions are required to install the client software and the host-agent software
Operating system	See the README file located on CD-ROM

Table 1-3 lists the hardware required for installing TPSSM.

**Table 1-3** Hardware Requirements

Hardware Component	Requirements
Storage Arrays	Storage Arrays with controllers running firmware version 4.01.02.23 or later. Storage Arrays with firmware 4.00.04.03 will not be manageable unless the firmware is updated to 4.01.12.23 or you are using an earlier version of TPSSM.
Management station or host (for client software)	See the README file located on CD-ROM.
Host OS	See the README file located on CD-ROM.



## Preparing for Installation

This chapter describes the two Storage Array management methods and the procedures necessary to prepare the SGI InfiniteStorage TP9300, SGI InfiniteStorage TP9500, and SGI InfiniteStorage TP9700 for installing the TPSSM software.

### The Installation Process

The installation process involves the following:

- Deciding on either a host-managed or direct managed Storage Array (“Storage Array Management Methods” on page 7).
- Preparing for the installation (“Preparing for a Network Installation” on page 13).
- Installing the TPSSM software (“TPSSM Software Installation Procedure” on page 26 and “Completing the Installation” on page 29).

### Storage Array Management Methods

The storage management software provides two methods for managing Storage Arrays:

- Host-managed via agent and client over Fibre Channel path(s)
- Direct-managed via network (Ethernet) connections

Depending upon your specific Storage Array configurations, you can use either or both methods.

## Host-Agent (Fibre Channel) Managed

With this method, you manage Storage Arrays through a Fibre Channel connection to a host. The host-agent receives communication from the storage management software and passes it to the Storage Array controllers via a Fibre Channel I/O path.

Figure 2-1 shows a system in which Storage Arrays are managed through the host-agent.

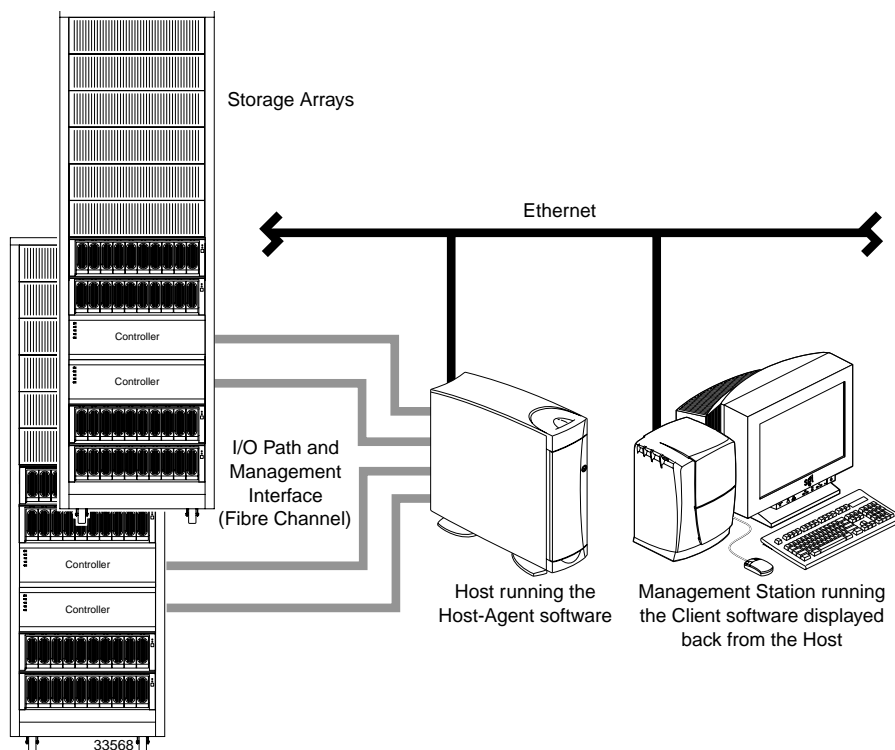

**Figure 2-1** Host-Agent Managed Storage Arrays

The advantages of using the host-agent managed method include the following:

- Ethernet cables are not required to connect each controller to the network.
- Network configuration tasks for each controller are not required.



- Only a host name or IP address for the host must be specified when you add Storage Arrays (rather than the information for each controller in a Storage Array). After you have added a specific name or IP address of a host, the host-agent software will automatically discover any Storage Arrays attached to that host.

The disadvantages of using the host-agent managed method include the following:

- You are limited to one less logical unit number (LUN) than the maximum allowed by your operating system and host adapter.
- The host-agent requires a special Access Volume to communicate with the Storage Array controllers. The Access Volume uses LUN 31 as the default.

## Direct (Ethernet) Managed

With this method, the Storage Array is managed directly over the network through each controller's Ethernet connection. To do this, you define each controller's IP address and host name, and attach a cable to each Ethernet connection on the controller enclosure.

The advantages of managing Storage Arrays directly include:

- You can use an IRIX management station to manage Storage Arrays connected to a host with an operating system other than that supported by the storage management software. Contact your customer support representative for more information.
- To manage the array, you can use an IRIX workstation (or Windows NT 4.0 or Windows 2000) to connect to an IRIX host. Check the README file on the CD-ROM or the Release Notes for your system to verify supported management platforms.

The disadvantages of using the direct managed method include:

- Each controller requires an Ethernet cable for connection (two per controller enclosure).
- You will need to specify an IP address or host name for each controller whenever you add Storage Arrays.
- You will need to complete several network preparation tasks (see "Preparing for a Network Installation" on page 13 for a summary of the preparation tasks).

Figure 2-2 shows a system in which Storage Arrays are managed directly.

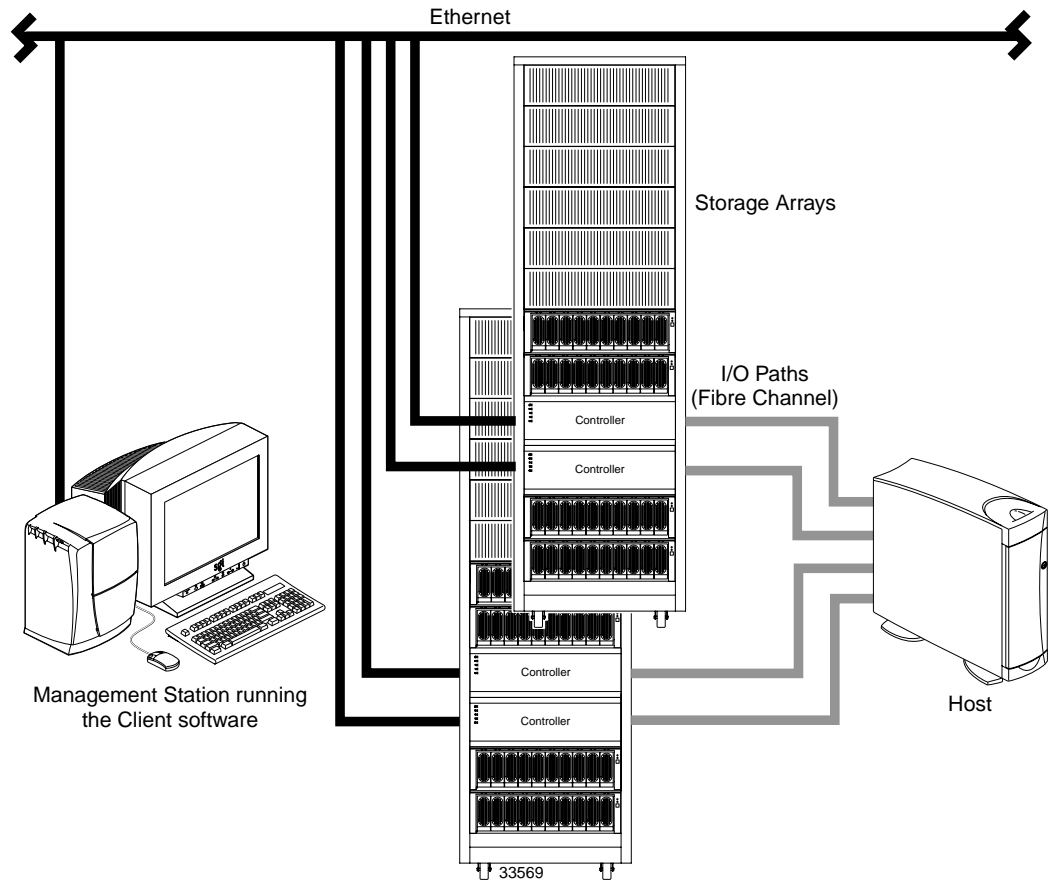

**Figure 2-2** Direct Managed Storage Arrays

## Integrating Your Storage Arrays Into a Network

You can manage Storage Arrays over the network using either or both of the Storage Array management methods described in “Storage Array Management Methods” on page 7.

1. Decide how you will manage your Storage Arrays. (See Figure 2-3 on page 12 for an example of a network that uses both types of management methods.)

**Network A** — Directly Managed Storage Array installation with the following components:

- Host connected to a Storage Array via a Fibre Channel I/O path
- Management station connected through the Ethernet network to the Storage Array controllers

**Network B** — Host-Agent Managed Storage Array installation with the following components:

- Host connected to a Storage Array via a Fibre Channel I/O path
- Management station connected through the Ethernet network to the host to manage the Storage Array controllers

2. Continue to “Preparing for a Network Installation” on page 13.

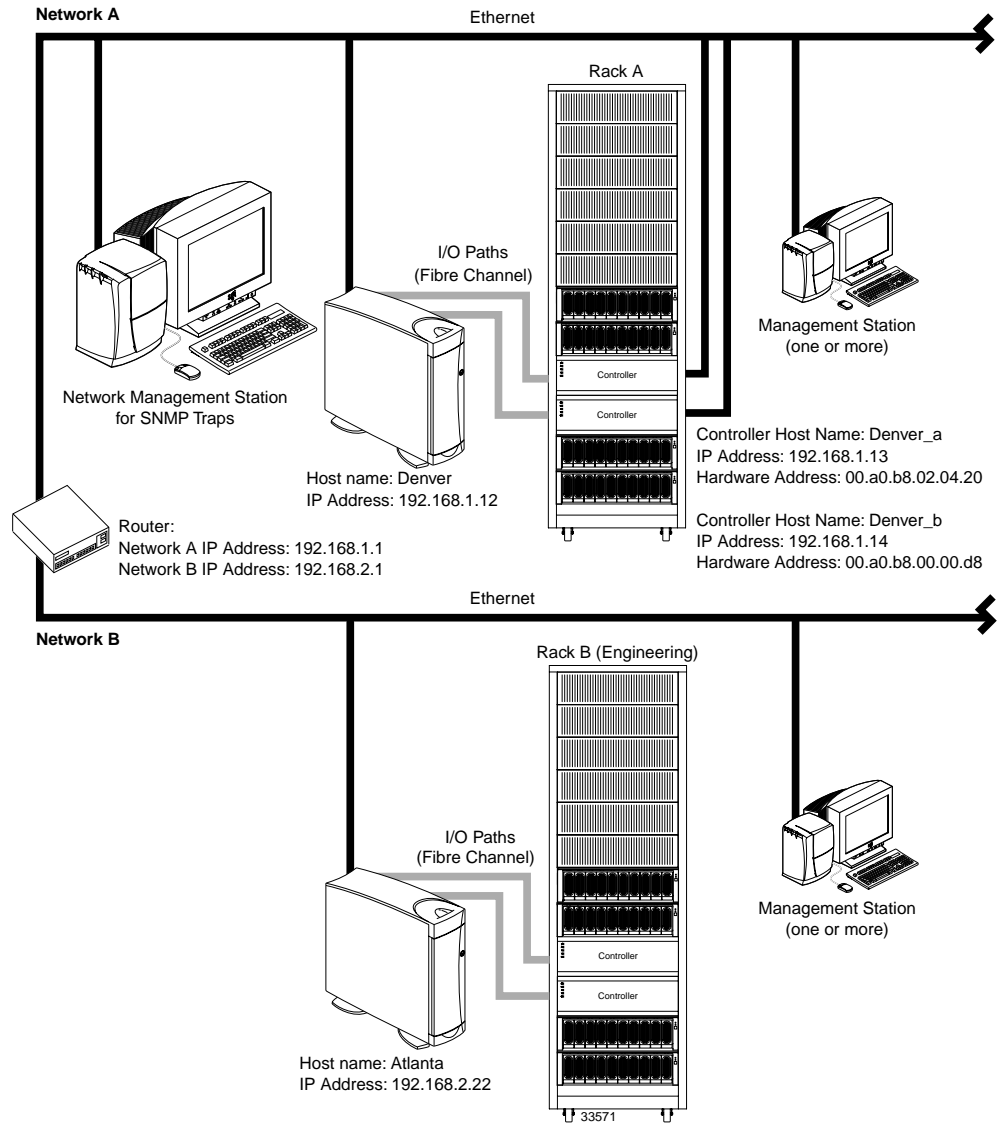

**Figure 2-3** Network Using Directly and Host-Agent Managed Storage Arrays

## Preparing for a Network Installation

To ensure that you have installed and checked all network components and that you have obtained and recorded all required host and controller information (see the blank information record provided in Table 2-3 on page 15), you must complete all of the applicable installation preparation tasks listed in Table 2-1. An example of a completed information record is provided in Table 2-2 on page 14.

**Note:** Actual installation of network components can be performed using the procedure described in “Network Setup Using the RS-232 Interface” on page 19 (also see task 4 or task 5 in Table 2-1).

**Table 2-1** Summary of Network Preparation Tasks

Management Method	Task	Purpose	Go To:
Direct and host-agent	1. Install Ethernet connection.	To establish the Ethernet connection.	N/A
Direct and host-agent	2. Establish and record a naming scheme for your Storage Arrays.	To add the Storage Arrays to the management domain after installing the software.	“Naming the Storage Arrays” on page 16.
Direct and host-agent	3. Obtain IP addresses and host names from the network administrator.	Host-agent management requires host IP addresses and host names. Direct management requires controller IP addresses and host names to set up the host (or DNS) table.	“Obtaining IP Addresses and Host Names” on page 19.
Direct	4. Connect a VT100 terminal to the controller <sup>a</sup> .	To allow the a user to use the VT100 terminal to provide network configuration information to the controllers.	“Network Setup Using the RS-232 Interface” on page 19.
Direct and host-agent	5. Set up the host (or DNS) table.	To ensure that the management station can communicate with the host running host-agent software or with the controllers.	“Setting Up the DNS or Host Table” on page 24.
Direct and host-agent	6. Power up network devices	To ensure that all devices and links are operational.	The Installation Guide specific to each hardware component.

a. Use either task 5 or task 6 to provide network configuration information to the controllers.

Table 2-2 shows a sample information record with entries for a directly managed Storage Array and a Host-Agent Managed Storage Array.

**Table 2-2** Sample Information Record

<b>Storage Array Name</b>	<b>Management Type</b>	<b>Controller A— Ethernet, IP Address, and Host Name</b>	<b>Controller B— Ethernet, IP Address, and Host Name</b>	<b>Host— IP Address and Host Name</b>
Storage Array Name: <b>perf36</b>	<b>Direct</b>	Ethernet Address: <b>00a0b8020420</b> IP Address: <b>192.168.1.13</b> Host Name: <b>Denver_a</b>	Ethernet Address: <b>00a0b80000d8</b> IP Address: <b>192.168.1.14</b> Host Name: <b>Denver_b</b>	
Storage Array Name: <b>perf33</b>	<b>Host-Agent</b>			IP Address: <b>192.168.2.22</b> Host Name: <b>Atlanta</b>

Table 2-3 provides a blank information record. Photocopy the blank information record and complete the information for each network Storage Array and controller. This will help you correctly add Storage Arrays after initial installation.

**Table 2-3** Storage Array and Controller Information Record

Storage Array Name	Management Type (choose one)	Controller A— Ethernet, IP Address, and Host Name	Controller B— Ethernet, IP Address, and Host Name	Host— IP Address and Host Name
Name:	<input type="checkbox"/> Direct <input type="checkbox"/> Host-Agent	Ethernet Address:  IP Address:  Host Name:	Ethernet Address:  IP Address:  Host Name:	IP Address:  Host Name:
Name:	<input type="checkbox"/> Direct <input type="checkbox"/> Host-Agent	Ethernet Address:  IP Address:  Host Name:	Ethernet Address:  IP Address:  Host Name:	IP Address:  Host Name:
Name:	<input type="checkbox"/> Direct <input type="checkbox"/> Host-Agent	Ethernet Address:  IP Address:  Host Name:	Ethernet Address:  IP Address:  Host Name:	IP Address:  Host Name:
Name:	<input type="checkbox"/> Direct <input type="checkbox"/> Host-Agent	Ethernet Address:  IP Address:  Host Name:	Ethernet Address:  IP Address:  Host Name:	IP Address:  Host Name:

## Naming the Storage Arrays

When planning your network configuration, consider how you will name the Storage Arrays. When you start the storage management software for the first time, all Storage Arrays in the management domain will be displayed as <unnamed>. You then can use the **Array Management** window to rename individual Storage Arrays.

Use the following procedure to name Storage Arrays.

1. Decide on a Storage Array naming scheme that makes sense for your enterprise. Here are some tips on naming Storage Arrays:
  - The software allows a 30-character limit. All leading and trailing spaces will be deleted.
  - Use a unique, meaningful naming scheme that is easy to understand and remember.
  - Avoid arbitrary names or names that would quickly lose their meaning in the future.
  - The software displays Storage Array names with the prefix `Storage Array`. Therefore, if you rename a Storage Array *Engineering*, it will display as `Storage Array Engineering`.
2. Record the Storage Array names in the information record (Table 2-3 on page 15).

Depending on which management method or methods you will use, you might need to record your controller's hardware Ethernet addresses.

Do you plan to manage your Storage Arrays directly or with the host-agent software?

**Direct Managed**      Go to "Identifying the Controller Hardware Ethernet Address" on page 16.

**Host-Agent Managed**      Go to "Obtaining IP Addresses and Host Names" on page 19.

## Identifying the Controller Hardware Ethernet Address

Use the following procedure if you plan to directly manage Storage Arrays through Ethernet connections to each controller.



1. Remove the front panel from the controller tray (Figure 2-4).

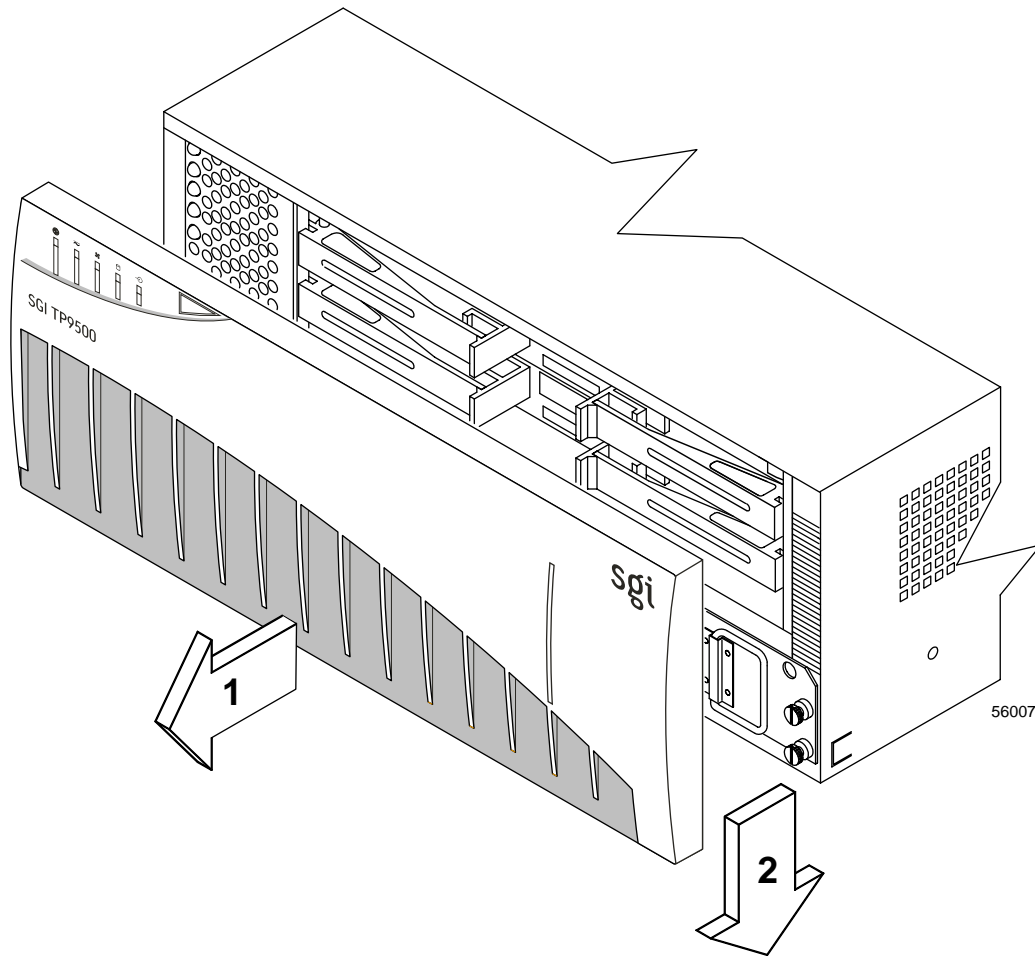

**Figure 2-4** Removing the Front Panel of the SGI InfiniteStorage TP9500 Controller Enclosure

2. Look on the front of the controller canister for a label with the controller's hardware Ethernet address. The number will be in hexadecimal form (for example, 00.a0.b8.00.00.d8). Figure 2-5 shows the location of the controller's hardware Ethernet address on the SGI InfiniteStorage TP9500 RAID Controller.

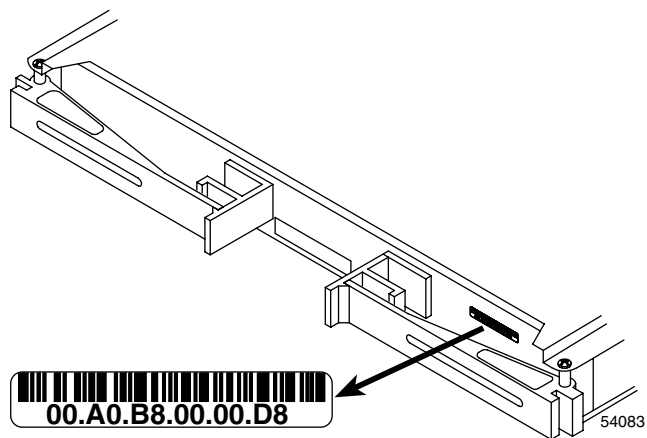

**Figure 2-5** Identifying the Controller Ethernet Address on the SGI InfiniteStorage TP9500 RAID Controller

Figure 2-6 shows the location of the hardware Ethernet address label on the SGI InfiniteStorage TP9300 RAID Controller.

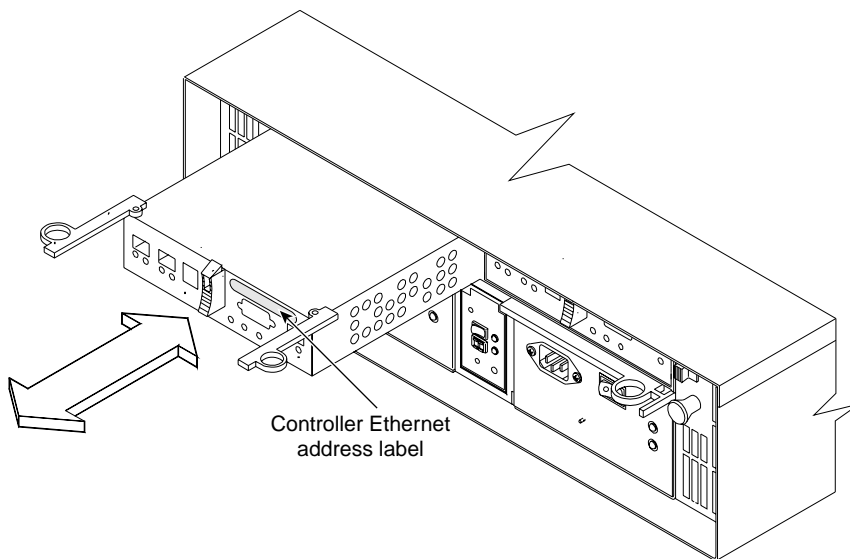

**Figure 2-6** Identifying the Controller Ethernet address on the SGI InfiniteStorage TP9300 RAID Controller

- Record each Ethernet address in the information record (Table 2-3 on page 15).

## Obtaining IP Addresses and Host Names

Depending on which management method or methods you will use, perform the following procedures to obtain IP addresses and host names. Within your enterprise, you might choose to manage some Storage Arrays directly and others with the host-agent software.

**Table 2-4** Management Method

Direct Management Method	Host-Agent Management Method
<ol style="list-style-type: none"> <li>Assign (or obtain from the network administrator) a unique IP address and associated host name for each Storage Array's controllers that you will manage directly. Record each controller IP address and host name in the information record (Table 2-3 on page 15).</li> <li>Go to "Network Setup Using the RS-232 Interface" on page 19.</li> </ol>	<ol style="list-style-type: none"> <li>Assign (or obtain from the network administrator) a unique IP address and associated host name of each host that you will use to manage the Storage Array via the host-agent method. Record the IP address and host name in the information record (Table 2-3 on page 15).</li> <li>Go to "Setting Up the DNS or Host Table" on page 24.</li> </ol>

## Network Setup Using the RS-232 Interface

The SGI InfiniteStorage TP9300, SGI InfiniteStorage TP9500, and SGI InfiniteStorage TP9700 allow you to set up the network interface through the RS-232 port on each controller. To interface to the RS-232 port, you need:

- A PC or device that can emulate a VT100 console.
- A 9-pin null modem cable with female connectors to attach to the RS-232 port on the controller.

On IRIX systems, perform the following procedure:

- Install the `eo.e.sw.uucp` software subsystem.
- Using a text editor, modify `/ect/uucp/Devices` to access the desired serial port. For example, change:

```
# Direct ttyd2 - 9600 direct
```

to:

```
Direct ttyd2 - 9600 direct
```

3. Use the `cu(1c)` command to access the serial port, as follows:

```
# cu -lttyd2
```

4. Enter `-b%` to transmit a CTRL-BREAK.

On Windows NT systems, perform the following procedure:

1. Install the version of Hyperterminal that supports the transmission of a CTRL-BREAK.
2. Select **Start >> Programs >> Accessories >> Hyperterminal**.
  - a. If this is the first time that HyperTerminal has been started, the **Location Information** dialog is displayed:
    - Select **Cancel**.
    - A **Confirmation** dialog is displayed. Select **Yes**.
    - An **Informational** dialog is displayed. Select **OK**.
    - The **New Connection Dialog** is displayed.
  - b. If this is not the first time that HyperTerminal has been started, the **New Connection** dialog is displayed.
3. Enter the desired name in the **Name:** text box and select **OK**. The **Connect to** dialog is displayed.
4. From the **Connect using:** spinner box, choose the COM port you will use to connect to the RAID controller serial port. Select **OK**. The **Properties** dialog is displayed.
5. From the **Bits per second:** spinner box, choose the baud rate you will use to send/receive data (for example, 9600). Select **OK**.
6. At this point, the configuration setup has been completed and you are ready to send and receive data. Before shutting down this application, save your settings so you will not have to repeat this procedure.

On Windows 2000 systems, perform the following procedure:

1. Select **Start >> Programs >> Accessories >> Communications >> Hyperterminal**.
  - a. If this is the first time that HyperTerminal has been started, the **Location Information** dialog is displayed:

- Select **Cancel**.
  - A **Confirmation** dialog is displayed. Select **Yes**.
  - An **Informational** dialog is displayed. Select **OK**.
  - The **New Connection Dialog** is displayed.
- b. If this is not the first time that HyperTerminal has been started, the **New Connection** dialog is displayed.
2. Enter the desired name in the **Name:** text box and select **OK**. The **Connect to** dialog is displayed.
  3. From the **Connect using:** spinner box, choose the COM port you will use to connect to the RAID controller serial port. Select **OK**. The **Properties** dialog is displayed.
  4. From the **Bits per second:** spinner box, choose the baud rate you will use to send/receive data (for example, 9600). Select **OK**.
  5. At this point, the configuration setup has been completed and you are ready to send and receive data. Before shutting down this application, save your settings so you will not have to repeat this procedure.

After you have connected the cable and started the VT100 emulator, you must establish communication to the controller following these steps:

1. Enter a Ctrl+break key sequence.
2. When prompted, press the space bar to set the transfer baud rate.
3. Enter another Ctrl+break sequence.
4. Press Esc to get the login prompt.
5. Enter the password of **infiniti**.
6. Enter the following:

```
> netCfgSet
```

A list of network configuration options appear.

7. Set the configuration values as follows for the SGI InfiniteStorage TP9300 and SGI InfiniteStorage TP9500:

```
Network Configuration: Ethernet
My MAC Address       : 00:a0:b8:06:6d:35 (Do not change)
My Host Name         : raid129          (sets the name of the controller)
My IP Address        : 163.154.44.155   (sets the IP address of the controller)
Server Host Name     : host             (do not change)
```

```
Server IP Address      : 0.0.0.0           (do not change)
Gateway IP Address    : 163.154.12.2      (sets the gateway IP address)
Subnet Mask           : 255.255.255.0    (sets the Subnet Mask)
User Name             : guest            (do not change)
User Password         :                  (do not change)
NFS Root Path         :                  (do not change)
NFS Group ID Number   : 0               (do not change)
NFS User ID Number    : 0               (do not change)
value = 0 = 0x0
```

Set the configuration values as follows for the SGI InfiniteStorage TP9700:

```
Network Configuration: Ethernet
My MAC Address        : 0 0:a0:b8:06:6d:35 (do not change)
My Host Name          : raid139           (sets the name of the controller)
IP Address if0        : 163.154.24.153    (sets the main IP address of the
controller)
Subnet Mask if0       : 255.255.255.0    (sets the Subnet Mask)
IP Address if1        : 192.168.129.101   (sets the alternate IP address of the
controller)
Subnet Mask if1       : 255.255.255.0    (sets the Subnet Mask for the
alternate IP address)
Server Host Name      :                  (do not change)
Server IP Address     :                  (do not change)
Gateway IP Address    : 163.154.24.1     (sets the gateway IP address)
Network Init Flags    : 0xC0            (do not change)
User Name             :                  (do not change)
User Password         : *****        (do not change)
value = 0 = 0x0
```

After these values are set, they are written to the controller's non-volatile memory (NVS RAM). You must now reboot the controller so that the changes will go into effect.

8. Enter the following:

```
> sysReboot
```

The controller now reboots itself.

9. Verify the changes by logging back into the controller and entering the following command:

```
netCfgShow
```

10. Verify that the following is displayed for the SGI InfiniteStorage TP9300 and SGI InfiniteStorage TP9500:

```
==== NETWORK CONFIGURATION: ALL INTERFACES ====
```

```

Network Init Flags      : 0x00
Network Mgmt Timeout   : 30
Startup Script         :
Shell Password         :

```

```

==== NETWORK CONFIGURATION: Ethernet ====
Interface Name         : dse0
My MAC Address         : 00:a0:b8:06:6d:35
My Host Name           : RAID5
My IP Address          : 163.154.14.155
Server Host Name      : host
Server IP Address      : 0.0.0.0
Gateway IP Address     : 163.154.12.2
Subnet Mask            : 255.255.255.0
User Name              : guest
User Password          :
NFS Root Path          :
NFS Group ID Number   : 0
NFS User ID Number    : 0
value = 0 = 0x0

```

Verify that the following is displayed for the SGI InfiniteStorage TP9700:

```

My Host Name           :raid129
Interface Name         if0 :fei0
MAC Address            if0: 00:a0:b8:11:12:8e
IP Address             if0: 163.154.24.153
Subnet Mask            if0: 255.255,255.0
Connection Status     if0: Link Up
Interface Name         if1: fei1
MAC Address            if1: 00La0:b8:11:12:8f
IP Address             if1: 192.168.129.101
Subnet Mask            if1: 255.255.255.0
Connection Status     if1: Link Down
...
Server IP Address: 0.0.0.0
Gateway IP Address: 163.154.24.1
Network Init Flags: 0xC0
...
value = 38 = 0x26 = '&'

```

11. Repeat steps 1–10 for each controller.

## Setting Up the DNS or Host Table

Use the following procedure to set up the Domain Name Server (DNS) or host table. Make sure the controller host names correspond to the appropriate controller IP addresses.

1. Edit either the DNS or the host table (`/etc/hosts`) to add the IP address and host name for each network controller.

For example, to set up the host table for the Network A controllers, (Figure 2-3 on page 12), use a text editor to create the following controller IP address and name entries

**Table 2-5** IP Address and Controller Host Name

<b>IP Address</b>	<b>Controller Host Name</b>
127.0.0.01	localhost
192.168.1.13	Denver_a
192.168.1.14	Denver_b

2. If you plan to manage Storage Arrays through a firewall, configure your firewall to open port 2463 to TCP data.
3. Go to Chapter 3, “Installing the TPSSM Software”.



## Installing the TPSSM Software

This chapter describes the process of uninstalling and installing the TPSSM Agent and Client software.

---

**Note:** If version 7.xx of the TPSSM7 software is already installed, it must be uninstalled before installing TPSSM version 8.3x or later.

---

### Uninstalling the TPSSM7 Software

To uninstall the TPSSM7 software, follow these steps:

1. Enter the following commands:  

```
> su to root
> inst -f none
```
2. Select option 7 (remove)
3. Enter the following:  

```
> tpssm*
```
4. To start the software removal, enter the following:  

```
> go
```

---

**Note:** For more information, see the README file located on CD-ROM, which contains TPSSM software.

---

The following output is normal during software removal:

```
: ( rm -f /etc/rc2.d/S99tpssm7agent; rm -f /etc/rc0.d/K00tpssm7agent )
Running exit-commands .. 97%
: ( kill -9 `ps -ef | grep 'opt/tp9400/bin/SM7age' | grep java | grep
-v grep |
awk '{print $2}' 2>/dev/null` )
```

---

**Note:** The above will only be seen if verbosity level is set on.

---

## TPSSM Software Installation Procedure

If you are installing the software on the host, install the agent, util, and runtime software. If you are installing the software on the management station, install the client and runtime software.

---

**Note:** The installation software includes Java JRE, so it does not matter if your system has the Java Runtime Environment (JRE) installed or not.

---

## IRIX Installation

Follow these steps to install the TPSSM software on an IRIX system:

1. To verify the version level of IRIX installed on the system, enter the following:

```
> uname -Ra
```

This should display:

```
IRIX perf36 6.5 6.5.9m or 6.5.9f
```

---

**Note:** The TPSSM software is supported only on IRIX 6.5.9 and later.

---

2. To display the main menu, enter the following:

```
> inst -f /CDROM/irix/dist
```

---

**Note:** /CDROM/ is the mount point for the CD-ROM. If this is not the mount point for your system, replace this part of the command with the actual CD-ROM mount point, for example: `inst -f /mnt/irix/dist`

---

3. Enter the following:

> **list**

A list of TPSSM software components will be displayed.

---

**Note:** All files are installed by default. If installing on a management station, you need only install TPSSM and TPSSM runtime files. If installing on a host server, you need only install TPSSM agent, TPSSM util, and TPSSM runtime. If installing on a host server acting as a management station, you need to install TPSSM, TPSSM agent, TPSSM util, and TPSSM runtime.

---

4. To verify that there are no software conflicts, enter the following:

> **conflicts**

---

**Note:** Before you install the TPSSM software, you must remove any earlier versions of the software. See “Uninstalling the TPSSM7 Software” on page 25.

---

5. To install the software, enter the following:

> **go**

This might take several minutes.

6. Enter the following:

> **quit**

At the end of the TPSSM installation process, a script will automatically run to configure the communication device and start the host software.

---

**Note:** TPSSM monitor will not be started automatically. It should only be started on a specific management station (when using direct (network) management).

---

## Linux Installation

To install the TPSSM software on a Linux system, perform the following procedure:

1. Ensure that you have root privileges, which are required to install the software.
2. Insert the CD that contains the management software and, if necessary, mount the CD-ROM drive.
3. Install the software packages in the order listed.
  - a. At the system prompt, type the appropriate installation command and press enter. In the following commands, *CDROM* is the mount point of the CD-ROM drive and *build* is the management software version level (for example, 09.10.A8.00-1).

```
> cd /CDROM/linux/rpms/ia64
> rpm -ivh TPSSMRuntime-LINUX-build.ia64.rpm
> rpm -ivh TPSSM-LINUX-build.noarch.rpm
> rpm -ivh TPSSMAgent-LINUX-build.ia64.rpm
> rpm -ivh TPSSMUtil-LINUX-build.ia64.rpm
```

---

**Note:** TPSSMAgent and TPSSMUtil should be installed only on the server that will be used for in-band (host agent) management.

---

- b. At the system prompt, type the appropriate verify command for each installed package and press enter:

```
> rpm -qi TPSSMRuntime
> rpm -qi TPSSM
> rpm -qi TPSSMAgent
> rpm -qi TPSSMUtil
```

## Windows Installation

To install the TPSSM software on a Windows system, run the following command line from the root of your CD-ROM drive:

```
x:\windows\SMclient\setup.exe
```

In the example, *x*: corresponds to the drive letter of your CD-ROM drive. If you prefer, navigate to the `\windows\SMclient` folder on the CD-ROM and double-click `setup.exe`.

## Completing the Installation

Use the following procedures to finish installing the TPSSM software.

### Starting the Enterprise Management Window

To complete the installation procedure, you must initiate Storage Array discovery using the **Enterprise Management** window. Start the **Enterprise Management** window using this procedure:

1. Enter the following:

```
> tpssm
```

The client software will start, displaying the **Enterprise Management** window and the **Enterprise Management Window Task Assistant** (Figure 3-1).

---

**Note:** If `tpssm: command not found` is reported, then try one of the following workarounds:

Enter **rehash**, then enter **tpssm**.

OR

Enter **/opt/tpssm/client/tpssm**.

The above workarounds are only applicable during the initial installation. The next time you log in or create a new shell window, they should not be required.

---

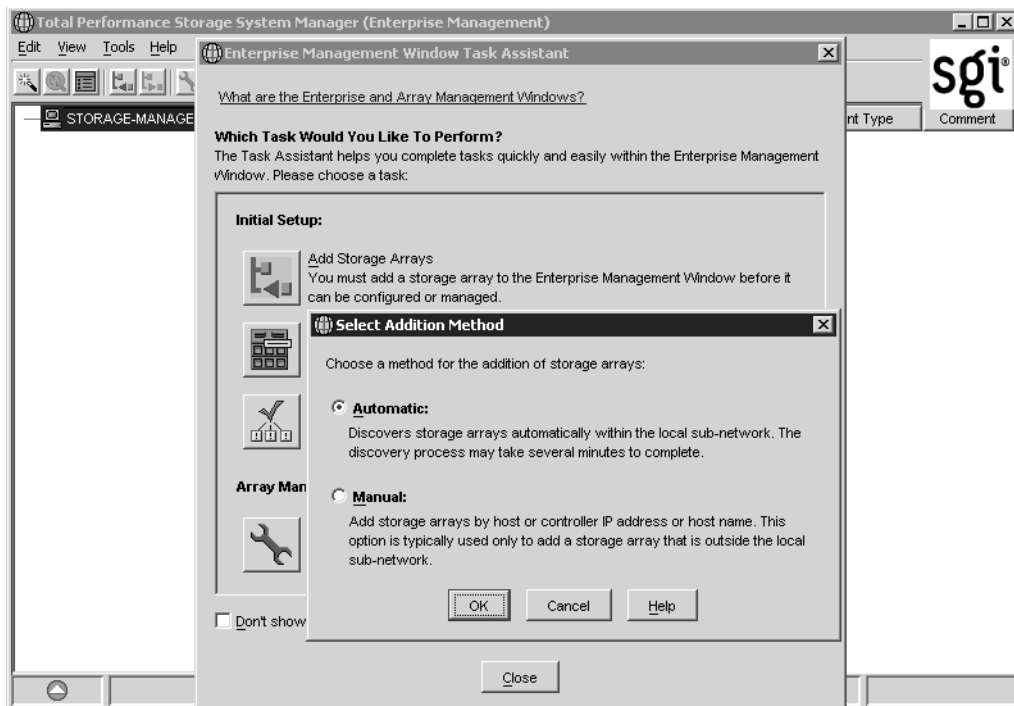

**Figure 3-1** The Add Storage Arrays Dialog Box of the Enterprise Management Window Task Assistant

**Note:** If `/usr/sbin` is not contained in the `PATH` environment variable, the full path name is required on the command line (`/opt/tpssm/client/tpssm`) to open the **Enterprise Management** window.

The **Enterprise Management** window might take several minutes to open. No wait cursor is displayed.

2. The **Enterprise Management Window Task Assistant** will launch by default. Common setup task shortcuts are available in the **Task Assistant** to simplify initial setup. The first available option, **Add Storage Arrays**, allows you to either perform automatic discovery of hosts and storage arrays on your subnet, or to add hosts or storage arrays manually via hostname or IP address. If you do not want to perform

the initial automatic discovery, select **Manual**. This will give you the option of adding storage arrays with up to two controllers, or a host that is running the In-Band management agent.

Select **Automatic** to begin an initial automatic discovery of hosts and Storage Arrays attached to the local subnetwork on which the management station is installed. This might take several minutes. The software sends a broadcast message across the local subnetwork where the management station is installed. It discovers host-agent managed Storage Arrays if the hosts that provide network management connections to the Storage Arrays respond to the broadcast. The software discovers directly managed Storage Arrays if the controllers in those Storage Arrays respond to the broadcast message.

---

**Note:** It might take several minutes for the **Enterprise Management** window to refresh after an initial automatic discovery. If you need to stop the automatic discovery operation for any reason, close the **Enterprise Management** window.

---

When the initial automatic discovery is completed, you should see all of the hosts and Storage Arrays attached to the local subnetwork (Figure 3-2 on page 32).

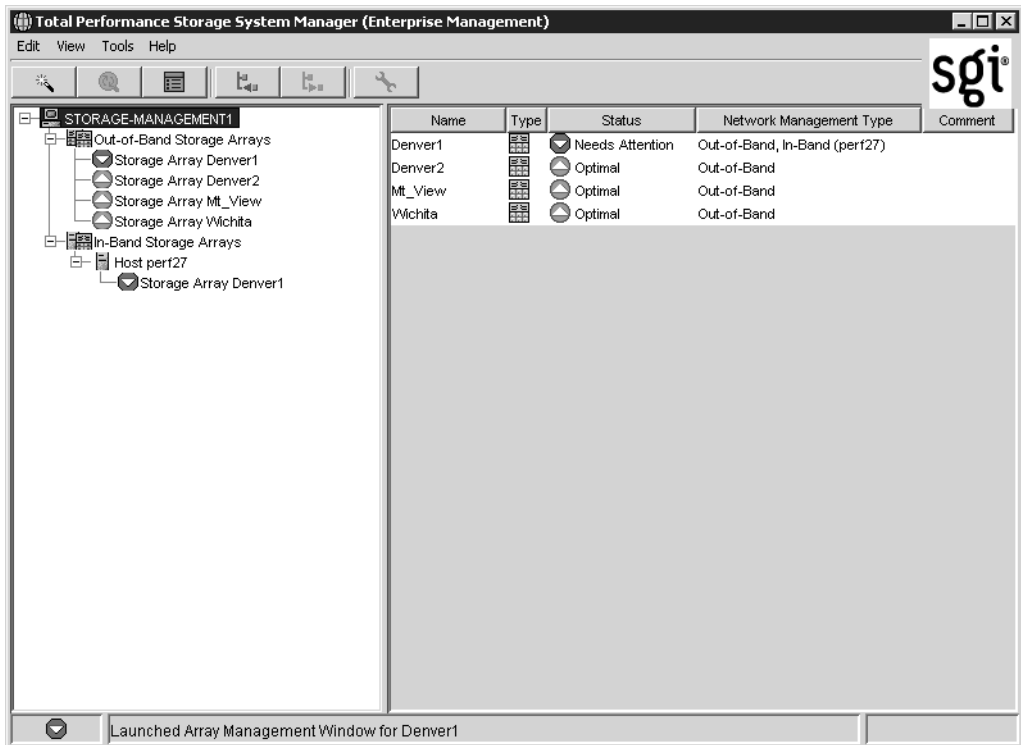

**Figure 3-2** Enterprise Management Window

If you do not see all of the hosts and Storage Arrays you expected to see:

- Check the hardware and connections for possible problems (see the hardware documentation listed in “Related Publications” on page xiv for specific procedures).
- Verify that the software is installed.
- Verify that TPSSM is running.
- See the **Enterprise Management** window Help topic about discovering Storage Arrays.
- Make sure that the device is on the local subnetwork. If not, use the **Add Device** option.



If any device shows a status of **Unresponsive**, use the software to remove the device from the management domain and add it again. See the **Enterprise Management** window Help for instructions on removing and adding devices.

---

**Note:** A Storage Array might be duplicated in the Device Tree after an automatic discovery if the Storage Array is directly managed but is attached to a host with the host-agent software installed and running. In this case, remove the duplicate Storage Array icon from the Device Tree using the **Remove Device** option in the **Enterprise Management** window.

---

## Adding Devices

You might want to add hosts or Storage Arrays outside the local subnetwork. To learn more about this option, see the **Enterprise Management** window Help.

---

**Note:** If you are managing Storage Arrays through the host-agent software and you physically add new Storage Arrays, you must stop and restart the host-agent software so it can recognize the new Storage Arrays (see “Stopping and Starting the Host-Agent Software on IRIX Systems” on page 40). Then go to the **Enterprise Management** window and select **Tools > Rescan** to add the new Storage Arrays to the management domain.

---

## Setting Up Alert Notifications

After you have added devices to the management domain, you should set up alert notification options to report critical events on the Storage Arrays. The following options are available for alert notification:

- Notification to designated e-mail addresses.
- Notification to designated alphanumeric pagers (when a third-party software package is used to convert e-mail messages).

The **Enterprise Management** window must remain open if you want to monitor the condition of Storage Arrays included in your management domain. If you close this window, you will not receive alert notifications. You can minimize the window.

---

**Note:** See the **Enterprise Management** window Help for more information on alert notification options.

---

## Starting the Array Management Window

Use this procedure to start an **Array Management** window for a selected Storage Array.

1. In the **Enterprise Management** window, select a Storage Array.
2. Select **Tools > Manage Device**.

---

**Note:** Optionally, right-click the storage array and select **Manage Devices** to start an **Array Management** window.

---

The software displays the **Array Management** window for the selected Storage Array (Figure 3-3).

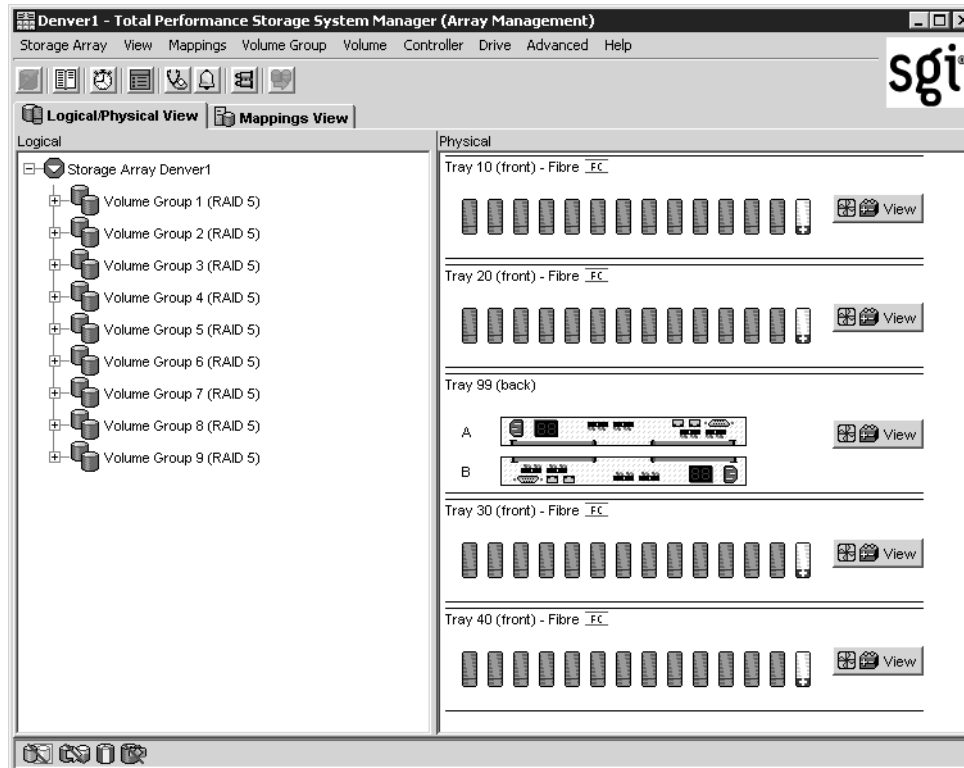

**Figure 3-3** Array Management Window

---

**Note:** The **Array Management** window you opened lets you manage only the selected Storage Array. However, you can open multiple **Array Management** windows to manage other Storage Arrays.

---

## Renaming Storage Arrays

When you start the storage management software for the first time, the Storage Arrays are unnamed. You must use the **Array Management** window to rename each Storage Array from <unnamed> to the name you want. Refer to the names you entered in the

information record you created using Table 2-3 on page 15. Then, see the renaming Storage Arrays topic in the **Array Management** window Help. The Help topic provides detailed instructions for renaming Storage Arrays.

## Other Storage Array Management Tasks

There are several other tasks you might want to perform at this time. These tasks include:

- Locating a Storage Array
- Viewing a Storage Array profile
- Configuring a Storage Array password
- Creating and managing volumes and volume groups
- Creating storage partitions (if applicable)
- Synchronize the controller clocks

To create storage partitions, you must obtain the worldwide name or port name of each host adapter in each host connected to the Storage Array.

---

**Note:** To learn more about these and other Storage Array management tasks, see the appropriate topics in the **Array Management** window Help.

---

## Operating System Support

This chapter describes the restrictions of using TPSSM in the IRIX environment, identifying volumes by device names, stopping and starting TPSSM, disabling and enabling the Event Monitor, and uninstalling storage management software.

### Understanding the Restrictions

Table 4-1 provides information on the restrictions that apply to using TPSSM in the IRIX environment.

---

**Note:** Always check for a `README` file on the CD-ROM. This `README` file might contain important, late-breaking information that was not available when this Administration Guide was written. Also, see release notes, which contain a list of known issues, bug fixes, as well as enhancements. See the `README` file on the CD-ROM for instructions on how to view the release notes.

---

**Table 4-1** Restrictions for the IRIX Operating Environment

Restriction	Workaround
Clicking on the vertical scroll arrows (either up or down) causes the scroll box to move all the way to the opposite end of the scroll bar.	This is a known defect in the Java Runtime Environment. Click the scroll box and slide it until you reach the desired position in the window.
If you are managing Storage Arrays with the host-agent software, do not download an NVSRAM configuration settings file with the <code>Access Volume Disabled</code> attribute. Doing so deletes the Access Volume on host-agent managed Storage Arrays, causing those Storage Arrays to become inaccessible.	If you download NVSRAM files to a host-agent managed Storage Array using the <b>Storage Array &gt; Download &gt; NVSRAM</b> option, select an NVSRAM file in the NVSRAM Download File Selection area, and then check the File Information to make sure that the file does not contain the <code>Access Volume Disabled</code> attribute. <b>Note:</b> If you accidentally delete the Access Volume, contact your customer support representative for assistance.
After trying to add a host device to the management domain of more than five clients, the host-agent managed Storage Arrays attached to that host become unresponsive.	A single instance of the host-agent software can only communicate with five or fewer clients.
When both ports of a dual-port Fibre Channel drive fail while the drive is part of a Storage Array, both A and B loops are brought down. You will lose access to the data on the storage devices. The probability of both ports failing on a single drive is remote. For example, based on 1.2 million hours MTBF, the likelihood for both ports to fail is 0.08%.	Shut down all drive tray(s) and the controller tray. Power up all of the drive tray(s) and then power up the controller tray. The drive with the port failures will not display in the <b>Array Management</b> window. Revive any failed drives caused by the drive failure (data integrity is preserved.) Replace the drive that does not display in the <b>Array Management</b> window with a good drive. Reconstruction begins and the volume is restored.

**Table 4-1** Restrictions for the IRIX Operating Environment (**continued**)

Restriction	Workaround
After pulling all drives from a Storage Array, the storage management software prompts you for a password when you start the software or when you perform protected operations. Any password you enter fails.	Password information is stored on a reserved area of each drive on the Storage Array. Each drive stores a mirrored copy of the password data. With no drives in the Storage Array, the storage management software does not find the password data when you attempt password protected operations. Add one of the drives to the Storage Array and reattempt the operation.
If you configure a new Storage Array with a single controller, you must place the controller in the left slot of the controller enclosure (slot A). The controller firmware cannot recognize or talk to a single controller until slot A is populated. This restriction does not apply to Storage Arrays that are configured with two controllers.	None.
The Automatic Discovery option of the Enterprise Management window does not discover all of the appropriately configured Storage Arrays on a subnetwork.	Add the devices manually using the Add Device option. See the <b>Enterprise Management</b> window Help for more information.
A controller fails during I/O transfer. The host hangs, and you might see an I/O error message.	Fix the controller, using the <b>Recovery Guru</b> . Restart the I/O application. No data corruption occurs.

## Identifying Volumes by Operating System Device Names

The host-util software includes a utility that lets you see which Storage Array volume is associated with a particular operating system device name. The `tpssmdevice` provides a detailed listing of IRIX device names to the Storage Array Volume names and their World Wide Name IDs. This capability is useful for operations such as data placement and volume deletion.

To use the utility, enter the following:

```
> tpssmdevices
```

The software displays device identification information. The table below shows an example output with a description of each column.

**Note:** If `/usr/sbin` is not contained in the `PATH` environment variable, the full path name is required on the command line (`/opt/tpssm/util/tpssmdevices`).

**Table 4-2** Device Identification Information

Entry in IRIX	Controller Name	Volume Group	Vol. Name	World Wide Name of Device
/dev/scsi/sc11d118	[Storage Array RAID7/8,	Volume LUN 0,	LUN 0,	WWN <600a0b80000664d400000073396cd12f>]
/dev/scsi/sc11d111	[Storage Array RAID7/8,	Volume LUN 1,	LUN 1,	WWN <600a0b80000664d400000075396cd134>]
/dev/scsi/sc11d112	[Storage Array RAID7/8,	Volume LUN 2,	LUN 2,	WWN <600a0b80000664d400000077396cd138>]
/dev/scsi/sc11d113	[Storage Array RAID7/8,	Volume LUN 3,	LUN 3,	WWN <600a0b80000664d400000079396cd13c>]
/dev/scsi/sc11d114	[Storage Array RAID7/8,	Volume LUN 4,	LUN 4,	WWN <600a0b8000001396000000833977470f>]
/dev/scsi/sc11d115	[Storage Array RAID7/8,	Volume LUN 5,	LUN 5,	WWN <600a0b800007b8370000000b39775aa1>]
/dev/scsi/sc11d1131	[Storage Array RAID7/8,	Vol. Acc. volume,	LUN 31,	WWN <600a0b800007b8370000000000000000>]
/dev/scsi/sc12d310	[Storage Array RAID7/8,	Volume LUN 0,	LUN 0,	WWN <600a0b80000664d400000073396cd12f>]
/dev/scsi/sc12d311	[Storage Array RAID7/8,	Volume LUN 1,	LUN 1,	WWN <600a0b80000664d400000075396cd134>]
/dev/scsi/sc12d312	[Storage Array RAID7/8,	Volume LUN 2,	LUN 2,	WWN <600a0b80000664d400000077396cd138>]
/dev/scsi/sc12d313	[Storage Array RAID7/8,	Volume LUN 3,	LUN 3,	WWN <600a0b80000664d400000079396cd13c>]
/dev/scsi/sc12d314	[Storage Array RAID7/8,	Volume LUN 4,	LUN 4,	WWN <600a0b8000001396000000833977470f>]
/dev/scsi/sc12d315	[Storage Array RAID7/8,	Volume LUN 5,	LUN 5,	WWN <600a0b800007b8370000000b39775aa1>]
/dev/scsi/sc12d3131	[Storage Array RAID7/8,	Vol. Acc. volume,	LUN 31,	WWN <600a0b80000013960000000000000000>]

## Stopping and Starting the Host-Agent Software on IRIX Systems

On IRIX systems, follow these procedures to stop and start the host-agent software installed on the host.

You must stop the host-agent software if you want to add Storage Arrays. When you restart the software, the host-agent discovers the new Storage Arrays and adds them to the management domain.

- To stop the host-agent software, enter the following:

```
> /etc/init.d/tpssmagent stop
```

The host-agent software automatically starts after you reboot the host. However, you must start the software manually if you stop it to add Storage Arrays.

- To start the host-agent software, enter the following:



```
> /etc/init.d/tpssmagent start
```

---

**Note:** It might take several minutes for the agent daemon startup process to complete.

---

---

**Note:** The agent will not be started if the `tpssmagent` configuration flag is set to `off` (see `chkconfig(1M)` for details).

---

## Starting and Stopping the Host-Agent Software on Linux Systems

On Linux systems, follow these procedures to stop and start the host-agent software installed on the host.

You must stop the host-agent software if you want to add Storage Arrays. When you restart the software, the host-agent discovers the new Storage Arrays and adds them to the management domain.

- To stop the host-agent software, enter the following:

```
> /etc/rc.d/init.d/tpssmagent stop
```

The host-agent software automatically starts after you reboot the host. However, you must start the software manually if you stop it to add Storage Arrays.

- To start the host-agent software, enter the following:

```
> /etc/rc.d/init.d/tpssmagent start
```

---

**Note:** It might take several minutes for the agent daemon startup process to complete.

---

---

**Note:** For Altix systems with 2.4.x kernels and XSCSI software subsystem, you must invoke the following before starting the agent, where *CDROM* is the mount point of the CD-ROM drive.

```
> cp /CDROM/Linux/client/xscsi_to_sg_utm_init /opt/tpssm/agent  
> /opt/tpssm/agent/xscsi_to_sg_utm_init
```

---

## Disabling and Enabling the Event Monitor

The Event Monitor, which is packaged with TPSSM client software, monitors storage arrays and handles error notification through e-mail or SNMP traps when the storage management software is not actively running on the storage management station or host.

---

**Note:** If you installed TPSSM client software and configured alert notifications on multiple machines, you may receive duplicate error messages from the same storage array. To avoid receipt of duplicate error messages, disable the Event Monitor on all but one machine. It is recommended that you run the Event Monitor on one machine that will run continually.

---

---

**Note:** If using direct (network) management, only one machine should be running the Event Monitor software.

---

You can disable and enable the event monitor without having to reboot a management station (workstation) or host (server), or you can permanently disable or enable the boot-time loading of the event monitor.

### Disabling the Event Monitor

On IRIX systems, enter the following to disable the Event Monitor:

```
> /etc/init.d/tpssmmonitor stop
```

On Linux systems, enter the following to disable the Event Monitor:

```
> /etc/rc.d/init.d/tpssmmonitor stop
```

### Enabling the Event Monitor

On IRIX systems, enter the following to enable the Event Monitor:

```
> /etc/init.d/tpssmmonitor start
```

---

**Note:** The Event Monitor will not be started if the `tpssm` monitor configuration file is set to `off` (see `chkconfig(1M)` for details).

---

On Linux systems, enter the following to enable the Event Monitor:

```
> /etc/rc.d/init.d/tpssmmonitor start
```

## Disabling Boot-time Loading of the Event Monitor

On IRIX systems, enter the following to disable boot-time loading of the Event Monitor:

```
> chkconfig tpssmmonitor off
```

On Linux systems, enter the following to disable boot-time loading of the Event Monitor, where *CDROM* is the mount point of the CD-ROM drive:

```
> cp /CDROM/Linux/client/tpssmmonitor_symlink /opt/tpssm/client
> /opt/tpssm/client/tpssmmonitor_symlink delete
```

## Enabling Boot-time Loading of the Event Monitor

On IRIX systems, enter the following to enable boot-time loading of the Event Monitor:

```
> chkconfig tpssmmonitor on
```

On Linux systems, enter the following to enable boot-time loading of the Event Monitor, where *CDROM* is the mount point of the CD-ROM drive:

```
> cp /CDROM/Linux/client/tpssmmonitor_symlink /opt/tpssm/client
> /opt/tpssm/client/tpssmmonitor_symlink create
```

## Uninstalling the TPSSM Software

See the `README` file located on the CD-ROM for instructions on removing the storage management software.



---

# Index

## A

- Access Volume
  - LUN use, 9
  - restriction, 38
- Add Device option, 32, 39
- adding devices, 33
- agent software, 2
  - installing, 26
- alert notifications, 33
- alphanumeric pagers, 33
- Array Management window, 2
  - Help, xiii
  - starting, 34
- automatic discovery
  - troubleshooting, 32, 39

## C

- client software, 1
  - installing, 26
  - operating system requirements, 5
  - permissions requirements, 5
- controller
  - failover and I/O transfer, 39
  - hardware Ethernet address, 16
  - IP address, 13
  - restriction, 39
- customer support representative, 9, 38

## D

- device name
  - identifying with volumes, 39
- devices, adding, 33
- directly managed Storage Array
  - advantages and disadvantages, 9
- DNS table, editing, 24
- dual-port failure, Fibre Channel drive, 38

## E

- e-mail addresses, 33
- Enterprise Management window, 1
  - and automatic discovery, 29
  - Help, xiii
  - starting, 29
- Ethernet address
  - location of label, 16

## F

- firewall, managing Storage Arrays through, 24

## H

- hardware requirements, 5

**Help**

- for Array Management window, xiii
- for Enterprise Management window, xiii

**host**

- client software requirements, 5
- in a sample network, 11
- management software on, 3

**host name, 19****host operating system, 5****host table, editing, 24****host-agent managed Storage Array**

- advantages and disadvantages, 8
- in a sample network, 11

**host-agent software, 2, 41**

- installing on the host, 3
- installing on the Management Station, 3
- restriction on number of clients, 38
- stopping and starting, 40
- when to stop and restart, 33

**I****information record, 15**

- Ethernet address, obtaining, 16
- Ethernet addresses, IP addresses, and host names, 14, 15
- IP addresses and host names, obtaining, 19
- sample, 14

**installation**

- hardware requirements, 5
- procedure, 26

**I/O path, sample network, 12****IP address**

- of host, 19
- pre-installation tasks, 13

**IRIX**

- identifying version, 26

**M****management station**

- client software on, 3
  - client software requirements, 5
  - in a sample network, 11
  - operating system requirements, 5
- managing Storage Arrays, 7**

**N****network management connection, 31****Network Management Station**

- in sample network, 12

**NVSRAM, 38****P****password, no drives in Storage Array, 39****permissions, 5****product support, xv****R****readme file, xiii****recording controller and host information, 14****Remove Device option, 33****renaming Storage Arrays, 35****requirements**

- client software, 5
- for installation, 5
- hardware, 5
- management station, 5
- operating system, 5
- permissions, 5
- software component installation, 3

## restrictions

- adding host devices, 38
- controller failure, 39
- controller slots, 39
- downloading NVSRAM config settings, 38
- passwords with no drives installed, 39
- using scroll arrows, 38
- when drive ports fail, 38

**S**

- scrolling problem, 38
- software, installing, 26
- stopping and starting, 41
- stopping and starting TPSSM, 40, 41
- Storage Array
  - direct managed, 9
  - duplicated in Device Tree, 33
  - host-agent managed, 8
  - management tasks, 36
  - monitoring, 33
  - naming, 16
  - renaming, 35
  - requirements, 5
- storage management software
  - client software, 1
  - features, 1
  - host-agent software, 2
- subnetwork
  - adding devices outside of, 33
  - automatic discovery, 31
- support for product, xv
- system requirements, 5

**T**

- Task Assistant, Enterprise Management Window, 30

- Tools > Rescan option, 33

## TPSSM

- adding devices, 33
- alert notification, 33
- Array Management window, 34
- described, 1
- installation procedure, 26
- installation requirements, 3
- product support, xv
- renaming storage arrays, 35
- restrictions, 37
- software components, 27
- stopping and starting, 40, 41
- storage array management methods, 7

## TPSSM7

- system requirements, 5

## TPSSMdevices utility, 39

## tpssmdevices utility, 3

**U**

- Unresponsive status, 33

**V**

## version

- identifying IRIX, 26

## volumes

- identifying by device name, 39

**W**

- World Wide Name, 40

