



SGI[®] InfiniteStorage 15000 RAID User's Guide

007-5510-001

COPYRIGHT

© 2008 SGI. All rights reserved; provided portions may be copyright in third parties, as indicated elsewhere herein. No permission is granted to copy, distribute, or create derivative works from the contents of this electronic documentation in any manner, in whole or in part, without the prior written permission of SGI.

LIMITED RIGHTS LEGEND

The software described in this document is “commercial computer software” provided with restricted rights (except as to included open/free source) as specified in the FAR 52.227-19 and/or the DFAR 227.7202, or successive sections. Use beyond license provisions is a violation of worldwide intellectual property laws, treaties and conventions. This document is provided with limited rights as defined in 52.227-14.

The electronic (software) version of this document was developed at private expense; if acquired under an agreement with the USA government or any contractor thereto, it is acquired as “commercial computer software” subject to the provisions of its applicable license agreement, as specified in (a) 48 CFR 12.212 of the FAR; or, if acquired for Department of Defense units, (b) 48 CFR 227-7202 of the DoD FAR Supplement; or sections succeeding thereto. Contractor/manufacturer is SGI, 1140 E. Arques Avenue, Sunnyvale, CA 94085.

TRADEMARKS AND ATTRIBUTIONS

SGI, the SGI logo, and Clusterworx are registered trademarks of SGI in the United States and/or other countries worldwide.

Windows is a registered trademark of Microsoft Corporation in the United States and/or other countries.

All other trademarks mentioned herein are the property of their respective owners.

1	Introduction	1
1.1	Controller Features	1
1.2	The Controller Hardware	2
1.2.1	Power Supply and Fan Modules	4
1.2.2	I/O Connectors and Status LED Indicators	5
1.2.3	Uninterruptible Power Supply (UPS)	9
2	Controller Installation	11
2.1	Setting Up the Controller	11
2.2	Unpacking the System	12
2.2.1	Rack-Mounting the Controller Chassis	12
2.2.2	Connecting the Controller in Dual Mode	12
2.2.3	Connecting the Controller	13
2.2.4	Selecting SAS- ID for Your Drives	13
2.2.5	Laying Out your Storage Drives	13
2.2.6	Connecting the RS-232 Terminal	14
2.2.7	Powering On the Controller	15
2.3	Configuring the Controller	16
2.3.1	Planning Your Setup and Configuration	16
2.3.2	Configuration Interface	17
2.3.3	Login as Administrator	17
2.3.4	Setting System Time & Date	17
2.3.5	Setting Tier Mapping Mode	18
2.3.6	Checking Tier Status and Configuration	19
2.3.7	Cache Coherency and Labeling in Dual Mode	20
2.3.8	Configuring the Storage Arrays	21
2.3.9	Setting Security Levels	24
3	Controller Management	29
3.1	Managing the Controller	29
3.1.1	Management Interface	29
3.1.2	Available Commands	30
3.1.3	Administrator and User Logins	30
3.2	Configuration Management	32
3.2.1	Configure and Monitor Status of Host Ports	32
3.2.2	Configure and Monitor Status of Storage Assets	34
3.2.3	Tier Mapping for Enclosures	42
3.2.4	System Network Configuration	43
3.2.5	Restarting the Controller	45
3.2.6	Setting the System's Date and Time	46
3.2.7	Saving the Controller's Configuration	47
3.2.8	Restoring the System's Default Configuration	47
3.2.9	LUN Management	48
3.2.10	Automatic Drive Rebuild	50
3.2.11	SMART Command	51
3.2.12	Couplet Controller Configuration (Cache/Non-Cache Coherent)	53
3.3	Performance Management	55
3.3.1	Optimizing I/O Request Patterns	55
3.3.2	Audio/Visual Settings of the System	58
3.3.3	Locking LUN in Cache	59
3.3.4	Resources Allocation	66

3.4	Security Administration	72
3.4.1	Monitoring User Logins	73
3.4.2	Zoning (Anonymous Access)	73
3.4.3	User Authentication	74
3.5	Firmware Update Management	75
3.5.1	Displaying Current Firmware Version	75
3.5.2	Firmware Update Procedure	75
3.6	Remote Login Management	76
3.6.1	When a Telnet Session is Active	77
3.7	System Logs	79
3.7.1	Message Log	79
3.7.2	System and Drive Enclosure Faults	79
3.7.3	Displaying System Uptime	80
3.7.4	Saving a Comment to the Log	80
3.8	Other Utilities	81
3.8.1	APC UPS SNMP Trap Monitor	81
3.8.2	API Server Connections	81
3.8.3	Changing Baud Rate for the CLI Interface	81
3.8.4	CLI/Telnet Session Control Settings	82
3.8.5	Disk Diagnostics	82
3.8.6	Disk Reassignment and Miscellaneous Disk Commands	83
3.8.7	SPARE Commands	83
4	Controller Remote Management and Troubleshooting	85
4.1	Remote Management of the Controller	85
4.1.1	Network Connection	85
4.1.2	Network Interface Set Up	85
4.1.3	Login Names and Passwords	87
4.1.4	SNMP Set Up on Host Computer	88
4.2	Troubleshooting the Controller	89
4.2.1	Component Failure Recovery	89
4.2.2	Recovering from Drive Failures	90
4.2.3	Component Failure on Enclosures	94
5	Drive Enclosure System	95
5.1	The SGI InfiniteStorage 15000 Drive Enclosure	95
5.2	Enclosure Core Product	96
5.2.1	Enclosure Chassis	97
5.3	The Plug-in Modules	97
5.3.1	Power Cooling Module (PCM)	97
5.3.2	Input/Output (I/O) Module	98
5.3.3	Drive Carrier Module and Status Indicator	100
5.3.4	DEM Card	100
5.4	Indicators	101
5.4.1	Front Panel Drive Activity Indicators	101
5.4.2	Internal Indicators	104
5.4.3	Rear of Enclosure Activity Indicators	104
5.5	Visible and Audible Alarms	105
5.6	Drive Enclosure Technical Specification	105
5.6.1	Dimensions	105
5.6.2	Weight	106

5.6.3	AC INPUT PCM	106
5.6.4	DC INPUT PCM	106
5.6.5	DC OUTPUT PCM	107
5.6.6	PCM Safety and EMC Compliance	107
5.6.7	Power Cord	107
5.7	Environment	107
6	Drive Enclosure Installation	109
6.1	Introduction	109
6.2	Planning Your Installation	109
6.2.1	Enclosure Bay Numbering Convention	110
6.3	Enclosure Installation Procedures	112
6.4	I/O Module Configurations	112
6.4.1	Controller Options	112
6.5	SAS DEM	113
6.6	SATA Interposer Features	113
6.7	Drive Enclosure Device Addressing	113
6.8	Grounding Checks	113
7	Drive Enclosure Operation	115
7.1	Before You Begin	115
7.2	Power On / Power Down	115
7.2.1	PCM LEDs	115
7.2.2	I/O Panel LEDs	116
8	Drive Enclosure Troubleshooting	117
8.1	Overview	117
8.2	Initial Start-up Problems	117
8.2.1	Faulty Cords	117
8.2.2	Alarm Sounds On Power Up	117
8.2.3	Green "Signal Good" LED on I/O Module Not Lit	117
8.2.4	Computer Doesn't Recognize the Drive Enclosure Subsystem	117
8.3	LEDs	118
8.3.1	HDD (Hard Disk Drive)	118
8.3.2	PCM (Power Cooling Module)	118
8.3.3	DEM (Drive Expander Module)	118
8.3.4	I/O Module	119
8.3.5	Front Panel Drive Activity Indicators	120
8.4	Audible Alarm	121
8.4.1	Top Cover Open	121
8.4.2	SES Command	121
8.5	Troubleshooting	121
8.5.1	Thermal Control	121
8.5.2	Thermal Alarm	123
8.5.3	Thermal Shutdown	123
8.6	Dealing with Hardware Faults	123
8.7	Continuous Operation During Replacement	124
8.8	Replacing a Module	124
8.8.1	Power Cooling Modules	124
8.8.2	I/O Module	126
8.8.3	Replacing the Drive Carrier Module	126

8.9 Replacing the DEM	127
Appendix A. Controller Technical Specifications	129
Appendix B. Drive Addressing	131
Appendix C. Cabling Controllers and Drive Enclosures	135

Preface

What is in this guide

This user guide gives you step-by-step instructions on how to install, configure, and connect the SGI InfiniteStorage 15000 system to your host computer system, as well as to use and maintain the system.

Who should use this guide

This user guide assumes that you have a working knowledge of the Serial Attached SCSI (SAS) protocol environments into which you are installing this system.

International Standards

The SGI InfiniteStorage 15000 system complies with the requirements of the following agencies and standards:

- CE
- UL
- cUL

Potential for Radio Frequency Interference

USA Federal Communications Commission (FCC)

Note This equipment has been tested and found to comply with the limits for a class A digital device, pursuant to Part 15 of the FCC rules. These limits are designed to provide reasonable protection against harmful interference when the equipment is operated in a commercial environment. This equipment generates, uses and can radiate radio frequency energy and, if not installed and used in accordance with the instruction manual, may cause harmful interference to radio communications. Operation of this equipment in a residential area is likely to cause harmful interference in which case the user will be required to correct the interference at his own expense.

Properly shielded and grounded cables and connectors must be used in order to meet FCC emission limits. The supplier is not responsible for any radio or television interference caused by using other than recommended cables and connectors or by unauthorized changes or modifications to this equipment. Unauthorized changes or modifications could void the user's authority to operate the equipment.

This device complies with Part 15 of the FCC Rules. Operation is subject to the following two conditions: (1) this device may not cause harmful interference, and (2) this device must accept any interference received, including interference that may cause undesired operation.

European Regulations

This equipment complies with European Regulations EN 55022 Class A: Limits and Methods of Measurement of Radio Disturbance Characteristics of Information Technology Equipment and EN50082-1: Generic Immunity.



Qualified Personnel

Qualified personnel are defined as follows:

- **Service Person:** A person having appropriate technical training and experience necessary to be aware of hazards to which that person may be exposed in performing a task and of measures to minimize the risks to that person or other persons.
- **User/Operator:** Any person other than a *Service Person*.

Safe Handling

- Remove drives to minimize weight.
- Do not try to lift the enclosure by yourself.

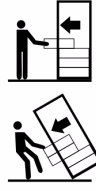
⚠ WARNING					
	Falling Weight Hazard Will result in injury Stop! Do not pull further.	 80kg (177lbs)	Lifting Hazard May result in injury. Remove all modules and drives to minimise weight. Use assistance when moving or lifting.		Tipover Hazard May result in injury. Don't pull out more than one product at a time.
⚠ WARNING					

Weight Handling Label: Lifting and Tipping

⚠ CAUTION	
	Pinch points. May injure hands. Keep hands clear of edges.

Pinch Hazard Label: Keep Hands Clear

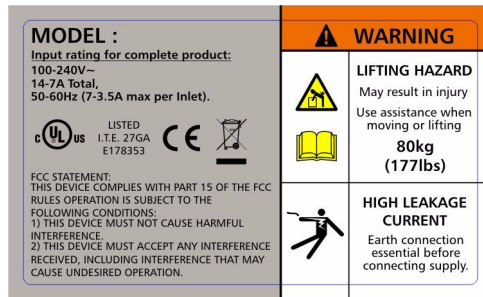

Chassis Warning Label: Weight Hazard

- Do not lift the drive enclosure by the handles on the power cooling module (PCM); they are not designed to support the weight of the populated enclosure.

Safety

Important SGI InfiniteStorage 15000 drive enclosures must be always installed in SGI InfiniteStorage 15000 racks. SGI does not authorize or support the use of these drive enclosures in any standalone benchtop or enclosure-on-enclosure stacking configuration.

If this equipment is used in a manner not specified by the manufacturer, the protection provided by the equipment may be impaired.

Warning The SGI InfiniteStorage 15000 *MUST* be grounded before applying power.

Unplug the unit if you think that it has become damaged in any way and before you move it.

Caution Plug-in modules are part of the fire enclosure and must only be removed when a replacement can be immediately added. The system must not be run without all units in place. Operate the system with the enclosure top cover closed.

- In order to comply with applicable safety, emission and thermal requirements no covers should be removed.
- The drive enclosure unit must only be operated from a power supply input voltage range of 200 V AC to 240 V AC.
- The plug on the power supply cord is used as the main disconnect device. Ensure that the socket outlets are located near the equipment and are easily accessible.

Warning To ensure protection against electric shock caused by HIGH LEAKAGE CURRENT (TOUCH CURRENT), the SGI InfiniteStorage 15000 must be connected to at least two separate and independent sources. This is to ensure a reliable earth connection.

- The equipment is intended to operate with two (2) working PCMs. Before removal/replacement of any module disconnect all supply power for complete isolation.
- A faulty PCM must be replaced with a fully operational module within 24 hours.

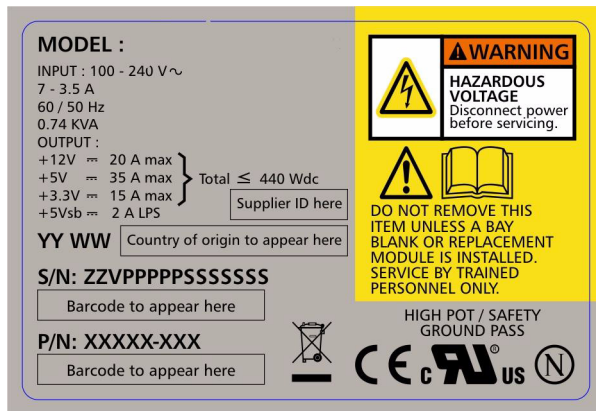

Power Cooling Module (PCM) Caution Label: Do not operate with modules missing

Warning To ensure your system has warning of a power failure please disconnect the power from the power supply, by either the switch (where present) or by physically removing the power source, prior to removing the PCM from the enclosure/shelf.

- Do not remove a faulty PCM unless you have a replacement unit of the correct type ready for insertion.



PCM Warning Label: Power Hazards

- The power connection must always be disconnected prior to removal of the PCM from the enclosure.
- A safe electrical earth connection must be provided to the power cord.
- Provide a suitable power source with electrical overload protection to meet the requirements laid down in the technical specification.

Warning Do not remove covers from the PCM. Danger of electric shock inside. Return the PCM to your supplier for repair.



PCM Safety Label: Electric Shock Hazard Inside

Warning Operation of the Enclosure with **ANY** modules missing will disrupt the airflow and the drives will not receive sufficient cooling. It is **ESSENTIAL** that all apertures are filled before operating the unit.

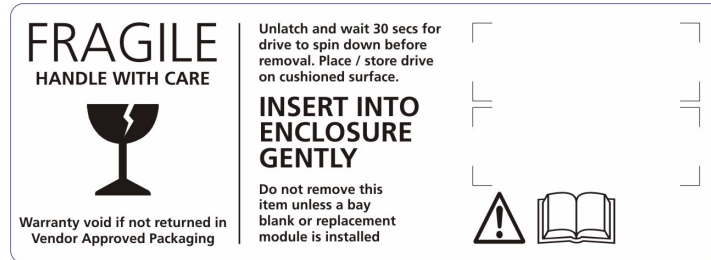

- **Drive Carrier Module Caution Label:** Drive spin down time 30 seconds

Recycling of Waste Electrical and Electronic Equipment (WEEE)

At the end of the product's life, all scrap/ waste electrical and electronic equipment should be recycled in accordance with National regulations applicable to the handling of hazardous/ toxic electrical and electronic waste materials.

Please contact your supplier for a copy of the Recycling Procedures applicable to your product.

Important Observe all applicable safety precautions, e.g. weight restrictions, handling batteries and lasers etc., detailed in the preceding paragraphs when dismantling and disposing of this equipment

Rack System Precautions

Important SGI InfiniteStorage 15000 drive enclosures should only be installed in SGI InfiniteStorage 15000 racks. Mounting and installing these drive enclosures in any other rack is not authorized or supported by SGI.

The SGI InfiniteStorage 15000 drive enclosures are pre-installed in the rack before shipment. If the drive enclosures must be re-installed and mounted, the following safety requirements must be considered when the unit is mounted in a rack.

- The rack stabilizing (anti-tip) plates should be installed and secured to prevent the rack from tipping or being pushed over during installation or normal use.
- When loading a rack with the units, fill the rack from the bottom up and empty from the top down.
- Always remove all modules and drives, to minimize weight, before loading the chassis into a rack.

Warning It is recommended that you do not slide more than one enclosure out of the rack at a time, to avoid danger of the rack tipping over.

- When mounting in a rack, ensure that the enclosure is pushed fully back into the rack.

- The electrical distribution system must provide a reliable earth ground for each unit and the rack.
- Each power supply in each unit has an earth leakage current of 1.5mA. The design of the electrical distribution system must take into consideration the total earth leakage current from all the power supplies in all the units.

OPTIONAL (2 x 30) DRIVE CONFIGURATION

DRIVE 1	DRIVE 7	DRIVE 13	DRIVE 19	DRIVE 25
DRIVE 2	DRIVE 8	DRIVE 14	DRIVE 20	DRIVE 26
DRIVE 3	DRIVE 9	DRIVE 15	DRIVE 21	DRIVE 27
DRIVE 4	DRIVE 10	DRIVE 16	DRIVE 22	DRIVE 28
DRIVE 5	DRIVE 11	DRIVE 17	DRIVE 23	DRIVE 29
DRIVE 6	DRIVE 12	DRIVE 18	DRIVE 24	DRIVE 30
AUX DRIVE (2 X 30)				
DRIVE 1	DRIVE 7	DRIVE 13	DRIVE 19	DRIVE 25
DRIVE 2	DRIVE 8	DRIVE 14	DRIVE 20	DRIVE 26
DRIVE 3	DRIVE 9	DRIVE 15	DRIVE 21	DRIVE 27
DRIVE 4	DRIVE 10	DRIVE 16	DRIVE 22	DRIVE 28
DRIVE 5	DRIVE 11	DRIVE 17	DRIVE 23	DRIVE 29
DRIVE 6	DRIVE 12	DRIVE 18	DRIVE 24	DRIVE 30

FRONT PANEL DRIVE (2 X 30) ACTIVITY INDICATORS

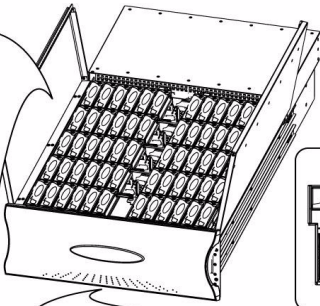

ATTENTION!
OPENING COVERS AFFECT SYSTEM COOLING. LIMIT SERVICE TIME TO 5 MINUTES. REMINDER BEEPS WILL OCCUR EVERY 20 SECONDS. A CONTINUOUS ALARM WILL SOUND AFTER 5 MINUTES.

MAXIMUM IO & PS REMOVAL TIME: 10 MIN

IO A

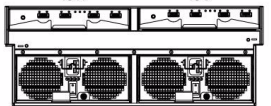

IO B



PS A REAR VIEW PS B



FRONT PANEL DRIVE ACTIVITY INDICATORS

DRIVE REMOVAL:

1. SLIDE BUTTON BACKWARD
2. LIFT HANDLE AND PULL DRIVE UP TO REMOVE

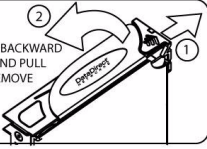

DRIVE EXP MODULE (DEM):
HANDLE INDICATOR WILL LIGHT UP BLUE FOR SERVICE.

REMOVAL:
ROTATE UP TO LIMIT AND LIFT UP.

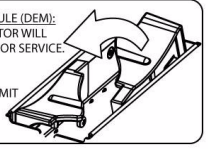

AUX DRIVE REMOVAL:

UNSCREW CAPTIVE SCREW, ROTATE HANDLE UP.

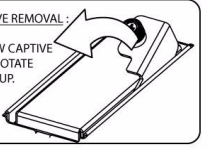

Cover Label

ESD Precautions

Caution *It is recommended that you fit and check a suitable anti-static wrist or ankle strap and observe all conventional ESD precautions when handling plug-in modules and components. Avoid contact with backplane components and module connectors, etc.*

Data Security

- Power down your host computer and all attached peripheral devices before beginning installation.
- Each enclosure contains up to 60 removable disk drive modules. Disk units are fragile. Handle them with care, and keep them away from strong magnetic fields.
- *All* the supplied plug-in modules and blanking plates must be in place for the air to flow correctly around the enclosure and also to complete the internal circuitry.

- If the subsystem is used with modules or blanking plates missing for more than a few minutes, the enclosure can overheat, causing power failure and data loss. Such use may also invalidate the warranty.
- If you remove any drive module, you may lose data.
 - If you remove a drive module, replace it immediately. If it is faulty, replace it with a drive module of the same type and capacity
- Ensure that all disk drives are removed from the enclosure before attempting to move the rack installation.
- Do not abandon your backup routines. No system is completely foolproof.

Chapter 1

Introduction

The SGI InfiniteStorage 15000 controller is an intelligent storage infrastructure device designed and optimized for the high bandwidth and capacity requirements of IT departments, rich media, and high performance workgroup applications.

The controller plugs seamlessly into existing SAN environments, protecting and upgrading investments made in legacy storage and networking products to substantially improve their performance, availability, and manageability.

The controller's design is based on an advanced pipelined, parallel processing architecture, caching, RAID, and system and file management technologies. These technologies have been integrated into a single plug-and-play device—the SGI InfiniteStorage 15000—providing simple, centralized, and secure data and SMNP management.

The SGI InfiniteStorage 15000 is designed specifically to support high bandwidth, rich content, and shared access to and backup of large banks of data. It enables a multi-vendor environment comprised of standalone and clustered servers, workstations and PCs to access and back-up data stored in centralized or distributed storage devices in an easy, cost-effective, and reliable manner.

Each controller orchestrates a coherent flow of data throughout the storage area network (SAN) from users to storage, managing data at speeds of up to 3000 MB/second (or 3 GB/second). This is accomplished through virtualized host and storage connections, a DMA-speed shared data access space, and advanced network-optimized RAID data protection and security—all acting in harmony with sophisticated SAS storage management intelligence embedded within the controller.

The controller can be “coupled” to form data access redundancy while maintaining fully pipelined, parallel bandwidth to the same disk storage. This modular architecture ensures high data availability and uptime along with application performance. With its PowerLUN technology, the system provides full bandwidth to all host ports simultaneously and without host striping.

1.1 Controller Features

The SGI InfiniteStorage 15000 controller incorporates the following features:

- **Simplifies Deployment of Complex SANs**
The controller provides SAN administration with the management tools required for large number of clients.
- **Infiniband Connectivity Throughput**
The controller provides up to four (4) individual double data rate four-lane Infiniband host port connections, including simultaneous access to the same data through multiple ports. Each IB host port supports point-to-point and switched fabric operation.
- **Highly Scalable Performance and Capacity**
The RAID engine provides both fault-tolerance and capacity scalability. Performance remains the same, even in degraded mode. Internal data striping provides generic load balancing across drives. The RAID engine can support from 10 drives minimum to 1200 drives maximum. Formatable capacity is drive capacity.

- **Comprehensive, Centralized Management Capability**
The controller provides a wide range of management capabilities: Configuration Management, Performance Management, Logical Unit Number (LUN) Management, Security Administration, and Firmware Update Management.
- **Management Options via RS-232 and Ethernet (Telnet)**
A RS-232 port and Ethernet port are included to provide local and remote management capabilities. SNMP is also supported.
- **Data Security with Dual-Level Protection**
Non-host based data security is maintained with scalable security features including restricted management access, dual-level protection, and authentication against authorized listing (up to 256 direct host logins per host port are supported). No security software is required on the host computers.
- **Storage Virtualization and Pooling**
Storage pooling enables different types of storage to be aggregated into a single logical storage resource from which virtual volumes can be served up to multi-vendor host computers. Up to 1024 LUNs are supported.
- **SES (SCSI Enclosure Services) Support for Enclosure Monitoring**
Status information on the condition of enclosure, disk drives, power supplies, and cooling systems are obtained via the SES interface.
- **Absolute Data Integrity and Availability**
Automatic drive failure recovery procedures are transparent to users.
- **Hot-Swapable and Redundant Components**
The controller utilizes redundant, hot-swappable power supplies and a hot swappable fan module that contains redundant cooling fans.

1.2 The Controller Hardware

The basic controller (See Figure 1–1.) includes:

- A chassis enclosure (with a minimum of 2.56GB cache memory)
- 10 SAS connectors that connect the controller to the drive enclosures
- Connector(s) for host Infiniband connection(s)
- Serial connectors for maintenance/diagnostics
- Ethernet RJ-45 connector

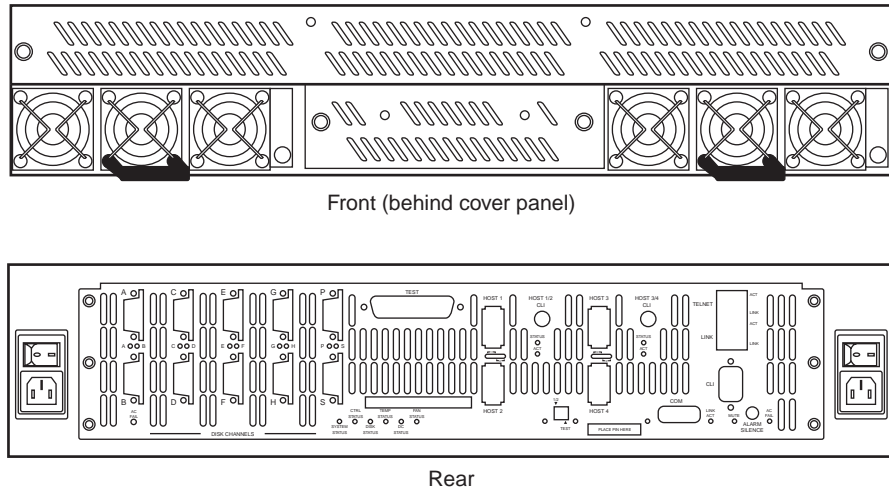

Figure 1-1 SGI InfiniteStorage 15000 IB - Front and Rear Views

The controller is a high-performance controller designed to be rack-mounted in standard 19" racks. Each controller is 3.5" in height, requiring 2U of rack space. The system uses 10 independent SAS drive channels to manage data distribution and storage for up to 120 disk drives per channel (which can be limited by drive enclosure type).

1.2.1 Power Supply and Fan Modules

Each controller is equipped with two (2) power supply modules and one (1) fan module. The PSU (power supply unit) voltage operating ranges are nominally 110V to 230V AC, and are autoranging.

The two Power Supply modules provide redundant power. If one module fails, the other will maintain the power supply and cooling while you replace the faulty module. The faulty module will still be providing proper air flow for the system so do not remove it until a new module is available for replacement.

The two power supply modules are installed in the lower left and right slots at the front of the unit, behind the cover panel (Figure 1–1). Each PSU module is held in place by one thumbscrew.

The fan module (Figure 1–1) is installed in the front top slot, behind the cover panel, and held in place by two thumbscrews.

The two LEDs mounted on the front of the power supply module (located on the right and left of the power supply handle) indicate the status of the PSU:

- Both LEDs will be lit green when the supply is active and the output is within operating limits with no faults.
- The left LED indicates the status of the AC input. The LED is lit green as long as the AC input is present.
- The right LED indicates the status of the DC output of the power supply. The LED is lit green when the supply is enabled and the outputs are within specification. The LED will be off when AC input is not present, the outputs are disabled (after a SHUTDOWN command), or the outputs are not within specification. A cooling fan failure will not turn this LED off unless the failure results in a thermal shutdown of the supply.

The AC switch for each supply is located on the rear of the controller unit.

The fan module contains multiple fans for cooling the controller. It is the primary source of cooling and must be installed at all times during operation (except when it is being replaced due to a faulty fan).

NOTE : For more information on fan status, see the description of the Status LEDs on rear panel in the next section.

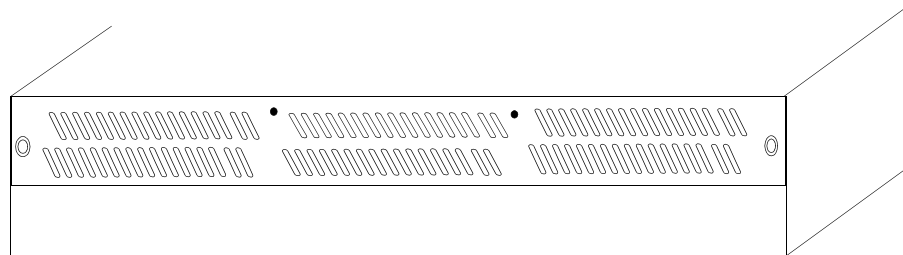

Figure 1–2 Fan Module (front panel)

1.2.2 I/O Connectors and Status LED Indicators

Figure 1–3 shows the ports at the back of the controller 4 Infiniband (IB) unit.

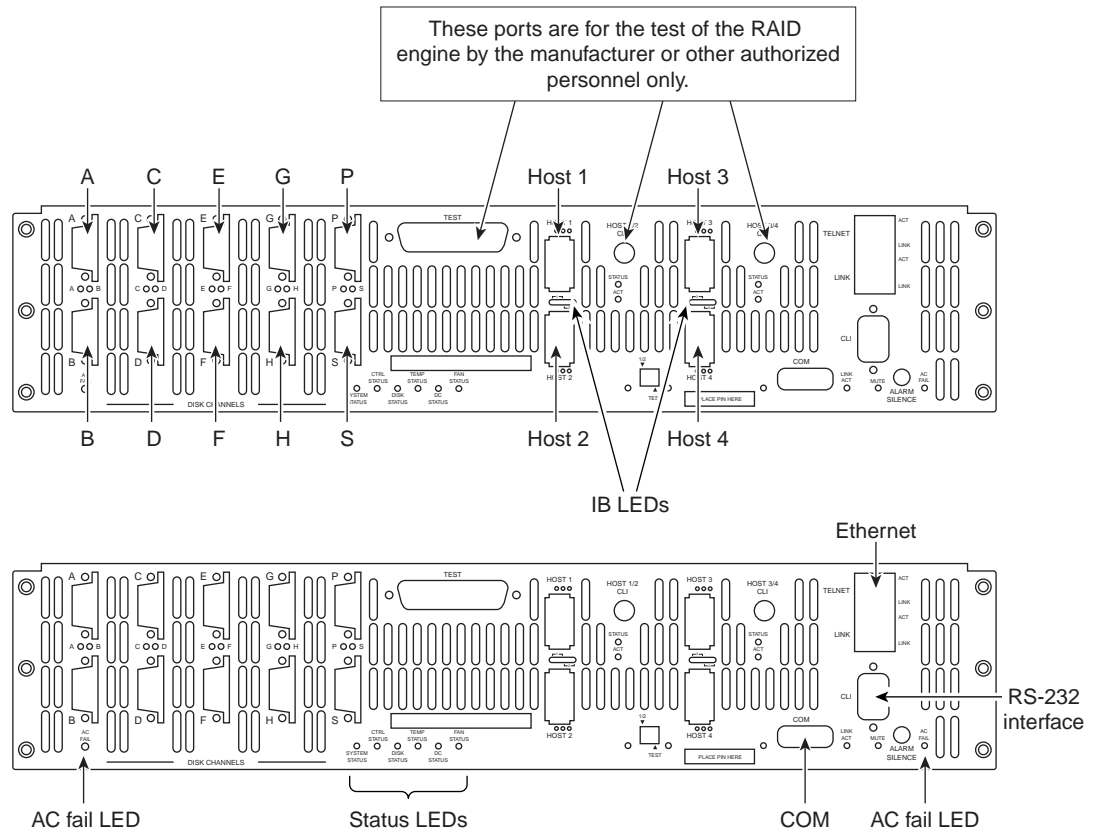

Figure 1–3 I/O Ports on the Rear Panel of the Controller

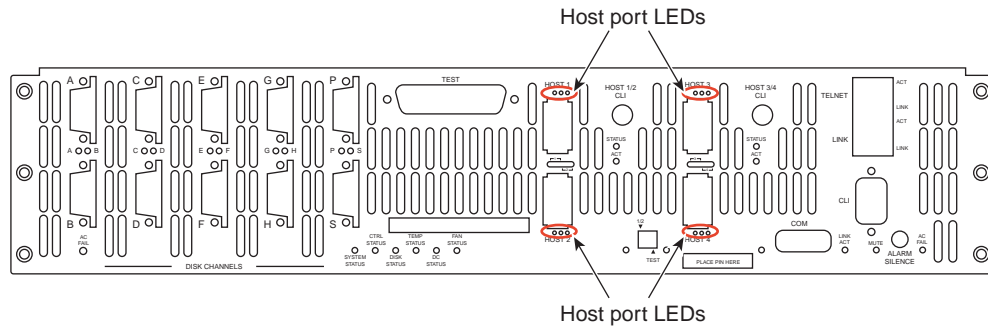

Figure 1-4 Host Port LEDs

The four **HOST** ports (IB latch-style connectors) are used for IB host connections. You can connect your host servers IB HCA port(s) directly to these ports or connect the ports to your IB switches and hubs.

The **IB LEDs** (the Infiniband LEDs) located between the host ports, when solid **green**, indicate that there is physical connectivity with the host; when steady **amber**, they indicate that the subnet manager is communicating with the host.

The **DISK CHANNEL** ports (jackscrew style connectors) are for disk connections. The ten ports are labeled by data channels (**ABCDEFGHPS**). **Flashing** LEDs indicate activity.

The **RS-232** connector provides local system monitoring and configuration capabilities and uses a standard DB-9 null modem female-to-male cable.

The **TELNET** port provides remote monitoring and configuration capabilities. The **ACT** (Activity) LED flashes **green** when there is Ethernet activity. It is unlit when there is no Ethernet link. The **LINK** LED turns **green** when the link speed is **1000MB/s**, **amber** when the link speed is **100MB/s**, and is **unlit** when the link speed is **10 MB/s**.

The **LINK** port is used to connect single controller units in order to form a couplet via a cross-over Ethernet cable. The **ACT** (Activity) LED flashes **green** when there is Ethernet activity. The LED is **unlit** when there is no Ethernet link. The **LINK** LED turns **green** when the link speed is **1000MB/s**, **amber** when the link speed is **100MB/s**, and is **unlit** when the link speed is **10 MB/s**.

The **COM** port is an RS-232 Interface that uses an RJ-45 cable and connects controller units. The **COM** port has two(2) LEDs associated with it: **HDD ACT** (Activity) and **LINK ACT**.

The **Controller ID Selection Switch (labeled as 1/2)** allows the user to configure the units as **Unit 1** or **Unit 2**. Each unit has an **activity** LED. It is **green** for the selected unit. The switch is comprised of two DIP switches. The first DIP switch (indicated by the 1/2 label) is used to select the unit configuration. Flip the switch up for Unit 1---down for Unit 2. When two controller controllers are paired together to form a couplet, one controller must be configured as unit 1 and its partner must be configured as unit 2.

There are two **AC Fail** LEDs. Each LED is connected to its power supply independent of the other supply. The LEDs are **green** to indicate that the AC input to the supply is present. The LEDs turn **red** if the AC input to the supply is not present. If this occurs, check the LEDs on the front side of the unit. If you lose AC power from one supply cord, the LED for that supply outlet will turn **red**.

Figure 1-5 shows the following status LEDs: System, Controller, Disk, Temperature, DC, and Fan.

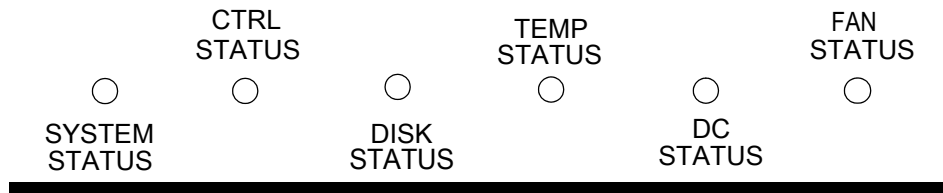

Figure 1–5 LED Status Indicators - Rear Panel of the Controller

The **SYSTEM STATUS** LED is **solid green** when the entire storage system is operating normally.

The **CTRL (CONTROLLER) STATUS** LED is **green** when the controller is operating normally and turns **red** when the controller unit is failed.

The **DISK STATUS** LED is **green** when a disk enclosure is operating normally and turns **amber** when there is a problem.

The **TEMP STATUS** LED is **green** when the temperature sensors (6 total) indicate that the system is operating normally, **amber** when one (1) temp sensor indicates an over-temperature condition, and **red** when two (2) or more sensors indicate an over-temperature condition.

The **DC STATUS** LED is **green** when indicating normal operating status. It turns **amber** if there is a non-critical power Supply DC fault (that is, a power supply is not installed or is not indicating “**Power Good**”). It turns **red** if an on-board supply fails or if there is a critical supply fault. If this occurs, check the LEDs on the front side of the unit.

The **FAN STATUS** LED is **solid green** when fans are operating normally. A **flashing green** LED indicates system monitoring activity such that the monitoring is being updated. The LED flashes **amber** if one of the fans in the module fails. If 2 or more fans fail, the LED flashes a **solid red** and the system will begin the shut down process at 5 seconds, for a total of 30 seconds to complete shutdown.

Table 1-1 LED Indicators

Status Indicator	Led Activity	Explanation
IB	Solid Green	(Infiniband) Physical Connectivity with host
	Solid Amber	Subnet Manager communicating with host
DISK ports	Flashing Green	Activity. There is an LED for each of the ten ports/channels (ABCDEFGPS)
	Unlit	
Telnet ACT	Flashing Green	Activity
	Unlit	No activity
Telnet LINK (Speed)	Solid Green	Link Speed=1000 mb/s
	Solid Amber	Link Speed=100 mb/s
	Unlit	Link Speed= 0 mb/s
Link ACT	Flashing Green	Activity
	Unlit	No activity
Link LINK (Speed)	Solid Green	Link Speed=1000 mb/s
	Solid Amber	Link Speed=100 mb/s
	Unlit	Link Speed=10 mb/s
Com Port HDD ACT	Open	
Com Port LINK ACT	Open	
Host 1/2 CLI STATUS	Open	
Host 1/2 CLI STATUS	Open	
Host 3/4 CLI ACT	Open	
Host 3/4 CLI ACT	Open	
System	Solid Green	System is operating normally
Ctrl	Solid Green	System is operating normally
	Solid Amber	System is shutting down

Table 1–1 LED Indicators

Status Indicator	Led Activity	Explanation
Disk	Solid Green	All related disk enclosures are operating normally
	Solid Amber	There is a problem with 1 or more of the disk enclosures
Temp Status	Solid Green	All temp sensors operating normally
	Solid Amber	At least 1 temp sensor has reported over-temperature conditions
	Solid Red	2 or more temp sensors has reported over-temperature condition
DC	Solid Green	Operating normally
	Solid Amber	Non-critical power supply fault
	Solid Red	Critical power supply fault
Fan Status	Solid Green	Operating normally
	Flashing Green	System monitoring activity
	Flashing Amber	1 fan has failed and needs to be replaced
	Solid Red	2 or more fans have failed or are undetected and the system will shutdown in 30 seconds
AC Fail	Solid Green	Operating normally
	Solid Red	Power input to supply not present. AC failure

1.2.3 Uninterruptible Power Supply (UPS)

Using an Uninterruptible Power Supply (UPS) with the controller is highly recommended. The UPS can guarantee power to the system in the event of a power failure for a short time, which will allow the system to power down properly.

SGI offers two types of UPS: *basic* and *redundant*. The basic UPS is rack-mountable. It can maintain power to a five (5) enclosure system for seven (7) minutes while the system safely shuts down during a power failure. The redundant UPS contains power cells that provide a redundant UPS solution.

NOTE : The UPS should be installed by a licensed electrician. Contact SGI to obtain circuit and power requirements.

Chapter 2

Controller Installation

These steps provide an overview of the controller installation process. The steps are explained in detail in the following sections of this chapter.

1. Unpack the controller system.
2. If it is necessary to install the controller in the 19-inch cabinet(s), contact your service provider.

NOTE : Most controller configurations arrive at sites pre-mounted in a 42U or 45U rack supplied by SGI.

3. Set up and connect the drive enclosures to the controller.
4. Connect the controller to your Infiniband (IB) switch and host computer(s).
5. Connect your RS-232 terminal to the controller.
6. Power up the system.
7. Configure the storage array (create and format LUNs - Logical Units) via RS-232 interface, Telnet, or GUI.
8. Define and provide access rights for the clients in your SAN environment. Shared LUNs need to be managed by SAN management software. Individual dedicated LUNs appear to the client as local storage and do not require management software.
9. Initialize the system LUNs for use with your server/client systems. Partition disk space and create file systems as needed.

2.1 Setting Up the Controller

This section details the installation of the hardware components of the controller system.



The SGI InfiniteStorage 15000 must be removed from the shipping pallet using a minimum of 4 people. The racked unit may not be tipped more than 10 degrees, either from a level surface or rolling down an incline (such as a ramp).

NOTE : Follow the safety guidelines for rack installation given in the “Preface”.

2.2 Unpacking the System

Before you unpack your controller, inspect the shipping container(s) for damage. If you detect damage, report it to your carrier immediately. Retain all boxes and packing materials in case you need to store or ship the system in the future.

While removing the components from their boxes/containers, inspect the controller chassis and all components for signs of damage. If you detect any problems, contact SGI immediately.

Your controller ships with the following:

- controller chassis
- two (2) power cords
- RS-232 and Ethernet cables for monitoring and configuration
- cover panel and rack-mounting hardware



Wear an ESD wrist strap or otherwise ground yourself when handling controller modules and components. Electrostatic discharge can damage the circuit boards.

2.2.1 Rack-Mounting the Controller Chassis

For instructions on mounting the controller in the rack, contact your service provider.

2.2.2 Connecting the Controller in Dual Mode

For dual mode configuration only:

1. Connect the **LINK** ports on the two controller units using the supplied cable.
2. Connect the **COM** ports on the two units using the supplied cable.

2.2.3 Connecting the Controller

To set up the disk enclosures and connect them to the controller, do the following.

1. There are 10 disk channels on the controller. They correspond with disk ports. The disk ports are labeled as follows (Figure 2–1):

DISK A = Channel A	DISK B = Channel B
DISK C = Channel C	DISK D = Channel D
DISK E = Channel E	DISK F = Channel F
DISK G = Channel G	DISK H = Channel H
DISK P = Channel P (parity)	
DISK S = Channel S (spare)	

Using the 10 copper SAS cables provided, connect these disk ports to your ten disk channels.

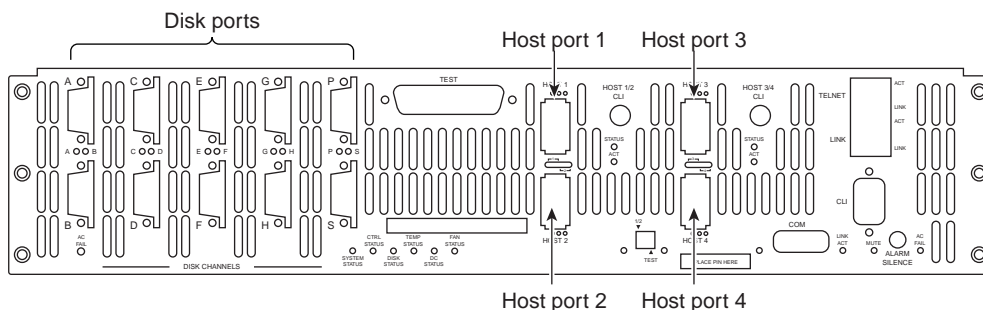

Figure 2–1 I/O Connectors

2. Each controller supports up to 4 Infiniband (IB) host connections. You may connect more than four client systems to the controller using switches and you can restrict user access to the LUNs (as described in Section 2.3 "Configuring the Controller" of this guide).

The Host ports are numbered 1 through 4 as shown in Figure 2–1. Connect your host system(s) or switches to these ports.

2.2.4 Selecting SAS- ID for Your Drives

NOTE : The controller uses a select ID of 1.

2.2.5 Laying Out your Storage Drives

Tiers, or RAID groups, are the basic building blocks of the controller. A tier can be catalogued as 8+1 or 8+2. In 8+1 mode, a tier contains 10 drives—eight (8) data drives (Channels A through H), one parity drive (Channel P), and one *optional* spare drive (Channel S). In 8+2 mode, a tier contains 10 drives—eight (8) data drives (Channels A through H) and two parity drives (Channel P and S).

The controller can manage up to 120 tiers.

Configuration of disks in the enclosures must be in sets of complete tiers (Channels A through P). Allocating one spare drive per tier gives you the best data protection but this is not required. The spare drives on the controller are global hot spares.

2.2.6 Connecting the RS-232 Terminal

For first time set-up, you will need access to an RS-232 terminal or terminal emulator (such as Windows hyperterminal). Then you may set up the remote management functions and configure/monitor the controller remotely via Telnet.

1. Connect your terminal to the CLI port at the back of the controller using a standard DB-9 female-to-male null modem cable (Figure 2–2).

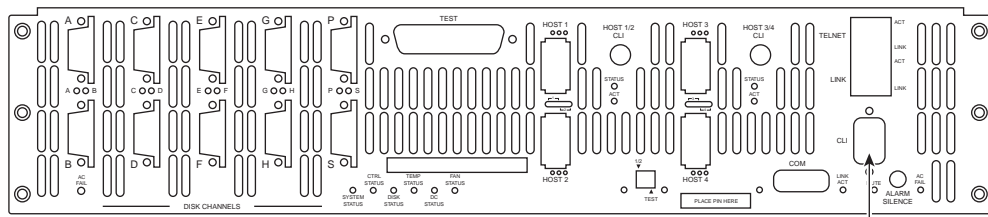

CLI (RS-232 Interface)

Figure 2–2 Controller CLI Port

2. Open the terminal window.
3. Use the following settings for your serial port:

Setting	Value
Bits per second:	115,200
Data bits:	8
Parity:	None
Stop bits:	1
Flow Control:	None

2.2.6.1 Basic Key Operations

The command line editing and history features support **ANSI** and **VT-100** terminal modes. The command history buffer can hold up to 64 commands. The full command line editing and history only work on main CLI and telnet sessions when entering new commands. Basic Key Assignments are listed in Table 2–1 on page 15.

Simple, not full command, line editing only is supported when the:

- CLI prompts the user for more information.
- alternate CLI prompt is active. (The alternate CLI is used on the RS-232 connection during an active telnet session.)

NOTE : Not all telnet programs support all the keys listed in Table 2–1 "Basic Key Assignments". The Backspace key in the terminal program should be setup to send 'Ctrl-H'.

Table 2–1 Basic Key Assignments

Key	Escape Sequence	Description
Backspace	Ctrl-H, 0x08	deletes preceding character
Del	Del, 0x7F or Esc [3~	deletes current character
Up Arrow	Esc [A	retrieves previous command in the history buffer
Down Arrow	Esc [B	retrieves next command in the history buffer
Right Arrow	Esc [C	moves cursor to the right by one character
Left Arrow	Esc [D	moves cursor to the left by one character
Home	Esc [H or Esc [1~	moves cursor to the start of the line.
End	Esc [K or Esc [4~	moves cursor to the end of the line
Ins	Esc [2~	toggles character insert mode, on and off
NOTE: Insert mode is ON by default and resets to ON for each new command.		
PgUp	Esc [5~	retrieves oldest command in the history buffer
PgDn	Esc [6~	retrieves latest command in the history buffer

2.2.7 Powering On the Controller

NOTE : Systems that have dual controllers (couplets) should have the controllers powered on simultaneously ensure correct system configuration.

1. Verify that the power switches on the two (2) power supply module at the back of each controller are off.
2. Connect the two AC connectors, using the power cords provided at the back to the AC power source for each controller unit. For maximum redundancy, connect the two power connectors to two different AC power circuits for each unit.
3. Check that all your drive enclosures are powered up.
4. Check that the drives are spun up and ready.
5. Turn on the power supplies on the controller unit(s). The controller will undergo a series of system diagnostics and the bootup sequence is displayed on your terminal.
6. Wait until the bootup sequence is complete and the controller system prompt is displayed.

NOTE : Do not interrupt the boot sequence without guidance from SGI support personnel.

You may now configure the system as described in Section 2.3 "Configuring the Controller".

2.3 Configuring the Controller

This section provides information on configuring your controller.

NOTE :The configuration examples provided here represent only a general guideline. These examples should not be used directly to configure your particular controller.

The CLI (command line interface) commands used in these examples are fully documented in sections 3.1 through 3.8—though exact commands may change depending on your firmware version. To access the most up-to-date commands, use the CLI’s online HELP feature.

2.3.1 Planning Your Setup and Configuration

Before proceeding with your controller configuration, determine the requirements for your SAN environment, including the types of I/O access (random or sequential), the number of storage arrays (LUNs) and their sizes, and user access rights.

The controller uses either an 8+2 or an 8+1+1 parity scheme. It is a unique implementation that combines the virtues of RAID 3, RAID 0, and RAID 6 (Figure 2–3). Like RAID 3, a dedicated parity drive is used per 8+1 parity group; two parity drives are dedicated in the case of an 8+2 parity group or RAID 6. A parity group is also known as a **Tier**.

This RAID implementation exhibits RAID 3 characteristics such as tremendous large block-transfer—READ and WRITE—capability with NO performance degradation in crippled mode. This capability also extends to RAID 6, delivering data protection against a double disk drive failure in the same tier with no loss of performance.

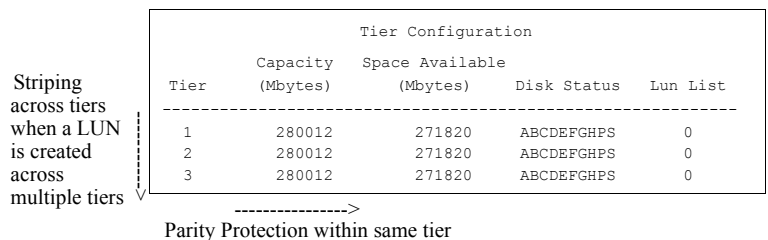

Figure 2–3 Striping Across Tiers - RAID

However, Like RAID 5, this RAID implementation does not lock drive spindles and does allow the disks to re-order commands to minimize seek latency, and the RAID 0-like functionality allows multiple tiers to be striped, providing “PowerLUNs” that can span hundreds of disk drives. These PowerLUNs support very high throughput and have a greatly enhanced ability to handle small I/O (particularly as disk spindles are added) and many streams of real-time content.

LUNs can be created on just a part of a tier, a full tier, across a fraction of multiple tiers, or across multiple full tiers. A minimum configuration for tiers of drives require either 9 drives in an 8+1 configuration or 10 drives in an 8+2 configuration. When configured in 8+1+1 mode, the tenth data segment is reserved for global hot spare drives. When configured in 8+2 mode, spares may reside on each data segment and are global only to that data segment.

The controller supports various disk drive enclosures that can be used to populate the 10 <ABCDEFGHPS> disk channels in both SAS 1x and SAS 2x modes. Each chassis has a limit to the tiers that can be created and supported. Refer to the specific disk enclosure user guides for further information.

You can create up to 1024 LUNs in a controller. LUNs can be shared or dedicated to individual users, according to your security level setup, with Read or Read/Write privileges granted per user. Users only have access to their own and “allowed-to-share” LUNs. Shared LUNs need to be managed by SAN management software. Individual dedicated LUNs appear to users as local storage and do not require external management software.

NOTE : In dual mode, LUNs are “owned” by the controller unit on which they are created. Hosts only see the LUNs on the controller to which they are connected, unless cache coherency is enabled.

For random I/O applications, use as many tiers as possible and create one or more LUNs. For applications that employ sequential I/O, use individual or small grouping of tiers. If you need guidance in determining your requirements, contact SGI support.

2.3.2 Configuration Interface

You can use the Command Line Interface (CLI) to configure the controller system. This user guide provides information for setup using the CLI.

2.3.3 Login as Administrator

The default Administrator account name is `admin` and its default password is `password`. (See Section 3.1.3 "Administrator and User Logins" for information on how to change the user and administrator passwords.) Only users with administrator rights are allowed to change the configuration.

To login:

1. At the login prompt, type:

```
login admin<Enter>
```
2. At the password prompt, type:

```
password<Enter>
```

2.3.4 Setting System Time & Date

The system time and date for the controller are factory-configured for the U.S. Pacific Standard Time (PST) zone. If you are located in a different time zone, you need to change the system date and time so that the time stamps for all events are correct. In dual mode, changes should always be made on Unit 1. New settings are automatically applied to both units.

To set the system date, at the prompt, type:

```
date mm dd yyyy <Enter>
```

where **mm** represents the two digit value for month, **dd** represents the two digit value for day, and **yyyy** represents the four digit value for year.

For example, to change the system date to **March 1, 2009**, enter:

```
date 3 1 2009<Enter>
```

To set the system time, at the prompt, type:

```
time hh:mm:ss<Enter>
```

where **hh** represents the two digit value for hour (00 to 24), **mm** is the two digit value for minutes, and **ss** represents the two digit value for seconds

For example, to change the system time to **2:15:32 p.m.**, enter:

```
time 14:15:32<Enter>
```

NOTE :The system records time using the military method, which records hours from 00 to 24, not in a.m. and p.m. increments of 1 to 12.

2.3.5 Setting Tier Mapping Mode

When the controller system is first configured, it is necessary to select a tier mapping mode for the attached enclosures.

The controller currently supports SAS drive enclosures.

To display the current mapping mode, type: `tier map<Enter>`.

```
15000[1]: tier changemap

Supported mapping modes:
-----
15) SAS_2X   Enclosure mapping.
16) SAS_1X   Enclosure mapping.

Current mapping mode: 15, SAS_2X   Enclosure.
Enter the new mapping mode (15..16), 'e' to escape:
```

Figure 2-4 Tier Changemap Screen

To change the mapping mode (Figure 2-4):

1. Enter: `tier changemap<Enter>`
2. Enter the appropriate mapping mode.
 - For 10 and 20 box solutions, choose SAS_2X.
 - For 5 box solutions, choose SAS_1X.
3. For the changes to take effect, enter: `restart<Enter>`.

2.3.6 Checking Tier Status and Configuration

Use the `tier` command to display your current tier status. Figure 2–5 illustrates the status of a system containing 80 drives on 8 tiers with both parity modes of 8+1 and 8+2 tiers. The plus sign (+) adjacent to the tier number indicates that the tier is in 8+2 mode.

```
15000 [1]: tier
Tier Status
-----
Tier  Owner  Capacity  Space Available  Disk Status  Lun List
-----
1 +   1       280012    280012          ABCDEFGHPS
2     1       280012    280012          ABCD FGHP
3     1       280012    280012          ABCDEFGHPS
4     1       280012    280012          ABCDEFGHPS
5     1       280012    280012          AB.DEFGHPS
6 +   1       280012    280012          ABCDEFGHPS
7     1       280012    280012          ABCDEFG?PS
8 +   1       280012    280012          ABCDEFGHPS

Automatic disk rebuilding is Enabled
System rebuild extend: 32 Mbytes
System rebuild delay: 60
System Capacity 2240096 Mbytes, 2240096 Mbytes available.
```

Figure 2–5 Tier Status Screen

Each letter under the “Disk Status” column represents a healthy drive at that channel (as shown in Figure 2–5). Verify that all drives can be seen by the controller.

“Unhealthy” drives appear as follows:

- A blank space indicates that the drive is not present (or detected) at that location.
- A period (.) denotes that the disk was failed by the system.
- A question mark (?) indicates that the disk has failed the diagnostics tests or is not configured correctly.
- The character “r” indicates that the disk at that location is being replaced by a spare drive.

After entering the `tier` command, perform the following steps if necessary:

1. If a drive is not displayed at all (that is, it is “missing”), check to ensure that the drive is properly seated and in good condition. To search for the drive, enter:

```
disk scan<Enter>
```

2. If the same channel is missing on all tiers, check the cable connections for that channel.
3. If “automatic disk rebuilding” is not enabled, enable it by entering:

```
tier autorebuild=on<Enter>
```

4. To display the detailed disk configuration information for all of the tiers (Figure 2–6) enter:

```
tier config<Enter>
```

```

15000 [1]: tier config

                                Tier Configuration

Tier Owner  Total  Disk  Installed  Healthy  F  R  Sp  Sp  Spare  Spare  Repl
Tier Owner LUNs  Status  Disks  Disks  Disks  F  R  H  A  Owner  Used  Spare
-----
1 +         0  ABCDEFGHPS ABCDEFGHPS ABCDEFGHPS      8+2 Mode no spares
2 +         0  ABCDEFGHPS ABCDEFGHPS ABCDEFGHPS      8+2 Mode no spares
3 +         0  ABCDEFGHPS ABCDEFGHPS ABCDEFGHPS      8+2 Mode no spares
4 +         0  ABCDEFGHPS ABCDEFGHPS ABCDEFGHPS      8+2 Mode no spares
121
*****

All disks are healthy.

Automatic disk rebuilding: Enabled
Automatic SMART replacement: Disabled

15000 [1]:
    
```

Figure 2-6 Current Tier Configuration

2.3.6.1 Heading Definitions

- **Total LUNs.** LUNs that currently reside on the tier.
- **Healthy Disk.** The “health” of the spare disk currently being used (if any is being used) to replace a disk on the listed tier. The health indication for the spare channel that is physically on the listed tier is found under **SP H**.
- **F** indicates the failed disk (if any) on the tier.
- **R** indicates the replaced disk (if any) on the tier.
- **Sp H** indicates if the spare disk that is physically on the tier is healthy.
- **Sp A** indicates if the spare disk that is physically on the tier is available for use as a replacement.
- **Spare Owner** indicates the current owner of the physical spare, where ownership is assigned when the spare is used as a replacement. “**RES-#**” will appear under the Spare Owner heading while a replacement operation is underway to indicate that unit “**#**” currently has the spare reserved.
- **Spare Used on** indicates the tier (if any) where this physical spare is being used as a replacement.
- **Repl Spare from** indicates the tier (if any) whose spare disk is being used as a replacement for this tier.

NOTE : Tiers are 8+1 mode by default.

2.3.7 Cache Coherency and Labeling in Dual Mode

Use the `DUAL` command to check the status of the units that are healthy and verify that the “Dual” (COM2) and “Ethernet” (LINK) communication paths between the two controller units are established (Figure 2-7).

```

15000[1]: dual

                        Dual Unit Configuration
-----
                        Unit 1                      Unit 2
-----
Label                    15000[1]                  15000[2]
Status                   Healthy                   Healthy

Dual communication:     established.
Ethernet communication: established.
Cache coherency:       not enabled.
Cache coherency timeout: 0

```

Figure 2–7 Dual Controller Configuration

If you require multi-pathing to the LUNs, enable cache coherency. If you do not require multi-pathing, disable cache coherency.

To enable/disable the cache coherency function, enter the following (**ON** enables, **OFF** disables):

```
dual coherency=on|off<Enter>
```

You may change the label assigned to each unit. This allows you to uniquely identify each unit in the system. Each unit can have a label of up to 31 characters long.

1. To change the label, enter:

```
dual label<Enter>
```

2. Select which unit you want to re-label (see Figure 2–8).
3. When prompted, type in the new label for the selected unit. The new name is displayed.

```

15000 [1]: dual label

Enter the number of the Unit you wish to rename.
  LABEL=1 for Unit 1, Test System[1]
  LABEL=2 for Unit 2, Test System[2]
Unit: 1
Enter a new label for Unit 1, or DEFAULT to return to the default label.
Up to 31 characters are permitted.
Current Unit name: Test System[1]
  New Unit name: System[1]
15000 [1]:

```

Figure 2–8 Labeling a Controller Unit

2.3.8 Configuring the Storage Arrays

When you have determined your array configuration, you need to create and format the LUNs. You have the option of creating a 32-bit or a 64-bit address LUN.

In the example below, 2 LUNs (32-bit addressing) are created:

- LUN 0 on Tiers 1 to 8 with capacity of 8192MB each.
- LUN 1 on Tiers 1 and 2 with capacity of 8192MB each.

NOTE : You may press `e` at any time to exit and cancel the command completely.

NOTE : In dual mode, LUNs are “owned” by the controller unit where they are created. Hosts only see the LUNs on the unit to which that they are connected, unless cache coherency is enabled.

1. To display the current cache settings, type: `cache<Enter>`
2. Select a cache segment size for your array. For example, to set the segment size to 128 KBytes, type:

```
cache size=128<Enter>
```

This setting can also be adjusted on-the-fly for specific application tuning: see section 3.2.12 "Couplet Controller Configuration (Cache/Non-Cache Coherent)". The default setting is 1024.

3. Type: `lun<Enter>`.

The Logical Unit Status chart should be empty, as no LUN is present on the array.

4. To create a new LUN, type: `lun add=x<Enter>`

where *x* is the LUN number. Valid LUN numbers are 0..1023.

If only `lun add` is entered, you are prompted to enter a LUN number.

5. You will be prompted to enter the parameter values for the LUN. In this example:

- Enter a label for the LUN (you can include up to 12 characters). The label may be changed later using the LUN LABEL command.

- Enter the capacity (in Mbytes) for a single LUN in the LUN group: `8192<Enter>`

- Enter the number of tiers to use: `8<Enter>`

- Select the tier(s) by entering the Tier number. Enter each one on a new line. Tiers are numbered from 1 through 125.

```
1 <Enter>
2 <Enter>
3 <Enter>
4 <Enter>
5 <Enter>
6 <Enter>
7 <Enter>
8 <Enter>
```

- Enter the block size in Bytes: `512<Enter>`

NOTE : **512** is the recommended block size. A larger block size may give better performance. However, verify that your OS and file system can support a larger block size before changing the block size from its default value.

This message will display: `Operation successful: LUN 0 added to the system`

6. When you are asked to format the LUN, type: `Y<Enter>`

After you have initiated LUN format, the message `Starting Format of LUN` is displayed. You can monitor the format progress by entering the command `LUN` (see Figure 2–9).

Upon completion, this message: `Finished Format of LUN 0` displays.

```
15000 [1]: lun
                Logical Unit Status
LUN  Label  Owner   Status   Capacity  Block   Tiers  Tier List
      (Mbytes) Size
-----
0      1      1      Format 14%  8192     512     8      1 2 3 4 5 6 7 8
                System Capacity 2240096 Mbytes, 2207328 Mbytes available.
```

Figure 2–9 Logical Unit Status - Formatting

7. Enter the command `LUN` to check the status of the LUN, which should be “Ready” (see Figure 2–10).

```
15000 [1]: lun
                Logical Unit Status
LUN  Label  Owner   Status   Capacity  Block   Tiers  Tier List
      (Mbytes) Size
-----
0      1      1      Ready    8192     512     8      1 2 3 4 5 6 7 8
                System Capacity 2240096 Mbytes, 2207328 Mbytes available.
```

Figure 2–10 LUN Status - Ready

8. To create the LUN 1, type:

```
lun add=1<Enter>
```

9. Enter these parameters:

- Enter a label for the LUN 1
- For capacity, enter the value in MBytes: 8192 <Enter>
- Enter the number of tiers to use: 2<Enter>
- Select the tier(s) by entering the Tier number. Enter each one on a new line and press the <Enter> key. The tiers are numbered from 1 through 125.

```
1 <Enter>
```

```
2 <Enter>
```

- Enter the block size in Bytes: 512<Enter>
- When asked to format the LUN, type: Y<Enter>

NOTE :LUN format is a background process and you can start adding the next LUN as soon as the format for the previous LUN has started.

2.3.9 Setting Security Levels

After you have formatted all the LUNs, you can define users' access rights. Configurations come in two types:

- **authorized user**
- **host port zoning**

The **Authorized User** configuration is highly recommended for use in a SAN environment-- your data is completely secured and no accidental plug-in is allowed to do damage such as data change or deletion. Authorized users have access only to their own and "allowed to share" data. Administrators can also restrict users' access to the host ports and their read/write privileges to the LUNs. Another advantage of this configuration is that the users see the same LUN identification scheme regardless of the host port connection.

The **Host Port Zoning** configuration provides the minimum level of security. The LUN mappings change according to the host port connection. The read-only and read/write privileges can be specified for each LUN.

The **place holder** LUN feature allows the controller administrator to map a zero-capacity LUN to a host or group of hosts (via zoning or user authentication). The administrator can then create a real LUN and map it to the host(s) to replace the **place holder** LUN in the future. In most cases, the host does not have to reboot since it already mapped to the **place holder** LUN.

NOTE : Support of place holder LUNs is dependent upon the OS (operating system), the driver, and the Host Card Adapter (HCA-IB), or Host Bus Adapter.

2.3.9.1 User Authentication (Recommended for SAN Environment)

Each user connected to the controller is identified by a **World Wide Name** (WWN) or GUID, and is given a unique user ID number. The controller can store configurations for up to 512 users and the security settings apply to all host ports.

Below is an example for adding two users to a system containing two LUNs (numbered 0 and 1). Each user has an internal LUN 1 is shared and "read-only." Both users see the shared LUN as LUN 0 and they see their own LUN as LUN 1. User 1 has access to host ports 1 and 4 while User 2 only has access to host port 2.

Prior to adding any users, verify that no "anonymous" access is allowed to the system:

1. Enter: `zoning<Enter>`

2. Check to ensure that the LUN Zoning chart is empty (Figure 2–11).

```
15000 [1]: zoning
```

		LUN Zoning	
Port	World Wide Name	External LUN, Internal LUN	
1	21000001FF040004		
2	22000001FF040004		
3	23000001FF040004		
4	24000001FF040004		

Figure 2–11 LUN Zoning Screen

To add a user:

1. Type: `user audit=on<Enter>` The controller reports which users are connected.
2. Type: `user add<Enter>`.
3. Specify a new Host User's world wide name, enter `s`.
4. Specify a 64-bit world wide name or GUID, taken from the list of available anonymous users.
5. Enter an alias name for the user. The name may contain up to 12 characters. Type in a name and press `<Enter>`.
6. Host users can have their port access zoned. Enter `y` to specify host port zoning.
7. For Unit 1, enter each active port on a new line and then exit. For this example, type:

```
1<Enter>
4<Enter>
e<Enter>
```
8. For Unit 2, enter each active port on a new line and then exit. For this example, type:

```
1<Enter>
4<Enter>
e<Enter>
```

Host users are limited to accessing specific LUNs, as follows:

- a host user may have its own unique LUN mapping, or
- a host user may use the anonymous LUN mapping.

The anonymous user LUN mapping is handled by the port ZONING command. In either case, the LUN mapping applies on all the ports for which the user has been zoned.

9. Enter `y` to specify the unique LUN mapping (Table 2–2).

- Enter a new unique LUN mapping for this user. Options are shown in Table 2–2 on page 26.

Table 2–2 LUN Mapping Options.

Option	Description
G.1	GROUP.LUN number
P	place-holder
R	Read-Only. Place before the GROUP.LUN
N	Clear current assignment
<cr>	No Change
E	EXIT
?	Display detailed help text.

- Connect user 2 and repeat steps 2--10 to specify the host port zoning and LUN mappings with the following changes:

- For active host port (step 6), enter port 2 only.
- For LUN mapping:

```
External LUN 0 is mapping to internal LUN: R1
External LUN 1 is mapping to internal LUN: 1
External LUN 2 is mapping to internal LUN: q
```

NOTE : In this scheme, users 1 and 2 have their own custom LUN identification scheme. The internal LUN 1 that is shared by the users needs to be managed by SAN management software. The individual dedicated LUN appears to the user as local storage and does not require external management software.

- To display the new security settings, type:

```
user<Enter>
```

Figure 2–12 shows a finished sample.

15000 [1]: user					
		Ports		LUN Zoning	
User	World Wide Name	1	2	External LUN, Internal LUN	

000 client1	210000E08B057383	1	4	R000,001 001,0	
128 client2	210000E08B028233	2		R000,001 001,1	
User auditing is enabled.					

Figure 2–12 Security Settings Screen

2.3.9.2 Host Port Zoning (Anonymous Access)

Host Port Zoning (Anonymous Access) should only be used for non-SAN environment. Users are given “general admission” to the data.



Anonymous Access (host port zoning) provides only the minimum level of security.

One zoning configuration is supported for each of the host ports. Any unauthorized user accessing the storage is considered “anonymous” and granted zoning access for the host port to which they are connected. Given below is an example for adding LUN zoning to host port 1. External LUN 1 is mapped to internal LUN 0 and it is read-only for the users.

1. To edit the default zoning on a host port, type: `zoning edit<Enter>`. The current settings are displayed.
2. Select a host port (1..4): `1<Enter>`
3. Specify the internal LUN (0..1023) to be mapped to the external LUN. The new settings will display .
4. Repeat steps 1–3 to configure other host ports.

Chapter 3

Controller Management

3.1 Managing the Controller

The controller provides a set of tools that enable administrators to centrally manage the network storage and resources that handle business-critical data. These include Configuration Management, Performance Management, Remote Login Management, Security Administration, and Firmware Update Management. Bundled together, this is called the controller's *Administrator Utility*.

3.1.1 Management Interface

SAN management information for the controller can be accessed locally through a serial interface, or remotely through Telnet.

NOTE : A controller may have only one active login (serial or Telnet) at any given time.

Locally - Serial Interface

Any RS-232 terminal or terminal emulator (such as Microsoft Windows HyperTerminal) can be used to configure and monitor the controller.

1. Connect your terminal to the CLI port at the back of the controller using a standard DB-9 female-to-male null modem cable (Figure 3–1).

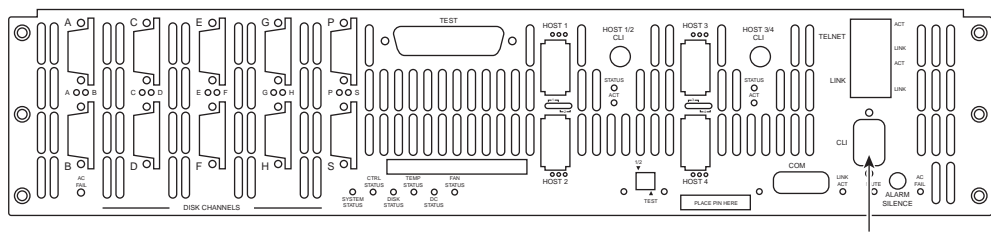

Figure 3–1 Controller CLI Port

2. Open your terminal window and use these settings for your serial port:

Setting	Value
Bits per second:	115,200
Data bits:	8
Parity:	None
Stop bits:	1
Flow Control:	None

3. With the controller ready, press **<Enter>** to get the controller prompt.

NOTE :To change the baud rate on controller, see section 3.8.3 "Changing Baud Rate for the CLI Interface" in this guide.

Remotely - Telnet

To configure and monitor the controller remotely, connect the controller to your Ethernet network. Refer to Section 4.1, "Remote Management of the Controller" for information on how to set up the controller's network interface.

3.1.2 Available Commands

Use the **Help** command to display the available commands within the utility. To get help information on a command, type the command followed by a question mark.

For example, type: **cache?**<Enter>

to display help on cache options on the system.

3.1.3 Administrator and User Logins

The **login** command allows the user to log into a (new) terminal or Telnet session at a specific security user level—*administrative* or *general purpose*. You will need Administrator access on the controller in order to change the system configurations.

For RS-232 terminal session, the general purpose user does not require login. For a Telnet session, you are required to login as either an administrator or a general purpose user. If you login as an administrator, you will have access to all the management and administrative functions. You can obtain status information and make changes to the system configuration.

At the general purpose user access level, you are only allowed to view status and configuration information. If the controller determines that the individual does not have the proper privileges, it will return a message (where the "user entered command" represents a command keyed in by the user):

```
<user entered command>: Permission denied
```

3.1.3.1 Login

To login to the system, do the following:

1. To login (Figure 3–2), enter: **login**<Enter>
The prompt will display Enter a login name:
2. Enter a login name.
This prompt will display Enter the password:
3. Enter a password (see Figure 3–2).

NOTE : The default administrator account name is “admin” and its password is “password.” Similarly, the default user account name is “user” and its password is “password.”

```
15000 [1]: login
Enter a login name: admin
Enter the password: *****

Successful CLI session login.
New owner      : admin.
New security level: Administrative.
```

Figure 3–2 Login Screen

3.1.3.2 Logout

To log out of the system, enter:

```
logout<Enter>
```

For a terminal session, you are returned to the general purpose user level.

For Telnet, the current session is disconnected.

3.1.3.3 Password

Entering the **PASSWORD** command allows the administrator to change the login names and passwords for administrative and general purpose users (Figure 3–3). The associated privileges remain the same regardless of the name or password changes.

```
15000 [1]: password
Enter new name to replace <admin>:
Enter old password: *****
Enter new name to replace <user>:
Enter old password: *****
```

Figure 3–3 Password Configuration Screen

Login names and passwords can be changed using the **PASSWORD** command, via RS-232 or Telnet (see Section 3.1.3 in this guide). By default, the administrator name is “admin” and its password is “password”. Similarly, the default user name is “user” and its password is “password.” If a user forgets the password, entering **PASSWORD DEFAULTS** while logged in as “admin”, will restore all passwords and user names to the default values.

3.1.3.4 Who Am I

To display the owner and the security level of the current terminal or Telnet session (Figure 3–4), enter:

```
whoami<Enter>
```

```

15000 [1]: whoami
CLI session:
Current owner      : admin.
Current security level: Administrative.

```

Figure 3–4 WHOAMI Screen

3.2 Configuration Management

The controller provides uniform configuration management across heterogeneous SANs. Status of host ports and storage assets are continuously being monitored.

Table 3–1 Controller Limits

Item	Limit
Number of LUNs	1024
Total Number of Users	512
Number of LUNs Per User	255
Number of LUNs per port (zoning)	255
Number of IB Logins per HCA (2 ports)	256
Max RDMA size (IB only)	256 KB
Max Msg size (IB only)	4 KB
Max Msg Depth (IB only)	32
Max number of tiers per LUN	8
Max number of tiers	120
Max size of 32-bit LUN	0xFFFF0000 (blocks)
Max size of 64-bit LUN	168 TB
Granularity of LUN size	2 MB x number of tiers
Support LUN block sizes	512 bytes, 1K, 2K, 4K
Active host commands	32 per port
Max queued commands per host port (does not include active host commands)	512
Max commands per disk	32 (can be lower for SATA)

3.2.1 Configure and Monitor Status of Host Ports

The status information of the host ports can be obtained at any time.

The **HOST** command displays the current settings and status for each host port (Figure 3–5). It also displays a list of the users currently logged into the system. An unauthorized user is given the user name **Anonymous**.

The **PORT=X|ALL** parameter specifies the specific host port(s) (1 to 4) to be affected when used in combination with any of the other parameters: **ID** or **WWN**. The default is to apply changes to ALL host ports.

```
15000[1]: host
```

Host Infiniband Port Configuration							
Host Port	LID	Depth	MaxMsgSize	Timeout seconds	Current GUID	Rate(Gbps)	Port Status
1	7	64	4192	75	21000001FF0501DF	20.0	Good
2	2	64	4192	75	22000001FF0501DF	Link Down	Not connected
3	8	64	4192	75	23000001FF0501DF	20.0	Good
4	2	64	4192	75	24000001FF0501DF	Link Down	Not connected

Current Logins					
User	Port	Frame/MTU	S_ID/LID	World Wide Name	Login
Anonymous	1	2048	3	0002C9030001D59B	FRI SEP 12 17:55:17 2008
Anonymous	1	2048	4	0008F10403988589	FRI SEP 12 17:55:17 2008
Anonymous	1	2048	6	0008F10403988589	FRI SEP 12 17:56:34 2008
Anonymous	1	2048	5	0008F10403988172	FRI SEP 12 17:59:12 2008
Anonymous	3	2048	3	0002C9030001D59B	FRI SEP 12 17:55:22 2008
Anonymous	3	2048	4	0008F10403987CD6	FRI SEP 12 17:55:17 2008
Anonymous	3	2048	6	0008F10403988589	FRI SEP 12 17:56:34 2008
Anonymous	3	2048	5	0008F10403988172	FRI SEP 12 17:59:12 2008

Figure 3–5 IB Host Ports Configuration Screen

3.2.1.1 Host ID

HOST ID=<new ID> changes the hard loop ID of a host port. The system selects a soft ID if the hard loop ID is already taken by another device. This parameter is entered as an 8-bit hex value. The default value is EF.

Host WWN

HOST WWN=X|DEFAULT overrides the system ID and specifies a different World Wide Name (WWN) for a host port. This parameter is entered as an 64-bit hex value. Default WWN is based on the serial number of the unit.

3.2.1.2 Host Status

HOST STATUS displays the loop status of each host port (Figure 3–6).

HOST STATUSCLEAR resets the error counts.

```
15000[1]: host status
```

	Host Port IB Status			
	Port 1	Port 2	Port 3	Port 4
Symbol Errors	0	0	0	0
Link Err Recovery	0	0	0	0
Link Downed Count	2	0	1	0
Port Rcv Errors	1	0	0	0
Prt Rcv Remote Err	0	0	0	0
Prt Rcv Switch Err	0	0	0	0
Port Xmit Discards	2	0	1	0
Prt Xmit Const Err	0	0	0	0
Port Rcv Const Err	0	0	0	0
Local Link Int Err	0	0	0	0
Excess buff overrun	0	0	0	0
VL15 dropped	2	0	1	0
Port Xmit Data	4294967295	0	4294967295	0
Port Rcv Data	4294967295	0	4294967295	0
Port Xmit Pkts	4294967295	0	4294967295	0
Port Rcv Pkts	4294967295	0	4294967295	0

Figure 3–6 IB Host Ports Status Screen

3.2.1.3 Host IB Users

HOST ibusers displays additional information on the Infiniband (IB) users logged into the controller. (Figure 3–7).

```
15000[1]: host ibusers
```

Current Infiniband Logins							
User	Port	MTU	LID	Depth	MaxMsg	Node GUID	Login
Anonymous	1	2048	2	4	260	0002C90200253D81	FRI JUL 11 17:05:56 2008
Anonymous	2	2048	4	4	260	0002C90200253D2D	FRI JUL 11 17:05:56 2008

```
15000[1]:
```

Figure 3–7 Host IB Users Screen

3.2.1.4 Host Port Speed

HOST SPEED lets you display and change the port speed on the host port(s). You are prompted for the desired speed as well as for the choice of host port(s).

3.2.2 Configure and Monitor Status of Storage Assets

Disk and Channel Information

The **DISK** command displays the current disk configuration and the status of the ten disk channels (ABCDEFGHIPS) on the controller (Figure 3–8).

```

16000[1]: disk

Disk Channel Status

Channel A SAS 3.0 Gb - healthy.
Channel B SAS 3.0 Gb - healthy.
Channel C SAS 3.0 Gb - healthy.
Channel D SAS 3.0 Gb - healthy.
Channel E SAS 3.0 Gb - healthy.
Channel F SAS 3.0 Gb - healthy.
Channel G SAS 3.0 Gb - healthy.
Channel H SAS 3.0 Gb - healthy.
Channel P SAS 3.0 Gb - healthy.
Channel S SAS 3.0 Gb - healthy.

All disks are healthy.

Disk rebuild verify:           Disabled
Disk total command timeout:    68 seconds
Disk command abort/retry timeout: 31 seconds
Disk maximum commands:        16
Auto Reassign:                 Enabled
Write Same command:           Disabled

Disk commands outstanding: 0
    
```

Figure 3–8 Disk Channel Screen

If the channel status is “acquiring loop synchronization,” this may indicate a channel problem. Refer to 4.2.2, “Recovering from Drive Failures” for recovery information.

Entering **DISK INFO=<tier><channel>** retrieves information about a specific disk (tier, channel).

DISK LIST displays a list of the disks installed in the system and indicates how many were found.

DISK SCAN checks each disk channel in the system for any new disks and verifies that the existing disks are in the correct location. **DISK SCAN** also starts a rebuild operation on any failed disks which pass the disk diagnostics.

DISK STATUS displays the loop status of each disk channel and a count of the SAS errors encountered on each channel (Figure 3–9).

```

15000 [1]: disk status

Disk Channel Status

LUN      A  B  C  D  E  F  G  H  P  S
-----
InValDw:0 0  0  0  0  0  0  0  0  0  0
InValDw:1 0  0  0  0  0  0  0  0  0  0
InValDw:2 0  0  0  0  0  0  0  0  0  0
InValDw:3 0  0  0  0  0  0  0  0  0  0
LsDwSyn:0 0  0  0  0  0  0  0  0  0  0
LsDwSyn:1 0  0  0  0  0  0  0  0  0  0
LsDwSyn:2 0  0  0  0  0  0  0  0  0  0
LsDwSyn:3 0  0  0  0  0  0  0  0  0  0
PhyRst:0  0  0  0  0  0  0  0  0  0  0
PhyRst:1  0  0  0  0  0  0  0  0  0  0
PhyRst:2  0  0  0  0  0  0  0  0  0  0
PhyRst:3  0  0  0  0  0  0  0  0  0  0
RunDisp:0 0  0  0  0  0  0  0  0  0  0
RunDisp:1 0  0  0  0  0  0  0  0  0  0
RunDisp:2 0  0  0  0  0  0  0  0  0  0
RunDisp:3 0  0  0  0  0  0  0  0  0  0
Recovery  0  0  0  0  0  0  0  0  0  0
    
```

Figure 3–9 Disk Status Screen

DISK STATUSCLEAR=<tier><channel> resets the channel error counts.

DISK DEFECTLIST=<tier><channel> displays the defect list information for a specified disk. The tier is in the range of <1..125>. The channel is one of the following: **A**, **B**, **C**, **D**, **E**, **F**, **G**, **P**, or **S**. The list is classified into two types: **G** (Grown) and **P** (Permanent) (Figure 3–10).

The **G** list consists of the sectors that have become bad after the disk has left the factory and which can be added to at any time. The **P** list consists of the bad sectors that are found by the disk manufacturer .

```
15000[1]: disk defectlist=1a
Number of defects in P List = 2619
Number of defects in G List = 0
15000[1]:
```

Figure 3–10 Disk Defect List Screen

DISK FAIL=<tier><channel> instructs the system to fail the specified disk at the physical tier in the range of <1 ... 125> and channel in the range of <ABCDEFGHPS>. When a non-SPARE disk is specified and it is failing, the disk will not cause a multi-channel failure. The disk is marked as failed. An attempt is made to replace it with a spare disk. When a SPARE disk is specified and it is currently in use as a replacement for a failed disk, the disk that the spare is replacing is put back to a failed status and the spare is released, but marked as unhealthy and unavailable.

DISK PLS=<tier><channel> requests/displays the PHY Link Error Status Block information for the specified drive.

The disk is specified by its physical tier and channel locations, 'tc', where:

- 't' indicates the tier in the range <1..120>, and
- 'c' indicates the channel in the range <ABCDEFGHPS>.

If neither the tier nor the channel are specified, the PLS information is requested from all drives. If only the tier is specified, the PLS information is requested from all the drives on the specified tier.

Table 3–2 on page 37 shows the types of PHY errors. Note that SATA and SAS drives report PHY errors differently.

Table 3–2 PHY Link Error Status Block Information

SATA AAMUX PHY ERRORS	
H-RX	The number of SATA FIS CRC errors received on the host port of the AAMUX
H-TX	The number of SATA R_ERR primitives received on the host port indicating a problem with the transmitter of the AAMUX
H-Link	The number of times the PHY has lost link on the host port.
H-Disp	The number of frame errors for the host port of the AAMUX. These include: code error, disparity error, or realignment
O-RX	The number of SATA FIS CRC errors received on the other host port of the AAMUX
O-TX	The number of SATA R_ERR primitives received on the other host port indicating a problem with the transmitter of the AAMUX
O-Link	The number of times the PHY has lost link on the other host port.
O-Disp	The number of frame errors for the other host port of the AAMUX. These include: code error, disparity error, or realignment.
D-RX	The number of SATA FIS CRC errors received on the device port of the AAMUX
D-TX	The number of SATA R_ERR primitives received on the device port indicating a problem with the transmitter of the AAMUX.
D-Link	The number of times the PHY has lost link on the device port.
D-Disp	The number of frame errors for the device port of the AAMUX. These include: code error, disparity error, or realignment.
SAS PHY ERRORS	
InvDW	Invalid DWORD Count - The number of invalid dwords received outside of the PHY reset sequence.
RunDis	Running disparity Count - The number of dwords containing running disparity errors received outside of the PHY reset sequence
LDWSYN	Loss of DWORD synchronization count - The number of times the PHY has lost synchronization and restarted the link reset sequence
PHYRES	PHY Reset Problem count - The number of times the PHY reset sequence has failed.

NOTE : SATA drives have an Active/Active MUX (AAMUX) installed. Error counts are read directly from the AAMUX.

```

15000 [1]: disk pls

                Tier 1
                PHY Error Status Blocks
-----
Channel   A   B   C   D   E   F   G   H   P   S
-----
H-RX:    .   .   .   .   .   .   .   .   .   .
H-TX:    .   .   .   .   .   .   .   .   .   .
H-Link:   .   .   .   .   .   .   .   .   .   .
H-Disp:   .   .   .   .   .   .   .   .   .   .
O-RX:    .   .   .   .   .   .   .   .   .   .
O-TX:    .   .   .   .   .   .   .   .   .   .
O-Link:   .   .   .   .   .   .   .   .   .   .
O-Disp:   .   .   .   .   .   .   .   .   .   .
D-RX:    .   .   .   .   .   .   .   .   .   .
D-TX:    .   .   .   .   .   .   .   .   .   .
D-Link:   .   .   .   .   .   .   .   .   .   .
D-Disp:   .   .   .   .   .   .   .   .   .   .
InvDW:   0   0   0   0   0   0   0   0   0   0
RunDis:  0   0   0   0   0   0   0   0   0   0
LDWSYN:  0   0   0   0   0   0   0   0   0   0
PHYRES:  0   0   0   0   0   0   0   0   0   0

```

Figure 3–11 Disk PLS Tier 1 Status Screen

For other **DISK** parameters, see section 3.2.10 "Automatic Drive Rebuild" in this guide.

3.2.2.1 Tier View

Tiers (also known as RAID groups) are the basic building blocks of the controller. In an 8+1 mode, a tier contains 10 drives: eight (8) data drives (Channels **A** through **H**), one(1) parity drive (Channel **P**), and an optional spare drive (Channel **S**). In an 8+2 mode, a tier contains 10 drives, but the setup is different: eight (8) data drives (Channels **A** through **H**), and two (2) parity drives (Channel **P** and **S**). Drives that have the same SAS ID across all ten channels are put on the same tier. Tiers are automatically added to the system when the disks are detected. A tier will automatically be removed if it is not in use by any of the LUNs and all of the disks in the tier are removed or moved to another location.

Entering **TIER** lets you display the current status and configuration of the tiers in the system.

The tiers' total and available capacities are shown under the "Capacity" and "Space Available" columns respectively.

The **TIER** command shows the status of each disk on the tier as follows:

- A letter <**ABCDEFGHPS**> represents a healthy disk at that location.
- A space indicates that the disk is not present or detected.
- A period (.) denotes that the disk was failed by the system.
- The symbol "?" indicates that the disk has failed the diagnostic tests or is not configured correctly.
- The character "r" indicates that the disk was failed by the system and replaced by a spare disk.
- The symbol "!" indicates that the disk is in the wrong location.

NOTE : The rate of rebuild and format operations can be adjusted with the commands, **Tier Delay=x** and **Tier Extent=x**.

3.2.2.2 Tier Configuration

TIER CONFIG displays the detailed tier configuration information for all of the tiers (Figure 3–12).

```

15000[1]: tier config

Tier Configuration

Tier Owner  Total  Disk  Installed  Healthy  F  R  Sp Sp  Spare  Spare  Repl
            LUNs  Status  Disks     Disks    F  R  H  A  Owner  Used  Spare
            -----
1 +         0  ABCDEFGHPS ABCDEFGHPS ABCDEFGHPS      8+2 Mode no spares
2 +         0  ABCDEFGHPS ABCDEFGHPS ABCDEFGHPS      8+2 Mode no spares
3 +         0  ABCDEFGHPS ABCDEFGHPS ABCDEFGHPS      8+2 Mode no spares
4 +         0  ABCDEFGHPS ABCDEFGHPS ABCDEFGHPS      8+2 Mode no spares
121
*****
All disks are healthy.

Automatic disk rebuilding: Enabled
Automatic SMART replacement: Disabled

15000[1]:
    
```

Figure 3–12 Tier Configuration Screen

The headings for the **Tier Configuration** screen indicate the following values or conditions for the tiers.

Total LUNs lists the number of LUNs that currently reside on the tier.

NOTE : The health indication for the spare channel under the **'Healthy Disks'** heading is an indication of the health of the spare disk (if any) that is currently being used to replace a disk on the listed tier. The health indication for the spare channel that is physically on the listed tier is found under the **'Sp H'** heading.

These headings indicate the respective conditions on the tier.

- F** failed disk (if any).
- R** replaced disk (if any).
- Sp H** whether the spare disk that is physically on the tier is healthy.
- Sp A** whether the spare disk that is physically on the tier is available for use as a replacement.
- Spare Owner** current owner of the physical spare tier, where ownership is assigned when the spare is used as a replacement.
- Spare Used on** tier (if any) on which this physical spare is being used as a replacement.
- Repl Spare from** tier (if any) whose spare disk is being used as a replacement. Tiers are in 8+1 mode by default.

NOTE : **RES-#** will display under the **Spare Owner** heading while a replacement operation is underway to indicate that unit **'#'** currently has the spare reserved.

TIER CONFIG=ALL displays tier configuration and replacements for both 8+1 and 8+2 modes. (Figure 3–13).

```

15000[1]: tier config=all

Tier Configuration

Tier Owner Total Disk Installed Healthy F R Sp Sp Spare Spare Repl
         LUNs Status Disks Disks   F R  H A Owner  Used Spare
-----
1 + 1    1  ABCDEFGHFS ABCDEFGHFS ABCDEFGHFS      8+2 Mode no spares
2 + 2    1  ABCDEFGHFS ABCDEFGHFS ABCDEFGHFS      8+2 Mode no spares
3 s      0  ABCDEFGHFS ABCDEFGHFS ABCDEFGHFS      Ch Spares-See Below
4 + 2    1  ABCDEFGHFS ABCDEFGHFS ABCDEFGHFS      8+2 Mode no spares
5 + 1    1  ABCDEFGHFS ABCDEFGHFS ABCDEFGHFS      8+2 Mode no spares
6 + 2    1  ABCDEFGHFS ABCDEFGHFS ABCDEFGHFS      8+2 Mode no spares
7 + 1    1  ABCDEFGHFS ABCDEFGHFS ABCDEFGHFS      8+2 Mode no spares
8 + 2    1  ABCDEFGHFS ABCDEFGHFS ABCDEFGHFS      8+2 Mode no spares
121     *****

Channel Spares Configuration

Ch  Sp Sp Spare Spare
Spares H A Owner Replaces
-----
3A  Y Y
3B  Y N 1 1B
3C  Y Y
3D  Y Y
3E  Y Y
3F  Y Y
3G  Y Y
3H  Y Y
3P  Y Y
3S  Y Y

Disk 1B Failed. Replaced by 3B.

Automatic disk rebuilding: Enabled
Automatic SMART replacement: Enabled

Other unit host busy: 0.
Other unit disk busy: 0.

15000[1]:

```

Figure 3-13 Tier Configuration ALL Screen

3.2.2.3 LUN View

Entering the **LUN** command displays the current status of the LUNs (

). “Ready” indicates that the LUN is in good condition. The percentage of completion is displayed if the LUN is being formatted or rebuilt. A status of “Unavailable” may result from multiple drive failures. “Ready [GHS]” indicates that a spare drive has been successfully swapped for one of the drives the tier.

```

15000 [1]: lun

Logical Unit Status

LUN Label Owner Status Capacity Block Tiers Tier List
      (Mbytes) Size
-----
0  vol1 1 Ready [GHS] 10002 512 1 1
1  vol2 1 Ready 10002 512 1 2
2  vol3 1 Ready 10002 512 1 3
3  vol4 1 Format 14% 10002 512 1 4

System Capacity 2240096 Mbytes, 2200088 Mbytes available.

```

Figure 3-14 LUN Status Screen

LUN LIST displays a list of all valid LUNs in the system. The list shows the capacity, owner, status, and serial number of each LUN (Figure 3-15).

```
15000 [1]: lun list
```

Logical Unit Status						
LUN	Label	Owner	Status	Capacity (Mbytes)	Serial Number	
0	vol1	1	Ready [GHS]	10002	00015A1300A7	
1	vol2	1	Ready	10002	0001A28101A7	
2	vol3	1	Ready	10002	0001A29A03A7	
3	vol4	1	Ready	10002	0001A2b10400	

System Capacity 2240096 Mbytes, 2200088 Mbytes available.

Figure 3–15 LUN List Screen

3.2.2.4 LUN Configuration

LUN CONFIG displays the configuration information for all the valid LUNs in the system (Figure 3–16).

```
15000 [1]: lun config
```

Logical Unit Configuration						
LUN	Capacity (Blocks)	Block Size	LUN Offset	Tier Start	Tier End	Tier List
0	1000000	512	0	0	1FFFFFF	1 2
1	2000000	512	0	200000	2FFFFFF	1 2 3 4
1.00	1000000	512	0	200000	27FFFF	
1.01	1000000	512	1000000	280000	2FFFFFF	

Figure 3–16 LUN Configuration Screen

3.2.2.5 LUN Reservations

LUN RESERVATIONS displays a list of all valid LUNs in the system and shows which LUNs currently have a SCSI reservation and which initiator holds the reservation (Figure 3–17).

LUN RELEASE releases any SCSI reservations and registrations on a LUN.

```
15000 [1]: lun reservations
```

Current SCSI LUN Reservations					
LUN	Label	Status	Reservation ID	Port	User Name
0		Ready	No SCSI Reservations		
1		Ready	No SCSI Reservations		
2		Ready	No SCSI Reservations		

Figure 3–17 LUN Reservations Screen

3.2.2.6 Adding/Removing Storage Assets

The controller supports up to 120 tiers. New tiers can be added without affecting system operations.

DISK SCAN checks each disk channel in the system for any new disks. New tiers are automatically added to the system when the disks are detected. A tier is automatically deleted if it is not in use by any of the LUNs and all of the disks in the tier are removed or moved to another location.

3.2.2.7 Status of Drive Enclosures

The **SES** command displays the failures reported by the enclosure (Figure 3–18), through the *SCSI Enclosure Services* (SES). It also provides a means to access SES specific functions such as disk, channel, and LUN. Drive failures are not displayed using the SES command; you must use the **TIER** command to view drive status.

```
15000 [1]: ses
EncID:50050CC0000033C8: Power Supply 1:DC Power Failure
```

Figure 3–18 Displaying the Current Disk Enclosure Failures

If your enclosures provide redundant SES communication paths, the error is reported twice. In Figure 3–18, **EncID** is the **Enclosure Logical Identifier** of the enclosure that reported the failure. The last four digits of the WWN are the last four digits of the enclosure’s serial number.

SES ON saves the SES state to the parameter blocks, and starts up the SES monitors.

SES OFF saves the SES state to the parameter blocks, and shuts down the SES monitors.

3.2.2.8 Display SES Devices Information

SES SHOWDEVICES displays all the SES devices on all channels.

SES SHOWALL displays all configuration information for all the SES devices on all channels.

SES SHOW=<tier><channel> displays the configuration information and the status information returned from an SES Enclosure Status page for the SES device for the specified drive in the range of <1..120> and <ABCDEFGHPS>.

3.2.2.9 Visual Indication of Drive

SES IDDISK=<tier><channel> provides a visual indication of the specified drive (<1..120><ABCDEFGHPS>). The status LED of the drive blinks until the command **SES ID=OFF** is issued. The **SES ID=OFF** command restores the system to its original visual state.

3.2.2.10 Visual Indication of Tier

SES IDTIER=<tier> provides a visual indication of the specified tier <1..125>. The status LED of the drives blinks until the command **SES ID=OFF** is issued, which restores the system to its original visual state.

3.2.2.11 Visual Indication of Channel

SES IDCHANNEL=<channel> provides a visual indication of the specified channel <ABCDEFGHPS>. The status LED of the drives blinks until the command **SES ID=OFF** is issued, which restores the system to its original visual state.

3.2.3 Tier Mapping for Enclosures

The controller supports various drive enclosures. When the system is first configured, it is necessary to select a tier mapping mode so that the position of the tiers in the system are changed to conform with the layout of your drive enclosures. The tier mapping information also allows the controller to properly light the enclosure fault LEDs.

TIER MAP displays the current mapping mode for the disks in the array.

TIER CHANGEMAP changes the current tier mapping for the disks in the array. To change the current tier mapping, do the following:

1. Enter: **tier changemap**<Enter>
2. Select the appropriate mapping mode for your drive enclosures and press <Enter>.
3. For the changes to take effect, enter: **restart**<Enter>.

NOTE : The **CHANGEMAP** command should only be used when the system is first configured. Changing the mapping mode will alter all the tier information, making LUN information inaccessible.

3.2.4 System Network Configuration

These commands do the following:

NETWORK displays the current network interface settings.

NETWORK USAGE displays the address resolution protocol map, ICMP (ping), general network, and IP, TCP, and UDP layer statistics.

NETWORK IP=<new address> changes the IP address. (The system must be restarted before the changes will take effect).

NETWORK NETMASK=<aaa.bbb.ccc.ddd> changes the netmask.

NETWORK GATEWAY=<aaa.bbb.ccc.ddd> sets the current gateway in the network routing table to the supplied Internet address. The gateway is where IP datagrams are routed when there is no specific routing table entry available for the destination IP network or host.

NOTE : **GATEWAY=<no Internet address>** clears out the current gateway.

NETWORK PRIVATE displays the MAC address for the private network device.

3.2.4.1 Telnet

NETWORK TELNET=ON|OFF enables/disables the Telnet capability on the controller. The system must be restarted before the changes will take effect.

NOTE : To only temporarily affect Telnet session availability during a concurrent power-cycle, refer to the TELNET command in Section 3.6 "Remote Login Management" in this guide.

NOTE : Telnet connections are "clear text." If Telnet connections are used, you may expose controller passwords to third parties. For greater security, turn off Telnet access if it is not required.

NETWORK TELNETPORT=<port number> changes the Telnet port number for the current controller. The system must be restarted before the changes will take effect. Valid port numbers are **0** to **32768**; however, the results may be unpredictable if the port number chosen is already in use (on this unit) by either the GUI or SYSLOG facilities. The default port number is **23**.

3.2.4.2 SNMP & Syslog

NETWORK SNMP=ON|OFF enables and disables the SNMP functionality. The system must be restarted before the changes will take effect.

NETWORK LIMIT_SNMP=ON|OFF specifies whether the SNMP functionality will only report component-level information, or all levels of information, The default setting is **OFF**.

NETWORK TRAPIP=<aaa.bbb.ccc.ddd> changes the destination IP address for SNMP trap packets. The system must be restarted before the changes will take effect.

NETWORK SYSLOG=ON|OFF enables and disables the Syslog capability.

NOTE : **NETWORK SYSLOG** should be enabled , since it is the best way to find out what occurred in the event of a problem. However, since some problems can produce a large amount of output, it is a good idea to have your **syslog** program configured to rotate based on log size rather than date.

NETWORK SYSLOGIP=<aaa.bbb.ccc.ddd> changes the destination IP address for syslog packets, Both controllers in the couplet pair will share the same syslog destination IP address but each controller can specify a different destination port.

NETWORK SYSLOGPORT=<port number> changes the destination port number for syslog packets for the current controller. Both controllers in the couplet pair will share the same syslog destination IP address but each controller can specify a different destination port. Valid ports are **0** to **32768**. However the results may be unpredictable if the port number chosen is already in use (on this unit) by the TELNET facilities. Default port number is **514**.

NOTE : The controller sends syslog messages via the local 7 (23) facility.

Refer to Chapter 4, "Controller Remote Management and Troubleshooting" in this guide for information on how to set up Telnet and SNMP functionality on your host computer.

3.2.4.3 API Server Connections

NETWORK API_SERVER=ON|OFF enables/disables the API server capability. The system must be restarted before the changes will take effect.

NOTE : To affect the API Server connection availability only temporarily during the current power-cycle, see Section 3.8.2, "API Server Connections".

NETWORK API_PORT=<port number> specifies the API Server port number for the current controller. The system must be restarted before the changes will take effect. Valid ports are 0 to 32768. The results may be unpredictable if the port number chosen is already in use (on this unit) by either the TELNET or SYSLOG facilities. The default port number is 8008.

3.2.4.4 Displaying and Editing the Routing Table

The **ROUTE** command displays the current routing table of the system (Figure 3–19) and allows the administrator to change it. The routing table describes how the controller can communicate with the hosts on other networks.

```

15000 [1]: route
Gateway 172.16.0.254
Permanent Routing Table:
=====
destination    gateway
-----
0.0.0.0        172.16.0.254
-----

Current Routing Tables:
=====

ROUTE NET TABLE
destination    gateway    flags    Refcnt    Use    Interface
-----
0.0.0.0        172.16.0.254    3        0        46569    fei0
172.16.0.0     172.16.0.1     101      0        3        fei0
192.168.0.0    172.13.0.254   3        0        1        fei0
-----

ROUTE HOST TABLE
destination    gateway    flags    Refcnt    Use    Interface
-----
127.0.0.1     127.0.0.1     5        1        2        100
-----

```

Figure 3–19 Routing Table

ROUTE ADD=<aaa.bbb.ccc.ddd> GATEWAY=<aaa.bbb.ccc.ddd> adds gateways to the routing table. Up to 6 permanent routes can be added to the tables. For example, to indicate that the machine with Internet address 91.0.0.3 is the gateway to the destination network 90.0.0.0, enter: **ROUTE ADD=90.0.0.0 GATEWAY=91.0.0.3**

ROUTE DEL=<aaa.bbb.ccc.ddd> GATEWAY=<aaa.bbb.ccc.ddd> deletes gateways from the routing table.

ROUTE GATEWAY=<aaa.bbb.ccc.ddd> sets the current gateway in the network routing table to the specified Internet address. The gateway is where IP datagrams are routed when there is no specific routing table entry available for the destination IP network or host. If an empty gateway value is provided, then the current gateway is cleared.

3.2.5 Restarting the Controller

3.2.5.1 System Restart

RESTART performs a restart on the controller on which the command is issued. This command prepares the system to be restarted. The system halts all I/O requests and saves the data to the disks before restarting. The restart process may take several minutes to complete.

NOTE : If cache coherency is enabled, restarting a controller unit will cause the partner controller to fail the restarting unit. Once the reboot is complete, you will have to heal the controller unit.

RESTART DELAY=X (where “X” is minutes) delays a restart of a unit between 0 and 255 minutes.

RESTART DUAL restarts both units.

RESTART KILL stops a timed restart that is in progress.

3.2.5.2 System Shutdown

SHUTDOWN shuts down the controller unit.

If you need to power down the controller, use **SHUTDOWN** prior to shutting off power. This will cause the controller to flush its cache, abort all format and rebuild operations, and proceed with an orderly shutdown.

All hosts actively using the controller should be safely shutdown and all users logged out before using this command. The controller will halt all I/O requests and save the data to the disks.

NOTE : Use **SHUTDOWN** whenever you power down the controller for maintenance. **SHUTDOWN** flushes any data left in the cache and prepares the controller for an orderly shutdown. For couplet controller configuration, issue **SHUTDOWN** to both controllers.

To perform a hard restart of the unit by cycling the power, use: **SHUTDOWN RESTART=X**, where X is a value between 1 and 1023 seconds before the unit powers up again. If the number is not specified, the default is 15 seconds.

NOTE : If **SHUTDOWN RESTART** is used in conjunction with the **DUAL** parameter, the restart will only affect unit where it was issued on and not both.

SHUTDOWN DELAY=X delays a shutdown of a unit between 0 and 255 minutes (where x is minutes delayed).

SHUTDOWN DUAL shutdowns both units.

SHUTDOWN KILL stops a timed shutdown that is in progress.

3.2.6 Setting the System's Date and Time

Valid date settings are between years 2000 and 2104. In dual mode, settings should always be done on Unit 1. Changes will automatically be applied to both units. Settings are automatically adjusted for leap years.

3.2.6.1 System Date

DATE displays the current system date.

You can also change the system date. At the prompt, type:

date mm dd yyyy <Enter>

where **mm** represents the two digit value for month, **dd** represents the two digit value for day, and **yyyy** represents the four digit value for year.

For example, to change the date to March 14, 2009, type:

date 03 14 2009<Enter>.

3.2.6.2 System Time

TIME displays the current system time.

You can also change the system time. At the prompt, type:

```
time hh:mm:ss<Enter>
```

where **hh** represents the two digit value for hour (00 to 24), **mm** represents the two digit value for minutes, and **ss** represents the two digit value for seconds.

For example, to change the system time to **2:15:32 p.m.**, type:

```
time 14:15:32<Enter>
```

NOTE : The system records time using the military method, which records hours from 00 to 24, not in a.m. and p.m. increments of 1 to 12.

3.2.7 Saving the Controller's Configuration

The **SAVE** command can be used to save the system configuration to non-volatile memory (Figure 3–20).

```
15000 [1]: save
Saving system parameters. Done.
```

Figure 3–20 Saving System Parameters Screen

Backup copies of the system configuration are also saved on the disks. The system will automatically save and update the backup copies when changes are made to the system configuration or status.

The **SAVE STATUS** command, in addition to saving the parameter blocks to non-volatile memory and on the disks, displays the current status of the system parameters (Figure 3–21).

```
15000 [1]: save status

          System Parameters Status
PB      Revision  Updates  Last Update
Number
  0         200      6149    14:40:54 07/30/2008
  1         200         3    10:46:49 07/28/2008
  2         200     3395    10:46:49 07/28/2008
  3         200         1     00:00:01 01/01/1970

15000 [1]:
```

Figure 3–21 Current System Parameters Status Screen

Normally, the system must determine which copy of the parameter blocks is more recent, the one on the disks or the internal copy. When the system reboots, it will load the more recent copy.

3.2.8 Restoring the System's Default Configuration

The **DEFAULTS** command may be used to restore the system to its default configuration.



The DEFAULT command will delete all LUN configuration and data unconditionally. Do not issue this command without guidance from SGI.

The system will halt all I/O requests, delete all the LUNs and restore all the parameters back to their default values. This is a **destructive** operation which will delete all the data stored in the system.

The system will ask if you want to erase all the configuration information stored on the disks. This will prevent the system from retrieving the backup copies of the configuration settings from the disks after the system is restarted. After the default settings have been loaded, the system will ask if you want to begin reconfiguration by scanning for the disks. New LUNs can be created after the disks have been added back to the system.

3.2.9 LUN Management

The controller creates centrally-managed and vendor-independent storage pooling. It enables different types of storage to be aggregated into a single logical storage resource from which virtual volumes (LUNs) can be served up to multi-vendor host computers. The networked storage pools will provide the framework to manage the growth in storage demand from web-based applications, database growth, network data-intensive applications, and disaster tolerance capabilities.

3.2.9.1 Configuring the Storage Array

The storage array may consist of up to 120 tiers, depending on individual disk enclosure's numbering scheme. The tiers can be combined, used individually, or split into multiple LUNs. A LUN can be as small as part of a tier or as big as the whole system. LUNs can be shared or dedicated to individual users. Up to 1024 LUNs are supported in total. LUNs are "owned" by the controller via which they are created.

You can add and remove LUNs without affecting system operations. Use the **LUN** command to display the current Logical Unit Status (Figure 3–22).

NOTE : In dual mode, LUNs will be "owned" by the controller unit on which they are created. Hosts will only see the LUNs on the controller to which they are connected, unless cache coherency is used.

```
15000[1]: lun
                                     Logical Unit Status
-----
LUN Label      Owner Status      Capacity Block
(Mbytes)      Size Tiers Tier list
-----
System verify extent: 16 Mbytes
System verify delay: 30

System Capacity 9082544 Mbytes, 9082544 Mbytes available.

15000[1]:
```

Figure 3–22 Logical Unit Status Screen

3.2.9.2 Creating a LUN

LUNs can be added to the system based on two commands.

To add a 32-bit LUN that will not exceed 2 TB, type:

```
lun add=X<Enter>
```

To add a 64-bit LUN, that exceeds 2 TB:

```
lun add64=X<Enter>
```

For both cases, “X” is the Logical Unit with a range of <0..1023>.

For either case, the system prompts you for all the necessary information to create the LUN and indicates if the LUN was successfully added to the system.

The required LUN information includes:

- **Capacity** (in MBytes) - default is to use all available capacity
- **Number of tiers** - default is to use all tiers
- **Block size** (in Bytes) - default is 512Bytes
- **Label** - may contain up to 12 characters

3.2.9.3 Formatting a LUN

A LUN must be formatted before it can be used.

To format a LUN, use **LUN FORMAT**. Specify the LUN <0..1023> when prompted. This performs a destructive initialization on the specified LUN by over-writing all the data on the LUN with zeroes.

The rate of format can be adjusted using the **DELAY** and **EXTENT** parameters of the **LUN** command.

3.2.9.4 Interrupting a LUN Format Operation

If you need to interrupt a format operation, for any reason, use these commands:

- **LUN PAUSE** pauses the current format operations.
- **LUN RESUME** releases the paused format operations.
- **LUN STOP** aborts all the current format operations.

3.2.9.5 Changing a LUN Label

To change the label of a LUN:

1. Type:

```
lun label <Enter>.
```

2. Select the LUN to change <0..1023> and press Enter.
3. Type in the new label and press Enter. A LUN label may contain up to 12 characters (Figure 3–23).

```

15000 [1]: lun label

Enter the LUN to label (0..1023), 'e' to exit:
0

Enter a new label for LUN 0, up to 12 characters:
voll

          Logical Unit Status
LUN  Label  Owner  Status  Capacity  Block  Tiers  Tier List
          (Mbytes)  Size
-----
0     voll   1     Ready [GHS]  10002  512    1     1
1     2     2     Ready        10002  512    1     2
2     1     1     Ready        10002  512    1     3
3     2     2     Ready        10002  512    1     4

          System Capacity 277810 Mbytes, 237802 Mbytes available.

```

Figure 3–23 Changing a LUN Label Screen

3.2.9.6 Moving a LUN (Dual Mode Only)

To change the ownership of a LUN from one controller to its partner (when the units are in dual mode), enter:

lun move=x <Enter>

where **x** is the Logical Unit number <0..1023> (Figure 3–24). If a LUN is on a tier that is shared by other LUNs, the controller will prompt and then move the other dependent LUNs as well.

```

15000 [1]: lun move=0

LUN 0 is owned by this 15000.

Do you want to move ownership to the OTHER 15000? (y/n):

```

Figure 3–24 Moving a LUN

3.2.9.7 Deleting a LUN

LUN DEL=x (where “x” is the LUN <0..1023>) deletes a LUN from the system. You can only delete a LUN that is owned by the controller unit onto which you are logged.

SCSI Reservations

LUN RELEASE=x allows you to release all SCSI reservations on a LUN. The command **LUN RESERVATIONS** can be used to view the current SCSI reservations on all of the LUNs in the system. The LUN to be released can be specified by “x” where “x” is in the range <0..1023>.

LUN START lets you start all the LUNs that have been stopped by a SCSI START/STOP request. This parameter is not related to the **LUN STOP** command.

3.2.10 Automatic Drive Rebuild

The controller’s automatic drive failure recovery procedures ensure that absolute data integrity is maintained while operating in degraded mode. In the event of a drive failure, the controller will automatically initiate a drive rebuild using a spare drive if the “autorebuild” function has been enabled.

Use the **TIER** command to display the current setting (Figure 3–25). The rebuild operation can take up to several hours to complete, depending on the size of the disk and rate of rebuild.

```
15000 [1]: tier
```

Tier Status					
Tier	Owner	Capacity (Mbytes)	Space Available (Mbytes)	Disk Status	Lun List
1		280012	280012	ABCDEFGHPS	
2		280012	280012	ABCDEFGHPS	
3		280012	280012	ABCDEFGHPS	

Automatic disk rebuilding is Enabled
System rebuild extent: 32 Mbytes
System rebuild delay: 60

System Capacity 840036 Mbytes, 840036 Mbytes available.

Figure 3–25 Automatic Disk Rebuilding Parameter

TIER AUTOREBUILD=ON|OFF enables/disables the automatic disk rebuild function. A disk will only be replaced by a spare disk if it fails and Autorebuild is **ON** (ON being the default setting). This function should always be enabled so that data can be reconstructed on the spare drive when a drive failure occurs. After the failed drive is replaced, data will be automatically copied from the spare drive to the replacement drive.

3.2.10.1 Manual Drive Rebuild

DISK REBUILD=<tier><channel> initiates a rebuild on a specific drive. This operation will reconstruct data on the replacement drive and restore a degraded LUN to healthy status.

3.2.10.2 Drive Rebuild Verify

DISK REBUILDVERIFY=ON|OFF determines if the system will send **SCSI Write with Verify** commands to the disks when rebuilding failed disks. This feature is used to guarantee that the data on the disks is rebuilt correctly. Default is OFF. This feature will increase the time it takes for rebuilds to complete.

3.2.10.3 Manual Drive Replace

To replace the specified failed drive with a spare drive, enter: **DISK REPLACE=<tier><channel>**

A Replace operation is used to temporarily replace a failed disk with a healthy spare disk.

3.2.10.4 Interrupting a Rebuild Operation

To interrupt a Rebuild operation, use these commands:

- **TIER PAUSE** pauses the current rebuild operations.
- **TIER RESUME** releases the paused rebuild operations.
- **TIER STOP** aborts all the current rebuild operations.

3.2.11 SMART Command

Use the **SMART** command to identify failing drives before they fail.

SMART ENABLE enables SMART on all the disk drives installed in the system and updates the parameter blocks on the disk. This enables the Information Exception and the Temperature warnings. However, the user can skip the update part and enter SMART DISKUPDATE later to write the parameter blocks to the disks.

SMART DISABLE disables SMART on all the disk drives installed in the system and updates the parameter blocks on the disk. However, the user can skip the update part and call and enter SMART DISKUPDATE later to write the parameter blocks to the disks.

SMART STATUS displays the SMART ENABLE status of a specified disk. The disk is specified by its physical tier and channel locations, 'tc', where:

- 't' indicates the tier in the range <1..125>
- 'c' indicates the channel in the range <ABCDEFGHPS>.

Displays the Information Exception and the Temperature warnings if enabled for a specified disk; (i.e. SMART ENABLE).

SMART UPDATE updates the parameter blocks that correspond to the SMART configuration.

SMART DATA=tc displays the SELF TEST log. Also reads and displays the SMART information of the specified disk. The disk is specified by its physical tier and channel locations, 'tc', where:

- 't' indicates the tier in the range <1..125>
- 'c' indicates the channel in the range <ABCDEFGHPS>.

SMART SELFTEST=tc|testtype starts a specified self test on a specified hard disk. The disk is specified by its physical tier and channel locations, 'tc', where:

- 't' indicates the tier in the range <1..125>
- 'c' indicates the channel in the range <ABCDEFGHPS>.

There are 3 tests to choose from: default test, Background short test, and Background long test. All the tests are supported on the SAS drives, while only the Background short test is supported on the SATA drives.

SMART ABORTSELFTEST=tc aborts a self test that has been launched using the SMART SELFTEST command. The abort event will be logged to the self test log.

The disk is specified by its physical tier and channel locations, 'tc', where:

- 't' indicates the tier in the range <1..125>
- 'c' indicates the channel in the range <ABCDEFGHPS>.

SMART ABORTSELFTEST=ALL. This command only works for SAS disks. Aborts background self tests on all disks.

SMART CLEAR=tc|all Clears SMART trips on specified drives or all drives.

- 't' indicates the tier in the range <1..125>
- 'c' indicates the channel in the range <ABCDEFGHPS >
- 'ALL' indicates all drives.

SMART LOG=tc|ALL reads the self test log from the specified disk and displays it.

- 't' indicates the tier in the range <1..125>
- 'c' indicates the channel in the range <ABCDEFGHPS>.

SMART TEST=ON enables the test bit in the Information exception mode page for all the disks installed. Setting the test bit simulates a FALSE SMART trip condition which raises a FALSE check condition to the controller. Currently, this parameter is valid only with Fibre Channel disks.

SMART TEST=OFF disables the test bit in the Information exception mode page for all the disks installed.

SMART INTERVALTIME displays the interval (in hours) in which the SMART Information will be polled.

SMART INTERVALTIME=h sets the interval (in hours) that SMART Information polling will occur. 'h' indicates the interval in hours in the range <1..24>.

3.2.12 Couplet Controller Configuration (Cache/Non-Cache Coherent)

There are two primary couplet controller configurations: **cache coherent** and **non-cache coherent**.

The **DUAL** command displays information about couplet system configuration (Figure 3–26).

```

15000 [1]: dual

                                Dual Unit Configuration
                                -----
                                Unit 1                               Unit 2
                                -----
Label                          15000[1]                          15000 [2]
Status                          Healthy                            Healthy

Dual communication:          established.
Ethernet communication:     established.
Cache coherency:             not enabled.
Cache coherency timeout:    0

15000 [1]:

```

Figure 3–26 Couplet Controller Configuration

3.2.12.1 Cache Coherent

In this configuration, each controller can access all LUNs. The couplet controller communication occurs over the internal **UART** and private Ethernet. If the controllers detect an Ethernet failure, controller 2 will be failed. (This means that an external event can cause a controller to fail even though the controller may be perfectly fine.) Therefore, it is mandatory that the controller Ethernet resides on a private Ethernet segment.

NOTE : Data cache is not copied from one controller to another. If a controller fails, all “dirty” data in cache will be lost. Thus if power failures are a concern, writeback cache should be disabled.

Non-Cache Coherent

In this configuration, the couplet controller communication occurs over the internal **UART**. Each controller owns LUNs and tiers. Spare drives are “owned” by individual controller units, according to tier ownership.

In healthy situations, the controller cannot access LUNs or tiers owned by the other controller. However, if the other controller is failed, the healthy controller will have access to all LUNs and tiers.

Users, via mapping, can be assigned any combination of LUNs. In a healthy environment, users will only see LUNs owned by the controller to which they are connected.

For example, a user is given access to internal LUNs 5, 6, and 7, which are mapped to external LUNs 0, 1, and 2, respectively. controller 1 owns LUNs 0 and 1 while controller 2 owns LUN 2. The user is physically connected to controller 1, thus, they will only see LUNs 0 and 1. The user will not be able to access LUN 2. If the user was physically connected to controller Unit 2, the reverse would be true: only LUN 2 would be accessible. When a controller fails, the user will be given access to all mapped LUNs regardless of the physical connection.

Data cache is not copied from one controller to another. If a controller fails, all “dirty” data in cache will be lost. Thus if power failures are a concern, writeback cache should be disabled.

DUAL COHERENCY=ON|OFF enables/disables the cache coherency function. Default is dual coherency disabled which is the non-cache coherent configuration.

DUAL TIMEOUT=X allows you to set the cache coherency timeout for cache node requests in seconds. Valid range is <0...255>. Default is zero (0) seconds. The timeout value should be less than the host timeout value (**HOST TIMEOUT=X**). A timeout value of **0** allows for only one retry.

NOTE : In dual mode, LUNs will be “owned” by the controller unit on which they are created. Hosts will only see the LUNs on the controller to which they are connected, unless cache coherency is enabled.

3.2.12.2 Fail / Restore the Other Controller Unit in the Couplet Pair

To fail the other controller unit in the system (for example, in order to perform maintenance), enter:

dual fail <Enter>

The healthy controller unit will take ownership of all the LUNs/tiers from the failed controller unit.

To restore the other controller unit in the system to healthy status after failure recovery, enter:

dual heal <Enter>

Ownership of LUNs/tiers are transferred back to the formerly failed controller unit.

3.2.12.3 Labeling the Controller Unit(s)

You may change the label assigned to each controller unit. This allows you to uniquely identify each unit in the controller system. The CLI prompt for each controller is built by adding a colon (:) and a space at the end of the label. Each controller can have a label up to 31 characters long.

To change the label:

1. Type: **dual label=1|2** <Enter>.
2. Select which unit you want to rename (Figure 3–27).
3. When prompted, type in the new label for the selected unit. The new name is displayed.

NOTE : If you type **DEFAULT** for the new label, the label for the unit is restored to its default setting.

```

15000 [1]: dual label

Enter the number of the unit you wish to rename.
  LABEL=1 for unit 1, Test System[1]
  LABEL=2 for unit 2, Test System[2]

unit: 1
Enter a new label for unit 1, or DEFAULT to return to the default label.
Up to 31 characters are permitted.
Current unit name: Test System[1]
New unit name: System[1]

```

Figure 3–27 Labeling a Controller Unit

3.2.12.4 Singlet

The **DUAL SINGLET** command sets the system in the singlet mode. System recognizes only Unit 1. This command:

- disables cache coherency
- heals unit 1 if it is failed
- fails unit 2 before attempting to remove it.

To set the system in singlet mode not couplet mode, type: **dual singlet**<Enter>.

NOTE : The system may automatically add unit 2 if it is connected to the system. Therefore, we advise you to power off and remove unit 2 from the system after the **Dual Singlet** command is completed.

3.3 Performance Management

The controller optimizes performance operations due to its extensive monitoring and reporting capability.

3.3.1 Optimizing I/O Request Patterns

The controller manages pre-fetch and cache efficiency through the LUN.

Display Current Cache Settings

The **CACHE** command displays the current cache settings for each LUN in the system(Figure 3–28).

```

15000 [1]: cache
                                Current Cache Settings
                                -----
                                Write   Maximum   MF       Prefetch
                                Caching Prefetch  Bit      Ceiling
                                -----
                                0      Enabled   x1       On       65535
                                1      Enabled   x1       On       65535
                                2      Enabled   x1       On       65535
                                3      Enabled   x1       On       65535
writeback limit: 75%
                                640.0 Mbytes of Cache Installed

```

Figure 3–28 Cache Setting Screen

You can use the **LUN=x** option to specify which LUN to change. If no LUN is specified, changes will be applied to all the LUNs. Valid LUN values are 0 to 1023. The default value will apply changes to all LUNs.

3.3.1.1 Cache Segment Size

A large cache segment size may give better performance for large I/O requests and a small cache segment size may give better performance for small I/O requests. For optimal performance, the cache segment size should be larger than the average host I/O request size. You may use the **STATS LENGTH** command to determine the average host I/O request size. The cache segment size should not be changed during heavy I/O conditions because the system will temporarily halt all I/O requests while the changes are taking effect.

Use the **CACHE SIZE=x** command to set the cache segment size for the specified LUN in kilobytes (kbs). Valid segment sizes are 128, 256, 512, 1024, and 2048 kilobytes (kbs). The default value is 1024. This command should not be issued under heavy I/O conditions because the system will momentarily halt all I/O requests while the changes are taking effect.

3.3.1.2 Writeback Cache Settings

Writeback caching allows the system to increase the performance of handling write I/O requests by storing the data in cache and saving the data to the disks at a later time.

CACHE WRITEBACK=ON|OFF enables or disables writeback caching for the specified LUN. Default setting is ON.

CACHE WRITELIMIT=x specifies the maximum percentage of the cache that can be used for writeback caching. The system will force all writeback requests to be flushed to the disks immediately if the percentage of writeback data in the cache exceeds this value. Valid range is <0...100>. Default value is 75.

3.3.1.3 Prefetch Settings

When the system receives a request, it can read more data than has been requested. **PREFETCH** tells the system how much data to look ahead. This will improve performance if your system needs to perform sequential reads. For random I/O applications, however, use the smallest prefetch value.

CACHE PREFETCH=x sets the prefetch that will occur on read commands for the specified LUN. Valid range is 0 to 65535. Default setting is 1.

If the **MF** (Multiplication Factor) parameter is **OFF**, the system will only prefetch the number of blocks specified by **PREFETCH** after every read command. If the MF parameter is **ON**, then the system will multiply the transfer length of the command by the prefetch value to determine how much data will be prefetched. A prefetch value of less than 8 is recommended when the **MF** parameter is **ON**.

CACHE MF=ON|OFF enables/disables the MF bit on the specified LUN. Default is ON.

The **Maximum Prefetch Ceiling** parameter sets the maximum prefetch ceiling in blocks for prefetches on read commands. It sets an upper limit on prefetching when the MF parameter is ON. The system will automatically limit the amount of prefetching if the system is running low on resources.

CACHE MAX=x (where X is a range from 0...65535) sets the maximum prefetch ceiling in blocks for prefetches on Read commands for the specified LUN. Valid range is 0 to 65535. Default setting is 65535.

3.3.1.4 Cache Settings Reset

CACHE DEFAULTS loads the default settings for all of the cache parameters for the specified LUNs.

Disk Configuration Settings

The **DISK** command displays the current disk configuration settings (Figure 3–29).

```

15000 [2]: disk
Disk Channel Status
Channel A SAS 3.0 Gb - healthy.
Channel B SAS 3.0 Gb - healthy.
Channel C SAS 3.0 Gb - healthy.
Channel D SAS 3.0 Gb - healthy.
Channel E SAS 3.0 Gb - healthy.
Channel F SAS 3.0 Gb - healthy.
Channel G SAS 3.0 Gb - healthy.
Channel H SAS 3.0 Gb - healthy.
Channel P SAS 3.0 Gb - healthy.
Channel S SAS 3.0 Gb - healthy.

All disks are healthy.

Disk rebuild verify:           Disabled
Disk total command timeout:    68 seconds
Disk command abort/retry timeout: 31 seconds
Disk maximum commands:        16
Auto Reassign:                 Enabled
Write Same command:            Disabled

Disk commands outstanding: 0

15000 [2]:

```

Figure 3–29 Disk Configuration Setting Screen

The **writeback cache** and **disk timeout** settings can be configured manually.

DISK TIMEOUT=x sets the disk timeout for an I/O request in seconds. Valid range is 1 to 512 seconds. Default setting is 68 seconds.

DISK CMD_TIMEOUT=x sets the Retry Disk timeout (in seconds) for an I/O request. The retry timeout value indicates the maximum amount of time that is allotted to receive a reply for each retry of an I/O request. If the I/O request does not complete within this time, it is aborted and potentially retried: if there is still time remaining in the overall disk timeout to allow for another retry, it is retried; if not, it completes with an error status.

NOTE : The **DISK CMD_TIMEOUT** value must be smaller than or equal to **DISK TIMEOUT**. Valid range is 1 to 512 seconds.

3.3.2 Audio/Visual Settings of the System

The **audio** and **visual (AV)** settings of the system and the disks can be tuned to provide better performance and a lower latency. The writeback and prefetch settings for each LUN are changed with the **CACHE** command.

The **AV** command displays information about the audio/visual settings of the system (Figure 3–30).

```
15000(1): av
Current LUN Audio/Visual settings
LUN Label          FastAV Continuous Caching Maximum
-----
Disk Audio/Visual settings are: Disabled (Using disk defaults)
Recovery Time Limit: 65535
Ordered Tag Count: 0
Unit Attention: Enabled
FASTAV Timeout: 0
FC Timeout: 0
Fail Check Condition: Disabled
15000(1):
```

Figure 3–30 Current Audio/Visual Settings

AV FASTAV=ON|OFF enables/disables the disk fast audio/video read options for streaming data. When enabled, the system will start the data transfer for read operations before all of the disk commands have finished. This feature reduces the latency for read operations but the system will be unable to check the integrity of the data. This parameter is saved on a LUN by LUN basis. Use LUN=X command to change the settings for a single LUN. Default setting is OFF.

NOTE : When **FASTAV** mode is enabled, the controller no longer checks data in real-time.

Changing the disk parameters can adversely affect the I/O operation of the system. This parameter should only be adjusted when the system is idle. Default setting is OFF.

FASTAVTIMEOUT=x sets the timeout before the FASTAV option activates on a host read command. The FASTAV mechanism is not used until the host command takes longer than the timeout value. A value of zero indicates that the system starts the data transfer as soon as a minimum number of drives are ready. This value is in 100 millisecond increments. The range for “x” is 0 to 255. The default is 50.

ORDEREDQUEUE=x enables the use of ordered tags when communicating with the drives. The value “x” indicates the number of disk commands that can be sent before an ordered tag must be sent to the disks. Valid range is 0 to 255. Default is 0.

UA=ON enables the initial Unit Attention condition when an initiator logs into the system; the system reports a Unit Attention condition on the first SCSI command after the initiator logs in. Default is ON.

UA=OFF disables the initial Unit Attention condition when an initiator logs into the system; the system automatically clears the unit attention condition when an initiator logs in.

RC=ON|OFF enables the **Read Continuous (RC)** option for Audio/Video streaming data; the system starts the data transfer for read operations after RCTIMEOUT is reached, even if the disks commands have not finished. Use this to reduce the latency for read operations in Audio/Visual environments where latency is more important than data integrity. This parameter is saved on a per-LUN basis. Use in combination with the LUN=x parameter to change the settings for a single LUN. Enabling this feature automatically enables FASTAV.

WARNING! This feature allows the system to return invalid data to the initiator.

RCTIMEOUT=x Default setting: disables the Read Continuous option for Audio/Video streaming data. Note: This parameter is saved on a per-LUN basis. Use in combination with the LUN=x parameter to change the settings for a single LUN.

LUN=x sets the host command timeout for the Read Continuous option for Audio/Video streaming data. Set to 0 to disable the Read Continuous feature in the system. This value is in 100 millisecond increments. The range for 'x' is 0 to 255. The default is 8.

FAILCC=ON instructs the host ports to report a check condition for all SCSI commands when the unit is in a failed state. This command should only be used in AV environments when a check condition is required instead of taking the unit off the loop.

FAILCC=OFF This is the default setting. Host ports will NOT report a check condition for all SCSI commands when the unit is in a failed state.

3.3.3 Locking LUN in Cache

Locking a LUN in data cache will keep all of the data for the LUN in the cache for faster access. Once a LUN is locked, the data that is gathered to service read and write commands will stay permanently in the cache. The controller will continue to fill up the cache until 50% of the total cache is filled with data from locked LUNs, while the other 50% of the cache is reserved to service I/O for unlocked LUNs.

Initial Cache

50% of Data Cache used to service Unlocked LUNs	50% of Data Cache used to service Locked LUNs
---	---

For example, when a host issues a read command for data from LUN 1 that has been locked in cache, the following will occur:

- The controller reads data from disks, locks data in cache, and sends data to host
- Any reads of the same data will be serviced from cache, which provides faster access than reading from disks.

Cache allocation after I/O completes

Unlocked LUN data	Unallocated cache*	Data for LUN 1
-------------------	--------------------	----------------

* Unallocated cache can be used for unlocked LUNs' or locked LUNs' data. Once cache has been allocated to a locked LUN, however, it cannot be used by an unlocked LUN.

Once the size of the locked LUNs exceeds 50% of the total cache, the controller must create cache space to process a new I/O by removing older data from the locked portion of cache. The **Least Recently Used (LRU)** algorithm is used to determine which locked data to remove from cache.

For example, LUNs 0 to 3 are locked in cache and all 50% of the total cache has been filled by data from LUN 0, 1, and 2.

Initial Cache

Unlocked LUN data	Data for LUN 0	Data for LUN 1	Data for LUN 2
-------------------	----------------	----------------	----------------

When a host issues a read command for data from LUN 3, the following will occur:

- The controller unit determines which data to remove from the locked portion of cache, using the LRU algorithm. The LRU algorithm is thus: If LUN 0 has not been accessed for 1 hour, LUN 1 has not been accessed for 30 minutes, and LUN 2 has not been accessed for 2 minutes, then LUN 0's data will be removed from cache because it is the least recently used data.
- The controller reads data from disks, locks data in cache, sends data to host.
- Any reads of same data will be serviced from cache (until data is removed from cache due to its being the least recently used data).

Cache allocation after I/O completes

Unlocked LUN data	Data for LUN 3	Data for LUN 1	Data for LUN 2
-------------------	----------------	----------------	----------------

3.3.3.1 Locking / Unlocking a LUN

To lock a LUN in the data cache, enter:

LUN LOCK=X<Enter>

where "X" is the Logical Unit number <0..1023> (Figure 3–31).

```
15000 [1]: lun lock=0
```

Logical Unit Status							
LUN	Label	Owner	Status	Capacity (Mbytes)	Block Size	Tiers	Tier List
0		1	Cache Locked	10002	512	3	1 2 3
1		1	Ready	10002	512	3	1 2 3
2		1	Ready	10002	512	3	1 2 3
3		1	Ready	10002	512	3	1 2 3

System Capacity 277810 Mbytes, 237802 Mbytes available.

Figure 3–31 Logical Unit Status - LUN Locked in Cache

LUN UNLOCK=x unlocks a LUN and releases its cache locked by the LUN.

3.3.3.2 System Performance Statistics

The controller monitors pre-fetch and cache efficiency, request distribution, transaction, and transfer rates by port.

The **STATS** command displays the **Performance Statistics** for the host ports, disk channels, and cache memory (Figure 3–32). It will show the read and write performance of each of the host ports.

```

15000[1]: stats
                                     System Performance Statistics
Read MB/s:   All Ports   Port 1   Port 2   Port 3   Port 4
Write MB/s:   0.0       0.0     0.0     0.0     0.0
Total MB/s:   0.0       0.0     0.0     0.0     0.0

Read IO/s:    0         0       0       0       0
Write IO/s:   0         0       0       0       0
Total IO/s:   0         0       0       0       0

Read Hits:    0.0%     0.0%   0.0%   0.0%   0.0%
Prefetch Hits: 0.0%     0.0%   0.0%   0.0%   0.0%
Prefetches:   0.0%     0.0%   0.0%   0.0%   0.0%
Writebacks:   0.0%     0.0%   0.0%   0.0%   0.0%
Rebuild MB/s: 0.0       0.0     0.0     0.0     0.0
Verify MB/s:  24.2     12.1    12.1    0.0     0.0

Disk IO/s:    Total      Reads   Writes
Disk MB/s:    24         24      0
Disk MB/s:    30.2      30.2    0.0
Disk Pieces:  43793328  43793328 0
BDB Pieces:   0

Cache Write Data: 0.0%
Rebuild/Verify Data: 0.0% 0.1%
Cache Data locked: 0.0%
15000[1]:
    
```

Figure 3–32 System Performance Statistics Screen

Read Hits shows the percentage of Read I/O requests where the data was already in the cache. **Prefetch Hits** shows the percentage of Read I/O requests where the data was already in the cache due to prefetching. **Prefetches** shows the percentage of host Read I/O requests to the disks due to prefetching.

The bottom of the screen displays the Read and Write performance of the disks. **Disk Pieces** shows the total number of disk I/O requests from the host ports. The system will combine several host I/O requests into a single disk I/O request. The histogram at the lower right shows how often this is occurring for reads and writes. BDB Pieces is the number of host I/O blocking and deblocking requests.

Cache Writeback Data shows the percentage of the cache which contains writeback data that must be written to the disks. Cache Rebuild Data shows the percentage of the cache in use for rebuild operations. Cache Data Lock shows the percentage of the cache which is locked by the locked LUNs.

STATS CLEAR resets all the statistics back to zero.

STATS DELAY displays a histogram of the time it takes for the host and disk I/O requests to complete in 100 msec intervals (Figure 3–33).

```
15000 [1]: stats delay
```

Command Delay Statistics				
Time seconds	Host Reads	Host Writes	Disk Reads	Disk Writes
0.1	1690087	1446110	281633	253704
0.2	82900	79522	87112	45260
0.3	389	263	13243	7728
0.4	64	77	3319	3149
0.5	12	24	970	1435
0.6	5	7	336	672
0.7	0	8	92	344
0.8	0	4	38	136
0.9	0	3	13	84
1.0	0	9	8	8445
1.1	6	3	4	24
1.2	9	19	2	14
1.3	12	15	1	18
1.4	12	17	0	10
1.5	12	19	0	9
1.6	7	32	0	0
1.7	14	34	0	0
1.8	22	12	0	0
1.9	23	12	0	0
2.0	56	19	0	0
2.1	175	4	0	0
2.2	70	1	0	0

Figure 3–33 Command Delay Statistics Screen

STATS HOSTDELAY displays a histogram of the time delay between when the last data transfer is set ready and the host command completes (Figure 3–34). The host ready delay information is shown in 100msec intervals.

```
15000 [1]: stats hostdelay
```

Host Command Ready Delay Statistics									
Time seconds	Port 1		Port 2		Port 3		Port 4		
	Reads	Writes	Reads	Writes	Reads	Writes	Reads	Writes	
0.1	0	0	0	0	0	0	0	0	0
0.2	0	0	0	1	0	0	0	0	0
0.3	0	0	0	1	2	1	0	0	0
0.4	0	0	1	2	0	2	0	0	0
0.5	0	0	0	0	0	0	0	0	0
0.6	0	0	0	1	0	2	0	0	0
0.7	0	0	0	1	0	2	0	0	0
0.8	0	0	0	0	0	0	0	0	0
0.9	0	0	0	0	0	0	0	0	0
1.0	0	0	0	0	0	2	0	0	0
1.1	0	0	0	0	0	0	0	0	0
1.2	0	0	0	0	0	1	0	0	0
1.3	0	0	0	0	2	1	0	0	0
1.4	0	0	0	0	2	1	0	0	0
1.5	0	0	0	0	0	0	0	0	0
1.6	0	0	0	0	0	0	0	0	0

Figure 3–34 Host Delay Statistics Screen

STATS TIERDELAY=<tier> displays a histogram of the time it takes for the disk I/O request to complete for all the disks in the specified tier (Figure 3–35). If no tier is specified, all valid tiers will be displayed.

```
15000 [1]: stats tierdelay
```

Tier 1 Delay Statistics											
Time seconds	Disk Channels										
	A	B	C	D	E	F	G	H	P	S	
0.1	3407b	33108	339bd	3409f	572c5	34c0d	33640	30603	3391a	7ed5d	
0.2	480f4	4885c	4866a	48190	27b83	47910	484cc	4acc1	48196	21e	
0.3	2ca6	33d8	2def	2c1f	127	2928	324f	3a63	32a7	0	
0.4	d1	1bc	cd	c7	0	c0	185	10f	176	0	
0.5	2c	2b	26	12	0	23	27	33	36	0	
0.6	13	1b	14	12	0	e	13	1d	1d	0	
0.7	13	15	7	a	6	e	15	28	17	0	
:											
:											
:											
1.8	0	0	0	0	0	0	0	0	0	0	
1.9	0	0	0	0	0	0	0	0	0	0	
2.0	0	0	0	0	0	0	0	0	0	0	

Hit enter to continue, 'e' to escape:

Figure 3–35 Tier Delay Statistics Screen

STATS DISK displays a histogram of the disks in the system that have taken an unusually long time to complete an I/O request (Figure 3–36). The count is incremented for a disk if that disk takes longer than the other disks to finish an I/O request. This command is used to determine if a disk in the array is slowing down system performance.

Normally all the disks in a tier should have similar counts. A disk with a significantly higher count indicates that the disk may be slower than the other disks or have problems.

```
15000 [1]: stats disk
```

Delayed Disk Command Counts										
0	A	B	C	D	E	F	G	H	P	S
1	0	0	0	0	0	0	0	0	0	0
2	3C5	392	34D	4DC	37C	361	3BD	3EE	48B	0
3	0	0	0	0	0	0	0	0	0	0
4	421	7F7	37F	396	7DB	3D2	5B6	3C6	55E	0
5	0	0	0	0	0	0	0	0	0	0
6	338	37E	37F	36C	30F	38B	8DF	5D1	58E	0
7	0	0	0	0	0	0	0	0	0	0
8	0	0	0	0	0	0	0	0	0	0
9	3F1	347	6D4	7DD	929	357	3B4	4D4	5FA	0
10	78C	3B3	412	2ED	642	40A	788	33B	43E	0
11	465	3EE	739	34C	2FC	A2F	358	310	382	0
12	0	0	0	0	0	0	0	0	0	0

Disks in the same tier should have similar results.

Figure 3–36 Host Command Offsets Screen

STATS DUAL displays the statistics for the dual mode messages (Figure 3–37).

```

15000(2): stats dual
Message          Dual Message Statistics
                Total          Megs/sec.
Lock requests    0
Release requests 0000
Lock acknowledges 0000
Lock releases    0000
Lock requests received 0000
Release requests received 0000
Lock acknowledges received 0000
Lock releases received 0000
Total Messages sent 00
Total Messages received 00
15000(2):
    
```

Figure 3–37 Dual Message Statistics Screen

STATS LENGTH displays a histogram of the length of the host I/O requests in 16 kb intervals (Figure 3–38).

Command Length Statistics									
Length Kbytes	Port 1		Port 2		Port 3		Port 4		
	Reads	Writes	Reads	Writes	Reads	Writes	Reads	Writes	
> 0	0	0	0	0	0	0	0	0	0
> 2	0	0	0	0	0	0	0	0	0
> 4	0	0	0	0	0	0	0	0	0
> 8	0	0	0	0	0	0	0	0	0
> 16	0	0	0	0	0	0	0	0	0
> 32	0	0	0	0	0	0	0	0	0
> 48	0	0	0	0	0	0	0	0	0
> 64	0	0	0	0	0	0	0	0	0
> 80	0	0	0	0	0	0	0	0	0
> 96	0	0	0	0	0	0	0	0	0
> 112	0	0	0	0	0	0	0	0	0
> 128	0	0	0	0	0	0	0	0	0
> 144	0	0	0	0	0	0	0	0	0
> 160	0	0	0	0	0	0	0	0	0
> 176	0	0	0	0	0	0	0	0	0
> 192	0	0	0	0	0	0	0	0	0
> 208	0	0	0	0	0	0	0	0	0
> 224	0	0	0	0	0	0	0	0	0
> 240	0	0	0	0	0	0	0	0	0

Figure 3–38 Command Length Statistics Screen

STATS OFFSET displays a histogram of the offset of the host I/O requests into the cache segments (Figure 3–39). Host I/O requests with offsets that are not in the 0x0 column may require blocking/deblocking which can slow down the performance of the system.

```

15000 [1]: stats offset

                        Host Command Offsets
                        x0      x1      x2      x3      x4      x5      x6      x7
0  720943                8      11      5      0      2      0 343AAD2
8  3FE8E9                5      10      1      0      2      0 3486F35
10 42754D                3       6      0      0      4      1 39B0635
18 4AA571                1       4      2      0      6      0 40677A9

Most commands should be in column 0 or 4 for the best performance.

```

Figure 3–39 Host Command Offsets Screen

STATS REPEAT=OFF|MBS|IOS allows you to enable/disable the repeating statistics display where **MBS** displays MB/s, **IOS** displays IO/s, and **OFF** turns off (both) the repeating displays.

3.3.4 Resources Allocation

Background Format/Rebuild Operations

Format and rebuild operations are background processes; their rates can be adjusted to minimize their impact on system performance.

```

15000 [1]: tier

                        Tier Status
Tier Owner      Capacity  Space  Available  Disk  LUN List
                  (Mbytes) (Mbytes) Status
-----
1 +             1119856  1119856 ABCDEFGHPS
2 +             1119856  1119856 ABCDEFGHPS
3 +             1119856  1119856 ABCDEFGHPS
4 +             1119856  1119856 ABCDEFGHPS
5 +             1119856  1119856 ABCDEFGHPS
6 +             1119856  1119856 ABCDEFGHPS
7 +             1119856  1119856 ABCDEFGHPS
8 +             1119856  1119856 ABCDEFGHPS

All disks are healthy.

Automatic disk rebuilding: Enabled
Automatic SMART replacement: Disabled
Maximum active rebuilds: 4
Maximum active verifies: 2
System rebuild extent: 32 Mbytes
System rebuild delay: 30
Journaling: Disabled

System Capacity 8958848 Mbytes, 8958848 Mbytes available.

```

Figure 3–40 Displaying the Current Rebuild Parameters

TIER displays the current rebuild parameter settings for the system (Figure 3–40).

The **TIER DELAY** parameter controls the amount of system wait time before rebuilding the next chunk of data. This parameter slows down the rebuild and format operations so they will not affect the performance of the system. **TIER DELAY=0** will remove many delays so the rebuild and format operations will go as fast as possible, but this could significantly affect the performance of the system.

NOTE : A delay value less than 1 (<1) is not recommended.

TIER DELAY=x is used to set the system rebuild/format delay. This value is in 100 millisecond increments. The range is 0 to 1000. The default setting is 30 milliseconds (3 seconds).

The **REBUILD EXTENT** parameter determines how much data to rebuild or format at one time. A small **EXTENT** value will slow down the rebuild and format operations so they will not affect the performance of the system. Increasing the **EXTENT** value will allow more data to be rebuilt in a single pass. The recommended setting is to use the default value of 32 MBytes (MBs) and only adjust **DELAY** to match your user load.

TIER EXTENT=X (where X is a value from 1 to 128) sets the system rebuild/format extent in MBs. The range is 1 to 128 MBs. Default is 32MBs.

3.3.4.1 Background LUN Verify Operations

LUN VERIFY displays the current setting for background verify on all LUNs.

LUN VERIFY=X turns on background verify for LUN X, where X is a Logical Unit <0..1023>.

LUN VERIFY=ON|OFF prompts you for a list of LUNs where the background verify will be turned either ON or OFF.

LUN VERIFY=ON will both turn on the background verify for the specified LUN(s), as well as start up the verify operation(s).

LUN VERIFY=OFF only turns off the **Background Verify** setting for the specified LUN(s). Therefore, any Verifys that are already active on the LUN(s) will not terminate until after the completion of that Verify's current iteration. To stop all verify operations immediately, use the **LUN STOP** command.

NOTE : It is recommended that you run LUN VERIFY in continuous mode, since it can help increase disk reliability.

LUN DELAY= X sets the system Verify Delay value to X, where x is a value from 0 to 1000. The Verify Delay value determines how long a verify operation will pause after it reaches the verify extent. This parameter slows down the verify operation so that it will not affect the performance of the system (except in the case where X is set to 0, as described below).

DELAY=X will remove all delays so that the verify operation will go as fast as possible; however, this will slow down the performance of the system. This value is in 100 millisecond increments. The range for X is 0 to 1000. Default is 40.

LUN EXTENT=X sets the system verify extent value X in Mbytes. The verify extent determines how much data can be verified before the verify operation must pause. This parameter slows down the verify operation so that it will not affect the performance of the system. Increasing the extent value will allow more data to be verified in a single pass. The range for X is 1 to 128 MBs. Default is 32 MBs.

3.3.4.2 Background TIER Verify Operations

TIER VERIFY verifies LUNs on a tier by tier basis. **TIER VERIFY** differs from **LUN VERIFY** in that the number of simultaneous Tier Verifys is limited to a value that is set by **TIER MAXVERIFIES** (default = 2) parameter. The valid range is 1 to 16. If a tier is marked for continuous verification, once the verification completes, the next sequential tier marked for verification, not presently being verified, will start.

TIER VERIFY Displays a summary of verifications.

To enable Tier Verify (Figure 3–41):

1. At the prompt, type **TIER VERIFY=ON** <Enter>.
2. The system will ask which tier you wish to verify. Enter the tier number or type **a** for “All.”
3. The system will ask if you want run the Tier Verify operation continuously or not. Type **y** to run continuously or **N** to run just once. The default is **N**.

```

19000[1]: tier verify=on

Tier Status

Tier Owner Capacity Available Space Disk LUN List
(Mbytes) (Mbytes) Status
-----
1 + 1 1119856 1117856 ABCDEFGHFS 0 1
2 + 1119856 1119856 ABCDEFGHFS
3 + 2 1119856 0 ABCDEFGHFS 3
4 + 1119856 1119856 ABCDEFGHFS
5 + 2 1119856 0 ABCDEFGHFS 5
6 + 1119856 1119856 ABCDEFGHFS
7 + 2 1119856 0 ABCDEFGHFS 7
8 + 1119856 1119856 ABCDEFGHFS

Tier Verification Status:

TIER Scheduled Continuous Progress Passes Last Verify Completion Time
-----
1 No No 0 40 12:06:53 08/04/2008
2 No No 0 0
5 No No 0 0
7 No No 0 0

System verify extent: 32 Mbytes
System verify delay: 40
Maximum active verifies: 2

Please enter a TIER ('a' for all TIERS owned by this unit or 'q' to quit): a
ALL valid TIERS owned by this unit selected
Do you want the verify to run continuously? (y/N): y

SEA 9900[1]: tier verify

Tier Verification Status:

TIER Scheduled Continuous Progress Passes Last Verify Completion Time
-----
1 Yes Yes 99.9% 40 12:06:53 08/04/2008
2 No No 0 0
5 No No 0 0
7 No No 0 0

System verify extent: 32 Mbytes
System verify delay: 40
Maximum active verifies: 2

```

Figure 3–41 Tier Verify ON Screen

To disable Tier Verify (Figure 3–42):

1. At the prompt, type **TIER VERIFY=OFF** <Enter>.
2. The system will ask which tier you wish to verify. Enter the tier number or type **a** for “All.”

Tier Verify will be disabled off after the next iteration has completed.

```

15000[1]: tier verify=off

Tier Verification Status:
-----
TIER  Scheduled  Continuous  Progress  Passes  Last Verify Completion Time
-----
1      Yes       Yes       42       0       12:11:18 08/04/2008
3      No        No        0        0
5      No        No        0        0
7      No        No        0        0

System verify extent: 32 Mbytes
System verify delay: 40
Maximum active verifies: 2

This command only stops a Background Verify operation
from running continuously on the TIER(s). The
Verify on these TIERS will stop after the next iteration.

To stop all Verify operations immediately, use 'TIER STOP'.

Please enter a TIER ('a' for all TIERS owned by this unit or 'q' to quit): a
ALL valid TIERS owned by this unit selected
Changed TIER 1 to stop continuous Background Verify
Done

15000[1]: tier verify

Tier Verification Status:
-----
TIER  Scheduled  Continuous  Progress  Passes  Last Verify Completion Time
-----
1      No        No        42       0       12:11:18 08/04/2008
3      No        No        0        0
5      No        No        0        0
7      No        No        0        0

System verify extent: 32 Mbytes
System verify delay: 40
Maximum active verifies: 2

```

Figure 3–42 Tier Verify OFF Screen

TIER VERIFY=X A specified tier will be verified if possible.

These API and CLI commands will affect the TIER verification process:

- The CLI commands **TIER PAUSE**, **TIER RESUME**, **TIER STOP**.
- The API command **TIER STATUSCHANGE**.

LUN operations (add, delete, move) can affect TIER VERIFY operations. As tiers are verified, only LUNs that are valid and formatted are verified.

If a tier is owned by the other unit, and it is healthy, the user is notified that the verification cannot occur due to the ownership of the tier. The user can then retry the verification on the other unit.

The verification of LUNs on a tier is performed in the order of addressing on the tier. Only valid and formatted LUNs can be verified.

3.3.4.3 Rebuild Journaling

The **rebuild journaling** feature is intended to speed the recovery from disk-side loss of communication problems. A loss of communication includes, but is not limited to, SAS expanders, hardware/software failures, and SAS cable failures, and SFP failures.

Currently, when the controller encounters a loss of communication with a drive or a group of drives on a SAS link, the software fails the drive(s) and continues operation. When cache coherency is enabled, if either controller encounters a loss of communication with a drive, the firmware will fail the drive. This allows a controller unit to maintain operation during disk-side events. Once the loss of communication is resolved, however, the controller must rebuild all the affected drives. For large installations, a loss of

communication, such as a cable failure, can cause the controller to fail numerous disk drives. Once the loss of communication is resolved, the time to rebuild all the failed drives can take many weeks.

The rebuild journals contain bitmaps that indicate which portions of the disks in a tier have been updated with new data while a disk was failed or replaced. The system uses the information in the journals to reduce the rebuild time of drives that have not been swapped out. This can dramatically lower rebuild time, since only portions of the tier may have been updated while the drive was failed or replaced.

The granularity of the journal will be 4MB of data on a single disk or 32MB of host data. Thus a single host write will force the system to rebuild a minimum of 4MB of data on the disk. A new host write into a 4MB section that has already been journaled will not cause a new journal entry. The system will automatically update journals when disks are failed or replaced regardless of whether journaling is enabled.

To ensure that the journals are correct, the system carefully monitors the state of the journals and will automatically invalidate or disable the journals if it detects a condition where the journal cannot be used or journal information could potentially be lost.

The following summarizes the limitations that apply to journaling:

- Rebuild journaling will automatically be disabled if the failed disk is swapped with a new disk. The system will track the serial number of the disks when they are failed and will force a rebuild of the entire disk if the serial number changes.
- Rebuild journaling will not be used when a failed disk is replaced by a spare. The rebuild journal can be used when rebuilding a replaced disk that has not been swapped.
- The system will invalidate the journal on tiers that have failed or replaced disks on boot up. This is required because the system does not save the journal information.
- Rebuild journaling will be managed by the controller that owns the tier. If a controller is failed, then the journals on the tiers owned by that controller will be invalidated.
- The system tracks the original owner of a tier when a drive is failed so changing the ownership of the tier will disable use of the journal for rebuilds on that tier.
- Rebuild journaling will be disabled when rebuilding disks that are failed due to a change in the parity mode of the tier.
- Use of the rebuild journal will be temporarily disabled if the system is rebuilding a LUN that is a backup LUN in a mirror group.

To display the information about the rebuild journal, use the **TIER JOURNAL** command (Figure 3–43). To display the information for a specified tier, use the **TIER JOURNAL=t** command, where **t** is the specified tier. This screen will give detailed information about the status of the journal and a display of all the journal entries for the tier. This screen will also give more detailed information on the status of the journal and will indicate why it was disabled or invalidated.

```
15000[1]: tier journal
```

Tier	Owner	Status	Rebuild OK	Disk Status	Capacity (Mbytes)	Journal Entries
1	+	1	Ready	ABCDEFHGHS	1121384	n/a 17522
2	+	2	Ready	ABCDEFHGHS	1121384	0 of 17522 0.0%
3	+	1	Ready	ABCDEFHGHS	3815264	0 of 59614 0.0%
4	+	2	Ready	ABCDEFHGHS	3815264	n/a 59614
5	+	1	Ready	ABCDEFHGHS	3815264	0 of 59614 0.0%
6	+	2	Ready	ABCDEFHGHS	3815264	n/a 59614
7	+	1	Ready	ABCDEFHGHS	3815264	0 of 59614 0.0%
8	+	2	Ready	ABCDEFHGHS	3815264	n/a 59614

Figure 3–43 Sample Tier Journal Command Screen

The status field indicates the current status of the journal:

- Ready - The journal is waiting for updates.
- Active - A disk is failed and the journal has updates.
- All other statuses indicate why the journal cannot be used.

The Rebuild OK field indicates if a rebuild can use the journal:

- Off - Journaling not enabled. Use **JOURNAL=ON** to enable.
- Yes - Journaling can be used when rebuilding.
- No - Journaling cannot be used.

The rebuilds will only use the journals if the “Rebuild OK” field indicates “Yes”. In order to use journaling on rebuilds, the operation must be manually started using **DISK REBUILD=tc** where ‘t’ indicates the tier, and ‘c’ indicates the channel or **REBUILD=ALL** which will start a rebuild on all disks.

The **TIER JOURNAL=ON|OFF** command enables/disables use of the journals during rebuild operations. The system will automatically update the journals when disks are failed or replaced regardless of this setting. This parameter only indicates if the journal can be used during the rebuild. The default is OFF.

3.3.4.4 SES Device Monitoring Rate

The **SES device monitoring rate** can be adjusted to minimize its impact on system performance. **SES M_WAIT** displays the current setting in seconds (Figure 3–44).

```
15000 [1]: ses m_wait
SES timer m_wait = 6 seconds
```

Figure 3–44 SES Device Monitoring Rate

SES M_WAIT=x sets the SES device monitoring rate for the system in seconds. Valid range is 4 to 90. The default monitoring rate is 6 seconds.

NOTE : Improper use of the **SES M_WAIT command** can prevent the SES monitors from detecting an enclosure fault before the enclosure automatically shuts down.

3.3.4.5 Host Command Timeout

The **Host Command Timeout** parameter allows the system to free up resources and make them available to other users if the request from a particular user cannot be completed. This helps to improve performance in a SAN environment where there are a lot of users accessing the storage.

HOST TIMEOUT=X (where X is value range 1..512) lets the host command timeout for an I/O request in seconds. Valid range is 1 to 512 seconds. Default setting is 75 seconds.

3.4 Security Administration

The controller's dual-level, non-host based data security is maintained with scalable features including restricted management access and authentication against authorized listing. No security software is required on the host computers. (Refer to Section 3.1.3, "Administrator and User Logins" for information regarding Telnet and serial port security.)

Each authorized user will have its customized LUN identification scheme which applies to all host ports (Figure 3-45).

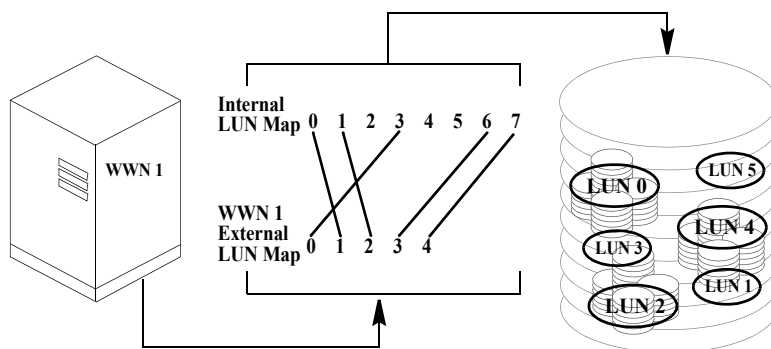

Figure 3-45 Mapping Internal LUNs to External LUNs

Read-only and read/write privileges can be specified for each LUN and for each user.

The “place holder” LUN feature allows the controller administrator to map a zero capacity LUN to a host or group of hosts (via zoning or user authentication). The administrator can then create a real LUN and map it to the host(s) to replace the “place holder” LUN in the future. In most cases, the host will not have to reboot since it already mapped to the “place holder” LUN.

NOTE : Support of place holder LUNs is dependent upon the operating system, the driver, Host Card Adapter (HCA), and host bus adapter.

3.4.1 Monitoring User Logins

The **AUDIT** function continuously monitors logins to the controller and provides alerts in the event of unauthorized login attempts (Figure 3–46).

```
Host Int 15:04:07 User Logout Client1, port:4 S_ID:000004
Host Int 15:04:47 Authenticated Login Client10, port:3 S_ID:000002
```

Figure 3–46 User Login Messages

USER AUDIT=ON|OFF enables/disables the user auditing function. When enabled, the system will display a message when a user logs in or out. Default is OFF.

USER CONNECTIONS displays a list of all the currently connected users and the host port to which the user is connected (Figure 3–47).

```
15000[1]: user connections
Current Host User Connections:
User Name      World Wide Name  On      Type      LUN Zoning
                (External LUN, Internal LUN)
-----
Anonymous     2100001B3211CF79  1      User      000,000  001,007  002,Place  003,000
Anonymous     2101001B3231CF79  2      User
Anonymous     2100001B321054DD  3      User
Anonymous     2101001B323054DD  4      User
15000[1]:
```

Figure 3–47 User Connections Screen

3.4.2 Zoning (Anonymous Access)

This type of configuration provides the first-level protection. The LUN **identification scheme** can be customized for each host port. Any unauthorized user accessing the controller will be considered “anonymous” and granted the zoning rights for the host port to which they are connected.

The **ZONING** command will display the current settings for the host ports. The LUN Zoning chart indicates which internal LUNs the users will be able to access (with Read-only and Read/Write privileges) and where the internal LUN will appear to the users. In Figure 3–48, only internal LUN 1 can be accessed and it is read-only. It will appear as LUN 0 to the users.

```
15000[1]: zoning
Port Zoning Summary:
Port  World Wide Name      LUN Zoning
      (External LUN, Internal LUN)
-----
1     50001FF100050309    000,000  001,007  002,Place  003,000
2     50001FF200050309
3     50001FF300050309
4     50001FF400050309
15000[1]:
```

Figure 3–48 Current Zoning Configuration Screen

ZONING EDIT lets you change the settings for the host ports. You will be asked to select a host port to change and enter the mapping for each LUN (Figure 3–49). The default configuration is to deny access to all the LUNs.

ZONING DEFAULT restores the zoning of a host port back to its default settings.

```

15000[1]: zoning edit

Port      World Wide Name      LUN Zoning
          (External LUN, Internal LUN)
-----
1         21000001FF050120    000,000   001,007   002,Place  003,000
2         22000001FF050120
3         23000001FF050120
4         24000001FF050120

Enter the host port (1..4), or 'e' to escape.
1
Enter the new LUN zoning for host port 1.

Enter the unique LUN mapping, as follows:

G.1  GROUP LUN number
P    Place-holder
R    Before GROUP LUN to indicate Read-Only
N    Clear current assignment
<cr> No change
E    Exit command
?    Display detailed help text

External LUN 0: is not mapped. Enter new internal LUN:

```

Figure 3–49 Edit Zoning Configuration Screen

3.4.3 User Authentication

The controller creates correspondence between users (World Wide Name or GUIDs), storage LUNs, and permissions. The system can store configurations for up to 512 users in total, and the settings apply to all host ports.

Each authorized user will only have access to their own and “allowed-to-share” data determined by their customized LUN identification scheme. Administrators can also restrict users’ access to the host ports and their Read/Write privileges to the LUNs. Unauthorized users will be given the “host port zoning” rights as defined in Section 3.4.2, “Zoning (Anonymous Access)”.

USER displays the current settings for all authorized users (Figure 3–50). Each user is identified by their 64-bit World Wide Name (or GUID) and is given a unique user ID number. The Ports column indicates which host ports, on each controller, the user is allowed. The LUN Zoning chart indicates which internal LUNs the user will have access to (with read-only and read/write privileges), and where the internal LUN is displayed to the user.

```

15000[1]: user

Host Port Users Summary:

ID  User Name      World Wide Name      Unit Port-Map      Zoning Method
-----
User auditing is enabled.
There are 4 users currently connected.

15000[1]:

```

Figure 3–50 User Settings Screen

To configure/change the settings, use these commands:

- **USER ADD** adds a new user and defines the user’s access rights
- **USER EDIT** edits the access rights of an existing user
- **USER DELETE** deletes an existing user from the system.

See Section 2.3.9, “Setting Security Levels”, subsection entitled User Authentication (Recommended for SAN Environment) for further information on how to add a new user.

3.5 Firmware Update Management

SGI periodically releases firmware updates to enhance features of their products. Contact SGI technical support to obtain the latest firmware files.

3.5.1 Displaying Current Firmware Version

The **VERSION** command displays version information of the controller's hardware and firmware (Figure 3–51).

```

15000 [1]: version
DataDirect Networks Silicon Storage Appliance Model 9900
Firmware Version: 5.00_pre_16

Firmware date: Jul 29 2008, 13:04:10
IEEE ULA Number: 00050120
Bootrom Version: 53-20067-003 Version 1.02
Platform: 15000 9900

15000 [1]:

```

Figure 3–51 Version Information Screen

3.5.2 Firmware Update Procedure

TFTP enables the administrator to download the new controller firmware from a TFTP server to the controller. When using the TFTP command, a TFTP server must be running and a copy of the firmware file image must be on the TFTP server. This command will “fail” the current controller and should not be used during active I/O.

Follow these steps to update the firmware files.

1. Collect and save the output of the following commands before you update the firmware:

VERSION	AV	CACHE
DISK	DISK LIST	DUAL
HOST	HOST STATUS	LOG
LUN	LUN CONFIG	NETWORK
STATS	STATS DELAY	STATS TIER DELAY
TIER	TIER CONFIG	

2. Copy the new firmware file to your TFTP server.
3. Connect to the controller via Telnet or serial (CLI port).
4. Enter **TFTP**
5. You will be asked to confirm action (Figure 3–52). Enter **y** to continue.

```
15000[1]: tftp
WARNING: This command will upgrade the firmware of the unit.

Do you want to continue? (y/N): y
Enter the TFTP server IP Address or hit
return to use the last TFTP address: 192.168.1.127
TFTP address (Q to quit): q
15000[1]:
```

Figure 3–52 Downloading Controller Firmware

6. Enter the TFTP server's IP address: **TFTP <IP_address>**
7. Enter the firmware path and filename: **TFTP <filename>**
8. For the couplet controller configuration, connect and log into the other controller. Repeat Steps 4-7 above to update the firmware.
9. Enter **RESTART** to restart the unit(s).

NOTE : RESTART can be done at a later time.

10. (*For dual mode only*): After both controllers are back on-line, use the **DUAL** command to verify that both controller units are healthy. If either controller shows failed, login to the healthy controller and issue the **DUAL HEAL** command.

3.6 Remote Login Management

TELNET ENABLE allows the administrator to *temporarily enable* the establishment of a remote Telnet session. Use the **TELNET** command to display the current setting.

TELNET DISABLE allows the administrator to *temporarily disable* the establishment of a remote Telnet session.

NOTE : Telnet capability is reset to **ON** after a controller restart. To turn off Telnet access permanently, use the **NETWORK** command.

TELNET STATS allows the administrator to view various statistics maintained on remote Telnet sessions (Figure 3–53). These statistics are kept from the time that the system is powered on.

```

15000[1]: telnet stats

Telnet Session Statistics
=====

Time      Date
-----
System Boot-Up Completion : 10:15:49 07/30/2008
System's Current          : 15:20:47 07/30/2008
Telnet Services Initiation : 10:13:42 07/30/2008

Telnet Sessions have been : Enabled
                          since : 10:13:42 07/30/2008

Telnet Sessions have been :
Enabled : 1 time.
Disabled : 1 time.

Exited gracefully (via LOGOUT) : 0 times.
Disconnected at the remote site : 0 times.
KILLED by the administrator    : 0 times.

Telnet session attempts      : 1
SUCCESSFUL Telnet Sessions   : 1
UNsuccessful Telnet session attempts : 0
Consecutive UNsuccessful Telnet session attempts : 0
Telnet session was already active : 0
Telnet sessions were disabled : 0
User supplied invalid login information : 0
Other (miscellaneous)       : 0

15000[1]:

```

Figure 3–53 Telnet Statistics

The administrator is strongly advised to perform any commands affecting the system's configuration from the CLI **UART** only (and not from a Telnet session), and to only perform such commands after issuing the **TELNET DISABLE** command, so that remote users cannot log into the system in the middle of an administrative command.

3.6.1 When a Telnet Session is Active

Whenever a remote Telnet session is active, the current RS-232 console switches to a CLI sub-shell which allows the administrator to enter a very limited sub-set of the CLI commands. The following message is displayed on the console when a Telnet session is initiated from a remote site (Figure 3–54).

```

15000 [1]:
New TELNET Session initiated from IP address: 010:123:139:005
[Remote TELNET session ON] Local SUBshell 15000 [1]:

```

Figure 3–54 Telnet Session Initiated

Within the CLI subshell, the **TELNET** command allows the administrator to view information regarding the currently active Telnet session (Figure 3–55).

```
[TELNET from 192.168.2.3] Local SUBshell 15000 [1]: telnet
Telnet Sessions are currently: Enabled
A Telnet Session is currently in progress.
[TELNET from 192.168.2.3] Local SUBshell 15000 [1]:
```

Figure 3–55 Telnet Session Information

TELNET KILL=m lets the system administrator terminate the remote Telnet session (Figure 3–56). The **KILL** parameter may also be specified with **TELNET KILL=m**, where **m** indicates the number of minutes that will be allowed to elapse before the remote Telnet session is terminated. The valid range is <0..15> minutes. Default is 1 minute. An administrative login is required before the command is processed.

```
[Remote TELNET session ON] Local SUBshell 15000 [1]: telnet kill=1

-- WARNING --

Any CLI command that may be in progress on the remote Telnet site
will need to be completed locally after the remote session has been
terminated.

Enter the administrative (or higher) login name: admin
Enter the appropriate password: *****

-- Please wait for the remote TELNET session to be terminated. --
.....
Telnet Session termination.
```

Figure 3–56 Terminating a Telnet Session

The remote user is given a warning that the administrator has killed his session, and indicates to him the amount of time (if any) that he has remaining (Figure 3–57). An **m** value of **0** (zero) is an immediate KILL. The remote user will be notified, but most likely will be unable to read the entire warning message before the session ends.

```
15000 [1]:
-- The System Administrator will terminate this TELNET Session in 1 minute --
-- The System Administrator will terminate this TELNET Session in 30 seconds --
Connection closed by foreign host.
```

Figure 3–57 Telnet Session Being Terminated

NOTE : If a user is in the middle of running a CLI command at a remote Telnet site when the administrative KILL is issued, the command will continue on the CLI console.

3.7 System Logs

3.7.1 Message Log

All controller events are logged and saved in non-volatile memory. The log will automatically roll over when it is full.

LOG displays the log of previous system messages.

LOG CLEAR clears the log of all previous messages.

LOG CHECKCONDITION displays the Check Condition log.

LOG CHECKCONDITION=MORE will display additional information concerning the check condition.

LOG CHECKCLEAR clears the Check Condition log, enter **LOG CHECKCLEAR**.

LOG QUIET= ON|OFF. This Administrator command enables a “quiet mode” on the CLI where Message Log statements will still be logged, but not displayed.

LOG QUIET will display the current state of the Log Quiet mode. There should be the word “Quiet” at the CLI prompt when the Log Quiet mode has been enabled.

3.7.2 System and Drive Enclosure Faults

Use the **FAULTS** command to display a list of all current disk, system, and drive enclosure faults or failures (Figure 3–58).

```

15000[1]: faults
      Current System Faults
-----

APC UPS task not running.
Unable to clear any outstanding APC UPS faults.

Disk channel B not ready.
Disk channel D not ready.
Disk channel F not ready.
Disk channel H not ready.
Disk channel S not ready.

Disk AB processor restarts = 4

--- Faults detected! ---

Multi-bit ECC Error Shutdown: Enabled
Task Exception Shutdown:      Enabled

```

Figure 3–58 Current System Faults

To display the current SDRAM memory faults (ECC- *error controller counters*), use **FAULTS MEMORY** command. To clear the values in the memory faults (ECC) statistics, use **FAULTS MEMCLEAR** command.

To display the current status of the host and disk SFPs, use the **FAULTS SFP** command.

NOTE : A transmitter fault and a loss of signal on a disk channel or host port may indicate that there is no connection at the corresponding connector.

To display the number of LUN array parity errors detected by the system, use the **FAULTS ARRAYPARITY** command. The system saves the counts for each tier of all the LUNs. To clear the count of LUN array parity errors in the system, use the **FAULTS ARRAYPARITYCLEAR** command.

FAULTS BUSPARITY displays the number of bus parity and data path errors detected by the system.

FAULTS BUSPARITYCLEAR clears the count of errors.

You may set a parameter (**ECCSHUTDOWN**) that allows the system to automatically shutdown if it encounters an unrecoverable error. Use the **FAULTS ECCSHUTDOWN=on** command to enable automatic shutdown for unrecoverable ECC errors. This is the default setting. To disable and allow the system to continue to run in spite of unrecoverable ECC errors, use the **FAULTS ECCSHUTDOWN=off**.

The **EXCEPTIONSHUTDOWN** command parameter allows the system to automatically shutdown if it encounters a task exception.

FAULTS EXCEPTIONSHUTDOWN=ON enables automatic shutdown for task exceptions. This is the default setting.

The **FAULTS EXCEPTIONSHUTDOWN=OFF** disables automatic shutdown and allows the system to continue to run in spite of task exceptions.

3.7.3 Displaying System Uptime

UPTIME displays the total time the system has been operational--or “uptime”(also known as **Power on Hours**), as well as the total time since the last system restart. The uptime is displayed as **YY:DDD:HH:MM** where **YY** is the number of years, **DDD** is the number of days, **HH** is the number of hours, and **MM** is the number of minutes (Figure 3–59) the system has been continually in operation.

```
15000(1): uptime
System Uptime (YY:DDD:HH:MM): 00:042:12:33
Since Restart (DDD:HH:MM:SS): 000:008:12:33
15000(1):
```

Figure 3–59 Display System Uptime

3.7.4 Saving a Comment to the Log

COMMENT <text of message> allows you to echo a message to the screen. The message is saved in the LOG and is also sent to syslog if it is enabled. Any printable text can be entered.

3.8 Other Utilities

3.8.1 APC UPS SNMP Trap Monitor

APC_UPS displays the status of the APC UPS SNMP trap monitor (Figure 3–60).

```
15000 [1]: apc_ups
APC UPS SNMP trap monitor is off.
No APC UPS faults detected via SNMP trap.
```

Figure 3–60 APC UPS SNMP Trap Monitor Status

APC_UPS CLEAR_FAULTS will delete all pending APC UPS faults from the fault list. All APC UPS events that disabled writeback caching will be cleared.

3.8.2 API Server Connections

The **API** command displays the current status of the API connections (Figure 3–61).

```
15000 [1]: api
API Server connections are currently -- ENABLED--
```

Figure 3–61 Displaying Status of API Connections

API DISABLE temporarily enables/disables the establishment of connections to the API server. When disabled, users at remote locations will be unable to establish a new API connection until an **API ENABLE** command is issued. This command only provides control over API connections during the current power cycle.

API STATS displays the collected statistics on API connections (Figure 3–62).

API CLEARSTATS resets the collected statistics.

```
15000 [1]: api stats
API Server Connection Statistics
=====
Time      Date
-----
System Boot-Up Completion : 17:54:51 07/30/2009
System's Current          : 18:16:14 07/31/2009
API Server Initiation     : 17:54:43 07/30/2009
API Server Connections have been : Enabled
since : 09:42:39 07/31/2009
API Server services have been :
Enabled : 2 times.
Disabled : 1 time.
```

Figure 3–62 API Server Connection Statistics

3.8.3 Changing Baud Rate for the CLI Interface

The **CONSOLE** command displays the current serial console setting (Figure 3–63) of the controller.

```

15000 [1]: console
Serial console baud rate is 115200 baud.
Console hardware flow control is OFF.
Console software flow control is OFF.

15000 [1]:

```

Figure 3–63 Displaying the Serial Console Setting

CONSOLE BAUD changes the baud rate of the CONFIG port of the controller (Figure 3–64).

```

15000 [1]: console baud

Select the new serial console baud rate from choices below:
 1 - 9600
 2 - 19200
 3 - 38400
 4 - 57600
 5 - 115200 <- Current setting
 e - escape out of this command

Enter selection:

```

Figure 3–64 Changing the Baud Rate

3.8.4 CLI/Telnet Session Control Settings

You may change the CLI's and Telnet's various session control settings. The **SETTINGS** command displays the current setting (Figure 3–65).

```

15000 [1]: settings

Current Session Control Settings
-----
Lines per page:          0 (No paging - continuous scroll)
Prompt status information: Enabled

```

Figure 3–65 Current Session Control Settings

SETTINGS DEFAULTS resets all the CLI and Telnet session control settings to their default values.

SETTINGS LINES=<number of lines> sets the number of lines displayed at a time in a page of screen information. Pages provide a way to control the amount of information displayed to the user at one time. You will be prompted to either press a specified key in order to scroll from one page to the next, or (in certain circumstances), to terminate the display. Valid range is 0 to 512 lines, where 0 indicates that no paging is to be performed on the output information. Default setting is 0.

SETTINGS PROMPTINFO=ON enables extra status information in the CLI prompt. **OFF** disables extra status information in the CLI prompt. When enabled, the CLI prompt indicates whether the system is booting (**BOOTING**), failed (**FAILED**) or waiting for a restart (**RESTART NEEDED**). **ON** is the default.

3.8.5 Disk Diagnostics

The **DISK DIAG=tc** command performs a series of diagnostics tests on the specified disk. The disk is specified by its physical: tier (t) in the range <1..125>, and channel (c) in the range <ABCDEFGHPS>.

3.8.6 Disk Reassignment and Miscellaneous Disk Commands

The **DISK REASSIGN=tc 0xh** command allows for the reassigning of defective logical blocks on a disk to an area of the disk reserved for this purpose. The disk is specified by its: tier (t) in the range <1..125>, and channel (c) in the range <ABCDEFGHPS> 0xh is the hexadecimal value of the LBA (Logical Block Address) to be reassigned.

The **DISK LLFORMAT=tc** command allows the user to perform a low level format of a disk drive. The disk is specified by its: tier (t) in the range <1..125>, and channel (c) in the range <ABCDEFGHPS>.

The **DISK AUTOREASSIGN=ON** command is the default setting. When enabled bad blocks are reassigned when a medium error occurs on a healthy tier, the **DISK AUTOREASSIGN=OFF** command disables this feature and bad blocks are NOT reassigned when a medium error occurs on a healthy tier.

The **DISK MAXCMDS=x** command sets the maximum command queue depth to a tier of disks in the range of 1 to 32 commands per tier. The default is 32 commands.

3.8.7 SPARE Commands

Use the **SPARE** commands to display information about the spare disks in the system or to change the configuration settings for background diagnostics in the system. The information displayed pertains to the current spare configuration settings as well as task status.

The **SPARE CLI** commands are for background diagnostics. The intent of these commands is to test otherwise idle spare disks at least one (1) time per month to validate that they are continuing to function properly, and are truly available to be swapped in as a replacement disk. It is testing of the “hot” spares. They are intended to run in the background and SPARE operations are always at lower priority than any other kind of I/O in the system.

The **SPARE INFO=tc** command displays the information and status about a specific spare disk in the system. The disk is specified by its physical tier and channel locations, “tc.” The “t” indicates the tier in the range <1..125>, and the ‘c’ indicates the channel in the range <ABCDEFGHPS>.

The **SPARE CLEAN=tc** command erases any previous test data stored on the disk indicated. The disk is specified by its physical tier and channel locations, “tc.” The “t” indicates the tier in the range <1..125>, and the ‘c’ indicates the channel in the range <ABCDEFGHPS>.

The **SPARE COVERAGE=x** command sets the spare diagnostic coverage of the blocks being tested as a percent of the total number of blocks available for test. Note that increasing the coverage to higher numbers means that more blocks on the disk will be tested for better coverage, but it also will take a longer time for the test to complete. This parameter can be tuned to provide an optimal test time for a single disk in the system such that all spares are tested in a reasonable amount of time. The parameter is limited to a discrete set of values. The valid parameters for “x” are [1, 5, 10, 20, 40, 80, 100] Percent. Default is 1 Percent.

The **SPARE EXTENT=x** command sets the spare diagnostic extent in Mbytes. The diagnostic extent determines how much data can be tested before the test must sleep. This parameter slows down the test operations so they will not affect the performance of the system. Increasing the extent will allow more data to be tested in a single pass. Any changes applied to extent will affect tests in progress as well as future testing. The valid range for ‘x’ is 1..32 Mbytes. Default is 8 Mbytes.

The **SPARE DELAY=x** command sets the system spare diagnostics delay. The test delay determines how long a test operation will pause after it reaches the test extent. This parameter slows down the spare

test so it will not affect the performance of the system. Any changes applied to delay will affect tests in progress as well as future testing. This system spare diagnostic delay value is given in 100 millisecond increments. The valid range for 'x' is 0..100. The default is 0.

The **SPARE PATTERN=x** command sets the system spare diagnostics pattern. The test pattern determines the pattern written to the disks during the test. The system supports the following patterns:

- **UNIQUE** Includes unique information including timestamp
- **AA** 0xAA is written to each byte
- **55** 0x55 is written to each byte
- **FF** 0xFF is written to each byte
- **00** 0x00 is written to each byte
- **COUNTUP** A pattern of counting up is written to each byte
- **COUNTDOWN** A pattern of counting down is written to each byte

The default is **UNIQUE**. Note that the tests in progress are not affected by this parameter setting. Changing the pattern only applies to tests started after the parameter was modified.

The **SPARE START** command starts the spare diagnostics task if it is not running. Note that this will start diagnostics on both units in a dual system, as this is a system parameter.

The **SPARE STOP** command aborts any ongoing diagnostic operations. Note that this command will stop them and then the task will be idle until the **SPARE RESTART** command is executed. Note that this will stop diagnostics on both units in a dual system as this is a system parameter.

The **SPARE PAUSE** command pauses but does not stop any ongoing diagnostic operation, only on the unit from which the command is run. If a test is being run from the other unit in a dual, the pause command will NOT affect that test.

The **SPARE RESUME** command releases any paused diagnostic operations and allows them to continue only on the unit from which the command is run. If a test has been paused on the other unit in a couplet, the **SPARE RESUME** command will NOT affect that test.

Chapter 4

Controller Remote Management and Troubleshooting

4.1 Remote Management of the Controller

The controller can be managed locally through the RS-232 interface, or remotely via Telnet. The Administrative Utility is the same regardless of the management interface (RS-232 or Telnet).

The controller supports SNMP and allows the system to be remotely monitored.

4.1.1 Network Connection

Connect the Telnet port on the back of the controller to your Ethernet network (Figure 4–1). Then set the IP addresses, login names, and passwords as described below.

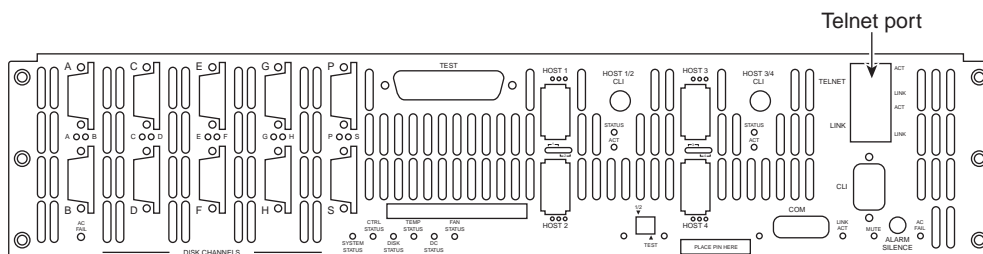

Figure 4–1 Telnet Port on the Controller

NOTE : Currently, the controller does not support network configuration protocols such as DHCP or BOOTP.

4.1.2 Network Interface Set Up

For first time set up, you will need to connect to the CLI (RS-232) port in order to change the IP address and/or network settings.

To set up the network interface:

1. Use the **NETWORK** command to display the current settings (Figure 4–2).
2. Change the controller’s IP address for your network environment: **network IP=<new IP address>**.
3. Change the netmask of the controller (if needed): **network netmask=<new netmask>**.
4. Enable the Telnet capability (if needed): **network telnet=ON**.

NOTE : Telnet connections are clear text. If Telnet connections are used, you may expose controller passwords to third parties. For higher security, we recommend that you disengage Telnet access if it is not required.

5. Decide whether the SNMP functionality should be enabled.

To enable or disable SNMP, use the appropriate version of the command **network SNMP=on|off**.

```
15000 [1]: network
Network Configuration
-----
MAC Address:          00:01:ff:05:03:09
Link Status:         1000 Mbps Full duplex
-----
                        Unit 1          Unit 2
-----
IP Address:          192.168.12.81      192.168.12.82
Subnet Mask:        255.255.0.0        255.255.0.0
Default Gateway:
-----
Telnet:             Enabled      23          23
API Server:         Enabled      8008       8008
Syslog:             Disabled     514        514
Syslog IP Address:
SNMP:              Disabled
SNMP IP Address:
SNMP:              Disabled
SNMP IP Address:
Limited SNMP:      Disabled
```

Figure 4–2 Current Network Configuration Screen

NOTE : If you are using an external system console option like Telnet, the **SNMP** function should be enabled.

6. If the SNMP function is enabled, enter the IP address of the computer to be used to monitor the SNMP traps:

network trapip=<computer's IP address>

7. Decide whether the Syslog capability should be enabled. To enable (**ON**) or disable (**OFF**) the Syslog, enter:

network syslog=on|off

NOTE : The SGI default is the Syslog capability enabled.

8. If the SYSLOG function is enabled, enter the destination IP address for the Syslog packets:

network SYSLOGIP=<destination IP address>

Ensure your destination computer supports the SYSLOG feature. For example, on UNIX systems, the SYSLOG application must be properly installed and running.

9. The default destination port number for Syslog packets is **514**. To change it, enter:

network SYSLOGPORT=<port number>

10. Set up the routing table. This table describes how the controller communicates with the hosts on other networks. Use the **ROUTE** command to display the current settings (Figure 4–3).

- **ROUTE GATEWAY=<aaa.bbb.ccc.ddd>** sets the current gateway in the network routing table to the specified Internet address.
- **ROUTE DEL=<aaa.bbb.ccc.ddd> GATEWAY=<aaa.bbb.ccc.ddd>** deletes gateways from the routing table.
- **ROUTE ADD=<aaa.bbb.ccc.ddd> GATEWAY=<aaa.bbb.ccc.ddd>** adds new gateways to the table.
- If you have couplet controller, connect to (or Telnet to if this is not the initial set up) and log into the other controller. Repeat the appropriate steps to set its network parameters.

```

15000 [1]: route
Gateway NONE

Permanent S2A Routing Table
destination      gateway
-----
0.0.0.0          191.9.161.222
-----

Current 15000 Routing Table
ROUTE NET TABLE
destination      gateway      flags      Refcnt      Use      Interface
-----
0.0.0.0          191.9.161.222  3          0            0        fei0
160.100.0.0     191.9.161.222  3          0            3        fei0
191.9.0.0        191.9.160.208  101        0            0        fei0
-----

ROUTE HOST TABLE
destination      gateway      flags      Refcnt      Use      Interface
-----
127.0.0.1        127.0.0.1    5          0            0        lo0
-----

```

Figure 4-3 Current Controller Routing Table

11. On boot up, verify the network connections, enter **NETWORK PING=<IP address of a network system>**.
 - a) Ping a host on the same subnet as the controller.
 - b) Ping another host on a different subnet.
12. Make sure your firewall is running (which will block traffic and keep hosts from talking to each other), ensure it is set up to allow the controller to pass information on Port 23 (for Telnet), Port 161 (for SNMP), and Port 162 (for SNMP traps).

4.1.3 Login Names and Passwords

The controller’s two levels of security, administrative and general purpose user access, also applies to remote management. If you login as an administrator, you can access all the management and administrative functions. You can obtain status information and make changes to the system configuration. At the user access level, you are only allowed to view the status and configuration information of the system.

The login names and passwords can be changed using the **PASSWORD** command, via RS-232 or Telnet. By default, the administrator name is **admin** and its password is **password**. Similarly, the default user name is **user** and its password is **password**. If a user forgets the password, entering **PASSWORD DEFAULTS** while logged in as “admin” will restore all passwords and user names to the default values.

Only one Telnet session is permitted at a time. Once a Telnet session is initiated, the RS-232 console switches to a CLI sub-shell. For more information, see 3.6 ”Remote Login Management” beginning on page 76. The Telnet client should be using port 23 and have its local echoing function disabled.

4.1.4 SNMP Set Up on Host Computer

The following procedure explains how to set up the host computer to monitor the controller's events (SNMP traps).

NOTE : It is not possible to configure the controller through SNMP.

Refer to Section 4.1.2 in this guide for information regarding network and SNMP configuration on the controller. Contact SGI to obtain the **Management Information Base (MIB)** files for the controller.

1. Ensure the host computer, which will receive the traps, has an SNMP browser (such as HP OpenView) properly installed and configured. Refer to your browser's documentation for instructions on how to load the MIB files.
2. Set up the host computer to listen to Ports 161 and 162.
3. Load the following controller MIB. Note these MIB files:
 - **sdd.mib**
 - **sdd_trap.mib**

NOTE : When loading the controller MIB, **sdd_trap.mib** must be loaded last.

4. Start a query. You should be able to see various controller information such as **tempLevel**, **powerNumber**, **fanNumber**, **powerTable**, **tierNumber**, and **tierTable**.
5. To verify that the SNMP function has been set up correctly:
 - a) Unplug one of the power supplies.
 - b) Check that a power failure message appears in your SNMP browser.

4.1.4.1 Controller Implementation of SNMP

InfiniteStorage 15000 MIB (The InfiniteStorage 15000 MIB is read only.)

- Temperature status {normal, warning, critical}
- Fan Status ¥1{healthy, failure}
- Power Supply Status ¥4{healthy, failure}
- Tier Status ¥125
 - Disk A Status {healthy, failure, missing}
 - Disk B Status {healthy, failure, missing}
 - Disk C Status {healthy, failure, missing}
 - Disk D Status {healthy, failure, missing}
 - Disk E Status {healthy, failure, missing}
 - Disk F Status {healthy, failure, missing}
 - Disk G Status {healthy, failure, missing}
 - Disk H Status {healthy, failure, missing}
 - Disk P Status {healthy, failure, missing}
 - Disk S Status {healthy, failure, missing}

4.1.4.2 Traps

- Generic Traps
 - coldStart (occurs when the controller is restarted)
- Enterprise Specific Traps
 - Any changes in controller MIB.

If any variable in the controller MIB changes, a trap will be sent. For example, when a power supply fails or is replaced, a trap is sent. Trap includes ASCII string declaring new status of 15000 element.
 - 15000 status alerts.

Trap includes ASCII string declaring the controller as failed or healed.

4.2 Troubleshooting the Controller

This section details how to perform error recovery on the controller.

To display a list of all current controller system and drive enclosure faults, enter: **faults**

4.2.1 Component Failure Recovery

The controller contains redundant and hot-swappable fans and power supply units. A single component failure, therefore, will not shut down the system. However, in the unlikely event of component failure, you can replace the failed component while the controller is running. The replaced component will automatically be returned to service once the component has been installed and booted up.

4.2.1.1 Power Supply Failure

A power supply failure message will be displayed on your console if a power supply fails. The status LED on the power supply module will turn **off** (Figure 4–4).

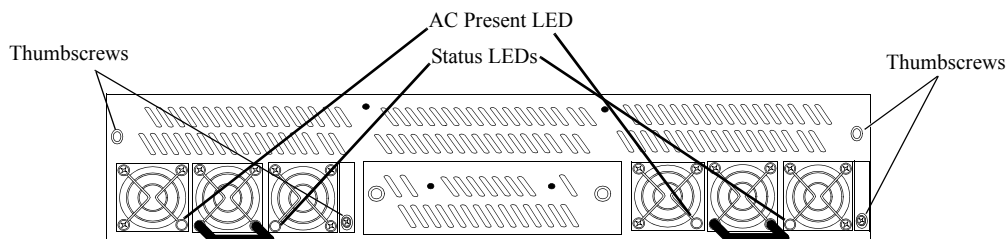

Figure 4–4 Power Modules - Front View

NOTE : Make sure you have the replacement power supply available before removing the failed module.

1. Remove the cover panel (if the panel is installed).
2. Locate the failed power supply module (indicated by an **off** Status LED).
3. Turn off module’s power switch (found on back of unit).

4. Remove the module's thumbscrews, then slide the module out of the bay.
5. Slide the module into the bay making sure it is fully inserted. Install the two thumbscrews to secure it.
6. Turn on the power switch. Check that the Status LED is **green**, indicating that the module is operating normally.
7. Replace the cover panel (if necessary).

4.2.1.2 Fan Failure

A fan failure error message will display on your console if the fan module fails. Follow these steps to replace the module.

NOTE : The controller should not be operated without the fan module for more than 15 seconds. Make sure you have the replacement fan unit available before removing the failed fan unit.

1. If a cover panel has been installed, take it off by removing its two thumbscrews.
2. Remove the two thumbscrews from the fan module (Figure 4–5).
3. Slide the module out of its bay.

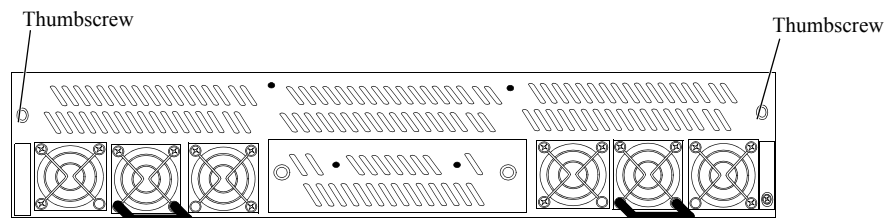

Figure 4–5 Fan Module

4. Slide the new module into the bay, making sure it is fully inserted.
5. Install the thumbscrews to secure it.
6. Replace the cover panel (if necessary).

4.2.2 Recovering from Drive Failures

When a drive failure occurs on the controller, the tier containing that drive will begin operating in degraded mode. This means that the tier will continue to handle I/O commands from the host, but there will be no redundancy to protect against additional drive failures on the same tier. If another disk drive fails on the same tier before the data on the first drive is rebuilt (to a replacement disk or hot spare), the tier will go offline.

If one disk in a tier fails, the data or parity information on the failed disk will be reconstructed from the parity disk and data disks of that tier. An entire channel may fail without data loss.

It is recommended that the controller's Automatic **Disk Rebuild** function be enabled at all times (**TIER AUTOREBUILD=ON**).

NOTE : If more than one disk is failed in a single tier, only the first disk to fail will be replaced by the spare disk. Any disks which fail after the first in each tier will not be reconstructed using a hot spare.

4.2.2.1 Single Drive Failures

A single drive failure in any tier does not result in the data loss. The LUN(s) on that tier will continue to operate in degraded mode. If a spare drive is available, the controller will automatically rebuild the data on the spare drive if “autorebuild” is enabled. System operation is not affected while recovery is taking place.

When a drive failure occurs, the controller displays an error message on your console, indicating which drive has failed and which spare drive (if available) is replacing the failed drive. If your drive enclosure is on the SGI official controller compatibility list, the **Fault LED** on the failed drive will turn **amber**. The error is also written to the event log. The controller will rebuild the drive automatically once it finds a suitable spare drive. You may monitor the rebuild progress or change the rebuild rate to match the user load. To obtain additional information, use the **TIER** or **LOG** command.

TIER displays the status of the disks. The failed drive is denoted by an “**r**”.

If a Rebuild is taking place, the percentage of completion is also displayed. Figure 4–6 illustrates a system that has a failed drive on Tier 2, Channel D and it is being rebuilt.

DISK INFO will indicate what spare drive is replacing the failed drive (Figure 4–6).

```
15000 [1]: disk info=2d
Disk:          2D
Status:        Failed and replaced by Spare 2s
Fail Status:   None
SMART Status:  Healthy
Disk DP Status: Present
Main DP Status: Present
Capacity:      140014 (Mbytes)
Blocks:        0x1117732F
Block size:    512
Medium RPM:    15K
Write cache:   Disabled
Interface:     SAS
Vendor Id:     SEAGATE
Product Id:    ST3146854SS
Product Rev:   0003
Serial Num:    3KN2M2R8
Link Speed:    SAS 3.0 Gb
Global Id:     5000C500000FF309

15000 [1]:

15000 [1]: disk info=2s
Disk:          2S
Status:        Replaced failed drive 2d
Fail Status:   None
SMART Status:  Healthy
Disk DP Status: Present
Main DP Status: Present
Capacity:      140014 (Mbytes)
Blocks:        0x1117732F
Block size:    512
Medium RPM:    15K
Write cache:   Disabled
Interface:     SAS
Vendor Id:     SEAGATE
Product Id:    ST3146854SS
Product Rev:   0003
Serial Num:    3KN2N28V
Link Speed:    SAS 3.0 Gb
Global Id:     5000C500000FED59

15000 [1]:
```

Figure 4–6 Obtaining Disk Information

4.2.2.2 Returning the System to a Fault-Tolerant State

When you find a failed drive on a tier, replace it as soon as possible so that the tier can return to its optimal state. If you replace the failed drive while a rebuild is taking place, the system will finish rebuilding data on the spare drive first. When a rebuild is complete and the failed drive has been replaced, the system will automatically copy the data from the spare drive to the new drive, and return the spare drive to its standby state. The tier is then fully restored.

If no suitable spare drive exists when a drive fails, replace the failed drive as soon as possible. Once the replacement drive is inserted and verified by the system, a rebuild will start automatically if Autorebuild is ON. If not, initiate a rebuild by doing the following:

1. Enter: **diskscan**

The system checks each channel and looks for newly inserted drive(s).

2. Enter: **disk rebuild=<tier><channel>**.

This command initiates a disk build by tier and channel.

4.2.2.3 Manually Replacing a Failed Disk with Spare Disk

You may manually replace a specified failed disk with a spare disk using **DISK REPLACE=<tier><channel>**. A Replace operation is used to temporarily replace a failed disk with a healthy spare disk. The operation can take several hours to complete depending on the size of the disk and speed of the replace operation. The speed of the replace operation can be adjusted with the **DELAY** and **EXTENT** parameters. (See “Resources Allocation” on page 66.)

4.2.2.4 Changing the Rate of Rebuild

The commands **TIER DELAY** and **TIER EXTENT** control the percentage of processor time allocated to rebuild compared to I/O handling. Rebuild is done in steps. **DELAY** will control the amount of wait time before rebuilding the next chunk of data. **EXTENT** determines the size of data used to rebuild.

To increase the rate of rebuild, reduce the **DELAY** value. (See “Resources Allocation” on page 66.) We recommend that you use the default **DELAY** and **EXTENT** settings unless you have a specific need to change them.

4.2.2.5 Interrupting the Rebuild Operation

To abort the rebuild, enter **tier stop** to stop all current rebuild operations.

4.2.2.6 Multiple Drive and Channel Failures

If multiple drives on the same drive channel fail simultaneously, the problem may be a channel failure rather than a series of drive failures. For example, if drives 1D, 2D, and 3D fail at the same time, the problem may be in Channel D rather than in the drives. If the drives fail as the result of a channel failure, data on the drives may not be lost. Any single channel failure can be recovered.

Before you replace any drives:

1. Use the **TIER** command to check the current disk status and see if the drives failed are all on the same channel.
2. Use the **DISK** command to check the status of the channel.

The Recovery steps are:

1. Contact SGI technical support to determine the cause of error and what steps may need to be taken to recover from the error.
2. Isolate the cause of channel failure (for example, loose cable connections).
3. Rebuild all the drives on that channel individually by issuing the command:

disk rebuild=<tier><channel>

For example, **disk rebuild=1d**, **disk rebuild=2d**, **disk rebuild=3d**.

Several rebuild operations are processed at the same time. The other rebuild jobs are queued up and processed in the same order as they were entered.

4.2.3 Component Failure on Enclosures

The controller implements the **SCSI Enclosure Services (SES)** protocol to communicate with its drive enclosures. If your enclosure provides SES communications, then enclosure status information of the , including power supply, fan, and presence of drive, will be obtained and evaluated. If a change in status is found, an SES message is displayed on your console (Figure 4–7).



```
EncID: 50001FF1:3E081000 Power Supply 1: OK
```

Figure 4–7 Example of SES Message

If your enclosures provide redundant SES communication paths, the message will be reported twice. “EncID” is the Enclosure Identifier of the enclosure that reported the failure. The last four digits of the WWN is the last four digits of the enclosure’s serial number.

Chapter 5

Drive Enclosure System

5.1 The SGI InfiniteStorage 15000 Drive Enclosure

The SGI InfiniteStorage 15000 drive enclosure storage system is an ultra dense 4U 60 disk drive enclosure. [Figure 5-1](#) and [Figure 5-2](#) show front and rear views of a drive enclosure, respectively. Module and major components and their locations are shown in [Figure 5-3](#).

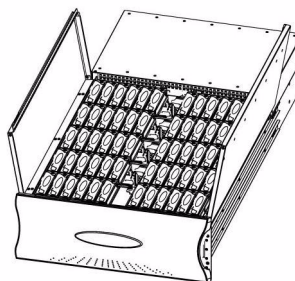

Figure 5-1 The Drive Enclosure System - front open view

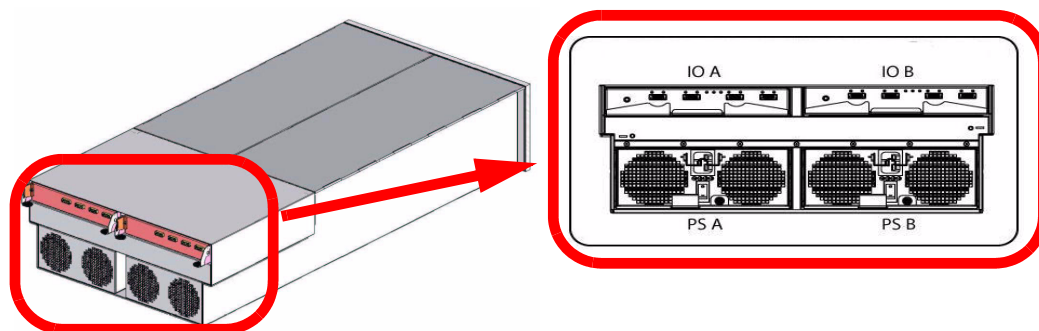

Figure 5-2 The Drive Enclosure System - rear isometric and rear views

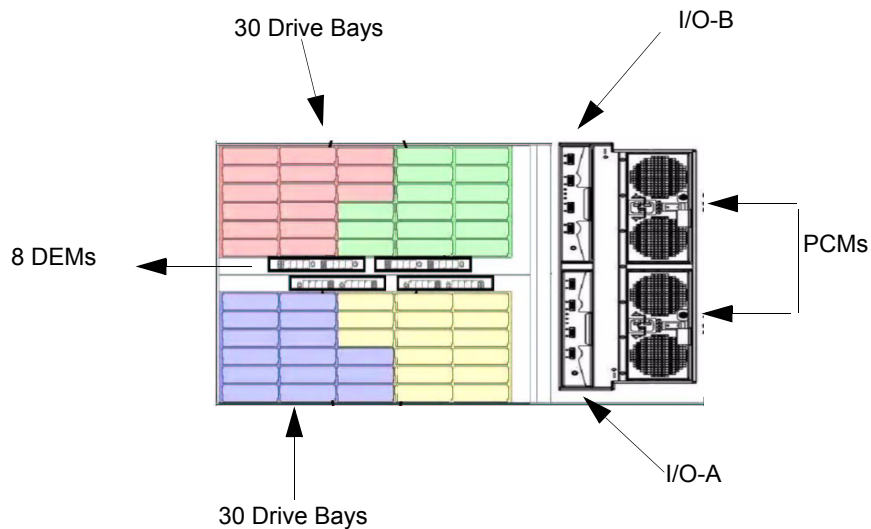

Figure 5–3 Drive Enclosure Module Locations

5.2 Enclosure Core Product

The drive enclosure design concept is based on a subsystem together with a set of plug-in modules and *(as supplied)* comprises:

- **Enclosure Chassis** with integral Front Panel Drive Status Indicator ([Figure 5–9](#)).
- Two (2) 1865W **Power Cooling (PCM)** plug-in modules ([Figure 5–4](#)).
- Two (2) plug-in **Input/Output (I/O)** modules ([Figure 5–5](#)).
- A midplane separates the front and back of the chassis and provides the interconnect system between the PCMs, I/O modules, and the baseboard.
- Up to 60 top loadable hard disk drives (HDDs) in a 5x12 matrix.
- SAS and SATA drive intermix allowed.
The InfiniteStorage 15000 supports both SATA and SAS interface drives. SATA and SAS interface drives can be mixed with a configuration. However, the mixing of SAS and SATA drives within a tier is not recommended or supported.
- Eight (8) SAS disk expander modules (DEMs).

5.2.1 Enclosure Chassis

The chassis assembly contains 60 drive bays at the front, each of which accommodates a plug-in drive carrier module. The 60 drive bays are arranged in five rows of twelve drives (5x12). At the rear, the chassis assembly contains two (2) PCMs and two (2) I/O modules.

The chassis is fitted with 19-inch rack mounting features which enables it to be fitted to four (4) 19-inch racks and uses four (4) EIA units of rack space.

5.3 The Plug-in Modules

A drive enclosure requires the following modules for normal operation:

- Power Cooling Module (PCM)
- Input/Output Module (I/O)
- Drive Carrier Module
- Drive Expander Module (DEM)

5.3.1 Power Cooling Module (PCM)

Two (2) auto ranging AC 1865W Power Cooling modules ([Figure 5-4](#)) are supplied already mounted in the rear of the enclosure as part of the subsystem core product.

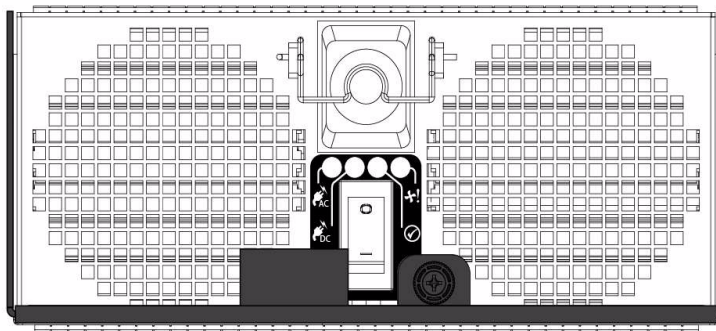
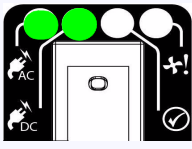
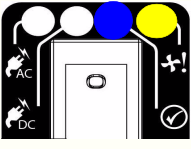





Figure 5-4 Power Cooling Module (1)

The drive enclosure must always be operated with two Power Cooling Modules fitted (2 PCMs). Module replacement should only take a few minutes to perform but must be completed within 10 minutes from removal of the failed module. Four (4) LEDs mounted on the PCM ([Table 5-1](#)) indicate the status of the PCM and the fans. PCM voltage operating ranges are nominally 200V to 240V AC.

Table 5–1 PCM LEDs

PCM LEDs				
				
Normal Operation LEDs		Faults LEDs		Enclosure Audible Alarm
	GREEN	AC Input FAILURE	off	Off
	GREEN	DC Output FAILURE	off	Off
	OFF	Fan Fault / Power Supply Fault	AMBER	Off
	OFF	ID	BLUE	Off

5.3.2 Input/Output (I/O) Module

The drive enclosure storage subsystem includes an enclosure with rear facing bays which house two (2) I/O modules (Figure 5–5). Processors housed on the I/O modules provide enclosure management and interface to devices on the Backplane, PCM, and Display Panel in order to monitor internal functions.

The plug-in I/O modules have been designed for integration into a drive enclosure storage subsystem, providing external SAS cable interfacing with up to 60 SAS or SATA disk drives.

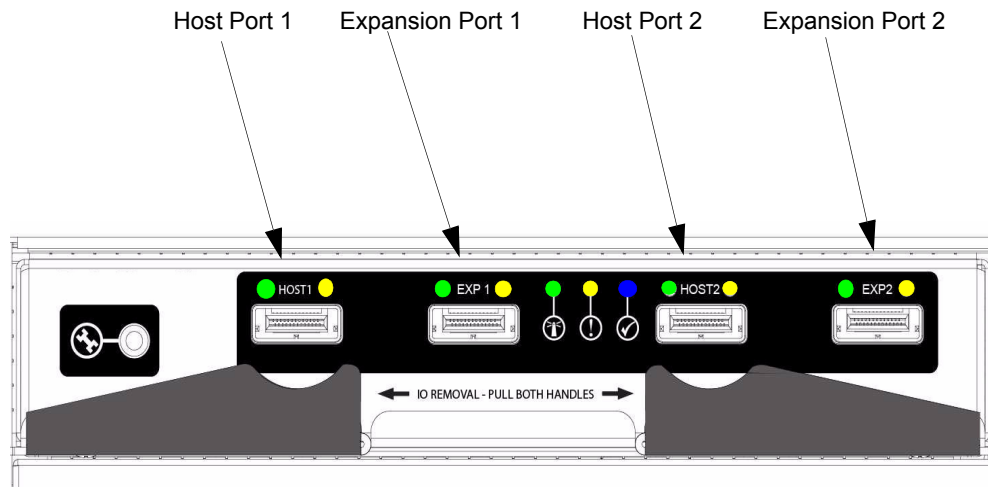

Figure 5-5 I/O Module

Table 5-2 defines the LED indicators incorporated on the I/O module.

Table 5-2 I/O Module LEDs



LED	Color	STATUS	Definition	Enclosure Audible Alarm
Host Port 1 Expansion Port 1 Host Port 2 Expansion Port 2	Green	ON OFF	<ul style="list-style-type: none"> Incoming signal is GOOD No connection or incorrect connection 	•Off
Host Port 1 Expansion Port 1 Host Port 2 Expansion Port 2	Amber	ON OFF	<ul style="list-style-type: none"> Fault No faults 	•Off
 I/O Module OK	Green	ON OFF	<ul style="list-style-type: none"> properly booted and functioning correctly internal fault 	•Off

Table 5-2 I/O Module LEDs

	I/O Module Fault	Amber	OFF ON	•No Faults present I/O Fault	•Off
	I/O Module Identity	Blue	ON OFF	•Receiving SES Command Not receiving SES Command	•Off

5.3.3 Drive Carrier Module and Status Indicator

The Drive Carrier Module comprises a hard disk mounted in a carrier (Figure 5-6). Each drive bay can house a single Low Profile 1.0 inch high, 3.5 inch form factor disk drive in its carrier.

The handle provides the following functions:

- Camming of carrier into and out of drive bays.
- Positive 'spring loading' of the drive/baseplane connector.
- The handle assembly also incorporates a Drive Status LED (Figure 5-6).

Note The enclosure system design allows for drive bays to be left empty without the need for fitting dummy drive carriers.

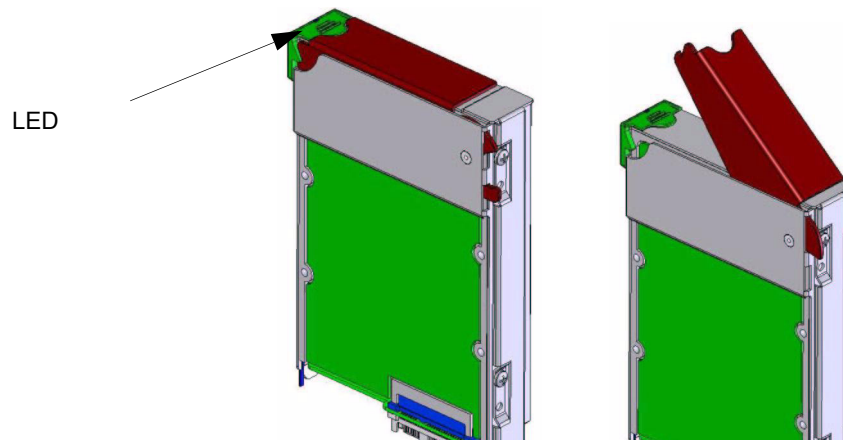

Figure 5-6 Drive Carrier Module: Closed and Opened

5.3.4 DEM Card

The drive enclosure contains eight (8) top-loadable DEMs. The DEMs (Figure 5-7) provide the SAS connectivity between the I/O module and the HDDs located within the enclosure.

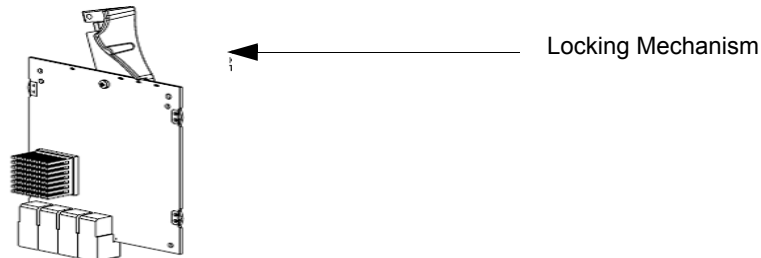

Figure 5-7 DEM

Note The DEM is a serviceable PCB which may be replaced by trained personnel.

Each DEM connects to a single port of the HDD based on the location within the enclosure within which it is installed ([Figure 5-8](#)). Each provides power control signals to each drive slot. It controls HDD identify/service LEDs and monitors the status from partner DEM. Each pair set DEM supports 15 drives; there are 8 DEMs in a fully configured system.

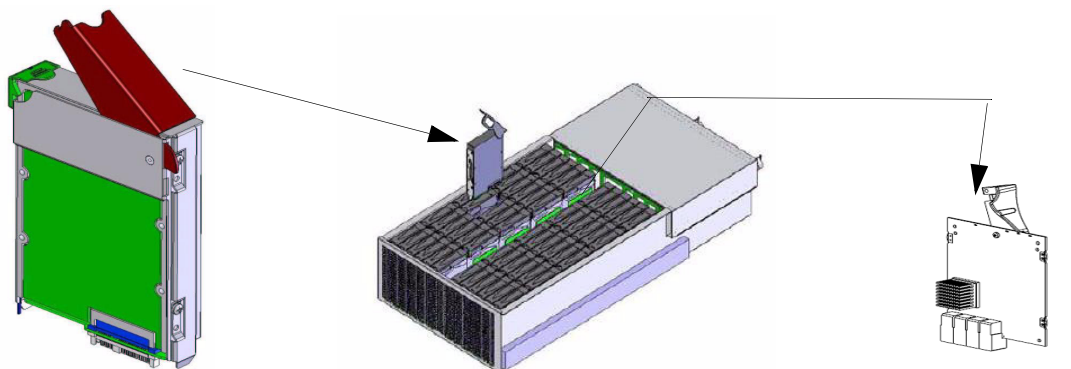

Figure 5-8 Drive Carrier and DEM Locations

5.4 Indicators

The drive enclosure has both FRU and status LEDs to indicate the state of various components within the enclosure. Each FRU has a visible BLUE identity LED. Each FRU, except the HDD, has a visible AMBER LED which indicates a fault.

Note In some components, the failure LED is internal to the enclosure and visible only when the cover is open.

The state of each LED within the enclosure is available through the in-band SES functionality at all times. The host can manually set the state of each LED through an in-band SES page.

5.4.1 Front Panel Drive Activity Indicators

The Front Panel Drive Activity Indicators show the aggregated status of all the modules. This panel and its associated LEDs are shown in [Figure 5-9](#). Drive activity LEDs flash during data I/O when transition

cards are fitted to drives. These LEDs indicate drive presence. The Front Display Panel LEDs are defined in [Table 5-3](#).

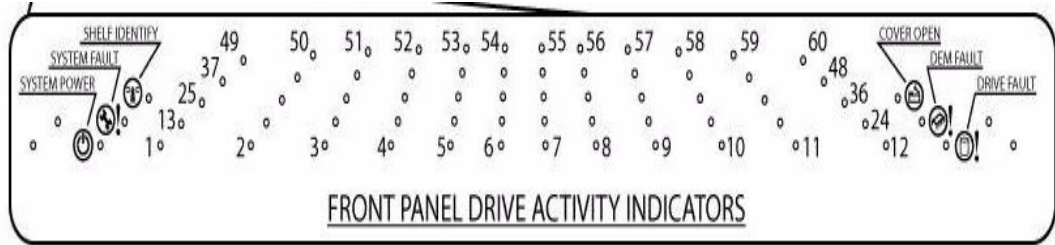



Figure 5-9 Front Panel Drive Activity Indicators Panel

Table 5-3 Display Panel LEDs

ICON	LABEL	COLOR	Definition	Normal Behavior	Enclosure Audible Alarm
	Shelf Identify	BLUE	enclosure Identity	ON -SES is sending an identity command. OFF -SES is NOT sending an identity command	Off
	System Fault	AMBER	Enclosure Fault	ON -one or more components within enclosure have failed. A service action is required. Exact failed component has its own amber fault LED lit. OFF -no detectable faults	Off
	System Power	GREEN	Enclosure Powered ON	ON - DC power is present OFF - DC power is NOT present LED does NOT flash under normal operating conditions.	Off
	Cover Open	AMBER	Enclosure cover is open	OFF -both cover pieces securely closed and latched in place. ON -either of the cover pieces is NOT securely closed and latched in place	Off
	DEM Fault	AMBER	DEM fault	OFF -all DEMs operating correctly. ON -at least one DEM has failed; service action required	Off

Table 5-3 Display Panel LEDs

ICON	LABEL	COLOR	Definition	Normal Behavior	Enclosure Audible Alarm
	Drive Fault	AMBER	Drive fault	ON -one or more HDDs are faulted. SES must determine exact HDD. OFF -no detectable drive faults	Off
Individually numbered	HDDs	GREEN	HDD activity	ON -indicates HDD activity OFF -no HDD activity	Off

5.4.2 Internal Indicators

Note In some components, the failure LED is internal to the enclosure and visible only when the cover is open. The Internal LED indicators are explained in [Table 5-4](#).

Table 5-4 INTERNAL LED Indicators

Description	Location	Color	Normal Behavior	Enclosure Audible Alarm
DEM DC	DEM internal to enclosure	GREEN	ON -1.2VDC regulator circuit correctly functioning OFF - faulty 2.1VDC regulator circuit	Off
DEM ID	DEM internal to enclosure	BLUE	ON -receiving SES identity command OFF -NOT receiving SES identity command	Off
HDD ID	HDD internal to enclosure	BLUE	ON -receiving SES identity command OFF -NOT receiving SES identity command	Off

5.4.3 Rear of Enclosure Activity Indicators

The PCMs and the I/O Modules are located on the rear of the enclosures. The LEDs on the rear of the enclosure are explained in [Table 5-5](#).

Table 5-5 LEDs on the Rear of the Enclosure

Description	Location	COLOR	Normal Behavior	Enclosure Audible Alarm
PCM DC ok	PCM rear of enclosure	GREEN	ON -DC output of PCM within tolerances. OFF -failed PCM	Off
PCM AC ok	PCM rear of enclosure	GREEN	ON -AC input to PCM within tolerances. OFF -failed PCM	Off
PCM Fault	PCM rear of enclosure	AMBER	ON - PCM fault detected OFF - no detected PCM faults.	Off
PCM ID	PCM rear of enclosure	BLUE	ON -receiving SES identity command OFF -NOT receiving SES identity command	Off
I/O Module ok	I/O Module rear of enclosure	GREEN	ON -properly booted and functioning correctly. OFF -I/O Module internal fault	Off
I/O Fault	I/O Module rear of enclosure	AMBER	ON - I/O module fault detected OFF - no detected I/O module faults.	Off
I/O Module ID	I/O Module rear of enclosure	BLUE	ON -receiving SES identity command OFF -NOT receiving SES identity command	Off

Table 5-5 LEDs on the Rear of the Enclosure

Description	Location	COLOR	Normal Behavior	Enclosure Audible Alarm
SAS Link	I/O Module rear of enclosure	GREEN	ON -a valid SAS link established on at least 1 of the 4 SAS links of the 4-wide SAS port. OFF -no SAS links	Off
SAS Link Fault	I/O Module rear of enclosure	AMBER	ON -a detectable fault on at least 1 of the 4 SAS links of the 4-wide SAS port. OFF -no detectable faults	Off

5.5 Visible and Audible Alarms

The functional modules have associated status LEDs. The Display Panel ([Table 5-3](#)) shows a consolidated status for all modules:

- Constant GREEN or BLUE LEDs indicate good or positive indication.
- Constant AMBER LEDs indicate that there is a fault present within that module.

Note The Display Panel also incorporates an *Audible Alarm*. The only time the enclosure will sound an alarm is when the top cover of the enclosure is opened. There is a warning beep when the cover is first opened. If the top cover is left open for more than five minutes, the audible alarm will be continuous.

Warning The Display Panel is an integral part of the enclosure chassis assembly and is not field replaceable.

5.6 Drive Enclosure Technical Specification

5.6.1 Dimensions

Enclosure	inches	millimeters
Height	6.97	177
Width front	16.56	420.6
Width rear	17.56	446
Depth	42	1067
front surface of bezel to end of cable management arms		
LENGTH	36	914
rack mounting surface to rear connectors surface		

5.6.2 Weight

Item	Quantity per System	LBS (kg)	Extended Weight
Chassis Includes Base PCB & Midplane	1	83	83
PCM	2	12	24
I/O Module Drives	2	4	8
	60	2	120
Miscellaneous	1	5	5
Total Weight			240

5.6.3 AC INPUT PCM

Input Parameter	Value
Input Voltage	190 - 264 VAC
Input Frequency	47 - 63 Hz and 400 hz
Maximum Input Current	13.1A RMS @ 190 VAC
Peak Inrush Current	50A @ 230VAC, 25°C, 5 msec max
Minimum Efficiency measured at 30% and 50% load and nominal line (208 VAC)	90%
Maximum Average Output Power	1750 W
Maximum Peak Output Power, 1 second	1922W

5.6.4 DC INPUT PCM

Input Parameter	Value
Input Voltage	36 - 72 VAC
Maximum Input Current	TBD
Peak Inrush Current	TBD
Minimum Efficiency measured at 30% and 50% load and nominal line (48 DVC)	90%
Maximum Average Output Power	1750 W
Maximum Peak Output Power, 1 second	1922W

5.6.5 DC OUTPUT PCM

Output Parameter	3.3 VDC Output	5 VDC Output	12 VDC Output
Normal Voltage	3.3 VDC	5.10 VDC	12.10 VDC
Full Load	5.0A	55.0A	120.0A
Peak Load for 1 Second	5.0A	65.0A	130.0A
Minimum Load (A)	0.0A	0.0A	0.0A

5.6.6 PCM Safety and EMC Compliance

Safety Compliance UL 60950
 IEC 60950
 EN 60950

EMC Compliance CFR47 Part 15B Class A
 EN55022
 EN55024

5.6.7 Power Cord

(minimum requirements)

Cord Type SV or SVT, 18 AWG minimum, 3 conductor
 Plug 250V, 10A
 Socket IEC 320 C-14, 250V, 15A

Note Power cord is not included in the standard drive enclosure package.

5.7 Environment

The enclosure and all of its sub-components are compliant to the European Union RoHS (Restriction of Hazardous Substances) Directive (Directive 2002/95/EC) with no exceptions or exemptions.

Chapter 6

Drive Enclosure Installation

6.1 Introduction

Caution When connecting up the drive enclosure subsystem, use only the cables supplied.

6.2 Planning Your Installation

Before you begin installation, you should become familiar with the configuration requirements of your drive enclosure system and the correct positions of each of the optional plug-in modules (Table 6-1).

Table 6-1 Drive Enclosure Configuration

Module	Location
Drive Bays	<p>You can install from 1 - 60 drives in the enclosure.</p> <p>In 1x mode, (connected to 10 enclosures), you can install any number of drives in the enclosure, but every enclosure should have the same number of drives.</p> <p>In 2x mode, (connected to 5 enclosures), you must install drives in multiples of two (2).</p>

Table 6–1 Drive Enclosure Configuration

Module	Location
Power Cooling Modules (PCM)	Two (2) PCMs must be fitted. Full power and cooling redundancy is provided while a faulty module is replaced. Install the PCMs in lower rear bays A and B. Note: Rear bays are numbered from A and B starting from the left when viewed from the back.
I/O Module	One or two I/O modules should be Installed in the upper rear bays A & B. Note: If only one module is installed, it should be fitted in Module Location A and a blank plate must be fitted over the unused bay.

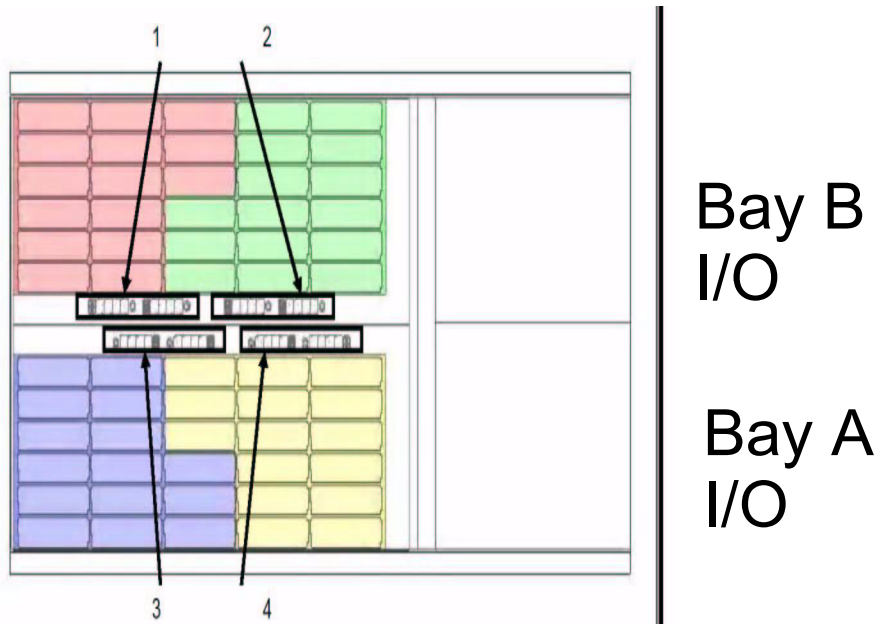

Figure 6–1 DEM Pair Locations

6.2.1 Enclosure Bay Numbering Convention

Warning Operation of the Enclosure with *ANY* of the plug-in modules missing from the rear of the enclosure will disrupt the airflow and the drives will not receive sufficient cooling. It is *ESSENTIAL* that all (rear) apertures are filled before operating the unit.

The drive enclosure subsystem is housed in a 60-drive bay enclosure, arranged in four (4) groups. Each group comprises two banks of 15 bays, that is, (as viewed from the front): 12 bays across the enclosure by 5 bays deep. There are two numbering schemes: 1x60 and 2x30. The drive bays are numbered in accordance with the tables shown in [Figure 6–2](#) and [Figure 6–3](#), when viewed from above.

Note Drive 61 is optional drive.

DRIVE 1	DRIVE 13	DRIVE 25	DRIVE 37	DRIVE 49
DRIVE 2	DRIVE 14	DRIVE 26	DRIVE 38	DRIVE 50
DRIVE 3	DRIVE 15	DRIVE 27	DRIVE 39	DRIVE 51
DRIVE 4	DRIVE 16	DRIVE 28	DRIVE 40	DRIVE 52
DRIVE 5	DRIVE 17	DRIVE 29	DRIVE 41	DRIVE 53
DRIVE 6	DRIVE 18	DRIVE 30	DRIVE 42	DRIVE 54
AUX DRIVE	DEM 2B DEM 4A	DEM 2A DEM 4B	DEM 3B DEM 3A	DEM 1A DEM 3B
DRIVE 7	DRIVE 19	DRIVE 31	DRIVE 43	DRIVE 55
DRIVE 8	DRIVE 20	DRIVE 32	DRIVE 44	DRIVE 56
DRIVE 9	DRIVE 21	DRIVE 33	DRIVE 45	DRIVE 57
DRIVE 10	DRIVE 22	DRIVE 34	DRIVE 46	DRIVE 58
DRIVE 11	DRIVE 23	DRIVE 35	DRIVE 47	DRIVE 59
DRIVE 12	DRIVE 24	DRIVE 36	DRIVE 48	DRIVE 60

Figure 6–2 1X60 Drive Numbering Table.

DRIVE 1	DRIVE 7	DRIVE 13	DRIVE 19	DRIVE 25
DRIVE 2	DRIVE 8	DRIVE 14	DRIVE 20	DRIVE 26
DRIVE 3	DRIVE 9	DRIVE 15	DRIVE 21	DRIVE 27
DRIVE 4	DRIVE 10	DRIVE 16	DRIVE 22	DRIVE 28
DRIVE 5	DRIVE 11	DRIVE 17	DRIVE 23	DRIVE 29
DRIVE 6	DRIVE 12	DRIVE 18	DRIVE 24	DRIVE 30
AUX DRIVE	DEM 2B DEM 4A	DEM 2A DEM 4B	DEM 1B DEM 3A	DEM 1A DEM 3B
DRIVE 1	DRIVE 7	DRIVE 13	DRIVE 19	DRIVE 25
DRIVE 2	DRIVE 8	DRIVE 14	DRIVE 20	DRIVE 26
DRIVE 3	DRIVE 9	DRIVE 15	DRIVE 21	DRIVE 27
DRIVE 4	DRIVE 10	DRIVE 16	DRIVE 22	DRIVE 28
DRIVE 5	DRIVE 11	DRIVE 17	DRIVE 23	DRIVE 29
DRIVE 6	DRIVE 12	DRIVE 18	DRIVE 24	DRIVE 30

Figure 6–3 2x30 Drive Numbering Table

6.3 Enclosure Installation Procedures

Important SGI InfiniteStorage 15000 drive enclosures should only be installed in SGI InfiniteStorage 15000 racks. Mounting and installing these drive enclosures in any other rack is not authorized or supported by SGI.

Warning The drive enclosure with all its component parts installed is too heavy for a single person to easily install into a Rack cabinet.

Caution Ensure that you have fitted and checked a suitable anti-static wrist or ankle strap and observe all conventional ESD precautions when handling drive enclosure modules and components. Avoid contact with Backplane components and module connectors, etc.

Note Drive enclosures are supplied and delivered populated with Backplane, Baseplane, Front Panel, DEMs, and with PCMs installed. The Drive Carrier Modules are supplied as a separate package.

A typical rack mounting installation is shown in [Figure 6-4](#)

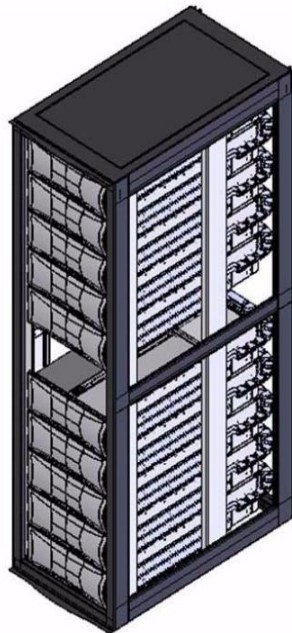

Figure 6-4 Full Rack without Controllers.

6.4 I/O Module Configurations

6.4.1 Controller Options

- The drive enclosure has a standard SAS JBOD IO controller, which employs a 36-port expander with zoning. The zoning is implemented via a preset piano-switch located on the enclosure baseboard. Host ports 1 and 2 present drives 1 through 30 and host ports 3 and 4 present drives 31 through 60. Each host port responds with drive information applicable only to the drives presented on the respective zone and enclosure status information for the entire enclosure.

6.5 SAS DEM

The drive enclosure contains eight (8) top-loadable DEMs. The DEMs provide the SAS connectivity between the I/O module and the HDDs located within the enclosure. Each DEM connects to a single port of the HDD based on the location within the enclosure in which it is installed. Each of the eight DEMs installed in the enclosure has a unique I²C and SAS address based on a proprietary SAS address generation scheme.

6.6 SATA Interposer Features

The drive enclosure supports an active/active SATA MUX interposer which allows simultaneous access to the SATA HDD from both I/O modules installed in the enclosure. The MUX is implemented as a dongle module installed in the HDD carrier assembly. Additionally, the SATA interposer allows the power cycling of an individual HDD via SES commands.

6.7 Drive Enclosure Device Addressing

See Appendix B, “Drive Addressing”.

6.8 Grounding Checks

The product must only be connected to a power source that has a safety electrical earth connection.

Warning **If more than one product is fitted in a rack, the earth connection to the rack is even more important, because the rack will then have a high “EARTH LEAKAGE CURRENT” (“TOUCH CURRENT”).**

The earth connection to the rack must be checked before switching on, by an electrical engineer who is qualified to the appropriate local and National standards to perform the check.

Chapter 7

Drive Enclosure Operation

7.1 Before You Begin

Before powering up the enclosure, please ensure that all the modules are firmly seated in their correct bays.

7.2 Power On / Power Down

Caution *Do not operate the subsystem until the ambient temperature is within the specified operating range. If the drives have been recently installed, ensure they have had time to acclimatize before operating them.*

To Power On the enclosure.

- Apply AC power to the enclosure. Turn the PCMs to ON.

All LEDs on the I/O Panel should be lit (Green) when the enclosure power is activated (and the disk drive motors should start).

Important **If AC power is lost for any reason, on restoration of power the enclosure will re-start automatically.**

To power the enclosure down:

- Switch off the PCMs installed in the enclosure.

7.2.1 PCM LEDs

The PCM incorporates 4 LEDs, located above the On/Off switch. Please refer to [Figure 5-4](#) and [Table 5-2](#).

7.2.2 I/O Panel LEDs

The I/O Panel LEDs fault and status conditions are shown in [Figure 7-1](#).

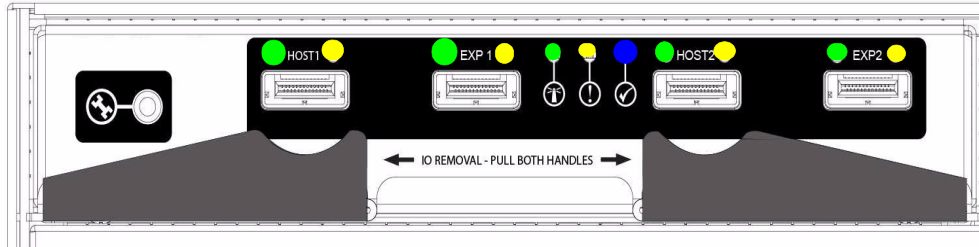







Figure 7-1 I/O Panel LEDs

[Table 7-1](#) defines the LED indicators incorporated on the I/O module.

Table 7-1 I/O Module LEDs

LED	Color	STATUS	Definition
 Host Port 1 Expansion Port 1 Host Port 2 Expansion Port 2	Green	ON OFF	<ul style="list-style-type: none"> Incoming signal is GOOD No connection or incorrect connection
 Host Port 1 Expansion Port 1 Host Port 2 Expansion Port 2	Amber	ON OFF	<ul style="list-style-type: none"> Fault No faults
 I/O Module OK	Green	ON OFF	<ul style="list-style-type: none"> properly booted and functioning correctly internal fault
 I/O Module Fault	Amber	OFF ON	<ul style="list-style-type: none"> No Faults present I/O Fault
 I/O Module Identity	Blue	ON OFF	<ul style="list-style-type: none"> Receiving SES Command Not receiving SES Command

Chapter 8

Drive Enclosure Troubleshooting

8.1 Overview

The SGI InfiniteStorage15000 Drive Enclosure includes an Enclosure Services Processor and associated monitoring and control logic to enable it to diagnose problems within the enclosure's power, cooling, and drive systems.

The sensors for power and cooling conditions are housed within the PCMs. Each unit is independently monitored.

8.2 Initial Start-up Problems

8.2.1 Faulty Cords

First check that you have wired up the subsystem correctly. If:

- cords are missing or damaged,
- plugs are incorrect,
- cords are too short,

Call your supplier for a replacement.

8.2.2 Alarm Sounds On Power Up

Please refer to Section [8.4](#).

8.2.3 Green “Signal Good” LED on I/O Module Not Lit

Check to ensure that the cables have not been reversed during installation.

8.2.4 Computer Doesn't Recognize the Drive Enclosure Subsystem

- 1 Check that the SAS interface cables from the drive enclosure to the host computer, or I/O controller, are fitted correctly.
- 2 Check that all drive carrier modules have been correctly installed.

- 3 Check that there is a valid SAS signal present at the I/O connector. If there is no signal present, ensure the cable has been properly inserted.
- 4 Check the I/O module setup as follows:
 - Ensure the I/O module has been correctly installed and all external links and cables are securely fitted.
 - Ensure the maximum cable length has not been exceeded.

8.3 LEDs

Green LEDs are always used for good or positive indication. Amber LEDs indicate there is a critical fault present within the module. See specific LED tables for further information.

8.3.1 HDD (Hard Disk Drive)

When a HDD is faulted, [Table 8–1](#) describes the fault LED behavior.

- Under Normal conditions, the LEDs should all be illuminated constant GREEN.
- If a problem is detected, the color of the relevant LED will change to AMBER.

Table 8–1 HDD LEDs

Location	Color	Identifier	Behavior
Enclosure front	Amber	Enclosure fault	This LED is ON with a drive fault
Enclosure front	Amber	Drive fault	This LED is ON with a drive fault

8.3.2 PCM (Power Cooling Module)

The PCM LEDs are shown in [Table 8–2](#).

- Under Normal conditions, the LEDs should all be illuminated constant GREEN
- If a problem is detected, the color of the relevant LED will change to AMBER.

Table 8–2 PCM LEDs

Location	Color	LED Identifier	Behavior
FRONT Enclosure	Amber	Enclosure fault	This LED is ON with a PCM fault.
REAR Enclosure PCM	Amber	PCM fault	This LED is ON with an AC input, DC output, fan or other PCM fault.
REAR Enclosure PCM	Green	AC OK	This LED is ON with a DC or fan fault. This LED is OFF with an AC input failure.
REAR Enclosure PCM	Green	DC OK	This LED is ON with an AC or fan fault. This LED is OFF with an DC output failure

8.3.3 DEM (Drive Expander Module)

The DEM fault LEDs are explained in [Table 8–3](#).

- Under Normal conditions, the LEDs should all be illuminated constant GREEN
- If a problem is detected, the color of the relevant LED will change to AMBER.

Table 8–3 DEM LEDs

Location	Color	LED Identifier	Behavior
FRONT Enclosure	Amber	Enclosure fault	ON with a DEM fault.
FRONT Enclosure	Amber	DEM fault	ON with a DEM fault.
Internal (DEM) Enclosure	Amber	DEM fault	ON with a DEM fault.
Internal (DEM) Enclosure	Green	DC OK	ON when the DC voltage regulation is within limits. OFF with a DC output failure.
Internal (DEM) Enclosure	Green	Expander MIPS ready	ON when the expander internal processor is booted and operating correctly. OFF when the expander internal processor is NOT booted or ready.
Internal (DEM) Enclosure	BLUE	DEM identify	ON indicates that this DEM is being sent an identify command by the SEP.

8.3.4 I/O Module

The I/O fault LEDs are explained in [Table 8–4](#).

- Under Normal conditions, the LEDs should all be illuminated constant GREEN
- If a problem is detected, the color of the relevant LED will change to AMBER.

Table 8–4 I/O LEDs

Location	Color	LED Identifier	Behavior
FRONT Enclosure	Amber	Enclosure fault	ON with an I/O fault.
REAR Enclosure	Green	I/O OK	OFF when an I/O module detectable fault is present. INDEPENDENT of SAS link fault condition and stays lit during a SAS link fault.
REAR Enclosure	Amber	I/O fault	ON when a detectable fault is present in the I/O module. INDEPENDENT of SAS link fault condition and stays lit during a SAS link fault.

Table 8-4 I/O LEDs

REAR Enclosure	Green	SAS Link Activity	ON when a valid link is present on any of the 4 links of the 4-wide port. OFF when none of the 4 links of the 4-wide port have a valid connection.
REAR Enclosure	Amber	SAS Link Fault	ON when a fault is present on any of the 4 links of the 4-wide port. OFF when none of the 4 links of the 4-wide port have a fault.

8.3.5 Front Panel Drive Activity Indicators

The Front Panel Drive Activity Indicators show the aggregated status of all the modules. This panel and its associated LEDs are shown in [Figure 8-1](#). The Display Panel LEDs are defined in [Table 8-5](#).

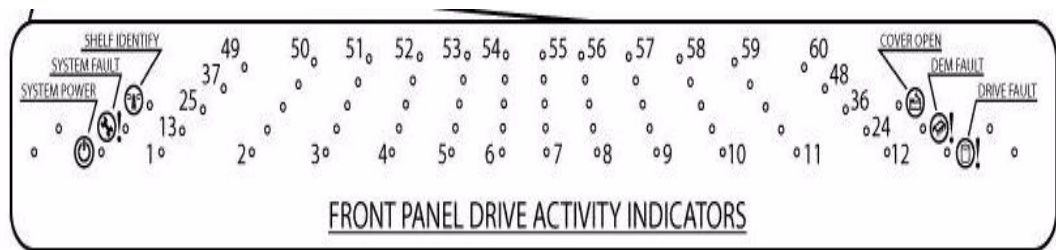





Figure 8-1 Front Panel Drive Activity Indicators Panel

Table 8-5 Display Panel LEDs

ICON	LABEL	COLOR	Definition	Normal Behavior
	Shelf Identify	BLUE	enclosure Identity	ON -SES is sending an identity command. OFF -SES is NOT sending an identity command
	System Fault	AMBER	Enclosure Fault	ON -one or more components within enclosure have failed. A service action is required. Exact failed component has its own amber fault LED lit. OFF -no detectable faults
	System Power	GREEN	Enclosure Powered ON	ON - DC power is present OFF - DC power is NOT present LED does NOT flash under normal operating conditions.

Table 8–5 Display Panel LEDs

ICON	LABEL	COLOR	Definition	Normal Behavior
	Cover Open	AMBER	Enclosure cover is open	OFF -both cover pieces securely closed and latched in place. ON -either of the cover pieces is NOT securely closed and latched in place
	DEM Fault	AMBER	DEM fault	OFF -all DEMs operating correctly. ON -at least one DEM has failed; service action required
	Drive Fault	AMBER	Drive fault	ON -one or more HDDs are faulted. SES must determine exact HDD. OFF -no detectable drive faults

8.4 Audible Alarm

When the Audible Alarm sounds, use the appropriate SES CLI command.

8.4.1 Top Cover Open

The Audible Alarm sounds anytime the top cover is open. The alarm mutes automatically once the cover is closed.

8.4.2 SES Command

The Audible Alarm can be set through SES communication. When set in this manner, the alarm remains on until any one of the following conditions is met:

- Enclosure is power cycled.
- Alarm is turned off through SES command.

8.5 Troubleshooting

The following sections describe common problems (and possible solutions) you might encounter with your drive enclosure system.

8.5.1 Thermal Control

The drive enclosure uses extensive thermal monitoring and takes a number of actions to ensure component temperatures are kept low and also to minimize acoustic noise. Air flow is from the front, over the drive section, through the midplane, through the I/O modules to rear of the enclosure.

Symptom	Cause	Action
<p>If the ambient air is cool (below 25 °C) and the fans are observed to increase in speed, then some restriction on airflow may be causing additional internal temperature rise.</p> <p>Note: This is not a fault condition.</p>	<p>The first stage in the thermal control process is for the fans to automatically increase in speed when a thermal threshold is reached. This may be caused by higher ambient temperatures in the local environment and may be perfectly normal.</p> <p>Note: This threshold changes according to the number of drives and PCMs fitted.</p>	<ol style="list-style-type: none"> 1 Check the installation for any airflow restrictions at either the front or rear of the enclosure. A minimum gap of 25mm at the front and 50mm at the rear is recommended. 2 Check for restrictions due to dust build-up; clean as appropriate. 3 Check for excessive re-circulation of heated air from rear to the front. Use in a fully enclosed rack installation is not recommended. 4 Check that all Blank modules are in place. 5 Reduce the ambient temperature.

8.5.2 Thermal Alarm

Symptom	Cause	Action
<ul style="list-style-type: none"> • Display Panel PCM/ Cooling Fault LED. • An AMBER LED on one or more PCMs. • Audible Alarm Sounding. • Air temperature exiting PCM above 35°C. 	<p>If the internal temperature measured in the airflow through the enclosure exceeds a pre-set threshold, a thermal alarm will sound.</p>	<ol style="list-style-type: none"> 1 Check local ambient environment temperature is below the upper 40°C specification. 2 Check the installation for any airflow restrictions at either the front or rear of the enclosure. A minimum gap of 25mm at the front and 50mm at the rear is recommended. 3 Check for restrictions due to dust build-up. Clean as appropriate. 4 Check for excessive re-circulation of heated air from rear to the front. Use in a fully enclosed rack installation is not recommended. 5 If possible, shutdown the enclosure and investigate the problem before continuing.

8.5.3 Thermal Shutdown

Important An enclosure will shut down when a critical temperature threshold is exceeded in order to prevent permanent damage to the disk drives.

8.6 Dealing with Hardware Faults

Ensure that you have obtained a replacement module of the same type *before* removing any faulty module.

Warning If the drive enclosure subsystem is powered up and you remove any module, replace it immediately. If the subsystem is used with modules or module blanks missing for more than a few minutes, the enclosure can overheat, causing power failure and data loss. Such use will invalidate the warranty.

- Replace a faulty drive with a drive of the same type and equal or greater capacity.
- All the supplied plug-in PCMs, electronics modules, and blank modules must be in place for the air to flow correctly around the cabinet.

8.7 Continuous Operation During Replacement

Depending on how the subsystem is set up, if a disk unit fails, it can normally be replaced without interrupting the use of the system.

8.8 Replacing a Module

Warning Whenever replacing a module NEVER leave an EMPTY bay in the rear of the enclosure, obtain a replacement before removing the problem part.

Please refer to [Chapter 6, "Drive Enclosure Installation"](#) for information on the initial installation of the plug-in modules in the drive enclosure.

Warning Observe all conventional ESD precautions when handling drive enclosure modules and components. Avoid contact with Backplane components and module connectors, etc.

8.8.1 Power Cooling Modules

Warning Do not remove covers from the Power Cooling module (PCM). There is a danger of electric shock. Return the PCM to your supplier for repair.

Warning To ensure your system has warning of a power failure please disconnect the power from the power supply, by either the switch (where present) or by physically removing the power source, prior to removing the PCM from the enclosure/shelf. Do not remove the faulty PCM unless you have a replacement unit of the correct type ready for insertion. The system must not be run without all units in place.

[If a power supply unit or its fan is faulty, you must replace the whole PCM. You must not take any longer than 5 minutes to replace this unit to prevent the enclosure from over-heating.](#)

As there should always be two (2) PCMs installed, you can continue working while replacing the faulty module.

To remove an AC PCM/Cooling Module- Handle Model:

Warning Do not remove the faulty PCM/Cooling module unless you have a replacement unit of the correct type ready for insertion.

If a power supply unit or its fan is faulty, you must replace the whole PCM/Cooling module.

As there should always be two PCMs installed, you can continue working while replacing the faulty module.

- 1 Make sure you identify the faulty PCM correctly from the two modules installed.
- 2 Lift latch which secures the power supply cord.
- 3 Switch off and disconnect the power supply cord.
- 4 Lift the PCM handle to the open position to cam the PCM out of the enclosure.
- 5 Grip the handle and withdraw the PCM.

To remove an AC PCM - Thumb Screw Model:

Warning Do not remove the faulty PCM unless you have a replacement unit of the correct type ready for insertion.

If a power supply unit or its fan is faulty, you must replace the whole PCM.

As there should always be two PCMs installed, you can continue working while replacing the faulty module.

- 1 Make sure you identify the faulty PCM correctly from the two modules installed.
- 2 Lift latch which secures the power supply cord.
- 3 Switch off and disconnect the power supply cord.
- 4 Remove the two thumbscrews on the right and left sides of the unit.
- 5 Firmly grip the handle on the bottom of the unit and withdraw the PCM.

To install an AC PCM - Handle Model:

- 6 Check for damage, especially to the rear connector on the PCM.

Caution Handle the module carefully and avoid damaging the connector pins. Do not install the module if any pins appear to be bent.

- 7 With the PCM handle in the open position, slide the module into the enclosure.
- 8 Cam the module home by manually closing the PCM handle. A click should be heard as the handle latches engage.
- 9 Connect the power supply cord to the power source, secure the latch over the cord, and switch the power supply ON.

Note The alarm will sound until the new PCM is operating correctly.

To install an AC PCM - Thumbscrew Model:

- 1 Check for damage, especially to the rear connector on the PCM.

Caution Handle the module carefully and avoid damaging the connector pins. Do not install the module if any pins appear to be bent.

- 2 Slide the module into the enclosure and push unit you hear a click as the latch is engaged.
- 3 Secure the two thumbscrews on the left and right sides of the unit.
- 4 Connect the power supply cord to the power source; secure latch, and switch the power supply ON.

Note The alarm will sound until the new PCM is operating correctly.

8.8.2 I/O Module

Warning Do not remove this module unless a replacement can be immediately added. The system must not be run without all units in place.

To remove the I/O Module:

- 1 Release the two latches on the bottom of the unit by simply pulling each latch out and away from unit.
- 2 Pull the latches forward to cam the module out of the enclosure.
- 3 Grip the unit securely and withdraw the module.

To installing the I/O Module:

- 4 With the latches in the open position, slide the EBOD module into the enclosure until the latch engages automatically.
- 5 Cam the module home by manually closing the latches. A click should be heard as the latch engages.

8.8.3 Replacing the Drive Carrier Module

Warning Observe all conventional ESD precautions when handling drive enclosure modules and components. Avoid contact with backplane components and module connectors, etc.

Instructions are also clearly labeled on the inside cover of the enclosures.

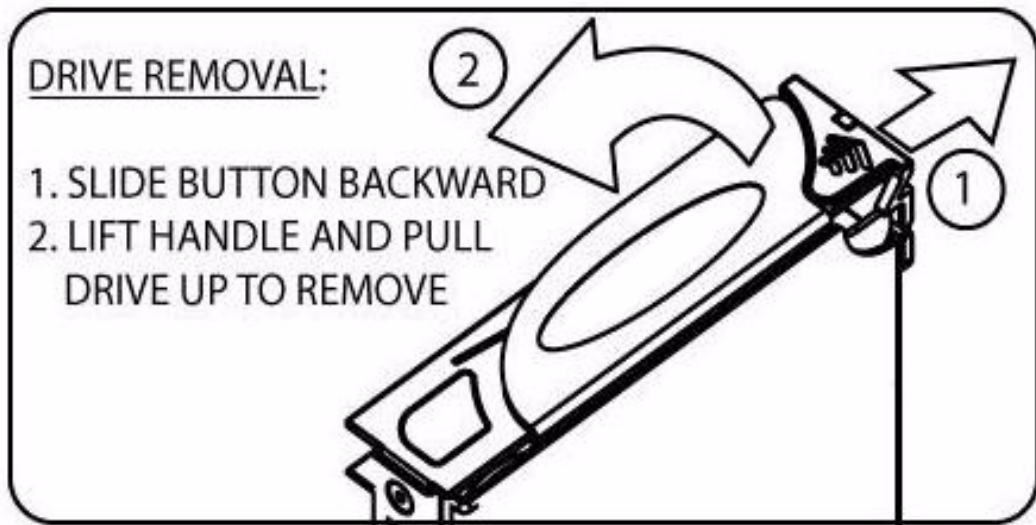

Figure 8-2 Drive Carrier - Handle Released

Caution *Drive spin down*

Damage can occur to a drive if it is removed while still spinning. If possible, use the operating system to

*spindown the drives prior to removal. If this is not possible, we recommend that you perform **All** steps of the following procedure to ensure that the drive has stopped prior to removal:*

To Insert the Drive Carrier Module

- 1** Release the carrier handle by sliding the latch backwards.
- 2** Insert the carrier into the enclosure.
- 3** Slide the drive carrier, gently, all the way into the enclosure.
- 4** Cam the drive carrier home. The camming foot on the base of the carrier will engage into a slot in the enclosure.
- 5** When the carrier is fully home, close the handle. You should hear a click as the latch engages and holds the handle closed.
- 6** Close the enclosure.

8.9 Replacing the DEM

Important The DEM card should only be replaced by trained personnel.

Controller Technical Specifications

The following are the technical specifications of the SGI InfiniteStorage 15000 controller.

NOTE : Specifications subject to change without notice.

Configuration, Performance, & Capacity

Host interface	IB 4xDDR, FC8
Drive interface	SAS
Management interface	RS-232 and Ethernet (Telnet)
Cache memory	2.5GB
Independent drive channels	10
Number of host ports	4
Number of host connections	Up to 512
Number of drives supported	Up to 1200 (1000 drives for data)
Number of LUN groups supported	Up to 1024
Hot spare capability	Yes
Full duplex 10/100/1000 BaseT onboard	Yes

Reliability

SES (SCSI Enclosure Services) protocol support	Yes
Temperature monitoring	Yes
Redundant hot-swappable power supplies	2
Redundant hot-swappable cooling fans	3

Physical, Power & Environmental

Controller chassis (H×W×D, Weight)	3.5" × 19.0" × 31", 45lbs
Electrical/AC	100-120V / 200-240V @ 47-63Hz
Power consumption (maximum current)	2.65A @ 208VAC Couplet: 8.0A @ 110VAC, 3.8A @ 230VAC
Power consumption (average current)	3.0A @ 110VAC, 1.5A @ 230VAC Couplet: 6.0A @ 110VAC, 4.2 @ 208VAC
Operating environment (temperature / relative humidity)	5°C to 35°C / 20% - 80%, non-condensing (at sea level)
Non-operating environment (temperature/ relative humidity)	-10°C to 50°C / 20% - 80%, non-condensing
Thermal rating (single mode/dual mode)	1880 BTU / 3760 BTU
Certification	UL, CE, CUL, C-Tick, FCC

B

Drive Addressing

This appendix illustrates the drive addressing for the disk enclosures. There are two drive numbering options:

- 1 x 60 (one set of drives 1 through 60); (Figures B-1 and B-3).
- 2 x 30 (two sets of drives 1 through 30); (Figures B-2 and B-4)

Figure B-1 1x60 Drive Layout Configuration

DRIVE 1	DRIVE 13	DRIVE 25	DRIVE 37	DRIVE 49
DRIVE 2	DRIVE 14	DRIVE 26	DRIVE 38	DRIVE 50
DRIVE 3	DRIVE 15	DRIVE 27	DRIVE 39	DRIVE 51
DRIVE 4	DRIVE 16	DRIVE 28	DRIVE 40	DRIVE 52
DRIVE 5	DRIVE 17	DRIVE 29	DRIVE 41	DRIVE 53
DRIVE 6	DRIVE 18	DRIVE 30	DRIVE 42	DRIVE 54
AUX DRIVE	DEM 2B	DEM 2A	DEM 1B	DEM 1A
	DEM 4A	DEM 4B	DEM 3A	DEM 3B
DRIVE 7	DRIVE 19	DRIVE 31	DRIVE 43	DRIVE 55
DRIVE 8	DRIVE 20	DRIVE 32	DRIVE 44	DRIVE 56
DRIVE 9	DRIVE 21	DRIVE 33	DRIVE 45	DRIVE 57
DRIVE 10	DRIVE 22	DRIVE 34	DRIVE 46	DRIVE 58
DRIVE 11	DRIVE 23	DRIVE 35	DRIVE 47	DRIVE 59
DRIVE 12	DRIVE 24	DRIVE 36	DRIVE 48	DRIVE 60

Figure B-1 2x30 Drive Layout Configuration

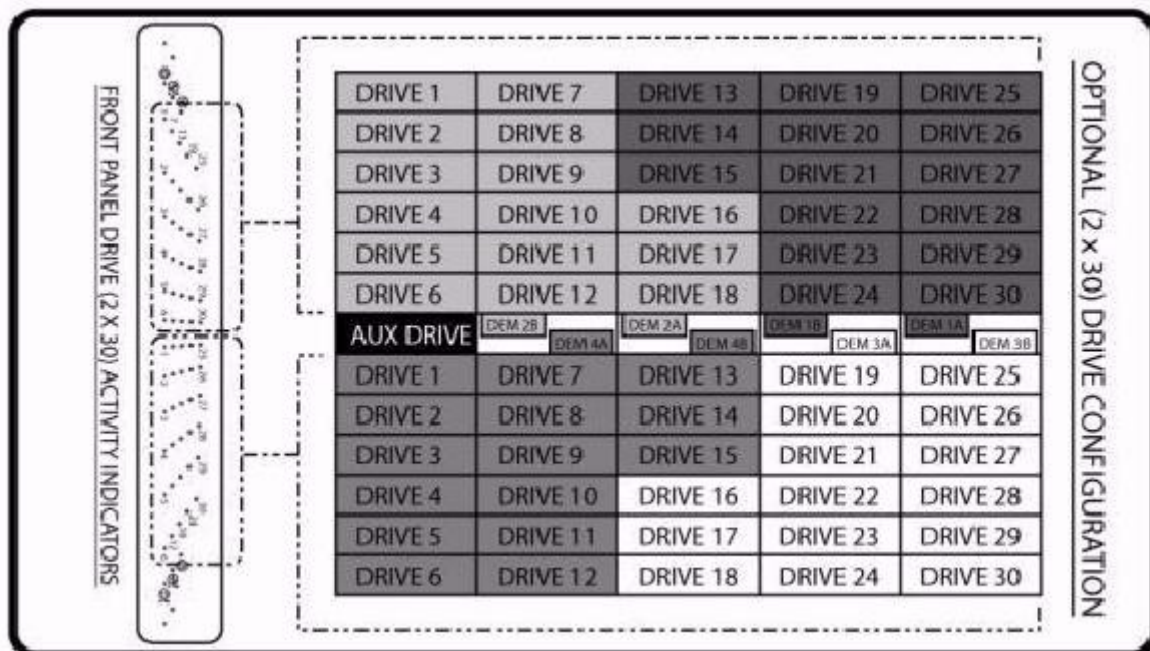

Figure B-3 Controller-Drive Enclosure Couplet (1x Configuration)

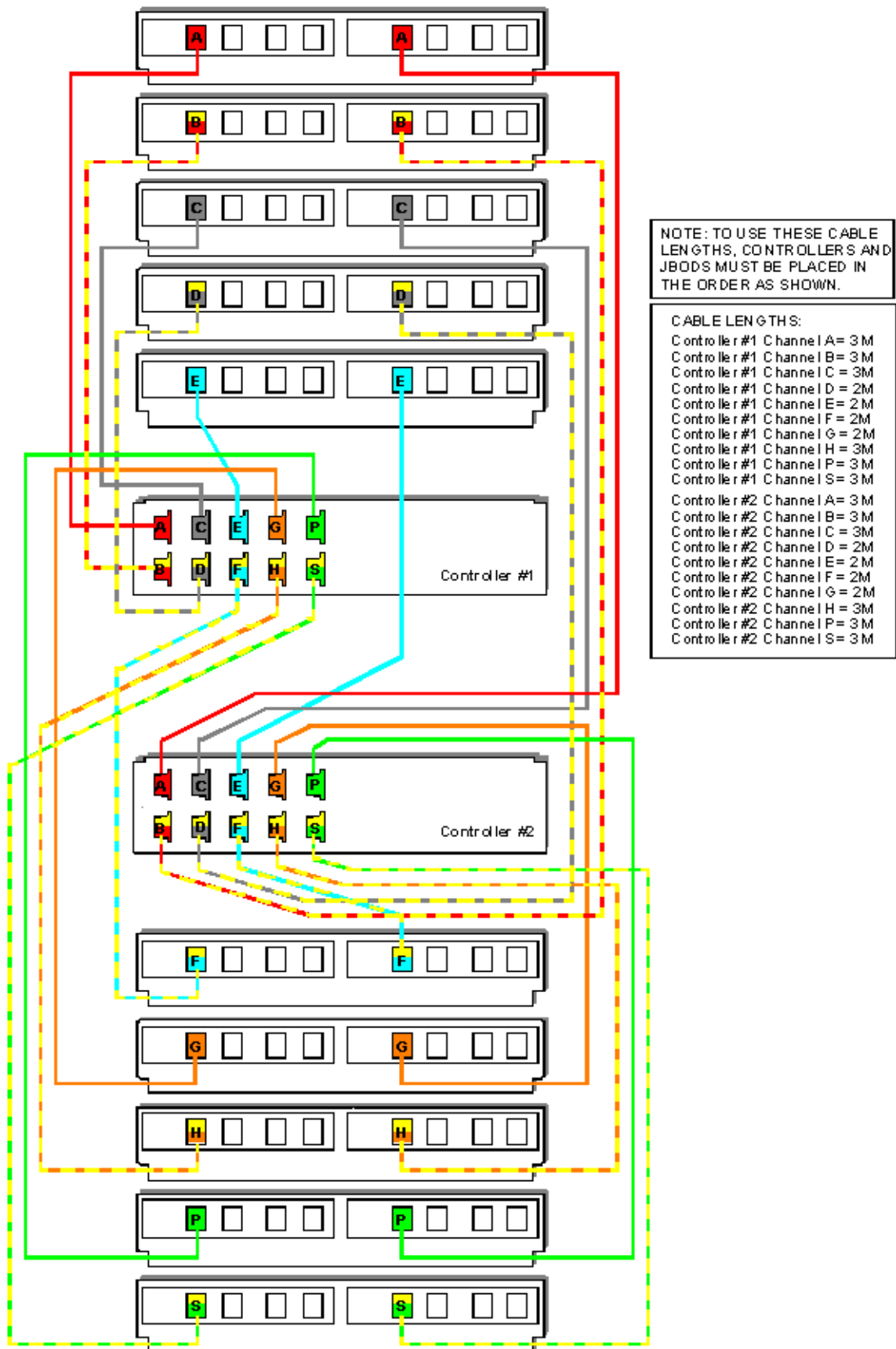
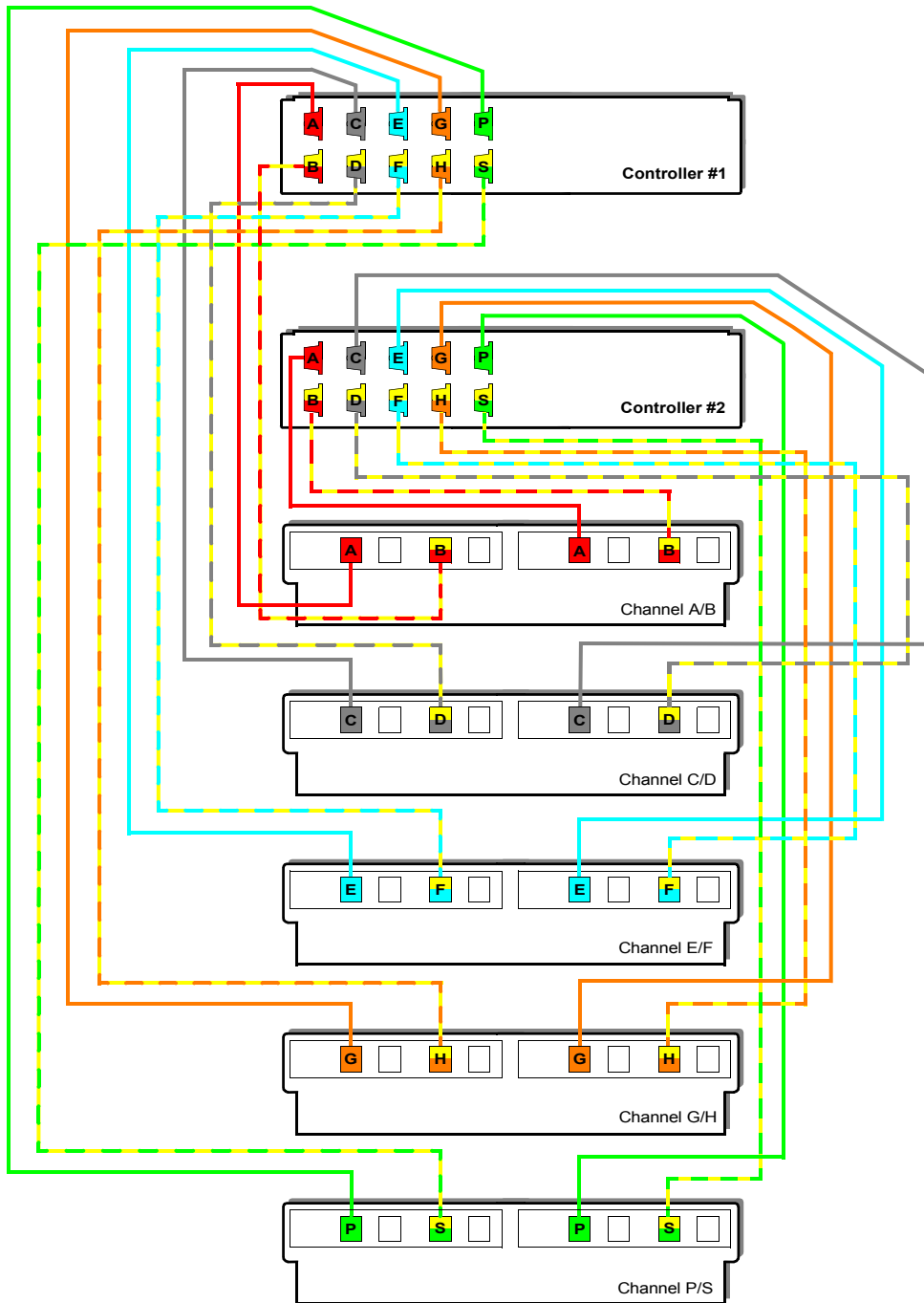

Figure B-4 Controller-Drive Enclosure Couplet (2x Configuration)



C

Cabling Controllers and Drive Enclosures

This appendix illustrates the proper cabling of the following two configurations:

- 2 controllers and 5 drive enclosures (Figures C-1 and C-2)
- 2 controllers and 10 drive enclosures (Figures C-3 and C-4)

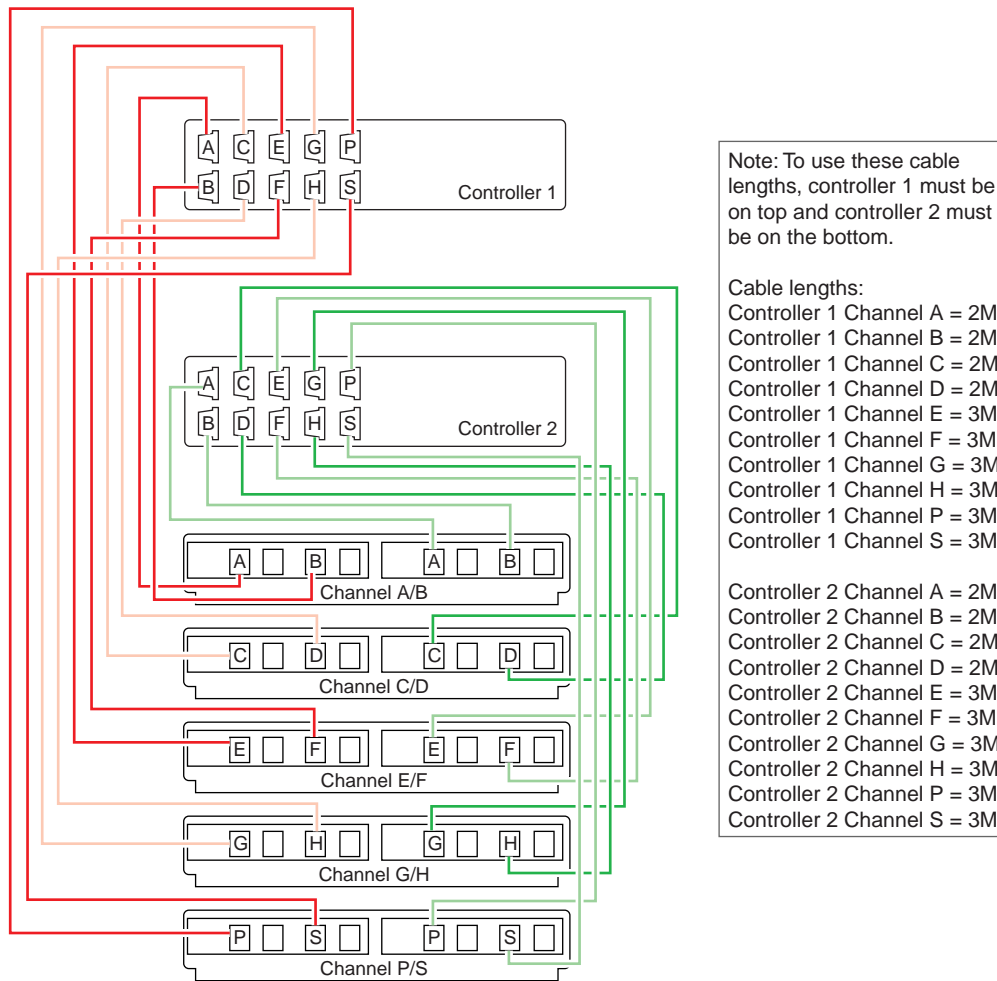

Figure C-1 Controller Cabling (2 Controllers and 5 Drive Enclosures)

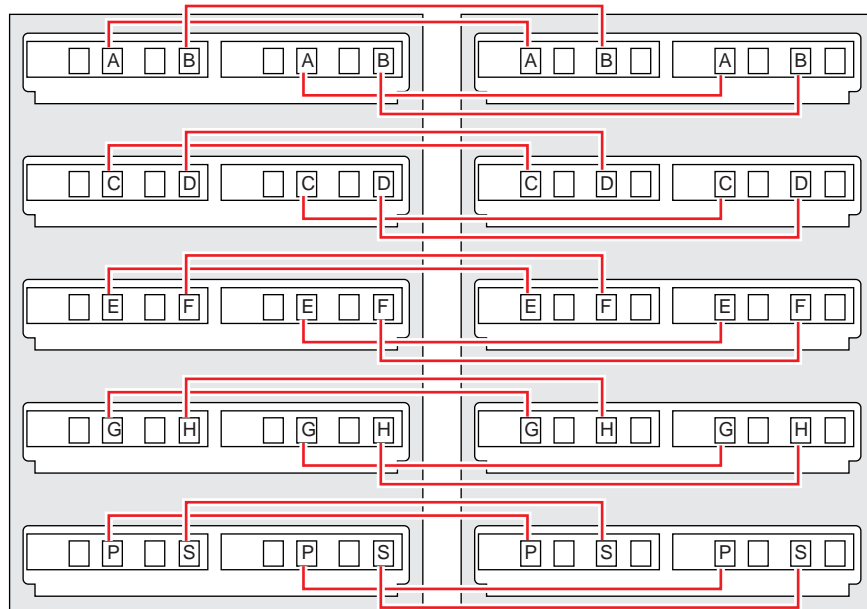
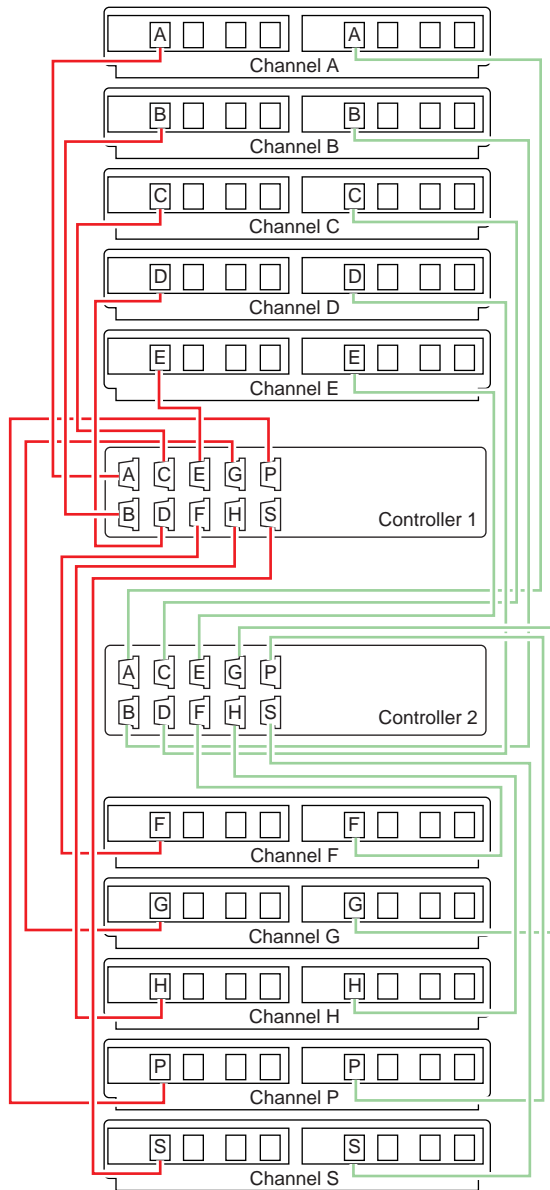

Figure C-2 Drive Enclosure Cabling (2 Controllers and 5 Drive Enclosures)



Note: To use these cable lengths, controllers and jbods must be placed in the order as shown.

Cable lengths:

- Controller 1 Channel A = 3M
- Controller 1 Channel B = 3M
- Controller 1 Channel C = 3M
- Controller 1 Channel D = 2M
- Controller 1 Channel E = 2M
- Controller 1 Channel F = 2M
- Controller 1 Channel G = 2M
- Controller 1 Channel H = 3M
- Controller 1 Channel P = 3M
- Controller 1 Channel S = 3M

- Controller 2 Channel A = 3M
- Controller 2 Channel B = 3M
- Controller 2 Channel C = 3M
- Controller 2 Channel D = 2M
- Controller 2 Channel E = 2M
- Controller 2 Channel F = 2M
- Controller 2 Channel G = 2M
- Controller 2 Channel H = 3M
- Controller 2 Channel P = 3M
- Controller 2 Channel S = 3M

Figure C-3 Controller Cabling (2 Controllers and 10 Drive Enclosures)

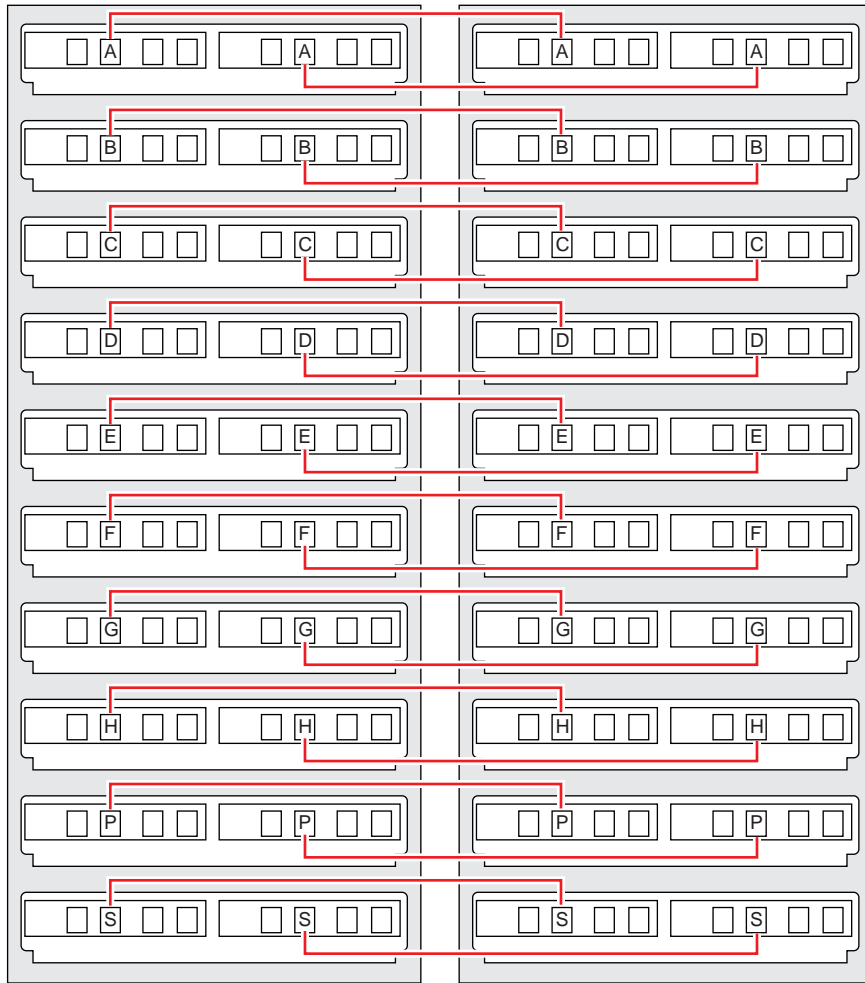

Figure C-4 Drive Enclosure Cabling (2 Controllers and 10 Drive Enclosures)