



**SGI® Altix® UV System Management
Node Administrator's Guide**

007-5694-006

COPYRIGHT

© 2010, 2011, SGI. All rights reserved; provided portions may be copyright in third parties, as indicated elsewhere herein. No permission is granted to copy, distribute, or create derivative works from the contents of this electronic documentation in any manner, in whole or in part, without the prior written permission of SGI.

LIMITED RIGHTS LEGEND

The software described in this document is "commercial computer software" provided with restricted rights (except as to included open/free source) as specified in the FAR 52.227-19 and/or the DFAR 227.7202, or successive sections. Use beyond license provisions is a violation of worldwide intellectual property laws, treaties and conventions. This document is provided with limited rights as defined in 52.227-14.

TRADEMARKS AND ATTRIBUTIONS

SGI, Altix, and the SGI logo are trademarks or registered trademarks of Silicon Graphics International Corp. or its subsidiaries in the United States and other countries.

Firefox and Mozilla are registered trademarks of the Mozilla Foundation. Linux is a registered trademark of Linus Torvalds in the United States and other countries. Microsoft and Windows are registered trademarks or trademarks of Microsoft Corporation in the United States and/or other countries. Novell and SUSE are registered trademarks of Novell, Inc., in the United States and other countries. Red Hat and all Red Hat-based trademarks are trademarks or registered trademarks of Red Hat, Inc. in the United States and other countries. SUPERMICRO is a registered trademark of Super Micro Computer, Inc. All other trademarks mentioned herein are the property of their respective owners.

New Features in This Manual

This rewrite of the *SGI Altix UV System Management Node Administrator's Guide* supports the SGI Foundation Software 2.4 release.

Major Documentation Changes

Performed the following:

- Updated "System Management Node Software Requirements" on page 1.
- Updated "System Management Node Software Installation" on page 13.
- Added "SMN RPMs for SSI" on page 30.
- Updated "Updating Firmware" on page 31.
- Added "SMN Backup Files" on page 32.
- Updated "Altix UV CMC IP Address Assignment" on page 37.
- Added information about how to determine the BaseIO BMC firmware version in "Enabling a Remote Console" on page 41.
- Added "Setting an Administrative Password on the Console" on page 64.
- Added "Booting from Fibre Channel Disk" on page 70.
- Added "Verifying the SMN Software Stack" on page 72.

Record of Revision

Version	Description
001	October 2010 Original Printing.
002	February 2011 Updated to support the SGI Foundation Software 2.3 release.
003	February 2011 Updated to support additional changes for the SGI Foundation Software 2.3 release.
004	February 2011 Updated to add information about remote console and reinstalling operating system software.
005	March 2011 Updated to support additional changes for the SGI Foundation Software 2.3 release.
006	April 2011 Updated to support changes for the SGI Foundation Software 2.4 release.

Contents

About This Manual	xi
Obtaining Publications	xi
Related Publications and Other Sources	xi
Conventions	xii
Reader Comments	xiii
1. System Management Node Software Installation and Operation	1
System Management Node Software Requirements	1
System Management Node	2
System Control Network Overview	3
System Management — Physical Connections	5
System Management Node Command Line Interface	8
SMN Specific CLI Commands	9
List of Valid CLI Commands Used With the System Management Node (SMN)	10
power command	10
console Command	12
System Management Node Software Installation	13
Installing SLES 11 SP1 on the SMN	15
Installing SLES 11 SP1 and SGI Foundation Software 2.4	23
Installing and Configure RHEL 6 and SGI Foundation 2.4 Software	26
SGI Altix UV 100 and Altix UV 1000 System Installation Instructions	30
Install and Configure SLES 11 SP1 and SGI Foundation Software 2.4	30
Install and Configure RHEL 6 and SGI Foundation Software 2.4	30
Installing Windows Server 2008 R2 Datacenter Software	30
007-5694-006	vii

SMN RPMs for SSI	30
SGI Management Center Software Installation	30
Updating Firmware	31
SMN Backup Files	32
2. System Network Addressing	35
System Network Addressing Overview	35
System Management Node Ethernet Ports	36
eth1smn	36
eth2smn	37
eth3smn	37
Altix UV CMC IP Address Assignment	37
Multiple Altix UV Partitions or Systems on a Single SMN	38
Non Altix UV 100 or UV 1000 Systems on the SMN	38
SMN Firewall Capabilities	38
3. System Configuration from the SMN	41
Enabling a Remote Console	41
Changing Configuration Settings	54
Reinstalling the Operating System on an Altix UV System	55
Determining the IP Address of the BaseIO BMC	60
Accessing the SGI BIOS Setup Utility	62
Setting an Administrative Password on the Console	64
Enabling BaseIO VGA	69
Booting Using iSCSI Protocol	69
Booting from Fibre Channel Disk	70
4. Simple Network Management Protocol	71

SNMP Agent Overview	71
Verifying the SMN Software Stack	72
SNMP Configuration	75
Automatic Configuration Using <code>uv_snmpconfig</code>	75
Manual Configuration	76
Index	79

About This Manual

This manual describes the system management node (SMN) for SGI Altix UV 100 and SGI Altix UV 1000 series systems.

Obtaining Publications

You can obtain SGI documentation in the following ways:

- See the SGI Technical Publications Library at: <http://docs.sgi.com>. Various formats are available. This library contains the most recent and most comprehensive set of online books, release notes, man pages, and other information.
- You can also view man pages by typing `man title` on a command line.

Related Publications and Other Sources

This section describes documentation you may find useful, as follows:

- *SGI Foundation Software 2.4 Start Here*

Provides information about the SGI Foundation Software 2.4 release that supports SGI differentiated server solutions.

- *SGI Management Center Installation and Configuration*

This guide is intended for system administrators. It describes how to install and configure the SGI Management Center. A companion manual, *SGI Management Center System Administrator's Guide*, describes general cluster administration.

- *SGI Management Center System Administrator's Guide*

This manual describes how you can monitor and control a cluster using the SGI Management Center. A companion manual, *SGI Management Center Installation and Configuration Guide*, describes installing and configuring the SGI Management Center.

- *SGI Management Center Quick Start Guide*

This guide is intended for system administrator's. It tells you how to get your SGI Management Center up and running.

- *SGI Altix UV CMC Controller Software User's Guide*

Describes how to use the controller commands on your chassis manager controller (CMC) to monitor and manage SGI Altix UV 100 and SGI Altix UV 1000 systems.

- *SGI Altix UV Systems Software Install Guide*

This guide describes how to install software on an SGI Altix UV 100 or SGI Altix UV 1000 system in case of root disk failure.

- *Windows on SGI Altix UV Software Install Guide*

This guide describes how to install Windows Server 2008 R2 Datacenter software on an SGI Altix UV 100 or SGI Altix UV 1000 system. It also describes disk preparation for Windows.

- *SGI Altix UV 1000 System User's Guide*

This guide provides an overview of the architecture and descriptions of the major components that compose the SGI Altix UV 1000 system. It also provides the standard procedures for powering on and powering off the system, basic troubleshooting information, and important safety and regulatory specifications.

- *SGI Altix UV 100 System User's Guide*

This guide provides an overview of the architecture and descriptions of the major components that compose the SGI Altix UV 100 system. It also provides the standard procedures for powering on and powering off the system, basic troubleshooting information, and important safety and regulatory specifications.

Conventions

The following conventions are used throughout this document:

Convention	Meaning
<code>command</code>	This fixed-space font denotes literal items such as commands, files, routines, path names, signals, messages, and programming language structures.

<code>manpage(x)</code>	Man page section identifiers appear in parentheses after man page names.
<i>variable</i>	Italic typeface denotes variable entries and words or concepts being defined.
user input	This bold, fixed-space font denotes literal items that the user enters in interactive sessions. (Output is shown in nonbold, fixed-space font.)
[]	Brackets enclose optional portions of a command or directive line.
...	Ellipses indicate that a preceding element can be repeated.

Reader Comments

If you have comments about the technical accuracy, content, or organization of this publication, contact SGI. Be sure to include the title and document number of the publication with your comments. (Online, the document number is located in the front matter of the publication. In printed publications, the document number is located at the bottom of each page.)

You can contact SGI in any of the following ways:

- Send e-mail to the following address:
techpubs@sgi.com
- Contact your customer service representative and ask that an incident be filed in the SGI incident tracking system.
- Send mail to the following address:
SGI
Technical Publications
46600 Landing Parkway
Fremont, CA 94538

SGI values your comments and will respond to them promptly.

System Management Node Software Installation and Operation

This chapter describes the system management node (SMN), how to install software on the SMN, and software operation. It covers these topics:

- "System Management Node Software Requirements" on page 1
- "System Management Node" on page 2
- "System Management Node Software Installation" on page 13
- "SGI Altix UV 100 and Altix UV 1000 System Installation Instructions" on page 30
- "SMN RPMs for SSI" on page 30
- "SGI Management Center Software Installation" on page 30
- "Updating Firmware" on page 31

An SMN is generally required for SGI Altix UV 1000 series systems and are optional with SGI Altix UV 100 systems.

System Management Node Software Requirements

Note: There is **no** Redundant Array of Independent Disks (RAID) support on the SMN.

The SMN requires the following software components:

- SUSE Linux Enterprise Server 11 Service Pack 1 (SLES 11 SP1) or Red Hat Enterprise Linux 6 (RHEL 6)
- SGI Foundation Software 2.4
- SGI System Management Software bundle

Note: SGI Management Center (SMC) software is optional for provisioning, installing, configuring, operating, and monitoring SGI Altix UV 1000 and 100 series systems. The *SGI Management Center System Administrator's Guide* provides information on using the GUI to administer your Altix UV system.

For the location of the SMN release notes, perform the following command:

```
uv44-smn:~ # rpm -ql sgi-smn-release
/etc/opt/sgi/features/sgi-smn
/etc/products.d/sgi-smn.prod
/etc/sgi-smn-release
/usr/share/doc/packages/sgi-smn-1/SGI-SMN-1.2-readme.txt
/usr/share/doc/packages/sgi-smn-1/SGI-SMN-1.2-rpms.txt
```

System Management Node

Both Altix UV 100 and 1000 system individual rack units (IRUs) use an embedded chassis management controller (CMC). The CMC communicates with both the blade-level board management controllers (BMCs) and the system management node (SMN). These components are generically known as the system control network. Remote administration requires that the SMN be connected by an Ethernet connection to a private or public Local Area Network (LAN).

The SMN can run SGI Management Center software. The *SGI Management Center System Administrator's Guide* provides information on using the GUI to administer your Altix UV 100 or Altix UV 1000 system.

For information on the CMC, see *SGI UV CMC Controller Software User's Guide*, *SGI Altix UV 100 System User's Guide*, or *SGI Altix UV 1000 System User's Guide*.

This chapter describes the system management node and covers the following topics:

- "System Control Network Overview" on page 3
- "System Management — Physical Connections" on page 5
- "System Management Node Command Line Interface" on page 8

System Control Network Overview

The system control network configuration of your server will depend on the size of the system and control options selected. Typically, an Ethernet LAN connection to the system controller network is used.

The SMN is a separate stand-alone server installed in the SGI Altix UV 1000 rack (see Figure 1-1 on page 4). The SMN can be installed at the top of a UV rack or in one of the four 1U slots between the individual rack units (IRU), as shown in Figure 1-7 on page 14. The SMN acts as a gateway and buffer between the Altix UV system control network and any other public or private local area networks. The Altix UV system control network will generally include the following three areas:

- The system management node (SMN)
- The chassis management controllers (CMC) boards - one per IRU
- The individual blade-based board management controllers (BMC) - report to the CMCs



Warning: The SGI Altix UV system control network is a private, closed network. It should not be reconfigured in any way to change it from the standard SGI Altix UV factory installation. It should not be directly connected to any other network. The Altix UV system control network is not designed for and does not accommodate additional network traffic, routing, address naming (other than its own schema), or DHCP controls (other than its own configuration). The Altix UV system control network also is not security hardened, nor is it tolerant of heavy network traffic, and is vulnerable to Denial of Service attacks.

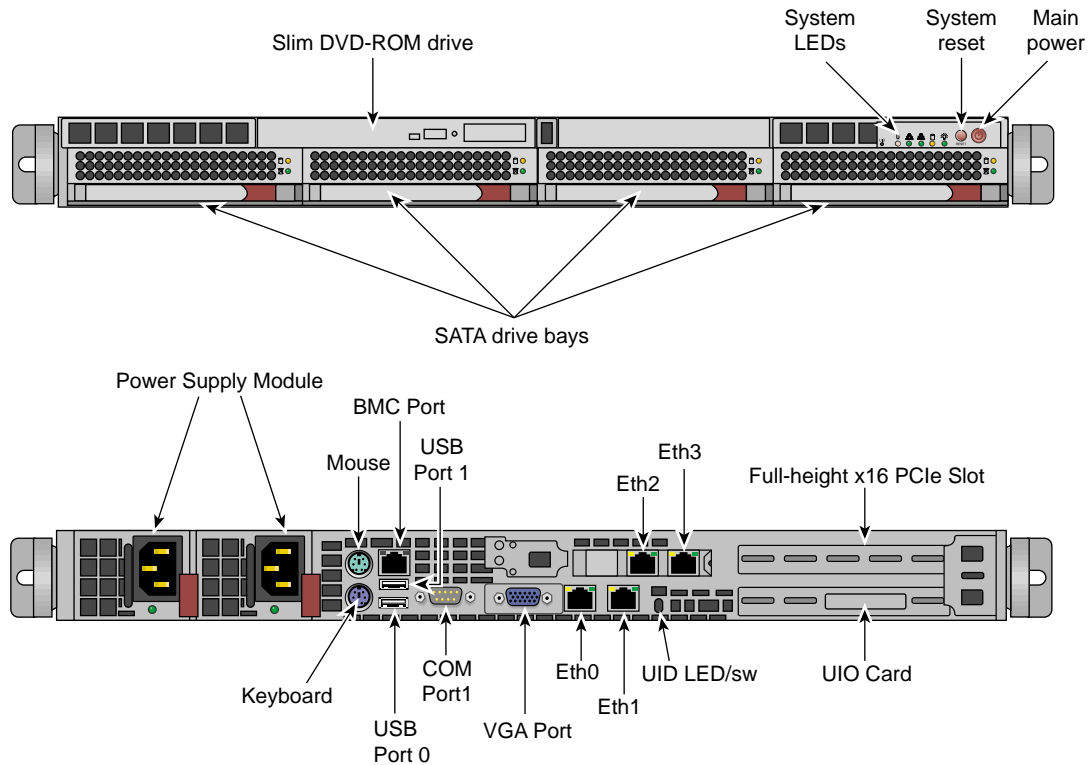

Figure 1-1 System Management Node Front and Rear Panels

In all Altix UV 1000 servers all the system controller types (SMNs, CMCs and BMCs) communicate with each other in the following ways:

- System control commands and communications are passed between the SMN and CMCs via a private dedicated Gigabit Ethernet. The CMCs communicate directly with the BMC in each installed blade by way of the IRU's internal backplane.
- All the CMCs can communicate with each other via an Ethernet "string" configuration network.
- In larger configurations the system control communication path includes a private, dedicated Ethernet switch.

An Ethernet connection directly from the SMN to a local private or public Ethernet allows the system to be administered directly from a local or remote console via the

SGI Management Center interface (most often installed on the SMN). Note that there is no direct inter-connected system controller function in the optional expansion PCIe modules.

For more detailed information on the SMN, see "System Management Node Ethernet Ports" on page 36.

System Management — Physical Connections

Each IRU contains a chassis management controller (CMC). Each CMC has seven Thereinto connectors that connect internally to the 48-port Ethernet switch (see Figure 1-2 on page 5) The CMC communicates with compute blades via Intelligent Platform Management Interface (IPMI) protocol and monitors the individual rack unit (IRU) voltages and temperatures. The Ethernet ports on the CMC connect to the SMN and CMCs in other IRUs. You can communicate with the CMC via ssh or serial protocol.

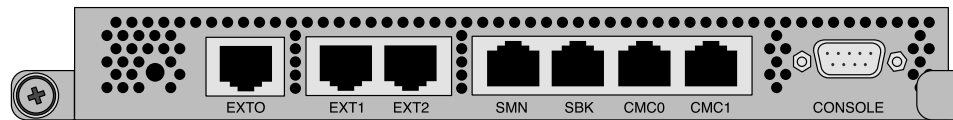

Figure 1-2 Chassis Management Controller

The Ethernet ports are used as follows:

- EXT0 (100 Mb)
 - EXT1 (100 Mb)
 - EXT2 (100 Mb)
 - SMN (1 Gigabit)
 - SBK (1 Gigabit) → VLAN - SBK
 - CMC0 (1 Gigabit)
 - CMC1 (1 Gigabit)
- } VLAN - EXT
 } VLAN - CMC

Figure 1-3 CMC Ethernet Port Usage

The CMC0 and CMC1 jacks are used to connect all the CMCs in a ring.

The SBK jack is used to interconnect building blocks into another ring. Up to four building blocks may be interconnected creating a Super block (SBK). Using only the SBK jacks on the CMCs for these connections, connect a cable from a CMC in the first building block to a CMC in the second building block. Then select another CMC in the second building block and connect it to a CMC in the third building block (or back to a CMC in the first building block in the case of only two building blocks). To minimize network hops, its recommended that the two connections within a building block be in different racks (for redundancy) and that the two racks be adjacently cabled with respect to the CMC ring.

One system management node (SMN) is required for each system. Systems with more than one partition or more than one building block will require a GigE switch. Systems with more than one Super Block will require two GigE switches.

The SMN should be connected to the SMN jack in a CMC that also has an SBK connection. The SMN requires a GigE switch to support connections to two different Super Blocks.

The EXT[0,1,2] jacks are used for connections from the smart door controller, and so on. The SMN jack can be used for other in-rack devices if its available and all SMNs in the configuration are already connected. Only the primary CMC SMN ports are to be used.

Figure 1-4 on page 7 shows the Altix UV BaseIO riser card. The BaseIO riser card has the following electrical features:

- One x4 serial attached SCSI (SAS) port
- Two Gigabit Ethernet ports
- Three universal serial bus (USB) 2.0 ports
- One Video port
- One RS-232 serial port
- One BMC/ENET port

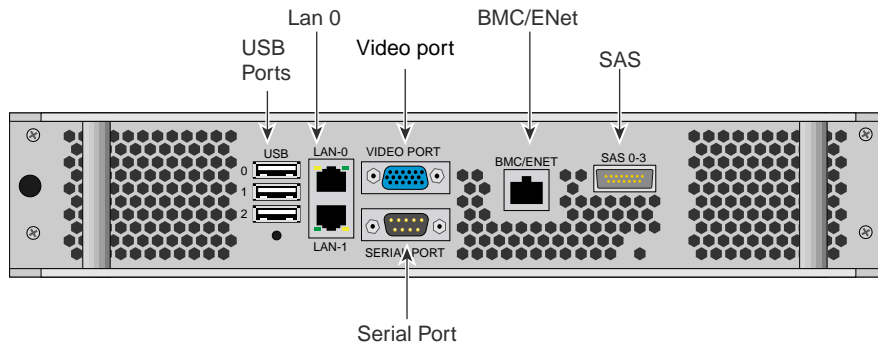

Figure 1-4 Altix UV BaseIO Riser

Figure 1-5 on page 7 shows the an SMN Ethernet cabling example for a single Altix UV rack.

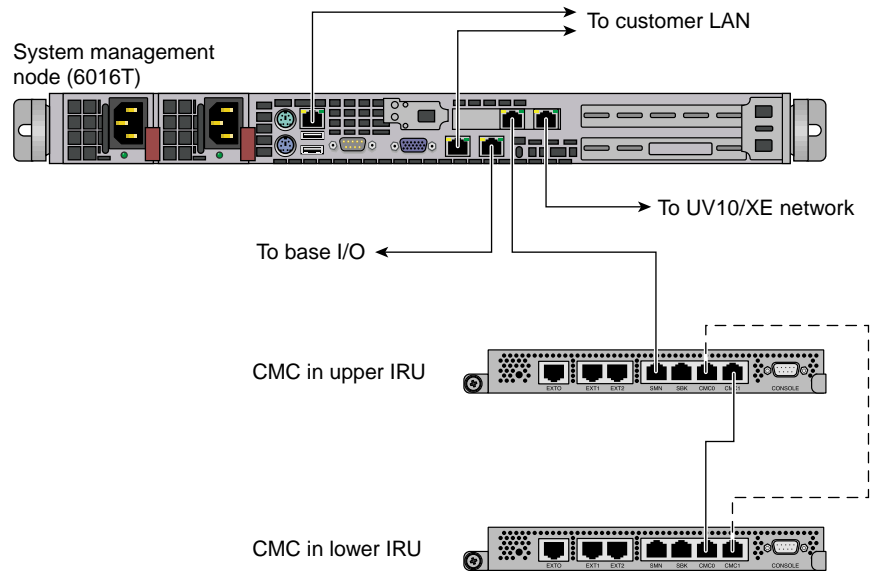

Figure 1-5 SMN Ethernet Cabling for a Single Altix UV Rack

Figure 1-6 on page 8 shows an example layout.

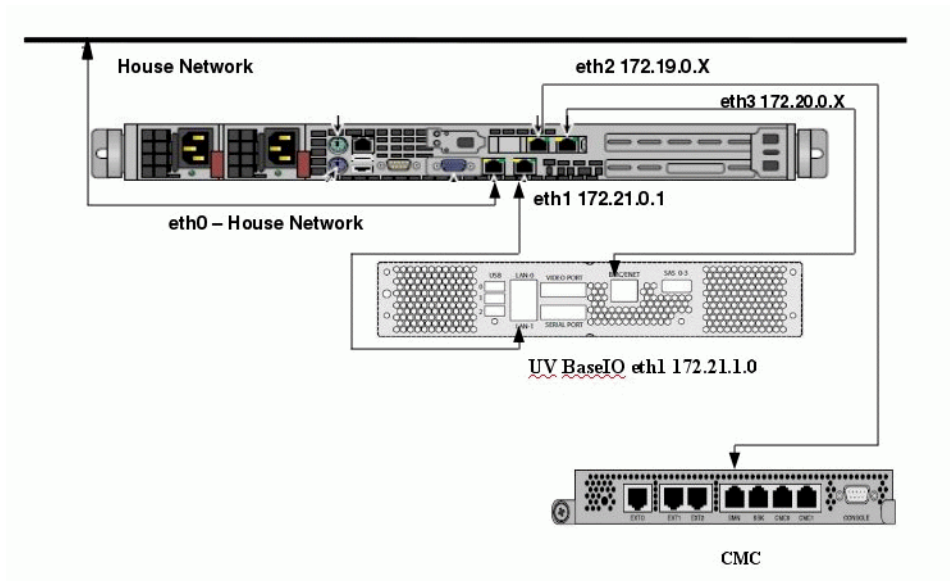

Figure 1-6 SMN Ethernet Cabling Layout for a Single Altix UV Rack

System Management Node Command Line Interface

The UV command line interface is accessible by logging into either a system maintenance node (SMN) or chassis management controller (CMC).

Log in as `root`, when logging into the CMC, similar to the following:

```
# ssh root@hostname-cmc
SGI Chassis Manager Controller, Firmware Rev. 1.1.11

CMC:r1i1c>
```

Login as `sysco`, when logging into the SMN, similar to the following:

```
# ssh -X sysco@uv-system-smn
sysco@system-smn:~/hw>
```

Once a connection to the SMN or CMC is established, various system control commands can be entered.

SMN Specific CLI Commands

The following CLI command options are available specifically for the SMN:

-h --help	This help message.
hh --help	This help message + CLI help message.
-q --quiet	No diagnostic message.
-s --system	Select UV system. If only one system is present, this one is selected. Otherwise, this option is mandatory.
-S --show depth	Show nodes at depth >= 1 using optional supplied pattern. Default pattern=*
-t --target	One target in one of the two following formats: <ol style="list-style-type: none"> rack[/slot[/blade]] r{1..}{s i}{1..2}{b n}{0..15}]

Note: This format is NOT for `uvcli` only.

Examples:

`r1i02` = rack 1, slot 2

`r2i1b4` = rack 2, slot 1, blade 4

Select the target from the CLI command itself, or, if not available, using the `-t` option.

The following are examples of `uvcli` commands:

<code>uvcli --help</code>	This help.
<code>uvcli --leds --help</code>	Help on <code>leds</code> command.
<code>uvcli leds r1i1b4</code>	Show leds on BMC located at rack 1, slot1, blade 4.
<code>uvcli -t 1/1 leds</code>	Show LEDs on all BMCs in rack 1, slot 1.
<code>uvcli --leds -v r1i1</code>	Same as previous command but more verbose
<code>uvcli -S 1</code>	Show all system serial numbers.

```
uvcli -S 1 '*/part*'          Show all system partitions.
```

List of Valid CLI Commands Used With the System Management Node (SMN)

The following list of available CLI commands are specifically for the SMN:

auth	Authenticate SSN/APPWT change
bios	Perform BIOS actions
bmc	Access the BMC shell
cmc	Access the CMC shell
config	Show system configuration
console	Access system consoles
help	List available commands
hel	Access hardware error logs
hwcfg	Access hardware configuration variable
leds	Display system LED values
log	Display system controller logs
power	Access power control/status
Enter <cmd> --help	Get a help statement for individual commands

power command

The `power` command, also available on the chassis management controller (CMC), can be run from the SMN command line. When a `power` command is issued, it checks to see if the individual rack units (IRUs) are powered on; if not on, the `power` command powers up the IRUs and then the blades in the IRU are powered on.

To see a help statement for the `power` command, perform the following:

```
uv45-smn:~ # power --help
```

```
usage: power [-vchosw] on|up [bmc] [--noio] [TARGET]...
on|up          turn power on
bmc           turn aux power on
--noio        do not power on accessories (IO)
-v, --verbose verbose output
-c, --clear   clear EFI variables (system/partition targets only)
```



```
-h, --hold                hold in reset
-o, --override            override partition check
-s, --single              single node boot
-w, --watch               watch boot progress

usage: power [-vo] off|down [bmc] [--noio] [--nochassis] [TARGET]...
off|down                  turn power off
bmc                       turn aux power off
--noio                    do not power off accessories (IO)
--nochassis               do not power off chassis power
-v, --verbose             verbose output
-o, --override            override partition check

usage: power [-vchosw] reset [bmc|iobmc] [TARGET]...
reset                     system reset
bmc|iobmc                 BMC reset
-v, --verbose             verbose output
-c, --clear               clear EFI variables (system/partition targets only)
-h, --hold                hold in reset
-o, --override            override partition check
-s, --single              single node boot
-w, --watch               watch boot progress

usage: power [-vchosw] cycle [bmc] [--noio] [--nochassis] [TARGET]...
cycle                     cycle power off on
bmc                       cycle aux power
--noio                    do not power cycle accessories (IO)
--nochassis               do not power cycle chassis power
-v, --verbose             verbose output
-c, --clear               clear EFI variables (system/partition targets only)
-h, --hold                hold in reset
-o, --override            override partition check
-s, --single              single node boot
-w, --watch               watch boot progress

usage: power [-v10ud] [status] [TARGET]...
status                    show power status
-v, --verbose             verbose output
-l, --on                  show only blades with on status
-0, --off                 show only blades with off status
-u, --unknown             show only blades with unknown status
```

-d, --disabled show only blades with disabled status

usage: power [-ov] nmi|debug [TARGET]...

nmi|debug issue NMI
-o, --override override partition check
-v, --verbose verbose output

usage: power [-v] margin [high|low|norm|] [TARGET]...

margin power margin control
high|low|norm| margin state
-v, --verbose verbose output

usage: power cancel [TARGET]...

cancel cancel outstanding power action

usage: power --help

--help display this help and exit

console Command

Use the console command (formerly, uvcon) to open a console to an Altix UV system.

To see a help statement for the console command, perform the following:

```
uv45-smn:~ # console --help
```

```
usage: console [-bnd23] [--steal] [--spy] [--kill] [--notty] [--nocache] [--clrcache] [[:]TARGET]
```

```
-b, --baseio specifies baseio bmc console  
-n, -0, --normal specifies node BMC console (normal channel)  
-d, -1, --debug specifies node BMC console (debug channel)  
-2, --chan2 specifies node BMC console (channel 2)  
-3, --chan3 specifies node BMC console (channel 3)  
--steal steal the console  
--spy spy the console  
--kill kill all other uvcon sessions  
--notty disables tty interventions  
--nocache don't return cached output  
--clrcache clear cached output  
[:]TARGET console target
```

NOTE: When tty mode is enabled, use 'CTRL-]' 'q' to exit.

```
usage: console -d[band23c] [-l ] [TARGET]...
-d, --dump                dump cached console output
-b, --baseio              specifies baseio bmc console
-a, --all                 all node BMC consoles
-n, -0, --normal          specifies node BMC console (normal channel)
-d, -1, --debug           specifies node BMC console (debug channel)
-2, --chan2               specifies node BMC console (channel 2)
-3, --chan3               specifies node BMC console (channel 3)
-l, --lines=              limit output to last lines
-c, --clear               clear after dumping (-cc to clear without dumping)
TARGET                    console target(s)

usage: console --help
--help                    display this help and exit
```

For more detailed information on the commands available from the SMN or CMC and how to use them, see the *SGI Altix UV CMC Controller Software User's Guide*.

System Management Node Software Installation

This section describes how to install software on the system management node itself.

The system management node (SMN) is either located in the top 1U slot between the individual rack units (IRUs) or at the top of the rack as shown in Figure 1-7 on page 14. Figure 1-8 on page 15 shows an image of an SMN.

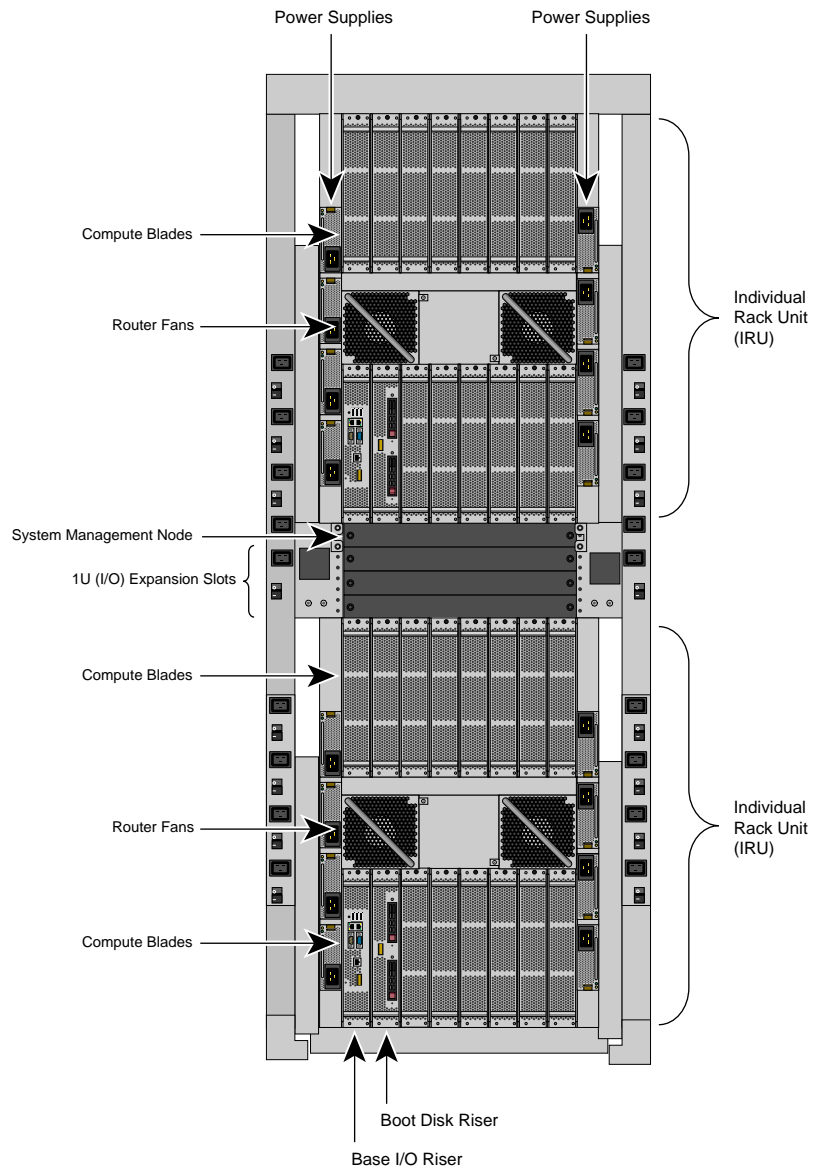

Figure 1-7 SGI Altix UV 1000 System Rack

This section covers these topics:

- "Installing SLES 11 SP1 on the SMN" on page 15
- "Installing and Configure RHEL 6 and SGI Foundation 2.4 Software" on page 26

Installing SLES 11 SP1 on the SMN

This section describes how to install SLES 11 SP1 and SGI Foundation Software 2.4 on the SGI Altix UV system management node.

Procedure 1-1 Installing SLES 11 SP1 Software on the System Management Node (SMN)

To install SLES 11 software images on the SMN, perform the following steps:

1. Turn on, reset, or reboot the SMN. The power on button is on the right of the SMN, as shown in Figure 1-8 on page 15.

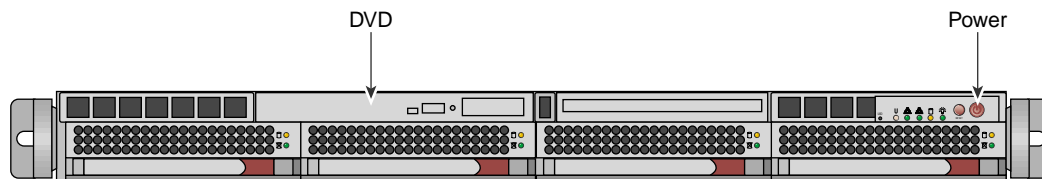

Figure 1-8 System Management Node Power On Button and DVD Drive

2. Insert the SLES 11 Service Pack 1 DVD in the DVD drive on the left of the SMN as shown in Figure 1-8 on page 15.
3. Once installation of software on the system management node is complete, remove the DVD from the DVD drive.
4. After the reboot completes, you will eventually see the **YaST2 - firstboot@Linux Welcome** screen, as shown in Figure 1-9 on page 16. Select the **Next** button to continue.

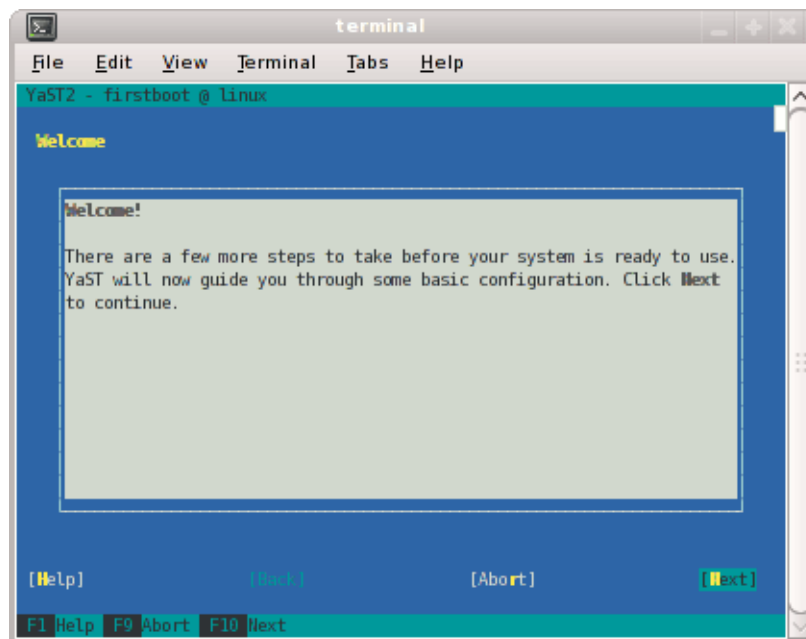

Figure 1-9 YaST2 - firstboot@Linux Welcome Screen

Note: The YaST2 Installation Tool has a main menu with sub-menus. You will be redirected back to the main menu, at various times, as you follow the steps in this procedure.

You will be prompted by YaST2 firstboot installer to enter your system details including the root password, network configuration, time zone, and so on.

5. From the **Hostname and Domain Name** screen, as shown in Figure 1-10 on page 17, enter the hostname and domain name of your system in the appropriate fields. Make sure that **Change Hostname via DHCP** is **not** selected (no **x** should appear in the box). Note that the hostname is saved to `/etc/hosts` in step 10, below. Click the **Next** button to continue.

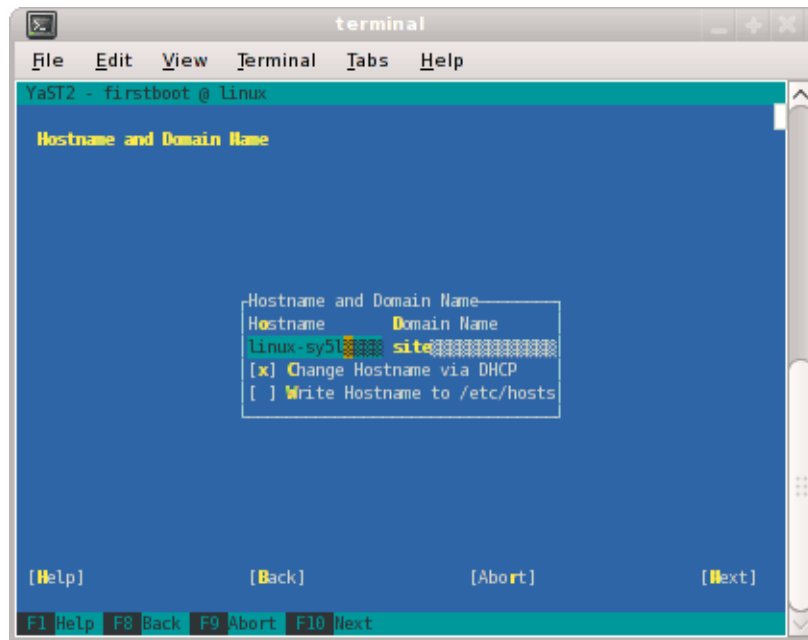

Figure 1-10 Hostname and Domain Name Screen

Note: The mostly used keys are Tab and Shift + Tab to move forward and backward in modules, the arrow keys to move up and down or left and right in lists, the shortcuts (press Alt + highlighted letter) and Enter to execute the selected action or activate a menu item.

You can use Ctrl L to refresh the YaST screen as necessary.

6. The **Network Configuration II** screen appears, as shown in Figure 1-11 on page 18. Select **Change** and a small window pops up that lets you choose **Network Interfaces...** or **Reset to Defaults**. Choose **Network Interfaces**.

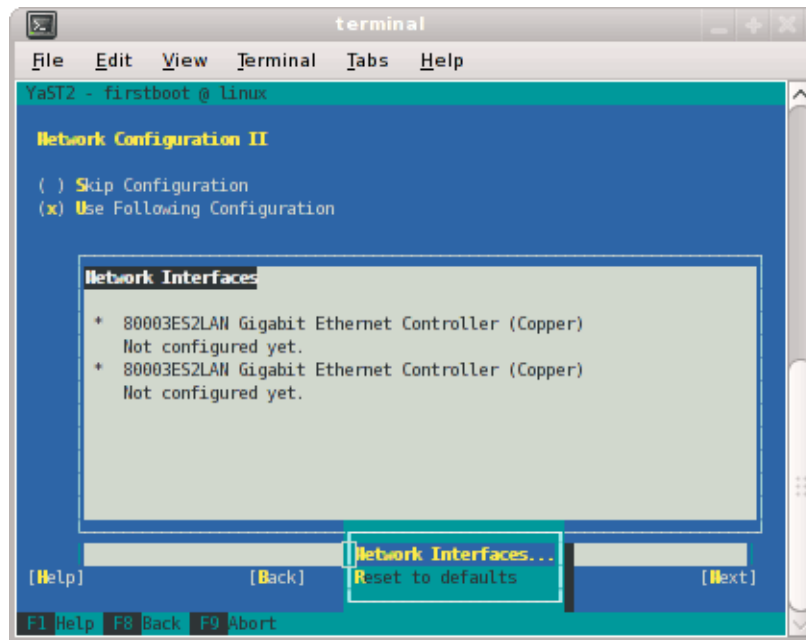

Figure 1-11 Network Configuration II Screen

7. From the **Network Settings** screen, as shown in Figure 1-12 on page 19, configure the first card under **Name** to establish the public network (sometimes called the house network) connection to your system management node (SMN). To do this, highlight the first card and select **Edit**.

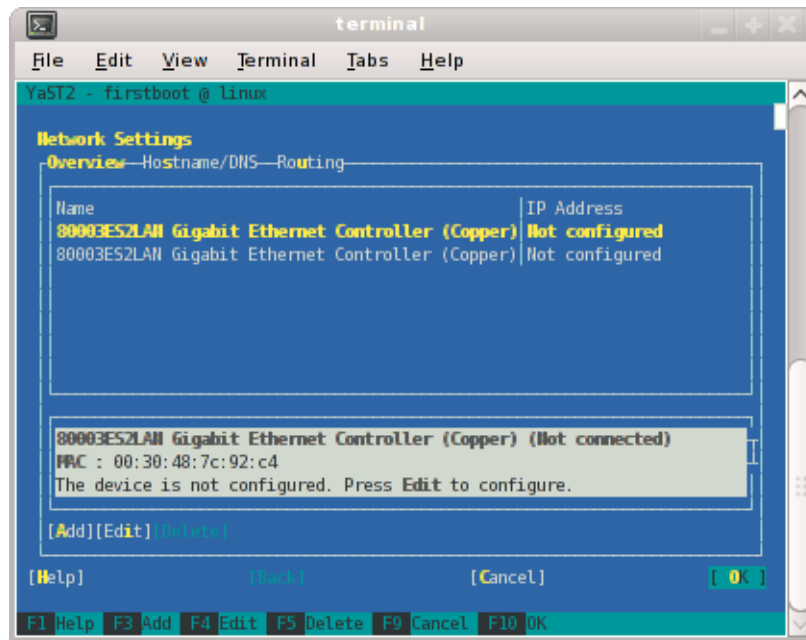

Figure 1-12 Network Settings Screen

Note: In SLES11, this screen is also where we will come back to in order to set up things like the default route and DNS. You can see all of those menu choices just to the right of **Overview** in Figure 1-12 on page 19.

8. The **Network Card Setup** screen appears, as shown in Figure 1-13 on page 20. SGI suggests using static IP addresses and not DHCP for admin nodes. Select **Statically assigned IP Address**. Once selected, you can enter the IP Address, Subnet Mask, and Hostname.

Note: You must use a fully qualified hostname (host + domain), such as, *mssystem-admin.domainname.mycompany.com*.

These are the settings for your admin node's house/public network interface. You will enter the default route, if needed, in a different step. Select **Next** to continue.

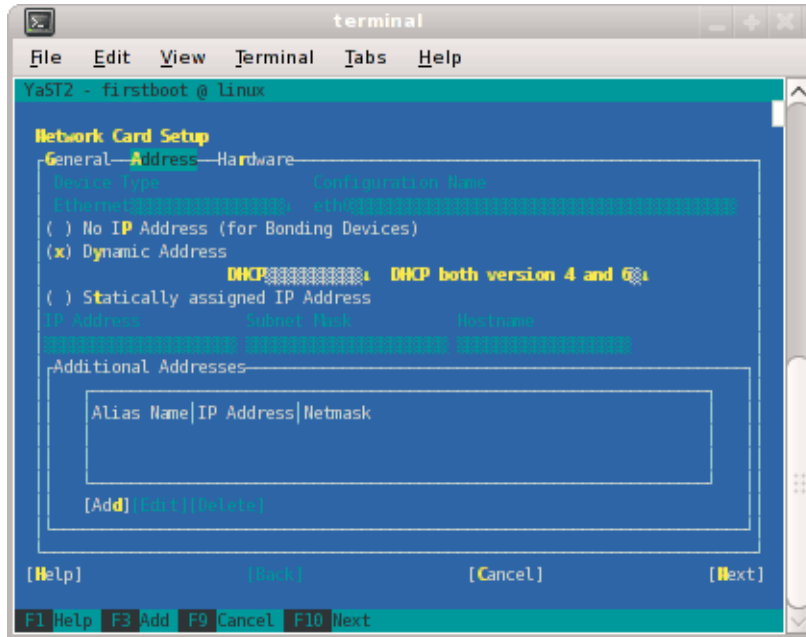

Figure 1-13 Network Card Setup Screen

9. At this point, you are back at the **Network Settings** screen as shown in Figure 1-14 on page 21. At this time, select **Hostname/DNS**. In this screen, you should enter your house/public network hostname and fully qualified domain names. In addition, any name servers for your house/public network should be supplied. Please select (ensure an x is in the box) for **Write hostname to /etc/hosts**. Do not select **OK** yet.

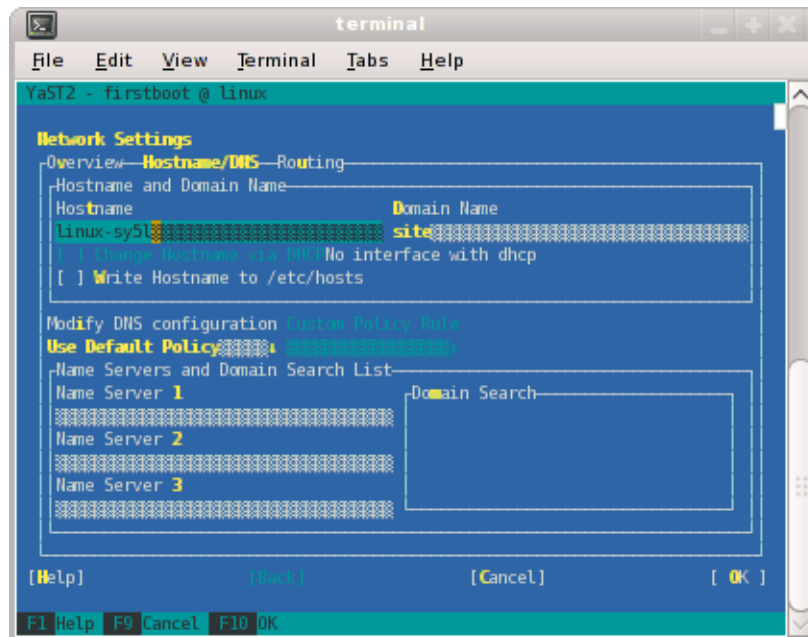

Figure 1-14 Network Settings Screen

10. Select **Routing** shown in Figure 1-15 on page 22 and enter your house/public network default router information there. Now you can select **OK**.

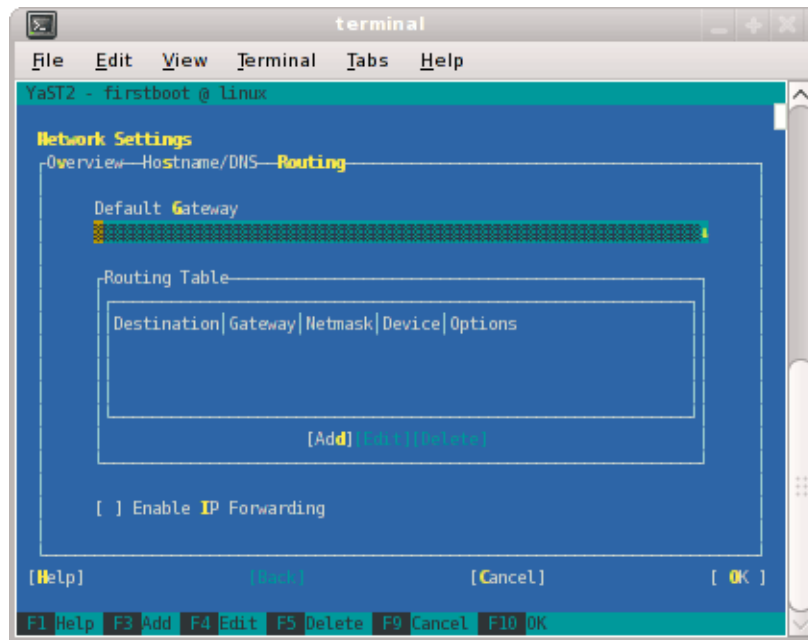

Figure 1-15 Network Settings Routing Screen

11. You are now back at the **Network Configuration II** screen, Click **Next**.
12. In the **Clock and Time Zone** screen, you can enter the appropriate details. Select **Next** to continue.
13. In the **Password for the System Administrator "root"** screen, enter the password you wish to use. Select **Next** to continue.
14. In the **User Authentication Method** screen, most customers will want to stick with the default (**Local**). Select **Next** to continue.
15. In the **New Local User** screen, you can just select **Next** (and say **Yes** to the **Empty User Login** warning). Select **Next** to continue.
16. In **Installation Completed**, select **Finish**.
17. After you have completed the YaST first boot installation instructions, login into the SMN. You can use YaST2 to confirm or correct any configuration settings.

18. You need to install SGI Foundation 2.4 software at this point. For installation instructions, see "Installing SLES 11 SP1 and SGI Foundation Software 2.4 " on page 23.
- 19.

Note: The SGI System Management Node Software 1.2 Release Notes are available on SGI SupportFolio <https://support.sgi.com/login>.

Using YaST2 or manually using the `rpm` command, from the SGI-System-Management-Node-Software-1.2 ISO, install the following:

```
rpm -i monit-5.0.3-1sgi703rp1.sles11.x86_64.rpm
rpm -i monit-sgi-rules-5.0.3-1sgi703rp1.sles11.x86_64.rpm
rpm -i sgi-base-smn-uv-1.0-sgi703rp3.sles11.x86_64.rpm
rpm -i sgi-common-smn-uv-1.0-sgi703rp3.sles11.x86_64.rpm
rpm -i sgi-db-smn-uv-1.0-sgi703rp3.sles11.x86_64.rpm
rpm -i sgi-gather-smn-uv-1.0-sgi703rp3.sles11.x86_64.rpm
rpm -i sgi-smn-docs-1-sgi703rp3.sles11.noarch.rpm
rpm -i sgi-smn-release-1.2-sgi703rp31.sles11.noarch.rpm
rpm -i sgi-snmpagent-smn-uv-1.0-sgi703rp3.sles11.x86_64.rpm
rpm -i sgi-uv-bmc-1.2.5_5-20110121.noarch.rpm
rpm -i sgi-uv-cmc-1.2.6_3-20110121.noarch.rpm
rpm -i sgi-uv-iobmc-1.2.2_3-20110121.noarch.rpm
rpm -i sysco-uv-1.0-20110118.1858sgi703rp1.sles11.x86_64.rpm
rpm -i sysco-uv-libs-1.0-20110118.1858sgi703rp1.sles11.x86_64.rpm
```

Installing SLES 11 SP1 and SGI Foundation Software 2.4

The following set of instructions is based on an install using the physical product media. For other installation methods, see the product release notes.

For an overview of SLES11 SP1 installation, see the *SUSE Linux Enterprise Server 11 Installation Quick Start* (`installquick.pdf`). This document provides a quick overview of how to run through the default installation of SLES walking you through a number of installation screens. For detailed installation instructions, see the *SUSE Linux Enterprise Server 11 Deployment Guide* (`deployment.pdf`)

Note: Documentation for SUSE Linux Enterprise Server 11 SP1 is located on your system in the `/docu/en` directory.

Procedure 1-2 Install SLES 11 SP1 and SGI Foundation Software 2.4

To install SUSE Linux Enterprise Server 11 (SLES11) SP1 from the DVD media and SGI Foundation Software 2.4 as an add-on product, perform the following steps:

1. Insert the SLES 11 SP1 Installation DVD in the DVD drive and reboot your system.
2. Follow the steps in the *SUSE Linux Enterprise Server 11 Installation Quick Start*. When you get to the **Installation Mode** screen, as shown in Figure 1-16 on page 24, click the button next to **Include Add-On Products from Separate Media** and then click **Next** to continue.

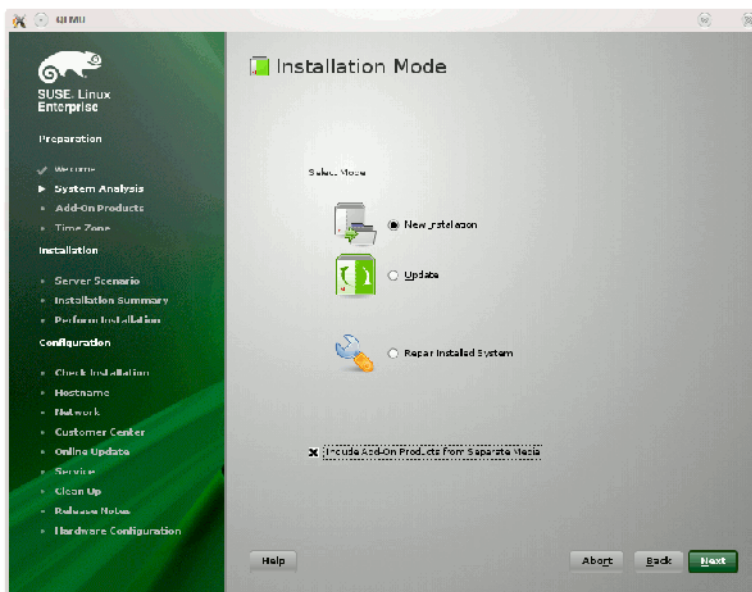

Figure 1-16 SLES11 **Installation Mode** Screen

3. From the **Media Type** screen, shown in Figure 1-17 on page 25, click the button to the left of **CD**.

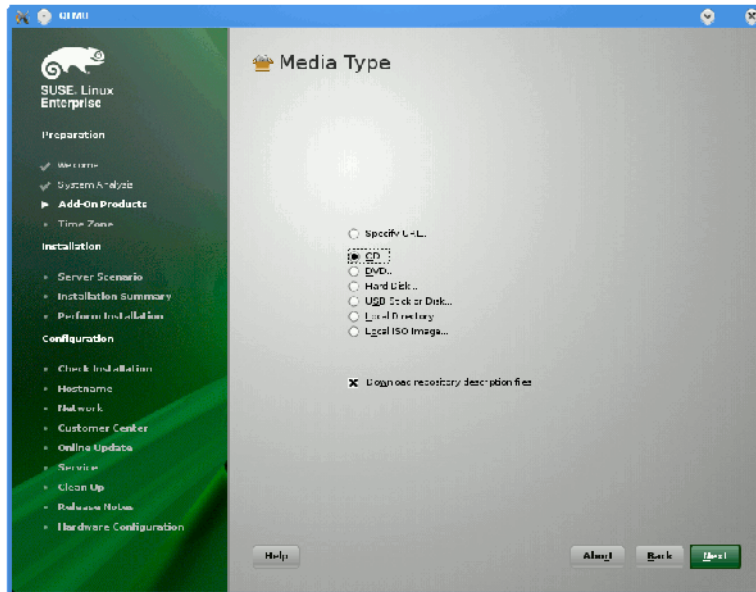

Figure 1-17 SLES11 Media Type Screen

4. The **Insert the add-on product CD** dialog box appears. Insert the SGI -Foundation-x86_64 CD into the drive and click the **Continue** button and then **Next** to proceed.
5. From the **Add-On Product Installation** screen, as shown in Figure 1-18 on page 26, click on **SGI-Foundation-x86_64 1-6 cd:///Directory** and click the **Add** button and then **Next** to proceed
6. Follow the SLES11 SP1 instructions to complete the installation.

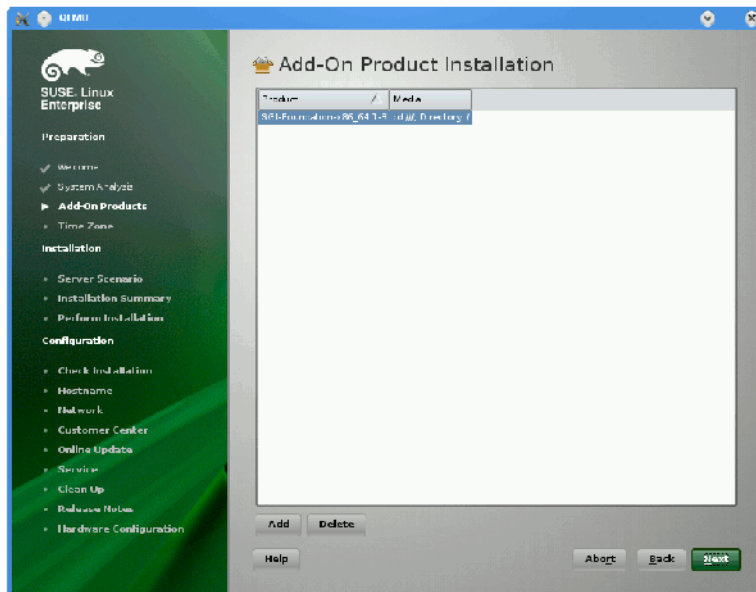

Figure 1-18 SLES11 SP1 Add-On Product Installation Screen Showing SGI Foundation

Installing and Configure RHEL 6 and SGI Foundation 2.4 Software

This section describes how to install Red Hat Enterprise Linux 6 on the system management node.

Installation instructions for Red Hat Enterprise Linux 6 (RHEL 6) are contained in the *Red Hat Enterprise Linux 6 Installation Guide* available at http://docs.redhat.com/docs/en-US/Red_Hat_Enterprise_Linux/6/pdf/Installation_Guide/Red_Hat_Enterprise_Linux-6-Installation_Guide-en-US.pdf

These instructions assume that you have a VGA display or that you are able to remotely display X11 graphics. If you do not have a VGA display, you should connect from your workstation to the target server with the following command:

```
% ssh -X root@target-server
```

Procedure 1-3 Installing RHEL 6 Software on the System Management Node

To install RHEL 6 software images on the system management node, perform the following steps:

1. Insert the product media and enter the following command to mount it:

```
% mount /dev/cdrom/mnt
```

2. Run the following command and follow the examples provided:

```
% /mnt/create-yum-config-file
```

Additional installation instructions for installing SGI Foundation Software (SFS) 2.4 and RHEL 6 are provided in the SFS 2.4 release notes file.

3. By default RHEL 6 uses NetworkManager and all the directions here assume it is off. Perform the following commands, before proceeding:

```
# chkconfig NetworkManager off
# service NetworkManager stop
```

4. Add the IPADDR, NETMASK, and NETWORK values appropriate for the network interface to the /etc/sysconfig/network-scripts/ifcfg-eth0 file similar to the following example:

```
IPADDR=128.162.244.88
NETMASK=255.255.255.0
NETWORK=128.162.244.0
```

5. Create the /etc/sysconfig/network file similar to the following example:

```
[root@localhost ~]# cat /etc/sysconfig/network
NETWORKING=yes
HOSTNAME=my-system-admin
GATEWAY=128.162.244.1
```

6. Create the /etc/resolv.conf file similar to the following example:

```
[root@localhost ~]# cat /etc/resolv.conf
search domain-name.mycompany.com
nameserver 137.38.224.40
nameserver 137.38.31.248
nameserver 137.38.225.5
```

7. Add the IP address of the house network interface and the name(s) of the admin node to `/etc/hosts` file similar to the following example:

```
# echo "128.162.244.88 my-system-admin.domain-name.mycompany.com my-system-admin"
```

8. Set the admin node hostname, as follows:

```
# hostname my-system-admin
```

9. Force the invalidation of the host cache of `nscd` with the `nscd(8)` command on the `hosts` file, as follows:

```
# nscd -i hosts
```

10. Restart the following services (in this order), as follows:

```
# /etc/init.d/network restart
# /etc/init.d/rpcbind start
# /etc/init.d/nfslock start
```

11. Set the local timezone. The timezone is set with `/etc/localtime`, a timezone definition file. The timezone defined in `/etc/localtime` can be determined, as follows:

```
# strings /etc/localtime | tail -1
CST6CDT,M3.2.0,M11.1.0
```

Link the appropriate timezone file from directory `/usr/share/zoneinfo` to `/etc/localtime`. For example, set timezone to Pacific Time / Los Angeles, as follows:

```
# /bin/cp -l /usr/share/zoneinfo/PST8PDT /etc/localtime.$$
# /bin/mv /etc/localtime.$$ /etc/localtime
```

Confirm the timezone, as follows:

```
# strings /etc/localtime | tail -1
PST8PDT,M3.2.0,M11.1.0
```

12. Set network time configuration. By default, the configuration in `/etc/ntp.conf` directs requests to public servers of the `pool.ntp.org` project. Use public servers from the `http://www.pool.ntp.org/en/` project:

```
server 0.rhel.pool.ntp.org
server 1.rhel.pool.ntp.org
```

```
server 2.rhel.pool.ntp.org
```

You may need to modify this `ntp` configuration file to point at a time server on your network. Please do not remove any entries that serve the cluster networks. For example, to direct requests to, for example, `my.corp.mycompany.com`, comment/delete the pool entries and insert the local entry, as follows:

```
# Use public servers from the pool.ntp.org project.
# Please consider joining the pool (http://www.pool.ntp.org/join.html).
#server 0.rhel.pool.ntp.org
#server 1.rhel.pool.ntp.org
#server 2.rhel.pool.ntp.org
server my.corp.mycompany.com
```

Restart the `ntp` server, as follows:

```
# /etc/init.d/ntpd restart
```

13. Make sure you have registered with the Red Hat Network (RHN). If you have not yet registered, run the following command:

```
% /usr/bin/rhn_register
```

14. From the SGI-System-Management-Node-Software-1.2 ISO, install the following:

```
rpm -i monit-5.0.3-1sgi703rp2.rhel6.x86_64.rpm
rpm -i monit-sgi-rules-5.0.3-1sgi703rp2.rhel6.x86_64.rpm
rpm -i sgi-base-smn-uv-1.0-sgi703rp5.rhel6.x86_64.rpm
rpm -i sgi-common-smn-uv-1.0-sgi703rp5.rhel6.x86_64.rpm
rpm -i sgi-db-smn-uv-1.0-sgi703rp5.rhel6.x86_64.rpm
rpm -i sgi-gather-smn-uv-1.0-sgi703rp5.rhel6.x86_64.rpm
rpm -i sgi-smn-docs-1-sgi703rp12.rhel6.noarch.rpm
rpm -i sgi-smn-release-1.2-sgi703rp49.rhel6.noarch.rpm
rpm -i sgi-snmagent-smn-uv-1.0-sgi703rp5.rhel6.x86_64.rpm
rpm -i sgi-uv-bmc-1.2.5_5-20110121.noarch.rpm
rpm -i sgi-uv-cmc-1.2.6_3-20110121.noarch.rpm
rpm -i sgi-uv-iobmc-1.2.2_3-20110121.noarch.rpm
rpm -i sysco-uv-1.0-20110118.1858sgi703rp2.rhel6.x86_64.rpm
rpm -i sysco-uv-libs-1.0-20110118.1858sgi703rp2.rhel6.x86_64.rpm
rpm -i sysco_uv-tools-1.6-20110121.i386.rpm
```

SGI Altix UV 100 and Altix UV 1000 System Installation Instructions

This sections describes where you can find installation instruction to install software on SGI Altix UV 100 and Altix UV 1000 systems.

Install and Configure SLES 11 SP1 and SGI Foundation Software 2.4

To install and configure SLES 11 SP1 and SGI Foundation Software 2.4 on an SGI Altix UV 100 or Altix UV 1000 system, see the appropriate sections in the *SGI Altix UV Systems Software Install Guide*.

Install and Configure RHEL 6 and SGI Foundation Software 2.4

To install and configure RHEL 6 and SGI Foundation Software 2.4 on an SGI Altix UV 100 or Altix UV 1000 system, see the appropriate sections in the *SGI Altix UV Systems Software Install Guide*.

Installing Windows Server 2008 R2 Datacenter Software

For information on installing Windows Server 2008 R2 Datacenter software, see the *Windows on SGI Altix UV Software Install Guide*.

SMN RPMs for SSI

For this release, there is an RPM on the SMN media that is installed on each single-system image (SSI).

- SLES 11

```
rpm -i sysco-uv-smnconfig-1.0-20110118.1858sgi703rp1.sles11.x86_64.rpm
```

- RHEL 6

```
rpm -i sysco-uv-smnconfig-1.0-20110118.1858sgi703rp2.rhel6.x86_64.rpm
```

SGI Management Center Software Installation

For information on how to install SGI Management Center (SMC) software, see the *SGI Management Center Installation and Configuration* guide available at <http://docs.sgi.com>. In particular, see Chapter 1, “Installing SGI Management

Center” and “Install Management Center Payload” section in Chapter 4, “Creating Payloads and Images”.

Updating Firmware

A set of commands is available from the system management node (SMN) to update Altix UV firmware. The general syntax for the tool is, as follows:

```
flashXXX [-r] <image name> <CMC host/IP> [... <CMC host/IP>
```

There are three firmware flashing commands based on the general syntax, above:

- flashcmc
- flashbmc
- flashiobmc

These tools have the following in common:

- These tools are run from the SMN.
- The commands update the specified image, but will **not** reboot the updated BMCs or CMCs. When you specify the `-r` option, the updated BMCs/CMCs are reset/rebooted so that the firmware update takes effect immediately.
- The flash tools flash the entire system, not just the CMC specified on the command line. When flashing multi-IRU systems you **must** specify only one CMC hostname.
- For SGI service personnel, when updating these images where the firmware archives is not directly accessible (from an SMN or at a customer site), simply download the firmware binary and flash tool onto the SMN (or service laptop for updates on sites without SMNs) and run the flash tools as indicated below.

To update the system firmware, perform the following:

1. Obtain the latest firmware from SGI SupportFolio at <https://support.sgi.com> or from SGI site personnel.

Note: Firmware versions for the Node BMC, BaseIO BMC, and the CMC are likely to have different version numbers. See examples below. You can use the `version` command on the CMC, Node BMC, or BaseIO BMC to determine the current firmware level. For information on the `version` command, see Chapter 3. “Altix UV CMC Software Commands” in the *SGI Altix UV CMC Controller Software User’s Guide*.

2. To update the Node BMC firmware on your SGI Altix UV 100 or Altix UV 1000 system, perform the following:

```
$ cd /usr/local/sysco/firmware/bmc/1.2.5
$ flashbmc -r uvbmc.bin* <CMC hostname/IP>
```

3. To update the BaseIO BMC firmware on your SGI Altix UV 100 or Altix UV 1000 system, perform the following:

```
$ cd /usr/local/sysco/firmware/iobmc/1.2.2
$ flashiobmc -r uvbaseio.bin* <CMC hostname/IP>
```

4. To update the CMC firmware on your SGI Altix UV 100 or Altix UV 1000 system, perform the following:

```
$ cd /usr/local/sysco/firmware/cmc/1.2.6
$ flashcmc -r cmc.bin* <CMC hostname/IP>
```

SMN Backup Files

For information on the `/smnbackup` command, perform the following:

```
uv44-smn:~ # /smnbackup -h
```

```
Usage: /smnbackup [options]
```

Options:

-h	Display this message.
-v	Verbose Output
-b <base dir>	The base directory for your output files. Default is /data1
-n <base filename>	The base file name for tarball,log,md5sum etc. Default is uv44-smn
-x <additional excludes>	Add additional exclude params to tar.
EX -x "--exclude ./path/to/exclude/* "	

```
-s                Make SGI Prep Clone

-p                Make Prep Clone
WARNING: This excludes things such as /opt/sgi/sgimc/vcs and ssh keys.
WARNING: While including /opt/sgi/sgimc/images.

-t                Start the tar
```

Deprecated options:

```
-l <log file name>      The file name of the log file. Default is uv44-smn.log
-e <error log file name> The file name of the error log file. Default is uv44-smn.error.log
-c <checksum file name> The file name of the checksum. Default is uv44-smn.md5sum
```

NOTE:

```
Passing no arguments with the -t option creates the following files:
/data1/uv44-smn.tar.gz
/data1/uv44-smn.log
/data1/uv44-smn.error.log
/data1/uv44-smn.md5sum
```

The `uv_con` facility collects all SMN UV BaseIO UV consoles locally for consultation purposes. For a usage statement, perform the following:

```
uv44-smn:~ # uv_con -h
Usage: uv_con without arguments: same as "-s"
      uv_con -g [-v] [-k N ] [-n]
           Get logs.
           -v for verbosity.
           -k(eep) default = 24.
           0 = NO rotation.

      uv_con [-l]
           List all available logs

      uv_con [-l] partition_number < partition_number > ...
           Show log for all UV systems with partition      More than 1 partitions can be request
           Use * or "all" for all partitions.

      uv_con [-s] [-ro]
           Show or list compressed/non-compressed logs.
           -s: Browse logs.
```

```
-r for reservse list.  
-o to show /sysco/uv_con/old  
Browser prompt for:  
Log No.: .  
        See 'h' for details.  
How: m   for more  
      l   for less ( or empty line )  
      L   for less -R  
        See 'h' for details.  
uv_con -S Edit /etc/sysconfig/uv_con  
uv_con -C Edit /etc/cron.d/uv_con  
uv_con -L Edit /etc/logrotate.d/uv_con
```

System Network Addressing

This chapter describes the internal system management network addressing scheme for Altix UV 1000 and Altix UV 100 series systems.

It covers the following topics:

- "System Network Addressing Overview" on page 35
- "System Management Node Ethernet Ports" on page 36
- "Altix UV CMC IP Address Assignment" on page 37
- "Multiple Altix UV Partitions or Systems on a Single SMN" on page 38
- "Non Altix UV 100 or UV 1000 Systems on the SMN" on page 38
- "SMN Firewall Capabilities" on page 38

System Network Addressing Overview

The SGI Altix UV hostname assignment is based on the rack and u position of the blade or other component. The rack/u position must be uniform across all Altix UV systems that are attached to an system management node (SMN). In other words, a single Altix UV 1000 system that encompasses multiple racks will have racks numbers 1 to N in increments of 1, and u positions (upos) within each rack will range from 1 to 42, with an increment of 3 (there is an exception where upos 2 is also present). In the case of multiple Altix UV 100 systems, each Altix UV 100 is assigned a unique rack/upos in the same manner, so all Altix UV 100 systems are identifiable in this way.

The system management node (SMN) has three dedicated Ethernet ports to connect to the Altix UV systems, specifically, for the system control network and the primary BaseIO of each partition. There is one Ethernet port on the SMN that is to be attached to the customer network. The connections described in this manual are very specific. Sites are not allowed to also attach other unrelated customer equipment to these dedicated networks because this would interfere with Altix UV system management network.

The SMN detects and then assigns hostnames, IP addresses, and name binding for the Altix UV systems and any additional systems that have a dedicated BMC port connection to the single system image (SSI) segment. For more information, see

"eth1smn" on page 36 and "Multiple Altix UV Partitions or Systems on a Single SMN" on page 38. Because the Altix UV rack/upos convention for identification is used and the network connections are very specific, guidelines must be adhered to carefully.

System Management Node Ethernet Ports

The SMN is a SuperMicro SuperServer 6016T-URF 1U server, with two Gigabit Ethernet (GigE) ports residing on the motherboard, and two additional Ethernet ports provided via an adapter card. The ports are designated eth0 through eth3. The eth0 port is attached to the customer network. Its address is not assigned by the SMN software stack. Customers assign the IP address of the eth0 port. The ports eth1 through eth3 are dedicated to the system management network. To distinguish the SMN Ethernet ports from other ports on BaseIO blades or CMCs, the port is suffixed with "smn", for example eth0smn.

You can get product specification information and other documentation for the SuperMicro 6016T-URF server at <http://www.supermicro.com/> or at <http://docs.sgi.com/>. Search on the title *SuperServer 6016T-URF User's Manual* or on the part number 860-0498-001.

eth1smn

eth1smn is the port for the private network known as the SSI network. This is a dedicated, known path between the SGI Management Center (SMC) application and each kernel instance, or single system image (SSI). If an Altix UV system is partitioned, each partition requires at least one BaseIO blade, and the primary BaseIO of each partition is connected to the SMN. eth1smn is also the network that connects the BaseIO baseboard management controller (BMC) to the SMN. This network is also used to attach non Altix UV system BMCs, such as, SGI Altix XE series systems, the SGI C1103-TY12 system, SGI Altix UV 10, and SGI Rackable series systems, to the SMN, to allow the SMC a means to control these non Altix UV systems.

The IP address range for eth1smn is 172.21.0.0/16 with starting address 172.21.1.1. Within this range, a convention is followed to designate 172.21.1-128.x for BaseIO Ethernet and 172.21.129-254.x for non Altix UV BMCs.

eth2smn

eth2smn is the port for the private network known as the primary CMC network. The Altix UV 100 and Altix UV 1000 systems with multiple CMCs are very specifically configured into a small network, and the SMN is a peer on this network.

The range of IP addresses for devices attached to eth2smn is 172.19.0.0/16 with starting address 172.19.1.1.

eth3smn

eth3smn is the port dedicated to the secondary CMC network. The secondary CMC capability is currently not implemented. However, the IP space is still reserved.

The range of IP addresses for devices attached to eth3smn is 172.20.0.0/16 with starting address 172.20.1.1.

Altix UV CMC IP Address Assignment

The chassis management controllers (CMCs) are given IP addresses based on their location in the racks. The address is determined, as follows:

172.{19|20}.rh.ruuuuuu

Where:

- 'rh' is the lower 8 bits of the rack number.
- 'rr' is the upper two bits of the rack number, shifted down 2. Rarely used.
- 'uuuuuu' is the upos (6 bits)

eth0 is the WAN interface (see Figure 1-5 on page 7 and Figure 1-5 on page 7). By default, SGI Altix UV systems are shipped with dynamic host configuration protocol (DHCP).

eth2 is 172.19.0.1 on the SMN. 172.19.xx.yy is the IP address when the SMN assigns the IP address to the CMC.

eth3 is same as eth2 except it is 172.20.

eth1 is the same but 172.21.x.y. This is the link to the single-system image (SSI) Altix UV BaseIO. The Altix UV SSI BaseIO will get IP address either from system

management node (SMN) or the SGI Management Center (SMC), when installed. For this segment, the SMN do not use rack/upos since it is not relevant for SSI BaseIO.

Multiple Altix UV Partitions or Systems on a Single SMN

A single Altix UV system may be partitioned and have multiple kernels running. The BaseIO blade from each partition must have its `eth0` and BMC ports attached to the system management node (SMN). To accommodate the additional cabling, a GigE switch is needed.

In a similar way, a single SMN can be configured to manage multiple Altix UV100 and Altix UV 1000 systems. One GigE switch is used for the SSI network, another switch for the CMC network.

The `smnconfig` tool performs discovery and address assignment in both of these configurations, if the cabling is connected per the guideline and the multiple Altix UV 100 and Altix UV 1000 systems have their CMCs uniquely designated with the rack/upos method.

Non Altix UV 100 or UV 1000 Systems on the SMN

In addition to managing Altix UV 100 and Altix UV 1000 systems, the SMN can also provide system management for other systems, such as the Altix UV 10, Altix XE systems, and so on. For these class of systems, the only connection to the SMN required is the BMC port from the motherboard to the SSI network. As described previously, the SSI network `172.21.0.0/16` is used to connect the UV BaseIO `eth0` ports and the BaseIO BMC ports. The non Altix UV systems connect their BMC ports to this network and will be assigned addresses from the `172.21.129-254.x` range.

SMN Firewall Capabilities

Because of system addressing requirements for the system management node (SMN), see "System Network Addressing Overview" on page 35, firewall capabilities should **only** be applied to the SMN wide area network (WAN) interface `eth0smn`. The interfaces `eth1smn`, `eth2smn`, and `eth3smn` (see "System Management Node Ethernet Ports" on page 36) should not be firewalled in any manner with one exception, as follows:

If you use a remote client (installing the client-only installation of SMC on a different server), then TCP ports 7620, 4672, and 7673 need to be opened up in the firewall. This is the only requirement for the WAN interface.

System Configuration from the SMN

This chapter walks you through various system configuration procedures performed from the system management node (SMN) on an SGI Altix UV 100 or an SGI Altix UV 1000 system. It covers the following topics:

- "Enabling a Remote Console" on page 41
- "Changing Configuration Settings" on page 54
- "Determining the IP Address of the BaseIO BMC" on page 60
- "Accessing the SGI BIOS Setup Utility" on page 62
- "Setting an Administrative Password on the Console" on page 64
- "Enabling BaseIO VGA" on page 69
- "Booting Using iSCSI Protocol" on page 69
- "Booting from Fibre Channel Disk" on page 70

Enabling a Remote Console

This section describes how to enable remote console access.

Note: Remote console is now available and is in BaseIO BMC firmware versions 1.2.2 or later. The node BMC firmware and the BaseIO BMC firmware typically have different version numbers. Make sure the BaseIO BMC firmware is 1.2.2 or later to have the remote console capability.

You can use the `ssh` command to connect to the BaseIO blade BMC and use the `version` command to determine the firmware version, as follows:

```
uv44-cmc CMC:r001i01c> ssh ibmc0

SGI UV BMC, Firmware Rev. 1.3.9
r001i01b00i> version
SGI Chassis Manager Controller, Firmware Rev. 1.3.9 [Bootloader 0.3.0]
```

Procedure 3-1 Enabling a Remote Console

Note: Make sure your workstation has Java 6 (Java 1.6.0 or later). You can also use a VNC viewer or similar remote desktop to make sure you get Firefox running on the SMN and not running on your local system.

To enable a remote console to your SGI Altix UV system, perform the following steps:

1. Establish a network connection to the SMN, as follows:

```
# ssh -X sysco@uv-system-smn
```

The password set out of the factory is **sysco**.

2. From the SMN, launch the Mozilla Firefox web browser, as follows:

```
sysco@system-smn:~/hw>firefox -no-remote 2>dev/null &
```

3. Enter the IP address of the BaseIO node baseboard management controller (BMC), similar to the following:

```
http://192.168.1.200
```

To determine the IP address of the BaseIO node BMC, see "Determining the IP Address of the BaseIO BMC" on page 60.

4. The BaseIO node BMC login screen appears, as shown in Figure 3-1 on page 43. Login as **root** with the password **superuser**.

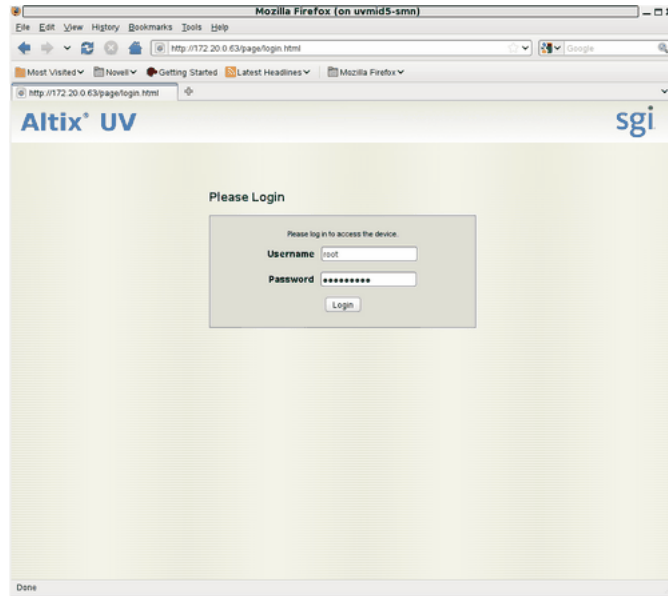

Figure 3-1 BMC Login Screen

5. The **System Information** screen appears, as shown in Figure 3-2 on page 44. Click on the **Remote Control** tab.

3: System Configuration from the SMN

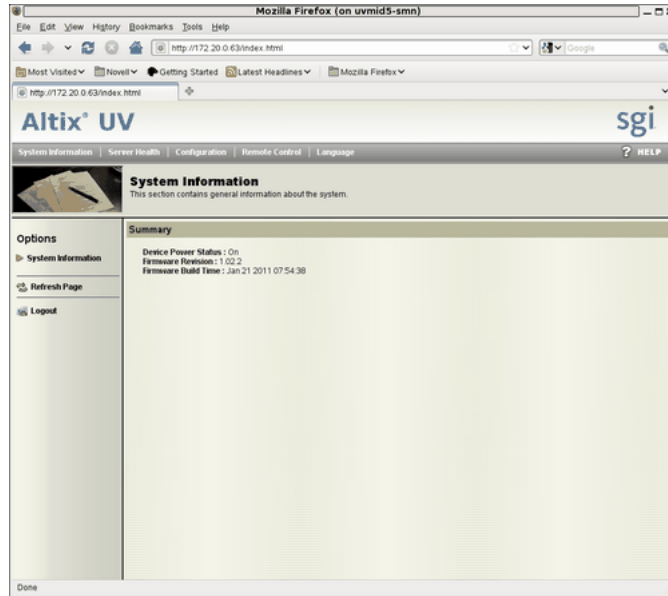

Figure 3-2 BMC System Information Screen

6. The **Remote Control** screen appears, as shown in Figure 3-3 on page 45. Click on the **Console Redirection** button.

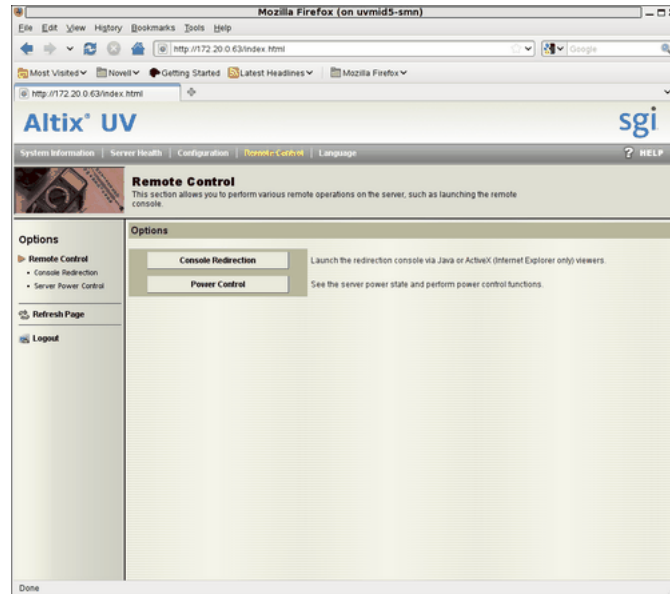

Figure 3-3 BMC Remote Control Screen

7. The **Console Redirection** screen appears, as shown in Figure 3-4 on page 46. Click on the **Launch Console** button.

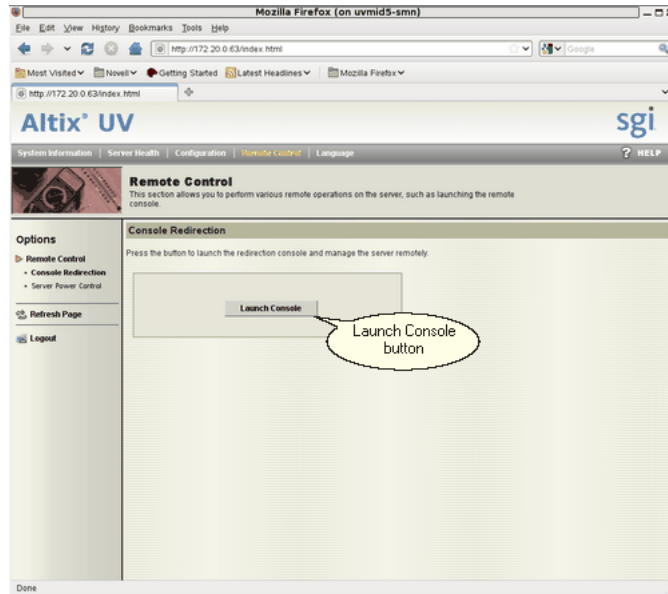

Figure 3-4 BMC Remote Control Console Redirection Screen

You may need to enable pop-ups for this address for the Firefox browser first. From the **Preferences** dialog box, allow access from the IP address of the BaseIO.

8. A Java application under Firefox will open. **Select Execute Java Web Start file (default)** from the pop-up menu, as shown in Figure 3-5 on page 47. You can also click the checkbox to keep it from showing up later.

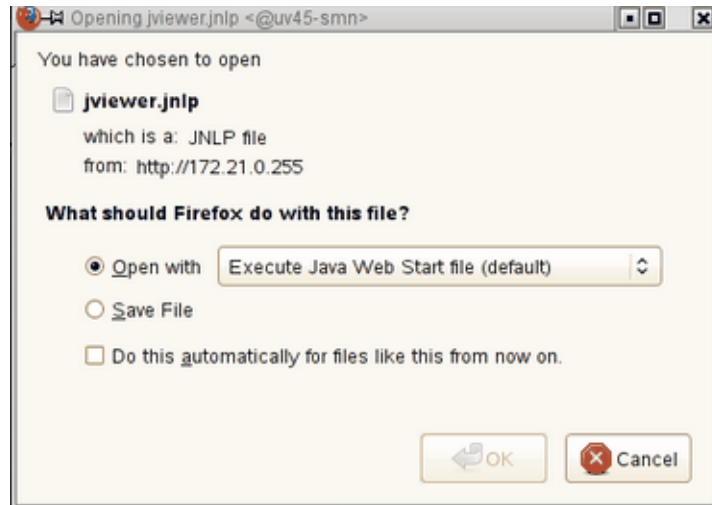

Figure 3-5 Select Execute Java Web Start file (default) Pop-up Menu

9. You will then get a screen about **The web site's certificate cannot be verified. Do you want to continue?**, as shown in Figure 3-6 on page 47. Click the **Yes** button to continue. You can also click the checkbox to keep it from showing up later.

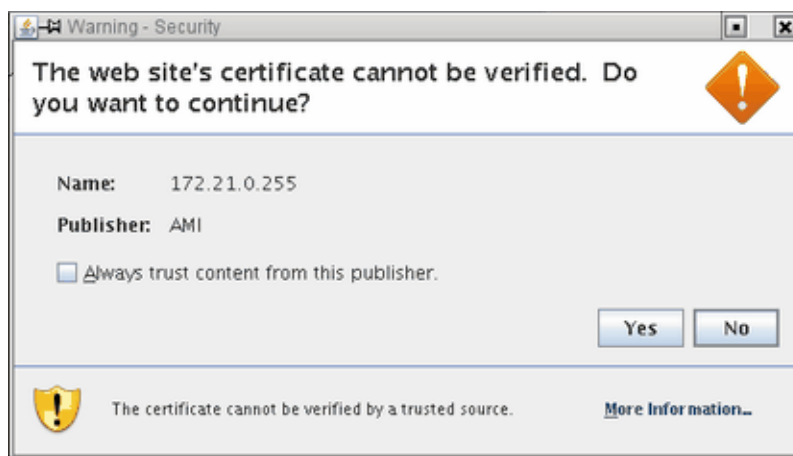

Figure 3-6 Web site Warning-Security Screen

10. You will then get a screen about **The application's digital signature cannot be verified. Do you want to run the application?**, as shown in Figure 3-7 on page 48. Click the **Run** button to continue. You can also click the checkbox to keep it from showing up later.



Figure 3-7 Application **Warning-Security** Screen

11. The JViewer KVM redirection window appears with a **Shell>** prompt, as shown in Figure 3-8 on page 49.

```

A-8089-4298-972E-56A609288F11,0x283BAF,0xD693B)
blk4 :Removable HardDisk - Alias (null)
        PciRoot (0x0)/Pci (0x3,0x0)/Pci (0x0,0x0)/Scsi (0xA,0x0)/HD (5,GPT,E1BEF3D
C-B5D6-4358-9B1E-4916F98A279A,0x35A4EA,0x783BD6A)
blk5 :Removable HardDisk - Alias (null)
        PciRoot (0x0)/Pci (0x3,0x0)/Pci (0x0,0x0)/Scsi (0xA,0x0)/HD (6,GPT,618D6ED
E-D103-431D-9355-24CF815E4AE4,0x7B96254,0x783BD6B)
blk6 :Removable HardDisk - Alias (null)
        PciRoot (0x0)/Pci (0x3,0x0)/Pci (0x0,0x0)/Scsi (0xA,0x0)/HD (7,GPT,1126DBD
6-28C7-4D2D-A4DC-60E1B3B90BF5,0xF3D1FBF,0x783BD6B)
blk7 :Removable HardDisk - Alias (null)
        PciRoot (0x0)/Pci (0x3,0x0)/Pci (0x0,0x0)/Scsi (0xA,0x0)/HD (8,GPT,FC51B06
E-5D80-479D-A7DA-3B1532113FDC,0x16C0DD2A,0x783BD6B)
blk8 :Removable HardDisk - Alias (null)
        PciRoot (0x0)/Pci (0x3,0x0)/Pci (0x0,0x0)/Scsi (0xA,0x0)/HD (9,GPT,FAB18DB
3-130B-47DA-B7A7-C457F8E59E3D,0x1E449A95,0x4A817A6)
blk9 :Removable BlockDevice - Alias (null)
        PciRoot (0x0)/Pci (0x3,0x0)/Pci (0x0,0x0)/Scsi (0xA,0x0)
blkA :Removable BlockDevice - Alias (null)
        PciRoot (0x0)/Pci (0x1A,0x7)/USB (0x3,0x0)
blkB :Removable BlockDevice - Alias (null)
        PciRoot (0x0)/Pci (0x1A,0x7)/USB (0x3,0x0)/Unit (0x1)

Press ESC in 1 seconds to skip startup.nsh, any other key to continue.
Shell> _

```

KVM Remote Console started...

Figure 3-8 KVM JViewer Shell Prompt Screen

Note: You may need to expand the JViewer window in order to see the entire desktop of the system in the following steps.

12. From the **Shell>** prompt issue the following commands, as shown in Figure 3-9 on page 51:

```
Shell>fs0:  
fs0:\>cd efi  
fs0:\efi>cd SuSE  
fs0:\efi\SuSe>elilo
```

You combine the above commands at the shell prompt, as follows:

```
Shell> fs0:\efi\suse\elilo
```

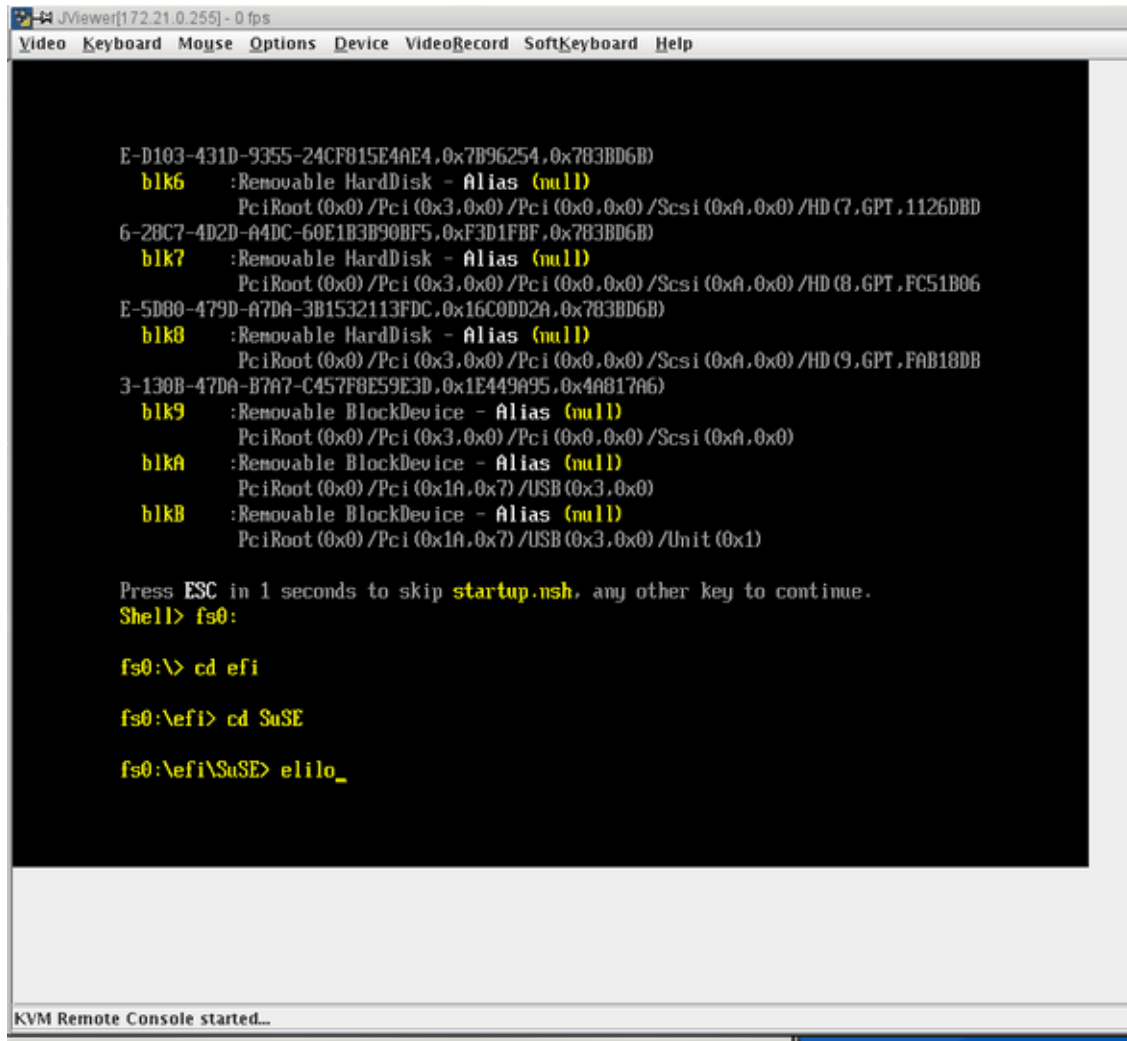
```
JViewer[172.21.0.255] - 0 fps
Video Keyboard Mouse Options Device VideoRecord SoftKeyboard Help

E-D103-431D-9355-24CF815E4AE4,0x7B96254,0x783BD6B)
  blk6 :Removable HardDisk - Alias (null)
        PciRoot (0x0) /Pci (0x3,0x0) /Pci (0x0,0x0) /Scsi (0xA,0x0) /HD (7,GPT,1126DBD
6-28C7-4D2D-A4DC-60E1B3B90BF5,0xF3D1FBF,0x783BD6B)
  blk7 :Removable HardDisk - Alias (null)
        PciRoot (0x0) /Pci (0x3,0x0) /Pci (0x0,0x0) /Scsi (0xA,0x0) /HD (8,GPT,FC51B06
E-5D00-479D-A7DA-3B1532113FDC,0x16C0DD2A,0x783BD6B)
  blk8 :Removable HardDisk - Alias (null)
        PciRoot (0x0) /Pci (0x3,0x0) /Pci (0x0,0x0) /Scsi (0xA,0x0) /HD (9,GPT,FAB18DB
3-130B-47DA-B7A7-C457F8E59E3D,0x1E449A95,0x4A817A6)
  blk9 :Removable BlockDevice - Alias (null)
        PciRoot (0x0) /Pci (0x3,0x0) /Pci (0x0,0x0) /Scsi (0xA,0x0)
  blkA :Removable BlockDevice - Alias (null)
        PciRoot (0x0) /Pci (0x1A,0x7) /USB (0x3,0x0)
  blkB :Removable BlockDevice - Alias (null)
        PciRoot (0x0) /Pci (0x1A,0x7) /USB (0x3,0x0) /Unit (0x1)

Press ESC in 1 seconds to skip startup.nsh, any other key to continue.
Shell> fs0:

fs0:\> cd efi

fs0:\efi> cd SuSE

fs0:\efi\SuSE> elilo_

KVM Remote Console started...
```

Figure 3-9 Booting the Operating System from the JViewer Shell> Prompt Screen

Note: This example shows booting SLES11 SP1. Alternatively, you could boot RHEL 6 at the Shell> prompt.

13. The operating system login screen appears. At the prompt enter **init 5**, as shown in Figure 3-10 on page 52.

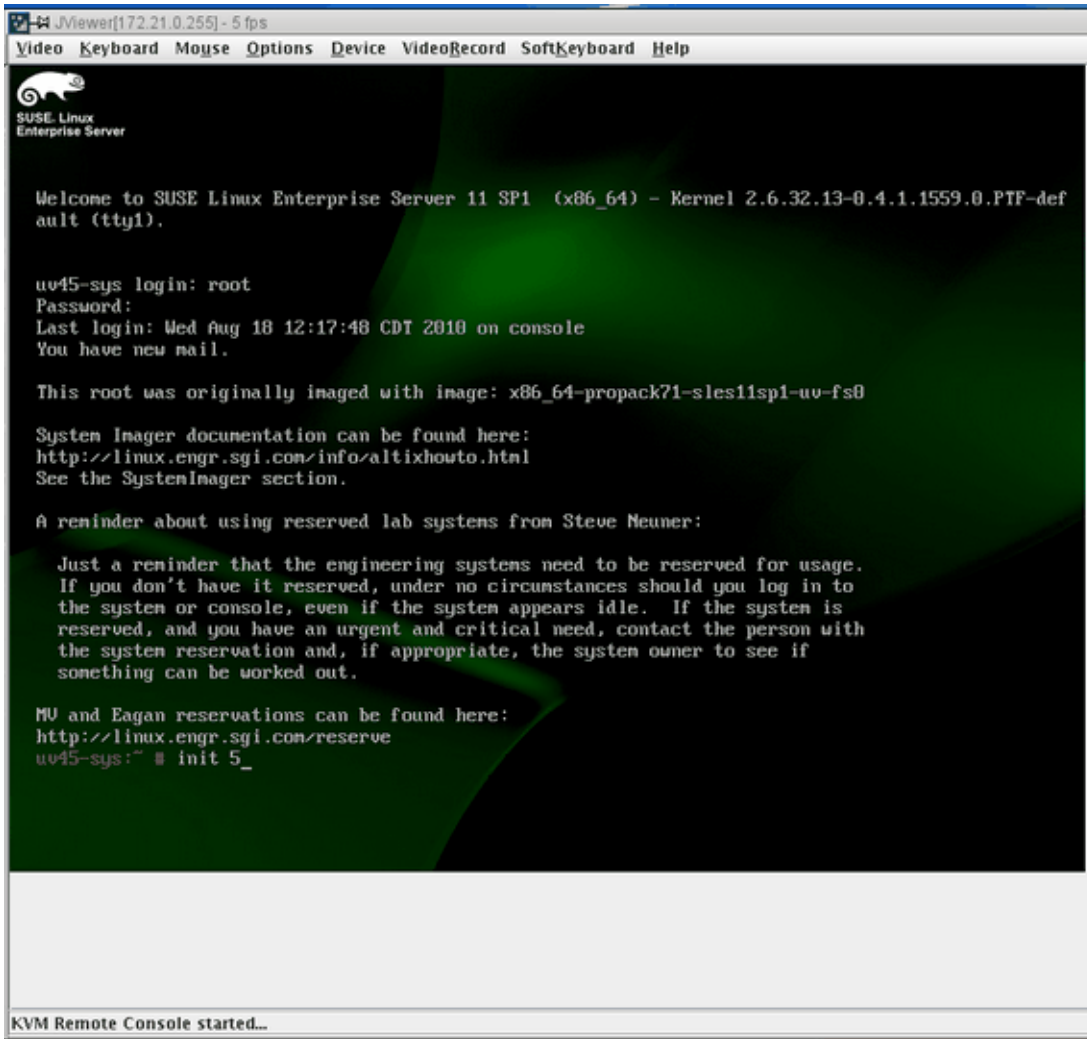

Figure 3-10 JViewer Operating System Login Screen

Note: To see the SUSE graphics screen you want system run level 5.

14. The **SUSE Linux Enterprise Server 11 (x86_64)** login screen appears, as shown in Figure 3-11 on page 53. Log in as root user

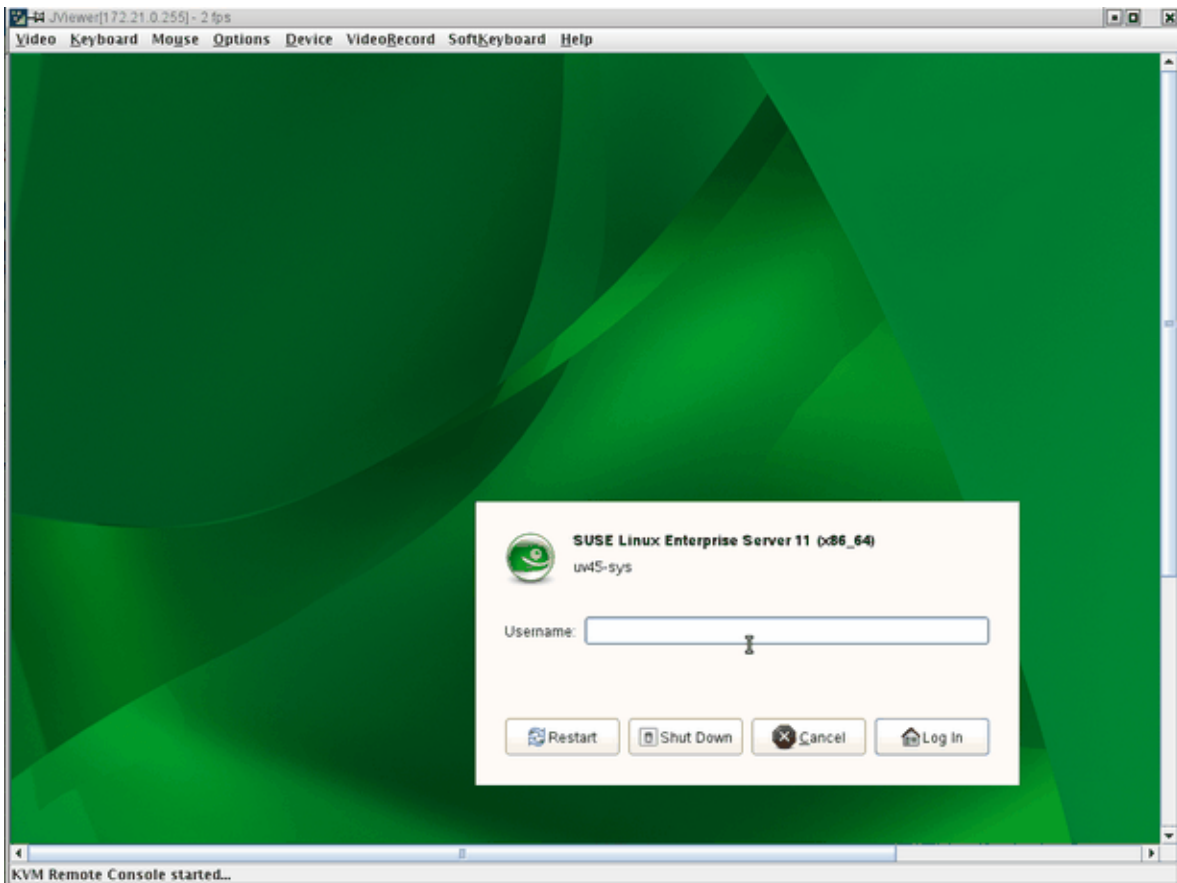

Figure 3-11 SUSE Linux Enterprise Server 11 (x86_64) Login Screen

15. The SUSE Linux Enterprise Server 11 (x86_64) desktop appears, as shown in Figure 3-12 on page 54.

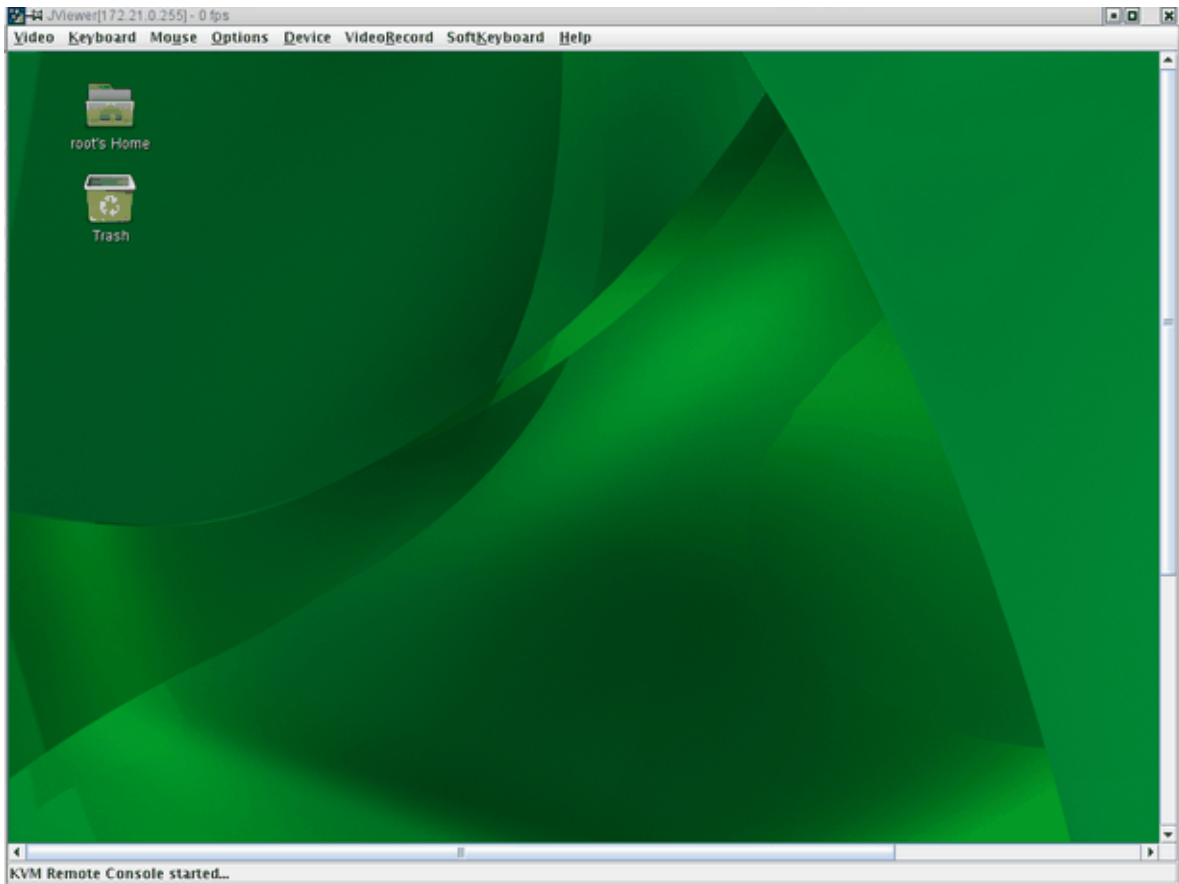

Figure 3-12 SUSE Linux Enterprise Server 11 (x86_64) Desktop Screen

Changing Configuration Settings

From the **Configuration** tab shown in Figure 3-13 on page 55, you can access various configuration setting pages. For example, you can configure fixed network settings under the **Network Settings** page.

Under the **Mouse Mode Settings** page, the **Absolute** setting should be selected for both Linux and Windows operating systems on the host. Older Linux distributions required **Relative** mouse mode. SGI Altix UV systems use **Absolute** mouse mode.

The remainder of the configuration pages are security related and may be of use to you if you connect the BaseIO BMC to your house network rather than the system management node.

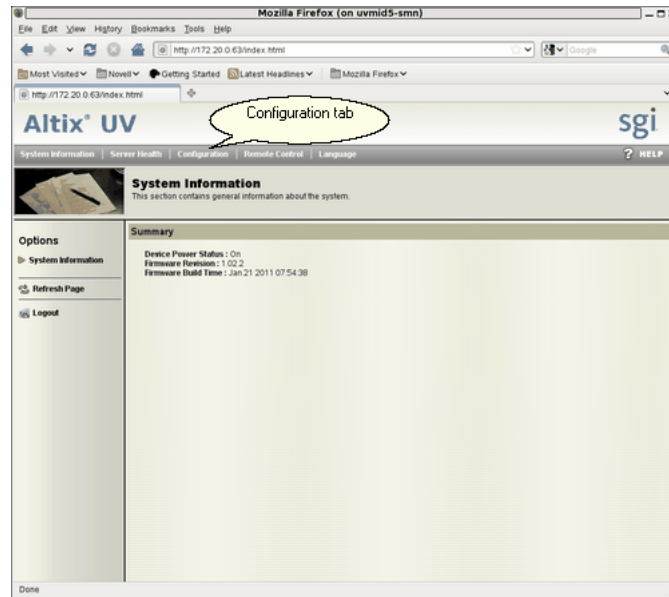

Figure 3-13 Configuration Tab

Reinstalling the Operating System on an Altix UV System

This section describes how to use virtual media redirection to mount a CD-ROM or ISO image from the system management node (SMN) and use it on your Altix UV 100 or Altix UV 1000 system to reinstall the operating system.

Procedure 3-2 Reinstalling and Booting the Altix UV 100 or Altix UV 1000 Operating System

To reinstall and boot an Altix UV 100 or Altix 1000 system using remote media, perform the following steps:

1. Bring up the KVM (JViewer) client on the BaseIO BMC (see "Enabling a Remote Console" on page 41).

- To specify an ISO image file to redirect to the Altix UV operating system ISO image, select **Device-> Redirect ISO** on the JViewer client, as shown in Figure 3-14 on page 56. Then select the ISO image file to use, as shown in Figure 3-15 on page 56. If you are using physical media, to redirect a CD-ROM or DVD, place the CD in the drive of the machine where JViewer is running, then select **Device-> Redirect CDROM** on the JViewer client, as shown in Figure 3-16 on page 57.

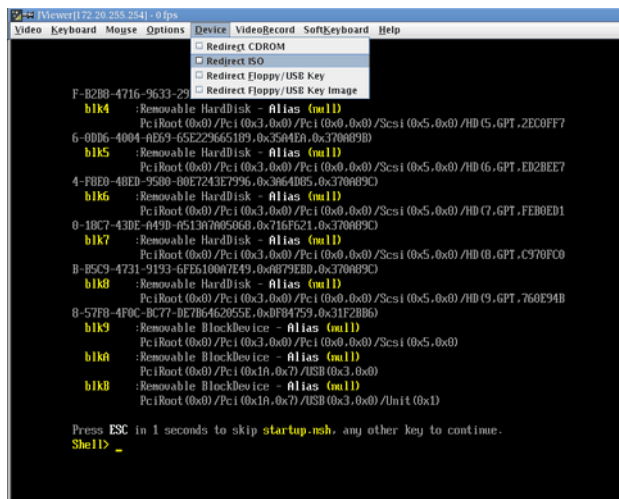

Figure 3-14 Redirect ISO Pull Down Menu

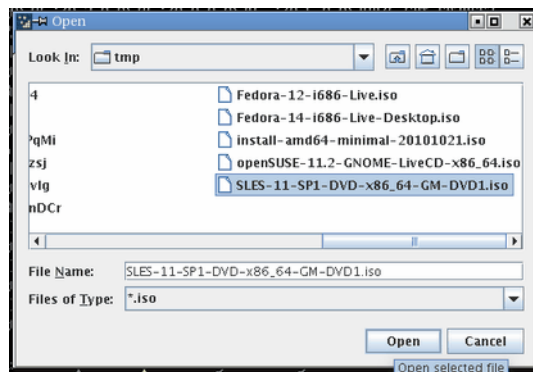

Figure 3-15 ISO Image File Name Screen

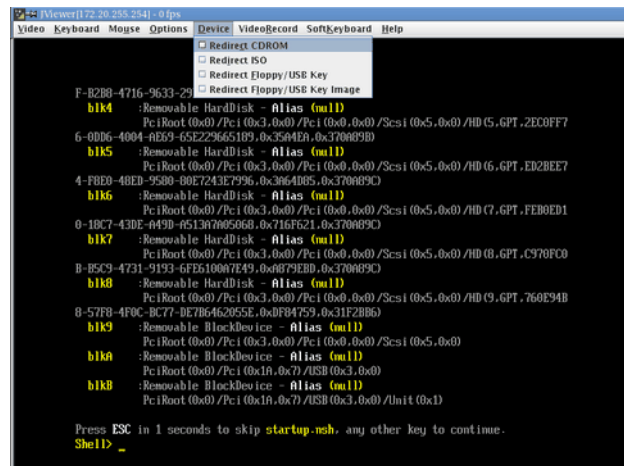

Figure 3-16 Redirect CRROM Pull Down Menu

- When the system gets to the EFI prompt, enter `exit` to get to the BIOS setup screen, as shown in Figure 3-17 on page 57.

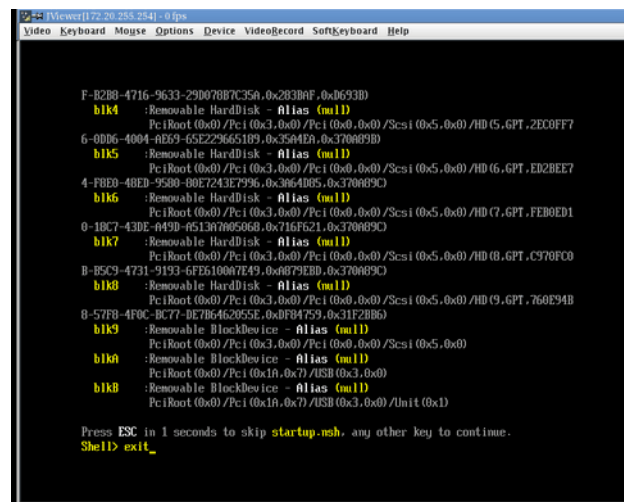

Figure 3-17 KVM JViewer Shell Prompt Screen

4. From the BIOS setup utility, select **Boot Manager**, as shown in Figure 3-18 on page 58.

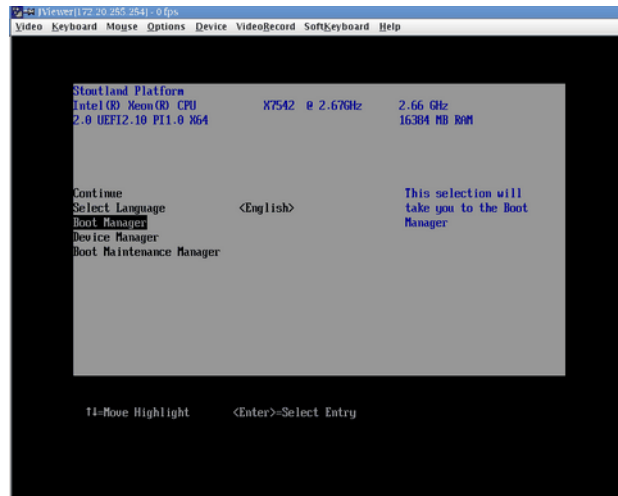

Figure 3-18 BIOS Setup Utility **Boot Manager** Selection

5. From the **Boot Manager** screen, select **EFI USB Device**, as shown in Figure 3-19 on page 59.

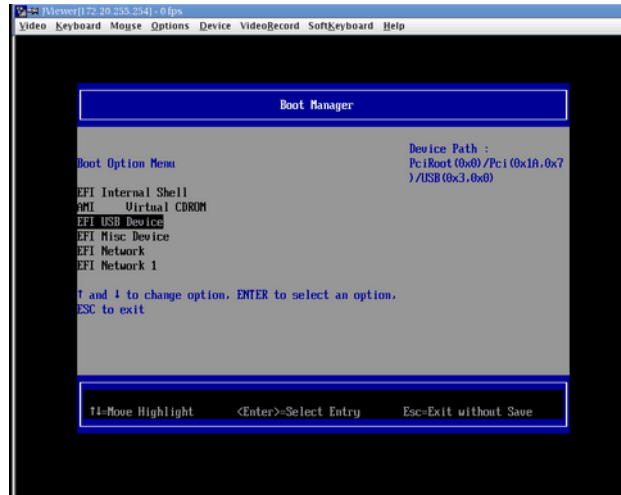

Figure 3-19 Boot Manager Screen

6. The ELILO boot manager starts executing, as shown in Figure 3-20 on page 59.

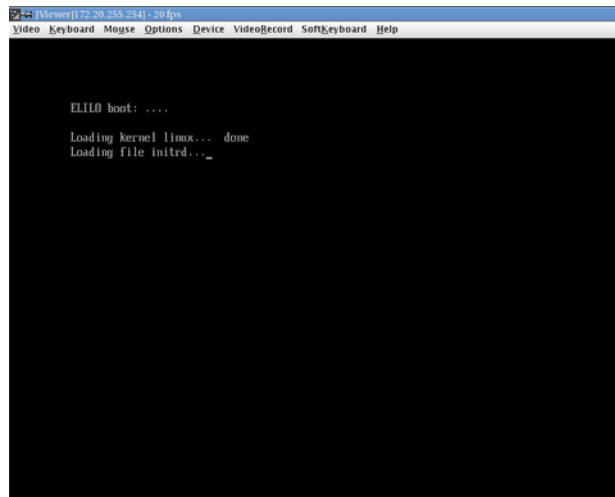

Figure 3-20 ELILO Boot Manager

When using the SLES install DVD, the installer will boot without any further intervention.

Note: Due to a software bug or mismatch between the X configuration software on the SLES install DVD and the KVM viewer, mouse tracking in the install screens does not work well. You can use the `Enter` key, to select the **Next** button and use the arrow keys to move back and forth on each screen.

7. When using the RHEL install DVD, manual intervention is required to allow the install to boot.

Shortly after selecting "**EFI USB Device**", the KVM screen will give a countdown with a "press any key to see menu" type of message. Enter a key, which will take you to the RedHat grub menu. With the first menu selection highlighted, press '**e**', which will allow you to edit the boot options. This brings up a new screen, where the first line starts with 'kernel'. With this line selected, press '**e**' again, and enter "**virtEFI**" at the end of the line. Press **Enter**, which will return you to the previous menu. Then press '**b**' to boot the configuration. The RedHat graphical installer will then start.

Determining the IP Address of the BaseIO BMC

This section describes how to determine the IP address of the BaseIO BMC.

By default, the external Ethernet port on the BaseIO BMC is configured to use DHCP. In the case that it is connected to an SMN, the SMN will serve it an IP address mapped to a known host name.

Procedure 3-3 Determining the IP address of the BaseIO BMC without an SMN

To determine the IP address of the BaseIO, perform the following steps:

1. Login to the CMC, as follows:

```
ssh root@hostname-cmc
SGI Chassis Manager Controller, Firmware Rev. 1.1.11

CMC:r1i1c>
```

2. Run the `iodcon` command on the CMC to get to the BaseIO BMC' `ibmc0`, as follows:

```
uv14-cmc CMC:r001i01c> iodcon
```

The `iodcon` tool brings up an internal serial connection to the BaseIO BMC (it is serial, which is why you need to hit `ENTER` to see the prompt in the next step).

Press the `Enter` key to get the `r001i01b00i>` prompt

3. Run the `ifconfig eth1` command to obtain the `inet addr`, as follows:

```
r001i01b00i> ifconfig eth1
eth1      Link encap:Ethernet  HWaddr 08:00:69:15:C0:57
          inet addr:172.20.255.254  Bcast:172.20.255.255  Mask:255.255.0.0
          UP BROADCAST RUNNING MULTICAST  MTU:1500  Metric:1
          RX packets:1508779 errors:204 dropped:28 overruns:0 frame:204
          TX packets:2262923 errors:0 dropped:0 overruns:0 carrier:0
          collisions:0 txqueuelen:1000
          RX bytes:924130317 (881.3 MiB)  TX bytes:3017177156 (2.8 GiB)
          Interrupt:1
```

4. Enter `CTRL-X` to exit the console.
5. The output also displays the MAC address as the `HWaddr`. You can use this information to configure a known MAC to IP address/host name mapping in your DHCP server.

Procedure 3-4 Determining the IP address of the BaseIO BMC with an SMN

To determine the IP address of the BaseIO, perform the following steps:

1. Establish a network connection to the SMN, as follows:

```
# ssh -X sysco@uv-system-smn
```

The password set out of the factory is `sysco`.

2. Perform the following command to find the IP address of the BaseIO BMC, as follows:

```
sysco@uv14-smn:~/hw> cmclist -a
sysco@uv14-smn:~/hw> cmclist -a
# File: /var/lib/dhcp/db/dhcpd.leases
# UID                IP Address
```

```
d \001\010\000i\025\300W 172.20.255.254
sysco@uv14-smn:~/hw>
```

Accessing the SGI BIOS Setup Utility

This section describes how to access the SGI BIOS setup utility software residing on the BaseIO blade using the KVM (JViewer) window. This is the same BIOS setup utility that you can access using the text-based console (formerly, `uvcon`) command.

Procedure 3-5 Accessing the SGI BIOS Setup Utility

To access the SGI BIOS setup utility software, perform the following steps:

1. Perform steps one through 11 in Procedure 3-1 on page 42.
2. When the **Shell>** prompt appears enter `exit`, as shown in Figure 3-21 on page 62.

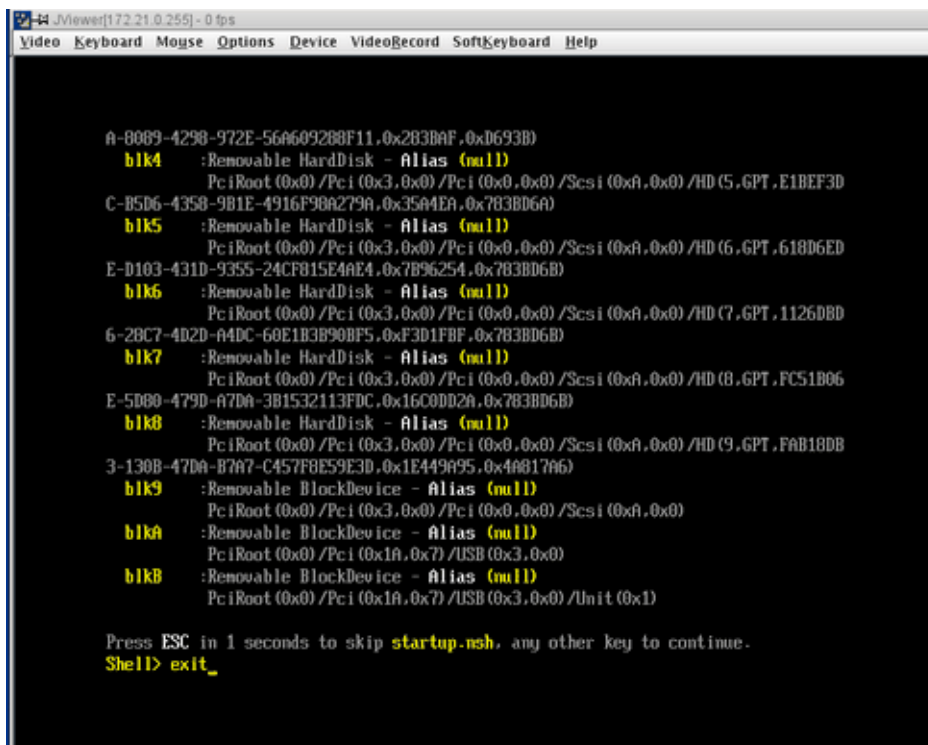

Figure 3-21 KVM JViewer Shell Prompt with `exit` Command Screen

3. The SGI KVM screen appears, as shown in Figure 3-22 on page 63.



Figure 3-22 SGI KVM Console Startup Screen

After the SGI KVM Console software completes loading, the BIOS setup utility appears, as shown in Figure 3-23 on page 64.

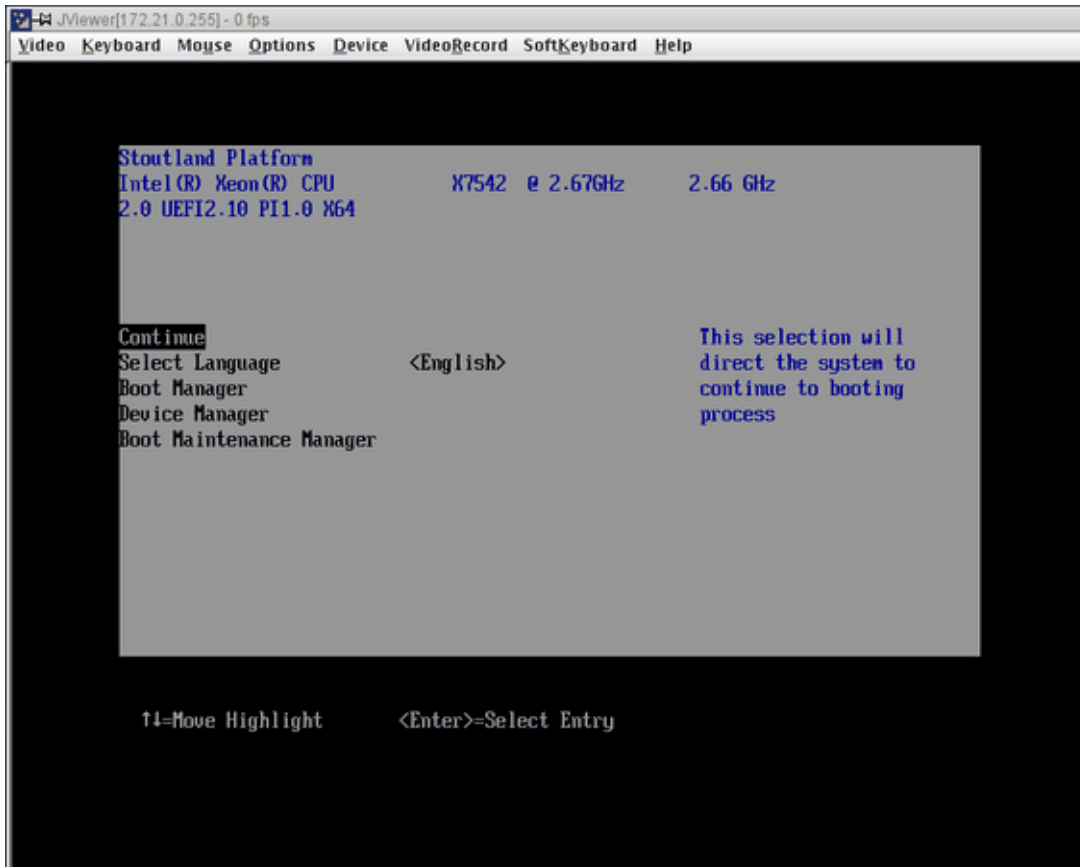

Figure 3-23 BIOS Setup Utility

Setting an Administrative Password on the Console

This section describes how to use the SGI BIOS setup utility software residing on the BaseIO blade to set an administrative password on the console.

Procedure 3-6 Setting an Administrative Password on the Console

To set an administrative password on the console using the BIOS setup utility, perform the following steps:

1. From the CMC, perform a power reset, as follows:

```
system-cmc CMC:r001i01c>power reset
```

2. When prompted on the console, hit the space bar for the **Boot Menu**, as shown in Figure 3-24 on page 65.

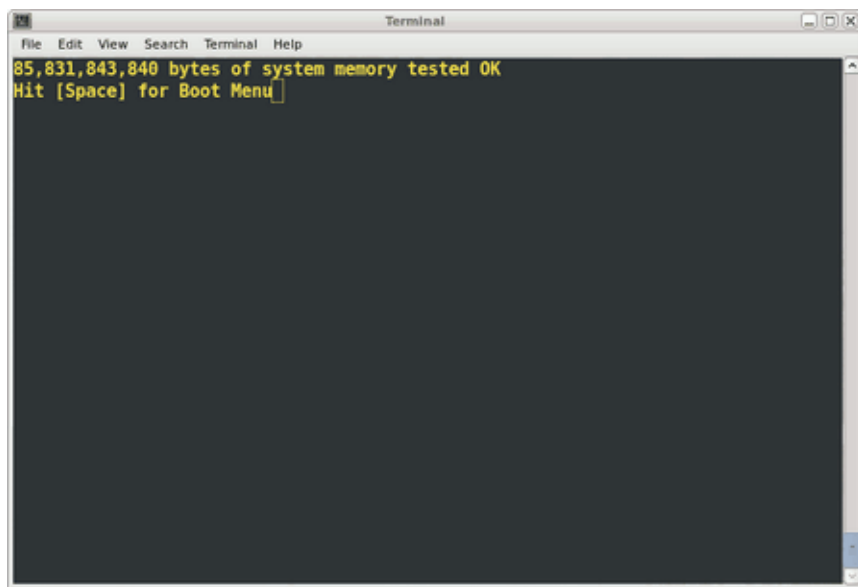

Figure 3-24 Console Prompt for Boot Menu Screen

3. From the boot manager screen, select **Device Manager**, as shown in Figure 3-28 on page 68.

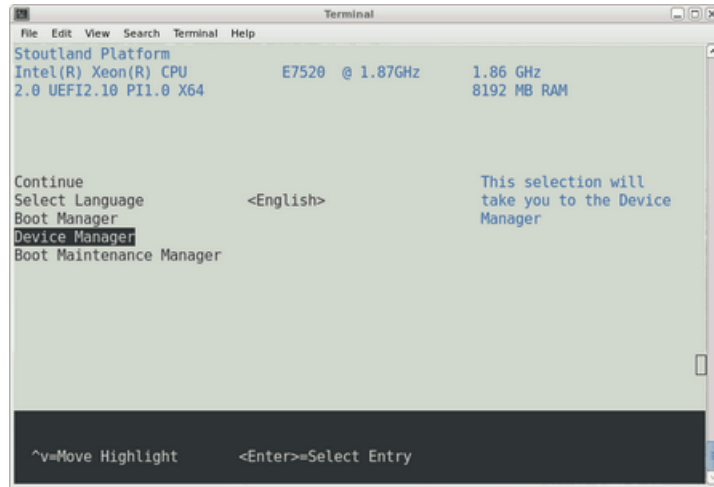

Figure 3-25 Device Manager Screen

Navigate the **Device Manager**, as follows:

- F1=Scroll Help
 - Shift-6(^),v or arrow keys to Move Highlight
 - F9=Reset to Defaults
 - Enter=Select Entry
 - F10=Save
 - Esc= Exit without Save
 - Change setting values with plus (+) and minus (-) keys
 - Use CTRL-] q to exit the console.
4. From the **Device Manager** screen, select Security, as shown in Figure 3-26 on page 67.

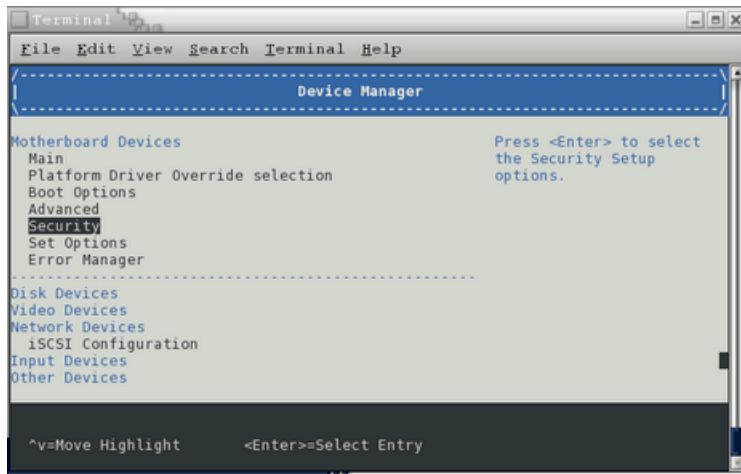

Figure 3-26 Device Manager Screen Security Option

- From the **Security** screen, select the **Admin Password** option, as shown in Figure 3-27 on page 67.

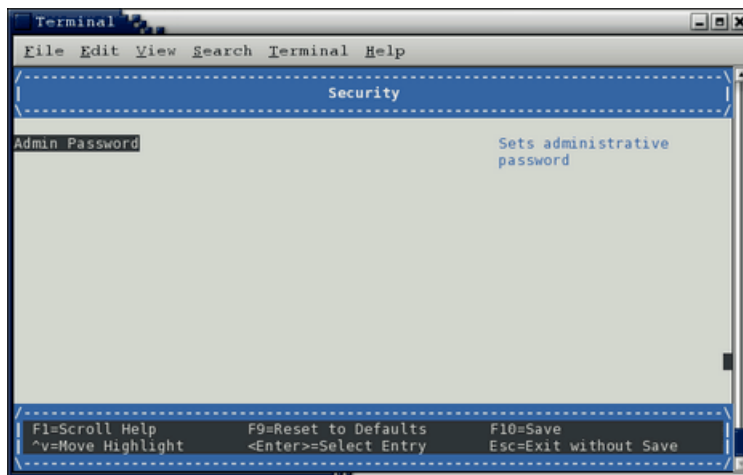

Figure 3-27 Security Screen Admin Password Option

6. From the **Security Admin Password** screen, enter the new administrative password, as shown in Figure 3-28 on page 68.

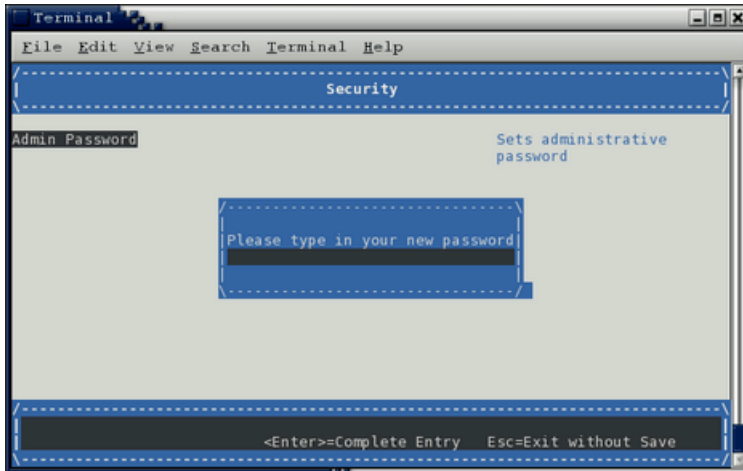

Figure 3-28 Security Screen for Setting Administrative Password

7. When you reboot the system, the console will be locked and you will be prompted for a password before the system finishes booting and the `Shell>` prompt appears, as shown in Figure 3-29 on page 69.

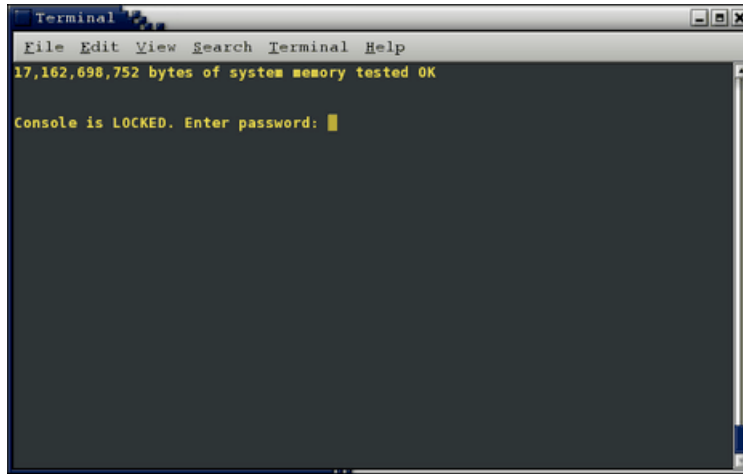

Figure 3-29 Console Administrative Password Prompt

8. The console password can be deleted by clearing the EFI variables, as follows:

```
# power -c reset
```

You can change the console password in the same manner you originally set it. If you delete the password with the `power -c reset` command, you need to go back through the setup screens to set it again.

Enabling BaseIO VGA

The “Enabling BaseIO” section of the *SGI Altix UV Software Install Guide* walks you through steps to enable BaseIO video graphics array (VGA) on an SGI Altix UV 100 or an SGI Altix UV 1000 system.

Booting Using iSCSI Protocol

The “Booting Using iSCSI Protocol” section of the *SGI Altix UV Software Install Guide* walks you through steps to boot an SGI Altix UV system using iSCSI protocol.

Booting from Fibre Channel Disk

The “Booting from Fibre Channel Disk” section of the *SGI Altix UV Software Install Guide* walks you through steps to boot an SGI Altix UV system using Fibre channel disk.

Simple Network Management Protocol

The Simple Network Management Protocol (SNMP) is part of the Internet protocol suite, as defined by the Internet Engineering Task Force (IETF). The SNMP provides a means to monitor and manage network-attached devices. For general information about SNMP, see <http://www.snmplink.org/>.

This section describes the `snmpd-uv(8)` agent which is the SGI SNMP agent for Altix UV 100 and 1000 series systems. The `snmpd-uv(8)` agent is **only** available on the System Management Node (SMN) node.

SNMP Agent Overview

The `snmpd-uv(8)` agent fetches configuration information from the System Controller (SYSCO) network attached to the System Management Node (SMN). The SYSCO network contains all the Chassis Management Controller (CMC) and Base Management Controller (BMC) and accessories, such as, the I/O expansion chassis.

The `snmpd-uv(8)` agent supports multiple Altix UV systems attached to the SMN.

The `snmpd-uv(8)` retrieves information stored in a MySQL database by translating SNMP `pass_persist GET` and `GETNEXT` OID requests into equivalent MySQL `SELECT` queries on appropriate tables corresponding to those defined in the Altix UV SNMP.

The `snmpd-uv(8)` agent does not perform data gathering or MySQL tables update operations. Instead, two additional services are used in tandem to perform the following:

- Data gathering

A system daemon, called `uv_gather`, collects information from the SYSCO network attached to the SMN. After parsing the data in a readable format, it pushes the data to another system daemon, `uv_db`, to perform MySQL updates.

- MySQL Tables updates

A system daemon, `uv_db`, is responsible for receiving data from `uv_gather` and performs appropriate MySQL tables update.

Since the `snmpd-uv(8)` agent does not perform data gathering, it is important to make sure the `uv_gather` and `uv_db` services are enabled in order to get up-to-date information from the periodically updated MySQL Altix UV database (see "Verifying the SMN Software Stack" on page 72). The `uv_gather` and `uv_db` services are normally setup to start at boot time.

The SNMP Agent companion services maintain information of all the Altix UV nodes attached to the SMN. They also fetch environmental information, such as, fan speed and voltage margins. For further details, please consult the management information base (MIB) file that comes with the package.

The `snmpd-uv(8)` agent can also send trap if the configuration file contains `trapsink` or `trapsink2` directives.

Note: The current version of the agent does not yet support sending traps. This functionality will be offered in future updated version of the agent. Instead, the user can still use the `NET-SNMP DISMAN Net-SNMP` standard embedded sub-agent facilities to perform various trap configuration.

Normally, the `snmpd-uv(8)` agent is not manually invoked. It is actually invoked by `snmpd(8)` daemon via a configuration file. See "SNMP Configuration" on page 75.

Verifying the SMN Software Stack

The `smn_info_gather` script is the most complete and preferred method of verifying the SMN software stack. When the `system_info_gather` script (provided by the `sgi-support-tools` package in the SGI Foundation Software product) is run, it automatically calls the `smn_info_gather` script on SMN nodes as well.

There are several ways to verify that the system management node (SMN) software stack is operating properly, as follows:

- To perform a sanity test on the various SMN software components, perform the following:

```
uv44-smn:~ # /usr/sbin/smn_info_gather -h
Usage: smn_info_gather [ options ] [test1 test2 ...]
Options:
  -h          this help message
  -s          show test(s) it would run
Tests Group:
```

```

all      : restart install running info dump dumpfull gather snmp
restart  : restart
install  : release rpm chkconfig sysco
running  : sysco sysco_mount running cmc_ping console
info     : release sysco_system sysco_topology sysco_release rpm_info sysco_info
dump     : dump
dumpfull : dumpfull
gather   : release sysco_system sysco_topology sysco_release rpm rpm_info chkconfig sysco_info sysco
snmp     : snmp
Default test: gather

```

Available individual tests:

```
release rpm chkconfig sysco restart sysco sysco_mount running cmc_ping console release sysco_system sysco
```

```
uv44-smn:~ # smn_info_gather running
```

```

check_sysco      :
    sysco          user exist          : Pass
    /sysco         home exist          : Pass
check_sysco_mount :
    /sysco/hw/.fuse mount exist        : Pass
check_running    :
    status         monit               : Pass
    status         named               : Pass
    status         dhcpd               : Pass
    status         smnd                : Pass
    status         syscofs             : Pass
    status         mysql               : Pass
    status         smn_uv_db           : FAIL
    status         smn_uv_gather       : FAIL
    daemons       named               : Pass
    daemons       dhcpd               : Pass
    daemons       smnd                : Pass
    daemons       syscofs             : Pass
    daemons       mysqld              : Pass
    daemons       uv_db               : FAIL
    daemons       uv_gather           : FAIL
    daemons       logman              : Pass
    monit         smnd                : Pass
    monit         syscofs             : Pass
    monit         syscofs_mount       : Pass
    ...

```

- To display the status of the various SMN daemons running on the SMN, perform the following:

```
uv44-smn:~ # monit status
```

```
The Monit daemon 5.0.3 uptime: 61d 16h 59m
```

```
Process 'syscofs'
```

```
status                running
monitoring status     monitored
pid                   21262
parent pid            1
uptime                47d 16h 55m
children              0
memory kilobytes      1388
memory kilobytes total 1388
memory percent        0.0%
memory percent total  0.0%
cpu percent           0.0%
cpu percent total     0.0%
data collected        Tue Apr 26 12:37:24 2011
```

```
File 'syscofs_mount'
```

```
status                accessible
monitoring status     monitored
permission            444
uid                   0
gid                   0
timestamp             Tue Mar 15 11:20:28 2011
size                  0 B
data collected        Tue Apr 26 12:37:24 2011
```

```
Process 'smnd'
```

```
status                running
monitoring status     monitored
pid                   21351
parent pid            1
uptime                47d 16h 55m
children              0
memory kilobytes      2115648
memory kilobytes total 2115648
memory percent        35.3%
```



```
memory percent total      35.3%
cpu percent               0.0%
cpu percent total        0.0%
data collected            Tue Apr 26 12:37:24 2011

Process 'uv_gather'
status                   not monitored
monitoring status       not monitored
data collected           Tue Apr 26 12:37:24 2011

Process 'uv_db'
status                   not monitored
monitoring status       not monitored
data collected           Tue Apr 26 12:37:24 2011

System 'localhost'
status                   running
monitoring status       monitored
load average             [0.04] [0.05] [0.01]
cpu                      0.3%us 0.3%sy 0.0%wa
memory usage             3406740 kB [56.9%]
data collected           Tue Apr 26 12:37:24 2011
```

- You can access the `monit` status at a web browser interface at <http://admin:11110>.

SNMP Configuration

In order to integrate the `snmpd-uv` agent into `snmpd`, two configuration methods are available, as follows:

- "Automatic Configuration Using `uv_snmpconfig`" on page 75
- "Manual Configuration " on page 76

Automatic Configuration Using `uv_snmpconfig`

This is the easiest and recommended method. The `uv_snmpconfig` command performs all the configuration steps explained in the manual configuration section below. It also offers an option to test the configuration consisting in verifying:

- MIB translation of Object Identifiers (OIDs) using `snmptranslate`.
- The SNMP agent can `snmpwalk` the entire `uv` SNMP agent SQL database
- Basic and configured (if relevant) traps are captured.

Run `uv_snmpconfig -h` on the SMN for help and command-line options, as follows:

```
uv41-smn:~ # uv_snmpconfig -h
Jan 3 12:03:00 ----- uv_snmpconfig NOTICE: SNMPCONFIG mode. INSTANCE=uv
Usage: uv_snmpconfig [-hfctr] args
```

Configure SNMP, test and restore configuration files depending on command-line flags:

```
-h          This help message
-f          Overwrite configuration files
-c          Configure SNMP
-t          Test SNMP
-r          Restore configuration files if '-c' is used.
```

Agent	Args
a4700	l2:IP addresss or hostname
xe	
xe_cluster	pm tempo isle file config_file
uv	

Note: The utility will not overwrite already installed SNMP configuration files unless the command-line option `-f` (force) is used. However, in most cases, although the utility backs up files before overwriting them (when `-f` is used), it is recommended to make a copy of the configuration files before proceeding. `uv_snmpconfig` is a generic script for all the agents supported by SGI.

Manual Configuration

To manually configure the SNMP agent, three steps are required, as follows:

1. Integrate the agent MIB.

On RHEL, modify or create the `snmpd /etc/snmp/snmpd.options` file. The easiest is to make sure the following start-up parameters are defined:

```
# Original option
OPTIONS="-Lsd -Lf /dev/null -p /var/run/snmpd.pid -a"

# Adding SGI agent
OPTIONS="${OPTIONS} -M +/opt/sgi/snmpagents/mibs -m ALL"
```

On SLES, the `/opt/sgi/snmpagents/mibs/sgi-uv-smi.mib` should be copied to `/usr/share/snmp/mibs/` directory. Also, if not already done, the remaining `/opt/sgi/snmpagents/mibs/` files should also be copied.

Optionally, apply the same changes in the global `/etc/snmp/snmp.conf` file by adding the following two lines:

```
mibs          ALL
mibdirs       +/opt/sgi/snmpagents/mibs
```

2. Configure agent configuration file.
3. This is where the agent is actually called by `snmpd(8)` using the `pass_persist` protocol. Also, this is where various monitored events are defined. The file itself contains configuration instructions.

Copy or append `/opt/sgi/snmpagents/etc/snmpd.uv.conf` to `/opt/sgi/snmpagents/etc/snmpd.local.conf`. Do NOT edit the file directly as it can be replaced later by an RPM package update.

Finally, if NET-SNMP DISMAN facilities are used and you want to change monitoring intervals, the `monitor -r 300` lines should be changed.

You also have to specify the `-c /opt/sgi/snmpagents/etc/uv.conf` file for use by agent itself. A template file `/opt/sgi/snmpagents/etc/uv.conf.template` contains instructions on how to configure this file.

4. Integrate agent configuration file.

On RHEL, modify or create `snmpd /etc/snmp/snmpd.options` file and set the following environment variable:

```
# Add SGI agent configurations
OPTIONS="${OPTIONS} -c /opt/sgi/snmpagents/etc/snmpd.local.conf"
```

On SLES, a properly substituted `/opt/sgi/snmpagents/etc/snmpd.uv.conf` file should be appended to the `/etc/snmp/snmpd.local.conf` file.

Index

A

access SGI BIOS setup utility, 62

B

BaseIO riser card, 6

BaseIO VGA, 69

BIOS setup utility, 62

boot manager, 58

booting

 RHEL, 60

 SLES, 60

booting using Fibre channel disk, 70

booting using iSCSI protocol, 69

C

changing configuration settings, 54

CMC IP address assignment, 37

cmclist command, 61

command

 power reset, 65

commands

 SMN, 10

console

 exiting, 66

D

determining IP address of BaseIO BMC

 with an SMN, 61

 without an SMN, 60

E

ELILO boot manager, 59

enabling a remote console, 41

enabling BaseIO VGA, 69

enabling remote console access, 41

Ethernet cabling, 7

exit console, 66

F

Fibre Channel disk

 booting, 70

firewalls, 38

I

install RHEL 6, 26

install SLES11 on the system management node, 15

install software

 SGI Management Center, 30

 SLES 11 SP1 and SGI Foundation 2.4 software, 23

 system management node, 14

installing RHEL 6 on the system management
node, 27

introduction, 1

iodcon command, 61

iSCSI

 booting, 71

M

Mouse mode settings, 54

multiple partitions, 38

N

- navigate the device manager, 66
- network addressing overview, 35

P

- power reset command, 65

R

- RAID support, 1
- reinstalling the operating system on an Altix UV system, 55
- remote console, 41
- remote media, 55

S

- SGI Altix UV 1000 system rack, 14
- SGI Management Center, 2
- SGI Management Center software installation, 30
- Simple Network Management Protocol (SNMP) configuration, 75
 - automatic, 75
 - manual, 76
- overview, 71
- snmpd-uv agent, 71
- SLES 11 SP1 and SGI Foundation 2.4 software installation, 23

- SMN command line interface (CLI), 9
- SMN commands, 10
- SMN firewall capabilities, 38
- SMN Non Altix UV 100 or Altix UV 1000 Systems, 38
- SMN specific CLI commands, 9
- SMN with multiple partitions or systems, 38
- snmpd-uv agent, 71
- software requirements
 - SMN, 1
- system management node Ethernet ports, 36
- system control network
 - overview, 3
 - physical connections, 5
- system management node (SMN), 15
- system management node Ethernet ports
 - eth1smn, 36
 - eth2smn, 37
 - eth3smn, 37
- system management node software installation, 14
- system network addressing overview, 35

V

- VGA, 69

Y

- YaST2 firstboot installer, 16
- YaST2 installation tool, 16