



**SGI® Rackable™ C2005 Server Family
User's Guide**

007-5717-002

COPYRIGHT

© 2012, 2013 Silicon Graphics International Corp. All rights reserved; provided portions may be copyright in third parties, as indicated elsewhere herein. No permission is granted to copy, distribute, or create derivative works from the contents of this electronic documentation in any manner, in whole or in part, without the prior written permission of SGI.

LIMITED RIGHTS LEGEND

The software described in this document is “commercial computer software” provided with restricted rights (except as to included open/free source) as specified in the FAR 52.227-19 and/or the DFAR 227.7202, or successive sections. Use beyond license provisions is a violation of worldwide intellectual property laws, treaties and conventions. This document is provided with limited rights as defined in 52.227-14.

The electronic (software) version of this document was developed at private expense; if acquired under an agreement with the USA government or any contractor thereto, it is acquired as “commercial computer software” subject to the provisions of its applicable license agreement, as specified in (a) 48 CFR 12.212 of the FAR; or, if acquired for Department of Defense units, (b) 48 CFR 227-7202 of the DoD FAR Supplement; or sections succeeding thereto. Contractor/manufacturer is SGI, 46600 Landing Parkway, Fremont, CA 94538.

TRADEMARKS AND ATTRIBUTIONS

Silicon Graphics, SGI, the SGI logo, Rackable, Roamer, and Supportfolio are trademarks or registered trademarks of Silicon Graphics International Corp. or its subsidiaries in the United States and/or other countries worldwide.

Intel and Xeon are trademarks or registered trademarks of Intel Corporation or its subsidiaries in the United States and other countries.

AMD Opteron is a trademark or registered trademark of Advanced Micro Devices Corporation.

PCIe is a registered trademark of PCI SIG.

All other trademarks mentioned herein are the property of their respective owners.

Record of Revision

Version	Description
001	January 2012 Formally published.
002	September 2013 Added support for Intel® Xeon® E5-2600 and E5-2600v2 Series processors plus miscellaneous front matter changes.

Contents

	About This Guide	vii
	Audience	vii
	Related Publications	viii
	Product Support	ix
	Reader Comments	x
1	Overview	1
	Features	2
	Flexible Configurations	2
	Leading Efficiency	2
	High Density	2
	Simplified Serviceability	3
	Versatile 2.5” and 3.5” Local Storage Support	3
	System Configuration Options	3
	Storage Configurations	5
	Upper Modular Zone	6
	Lower Modular Zone	7
	Front and Rear Panel Components	8
2	Pre-Installation Guidelines	13
	Server and Rack Positioning	13
	Electrical Power	14
	Operating Environment	14
	Rack Stability	15
	Cables	15
	Security	15

- 3 Installation Guidelines 17**
 - Getting Ready to Install 18
 - Determine Server Positioning in the Rack 18
 - Installing into a Rack or Cabinet 19
 - Installing into a Telco Rack 19
 - Cabling 20
 - Installing a Hard Drive into the Hard Drive Carrier 21

- 4 Using the Server. 23**
 - Powering the Server On 23
 - Powering the Server Off 24
 - Working with Roamer Remote Management 25

- 5 Safety Guidelines 27**
 - Electrical Safety 27
 - General Safety 28
 - Handling Your Server 29

- A Technical Specifications 31**

About This Guide

This guide provides an overview of the SGI® Rackable™ C2005 2U servers along with instructions for system installation and general operation. The appendices include technical specifications and safety practices.

If your server was ordered from SGI and was not constructed in one of the standard 2U form factors that are detailed in this manual, then this manual will provide a general guideline to your product. Details that are specific to your design can be found in the datasheet or custom documentation that came with your product.

Audience

This guide is written for owners, installers, system administrators, and users of C2005 servers. It is written with the assumption that the reader has a good working knowledge of computers and computer systems.

Related Publications

Depending on your choice of system components and operating system, the following SGI documents may be relevant to your C2005 server:

- SGI Foundation Software release notes
- SGI Performance Suite release notes
- SGI InfiniteStorage series documentation
- Man pages

You can obtain SGI documentation, release notes, or man pages in the following ways:

- Refer to the SGI Technical Publications Library at <http://docs.sgi.com>. Various formats are available. This library contains the most recent set of books and man pages.
- Refer to the SGI Supportfolio™ webpage for release notes and other documents whose access require a support contract. See [“Product Support” on page ix](#).

Note: For information on your motherboard and related system components, see the documentation provided by the manufacturer/supplier.

Product Support

SGI provides a comprehensive product support and maintenance program for its products. SGI also offers services to implement and integrate Linux applications in your environment.

- Refer to <http://www.sgi.com/support/>
- If you are in North America, contact the Technical Assistance Center at +1 800 800 4SGI or contact your authorized service provider.
- If you are outside North America, contact the SGI subsidiary or authorized distributor in your country.

Be sure to have the following information before you call Technical Support:

- Product serial number
- Product model name and number
- Applicable error messages
- Add-on boards or hardware
- Third-party hardware or software
- Operating system type and revision level
- Motherboard BIOS revision

Reader Comments

If you have comments about the technical accuracy, content, or organization of this document, contact SGI. Be sure to include the title and document number of the manual with your comments. (Online, the document number is located in the front matter of the manual. In printed manuals, the document number is located at the bottom of each page.)

You can contact SGI in any of the following ways:

- Send e-mail to the following address: techpubs@sgi.com
- Contact your customer service representative and ask that an incident be filed in the SGI incident tracking system:

<http://www.sgi.com/support/supportcenters.html>

SGI values your comments and will respond to them promptly.

Overview

This chapter provides an overview of the SGI Rackable C2005 2U server family:

- “Features” on page 2
- “System Configuration Options” on page 3
- “Storage Configurations” on page 5
- “Front and Rear Panel Components” on page 8

Figure 1-1 shows a typical C2005 server.



Figure 1-1 SGI Rackable C2005 Server

Features

The SGI Rackable C2005 are half-depth, rackmount servers that leverage a unique, industry-leading approach to thermal management and power efficiency. They provide power savings and higher levels of reliability in any data center environment. Mounted back-to-back, C2005s can achieve typically twice the density over competing solutions. The C2005 offers industry-leading direct-attached storage and expansion capabilities unheard of at a 1U-effective rack density.

With the processing power of up to 672 cores and local storage capacity of up to 420 TB per cabinet, the C2005 server is ideal for IT environments where space and power are constrained. Its high-efficiency AC and DC power technologies reduce overall power consumption and heat output in any legacy data center while increasing uptime and reliability.

Flexible Configurations

The highly modular C2005 server is built to order to address specific data center needs while eliminating unnecessary costs. Based on an open architecture approach using AMD Opteron™ or Intel® Xeon® processors, the C2005 server takes configuration flexibility to the next level with two modular zones determining the balance between multiple 2.5” and 3.5” hard drive configurations and expansion slot capabilities.

Leading Efficiency

The unique SGI approach to thermal management begins with each component inside our servers. Leveraging high-efficiency power supplies, memory and processors, the patented SGI solutions strive to draw the lowest possible wattage and reduce heat output. Innovative, award-winning AC and DC power solutions at the system, cabinet and data center level enable any legacy data center to immediately achieve reduced power costs.

High Density

Our unique half-depth form factor enables back-to-back mounting to achieve high density levels of up to 44 dual-processor servers or networking gear per cabinet. Supporting today’s fastest AMD and Intel dual- and quad-core processors, one cabinet can deliver—and effectively cool—the compute power of 352 processing cores and 220TB of local storage.

Simplified Serviceability

Time-saving Roamer™ remote management technology helps reduce administrative resources and overhead. This single, highly intuitive interface provides effortless local or remote control with total lights-out management. Front-facing IO means RJ-45 ports, connectors and cables are located in front for rapid service and maintenance.

Versatile 2.5" and 3.5" Local Storage Support

The C2005 server is an ideal match for many different applications. With up to ten 2.5" high-performance SAS or SSD drives, the C2005 is well-suited for applications such as scale-out database servers. With up to five 3.5" SATA drives, it also meets the need for configurations requiring high-capacity local storage. The C2005 can even support a mixture of drive technologies and sizes.

System Configuration Options

This versatile system allows for many different types of build-to-order options. There are a few limitations:

- Maximum of 2 sockets
- Maximum 288 GB of memory (18 x 16GB DIMMs)
- Maximum storage capacity of 15TB (SAS/SATA 3.5" HDDs)
- Onboard Networking: Dual GigE native + PCIe®-based cards
- IPMI 2.0 support

The compute configurations for the C2005 support both Intel and AMD processors. Limitations are based on what options are available on current motherboards in the E-ATX form factor. [Table 1-1](#) charts the configuration options.

Table 1-1 Configuration Options

Attribute	Intel-based C2005	AMD-based C2005
Chassis Profile	2U half-depth	2U half-depth
Processors	Up to two identical dual-core processors from the following: – Intel Xeon 5500 or 5600 Series – Intel Xeon E-5 2600 Series – Intel Xeon E-5 2600v2 Series	Up to two multi-core AMD Opteron 4100 or 61xx Series processors
Max. Cores	12	32
Chipset	Intel 5400 or 5500	NVIDIA nForce Pro 3600
Front Side Bus Speed	Up to 1600MHz	N/A
Memory*	Up to 288GB (18 x 16GB DIMMs); max speed of 1333 Mhz	Up to 256GB (16 x 16GB DIMMs); max speed of 1600 Mhz
Hard Disk Drives	Up to five 3.5", ten 2.5" hot-swap SAS or SATA II drives or a combination of both	Up to five 3.5", ten 2.5" hot-swap SAS or SATA II drives or a combination of both
Max. Capacity	SAS/SATA 3.5" HDDs: 15TB SAS/SATA 2.5" HDDs: 10TB	SAS/SATA 3.5" HDDs: 15TB SAS/SATA 2.5" HDDs: 10TB
RAID Card Levels (optional)	RAID 0, 1, 5, 6, 10, 50, 60*	RAID 0, 1, 5, 6, 10, 50, 60*
Expansion Cards	Up to five PCI Express low-profile slots or one slot on a riser*	Up to five PCI Express low-profile slots or one slot on a riser*
Networking, Onboard*	Up to 4GigE	Up to 4GigE
Roamer Remote Mgmt. Card/LCD (optional)	Serial or IP + Keyboard, Video and Mouse (KVM)	Serial or IP + Keyboard, Video and Mouse (KVM)
IPMI Remote System* Management (optional)	IPMI 2.0	IPMI 2.0
Power Supply	Auto-switching 100–240 VAC or –48 VDC, optional redundant power supply (AC 650W)	Auto-switching 100–240 VAC or –48 VDC, optional redundant power supply (AC 650W)

Table 1-1 Configuration Options (continued)

Attribute	Intel-based C2005	AMD-based C2005
Chassis Mount	SGI cabinets with back-to-back mounting for double density; standard 19-rack compatible	
Dimensions (HxWxD)	3.5" x 17.6" x 15.5"	3.5" x 17.6" x 15.5"
* Dependent on motherboard features.		

Storage Configurations





Two modular zones of the C2005 chassis provide unparalleled build-to-order flexibility for configuring hard drives and expansion slots. This section describes those two zones:

- “Upper Modular Zone” on page 6
- “Lower Modular Zone” on page 7

Upper Modular Zone

The upper modular zone consists of a top drive tray coupled with either a horizontal or vertical PCIe cage on the right of the chassis. [Table 1-2](#) describes the configuration options.

Table 1-2 Storage Configurations—Upper Modular Zone

Storage Configuration	Expansion Slots
<p>Four 3.5" hot-swap drives</p> 	<p>One PCIe slot on riser</p>
<p>Two 3.5" and four 2.5" hot-swap drives</p> 	<p>One PCIe slot on riser</p>
<p>Two 3.5" hot-swap drives</p> 	<p>Up to five low-profile slots</p>
<p>Eight 3.5" hot-swap drives</p> 	<p>Up to five low-profile slots</p>

Lower Modular Zone

The lower modular zone is the lower left portion of the chassis. This zone provides the additional storage options shown in Figure 1-2. The 2.5" drives are SAS or SATA and the CD/DVD-ROM is a low-profile device.



Lower Modular Zone
STORAGE CONFIGURATIONS
One 3.5" hot-swap drive
Two 2.5" hot-swap drives
One internal 3.5" drive and/or CD/DVD-ROM

Figure 1-2 Lower Modular Zone—Additional Storage Options

Front and Rear Panel Components

Figure 1-3 shows the components of the front and rear panels of a typical C2005 server.

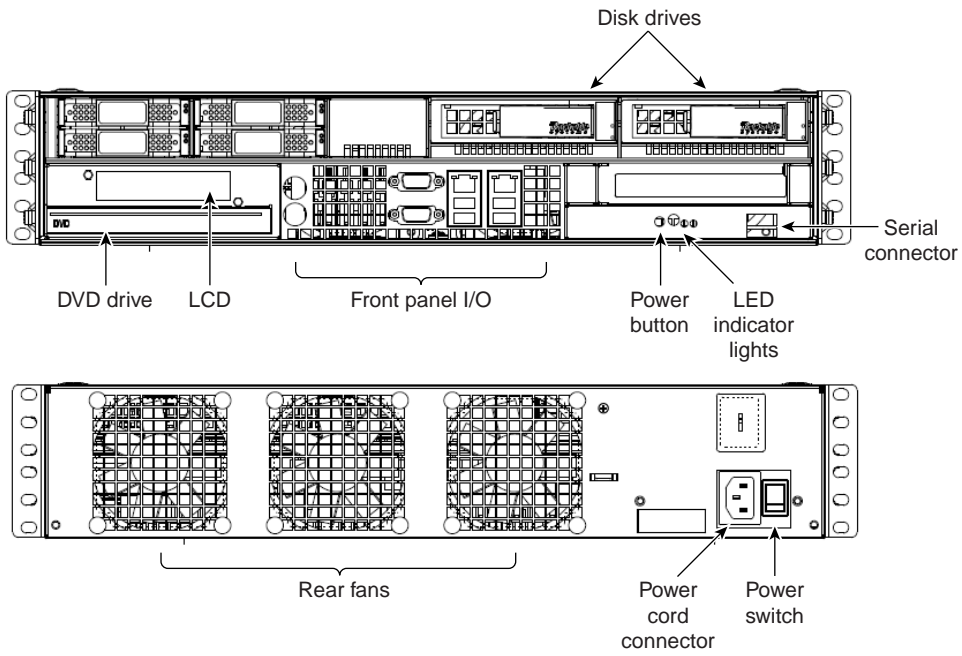

Figure 1-3 Front and Rear Panel Components

Table 1-3 describes the various components illustrated in Figure 1-3.

Table 1-3 Front Panel Components

Component	Description
Disk drives	These removable hard drives can be placed in drive carriers and can be hot-swappable. The drive carriers are connected to the system internally via a custom backplane that interfaces with a RAID storage card. Specifics of the RAID card used depend on the system specifications of your order.
DVD drive	Depending on the configuration of your server, a DVD/DVD-RW or CD/CD-RW drive may be present. Also, in this area is space for an LCD display that is used with a Roamer remote management module if one was purchased with the server.
Front panel I/O	The I/O interface to the motherboard. The configuration of the various I/O ports is dependent on the motherboard used in your configuration. For detailed I/O specifications, refer to the motherboard manual included with the documentation and accessory kit. Typical I/O includes the following: <ul style="list-style-type: none"> – serial port (RS-232, 9600 baud) – USB ports – PS-2 connector for mouse and keyboard – VGA port – Ethernet ports (RJ-45, eth0/eth1, 10/100/1000Mb)
LCD	(Optional) The LCD screen is used to display messages from the Roamer remote management solution. The Roamer module has the ability to display information relating to the system that can be customized according to your need.

Table 1-3 Front Panel Components **(continued)**

Component	Description
LED indicator lights	<p>These LEDs provide you with critical information related to different parts of the system.</p> <p>Green (PWR): The LED farthest to the left indicates that power is applied to the server and the system is on. When the LED is off, the system is off, even if the AC power cord is plugged into the server.</p> <p>Blue (HDD): The LED in the middle indicates that the hard drive(s) are currently being accessed and activity is occurring.</p> <p>Red/Tri-color (ID2): The LED to the far right may have several functions depending on the configuration of your server. If your server was purchased with the Roamer remote management module, then this LED can be turned on or set to blink via Roamer so that a technician can easily identify a unit that may need service.</p>
Power button	<p>This single-push, push button is a power on/off button. When the system is in an off state, pushing the button once powers the system on. When the system is in an on state, pushing and releasing the button power the system off. This button does not have a reset function.</p>
Power supply connector	<p>AC: Connect only 100-240 Volt AC, 3A or 5A maximum, 50-60 Hz. Use a standard AC connector to connect power to the server. An AC power cord is included in your documentation and accessory kit.</p> <p>DC: Connect only.</p>
Power switch	<p>This power switch turns the server on and off. It controls the power supply that is inside the chassis.</p>

Table 1-3 Front Panel Components (continued)

Component	Description
Rear fans	Keep the area behind the fans clear and unobstructed. This will ensure proper airflow to the components inside the server chassis.
Serial connector	This port is accessed with an RJ-45 connector. When the Roamer remote management module is installed, this port functions as an interface to the module. When the Roamer remote management module is not installed, the pinout for the serial connector is as shown in Table 1-4 .

[Table 1-4](#) describes the pinouts for the serial connector when Roamer is not installed.

Table 1-4 Pinouts for the Serial Connector J3

Pin	Name	Description
1	RTS	Request To Send (JP1 "A")
	CTS	Clear To Send (JP1 "B")
2	DSR	Data Set Ready
3	RxD	Receive Data
4	GND	Ground Return
5	GND	Ground Return
6	TxD	Transmit Data
7	DTR	Data Terminal Ready
8	CTS	Clear To Send (JP1 "B")
	RTS	Request To Send (JP1 "B")

Pre-Installation Guidelines

To ensure safe and efficient operation of your server, proper planning is essential. Factors such as the proper location of the server in its rack, adequate power to the components in the rack, and the appropriate operating environment for the rack. The guidelines described in this chapter are categorized as follows:

- “Server and Rack Positioning” on page 13
- “Electrical Power” on page 14
- “Operating Environment” on page 14
- “Rack Stability” on page 15
- “Cables” on page 15
- “Security” on page 15

Server and Rack Positioning

Follow these guidelines to ensure that the server is safely and appropriately positioned for efficient operation and service.

- When determining the location for the server, position it so that there is adequate space for airflow and servicing.
- When positioning the server in a rack, be sure to allow adequate space for airflow and servicing from the front and the rear.
- Clearance in the front of the server should be a minimum of 36” to allow the chassis to easily slide in and out of the rack.
- Clearance in the rear should be approximately 30” to allow for sufficient space for airflow and ease of servicing.
- Do not cover the front or rear of the server or any of the openings on the server front and rear panels.

- If you are installing multiple servers or other components in the rack, place the components and servers in positions that they can be easily opened and serviced. For example, the heaviest components—such as a uninterruptible power supply—are placed at the bottom of the rack; servers are often in the middle of the rack.

Electrical Power

If installing this server in a rack that contains multiple components, be sure that the power connections to the rack are sufficient for the combined power requirements of all the components. Ensure adequate and safe power by following these guidelines:

- Check documentation of all the components in the rack to obtain the total power requirement that the rack will use. Cross-reference this need with information on the total available power to see if the power supply for the rack is sufficient for the planned components.
- When planning electrical power arrangements, make sure you have more power available than specified for all components. Also, make sure the power load is distributed evenly among circuits to the location of the rack.
- Make sure power connections for the server and all other components are grounded.
- See the [Appendix A, “Technical Specifications”](#) for specific data on the electrical power requirements for this server.

Operating Environment

The operating environment where the server is installed must meet the following temperature and ventilation requirements:

- Verify the temperature range of the datacenter or room where the server is installed. Ensure that it is within the limits established for the server and all other components. This server is designed to function within the temperature range of 10–35°C / 50–90°F.
- Adequate ventilation must be present to maintain the specified temperature range. This is particularly important for a server or rack enclosed in a cabinet.

Rack Stability

The rack must be strong enough to hold the installed components.

- Ensure that the leveling jacks at the bottom of the rack are fully extended and are secure.
- If using a two-post (telco) rack, be sure that the rack is securely fastened to the building at the top and the bottom.
- In single rack installations, stabilizers should be attached to the rack.
- When working with components in the rack, never slide out more than one unit at a time.

Cables

For optimal efficiency in server operation and ease of maintenance, handling cables properly is required.

- Arrange all component cables so they do not interfere with access to the rack.
- To ensure full signal strength for Ethernet, serial, and other connections, make sure the cables do not exceed established length limits.

Security

The following are security considerations:

- If using a server cabinet that is not in a secure room, be sure the cabinet is adequately locked and access is limited to authorized staff.
- Control access to the server environment with a plan for distributing and controlling keys and access information.
- Store a copy of server access information at a safe location away from the server site.

Installation Guidelines

This chapter describes how to install your server into the rack.

Warning: Your server is designed for rack mounting. It is not designed for use as a desktop system. Do not place a monitor on the server or place anything on top of the enclosure. Additional weight on top of the server could cause damage to internal components.

Your server can be installed in these types of racks:

- Open four-post rack, 19" wide, 24–26" deep or 29–36" deep
- Cabinet with four-post rack inside, 19" wide, and 29–36" deep
- Two-post Telco rack, 19" wide.

The server is two rack units (2RUs) tall.

Getting Ready to Install

You can install the server into any four-post rack or two-post (Telco) rack. Preparations for installing are the same regardless of what type of rack you using for the server.

Important: Check the documentation for your rack for any special instructions or requirements.

Before beginning work with the server and rack, make the following preparations:

- If possible, arrange to work with another person for safety.
- Assemble the tools, brackets, and connectors you will need for installation.
- Note the screw sizes that you will need to use with your rack. Typically, racks use one of the following two:
 - English size 10–32 or 12–24
 - Metric size M5 for racks with metric holes

Check the documentation for your rack and if screws are provided, use those.

- Clear a table, cart, or other flat surface near the rack. You will need a space to temporarily place the server during installation.

Determine Server Positioning in the Rack

Review the guidelines for positioning the server in the rack explained earlier. Then follow these steps to determine its positioning.

1. Determine the exact position where you want to attach the server and mark it on the side of the rack.

Some racks have marks already to aid in positioning a server. If your rack does not have such aids, measure and count holes to determine desired positioning. The distance between holes on a rack varies on racks made by different manufacturers.

2. Once positioning is correctly determined in the rack you are ready to connect the server to the rack. The server can be connected to standard Telco two- or four-post racks.

Installing into a Rack or Cabinet

A rack can be either open or enclosed in a cabinet. Follow the same instructions to attach the server to either type of rack. For a cabinet, it helps to remove the door before installing the server. The server does not require conventional rack or server rails to be installed. The server is designed to slide easily between the mounting rails of the rack. Once the exact position of the server is determined on the rack, installation of the server is as follows:

1. Position the server so that the two “ears” on the side of the server are positioned equally and level in the rack.
2. Install four screws through the mounting ears and into the rails of the rack.

Typical screw sizes are 10–32 and 12–24. Check the accessory kit for spare screws.

If your rack does not have threaded holes, you will be required to provide threaded inserts to snap into the rails.

Installing into a Telco Rack

Installing the server into a Telco rack is exactly the same procedure as just described. The only difference in the installation procedure will be the positioning of the server mounting ears to the rack. The ears should be moved to the middle of the server to accommodate installation into a Telco rack.

Cabling

Once the server is secured in the rack, you can connect the Ethernet cables and power cord directly to its front and back panels, respectively. Before connecting them, do the following:

1. Gather the cables you will connect to the server.
2. Make certain each cable has the proper connector and that it is designed for use in a high-capacity server.
3. Label each cable so that you can locate a specific cable quickly.

Ethernet ports on the server are numbered 0 and 1. 0 is the primary Ethernet port, and 1 is the secondary.

Warning: Because the server is being installed into a rack with other equipment, be certain that the power used with the rack is designed to carry the electrical load of all of the devices in the rack. Refer to [Appendix A, “Technical Specifications”](#) for details on the power requirements for this server.

Installing a Hard Drive into the Hard Drive Carrier

To install a hard drive into the hard drive carrier, perform the following steps after removing the hard drive from the chassis:

1. Place the hard drive carrier on a flat, stable surface such as a desk, table, or work bench.
2. Slide the hard drive into the carrier with the printed circuit board side facing down (see [Figure 3-1](#)).
3. Carefully align the mounting holes in the hard drive and the carrier. Make sure the bottom of the hard drive and bottom of the hard drive carrier are flush.
4. Secure the hard drive using all four screws (see [Figure 3-1](#)).
5. Replace the drive carrier into the chassis. Make sure to close the drive carrier using the drive carrier handle.

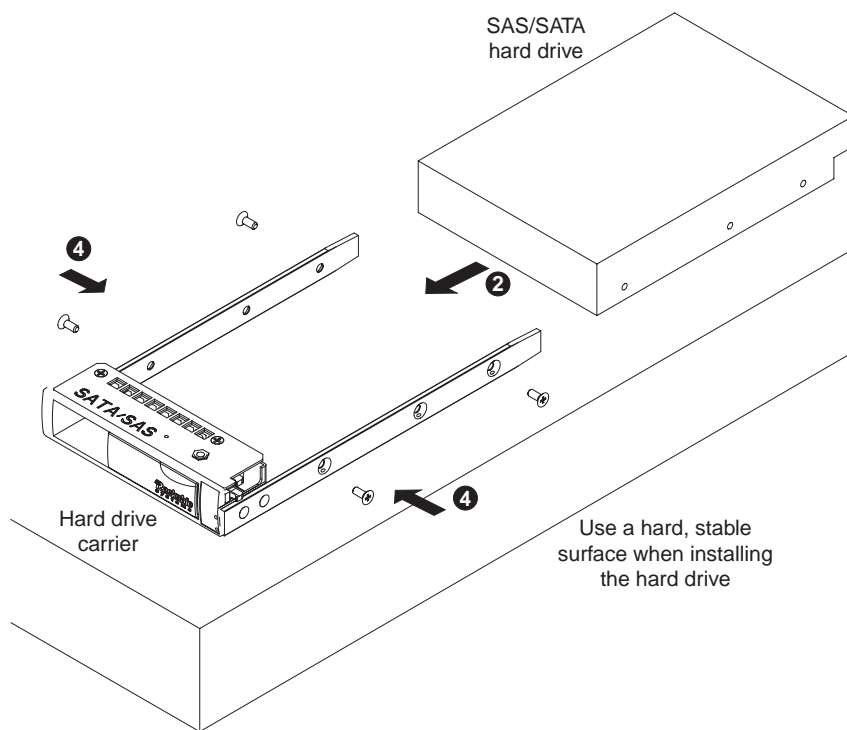

Figure 3-1 Inserting Hard Drive into Carrier

Using the Server

This chapter describes basic server operation, how to turn the server on and off, and how to use Roamer remote management.

Powering the Server On

After the server chassis is connected to AC power, the server can be turned on in any of the following ways:

- Press the power-control button on the front of the server.
While the server is powering up, the power LED on the front of the chassis is lit.
- If a power failure occurs, the server can be started automatically when power is restored.
This is only available if the Rackable Roamer remote management module was ordered for the server.
- If the operating system you installed on the server supports the Wake on LAN feature, the Wake on LAN feature can turn on the server.

The Wake on LAN feature only works if it was not disabled through the system BIOS, and if the server was previously turned on and the operating system was shut down properly.

Powering the Server Off

When the server is turned off, it remains connected to AC power through the server chassis. The server can respond to requests to turn on remotely or locally through Roamer. To remove all power from the server, power must be disconnected from the server chassis.

Shut down your operating system before turning off the server. Refer to the operating system documentation in reference to proper operating system shutdown. Improper shutdown of a server will not allow the server to be restarted using Wake on LAN.

The server can be turned off in the following ways:

- Press the power-control button on the front of the server.
This begins the shutdown of the operating system, if this feature is supported by your system.
- If the operating system stops functioning, you can press and hold the power-control button to turn off the server.
- The Roamer remote management module (if one is present in your server) can be used to turn off the server.

Working with Roamer Remote Management

If the server you purchased has the optional Roamer remote management hardware present, then the server can be managed remotely using this option. The Roamer option provides standard motherboards with enhanced remote control and serial redirection capabilities. The Roamer is accessed locally using an RJ-45 serial connection (shown in [Figure 4-1](#)).

With the Roamer option comes a LCD display. This display can be directly programmed within the OS. The LCD display can also be used to display server status, and other information as needed.

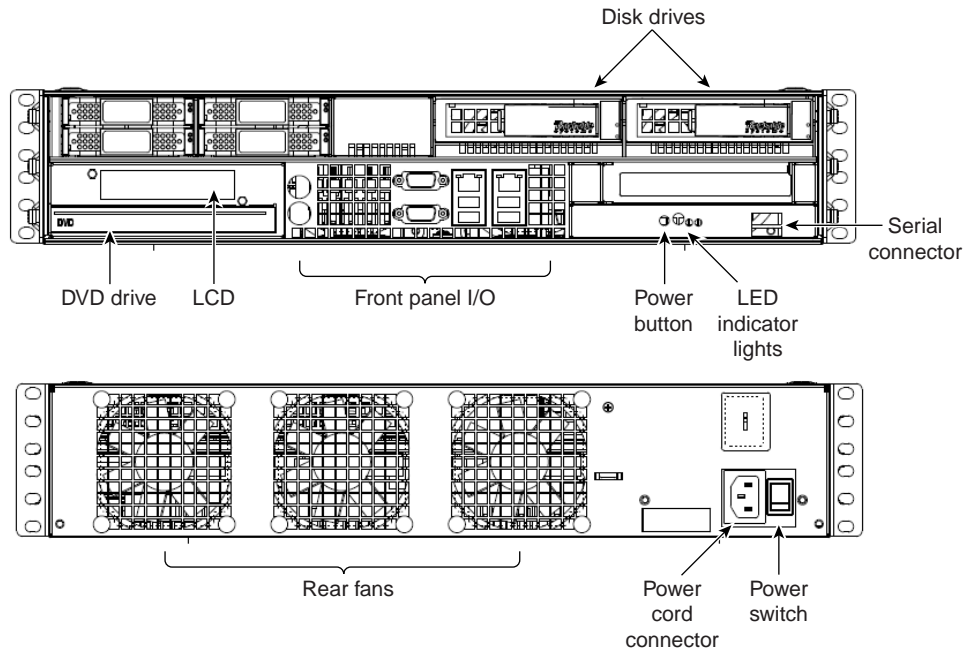

Figure 4-1 Front and Rear Panel Components

Safety Guidelines

The safety guidelines categorized as follows:

- “Electrical Safety” on page 27
- “General Safety” on page 28
- “Handling Your Server” on page 29

Electrical Safety

Observe the following basic electrical safety precautions to protect yourself from harm and the server from damage:

- Be aware of the locations of the power on/off switch on the chassis as well as the room's emergency power-off switch, disconnection switch, or electrical outlet. If an electrical accident occurs, you can then quickly remove power from the system.
- Do not work alone when working with high voltage components.
- Power should always be disconnected from the system when removing or installing main system components—such as the motherboard, memory modules, and drives. When disconnecting power, you should first power down the system with the operating system first and then unplug the power cords of all the power supply units in the system.
- When working around exposed electrical circuits, another person who is familiar with the power-off controls should be nearby to switch off the power if necessary.
- Use only one hand when working with powered-on electrical equipment. This is to avoid making a complete circuit, which will cause electrical shock. Use extreme caution when using metal tools, which can easily damage any electrical components or circuit boards they contact.
- Do not use mats designed to decrease static electrical discharge as protection from electrical shock. Instead, use rubber mats that have been specifically designed as electrical insulators.

- The power supply power cords must include a grounding plug and must be plugged into grounded electrical outlets.
- Verify that the electrical outlets and power strips used by the server have reliable earthing.
- Verify that the server is plugged into an electrical outlet with appropriate circuit overloading protection.

General Safety

The following are general safety guidelines:

- Keep the area around the server clean and free of clutter.
- The server weighs approximately 27 lbs when fully loaded. When lifting the system, two people at either end should lift slowly with their feet spread out to distribute the weight. Always keep your back straight and lift with your legs.
- Place the chassis top cover and any system components that have been removed away from the system or on a table so that you will not step on them.
- While working on the system, do not wear loose clothing such as neckties and unbuttoned shirt sleeves, which can come into contact with electrical circuits or be pulled into a cooling fan.
- Remove any jewelry or metal objects from your body. They are excellent metal conductors that can create short circuits and harm you if they come into contact with printed circuit boards or areas where power is present.
- After accessing the inside of the system, close the system back up and secure it to the rack unit with the retention screws after ensuring that all connections have been made.
- If you replace the motherboard battery, ensure that you install it properly. This battery must be replaced only with the same or an equivalent type recommended by the manufacturer. Dispose of used batteries according to the manufacturer's instructions.

Caution: There is a danger of explosion if the onboard battery is installed upside down, which will reverse its polarities

- To ensure proper cooling when the server is operating, take care to ensure that all chassis covers are in place, that all drive bays either have a drive or a blank installed, and that the room ambient temperature is within the specified operating temperature range.

Handling Your Server

When handling the server, use the following guidelines:

- When the server is removed from the rack, set it on a sturdy and flat surface. Do not set any heavy objects on top of the server. Any additional weight could possibly damage essential internal components.
- When connecting or disconnecting a cable, always hold the cable by its connector.
- Never force a connector into a port. If the connector and port do not join with ease, check the matching of the connector with the port. Correct positioning when joining a connector to a port is also essential.
- Protect the server and its components from direct sunlight and rain or other moisture.
- Keep all ventilation openings clear and unobstructed. Without proper air circulation, components can overheat, causing damage or unreliable operation.

Technical Specifications

Table A-1 lists allowable ranges for temperature, humidity, and altitude for the SGI Rackable C2005 family of 2U servers.

Table A-1 Temperature, Humidity, and Altitude Specifications

Attribute	Specification	Rate of Change Constraints
While Product Operating		
Temperature	– Up to 1500m (5000ft) +5°C (41°F) to +35°C (95°F) – 1525m (5000ft) to 3050m (10,000ft) Reduce max temperature (35°C) by 1°C per 305m (1000ft) of altitude above 1525m (5000ft).	Maximum: 10°C/hour (18°F/hour)
Humidity	20% to 80% Non-condensing	Maximum: 10% relative humidity/hour
Altitude	3050m (10,000ft)	
While Product Power Off		
Temperature	+5°C (41°F) to +45°C (113°F)	Maximum: 20°C/hour (36°F/hour)
Humidity	8% to 80% Non-condensing	
Altitude	3050m (10,000ft)	
While Product Packaged for Shipping		
Temperature	-40°C (-40°F) to +60°C (140°F)	Maximum: 20°C/hour (36°F/hour)
Humidity	8% to 80% Non-condensing	
Altitude	12,200m (40,000ft)	

Table A-2 lists physical, thermal, power, and compliance specifications for C2005 servers. The numbers reflect a typical configuration with four hot-swap drives.

Table A-2 Physical, Thermal, Power, and Compliance Specifications

Attribute	Specification
Form	2U rack mount / half-depth (14.5")
Dimensions	3.5" x 17.6" x 15.5" (HxWxD)
Gross weight	~27lbs.
Max. thermal sustained output	1121BTU/hr (AC) and 839BTU/hr (DC) (approximate, based on a typical configuration)
Actual max. power number	346W (AC) and 256W (DC) (approximate, based on a typical configuration)
Power supply	Input: 100–240VAC (standard), –48VDC (optional) 250W or 450W with +3.3V, +5V, +12V, –5V, and –12V main DC outputs and a 5V standby
Compliance	US (FCC, CFR47 Part 15, Class) Canada (ICES Class A) Europe (CE, EN55022 & EN55024) Australia (C-TICK) Japan (VCCI)