

**POWERED BY**

**matrox**

**Millennium G450 • Millennium G450 LE**

**User Guide**

10711-301-0102  
2000.08.25

**ENGLISH**



---

# Hardware installation

---

This section describes how to install your Matrox card. For information specific to your computer, like how to remove its cover, see your system manual.

---

**⚠ WARNING:** To avoid personal injury, turn off your computer, unplug it, and then wait for it to cool before you touch any of its internal parts. Also, static electricity can severely damage electronic parts. Before touching any electronic parts, drain static electricity from your body (for example, by touching the metal frame of your computer). When handling a card, carefully hold it by its edges and avoid touching its circuitry.

---

## 1 Switch to the standard VGA display driver

If you're running Windows 95/98/2000 on your computer, this step isn't necessary.

If you're using another operating system (for example, Windows NT 4.0), see its documentation for how to switch to VGA mode.

## 2 Open your computer and remove your existing graphics card\*

Turn off your computer and all peripherals such as your monitor or printer. Open the computer and remove your existing graphics card (if any). (If graphics hardware is built into the motherboard of your computer, this graphics hardware should automatically disable itself after your Matrox card is installed.)

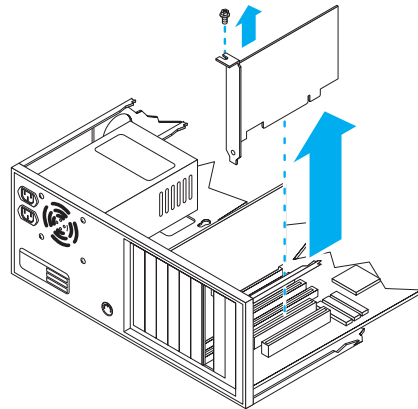

---

\* With multi-display mode, you may be able to use your existing graphics card. For Windows 98/2000, see Windows 98/2000 online help under "Multiple Display Support". For Windows NT 4.0, only Matrox graphics card models supported by the Matrox display driver can be used.

### 3 Choose an expansion slot

Most computers have different types of expansion slots. Choose an AGP or PCI slot, depending on the type of Matrox card you have. Your system manual should identify the location of each type of expansion slot in your computer.

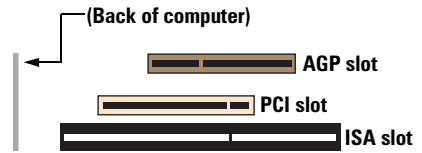

**WARNING:** Inserting your Matrox card into the wrong type of slot could damage your card, your computer, or both.

If you have an AGP card, *don't* insert the plastic tab (see picture) into the slot.

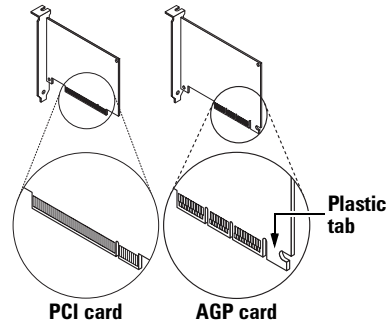

### 4 Insert your Matrox card

- a Remove the cover for the slot you intend to use.
- b Save the screw for the mounting bracket. Position your Matrox card over the expansion slot you've chosen.
- c Push the card in firmly and evenly until it's fully seated in the slot.
- d Replace the screw to secure the bracket of your Matrox card to the computer frame.

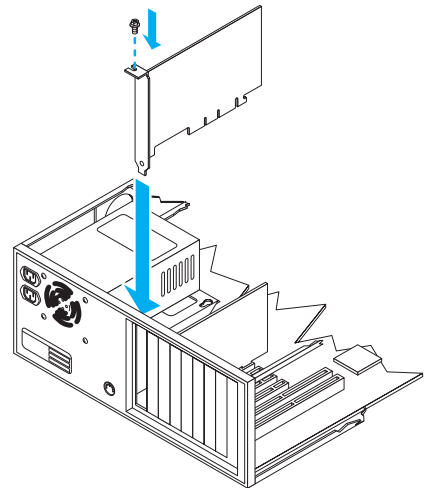

## 5 Connect your monitors

Simply plug your monitor cables into the monitor connectors on your Matrox card. Make sure each end of the monitor cables are properly connected and fastened.

- i** **Note:** Before you restart your computer, make sure your monitors are turned on. Do this each time you restart your computer. Otherwise, the software may not be able to properly detect your monitors.

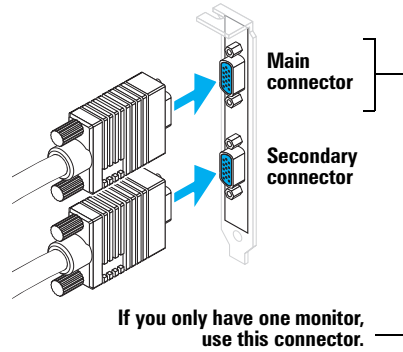

- i** **Note:** With the special TV output adapter\* included with your Matrox product, you can connect a TV or video recorder to the *secondary* connector on your graphics card. For more information, see “TV output” in the online version of this guide.

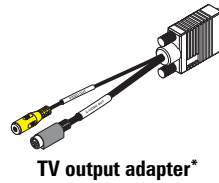

\* If your Matrox product was included with your computer, your product may not include this adapter.

Your Matrox card is now installed. To get the most out of your Matrox card, install Matrox software – see “Software installation”, page 5.

---

# Software installation

---

**Win9x  
NT2k** This section describes how to install Matrox software for *Windows 95/98\* /2000 or NT 4.0*. (For other operating systems, see the *Readme* file in the root folder of the Matrox installation CD-ROM.)

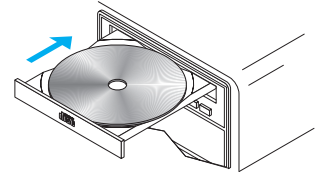

**WinNT  
2k** **Windows 2000 or NT 4.0** – You may need administrator rights to install certain software. For more information, see Windows documentation.

**1 Restart your computer** If you're using **Windows 95/98/2000**, it detects new hardware when you restart. If Matrox display drivers haven't been previously installed, Windows reports finding a PCI adapter (even if you have an AGP card). Windows prompts you to install a display driver. Follow the on-screen instructions. (The Matrox Windows 95/98 display driver is in the *Win9x* folder of your Matrox installation CD-ROM. The Matrox Windows 2000 display driver is in the *Win2k* folder.)

**2 Install required software** After your computer has restarted, insert (or reinsert) the Matrox installation CD-ROM in your CD-ROM drive – the setup program automatically starts.† This setup program works with Windows 95/98/2000 and NT 4.0, and detects which operating system you're using. If the required display software isn't already installed, the setup program automatically prompts you to install this software. Follow the on-screen instructions.

After the required display software is installed, you're prompted to restart your computer for changes to take effect. Leave your Matrox CD-ROM in your CD-ROM drive.

**3 Install optional software** After your computer restarts, the setup program shows you a list of additional items you can install. For each item you want to install, select a list item, click **Install**, then follow the on-screen instructions.

**4 Set up your display software** See “Software setup”, page 6.

---

\* Unless otherwise indicated, references to *Windows 98* apply to *Windows Me* (Millennium Edition).

† If Windows doesn't automatically start the setup program, you can start it manually from the root folder of the CD-ROM.

---

# Software setup

---

Your Matrox display driver includes Matrox PowerDesk software. This software helps you get the most out of your Matrox graphics card. This section has important information on how to configure your display settings using Matrox PowerDesk software.

---

## Accessing PowerDesk property sheets

---

Many display controls are on Matrox PowerDesk property sheets. You can identify Matrox PowerDesk property sheets by the icon appearing on the tab. To access these property sheets:

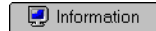

- W<sub>95</sub>** ■ **Windows 95** – Right-click your Windows desktop background, then click **Properties**.
- W<sub>98/2k</sub>** ■ **Windows 98/2000** – Right-click your Windows desktop background, then click **Properties** → **Settings** → **Advanced**. If you're using a multi-display desktop, select a display before clicking **Advanced**.
- W<sub>NT</sub>** ■ **Windows NT 4.0** – Click  → **Programs** → **Matrox PowerDesk NT** → **Matrox Display Properties**.

Also, to quickly access PowerDesk features, click the Matrox QuickDesk icon () on your Windows taskbar.

---

 **Note:** Multi-display mode is supported under Windows 98/2000 and NT 4.0. For more information on multi-display mode, see Windows 98/2000 online help under “Multiple Display support” and see [“DualHead Multi-Display setup”, page 7](#). (Windows 95 doesn't support multiple displays.)

---

---

## Monitor setup

---

Before changing your display resolution, color palette, or other Matrox PowerDesk settings, make sure correct software monitor settings are selected. If you have a Plug-and-Play (DDC) monitor, the correct settings are usually automatically selected. The following explains how to make sure your monitor settings are okay.

---

 **WARNING:** If incorrect software monitor settings are applied, *some* monitors can be permanently damaged. For more information, see your monitor manual.

---



**Windows 95/98/2000** – If you have a Plug-and-Play (DDC) monitor, Windows should automatically use the correct settings for your monitor. To make sure the correct monitor is selected in Windows:

- 1 Right-click your Windows desktop background, then click **Properties** → **Settings**.
- 2 Depending on what version of Windows you have, click **Change Display Type**, or **Advanced Properties** → **Monitor**, or **Advanced** → **Monitor**. If you're using a multi-display desktop, select a display before clicking **Advanced**.
- 3 If the monitor name listed doesn't match your monitor, click the **Change** button to select a new monitor name. Follow the on-screen instructions.

For more information on Windows monitor settings, see Windows documentation.

If you want to customize your Windows monitor settings:

- 1 Access the PowerDesk **Monitor Settings** property sheet (see “[Accessing PowerDesk property sheets](#)”, page 6).
- 2 Depending on what you want to do, click one of the buttons in the **Monitor settings selection method** box, then follow the on-screen instructions.



**Windows NT 4.0** –

- 1 Click  → **Programs** → **Matrox PowerDesk NT** → **Matrox Display Properties** → **Monitor**.

- 2 **If you have a Plug-and-Play monitor:**

Make sure the **Plug-and-Play (DDC) monitor** button is selected. If so, the Matrox display driver *automatically* uses the correct settings for your monitor. If not, click this button, then click **Apply**.

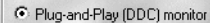

- 2 **If you don't have a Plug-and-Play monitor:**

See if the **Default monitor (60 Hz)** button is selected. If so, use the Matrox monitor selection method. For more information on Matrox monitor selection, see Matrox PowerDesk online documentation.

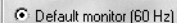

## DualHead Multi-Display setup

---

With your Matrox graphics card, you can enable a second display (for example, a computer monitor or a TV) as part of your Windows desktop. This is the Matrox *DualHead Multi-Display* feature. To use this feature:



**Windows 98** –

- 1 Access the PowerDesk **DualHead** property sheet (see “[Accessing PowerDesk property sheets](#)”, page 6).
- 2 Select the **DualHead Multi-Display** option button.

- 3 Click **OK** → **Yes** to restart your computer and for changes to take effect.
- 4 If multi-display mode isn't automatically enabled when you restart Windows:
  - a Right-click your Windows desktop background, then click **Properties** → **Settings**.
  - b Select the disabled display, enable the **Extend my Windows desktop onto this monitor** check box, then click **OK**.



#### Windows 2000 –



- 1 Access the PowerDesk **DualHead** property sheet (see “[Accessing PowerDesk property sheets](#)”, page 6).
- 2 Select the **DualHead Multi-Display** option button.
- 3 Click **Multi-Display Settings** to adjust your DualHead Multi-Display settings. Click **OK** when you're done.
- 4 Click **OK** → **OK** for changes to take effect.
- 5 Move the **Screen area** slider to adjust your display resolution and to select single-display or DualHead Multi-Display mode. A DualHead Multi-Display resolution is twice as wide or tall as its corresponding single-display resolution. For example, 640 × 480 is a single-display resolution and 1280 × 480 is a DualHead Multi-Display resolution.
- 6 Click **OK** to accept your changes.



**Note:** In DualHead Multi-Display mode under Windows 2000, Windows treats the main and secondary displays as a single display (which the Matrox display driver divides between two monitors). As a result, these displays always use the same resolution and color palette settings. The resolution of both displays is limited by the display with the lower maximum resolution.



#### Windows NT 4.0 –

- 1 Click  **Start** → **Programs** → **Matrox PowerDesk NT** → **Matrox Display Properties** → **DualHead**.
- 2 Select the **DualHead Multi-Display** option button.
- 3 Click **OK** → **Yes** to restart your computer and for changes to take effect.
- 4 Click  **Start** → **Programs** → **Matrox PowerDesk NT** → **Matrox Display Properties** → **Settings**.
- 5 Click **Multi-Display Desktop** ().



- 6 Move the **Desktop area** slider to adjust your multi-display desktop, then click **OK** to accept your changes.

---

 **Note:** In multi-display mode under Windows NT 4.0, the same display resolution and color palette is used for each display.

---



## Other DualHead features

If your Matrox graphics card has a second monitor connector you can also use these features:

### Windows 95/98/2000 or NT 4.0 –

- **DualHead Clone** – View a copy of your main display on your secondary display. Each display can use different monitor settings (refresh rates).
- **DualHead Zoom** – Use your secondary display to view a zoomed-in portion of your main display.

### Windows 95/98/2000 –

- **DualHead DVDMax** – Play digital video in a window on your main display and, at the same time, view that video full-screen on a TV.

---

 **Note:** You can also use your main and secondary display for two distinct views in games that use the DualHead Multi-Display feature. For more information on games that use this feature, see the Matrox Web site ([www.matrox.com/mga](http://www.matrox.com/mga)).

---

## More PowerDesk information

---

For more information on Matrox PowerDesk:



### Windows 95/98/2000 or NT 4.0 –

- For context-sensitive help where available, click the “” icon in the title bar, then click the item you want help on. Right-click a help topic for a pop-up menu that lets you print or copy it. (Some help topics are only available through context-sensitive help.)





### Windows 95/98/2000 –

- Access the PowerDesk **Information** property sheet (see “[Accessing PowerDesk property sheets](#)”, page 6), then click **Help** or **View Readme File**.



### Windows NT 4.0 –

- Click  → **Programs** → **Matrox PowerDesk NT** → **Matrox Display Properties** → **Information**.
- Click  → **Programs** → **Matrox PowerDesk NT** → **Matrox PowerDesk Guide**.
- Click  → **Programs** → **Matrox PowerDesk NT** → **Readme**.

---

# Troubleshooting

---

## Basic procedures

---



This section explains basic procedures that are referred to by some troubleshooting items in this guide.

### Restarting in safe mode

What follows is information on how to restart your computer in *safe mode* (or *VGA mode*).

If your primary display is *usable*:

#### Windows 95/98/2000 or NT 4.0 –

- 1 Restart your computer:
  - **Windows 95/98** – Click  → **Shut Down** → **Restart** → **OK**.
  - **Windows 2000** – Click  → **Shut Down**, select **Restart**, then click **OK**.
  - **Windows NT 4.0** – Click  → **Shut Down** → **Restart your computer** → **Yes**.
- 2 **Windows 95/98/2000** – *Before* Windows starts, press [F8] for the Windows startup menu to appear. (With Windows 98, if [F8] doesn't work, instead try pressing and holding [Ctrl] before Windows starts.)
- 3 Select “safe mode” or “VGA mode”, then press [Enter].

If your primary display is *unusable*:

#### Windows 95/98 –

- 1 Press [Ctrl]+[Alt]+[Del] twice to restart your computer.
- 2 *Before* Windows starts, press [F8] for the Windows startup menu to appear. (With Windows 98, if [F8] doesn't work, instead try pressing and holding [Ctrl] before Windows starts.)
- 3 Select “safe mode”, then press [Enter].

#### Windows 2000 –

- 1 Press [Ctrl]+[Alt]+[Del] → [Tab] → [Tab] → [Enter] → [↓] (down arrow) → [Enter] to restart your computer.
- 2 *Before* Windows starts, press [F8] for the Windows startup menu to appear.
- 3 Select “safe mode”, then press [Enter].



## Windows NT 4.0 –

- 1 Press [Ctrl]+[Alt]+[Del] → [Tab] → [Tab] → [Enter] → [↓] (down arrow) → [Enter] to restart your computer.
- 2 From the startup menu, choose Windows “VGA mode”.

## Main troubleshooting

---

This section addresses possible problems that could prevent you from using your computer.

### **Problem** Computer doesn't display information or boot after Matrox card is installed

**Cause** Your Matrox card may not be properly installed.

**Solution** Make sure your Matrox card is properly installed. Specifically, make sure the card is firmly inserted in its expansion slot and that all connections to it are firmly in place. For more information, see “[Hardware installation](#)”, page 2.

**Cause** There may be an unsupported graphics adapter in your computer. (For Matrox *multi-display mode* in Windows NT, all graphics cards in your computer must be Matrox cards supported by the display driver.)

**Solution** If an unsupported graphics card is plugged into an expansion slot, remove it.

**Solution** If a graphics adapter is built into your computer motherboard, your system may not have automatically disabled it when you inserted your Matrox card. Check your system manual for instructions on how to disable your computer's built-in graphics adapter.

**Cause** Your computer BIOS (Basic Input/Output System) may not be up to date. For more information on your computer BIOS, see your system manual.

**Solution** Reinstall your previous graphics card and, if possible, update your computer BIOS. This can usually be done with software from the manufacturer of your computer. Contact your system vendor or manufacturer to get a BIOS update for your computer.

To get the correct BIOS update, you may need to know the serial number your computer displays when it restarts. (This number is usually in the lower-left corner of the display.)

**Cause** The BIOS of your Matrox graphics card may need to be updated or restored.

**Solution** **For advanced users** – If you have another VGA-compatible graphics card (ISA or PCI), you can try resetting the BIOS of your Matrox graphics card.

- 1 Turn off your computer and insert the other graphics card into an expansion slot. For more information on expansion slots, see “Choose an expansion slot”, page 3.
- 2 Plug your monitor into the other graphics card and restart your computer.



**Note:** Make sure your computer uses the other graphics card to control your primary display. The graphics card that controls your primary display is the one that first displays information when you restart your computer. (A DualHead-supporting graphics card may display this startup information on both of its displays at the same time.)

Your computer BIOS (Basic Input/Output System) and the slot type (ISA, PCI, or AGP – see “Choose an expansion slot”, page 3) of each graphics card help determine which graphics card controls your primary display.

To control which graphics card is used for your primary display, you may be able to change the configuration of your computer BIOS. For information on how to change your computer BIOS settings, see your system manual.

---

- 3 Make sure **Matrox System Utilities** are installed on your computer. (These can be installed from your Matrox CD-ROM.)
- 4 Restart your computer in DOS mode, then type:  

```
cd c:\matrox\util [Enter]  
upbiosdos [Enter]
```
- 5 Turn off your computer, remove the other graphics card, then plug your monitor into your Matrox graphics card.
- 6 Restart your computer.

---

## **Problem** **Wrong color balance, screen image off-center, or no picture at all**

---

**Cause** Your monitor video controls may be improperly set.

**Solution** Adjust your monitor controls (brightness, contrast, and so on). For more information, see your monitor manual.

**Cause** Your monitor may not be properly connected.

**Solution** Make sure your monitor is properly connected to the correct connector on your Matrox graphics card (see “Connect your monitors”, page 4).

**Solution** Make sure the monitor power cable is firmly in place.

**Solution** Make sure the connection to the back of the monitor is firmly in place.

If your monitor uses BNC input, make sure the Red (**R**), Green (**G**), Blue (**B**), Horizontal Sync (**HSYNC** – white or gray wire), and Vertical Sync (**VSYNC** – black wire) connections are firmly in place and plugged into the correct input.

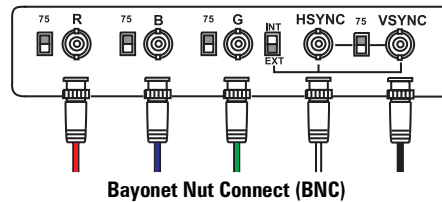

**Cause** If your monitor uses BNC input, one or more connection settings may be incorrect.

**Solution** Set each of your monitor RGB input and sync switches (if available) to 75 ohms, with the sync set to “external”. These controls are usually switches on the back of your monitor.

**Cause** If display problems occur after the startup screen of your operating system, your software monitor settings may be incorrect.

**Solution** Make sure correct software monitor settings are selected.



If your primary display is still usable, see “[Monitor setup](#)”, page 6. Otherwise, see the next troubleshooting item.

**Problem** **After the startup screen, or after display settings are changed, the screen image is garbled or unusable**

**(blank screen, rolling or overlapping screen images)**

**Cause** The Matrox display driver may be trying to use settings your monitor doesn’t support. This can happen if a monitor was never selected in the software and the display resolution was changed to one your monitor doesn’t support, or if the monitor connected to your computer was changed without changing it in the software.



**WARNING:** If incorrect software monitor settings are applied, *some* monitors can be permanently damaged. For more information, see your monitor manual.

**Solution** **Windows 95/98/2000 –**



- 1 If your primary display is unusable, restart your computer in safe mode (see “[Restarting in safe mode](#)”, page 10).
- 2 Right-click the Windows desktop background, then click **Properties** → **Settings**.
- 3 Move the **Desktop area** (Windows 95) or **Screen area** (Windows 98/2000) slider down to its lowest setting, then click **OK**.

- 4 Restart your computer normally.
- 5 Make sure the correct monitor is selected in Windows (see “[Monitor setup](#)”, page 6).
- 6 Make sure you’re not using inappropriate monitor setting customizations: Access the PowerDesk **Monitor Settings** property sheet (see “[Accessing PowerDesk property sheets](#)”, page 6), then click **Delete all customizations**.
- 7 Restore your original display settings (see steps 2 and 3).



**Note:** In multi-display mode (see “[DualHead Multi-Display setup](#)”), each monitor has its own monitor settings (refresh rates).

---



#### Windows NT 4.0 –

- 1 If your primary display is unusable, restart your computer in VGA mode (see “[Restarting in safe mode](#)”, page 10).
- 2 Right-click the Windows desktop background, then click **Properties** → **Settings**.  
Windows may prompt you that the display settings are incorrect for the current mode; click **OK** to continue.
- 3 Move the **Desktop area** slider down to its lowest setting, then click **OK**.
- 4 Restart your computer normally.
- 5 Select a monitor with the Matrox PowerDesk **Monitor** property sheet, then adjust your display settings. For more information, see the Matrox PowerDesk online documentation.

**Cause** Files on your system may have been deleted or corrupted.

**Solution** Remove, then restore Matrox software:



**Note:** Before removing software, make sure you have all the necessary files to reinstall software that may still be needed. Also, make sure the display driver you reinstall supports *all* Matrox products in your computer.

---



**Windows 95/98/2000 or NT 4.0 –**

- 1** If your primary display is unusable, restart your computer in safe mode or VGA mode (see “Restarting in safe mode”, page 10).
- 2** To remove Matrox software:
  - **Windows 95/98/2000** – Click  **Start** → **Settings** → **Control Panel** → **Add/Remove Programs** (double-click) → **Matrox Graphics Software (remove only)** → **Add/Remove** → **Yes**.
  - **Windows NT 4.0** – Run the separate uninstall program included with **Matrox System Utilities**. For more information, see the *Readme* file on your Matrox installation CD-ROM.
- 3** After removing Matrox software, install the latest display driver for your Matrox graphics card. You may also need to reinstall other Matrox software.

## More information

---

We provide additional documentation in help files, *Readme* files, and Adobe Acrobat PDF (Portable Document Format) files. To view or print PDF files, use the **Acrobat Reader** program, which you can install from the Matrox installation CD-ROM. This guide is available on the CD-ROM as a PDF file (*Doc\English\Guide\Guide\_en.pdf*).

The online version of this guide has additional information, including the following sections: “TV output”, “Extra troubleshooting”, “Display information”, “Hardware information”, “Customer support”, “Warranty”, and “Software license agreement”.

The “Extra troubleshooting” section includes more information on the following problems:

- Can't use Windows, Windows reports a configuration error, and/or can't install or uninstall Matrox display driver
- Monitor settings aren't automatically detected
- After game for Windows 95/98/2000 starts, monitor doesn't display properly
- Matrox Diagnostic or setup program reports an IRQ problem
- Game for Windows 95/98 doesn't start or runs slower than normal
- After restarting computer, Windows 95/98 warns that the graphics card isn't configured correctly
- Using multiple displays under Windows 98/2000 or NT 4.0, program doesn't work with main graphics card
- Not all graphics cards in the computer are fully supported
- In multi-display mode, displays aren't numbered consecutively
- Screen image defects appear, program doesn't run properly, or Windows doesn't work properly
- Program window or dialog box doesn't appear on screen
- Video file playback is jerky (skipping frames)
- DVD video playback is jerky (skipping frames)
- Can't play certain DVD videos
- Can't record DVD video
- TV image is garbled or unusable
- Computer text is hard to read with a TV
- Poor TV or video recorder image quality
- Can't record video with a video recorder
- Video appears stretched or squished on a TV
- Sound doesn't record, video files play back with no sound, or sound output is distorted or too loud



**Note:** Be sure to check for any last-minute release notes at the end of this manual and in the Matrox CD-ROM *Readme* file. Also, check the Matrox Web site ([www.matrox.com/mga](http://www.matrox.com/mga)) for the latest Matrox software, technical support, and product information.

---



---

# TV output

---

You can view or record the secondary display of your Matrox graphics card with a TV or a video recorder. This section describes this *TV output* feature:

**i** **Note:** TV output isn't supported with full-screen DOS display modes (for example, the information you see before Windows starts) or with standard VGA mode (for example, when you restart Windows in "safe mode"). Older programs may use these display modes. While one of these display modes is in use, your TV displays nothing (black).

---

## Connection setup

---

### 1 Turn off computer



**Windows 95/98/2000 or NT 4.0** – To shut down your computer, click  **Start** → **Shut Down** → **Shut down** → **OK**, then turn off your computer.



**WARNING:** Don't change monitor connections while your computer is turned on. While your computer is turned on, it may be using monitor settings that are specific to the current monitor connections.

If a display device (monitor, TV or video recorder) is connected while your computer is using settings intended for another display device, the display of the new device may be garbled or unusable. *Some* devices may be permanently damaged if incorrect settings are used.

---

### 2 Attach TV adapter

Attach the TV output adapter\* included with your Matrox product to the **Analog/TV** connector of your graphics card.

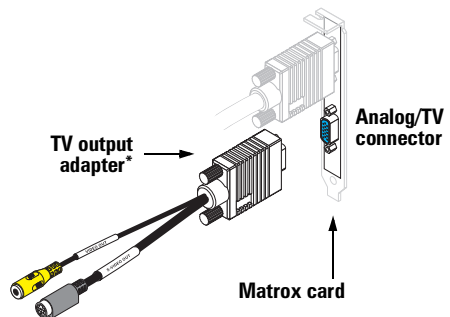

---

\* If your Matrox product was included with your computer, your product may not include this adapter.

### 3 Connect video output

To connect to a TV or a video recorder, you'll need a composite video (RCA) or S-video cable.

If your video device (a TV or a video recorder) didn't come with one of these cables, these types of cable are available at most electronics stores. The type of cable you use depends on what your video device supports. Many video devices support composite video connections, and some higher-quality video devices support S-video connections.

- a** Attach one end of your composite video or S-video cable to the appropriate connector on your TV adapter.
- b** Attach the other end to the **VIDEO IN**\* connector on your TV† or video recorder.
- c** Before viewing or recording video output directly from your computer, make sure your TV or video recorder is set up to use *line* input. For example, if your TV has a **TV/VIDEO** switch, set it to **VIDEO**; or if your video recorder has a **TUNER/LINE** switch, set it to **LINE**.

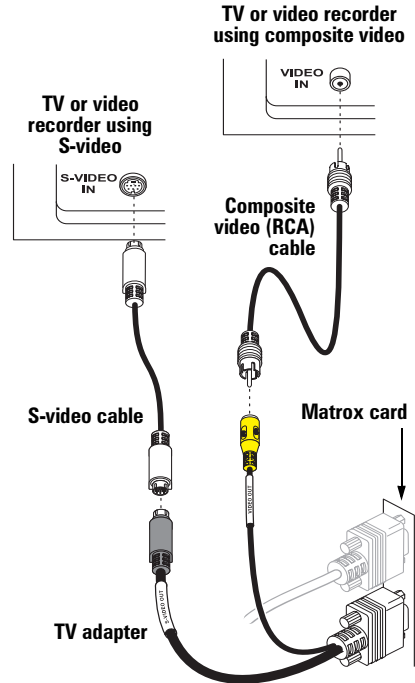

**(Note: Using the Matrox composite video and S-video connectors at the same time is optional.)**

Optionally, if you use the composite video *and* S-video connectors on your Matrox TV adapter, you can directly connect two different video devices at the same time.

To view *and* record output from the same Matrox video connector, you can connect it to a video recorder and connect the video recorder to a TV. For more information, see your video recorder and TV manuals.

\* The labels on your devices may not be consistent with what's in this guide. Different manufacturers sometimes use different labels for the same type of controls and connectors. For example, the **VIDEO IN** connector on your TV may be labeled **VIDEO 1** (or **VIDEO 2**). To match labels, see the documentation for your video devices.

† If your TV only has an antenna or cable TV connector, you can use an *RF modulator* to connect it to your Matrox card. RF modulators are available at most electronics stores.

#### 4 Connect audio output

Typically, the sound output from a computer comes from speakers connected to your sound card. If you prefer, you can hear or record the sound output from your computer using the same TV or video recorder you connect to your graphics card. To do this, you need an audio cable with a stereo jack on one end and two RCA connectors on the other end. If you don't have this type of cable, you can buy one at most consumer electronics stores.

- a Plug the stereo-jack end of the audio cable into the **LINE OUT\*** connector on your sound card.
- b Plug the other end of the cable into the left (L) and right (R) **AUDIO IN** connectors of your video device. For more information, see your sound card manual.

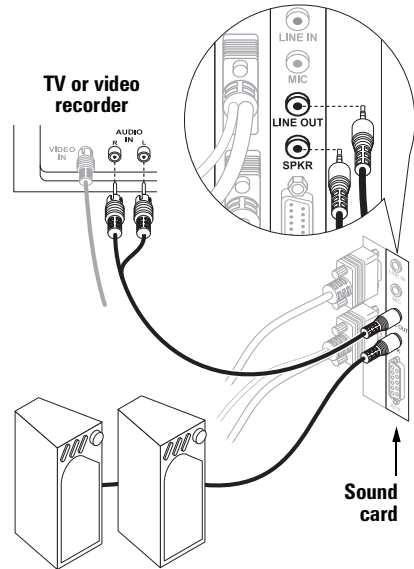

### SCART adapter

Some video devices in Europe only have SCART connectors. This type of connector includes video *and* audio, whereas composite video or S-video connectors include only video.

If your TV or video recorder *only* uses a SCART connector, you need a SCART cable adapter to connect your computer to that TV or video recorder. You need a SCART adapter that has at least 2 or 3 connectors – 1 video and 1 or 2 audio. The video connector has to be either composite or S-video. If you don't already have this type of adapter, it should be available at your local electronics store. To find out if your TV or your video recorder supports composite or S-video, see its documentation.

To use a SCART adapter, connect the SCART end of the adapter to your TV or video recorder, then connect the other end to your Matrox TV adapter *and* sound card.

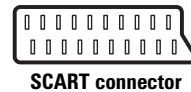

SCART connector

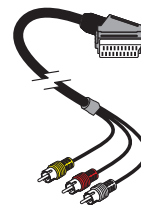

Composite SCART adapter with 3 connectors

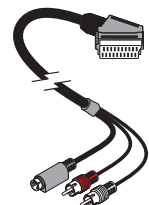

S-video SCART adapter with 3 connectors

\* If your sound card has no **LINE OUT** connector, you can use its **SPKR** connector instead. In this case, all your computer's sound output goes to the video device you connected to.

## Software setup

---

If a TV or video recorder is connected to the second monitor connector on your Matrox graphics card, you can use TV output mode to view or record your display on your TV or video recorder. (To connect video devices to your computer, [see page 17.](#))

TV settings have lower resolutions and refresh rates than typical computer monitor settings. Lower refresh rates may result in more noticeable flicker.

---

**i** **Note:** Two TV standards are supported for TV output. The NTSC standard is used in North America and Japan, among other places. The PAL standard is used in most of Western Europe and in China, among other places.

If an incorrect TV standard is selected in Matrox software, the output from your computer may not appear or record properly on your TV or your video recorder. To find out what standard your TV or video recorder supports, see its documentation.

---

**W<sup>98</sup><sub>2k</sub>** **Windows 98/2000** – To add a TV to your Windows desktop, [see “DualHead Multi-Display setup”, page 7.](#)

**W<sup>9x</sup><sub>NT 2k</sub>** **Windows 95/98/2000 or NT 4.0** – To use TV output, you can use the *DualHead Clone*, *DualHead Zoom*, or *DualHead DVDMax\** features ([see “Other DualHead features”, page 9.](#))

**W<sup>9x</sup><sub>2k</sub>** **Windows 95/98/2000** – To adjust TV settings, access the Matrox PowerDesk **DualHead** property sheet ([see “Accessing PowerDesk property sheets”, page 6.](#)) To adjust advanced desktop TV settings, click **Desktop TV Settings**. To adjust advanced DVDMax TV settings, click **DVDMax TV Settings**.

**W<sub>NT</sub>** **Windows NT 4.0** – To adjust TV settings, click  **Start** → **Programs** → **Matrox PowerDesk NT** → **Matrox Display Properties** → **Monitor**. To adjust advanced TV settings, click **Advanced TV Settings**.

For more information on how you can use your secondary display, see Matrox PowerDesk online help.

---

\* Under Windows NT 4.0, the DualHead DVDMax feature isn't supported.

---

# Extra troubleshooting

---

## Graphics

---

The following troubleshooting items address problems related to graphics cards.

**Problem** **Can't use Windows, Windows reports a configuration error, and/or can't install or uninstall Matrox display driver**

---

 **Note: Windows 2000 or NT 4.0** – You may need administrator rights to install certain software. For more information, see Windows documentation.

---

**Cause** The problem may be specific to the motherboard in your computer.

**Solution** There may be a software update available for your motherboard. To find out what motherboard model your computer is using, see your system manual. For more information, contact the maker of your motherboard or computer. Many motherboard or computer manufacturers have software updates available on their Web site.

**Cause** Files on your system may have been deleted or corrupted.

**Solution** Remove, then restore Matrox software. For more information, [see page 15](#).

**Solution** **Windows 95/98 – For advanced users** – Manually remove any old or new display drivers, then reinstall the latest display driver for your Matrox graphics card.

 **Note:** Before removing software, make sure you have all the necessary files to reinstall software that may still be needed. Also, make sure the display driver you reinstall supports *all* Matrox products in your computer.

---

- 1 Restart your computer in safe mode (see “Restarting in safe mode”, page 10).
- 2 Right-click the **My Computer** icon on the Windows desktop background, then click **Properties** → **Device Manager**.
- 3 Click the plus sign next to **Other devices** (if it appears) and **Display adapters**. Delete all listed display adapters (click each, then click **Remove**), then click **OK**.

- 4 In the following folders, remove all files or folders related to “PowerDesk” (*pd\*.\**), “Matrox” or “MGA”. (For more information on some files, right-click on them in Windows Explorer, then click **Properties** → **Version**. The following paths assume default installations and may be different on your computer.)

- *C:\Windows\Start Menu\Programs\StartUp*
- *C:\Windows\Startmenu\Programs*
- *C:\Windows\System*
- *C:\Program Files*



**Note:** Recent versions of Matrox PowerDesk for Windows 95/98 (5.x and later) install files only to your Windows *System* folder.

---

- 5 Click  → **Run**, type *regedit*, then click **OK**.
- 6 Under **HKEY\_LOCAL\_MACHINE** → **SOFTWARE**, remove all items starting with “Matrox” or “MGA”.



**Note:** Recent versions of Matrox PowerDesk for Windows 95/98 (5.x and later) store registry settings under **HKEY\_CURRENT\_USER** → **SOFTWARE**. *Your* settings under **HKEY\_CURRENT\_USER** are only accessible if you’re logged into Windows with your user name.

---

- 7 Restart your computer, then install the latest display drivers for your Matrox graphics card. You may also need to reinstall other Matrox software.

## Problem **Monitor settings aren't automatically detected**

---



**WARNING:** If incorrect software monitor settings are used, your display may become unusable and *some* monitors can be permanently damaged. For more information, see your monitor manual.

---



**Note:** To check if your monitor settings are properly selected:

**1 Windows 95/98/2000** – Right-click your Windows desktop background, then click **Properties** → **Settings** → **Advanced** → **Monitor**. If you're using multi-display mode, select a display before clicking **Advanced**.

**Windows NT 4.0** – Access the Matrox PowerDesk **Monitor** property sheet (see [“Accessing PowerDesk property sheets”, page 6](#)). If you're using multi-display mode, select a display number.

**2** If you see the name of your monitor or “Plug-and-Play”, your monitor settings are properly selected.

If you see the wrong monitor name, **Unknown monitor** (Windows 95/98), or **Default monitor** (Windows 98/2000 or NT 4.0), your monitor settings aren't properly selected.

---

**Cause** Your monitor may not be Plug-and-Play. Most new monitors are Plug-and-Play but many older ones aren't. Software can't automatically detect settings for monitors that aren't Plug-and-Play.

**Solution** Manually select your monitor settings in the software. For Windows 95/98/2000 or NT 4.0, see [“Monitor setup”, page 6](#).

**Cause** If a monitor was changed or added while Windows was running, the new monitor may not be detected by the software.

**Solution** Restart your computer. If your monitor is a Plug-and-Play (DDC) monitor, it should be automatically detected by the software.

**Cause** You may be using BNC connectors with a Plug-and-Play monitor. The Plug-and-Play feature of a monitor can't be used with BNC connectors.

**Solution** If there's an HD-15 connector at the back of your monitor, use this connector instead of the BNC connectors.

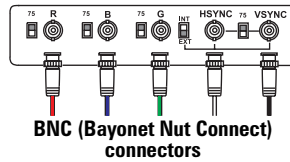

HD-15 connector

**Problem** After game for Windows 95/98/2000 starts, monitor doesn't display properly (blank screen, rolling or overlapping screen images)

**Cause** If your game uses a low-resolution (640 × 480 and below), full-screen display mode, your monitor may not support the refresh rate the Matrox driver is using.

**Solution** Windows 95/98/2000 –



- 1 If the game is still running in full-screen mode and your monitor is unusable, exit the game. To do this, press [Alt]+[Tab] **once**, right-click the name of the game on the Windows taskbar, then click **Close**.
- 2 Make sure the correct monitor is selected in Windows (see “Monitor setup”, page 6).

**Solution** Windows 95/98/2000 –



- 1 If the game is still running in full-screen mode and your monitor is unusable, exit the game. To do this, press [Alt]+[Tab] **once**, right-click the name of the game on the Windows taskbar, then click **Close**.
- 2 Access the Matrox PowerDesk **Monitor Settings** property sheet (see “Accessing PowerDesk property sheets”, page 6).
- 3 Click **Select customizations from the Matrox list**.
- 4 From the Matrox monitor list, select the monitor model you're using. If your monitor model doesn't appear in the list, select a monitor that runs at 60 Hz at 640 × 480 (for example, **Standard monitor types** → **Vesa 1024X768 @60Hz** → **Next**). Follow the on-screen instructions to complete the selection.



**Problem** Matrox Diagnostic or setup program reports an IRQ problem  
(3D and video programs don't work)

**Cause** Your computer or program may not work well with bus mastering.

**Solution** Disable bus mastering:  
(If you want to continue using bus mastering, see the other solutions.)



**Windows 95/98/2000 –**

- 1 Access the Matrox PowerDesk **Options** property sheet (see “Accessing PowerDesk property sheets”, page 6).
- 2 Clear the **Use bus mastering** check box.
- 3 Click **OK** → **OK** → **Yes** to accept the changes and restart your computer.



**Windows NT 4.0 –**

- 1 Click  **Start** → **Programs** → **Matrox PowerDesk NT** → **Matrox Display Properties** → **Performance**.
- 2 Clear the **Use bus mastering** check box.
- 3 Click **OK** → **Yes** to accept the changes and restart your computer.

**Cause** Your computer may not have given an interrupt request (IRQ) to your Matrox graphics card or may have given one used by another device in your computer. This may be because your computer's “Plug-and-Play” feature is turned off.



**Windows 95/98/2000 –** To check the display adapter's IRQ:

- 1 Right-click the **My Computer** icon on the Windows desktop background, then:
  - **Windows 98** – click **Properties** → **Device Manager**.
  - **Windows 2000** – click **Properties** → **Hardware** → **Device Manager**.
- 2 Click the plus sign to the left of the **Display adapters**. An “X” through an icon means the hardware has been disabled. A circled exclamation point through the icon means the hardware has a problem.
- 3 Double-click the name of your Matrox display adapter to open a properties dialog box. The type of problem is displayed in the **General** tab → **Device status** area. Check also the **Resources** tab → **Resource type** list for an **Interrupt Request**.

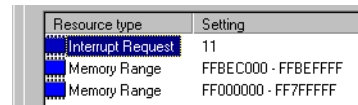

Resource type	Setting
Interrupt Request	11
Memory Range	FFBEC000 - FFBFFFFFFF
Memory Range	FF000000 - FF7FFFFFFF

**Solution** Change settings in your computer BIOS setup utility.

If your computer has the options of enabling Plug-and-Play detection, or assigning an IRQ to a VGA adapter, make sure they're enabled. If your computer doesn't have these options, you may be able to manually assign an IRQ to your graphics card using the BIOS setup utility.

For more information on the BIOS setup utility of your computer, see your system manual or contact your system manufacturer.

**Cause** **Windows 95/98** – Other devices in your computer may have IRQs unnecessarily allocated to them. Each time cards are moved to different expansion slots in your computer, new IRQs may be allocated without old ones being deallocated.

**Solution** **For advanced users** – Remove and restore device drivers.

---

**i** **Note:** Before removing software, make sure you have all the necessary files to reinstall software that may still be needed.

---

- 1** Restart your computer in safe mode (see “Restarting in safe mode”, page 10).
- 2** Right-click the **My Computer** icon on the Windows desktop background, then click **Properties** → **Device Manager**.
- 3** Under **Display adapters**, **Network adapters**, or **SCSI controllers**, remove any redundant or unused device drivers. To remove a driver, select its name, then click **Remove**. (If you're not sure whether a driver is redundant or unused, you can remove it. When Windows restarts, Windows automatically restores needed drivers or prompts you to reinstall them.)
- 4** Restart your computer normally.

**Cause** Your computer's other BIOS settings may be incorrect.

**Solution** Reset your computer BIOS settings to the factory defaults using your computer's built-in BIOS setup utility. The factory defaults are usually the “safest” settings. Check your system manual for more information.

**Problem** **Game for Windows 95/98 doesn't start or runs slower than normal**  
**W**<sub>9x</sub> **(program uses Microsoft DirectX interface)**

---

**Cause** An older version of DirectX may be installed. The Matrox CD-ROM setup program installs DirectX, but some programs install an older version of DirectX (overwriting your version). To see what version of DirectX is installed:

- 1 Access the Matrox PowerDesk **Information** property sheet (see “[Accessing PowerDesk property sheets](#)”, page 6).
- 2 Look at the **Microsoft DirectX** label.

**Solution** If DirectX 7.0 or later isn't installed, install it. Run the setup program from the *DirectX* folder of the Matrox installation CD-ROM.

**Problem** **After restarting computer, Windows 95/98 warns that the graphics card isn't configured correctly**  
**W**<sub>9x</sub>

---

**Cause** You may have a conflict because of previously installed display drivers.

**Solution** Delete all existing display drivers and reinstall Matrox display drivers.

- 1 If Windows prompts you to start the **Add New Hardware Wizard**, click **Cancel**. (If you start the Wizard, it will *not* detect your graphics card.)
- 2 Right-click the **My Computer** icon on the Windows desktop background.
- 3 Click **Properties** → **Device Manager**.
- 4 Click the plus sign next to **Other devices** (if it appears) and **Display adapters**.
- 5 Delete *all* listed display adapters (click each, then click **Remove**), then click **OK**.
- 6 Restart your computer and reinstall the Matrox display drivers (see page 5).

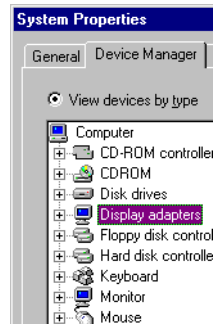

**Problem** **Using multiple displays under Windows 98/2000 or NT 4.0, program doesn't work with main graphics card**

---



**Cause** Your main graphics card may not be controlling your primary display. The graphics card that controls your primary display is the one that first displays information when you restart your computer. (A DualHead-supporting graphics card may display this startup information on both of its displays at the same time.)

Programs that don't recognize multiple displays may not work with a graphics card unless it's controlling your primary display.

Your computer BIOS (Basic Input/Output System) and the slot type (ISA, PCI or AGP – see “Choose an expansion slot”, page 3) of each graphics card help determine which graphics card controls your primary display.

**Solution** If you're having problems with a program that can be moved on your Windows desktop, run this program on your primary display. Make sure the program window doesn't overlap any other display. If the program doesn't work with the graphics card controlling your primary display, or you want your main graphics card to control your primary display, see the other solutions.

**Solution** Change the configuration of your computer BIOS so that the slot type of your main graphics card has priority for becoming the primary display. For information on how to change your computer BIOS settings, see your system manual.

If your computer BIOS doesn't let you select which slot type has priority for becoming the primary display, a BIOS update may be available to let you do this. (The BIOS of most computers can be updated with software.) For a possible BIOS update for your computer, contact your system vendor.

**Solution** If there's a graphics controller built into the motherboard of your computer, by changing your computer BIOS settings, you may be able to change which device controls your primary display. For more information, see your system manual.

**Solution** If you don't need to use the graphics card that's controlling your primary display, remove it from your computer. If your primary display is controlled by the motherboard of your computer, see your system manual for information on how to disable this graphics controller.

**Cause** The program you're using may not work properly with systems using more than one display at a time.

**Solution** An update may be available for the program you're using. This update may fix problems this program has with multi-display systems. For more information, contact the software distributor for the program you're using.

**Solution**  
**W<sup>98</sup><sub>2k</sub>**

**Windows 98/2000 – For advanced users** – To use a program that doesn't support multi-display systems, you can disable all displays other than your primary display:

- 1 Make sure the **DualHead disabled** option button is selected on the **DualHead** property sheet. To access this property sheet, see “[Accessing PowerDesk property sheets](#)”, page 6.
- 2 **Windows 2000** – Restart your computer in safe mode (see “[Restarting in safe mode](#)”, page 10).
- 3 Right-click the **My Computer** icon on the Windows desktop background, then:
  - **Windows 98** – click **Properties** → **Device Manager**.
  - **Windows 2000** – click **Properties** → **Hardware** → **Device Manager**.
- 4 Click the plus sign to the left of the **Display adapters**.
- 5 For each display adapter, *except* for the one controlling your primary display:

**Windows 98** – Double-click the name of a display adapter to open a properties dialog box. Enable the **Disable in this hardware profile** check box, then click **OK**.

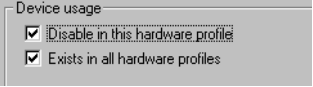

**Windows 2000** – Right-click the name of a display adapter, then click **Disable** → **Yes**.



**Note:** Your primary display can't be disabled.

---

- 6 **Windows 98** – Click **Close** → **Yes**.
- 7 Restart your computer for changes to take effect.



**Note:** To restore display adapters, repeat steps 3–7, but do the following in step 5:

- **Windows 98** – clear the **Disable in this hardware profile** check box.
- **Windows 2000** – click **Enable**.

---

## Problem **Not all graphics cards in the computer are fully supported**

W  
NT 98  
2k

**(Software doesn't work with a certain graphics card, or another graphics card doesn't work at all)**

**Cause** If you have different models of graphics cards in your computer, your Matrox display driver may not support all the graphics cards in your computer.

Under Windows 98/2000, a display driver may support one or more graphics cards. If a display driver doesn't support a certain card, a different display driver must be used for that card. Software that depends on a certain display driver may not work with a graphics card that's not using the same display driver.

Under Windows NT 4.0, only one display driver at a time may be used. To use more than one graphics card, the display driver must support all the graphics cards installed. If an unsupported graphics card is installed in your computer, that card either isn't used or your computer restarts in VGA mode (single-display, 640 × 480 resolution, 16 colors).

**Solution** Install the latest unified display driver for your Matrox graphics cards. (A *unified* display driver supports more than one model of graphics card.) This driver is available on the Matrox Web site ([www.matrox.com/mga](http://www.matrox.com/mga)). Make sure that the display driver supports *all* Matrox products in your computer. Install the display driver by running the setup program included with it.



**Note:** A unified Matrox display driver may not be available for all the models of Matrox graphics cards installed in your computer (especially for older models). Under Windows 98/2000, you can use more than one display driver in this case.

**Solution** If a graphics card isn't supported, you may need to remove it. If there's a graphics processor built into the motherboard of your computer that's not supported by your software, see your system manual for information on how to disable this graphics processor.

**Cause** **Windows 98/2000** – If the Windows method for display driver installation was used (instead of running the setup program included with your Matrox display driver), the driver may not be installed for all the graphics cards it supports.

W  
NT 98  
2k

**Solution** Run the setup program included with the Matrox display driver. The setup program automatically installs the display driver for each Matrox graphics card it supports.



## Problem In multi-display mode, displays aren't numbered consecutively

---

W<sup>98</sup>  
NT<sup>2k</sup>

**Cause** If you have more than one graphics card in your computer, the display numbering may not be consecutive for the displays of a multiple-display card (for example, a DualHead supporting card). Display numbering depends on the types of expansion slots used in your computer (AGP and PCI) and the BIOS settings of your computer.



**Solution** **Windows 98/2000** – Move the displays in Windows.

- 1 Right-click your Windows desktop background, then click **Properties** → **Settings**.
- 2 Select a display and move it according to the physical position of the monitor it's associated with.



**Note:** In DualHead Multi-Display mode for Windows 2000 and in multi-display mode for Windows NT 4.0, you have limited control over the arrangement of your displays. For more information, see Matrox PowerDesk documentation.

---

## Problem Screen image defects appear, program doesn't run properly, or Windows doesn't work properly

---

(example: mouse pointer not drawn properly)

**Cause** Some programs may not work properly with some Matrox acceleration.

**Solution** Disable specific types of software acceleration:

W<sup>9x</sup>  
2k

**Windows 95/98/2000** –

- 1 Access the Matrox PowerDesk **Options** property sheet (see “[Accessing PowerDesk property sheets](#)”, page 6).
- 2 Clear one or more check boxes, starting with **Use device bitmaps caching**. For more information, see context-sensitive help.
- 3 Click **OK** → **Close** to accept the changes. (Depending on the feature you disabled, you may have to restart your computer for the changes to take effect.)

W<sup>NT</sup>

**Windows NT 4.0** –

- 1 Click  **Start** → **Programs** → **Matrox PowerDesk NT** → **Matrox Display Properties** → **Performance**.
- 2 Clear one or more check boxes. For more information, see context-sensitive help.
- 3 Click **OK** → **Yes** to accept the changes. (Depending on the feature you disabled, you may have to restart your computer for the changes to take effect.)

**Solution** Windows 95/98/2000 – Disable Windows effects:

W<sup>9x</sup><sub>2k</sub>

- 1 Right-click your Windows desktop background, then click **Properties** → **Effects**.
- 2 Disable one or more features under **Visual effects**.

**Solution** If possible, update your Matrox display driver. Matrox makes new display drivers available on the Matrox Web site ([www.matrox.com/mga](http://www.matrox.com/mga)).

**Solution** Disable Matrox hardware acceleration:

W<sup>9x</sup>

Windows 95/98 –

- 1 Right-click the **My Computer** icon on the Windows desktop background.
- 2 Click **Properties** → **Performance** → **Graphics**.
- 3 Move the **Hardware acceleration** slider to **None**.
- 4 Click **OK** → **Close** → **Yes** to accept the changes and restart your computer.

W<sup>2k</sup>

Windows 2000 –

- 1 Right click your Windows desktop background, then click **Properties** → **Settings** → **Advanced** → **Troubleshooting**.
- 2 Move the **Hardware acceleration** slider to **None**.
- 3 Click **OK** → **OK** to accept the changes.

**Cause** Windows 95/98 – There may be a conflict between resources in your system.

**Solution** 1 Right-click the **My Computer** icon on the Windows desktop background, then click **Properties** → **Device Manager**.

W<sup>9x</sup>

- 2 Click the plus sign next to **Other devices** (if it appears) and **Display adapters**.
- 3 Delete any display adapter *other than* the one for your Matrox graphics card.
- 4 Restart your computer.



---

**Note:** If you identify a program that doesn't work well with Matrox acceleration, please contact Matrox technical support (see page 49) and describe the problem. This information may help us come up with a fix or work-around in a future driver release.

---





## **Problem** Program window or dialog box doesn't appear on screen

---

**Cause** Another window or dialog box may be covering the window or dialog box you want to see.

**Solution** Move, close, or minimize any window or dialog box that may be covering the window or dialog box you want to see.

**Cause** **Windows 98/2000 or NT 4.0** – If you're using multi-display mode, the program window or dialog box may be in a display or on a monitor that's unusable.

**Solution** Make sure all the displays and monitors you want to use are usable. For more information, see other troubleshooting items in this guide.

**Cause** The software may be using a display you didn't intend to use or the software may be configured to use more displays than the actual number of monitors you have. (For example, you may be in DualHead Multi-Display mode but you only have one monitor.)

**Solution** Disable the display:

**W**<sup>98</sup><sub>2k</sub>

**Windows 98/2000** –



**Note:** In DualHead Multi-Display mode under Windows 2000, if you want to disable the secondary display of your graphics card, [see page 8](#).

---

- 1 Right-click your Windows desktop background, then click **Properties**.
- 2 Select the display you want to disable, then clear the **Extend my Windows desktop onto this monitor** check box.

**W**<sub>NT</sub>

**Windows NT 4.0** –

- 1 Click  **Start** → **Programs** → **Matrox PowerDesk NT** → **Matrox Display Properties** → **Settings**.
- 2 Move the **Desktop area** slider until the number of displays used matches the number of monitors connected, then click **OK** to accept your changes. (The display you disable must be the last one, if it's not, to change your display configuration, [see page 31](#).)



**Note:** If the monitor you disabled in the software is your primary display, you need to configure your computer so that your primary display is on the monitor that's connected. [See "Using multiple displays..."](#), page 28, solutions 2, 3 and 4.

---



The program window or dialog box may be somewhere off-screen.

### Solution

If the program window you want to see is named on the Windows taskbar, right-click on it and select **Maximize**. (If you click **Restore** the program window goes back to its previous position. To fix this problem, see the other solutions.)

### Solution

Manually move the program window or dialog box:

- 1 Press [Alt]+[Space].
- 2 If you see a pop-up menu, click **Move**. If you don't see a pop-up menu, press [M] (for **Move**).
- 3 Press on one of the arrow keys once and move your mouse pointer to where you want the window or dialog box to appear, then click. The program window or dialog box should appear where you clicked.

### Solution



**Windows 98/2000** – Use the **Move All Windows to Primary Display** feature to move the program window or dialog box. Simply press the keyboard shortcut assigned to this feature.

To assign a keyboard shortcut to this feature:

- 1 Right-click the Matrox QuickDesk icon () on your Windows taskbar, then click **Hot Keys**.
- 2 Create a keyboard shortcut for the **Move All Windows to Primary Display** feature.

### Solution



**Windows 2000 or NT 4.0** –

- 1 **Windows 2000** – Click the Matrox QuickDesk icon () on your Windows taskbar, then click **Multi-Display Controls**.

**Windows NT 4.0** – Click  → **Programs** → **Matrox PowerDesk NT** → **Matrox Display Properties** → **PowerDesk**.

- 2 Enable the **Open program windows in display** feature, then choose where you want the program window or dialog box to appear. For more information, see Matrox PowerDesk context-sensitive help.

### Solution



**Windows 2000 or NT 4.0** –

- 1 **Windows 2000** – Click the Matrox QuickDesk icon () on your Windows taskbar, then click **Multi-Display Controls**.

**Windows NT 4.0** – Click  → **Programs** → **Matrox PowerDesk NT** → **Matrox Display Properties** → **PowerDesk**.

- 2 Enable the **Use CenterPOPUP** (Windows 2000) or **Center dialog boxes** (Windows NT 4.0) feature, then choose where you want the program window or dialog box to appear. For more information, see Matrox PowerDesk context-sensitive help.

## Video

---

The following troubleshooting items address problems related to video files.

### Problem **Video file playback is jerky (skipping frames)**

---

 **Note:** Jerky video file playback may be the result of slow playback or recording. Slow recording causes frames to be dropped (frames aren't recorded). If jerky video is caused by frames that were dropped during recording, the problem can only be fixed by recapturing the video under better conditions.

---

**Cause** Your hard disk may be too slow.

**Solution** Try *defragmenting* your hard disk.

 **Windows 95/98/2000** – To defragment a hard disk, click  **Start** → **Programs** → **Accessories** → **System Tools** → **Disk Defragmenter**.

**Solution** If possible, try using a faster disk.

 **Tip:** If your computer has more than one hard disk, you may get better results if you play back video files from a disk *other than* the one where the Windows swap file is stored. The Windows swap file is usually stored on drive “C:”.

---

**Solution** Make sure the drive you're using (a hard disk drive or DVD drive) is using DMA (if your drive supports DMA transfers). To use DMA:

 **WARNING:** Not all drives support DMA well. For more information, see the documentation that came with your hard disk.

---

 **Windows 95/98** –

- 1 Right-click the **My Computer** icon on your Windows desktop background, then click **Properties** → **Device Manager**.
- 2 Double-click the **Disk drives** list item to expand it, then double-click the name of the drive device you're using.
- 3 Click **Settings**, then enable the **DMA** check box.
- 4 Click **OK** → **OK** → **Yes** to restart your computer and for changes to take effect.



## Windows 2000 –

- 1 Right-click the **My Computer** icon on your Windows desktop background, then click **Properties** → **Hardware** → **Device Manager**.
- 2 Double-click the **IDE ATA/ATAPI controllers** list item to expand it, then double-click the name of the appropriate controller.
- 3 Change each **Transfer Mode** setting to “**DMA if available**”.
- 4 Click **OK** to accept the changes.



**Windows NT 4.0** – Install a DMA driver. For most computers, a DMA driver is available for Windows NT 4.0 (for example, the “PIIX Bus Master IDE” driver supports many computers). For more information on how to get this driver, contact your system vendor.

**Cause** Too many programs may be running (using up computer resources).

**Solution** Close other programs, including memory-resident programs like **System Agent**.

**Cause** Your display settings may be too high. As a result, video file playback may not be fully supported by Matrox hardware.

**Solution** Try lowering your display settings. We recommend a 1024 × 768 or lower display resolution with a 16-bit color palette.



To access display settings:

- **Windows 95/98/2000** – Right click your Windows desktop background, then click **Properties** → **Settings**.
- **Windows NT 4.0** – Click  → **Programs** → **Matrox PowerDesk NT** → **Matrox Display Properties** → **Settings**.

**Cause** Your Matrox graphics card may be sharing an IRQ (interrupt request) with another PCI card in your computer (for example, a network card).



**Windows 95/98** – To see if your graphics card is sharing an IRQ:

- 1 Right-click the **My Computer** icon on your Windows desktop background, then click **Properties** → **Device Manager** → **Properties**.
- 2 Look in the list box to see if your Matrox graphics card is assigned the same IRQ number as another PCI card in your computer.

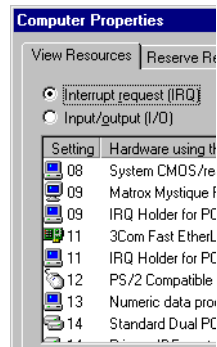

**Solution** Try moving the PCI card to another PCI slot in your computer. For more information, see the documentation for this card or see your system manual.

## DVD

---

The following troubleshooting items address problems related to DVD. (For general video-related troubleshooting items, see “Video”, page 35.)

### **Problem** DVD video playback is jerky (skipping frames)

---

**Cause** Your DVD drive may be too slow.

**Solution** If your DVD drive supports DMA transfers, enable this feature (see page 35).

### **Problem** Can't play certain DVD videos

---

**Cause** A DVD video may not play back because the region setting on your DVD player doesn't match the region code on the DVD-ROM disc. DVD players and videos use region codes to prevent the playback of video that was intended only for a certain region or market.

**Solution** To get a copy of a DVD video that's compatible with the region code of your DVD player, contact the vendor of that video.

### **Problem** Can't record DVD video

See “Can't record video with a video recorder”, page 39.

## TV output

---

The following troubleshooting items are related to TV output support (see “TV output”, page 17).

### **Problem** TV image is garbled or unusable (a blank screen, or rolling or overlapping screen images)

---

**Cause** Your TV or video recorder may not be properly connected.

**Solution** Make sure your TV or video recorder is properly connected. For more information, see “Connection setup”, page 17.

**Cause** Your TV or video recorder may not be properly set up.

**Solution** If a TV is connected to your Matrox graphics card and the TV has a **TV/VIDEO** switch, set it to **VIDEO**. For more information, see your TV manual.

**Solution** If a video recorder is connected to your Matrox graphics card and the video recorder has a **TUNER/LINE** switch, set it to **LINE**. For more information, see your video recorder manual.

**Cause** Matrox software may not be set up for TV output. Particularly, the TV standard selected may not be correct.

**Solution** **Windows 95/98/2000 or NT 4.0** – See “Software setup”, page 20.

**Cause** TV output isn’t supported with full-screen DOS display modes (for example, the information you see before Windows starts) or with standard VGA mode (for example, when you restart Windows in “safe mode”). Older programs may use these display modes. While one of these display modes is in use, your TV displays nothing (black).

**Solution** View the program you’re using with your computer monitor instead of your TV.

## **Problem** **Computer text is hard to read with a TV**

---

**Cause** The resolution of a TV is lower than a typical computer display. As a result, some text may be harder to read with a TV than with a computer monitor.

**Solution** Lower your computer display resolution:



**Windows 95/98/2000** –

- 1 Right-click your Windows desktop background, then click **Properties** → **Settings**.
- 2 Move the **Desktop area** (Windows 95) or **Screen area** (Windows 98/2000) slider to a lower setting.
- 3 Click **OK** to close the dialog box and apply changes.



**Windows NT 4.0** –

- 1 Click  **Start** → **Programs** → **Matrox PowerDesk NT** → **Matrox Display Properties** → **Settings**.
- 2 Move the **Display area** slider to a lower setting.
- 3 Click **OK** to close the dialog box and apply changes.

**Solution** If you’re using a display area larger than 640 × 480, you can use larger system fonts to make some text more readable:



**Windows 95/98/2000 or NT 4.0** –

- 1 **Windows 95** – Right-click your Windows desktop background, then click **Properties** → **Settings**.

**Windows 98/2000** – Right-click your Windows desktop background, then click **Properties** → **Settings** → **Advanced** → **General**.

**Windows NT 4.0** – Click  **Start** → **Programs** → **Matrox PowerDesk NT** → **Matrox Display Properties** → **Settings**.

- 2 Under **Font size**, select **Large Fonts**.
- 3 Click **OK** to close the dialog box and apply changes.

### **Problem** Poor TV or video recorder image quality

---

**Cause** Your software TV settings may need adjusting.

**Solution** See “Software setup”, page 20.

**Cause** There may be too many video devices between your video source and destination, or one or more of the video devices may be degrading the quality of the video signal. Demodulators, long cables, cable extensions and improper connections can all affect video signal quality.

**Solution** If your video equipment supports it, use S-video connections. For more information, see “Connection setup”, page 17.

**Solution** Try changing one or more video devices.

**Solution** If possible, use fewer connections. For example, don’t use cable extensions.

**Cause** The image settings on your TV may need adjusting.

**Solution** Some TVs have an aperture control sometimes called **PICTURE**. Lowering this setting may reduce this problem. Reducing your TV’s brightness setting may also improve image quality. For more information, see your TV manual.

### **Problem** Can’t record video with a video recorder

---

**Cause** The video source may be copy protected. Your Matrox product may not let you make copies of copy-protected video. (Some video sources let you make a copy of a video, but you may not be able to make a copy of that copy.)

**Solution** To get copies of a copy-protected video, contact the vendor of the video.

### **Problem** Video appears stretched or squished on a TV

---

**Cause** **Windows 95/98/2000** – If you’re using the *DualHead DVDMax* feature to view video full-screen on your TV, the aspect ratio of a video may not match the aspect ratio of your TV.

**Solution** Adjust software settings:

- 1 Access the Matrox PowerDesk **DualHead** property sheet (see “Accessing PowerDesk property sheets”, page 6).

- 2 Click **DVDMax Options**.
- 3 Select **Preserve aspect ratio**.
- 4 Select the aspect ratio of your TV (4:3 or 16:9 – most TVs are 4:3).
- 5 Select **Detect based on video window size**.
- 6 Click **OK** or **Apply** for your changes to take effect.

For more information, see context-sensitive help.

## Sound

---

The following troubleshooting items address problems related to sound cards.

### **Problem** Sound doesn't record, video files play back with no sound, or sound output is distorted or too loud

---

**Cause** If the sound problem is with a particular device (for example, TV or speaker), the volume control on the device itself may need adjusting.

**Solution** Adjust the volume control on the device itself.

**Cause** Audio cables may be loose or incorrectly wired.

**Solution** Make sure your sound card cables are properly connected (see “Connect audio output”, page 19).

**Cause** Your sound card's Windows software settings may be incorrect. Specifically, input or output may be disabled, or volume levels may be too low or too high.

**Solution** **Windows 95/98/2000 or NT 4.0** – Make sure your sound card's Windows software settings are correct.



- 1 Double-click the speaker icon () on the Windows taskbar.

If you *don't* see the speaker icon:

- a Click  → **Settings** → **Control Panel**.
- b Double-click the **Multimedia** or **Sounds and Multimedia** icon.
- c Enable the “**Show volume control on the taskbar**” check box.
- d Click **OK**.
- e Double-click the speaker icon on the taskbar.

- 2 Click **Options** → **Properties**.



- 3 Click the **Recording** button, enable all check boxes in the list box, then click **OK**.
- 4 For the **Line In** and/or **Microphone** controls, make sure the **Volume** slider levels are okay (if you're not sure, try half level), and the appropriate **Select** check box is enabled.
- 5 Click **Options** → **Properties**.
- 6 Click the **Playback** button, enable all check boxes in the list box, then click **OK**.
- 7 For the **Master**, **Line** and/or **Wave** controls, make sure the **Volume** sliders are at one-quarter to one-half levels (if you're not sure, try half level), and the **Mute** check boxes are cleared.
- 8 Close the dialog box.

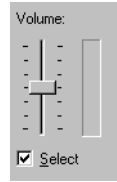

---

**Note:** Depending on your sound driver, certain labels may be different. For example, **Line In** may be labeled **Line**.

---

**Cause** The problem may be specific to the sound card you have.

**Solution** For more information, see your sound card manual.

---

# Display information

---

## Notes

- Your Matrox graphics card is 100% VGA compatible and supports all VESA standards: VBE 2.0 (Super VGA modes), DPMS (energy saving), and DDC-2B (Plug-and-Play monitor).
- Matrox graphics cards that can support a secondary display have the Matrox *DualHead* feature.

## 

- **Windows 95/98** – In *DualHead Multi-Display* mode (see page 7), the graphics memory is divided equally between the main and secondary display. For example, if you have a 16 MB graphics card, the main and secondary displays each have 8 MB available to them. As a result, maximum display capabilities may be affected.
  - The secondary display of your graphics card only supports a 16- or 32-bit color palette.
  - 3D acceleration is only available with a 16- or 32-bit color palette.
  - The display resolutions available depend on your Matrox graphics card, display driver and software monitor settings. Different software monitor settings have different resolutions available to them. With your software monitor settings, some of the resolutions listed in this section may not be available, *or* resolutions not listed in this section may be available. For more information on software monitor settings with Windows 95/98/2000 or NT 4.0, see “[Monitor setup](#)”, page 6.
  - Many Plug-and-Play monitors don’t automatically report if they’re capable of 1152 × 864, or 1600 × 1200 and higher display resolutions. To use these resolutions, or higher refresh rates than those reported by the monitor, you can use the Matrox monitor selection method. To use Matrox monitor settings with Windows 95/98/2000 or NT 4.0, see “[Monitor setup](#)”, page 6.
  - The maximum refresh rates listed in this section have been rounded and are based on a monitor with a maximum horizontal refresh rate of 130 kHz. Depending on your monitor, refresh rate capabilities may vary. For information on the capabilities of your monitor, see your monitor documentation.
  - If you’re using BNC connectors with a Plug-and-Play monitor, the Plug-and-Play feature of your monitor can’t be used. To use the Plug-and-Play feature of your monitor, instead of the BNC connectors, use the 15-pin connector at the back of your monitor.
-  ■ In Windows 95/98/2000, Matrox monitor settings are based on Windows monitor settings. If you change your Windows monitor settings, you may have to reselect or readjust your Matrox monitor settings.

- In multi-display mode (see “DualHead Multi-Display setup”), each monitor has its own monitor settings (refresh rates).

## Maximum display resolution

Aspect ratio	Main display*	Secondary display*
4:3/5:4 (traditional)	2048 × 1536	1600 × 1200
16:9/16:10 (wide screen)	1920 × 1200	1600 × 1024

\* Millennium G450 LE – With a 24- or 32-bit color palette, the maximum display resolution may be 1280 × 1024.

## Maximum vertical refresh rate (Hz)\*

Aspect ratio	Display resolution	Main display (360 MHz RAMDAC)	Secondary display† (230 MHz RAMDAC)
4:3/5:4 (traditional)	640 × 480	200	200
	800 × 600	200	200
	1024 × 768	160	160
	1152 × 864	140	150
	1280 × 1024	120	120
	1600 × 1200	100	85
	1800 × 1440	85	—
	1920 × 1440	85	—
	2048 × 1536	85	—
16:9/16:10 (wide screen)	856 × 480	200	200
	1280 × 720	160	140
	1600 × 1024	120	90
	1920 × 1080	110	—
	1920 × 1200	100	—

\* Based on a monitor with a maximum horizontal refresh rate of 130 kHz

† Maximum refresh rates are attainable when using 8- or 16-bit color palettes.

Maximums may not be attainable at the highest display resolutions *with* a 24- or 32-bit color palette.

## Maximum horizontal refresh rate (kHz) \*

Aspect Ratio	Display resolution	Main display (360 MHz RAMDAC)	Secondary display <sup>†</sup> (230 MHz RAMDAC)
4:3/5:4 (traditional)	640 × 480	130	130
	800 × 600	130	130
	1024 × 768	130	130
	1152 × 864	130	130
	1280 × 1024	130	120
	1600 × 1200	130	107
	1800 × 1440	130	—
	1920 × 1440	130	—
	2048 × 1536	130	—
16:9/16:10 (wide screen)	856 × 480	130	130
	1280 × 720	130	110
	1600 × 1024	130	90
	1920 × 1080	130	—
	1920 × 1200	130	—

\* Based on a monitor with a maximum horizontal refresh rate of 130 kHz

† Maximum refresh rates are attainable when using 8- or 16-bit color palettes.  
Maximums may not be attainable at the highest display resolutions *with* a 24- or 32-bit color palette.

## Supported VESA modes (main display)

In the table below, VESA modes supported by your Matrox graphics card are indicated by a VESA mode number. Many Super VGA DOS programs use VESA modes.

Display resolution	16 colors	256 colors	32 K colors	64 K colors	16 M colors
640 × 400	—	100	—	—	—
640 × 480	(VGA)	101	110	111	112
800 × 600	102	103	113	114	115
1024 × 768	—	105	116	117	118
1280 × 1024	—	107	119	11A	11B

# Hardware information

## Features

	Millennium G450	Millennium G450 LE
<b>Graphics chip</b>	Matrox G450 (256-bit DualBus)	
<b>3D features</b>	VCQ <sup>2</sup> (Vibrant Color Quality <sup>2</sup> ), environment-mapped bump mapping, stencil buffering, anisotropic filtering, bilinear filtering, trilinear filtering, alpha blending, anti-aliased vectors, vertex fogging, table fogging, specular highlighting, 16-bit Z-buffering, 32-bit Z-buffering, single buffering, double buffering, triple buffering, texture mapping, MIP mapping, Gouraud shading	
<b>Main RAMDAC</b>	360 MHz	
<b>Secondary RAMDAC</b>	230 MHz	
<b>Memory</b>	16 MB or 32 MB	
<b>Memory type</b>	DDR (Double Data Rate) SDRAM	SDR (Single Data Rate) SDRAM
<b>DualHead</b>	✓	✓
<b>TV output*</b> (Composite video and S-video, NTSC and PAL)	✓	✓
<b>Card type</b>	AGP 2× and 4× compatible	
<b>AGP form factor</b>	ATX	

\* See "TV output", page 17.

## Environmental specifications

- Minimum/maximum ambient operating temperatures: 0 to 55° C
- Minimum/maximum storage temperature: -40 to 75° C
- Maximum altitude for operation: 3,000 meters
- Maximum altitude for transport: 12,000 meters
- Operating humidity: 20 to 80% relative humidity (non-condensing)
- Storage humidity: 5 to 95% relative humidity (non-condensing)
- Estimated MTBF (Mean Time Before Failure): 87 years – for the model with the lowest estimated MTBF under normal working conditions

## Pinouts for analog (HD-15) connector

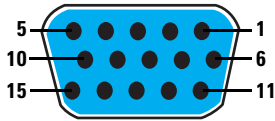

Pin	Signal	Pin	Signal	Pin	Signal
1	Analog red output	6	Ground	11	Not connected
2	Analog green output	7	Ground	12	SDA (DDC)
3	Analog blue output	8	Ground	13	TTL horizontal sync
4	Not connected	9	+5 V (DDC)	14	TTL vertical sync
5	Ground	10	Ground	15	SCL (DDC)

## Pin usage with Matrox TV output adapter (see "TV output", page 17)

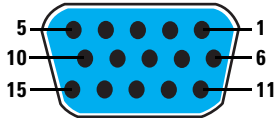

Pin	Signal	Pin	Signal	Pin	Signal
1	Composite video	6	Ground	11	Not connected
2	Y (S-video)	7	Ground	12	Shorted with 15 by adapter
3	C (S-video)	8	Ground	13	Not used by adapter
4	Not connected	9	Not used by adapter	14	Not used by adapter
5	Ground	10	Ground	15	Shorted with 12 by adapter

## Maximum card dimensions

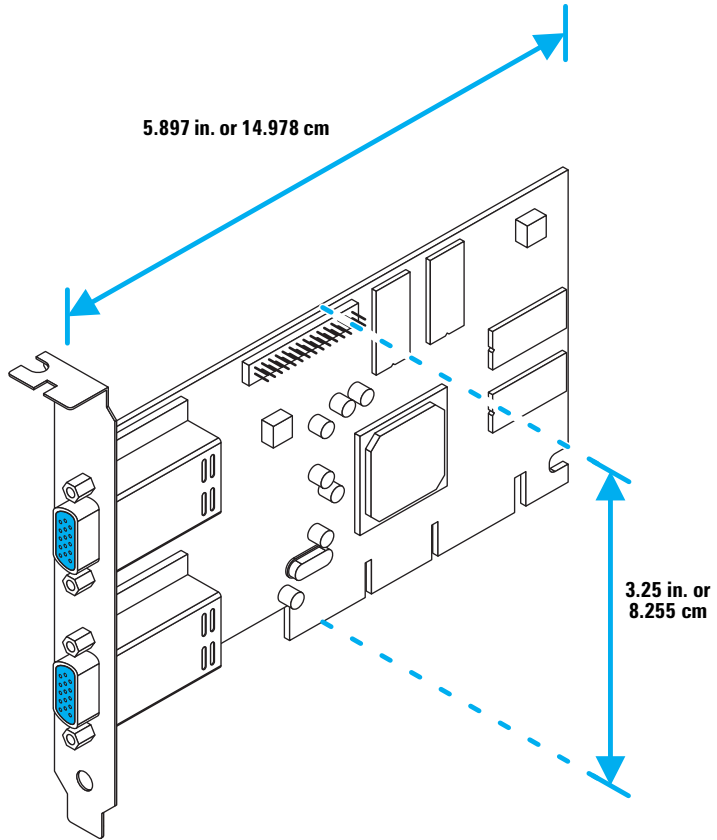

---

# Customer support

---

## Matrox Web and FTP sites

---

Matrox is on the Internet with a World Wide Web (WWW) and File Transfer Protocol (FTP) site. Our Web site has product literature, press releases, technical material, a sales office list, trade show information, and other relevant material. Our FTP site contains current drivers for Matrox products. You can download drivers using the Internet FTP site, in addition to our BBS. You can access our FTP server independently, or from the Matrox Web site.

Our address for Matrox Graphics Inc. is:

WWW;      [www.matrox.com/mga](http://www.matrox.com/mga)

FTP;        [ftp.matrox.com/pub/mga/](ftp://ftp.matrox.com/pub/mga/)

Send questions or comments regarding the site to:

e-mail;     [webmaster@matrox.com](mailto:webmaster@matrox.com)

## If you have a problem

---

If you have a problem, we recommend that you follow the procedure below for the quickest results.

- 1 Contact your dealer** – This is usually the quickest and most effective method of technical assistance. Your dealer is local and may be familiar with your complete system. In the case of hardware warranty assistance, the product must be returned to the dealer, who will return it to Matrox.
- 2** If your Matrox product was provided by your computer manufacturer, contact this manufacturer. For contact information, see your computer documentation or contact the vendor.
- 3 Matrox BBS** – You can download driver updates (which may eliminate a particular bug), utilities, and other information from our 24-hour Bulletin Board Service (BBS). The phone number is **514-685-6008**. The communication parameters are 8 data bits, 1 stop bit, and no parity. You'll be prompted to enter your first and last name and a password. If you don't have an account, it's created when you enter your name for the first time. See also "Matrox Web and FTP sites".
- 4 MATFAX instant fax** – Call our dial-up Matrox fax service at **514-685-0174**. Using a touch-tone phone, you can have faxes sent to you automatically 24 hours a day. Available documents include common installation problems, available drivers and updates, and product data sheets.



**5 Direct Matrox Technical Assistance** – If you still can't resolve a problem (and your Matrox product wasn't provided by your computer manufacturer), you can get direct technical assistance four ways:

- Call Technical Support (Canada) at **514-685-0270**. For residents of Quebec only, call **514-822-6330**.
- Send a FAX to **514-822-6363**, Attention: Graphics Technical Assistance.
- Visit our technical support Web site at [www.matrox.com/mga/tech\\_supp/home.htm](http://www.matrox.com/mga/tech_supp/home.htm).
- Write a letter to Graphics Customer Support at our Corporate Headquarters. The address is: **Matrox Graphics Inc., 1055 St. Regis Blvd., Dorval, QC, Canada, H9P 2T4**.

### Information we need

Please give a complete description of the problem, and include:

- Matrox card serial number, model number, revision number, BIOS number, driver type and version, and memory address at which the Matrox card is installed.
- Computer brand name, system BIOS manufacturer and version number or date, bus type, model, processor speed, and amount of memory.
- Monitor brand and model name.
- Operating system and version – if you're using a memory manager, its brand and version. Also, list any memory-resident programs in use.
- If you're using a network card, its brand and version.
- Brand and model of any other cards and devices installed on your system.

### Program specific problems

If a problem appears with a specific program, please give us the following information:

- Display settings (color palette, display resolution, and so on) applied when the problem occurs.
- Program name and version. Name any add-on packages you're using.
- If possible, take note of the file and segment address that caused the problem.
- Detailed steps known to cause the bug, so we can reproduce it.

---

## Where to get information

For display information:

**W**  
9x  
2k

- **Windows 95/98/2000** – access the **Information** property sheet (see “[Accessing PowerDesk property sheets](#)”, page 6).

**W**  
NT

- **Windows NT 4.0** – click  **Start** → **Programs** → **Matrox PowerDesk NT** → **Matrox Display Properties** → **Information**.

For system information:

**W**  
9x  
2k

- **Windows 95/98/2000** – right-click the **My Computer** icon on your Windows desktop background, then click **Properties**.

**W**  
98  
2k

- **Windows 98/2000** – click  **Start** → **Programs** → **Accessories** → **System Tools** → **System Information**.

**W**  
NT

- **Windows NT 4.0** – click  **Start** → **Administrative Tools (Common)** → **Windows NT Diagnostics**.
-

---

# Warranty

---

## A. Limited Warranty Statement

---

1. Matrox Graphics Inc. ("Matrox") warrants to the end-user customer, who provides adequate proof of purchase that Matrox hardware products purchased from Matrox authorized dealers will be free from defects in materials and workmanship for a period of three (3) years from the date of purchase. This warranty applies only to the original end-user purchaser and is non-transferable. Conditions and limitations of Matrox's warranty are stated below.
2. Matrox's limited warranty covers only those defects which arise as a result of normal use of the hardware and does not apply to any:
  - a. improper or inadequate maintenance;
  - b. incompatibilities due to the user's hardware or software applications with or in which the Matrox product interfaces;
  - c. product of a special or custom-made nature;
  - d. unauthorized modification or misuse;
  - e. improper installation, misapplication or negligence;
  - f. operation outside the product's environmental specifications;
  - g. improper site preparation or maintenance;
  - h. software;
  - i. other causes that do not relate to a product defect;
  - j. defects or damage suffered as a result of force majeure (including theft);
  - k. defects or damage suffered as a result of normal wear and tear; and/or
  - l. stolen goods.
3. If Matrox receives, during the applicable warranty period, notice of a defect in a warranted hardware product and the defective Matrox product in question, Matrox shall at its sole option, either repair or replace the product, and shall return the repaired product or a replacement product within a reasonable delay. The replacement product may not be new, provided that it has functionality at least equal to that of the product being replaced.
4. This warranty is valid in any country where Matrox hardware products are distributed by Matrox or its authorized dealers.
5. This Limited Warranty Statement gives the customer specific legal rights. The customer may also have other rights which vary from state to state in the United States, from province to province in Canada, and from country to country elsewhere in the world.

## B. Limitations of Warranty

---

1. NEITHER MATROX NOR ANY OF ITS THIRD PARTY SUPPLIERS MAKES ANY OTHER WARRANTY OF ANY KIND, WHETHER EXPRESSED OR IMPLIED, WITH RESPECT TO MATROX PRODUCTS. MATROX SPECIFICALLY DISCLAIMS (and the customer, by accepting the Matrox product, specifically accepts such disclaimer and waives) ALL OTHER WARRANTIES, EITHER EXPRESSED OR IMPLIED, INCLUDING BUT NOT LIMITED TO THE IMPLIED WARRANTIES OF MERCHANTABILITY AND FITNESS FOR A PARTICULAR OR INTENDED PURPOSE OR USE AND THE WARRANTY AGAINST LATENT DEFECTS, WITH RESPECT TO THE HARDWARE AND/OR SOFTWARE.
2. To the extent that this Limited Warranty Statement is inconsistent with the law of the locality where the customer purchases the Matrox product, this Limited Warranty Statement shall be deemed modified to be consistent with such local law. Under such local law, certain limitations of this Limited Warranty Statement may not apply to the consumer.
3. To the extent allowed by local law, the remedies provided in this Limited Warranty Statement are the customer's sole and exclusive remedies.

## **C. Limitations of Liability**

---

1. EXCEPT FOR THE OBLIGATIONS SPECIFICALLY SET FORTH IN THE LIMITED WARRANTY STATEMENT, IN NO EVENT SHALL MATROX BE LIABLE FOR:
  - a. any direct, indirect, special, incidental, consequential, foreseeable or unforeseeable, or punitive damages, whether based on contract, tort, delict or any other legal theory and whether advised of the possibility of such damages; and/or
  - b. damages arising from the loss of use, data, production revenue and/or profit of in connection with the Matrox product or any business interruption.
2. Without prejudice to the foregoing, any liability of Matrox for any breach of warranty shall be limited to the amount paid by the customer for the defective hardware in question.
3. To the extent allowed by local law, Matrox's entire liability and the customer's exclusive remedy shall be the repair or replacement of any defective product during the warranty period. Matrox does not offer any other warranty with respect to Matrox hardware or software or any other hardware or software.
4. Customer shall be responsible for all applicable taxes, duties and customs fees on any replacement unit, as well as all transport, insurance, storage and other charges incurred on all returned products.

## **D. Obtaining Service**

---

1. Verify that your Matrox product was installed and configured according to the information in its accompanying documentation.
2. Read the "Troubleshooting" information included with the Matrox product to see if you can solve the problem yourself.
3. If you are still experiencing difficulties, please contact your dealer where you purchased your Matrox product.
4. If you must return a Matrox product, leave the configuration as it was when you were using it, and leave all identification stickers on the product. Pack the product in its original box and return to your Matrox dealer where the product was purchased, together with your proof of purchase. Your Matrox dealer will return the product for you. Alternatively, if this first option is unavailable to you, you may contact the Matrox Technical Support group who will issue a Return Merchandise Authorization (RMA) number, upon receipt of adequate proof of purchase, and inform you of shipping instructions. DO NOT RETURN THE PRODUCT TO MATROX WITHOUT MATROX'S RMA NUMBER AND EXPRESS AUTHORIZATION.

## **E. General**

---

This limited warranty shall be governed by the laws of the Province of Quebec, Canada and the federal laws of Canada applicable therein and the courts of the Province of Quebec shall have exclusive jurisdiction to hear and decide any dispute instituted by the customer in connection with this limited warranty; the customer waives, by accepting the product, its rights to institute proceedings in connection with this warranty against Matrox in any jurisdiction other than Quebec.

---

# Software license agreement

---

**Single User Products** This Matrox software (the "Software") is copyrighted by Matrox Graphics Inc. All rights are reserved. The purchaser is granted a license to use the software only, subject to the following restrictions and limitations.

1. The license is for the original purchaser only, and is not transferable without written permission of Matrox.
2. The original purchaser may use the Software on a single computer owned or leased by the original purchaser. You may not use the Software on more than a single machine, even if you own or lease more than one machine, without written consent of Matrox.
3. The original purchaser may make back-up copies of the Software for his or her own use only, subject to the use limitations of this license.
4. The original purchaser may not engage in, nor permit third parties to engage in, any of the following:
  - Providing or disclosing the Software to third parties.
  - Providing use of the Software in a computer service business, network, time-sharing, multiple CPU or multi-user arrangement to users who are not individually licensed by Matrox.
  - Making alterations or copies of any kind in the Software (except as specifically permitted above).
  - Attempting to unassemble, de-compile or reverse engineer the Software in any way.
  - Granting sublicenses, leases, or other rights in the Software to others.
  - Making copies, or verbal or media translations, of the user's guide.
  - Making telecommunication data transmissions of the Software.

Matrox reserves the right to terminate this license if there is a violation of its term or default by the Original Purchaser. Upon termination, for any reason, all copies of the Software must be immediately returned to Matrox, and the Original Purchaser shall be liable to Matrox for any and all damages suffered as a result of the violation or default.

**Limited warranty** Matrox warrants to you, for a period of ninety (90) days normal use from your date of purchase, that:

1. The CD/disks on which the software is furnished and the documentation are not defective.
2. The Software is properly recorded upon the CD/disks included.
3. The documentation is substantially complete and contains all the information Matrox deems necessary to use the software.
4. The Software functions substantially as described in the documentation.

Matrox's entire liability and your exclusive remedy shall be the replacement of any CD/Disks or documentation not meeting these warranties, which is returned to Matrox or an authorized dealer, together with a copy of your paid receipt. The above is the only warranty of any kind, either express or implied, including, but not limited to the implied warranties of merchantability and fitness for a particular use that is made by Matrox on this Licensed Software. In no event shall Matrox be liable to you or to any third party for consequential, special, indirect or incidental damages which you may incur as a result of using the licensed software, including, but not limited to, loss of data, or information of any kind which you may experience.

---

# Index

---

## A

address, Matrox 49  
Adobe Acrobat 16  
AGP 3

## B

BBS, Matrox 48  
BIOS 12, 26, 28  
BNC monitor connection 13, 24  
bus mastering 25

## C

CD-ROM, Matrox 4, 12, 16, 27  
composite video 19  
customer support 48–50, 51–52

## D

DDC 7  
DirectX 27  
display  
  modes 17  
  primary 12, 28, 33  
  secondary 17  
display information 42–44  
DualHead 7, 42

## E

expansion slots 3, 11

## F

FAX, Matrox 48  
FTP, Matrox 48

## H

hardware  
  acceleration 31  
  information 45–47  
  installation 2–4

## I

installation  
  hardware 2–4  
  software 5  
IRQ 25, 26

## M

monitor  
  connection setup 4  
  connectors 46  
  settings 6–7, 12–15, 24  
multi-display  
  mode 6, 8, 9, 11, 14, 31  
  setup 7–9

## O

online documentation 7, 14

## P

PCI 3  
PDF 16  
Plug-and-Play 7  
PowerDesk 6, 9, 22  
  property sheets 6

## S

SCART 19  
software  
  installation 5  
  setup 6–9  
sound output 19

S-video 19

## T

technical assistance 49  
troubleshooting 10–16  
  DVD 37  
  graphics 21–32  
  sound 40–41  
  TV output 37–40  
  video 35–36  
TV output  
  adapter 4, 17  
  connection setup 17–19  
  display modes 38  
  software setup 20  
  troubleshooting 37–40

## U

unified display driver 30

## V

VESA 7, 42, 44  
VGA 2, 42, 44

## W

warning 2, 3, 6, 13, 17, 23, 35  
warranty 51–52  
Web, Matrox 48  
Windows Me 5

# Thank you for choosing Matrox

---

Please register online ([www.matrox.com/register](http://www.matrox.com/register)) to be eligible for customer support, new product announcements, and information on special offers and upcoming events.

**matrox**

---

---

USA

### FCC Compliance Statement



**Remark for the Matrox hardware products supported by this guide** These devices have been tested and found to comply with the limits for a Class B digital device, pursuant to Part 15 of the FCC Rules. These limits are designed to provide reasonable protection against harmful interference in a residential installation. This equipment generates, uses and can radiate radio frequency energy and, if not installed and used in accordance with the instructions, may cause harmful interference to radio communications. However, there is no guarantee that interference will not occur in a particular installation. If this equipment causes harmful interference to radio or television reception, which can be determined by turning the equipment off and on, the user is encouraged to try to correct the interference by one or more of the following measures: • Reorient or relocate the receiving antenna • Increase the separation between the equipment and receiver • Connect the equipment into an outlet on a circuit different from that to which the receiver is connected • Consult the dealer or an experienced radio/TV technician for help.

**WARNING** Changes or modifications to this unit not expressly approved by the party responsible for the compliance could void the user's authority to operate this equipment. The use of shielded cables for connection of the monitor to the card is required to meet FCC requirements.

### Declaration of conformity of a Class B digital device according to the FCC rules

**We, the Responsible Party** Matrox, 1075 Broken Sound Parkway, Boca Raton, FL 33487 • Telephone: (561) 989-9626 • Attention: Conformity Group Matrox

**Declaration** The Matrox hardware products supported by this guide comply with Part 15 of the FCC Rules. Operation is subject to the following two conditions: (1) these devices may not cause harmful interference, and (2) these devices must accept any interference received, including interference that may cause undesired operation. Any question regarding this declaration should be forwarded to the above coordinates.

---

---

CANADA

### (English) Industry Canada Compliance Statement

**Remark for the Matrox hardware products supported by this guide** These digital devices do not exceed the Class B limits for radio noise emission from digital devices set out in the Radio Interference Regulation of Industry Canada.

### (Français) Conformité avec les exigences du ministère de l'Industrie Canada

**Remarque sur les produits matériels Matrox couverts par ce guide** Ces appareils numériques n'émettent aucun bruit radioélectrique dépassant les limites applicables aux appareils numériques de Classe B prescrites dans le Règlement sur le brouillage radioélectrique édicté par Industrie Canada.

---

---

JAPAN

### VCCI Compliance Statement



**Remark for the Matrox hardware products supported by this guide** These are Class B products based on the standard of the Voluntary Control Council for Interference from Information Technology Equipment (VCCI). If these are used near a radio or television receiver in a domestic environment, they may cause radio interference. Install and use the equipment according to instructions in the manual.

この装置は、情報処理装置等電波障害自主規制協議会（VCCI）の基準に基づくクラスB情報技術装置です。この装置は、家庭環境で使用することを目的としていますが、この装置がラジオやテレビジョン受信機に近接して使用されると、受信障害を引き起こすことがあります。

取扱説明書に従って正しい取り扱いをして下さい。



**(English) European user's information – Declaration of Conformity**

**Remark for the Matrox hardware products supported by this guide** These devices comply with EC Directive 89/336/EEC for a Class B digital device. They have been tested and found to comply with EN55024/CISPR22 and EN55024/CISPR24. In a domestic environment these products may cause radio interference in which case the user may be required to take adequate measures. To meet EC requirements, shielded cables must be used to connect the monitor and other peripherals to the card. These products have been tested in a typical class B compliant host system. It is assumed that these products will also achieve compliance in any class B compliant system.

**(Français) Informations aux utilisateurs Européens – Déclaration de conformité**

**Remarque sur les produits matériels Matrox couverts par ce guide** Ces unités sont conformes à la directive communautaire 89/336/EEC pour les unités numériques de classe B. Les tests effectués ont prouvé qu'elles sont conformes aux normes EN55024/CISPR22 et EN55024/CISPR24. Le fonctionnement de ces produits dans un environnement résidentiel peut causer des interférences radio, dans ce cas l'utilisateur peut être amené à prendre les mesures appropriées. Pour respecter les impératifs communautaires, les câbles de connexion entre le moniteur ou autres périphériques et la carte doivent être blindés. Ces produits ont été testés dans un système hôte typique compatible classe B. On suppose qu'ils présenteront la même compatibilité dans tout système compatible classe B.

**(Deutsch) Information für europäische Anwender – Konformitätserklärung**

**Anmerkung für die Matrox Hardware-Produktunterstützung durch dieses Handbuch** Diese Geräte entsprechen EC Direktive 89/336/EEC für ein digitales Gerät Klasse B. Sie wurden getestet und entsprechen demnach EN55024/CISPR22 und EN55024/CISPR24. In einer Wohnumgebung können diese Produkte Funkinterferenzen erzeugen, und der Benutzer kann genötigt sein, entsprechende Maßnahmen zu ergreifen. Um EG-Anforderungen zu entsprechen, müssen zum Anschließen des Monitors und anderer Peripheriegeräte an die Karte abgeschirmte Kabel verwendet werden. Diese Produkt wurden in einem typischen, der Klasse B entsprechenden, Host-System getestet. Es wird davon ausgegangen, daß diese Produkte auch in jedem Klasse B entsprechenden System entsprechend funktionieren.

**(Italiano) Informazioni per gli utenti europei – Dichiarazione di conformità**

**Nota per i prodotti hardware Matrox supportati da questa guida** Questi dispositivi sono conformi alla direttiva CEE 89/336/EEC relativamente ai dispositivi digitali di Classe B. Sono stati provati e sono risultati conformi alle norme EN55024/CISPR22 e EN55024/CISPR24. In un ambiente domestico, questi prodotti possono causare radiointerferenze, nel qual caso all'utente potrebbe venire richiesto di prendere le misure adeguate. Per soddisfare i requisiti CEE, il monitor e le altre periferiche vanno collegati alla scheda grafica con cavi schermati. Questi prodotti sono stati provati in un tipico sistema host conforme alla classe B. Inoltre, si dà per scontato che questi prodotti acquisiranno la conformità in qualsiasi sistema conforme alla classe B.

**(Español) Información para usuarios europeos – Declaración de conformidad**

**Observación referente a los productos de hardware de Matrox apoyados por este manual** Estos dispositivos cumplen con la directiva de la CE 89/336/EEC para dispositivos digitales de Clase B. Dichos dispositivos han sido sometidos a prueba y se ha comprobado que cumplen con las normas EN55024/CISPR22 y EN55024/CISPR24. En entornos residenciales, estos productos pueden causar interferencias en las comunicaciones por radio; en tal caso el usuario deberá adoptar las medidas adecuadas. Para satisfacer las disposiciones de la CE, deberán utilizarse cables apantallados para conectar el monitor y demás periféricos a la tarjeta. Estos productos han sido sometidos a prueba en un típico sistema anfitrión que responde a los requisitos de la clase B. Se supone que estos productos cumplirán también con las normas en cualquier sistema que responda a los requisitos de la clase B.

## **Avertissement sur l'épilepsie**

**À lire avant toute utilisation d'un jeu vidéo par vous-même ou votre enfant** Certaines personnes sont susceptibles de faire des crises d'épilepsie ou d'avoir des pertes de conscience à la vue de certains types de lumières clignotantes ou d'éléments fréquents dans notre environnement quotidien. Ces personnes s'exposent à des crises lorsqu'elles regardent certaines images télévisées ou qu'elles jouent à certains jeux vidéo. Ces phénomènes peuvent apparaître alors même que le sujet n'a pas d'antécédent médical ou n'a jamais été confronté à une crise d'épilepsie.

Si vous-même ou un membre de votre famille avez déjà présenté des symptômes liés à l'épilepsie (crise ou perte de conscience) en présence de stimulations lumineuses, veuillez consulter votre médecin avant toute utilisation.

Nous conseillons aux parents d'être attentifs à leurs enfants lorsqu'ils jouent avec des jeux vidéo. Si vous-même ou votre enfant présentez un des symptômes suivants: vertige, trouble de la vision, contraction des yeux ou des muscles, perte de conscience, trouble de l'orientation, mouvement involontaire ou convulsion, veuillez immédiatement cesser de jouer et consultez un médecin.

**Précautions à prendre dans tous les cas pour l'utilisation d'un jeu vidéo**

- Ne vous tenez pas trop près de l'écran.
- Jouez à bonne distance de l'écran de télévision et aussi loin que le permet le cordon de raccordement.
- Utilisez de préférence les jeux de vidéo sur un écran de petite taille.
- Évitez de jouer si vous êtes fatigué ou si vous manquez de sommeil.
- Assurez-vous que vous jouez dans une pièce bien éclairée.
- En cours d'utilisation, faites des pauses de dix à quinze minutes toutes les heures.

---

## **MACROVISION**

---

**(English)** A. Apparatus Claims of U.S. Patent Nos. 4,631,603, 4,577,216, 4,819,098, and 4,907,093 licensed for limited viewing uses only. B. This product incorporates copyright protection technology that is protected by method claims of certain U.S. patents and other intellectual property rights owned by Macrovision Corporation and other rights owners. Use of this copyright protection technology must be authorized by Macrovision Corporation, and is intended for home and other limited viewing uses only unless otherwise authorized by Macrovision Corporation. Reverse engineering or disassembly is prohibited.

**(Français)** A. Demande de numéros de brevet aux États-Unis 4,631,603, 4,577,216, 4,819,098 et 4,907,093 avec licence pour des utilisations limitées d'affichage uniquement. B. Ce produit bénéficie d'une technologie de protection de droits d'auteur mis en œuvre par des demandes de brevets américains et d'autres droits de propriété intellectuelle de Macrovision Corporation et d'autres propriétaires de droits. L'utilisation de cette technologie de protection de droits d'auteur doit être autorisée par Macrovision Corporation, et est destinée à des utilisations domestiques ou de consultation limitée autorisées par Macrovision Corporation. L'ingénierie à rebours ou le désassemblage est interdit.

**(Deutsch)** A. Patentansprüche für Geräte mit US-Patentnummern 4.631.603, 4.577.216, 4.819.098 und 4.907.093, die nur für eingeschränkte Anzeigen lizenziert sind. B. Dieses Produkt enthält urheberrechtlich geschützte Technologie, die durch Patentansprüche bestimmter US-Patente und andere geistige Eigentumsrechte der Macrovision Corporation und anderen Eigentümern von Rechten geschützt sind. Die Verwendung dieser urheberrechtlich geschützten Technologie muß von der Macrovision Corporation genehmigt werden und darf nur zum Abspielen für private Zwecke und anderen Einschränkungen unterliegende Zwecke eingesetzt werden, sofern keine Genehmigung für andere Zwecke von Macrovision vorliegt. Reverse Engineering und Disassemblieren ist untersagt.

**(Italiano)** A. Diritti di brevetto USA n. 4,631,603, 4,577,216, 4,819,098 e 4,907,093 in licenza solamente per la visualizzazione limitata. B. Questo prodotto incorpora una tecnologia per la protezione dei diritti d'autore che è coperta da brevetti USA e da altri diritti di proprietà intellettuale detenuti da Macrovision Corporation e da altri titolari. L'utilizzo di questa tecnologia di protezione dei diritti d'autore deve essere autorizzato da Macrovision Corporation, ed è intesa solamente per la visione casalinga ed altri utilizzi limitati salvo diversa autorizzazione di Macrovision Corporation. È proibito il disassemblaggio o procedimenti di reverse engineering.

**(Español)** A. Aparato patentado en los EE.UU. con los números siguientes. 4,631,603, 4,577,216, 4,819,098 y 4,907,093 con licencia para visualización limitada únicamente. B. Este producto incorpora una tecnología de protección por Copyright mediante la demanda de ciertas patentes en los EE.UU. y otros derechos de propiedad intelectual de Macrovision Corporation y otros propietarios de los derechos. La utilización de esta tecnología de protección por Copyright debe ser autorizada por Macrovision Corporation y está destinada a su utilización doméstica y otras formas de visualización limitada, a menos que Macrovision Corporation exprese lo contrario. Está prohibida la utilización de técnicas de ingeniería inversa y el desmontaje.

**Trademarks • Marques déposées • Warenzeichen  
• Marchi registrati • Marcas registradas**

---

Matrox Electronic Systems Ltd. ....	Matrox <sup>®</sup> , Matrox Mystique <sup>®</sup> , Rainbow Runner <sup>®</sup>
Matrox Graphics Inc. ....	CenterWINDOW <sup>™</sup> , DeskNav <sup>™</sup> , Desktop Navigator <sup>™</sup> , DualHead <sup>™</sup> , DVDMax <sup>™</sup> , DynaView <sup>™</sup> , Matrox G400 <sup>™</sup> , Matrox G450 <sup>™</sup> , Matrox HD Benchmark <sup>™</sup> , Matrox Impression <sup>™</sup> , Matrox m3D <sup>™</sup> , Matrox Marvel <sup>™</sup> , Matrox Media XL <sup>™</sup> , Matrox Millennium <sup>™</sup> , Matrox MMS <sup>™</sup> , Matrox Multi-Monitor Series <sup>™</sup> , Matrox PowerDesk <sup>™</sup> , Matrox Quick Connect <sup>™</sup> , MaxVIEW <sup>™</sup> , MGA <sup>™</sup> , MGA-G100 <sup>™</sup> , MGA-G200 <sup>™</sup> , Productiva <sup>™</sup> , QuickDesk <sup>™</sup> , MGA PowerDesk <sup>™</sup> , ModeSWITCH <sup>™</sup> , PanEND <sup>™</sup> , PanHOME <sup>™</sup> , PanLOCK <sup>™</sup> , PC-VCR Remote <sup>™</sup> , PixelTOUCH <sup>™</sup> , PowerDoc <sup>™</sup> , QCDP <sup>™</sup> , QuickAccess <sup>™</sup> , ResSwitch <sup>™</sup>
Adobe Systems Inc. ....	Acrobat <sup>®</sup> , Adobe <sup>®</sup>
Apple Computer, Inc. ....	Apple <sup>®</sup> , QuickTime <sup>®</sup>
Avid Technology, Inc. ....	Avid <sup>®</sup> , Avid Cinema <sup>™</sup> , Cecil B. DeMovie <sup>™</sup>
CompuServe Inc. ....	CompuServe <sup>®</sup>
Dolby Laboratories, Inc. ....	Dolby <sup>®</sup> , Dolby Digital <sup>®</sup>
Eastman Kodak Company ....	Kodak Precision <sup>™</sup>
Intel Corporation.....	Intel <sup>®</sup> , Indeo <sup>®</sup> , MMX <sup>™</sup> , Pentium <sup>®</sup>
International Business Machines Corporation .....	IBM <sup>®</sup> , OS/2 <sup>®</sup> , PowerPC <sup>®</sup> , VGA <sup>®</sup>
Macrovision Corporation.....	Macrovision <sup>™</sup>
Microsoft Corporation .....	ActiveMovie <sup>™</sup> , ActiveX <sup>™</sup> , Direct3D <sup>®</sup> , DirectDraw <sup>®</sup> , DirectShow <sup>™</sup> , DirectVideo <sup>™</sup> , DirectX <sup>™</sup> , Microsoft <sup>®</sup> , MS-DOS <sup>®</sup> , Windows <sup>®</sup> , Windows 95 <sup>™</sup> , Windows 98 <sup>™</sup> , Windows for Workgroups <sup>™</sup> , Windows NT <sup>™</sup> , Windows 2000 <sup>™</sup>
Radius Inc.....	Cinepak <sup>®</sup>
Silicon Graphics, Inc. ....	OpenGL <sup>®</sup>
Silicon Image, Inc. ....	PanelLink <sup>™</sup>
Sonetech Ltd. ....	Colorific <sup>®</sup>
Ulead Systems, Inc. ....	Ulead <sup>®</sup> , MediaStudio <sup>™</sup> , Photo Express <sup>™</sup>
U.S. Environmental Protection Agency.....	Energy Star <sup>™</sup>
VDOnet Corporation Limited.....	VDOnet <sup>®</sup> , VDOPhone <sup>™</sup>

• (English) All other nationally and internationally recognized trademarks and tradenames are hereby acknowledged.  
 • (Français) Toutes les autres marques et tous les autres noms déposés reconnus nationalement ou internationalement sont également reconnus par les présentes. • (Deutsch) Alle sonstigen national und international bekannten Warenzeichen und Produktnamen werden hiermit anerkannt. • (Italiano) Eventuali altri nomi di prodotti menzionati in questo manuale sono dei proprietà di rispettivi produttori. • (Español) Por medio del presente se reconocen todas las demás marcas y nombres comerciales reconocidos a nivel nacional e internacional.

## **(English) Disclaimer**

---

THE INFORMATION IN THIS GUIDE IS SUBJECT TO CHANGE AT ANY TIME AND WITHOUT NOTICE.

Matrox Graphics Inc. reserves the right to make changes in specifications at any time and without notice. The information provided by this document is believed to be accurate and reliable. However, no responsibility is assumed by Matrox Graphics Inc. for its use; nor for any infringements of patents or other rights of third parties resulting from its use. No license is granted under any patents or patent rights of Matrox Graphics Inc.

## **(Français) Responsabilité**

---

LES INFORMATIONS CONTENUES DANS CE MANUEL PEUVENT ÊTRE MODIFIÉES À TOUT MOMENT SANS PRÉAVIS.

Matrox Graphics Inc. se réserve le droit de modifier les spécifications à tout moment sans préavis. Les informations contenues dans ce manuel sont reconnues comme étant précises et fiables. Cependant, Matrox Graphics Inc. n'assume aucune responsabilité concernant leur utilisation, ni leur contrefaçon ou les autres droits des tiers résultant de leur utilisation. Aucune licence n'est accordée sur aucun brevet ou droit d'exploiter un brevet de Matrox Graphics Inc.

## **(Deutsch) Haftungsablehnungserklärung**

---

DIE IN DIESEM HANDBUCH ENTHALTENEN ANGABEN UND DATEN KÖNNEN OHNE VORHERIGE ANKÜNDIGUNG GEÄNDERT WERDEN.

Die Matrox Graphics Inc. behält sich das Recht vor, jederzeit und ohne Ankündigung technische Daten zu ändern. Es wird keine Garantie für die Richtigkeit des Inhalts dieses Handbuchs übernommen. Weiterhin übernimmt die Matrox Graphics Inc. keinerlei Verantwortung für die Benutzung dieses Handbuchs, weder für Verstöße gegen Patentrechte noch für andere Rechte Dritter, die aus seinem Gebrauch resultieren mögen. Es werden keinerlei Lizenzrechte gewährt für sämtliche Patente oder Patentrechte der Matrox Graphics Inc.

## **(Italiano) Discrezionalità**

---

LE INFORMAZIONI CONTENUTE NEL PRESENTE DOCUMENTO SONO SOGGETTE A MODIFICHE SENZA PREAVVISO.

Matrox Graphics Inc. si riserva il diritto di apportare variazioni di qualunque tipo alle specifiche tecniche in qualunque momento e senza alcun preavviso. Le informazioni contenute in questa documentazione sono ritenute corrette e attendibili. In ogni caso, non è imputabile a Matrox Graphics Inc. nessuna responsabilità per il loro utilizzo, come nessuna violazione a brevetti o diritti di altri produttori derivante dal loro utilizzo.

## **(Español) Renuncia**

---

LA INFORMACION QUE CONTIENE EL PRESENTE MANUAL ESTA SUJETA A CAMBIOS SIN PREVIO AVISO EN CUALQUIER MOMENTO.

Matrox Graphics Inc. se reserva el derecho de realizar modificaciones en cualquier momento y sin previo aviso. La información facilitada en este documento se considera que es exacta y fiable. Sin embargo, Matrox Graphics Inc. no asume ninguna responsabilidad por su uso; ni por cualquier infracción de patentes u otros derechos de terceras partes derivados de su uso. No se concede ninguna licencia bajo cualesquiera patentes o derechos de patentes de Matrox Graphics Inc.

## **Matrox Graphics Inc.**

1055 St-Regis Blvd.

Dorval, Quebec

Canada H9P 2T4

Tel: (514) 822-6320

Fax: (514) 822-6363

Fax-back service: (514) 685-0174

BBS: (514) 685-6008

Technical support: (514) 685-0270

In Quebec, call: (514) 822-6330

[www.matrox.com/mga/tech\\_supp/home.htm](http://www.matrox.com/mga/tech_supp/home.htm)

Web site: [www.matrox.com/mga](http://www.matrox.com/mga)

## **France**

Matrox France SARL

2, rue de la Couture, Silic 225

94528 Rungis Cedex, France

Tél: 01 45.60.62.00

Fax: 01 45.60.62.05

Support technique: 01.45.60.62.75

[www.matrox.com/mga/francais/tech\\_support/tech\\_request\\_form.htm](http://www.matrox.com/mga/francais/tech_support/tech_request_form.htm)

Site Web: [www.matrox.com/mga/francais](http://www.matrox.com/mga/francais)

## **Italia**

Agenzia Italiana di Matrox Graphics Inc.

3G electronics

via Boncompagni 3B

20139 Milano, Italia

Fax: 02-5253045

BBS: 02-5253044

Informazioni commerciali: 02-5253095

Posta elettronica: [commerciale.3g@treg.it](mailto:commerciale.3g@treg.it)

Assistenza tecnica: 02-5253099

Posta elettronica: [supporto.3g@treg.it](mailto:supporto.3g@treg.it)

Sito Web: [www.matrox.com/mga/italia](http://www.matrox.com/mga/italia)

## **Deutschland**

Matrox Electronic Systems GmbH

Inselkammerstraße 8

D-82008 Unterhaching bei

München, Deutschland

Tel: 089 614 474-0

Fax: 089 614 9743

BBS: 089 614 00 91

BBS (ISDN): 089 614 474-91

Vertriebs Infoline: 089 614 474-44

E-mail: [Produktinfo\\_Matrox@compuserve.com](mailto:Produktinfo_Matrox@compuserve.com)

Technische Unterstützung: 089 614 474-33

E-mail: [TechSupport\\_Matrox@compuserve.com](mailto:TechSupport_Matrox@compuserve.com)

Web-Site: [www.matrox.com/mga/deutsch](http://www.matrox.com/mga/deutsch)

## **United Kingdom**

Matrox UK

Sefton Park

Stoke Poges

Buckinghamshire

England SL2 4JS

Sales: + 44 (0) 1753 66 55 44

E-mail: [graphic.info.uk@matrox.com](mailto:graphic.info.uk@matrox.com)

Fax: + 44 (0) 1753 66 55 99

Technical support: + 44 (0) 1753 66 55 22

E-mail: [graphic.tech.uk@matrox.com](mailto:graphic.tech.uk@matrox.com)

## **Hong Kong**

Matrox Asia Ltd.

12/F, Guangdong Investment Tower

148 Connaught Road Central

Sheung Wan

Hong Kong

Tel: (852) 2281-5700

Fax: (852) 2537-9530

E-mail: [tech-support@matroxintl.com](mailto:tech-support@matroxintl.com)

# **matrox**