

Notice

The information in this guide is subject to change without notice.

COMPAQ COMPUTER CORPORATION SHALL NOT BE LIABLE FOR TECHNICAL OR EDITORIAL ERRORS OR OMISSIONS CONTAINED HEREIN; NOR FOR INCIDENTAL OR CONSEQUENTIAL DAMAGES RESULTING FROM THE FURNISHING, PERFORMANCE, OR USE OF THIS MATERIAL.

This guide contains information protected by copyright. No part of this guide may be photocopied or reproduced in any form without prior written consent from Compaq Computer Corporation.

© 1998 Compaq Computer Corporation.

All rights reserved. Printed in Singapore.

COMPAQ, ARMADA, LTE, and Prosignia are registered in the U.S. Patent and Trademark Office.

Microsoft, MS-DOS, and Windows, are trademarks or registered trademarks of Microsoft Corporation.

Software described herein is furnished under a license agreement or nondisclosure agreement. The software may be used or copied only in accordance with the terms of the agreement.

Product names mentioned herein may be trademarks and/or registered trademarks of their respective companies.

REFERENCE GUIDE

First Edition December 1998

Part Number 382710-001

Compaq Computer Corporation

CONTENTS

preface

USING THIS GUIDE

chapter 1

GETTING STARTED

Unpacking the Computer	1-1
Setting Up the Computer.....	1-2
Charging the Battery Pack for the First Time	1-2
Connecting the Power Cord.....	1-3
Opening the Computer.....	1-4
Adjusting the Keyboard.....	1-5
Turning On the Computer.....	1-6
Setting Up the Software	1-6
Operating the Computer During Setup.....	1-7
Choosing a Language.....	1-7
Removing the Operating System.....	1-8
Restoring Your Operating System and Software Preinstalled by Compaq	1-8
Completing Setup.....	1-9
Registering the Computer	1-9
Locating Online Resources.....	1-9

chapter 2

TAKING A LOOK AT THE COMPUTER

Front Components.....	2-1
Left Side Components.....	2-3
Right Side Components.....	2-4
Rear Components	2-5
Bottom Components.....	2-6
Status Indicator Lights	2-7

chapter 3

USING THE KEYBOARD AND TOUCHPAD

Keyboard Components	3-1
Special Keys.....	3-3
Using Hotkeys.....	3-5
Embedded Numeric Keypad.....	3-7
User Programmable Keys	3-8
Assigning the User-Programmable Keys	3-9
Unassigning the User-Programmable Keys	3-10
Adding Schemes.....	3-10
Removing Schemes	3-11
Showing the Key Assignments in the System Tray.....	3-11
Using the Touchpad.....	3-12
Customizing the Touchpad Controls.....	3-13
Cleaning the Touchpad.....	3-13

chapter 4

USING BATTERY PACKS

Learning About Batteries.....	4-1
Using a New Battery Pack	4-2
Charging Battery Packs	4-3
Using the Battery Gauge.....	4-4
Ensuring Battery Gauge Accuracy	4-5
Identifying a Low Battery Condition	4-5
Resolving a Low Battery Condition by Connecting the Power Cord	4-6
Resolving a Low-Battery Condition with a Charged Battery Pack.....	4-6
Resolving a Low Battery Condition When No Power Source Is Available	4-6
Inserting and Removing Battery Packs	4-7
Removing the Battery Pack from the Battery Bay.....	4-7
Inserting the Battery Pack into the Battery Bay.....	4-8
Storing Battery Packs.....	4-9
Maximizing Battery Pack Life.....	4-9
Recycling Used Battery Packs.....	4-10
System Beeps	4-11
Beeps with a Blinking Battery Charge Light.....	4-11
Beeps with a Blinking Power/Suspend Light	4-11
Turning Beeps On or Off.....	4-12

COMPUTER POWER AND POWER MANAGEMENT

Leaving On the Computer	5-1
Turning Off the Computer	5-1
Restarting the Computer	5-2
Disconnecting the Computer from External Power	5-3
Managing Power	5-3
Using Power Properties	5-5
Setting the Battery Conservation Level	5-5
Using Advanced Power Management	5-6
Using ACPI Power Control	5-6
Using Hibernation	5-7
Enabling Hibernation	5-7
Initiating Hibernation	5-7
Exiting Hibernation	5-8
Disabling Hibernation	5-8
Using Suspend	5-8
Identifying a Suspend Condition	5-10
Initiating Suspend	5-10
Exiting Suspend	5-10
Using Timeouts	5-11
Setting Component Timeouts	5-11
Setting the Screen Saver	5-12

WORKING WITH REMOVABLE DRIVES AND DEVICE BAYS

Bay Configuration	6-1
Caring for Removable Drives	6-2
Using the Diskette Drive	6-3
Selecting Diskettes	6-3
Inserting a Diskette	6-3
Removing a Diskette	6-3
Using the CD-ROM Drive	6-4
Inserting a Compact Disc into the CD-ROM Drive	6-4
Removing a Compact Disc from the CD-ROM Drive	6-4
Manually Ejecting a Compact Disc	6-5
Using the DVD-ROM Drive	6-5
MultiBay Devices	6-6
Inserting Devices into the MultiBay	6-6
Removing Devices from the MultiBay	6-7

USING THE INTERNAL MODEM

- Modem Overview 7-1
- Connecting the Modem..... 7-2
- Understanding How the Modem Works..... 7-2
 - Changing the Country Selection 7-3
- If you are running Windows NT..... 7-4
- Software Overview 7-4
- Modem Defaults..... 7-5
- Understanding Result Codes..... 7-5
- Modem Compatibility..... 7-9
 - Command Set 7-9
 - Data Communications 7-9
 - Facsimile Communications 7-9
 - Data Compression 7-9
 - Error Control 7-9
- Using AT Commands to Control the Modem 7-10
- Guidelines for Using AT Commands 7-11
 - Using the Attention Code 7-11
 - Entering a Command..... 7-11
 - Editing a Command..... 7-11
 - Executing a Command 7-11
 - Interpreting a Missing Parameter 7-12
 - Entering an Escape Code Sequence 7-12
 - Repeating a Command 7-12
- Dial Modifiers 7-15
- S Register Default Values..... 7-15
 - Modifying an S Register..... 7-16
 - Reading an S Register 7-16
- Audio Response Codes 7-17
- Uninstalling the Modem 7-18

chapter 8

CONNECTING EXTERNAL DEVICES

Connecting an External Enhanced Keyboard	8-1
Connecting an External Monitor	8-1
Connecting a Television Monitor	8-2
Connecting a Mouse or Other External Pointing Device	8-3
Connecting a Serial Printer	8-3
Connecting a Parallel Printer	8-3
Docking the Computer to the Convenience Base	8-4
Undocking the Computer from the Convenience Base	8-5
Connecting Infrared Equipment	8-5
Connecting USB Peripherals	8-6

chapter 9

USING PC CARDS

PC Card Types	9-1
Inserting a PC Card	9-1
Removing a PC Card	9-3
PC Card Device Drivers	9-4
Changing PC Card Settings	9-4
Managing PC Card Power	9-5
Zoomed Video	9-5
Stopping a PC Card	9-5

chapter 10

USING AUDIO FEATURES

Audio Components Overview	10-1
Identifying the Audio Components	10-2
Using Internal and External Microphones	10-3
Using Internal and External Speakers/Headphones	10-3
Controlling Audio Volume	10-4

chapter 11

UPGRADING THE COMPUTER

Upgrading System Memory.....	11-1
Checking the Amount of Memory	11-1
Obtaining an Optional Memory Expansion Board	11-2
Inserting a Memory Expansion Board	11-2
Removing a Memory Expansion Board.....	11-4
Upgrading the Hard Drive	11-6
Adding a CD-ROM or DVD Drive	11-6
Adding an Internal Modem.....	11-6

chapter 12

MAINTENANCE & TRAVEL GUIDE

Caring for the Computer	12-1
Caring for the Display	12-2
Traveling with the Computer.....	12-2
Shipping the Computer	12-4
Operating Temperatures	12-4

chapter 13

SECURITY FEATURES

Types of Security	13-1
Using the Cable Lock	13-2
Using Passwords Properties.....	13-3
Using the Power-On Password	13-3
Establishing the Power-On Password	13-3
Entering the Power-On Password	13-5
Changing the Power-On Password.....	13-6
Deleting the Power-On Password	13-7
If You Forget Your Power-On Password.....	13-8
Using the Quick Controls	13-8
Enabling the Quick Controls	13-9
Initiating the Quick Controls.....	13-9
Using the Setup Password	13-10
Establishing the Setup Password.....	13-10
Entering the Setup Password.....	13-11
Changing the Setup Password.....	13-11
Deleting the Setup Password.....	13-12

Enabling and Disabling Devices	13-13
DriveLock Overview	13-13
User and Master Passwords Overview	13-14
Establishing DriveLock Protection.....	13-14
Changing the User Password.....	13-16
Removing DriveLock Protection.....	13-17
Changing the Master Password	13-18

chapter 14

INTELLIGENT MANAGEABILITY

Intelligent Manageability Overview	14-1
Asset Management	14-2
Changing the Asset Tag Number.....	14-2
Fault Management.....	14-3
Fault Management Alerts.....	14-3
Security Management.....	14-4
Configuration Management	14-4

chapter 15

COMPUTER SETUP AND DIAGNOSTICS UTILITIES

Computer Setup Overview	15-1
Running Computer Setup	15-2
Exiting Computer Setup	15-3
Using Compaq Utilities.....	15-3
Running Compaq Diagnostics	15-4
Using the Diagnostics Utilities.....	15-4
Running Computer Checkup (TEST).....	15-5
Running View System Information (INSPECT).....	15-6
Using the Video Utility	15-6
Ordering Preinstalled Software	15-7
Boot Sequencing	15-7

chapter 16

TROUBLESHOOTING

Troubleshooting Checklist	16-1
Solving Software Application Problems	16-22

appendix A

COMPAQ CUSTOMER SUPPORT

Preparing for a Technical Support Call A-1
Worldwide Telephone Numbers A-2

appendix B

REGULATORY NOTICESB-1

appendix C

ELECTROSTATIC DISCHARGE

Preventing Electrostatic DischargeC-1
 When Handling Removable Drives.....C-1
 When Installing Internal ComponentsC-1
Grounding MethodsC-2

appendix D

SPECIFICATIONS D-1

INDEX I-1

USING THIS GUIDE

Some or all of the following format conventions are used in this guide to distinguish elements of text:

- Names of keys are shown in bold type as they appear on the keyboard, for example, **Ctrl**, **Backspace**, **Tab**.
- Keys that you should press at the same time are represented by the key names and the plus (+) symbol, for example, **Ctrl+Alt+Delete**.
- Commands are presented in lowercase, bold type as shown here: **install** or **a:\install**.
- An arrow symbol is used to separate icons or menu options that you should select in succession; for example, click the Start button → Settings → Control Panel.
- When you need to type information without pressing the **Enter** key, you are directed to “type” the information.
- When you need to type information *and* press the **Enter** key, you are directed to “enter” the information.

NOTE: Text set off in this manner presents commentary, sidelights, or interesting points of information.

IMPORTANT: Text set off in this manner presents clarifying information or specific instructions.



WARNING: Text set off in this manner indicates that failure to follow directions could result in bodily harm or loss of life.



CAUTION: Text set off in this manner indicates that failure to follow directions could result in damage to equipment or loss of information.

chapter 1

GETTING STARTED

Unpacking the Computer



Contents of the Computer Box

You should have the following items in the packing box:

- ❶ Computer (includes battery pack already installed)
- ❷ Power cord
- ❸ Modem cable (with internal modem models)

Items not illustrated vary by model and geographical region:

- Owner Registration Card
- Warranty and service information
- Printed documentation about the computer

Setting Up the Computer

Before you set up the computer for the first time, ensure that

- The computer is using AC power.
- The computer is not docked in a docking station.



WARNING: It is in your best interest to set up a comfortable and healthful workstation. Misuse of your personal computer or failure to establish a safe and comfortable workstation could result in discomfort or serious injury. Consult your *Safety & Comfort Guide* for more information.

Charging the Battery Pack for the First Time

The battery pack begins to charge when the computer is connected to external power.

Although a new battery pack can be used to power the computer after receiving a partial charge, Compaq recommends that a new battery pack be allowed to fully charge before the computer is disconnected from external power or before the battery pack is removed from the computer.

A new battery pack fully charges in approximately:

- 2 hours when the computer is connected to external power and is not being used.
- 5 hours when the computer is connected to external power and is being used.

Connecting the Power Cord

1. Place the computer on a flat surface near an electrical outlet.
2. Plug the power cord into the power connector on the rear panel of the computer ❶, then into the electrical outlet ❷.



Connecting the Power Cord



WARNING: To reduce the risk of personal injury, electric shock, fire, or damage to the equipment:

- Do not disable the power cord grounding plug. The grounding plug is an important safety feature.
 - Plug the equipment into a grounded (earthed) electrical outlet that is easily accessible at all times.
 - Disconnect power from the equipment by unplugging the power cord from the electrical outlet.
 - Do not place anything on power cords or cables. Arrange them so that no one may accidentally step on or trip over them. Do not pull on a cord or cable. When unplugging from the electrical outlet, grasp the cord by the plug.
-

Opening the Computer

Slide forward the display release latches **1** on the left and right sides of the display, then raise the display **2** to a comfortable viewing angle.

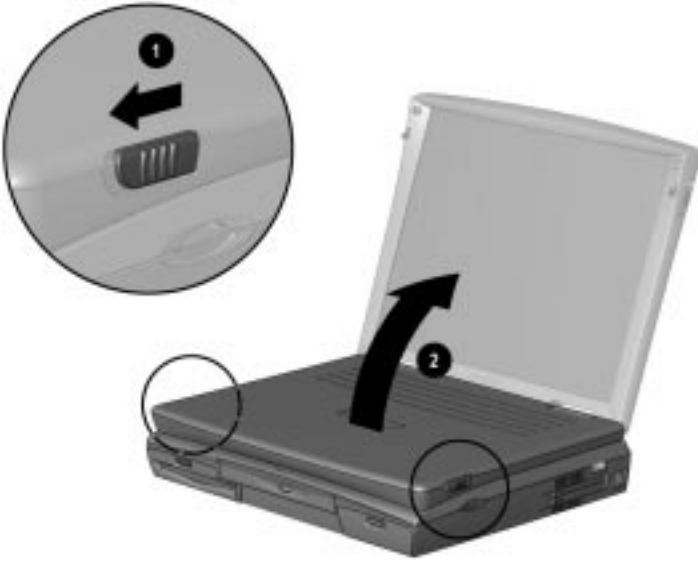

Opening the Computer

Adjusting the Keyboard

To elevate the back of the keyboard to a more comfortable typing position, open the tilt feet on the bottom of the computer until they lock into place. Close to return to the horizontal position.

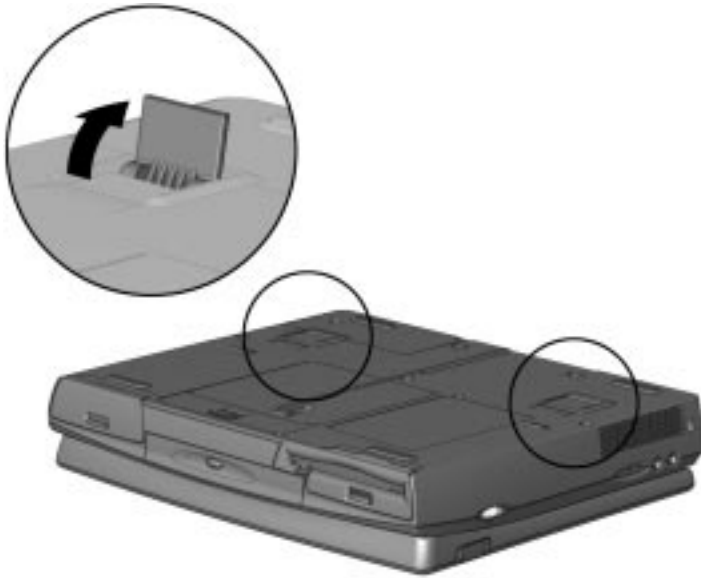

Lifting Keyboard Tilt Feet

Turning On the Computer

Slide the power switch ❶ to turn on the computer. The power/suspend light ❷ indicates the computer is on.

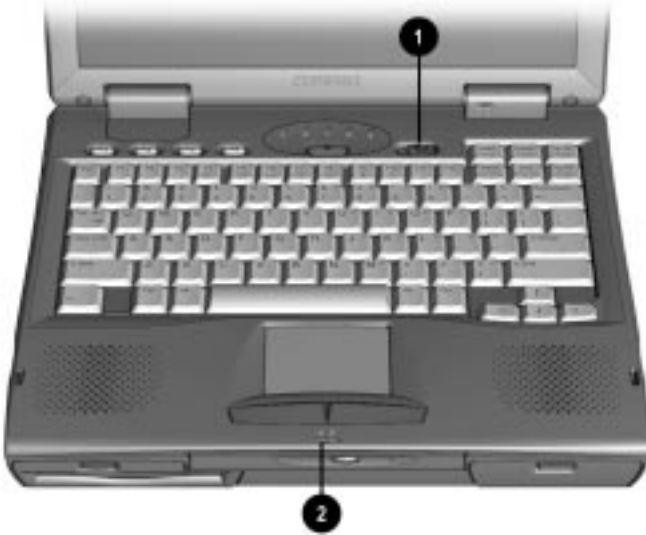

Turning On the Computer

Setting Up the Software

When you begin software setup, online instructions guide you through the setup process.

IMPORTANT: After you begin software setup, you must complete the entire process, which may require up to 20 minutes. Make sure the computer is plugged in for this process to ensure that software setup is uninterrupted.



CAUTION: To prevent file corruption and ensure the correct software drivers are installed:

- Do not dock the computer in a docking station.
 - Do not turn off or unplug the computer or remove a drive during software setup.
-

Operating the Computer During Setup

- To move around the screen while making selections and entering information:
 - press the **Tab** key, or
 - press the cursor (arrow) keys, or
 - use the touchpad built into the computer keyboard.
- To save your selections, press the **Enter** key or press one of the touchpad buttons below the touchpad on the computer keyboard.
- To restore the screen if it is cleared by the screen saver during a period of keyboard and touchpad inactivity, press the **Shift** key.

For more information about using the touchpad and touchpad buttons, refer to Chapter 3, “Using the Keyboard and Touchpad.”

Choosing a Language

If you are prompted to select your language, choose the appropriate language carefully.

IMPORTANT: The languages that you do **not** choose will be deleted from the computer and cannot be recovered.

Removing the Operating System

A Microsoft Windows operating system is preinstalled on the computer.

Compaq has enhanced the preinstalled version of this operating system to provide you with additional software features and increased computer functionality.

Before deleting the operating system preinstalled on the computer, please read the following caution:



CAUTION:

- Compaq recommends not replacing the preinstalled version of this operating system with a retail version will result in the loss of all enhancements added by Compaq such as PC Card support and enhanced power management.
 - Most preinstalled reference files, such as Help files, are available only through the Windows interface. If Windows is removed from the computer, these reference files will become unavailable.
 - Complete USB support is available only through the Windows interface. If the operating system preinstalled on the computer is replaced by an operating system other than this Windows version, USB support will be decreased.
-

Restoring Your Operating System and Software Preinstalled by Compaq

In addition to the preinstalled operating system, Compaq installs other software to provide additional functionality or enhancements. If it is necessary to reinstall the operating system and you do not want to lose these enhancements, it will also be necessary to reinstall all Compaq software for your computer. Use the restore software CD that comes with your computer to restore software on your hard drive. Additionally, Compaq software is available on Compaq's Web site at www.compaq.com.

Completing Setup

Compaq recommends that you:

- Register the computer.
- Locate the Compaq online resources, such as the online *Reference Guide* and the online *Safety & Comfort Guide*.

Registering the Computer

Be sure to register the computer according to the instructions on the *Owner Registration Card* included with the computer.

Locating Online Resources

For your convenience, all information contained in this *Reference Guide* is available online.

- To access the *Reference Guide* online:
 - Click Start → Compaq Information Center → Reference Guide
 - or
 - Click Start → Help → Contents
 - or
 - Click the Compaq Information Center icon on the desktop

To access information on the Internet, go to www.compaq.com.

chapter 2

TAKING A LOOK AT THE COMPUTER

Front Components



Front Components

Component	Function
① Display	The computer screen and the hardware in which it is enclosed.
② Lid switch	Blanks the screen if the display is closed and the computer is still on.

Continued

Front Components *Continued*

Component	Function
③ Stereo speakers	Built-in speakers for high-quality stereo sound and a multimedia sound system.
④ MultiBay	A multifunction device compartment that accepts a diskette drive, LS-120 diskette drive, Zip drive, second battery pack, or second hard drive.
⑤ Optical Disc Bay	Dedicated bay which houses either a CD-ROM drive or DVD-ROM drive. For those models without a factory-installed CD-ROM drive, you can easily upgrade to a CD-ROM drive or DVD-ROM drive.
⑥ Battery bay	Holds the main battery pack in the computer.
⑦ Internal microphone	Built-in monophonic microphone for the multimedia sound system.

Left Side Components

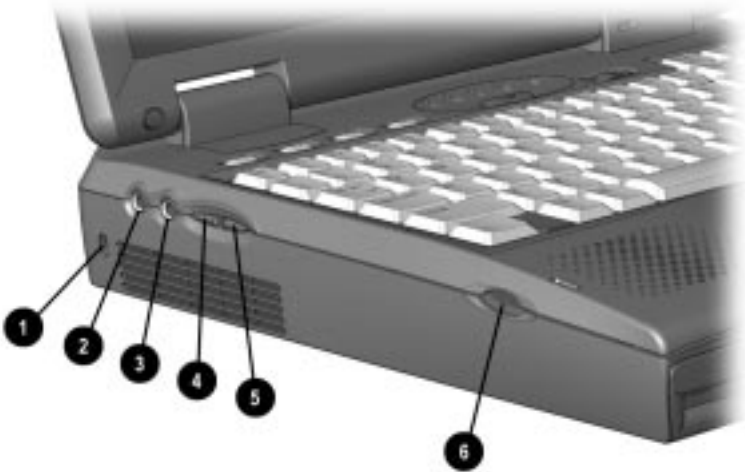

Left Side Components

Component	Function
❶ Cable lock	Accepts an anti-theft cable that secures the computer to a fixed object.
❷ Speaker/headphone line-out jack	Connects stereo speakers, headphones, or headset.
❸ Microphone line-in jack	Connects an external mono microphone.
❹ Volume control (up)	Increases volume to the built-in speakers, to external speakers, or to headphones plugged into the stereo speaker/headphone jack on the computer.
❺ Volume control (down)	Decreases volume to the built-in speakers, to external speakers, or to headphones plugged into the stereo speaker/headphone jack on the computer.
❻ Base reflex speaker port	Allows airflow to and from the internal stereo speakers.

Right Side Components

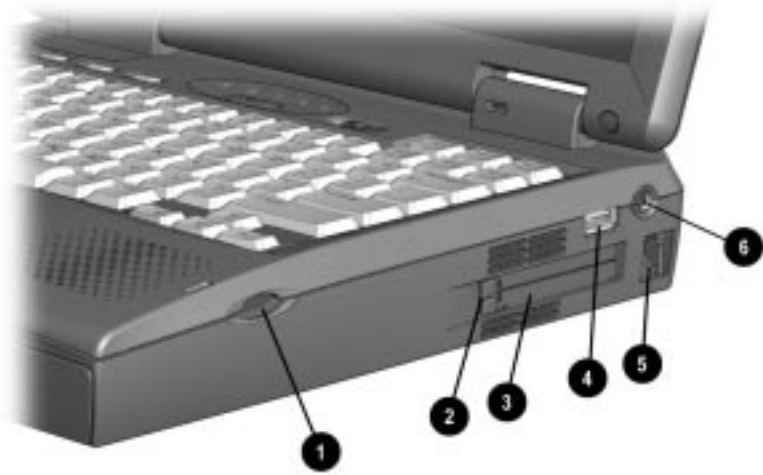

Right Side Components

Component	Function
❶ Base reflex speaker port	Allows airflow to and from the internal stereo speakers.
❷ PC Card eject button	Ejects PC Cards from the PC Card slots.
❸ PC Card slots	Slots that support Type II or Type III PC Cards, such as modem, hard drive, or network cards. These slots accept 16-bit PC Cards as well as 32-bit PC Cards.
❹ USB connector	A connector which allows you to attach Universal Serial Bus (USB) devices such as a keyboard or mouse, or a camera for video conferencing.
❺ RJ11	Used for connecting a standard telephone cable to the computer. For internal modem models only.
❻ TV Connector	A connector that allows you to attach a television monitor. See Chapter 8 for procedure on connecting a television monitor. This feature is available on selected models.

Rear Components

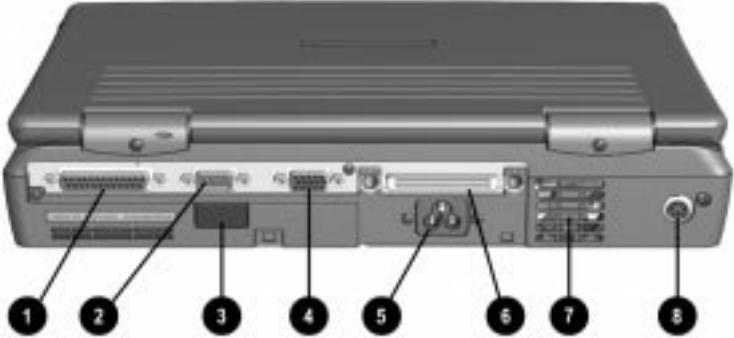

Rear Components

Component	Function
① Parallel connector	Connects an optional parallel device such as a printer.
② Serial connector	Connects an optional external serial device such as a mouse or printer.
③ Infrared port	Allows wireless communications between the computer and another infrared-equipped device using an infrared light beam. Available on specific models.
④ External monitor connector	Connects an optional external display, such as an external CRT monitor.
⑤ AC power connector	Connects to external (AC) power.
⑥ Docking connector	A 176-pin expansion bus connector that connects the computer to the optional convenience base.
⑦ Cooling fan	Regulates the temperature of the computer and its internal components.
⑧ Keyboard/mouse connector	Connects an optional full-sized keyboard and/or PS/2 compatible mouse.

Bottom Components

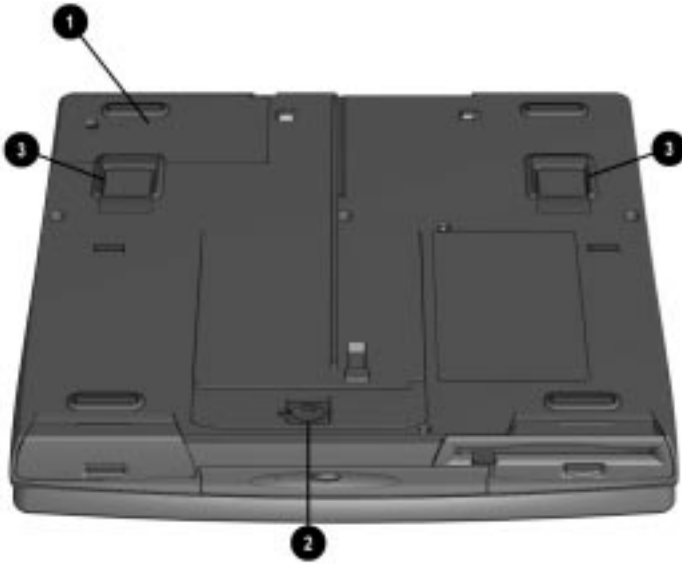

Bottom Components

Component	Function
❶ Modem compartment	Provides access to the internal modem. The modem is available on selected models and as an option for other models.
❷ Hard drive compartment	Provides access to the internal hard drive. A security screw prevents unauthorized access to the hard drive. Use a standard screwdriver to remove the screw.
❸ Tilt feet	Retractable feet on the bottom of the computer that open and lock into place in order to angle the keyboard to a more comfortable position.

Status Indicator Lights

There are five lights located above the keyboard which indicate system operations and status. These include:

Status Indicator Lights		
Light		Function
❶	Hard drive/ CD-ROM drive access indicator	Turns on when the hard drive, optional CD-ROM drive, or optional DVD-ROM drive is accessed.
❷	Diskette drive access indicator	Turns on when a device in the MultiBay is accessed.
❸	Num Lock	Turns on when the embedded numeric keypad is active.
❹	Caps Lock	Turns on when the Caps Lock function is on.
❺	Scroll Lock	Turns on when the Scroll Lock key is on.



chapter 3

USING THE KEYBOARD AND TOUCHPAD

Keyboard Components

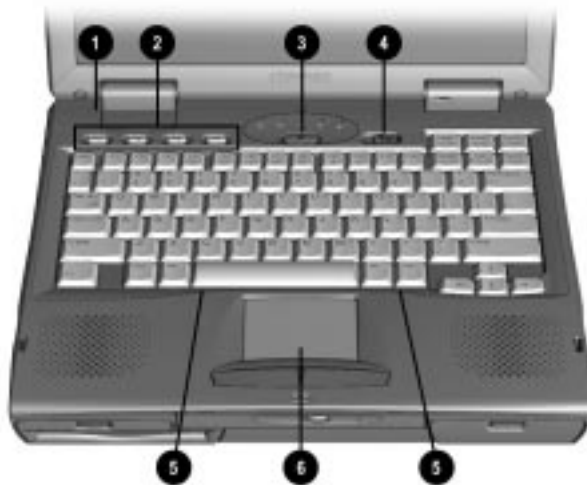

Keyboard Components

Component	Function
❶ Lid switch	Blanks the screen if the display is closed and the computer is still on.
❷ Programmable keys	Assign and launch frequently used applications and documents.

Continued

Keyboard Components *Continued*

Component	Function
③ Suspend button	Initiates and exits Suspend. Turns on the computer if it is in Suspend. When used with the Fn key on the computer, the Suspend button initiates Hibernation.
④ Power switch	Slides to turn the computer on or off. While working in Windows, click Start, Shut Down to exit the operating system and turn off the computer.
⑤ Keyboard releases	Allows access underneath the keyboard for installing memory expansion boards in the memory expansion slot, or a CD-ROM/DVD-ROM drive in the Optical Disc Bay.
⑥ Touchpad	Functions as an integrated pointing device.

Special Keys

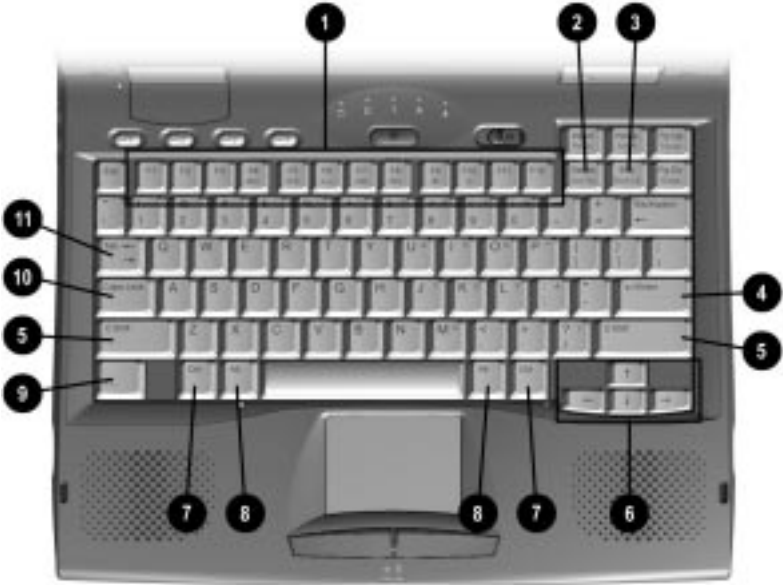

Special Keys

Key (s)	Function
① Function keys	Enter various commands in a program, depending on the program being used.
② Delete key	Deletes characters or selected text.
③ Num Lock key	Activates the embedded numeric keypad, a section of the keyboard used for numeric functions, by pressing the Fn + Num Lock keys.
④ Enter key	Signals the end of input or the end of a paragraph. To complete a command you must type or select the command then press the Enter key.

Continued

Special Keys *Continued*

Key (s)	Function
5 Shift keys	Toggle between uppercase character typing and lowercase character typing. The Shift key can also be used in combination with the Function keys for various commands.
6 Cursor keys	Move cursor left, right, up, and down.
7 Alt keys	Enter commands when used in combination with other keys enters commands. For example, to switch between open applications Microsoft Windows, press Alt+Tab. To close an application, press Alt+F4.
8 Ctrl keys	Used with other keys to enter commands.
9 Fn key	Used in conjunction with function keys to form hotkey combinations which simplify special computer operations. The special hotkey features are activated by pressing the Fn key and the function key.
10 Caps Lock key	Shifts the alphabetical characters on the keyboard into uppercase (capital) when on.
11 Tab key	Keyboard function key that moves the cursor to the next tab stop to the right.

Using Hotkeys

Hotkeys are keys that simplify the performance of special computer operations. The special hotkey functions are activated by pressing the Fn key and the associated function key. The function keys work as normally defined by application software when they are not used in conjunction with the Fn key.

Hotkey Quick Reference

Function	Hotkeys	Return to Original State
Moves the Hotkey popup window location.	Fn+F1	Fn+F1
Switches displays—Toggles through the following options: 1)computer display only, 2)computer display and external monitor at the same time, 3) external monitor display only, 4) television display only (on models with TV connectors).	Fn+F4	Fn+F4
Adjusts Speaker volume—Controls system warning beeps. To increase volume, press Fn+F5, then the right arrow key. To decrease volume, press Fn+F5, then the left arrow key. Adjusts system beeps only.	Fn+F5	Fn+F5
Sets QuickLock/QuickBlank—disables the keyboard and mouse, and clears the display. See Chapter 13 for more information on Quick Controls.	Fn+F6	Enter password
Sets Battery Conservation—adjusts the level of battery power used by the computer. See Chapter 5 for more information on power conservation.	Fn+F7	Fn+F7
Displays the battery gauge—shows the amount of power remaining in all system batteries. For more information on using the battery gauge, see Chapter 4.	Fn+F8	Fn+F8

Continued

Hotkey Quick Reference *Continued*

Function	Hotkeys	Return to Original State
Adjusts display contrast. Not applicable on active matrix displays.	Fn+F9	Fn+F9
Adjusts display brightness.	Fn+F10	Fn+F10
Enables and disables the embedded numeric keypad. See “Embedded Numeric Keypad”, in this chapter.	Fn+Num Lk	Fn+Num Lk
Initiates Hibernation (Windows 95 and Windows NT only). See Chapter 5 for more information on using Hibernation.	Fn+Suspend	Suspend
Initiates Text-stretch function, which stretches the image so that more of the screen is filled (functions optimally on display panels less than 13 inches).	Fn+T	Fn+T

IMPORTANT: Popup windows associated with the hotkeys display correctly only from within applications that support the popup video mode. If a popup does not display correctly, exit the application and press the hotkeys again to invoke the popup window.

Embedded Numeric Keypad

The embedded numeric keypad is a section of the computer keyboard that converts to a numeric keypad when the number lock function is enabled.



Embedded Numeric Keypad

Press the **Fn+Num Lk** hotkeys to:

- Enable the embedded numeric keypad (Num Lk light turns on).
- Disable the embedded numeric keypad (Num Lk light turns off).

With the number lock function on (enabled):

- Press **Fn** to type lowercase letters.
- Press **Fn+Shift** to type uppercase letters.

User Programmable Keys

You can set the four user-programmable keys to bring up a document or emulate the Microsoft Windows and Application Logo Keys.

- ❶ Launches the Microsoft Internet Explorer
- ❷ Launches Microsoft Outlook
- ❸ Launches the Calculator
- ❹ Launches the programmable key definition application.

All keys can be reprogrammed to suit your needs.

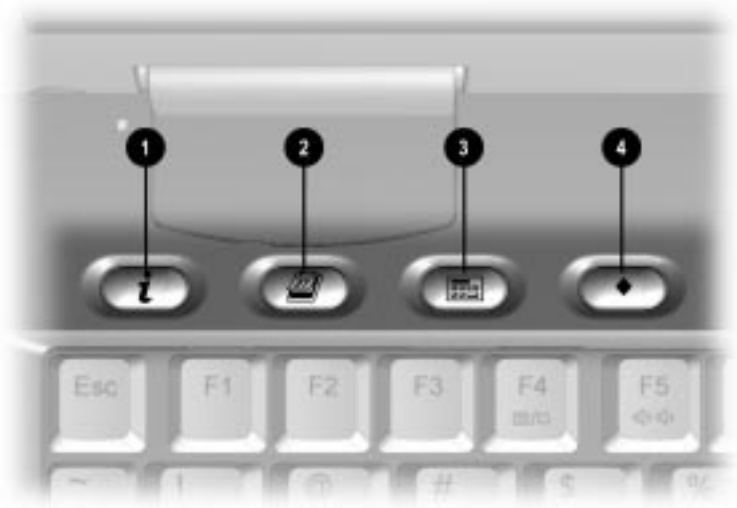

Programmable Keys

By assigning schemes to the programmable keys, you can create multiple sets of key assignments tailored to your own needs or to accommodate more than one user.

To assign the programmable keys and create schemes, see "Assigning the User-Programmable Keys" in this chapter.

Assigning the User-Programmable Keys

To assign or reassign a programmable key:

1. Access the Programmable Keys utility by clicking Start → Settings → Control Panel → Keyboard → Programmable Keys.
2. Select the current scheme programmable key you wish to assign or reassign by clicking its button in the Key Assignments group box.

NOTE: To access a larger number of programs, place a check in the Show Advanced Options check box. This changes the Assign button to the Browse button. By clicking the Browse button, you can access all applications on your computer. To emulate one of the Microsoft Windows and Application Logo Keys, select the appropriate file from the Program Files\Compaq\Programmable keys\Default directory.

3. Click the Assign button. A dialog box appears showing a list of programs or documents from the Programs menu.
4. Highlight the desired application and click OK. The icon and program name you select appear beside the programmable key's radio button.
5. Click OK to exit the utility. When you press the programmable key you have just assigned, your application and/or document appears on screen.

Unassigning the User-Programmable Keys

1. To remove a programmable key assignment:
2. Access the Programmable Keys utility by clicking Start → Settings → Control Panel → Keyboard → Programmable Keys.
3. Select the programmable key you wish to unassign by clicking the appropriate radio button in the Key Assignments group box.

NOTE: To unassign keys in other than the current scheme, place a check in the Show Advanced Options checkbox and select a different scheme. If you have never created a scheme, the Default scheme will be the only choice.

4. Click the Assign button, then select Unassigned from the list. The icon and program name previously assigned to the key will be removed.

NOTE: When the Show Advanced Options box is checked, you can unassign a programmable key by clicking the Browse button and selecting the file 'Unassigned' from the Program Files\Compaq\Programmable keys\Default directory.

5. Click OK to exit the utility.

Adding Schemes

To add a new scheme:

1. Access the Programmable Keys utility by clicking Start → Settings → Control Panel → Keyboard → Programmable Keys.
2. Ensure that the Show Advanced Options check box is checked.
3. Click the Add button.
4. Type a name for your new scheme in the popup dialog box that appears.
5. Make your programmable key assignments.
6. Click OK to exit the utility.

Removing Schemes

To remove a scheme:

1. Access the Programmable Keys utility by clicking Start → Settings → Control Panel → Keyboard → Programmable Keys.
2. Ensure that the Show Advanced Options checkbox is checked.
3. Select the scheme in the Scheme box that you want to delete. To view a different scheme, select a scheme from the drop-down list.

NOTE: The Default scheme is not removable.

4. Click the Remove button.
5. Click OK to exit the utility.

Showing the Key Assignments in the System Tray

One convenient way to see your user-programmable key assignments is to view them in a popup window that you activate from an icon in the system tray. To enable the icon:

1. Access the Programmable Keys utility by clicking Start → Settings → Control Panel → Keyboard → Programmable Keys.
2. Check mark the Show Key Assignments in the System Tray checkbox.
3. Click OK to exit the utility.
4. An icon appears in the system tray. To view the popup window, click the icon.

NOTE: The icon remains in the system tray until you disable it by unchecking the Show key assignments in the System Tray checkbox or by right-clicking the icon and choosing Exit from the menu.

Using the Touchpad

The computer includes the Synaptics Touchpad with an enhanced driver and provides the following key features:

- Vertical and horizontal scrolling to quickly find and manipulate data on the Web and business applications
- Customizing the touchpad to start up favorite applications
- Customizing buttons and taps
- Dragging icons, windows and other objects without using buttons
- Adjusting touch sensitivity
- Preventing accidental pointing while type (also know as Palm Check)
- Scrolling through documents without using bars
- Zooming in/out and panning on documents
- Moving the pointer long distances
- Fine tuning the pointer movement

To access the interface and set your preferred features, right click the mouse pad icon in the system tray on the desktop or click Start →Settings→Control Panel→double-click Mouse icon.

To operate the touchpad, move your finger across the touchpad surface ❶ to control cursor movement. Press the left ❷ and right buttons ❸ below the touchpad to select items, much like using the left and right mouse buttons.

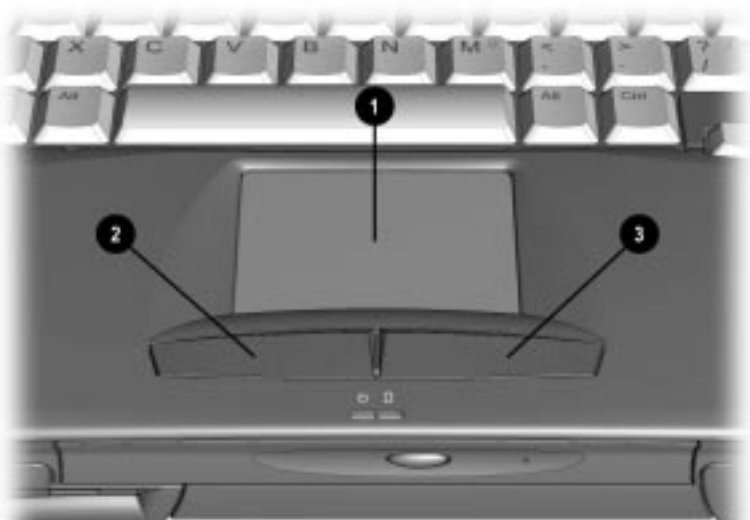

Touchpad and Touchpad Buttons

You can also single - and double-tap the touchpad to select and activate items, as well as use the touchpad to drag objects across the screen.

To customize the touchpad functions, click Start → Settings → Control Panel → double-click Mouse.

Customizing the Touchpad Controls

Access the Mouse utility by clicking Start → Settings → Control Panel → double-click Mouse →. Then you may:

- Customize the way the touchpad controls the pointer.
- Control the pointer motion.

Cleaning the Touchpad

To clean the touchpad:

1. Turn off the computer.
2. Remove the battery pack and disconnect the power cord.

Wipe the touchpad with a clean, dry cloth. To remove stubborn stains, wipe the touchpad with a damp cloth moistened with a small amount of dishwashing detergent.

USING BATTERY PACKS

Learning About Batteries

The computer accommodates up to two rechargeable battery packs at one time. Battery packs are supported in the:

- Battery bay in the computer (primary battery pack)
- MultiBay in the computer (secondary battery pack)

With the computer turned off, each battery pack will recharge in less than two hours. With the computer turned on, each battery pack will recharge in less than five hours.

If two fully charged battery packs are installed, you can remove one battery while the computer is on without affecting system operation. With only one battery pack installed, you must turn off the computer or initiate Hibernation before removing a battery, or you must connect to external AC power before you remove the battery pack. For more information on using Hibernation, see Chapter 5.

When the computer is in Suspend, you must always have a power source, either a fully charged battery pack or AC power, before removing a battery pack. For more information on using Suspend, see Chapter 5.



WARNING: Your computer contains a Lithium Ion battery pack. There is a risk of fire and burns if the battery pack is not handled properly. Do not disassemble, crush, puncture, short external contacts, or dispose of in fire or water. Do not expose to temperatures higher than 60°C. Replace only with the Compaq spare designated for this product.



WARNING: Batteries/battery packs and accumulators should not be disposed of with general household waste. In order to forward them to recycling or proper disposal, please use the public collection system or return them to Compaq, your authorized Compaq Partners, or other agents.

Using a New Battery Pack

You can charge the battery pack in the computer's battery bay or MultiBay while connected to an external power source or while docked in the convenience base. You can also charge up to two battery packs in the optional battery charger.

IMPORTANT: A new battery pack should be fully charged before it is used for the first time. The battery pack will work without being fully charged, but the battery gauge will not show an accurate charge until the battery pack receives its first full charge.

Charging Battery Packs

Battery packs charge in the following sequence:

1. The primary battery in the computer battery bay
2. A second battery pack in the computer MultiBay

Battery packs are discharged in the reverse order, with the battery pack in the MultiBay depleted first. See Chapter 2 for bay locations.

To charge battery packs, follow these steps:

1. With battery pack(s) in the battery bay and/or MultiBay, connect the power cord to the computer and plug it into an electrical outlet.
2. Turn on the computer if you want to use it while the battery packs are charging.

NOTE: The battery charge light is the right light on the front of the computer. It turns on (solid) when a battery pack (in the battery bay or MultiBay) is charging. It turns off when fully charged. It blinks in a low-battery condition.

When the battery charge light turns off, the battery packs are fully charged.

Using the Battery Gauge

Press the **Fn+F8** hotkeys to show the status of the battery pack(s). Two numbered boxes indicate the status of each installed battery pack.

- **Battery pack 1**—primary battery in the computer battery bay.
- **Battery pack 2**—battery in the computer MultiBay.

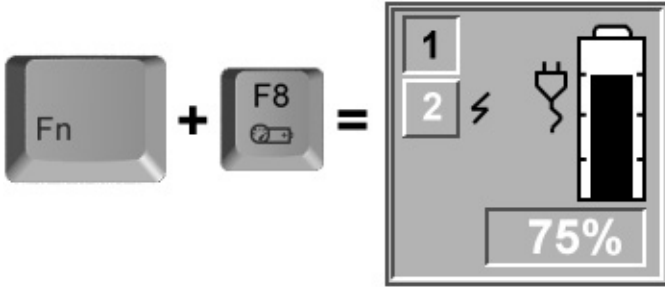

Using the Battery Gauge Hotkeys

Press the right or down arrow key to view the status of the next battery pack. If a battery pack is not in a bay, the corresponding bay cannot be selected. Press the left or up arrow key to select the previous battery pack.

The percentage of battery charge remaining for the selected battery pack is shown at the bottom of the popup. If the battery pack is charging, a lightning bolt symbol appears to the right of the box. If AC power is connected, the power connector is shown.

NOTE: If you do not press any key for five to seven seconds, the battery gauge popup will display the average remaining capacity (percent of charge remaining) for all installed batteries combined.

Ensuring Battery Gauge Accuracy

The built-in battery gauge, which displays the amount of charge remaining, is precalibrated for accuracy. To ensure continued battery gauge accuracy and to maximize battery operating time:

- Fully charge the battery pack before the first time you use it.
- Allow the battery pack to completely charge before removing external power from the computer, convenience base, or battery charger.
- If the battery has been out of the computer for two weeks or more, fully recharge the battery pack before using it.
- Approximately every 60 days, allow the battery to completely discharge to the low battery condition through normal use before recharging it.

NOTE: The various battery gauges available on your system should be regarded as an approximate indication of remaining battery life. Use the battery until the first warning is received, even if the gauge indicates "no power."

Identifying a Low Battery Condition

When a low battery condition is reached, the computer beeps twice approximately every five minutes, and the battery power light blinks once per second. When a **critical** low battery condition is reached, the computer beeps four times every five seconds, and the battery light blinks twice per second.



CAUTION: When you are alerted to a low battery condition, very little battery charge remains. Take immediate action to resolve the condition.

When a low battery condition is reached, save your files and initiate Suspend. You have approximately 5 to 10 minutes to resolve the low battery condition before the computer enters the critical low battery condition.

When a critical low battery condition occurs and Hibernation is enabled, the system initiates Hibernation.



CAUTION: If Hibernation is disabled, the computer cannot initiate Hibernation when a critical low battery condition is reached. If Hibernation is disabled, the computer initiates Suspend until the battery pack fully discharges. When this occurs, all unsaved data is lost.

Resolving a Low Battery Condition by Connecting the Power Cord

1. Connect the small end of the power cord to the AC power connector.
2. Insert the wall plug of the power cord into an electrical outlet.

Resolving a Low-Battery Condition with a Charged Battery Pack



CAUTION: If you are removing the battery pack while the computer is on, you can prevent loss of information by initiating Hibernation before removing the battery pack.

1. Stop working and save your work immediately.
2. Press the **Fn+Suspend** buttons to initiate Hibernation.
3. Remove the discharged battery pack.
4. Insert a fully charged battery pack.
5. Exit Hibernation.

Resolving a Low Battery Condition When No Power Source Is Available

To resolve a low battery condition when no power source is available, do one of the following:

- Initiate Hibernation until a power source is available. This automatically saves all current information in memory to the hard disk and turns off the computer. When power is available and the computer is turned on, all information returns to the screen at the point where Hibernation was initiated.
- Save your information, then turn off the computer until a power source is available.

Inserting and Removing Battery Packs

Removing the Battery Pack from the Battery Bay



CAUTION: If this is the only battery pack in the computer, initiate Hibernation or connect the computer to external power before removing the battery.

To remove the battery pack from the battery bay:

1. Pull down the battery release lever **1** to release the battery pack.
2. Remove the battery pack from the battery bay.



Removing the Battery Pack from the Battery Bay

Inserting the Battery Pack into the Battery Bay



CAUTION: If this is the only battery pack in the computer, initiate Hibernation or connect the computer to external power before removing the battery.

Insert a battery pack into the battery bay with the large label on the battery pack facing up and the battery contacts facing in. Push the battery pack into the battery bay until it is firmly seated.



Inserting the Battery Pack into the Battery Bay

Storing Battery Packs

When storing the computer for more than two weeks, remove the battery packs and store them separately to reduce the discharge rate and increase battery life.

Battery packs self-discharge even when they are not being used. The rate of self-discharge is affected by temperature. To prolong battery charge, store batteries in a cool, dry place. High temperatures cause battery packs to lose their charge more quickly, thus reducing battery life.

The recommended storage temperature range is from 32°F to 104°F (0°C to 40°C). However, batteries can be stored at 32°F to 140°F (0°C to 60°C) for up to 30 days.



CAUTION: To prevent damage to a battery pack, do not expose it to high temperatures for extended periods of time.

Maximizing Battery Pack Life

Battery pack operating time varies depending on the system components, options, and applications used. You can increase battery operating time by as much as 50 percent by controlling the energy used by the computer and the energy stored in the battery pack.

NOTE: The display, processor, and drive components use the majority of battery power.

To maximize battery pack life, use the following guidelines:

- Select the High level of power management (not available under Windows 98). See Chapter 5 for more information on power management.
- Initiate Suspend or Hibernation or turn the computer off when you are not using it.
- Reduce the display brightness and select a shorter screen save timeout.

- Keep a battery pack in the computer when you are using the computer with external power.
- Disconnect external equipment that does not have its own power source. (External equipment connected to the computer drains the battery pack.)
- Exit modem programs when you are not using them.
- Remove a PC Card when you are not using it.
- When storing the computer for more than two weeks, remove battery pack(s) and store them separately to reduce the discharge rate and increase battery life.
- Store the battery pack in a cool, dry place when it is not in use. High temperatures cause a battery pack to lose its charge more quickly and reduce battery pack life. For more information on storing battery packs, see "Storing Battery Packs" in this chapter.
- Format diskettes while using external power when possible. (Formatting diskettes increases the drain on a battery pack.)

Recycling Used Battery Packs

To find out if the battery pack recycling program is available in your geographical location, check the worldwide telephone numbers listed in Appendix A of this manual. If a number for recycling is not listed for your area, contact your Compaq authorized dealer, reseller, or service provider.

System Beeps

Beeps with a Blinking Battery Charge Light

When the computer beeps while the battery charge light is blinking, the computer has entered a low battery condition.



CAUTION: When you are alerted of a low battery condition, very little battery charge remains. Save your information and take immediate action to resolve the low battery condition.

If you prefer not to be alerted with system beeps, see “Turning Beeps On or Off” in this chapter.

Beeps with a Blinking Power/Suspend Light

When the computer beeps while the Power/Suspend light is blinking, the computer has initiated Suspend. See Chapter 5 for more information on using Suspend.

NOTE: When the computer is in Suspend and a low battery condition occurs, pressing the power button or suspend button will NOT exit Suspend. Connect the computer to AC power until a fully charged battery is available.

If you prefer not to be alerted with system beeps, see “Turning Beeps On or Off” in this chapter.

Turning Beeps On or Off

Based on the type of beeps you want to turn on or off, do one of the following:

- To enable or disable PC Card beeps, click Control Panel → double-click PC Card icon → Global Settings tab, then click to check or uncheck the Disable PC Card Sound Effects box.
- To toggle all system beeps on or off, use the Computer Setup Utility. The following beeps are affected (see Chapter 15 for more information on using Computer Setup):
 - Low battery warning beeps
 - Power-On Self-Test (POST) beeps
 - Suspend beeps
- To disable only low battery warning beeps, click Start → Settings → Control Panel → double-click Power → Power Properties → Conservation Settings tab. Then click the Warning Beeps Off button.

NOTE: Application-specific beeps must be controlled through the application software.

chapter 5

COMPUTER POWER AND POWER MANAGEMENT

IMPORTANT: If you are running Windows 98, several power conservation features described in this chapter will be disabled. For more information on power management under Windows 98, refer to the section "Using ACPI Power Control" in this chapter.

Leaving On the Computer

When the computer is left on for extended periods, such as overnight, you may want to initiate Suspend to conserve power.

The computer should be left in Suspend when it will be unattended and operating only on battery power. With a fully charged battery pack, the computer can be left in Suspend for up to several days, depending on your hardware configuration.

Turning Off the Computer



CAUTION: In Windows, use Shut Down to exit the operating system and turn off the computer. Failure to properly exit can result in lost data or corrupted files.

If you are working in DOS or if you experience a severe system crash, you can use the power switch to turn off the computer, or press **Ctrl+ALT+Delete** if either the keyboard or the system is locked up.

If you plan to store the computer for an extended period, such as two weeks, you should turn off the computer and remove the battery pack. This reduces the battery pack's discharge rate and extends its life.

If you use the computer frequently and want "instant-on" convenience, you do not have to turn off the computer. Simply initiate Suspend when the computer is not in use. With a fully charged battery pack, the computer can be left in Suspend up to several days, depending on your hardware configuration.

If you want to charge a battery pack while you are not using the computer, connect the computer to external power and turn it off. Although the battery pack will charge whether the computer is turned on or off, it takes more than twice as long to charge it with the computer on.

When external power is not available and battery power is low, initiate Hibernation by pressing **Fn+Suspend** buttons, or complete the following steps:

1. Save your information.
2. Exit your applications.
3. Turn off the computer using Windows Shut Down (if you are in Windows) or by using the power switch (if you are in DOS) until external power or a fully charged battery pack is available.

Restarting the Computer

There are several methods to restart the computer, depending on the power state:

From Hibernation	Slide the power switch.
From Suspend	Press the suspend button.
From Windows	Click Shut Down from the Start menu, then click Restart the Computer.

Disconnecting the Computer from External Power

When the computer does not contain a charged battery pack, save your work and turn off the computer before disconnecting it from external power.

When a charged battery pack is in the computer, you do not need to turn off the computer before disconnecting it from external power. The computer automatically switches to battery power.

IMPORTANT: If the computer will be unused and disconnected from external power for an extended period of time, remove the battery pack(s). This reduces the discharge rate and extends battery life.

Managing Power

The computer comes equipped with a collection of power management features that allow you to extend battery operating time or conserve AC power.

You can use power management to monitor most of the computer components, such as the hard drive, processor, and display. When these components are inactive for specified periods of time (called timeouts), you can use power management settings to shut them down temporarily. This will conserve battery or AC power.

Most power management settings are located under Power Properties (Click Start → Control Panel → double-click Power → Power Properties). These setting options allow you to configure the way your system uses battery and AC power.

Use the following table to view or change power management settings.

If You Want To:	Click This Tab in Power Properties:
Show Suspend on the Start menu	Power + Advanced button
Show battery gauge on the taskbar	Power (Windows 95 only)
Set battery conservation levels; enable/disable warning beeps; set timeouts	Battery Conservation Settings
Select Hibernation settings	Hibernation
Enable/disable Energy Saver	AC Energy Saver (Windows NT 4.0 only)
Set timeouts for drives when using battery power or AC power	Disk Drives (Windows 95 only)
Turn off power to the PC Card slots	PC Card Modems (Windows 95 only)
Set date and time to exit suspend; enable/disable Resume Timer	Resume Timer
Display the status of installed batteries	Battery Status

Using Power Properties

Power Properties allows you to control how AC and battery power are used in the computer. To access Power Properties, click Start → Control Panel → double-click Power → Power Properties.

If You Want To:	Click This Tab:
Set battery conservation levels and enable or disable warning beeps	Battery Conservation Settings
Select Hibernation settings	Hibernation
Display the status of installed batteries	Battery Status

NOTE: The Battery Status tab is a Compaq application that provides information on the status of each battery. This utility includes: a picture of each battery, showing where it is installed on the computer; the life remaining in each battery; and which battery is currently charging.

Setting the Battery Conservation Level

You can set battery conservation to one of four levels:

- **Medium**—The default setting. Balances system performance and battery operating time.
- **High**—Provides maximum battery conservation. Select this level if you need more battery life and do not mind shorter timeouts and a dimmer display.
- **None (Drain)**—Results in maximum battery drain because battery conservation is turned off. Recommended only for discharging the battery pack.



CAUTION: Hibernation does not automatically initiate while the computer is in Drain mode. Before selecting this conservation level, be sure the Hibernation feature has not been disabled.

- **Custom**—Lets you set the timeouts so that the computer works efficiently in your environment. The default setting (Medium) is used here until you set your own.

You can set the battery conservation level one of two ways:

- **Setting the Battery Conservation Level with Hotkeys:** Choose a preset level of battery conservation by pressing **Fn+F7**. If you select None (Drain), it remains in effect until you change it.
- **Using Power Properties:** Change the default levels of battery conservation through the Battery Conservation Settings tab in Power Properties (click Start → Control Panel → double-click Power → Power Properties). Choose a preset level or customize your own level. The level you set remains in effect until you change it.

Using Advanced Power Management

In Windows 95, some Windows applications require that Advanced Power Management (APM) be enabled in order to run effectively. APM, which is enabled by default on your computer, automatically reduces power consumption behind the scenes, saving power while you work. For example, APM turns off the microprocessor between keystrokes and when your applications are idle.

Using ACPI Power Control

Windows 98 provides ACPI (Advanced Configuration and Power Interface), which is a system-wide approach to system and device power control, as well as thermal management. ACPI enables the operating system to respond to events and manage power for the entire system and its devices. It makes the computer more accessible by reducing boot time and allowing the computer to wake up automatically. ACPI also incorporates power management that reduces power consumption of the computer by turning off the microprocessor and other components when applications are idle or between keystrokes.

With ACPI, some Compaq power management features such as power conservation settings in Computer Setup, battery conservation popup windows, and initiating Hibernation will be disabled.

Using Hibernation

Hibernation is a safeguard feature that saves your information when the computer reaches a low battery condition while it is left unattended. When your computer hibernates, all the information in system memory is saved to the hard disk and the power to the computer is turned off. When you turn on the computer, your information returns to the screen at the point where Hibernation initiated. Hibernation behaves like a bookmark, and none of your information is lost.

When Hibernation is initiated, it creates a file on the hard drive at least equal in size to the amount of total random access memory (RAM). If there is not enough space on the hard disk to store the information, an insufficient disk space message is displayed.

Hibernation will automatically initiate as long as it is not disabled (turned off) through the software. If you disable Hibernation and the computer reaches a low battery condition, your unsaved information will be lost.



CAUTION: If a low battery condition occurs and you continue to use the computer, the system may not hibernate and your unsaved information will be lost.

Enabling Hibernation

If you have disabled Hibernation, you can enable it again through the Hibernation tab in Power Properties (click Start → Control Panel → double-click Power → Power Properties). When you enable Hibernation this way, the system uses a certain amount of hard disk space necessary for Hibernation to take place.

Initiating Hibernation

Hibernation can be initiated by you or by the system.

When Hibernation occurs, the system:

- clears the screen.
- saves all current information in memory to the hard disk.
- turns off the computer.

In Windows 95, you can initiate Hibernation by pressing **Fn+Suspend** button at any time and from within any application.

System-initiated Hibernation takes place under the following conditions:

- when the computer is on and unattended, and a critical low battery condition occurs.
- when the computer is in Suspend, and a critical low battery condition occurs.

Exiting Hibernation

To exit hibernation and resume work:

1. Install a fully charged battery pack or connect to an external power source.
2. Turn on the computer by sliding the power switch.

The computer exits Hibernation. The information that was saved to the hard disk returns to the screen at the point where Hibernation was initiated.

NOTE: You may stop the restoration of information by pressing **Ctrl+Alt+Delete**. However, remember that if you use the **Ctrl+Alt+Delete** function, all unsaved data will be lost.

Disabling Hibernation

To disable Hibernation, click the Hibernation tab in Power Properties (click Start → Control Panel → double-click Power → Power Properties) and select **Off**.



CAUTION: You will lose unsaved information if a low battery condition occurs and Hibernation is disabled.

Using Suspend

Suspend is a reduced power condition during which most of the major components (such as the hard drive, processor, and display) shut down after a period of system inactivity called a timeout. Suspend can be initiated whether the computer is running on battery or external power.

Suspend is initiated in one of three ways:

- **Automatically**—when a predefined timeout has been reached. You can define the Suspend timeout period through the Battery Conservation Settings tab in Power Properties (click Start → Control Panel → double-click Power → Power Properties).
- **Manually**—by pressing the Suspend button on the computer.
- **Manually**—by clicking Suspend from the Windows Start menu.

With a fully charged battery pack, the computer can be left in Suspend for up to several days, depending on your hardware configuration.

When you exit Suspend, your information returns to the screen at the point where Suspend was initiated. No information is lost.

If the computer is in Suspend and a low battery condition occurs, the system initiates Hibernation, saves your information to the hard disk, and turns off your computer. When you install a fully charged battery pack or connect to an external power source, your information returns to the screen at the point where Suspend was initiated. No information is lost.



CAUTION: If you disable the Hibernation feature and a critical low battery condition occurs while the computer is in Suspend, your unsaved information will be lost.

Identifying a Suspend Condition

When Suspend initiates, the following occurs:

- the computer beeps twice.
- the screen blanks.
- the power/suspend light blinks.

NOTE: If a low battery condition occurs while the computer is in Suspend, the system initiates Hibernation and will not resume until a power source becomes available.

Initiating Suspend

Suspend can be initiated either by you or by the system.

- System-initiated Suspend occurs:
 - after a predetermined period of system inactivity.
 - during a normal battery condition (not during a low battery condition).
 - In Windows 95, when the Medium, High, or Custom level of battery conservation is used.
- You can initiate Suspend at any time by:
 - pressing the Suspend button.
 - clicking Suspend from the Windows Start menu.

When Suspend is initiated, the computer beeps twice, the screen blanks, and the power/suspend light blinks.

Exiting Suspend

To exit Suspend, press the suspend button.

When the system exits Suspend:

- the computer beeps twice.
- the power/suspend light turns on.
- your information returns to the screen.

IMPORTANT: The computer will not exit Suspend if battery power is low or the battery is dead. You must find a new power source for your computer. When a new power source is connected to the computer, press the suspend button to return your information to the screen.

Using Timeouts

Timeouts are specified periods of system or component inactivity. Timeouts work with battery conservation to conserve power. When a timeout period has expired, battery conservation shuts down the system or components in order to save power. For example, the hard disk idle default timeout is two minutes. Therefore, if an application does not access information on the hard disk in less than two minutes, the hard disk shuts down until it is accessed again.

Timeout values are set using the Battery Conservation Settings or Hibernation tab in Power Properties (click Start → Control Panel → double-click Power → Power Properties). Using these utilities, you can:

- use the preset timeouts provided with the medium (default) or high level of battery conservation.

or

- set your own component timeouts in conjunction with the custom level of battery conservation so that the computer works more efficiently with your applications.

Setting Component Timeouts

If you are running Windows 95, you can set your own timeout values for individual components of the computer. To set component timeouts:

1. Access the Power Properties utility by clicking Start → Control Panel → double-click Power → Power Properties.
2. Click the Battery Conservation Settings tab.
3. Set the Battery Conservation level to Custom.
4. Using the drop-down boxes, select or type a timeout value for specific components of the computer, such as system idle and hard disk idle.
5. To save your settings, click OK when you are done. They become effective immediately and remain in effect until you change them.

Setting the Screen Saver

In Windows 95, the screen save timeout is the amount of time that the system can be idle before a screen saving utility initiates. For example, if you want the screen saver to initiate after five minutes of computer nonuse, set the screen save timeout value to five minutes. If you want the screen to go blank after the specified period, select Blank Screen.

To customize the screen save timeout value for your computer:

1. Click Start → Settings → Control Panel → Display icon → Screen Saver tab.
2. Select a screen saver time-out value.
3. Click OK.

chapter 6

WORKING WITH REMOVABLE DRIVES AND DEVICE BAYS

Bay Configuration

The three computer bays support standard as well as optional devices. Some devices can be hot plugged, while others must be inserted after the computer has been turned off. The following is a list of devices supported in all bays, as well as the computer power state required before inserting the device (see Chapter 2 for bay locations):

Bay Configuration		
Functional Bay	Devices Supported	Power State
MultiBay	Diskette drive	On
	LS-120 Drive	Off
	Zip Drive	Off
	Second battery pack	On
	Second hard drive	Off
Optical Disc Bay	CD-ROM drive	Off
	DVD drive	Off
Battery Bay	Battery pack	On

Caring for Removable Drives

Removable drives such as the hard drive, the CD-ROM or DVD-ROM drive, diskette drive, LS-120 drive, and Zip Drive are fragile computer components that must be handled with care.



CAUTION: To prevent damage to the computer or removable drive or to prevent loss of information, observe the following precautions.

- Back up the information on a hard drive before removing it. Failure to back up the hard drive can result in loss of information if the drive is handled improperly.
- If there is a diskette, compact disc, or digital video disc in a drive, remove it prior to removing the drive from the computer.
- Do not remove a CD-ROM or DVD-ROM drive with the tray extended. Before removing the drive, push the drive tray into the drive.
- Ensure that you are discharged of static electricity before handling a removable drive. Electrostatic discharge can damage electronic components. When handling a removable drive, always grasp the outer case and avoid touching the connectors.
- Do not use force when inserting a drive into a bay. Excessive force may damage the connectors.
- Carefully handle the removable drive. **DO NOT DROP IT.**
- Avoid exposing a hard drive to products with magnetic fields such as video and audio tape erasure products, monitors, and speakers.
- Do not spray the drive with cleaners or expose it to liquids.
- Avoid exposing the drive to temperature extremes.

Using the Diskette Drive

Selecting Diskettes

The diskette drive, which is housed in the computer MultiBay, reads and writes information onto a 3.5-inch diskette.

The MultiBay also accommodates an optional LS-120 Drive or Zip Drive.

Each drive accepts the following diskettes:

Type of Drive	Diskettes accepted
Diskette Drive	1.44-MB high-density (HD) 720-Kbyte double-density (DD) 1.2-MB Japanese format
LS-120 Drive	120-MB SuperDisk 1.44-MB high-density (HD) 720-Kbyte double-density (DD)
Zip Drive	100-MB Zip Disk

Inserting a Diskette

Hold the diskette by the edge where the label is affixed. Insert the diskette, label facing up, into the diskette drive until it clicks into place.

If the diskette is inserted correctly, it drops into position inside the drive and the diskette drive button pops out.

Removing a Diskette

To remove a diskette, push the diskette drive button. After the diskette is ejected, gently pull it from the drive.

Using the **CD-ROM Drive**

Inserting a **Compact Disc** into the **CD-ROM Drive**

1. Turn on the computer.
2. Press the eject button on the bezel of the CD-ROM drive to release the CD loading tray.
3. Slowly pull out the CD loading tray until it is fully extended.
4. Remove the CD from its protective case and place it in the CD loading tray, label side up. Handle the CD by the edges, not by the flat surfaces.
5. Push lightly on the bezel of the CD loading tray to close it.

The light on the CD-ROM drive turns on while the CD is checked and the table of contents is being read. The light turns off when the CD-ROM drive is ready to receive commands.

Removing a **Compact Disc** from the **CD-ROM Drive**

1. Turn on the computer.
2. Press the eject button on the front panel to open the CD loading tray.
3. Slowly pull out the CD loading tray until it is fully extended.
4. Remove the CD from the tray. Handle the CD by the edges, not by the flat surfaces.
5. Place the CD in its protective case.
6. Gently push the front panel of the CD loading tray to close it.

Manually Ejecting a Compact Disc

If a compact disc becomes lodged in the CD-ROM drive, remove it by using the following steps:

1. Insert a paper clip or similar thin metal rod into the manual release hole on the front bezel of the CD-ROM drive. Press firmly.
2. Slowly pull the tray out from the drive until it is fully extended.
3. Remove the compact disc.

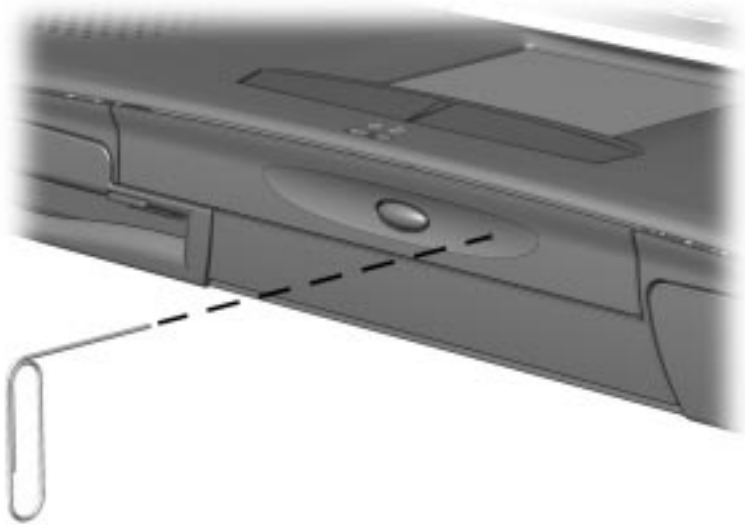

Manually ejecting a compact disc

Using the DVD-ROM Drive

The standard configuration of the DVD-ROM drive is for enhanced data storage. To take full advantage of multimedia features, you will need to purchase the DVD-to-Go PC Card from Margi Systems. This card enables you to play DVD encoded files and MPEG-2 videos with broadcast quality, full screen, full motion video. It will also enhance sound with synchronized Dolby Digital Surround Sound. For more information on the DVD-to-Go-PC Card, visit the Margi Systems web site at <http://www.margi.com>.

MultiBay Devices

The MultiBay supports a diskette drive, LS-120 drive, Zip Drive, second battery pack, or second hard drive.



CAUTION: Some but not all MultiBay devices can be hot plugged. Refer to "Bay Configuration" in this chapter to determine if the computer must be on or off before inserting or removing MultiBay devices. This helps protect the computer or the device from damage, or data loss.

Electrostatic discharge can damage electronic components. Before touching the hard drive, ensure that you are discharged of static electricity by touching a grounded metal object.

Inserting Devices into the MultiBay

To install a supported device into the computer MultiBay:

1. If your device is not hot-pluggable, turn off the computer.
2. Insert the device into the MultiBay until it locks into place.

IMPORTANT: A second hard drive must be installed into a hard drive adapter before it is inserted into the MultiBay.



Inserting a MultiBay Device

Removing Devices from the MultiBay

To remove a supported device from the computer MultiBay:

1. If your device is not hot-pluggable, turn off the computer.
2. Press the MultiBay release lever **1** to release the device.

IMPORTANT: A second hard drive must be installed in a hard drive adapter before it is inserted into the MultiBay. When removing a second hard drive, first remove the adapter from the MultiBay, then remove the hard drive from the adapter.

3. Remove the device



Removing a MultiBay Device

Using a Second Hard Drive

The computer is designed to use up to two hard drives: one in the computer and one in the computer MultiBay.

NOTE: The unit will not boot from the second hard drive. The unit will only boot from the internal hard drive.

chapter 7

USING THE INTERNAL MODEM

Modem Overview

The internal modem comes built into some models and is an option for other models. It provides data communications and fax functionality for applications running under Windows 95, Windows 98, and Window NT 4.0. Preloaded software drivers are required for modem operation and allow the modem to easily communicate with software applications.

The internal modem supports standard analog modem communication protocols (for speeds up to 33.6 Kbps) as well as up to the ITU-compatible V.90 and industry standard K56flex 56K protocols for higher speeds.

IMPORTANT: The V.90 and K56flex protocols allow faster downloads only from V.90 K56flex compliant digital sources. Maximum achievable download transmission rates are currently unknown, may not reach 56Kbps, and will vary with line conditions.

Without having to make hardware changes, the modem may be configured for operation in a variety of countries. An integrated RJ-11 jack provides for simple connectivity to phone cables. If accidentally plugged into a digital PBX phone outlet, the modem automatically protects itself from excessive current until it is plugged into an analog phone jack.

Connecting the Modem

To connect the modem to a standard telephone wall jack:



WARNING: To reduce the risk of electrical shock, always ensure that the modem line is disconnected from the telephone network when opening the equipment's enclosure.

1. Connect one end of the modem cable into the RJ-11 jack on the right side of the computer.

IMPORTANT: The internal modem uses a universal DAA (Direct Access Arrangement) that supports multiple countries. However, some countries may require an adapter to connect the modem to the telephone wall jack.

The modem cable includes EMI suppression circuitry near the end of the computer. For continued EMI emissions compliance, plug that end of the cable into the computer.

2. Plug the opposite end of the cable into a standard telephone wall jack.

IMPORTANT: Wall jacks for digital PBX systems may resemble standard telephone jacks but are not compatible with analog devices such as modems. Be sure the modem cable is connected to a regular analog phone line. Plugging the modem into a digital line will result in no dial tone and is not recommended. The modem includes protective circuitry against the digital lines producing excess current.

Understanding How the Modem Works

The modem serves two major functions:

- The data communications function allows your computer to send information to and receive information from an online service, a host mainframe computer that provides electronic mail, and even other personal computers.
- The facsimile function allows your computer to both send and receive text and images from facsimile (fax) machines or other computers.

After setting up your software, you are ready to start using your modem. In most cases, if you are using communications and fax software, the modem will be controlled by the software and you will not need to use the AT command set. Simply select the internal modem as the preferred communication device in your application.

NOTE: The maximum connection speed on a call is determined by the speed of the slowest modem on the connection. Your modem will automatically negotiate the fastest possible speed with the remote modem.

Changing the Country Selection

The internal modem is configured to meet operating approval in the country where you purchased your computer. If the modem is used in other countries during travel, the country selection setting for the modem needs to change to meet the telecommunications regulations for that country.

The Country Select Application (CSA) lists all of the countries for which the modem contains configuration information. To confirm that the modem has been approved for use by the telecommunications agency in the desired country, check the approvals label on the bottom of the computer. Or, for the most up-to-date information, refer to the Compaq Internet website at www.compaq.com.

NOTE: The internal modem supports specific countries that are included in the selection list.

If you are running Windows 95 or Windows 98:

1. Click Start → Settings → Control Panel → double-click the System icon.
2. Click the Device Manager tab.
3. Double-click modem icon, then double-click your modem.
4. Click the Country Setting for Modem tab, then select the country from the List of Countries.
5. If you are traveling, click the Change Country button. While traveling, you will be asked to confirm this setting at each reboot. If you have permanently relocated to the country, click the Home Country button, then click the Change Country button.
6. Click Yes to confirm your country selection.
7. Click Yes to restart your computer.

If you are running Windows NT

Click Start → Settings → Control Panel → double-click the CSA Control Panel

1. Select the country from the List of Countries.
2. If you are traveling, click the Change Country button. While traveling, you will be asked to confirm this setting at each reboot. If you have permanently relocated to the country, click the Home Country button, then click the Change Country button.
3. Click Yes to confirm.
4. Click Yes to restart your computer.

NOTE: When the Home Country and Current Country selections in the CSA do not match, you will be prompted each time the system restarts to confirm that the Country setting still reflects where the modem is being operated at this time. To disable these reminders, change the Home Country selection in the CSA to match the Current Country. The Current Country setting should always be set to the country in which the modem is currently being operated.

Software Overview

You need communications software to operate the modem. Such software issues commands to the modem, including modem connection speed, the number of rings before answering the telephone, listening for a dial tone, and dialing a phone number.

For information on controlling the phone dialing sequence, refer to “Dial Modifiers”. The internal modem, for example, includes the ability to wait for a “go ahead tone” after dialing a credit card number as part of the dialing sequence. To do this, add a \$ symbol at the appropriate point in the phone number string.

There is a wide range of communications software available that can be used with this modem for tasks such as accessing your computer from a remote location. Contact your Compaq authorized dealer, reseller, or service provider for a complete list of communications software applications.

IMPORTANT: If Hibernation initiates or a low battery condition occurs while you are using the modem with communications software, the modem will disconnect. Exit Hibernation or resolve the low battery condition, then restart the communications software to restore the original modem settings.

Modem Defaults

Some data or fax communications software prompts you for specific information about the model of modem you are using. In this case, if the internal modem is not available as a choice, select one of the following modems: Compaq Modem or Hayes Compatible.

NOTE: Choosing another modem does not affect the actual connection speed of the modem.

Use the following information if required for modem setup:

Modem Defaults	
COM port setting	COM2
DCE Speed	56 Kbps
DTE Speed	115.2 Kbps
Data Format	Databits - 8
Data Format	Parity - N
Data F ormat	Stopbits - 1
Dial Command	ATDT
AutoAnswer Command	ATS0 = 1
Sound	Enabled
Columns	80
Local Echo	Enabled

Understanding Result Codes

A result code is a modem response to an issued command. The screen displays the result code in one of two formats: the long form, also known as verbose, or numeric characters represented by digits. A typical example of a result code could be CONNECT 33600. This message is the modem's acknowledgement that it has established a connection at transfer rate of 33,600 bps.

The following is a table of supported modem result codes and definitions.

Modem Result Codes

Numeric Code	Result Code	Definition
0	OK	Command line executed
1	CONNECT	Modem connected to line
2	RING	Ring signal detected
3	NO CARRIER	Carrier signal lost or not detected
4	ERROR	Invalid command
5	CONNECT 1200	Connected at 1200 bps
6	NO DIAL TONE	No dial tone detected
7	BUSY	Busy signal detected
8	NO ANSWER	No "quiet" answer
88	DELAYED	Delay for the dialed number
10	CONNECT 2400	Connection at 2400 bps
11	CONNECT 4800	Connection at 4800 bps
12	CONNECT 9600	Connection at 9600 bps
13	CONNECT 14400	Connection at 14400 bps
14	CONNECT 19200	Connection at 19200 bps
24	CONNECT 7200	Connection at 7200 bps
25	CONNECT 12000	Connection at 12000 bps
86	CONNECT 16800	Connection at 16800 bps
40	CONNECT 300	Connection at 300 bps
55	CONNECT 21600	Connection at 21600 bps

Continued

Modem Result Codes *Continued*

Numeric Code	Result Code	Definition
56	CONNECT 24000	Connection at 24000 bps
57	CONNECT 26400	Connection at 26400 bps
58	CONNECT 28800	Connection at 28800 bps
59	CONNECT 31200	Connection at 31200 bps
60	CONNECT 33600	Connection at 33600 bps
70	CONNECT 32000	Connection at 32000 bps/56K rate
71	CONNECT 34000	Connection at 34000 bps/56K rate
72	CONNECT 36000	Connection at 36000 bps/56K rate
73	CONNECT 38000	Connection at 38000 bps/56K rate
74	CONNECT 40000	Connection at 40000 bps/56K rate
75	CONNECT 42000	Connection at 42000 bps/56K rate
76	CONNECT 44000	Connection at 44000 bps/56K rate
77	CONNECT 46000	Connection at 46000 bps/56K rate
78	CONNECT 48000	Connection at 48000 bps/56K rate
79	CONNECT 50000	Connection at 50000 bps/56K rate
80	CONNECT 52000	Connection at 52000 bps/56K rate
81	CONNECT 54000	Connection at 54000 bps/56K rate
82	CONNECT 56000	Connection at 56000 bps/56K rate
83	CONNECT 58000	Connection at 58000 bps/56K rate
84	CONNECT 60000	Connection at 60000 bps/56K rate

Modem Specifications

Temperatures

Operating	32 to 135 F	0 to +60 C
Storage	-40 to 155 F	-45 to +70 C

Relative Humidity (noncondensing)

Operating	95% maximum
Storage	95% maximum

Power Requirements	+5.0 VDC (+/-5%@1.5 W max.)
---------------------------	-----------------------------

Interfaces

Communications Connector	Standard RJ-11 Telephone Connector
Telephone, central office network	Internal DAA

Modem Compatibility

The internal modem is compatible with the following data and facsimile communications standards:

Command Set

Hayes AT command set (EIA/TIA 602)

Data Communications

ITU V.90 (speeds higher than 33600 bps)

ITU V.34 Annex (K56flex or 33600 bps)

ITU V.34 (28800 bps)

ITU V.32 (19200 bps)

ITU V.32bis (14400 bps)

ITU V.32 (9600 bps)

ITU V.23 (1200/75 bps)

ITU V.22bis (2400 bps)

ITU V.22 (1200 bps)

ITU V.21 (300 bps)

Bell 212A (1200 bps)

Bell 103 (300 bps)

Facsimile Communications

ITU V.17 (14400 bps)

ITU V.29 (9600 bps)

ITU V.27ter (4800 bps)

ITU V.21 Ch2 (300 bps)

Class I facsimile extensions to the Hayes AT command set (EIA/TIA 578)

Support for Group III facsimile machines

Data Compression

ITU V.42bis

MNP 5

Error Control

ITU V.42 (LAPM)

MNP 2-4

Using AT Commands to Control the Modem

The internal modem can be used in a variety of applications and is designed to interface with a wide range of computer and data communications equipment. Because each device has specific requirements of its own, the modem is equipped with an extensive set of commands and registers that you can set to meet the specific requirements of your system.

The modem always operates in one of two modes: the command mode or the online mode. When power is turned on, the modem automatically assumes the command mode. When the modem is in the command mode, it can be configured for your computer system or for a particular application.

You can use your communications software, such as Windows HyperTerminal, to program the modem. In most cases, you can merely select the options and operations required from a menu in the communications software program. The communications program transmits these selections to the modem in the form of commands. The modem then processes the data received as instructions to perform a particular task.

However, you can also issue commands directly from the terminal mode of the communications program. Using the AT command set, Class 1 fax extensions, and supporting S registers, you can instruct the modem to perform a particular function or set of functions. For example, you may instruct the modem to dial (ATDn), answer (ATA), and hang up (ATH0) with the appropriate commands.

You cannot enter commands when the modem is in the online mode, that is, sending or receiving data over the telephone lines. However, the modem returns to the command mode under the following circumstances:

- A call is disconnected, and the modem goes offline.
- The modem cannot successfully complete a call, or if the data carrier of the remote modem is dropped.
- The modem receives a defined escape sequence or break signal while in the online mode.
- A semicolon (;) occurs at the end of a dialing string.

If an error occurs during the execution of a command line, processing of the command line stops, and everything following the erroneous command is ignored.

Guidelines for Using **AT** Commands

You must follow certain rules when entering or using the AT command set. Read the topics in this section to learn more about these guidelines:

Using the **Attention Code**

You should precede all commands except A/ and +++ with the attention code AT.

Entering a **Command**

You can enter commands in uppercase or lowercase letters or a combination of both. However, always type the AT prefix in the same case (not At or aT).

You can enter a maximum of 60 characters for the internal modem following the AT. The modem doesn't count the AT prefix, carriage return (<cr>) character, or spaces. It counts, but doesn't act on, punctuation, such as hyphens and parentheses.

You can enter telephone numbers with or without punctuation; for example:

(123) 456-7890 or 1234567890

However, punctuation in the telephone number takes up space in the command buffer.

If a command sequence exceeds the 60-character maximum, the modem does not execute any part of the command line and returns an error message after the <cr> instead. If this occurs, reentering the command within the 60-character limit allows the command line to be executed.

Editing a **Command**

If you make an error while typing a command, simply backspace over the mistake, then retype the line. You cannot backspace over the AT prefix because it is interpreted immediately after it is typed.

Executing a **Command**

After you enter an AT command, execute it with the Enter or <cr> character (selected in register S3).

Interpreting a Missing Parameter

If you enter a command that normally includes a numeric parameter (such as ATHn) without the numeric parameter, the modem interprets the missing parameter as zero. For example, the Hn (hang-up) command can have a numeric parameter of zero (H0) or of one (H1); however, if the parameter is missing, ATH<cr> is the equivalent of ATH0<cr>. This rule applies to command parameters only, not to dial strings.

Entering an Escape Code Sequence

The escape code sequence (a 3-character code surrounded by escape guard times) forces the modem from the online mode to the command mode. You must enter the escape character three times consecutively, and the delay between entering each escape character must not exceed the escape guard time. After a short delay, the modem responds with the OK result code to let you know that it has successfully "escaped" to the command mode. Use the ATO command to return to the online mode.

The escape guard time is defined as the time delay required between the last character transmitted and the first character of the escape code. The default escape character (set in register S2) is +, the default escape guard time (set in register S12) is one second, and the default escape code sequence is +++.

Repeating a Command

You can repeat the last command line issued by entering the A/ command. This action also repeats the AT prefix and the <cr>; therefore, you are not required to enter the AT prefix or a <cr> when using this command.

Each string command remains in the command buffer until an AT is entered or power to the modem is turned off. Both actions clear the buffer and make the A/ command invalid, since there is no command for the modem to repeat.

AT Command Set

Command	Description
A	Answer Mode Command.
AT	Attention Code.
A/	Repeat Last Command.
A	Answer Command.
Bn	Communications Standard Option.
D	Dial Command.
Dn	Dial Command.
E	Echo Command.
En	Command Echo Option.
F	Online Echo Command.
H	Hook Control.
Hn	Hook Control Option.
I	Request ID information.
In	Request Identification Option.
Ln	Monitor Speaker Volume.
Mn	Speaker Control Option.
Nn	Modulation Handshake.
On	Online Command.
P	Pulse.
Q	Result Code Control.
Qn	Result Code Suppression.
Sr=n	Write to an S Register.
Sn?	Read an S Register.
T	Tone Dial.
Vn	Result Code Form Option.
Wn	Compatibility Check.
Xn	Result Code Set/Call Progress Option.
Z	Reset Command Option.
+++	Escape Code Sequence.

Advanced AT Commands

Command	Description
&Cn	Data Carrier Detect Options.
&Dn	Data Terminal Ready Option.
&F	Load Factory Defaults.
&Gn	Guard Tone Option.
&Kn	Local Flow Control Selection.
&Mn	Asynchronous Communications Mode.
&Qn	Asynchronous Communications Mode.
&Sn	Data Set Ready Option.
&Tn	Test Command Selection.
&V	View Current Configuration.
&W	Store Current Configuration.
&Zn	Store Telephone Number.
\J	Adjust Bits/s Rate Control.
\Nn	Error Control.
\Qn	Local Flow Control Selection.
\Tn	Inactivity Timer.
\Vn	Protocol Result Code.
-Cn	Data Calling Tone.
%B	View Numbers in Blacklist.
%Cn	Data Compression Control.

Fax Commands

Command	Description
+F<command> =?	Report Operating Capabilities.
+F<command> =n?	Report Supported Parameters.
+FCLASS?	Report Active Configuration.
+FCLASS=n	Select Service Class.
+FTS=n	Stop Transmission and Wait.
+FRS=n	Receive Silence.

Continued

Fax Commands *Continued*

Command	Description
+FTM=n	Transmit Data.
+FRM=n	Receive Data.
+FTH=n	Transmit Data with HDLC Framing.
+FRH=n	Receive Data with HDLC Framing.

Dial Modifiers

These commands may be used with the ATD command to dial telephone numbers.

Dial Modifiers	
Modifier	Description
L	Redial Last Number.
P	Pulse Dialing.
S=n	Dial Stored Number.
T	Tone Dialing.
W	Wait for Dial Tone.
;(semicolon)	Return to Command Mode.
@ (at character)	Wait for Quiet Answer Command.
! (exclamation)	Flash Hook Command.
, (comma)	Pause During Dialing.
\$ (bong detect)	Wait for calling card tone.
^ (carat)	Disable Data Calling Tone Transmission.
> (greater than)	Ground Start Dialing.
0 through 9	Dial Digits. Valid digits for pulse or tone dialing.
A, B, C, D, #, *	Dial Characters.

S Register Default Values

The S register default values are set to function appropriately under most circumstances. However, their values may be modified if necessary. For example, it may take an especially long time to get a dial tone in your office, so you may choose to reset S6 for a longer wait time.

Modifying an S Register

The correct command format for modifying an S Register is `ATSn=r`, where `n` is the register number to be modified and `r` is the value to which you wish to set the register. For example, to set register 37 to 7, enter:

```
ATS37=7<cr>
```

The register S37 is now set to a value of 7.

Reading an S Register

Entering the `ATSn?` command allows you to read the contents of a given S register. For example, to display the contents of the S11 register, enter this command: **ATS11?**

S Register Command Summary

Register	Description
S0	Automatic Answer.
S1	Ring Counter.
S2	AT Escape Character.
S3	Command Line Termination Character.
S4	Response Formatting Character.
S5	Command Line Editing Character.
S6	Pause Before Blind Dialing.
S7	Connection Completion Timeout.
S8	Comma Dial Modifier Time.
S10	Automatic Disconnect Delay.
S11	DTMF Dialing Speed.
S12	Escape Code Guard Time.
S28	V.34 Modulation.
S30	Inactivity Timer.
S32	Synthetic Ring Volume.
S33	Synthesized Ring Frequency.
S35	Data Calling Tone.
S37	Dial Line Rate.
S38	56K Dial Line Rate.
S42	Auto Rate. (default 1, range 0-1)

Continued

S Register Command Summary *Continued*

Register	Description
S89	Sleep Mode Timer.
S90	Read-only Local Phone.

Advanced Voice Commands

Command	Description
S32	Synthetic Ring Volume.
S33	Synthetic Ring Frequency.

Audio Response Codes

The modem alerts the DTE to the presence of tones detected on the phone line. During a voice call, the modem is capable of simultaneously detecting tones other than voice. When such a tone is detected, the modem responds via the communications interface with one of the following response codes:

Audio Response Codes

Code	Description
0-9, A-D,#,*	DTMF Tones
a	Answer Tone
b	Busy Tone
c	Fax Calling Tone
d	Dial Tone
e	Data Calling Tone
h	Local Phone On-Hook
H	Local Phone Off-Hook
R	Ring
r	Ringback
s	Silence Timer Has Expired
@	CAS Tone Detected

Uninstalling the Modem

To uninstall the modem software and hardware under Windows NT 4.0, you must log into Windows NT 4.0 with Administrator privileges. To uninstall the modem software and hardware if you are running Windows 95, Windows 98, or Windows NT 4.0:

1. Click Start, Settings, Control Panel.
2. Double-click the Add/Remove Programs icon.
3. Select the Compaq internal model from the list of software.
4. Click the Add/Remove button.
5. Click Yes to confirm.
6. If you are prompted to restart the system, click Yes.

Remove the modem hardware from the computer.

CONNECTING EXTERNAL DEVICES

Connecting an External Enhanced Keyboard

To connect an external enhanced keyboard to the computer, connect the keyboard cable to the keyboard/mouse connector on the computer.

Connecting an External Monitor



CAUTION: *To prevent damage to the computer, turn off the monitor before connecting it to the computer or disconnecting it from the computer. To prevent damage to the computer display, do not place an external monitor or any other object on top of the computer when the computer is closed.*

To connect an external VGA monitor:

1. Turn off the monitor.
2. Plug the monitor signal cable into the external monitor connector on the back of the computer.
3. Plug the monitor power cord into a properly grounded electrical outlet.
4. Turn on the monitor.
5. Ensure that the computer recognizes your monitor type by clicking Change Display Type under Display Properties (Start → Settings → Control Panel → Display). Select the appropriate manufacturer and model, if necessary.

NOTE: If the external monitor does not immediately show a display, try using the **Fn+F4** hotkeys.

Connecting a Television Monitor



CAUTION: *To prevent damage to the computer display, do not place a television monitor or any other object on top of the computer when the computer is closed.*

The TV connector is available on selected models. To connect a television monitor:

1. Be sure the computer is toggled to the computer display mode. Toggle the **Fn+F4** hotkeys to change the mode if necessary.
2. Plug an RCA-style television signal cable into the TV connector on the computer.

NOTE: You can purchase an RCA-style television signal cable at any home electronics store.

3. Plug the television power cord into a properly grounded electrical outlet.
4. If you are running Windows 95 or Windows 98, to ensure that the computer recognizes your television format, click Start → Settings → Control Panel → Display → Advanced. Select the Adjustment tab. Click on Display Device, and select TV. Select the appropriate television format (NTSC, NTSC-J, PAL, or PAL-M).

If you are running Windows NT, to ensure that the computer recognizes your television format, click Start → ATI Display Utility. Select the appropriate television format (NTSC, NTSC-J, PAL, or PAL-M).

5. Turn on the television.
6. Switch the display mode to television by toggling the **Fn+F4** hotkeys.
7. If the television does not display the correct image, toggle the **Fn+F4** hotkeys back to computer display mode. Then repeat Step 4 and select a different television format. Toggle the **Fn+F4** hotkeys back to television mode.

Connecting a Mouse or Other External Pointing Device

A PS/2 compatible mouse or external touchpad can be connected to the computer.

To connect an external pointing device, insert the pointing device cable into the keyboard/mouse connector.

External pointing devices need software device drivers to operate. The necessary drivers should be provided by the manufacturer or preinstalled with Microsoft Windows.

Connecting a Serial Printer

1. Turn off the printer.
2. Plug the printer end of the printer signal cable into the printer.
3. Connect the serial printer signal cable to the serial connector on the back of the computer.
4. Plug the printer power cord into a properly grounded electrical outlet.
5. Turn on the printer and resume your work.

NOTE: Windows should prompt you to set up your printer before printing for the first time. If you are not successful doing this, consult the printer documentation for printer device driver configuration information and instructions.

Connecting a Parallel Printer

1. Turn off the printer.
2. Plug the printer end of the printer signal cable into the printer.
3. Connect the parallel printer signal cable to the parallel connector on the back of the computer.
4. Plug the printer power cord into a properly grounded electrical outlet.
5. Turn on the printer and resume your work.

NOTE: Windows should prompt you to set up your printer before printing for the first time. If you are not successful doing this, you may need to consult the printer documentation for printer device driver configuration information and instructions.

Docking the Computer to the Convenience Base

1. Shut Down the computer if you are using Windows NT. You do not need to turn off the computer if you are using Windows 95 or Windows 98.

NOTE: Not all network operating systems support "hot docking" (while the computer is on). In order to establish a network connection, turn off the computer, then turn it on again while the computer is docked in the convenience base.

2. If configuring for a desktop system, Shut Down the computer and close the display.
3. Align the left edge of the computer with the left docking alignment guide on the convenience base. Push the computer in until the retaining latch **2** catches.
4. Push the docking lever **4** back until the docking connectors **1** are firmly joined and the computer is fully docked in the convenience base.
5. To configure for a desktop system,(a) place the Monitor Stand on top of the system, (b) place the external monitor on top of the stand, and (c) connect the external monitor, external keyboard, and mouse to the rear connectors on the convenience base.
6. Turn on all external devices connected to the convenience base.
7. Slide the power switch on the computer, or press the power button **3** on the convenience base.

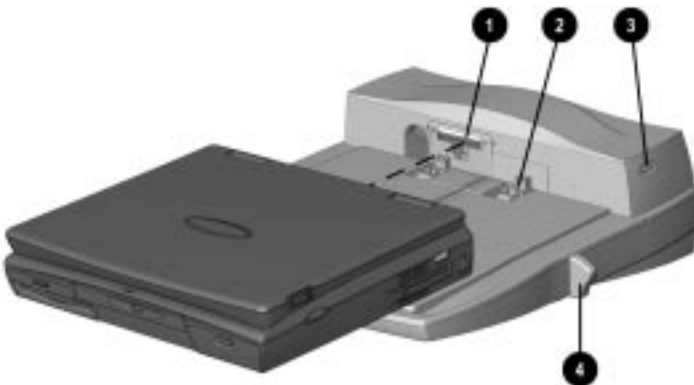

Docking the computer

Undocking the Computer from the Convenience Base

The undocking process depends on your operating system. To undock your computer from the optional convenience base:

1. From the Windows 95 or Windows 98 start menu, click Start → Eject PC. The computer will initiate Suspend and you can safely undock the computer. If you are using Windows NT, Shut Down the computer by clicking Start → Shut Down.



CAUTION: *Failure to use the ejection procedure may cause loss of data or unpredictable results.*

NOTE: Not all network operating systems support "hot docking" (while the computer is on).

2. Close the display if not already closed.

NOTE: Disconnect the PC Card cable and unlock the security cable, if applicable, to prevent damage.

3. Pull the docking lever fully forward to undock the computer.
4. Slide the computer forward from the convenience base to remove.
5. If the computer display is blank, press the computer hotkey combination **Fn+F4** to switch the display from the external monitor to the computer display.

Connecting Infrared Equipment

NOTE: Infrared-equipped computers are IrDA-compliant. Infrared performance may vary depending on peripherals, distance between infrared devices, and applications used. The infrared port is available only on specific models.

For infrared-equipped models, the infrared port allows wireless communication between your computer and other infrared-equipped devices. Operating system support for infrared communication is currently available with Microsoft Windows 95, but not for Windows NT.

The infrared port produces an invisible beam of infrared light to communicate with another infrared-equipped device.

To establish an infrared link:

- Be sure the infrared ports on both computers are turned on and facing each other at a distance no greater than 1.5 feet (about 0.5 meter).
- Avoid moving the infrared ports away from each other during data transmission.
- Avoid interference from remote control units, such as wireless headphones or audio devices, pointed at the infrared ports.
- Avoid direct sunlight, fluorescent light, or flashing incandescent light close to the infrared ports.
- Keep the path between the infrared ports free of any objects that might interfere with data transmission.
- Do not point one of the ports more than 30 degrees (plus or minus 15 degrees off the center line) away from the infrared port of the device you are connecting with.

Connecting **USB** Peripherals

Your computer comes equipped with a port that connects Universal Serial Bus (USB) devices to the computer.

Your computer can support certain USB devices without any special drivers. These include hubs and keyboards. For most other USB devices without special drivers provided by the USB device manufacturer, you will need an operating system which has USB support for your device built in, such as Windows 95 OSR2.1 or Windows 98. Later versions of the Windows operating systems will add functionality which may allow you to attach any USB device to your computer (for example, a video camera) and will allow many USB devices to be connected and working simultaneously.

A USB keyboard and mouse, optionally connected through a hub, offer the same functionality as a standard keyboard and mouse connected through the keyboard/mouse connector. Future operating systems will have extended USB capabilities which will replace the USB capabilities built into the computer.

chapter 9

USING PC CARDS

PC Card Types

This computer can support two Type II cards or one Type III card. It supports both 16-bit and CardBus (32-bit) PC Cards. Several kinds of PC Cards are supported, such as network cards, hard drive cards, memory cards, and fax/modem cards.

For a current list of third-party PC Cards qualified on this computer, call your Compaq authorized dealer, reseller, or service provider.

Inserting a PC Card

1. If you are running Windows NT 4.0 *but not* CardWare 5.0 from Compaq, turn off the computer. If you are running Windows 95, you do not need to turn off the computer or initiate Suspend before inserting a PC Card.

NOTE: If you are running Windows NT and CardWare 5.0 from Compaq, insertion of the PC Card while the computer is on is supported for most PC Cards. Contact your PC Card vendor directly for information about the level of support they offer for "hot insertion" with CardWare 5.0.

2. With the label side up, insert the 68-pin connector side of the PC Card into the PC Card slot, pushing gently until firmly seated.



CAUTION: To prevent damage to the connectors, use minimal pressure when inserting a **PC Card** into a **PC Card** slot.

If you are running Windows 95 and your computer is on, the computer automatically configures a plug and play card and most other PC Cards. If the computer is turned off or in Suspend, a card is not configured until you turn on the computer or exit Suspend.

Windows NT is not plug and play operating system at this time. If you are running Windows NT, the computer configures a card only when it is in the PC Card slot when the computer is turned on. The computer only recognizes that a PC Card has been removed if the PC Card slot is empty when the computer is turned on.

After the computer has configured the card, the computer beeps twice to indicate that the card is ready for use.

IMPORTANT: After the PC Card has been inserted and configured, it may be necessary to perform an initial setup procedure. For example, a new storage card may need to be formatted, or a new network card may need drivers installed. For detailed information on setup procedures for various Network PC Cards, refer to the instructions provided by the PC Card manufacturer.

Removing a PC Card

1. If you are running Windows 95, you must stop the PC Card before removing it (see “Stopping a PC Card” later in this chapter). You do not need to turn the computer off or initiate Suspend. If you are running Windows NT, you must close Windows NT and turn off the computer.



CAUTION: Failure to stop a **PC Card** before it is removed may damage the **PC Card** or computer.

2. To release the PC Card eject button, depress the button **1** once. To eject the PC Card, firmly depress PC Card eject button a second time.
3. Remove the card.

NOTE: If you are running Windows 95, the computer beeps twice if it is turned on when the PC Card is removed.



Releasing the PC Card

PC Card Device Drivers

Device drivers are programs or data files containing information needed to run a specific PC Card. Most of the device drivers you need are preinstalled on the computer.

NOTE: In order to save available memory, some device drivers are not enabled after being installed.

Some types of PC Cards, such as network cards, Global Positioning System (GPS) cards, SCSI cards, audio cards, and multifunction cards, require an additional PC Card-specific software device driver to function properly. This software device driver is provided on diskette by the PC Card manufacturer and should be installed according to the manufacturer's instructions. Do not install any other PC Card software on the computer such as Card and Socket Services, even if prompted to do so.



CAUTION: Compaq has tested the **PC Card** software preinstalled on the computer. If you install card and socket services or enablers provided by other vendors over software preinstalled on the computer, the computer may no longer work properly with all of your **PC Cards**.

Changing PC Card Settings

To view or configure the adapter in your PC Card, under Windows 95, access the Device Manager (Start → Settings → Control Panel → double-click System → Device Manager), and select the appropriate device type for the card you want to configure.

NOTE: If your PC Card has never been inserted, a dialog box will appear when you insert the card into the PC Card slot and will automatically display setting information for the card.

Managing PC Card Power

PC Cards are powered accessories in a small form factor. When PC Cards are installed in your computer, they draw power from the system even when they are not in use.

If you are running Windows 95, remove PC Cards when they are not in use to conserve power, or you may turn off power to the PC Card slots through Power Properties. (Click Start → Settings → Control Panel → double-click Power → Power Properties).

If you are running Windows NT, remove PC Cards when they are not in use to conserve power.

If you are operating the computer on a battery pack, you can disable power to the PC Card slots and extend the battery life. You can also conserve PC Card power when the computer is in Suspend.

Zoomed Video

A Zoomed Video PC Card promotes higher overall system performance for MPEG playback.

The computer supports Zoomed Video PC Cards under Windows 95. Windows NT does not support Zoomed Video.

Always insert a Zoomed Video card into the bottom PC Card slot.

Stopping a PC Card

If you are running Windows 95, you should always stop a PC Card before removing it from a PC Card slot. There are two ways to stop a PC Card:

IMPORTANT: Always stop a LAN, ATA, or SCSI card before removing.

- Click the PC Card icon in the notification area on the taskbar. A list of PC Cards in the system appears. Click the PC Card that you want to stop. Or
- Click Start → Settings → Control Panel → PC Card icon. Click the PC Card that you want to stop.

When the message appears that it is safe to remove the card, remove the PC Card.

chapter 10

USING AUDIO FEATURES

Audio Components Overview

The computer provides both internal and external audio capabilities. You can record and play sound, enhance an interactive demonstration with high-quality stereo sound, and take advantage of business programs, presentations, and multimedia educational and entertainment software.

The internal microphone supports audio input for spoken comments. An external electret condenser microphone can also be used to record voice or sound.

The integrated stereo speakers support sound output for WAV file and MIDI playback, and audio from the CD-ROM or DVD drive. They also support external audio input devices such as a CD player, tape deck, or stereo tuner connected to the computer through the microphone line-in jack. Headphones or external speakers can be connected to the computer through the stereo speaker/headphone jack.

Identifying the Audio Components

The computer provides the following internal and external audio capabilities:



Audio Components

Component	Function
① Stereo speaker/headphone line-out jack	Connects stereo speakers, headphones, or a headset. The jack requires 3.5 mm, 3-conductor plug.
② Microphone line-in jack	Connects an external mono microphone. The jack requires a 3.5mm, 2-conductor or 3-conductor plug.
③ Volume control (up)	Increases volume to the built-in speakers, to external speakers, or to headphones plugged into the stereo speaker/headphone jack on the computer.
④ Volume control (down)	Decreases volume to the built-in speakers, to external speakers, or to headphones plugged into the stereo speaker/headphone jack on the computer.
⑤ Stereo speakers	Built-in speakers for high-quality stereo sound and multimedia sound system.
⑥ Internal microphone	Built-in monophonic microphone for the multimedia sound system.

NOTE: With stereo speakers muted, system beeps are still audible unless they have been turned off.



WARNING: To reduce the risk of personal injury, adjust the volume control before putting on headphones.

Using Internal and External Microphones

The internal microphone is disabled when an electret condenser microphone with a 3.5-mm plug is plugged into the microphone line-in jack.

IMPORTANT: A mono electret condenser microphone in the mono microphone jack is acceptable, but the left channel will be recorded on both the left and right channels. A dynamic microphone will not achieve the recommended sensitivity.

Using Internal and External Speakers/Headphones

External speakers:

- Provide more separation for the left and right audio channels.
- Produce more volume with amplified speakers.
- Produce higher quality sound.



CAUTION: Use only a **3.5-mm stereo plug** in the stereo speaker/headphone jack. A mono plug can result in damage to the computer.

The internal stereo speakers are disabled when external speakers or headphones are connected to the speaker/headphone line-out jack.



WARNING: To reduce the risk of personal injury to hearing, check the volume level of software applications before you put on headphones.

Controlling Audio Volume

Audio volume control affects the stereo speakers, headphones, and external speakers that are connected to the stereo speaker/headphone jack.

There are three ways to control the audio volume:

- Using volume control buttons on the left side of the computer. The rear button turns up the volume. The forward button turns down the volume. To mute sound completely, press both volume buttons simultaneously.
- Using volume control features available under the Audio tab in Multimedia Properties.
- Using the **Fn+F5** hotkeys (adjusts only the volume of system warning beeps).

Some software applications, such as game programs, include their own volume controls. You may need to use the software to adjust volume to the desired sound level.

The volume control on the computer overrides all other volume controls in the software. That is, the volume from the integrated stereo speakers, external speakers, or headphones will never be louder than the sound level selected using the computer volume control.

chapter 11

UPGRADING THE COMPUTER

Upgrading System Memory

You can expand memory by installing memory expansion boards. You can easily upgrade memory by lifting the computer keyboard and inserting the memory expansion board. To order a memory expansion board, contact your Compaq authorized reseller. Refer to the instruction card that comes with the option kit for installation procedures.

IMPORTANT: If you upgrade memory, the computer increases the Hibernation file size to accommodate the additional memory. When the Hibernation files increases, it requires more hard disk space.

Checking the Amount of Memory

Memory upgrades are available in the following capacities:

- 32-Megabyte Memory Expansion Board
- 64-Megabyte Memory Expansion Board
- 128-Megabyte Memory Expansion Board (when available)

To view the amount of existing memory in the computer, click Start → Settings → Control Panel → double-click Compaq Diagnostics icon.

IMPORTANT: When memory is increased, the space on the hard disk reserved for the Hibernation file is also increased. If you experience problems with Hibernation after adding a memory expansion board, verify that your hard disk has enough free space for the larger Hibernation file. To view the amount of free space on your hard disk, click Start → Settings → Control Panel → double-click the Power icon → Hibernation tab.

Obtaining an Optional Memory Expansion Board

For a list of the memory expansion boards available for the computer:

- Refer to the *Accessories* flyer that came with the computer.
- Refer to Compaq Worldwide Telephone Numbers for the nearest Compaq authorized dealer, reseller, or service provider.

IMPORTANT: The computer only supports SDRAM (synchronous DRAM) memory expansion boards. If you install a different type of memory expansion board, you will receive the following message when you restart the computer:

This unit only supports SDRAM.

If you receive this message, turn the computer off and remove the memory expansion board.

Inserting a Memory Expansion Board

To insert an optional memory expansion board:

1. Shut down and turn off the computer. Disconnect any external cables.
2. Release the keyboard by successively inserting a paper clip or similar instrument into both the keyboard releases **1**.
3. Lift the keyboard **2**.

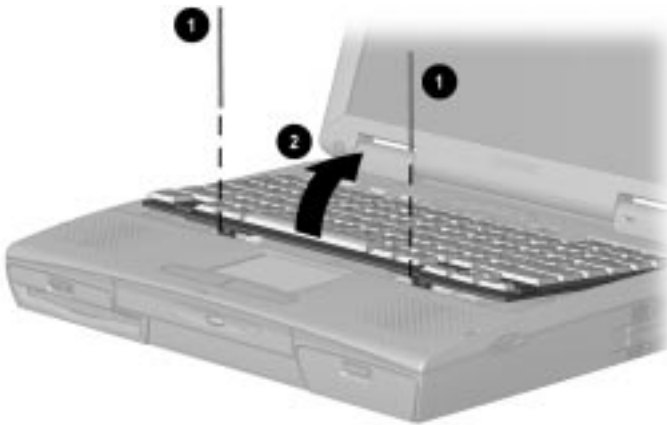

Lifting the Keyboard

4. Insert the memory expansion board into the empty memory expansion slot **1** at a 45-degree angle. Then slide it gently into place until it is seated while tilted.
- NOTE:** A memory expansion board is asymmetrically keyed (notched) to ensure correct positioning.
5. Push the memory expansion board down **2** until the retention clips snap back into place.
 6. Close the keyboard.

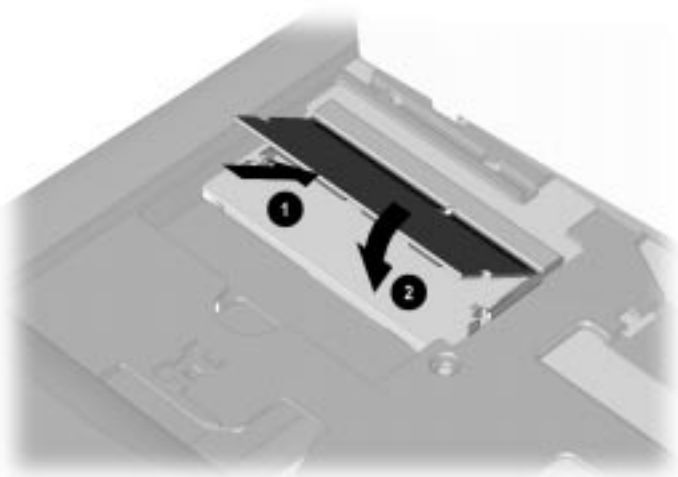

Inserting the Memory Board

Removing a Memory Expansion Board

To remove an optional memory expansion board:

1. Shut down and turn off the computer. Disconnect any external cables.
2. Release the keyboard by successively inserting a paper clip or similar instrument into both the keyboard releases **1**.
3. Lift **2** the keyboard.

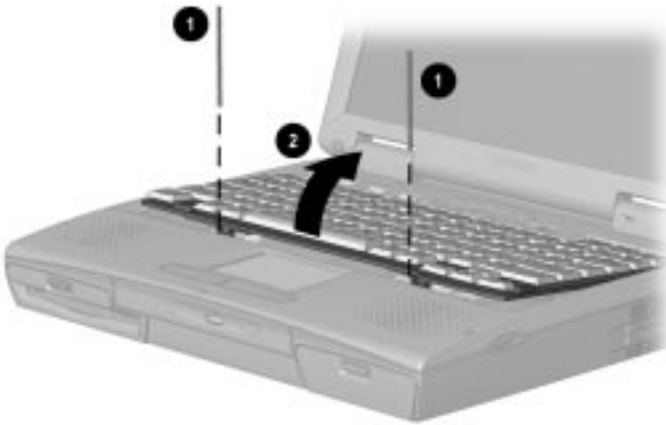

Lifting the Keyboard

4. Pull away the retention clips **1** on each side of the memory expansion board to release it. The memory expansion board tilts toward you.
5. Lift the edge of the memory expansion board **2** and slide it gently out of the memory expansion slot at a 45-degree angle.
6. Place the memory expansion board in an electrostatic-safe container.
7. Close the keyboard.

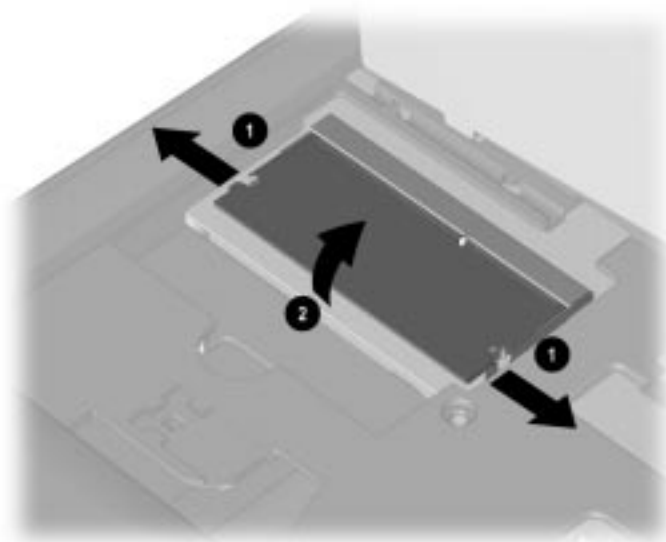

Removing the Memory Board

Upgrading the Hard Drive

Depending on your computer model, the hard drive can be upgraded to a larger capacity. Contact your Compaq authorized dealer, reseller, or service provider for the optional hard drives available for your computer. For installation procedures, refer to the instruction card that comes with the hard drive option kit.

Adding a **CD-ROM** or **DVD** Drive

Some models come standard with an internal CD-ROM drive in the Optical Disc Bay. An optional CD-ROM Drive or DVD drive can be easily added to other models in the Optical Disc Bay at the front center of the computer. Contact your Compaq authorized dealer, reseller, or service provider to place an order or for additional information. For installation procedures, refer to the instruction card that comes with the CD-ROM/DVD drive option kit.

Adding an Internal **Modem**

Some models come standard with an internal data/fax modem. An internal modem can be easily installed in other models. Contact your Compaq authorized dealer, reseller, or service provider to place an order or for additional information.

NOTE: Internal modems are not available in all countries.

chapter 12

MAINTENANCE & TRAVEL GUIDELINES

Caring for the Computer

Keep the computer in good condition and working properly by following these guidelines:

- Operate the computer with a battery pack installed, even when using external power. This supplies the battery pack with a charge and ensures a fully charged battery pack the next time the computer is used without external power.
- Keep the computer away from excessive moisture and temperature extremes. Do not expose the computer to liquids or precipitation.
- Remove the battery pack from the computer if the computer will not be used for an extended period of time (more than two weeks). Store the battery pack in a cool, dry place.
- To prevent possible damage to the display, do not place anything on top of the computer when it is closed. Store the computer in a slipcase.
- Occasionally wipe the exterior of the computer and the screen with a soft, damp cloth moistened only with water. Using soap or other cleaning products may discolor the finish and damage the screen.



WARNING: Do not spray liquid directly on the computer screen. Excess liquid may drip down inside the computer and cause damage to the components or result in electrical shock.

- Avoid exposing the computer to direct sunlight or strong ultraviolet light for extended periods of time. Avoid scratching the surface of the screen and banging it against hard objects.
- Use a carrying case to store the computer and any external devices when transporting the computer.

Caring for the Display

- To clean the screen, occasionally wipe it with a soft, damp cloth moistened only with water. Using soap or other cleaning products may damage the screen.
- Avoid exposing the computer to direct sunlight or strong ultraviolet light for extended periods of time.
- Avoid scratching the surface of the screen and banging it against hard objects.



WARNING: Do not spray any type of cleaning fluid directly on the computer screen. Excess liquid may drip inside the computer and damage the components or result in electrical shock.

Traveling with the Computer

For safety and convenience when traveling, follow these guidelines:

- Safeguard your data before you leave on a trip by making a backup copy.
- Take an extra backup copy of the data with you.
- Remove the diskette from the diskette drive, and compact disc or digital video disc from the CD-ROM drive or DVD-ROM drive.
- Disconnect the power cord from the computer. Take the power cord or an extra fully charged battery pack with you.

- Disconnect external equipment from the computer.
- Hand-carry the computer in its carrying case or in a briefcase. Do not check it in with your luggage.
IMPORTANT: There are three types of airport security devices: X-ray machines (the conveyor belt device you set your bags on), magnetic detectors (the device you walk through), and security magnetic wands (the hand-held device used by security personnel). You can send your computer and diskettes through airport X-ray machines. However, Compaq recommends that you do not send your computer and diskettes through airport magnetic detectors or expose them to security magnetic wands.
- Check with the airline if you plan to use the computer on the plane. In-flight computer use is regulated and varies by airline.

Before traveling internationally with the computer, follow these guidelines:

- Check local customs regulations for restrictions and requirements on traveling with a computer.
- Purchase from a Compaq authorized dealer, reseller, or service provider a power cord for the country where you will be using the computer. These power cords are designed to meet the voltage and frequency requirements of each country.



CAUTION: Do not use the converter kits sold for appliances to power the computer

- Make sure you have the correct modem cable adapter for the country you will be visiting. Telephone line standards and modem protocols differ from country to country.

Shipping the Computer

1. Back up your data. Do not expose your backups to electrical or magnetic impulses while stored or in transit.
2. If there is a diskette, compact disc or digital video disc in a drive, remove it.
3. Turn off the computer and all external devices.
4. Close the computer.
5. Disconnect external devices from the computer.
6. Pack the computer and external devices in their original packing boxes or similar packaging with sufficient packing material to protect them and prevent shifting or movement in transit.

Operating Temperatures

The computer is designed to run demanding applications that may require the use of PC Cards, CD-ROM or DVD-ROM drives, and large amounts of memory. The computer complies with international safety standards for operating temperatures, including those of user accessible surfaces. However, as a result of the computer's power consumption while running these demanding applications, it is normal for the external surfaces of the computer to feel warm when the computer is in use for extended periods.

chapter 13

SECURITY FEATURES

Types of Security

Security features protect your computer and the information stored on it from unauthorized access.

- The power-on password prevents unauthorized use of the computer when it is turned on, restarted, or resumed from Suspend or Hibernation.
- The setup password prevents unauthorized users from changing your computer's configuration through Computer Setup. The setup password may also be used by network administrators to protect and access the configuration of multiple computers in a network.
- Quick Controls clear the screen and disable the keyboard and other input devices while the computer is running.
- DriveLock security prevents unauthorized use of the hard drive even if the drive is removed from your computer and booted in a different computer.
- The login password (Windows NT only) is used to log in to Windows NT. When combined with the security features above, it prevents unauthorized users from accessing your hard drive. Windows NT has a multiple boot menu which can allow users to boot up Windows 3.1 or Windows 95, bypassing Windows NT security.
- Computer Setup allows you to disable devices and prevent unauthorized use of specific computer components.
- The cable lock provision allows you to attach the computer to an immovable object such as a desk to prevent unauthorized removal of the computer.
- The hard drive compartment cover provides a security screw to prevent unauthorized access to the internal hard drive.

Using the Cable Lock

To help protect your computer from theft, use the cable lock provision to secure the computer to a work area.

To attach the cable lock:

1. Loop the cable around a heavy, fixed object to which you want to secure the computer.
2. Insert the lock end of the cable through the loop end of the cable.
3. Insert the lock into the security slot on the computer.
4. Lock with the key.



Attaching a Cable Lock Device

NOTE: The cable lock can be purchased from Kensington Microware Limited or from Compaq authorized dealers, resellers, and service providers worldwide.

Using Passwords Properties

Passwords Properties (Start → Settings → Control Panel → double-click Passwords → Passwords Properties) allows you to protect your computer against unauthorized use.

If you want to set the power-on password, QuickLock or QuickBlank, click the Computer Security tab.

Using the Power-On Password

The power-on password is a security feature that prevents use of the computer when it is turned on until a secret word or code is entered. This prevents unauthorized access to your information. If you establish a power-on password, you must enter it each time you turn on the computer.

Establishing the Power-On Password

Using Windows 95

The power-on password prevents unauthorized use of the computer when it is turned on or resumed from Suspend, Hibernation, or QuickLock/QuickBlank.



CAUTION: You cannot use the computer if you forget your power-on password. Therefore Compaq recommends that you record your password and put it in a safe place.

To establish your power-on password in Windows 95, do the following:

1. Click the Computer Security tab in Passwords Properties (Start → Settings → Control Panel → double-click Passwords → Passwords Properties).
2. Click the Set button.
3. Enter your new password twice, then click OK.

IMPORTANT: Type carefully, because the password is not displayed as you type. The password is not case sensitive. However, you must use the same keys each time you enter the password. For example, the numbers at the top of the keyboard are not recognized as being the same as the numbers in the embedded numeric keypad.

4. You may enter up to eight alphanumeric characters for the password. The next time you restart the computer, or resume from Hibernation, Suspend, or QuickLock/QuickBlank, you will be prompted to enter your power-on password.

Using Windows NT

The power-on password prevents unauthorized use of the computer when it is turned on or resumed from Suspend, Hibernation, or QuickLock/QuickBlank.



CAUTION: You cannot use the computer if you forget your power-on password. Therefore Compaq recommends that you record your password and put it in a safe place.

To establish your power-on password in Windows NT, do the following:

1. Run Computer Setup by turning on or restarting the computer (Start → Shut Down → Restart). When the blinking cursor appears in the upper-right corner of the screen, press F10.
2. Click the System Features icon → Security Management menu.
3. Under Power-On Password, click Set.
4. Enter your power-on password. (You can use up to eight alphanumeric characters, and you may use the same password you are using for the setup password.)

IMPORTANT: Type carefully, because the password is not displayed as you type. The password is not case sensitive. However, you must use the same keys each time you enter the password. For example, the numbers at the top of the keyboard are not recognized as being the same as the numbers in the embedded numeric keypad.

5. Enter the password again to verify it.
6. If you want to require entry of a password whenever the computer is turned on, click Enable Password to Power-On.
7. Click OK → Exit → Save.

Once the power-on password is set, you must enter it every time you turn on or restart the computer, or resume from Hibernation, Suspend, or QuickLock/QuickBlank.

Entering the Power-On Password

1. Turn on or restart the computer.
2. At the password prompt, type your power-on password.

If you enter the password incorrectly, an incorrect password prompt displays. Try again to enter the password. After three unsuccessful attempts, you must turn the computer off and back on again before you can continue.

NOTE: The password is not case sensitive. However, you must use the same keys each time you enter the password. For example, the numbers at the top of the keyboard are not recognized as being the same as the numbers in the embedded numeric keypad.

Changing the Power-On Password

Once your power-on password has been established, you can change it using your computer keyboard. Each computer keyboard is designed to meet specific country requirements. The syntax for changing the password varies according to the keyboard purchased with your computer. When you wish to change or delete your password, you may have to substitute another key character for the slash mark (/). To determine which character is appropriate for your keyboard, refer to the table below.

Country	Key Character
Belgian	=
Brazilian	;
Danish	-
French	!
French Canadian	é
German	-
Italian	-
Japanese	/
Korean	/
Latin American	-
Norwegian	-
Portuguese	-
Spanish	-
Swedish/Finnish	-
Swiss	-
Taiwanese	/
U.K. English	/
U.S. English	/

To change your power-on password:

1. Turn on the computer.
2. When the password prompt is displayed, enter your current password, then enter the new password twice, typing the appropriate syntax for your computer keyboard between the passwords. For example, if you have a Belgian keyboard, type the following:

current password=new password=new password

IMPORTANT: Type carefully. For security reasons, the characters you type do not appear on the screen

The new password takes effect the next time you turn on the computer, or resume from Suspend, Hibernation, or QuickLock/QuickBlank.

Deleting the Power-On Password

Once your power-on password has been established, you can delete it using your computer keyboard. Each computer keyboard is designed to meet specific country requirements. The syntax for changing the password varies according to the keyboard purchased with your computer. When you wish to change or delete your password, you may have to substitute another key character for the slash mark (/). To determine which character is appropriate for your keyboard, refer to the table in “Changing the Power-On Password.”

To delete your power-on password:

1. Turn on the computer. The power-on password prompt is displayed.
2. Enter your current power-on password followed by the appropriate syntax for your computer keyboard. For example, if you have a Belgian keyboard, type the following:

current password=

IMPORTANT: Type carefully. For security reasons, the characters you type do not appear on the screen.

3. The password is deleted.

If You Forget Your Power-On Password

IMPORTANT: You cannot use the computer if you forget your power-on password. Therefore, Compaq recommends that you record your password and put it in a safe place.

If you forget your power-on password, the computer must be disassembled and memory cleared. Contact your Compaq authorized dealer, reseller, or service provider for assistance.

Using the Quick Controls

The Quick Controls establish security measures on your computer when it is on but not in use. If you are running Windows 95, they are located in Passwords Properties (Start → Settings → Control Panel → double-click Passwords → Passwords Properties). If you are running Windows NT, they are located under the Security Management menu in Computer Setup.

- QuickLock disables your keyboard and pointing device while the computer is running. It leaves your information on the screen but prevents it from being accessed until a power-on password is entered to enable the keyboard.
- QuickBlank, used in conjunction with QuickLock, clears the screen when the keyboard and pointing device are disabled.
- QuickLock on Standby (Suspend) automatically disables the keyboard and pointing device when the computer enters Suspend. It prevents your information from being accessed until a power-on password is entered. Entering the password allows the computer to exit Suspend and enables the keyboard and pointing device.

Enabling the Quick Controls

The Quick Controls establish security measures on your computer when it is on but not in use. After setting the power-on password in Passwords Properties, the following Quick Controls can be enabled or disabled:

To enable the Quick Controls:

1. Click the Computer Security tab in Passwords Properties (Start → Settings → Control Panel → double-click Passwords → Passwords Properties).
2. If a power-on password has been set, the QuickLock and QuickLock on Standby options become available. When you select QuickLock, the QuickBlank option also becomes available. Check each box with the features you want enabled.

Initiating the Quick Controls

You can initiate QuickLock and QuickBlank at any time while the computer is on. Before initiating these security features, the following conditions must be met:

- A power-on password must be established.
- QuickLock and QuickBlank must be enabled.

Once these requirements are met, you can initiate QuickLock and QuickBlank in one of two ways:

- Using the **Fn+F6** hotkeys, which work only on the computer keyboard.
- Using the key combination **Ctrl+Alt+L**, which works on both the computer and external keyboards.

To exit QuickLock and QuickBlank once they have been initiated, enter your power-on password.

NOTE: QuickLock on Suspend cannot be initiated from the keyboard.

Using the Setup Password

Establishing the Setup Password

The setup password prevents unauthorized users from changing your computer configuration through Computer Setup.

Setup passwords can also be used by the network administrator to protect and access the configuration of computers in a network.

NOTE: After you establish the setup password, you must enter it each time you want to change the computer configuration.



CAUTION: You cannot change the computer configuration if you forget your setup password. Record the password and put it in a safe place.

1. Run Computer Setup by turning on or restarting the computer (Start → Shut Down → Restart). When the blinking cursor appears in the upper-right corner of the screen, press **F10**.
2. Click the System Features icon → Security Management box.
3. Under the Setup Password section, Passwords tab, click Set.
4. Enter your new setup password. (You may use up to eight alphanumeric characters, and you may use the same password you are using for the power-on password.)

NOTE: Type carefully because the password does not display as you type it.

5. Enter the password again to verify it.
6. Click OK → Exit → Save.

You will be prompted to enter your setup password the next time you try to change the computer configuration using Computer Setup.

Entering the Setup Password

After you establish the setup password, you must enter it each time you want to change the computer configuration.

1. Turn on or restart the computer.
2. When the cursor moves to the upper right corner of the screen, press **F10**.
3. Enter your setup password at the password prompt.
4. Press Enter.

NOTE: You can use the setup password for both setup and power-on passwords.

Changing the Setup Password

Once your setup password has been established, you can change it using your computer keyboard. However, you can only change the password after the computer has been restarted and you are prompted to enter the current setup password.



CAUTION: You cannot change the computer configuration if you forget your setup password. Record the password and put it in a safe place.

Each computer keyboard is designed to meet specific country requirements. The syntax for changing the password varies according to the keyboard purchased with your computer. When you wish to change or delete your password, you may have to substitute another key character for the slash mark (/). To use the character that is appropriate for your keyboard, refer to the table under “Changing the Power-On Password.”

To change your setup password, do the following:

1. Save your work, restart your computer, then press **F10** as soon as the cursor moves to the top-right corner of the screen.
2. The password prompt is displayed.
3. Enter your current password, then enter the new password twice, typing the appropriate syntax for your computer keyboard between the passwords. For example, if you have a Belgian keyboard, you will type the following:

current password=new password=new password

IMPORTANT: Type carefully. For security reasons, the characters you type do not appear on the screen.

The new password takes effect the next time you turn on the computer.

Deleting the Setup Password

Once your setup password has been established, you can delete it using your computer keyboard. Each computer keyboard is designed to meet specific country requirements. The syntax for changing the password varies according to the keyboard purchased with your computer. When you wish to change or delete your password, you may have to substitute another key character for the slash mark (/). To use the character that is appropriate for your keyboard, refer to the table under “Changing the Power-On Password.”

To delete your setup password, do the following:

1. Save your work, restart your computer, then press **F10** as soon as the cursor moves to the top-right corner of the screen.
2. The password prompt is displayed.
3. Enter your current password, followed by the appropriate syntax for your computer keyboard. For example, if you have a Belgian keyboard, you will type the following:

current password=

IMPORTANT: Type carefully. For security reasons, the characters you type do not appear on the screen

4. The password is deleted.

Enabling and Disabling Devices

Several devices can be disabled to prevent the unauthorized transfer of data using these devices:

- Diskette drive
- Diskette drive boot ability
- Serial port
- Infrared port
- Parallel port
- PC Card slots

To disable or enable a device:

1. Run Computer Setup by turning on or restarting the computer (Start → Shut Down → Restart). When the blinking cursor appears in the upper-right corner of the screen, press **F10**.
2. Under the View menu, select either View by Type or View by Connection.
3. Click the icon for the device you want to disable.
4. Select the tab for the device you want to disable or enable. An **X** indicates that the selected device is disabled.
5. Click OK → Exit → Save.

Changes take effect when you restart the computer.

DriveLock Overview

DriveLock security prevents unauthorized access to hard drive applications and user data. DriveLock sets a user password and a master password for hard drives. The correct user password must be entered when the computer is turned on before a protected hard drive can be accessed. Protected hard drives remain protected even if removed and inserted into another computer.

After you enable DriveLock, you must enter the user password each time you turn on or restart the computer or resume from Hibernation.

When the DriveLock password prompt displays, enter your user password.

If you type the user password incorrectly, you are prompted to reenter it. After two unsuccessful attempts to unlock a protected hard drive, it will be necessary to restart the computer.

User and Master Passwords Overview

The user password is the password primarily used when turning on the computer. It prevents unauthorized users from gaining access to your removable hard drive. The owner of the user password should be the day-to-day user of the hard drive, not a system administrator.

NOTE: After you establish the user password, you must enter it each time you want to access your removable hard drive. This password will be required even if the hard drive is inserted into another computer. If the correct password is not entered, the hard drive will remain locked and inaccessible.

The master password is used instead of the user password to remove DriveLock protection and to gain access to the hard drive. The owner of the master password may be the system administrator.



CAUTION: Forgetting or losing both the user and master passwords will render the protected hard drive permanently unusable. Record your master password and keep it in a secure location physically separate from your computer. In the event you lose the user password, the master password can be used to unlock a protected hard drive and reset the user password.

NOTE: If you forget your user or master password, contact Compaq customer support for further instructions before proceeding.

Establishing DriveLock Protection



CAUTION: Forgetting or losing both the user and master passwords will render the protected hard drive permanently unusable. Record your master password and keep it in a secure location physically separate from your computer. In the event you lose the user password, the master password can be used to unlock a protected hard drive and reset the user password.

To establish DriveLock protection:

1. Run Computer Setup by turning on or restarting the computer (Start → Shut Down → Restart). When the blinking cursor appears in the upper-right corner of the screen, press **F10**.
2. Click the System Features icon → Security Management box → DriveLock tab.
3. In the Current Drive section, select MultiBay.
4. In the Drive Protection section, click Set to establish DriveLock protection for the selected hard drive.
5. Read the warning message. If you wish to continue, click OK.
6. In the Set User Password section, enter your new user password. (You may use up to 32 alphanumeric characters, and you may use the same password you are using for the power-on password.)
NOTE: Type carefully because the password does not display as you type it.
7. Enter the user password again to verify it.
8. Click OK.
9. In the Set Master Password section, enter your new master password. (You may use up to 32 alphanumeric characters, and you may use the same password you are using for the power-on password.)
NOTE: Type carefully because the password does not display as you type it.
10. Enter the master password again to verify it.
11. Click OK.
12. Read the warning message. If you wish to establish DriveLock, type “DriveLock” at the prompt.
13. Click OK.

The changes will take place when Computer Setup has been exited normally. You will be prompted to enter your user password the next time you boot your computer using that hard drive.

Changing the User Password

NOTE: If you forget your user password, you can access your removable hard drive with the master password. Make note of the user password. Record the master password and put it in a safe place physically separate from the computer.

Once you create a user password, you can only change the password after the computer has restarted and the protected hard drive has been unlocked.

To change your password:

1. Turn on or restart the computer and enter your current user password.
2. Run Computer Setup.
3. Click the System Features icon → Security Management box → DriveLock tab.
4. In the Current Drive section, select MultiBay.
5. In the User Password section, click on Change.
6. Type the old user password.
7. Enter your new user password. (You may use up to 32 alphanumeric characters, and you may use the same password you are using for the power-on password.)

NOTE: Type carefully because the password does not display as you type it

8. Enter the password again to verify it.
9. Click OK.

Removing DriveLock Protection



CAUTION: Forgetting or losing both the user and master passwords will render the protected hard drive permanently unusable. Record your master password and keep it in a secure location physically separate from your computer. In the event you lose the user password, the master password can be used to unlock a protected hard drive and reset the user password.

Once you create a user password, you can only delete the passwords after the computer has restarted and the protected hard drive has been unlocked. Removing DriveLock protection deletes both the user password and the master password.

1. Turn on or restart the computer and enter your current user password.
2. Run Computer Setup.
3. Click the System Features icon → Security Management box → DriveLock tab.
4. In the Current Drive section, select MultiBay.
5. In the Drive Protection section, click on Remove.
6. Enter the master password.
7. Enter the master password again to verify it.
8. Click OK → Save → Exit.

The changes will take place when Computer Setup has been exited normally.

Changing the Master Password



CAUTION: Forgetting or losing both the user and master passwords will render the protected hard drive permanently unusable. Record your master password and keep it in a secure location physically separate from your computer. In the event you lose the user password, the master password can be used to unlock a protected hard drive and reset the user password.

Once you create a master password, you can only change the password after the computer has restarted and the protected hard drive has been unlocked.

To change your master password, follow these instructions after you have restarted your computer and entered the current user password:

1. Turn on or restart the computer and enter your current user password.
2. Run Computer Setup.
3. Click the System Features icon → Security Management box → DriveLock tab.
4. In the Current Drive section, select MultiBay.
5. In the Master Password section, click on Change.
6. Type the old master password.
7. Enter your new master password. (You may use up to 32 alphanumeric characters, and you may use the same password you are using for the power-on password.)

NOTE: Type carefully because the password does not display as you type it

8. Enter the password again to verify it.
9. Click OK.

chapter 14

INTELLIGENT MANAGEABILITY

Intelligent Manageability Overview

Intelligent Manageability consists of software tools for the computer and Compaq servers that assist in tracking, troubleshooting, protecting, and maintaining the computer. It provides the following functions:

- **Asset Management**—provides detailed configuration and diagnostic information.
- **Fault Management**—prevents, predicts, and alerts of impending hardware problems.
- **Security Management**—protects unauthorized access to data and components.
- **Integration Management**—uses industry-standard technologies such as DMI and SNMP to integrate with industry-leading PC management software providers.
- **Configuration Management**—optimizes computer performance by providing the latest drivers, utilities, and software, which are available on CD-ROM and the Compaq web site at www.compaq.com.
- All Intelligent Manageability features are available on your computer. The features work any time, whether on the road or connected to a network. The latest versions of Intelligent Manageability software are available on the Compaq website.

NOTE: For further help with Intelligent Manageability, refer to Intelligent Manageability Help (Start → Compaq Information Center → double-click Intelligent Manageability)

Asset Management

Asset Control enables the network administrator to remotely retrieve information from any Compaq computer connected to the network. This information can be used to assist in tracking and maintaining the computer and its components. It provides the following information:

- **Inventory information**—A network administrator can retrieve information about the computer via the network by using Compaq Insight Manager or any PC management tool provided by Compaq Solution Partners. The following Asset Control information can be retrieved:
 - Manufacturer, model and serial number of Compaq computers, monitors, hard drives, battery packs, memory boards, processor speeds, and operating systems.
 - Asset tag
 - System board and ROM revision levels
 - BIOS settings
- **Diagnostic information**—Using Diagnostics for Windows provides the performance status of hard drives, ports, video, sound and other components.

Once displayed, all of the above information can be viewed, printed, or saved.

Changing the Asset Tag Number

An asset tag may be changed by a network administrator if needed to comply with company or network standards. To change the asset tag:

1. Turn on or restart the computer.
2. Press **F10** when the cursor appears in the upper right corner of the screen.
3. Select Computer Setup → Systems Features → Intelligent Manageability.
4. The default asset tag is also the computer serial number. Change the asset tag default as needed or required.

Fault Management

The Fault Management utilities minimize downtime and data loss by monitoring system performance and generating the following alerts:

- **Hard drive alert**—warns you up to 72 hours in advance of impending hard drive problems and can automatically start optional backup software.
- **System temperature alert**—reports overheating. As the system temperatures rise, this utility first adjusts fan speed and other cooling components, then displays an alert, then shuts down the system.
- **Battery pack alert**—reports charging problems and battery pack failure.
- **Monitor alert**—diagnoses and displays external monitor operational problems.
- **Memory alert**—reports memory board configuration changes when a memory board is removed, added, or reconfigured. It also provides the previous and current configurations for comparison.

The alerts work with or without network connection. Of course, if your computer is not connected to the network, your network administrator cannot receive alerts from your computer until you reconnect to the network. When an alert occurs while the computer is disconnected from the network, your network administrator will receive the alert as soon as you reconnect to the network.

Fault Management Alerts

Alerts can be enabled, disabled, and tested, and software can be set to back up information whenever a hard drive alert occurs.

- While the computer is connected to a network, alerts pop up on the computer display and are simultaneously reported to the network console.

NOTE: A battery charging problem alert is reported only on the computer display.

- When the computer is disconnected from the network, the user will receive a local alert.

To set alerts, double-click the Intelligent Manageability icon in the system tray.

Security Management

The Security Management utilities customize system security.

- **Power-On and Setup Passwords**—prevent unauthorized access to your information and computer configuration.
- **DriveLock**—denies access to drives, or limits read-only access.
- **Device disabling**—prevents unauthorized data transfer through modems, serial ports, parallel ports, and infrared ports on the computer.
- **QuickLock/QuickBlank**—locks the keyboard and clears the screen.
- **Ownership Tag**—displays ownership information during system restart.

Configuration Management

Compaq provides you with support software to optimize the performance of your computer. This support software is distributed monthly on a CD-ROM which can be ordered from Compaq. Support software can also be downloaded from the Compaq website at www.compaq.com/support/files.

You can quickly locate support software for your computer by using the locator browser and Decision Support on the CD-ROM and Compaq website. To access support software:

- **Locator browser**—searches for the latest device drivers, utilities, ROM images, and other support software on a CD-ROM and at the Compaq web site at www.compaq.com.
- **Decision Support**—provides detailed information about drivers, utilities, and software available on the computer. The information includes descriptions, features, enhancements, dependencies, and necessary upgrades.

Also available on the Compaq website:

Info Messenger—Provides Internet and email access to the latest software updates and service documentation. Once you register for this free service at the Compaq website at www.compaq.com and build your computer profile, Info Messenger will search the Compaq website and collect information specific to your computing environment. Info Messenger will then send an email alerting you when new and/or updated information is available on a Compaq customized web page.

chapter 15

COMPUTER SETUP AND DIAGNOSTICS UTILITIES

Computer Setup Overview

Computer Setup contains utilities that give you an overall picture of the computer hardware configuration and aid in troubleshooting. These utilities also allow you to set custom features, such as security options, power conservation levels, and startup preferences.

If you are running Windows 95, the computer automatically recognizes and configures the system for new devices. If you have a configuration problem or want to view or reset configuration settings, you can use Computer Setup.

NOTE: If you are running Windows 95, you should use Computer Setup only to adjust system features such as the battery conservation level. Windows 95 may override other configuration changes.

If you are running Windows NT, the computer does not automatically recognize new devices added to the system. All devices ordered with your system have been configured for you. Use Computer Setup to view settings for a new device you have added or to reset configuration settings for preinstalled devices.

Computer Setup provides two methods of viewing the computer configuration—by type (factory setting) or connection.

Categories by type:

- **System Features**—security, power, boot management
- **Communication**—port, modem, and other communication devices
- **Storage**—storage-related devices such as hard drive, CD-ROM drive, diskette drive
- **Input Devices**—keyboard, mouse, and other input devices
- **Network**—network adapter or other network-related devices
- **Audio**—sound properties and audio device settings
- **Video**—monitor timeouts and video device resources
- **Other**—miscellaneous devices

Categories by connection:

- **System Features**—security, power, boot management
- **System Devices**—keyboard, mouse, parallel and serial ports
- **ISA**—ISA bus and related devices
- **PCI**—PCI bus and connected devices
- **PC Card**—PC Card devices

Running Computer Setup

1. Turn on or restart the computer by clicking Start → Shut Down → Restart the computer.
2. When the blinking cursor appears in the upper-right corner of the screen, press **F10**

NOTE: If you enabled a setup password, it must be used to access Computer Setup.

4. Click a language and press Enter.
5. Click Computer Setup and press Enter.
6. When you are finished, click Exit. A series of Exit options appear.

Exiting Computer Setup

1. Click Exit.
2. Select one of the following Exit options:
 - **Save**—Saves the new settings and exits Computer Setup.
NOTE: Some settings may not take effect until the computer is restarted.
 - **Ignore**—Exits Computer Setup and restores previous settings.
 - **Cancel**—Returns to Computer Setup.

Using Compaq Utilities

Compaq Utilities contain several functions that

- Determine if various computer devices are recognized by the system and are operating properly.
- Provide information about the system once it is configured.

Compaq Utilities include the following programs:

- Computer Setup
- Computer Checkup (TEST)
- View System Information (INSPECT)

To access Compaq Utilities

1. Turn on or restart the computer by clicking Start → Shut Down → Restart the computer.
2. When the blinking cursor appears in the upper-right corner of the display, press **F10**
3. Select a menu option.

Running Compaq Diagnostics

Compaq Diagnostics is a utility that inspects computer hardware, internal system temperature, and the SMART hard drive, then displays a prefailure warning message upon detecting a system temperature or hard drive fault.

If you are running Windows 95, access Compaq Diagnostics for Windows as follows:

1. Double-click My Computer.
2. Double-click Control Panel.
3. Double-click Compaq Diagnostics.

If you are running Windows NT, access Windows NT Diagnostics by clicking Start, Programs, Administrative tools, then Windows NT Diagnostics.

Using the Diagnostics Utilities

There are two ways you can identify and test your system components: using the Compaq Diagnostics utility or using the Diagnostics for Windows utility.

- Use the Compaq Diagnostics utility to identify and test all system devices.
- Use the Diagnostics for Windows utility to
 - determine if various computer devices are recognized by the system and are operating properly.
 - obtain information about the system once it is configured.

Running Computer Checkup (TEST)

Computer Checkup (TEST) determines whether the various computer components and devices are recognized by the computer and are functioning properly. You can display, print, or save the information generated by Computer Checkup.

1. Plug the computer into an external power source. (A low battery condition could interrupt the program.)
2. Connect a printer if you want to print a log of error messages.
3. Turn on the external devices that you want to test.
4. Turn on or restart the computer.
5. When a blinking cursor appears in the top right corner of the screen, press **F10**.
6. If prompted, select a language. The Configuration and Diagnostics menu is displayed.
7. Select Computer Checkup. The Test Option menu is displayed.
8. Select View the Device List from the Test Option menu.
 - If the list of installed devices is correct, select OK. The Test Option menu is displayed again.
 - If the list is incorrect, ensure that any new devices are installed properly. If you do not find an installation problem with a Compaq device not on the list, call your Compaq authorized dealer, reseller, or service provider. Non-Compaq devices may not be detected.
9. Select one of the following from the Test Option menu:
 - Quick Check Diagnostics
 - Automatic Diagnostics
 - Prompted Diagnostics
10. Follow the instructions on the screen as the devices are tested. When testing is complete, the Test Option menu appears.
11. Exit the menus to return to your original screen.

Running View System Information (INSPECT)

The View System Information (INSPECT) utility provides information about the computer and installed or connected devices. You can display, print, or save the information.

To run INSPECT, do the following:

1. Connect a printer if you want to print the INSPECT information.
2. Turn on or restart the computer.
3. When a blinking cursor appears in the top right corner of the screen, press **F10**.
4. If prompted, select a language. The Configurations and Diagnostics menu is displayed.
5. Select View System Information (INSPECT) from the menu.
6. Select the item you want to view from the following list:

System	Memory
ROM	Audio
Keyboard	Operating system
System ports	System files
System storage	Windows files
Graphics/Video	

7. Follow the instructions to cycle through the screens, return to the list and choose another item, or print the information.

Using the Video Utility

To access the video utility, click the Compaq tab in Display Properties (Start → Settings → Control Panel → Display). This utility allows you to configure your graphics system .

Ordering Preinstalled Software

It is recommended that you use a backup program to create a backup of the preinstalled software. However, for an additional cost, you can order a backup of the preinstalled software on a CD-ROM or on diskettes.

If an order form is included with your computer, complete the form and return it, or call one of the numbers listed on the order form. If an order form was not included with the computer, refer to the Compaq worldwide telephone numbers.

IMPORTANT: Before calling Compaq to place your order, be sure to have the serial number of your computer available. This number is necessary for all software backup purchases.

Boot Sequencing

Boot sequencing defines the order in which the system will look for an operating system from which to boot.

1. Run Computer Setup.
2. Click the System Features icon → Boot Management box → MultiBoot tab.
3. Designate the hard drive boot (startup) sequence you want.
4. Click OK to accept the changes.

chapter 16

TROUBLESHOOTING

Troubleshooting Checklist

If you encounter a minor problem with the computer or software applications, go through the following checklist for possible solutions:

- Is the computer connected to an external power source or does it have a fully charged battery pack installed?
- Is the computer turned on and is the power light on?
- Are all cables connected properly and securely?
- Did the diskette drive contain a nonbootable diskette when you turned on the computer?
- Have you installed all the necessary device drivers? For example, if you are using a mouse, you may need to install a mouse device driver.
- Have you installed printer drivers for each application?
- Did you exit properly from Windows before shutting off your computer? Failure to exit properly can result in file corruption.
- Have you scanned the computer for viruses?

While your computer is configured just for you, problems you encounter while working may not be unique. Eliminating the typical problems described in these troubleshooting sections may save you time and money. If you have a problem with your computer, consider the problems and possible solutions in the troubleshooting section. If the problem appears related to a software application, also check the documentation provided with the software. You may discover something you can resolve easily by yourself. If the condition persists, contact your Compaq authorized service provider or the Customer Support Center.

NOTE: You might also consider using Carbon Copy, a support tool that allows a Compaq technical support engineer remote access to your computer in order to help diagnose and fix specific software-related problems under Windows 95.

Solving Audio Problems

Problem	Possible Cause	Solution
Computer does not beep after the Power-On Self-Test (POST)	System beeps have been turned down.	Use the Fn+F5 hotkeys to turn up the system volume.
Internal speaker produces no sound	The volume controls on the left side of the computer may be set too low.	Adjust the volume of the stereo speakers using the volume control buttons on the left side of the computer. The left button adjusts the volume up; the right button adjusts the volume down.
		Use the volume control and mixing features available in Control Panel → Multimedia.
		Adjust the volume using the speaker icon on the taskbar.
	Line input may not be connected properly.	Check line input connection.
	Headphones or speakers are connected to the stereo headphone jack, which disables the internal speakers.	Disconnect the headphones or external speakers to enable the internal speakers.

Continued

Solving Audio Problems *Continued*

Problem	Possible Cause	Solution
External microphone does not work	You are using the wrong type of microphone or microphone plug for the computer.	Check to see if you are using a monophonic electret condenser microphone with a 3.5-mm plug.
	The microphone may not be connected properly.	Ensure that the microphone plug is properly connected to the microphone line-in jack.
	Sound source not selected.	Ensure that microphone is selected as the recording source in Control Panel → Multi-media and that the recording level is adjusted.
No sound is coming from the game program	Audio settings are not set correctly.	Check the game program's audio settings.
	Volume on the computer is turned down.	Adjust the speaker volume control on the left side of the computer.
	Headphones are connected.	Use or disconnect the headphones.
No sound is coming from the headphones	Volume or mixing controls are set incorrectly.	Adjust volume of stereo speakers using the volume controls on the left side of the computer. Use the volume control and mixing features available in Control Panel → Multimedia.
	Sound source not selected.	Verify that the sound source is selected in Control Panel → Multimedia.
	The headphones are connected to the wrong jack.	Check the connection.
Volume is too low or too loud	Volume and/or mixing controls are set incorrectly.	Check the volume and mixer controls in Control Panel → Multimedia.
		Adjust volume of stereo speakers using the volume controls on the left side of the computer.

Solving Battery Problems

Problem	Possible Cause	Solution
Computer is beeping and battery charge light is blinking	The computer has entered a low battery condition.	<p>Save your information, exit all applications, and turn off the computer.</p> <hr/> <p>If available, immediately connect the computer to an external power source.</p> <hr/> <p>If an external power source is not available, in Windows 95, initiate Hibernation by pressing Fn + the suspend button, or let the computer go into Hibernation automatically. Remember that the computer has not completed Hibernation until all lights are off.</p> <hr/> <p>Replace the battery pack.</p> <hr/> <p>Charge the battery pack.</p>
Battery charge light is blinking but computer does not beep	Computer entered a low battery condition while low battery warning beeps and/or system beeps are turned down or off.	<p>Immediately connect the computer to an external power source. If an external power source is not available and you are running Windows 95, be sure that Hibernation is enabled, then initiate Hibernation by pressing Fn + the suspend button, or let the computer go into Hibernation automatically. The computer has not completed Hibernation until all lights are off. Enable low battery warning beeps:</p> <ol style="list-style-type: none">1. Click the Conservation Settings tab in Power Properties and enable low battery warning beeps.2. Press the Fn+F6 hotkeys to adjust volume for system warning beeps.

Continued

Solving Battery Problems *Continued*

Problem	Possible Cause	Solution
Battery pack will not charge	Battery pack was exposed to temperature extremes.	Allow time for the battery pack to return to room temperature.
	Battery pack has exceeded its useful life.	Replace the battery pack.
	Battery pack is already fully charged.	Use the battery pack without attempting to fast charge it.
Computer shut down and information was lost when replacing a battery pack	You removed a battery from the computer when the computer had no other source of power.	Replace the discharged battery pack with a fully charged one or connect the computer to external power. Then turn on the computer to determine if any of your information is recoverable.
Battery charge does not last very long	Battery pack has been exposed to extremely warm temperatures.	Put the computer in a cool place and recharge the battery pack.
	Battery pack has been exposed to extremely cold temperatures.	Put the computer in a warm place and recharge the battery pack.
	Battery has partially self-discharged.	Recharge the battery.
	Power conservation is disabled or set to drain.	Reset the power conservation level.
Battery gauge appears inaccurate	There have been too many partial charges to the battery pack.	The battery pack must be completely discharged then recharged to maintain battery gauge accuracy.

Solving CD-ROM Drive/Compact Disc Problems

Problem	Possible Cause	Solution
CD-ROM drive cannot read a compact disc	The CD is not properly seated in the drive.	Eject the CD, reseal it and close the tray.
	The CD has been loaded upside down.	Eject the CD, turn it over, then reload
	The CD may be dirty or scratched.	Clean the CD and reload it.
		Load another CD.
Cannot eject compact disc	CD is not properly loaded in the drive.	Turn off the computer and insert a thin metal rod into the emergency eject hole on the front bezel of the CD-ROM drive. Press firmly. Slowly pull the tray out from the drive until the tray is fully extended, then remove the CD.

Solving Diskette Drive Problems

Problem	Possible Cause	Solution
Diskette drive light stays on	Diskette is damaged.	If you are running Windows 95, run ScanDisk on the diskette drive to determine the cause of damage. If you are running Windows NT, go to the system prompt and type a: chkdsk . The computer will automatically scan for errors.
	Diskette is incorrectly inserted.	Remove diskette and reinsert.
Diskette drive cannot write to a diskette	Diskette is not formatted.	Format the diskette. If you are running Windows 95: <ol style="list-style-type: none"> 1. From the Windows 95 desktop, double-click on My Computer. 2. Click on 3½ Floppy. 3. Click File → Format. 4. Fill in the appropriate information, then click Start. If you are running Windows NT, format the diskette by entering format a: at the system prompt.
	Diskette is write-protected.	Use a diskette that is not write-protected. If the contents of the diskette may be added to or deleted, remove write-protection from the diskette by sliding the tab on the corner of the disk until the window is closed.
	Computer is writing to the wrong drive.	Check your application to see which drive it is trying to access, then change the drive letter and/or path if necessary.
	Not enough space is left on the diskette.	Copy the information onto a diskette that has more free disk space.
Diskette drive is disabled.	Enable the diskette drive through Device Manager or through Computer Setup.	

Continued

Solving Diskette Drive Problems *Continued*

Problem	Possible Cause	Solution
Diskette drive cannot read a diskette	Diskette is not formatted or is formatted incorrectly.	If you are running Windows 95: <ol style="list-style-type: none">1. From the Windows 95 desktop, double-click on My Computer.2. Click on 3½ Floppy3. Click File → Format.4. Fill in the appropriate information, then click Start. If you are running Windows NT, format the diskette by entering format a: at the system prompt.
	You are using the wrong type of diskette for the drive.	Use the correct diskette type.
Error message appears while information is writing to diskette drive	Diskette was removed while drive light was on.	Diskette or files may be damaged. Recopy the information onto a new or reformatted diskette.



CAUTION: *You should maintain an up-to-date backup of your hard drive at all times in case of errors or failures.*

Solving **Hard Drive Problems**

Problem	Possible Cause	Solution
Reading the hard drive takes an unusually long time after restarting the computer	Computer entered Hibernation due to a low battery condition and is now exiting from it.	Give the computer time to restore the previously saved data to the state it was in before Hibernation occurred.
Hard drive error occurs	Hard drive has bad sectors or has failed.	<p>If you are running Windows 95, run ScanDisk after placing a check in the Automatically Fix Errors box.</p> <p>If you are running Windows NT, go to the system prompt and type chkdisk. The computer will automatically scan for errors.</p> <p>Reformat the hard drive.</p> <p>Contact your Compaq authorized dealer, reseller, or service provider or the Compaq Customer Support Center for assistance.</p>



CAUTION: *Reformatting the hard drive erases all of your files permanently; be sure to make backup diskettes of your information before reformatting the drive. Compaq also recommends that you have a backup of your pre-installed software before reformatting your hard drive.*

Solving Hardware Installation Problems

Problem	Possible Cause	Solution
Hardware devices are not working properly	The system did not automatically configure the new device.	Check the documentation that came with the new device to determine whether any device drivers need to be installed and, if necessary, install the correct device drivers.
	Cable(s) of the new external device may be loose or the power cable may be unplugged.	Ensure that all cables are properly and securely connected.
	The power switch of the new external device is not turned on or was turned on after the computer was turned on.	Place the computer in Suspend by pressing the suspend button. Turn on the new external device. Press the suspend button again to exit Suspend. This allows the system to recognize the new device.
	The device was plugged in while the computer was on or in Suspend and was not recognized by the system.	Turn the computer off. Reattach the new external device and turn it on. Press the power button to start the computer. This allows the system to recognize the new device.

Solving Keyboard Problems

Problem	Possible Cause	Solution
Embedded numeric keypad on the computer keyboard is disabled	Num Lock function is off.	Press Fn+Num Lk to enable the embedded numeric keypad.
Screen is on and keyboard is locked	You initiated QuickLock.	Enter your power-on password to exit QuickLock.
External keyboard does not work	You connected the external keyboard while the computer was still turned on.	Turn off the computer, reconnect the external keyboard, then turn on the computer.

Solving Memory Problems

Problem	Possible Cause	Solution
Memory counting during Power-On Self-Test (POST) is incorrect	Memory board is installed incorrectly.	Ensure that the memory board is installed correctly.
Insufficient memory error during operation	Too many terminate-and-stay resident (TSR) applications are running simultaneously.	Close any TSR applications that you do not need.
	System ran out of memory for the application.	Close all unnecessary applications. Check the documentation that came with the application for memory requirements and add more memory to the computer, if needed.

Solving Modem Problems

Problem	Possible Cause	Solution
Modem loses connection	The connection from the phone line to the modem is loose.	Disconnect, then reconnect the phone cable. Reestablish connection.
	Call Waiting has not been disabled.	To disable Call Waiting: <ol style="list-style-type: none">1. Click Start, Control Panel, double-click Modems.2. From the General tab of the Modems Properties page, click Dialing Properties.3. From the My Location tab of the Dialing Properties page, check the box labeled "This location has call waiting." Then select *70, 70#, or 1170 from the drop-down list to disable call waiting for your dialing area.
	Hibernation was initiated or a low-battery condition occurred.	Restart the communications software to restore the original modem settings after exiting Hibernation or resolving the low-battery condition.

Continued

Solving Modem Problems *Continued*

Problem	Possible Cause	Solution
No dial tone	Phone service is not connected to the telephone wall jack.	Verify service from the local phone company by the following steps: <ol style="list-style-type: none">1. Unplug the modem cable from the telephone wall jack.2. Connect a telephone to the jack, pick up the handset, and listen for a dial tone. If there is a dial tone, reconnect the modem to the telephone wall jack with the telephone cable and make sure all connections are secure. If there is still no dial tone, contact your local phone company or building manager.
	Phone is connected to a digital PBX jack.	Plugging the modem into a digital line will result in no dial tone. Reconnect the modem cable to an analog phone jack, then reestablish connection.
The modem is not responding to commands from the computer keyboard.		Verify the modem and computer are connected: <ol style="list-style-type: none">1. Click Start → Programs → Accessories → HyperTerminal.2. Go to Terminal Mode, then type AT and press the Enter key.3. If the modem displays OK, the modem and computer are working together. If the modem displays ERROR, or does not respond, restart the computer and repeat step 1.4. Type ATDT and listen for a dial tone.5. Type ATHO to hang up.

Continued

Solving Modem Problems *Continued*

Problem	Possible Cause	Solution
Garbled or missing characters, or slow data transfer speed	Noisy phone line.	Contact your local telephone company for a phone line filter. Check your telephone and modem cable connections. If they are slightly loose, this can cause noise on the line.
Recurring prompt to confirm country selection	Current modem country section does not match initial default.	To disable these reminders, change the Home Country selection in the CSA to match the Current Country selection. Refer to "Changing the Country Selection," Chapter 7.
Unable to connect the internal modem at speeds above 33.6Kbps	The site called does not support 56K or supports an incompatible 56K implementation.	The internal modem supports K56flex. Information about Internet service providers (ISPs) that support K56flex may be found on the Compaq web site at www.compaq.com . This site also contains information about updates that may be available for the 56K code in your modem.
	The phone line used does not support 56K implementation.	The 56K protocol requires that the phone line used must contain no more than one analog-to-digital conversion. Try connecting from an alternate site.
	The phone line used is noisy.	The 56K protocol will fall back to lower speeds if the phone line is too noisy for a high-speed connection. Try switching to another phone line.

Solving PC Card Problems



CAUTION: *Installing the wrong software can disable the system. Be sure you are installing PC Card device driver software and NOT Card and Socket Services software. If you are uncertain about this, call the PC Card vendor for specific instructions on software installation.*

Problem	Possible Cause	Solution
Computer does not beep when a PC Card is inserted	Card is not fully inserted into the slot or is upside down.	Try reinserting the card. Be sure the card is inserted in the correct orientation. Insert the card gently to prevent damage to the pins.
	PC Card beeps are disabled.	Click on Control Panel → double-click the PC Card icon → Global Settings tab → PC Card Sound Effects box.
	The PC Card device drivers for your card are not installed.	Network cards, audio cards and other types of PC Cards may need software device drivers in order to function properly. In such cases, refer to the instructions that came with the PC Card or contact the vendor for more information on installing the correct drivers.
	Card design or card driver may not be compatible with the PCMCIA software.	Call Compaq Customer Support for a current list of Compaq qualified PC Cards.

Continued

Solving PC Card Problems *Continued*

Problem	Possible Cause	Solution
Computer beeps only once when a PC Card is inserted	Card is not fully inserted into the slot or is upside down.	Try reinserting the card. Be sure the card is inserted in the correct orientation. Insert the card gently to prevent damage to the pins.
	Card is not recognized by the system.	Load the device drivers that came with the PC Card. Contact the PC Card vendor for updated Windows 95 or Windows NT PC Card device drivers.
	Card did not configure because of a conflict with another device in the computer.	If you are running Windows 95, run Device Manager, locate the card that has the conflict, and click Properties to see a list of resources causing the conflict. Remove the device that has the conflicting resource, then reinsert the PC Card. Call the PC Card vendor or Compaq Customer Support for assistance.
	PC Card device drivers for the card are not installed.	Network cards, audio cards and other types of PC Cards may need software device drivers in order to function properly. In such cases, refer to the instructions that came with the PC Card or contact the vendor for more on installing the correct device drivers.
	Card design or card driver may not be compatible with the PCMCIA software.	Call Compaq Customer Support for a current list of Compaq qualified PC Cards.

Continued

Solving PC Card Problems *Continued*

Problem	Possible Cause	Solution
PC Card drivers fail with error messages during system restart	The PC Card is not configured correctly.	Call the PC Card vendor or Compaq Customer Support for assistance.
Modem/fax PC Card does not work	The modem/fax card conflicts with a system board serial device (e.g., mouse).	If you are running Windows 95, click the modem icon in Device Manager, then click Properties to select another COM port for the modem/fax card. If you are running Windows NT, from the Windows desktop, double-click My Computer. Double-click Control Panel. Then double-click Ports to select another COM port for the modem/fax card.
	Card design or card driver may not be compatible with the PCMCIA software.	Call Compaq Customer Support for a current list of Compaq qualified PC Cards.
Network PC Card does not work	Network driver is not properly installed or configured.	If you are running Windows 95, use the Network Neighborhood to identify information about your network card and setup. Then use the Add New Hardware wizard to install the correct card driver. If you are running Windows NT, from the Windows desktop, double-click My Computer. Double-click Control Panel. Then double-click Networks to identify information about your network card and to install the correct card driver.
	The network card design or card driver may not be compatible with the PCMCIA software.	Call Compaq Customer Support for a current list of Compaq qualified PC Cards.
	Minor configuration adjustments are needed for the PC Card to work in the network operating system environment.	Call Compaq Customer Support or the PC Card vendor for help with configuration requirements.

Continued

Solving PC Card Problems *Continued*

Problem	Possible Cause	Solution
Storage PC Card does not work	Flash memory cards require the Microsoft Flash File System to be loaded.	Load the Microsoft Flash File System.
	The card is not formatted.	Format the PC Card as you would a diskette.
	The card is not supported by the computer.	Call Compaq Customer Support for a current list of Compaq qualified PC Cards.

Solving Power Problems

Problem	Possible Cause	Solution
Computer turned off while it was left unattended and power/suspend light is off	The system initiated Hibernation due to a low battery condition.	Connect the computer to an external power source.
		Charge the battery pack.
		Replace the depleted battery pack with a fully charged battery pack.
Computer turned off while unattended, power/suspend light is off, and information was lost	The computer entered a low battery condition while Hibernation was disabled.	Enable Hibernation through Power Properties after doing one or more of the following: <ol style="list-style-type: none">1. Connect the computer to an external power source.2. Charge the battery pack.3. Replace the battery pack with a fully charged battery pack.

Solving Printer Problems

Problem	Possible Cause	Solution
Printer will not turn on	The cables may not be connected properly or the printer is unplugged.	Ensure that the cables are properly connected and that the power plug is connected to an electrical outlet.
Printer will not print	Printer is not turned on.	Turn on the printer.
	Printer is not online.	Set the printer to online.
	The printer drivers for the application are not installed.	If you are running Windows 95, install the necessary printer drivers using the Add New Hardware wizard. If you are running Windows NT, from the Windows desktop, double-click My Computer. Double-click Control Panel. Then double-click Printers to install the necessary printer drivers.
Printer is offline	Paper tray is empty.	Fill the paper tray with paper. Set the printer to online.
Printer prints garbled information	Correct printer drivers are not installed.	Install the correct printer drivers.
	Cables are not connected properly.	Ensure that the printer cable is properly connected to the computer or convenience base.

Solving Screen Problems

Problem	Possible Cause	Solution
Characters on computer display are dim	The brightness and/or contrast controls are not properly set.	Press Fn+F10 to adjust brightness. On models with passive matrix displays, you can also press Fn+F9 to adjust contrast.
Screen is blank and the power/suspend light is on	A screen blanking utility is initiated.	Press any key and/or enter your power-on password to return your information to the screen.
	Brightness and contrast need adjusting.	Press Fn+F10 to adjust brightness. On models with passive matrix displays, you can also press Fn+F9 to adjust contrast.
	Screen save was initiated.	Press any key to return your information to the screen.
Screen is blank and the power/suspend light is blinking	Suspend is initiated.	Exit Suspend by pressing the suspend button
Screen is blank and the battery charge light is blinking	Computer entered a low battery condition.	If possible, immediately connect the computer to an external power source. If an external power source is not available, initiate Hibernation by pressing Fn + the power button, or let the computer automatically go into Hibernation. The computer has not completed Hibernation until all lights are off.

NOTE: The popup windows used to control brightness and contrast display correctly only when you are in an application that supports the popup video mode. If the popups do not display correctly, exit your application and press the hotkeys again to invoke the popup windows.

Continued

Solving Screen Problems Continued

Problem	Possible Cause	Solution
Screen is blank and no lights are on	The computer has either entered Hibernation or, if Hibernation is disabled, the battery pack has discharged without saving your information.	Connect the computer to an external power source.
		Charge the battery pack.
		Replace the battery pack with a fully charged battery pack.
Screen is blank and keyboard is locked	QuickLock and QuickBlank were initiated. These security features lock the keyboard and pointing device and clear the screen.	Type your power-on password to unlock the keyboard and pointing device and return the information to the screen.
Screen is blank and external monitor displays information	External monitor was turned on before the computer was turned on.	Press Fn+F7 on the computer keyboard to switch from the external monitor to the computer display.
Information does not display on the external monitor	External monitor was connected after the computer was turned on.	Place the computer in Suspend by pressing the suspend button. Be sure the external monitor is connected and turned on, then press the suspend button to exit Suspend.
	The computer does not recognize the correct display type.	Click the Settings tab in Display Properties. Click Change Display Type and reselect your display type, then restart the computer.

Solving Software Application Problems

Most software application or installation problems occur as a result of one or more of the following:

- The application was not installed correctly.
- Memory was not allocated correctly.
- A conflict exists between applications.

Solving Software Application Problems

Problem	Possible Cause	Solution
Insufficient memory to run application	There is not enough memory for the application.	Check the documentation that came with the software for memory requirements and install additional memory, if needed. <hr/> Call Compaq Customer Support for help with memory optimization.
Cannot run application from current directory	The application has not been added to the path statement in the AUTOEXEC.BAT file.	Using Windows Notepad, add the application directory with the full path name to the AUTOEXEC.BAT file.

Solving Pointing Device Problems

Problem	Possible Cause	Solution
External pointing device is not working	The external pointing device was connected to the computer while the computer was on.	Press the suspend button to initiate Suspend. Press the suspend button again to exit Suspend. This allows the computer to recognize the pointing device.
Touchpad is not working	Incorrect or no device driver is installed.	Install the correct device driver using the Add New Hardware wizard.
Device driver is loaded but pointing device does not work	The wrong mouse is selected.	<p>If you are running Windows 95, using the keyboard, select Automatically detect installed hardware in the Add New Hardware wizard. Then use the arrow keys to highlight the mouse icon in the selection box and choose the correct mouse hardware.</p> <p>If you are running Windows NT, using the keyboard, press F6. Then use the arrow keys to highlight My Computer, and press Enter. Use the arrow keys to highlight Control Panel, and press Enter. Use the arrow keys to highlight Mouse, and press Enter. Select the correct mouse hardware, and press Enter.</p>

Solving Infrared Problems

Problem	Possible Cause	Solution
Cannot communicate with another computer	The required software is not running on both computers.	Install the required software on the second computer, start the second device and start the program on both computers.
	One computer does not have an IrDA-compliant infrared port.	Communication between infrared devices must use the same protocol.
	The pathway between the infrared ports is obstructed, one port is more than 30 degrees (plus or minus 15 degrees off the center line) from the other, or the ports are more than 1.5 feet (about 0.5 meter) apart.	Remove the obstruction, align the infrared ports to within 30, and position computers within 1.5 feet (about 0.5 meter) of each other.
	There is an interrupt request (IRQ) conflict.	Check for IRQ conflicts in the Device Manager on one or both computers. If the Device Manager indicates an IRQ conflict, reassign the IRQ number for one of the conflicting devices.
	There is a baud rate conflict.	Select the same baud rate for both computers.
	There is a conflict with the # bits.	Select the same "# bits" setting for both computers.
	There is a stop bit conflict.	Select the same stop bit for both computers.
	There is a parity conflict.	Select the same parity setting for both computers.

Continued

Solving Infrared Problems *Continued*

Problem	Possible Cause	Solution
Cannot transmit data	Direct sunlight, fluorescent light, or flashing incandescent light is close to the infrared connections.	Remove the interfering light source(s).
	There is interference from other wireless devices.	Keep remote control devices such as wireless headphones and other audio devices away from the infrared connections.
	A physical obstruction is in the way.	Do not place objects that will interfere with a line-of-sight data transmission between the two devices.
	One of the devices was moved during data transmission.	Do not move either device during data transmission.
	The orientation of the units is incorrect.	Adjust the devices so that they point directly at each other.
	The distance between the devices is too great.	Verify that devices are not more than 1.5 feet (0.5 meter) apart.
Infrared port does not work	Direct sunlight, fluorescent light, or flashing incandescent light is close to the infrared connection.	Remove the interfering light source(s).
	There is interference from other wireless devices.	Keep remote control devices such as wireless headphones and other audio devices away from the infrared connections.

Solving USB Problems

Problem	Possible Cause	Solution
External device connected to a USB connector does not work	The operating system limits external devices connected by USB to two tiers which can include no more than two hubs on the first tier and no more than one keyboard and one pointing device on the first or second tier.	Reduce the number of connected external USB devices to no more than two hubs on the first tier, and no more than one keyboard and one pointing device on the first or second tier.
External device connected to USB connector does not work during startup (before Windows 95 loads)	During startup, only two tiers are supported by the USB connector. These tiers can include no more than two hubs on the first tier and no more than one keyboard and one pointing device on the first or second tier.	Use the external device only after Windows 95 has loaded. <hr/> Reduce the number of connected external USB devices to no more than two hubs on the first tier, and no more than one keyboard and one pointing device on the first or second tier.
External devices in lower tiers do not work	An unpowered hub is connected to another unpowered hub.	Use only powered hubs. <hr/> Make sure that all unpowered hubs are immediately preceded by powered hubs in the USB chain.

IMPORTANT: External USB keyboards will not function until the operating system has been booted.

COMPAQ CUSTOMER SUPPORT

Preparing for a Technical Support Call

If you cannot solve a problem using the troubleshooting tips in this guide, you may need to call technical support. To receive the fastest possible solution when you call, run the Compaq diagnostics utilities and have the following available when you call:

- The computer
- Serial number on the bottom of the computer
- Purchase date on invoice
- Conditions under which the problem occurred
- Error messages that occurred
- Hardware configuration
- Type of printer connected
- Hardware and software you are using
- Product identification number (PIN), which you entered when you set up the computer. (Click Start → Settings → Control Panel → System → General tab. Your PIN number is below your name.)
- Printed error message log from Computer Checkup (TEST), or a list of the devices and error messages received
- Configuration settings in View System Information (INSPECT), including contents of the system files

NOTE: If you take your computer to a Compaq authorized reseller, dealer, or service provider for service, remember to provide the power-on and setup passwords, if they are set.

Worldwide Telephone Numbers

Locate your geographical area in the following table and use one of the telephone numbers for Compaq assistance.

NOTE: If the number listed in your geographical region is not valid, refer to the Compaq website at www.compaq.com for the most current support telephone numbers.

General Information Numbers—Product information, technical assistance, and the location of your nearest Compaq authorized dealer, reseller, or service provider.

Technical Support Numbers—Hardware technical support in analyzing system configuration and diagnostic problems or troubleshooting.

Customer Support Numbers—Information on service and support programs including warranty, product catalogs, and white papers.

PaqFax Numbers—Automatic facsimile response system for technical and product-specific information that is transmitted to any fax machine. PaqFax is available 24 hours a day.

NOTE: Telephone numbers are subject to change without notice.

* Indicates toll-free domestic numbers.

Worldwide Telephone Numbers

Location	Country Code	Telephone Number
Argentina		
General Information	+54	-1-704-3800
Technical Support	+54	-38 1 704 00
Fax	+54	-1-704-3809
Australia		
General Information	+61	-2-9911-1999
Customer Service	+61	1 300 368 369
Technical Support	+61	-2-9911-1955
PaqFax	+61	-2-9911-1982
Austria		
General Information	+43	01-7956-7700
Technical Support	+43	01-7956-7700
Fax	+43	01-7956-7999

Continued

Worldwide Telephone Numbers

Location	Country Code	Telephone Number
Belgium		
General Information	32	02/713.13.00
Technical Support		0900-102.01 (6.05BEF/18s)
Fax	+32	02/713.14.44
QuickLine BBS	+32	02/716.95.92
Brazil		
General Information	+55	(11) 5188-4600
Canada		
General Information		1-905-707-1715
Product Information*		1-800-567-1616
Technical Support*		1-800-OKCOMPAQ (1-800-652-6672)
Customer Support*		1-800-263-5868
Order Software Backup*		1-800-952-7689
Battery Pack Recycling*		1-800-263-5868
Caribbean		
Technical Support		1-281-518-2200
Chile		
General Information	+56	-2-200-8100
Technical Support	+56	-2-225-9490
China		
General Information	+86	-10-6831-3399
Technical Support	+86	-10-6834-6721
Customer Response Center	+86	-10-6834-6738
BBS	+86	-10-6834-6709
PaqFax	+86	-10-6834-6724
Verification Center	+86	-10-6834-6739
Management Service Center	+86	-10-6831-3399 ext. 5873

Continued

Worldwide Telephone Numbers

Location	Country Code	Telephone Number
Colombia		
General Information	+57	-1-312-0201
Technical Support	+57	-1-523-1800
Czech Republic		
General Information	+420	2 22 187 111
Technical Support	+420	2 22 187 111
Denmark		
General Information	+45	45-90-45-90
Technical Support	+45	45-90-45-45
QuickLine BBS	+45	45-90-45-50
Eastern Europe, Middle East, and Africa		
Technical Support and Information	+353	1-402-6833
Technical Support Fax	+353	1-402-6855
Ecuador		
General Information	+59	-3-225-4343
Finland		
General Information	+358	0204 121
Technical Support*)		0203-206-720
France		
General Information*		0803 804 805 (1,09 FTTC/mn)
Technical Support*		0803 813 823 (1,09 FTTC/mn)
QuickLine BBS (RTC Standard)	+33	0141 33 44 50
QuickLine BBS (RNIS)	+33	0141 33 42 25
Germany		
General Information*		0180/3 22 12 21 (0,24 DM/min.)
General Information Fax*		0180/3 22 12 20 (0,24 DM/min.)
All Products Fax*		0180/5 21 21 17 (0,48 DM/min.)
Portables Hotline*		0180/5 21 21 11 (0,48 DM/min.)

Continued

Worldwide Telephone Numbers

Location	Country Code	Telephone Number
Greece		
General Information	+30	1 6141-371
Fax	+30	1 6141-370
Hong Kong		
General Information	+852	-28681600
Technical Support	+852	-90116633
PaqFax	+852	-28671648
Hungary		
General Information	+36	1-457-3650
Technical Support	+36	1-457-3680
Email		Info.hu@compaq.com
India		
General Information	+91	-80-559-6023
PaqFax	+91	-80-559-8989
BBS	+91	-80-559-8900
Ireland		
General Information*		01800 409 454
Israel		
General Information	+972	(03) 6363-444
Fax	+972	(03) 639-6601
Technical Support	+353	-1-402-6833
Italy		
General Information		0167 464911
Technical Support	+39	2 69633281
QuickLine BBS	+39	2 89200222
Fax	+39	2 69633282
Japan		
General Information*		0120-101-589
Technical Support*		0120-101-589
Windows 95 Support*		0120-505-589
Order Software Backup *		0120-250-589
FaxStation		81-3-5402-0991

Continued

Worldwide Telephone Numbers

Location	Country Code	Telephone Number
Korea		
Product Information	+82	-2-3470-0700
Technical Support	+82	-2-523-3575
Customer Support*		080-902-7777
Luxembourg		
General Information	352	49 1302 (12, 5FLUX/min)
Technical Support		089 89 232
Fax	352	49 14 40
QuickLine BBS	352	2 716 95 92
Malaysia		
General Information	+60	-3-754-1122
Customer Response Center	+60	-3-754-1155
Mexico		
General Information	+52	-5-229-7900
Technical Support	+52	-5-262-7180
PaqFax	+52	-5-229-7920
Netherlands		
General Information	+31	182 565 805
Technical Support*		0900-1681616 (Dfl. 0.75/min)
Fax*		0900-8991116 (Dfl. 0.40/min)
New Zealand		
General Information	+64	-9-307-3969
Technical Support	+64	-9-379-4646
Customer Support Center	+64	-9-379-7001
Norway		
General Information	+47	22-07-20-20
Technical Support	+47	22-07-20-20
Fax	+47	22-07-20-21

Continued

Worldwide Telephone Numbers

Location	Country Code	Telephone Number
Peru		
General Information	+51	-1-222-5012
Poland		
General Information	+48	(22)-630-3535
Technical Support	+48	(22)-630-3535
Portugal		
General Information	+351	-1-412-8400
Technical Support	+351	-1-412-8460
Technical Support	+351	-1-412-8417
Fax	+351	-1-412-0654
Russia		
General Information	+7	096-967-1700
Technical Support	+7	096-967-1700
Singapore		
General Information	+65	750-3030
Customer Response Center	+65	750-3030
PaqFax	+65	750-4514
South Africa		
General Information	+27	11 356 4444
Technical Support	+27	11 356 4444
Fax	+27	11 483 3411
Spain		
General Information	+34	902 10 14 14
Technical Support	+34	91-377-81-87
Fax	+34	91 634 88 11
Sweden		
General Information	+46	8-703-52 40
Technical Support*		0729-36 20 00 (75 SK per call)
Fax	+46	8 587-711 43

Continued

Worldwide Telephone Numbers

Location	Country Code	Telephone Number
Switzerland		
InfoLine*		0844 844 111
Technical Support (German)	+41	01/838 22 22
Technical Support (French)	+41	01/838 22 23
Taiwan		
General Information	+886	-2-7351000
Technical Support	+886	-2-3761170
Thailand		
General Information	+66	-2-679-6222
Turkey		
General Information	+90	(0212) 2363 241
Fax	+90	(0212) 2363 242
United Arab Emirates (Dubai)		
General Information	+97	14-818100
United Kingdom		
General Information*		0845-270 4000
General Information	+44	-141-270 4000
FaxPaq	+44	-181-332-3550
QuickLine BBS	+44	-181-332-9499
United States		
Product Information*		1-800-345-1518
Technical Support*		1-877-456-7878
PaqFax*		1-800-345-1518, Option 1
Download Facility* (modem access only)		1-281-518-1418
Ordering Software Backup*		1-800-952-7689
Battery Pack Recycling*		1-800-524-9859
Venezuela		
General Information	+58	-2-953-0854
Technical Support	+58	-2-953-9705

appendix **B**

REGULATORY NOTICES

Throughout these regulatory notices, Compaq products are referred to by their regulatory agency series numbers.

Regulatory Agency Series Numbers

Regulatory agencies worldwide use agency series numbers for product identification. Each approved product displays the assigned agency series number. To ensure continued safe and reliable operation, use your portable computer only with the products listed below:

Product	Agency Series Number
Notebook CPUs	PP2000
Lithium Ion Battery Pack	P2921A
Convenience Base	PP2005A
Convenience Base	PP2005B
Internal Modem	NC1005
Convenience Base	2925
Convenience Base	2926
External Battery Charger	2923

Federal Communications Commission Notice

This equipment has been tested and found to comply with the limits for a Class B digital device, pursuant to Part 15 of the FCC Rules. These limits are designed to provide reasonable protection against harmful interference in a residential installation. This equipment generates, uses, and can radiate radio frequency energy and, if not installed and used in accordance with the instructions, may cause harmful interference to radio communications. However, there is no guarantee that interference will not occur in a particular installation. If this equipment does cause harmful interference to radio or television reception, which can be determined by turning the equipment off and on, the user is encouraged to try to correct the interference by one or more of the following measures:

- Reorient or relocate the receiving antenna.
- Increase the separation between the equipment and receiver.
- Connect the equipment into an outlet on a circuit different from that to which the receiver is connected.
- Consult the dealer or an experienced radio or television technician for help.

Modifications

The FCC requires the user to be notified that any changes or modifications made to this device that are not expressly approved by Compaq Computer Corporation may void the user's authority to operate the equipment.

Cables

Connections to this device must be made with shielded cables with metallic RFI/EMI connector hoods to maintain compliance with FCC Rules and Regulations.

Declaration of Conformity for Products Marked with the FCC Logo (United States only)

This device complies with Part 15 of the FCC Rules. Operation is subject to the following two conditions: (1) this device may not cause harmful interference, and (2) this device must accept any interference received, including interference that may cause undesired operation.

For questions regarding this declaration, write

Compaq Computer Corporation
P. O. Box 692000, Mail Stop 510101
Houston TX 77269-2000
or call 281-514-3333

To identify your product, refer to the part, series, or model number found on the product.

If you have questions about your product that are *not* related to this declaration, please write

Compaq Computer Corporation
P. O. Box 692000, Mail Stop 530113
Houston TX 77269-2000

or call Compaq

Product Information Center	1-800-345-1518
Technical Support	1-877-456-7878

Canadian Notice

This Class B digital apparatus meets all requirements of the Canadian Interference-Causing Equipment Regulations.

Avis Canadien

Cet appareil numérique de la classe B respecte toutes les exigences du Règlement sur le matériel brouilleur du Canada.

European Notice

Products with the CE Marking comply with both the EMC Directive (89/336/EEC) and the Low Voltage Directive (73/23/EEC) issued by the Commission of the European Community.

Compliance with these directives implies conformity to the following European Norms:

- EN55022 (CISPR 22)—Electromagnetic Interference
- EN50082-1 (IEC801-2, IEC801-3, IEC801-4)—Electromagnetic Immunity
- EN60950 (IEC950)—Product Safety

Japanese Notice

この装置は、情報処理装置等電波障害自主規制協議会（VCCI）の基準に基づくクラスB情報技術装置です。この装置は、家庭環境で使用することを目的としていますが、この装置がラジオやテレビジョン受信機に近接して使用されると、受信障害を引き起こすことがあります。

取扱説明書に従って正しい取り扱いをして下さい。

German Ergonomics Notice

COMPAQ Series PP2000 laptop computers bearing the “GS” approval mark meet the requirements of ZH 1/618 (German Safety Regulations for Display Work Places in the Office Sector) when used in conjunction with docking bases, keyboards, and monitors that bear the “GS” approval mark. The COMPAQ Series PP2000 of laptop computers in a standalone mode are not intended for continuous use in an office environment.

Airline Travel Notice

Use of electronic equipment aboard commercial aircraft is at the discretion of the airline.

Energy Star Compliance

This computer is compliant with the U.S. Environmental Protection Agency (EPA) Energy Star Computers Program 2.0. The EPA Energy Star logo does not imply endorsement by the EPA. As an Energy Star Partner, Compaq Computer Corporation has determined the product meets the Energy Star guidelines for energy efficiency.

Battery Notice



WARNING: This computer contains a lithium ion battery pack. There is a risk of fire and chemical burn if the battery pack is handled improperly. Do not disassemble, crush, puncture, short external contacts, dispose in water or fire, or expose it to temperatures higher than 60°C (140°F). Replace only with the Compaq battery pack for this computer.

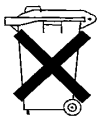

In North America, dispose of nickel metal hydride or lithium ion batteries by taking advantage of the Compaq battery recycling program. You will be provided with a postage-paid battery pack mailer preaddressed to a reclamation facility where the metals are recycled. Call the telephone number listed for your location in Appendix A for more information.

In Europe, do not dispose of batteries with general household waste. Dispose of or recycle them by using the public collection system or returning them to Compaq, your authorized Compaq partners, or their agents.

Power Cords

If you were not provided with a power cord for your computer or for an AC power accessory intended for use with your computer, you should purchase a power cord that is approved for use in your country.

The power cord must be rated for the product and for the voltage and current marked on the product's electrical ratings label. The voltage and current rating of the cord should be greater than the voltage and current rating marked on the product. In addition, the diameter of the wire must be a minimum of 0.75 mm²/18AWG, and the length of the cord must be between 5 feet (1.5 m) and 6½ feet (2 m). If you have questions about the type of power cord to use, contact your Compaq authorized service provider.

A power cord should be routed so that it is not likely to be walked on or pinched by items placed upon it or against it. Particular attention should be paid to the plug, electrical outlet, and the point where the cord exits from the product.

Laser Safety

All Compaq systems equipped with laser products comply with appropriate safety standards, including IEC 825. With specific regard to the laser, the equipment complies with laser product performance standards set by government agencies for Class 1 laser products. It does not emit hazardous light; the beam is totally enclosed during all modes of customer operation and maintenance.

CDRH Regulations

The Center for Devices and Radiological Health (CDRH) of the U.S. Food and Drug Administration implemented regulations for laser products on August 2, 1976. These regulations apply to laser products manufactured from August 1, 1976. Compliance is mandatory for products marketed in the United States.



WARNING: Use of controls or adjustments or performance of procedures other than those specified herein or in the laser product installation guide may result in hazardous radiation exposure.



This system is classified as a Class 1 laser product. This label appears on the laser product.

Laser Information

Laser Type:	Semiconductor GaAlAs
Wave Length:	$780 \pm 35 \text{ nm}$
Divergence Angle:	$53.5^\circ \pm 1.5^\circ$
Output Power:	Less than 0.2mW or $10,869 \text{ W}\cdot\text{m}^{-2}\cdot\text{sr}^{-1}$
Polarization:	Circular
Numerical Aperture:	0.45 ± 0.04

Only authorized technicians trained by Compaq should attempt to repair this equipment. All troubleshooting and repair procedures are detailed to allow only subassembly/module level repair. Because of the complexity of the individual boards and sub-assemblies, no one should attempt to make repairs at the component level or to make modifications to any printed wiring board. Improper repairs can create a safety hazard.

Modems

Consult the *Important Modem Information* booklet for information on safety and regulations governing the use of modems.

appendix **B**

REGULATORY NOTICES

Throughout these regulatory notices, Compaq products are referred to by their regulatory agency series numbers.

Regulatory Agency Series Numbers

Regulatory agencies worldwide use agency series numbers for product identification. Each approved product displays the assigned agency series number. To ensure continued safe and reliable operation, use your portable computer only with the products listed below:

<i>Product</i>	<i>Agency Series Number</i>
Notebook CPUs	PP 200
Lithium Ion Battery Pack	P 201
Convenience Base	PP 206A
Convenience Base	PP 206B
Internal Modem	NC 106
Convenience Base	2025
Convenience Base	2026
External Battery Charger	2023

Federal Communications Commission Notice

This equipment has been tested and found to comply with the limits for a Class B digital device, pursuant to Part 15 of the FCC Rules. These limits are designed to provide reasonable protection against harmful interference in a residential installation. This equipment generates, uses, and can radiate radio frequency energy and, if not installed and used in accordance with the instructions, may cause harmful interference to radio communications. However, there is no guarantee that interference will not occur in a particular installation. If this equipment does cause harmful interference to radio or television reception, which can be determined by turning the equipment off and on, the user is encouraged to try to correct the interference by one or more of the following measures:

- Reorient or relocate the receiving antenna.
- Increase the separation between the equipment and receiver.
- Connect the equipment into an outlet on a circuit different from that to which the receiver is connected.
- Consult the dealer or an experienced radio or television technician for help.

Modifications

The FCC requires the user to be notified that any changes or modifications made to this device that are not expressly approved by Compaq Computer Corporation may void the user's authority to operate the equipment.

Cables

Connections to this device must be made with shielded cables with metallic RFI/EMI connector hoods to maintain compliance with FCC Rules and Regulations.

Declaration of Conformity for Products Marked with the FCC Logo (United States only)

This device complies with Part 15 of the FCC Rules. Operation is subject to the following two conditions: (1) this device may not cause harmful interference, and (2) this device must accept any interference received, including interference that may cause undesired operation.

For questions regarding this declaration, write

Compaq Computer Corporation
P. O. Box 692000, Mail Stop 510101
Houston TX 77269-2000
or call 281-514-3333

To identify your product, refer to the part, series, or model number found on the product.

If you have questions about your product that are *not* related to this declaration, please write

Compaq Computer Corporation
P. O. Box 692000, Mail Stop 530113
Houston TX 77269-2000

or call Compaq

Product Information Center	1-800-345-1518
Technical Support	1-877-456-7878

Canadian Notice

This Class B digital apparatus meets all requirements of the Canadian Interference-Causing Equipment Regulations.

Avis Canadien

Cet appareil numérique de la classe B respecte toutes les exigences du Règlement sur le matériel brouilleur du Canada.

European Notice

Products with the CE Marking comply with both the EMC Directive (89/336/EEC) and the Low Voltage Directive (73/23/EEC) issued by the Commission of the European Community.

Compliance with these directives implies conformity to the following European Norms:

- EN55022 (CISPR 22)—Electromagnetic Interference
- EN50082-1 (IEC801-2, IEC801-3, IEC801-4)—Electromagnetic Immunity
- EN60950 (IEC950)—Product Safety

Japanese Notice

この装置は、情報処理装置等電波障害自主規制協議会（VCCI）の基準に基づくクラスB情報技術装置です。この装置は、家庭環境で使用することを目的としていますが、この装置がラジオやテレビジョン受信機に近接して使用されると、受信障害を引き起こすことがあります。

取扱説明書に従って正しい取り扱いをして下さい。

German Ergonomics Notice

COMPAQ Series PP2000 laptop computers bearing the “GS” approval mark meet the requirements of ZH 1/618 (German Safety Regulations for Display Work Places in the Office Sector) when used in conjunction with docking bases, keyboards, and monitors that bear the “GS” approval mark. The COMPAQ Series PP2000 of laptop computers in a standalone mode are not intended for continuous use in an office environment.

Airline Travel Notice

Use of electronic equipment aboard commercial aircraft is at the discretion of the airline.

Energy Star Compliance

This computer is compliant with the U.S. Environmental Protection Agency (EPA) Energy Star Computers Program 2.0. The EPA Energy Star logo does not imply endorsement by the EPA. As an Energy Star Partner, Compaq Computer Corporation has determined the product meets the Energy Star guidelines for energy efficiency.

Battery Notice



WARNING: This computer contains a lithium ion battery pack. There is a risk of fire and chemical burn if the battery pack is handled improperly. **Do not** disassemble, crush, puncture, short external contacts, dispose in water or fire, or expose it to temperatures higher than 60°C (140°F). Replace only with the Compaq battery pack for this computer.

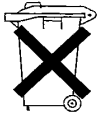

In North America, dispose of nickel metal hydride or lithium ion batteries by taking advantage of the Compaq battery recycling program. You will be provided with a postage-paid battery pack mailer preaddressed to a reclamation facility where the metals are recycled. Call the telephone number listed for your location in Appendix A for more information.

In Europe, do not dispose of batteries with general household waste. Dispose of or recycle them by using the public collection system or returning them to Compaq, your authorized Compaq partners, or their agents.

Power Cords

If you were not provided with a power cord for your computer or for an AC power accessory intended for use with your computer, you should purchase a power cord that is approved for use in your country.

The power cord must be rated for the product and for the voltage and current marked on the product's electrical ratings label. The voltage and current rating of the cord should be greater than the voltage and current rating marked on the product. In addition, the diameter of the wire must be a minimum of 0.75 mm²/18AWG, and the length of the cord must be between 5 feet (1.5 m) and 6½ feet (2 m). If you have questions about the type of power cord to use, contact your Compaq authorized service provider.

A power cord should be routed so that it is not likely to be walked on or pinched by items placed upon it or against it. Particular attention should be paid to the plug, electrical outlet, and the point where the cord exits from the product.

Laser Safety

All Compaq systems equipped with laser products comply with appropriate safety standards, including IEC 825. With specific regard to the laser, the equipment complies with laser product performance standards set by government agencies for Class 1 laser products. It does not emit hazardous light; the beam is totally enclosed during all modes of customer operation and maintenance.

CDRH Regulations

The Center for Devices and Radiological Health (CDRH) of the U.S. Food and Drug Administration implemented regulations for laser products on August 2, 1976. These regulations apply to laser products manufactured from August 1, 1976. Compliance is mandatory for products marketed in the United States.



WARNING: Use of controls or adjustments or performance of procedures other than those specified herein or in the laser product installation guide may result in hazardous radiation exposure.



This system is classified as a Class 1 laser product. This label appears on the laser product.

Laser Information

Laser Type:	Semiconductor GaAlAs
Wave Length:	780 ± 35 nm
Divergence Angle:	$53.5^\circ \pm 1.5^\circ$
Output Power:	Less than 0.2mW or $10,869 \text{ W}\cdot\text{m}^{-2}\cdot\text{sr}^{-1}$
Polarization:	Circular
Numerical Aperture:	0.45 ± 0.04

Only authorized technicians trained by Compaq should attempt to repair this equipment. All troubleshooting and repair procedures are detailed to allow only subassembly/module level repair. Because of the complexity of the individual boards and sub-assemblies, no one should attempt to make repairs at the component level or to make modifications to any printed wiring board. Improper repairs can create a safety hazard.

Modems

Consult the *Important Modem Information* booklet for information on safety and regulations governing the use of modems.

ELECTROSTATIC DISCHARGE

A discharge of static electricity from fingers or other electrostatic conductors may damage electronic components. Before handling electrostatic-sensitive components, discharge static electricity by one of the methods described in this appendix.

Preventing Electrostatic Discharge

When Handling Removable Drives

To prevent electrostatic damage to removable drives, observe these precautions:

- Before handling a removable drive, discharge static electricity by touching the unpainted metal surface or lug nuts on the connectors on the back of the computer.
- Avoid touching connector pins on the computer and on the removable drive.
- Keep a removable drive in its carrying case until you are ready to insert it into a drive bay.

When Installing Internal Components

To prevent electrostatic damage when installing internal components, observe these precautions:

- Keep components in their electrostatic-safe containers until you are ready to install them.
- Have everything needed for the installation within reach so that you do not have to leave the area after beginning installation.
- Use nonmagnetic tools.

- Before touching an electronic component, discharge static electricity by one of the grounding methods described later in this appendix. If you must leave the area during installation, remember to reground yourself before resuming installation.
- Avoid touching pins, leads, and circuitry. Handle electronic components as little as possible.
- If you remove a component, place it in an electrostatic-safe container.

Grounding Methods

There are several methods for grounding. Use one or more of the following grounding methods when installing components in the computer or expansion base.

- Touch the unpainted metal surface or lug nuts on the connectors on the back of the computer or expansion base. Avoid touching connector pins. If installation instructions direct you to unplug the computer or expansion base, unplug it after being properly grounded and before removing the cover.
- Touch an exterior unpainted metal surface of equipment that is connected to an electrical outlet by a grounding plug.
- Use a wrist strap connected by a ground cord to the computer chassis. Wrist straps are flexible grounding straps with a minimum of 1 megohm \pm 10 percent resistance in the ground cords. To provide proper ground, wear the strap snug against the skin.

NOTE: If you need more information about static electricity or assistance with product installation, contact your Compaq authorized dealer, reseller, or service provider.

appendix **D**

SPECIFICATIONS

Specifications		
Temperature		
Operating	5 to 104°F	10 to 35°C
Nonoperating	-22 to 40°F	-30 to 60°C
Relative Humidity (noncondensing)		
Operating	10 to 90% across the operating range	10 to 90%
Nonoperating ($t_w = 38.7^\circ\text{C}$ max)	5 to 90% RH, 38.7°C maximum Wet Bulb temperature	5 to 90%
Altitude		
Operating	0 to 10,000 ft	0 to 3.15 km
Nonoperating	0 to 30,000 ft	0 to 10.14 km

NOTE: Applicable product safety standards specify thermal limits for plastic surfaces. This computer operates well within this range of temperatures.

INDEX

A

- AC power connector, 2-5
- adjusting
 - keyboard using tilt feet. *See* keyboard
- alerts
 - system. *See* Intelligent Manageability, Fault Management
- Alt keys, 3-4
- applications. *See* software
- arrow keys
 - location of the. *See* keyboard
- AT commands. *See* internal modem
- audio
 - components overview, 10-1
 - controlling volume, 10-4
 - identifying components, 10-2
 - problems. *See* troubleshooting
 - using internal and external microphones, 10-3
 - using internal and external speakers/headphones, 10-3

B

- base reflex speaker port
 - location of the. *See* components, right side
 - side. *See* components, left side
- Battery bay, 2-2
- battery bay locations, 4-1
- battery gauge
 - ensuring accuracy of the, 4-5
 - using the, 4-4
- battery packs
 - charging, 4-3
 - first time charge, 1-2
 - identifying a low battery condition.
See low battery condition
 - inserting into the battery bay, 4-8
 - learning about, 4-1
 - maximizing life of, 4-9
 - problems with. *See* troubleshooting
 - recharge time, 4-1
 - recycling used, 4-10
 - removing from the battery bay, 4-7

- setting battery conservation level. *See* power management
 - storing, 4-9
 - using new, 4-2
- beeps
- turning on or off, 4-12
 - with a blinking battery light, 4-11
 - with a blinking power/suspend light, 4-11
- boot sequencing. *See* utilities

C

- cable lock. *See* security
 - location of the. *See* components, left side
- Caps Lock key
 - location of the. *See* keyboard
- caring for the computer, 12-1
- CD-ROM drive
 - inserting compact disc into, 6-4
 - manually ejecting compact disc, 6-5
 - problems. *See* troubleshooting
 - removing a diskette from, 6-4
 - upgrading to. *See* upgrading the computer
- commands
 - modem. *See* internal modem
- Compaq
 - phone numbers, A-2
- Compaq Diagnostics, A-1
- Compaq Support, A-1
- components
 - audio. *See* audio
 - bottom, 2-6
 - front, 2-1
 - keyboard, 3-1
 - left side, 2-3
 - rear, 2-5
 - right side, 2-4
- computer
 - care, 12-1
 - opening for first time, 1-4
 - serial number, A-1
- computer power. *See* power

- computer setup
 - completing, 1-9
 - exiting, 15-3
 - operating the computer during, 1-7
 - overview, 15-1
 - running, 15-2
- configuration
 - hardware. *See* Computer Setup
- connecting
 - the power cord, 1-3
- connecting external devices. *See* external devices
- contents of computer box, 1-1
- convenience base
 - docking computer to. *See* external devices
 - undocking computer from. *See* external devices
- conventions used in guide, xiii
- cooling fan
 - location of the. *See* components, rear
- Ctrl keys
 - location of the. *See* keyboard
- cursor control. *See* touchpad
- cursor keys
 - location of the. *See* keyboard
- customer support, A-2

D

- damage, preventing
 - from electrostatic discharge, C-1
 - internal components, C-1
 - removable drives, C-1
- defaults
 - modem. *See* internal modem
- device bays configurations, 6-1
- device disabling/enabling. *See* security
- diagnostics. *See* utilities
- dial modifiers. *See* internal modem
- diskette drive
 - inserting a diskette, 6-3
 - removing a diskette, 6-3
 - selecting diskettes, 6-3
- display
 - caring for the, 12-2
 - location of the. *See* components, front
 - problems. *See* troubleshooting
- docking connector
 - location of the. *See* components, rear
- DOS. *See* MS-DOS

- DriveLock
 - changing the master password, 13-18
 - changing the user password, 13-16
 - overview, 13-13
 - user and master passwords overview, 13-14
- drivers. *See* device drivers
- drives
 - removable. *See* removable drives
- drives supported. *See* device bays configurations
- DVD drive
 - upgrading to. *See* upgrading the computer

E

- electrostatic discharge, C-1
- embedded numeric keypad
 - location of the. *See* keyboard
 - using the, 3-7
- Enter key
 - location of the. *See* keyboard
- ESD. *See* electrostatic discharge
- external devices
 - connecting a mouse or pointing device, 8-2
 - connecting a parallel printer, 8-3
 - connecting a serial printer, 8-3
 - connecting enhanced keyboard, 8-1
 - connecting infrared equipment, 8-5
 - connecting monitor, 8-1
 - connecting television monitor, 8-2
 - connecting USB peripherals, 8-6
 - docking computer to convenience base, 8-4
 - undocking computer from convenience base, 8-5
- external monitor connector
 - location of the. *See* components, rear

F

- floppy disk drive. *See* diskette drive
- Fn key
 - location of the. *See* keyboard
- function keys
 - location of the. *See* keyboard

G

grounding methods, C-2

H

hard drive

problems. *See* troubleshooting
upgrading. *See* upgrading the
computer

using a second. *See* MultiBay

hard drive compartment

location of the. *See* components,
bottom

hard drive, problems, 16-9

hardware

configuration. *See* Computer Setup
installation problems. *See*
troubleshooting

hibernation

disabling, 5-8

enabling, 5-7

exiting, 5-8

initiating, 5-7

using, 5-7

hotkeys

quick reference, 3-5

using, 3-5

I

I/O address. *See* input/output address

infrared

problems. *See* troubleshooting

infrared equipment

connecting. *See* external devices

infrared port

location of the. *See* components, rear

INSPECT

View System Information. *See*
utilities

Intelligent Manageability

Asset Management, 14-2

changing the Asset Tag number, 14-2

Configuration Management, 14-4

Fault Management, 14-3

Fault Management Alerts, 14-3

overview, 14-1

Security Management, 14-4

internal microphone

location of the. *See* components, front
internal modem

AT command set, 7-13

audio response codes, 7-17

changing the country selection, 7-3

compatibility, 7-9

connecting the, 7-2

defaults, 7-5

dial modifiers, 7-15

guidelines for using AT commands,
7-11

overview, 7-1

problems. *See* troubleshooting

result codes, 7-5

S registers, 7-15

software overview, 7-4

specifications, 7-8

understanding how modem works,
7-2

uninstalling the, 7-18

upgrading to. *See* upgrading the
computer

using AT commands, 7-10

IRQ. *See* interrupt requests

items included in computer box, 1-1

K

keyboard

adjust position using tilt feet, 1-5

components, 3-1

connecting an external. *See* external
devices

problems. *See* troubleshooting

special keys, 3-3

keyboard releases

location of the. *See* components,
keyboard

keyboard/mouse connector

location of the. *See* components, rear

keys

programmable. *See* programmable
keys

L

language

choosing a, 1-7

lid switch

location of the. *See* components, front

- lights
 - status indicator. *See* status indicator
- lights
- low battery condition
 - identifying a, 4-5
 - resolving by connecting the power cord, 4-6
 - resolving when no power source is available, 4-6
 - resolving with a charged battery pack, 4-6

M

- master password. *See* DriveLock
- memory
 - checking the amount of, 11-1
 - inserting a memory expansion board, 11-2
 - obtaining a memory expansion board, 11-2
 - removing a memory expansion board, 11-4
 - upgrading system, 11-1
- microphone line-in jack
 - location of the. *See* components, left side
- microphones. *See* audio
- modem. *See* internal modem
- modem compartment
 - location of the. *See* components, bottom
- monitor
 - connecting an external. *See* external devices
- mouse
 - connecting an external. *See* external devices
- MultiBay
 - inserting devices into the, 6-6
 - location of the. *See* components, front
 - removing devices from the, 6-7
 - supported devices, 6-6
 - using a second hard drive in the, 6-7

N

- num lock key, 3-3
- number, serial, A-1
- numeric keypad. *See* embedded numeric keypad

O

- online resources
 - locating, 1-9
- opening the computer, 1-4
- operating system
 - removing the preinstalled, 1-8
 - restoring preinstalled. *See* software
- operating the computer during setup.
 - See* computer setup
- Optical Disc Bay
 - location of the. *See* components, front

P

- PaqFax, A-2
- parallel connector
 - location of the. *See* components, rear
- passwords
 - changing the power-on password, 13-6
 - changing the setup password, 13-11
 - deleting the power-on password, 13-7
 - deleting the setup password, 13-12
 - entering the power-on password, 13-5
 - entering the setup password, 13-11
 - establishing the power-on password, 13-3
 - establishing the setup password, 13-10
 - if you forget your power-on password, 13-8
 - user and master passwords. *See* DriveLock
 - using Passwords Properties, 13-3
 - using the power-on password, 13-3
- PC Card eject button
 - location of the. *See* components, right side
- PC Card slots
 - location of the. *See* components, right side
- PC Cards
 - changing settings, 9-4
 - device drivers, 9-4
 - inserting a PC Card, 9-1
 - managing power, 9-5
 - problems with. *See* troubleshooting
 - removing a PC Card, 9-3
 - stopping a PC Card, 9-5
 - types of, 9-1
 - Zoomed Video, 9-5

PCMCIA. *See* PC Cards
phone numbers, worldwide, A-2
pointing device
 problems. *See* troubleshooting
POST. *See* Power-on Self-Test
power
 disconnecting the computer from, 5-3
 leaving on the computer, 5-1
 problems. *See* troubleshooting
 restarting the computer, 5-2
 turning off the computer, 5-1
 turning on the computer, 1-6
power cord
 connecting the. *See* connecting
power management
 and PC Cards, 9-5
 hibernation. *See* hibernation
 Power Properties functions, 5-3
 setting the battery conservation level,
 5-5
 using ACPI power control, 5-6
 using Advanced Power Management,
 5-6
 using Power Properties, 5-5
 using Suspend. *See* Suspend
 using timeouts. *See* timeouts
power management, 5-3
Power Properties. *See* power
 management
power switch
 location of the. *See* components,
 keyboard
power-on password. *See* passwords
printer
 connecting a parallel. *See* external
 devices
 connecting a serial. *See* external
 devices
 problems. *See* troubleshooting
problem solving. *See* troubleshooting
problems
 solving. *See* troubleshooting
product identification number (PIN),
 A-1
programmable keys
 adding schemes, 3-10
 assigning, 3-9
 location of. *See* components,
 keyboard
 removing schemes, 3-11
 showing key assignments in system
 tray, 3-11
 unassigning, 3-10
 using, 3-8

Q

QuickLock/QuickBlank. *See* security

R

RAM. *See* random access memory
registering the computer, 1-9
removable drives, C-1
 caring for, 6-2
resources
 locating online. *See* online resources
restarting the computer. *See* power
result codes. *See* internal modem
RJ11
 location of the. *See* components, right
 side
ROM. *See* read only memory

S

S registers. *See* internal modem
schemes. *See* programmable keys
screen. *See* display
screen save timeouts. *See* timeouts
security
 DriveLock. *See* DriveLock
 enabling and disabling devices, 13-13
 enabling the Quick Controls, 13-9
 initiating the Quick Controls, 13-9
 passwords. *See* passwords
 types of, 13-1
 using the cable lock, 13-2
 using the Quick Controls, 13-8
serial connector
 location of the. *See* components, rear
serial number, computer, A-1
setting up the computer, 1-2
setup
 computer. *See* Computer Setup
 setup passwords. *See* passwords
shift keys
 location of the. *See* keyboard
shipping the computer, 12-4
show programmable key assignments.
 See programmable keys

- software
 - modem. *See* internal modem
 - ordering preinstalled, 15-7
 - problems. *See* troubleshooting
 - removing the operating system. *See* operating system
 - restoring preinstalled, 1-8
 - setting up the, 1-6
 - support, 14-4
 - tools. *See* Intelligent Manageability
- software drivers. *See* device drivers
- solving problems. *See* troubleshooting
- sound. *See* audio
- speaker/headphone line-out jack
 - location of the. *See* components, left side
- speakers
 - location of the. *See* components, front
- speakers and headphones. *See* audio
- special keys. *See* keyboard
- specifications
 - modem. *See* internal modem
- static electricity. *See* electrostatic discharge
- status indicator lights, 2-7
- support, Compaq, A-1
- Suspend
 - exiting, 5-10
 - identifying a Suspend condition, 5-10
 - initiating, 5-10
 - using, 5-8
- Suspend button
 - location of the. *See* components, keyboard
- symbols used in guide, xiii

T

- Tab key
 - location of the. *See* keyboard
- telephone numbers, worldwide, A-2
- television monitor
 - connecting. *See* external devices
- temperatures
 - battery pack. *See* battery packs
 - operating, 12-4

- TEST. *See* Computer Checkup (TEST)
- Computer Checkup. *See* utilities
- tilt feet
 - adjusting, 1-5
 - location of the. *See* components, bottom
- timeouts
 - setting component, 5-11
 - setting screen save, 5-12
 - using, 5-11
- touchpad
 - cleaning the, 3-13
 - customizing controls, 3-13
 - location of the. *See* components, keyboard
 - problems. *See* troubleshooting
 - using the, 3-12
- transporting the computer. *See* traveling with the computer
- traveling with the computer, 12-2
- troubleshooting
 - audio problems, 16-2
 - battery problems, 16-4
 - CD-ROM drive problems, 16-6
 - checklist, 16-1
 - hard drive problems, 16-9
 - hardware installation problems, 16-10
 - infrared problems, 16-24
 - internal modem problems, 16-11
 - keyboard problems, 16-11
 - PC Card problems, 16-15
 - pointing device problems, 16-23
 - power problems, 16-18
 - printer problems, 16-19
 - screen problems, 16-20
 - software application problems, 16-22
 - USB problems, 16-26
- turning on the computer. *See* power
- typographical conventions, xiii

U

Unpacking the Computer, 1-1
upgrading the computer
 CD-ROM or DVD drive, 11-6
 hard drive, 11-6
 internal modem, 11-6
 system memory, 11-1

USB

 problems. *See* troubleshooting
USB connector
 location of the. *See* components, right side

USB peripherals

 connecting. *See* external devices
 user password. *See* DriveLock

utilities

 boot sequencing, 15-7
 running Compaq diagnostics, 15-4
 running Computer Checkup (TEST), 15-5
 running View System Information (INSPECT), 15-6
 using Compaq utilities, 15-3
 using the diagnostics utilities, 15-4
 using the video utility, 15-6

V

video utility. *See* utilities
volume. *See* audio
volume controls
 location of the. *See* components, left side

W

worldwide phone numbers, A-2

Z

Zoomed Video. *See* PC Cards

