

SGI™ Fibre Channel PCI Option Board and  
XIO™ Option Board Owner's Guide

007-3633-004

---

## CONTRIBUTORS

Written by Carolyn Curtis

Updated by Matt Hoy

Illustrated by Dan Young

Production by Karen Jacobson

Contributions by William Mckevitt, Yin So, Carl Rigg, Michail Raskie,

Cover Design By Sarah Bolles, Sarah Bolles Design, and Dany Galgani, SGI Technical Publications.

---

## COPYRIGHT

© 2001 Silicon Graphics, Inc. All rights reserved; provided portions may be copyright in third parties, as indicated elsewhere herein. No permission is granted to copy, distribute, or create derivative works from the contents of this electronic documentation in any manner, in whole or in part, without the prior written permission of Silicon Graphics, Inc.

---

## LIMITED RIGHTS LEGEND

The electronic (software) version of this document was developed at private expense; if acquired under an agreement with the USA government or any contractor thereto, it is acquired as "commercial computer software" subject to the provisions of its applicable license agreement, as specified in (a) 48 CFR 12.212 of the FAR; or, if acquired for Department of Defense units, (b) 48 CFR 227-7202 of the DoD FAR Supplement; or sections succeeding thereto. Contractor/manufacturer is Silicon Graphics, Inc., 1600 Amphitheatre Pkwy 2E, Mountain View, CA 94043-1351.

---

## TRADEMARKS AND ATTRIBUTIONS

Silicon Graphics, Infinite Reality, O2, OCTANE, Onyx, and Onyx2and IRIX are registered trademarks and SGI, the SGI logo, IRIS FailSafe, IRIS InSight, Origin, Origin 200 GIGACHannel, and XIO are trademarks of Silicon Graphics, Inc. CrayLink is a trademark of Cray Research, L. L. C.

---

## FCC Warning

This equipment has been tested and found compliant with the limits for a Class A digital device, pursuant to Part 15 of the FCC rules. These limits are designed to provide reasonable protection against harmful interference when the equipment is operated in a commercial environment. This equipment generates, uses, and can radiate radio frequency energy and, if not installed and used in accordance with the instruction manual, may cause harmful interference to radio communications. Operation of this equipment in a residential area is likely to cause harmful interference in which case the user will be required to correct the interference at his own expense.

---

## Attention

This product requires the use of external shielded or optical cables in order to maintain compliance pursuant to Part 15 of the FCC Rules.

---

## European Union Statement

This device complies with the European Directives listed on the "Declaration of Conformity" which is included with each product. The CE mark insignia displayed on the device is an indication of conformity to the aforementioned European requirements.



---

#### International Special Committee on Radio Interference (CISPR)

This equipment has been tested to and is in compliance with the Class A limits per CISPR publication 22, Limits and Methods of Measurement of Radio Interference Characteristics of Information Technology Equipment; Germany's BZT Class A limits for Information Technology Equipment; and Japan's VCCI Class 1 limits.

---

#### Canadian Department of Communications Statement

This digital apparatus does not exceed the Class A limits for radio noise emissions from digital apparatus as set out in the Radio Interference Regulations of the Canadian Department of Communications.

---

#### Attention

Cet appareil numérique n'émet pas de perturbations radioélectriques dépassant les normes applicables aux appareils numériques de Classe A prescrites dans le Règlement sur les interférences radioélectriques établi par le Ministère des Communications du Canada.

---

#### VCCI Class 1 Statement for Japan

この装置は、情報処理装置等電波障害自主規制協議会（VCCI）の基準に基づくクラス A 情報技術装置です。この装置を家庭環境で使用すると電波妨害を引き起こすことがあります。この場合には使用者が適切な対策を講ずるよう要求されることがあります。

---

#### Chinese Class A Warning

警告使用者：

這是甲類的資訊產品，在居住的環境中使用時，可能會造成射頻干擾，在這種情況下，使用者會被要求採取某些適當的對策。



---

## Record of Revision

<b>Version</b>	<b>Description</b>
001	November 2001 Initial Rev



---

# Contents

<b>Figures</b> . . . . .	ix
<b>Tables</b> . . . . .	xi
Audience . . . . .	xiv
Structure of This Document . . . . .	xiv
Other Documentation . . . . .	xiv
<b>1. Fibre Channel Option Board Features</b> . . . . .	<b>1</b>
Fibre Channel PCI Option Boards . . . . .	2
Required IRIX Version . . . . .	2
PCI Board Versions . . . . .	3
PCI Board Connectors . . . . .	5
Installing the PCI Option Boards . . . . .	5
Fibre Channel XIO Option Boards . . . . .	6
Single-channel XIO Option Boards for Fabric . . . . .	6
Dual-channel XIO Option Boards . . . . .	9
Installing the XIO Option Boards . . . . .	14
<b>2. Fibre Channel Basics</b> . . . . .	<b>15</b>
The Fibre Channel Standard . . . . .	15
Networks, Channels, and Fibre Channel . . . . .	16
Fabric Topology . . . . .	17
Arbitrated Loop Topology . . . . .	17
Point-to-Point Topology . . . . .	18
Fibre Channel Applications . . . . .	18

<b>3. Fibre Channel Option Board Cabling</b>	.21
Cables for SGI Fibre Channel Options	.21
Cables Available From SGI	.22
Cable Characteristics	.23
Cable Distances and Shielding	.24
GBICs Available From SGI	.25
SFPs Available From SGI	.26
Connections for SGI Fibre Channel Options	.26
Connections	.27
Cable Interoperability	.30
Checking the Grounding in Configurations Using Copper Cabling	.30
Cable Labels	.31



---

# Figures

<b>Figure 1-1</b>	Fibre Channel PCI Boards . . . . .	4
<b>Figure 1-2</b>	PCI Board Style-2 Cable Connector Pin Assignments . . . . .	5
<b>Figure 1-3</b>	Single-channel XIO Boards . . . . .	7
<b>Figure 1-4</b>	Single-channel XIO Board Style-2 Cable Connector Pin Assignments . . . . .	8
<b>Figure 1-5</b>	Dual-channel XIO Board and Features (Origin 2000, Origin 200, and Silicon Graphics Onyx2 Version) . . . . .	11
<b>Figure 1-6</b>	Dual-channel Board Connector Pin Assignments . . . . .	12
<b>Figure 1-7</b>	Media Interface Adapter (MIA) for Optical Cables. . . . .	13
<b>Figure 2-1</b>	Fibre Channel in the Origin 2000 and Silicon Graphics Onyx2 I/O Structure . . . . .	19
<b>Figure 3-1</b>	Example Connections for SGI Fibre Channel Options . . . . .	29



---

## Tables

<b>Table 1-1</b>	SGI Fibre Channel PCI Boards . . . . .	3
<b>Table 1-2</b>	Single-channel XIO Option Boards for Fabric . . . . .	7
<b>Table 1-3</b>	XIO-to-PCI Converter LED Operating Modes . . . . .	8
<b>Table 1-4</b>	Dual-channel XIO Option Boards . . . . .	10
<b>Table 3-1</b>	SGI Fibre Channel Cabling Options . . . . .	22
<b>Table 3-2</b>	Characteristics of SGI Fiber Optic FC Cables . . . . .	23
<b>Table 3-3</b>	Characteristics of SGI Copper FC Cables . . . . .	24
<b>Table 3-4</b>	GBIC Kits for the SGI Fibre Channel Switch . . . . .	25
<b>Table 3-5</b>	SFPs Kits for the SGI Fibre Channel Switch . . . . .	26
<b>Table 3-6</b>	SGI Cable Connections. . . . .	27



---

## About This Guide

This guide describes these SGI Fibre Channel option cards, or host bus adapters (HBAs):

- SGI Fibre Channel Peripheral Component Interconnect (PCI) board with one copper high-speed style-2 balanced connector (PCI-FC-1PCOP-A) and SGI Fibre Channel PCI boards with one SC optical connector (PCI-FC-1POPT-A).

These option boards are designed for PCI slots in Silicon Graphics Octane, Silicon Graphics Octane2, Silicon Graphics O2, Origin 200, and Origin 200 GIGAchannel systems, and connect to SGI Fibre Channel storage options, the SGI Fibre Channel Hub, and the SGI 8-port or 16-port Fibre Channel switch.

- SGI PCI board with one SC optical connector (PCI-FC-1POPT-B).

This option board is designed for SGI Origin 3000 and SGI Origin 300 systems, and connects to SGI Fibre Channel storage options, and the SGI 8-port or 16-port Fibre Channel switch.

- SGI XIO board with one copper high-speed style-2 balanced connector (XT-FC-1PCOP-A) and SGI XIO board with one SC optical connector (XT-FC-1POPT-A).

The single-port option boards are designed for XIO slots in Origin 2000, Origin 200 GIGAchannel, and Silicon Graphics Onyx2 servers and graphics workstations, and connect to SGI Fibre Channel storage options, the SGI Fibre Channel Hub, and the SGI 8-port or 16-port Fibre Channel switch.

- SGI XIO board with two copper DB-9 connectors.

The SGI FC XIO option board (XT-FC-2P) provides two Fibre Channel ports per board for the Origin 2000, Origin 200 GIGAchannel, and Silicon Graphics Onyx2 systems to connect to SGI Fibre Channel storage options or to the SGI Fibre Channel Hub. It does not support fabric (Fibre Channel switches). This board is available in a different format (X9-FC-2P) for the Silicon Graphics Octane chassis.

## Audience

This guide is written for owners and users of an SGI Fibre Channel PCI or XIO option board. It presumes general knowledge of Fibre Channel technology, knowledge of the host system in which the option board is installed, and knowledge of the Fibre Channel devices to which the option board ports will be cabled.

## Structure of This Document

This guide consists of the following chapters:

- Chapter 1, “Fibre Channel Option Board Features,” describes Fibre Channel option boards.
- Chapter 2, “Fibre Channel Basics,” provides a brief introduction to the Fibre Channel standard, architecture, and applications, with regard to SGI Fibre Channel options.
- Chapter 3, “Fibre Channel Option Board Cabling” describes cables and connections for the boards.

---

**Note:** For information on installing the PCI or XIO board, see your workstation or server owner’s guide, user’s guide, or installation guide. For Origin 2000 and Silicon Graphics Onyx2 systems, only qualified support personnel may install XIO boards and set up storage options.

---

## Other Documentation

In addition to this manual, you may need to refer to the following documents:

- the owner’s guide, user’s guide, or installation guide for the server or workstation the Fibre Channel board is installed in.
- the owner’s guide or user’s guide for the peripheral device(s) the Fibre Channel board will interface with.

If you do not have these manuals you can find the information online in the following locations:

- IRIS InSight Library.  
From the Toolchest, select **Help** > **Online Books** > **SGI EndUser** or **SGI Admin**, and select the applicable guide.
- Technical Publications Library.  
If you have access to the Internet, see following URL:  
<http://techpubs.sgi.com/library/>

For full descriptions of related Fibre Channel products, see the latest versions of the following documents:

- For information about SGI Fibre Channel storage options, see *SGI TP9400 RAID Owner's Guide* (007-4304-001 or later), *SGI Total Performance 9100 Storage System Owner's Guide* (007-4068-003 or later), and *Origin FibreVault and Fibre Channel RAID Owner's Guide* (007-3428-004 or later).
- For information about the SGI Fibre Channel Hub, see *Fibre Channel Hub Owner's Guide* (007-3722-001 or later).
- For information about switches, see the manuals included with the products.





## Fibre Channel Option Board Features

The SGI Fibre Channel option boards (host bus adapter boards) provide interconnect capability between SGI servers or workstations and various SGI Fibre Channel storage and interconnect options. Fibre Channel enclosures can be RAID or JBOD (“just a bunch of disks”).

This chapter describes the Fibre Channel XIO and PCI option boards that interface between the host system and Fibre Channel peripherals as follows:

- “Fibre Channel PCI Option Boards” on page 2
- “Fibre Channel XIO Option Boards” on page 6

## Fibre Channel PCI Option Boards

The half-size 33-MHz SGI PCI Fibre Channel option boards (PCI-FC-1PCOP-A, PCI-FC-1POPT-A, and PCI-FC-1POPT-B) support Fibre Channel sustained data transfer rates as fast as 100 MB/sec with half-duplex operation. The PCI Fibre Channel option boards provide a high-performance interface between SGI host systems and the following:

- Fibre Channel storage (direct connection): one Fibre Channel arbitrated loop (FC-AL or FCAL) interface can control up to 110 Fibre Channel disks, such as SGI Fibre Channel storage options.
- SGI 8-port or 16-port switch.
- SGI Fibre Channel Hub.

---

**Note:** The PCI-FC-1POPT-B option board does not support the SGI Fibre Channel Hub.

---

This section consists of the following:

- “Required IRIX Version” on page 2
- “PCI Board Versions” on page 3
- “PCI Board Connectors” on page 5
- “Installing the PCI Option Boards” on page 5

### Required IRIX Version

The PCI-FC-1PCOP-A and PCI-FC-1POPT-A Fibre Channel option boards require IRIX version 6.5; version 6.5.4 or later is preferred. (Note that the SGI SAN product requires 6.5.5 with a specific patch or later.)

The PCI-FC-1POPT-B Fibre Channel option board requires IRIX version 6.5.13 or later, or 6.5.12 with a specific patch.

## PCI Board Versions

The PCI board is available in three versions, one with a copper Fibre Channel connector and two with an optical Fibre Channel connector. The PCI-FC-1POPT-B board is designed to be installed in SGI Origin 3000 or SGI Origin 300 systems, while the PCI-FC-1PCOP-A and PCI-FC-1POPT-A boards are designed to be installed in Silicon Graphics Octane, Silicon Graphics Octane2, Silicon Graphics O2, Origin 200, or Origin 200 GIGAchannel systems.

Table 1-1 summarizes the SGI FC PCI boards.

**Table 1-1** SGI Fibre Channel PCI Boards

Connection	Marketing Code	Part Number
Copper	PCI-FC-1PCOP-A	9210190
Optical	PCI-FC-1POPT-A	9210191
Optical	PCI-FC-1POPT-B	097-0102-001

Figure 1-1 shows each Fibre Channel PCI board.

PCI card, optical connection  
(PCI-FC-1POPT-A)

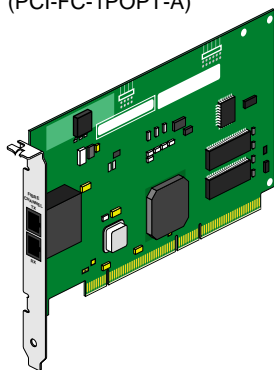

PCI card, copper connection  
(PCI-FC-1PCOP-A)

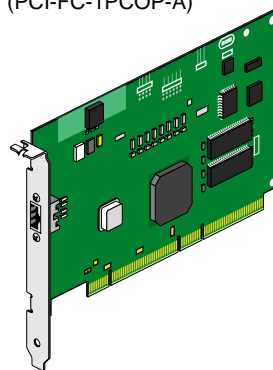

PCI card, optical connection (LC)  
(PCI-FC-1POPT-B)

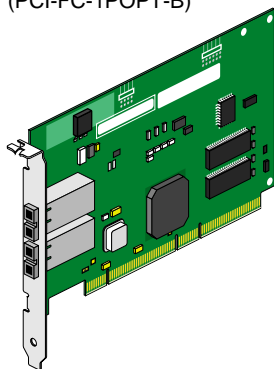
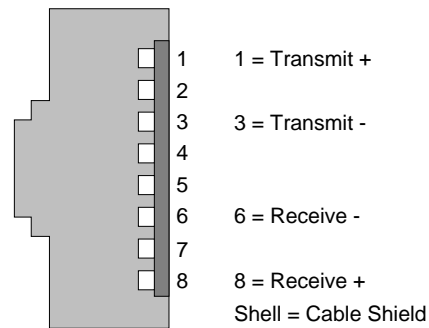

**Figure 1-1** Fibre Channel PCI Boards

## PCI Board Connectors

For the optical versions of the Fibre Channel PCI boards, there is a standard SC connector on PCI-FC-1POPT-A boards, and a standard LC connector on PCI-FC-1POPT-B boards.

Figure 1-2 shows pin assignments for the high-speed style-2 balanced cable connector (copper cabling interface) on the copper version of the single-channel PCI board.



**Figure 1-2** PCI Board Style-2 Cable Connector Pin Assignments

## Installing the PCI Option Boards

For information on installing PCI boards in a specific host system, see one of these manuals:

- *SGI Origin 3000 Series Owner's Guide*
- *SGI Origin 300 User's Guide*
- *Origin 200 and Origin 200 GIGAchannel Maintenance Guide.*
- *Octane Workstation Owner's Guide*
- *Octane2 Owner's Guide*
- *O2 Workstation Hardware Reference Guide*

## Fibre Channel XIO Option Boards

SGI provides two types of Fibre Channel XIO option board:

- Single-channel XIO boards for Origin 2000, Silicon Graphics Onyx2, and Origin 200 GIGACHannel systems (XT-FC-1PCOP-A and XT-FC-1POPT-A).
- Dual-channel XIO boards for Origin 2000, Silicon Graphics Onyx2, and Origin 200 GIGACHannel (XT-FC-2P) and for Silicon Graphics Octane systems (X9-FC-2P)

These option boards and their installation are discussed in separate subsections:

- “Single-channel XIO Option Boards for Fabric” on page 6
- “Dual-channel XIO Option Boards” on page 9
- “Installing the XIO Option Boards” on page 14

### Single-channel XIO Option Boards for Fabric

This section describes the single-channel XIO option boards (XT-FC-1PCOP-A and XT-FC-1POPT-A) for Origin 2000, Onyx2, and Origin 200 GIGACHannel systems in the following subsections:

- “Required IRIX Version” on page 6
- “Single-channel Board Features” on page 6
- “Single-channel XIO Board Versions” on page 7
- “Single-channel XIO Board Connectors” on page 8
- “Single-channel XIO Board LEDs” on page 8

#### Required IRIX Version

The single-channel XIO option boards (XT-FC-1PCOP-A and XT-FC-1POPT-A) require IRIX version 6.5; version 6.5.4 or later is preferred. (Note that the SGI SAN product requires 6.5.5, with a specific patch, or later.)

#### Single-channel Board Features

The half-size SGI single-channel Fibre Channel option boards (host bus adapter boards) provide a high-performance interface between an SGI host system and the following:

- Fibre Channel storage (direct connection): one FC-AL interface can control as many as 110 Fibre Channel disks, such as those available from SGI.
- SGI 8-port or 16-port Fibre Channel switch.
- SGI Fibre Channel Hub or other hub.

These 33-MHz boards support Fibre Channel sustained data transfer rates as fast as 100 MB/sec with half-duplex operation.

### Single-channel XIO Board Versions

Table 1-2 summarizes the SGI single-channel XIO boards.

**Table 1-2** Single-channel XIO Option Boards for Fabric

Connection	Marketing Code	Part Number
Copper	XT-FC-1PCOP-A	013-2810-001
Optical	XT-FC-1POPT-A	013-2815-001

Figure 1-3 shows each single-channel XIO board.

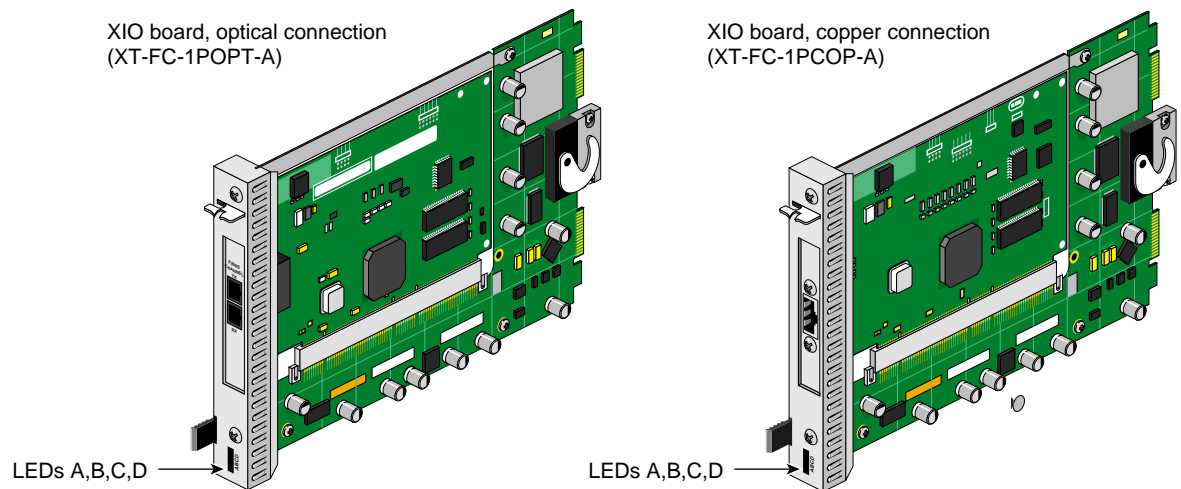
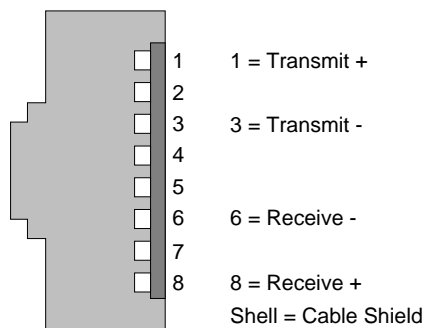

**Figure 1-3** Single-channel XIO Boards

### Single-channel XIO Board Connectors

The connector on the optical version of the single-channel XIO board is a standard SC connector.

Figure 1-4 shows pin assignments for the high-speed style-2 balanced cable connector (copper cabling interface) on the copper version of the single-channel XIO board.



**Figure 1-4** Single-channel XIO Board Style-2 Cable Connector Pin Assignments

### Single-channel XIO Board LEDs

Figure 1-3 points out the four LEDs on the outer part of the single-channel XIO option. When illuminated, the LEDs are green. Table 1-3 summarizes LED operation.

**Table 1-3** XIO-to-PCI Converter LED Operating Modes

LED	Purpose	Illuminated	Dark
A	33-MHz PCI clock	PCI clock functioning at 33-MHz	PCI clock not functioning at 33-MHz
B	100-MHz PCI clock	PCI clock functioning at 100-MHz	PCI clock not functioning at 100-MHz
C	Buffer status	Buffer full	Buffer not full
D	Maximum retry timeout status	Maximum retry timeout in process	Maximum retry timeout not in process



## Dual-channel XIO Option Boards

This section describes the dual-channel XIO option boards for Origin 2000, Silicon Graphics Onyx2, Silicon Graphics Octane, and Origin 200 GIGACHannel systems in the following subsections:

- “Required IRIX Version” on page 9
- “Dual-channel Board Features” on page 9
- “Dual-channel XIO Board Versions” on page 10
- “Dual-channel XIO Board Connectors” on page 12
- “Dual-channel XIO Board LEDs” on page 12
- “Optional Media Interface Adapter (MIA)” on page 12

### Required IRIX Version

Both dual-channel XIO option boards (XT-FC-2P and X9-FC-2P) require IRIX 6.5 or later, or IRIX 6.4.1 with the June 1999 patch set.

### Dual-channel Board Features

The half-size dual-channel XIO boards (XT-FC-2P and X9-FC-2P) provide the high-performance interface between an SGI workstation or server with an XIO slot and FC-AL interfaces, which connect to Fibre Channel disk enclosures or the SGI Fibre Channel Hub or another hub. (See Chapter 2, “Fibre Channel Basics,” for an explanation of Fibre Channel topology and architecture.)

The dual-channel XIO boards support Fibre Channel Class 3 operations as a loop port (L\_Port). The firmware supports Class 3 and FC-AL (arbitrated loop) transfers only. For details on ports and FC-AL, see Chapter 2.

---

**Note:** These boards do not support fabric, that is, Fibre Channel switches. For such support, use the single-channel XIO option boards discussed in “Single-channel XIO Option Boards for Fabric” on page 6.

---

## Dual-channel XIO Board Versions

The SGI dual-channel XIO board is available in two versions, as summarized in Table 1-4.

**Table 1-4** Dual-channel XIO Option Boards

Platform	Marketing Code	Part Number
Origin 2000, Origin 200, and Silicon Graphics Onyx2	XT-FC-2P	030-0927-00x
Silicon Graphics Octane	X9-FC-2P	013-2119-00x

The two versions have identical functionality and differ only in mechanical aspects appropriate to the platforms for which they are intended:

- The version for Origin 2000, Origin 200, and Silicon Graphics Onyx2 servers and graphics workstations has the hook actuator for the compression connector on the system midplane.
- The version for Silicon Graphics Octane workstations lacks the hook actuator, which is not needed for this platform and would prevent installation of the board.

Figure 1-5 shows the dual-channel XIO board and connectors (version for Origin 2000, Origin 200, and Silicon Graphics Onyx2 servers and graphics workstations). Figure 1-5 does not show the board version for Silicon Graphics Octane workstations, which lacks the hook actuator.

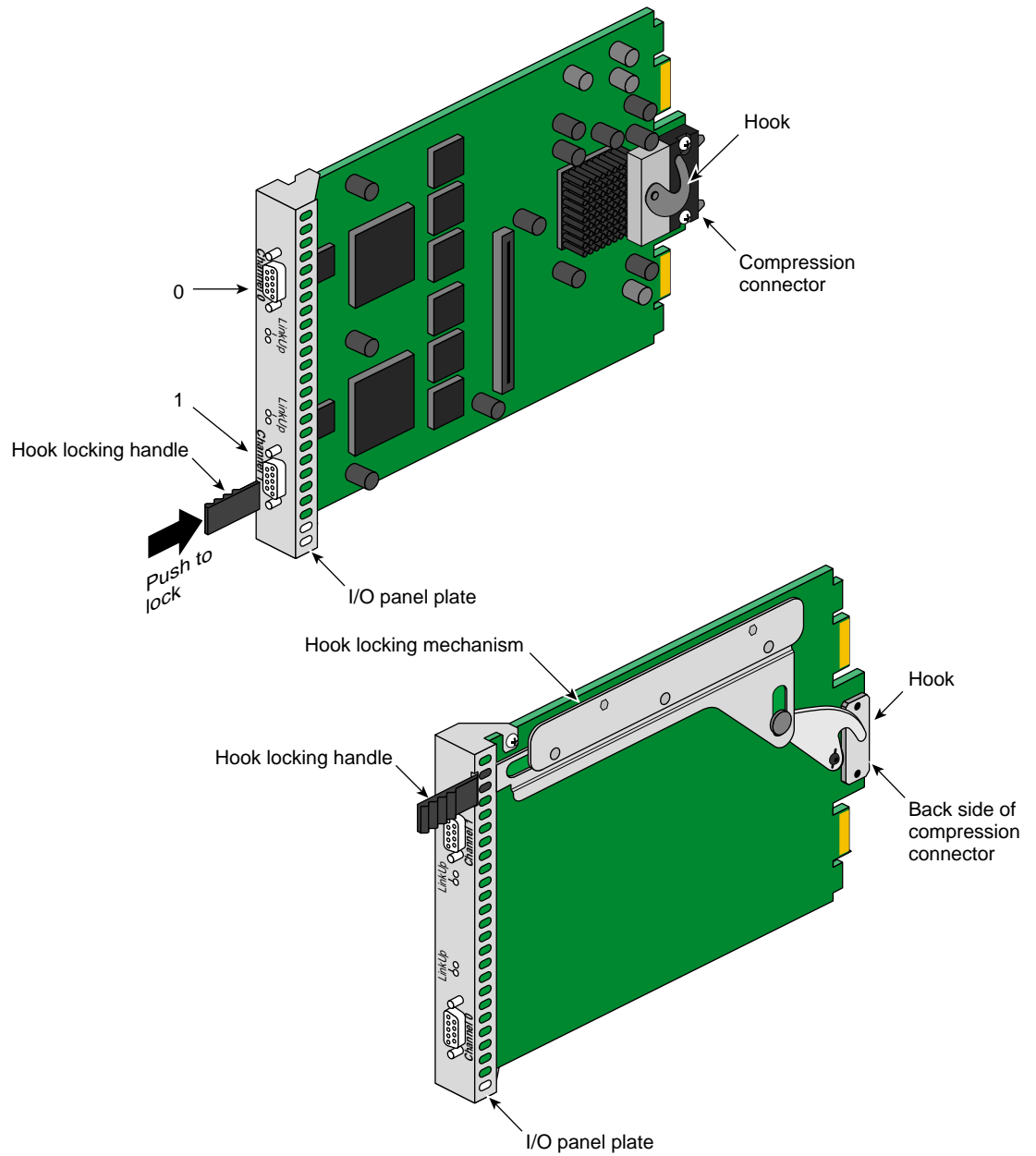

**Figure 1-5** Dual-channel XIO Board and Features (Origin 2000, Origin 200, and Silicon Graphics Onyx2 Version)

## Dual-channel XIO Board Connectors

Each dual-channel XIO board has two nine-pin (DB-9) female connectors, labeled **Channel 0** and **Channel 1**. Each channel can control as many as 110 Fibre Channel disks. Figure 1-6 shows pin assignments.

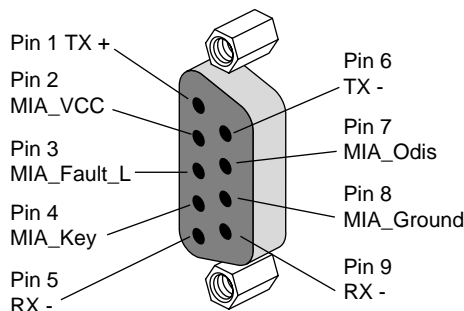

**Figure 1-6** Dual-channel Board Connector Pin Assignments

Both a copper and an optical interface are supported. The native interface is copper, as is standard for FC-AL. To use an optical cable, you must attach a media interface adapter, which is described in “Optional Media Interface Adapter (MIA).”

## Dual-channel XIO Board LEDs

Each connector on the board has a pair of LEDs. The LEDs have these functions:

- The green LED (**LinkUp**) lights and remains on when the board is successfully initialized.
- The orange LED lights and remains on when the loop is successfully initialized.

## Optional Media Interface Adapter (MIA)

SGI provides an optional fiber optic media interface adapter (MIA) to enable a connection between the dual-channel XIO option board’s DB-9 connectors and fiber optic cabling. For these connections, SGI supports optical cabling distances of 25, 100, or 300 meters. The MIA is used with 62.5  $\mu\text{m}$  optical cable.

The marketing code for the MIA (X-F-OE-KIT) includes two modules (part number 9980952), one for each end of an optical cable.

The MIA uses a shortwave laser (CD-ROM laser) with a wavelength of 780 nm. A full-duplex module, it converts photons to electrons in one direction, and converts electrons to photons in the other direction.

An industry-standard duplex SC connection supplies the external fiber optic connection. This connection consists of two parts: the female part is in the MIA and the male part is on the fiber optic cable connector, as indicated in Figure 1-7. This connection is keyed.

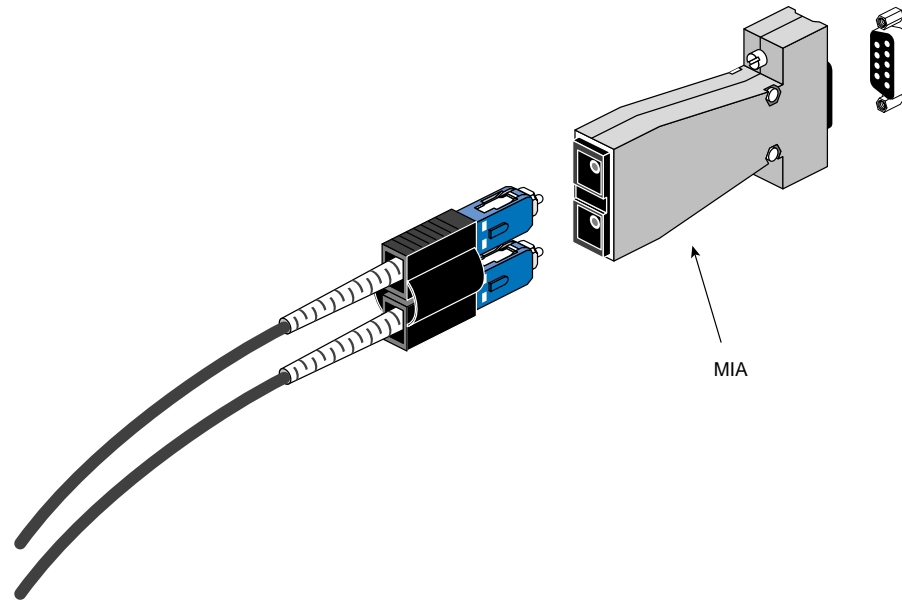

**Figure 1-7** Media Interface Adapter (MIA) for Optical Cables

Transceivers (SerDes) embedded on each board convert 8-bit parallel user data to 10-bit differential serial signals (8B10) and vice versa. They also provide frame synchronization, word alignment, and clock recovery for incoming serial data.

For incoming serial data, two recovered clocks at 53.125-MHz for odd or even bytes are provided as outputs on two pins, 180 degrees out of phase. Any required equalization to compensate for high-frequency losses for copper cables (by attenuating the lower frequencies to match) is supplied externally to the Fibre Channel option board. Serial data in both directions between the transformer and the external connector is AC-coupled via a capacitor.

If the dual-channel XIO option board loses power or the physical Fibre Channel connection is broken, the link to which the board is attached to becomes inoperable. High-availability loop configurations require the use of a Fibre Channel hub.

## Installing the XIO Option Boards

The board installation process depends on the type of Silicon Graphics workstation or server you have.

- For Origin 2000 and Silicon Graphics Onyx2 workstations and servers, contact your factory-authorized field service personnel.
- For all other applicable SGI workstations and servers, such as the Silicon Graphics Octane and Origin 200 GIGACHannel, refer to the owner's guide, user's guide, maintenance guide, or installation guide. If you do not have these guides, see "Other Documentation" on page xiv in "About This Guide."

For the dual-channel XIO board for Silicon Graphics Octane systems (X9-FC-2P), see *OCTANE™ XIO Standalone Option Board Installation Guide*, which is included with this option.

## Fibre Channel Basics

This chapter provides a brief overview of Fibre Channel with regard to SGI Fibre Channel options. It briefly explains the following:

- “The Fibre Channel Standard” on page 15
- “Networks, Channels, and Fibre Channel” on page 16
- “Fibre Channel Applications” on page 18

For more information, contact or see the following:

- ANSI Fibre Channel standards: Global Engineering Documents, 15 Inverness Way East, Englewood, CO 80112, USA Telephone: + 303 397 0271 or + 800 854 7179 (U.S. and Canada)
- Fibre Channel Association (FCA): <http://www.fca.org>
- Fibre Channel Loop Community (FCLC): <http://fclc.org>
- Storage Networking Industry Association (SNIA): <http://snia.org>

---

**Note:** Some information in this chapter was derived from the Fibre Channel Loop Community (FCLC) website, and the Fibre Channel Association (FCA) technical information website.

---

## The Fibre Channel Standard

Fibre channel is the general name of an integrated set of standards being developed by the American National Standards Institute (ANSI). The Fibre Channel standard defines a high-speed data transfer interface that can be used to connect workstations, mainframes, supercomputers, storage devices, and displays. The Fibre Channel standard addresses the need for very fast transfer of large amounts of information. Currently, Fibre Channel's is used primarily as an interface to storage.

Conceived as a generic, efficient physical transport system that can support multiple protocols, the standard also relieves system manufacturers of the burden of supporting the variety of channels and networks currently in place, because it provides one standard for networking, storage, and data transfer. Note that this SGI implementation is for communication with mass storage systems only.

Fibre channel can provide a general transport vehicle for Upper Level Protocols (ULPs), including the Intelligent Peripheral Interface (IPI) and Small Computer System Interface (SCSI) command sets, high-performance parallel interface (HIPPI) data framing, Internet Protocol (IP), and IEEE 802.2. Proprietary and other command sets can also use and share the Fibre Channel, although such use is not defined as part of the Fibre Channel standard and is not supported by SGI host systems. The SGI implementation currently supports only the SCSI Fibre Channel protocol.

---

**Note:** For a description of SGI Fibre Channel storage options, see *SGI TP9400 RAID Owner's Guide* (007-4304-001 or later), *SGI Total Performance 9100 Storage System Owner's Guide* (007-4068-003 or later), or *Origin FibreVault and Fibre Channel RAID Owner's Guide* (007-3428-004 or later).

---

## Networks, Channels, and Fibre Channel

The two most common peripheral protocols for device communication in the computer industry are networks and channels.

Networks have the following characteristics:

- Involve I/O interfaces that usually support many small transactions with relatively high overhead due to software involvement in the flow of information.
- Allow a host or device in the network to communicate with any other device.
- Operate in an open, unstructured, and unpredictable environment.

Channels have the following characteristics:

- Supply peripheral I/O interface to a host and transport large amounts of data between the host and peripherals.
- Keep data processing overhead to a minimum by handling data transfer in hardware, with little or no software involvement once an I/O operation begins.



- Operate in a closed, structured, and predictable environment where all devices that can communicate with a host are known in advance and any change requires host software or configuration table changes.

Fibre Channel technology attempts to combine the best of these two methods into an I/O interface that meets the needs of both channel users and network users. Fibre Channel communications can be conducted over copper twinax, twisted pair, or optical fiber.

Fibre Channel technology provides different interconnect topologies to serve the combined needs of channel and network usages. These topologies are:

- Fabric
- Arbitrated loop, including point-to-point

Currently, SGI supports both these topologies.

## Fabric Topology

A fabric is an active, intelligent interconnect scheme for Fibre Channel servers and storage. Fabric topology permits dynamic interconnections between nodes through ports connected to the fabric.

A Fibre Channel switch is the cornerstone of the fabric, supporting connectivity of a range of host and storage types. Switches can be cascaded for more complex configurations. Parallel fabrics can provide redundancy. SGI provides an 8-port and a 16-port switch with a number of cabling options. See “Connections for SGI Fibre Channel Options” on page 26 for details of connections.

## Arbitrated Loop Topology

In Fibre Channel arbitrated loop (FC-AL or FCAL) topology, each port arbitrates for access to the loop. Ports that “lose” the arbitration act as repeaters of all traffic on the loop. The loop is a dedicated transmit channel and a dedicated receive channel that are clad together into one cable to form a loop out and back. This protocol allows as many as 127 ports to be connected in a serial loop (one FL\_Port and 126 NL\_Ports). SGI supports a maximum of 110 disks in a single rack.

Ports are called Node Ports (N\_Ports), Node\_Loop Ports (NL\_Ports), Fabric\_Ports (F\_Ports), or Fabric\_Loop Ports (FL\_Ports).

An NL\_Port represents each disk in a disk array. Each NL\_Port sees all messages and passes messages not addressed to that port. Ports passing messages are said to be in "repeat mode."

The SGI Fibre Channel Hub, an intelligent digital hub for FC-AL storage clusters, provides gigabit-speed storage connectivity, network management, data reliability, and module network scalability for SGI storage configurations. The hub uses copper cabling, and optical cabling with MIAs. Its ten FC-AL ports can function as a single loop, can be segmented into two five-port loops, or can be connected (cascaded) another SGI Fibre Channel Hub to form one 18-port loop.

## Point-to-Point Topology

In point-to-point host applications, two ports are connected to a link. The transmitter of each port is connected directly to the receiver of the opposite port. This topology limits the number of connections that can be made across the wire.

## Fibre Channel Applications

Figure 2-1 shows Fibre Channel in the overall Origin 2000 and Silicon Graphics Onyx2 I/O structure.

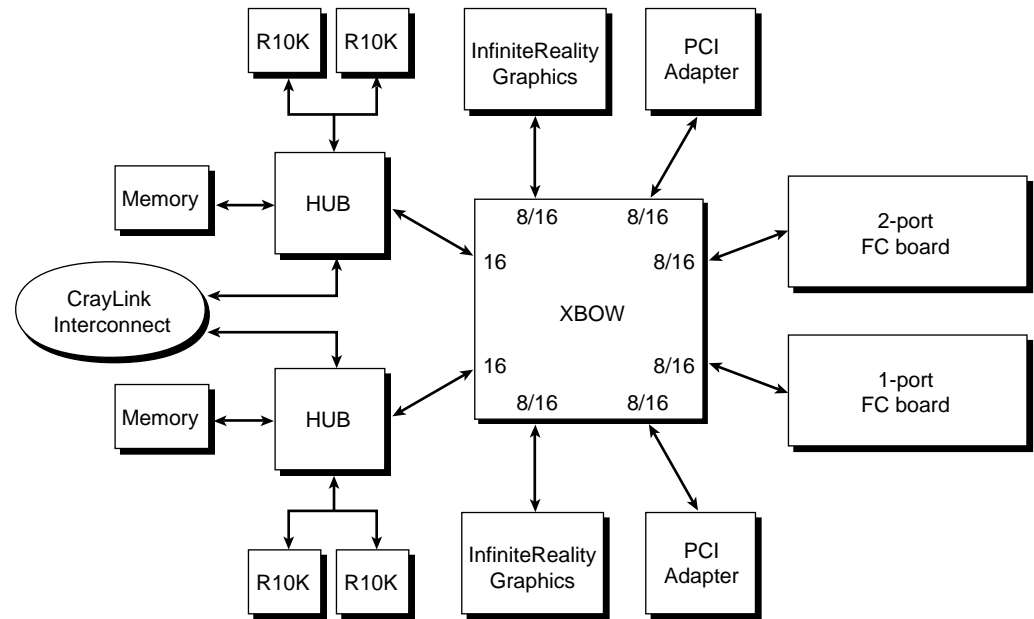

**Figure 2-1** Fibre Channel in the Origin 2000 and Silicon Graphics Onyx2 I/O Structure

Fibre channel is useful for many applications; including the following

- Scientific graphics and video markets, which use high-bandwidth rates with large I/O requests.
- Fileserver and database markets, which must support large amounts of I/Os per second (IOPS) with relatively small random I/Os.

High-availability RAID is also a requirement for this market. Fibre Channel RAID addresses the needs of this market by supporting several disks in a well-balanced access pattern on a single arbitrated loop. The arbitrated loop also provides an arbitration fairness scheme that prevents high-priority requests from starving low-priority requests. For more information on high availability and RAID within Fibre Channel options, see *SGI TP9400 RAID Owner's Guide* (007-4304-001 or later), *SGI Total Performance 9100 Storage System Owner's Guide* (007-4068-003 or later), or *Origin FibreVault and Fibre Channel RAID Owner's Guide* (007-3428-004 or later).



## Fibre Channel Option Board Cabling

This chapter describes cabling for the Fibre Channel XIO option board and PCI option board in the following sections:

- “Cables for SGI Fibre Channel Options” on page 21
- “Connections for SGI Fibre Channel Options” on page 26
- “Cable Labels” on page 31

### Cables for SGI Fibre Channel Options

Note the following shipping configurations for SGI Fibre Channel storage cables:

- Two 10-meter copper cables (DB-9 connectors at each end) are shipped with the Fibre Channel dual-channel XIO option boards.
- No cables are shipped with the single-channel XIO option boards or with the PCI option boards.
- No cables are included with the SGI Fibre Channel Hub or switches, or with the Origin FibreVault or Fibre Channel RAID enclosures.

Cables can be ordered separately from SGI.

This section discusses cables for SGI Fibre Channel options in the following subsections:

- “Cables Available From SGI” on page 22
- “Cable Characteristics” on page 23
- “Cable Distances and Shielding” on page 24
- “GBICs Available From SGI” on page 25

## Cables Available From SGI

Table 3-1 describes the copper and optical cables available from SGI. Table 3-2 and Table 3-3 provide additional information about these cables.

**Table 3-1** SGI Fibre Channel Cabling Options

Cable	Length	Marketing Code	Part Number
FC optical cable, SC connector to SC connector (62.5 $\mu\text{m}$ , for shortwave fiber optic transmissions)	3 m (9.8 ft)	X-F-OPT-3M	018-0656-001
<b>Note:</b> The 300 m cable is supported only with MIAs for use with the SGI Fibre Channel Hub and SGI Fibre Channel storage.	10 m (32.8 ft)	X-F-OPT-10M	018-0656-101
	25 m (82 ft)	X-F-OPT-25M	018-0656-201
	50 m (164 ft)	X-F-OPT-50M	018-0656-501
	100 m (328 ft)	X-F-OPT-100M	018-0656-301
	300 m (984 ft)	X-F-OPT-300M	018-0656-401
FC optical cable (50.0 $\mu\text{m}$ , for shortwave fiber optic transmissions Small form factor connector)	3 m (9.8 ft)	X-F21-OPT-3M	018-1023-001
<b>Note:</b> These cables are for use between a 1GB component and a 2GB component.	10 m (32.8 ft)	X-F21-OPT-10M	018-1030-001
	25 m (82 ft)	X-F21-OPT-25M	018-1024-001
	100 m (328 ft)	X-F21-OPT-100M	018-1025-001
FC optical cable (50.0 $\mu\text{m}$ , for shortwave fiber optic transmissions Small form factor connector)	3 m (9.8 ft)	X-F22-OPT-3M	018-1026-001
<b>Note:</b> These cables are for use with 2GB components.	10 m (32.8 ft)	X-F22-OPT-10M	018-1027-001
	25 m (82 ft)	X-F22-OPT-25M	018-1028-001
	100 m (328 ft)	X-F22-OPT-100M	018-1029-001
FC copper cable, high-speed style-2 balanced cable connector at each end	1 m (3.28 ft)	X-FSW-COP-1M	N/A

**Table 3-1 (continued)** SGI Fibre Channel Cabling Options

Cable	Length	Marketing Code	Part Number
	3 m (9.8 ft)	X-FSW-COP-3M	N/A
	12 m (39.36 ft)	X-FSW-COP-12M	N/A
FC copper cable, high-speed style-2 balanced cable connector to DB-9	3 m (9.8 ft)	X-FS-COP-3M	N/A
	12 m (39.36 ft)	X-FS-COP-12M	N/A
	25 m (82 ft)	X-FS-COP-25M	N/A
FC copper cable with DB-9 at each end	0.3 m (1 ft)	X-F-COP-0.3M	9470156
<b>Note:</b> Two of these 10 m cables are included with each 2-port FC XIO board (XT-FC-2P and X9-FC-2P).	10 m (32.8 ft)	X-F-COP-10M	018-0570-001
	25 m (82 ft)	X-F-COP-25M	018-0571-001
Two media interface adapter (MIA) modules (FC copper-to-optical).	N/A	X-F-OE-KIT	9980952

## Cable Characteristics

Table 3-2 provides additional information about the fiber optic cables available from SGI.

Shortwave fiber is 62.5  $\mu\text{m}$  or 50  $\mu\text{m}$  multimode.

**Table 3-2** Characteristics of SGI Fiber Optic FC Cables

Characteristic	Optical (X-F-OPT- <i>n</i> M)	LC-LC
Variant	100-M6-SN-I	200-M5-SN-I
Range	At least 175 m (depends on device)	At least 300 m (depends on device)
Transmitter	Optical laser: 780 nm	Optical laser: 780 nm

**Table 3-2 (continued)** Characteristics of SGI Fiber Optic FC Cables

Characteristic	Optical (X-F-OPT- <i>n</i> M)	LC-LC
Medium	62.5 µm multimode SC, 160 MHz/km	50.0 µm multimode LC
Connectors	SC duplex on each end	LC on each end

Table 3-3 provides additional information about copper cables available from SGI.

**Table 3-3** Characteristics of SGI Copper FC Cables

Characteristic	Copper (X-FSW-COP- <i>n</i> M)	Copper (X-FS-COP- <i>n</i> M)	Copper (X-F-COP- <i>n</i> M)
Variant	100-TW-EL-S full-duplex (quad conductor)	100-TW-EL-S full-duplex (quad conductor)	100-TW-EL-S full-duplex (quad conductor)
Range	12 m maximum	12 m with switch; 25 m point-to-point	25 m maximum
Transmitter	PECL	PECL	PECL
Medium	1 m and 3 m: 30 gauge unequalized 12 m: 23 gauge unequalized	3 m: 30 gauge unequalized 12 m: 23 gauge unequalized 25 m: 23 m equalized	10 m and under: 30 gauge unequalized 12 m: 23 gauge unequalized 25 m: 24 gauge equalized
Connectors	High-speed style-2 balanced on each end	Male DB-9; high-speed style-2 balanced	Male DB-9 on each end

## Cable Distances and Shielding

62.5 µm optical cables support a maximum distance of 100 m or, with MIAs, 300 m.

The three types of SGI copper cable are fully shielded, full-duplex, balanced cables capable of supporting distances of 12 meters at the 1.0625 Gbaud transfer rate.

The shield on the DB-9 connector (used in X-F-COP-*n*M and X-FS-COP-*n*M) connects directly to the connector shield, providing a DC ground on both ends.



The high-speed style-2 connector (used in X-FSW-COP-*n*M and X-FS-COP-*n*M) also connects directly to the connector shield, providing a DC ground on both ends.

## GBICs Available From SGI

GBICs (gigabit interface connectors) are adapters used on the SGI 8-port and 16-port 1-Gb Fibre Channel switches to interface with cables. Table 3-4 outlines GBICs available from SGI for its Fibre Channel switches.

**Table 3-4** GBIC Kits for the SGI Fibre Channel Switch

GBIC Type	Kit Marketing Code	Quantity	Part Number	Use These Cables
Copper	XCOPGBIC-1	1	9470357	X-FSW-COP-1M X-FSW-COP-3M X-FSW-COP-12M X-FS-COP-3M (unequalized) X-FS-COP-12M (unequalized) X-FS-COP-25M (equalized)
Shortwave optical	XSWOPTGBIC-1	1	9470358	X-F-OPT-3M X-F-OPT-10M X-F-OPT-25M
Longwave optical	XLWOPTGBIC	2	9470359	X-F-OPT-100M; also with longer cables not supplied by SGI

For short distances, a passive copper GBIC (XCOPGBIC) is available from SGI, which supports the following configurations:

- Cabling for distances up to 12 m; use this cabling with the SGI 8-port and 16-port Fibre Channel switches.
- Cabling for distances up to 25 m and equalized 22 AWG cabling for distances up to 25 m; use this cabling for a direct connection to storage.

For intermediate distances, a shortwave GBIC (XSWOPTGBIC) is available from SGI, which supports the following configurations:

- 62.5  $\mu\text{m}$  optical cabling for distances up to 100 m (cables available from SGI).
- 50  $\mu\text{m}$  optical cabling for distances up to 500 m (cables not available from SGI) at 1 GB.

- 50 µm optical cabling for distances up to 300 m (cables not available from SGI) at 2Gb.

For long distances, a longwave GBIC (XLWOPTGBIC) is available from SGI, which supports optical cabling for distances to 10 km (cabling not available from SGI).

See “Cable Characteristics” on page 23 for more information on these cables. For distance considerations with respect to cables, see “Connections” on page 27.

## SFPs Available From SGI

SFPs (small form factor pluggables) are adapters used on the SGI 16-port 2-Gb Fibre Channel switches to interface with LC-ended optical cables. Table 3-5 outlines SFPs available from SGI for its Fibre Channel switches.

**Table 3-5** SFPs Kits for the SGI Fibre Channel Switch

SFP Type	Kit Marketing Code	Use with These Cables
Short wave, multi mode	XSWOPTSFP-2	X-F21-OPT-nM X-F22-OPT-nM
Long wave, single mode	XLWOPTSFP-2	Cables not supplied by SGI.

See “Cable Characteristics” on page 23 for more information on these cables. For distance considerations with respect to cables, see “Connections” on page 27.

## Connections for SGI Fibre Channel Options

This section explains the various Fibre Channel option board connections, and the cables required for each, in these subsections:

- “Connections” on page 27
- “Cable Interoperability” on page 30
- “Checking the Grounding in Configurations Using Copper Cabling” on page 30

## Connections

Table 3-6 lists the cables required for specific connections.

**Table 3-6** SGI Cable Connections

From SGI FC Device	To SGI FC Device	Distance (m)	GBIC/MIA at Source Device	Cable	Type	GBIC/MIA at Target Device
PCI, style-2 copper connector (PCI-FC-1PCOP-A), or single-channel XIO board, style-2 copper connector (XT-FC-1PCOP-A)	FC storage	3 to 25	None	X-FS-COP- <i>n</i> M	Copper	None
	FC hub	3 to 25	None	X-FS-COP- <i>n</i> M	Copper	None
	FC switch	1 to 12	None	X-FSW-COP- <i>n</i> M	Copper	Copper GBIC
PCI, SC optical connector (PCI-FC-1POPT-A), or single-channel XIO board, SC optical connector (XT-FC-1POPT-A)	FC storage	3 to 100	None	X-F-OPT- <i>n</i> M	Optical	MIA
	FC hub	3 to 100	None	X-F-OPT- <i>n</i> M	Optical	MIA
	FC switch	3 to 100	None	X-F-OPT- <i>n</i> M	Optical	SW GBIC
Dual-channel XIO board, copper DB-9 connector (XT-FC-2P, X9-FC-2P)	FC storage	0.3 to 25	None	X-F-COP- <i>n</i> M	Copper	None
		3 to 100	MIA	X-F-OPT- <i>n</i> M	Optical	MIA
	FC hub	0.3 to 25	None	X-F-COP- <i>n</i> M	Copper	None
		3 to 100	MIA	X-F-OPT- <i>n</i> M	Optical	MIA
Fibre Channel Hub	FC storage	0.3 to 25	None	X-F-COP- <i>n</i> M	Copper	None
		3 to 100	MIA	X-F-OPT- <i>n</i> M	Optical	MIA
	FC hub	0.3 to 25	None	X-F-COP- <i>n</i> M	Copper	None
1-Gb 8-port or 16-port Fibre Channel switch	FC storage	0.3 to 25	Copper GBIC	X-FS-COP- <i>n</i> M	Copper	None
		3 to 100	SW GBIC	X-F-OPT- <i>n</i> M	Optical	MIA
	FC hub	0.3 to 25	Copper GBIC	X-FS-COP- <i>n</i> M	Copper	None
		3 to 100	SW GBIC	X-F-OPT- <i>n</i> M	Optical	MIA

For distances to 10 km, use a longwave GBIC and 9  $\mu$ m single-mode fiber optic cabling; this cabling is not available from SGI.

For information on cabling SGI Fibre Channel storage options to the Fibre Channel XIO or PCI board, see *SGI TP9400 RAID Owner's Guide* (007-4304-001 or later), *SGI Total Performance 9100 Storage System Owner's Guide* (007-4068-003 or later), or *Origin FibreVault and Fibre Channel RAID Owner's Guide* (007-3428-004 or later). In the case of Origin 2000 and Silicon Graphics Onyx2 systems, only qualified SGI support personnel can install the boards and cable the options.

Copper cabling is recommended over optical cabling for the following situations:

- Fibre Channel switch is inside the Fibre Channel storage rack.
- Fibre Channel switch is next to storage rack and uses the same ground.
- Fibre Channel switch is next to CPU and uses the same ground.
- A Fibre Channel switch is cabled to another switch, for cost reasons (unless distance warrants use of optical cable).

---

**Note:** No copper cabling solution is available for 2-GB Fibre Channel switches.

---

Figure 3-1 diagrams example connections for SGI Fibre Channel options.

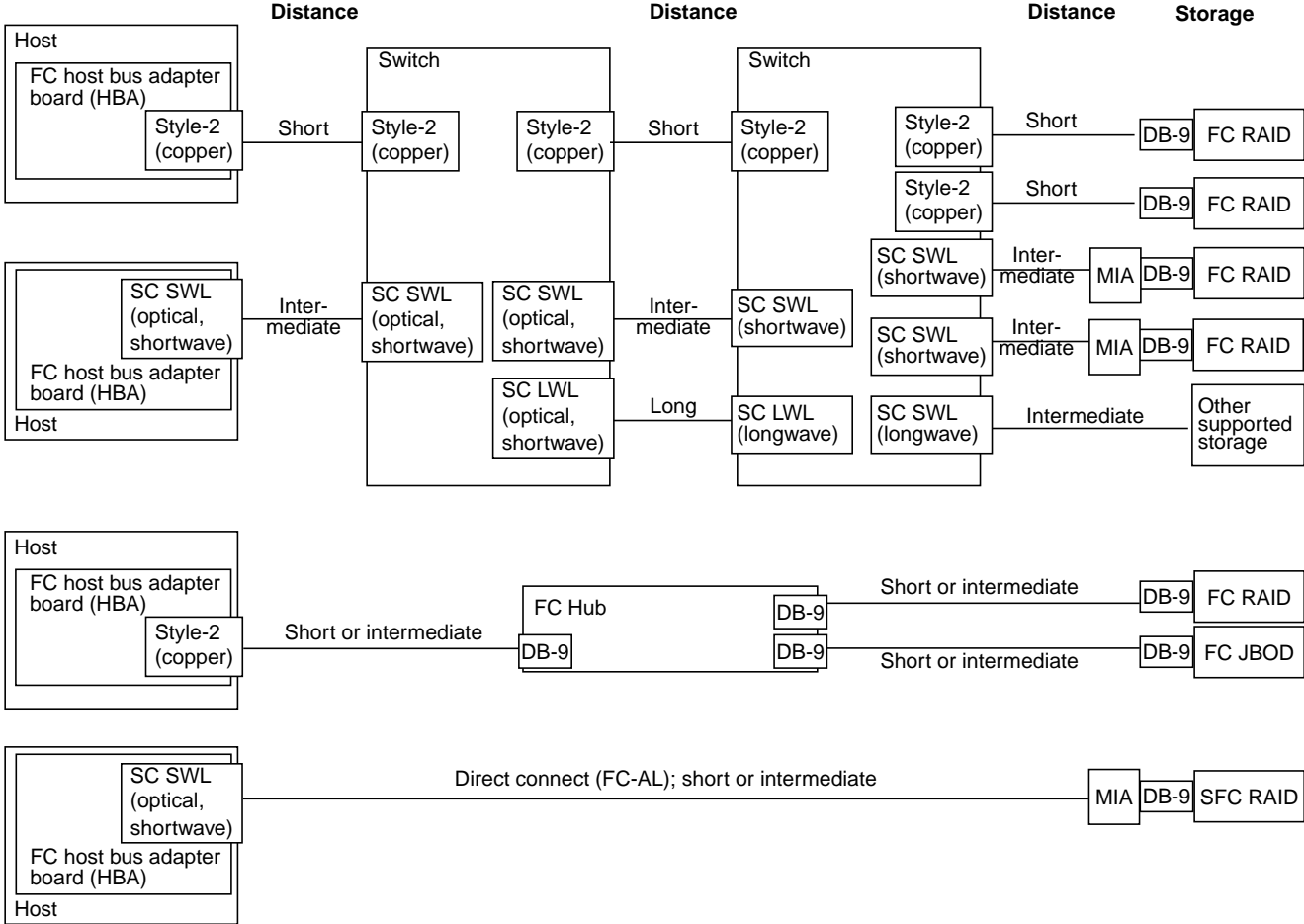

**Figure 3-1** Example Connections for SGI Fibre Channel Options

**Note:** In Figure 3-1, *direct connect* refers to a connection from HBA to storage. *Short distances* are 25 m or less, *intermediate distances* are 500 m or less, and *long distances* are 501 m to 10 km with long-wave 9 μm single-mode fiber optic cabling.

---

**Note:** The use of SGI FC JBOD with the Fibre Channel switch is not supported in any releases of the SGI SAN and switch products.

---

---

**Caution:** If a host system and a Fibre Channel enclosure are on separate building grounds, grounding problems may arise when this cabling is connected with a copper cable utilizing a DC ground shield on both ends. In this case, use fiber optic cabling to link host and enclosure. See the “Checking the Grounding in Configurations Using Copper Cabling” for more information.

---

## Cable Interoperability

To maintain acceptable quality and signal integrity, use only copper and optical cables from SGI with your SGI Fibre Channel enclosures. If you use both 62.5  $\mu\text{m}$  and 50  $\mu\text{m}$  fibre optic cabling in the same environment, use the same gauges for a patch cord and a trunk.

If your configuration uses cables and GBICs other than those available from SGI, support is limited.

## Checking the Grounding in Configurations Using Copper Cabling

Grounding is very important in Origin family systems. Each chassis must be well grounded through its power connector. All chassis with XIO boards with copper cables connected to them must share the same transformer, be grounded through the same earthing rod, and be on the same branch circuit. If you have any doubts about the quality of the ground connection, consult a qualified electrician.

Use an optical cable between the fibre enclosure(s) and the host XIO connection to eliminate any problems related to common grounding.

---

**Caution:** Any difference in ground potential greater than 500 millivolts (0.5 volts) between two chassis connected by copper XIO cables can cause severe equipment damage and can create hazardous conditions.

---

The branch circuit wiring must have an insulated grounding conductor that is identical in size, insulation material, and thickness to the earthed and unearthed branch-circuit supply conductors. The grounding conductor should be green, with or without one or more yellow stripes. This grounding or earthing conductor should be connected to earth at the service equipment or, if supplied by a separately derived system, at the supply transformer or motor-generator set. The power receptacles in the vicinity of the systems should all be of an earthing type, and the grounding or earthing conductors serving these receptacles should be connected to earth at the service equipment.

## **Cable Labels**

Included in the Fibre Channel option board shipment is a label kit for identifying Fibre Channel cable connectors. After identifying (and perhaps diagramming) all cable connections for your configuration, it is a good idea to label each end of each cable before attaching the cable. You can also use these labels to identify, for example, the FC option board that is connected to a particular Fibre Channel storage enclosure, fiber rack, fabric, or loop.

